

TITLE : MV190E0M-N10
Preliminary Product Specification
Rev.P2

For HYVISION Internal Use Only

BEIJING BOE Display TECHNOLOGY

SPEC. NUMBER
S

PRODUCT GROUP
TFT-LCD

Rev.P2

ISSUE DATE
2014.04.18

PAGE
1 OF 30



REVISION HISTORY

REV.	ECN No.	DESCRIPTION OF CHANGES	DATE	PREPARED
Rev.P0		Initial Release	Jan 22. 14'	Song guannan
Rev.P1		2 nd Release	Apr 8,14'	Song guannan
Rev.P2		Add Tr , Tf	Apr 18,14'	Song guannan

For HYVISION Internal Use Only

Contents

No.	Item	Page
1.0	General Description	4
2.0	Absolute Maximum Ratings	6
3.0	Electrical Specifications	7
4.0	Optical Specifications	8
5.0	Interface Connection	10
6.0	Signal Timing Specifications	13
7.0	Signal Timing Waveforms of Interface Signal	15
8.0	Input Signals, Display Colors & Gray Scale of Colors	17
9.0	Power Sequence	18
10.0	Mechanical Characteristics	19
11.0	Reliability Test	20
12.0	Handling& Cautions	21
13.0	Product Serial Number	22
14.0	Packing	23
15.0	Appendix	25

1.0 GENERAL DESCRIPTION

1.1 Introduction

MV190E0M-N10 is a color active matrix TFT LCD module using amorphous silicon TFT's (Thin Film Transistors) as an active switching devices. This module has a 19 inch diagonally measured active area with SXGA resolutions (1280 horizontal by 1024 vertical pixel array). Each pixel is divided into RED, GREEN, BLUE dots which are arranged in vertical stripe and this module can display 16.7M colors. The TFT-LCD panel used for this module is adapted for a low reflection and higher color type.

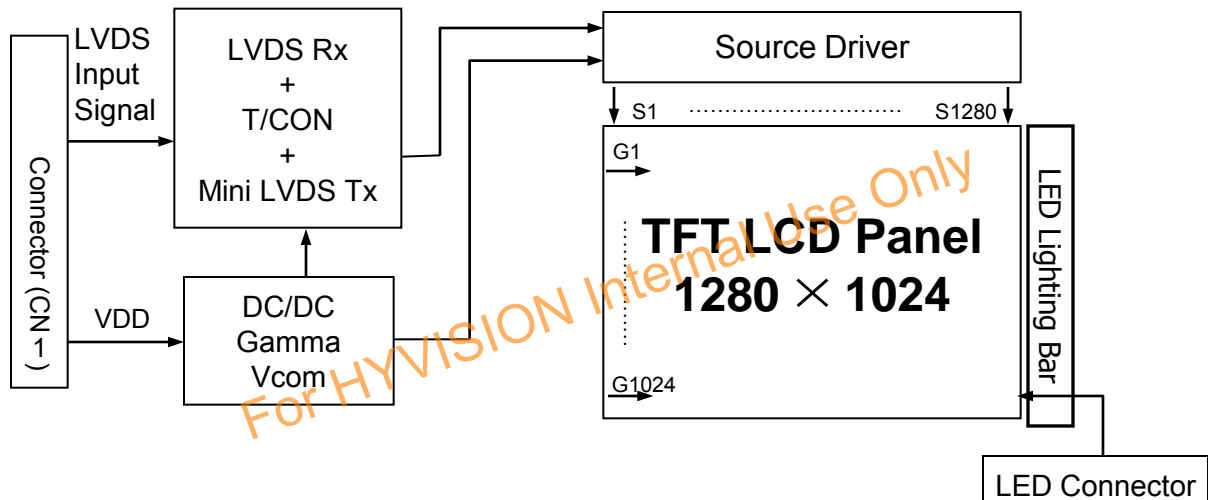

1.2 Features

- LVDS Interface with 2 pixel / clock
- High-speed response
- 6-bit (Hi-FRC) color depth, display 16. 7M colors
- Incorporated edge type back-light (LED)
- NTSC 72%
- High luminance and contrast ratio, low reflection and wide viewing angle
- DE (Data Enable) only
- RoHS/Halogen Free
- TCO 6.0 , E/S 6.0 compliant
- Gamma Correction

1.3 Application

- Desktop Type of PC & Workstation Use
- Slim-Size Display for Stand-alone Monitor
- Display Terminals for Control System
- Monitors for Process Controller

1.4 General Specification

The followings are general specifications at the model MV190E0M-N10.

<Table 1. General Specifications>

Parameter	Specification	Unit	Remarks
Active area	374.784(H) x 299.8272(V)	mm	
Number of pixels	1280(H) × 1024(V)	pixels	
Pixel pitch	0.0976(H) x 0.2928(V)	mm	
Pixel arrangement	RGB Vertical stripe		
Display colors	16.7M	colors	
Display mode	Normal Black		
Dimensional outline	396.0(H) × 324.0(V) × 9.9(D) typ.	mm	
Weight	1720 (Typ.)	g	
Surface Treatment	Haze 25%, 3H		
Back-light	Right edge side, 1-LED Lighting Bar type		Note 1
Power Consumption	P_D : 5.5 W (max)		
	P_{BL} : 10.89W (max)		Note 2
	P_{total} : 16.39 (max)		

Notes : 1. LED Lighting Bar (4*input pins)

2. $P_{LED} = \text{Input pins} * V_{PIN} \times I_{PIN}$

2.0 ABSOLUTE MAXIMUM RATINGS

The followings are maximum values which, if exceed, may cause faulty operation or damage to the unit. The operational and non-operational maximum voltage and current values are listed in Table 2.

< Table 2. Absolute Maximum Ratings >

[VSS=GND=0V]

Parameter	Symbol	Min.	Max.	Unit	Remarks
Power Supply Voltage	V_{DD}	-0.3	6.0	V	Ta = 25 °C
Logic Supply Voltage	V_{IN}	VSS-0.3	$V_{DD}+0.3$	V	
LED Light Bar Current Per Input Pin	IPIN	-	110	mA	
LED Light Bar Voltage Per Input Pin	VPIN	43.5	49.5	V	
Operating Temperature	T_{OP}	0	+50	°C	1)
Storage Temperature	T_{ST}	-20	+60	°C	1)

Note : 1) Temperature and relative humidity range are shown in the figure below.

Wet bulb temperature should be 39 °C max. and no condensation of water.

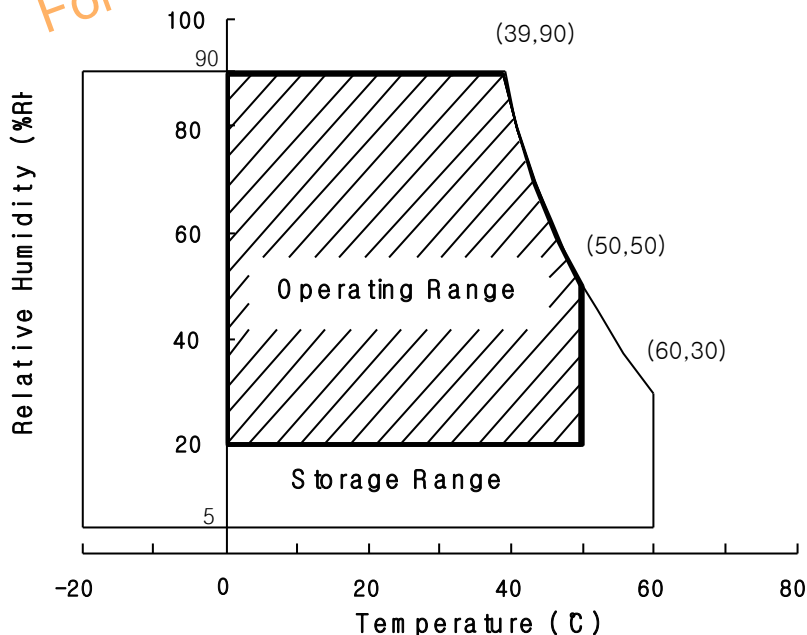

3.0 ELECTRICAL SPECIFICATIONS

3.1 Electrical Specifications

< Table 3. Electrical specifications >

[Ta =25 ± 2 °C]

Parameter		Min.	Typ.	Max.	Unit	Remarks
Power Supply Voltage	V _{DD}	4.5	5.0	5.5	V	Note 1
Power Supply Current	I _{DD}	-	600	1100	mA	
In-Rush Current	I _{RUSH}	-	2.0	3.0	A	Note 2
Permissible Input Ripple Voltage	V _{RF}	-	-	300	mV	Note 4
High Level Differential Input Threshold Voltage	V _{IH}	-	-	+100	mV	
Low Level Differential Input Threshold Voltage	V _{IL}	-100	-	-	mV	
Differential input voltage	V _{ID}	200	-	600	mV	
Differential input common mode voltage	V _{cm}	1.0	1.2	1.5		V _{IH} =100mV, V _{IL} =-100mV
Power Consumption	P _D	-	3	5.5	W	
	P _{BL}	9.57	10.23	10.89	W	Note 3
	P _{total}	-	13.23	16.39	W	

Notes : 1. The supply voltage is measured and specified at the interface connector of LCM.

The current draw and power consumption specified is for V_{DD}=5.0V, Frame rate=75Hz

Clock frequency = 92.89 MHz. Test Pattern of power supply current

a) Typ : Color Test

b) Max : Skip Subpixel255

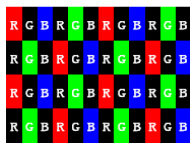

2. Duration of rush current is about 2 ms and rising time of V_{DD} is 520 μs ± 20 %

3. Calculated value for reference (Input pins*V_{PIN} × I_{PIN}) excluding inverter loss.

4. Permissible Input ripple Voltage should be measured under V_{DD} =5.0V, 25° C, fV(frame frequency)=MAX condition(@ Gray level 255 Gray level 0) and At that time, we recommend the bandwidth configuration of oscilloscope is to be under 20Mhz. Ripple Voltage should be covered by Input voltage Spec.

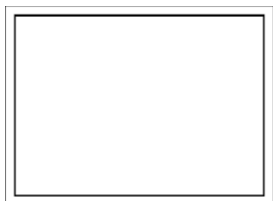

Gray level 255



Gray level 0

3.2 Backlight Unit

< Table 4. LED Backlight Unit >

Parameter		Min.	Typ.	Max.	Unit	Remarks
LED Light Bar Input Voltage Per Input Pin	VPIN	43.5	46.5	49.5	V	Duty 100%
LED Light Bar Input Current Per Input Pin	IPIN	-	110	-	mA	Note1,2,
LED Power Consumption	P _{BL}	9.57	10.23	10.89	W	Note 3
LED Life-Time	-	30,000	-		Hrs	Note 4

Note1: There are one light bar ,and the specified current is input LED chip 100% duty current

Note2: The sense current of each input pin is 110mA

Note3: $P_{BL}=2 \times \text{Input pins} \times V_{PIN} \times I_{PIN}$

Note4: The lifetime is determined as the time at which luminance of LED become 50% of the initial brightness or not normal lighting at IPIN=110mA on condition of continuous operating at $25 \pm 2 \text{ } ^\circ\text{C}$

For HYVISION Internal Use Only

4.0 OPTICAL SPECIFICATION

4.1 Overview

The test of Optical specifications shall be measured in a dark room (ambient luminance ≤ 1 lux and temperature = $25 \pm 2^\circ\text{C}$) with the equipment of Luminance meter system (Goniometer system and TOPCONE BM-5) and test unit shall be located at an approximate distance 50cm from the LCD surface at a viewing angle of θ and Φ equal to 0° . We refer to $\theta_{\Phi=0}$ ($=\theta_3$) as the 3 o'clock direction (the "right"), $\theta_{\Phi=90}$ ($=\theta_{12}$) as the 12 o'clock direction ("upward"), $\theta_{\Phi=180}$ ($=\theta_9$) as the 9 o'clock direction ("left") and $\theta_{\Phi=270}$ ($=\theta_6$) as the 6 o'clock direction ("bottom"). While scanning θ and/or Φ , the center of the measuring spot on the Display surface shall stay fixed. The measurement shall be executed after 30 minutes warm-up period. VDD shall be 5.0V +/-10% at 25°C . Optimum viewing angle direction is 6 o'clock.

4.2 Optical Specifications

[VDD = 5.0V, Frame rate = 60Hz, Clock = 74.25MHz, $I_{BL} = 240\text{mA}$, $T_a = 25 \pm 2^\circ\text{C}$]

Parameter		Symbol	Condition	Min.	Typ.	Max.	Unit	Remark
Viewing Angle range	Horizontal	θ_3	CR > 10	85	89	-	Deg.	Note 1
		θ_9		85	89	-	Deg.	
	Vertical	θ_{12}		85	89	-	Deg.	
		θ_6		85	89	-	Deg.	
Luminance Contrast ratio		CR	$\theta = 0^\circ$ (Center) Normal Viewing Angle	700	1000			Note 2
Luminance of White		Y_w		200	250		cd/m ²	Note 3
White luminance uniformity		ΔY		75	-		%	Note 4
Reproduction of color	White	W_x		0.283	0.313	0.343	-	Note 5
		W_y		0.299	0.329	0.359	-	
	Red	R_x		0.602	0.632	0.662	-	
		R_y		0.322	0.352	0.382	-	
	Green	G_x		0.286	0.316	0.346	-	
		G_y		0.604	0.634	0.664	-	
	Blue	B_x		0.121	0.151	0.181	-	
		B_y	0.021	0.051	0.081	-		
Response Time	GTG	T_g		14	20	ms	Note 6	
	Rising	T_r		8	11	ms		
	Falling	T_f		8	11	ms		
Cross Talk		CT		-	2.0	%	Note 7	

Note :

- Viewing angle is the angle at which the contrast ratio is greater than 10. The viewing are determined for the horizontal or 3, 9 o'clock direction and the vertical or 6, 12 o'clock direction with respect to the optical axis which is normal to the LCD surface.
- Contrast measurements shall be made at viewing angle of $\theta=0^\circ$ and at the center of the LCD surface. Luminance shall be measured with all pixels in the view field set first to white, then to the dark (black) state. (See FIGURE 1 shown in Appendix) Luminance Contrast Ratio (CR) is defined mathematically.

$$CR = \frac{\text{Luminance when displaying a white raster}}{\text{Luminance when displaying a black raster}}$$

- Center Luminance of white is defined as the LCD surface. Luminance shall be measured with all pixels in the view field set first to white. This measurement shall be taken at the locations shown in FIGURE 2 for a total of the measurements per display.
- The White luminance uniformity on LCD surface is then expressed as :
 $\Delta Y = (\text{Minimum Luminance of 9points} / \text{Maximum Luminance of 9points}) * 100$
 (See FIGURE 2 shown in Appendix).
- The color chromaticity coordinates specified in Table 4. shall be calculated from the spectral data measured with all pixels first in red, green, blue and white. Measurements shall be made at the center of the panel.

- Response time T_g is the average time required for display transition by switching the input signal as below table and is based on Frame rate $fV=60\text{Hz}$ to optimize.

Each time in below table is defined as Figure 3 and shall be measured by switching the signal for “any level of gray(bright)”and “any level of gray(dark)”. Response time T_r shall be measured by switching the signal from “ 0 level of gray” to “255 level of gray” in Figure 3. And response time T_f shall be measured by switching the signal from “ 255 level of gray” to “0 level of gray” in Figure 3.

Measured Response Time	Target																
	0	15	31	47	62	79	95	111	127	142	159	175	191	207	223	239	255
0																	
15																	
31																	
47																	
62																	
79																	
95																	
111																	
127																	
142																	
159																	
175																	
191																	
207																	
223																	
239																	
255																	

- Cross-Talk of one area of the LCD surface by another shall be measured by comparing the luminance (Y_A) of a 25mm diameter area, with all display pixels set to a gray level, to the luminance (Y_B) of that same area when any adjacent area is driven dark. (See FIGURE 4 shown in Appendix).

5.0 INTERFACE CONNECTION.

5.1 Electrical Interface Connection

5.1.1 LED Light Bar

< Table 1. LED Light Bar >

Pin No	Symbol	Description
1	IRLED1	LED current sense for string1
2	NC	No Connection
3	VLED	LED power supply
4	VLED	LED power supply
5	NC	No Connection
6	IRLED2	LED current sense for string2
7	CONNECTOR	3707K-S06N-00X

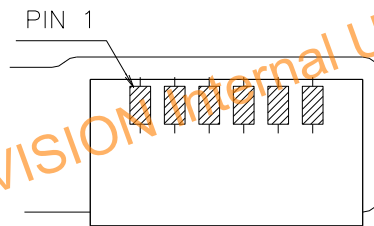

Figure1. Top View of LED Bar Connector

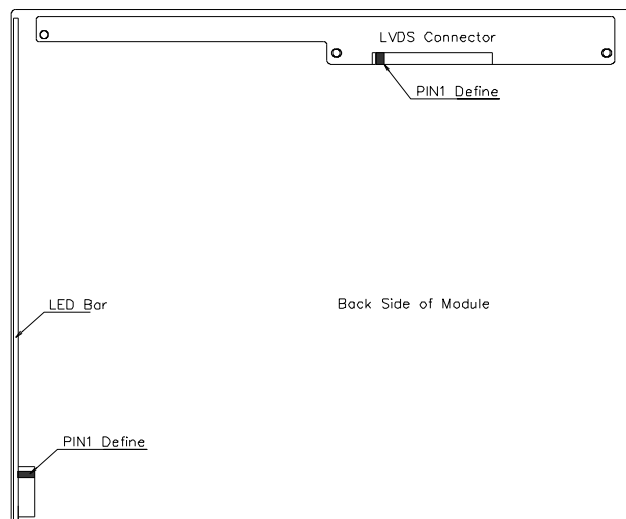

Figure2. Back Side of Module

5.0 INTERFACE CONNECTION.

5.1 Electrical Interface Connection

- CN11 Module Side Connector : UJU IS100-L30R-C23or Equivalent
User Side Connector : JAE FI-X30H or Equivalent

Pin No	Symbol	Function	Remark
1	RX00-	Negative Transmission data of Pixel 0 (ODD)	
2	RX00+	Positive Transmission data of Pixel 0 (ODD)	
3	RX01-	Negative Transmission data of Pixel 1 (ODD)	
4	RX01+	Positive Transmission data of Pixel 1 (ODD)	
5	RX02-	Negative Transmission data of Pixel 2 (ODD)	
6	RX02+	Positive Transmission data of Pixel 2 (ODD)	
7	GND	Power Ground	
8	RXOC-	Negative Transmission Clock (ODD)	
9	RXOC+	Positive Transmission Clock (ODD)	
10	RX03-	Negative Transmission data of Pixel 3 (ODD)	
11	RX03+	Positive Transmission data of Pixel 3 (ODD)	
12	RXE0-	Negative Transmission data of Pixel 0 (EVEN)	
13	RXE0+	Positive Transmission data of Pixel 0 (EVEN)	
14	GND	Power Ground	
15	RXE1-	Negative Transmission data of Pixel 1 (EVEN)	
16	RXE1+	Positive Transmission data of Pixel 1 (EVEN)	
17	GNG	Power Ground	
18	RXE2-	Negative Transmission data of Pixel 2 (EVEN)	
19	RXE2+	Positive Transmission data of Pixel 2 (EVEN)	
20	RXEC-	Negative Transmission Clock (EVEN)	
21	RXEC+	Positive Transmission Clock (EVEN)	
22	RXE3-	Negative Transmission data of Pixel 3 (EVEN)	
23	RXE3+	Positive Transmission data of Pixel 3 (EVEN)	
24	GND	Power Ground	Note 1
25	NC	No. Connection	
26	NC	No. Connection	
27	NC	No. Connection	
28	VDD	Power Supply: +5V	
29	VDD		
30	VDD		

Note 1 : This pin should be connected with GND.

5.2 LVDS Interface (Tx; THC63LVDF83A or Equivalent)
5.2.1 LVDS Interface

	Input Signal	Transmitter		Interface		HT236F01-100 (CN11)	Remark			
		Pin No.	Pin No.	System (Tx)	TFT-LCD (Rx)	Pin No.				
LVDS	OR0	51	48 47	OUT0- OUT0+	RX00- RX00+	1 2				
	OR1	52								
	OR2	54								
	OR3	55								
	OR4	56								
	OR5	3								
	OG0	4	46 45	OUT1- OUT1+	RX01- RX01+	3 4				
	OG1	6								
	OG2	7								
	OG3	11								
	OG4	12								
	OG5	14								
	OB0	15	42 41	OUT2- OUT2+	RX02- RX02+	5 6				
	OB1	19								
	OB2	20								
	OB3	22								
	OB4	23								
	OB5	24								
	Hsync	27	38 37	OUT3- OUT3+	RX03- RX03+	10 11				
	Vsync	28								
DE	30									
MCLK	31	40 39						CLK OUT- CLK OUT+	RX0 CLK- RX0 CLK+	8 9
OR6	50									
OR7	2									
OG6	8	RSVD	25							
OG7	10									
OB6	16									
OB7	18									

FOR HYVISION Internal Use Only

5.3 Data Input Format

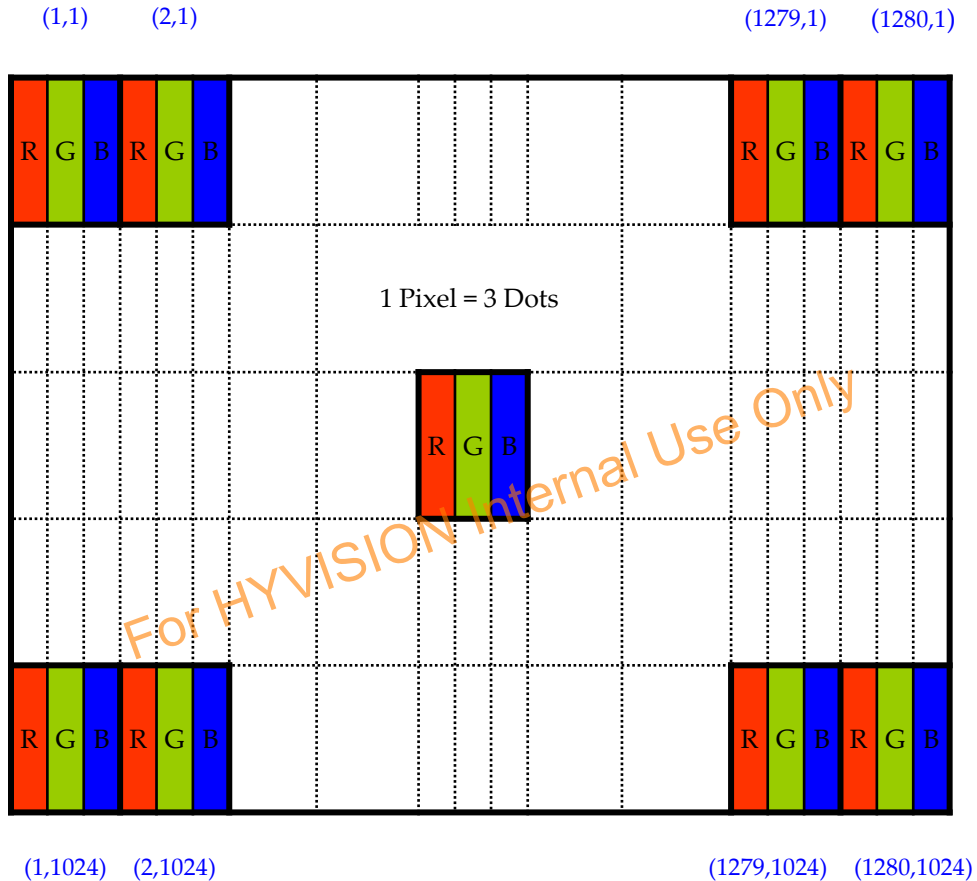

Display Position of Input Data (V-H)

6.0 SIGNAL TIMING SPECIFICATION

6.1 The MV190E0M-N10 is operated by the DE only.

Item		Symbols	Min	Typ	Max	Unit
Clock	Frequency	1/Tc	45	54	67.5	MHz
	High Time	Tch	-	4/7Tc	-	
	Low Time	Tcl	-	3/7Tc	-	
Frame Period		Tv	1036	1066	1096	lines
			50	60	75	Hz
			20	16.7	13.3	ms
Vertical Display Period		Tvd	-	1024	-	lines
One line Scanning Period		Th	704	844	960	clocks
Horizontal Display Period		Thd	640	640	640	clocks

For HYVISION Internal Use Only

6.2 LVDS Rx Interface Timing Parameter

The specification of the LVDS Rx interface timing parameter is shown in Table 4.

<Table 4. LVDS Rx Interface Timing Specification>

Item	Symbol	Min	Typ	Max	Unit	Remark
CLKIN Period	tRCIP	10.20	13.47	17.08	nsec	
Input Data 0	tRIP1	-0.4	0.0	+0.4	nsec	
Input Data 1	tRIP0	tRCIP/7-0.4	tRCIP/7	tRCIP/7+0.4	nsec	
Input Data 2	tRIP6	2 × tRCIP/7-0.4	2 × tRCIP/7	2 × tRCIP/7+0.4	nsec	
Input Data 3	tRIP5	3 × tRCIP/7-0.4	3 × tRCIP/7	3 × tRCIP/7+0.4	nsec	
Input Data 4	tRIP4	4 × tRCIP/7-0.4	4 × tRCIP/7	4 × tRCIP/7+0.4	nsec	
Input Data 5	tRIP3	5 × tRCIP/7-0.4	5 × tRCIP/7	5 × tRCIP/7+0.4	nsec	
Input Data 6	tRIP2	6 × tRCIP/7-0.4	6 × tRCIP/7	6 × tRCIP/7+0.4	nsec	

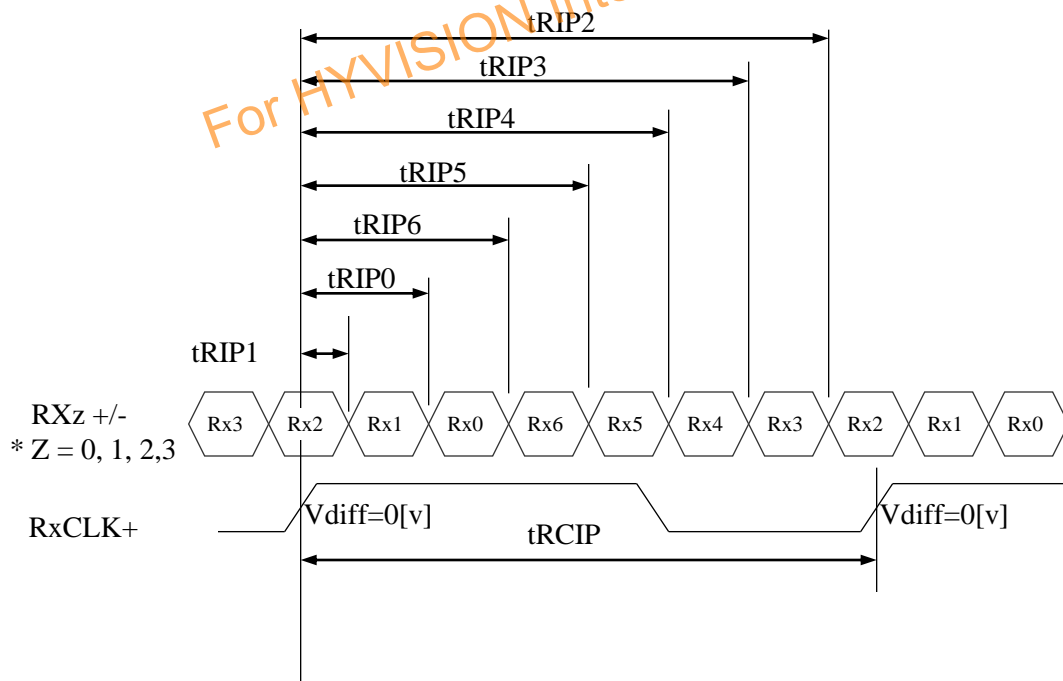

* Vdiff = (RXz+)-(RXz-),.... ,(RXCLK+)-(RXCLK-)

7.0 SIGNAL TIMING WAVEFORMS OF INTERFACE SIGNAL

7.1 Sync Timing Waveforms

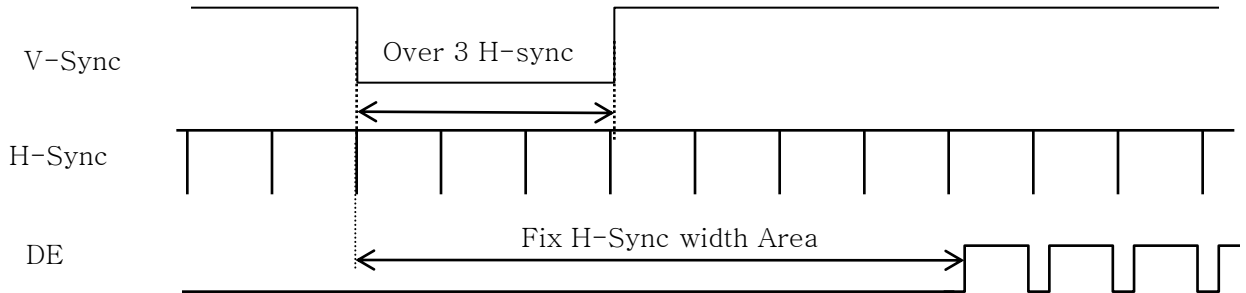

- 1) Need over 3 H-sync during V-Sync Low
- 2) Fix H-Sync width from V-Sync falling edge to first rising edge

7.2 Vertical Timing Waveforms

For HYVISION Internal Use Only

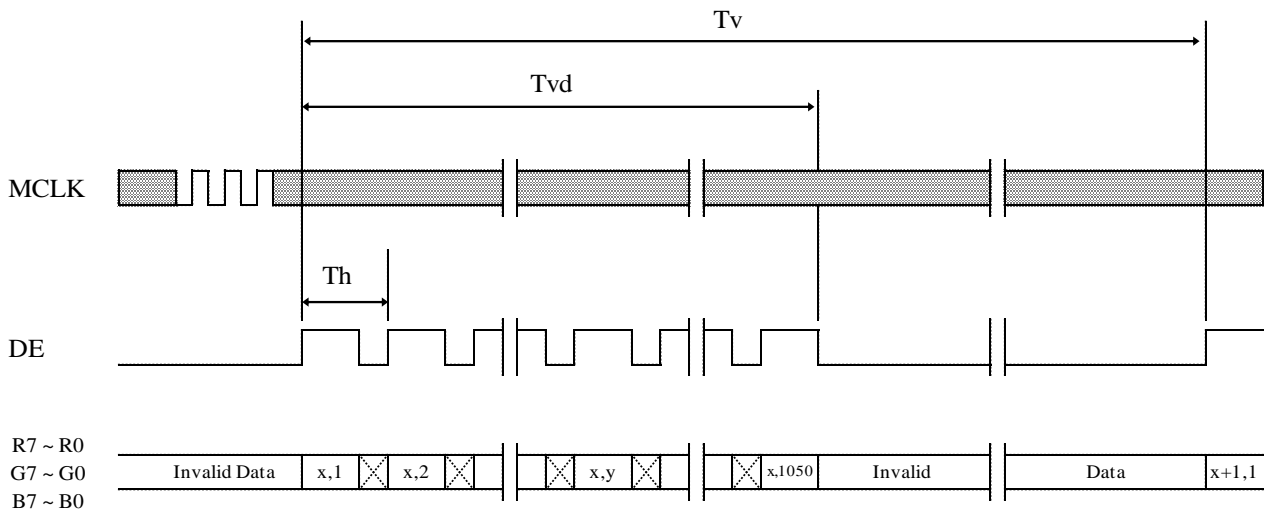

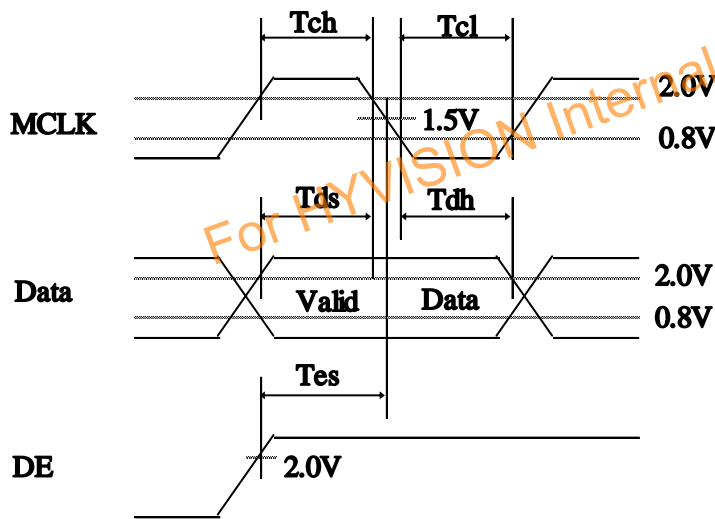
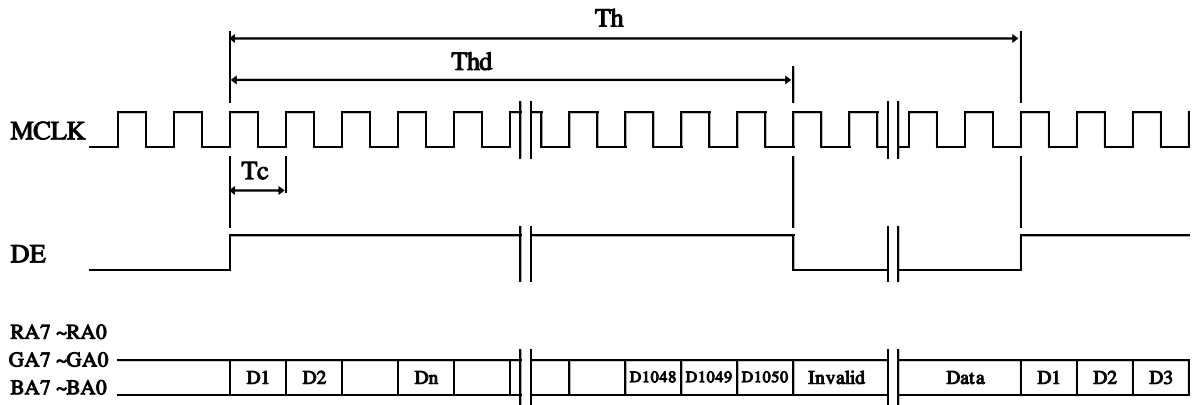
7.3 Horizontal Timing Waveforms

For Preview Internal Use Only

8.0 INPUT SIGNALS, BASIC DISPLAY COLORS & GRAY SCALE OF COLORS

Color & Gray Scale		RED DATA								GREEN DATA								BLUE DATA							
		R7	R6	R5	R4	R3	R2	R1	R0	G7	G6	G5	G4	G3	G2	G1	G0	B7	B6	B5	B4	B3	B2	B1	B0
Basic Colors	Black	0	0	0	0	0	0	0	0	0	0	0	0	0	0	0	0	0	0	0	0	0	0	0	0
	Blue	0	0	0	0	0	0	0	0	0	0	0	0	0	0	0	0	1	1	1	1	1	1	1	1
	Green	0	0	0	0	0	0	0	0	1	1	1	1	1	1	1	1	0	0	0	0	0	0	0	0
	Cyan	0	0	0	0	0	0	0	0	1	1	1	1	1	1	1	1	1	1	1	1	1	1	1	1
	Red	1	1	1	1	1	1	1	1	0	0	0	0	0	0	0	0	0	0	0	0	0	0	0	0
	Magenta	1	1	1	1	1	1	1	1	0	0	0	0	0	0	0	0	1	1	1	1	1	1	1	1
	Yellow	1	1	1	1	1	1	1	1	1	1	1	1	1	1	1	1	0	0	0	0	0	0	0	0
	White	1	1	1	1	1	1	1	1	1	1	1	1	1	1	1	1	1	1	1	1	1	1	1	1
Gray Scale of RED	Black	0	0	0	0	0	0	0	0	0	0	0	0	0	0	0	0	0	0	0	0	0	0	0	0
	△	0	0	0	0	0	0	0	1	0	0	0	0	0	0	0	0	0	0	0	0	0	0	0	0
	Darker	0	0	0	0	0	0	1	0	0	0	0	0	0	0	0	0	0	0	0	0	0	0	0	0
	△	↑								↑								↑							
	▽	↓								↓								↓							
	Brighter	1	1	1	1	1	1	0	1	0	0	0	0	0	0	0	0	0	0	0	0	0	0	0	0
	▽	1	1	1	1	1	1	1	0	0	0	0	0	0	0	0	0	0	0	0	0	0	0	0	0
	Red	1	1	1	1	1	1	1	1	0	0	0	0	0	0	0	0	0	0	0	0	0	0	0	0
Gray Scale of GREEN	Black	0	0	0	0	0	0	0	0	0	0	0	0	0	0	0	0	0	0	0	0	0	0	0	0
	△	0	0	0	0	0	0	0	0	0	0	0	0	0	0	0	1	0	0	0	0	0	0	0	0
	Darker	0	0	0	0	0	0	0	0	0	0	0	0	0	0	1	0	0	0	0	0	0	0	0	0
	△	↑								↑								↑							
	▽	↓								↓								↓							
	Brighter	0	0	0	0	0	0	0	0	1	1	1	1	1	1	0	1	0	0	0	0	0	0	0	0
	▽	0	0	0	0	0	0	0	0	1	1	1	1	1	1	1	0	0	0	0	0	0	0	0	0
	Green	0	0	0	0	0	0	0	0	1	1	1	1	1	1	1	1	0	0	0	0	0	0	0	0
Gray Scale of BLUE	Black	0	0	0	0	0	0	0	0	0	0	0	0	0	0	0	0	0	0	0	0	0	0	0	0
	△	0	0	0	0	0	0	0	0	0	0	0	0	0	0	0	0	0	0	0	0	0	0	0	1
	Darker	0	0	0	0	0	0	0	0	0	0	0	0	0	0	0	0	0	0	0	0	0	0	0	1
	△	↑								↑								↑							
	▽	↓								↓								↓							
	Brighter	0	0	0	0	0	0	0	0	0	0	0	0	0	0	0	0	1	1	1	1	1	1	0	1
	▽	0	0	0	0	0	0	0	0	0	0	0	0	0	0	0	0	1	1	1	1	1	1	1	0
	Blue	0	0	0	0	0	0	0	0	0	0	0	0	0	0	0	0	1	1	1	1	1	1	1	1
Gray Scale of WHITE	Black	0	0	0	0	0	0	0	0	0	0	0	0	0	0	0	0	0	0	0	0	0	0	0	0
	△	0	0	0	0	0	0	0	1	0	0	0	0	0	0	0	1	0	0	0	0	0	0	0	1
	Darker	0	0	0	0	0	0	1	0	0	0	0	0	0	0	1	0	0	0	0	0	0	0	1	0
	△	↑								↑								↑							
	▽	↓								↓								↓							
	Brighter	1	1	1	1	1	1	0	1	1	1	1	1	1	1	0	1	1	1	1	1	1	1	0	1
	▽	1	1	1	1	1	1	1	0	1	1	1	1	1	1	1	0	1	1	1	1	1	1	1	0
	White	1	1	1	1	1	1	1	1	1	1	1	1	1	1	1	1	1	1	1	1	1	1	1	1

9.0 POWER SEQUENCE

To prevent a latch-up or DC operation of the LCD module, the power on/off sequence shall be as shown in below

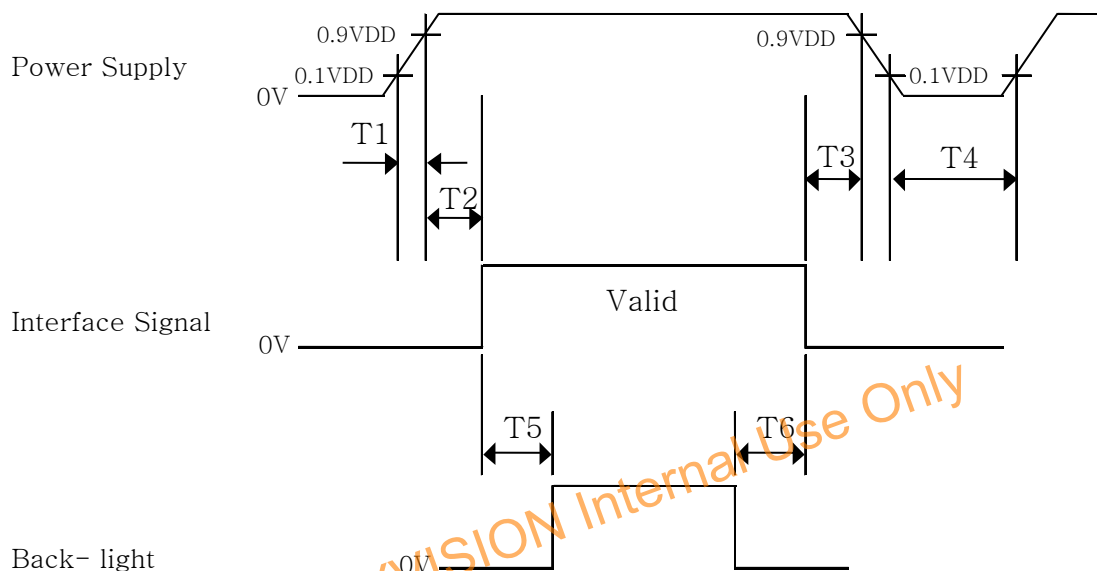

- $0.5 \text{ ms} \leq T1 \leq 10 \text{ ms}$
- $0 \leq T2 \leq 50 \text{ ms}$
- $0 \leq T3 \leq 50 \text{ ms}$
- $1 \text{ sec} \leq T4$
- $200 \text{ ms} \leq T5$
- $200 \text{ ms} \leq T6$

Notes:

1. When the power supply VDD is 0V, keep the level of input signals on the low or keep high impedance.
2. Do not keep the interface signal high impedance when power is on.
3. Back Light must be turn on after power for logic and interface signal are valid.

10.0 MECHANICAL CHARACTERISTICS

10.1 Dimensional Requirements

FIGURE 6 (located in Appendix) shows mechanical outlines for the model MV190E0M-N10. Other parameters are shown in Table 5.

<Table 5. Dimensional Parameters>

Parameter	Specification	Unit
Dimensional outline	396.0(H) × 324.0(V) × 9.9(D) typ.	mm
Weight	1720(typ)	gram
Active area	374.784(H) × 299.8272(V)	mm
Pixel pitch	0.0976(H) × 0.2928(V)	mm
Number of pixels	1280 (H) × 1024 (V) (1 pixel = R + G + B dots)	pixels
Back-light	Right edge side, 1-LED Lighting Bar type	

For HYVISION Internal Use Only

10.2 Mounting

See FIGURE 5. (shown in Appendix)

10.3 Anti-Glare and Polarizer Hardness.

The surface of the LCD has an anti-glare coating to minimize reflection and a coating to reduce scratching.

10.4 Light Leakage

There shall not be visible light from the back-lighting system around the edges of the screen as seen from a distance 50cm from the screen with an overhead light level of 350lux.

11.0 RELIABILITY TEST

The Reliability test items and its conditions are shown in below.

<Table 6. Reliability Test Parameters >

No	Test Items	Conditions
1	High temperature storage test	Ta = 60 °C, 240 hrs
2	Low temperature storage test	Ta = -20 °C, 240 hrs
3	High temperature & high humidity operation test	Ta = 50 °C, 80%RH, 240hrs
4	High temperature operation test	Ta = 50 °C, 240hrs
5	Low temperature operation test	Ta = 0°C, 240hrs
6	Thermal shock	Ta = -20 °C ↔ 60 °C (0.5 hr), 100 cycle
7	Vibration test (non-operating)	Frequency Random, 10 ~ 300 Hz, 30 min/Axis Gravity / AMP 1.5 Grms Period X, Y, Z 30 min
8	Shock test (non-operating)	Gravity 50G
		Pulse width 11msec, sine wave
		Direction ± X, ± Y, ± Z Once for each
9	Electro-static discharge test (operating)	Air : 150 pF, 330Ω, 15 KV Contact : 150 pF, 330Ω, 8 KV

12.0 HANDLING & CAUTIONS

- (1) Cautions when taking out the module
 - Pick the pouch only, when taking out module from a shipping package.
- (2) Cautions for handling the module
 - As the electrostatic discharges may break the LCD module, handle the LCD module with care. Peel a protection sheet off from the LCD panel surface as slowly as possible.
 - As the LCD panel and back - light element are made from fragile glass material, impulse and pressure to the LCD module should be avoided.
 - As the surface of the polarizer is very soft and easily scratched, use a soft dry cloth without chemicals for cleaning.
 - Do not pull the interface connector in or out while the LCD module is operating.
 - Put the module display side down on a flat horizontal plane.
 - Handle connectors and cables with care.
- (3) Cautions for the operation
 - When the module is operating, do not lose CLK, ENAB signals. If any one of these signals is lost, the LCD panel would be damaged.
 - Obey the supply voltage sequence. If wrong sequence is applied, the module would be damaged.
- (4) Cautions for the atmosphere
 - Dew drop atmosphere should be avoided.
 - Do not store and/or operate the LCD module in a high temperature and/or humidity atmosphere. Storage in an electro-conductive polymer packing pouch and under relatively low temperature atmosphere is recommended.
- (5) Cautions for the module characteristics
 - Do not apply fixed pattern data signal to the LCD module at product aging.
 - Applying fixed pattern for a long time may cause image sticking.
- (6) Other cautions
 - Do not disassemble and/or re-assemble LCD module.
 - Do not re-adjust variable resistor or switch etc.
 - When returning the module for repair or etc., Please pack the module not to be broken. We recommend to use the original shipping packages.

13.0 PRODUCT SERIAL NUMBER



BOE

LCO
RoHS Compliant

MADE IN CHINA

MV190E0M-N10 B4

XXXX

XXXXXXXXXXXXXXXXXXXXXXXXXX

XXXXXXXXXXXXXXXXXXXXXXXXXX

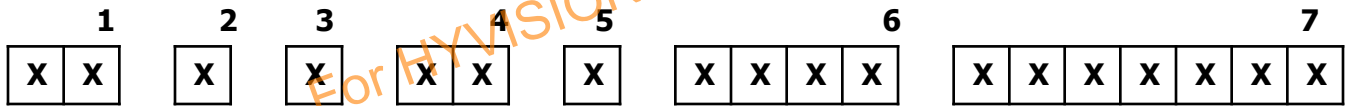

- 1. Control Number
- 2. Rank / Grade
- 3. Line Classification
- 4. Year (2001 : 01, 2002 : 02, ...)

- 5. Month (1,2,3, ... , 9, X, Y, Z)
- 6. Internal Use
- 7. Serial Number

14.0 Packing

14.1 Packing Order

Put pad into the box

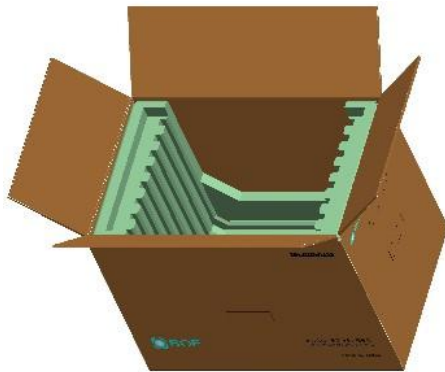

Place the modules bundled by packing bag in the box, 8pcs module per box, place a cover on the top of the box



For HYVISION Internal Use Only

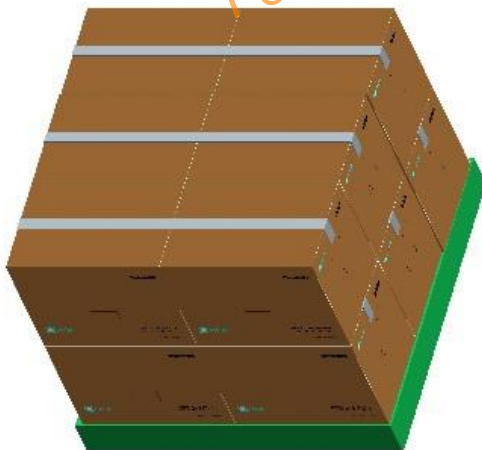

12ea box per pallet

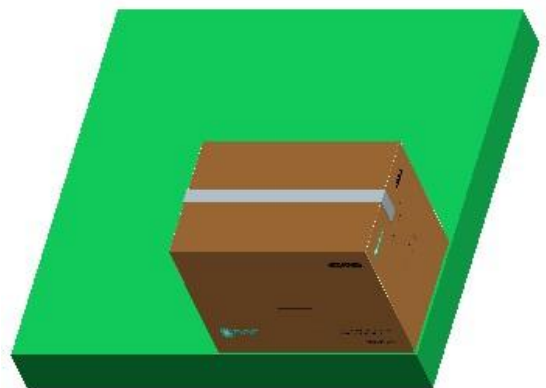

After sealing the box, put the box on the pallet

14.2 Packing Note

- Box Dimension : 521mm * 346mm * 403mm
- Package Quantity in one Box : 8 pcs

14.3 Box label

- Label Size : 108 mm (L) × 56 mm (W)
- Contents

Model : MV190E0M-N10

Q`ty : Module 8 Q`ty in one box

Serial No. : Box Serial No. See next page for detail description.

Date : Packing Date

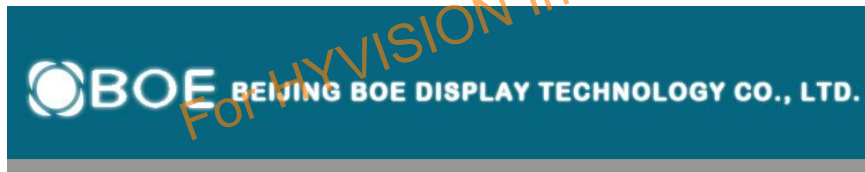

MODEL : MV190E0M-N10 Q'TY : 8

SERIAL NO. : 00000000000000 DATE : 20XX.X.XX



• QAA0330000268 •

5940



00	0	00	0	0	000000
Type	Grade	Year	Month	ITEM-CODE	Serial_no

Internal Use

RoHS Mark

15.0 APPENDIX

Figure 1. Measurement Set Up

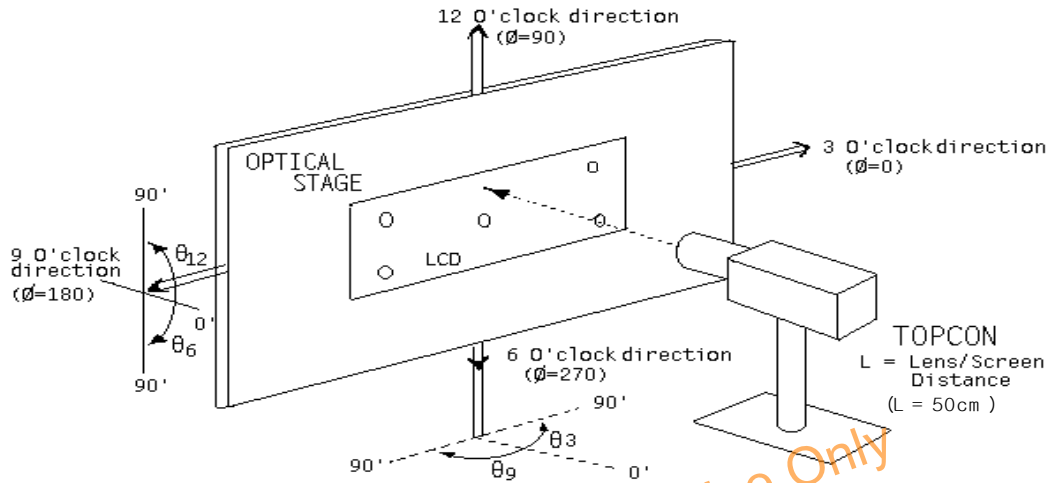

Figure 2. White Luminance and Uniformity Measurement Locations (9 points)

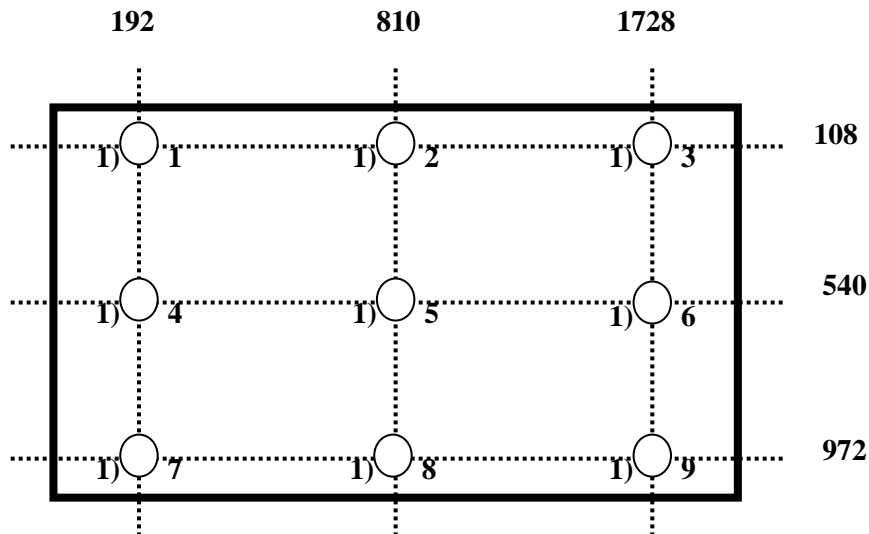
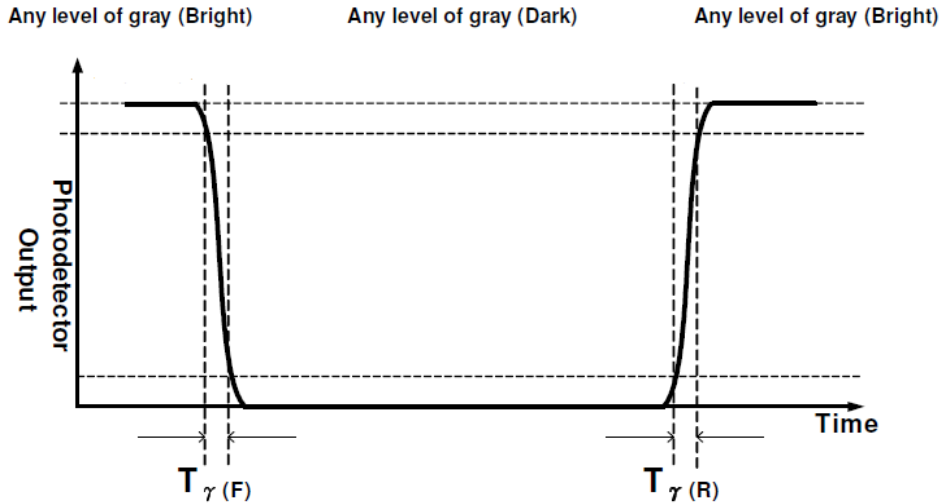
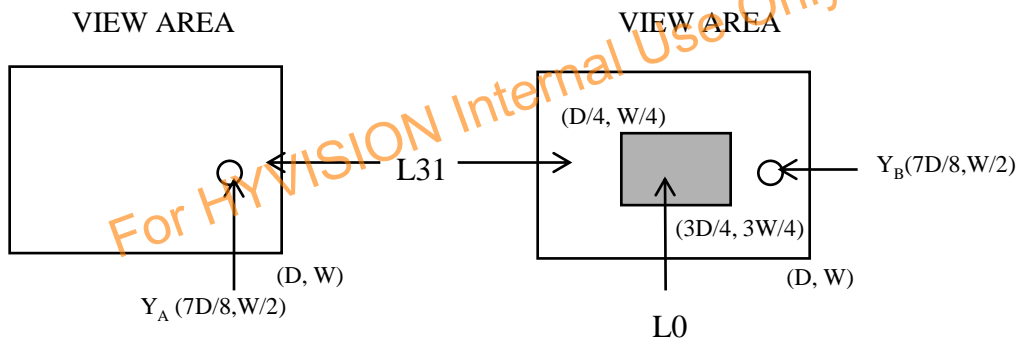

Figure 3. Response Time Testing

Figure 4. Cross Modulation Test Description

$$\text{Cross-Talk (\%)} = \left| \frac{Y_B - Y_A}{Y_A} \right| \times 100$$

Where: Y_A = Initial luminance of measured area (cd/m²)

Y_B = Subsequent luminance of measured area (cd/m²)

The location measured will be exactly the same in both patterns

Figure 5. TFT-LCD Module Outline Dimensions (Front view)

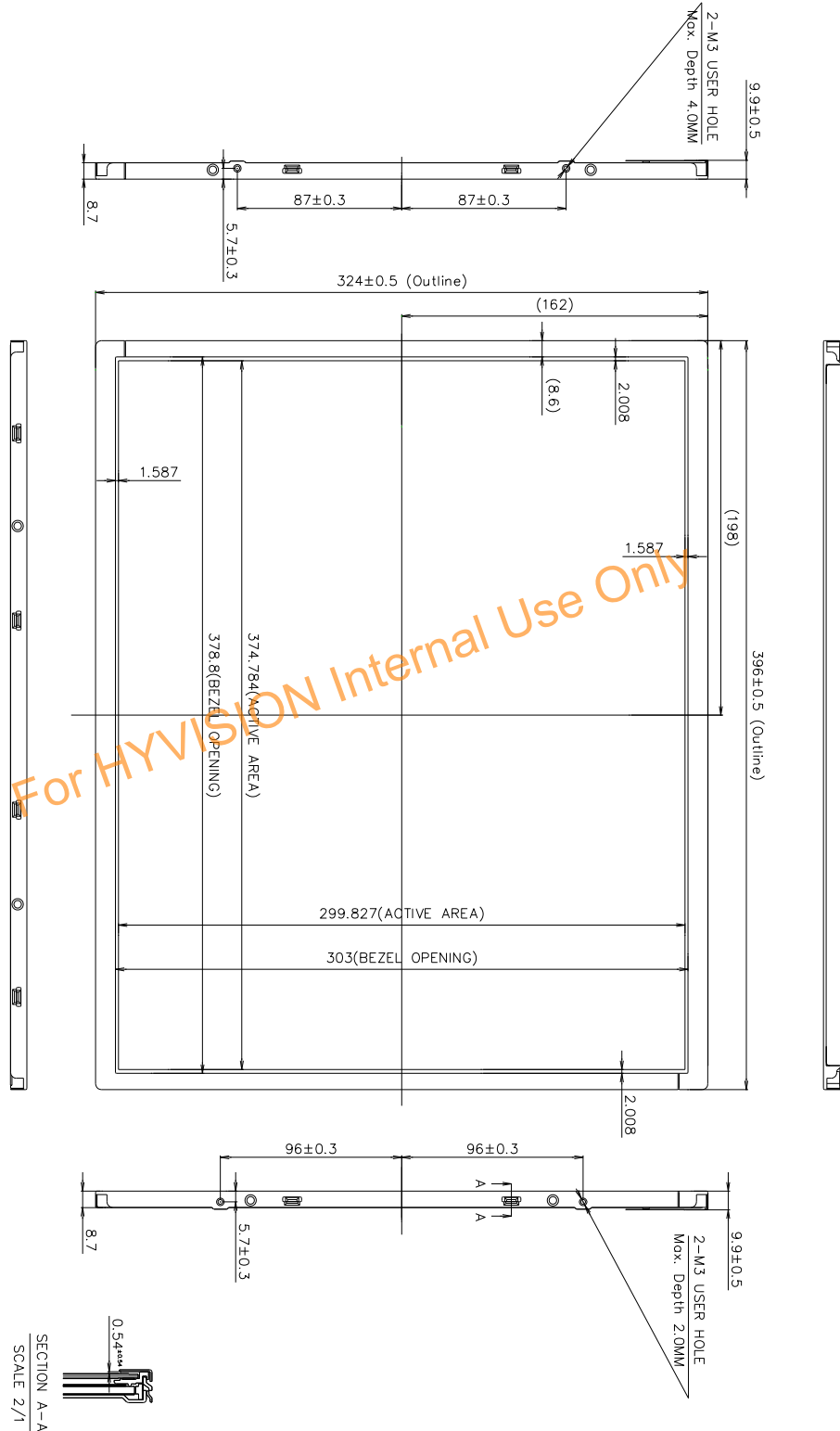

Figure 6. TFT-LCD Module Outline Dimensions (Rear view)

