

Programming i.MXRT ---with IDE and BOOT

By Jennie Zhang

i.MX RT is NXP new product. Recently we often have customers asking the possible methods of programming code to i.MX RT in both developing stage and manufacturing stage. In this article, I will summarize the programming methods based on MIMXRT1050-EVKB board.

1. Using MCUXpresso IDE programming

MCUXpresso IDE v10.2.0 was released last month

(<https://community.nxp.com/community/mcuxpresso/mcuxpresso-ide/blog/2018/05/18/mcuxpresso-ide-v1020-now-available>). Thus, I will take example based on this latest version.

1.1 Using MCUXpresso IDE debugger programming

In MCUXpresso IDE QuickStart Panel, Choose “debug”, it will trigger debugger to scan all probs (LinkerServer/PEMico/SeggerJlink) and connect board with the available one.

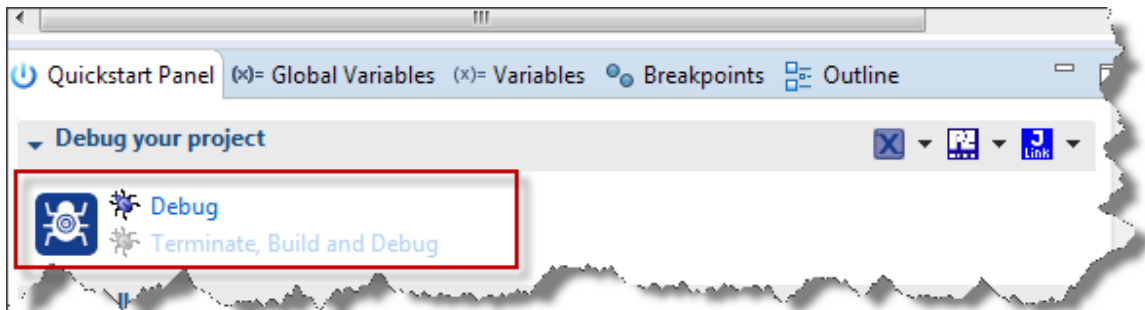

For example, below window will pop up if DAPLink CMSIS-DAP is discovered.

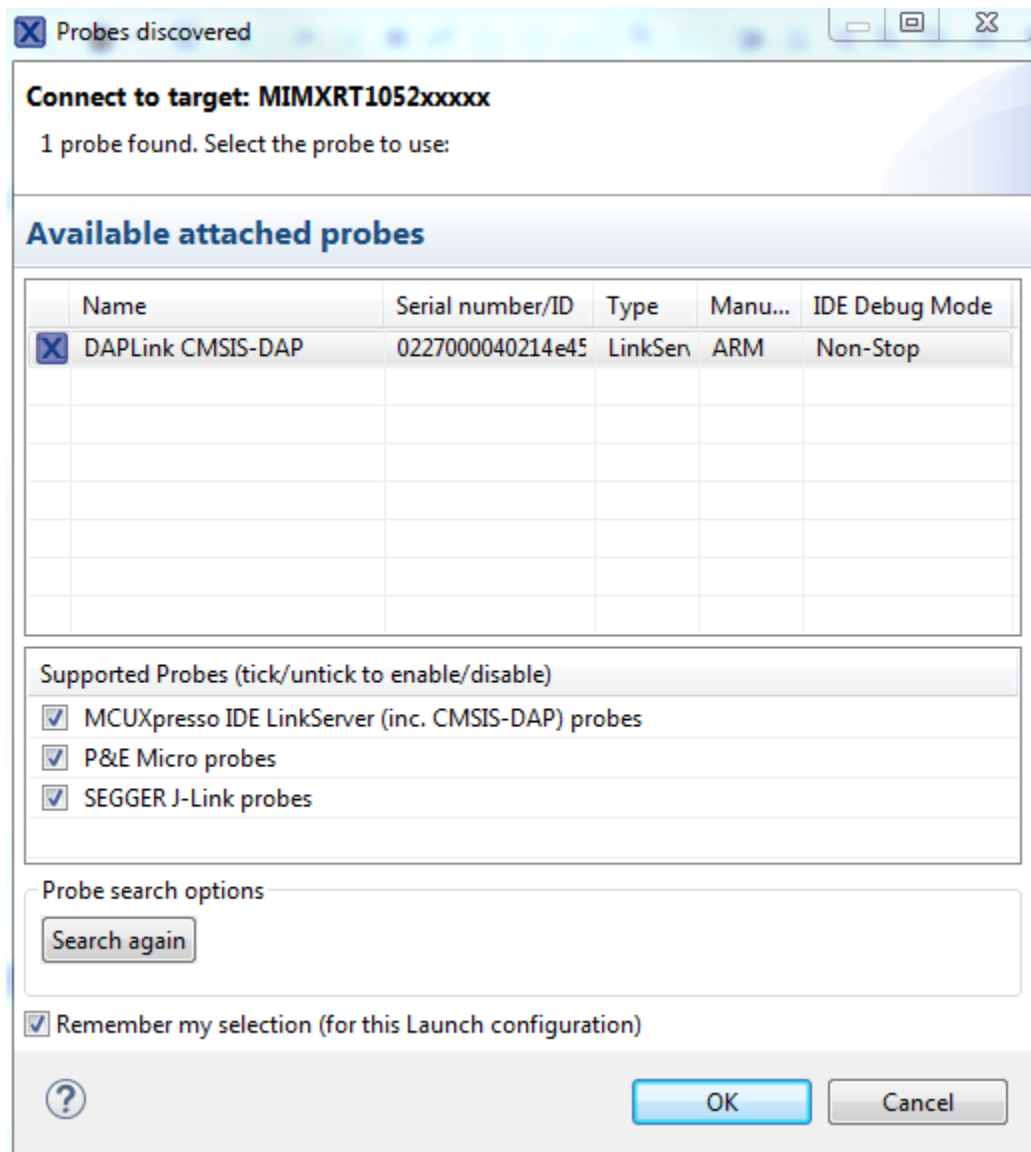

NOTE: combination of “SHIFT” key + clicking  Debug is very useful if user need to force IDE scan all probs to avoid old associations.

Last, click “OK” to proceed, **the burning file can be programed to target** during launching debugger.

1.2 Program flash action using LinkServer/etc.

Open the project in In MCUXpresso IDE, under Quickstart Panel, click “Program flash action using LinkServer”. The project burning file can be programed to target without launch debugger.

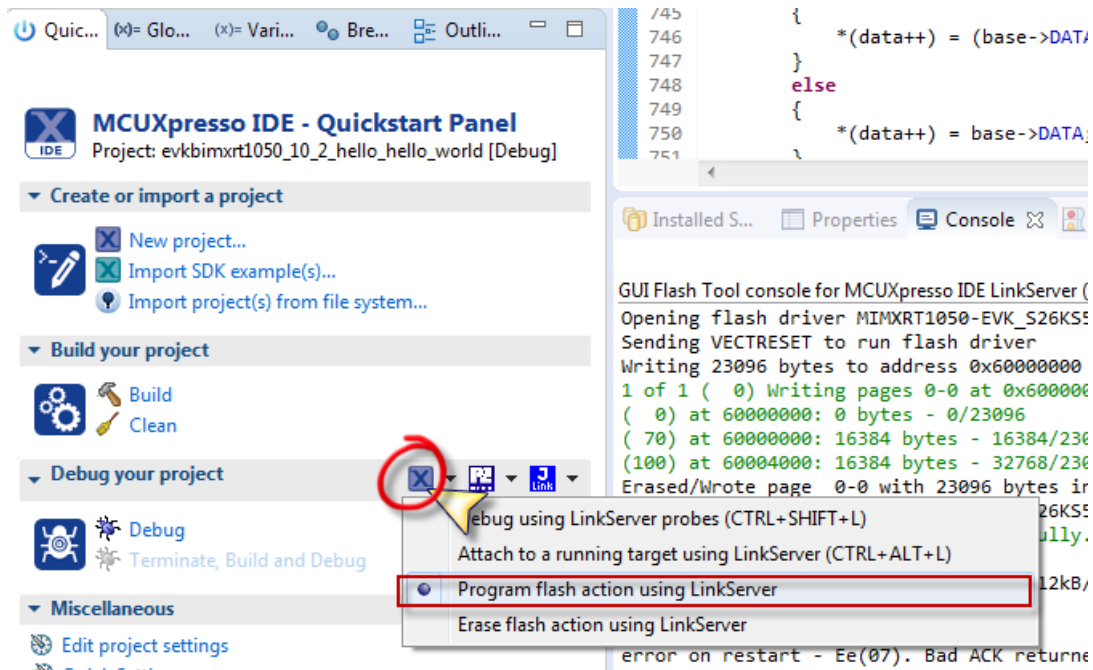

1.3 Program target with GUI Flash Tool

New in MCUXpresso IDE version 10.2.0, the rearchitected GUI Flash tool provides flash programming capabilities for all supported debug solutions.

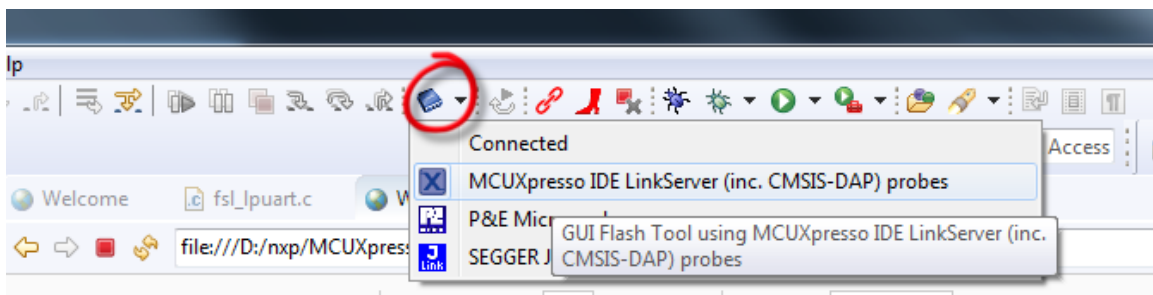

For detail, see {MCUXpresso IDE 10.2.0 install folder}/MCUXpresso_IDE_User_Guide.pdf, Chapter 13. The GUI Flash Tool.

2. DAP-Link (OpenSDA MSD drag/drop)

2.1 Boot Settings

The boot ROM uses the state of the **BOOT_MODE** register and **eFUSES** to determine the boot device. For development purposes, the eFUSES used to determine the boot device may be overridden using the GPIO pin inputs.

The BOOT_MODE is initialized by sampling the BOOT_MODE0 and BOOT_MODE1 inputs on the rising edge of the POR_B and stored in the internal BOOT_MODE register (can be read from SRC_SBMR2[BMOD[1:0]])

On MIMXRT1050-EVKB board. BOOT_MODE[1:0] connects SW7

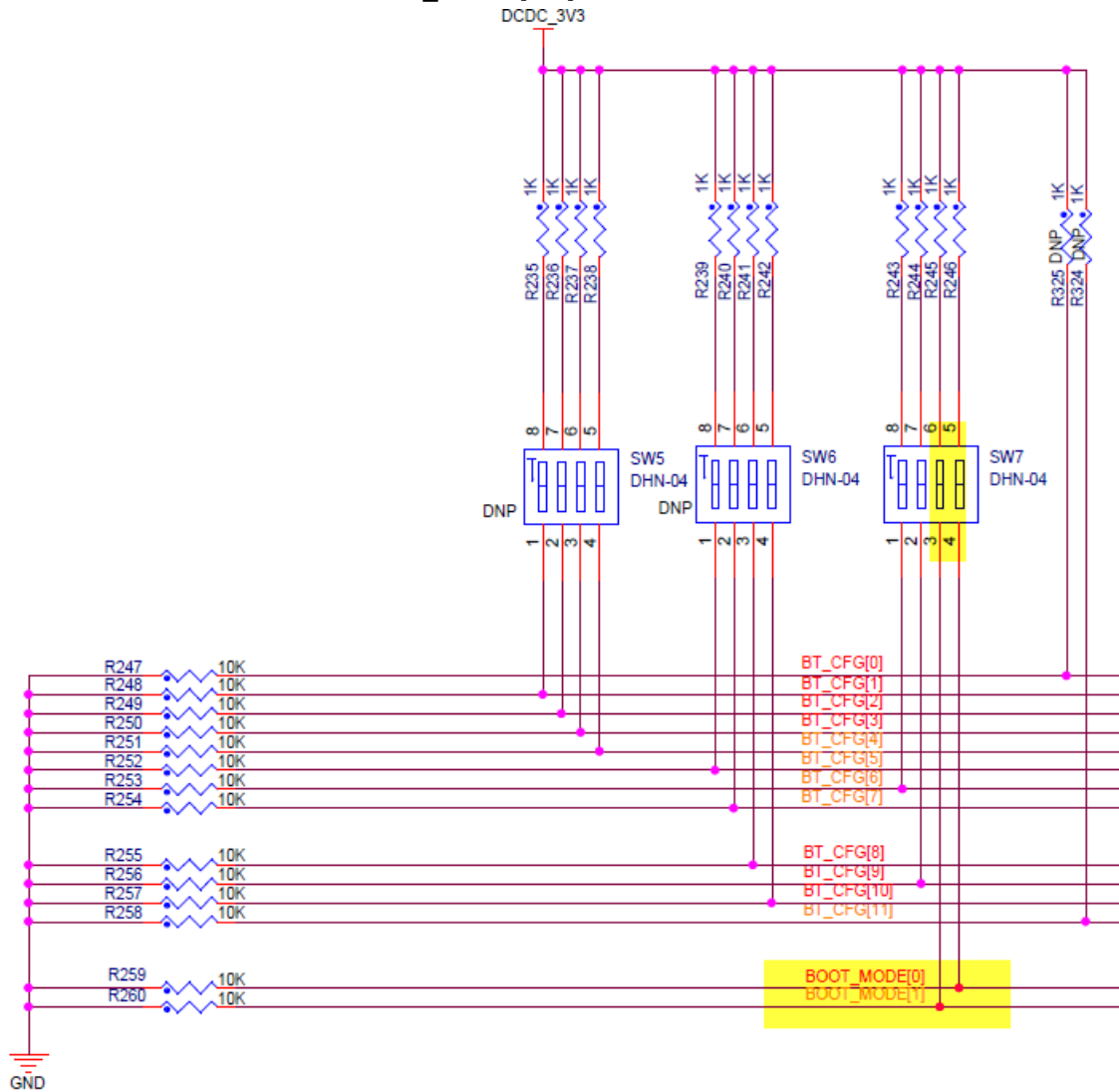

Boot MODE pin settings based on MIMXRT1050-EVKB

BOOT_MODE[1:0] (SW7-3 SW7-4)	Boot Type
00	Boot From Fuses
01	Serial Downloader (From USB or UART)
10	Internal Boot (Continues to execute the boot code from the internal boot ROM)
11	Reserved

Typical Boot Mode and Boot Device settings

SW7-1	SW7-2	SW7-3	SW7-4	Boot Device
OFF	ON	ON	OFF	Hyper Flash
OFF	OFF	ON	OFF	QSPI Flash
ON	OFF	ON	OFF	SD Card

For more information about boot mode configuration, see the System Boot chapter of the IMXRT 1050 Reference Manual.

For more information about MIMXRT1050 EVK boot device selection and configuration, see the main board schematic.

2.2 Check versions of SDK and DAP-Link

In the early SDK versions for RT1050 (SDK2.3.0 and earlier), the projects did not include the flash configuration block and IVT required to make a bootable image across all toolchains. Starting with the SDK 2.3.1 release, projects and its generated *.bin file include XIP files that add this information to the project. This allows for programming a bootable application to the external flash memory directly from the debugger.

With SDK2.3.1 and later, the on board DAP-Link firmware also changes.

Thus to work with SDK2.3.1 and later, Please make sure you use the latest version of firmware which can be downloaded from www.nxp.com/opensda

To check on board DAP-Link version, follow these steps:

- Configure the power supply is form the Debug USB (connect J1 5-6). Connect J28 OpenSDA interface with USB cable.
- Set SW7 to OFF-ON-ON-OFF
- Power on board
- Computer detects RT1050-EVK as removable device. Open it and details.txt. Check Git SHA number. **If it is lower than b3435dbed0ba4f09680e49d2fcfdaab32c7a4c71, go to www.nxp.com/opensda to get the latest version to update firmware.**

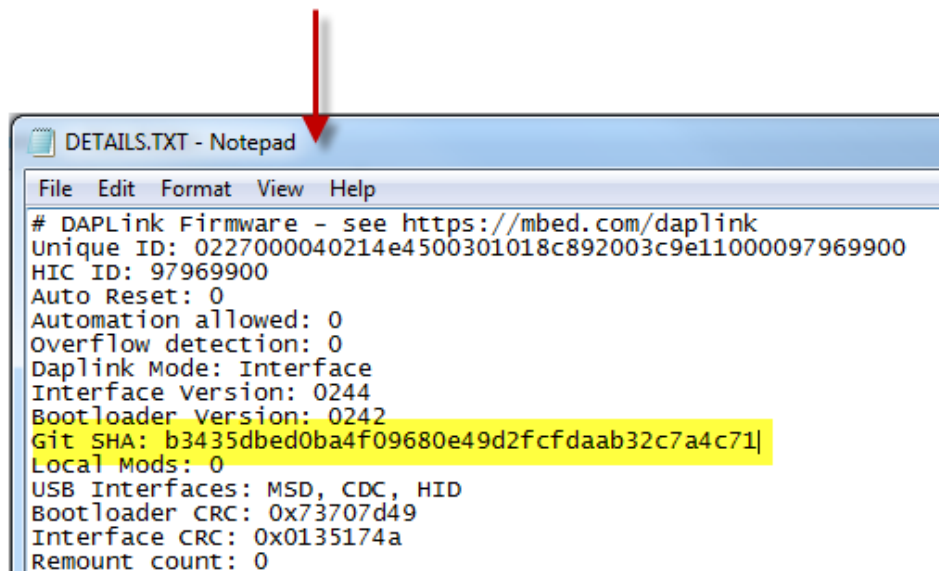
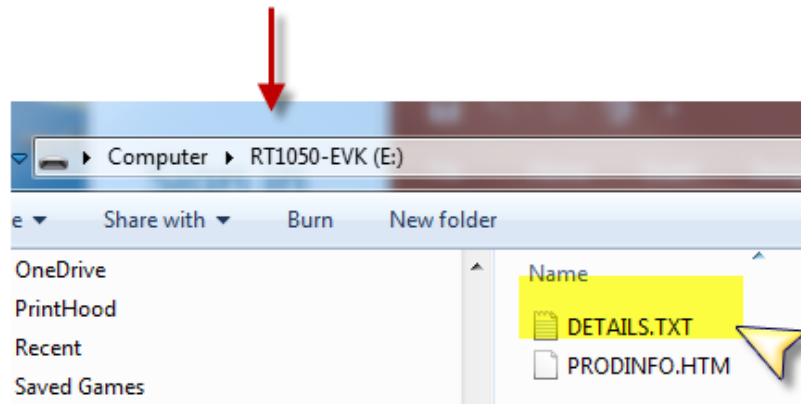
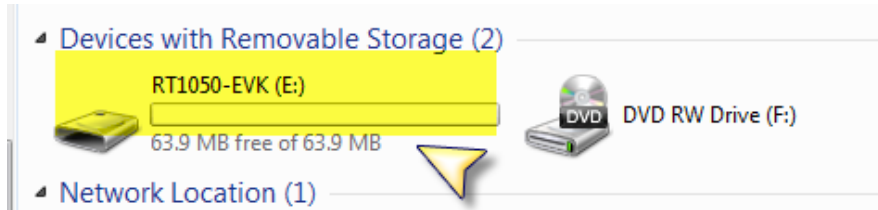

n gh

For more information, I recommend you read this article

<https://community.nxp.com/docs/DOC-340156>

2.3 Generate Binary file

MFGTool uses binary file (*.bin) as burning file image. With MCUXpresso IDE, right click on the .axf file, choose "Binary Utilities", "Create binary", a file with .bin extension will be generated under the project folder

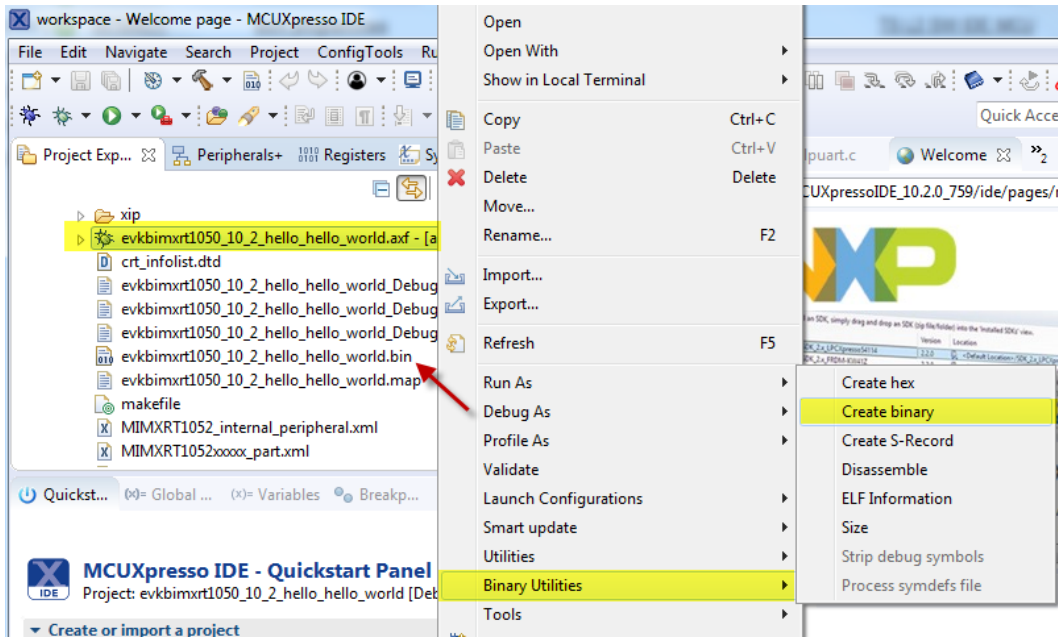

2.4 OpenSDA MSD drag/drop steps

Step1. Configure the power supply is form the Debug USB (connect J1 5-6). Connect J28 OpenSDA interface with USB cable.

Step 2. Set SW7 to OFF-OFF-OFF-ON

Step 3. Power on board

Step 4. Computer detects RT1050-EVK as removable device. Drag 2.2 generated *.bin file into RT1050-EVK.

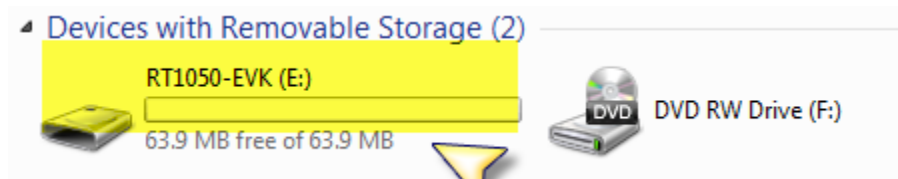

Step 5. Power off. Set SW7 to OFF-ON-ON-OFF

Step 6. Power on. Push on board reset button. Set PuTTY baud rate as 115200. We will see the programed file works.

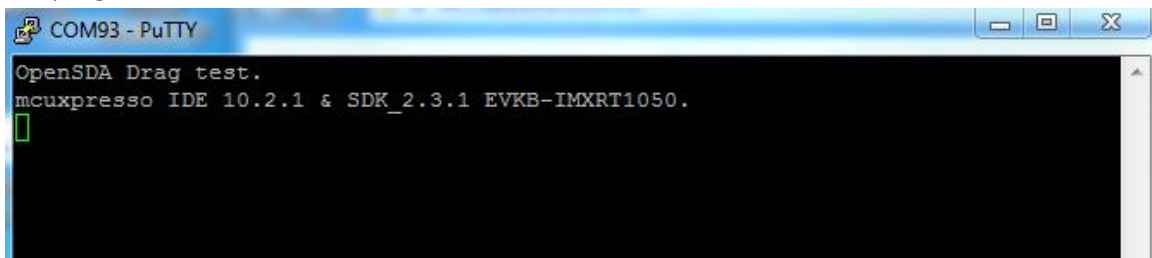

3. Using MFGTool program with Boot

The MfgTool supports I.MXRT BootROM and KBOOT based Flashloader, it can be used in factory production environment.

3.1 Boot Settings

Refer 2.1 Boot Settings

3.2 Check versions of SDK and DAP-Link

Refer 2.2 Check versions of SDK and DAP-Link

3.3 Generate Binary file

Refer 2.3 Generate Binary file

3.4 Using MFGTool burning HyperFlash with BOOT

Step1. Configure the power supply is form the Debug USB (connect J1 5-6). Connect J28 OpenSDA interface with USB cable. Connect J1 USB interface

Step 2. Set SW7 to OFF-OFF-OFF-ON

Step 3. Power on board

Step 4. Download and install Flashloader i.MX-RT1050 from nxp website

Step 5. Rename your application *.bin file to boot_image.bin and Copy it to Flashloader_i.MXRT1050_GA\Flashloader_RT1050_1.1\Tools\mfgtools-rel\Profiles\MXRT105X\OS Firmware\

Step 6. Open MfgTool

under ..\Flashloader_i.MXRT1050_GA\Flashloader_RT1050_1.1\Tools\mfgtools-rel, it will show the detected device as below:

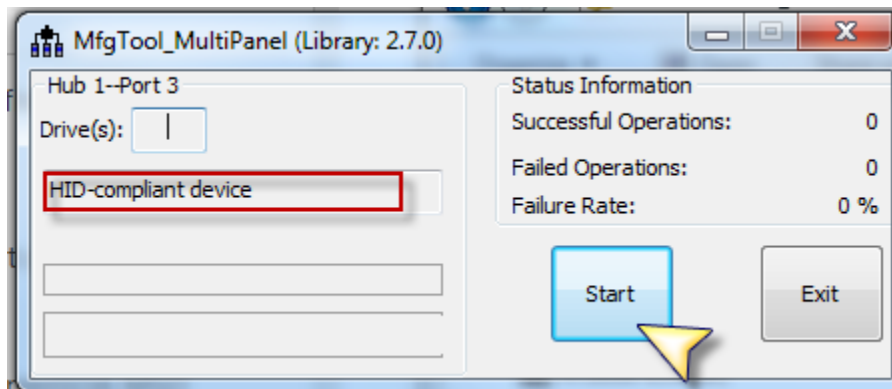

Hit Start button, boot_image.bin can be programmed to hyperflash. Once we see status changes to “Done”, we click “Stop” button and “Exit”.

Step 7. Power off. Set SW7 to OFF-ON-ON-OFF

Step 8. Power on. Push on board reset button. Set PuTTY baud rate as 115200. We will see the programed file works.

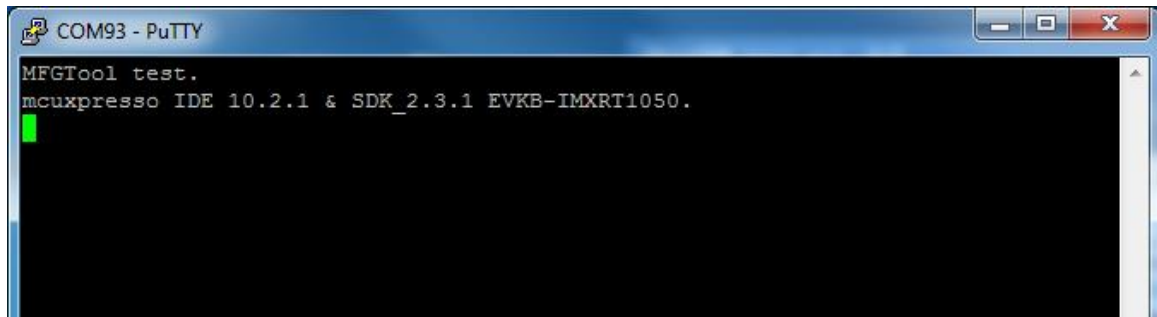

```
COM93 - PuTTY
MFGTool test.
mcuxpresso IDE 10.2.1 & SDK_2.3.1 EVKB-IMXRT1050.
```

Reference:

- AN12107.pdf
- AN12108.pdf
- IMXRT1050RM.pdf