

1 Preface

1.1 About This Document

This is a guide of how to do customization work on security features supported by i.MX Android software. It provides an overview of the i.MX Android security features and it focuses on how to configure and use these security features.

The released code can be built into images both with and without Trusty OS integrated while the Trusty OS related contents in this document can only be applied on the images with Trusty OS integrated.

1.2 Conventions

The following conventions are used in this document:

- Software code is shown in `Consolas` font.
- `#{MY_ANDROID}` is a reference to the i.MX Android source code root directory.
- `#{MY_TRUSTY}` is a reference to i.MX Trusty OS source code root directory.

2 Overview of i.MX Android Security Features

2.1 Introduction of security-related hardware modules

Security features are based on security-related codes, which need to do some cryptographic calculations to protect security data. Security requires that only security-related code is allowed to run on certain hardware resources. Therefore, these hardware resources are called security-related hardware modules. There are some security hardware modules on the i.MX platform, which co-work with the Trusty OS to guarantee security:

- CAAM: Cryptographic Acceleration and Assurance Module, is a hardware component of a System on Chip (SoC) that provides security assurance and hardware acceleration of cryptographic algorithms, packet encapsulation and decapsulation, and other cryptographic operations.
- TrustZone: ARM TrustZone creates an isolated secure world, which can be used to provide confidentiality and integrity to the system. It is used to protect high-value code and data for diverse use cases like authentication. It is frequently used to provide a security boundary for the Trusted Execution Environment, like Trusty OS.
- TZASC: TrustZone Address Space Controller, is an Advanced Microcontroller Bus Architecture (AMBA) compliant SoC peripheral. It is a high-performance, area-optimized address space controller to protect security-sensitive software and data in a trusted execution environment against potentially compromised software running on the platform.
- CSU: Central Security Unit sets access control policies between the bus masters and bus slaves, enabling the peripherals to be separated into distinct security domains.
- xRDC: On i.MX 8QuadMax and i.MX 8QuadXPlus, the eXtended Resource Domain Controller (xRDC) replaces the RDC and TrustZone components (CSU, TZASC, etc.), which can be found in previous i.MX processors.

Contents

1 Preface.....	1
2 Overview of i.MX Android Security Features.....	1
3 Customization work on i.MX Android Security Features	4
4 Revision History.....	36



i.MX 8QuadMax and i.MX 8QuadXPlus SoC contains a mix of Cortex-A and Cortex-M CPUs, which frequently operate in an asymmetric mode with different software environments executing on them. To keep these software environments from unintentionally interfering with each other, the SoC contains xRDC to enforce isolation. The xRDC operates in a manner like ARM's TrustZone. Transactions from masters are annotated with user-side band information to indicate their domain and the access control logic allows/disallows accesses to peripherals/memory based on this information.

- AHAB/HABv4: The Advanced High Assurance Boot (AHAB) and High Assurance Boot (HABv4) support authentication on the images by using cryptography operations to prevent unauthorized software from being executed during the device boot sequence. Details about how to verify images with HAB can be found in Chapter 2.1.
- SCU: The System Controller Unit (SCU) is only for i.MX 8QuadMax and i.MX 8QuadXPlus platforms. It consists of a Cortex-M4 processor and a set of peripherals and interfaces to connect to an external PMIC and to control internal subsystems. The SCU Cortex-M4 is the first processor to boot the chip. The SCU is dedicated to:
 - Boot management
 - Power management
 - External power management by communicating with external PMIC
 - Internal power management of all the subsystems
 - Clock and reset management
 - I/O configuration and muxing
 - Resource partitioning/access control
- SECO: The Security Controller Subsystem (SECO) is only for i.MX 8QuadMax and i.MX 8QuadXPlus platforms. It manages several security hardware modules (CAAM, SNVS, OTP, ADM, etc.) to perform cryptography acceleration and ensure the security of the whole system.
- eMMC RPMB: RPMB is a separate physical partition in the eMMC device designed for secure data storage. Every access to RPMB is authenticated and it allows the host to store data to this area in an authenticated and replay protected manner. In Trusty OS, the RPMB partition is managed as the secure storage to store all critical data like lock/unlock status, rollback index, etc.

The following table lists the modules on the i.MX 8QuadMax, i.MX 8QuadXPlus, i.MX 8M Mini, i.MX 8M Quad platforms:

Table 1. Modules on the i.MX 8QuadMax, i.MX 8QuadXPlus, i.MX 8M Mini, i.MX 8M Quad platforms

Modules	i.MX 8QuadMax and 8QuadXPlus	i.MX 8M Quad, 8M Mini, 8M Nano, and 8M Plus
CAAM	Y	Y
TZASC	N	Y
CSU	N	Y
xRDC	Y	N
AHAB	Y	N
HABv4	N	Y
SCU	Y	N
SECO	Y	N
eMMC	Y	Y

2.2 i.MX Android security framework

i.MX Android/Android Automotive security framework includes secure enhanced U-Boot, Android/Android Auto, i.MX Trusty OS, and the related hardware.

Secure enhanced U-Boot provides the Android Verified Boot module, keys provisioning interface, and secure storage proxy.

Android Verified Boot assures the end user of the integrity of the software loaded and started by secure-enhanced U-Boot. This is defined by Google, and more details can be found in <https://source.android.com/security/verifiedboot/avb>.

Key provisioning interface provides the RPMB keys, key attestation, and AVB keys provisioning interface. These interfaces can be used to inject the keys into the device to make it secure.

Secure Storage Proxy is the client of Secure Storage service from Trusty OS. It helps to access the RPMB secure storage device by SoC IPs.

Android/Android Auto platform, based on Google’s design, integrates the Keymaster HAL, Gatekeeper HAL, and Secure Storage proxy.

Keymaster HAL uses trusty-backed one and supports Keymaster V2 and Keymaster V3 APIs. For more details about keymaster, see <https://source.android.com/security/keystore>.

Gatekeeper also uses the Trusty-backed gatekeeper HAL. For more details about gatekeeper, see <https://source.android.com/security/authentication/gatekeeper>.

i.MX Trusty OS is based on Trusty OS that is released from Google. Secure TAs and services are integrated in it. Trusty OS is a very important module for the whole security of i.MX Android/Android Auto platform.

Trusty OS provides a trusty-ipc, which is used to realize communication between secure and non-secure world. Trusty OS has the hardware driver for CAAM used for keyblob calculation and security algorithm acceleration.

The following figure shows the logic between these components.

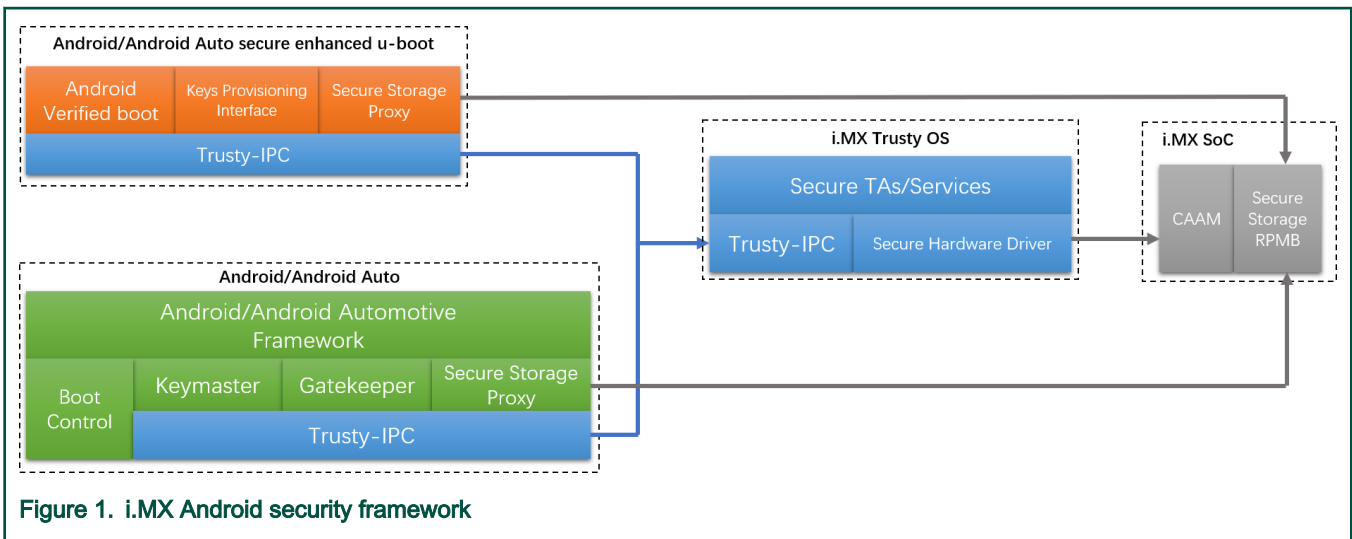

The following figure shows the i.MX Android/Android Auto security trust chain.

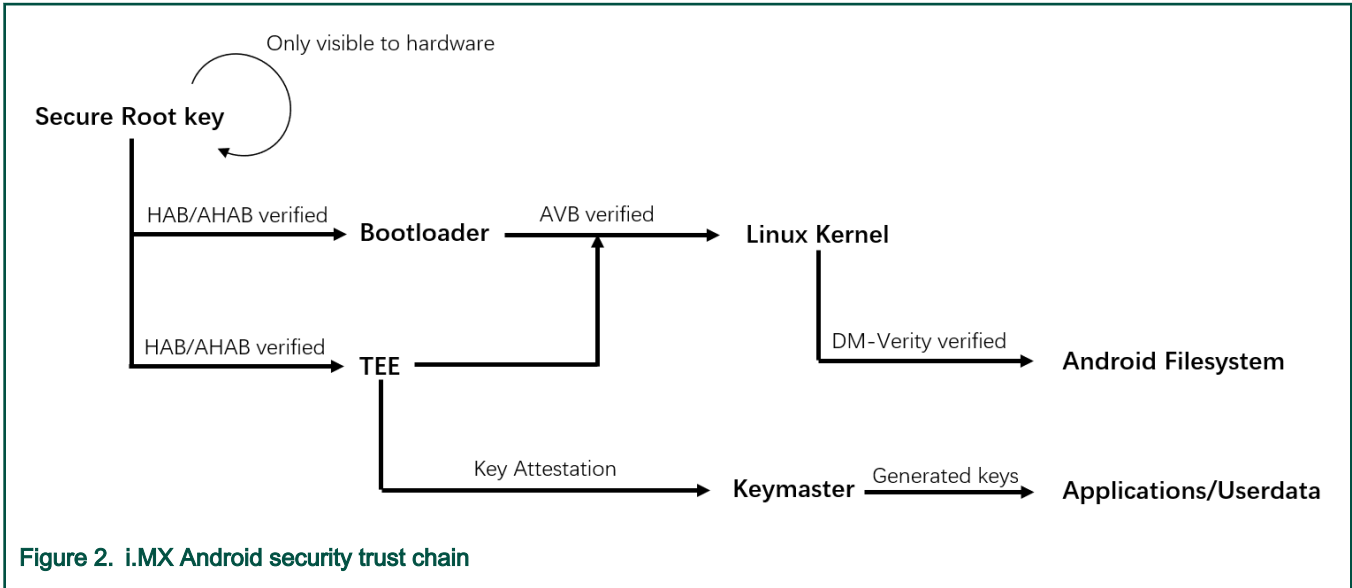

Figure 2. i.MX Android security trust chain

Secure root key is programmed into the One Time Programmable (OTP) eFuse hardware in i.MX chips and work as the root trust of the solution. It is used by CAAM to generate other keys. In the trust chain, the HAB/AHAB, AVB, and DM-Verity are used by a different level to verify the specific images or encrypt user data.

After power-on, the boot process begins, U-Boot and Trusty OS are loaded by ROM code. They are the first to be verified by ROM code with HAB/AHAB. They can only be executed after they pass the verification. U-boot loads the Linux kernel and uses AVB to verify it before jumping to the Linux kernel. The Linux kernel mounts the Android file system. Data access from Android file system will be verified by DM-Verity to assure integrity. The security chain is formed by these features.

3 Customization work on i.MX Android Security Features

3.1 Verifying images with HAB

The i.MX family of application processors provide the High Assurance Boot (HAB) feature in the on-chip ROM. The ROM is responsible for loading the initial image and verifying the image before the image is executed.

Due to the new architecture, multiple firmware and software images are required to boot i.MX 8Quad and i.MX 8M family devices. NXP defines "container" to organize images. AHAB for i.MX 8Quad devices can recognize the format of "container" and verify the images in a container. For i.MX 8M devices, these images are stored in the format of Flattened Image Tree (FIT) with an appropriate Image Vector Table (IVT) set. HABv4 for i.MX 8M devices can recognize this format and verify the images. By default, HAB verification is enabled and i.MX chip is in open stage, so failure of HAB verification does not block the boot process. After closing the chip, only correctly signed images can be executed.

This section covers AHAB used on i.MX 8Quad family devices and HABv4 used on i.MX 8M family devices.

3.1.1 Verifying images with AHAB

AHAB is closely bound with "container". Detailed information about "container" can be found in the Reference Manual of specific chips. According to the Reference manual, the hash values of multiple firmware and software components are stored in the container header. The container sign process described below embeds an SRK table in the container and signs the container. The contents described in the sign process is used to verify the container during the boot time.

For i.MX 8QuadMax MEK and i.MX 8QuadXPlus MEK, "container" is used to organize the SECO firmware, SCU firmware, Cortex-M4 software, Trusty OS, and U-Boot.

When U-Boot has SPL enabled, three containers are used to organize the images. If SPL is not enabled, two containers are used. We now distinguish containers by the order of these containers being loaded.

When the U-Boot image used by UUU does not have SPL enabled, two containers are used. The first container only has the SECO firmware in it, and this container is provided as a binary file and signed by NXP. The second container is constructed in build time and appended to the first container. The second container contains U-Boot, and it is not signed by default. Take u-boot-imx8qm-mek-uuu.imx as an example, its high-level layout structure is shown in the following figure.

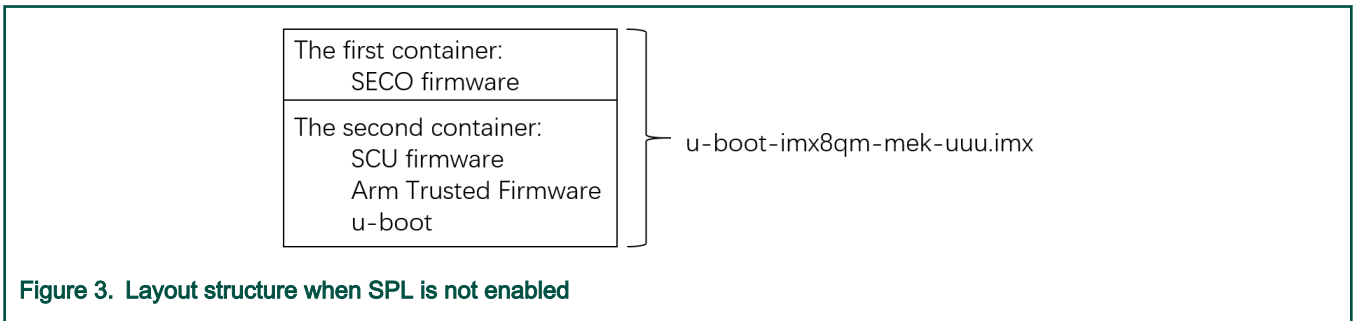

Figure 3. Layout structure when SPL is not enabled

When U-Boot to be flashed to the board has SPL enabled, three containers are used. The first container only has the SECO firmware in it, and this container is provided as a binary file and signed by NXP. The second container is constructed in build time and appended to the first container. This container contains SPL. The third container is also constructed in build time. It contains U-Boot proper. The two containers constructed at build time are not signed by default. These three containers are in two files if dual-bootloader is enabled. For single bootloader condition, taking "u-boot-imx8qm-trusty.imx" of standard Android images as an example, layout structure is shown in the following figure.

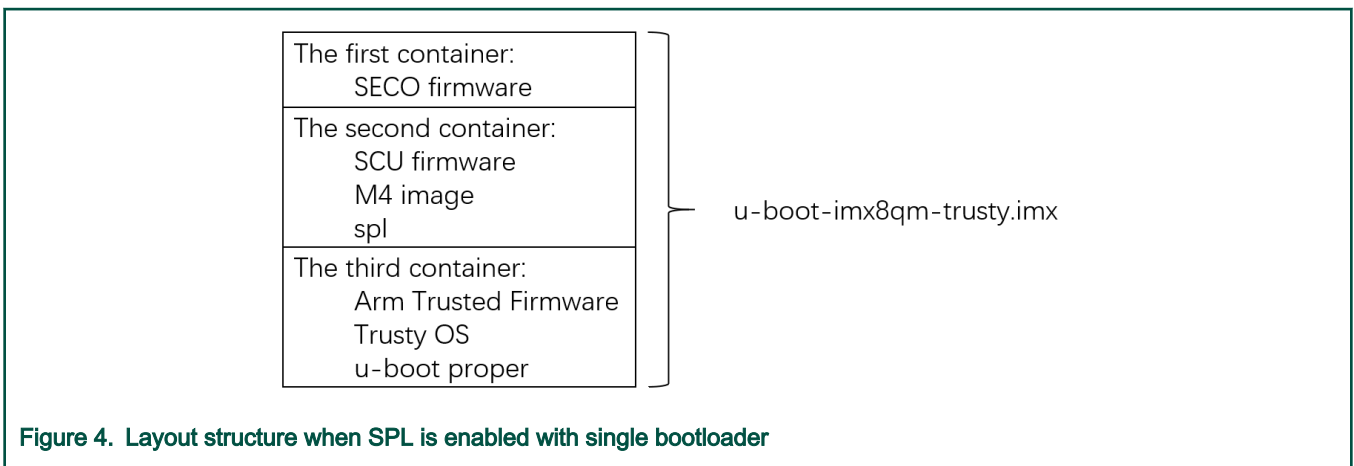

Figure 4. Layout structure when SPL is enabled with single bootloader

For dual-bootloader condition, taking "spl-imx8qm.bin" and "bootloader-imx8qm.img" of Android Automotive as an example, the layout structure is shown in the following figure.

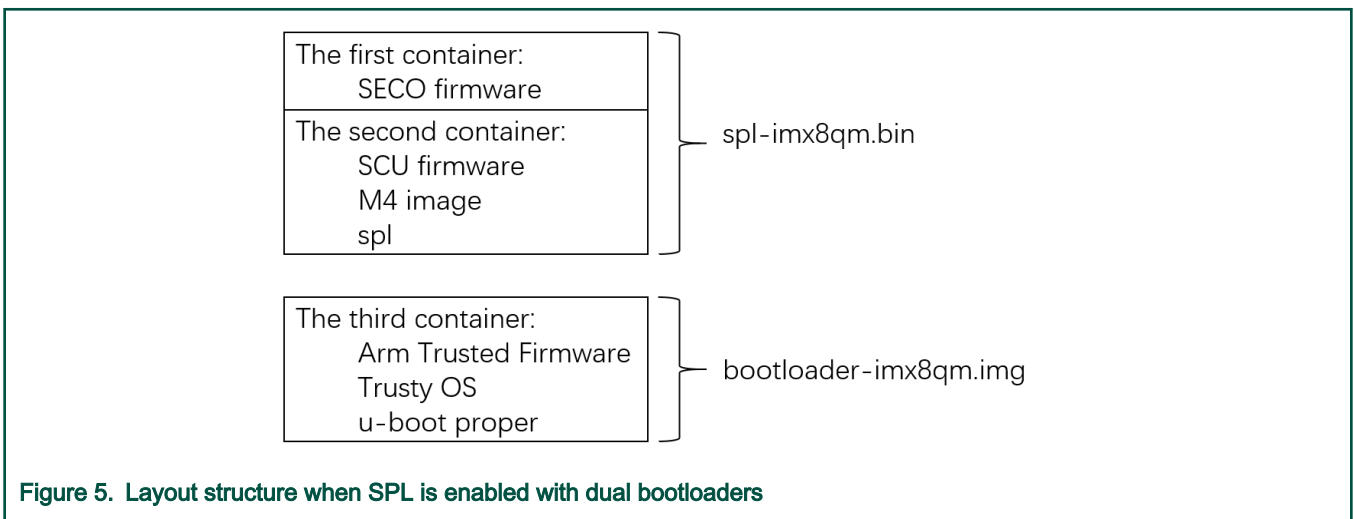

Figure 5. Layout structure when SPL is enabled with dual bootloaders

To **sign** the containers constructed in the process of building Android images, perform the following steps:

1. Download Code Signing Tool (CST) from the [NXP official website](#). Decompress the package using the following command:

```
$ tar zxvf cst-3.1.0.tgz
```

2. Generate AHAB PKI tree. After the tool package is decompressed, enter the directory of `release/keys/`, and execute the following command:

```
$ ./ahab_pki_tree.sh
```

Then enter some parameters based on the output of this script. An example is as follows:

```
Do you want to use an existing CA key (y/n)? : n
Do you want to use Elliptic Curve Cryptography (y/n)? : y
Enter length for elliptic curve to be used for PKI tree:
Possible values p256, p384, p521: p384
Enter the digest algorithm to use: sha384
Enter PKI tree duration (years): 5
Do you want the SRK certificates to have the CA flag set? (y/n)? : n
```

After the preceding command is successfully executed, private keys are under the `keys/` directory, and public key certificates are under the `crts/` directory.

3. Generate AHAB SRK tables and eFuse hash.

Enter the directory of `release/crts/`, and execute the following command:

```
$ ../linux64/bin/srktool -a -s sha384 -t SRK_1_2_3_4_table.bin \
-e SRK_1_2_3_4_fuse.bin -f 1 -c \
SRK1_sha384_secp384r1_v3_usr_cert.pem, \
SRK2_sha384_secp384r1_v3_usr_cert.pem, \
SRK3_sha384_secp384r1_v3_usr_cert.pem, \
SRK4_sha384_secp384r1_v3_usr_cert.pem
```

After the command is executed successfully, the SRK table and its SHA512 value are generated and saved respectively in two files under `release/crts/`.

The SRK table is embedded in the container in the process of signing that container. Therefore, during the boot time, it can be used to verify the signature. If the signature is authenticated, the hash value of firmware and software images can be trusted to verify the corresponding firmware and software. The SRK table SHA512 value will be fused to the OTP eFuse hardware and work as the "secure root key", it is used to verify the SRK table embedded in the container.

Files generated in `release/keys/` and `/release/crts/` are very important. If the SRK HASH value is fused to the chip and then the chip is changed from open to close state, the board can only boot with images signed with these files.

If you are a user of both i.MX 8Quad and i.MX 8M devices, use two copies of this CST respectively for two device families, since this process will generate files with the same names in the same directory, while these files should be prevented from being overwritten.

4. Build Android images to construct the containers to be signed.

To use AHAB to verify images in SPL, enable "CONFIG_AHAB_BOOT" configurations in the corresponding defconfig files in U-Boot code. They are not enabled by default. For i.MX 8QuadMax MEK and i.MX 8QuadXPlus MEK, the defconfig files are listed as follows. Some are used in standard Android platform, and some are used in Android Automotive platform.

```
imx8qm_mek_androidauto_trusty_defconfig
imx8qm_mek_androidauto_trusty_secure_unlock_defconfig
imx8qxp_mek_androidauto_trusty_defconfig
imx8qxp_mek_androidauto_trusty_secure_unlock_defconfig

imx8qm_mek_androidauto2_trusty_defconfig
```

```

imx8qm_mek_androidauto2_trusty_md_defconfig
imx8qxp_mek_androidauto2_trusty_defconfig

imx8qm_mek_android_defconfig
imx8qxp_mek_android_defconfig
imx8qm_mek_android_trusty_defconfig
imx8qm_mek_android_trusty_secure_unlock_defconfig
imx8qxp_mek_android_trusty_defconfig
imx8qxp_mek_android_trusty_secure_unlock_defconfig
    
```

"mkimage_imx8" is used to construct containers. It outputs the layout information of a container on standard output when constructing it. When building the Android images, save the log information of the build system. For example, execute the following command:

```

$ ./imx-make.sh -j12 2>&1 | tee make_android.txt
    
```

During the build process, the build system output information is also saved in `make_android.txt`.

After Android Auto images for i.MX 8QuadMax MEK and i.MX 8QuadXPlus MEK are built, all the files to be signed for both standard Android and Android Automotive are listed in the following table. The three examples mentioned above can be categorized into two when signing the images: the image file directly generated by `mkimage_imx8` and the image file not directly generated by `mkimage_imx8`. Because `mkimage_imx8` will output the container layout information into a file generated by itself, if the image file is directly generated by `mkimage_imx8`, the layout information parameter can be directly used. If the final image is assembled with intermediate files generated by `mkimage_imx8`, the layout information parameters need to be properly processed before being used.

Table 2. Image files for i.MX 8QuadMax and i.MX 8QuadXPlus

Image file	Remark
spl-imx8qm.bin	Two containers, one is signed by NXP, and one is not signed, directly generated by <code>mkimage_imx8</code> .
bootloader-imx8qm.img	One container, not signed, directly generated by <code>mkimage_imx8</code> .
spl-imx8qm-secure-unlock.bin	Two containers, one is signed by NXP, and one is not signed, directly generated by <code>mkimage_imx8</code> .
bootloader-imx8qm-secure-unlock.img	One container, not signed, directly generated by <code>mkimage_imx8</code> .
spl-imx8qxp.bin	Two containers, one is signed by NXP, and one is not signed, directly generated by <code>mkimage_imx8</code> .
bootloader-imx8qxp.img	One container, not signed, directly generated by <code>mkimage_imx8</code> .
spl-imx8qxp-secure-unlock.bin	Two containers, one is signed by NXP, and one is not signed, directly generated by <code>mkimage_imx8</code> .
bootloader-imx8qxp-secure-unlock.img	One container, not signed, directly generated by <code>mkimage_imx8</code> .
u-boot-imx8qm-mek-uuu.imx	Two containers, one is signed by NXP, and one is not signed, directly generated by <code>mkimage_imx8</code> .
u-boot-imx8qxp-mek-uuu.imx	Two containers, one is signed by NXP, and one is not signed, directly generated by <code>mkimage_imx8</code> .
u-boot-imx8qm.imx	Three containers, one is signed by NXP, and the other two are not signed, assembled with two files generated by <code>mkimage_imx8</code> .
u-boot-imx8qxp.imx	Three containers, one is signed by NXP, and the other two are not signed, assembled with two files generated by <code>mkimage_imx8</code> .

Table continues on the next page...

Table 2. Image files for i.MX 8QuadMax and i.MX 8QuadXPlus (continued)

u-boot-imx8qm-trusty.imx	Three containers, one is signed by NXP, and the other two are not signed, assembled with two files generated by mkimage_imx8.
u-boot-imx8qxp-trusty.imx	Three containers, one is signed by NXP, the other two are not signed, assembled with two files generated by mkimage_imx8.

If SPL is enabled, single bootloader image like "u-boot-imx8qm-trusty.imx" is assembled with two files generated by mkimage_imx8. In fact, dual bootloader condition keeps these two files separated as you can see in the preceding table, while single bootloader condition appends one file after another at 1 KB aligned boundary.

5. Get the layout information of containers in a file.

Layout information is needed when signing the container. To be more specific, it is the offset information of the container and the container signature block in a file. Code signing tool uses these offsets to locate the container in a file. The layout information can be found in make_android.txt just generated. With the following principles, the offset of the container to be signed in a file can be easily found.

The generated files with containers to be signed mentioned before are built based on different U-Boot defconfig files. Different U-Boot compilation targets with different U-Boot defconfig files can be found in \${MY_ANDROID}/device/fsl/imx8q/mek_8q/BoardConfig.mk. Android Auto related part is listed below, with some annotations.

```
# bootloader-imx8qm.img and spl-imx8qm.bin
TARGET_BOOTLOADER_CONFIG := imx8qm:imx8qm_mek_androidauto_trusty_defconfig
# bootloader-imx8qm-secure-unlock.img and spl-imx8qm-secure-unlock.bin
TARGET_BOOTLOADER_CONFIG += imx8qm-secure-
unlock:imx8qm_mek_androidauto_trusty_secure_unlock_defconfig
# bootloader-imx8qxp.img and spl-imx8qxp.bin
TARGET_BOOTLOADER_CONFIG += imx8qxp:imx8qxp_mek_androidauto_trusty_defconfig
# bootloader-imx8qxp-c0.img and spl-imx8qxp-c0.bin
TARGET_BOOTLOADER_CONFIG += imx8qxp-c0:imx8qxp_mek_androidauto_trusty_defconfig
# bootloader-imx8qxp-secure-unlock.img and spl-imx8qxp-secure-unlock.bin
TARGET_BOOTLOADER_CONFIG += imx8qxp-secure-
unlock:imx8qxp_mek_androidauto_trusty_secure_unlock_defconfig
# bootloader-imx8qm.img and spl-imx8qm.bin
TARGET_BOOTLOADER_CONFIG := imx8qm:imx8qm_mek_androidauto2_trusty_defconfig
# bootloader-imx8qm-md.img and spl-imx8qm-md.bin
TARGET_BOOTLOADER_CONFIG += imx8qm-md:imx8qm_mek_androidauto2_trusty_md_defconfig
# bootloader-imx8qxp.img and spl-imx8qxp.bin
TARGET_BOOTLOADER_CONFIG += imx8qxp:imx8qxp_mek_androidauto2_trusty_defconfig
# bootloader-imx8qxp-c0.img and spl-imx8qxp-c0.bin
TARGET_BOOTLOADER_CONFIG += imx8qxp-c0:imx8qxp_mek_androidauto2_trusty_defconfig
# u-boot-imx8qm.imx
TARGET_BOOTLOADER_CONFIG := imx8qm:imx8qm_mek_android_defconfig
# u-boot-imx8qxp.imx
TARGET_BOOTLOADER_CONFIG += imx8qxp:imx8qxp_mek_android_defconfig
# u-boot-imx8qxp-c0.imx
TARGET_BOOTLOADER_CONFIG += imx8qxp-c0:imx8qxp_mek_android_defconfig
# u-boot-imx8qm-trusty.imx
TARGET_BOOTLOADER_CONFIG += imx8qm-trusty:imx8qm_mek_android_trusty_defconfig
# u-boot-imx8qm-trusty-secure-unlock.imx
TARGET_BOOTLOADER_CONFIG += imx8qm-trusty-secure-
unlock:imx8qm_mek_android_trusty_secure_unlock_defconfig
# u-boot-imx8qxp-trusty.imx
TARGET_BOOTLOADER_CONFIG += imx8qxp-trusty:imx8qxp_mek_android_trusty_defconfig
# u-boot-imx8qxp-trusty-c0.imx
TARGET_BOOTLOADER_CONFIG += imx8qxp-trusty-c0:imx8qxp_mek_android_trusty_defconfig
# u-boot-imx8qxp-trusty-secure-unlock.imx
TARGET_BOOTLOADER_CONFIG += imx8qxp-trusty-secure-
```



```
unlock:imx8qxp_mek_android_trusty_secure_unlock_defconfig
# u-boot-imx8qm-mek-uuu.imx
TARGET_BOOTLOADER_CONFIG += imx8qm-mek-uuu:imx8qm_mek_android_uuu_defconfig
# u-boot-imx8qxp-mek-uuu.imx
TARGET_BOOTLOADER_CONFIG += imx8qxp-mek-uuu:imx8qxp_mek_android_uuu_defconfig
# u-boot-imx8qxp-mek-c0-uuu.imx
TARGET_BOOTLOADER_CONFIG += imx8qxp-mek-c0-uuu:imx8qxp_mek_android_uuu_defconfig
```

The defconfig file name can be used to locate the layout information of containers. Search the defconfig file name in `make_android.txt` just generated. A line prompts that the build process for that defconfig file has been finished. Container and container signature block offset can be found in several lines before this line.

Search the log file for container layout information. For the condition that images to be signed are directly generated by `mkimage_imx8`, the container layout information of "u-boot-imx8qm-mek-uuu.imx" with the defconfig file of "imx8qm_mek_android_uuu_defconfig" like below can be found in the log file. Unrelated lines are omitted and represented with ellipsis.

```
CST: CONTAINER 0 offset: 0x400
CST: CONTAINER 0: Signature Block: offset is at 0x590
...
===== Finish building imx8qm-mek-uuu:imx8qm_mek_android_uuu_defconfig
=====
```

The container layout information of "bootloader-imx8qm.img" and "spl-imx8qm.bin" with the defconfig file of "imx8qm_mek_androidauto_trusty_defconfig" like below can be found in the log file. The layout information of the first two lines is for "bootloader-imx8qm.im", and the information in the following two lines are for "spl-imx8qm.bin".

```
CST: CONTAINER 0 offset: 0x0
CST: CONTAINER 0: Signature Block: offset is at 0x190
...
CST: CONTAINER 0 offset: 0x400
CST: CONTAINER 0: Signature Block: offset is at 0x610
...
===== Finish building imx8qm:imx8qm_mek_androidauto_trusty_defconfig
=====
```

For the condition that images to be signed are not directly generated by `mkimage_imx8`, taking "u-boot-imx8qm-trusty.imx" with the defconfig file of "imx8qm_mek_android_trusty_defconfig" as an example, the following information should be retrieved in the log file. The first two lines are for the intermediate file "u-boot-atf-container.img". This file is the third container that has Arm Trusted Firmware and U-Boot proper in it. The layout information in the following two lines are for another intermediate file that has the second container in it. This intermediate file will be padded to 1 KB aligned boundary. Then "u-boot-atf-container.img" is appended to this file. Therefore, the second two lines can be directly used, while the first two lines should be added with an offset, which is 388 KB, 0x61000 in hexadecimal. Then the offset of the third container in the final "u-boot-imx8qm-trusty.imx" is 0x61000. Its signature offset in the file is 0x61000+0x190=0x61190.

```
CST: CONTAINER 0 offset: 0x0
CST: CONTAINER 0: Signature Block: offset is at 0x190
...
CST: CONTAINER 0 offset: 0x400
CST: CONTAINER 0: Signature Block: offset is at 0x610
...
append u-boot-atf-container.img at 388 KB
...
===== Finish building imx8qm-trusty:imx8qm_mek_android_trusty_defconfig
=====
```

The same method can be used on other targets. The targets for UUU generates one file with one set of offset values. All offset values can be found and a summary is in the following table.

Table 3. Container offset information

Files having container to be signed	Container offset in the file	Container signature block offset
bootloader-imx8qm.img	0x0	0x190
spl-imx8qm.bin	0x400	0x610
u-boot-imx8qm-mek-uuu.imx	0x400	0x590
u-boot-imx8qm-trusty.imx	0x4000x61000	0x6100x61190

6. Sign the image files.

Copy the files to be signed to the directory of `release/linux64/bin/` in Code Signing Tool (CST) directory. The binary file named `cst` is used to sign these files. This `cst` needs the CSF description file to be provided as an input file when it is executed. CSF examples are in the directory of `${MY_ANDROID}/vendor/nxp-opensource/uboot-imx/doc/imx/ahab/csf_examples/`. We copy one `cst_uboot_atf.txt` to CST `release/linux64/bin/`.

Make some changes to the `cst_uboot_atf.txt` just copied based on the image to sign. For the condition that images to be signed are directly generated by `mkimage_imx8`, taking "u-boot-imx8qm-mek-uuu.imx" as an example, the modification is as follows:

```
@@ -4,9 +4,9 @@ Version = 1.0

[Install SRK]
# SRK table generated by srktool
-File = "../crts/SRK_1_2_3_4_table.bin"
+File = "../../crts/SRK_1_2_3_4_table.bin"
# Public key certificate in PEM format on this example only using SRK key
-Source = "../crts/SRK1_sha384_secp384r1_v3_usr_cert.pem"
+Source = "../../crts/SRK1_sha384_secp384r1_v3_usr_cert.pem"
# Index of the public key certificate within the SRK table (0 .. 3)
Source index = 0
# Type of SRK set (NXP or OEM)
@@ -16,6 +16,6 @@ Revocations = 0x0

[Authenticate Data]
# Binary to be signed generated by mkimage
-File = "u-boot-atf-container.img"
+File = "u-boot-imx8qm-mek-uuu.imx"
# Offsets = Container header Signature block (printed out by mkimage)
-Offsets = 0x0 0x110
+Offsets = 0x400 0x590
```

Then execute the command below:

```
$ ./cst -i cst_uboot_atf.txt -o signed-u-boot-imx8qm-mek-uuu.imx
```

With preceding command successfully executed, `signed-u-boot-imx8qm-mek-uuu.imx` is generated. Copy it back to the output directory, and change its name as before, since `uuu_imx_android_flash` script flashes images based on their names.

Based on the description of signing "u-boot-imx8qm-mek-uuu.imx", sign all the other images directly generated by `mkimage_imx8` like "bootloader-imx8qm.img", "spl-imx8qm.bin", etc. Signing process of images not directly generated by `mkimage_imx8` is a bit different. It should be signed twice. Taking "u-boot-imx8qm-trusty.imx" as an example, first make the following change to the original "cst_uboot_atf.txt":

```
@@ -4,9 +4,9 @@ Version = 1.0

[Install SRK]
```

```
# SRK table generated by srktool
-File = "../crts/SRK_1_2_3_4_table.bin"
+File = "../../crts/SRK_1_2_3_4_table.bin"
# Public key certificate in PEM format on this example only using SRK key
-Source = "../crts/SRK1_sha384_secp384r1_v3_usr.crt.pem"
+Source = "../../crts/SRK1_sha384_secp384r1_v3_usr.crt.pem"
# Index of the public key certificate within the SRK table (0 .. 3)
Source index = 0
# Type of SRK set (NXP or OEM)
@@ -16,6 +16,6 @@ Revocations = 0x0

[Authenticate Data]
# Binary to be signed generated by mkimage
-File = "u-boot-atf-container.img"
+File = "u-boot-imx8qm-trusty.img"
# Offsets = Container header Signature block (printed out by mkimage)
-Offsets = 0x0 0x110
+Offsets = 0x400 0x610
```

Then execute the command below:

```
$ ./cst -i cst_uboot_atf.txt -o first_signed_u-boot-imx8qm-trusty.img
Apply the following change on the "cst_uboot_atf.txt" as below to do the second sign
@@ -16,6 +16,6 @@ Revocations = 0x0

[Authenticate Data]
# Binary to be signed generated by mkimage
-File = "u-boot-imx8qm-trusty.img"
+File = "first_signed_u-boot-imx8qm-trusty.img"
# Offsets = Container header Signature block (printed out by mkimage)
-Offsets = 0x400 0x610
+Offsets = 0x61000 0x61190
```

And execute the command below:

```
$ ./cst -i cst_uboot_atf.txt -o second_signed_u-boot-imx8qm-trusty.img
```

With preceding command successfully executed, "second_signed_u-boot-imx8qm-trusty.img" is generated, copy it back to the output directory, and change its name as before. All the images not directly generated by mkimage_imx8 can be signed with preceding method. SPL enabled single bootloader images can be signed with this method.

Images are signed now. When booting with signed images, SRK table embedded in image file is used to verify the signature. Embedded SRK table is verified based on its hash value. The hash value is programmed in OTP efuse in i.MX chips, so it is not tempered by others. Perform the following steps to fuse the SRK hash value.

7. Dump the SRK hash value.

Change the directory to `release/crts/` in Code Signing Tool (CST). Execute the following command to dump the SRK hash value:

```
$ od -t x4 SRK_1_2_3_4_fuse.bin
0000000 d436cc46 8eccda9 b89e1601 5fada3db
0000020 d454114a b6cd51f4 77384870 c50ee4b2
0000040 a27e5132 eba887cf 592c1e2b bb501799
0000060 ee702e07 cf8ce73e fb55e2d5 eba6bbd2
```

8. Use the U-Boot fuse command to fuse the hash value to a chip.

Because the fuse command is removed from U-Boot for Android Auto images to shorten the boot time, we use UUU to load the U-Boot used by UUU to RAM, and then use the fuse command.

Change the board to serial download mode, and execute the following command to download U-Boot to RAM. It then enters fastboot mode.

For i.MX 8QuadMax, it is as follows:

```
$ sudo ./uuu_imx_android_flash.sh -f imx8qm -i
```

For i.MX 8QuadXPlus, it is as follows:

```
$ sudo ./uuu_imx_android_flash.sh -f imx8qxp -i
```

With the commands above executed, U-Boot used by UUU under the current working directory is loaded to RAM on board and it enters fastboot mode.

On the U-Boot console, it shows that U-Boot is in fastboot mode. Press "CTRL+C" to exit fastboot mode and enter U-Boot command mode.

For i.MX 8QuadMax, execute the following commands on the U-Boot console:

```
=> fuse prog 0 722 0xd436cc46
=> fuse prog 0 723 0x8eccdda9
=> fuse prog 0 724 0xb89e1601
=> fuse prog 0 725 0x5fada3db
=> fuse prog 0 726 0xd454114a
=> fuse prog 0 727 0xb6cd51f4
=> fuse prog 0 728 0x77384870
=> fuse prog 0 729 0xc50ee4b2
=> fuse prog 0 730 0xa27e5132
=> fuse prog 0 731 0xeba887cf
=> fuse prog 0 732 0x592c1e2b
=> fuse prog 0 733 0xbb501799
=> fuse prog 0 734 0xee702e07
=> fuse prog 0 735 0xcf8ce73e
=> fuse prog 0 736 0xfb55e2d5
=> fuse prog 0 737 0xeba6bbd2
```

For i.MX 8QuadXPlus, execute the following commands on the U-Boot console:

```
=> fuse prog 0 730 0xd436cc46
=> fuse prog 0 731 0x8eccdda9
=> fuse prog 0 732 0xb89e1601
=> fuse prog 0 733 0x5fada3db
=> fuse prog 0 734 0xd454114a
=> fuse prog 0 735 0xb6cd51f4
=> fuse prog 0 736 0x77384870
=> fuse prog 0 737 0xc50ee4b2
=> fuse prog 0 738 0xa27e5132
=> fuse prog 0 739 0xeba887cf
=> fuse prog 0 740 0x592c1e2b
=> fuse prog 0 741 0xbb501799
=> fuse prog 0 742 0xee702e07
=> fuse prog 0 743 0xcf8ce73e
=> fuse prog 0 744 0xfb55e2d5
=> fuse prog 0 745 0xeba6bbd2
```

Now, images are signed and SRK hash value is fused. The images can be flashed to boards. For how to flash i.MX Android images, see the *Android™ Release Notes (ARN)*.

The chip is now in open stage, and verification failure does not block the boot process. To make sure that SRK hash value is correctly fused and images are correctly signed, check the SECO event during boot. After "CONFIG_AHAB_BOOT" is

enabled in the defconfig file of U-Boot, use a U-Boot command to check the SECO events. After images are signed and SRK hash value is programmed, boot the board to U-Boot command mode. On the U-Boot console, execute the following command:

```
=> ahab_status
```

If preceding command outputs the SECO event, use the following code to check whether it is related to AHAB verification.

```
0x0087EE00 = The container image is not signed.
0x0087FA00 = The container image was signed with wrong key that is not matching the OTP SRK hashes.
```

For example, if the SRK hash value is programmed, but images are not signed, after `ahab_status` is executed, the following prompt is displayed on the console:

```
=> ahab_status

Lifecycle: 0x0020, NXP closed

SECO Event[0] = 0x0087EE00
  CMD = AHAB_AUTH_CONTAINER_REQ (0x87)
  IND = AHAB_NO_AUTHENTICATION_IND (0xEE)

SECO Event[1] = 0x0087EE00
  CMD = AHAB_AUTH_CONTAINER_REQ (0x87)
  IND = AHAB_NO_AUTHENTICATION_IND (0xEE)
```

After it is confirmed that the SRK hash value is correctly fused, and signed images do not cause AHAB related SECO events, execute the following command on the U-Boot console to close the chip:

```
=> ahab_close
```

Note that this close operation is irreversible to the chips and the closed chips does not boot up if AHAB verification fails.

3.1.2 Verifying images with HABv4

HABv4 verifies images based on Image Vector Table (IVT) and Flattened Image Tree (FIT). Detailed information of the boot image format can be found in the Reference Manual of specific chips. According to the Reference manual, the sign process described below embeds the Command Sequence File (CSF) generated by code signing tool in the final image. The CSF is used to verify the images during the boot time.

To sign the images for i.MX 8M devices, perform the following steps:

1. Download Code Signing Tool (CST) from [NXP official website](#).

Decompress the package with the following command:

```
$ tar zxvf cst-3.1.0.tgz
```

2. Generate the HABv4 PKI tree.

After the tool package is decompressed, enter the directory of `release/keys/`, and execute the following command:

```
./hab4_pki_tree.sh
```

Then enter some parameters based on the output of this script. An example is as follows:

```
Do you want to use an existing CA key (y/n)? : n
Do you want to use Elliptic Curve Cryptography (y/n)? : n
Enter key length in bits for PKI tree: 2048
Enter PKI tree duration (years): 5
```

```
How many Super Root Keys should be generated? 4
Do you want the SRK certificates to have the CA flag set? (y/n)?: y
```

3. Generate AHAB SRK tables and eFuse hash.

Enter the directory of release/crts/, and execute the following command:

```
$ ../linux64/bin/srktool -h 4 -t SRK_1_2_3_4_table.bin -e \
SRK_1_2_3_4_fuse.bin -d sha256 -c \
SRK1_sha256_2048_65537_v3_ca.crt.pem, \
SRK2_sha256_2048_65537_v3_ca.crt.pem, \
SRK3_sha256_2048_65537_v3_ca.crt.pem, \
SRK4_sha256_2048_65537_v3_ca.crt.pem
```

After the preceding commands are executed successfully. The SRK table and its SHA256 value is generated and saved respectively in two files under release/crts/.

The SRK table is embedded in the CSF. Therefore, during the boot time, it can be used to verify the signature. The SRK table SHA256 value is fused to the OTP eFuse hardware and works as the "secure root key". It is used to verify the SRK table in CSF.

Files generated in "release/keys/" and "/release/crts/" are very important. If the SRK HASH value is fused to the chip and then changes the chip from open to close state, the board can only boot with images signed with these files.

If you are a user of both i.MX 8Quad and i.MX 8M devices, use two copies of this CST respectively for two device families, since this process generates files with the same names in the same directory, while these files should be prevented from being overwritten.

4. Build Android images to generate the file to be signed.

To support HAB features, enable "CONFIG_SECURE_BOOT" configurations in the corresponding defconfig files in U-Boot code. They are not enabled by default. Taking i.MX 8M Mini EVK and i.MX 8M Nano EVK as an example, the files are:

```
imx8mm_evk_android_defconfig
imx8mm_evk_android_dual_defconfig
imx8mm_evk_android_trusty_defconfig
imx8mm_evk_android_trusty_secure_unlock_defconfig
imx8mm_evk_android_trusty_dual_defconfig
imx8mm_evk_android_uuu_defconfig
```

Layout information of the final U-Boot image is needed during the signing process. When building the Android images, save the log information of build system. For example, execute the following command:

```
$ ./imx-make.sh -j12 2>&1 | tee make_android.txt
```

During the build process, the build system output information is also saved in make_android.txt.

5. Get the layout information of the file to be signed.

Final U-Boot image files are generated with different U-Boot defconfig files. Taking i.MX 8M Mini as an example, different U-Boot compilation targets with different U-Boot defconfig files can be found in \${MY_ANDROID}/device/fsl/imx8m/evk_8mm/BoardConfig.mk. They are listed below with some annotations.

```
TARGET_BOOTLOADER_CONFIG := imx8mm:imx8mm_evk_android_defconfig
TARGET_BOOTLOADER_CONFIG += imx8mm-dual:imx8mm_evk_android_dual_defconfig
TARGET_BOOTLOADER_CONFIG += imx8mm-trusty:imx8mm_evk_android_trusty_defconfig
TARGET_BOOTLOADER_CONFIG += imx8mm-trusty-secure-
unlock:imx8mm_evk_android_trusty_secure_unlock_defconfig
TARGET_BOOTLOADER_CONFIG += imx8mm-trusty-dual:imx8mm_evk_android_trusty_dual_defconfig
TARGET_BOOTLOADER_CONFIG += imx8mm-evk-uuu:imx8mm_evk_android_uuu_defconfig
```

Search the defconfig file name in the log of make_android.txt just generated for a line prompt that the build process for that defconfig file is finished. The layout information needed in the signing process is several lines before that. The layout information needs to be categorized based on whether dual-bootloader is enabled. The defconfig files with "dual" substring in their names have dual-bootloader enabled. On the contrary, the ones without "dual" substring in their names do not enable dual-bootloader.

For the single bootloader condition, take "imx8mm_evk_android_uuu_defconfig" as an example. Its corresponding output file is "u-boot-imx8mm-evk-uuu.imx". The lines directly related to the layout info of this output file are listed below, and unrelated lines are omitted and represented with ellipsis.

```
Loader IMAGE:
...
csf_off                0x2d600
spl hab block:        0x7e0fc0 0x0 0x2d600
...
Second Loader IMAGE:
...
sld_csf_off            0x58c20
sld hab block:        0x401fcdc0 0x57c00 0x1020
...
0x40200000 0x5AC00 0xAE710
0x402AE710 0x109310 0x8630
0x920000 0x111940 0x91D0
...
===== Finish building imx8mm-evk-uuu:imx8mm_evk_android_uuu_defconfig
=====
```

For the dual-bootloader condition, take "imx8mm_evk_android_trusty_dual_defconfig" as an example. Its corresponding output files are "spl-imx8mm-trusty-dual.bin" and "bootloader-imx8mm-trusty-dual.img". The lines directly related to the layout info of this output file are listed below, and unrelated lines are omitted and represented with ellipsis.

```
Loader IMAGE:
...
csf_off                0x2d600
spl hab block:        0x7e0fc0 0x0 0x2d600
...
Second Loader IMAGE:
...
sld_csf_off            0x58c20
sld hab block:        0x401fcdc0 0x57c00 0x1020
...
0x40200000 0x5AC00 0xAE710
0x402AE710 0x109310 0x8630
0x920000 0x111940 0x91D0
...
===== Finish building imx8mm-evk-uuu:imx8mm_evk_android_uuu_defconfig
=====
```

The same method of retrieving the layout information can be used on other targets.

6. Sign the image files.

Copy the files to be signed to the directory of release/linux64/bin/ in Code Signing Tool (CST) directory. The binary file named CST is used to sign these files. This CST needs CSF description file to be as an input file when it is executed. CSF examples are in the directory of \${MY_ANDROID}/vendor/nxp-opensource/uboot-imx/doc/imx/habv4/csf_examples/imx8m_mmx8mm/. Copy "csf_fit.txt" and "csf_spl.txt" to Code Signing Tool (CST) release/linux64/bin/. The file to be signed also needs to be copied to this directory. The signing process is different between single bootloader condition and dual-bootloader condition. The examples of the two conditions are described together in this section, but in practice, different U-Boot target files should be signed with the following steps one by one.

For the single bootloader example with "imx8mm-evk-android-uuu-defconfig" defconfig file, make the following modifications on the "csf_fit.txt" and "csf_spl.txt" just copied.

```
diff --git a/csf_fit.txt b/csf_fit.txt
index d9218ab..dfd0ded 100644
--- a/csf_fit.txt
+++ b/csf_fit.txt
@@ -8,12 +8,12 @@

[Install SRK]
# Index of the key location in the SRK table to be installed
- File = "../crts/SRK_1_2_3_4_table.bin"
+ File = "../../crts/SRK_1_2_3_4_table.bin"
Source index = 0

[Install CSFK]
# Key used to authenticate the CSF data
- File = "../crts/CSF1_1_sha256_2048_65537_v3_usr.crt.pem"
+ File = "../../crts/CSF1_1_sha256_2048_65537_v3_usr.crt.pem"

[Authenticate CSF]

@@ -23,14 +23,14 @@
# Target key slot in HAB key store where key will be installed
Target index = 2
# Key to install
- File = "../crts/IMG1_1_sha256_2048_65537_v3_usr.crt.pem"
+ File = "../../crts/IMG1_1_sha256_2048_65537_v3_usr.crt.pem"

[Authenticate Data]
# Key slot index used to authenticate the image data
Verification index = 2
# Authenticate Start Address, Offset, Length and file
- Blocks = 0x401fcdc0 0x057c00 0x01020 "flash.bin", \
- 0x40200000 0x05AC00 0x9AAC8 "flash.bin", \
- 0x00910000 0x0F56C8 0x09139 "flash.bin", \
- 0xFE000000 0xFE804 0x4D268 "flash.bin", \
- 0x4029AAC8 0x14BA6C 0x06DCF "flash.bin"
+ Blocks = 0x401fcdc0 0x57c00 0x1020 "u-boot-imx8mm-evk-uuu.imx", \
+ 0x40200000 0x5AC00 0xAE710 "u-boot-imx8mm-evk-uuu.imx", \
+ 0x402AE710 0x109310 0x8630 "u-boot-imx8mm-evk-uuu.imx", \
+ 0x920000 0x111940 0x91D0 "u-boot-imx8mm-evk-uuu.imx"
diff --git a/csf_spl.txt b/csf_spl.txt
index 39adf7a..80165a8 100644
--- a/csf_spl.txt
+++ b/csf_spl.txt
@@ -8,12 +8,12 @@

[Install SRK]
# Index of the key location in the SRK table to be installed
- File = "../crts/SRK_1_2_3_4_table.bin"
+ File = "../../crts/SRK_1_2_3_4_table.bin"
Source index = 0

[Install CSFK]
# Key used to authenticate the CSF data
- File = "../crts/CSF1_1_sha256_2048_65537_v3_usr.crt.pem"
+ File = "../../crts/CSF1_1_sha256_2048_65537_v3_usr.crt.pem"

[Authenticate CSF]
```



```

[Unlock]
# Leave Job Ring and DECO master ID registers Unlocked
Engine = CAAM
-     Features = MID
+     Features = MID, MFG

[Install Key]
# Key slot index used to authenticate the key to be installed
@@ -28,10 +28,10 @@
# Target key slot in HAB key store where key will be installed
Target index = 2
# Key to install
-   File = "../crts/IMG1_1_sha256_2048_65537_v3_usr.crt.pem"
+   File = "../../crts/IMG1_1_sha256_2048_65537_v3_usr.crt.pem"

[Authenticate Data]
# Key slot index used to authenticate the image data
Verification index = 2
# Authenticate Start Address, Offset, Length and file
-   Blocks = 0x7e0fc0 0x1a000 0x2a600 "flash.bin"
+   Blocks = 0x7e0fc0 0x0 0x2d600 "u-boot-imx8mm-evk-uuu.imx"

```

For the dual-bootloader example with "imx8mm_evk_android_trusty_dual_defconfig" defconfig file, make the following modifications on the "csf_fit.txt" and "csf_spl.txt" just copied.

```

diff --git a/csf_fit.txt b/csf_fit.txt
index d9218ab..dfd0ded 100644
--- a/csf_fit.txt
+++ b/csf_fit.txt
@@ -8,12 +8,12 @@

[Install SRK]
# Index of the key location in the SRK table to be installed
-   File = "../crts/SRK_1_2_3_4_table.bin"
+   File = "../../crts/SRK_1_2_3_4_table.bin"
Source index = 0

[Install CSFK]
# Key used to authenticate the CSF data
-   File = "../crts/CSF1_1_sha256_2048_65537_v3_usr.crt.pem"
+   File = "../../crts/CSF1_1_sha256_2048_65537_v3_usr.crt.pem"

[Authenticate CSF]

@@ -23,14 +23,14 @@
# Target key slot in HAB key store where key will be installed
Target index = 2
# Key to install
-   File = "../crts/IMG1_1_sha256_2048_65537_v3_usr.crt.pem"
+   File = "../../crts/IMG1_1_sha256_2048_65537_v3_usr.crt.pem"

[Authenticate Data]
# Key slot index used to authenticate the image data
Verification index = 2
# Authenticate Start Address, Offset, Length and file
-   Blocks = 0x401fcdc0 0x057c00 0x01020 "flash.bin", \
-           0x40200000 0x05AC00 0x9AAC8 "flash.bin", \
-           0x00910000 0x0F56C8 0x09139 "flash.bin", \
-           0xFE000000 0xFE804 0x4D268 "flash.bin", \

```

```

-          0x4029AAC8 0x14BA6C 0x06DCF "flash.bin"
+   Blocks = 0x401fcdc0 0x0 0x1020 "bootloader-imx8mm-trusty-dual.img", \
+          0x40200000 0x3000 0xAF2D0 "bootloader-imx8mm-trusty-dual.img", \
+          0x402AF2D0 0xB22D0 0x8630 "bootloader-imx8mm-trusty-dual.img", \
+          0x920000 0xBA900 0xA1D0 "bootloader-imx8mm-trusty-dual.img", \
+          0xBE000000 0xC4AD0 0x164C50 "bootloader-imx8mm-trusty-dual.img"
diff --git a/csf_spl.txt b/csf_spl.txt
index 39adf7a..80165a8 100644
--- a/csf_spl.txt
+++ b/csf_spl.txt
@@ -8,12 +8,12 @@

[Install SRK]
# Index of the key location in the SRK table to be installed
-   File = "../crts/SRK_1_2_3_4_table.bin"
+   File = "../../crts/SRK_1_2_3_4_table.bin"
Source index = 0

[Install CSFK]
# Key used to authenticate the CSF data
-   File = "../crts/CSF1_1_sha256_2048_65537_v3_usr.crt.pem"
+   File = "../../crts/CSF1_1_sha256_2048_65537_v3_usr.crt.pem"

[Authenticate CSF]

[Unlock]
# Leave Job Ring and DECO master ID registers Unlocked
Engine = CAAM
-   Features = MID
+   Features = MID, MFG

[Install Key]
# Key slot index used to authenticate the key to be installed
@@ -28,10 +28,10 @@
# Target key slot in HAB key store where key will be installed
Target index = 2
# Key to install
-   File = "../crts/IMG1_1_sha256_2048_65537_v3_usr.crt.pem"
+   File = "../../crts/IMG1_1_sha256_2048_65537_v3_usr.crt.pem"

[Authenticate Data]
# Key slot index used to authenticate the image data
Verification index = 2
# Authenticate Start Address, Offset, Length and file
-   Blocks = 0x7e0fc0 0x1a000 0x2a600 "flash.bin"
+   Blocks = 0x7e0fc0 0x0 0x34200 "spl-imx8mm-trusty-dual.bin"

```

Execute the following commands to generate CSF with the CSF description file. They are the same for single bootloader condition and dual-bootloader condition.

```

$ ./cst --i=csf_spl.txt --o=csf_spl.bin
$ ./cst --i=csf_fit.txt --o=csf_fit.bin

```

Execute the following commands to embed the CSF into the U-Boot image.

```

# For the single bootloader example with "imx8mm-evk-android-uuu-defconfig" defconfig file
$ dd if=csf_spl.bin of=u-boot-imx8mm-evk-uuu.imx seek=$((0x2d600)) bs=1 conv=notrunc
$ dd if=csf_fit.bin of=u-boot-imx8mm-evk-uuu.imx seek=$((0x58c20)) bs=1 conv=notrunc

```

```
# For the dual bootloader example with "imx8mm-evk-android-trusty-dual-defconfig" defconfig file
$ dd if=csf_spl.bin of=spl-imx8mm-trusty-dual.bin seek=$((0x34200)) bs=1 conv=notrunc
$ dd if=csf_fit.bin of=bootloader-imx8mm-trusty-dual.img seek=$((0x1020)) bs=1 conv=notrunc
```

With preceding commands successfully executed, "u-boot-imx8mm-evk-uuu.imx" or "spl-imx8mm-trusty-dual.bin" and "bootloader-imx8mm-trusty-dual.img" are well signed. Then sign other images according to the description of the signing process.

Image are signed now. When booting with signed images, the SRK table embedded in the image file is used to verify the signature. Embedded SRK table is verified based on its hash value. The hash value is programed in OTP eFuse in i.MX chips, so it is not affected by others. The way to fuse SRK hash value will be described.

7. Dump the SRK hash value.

Change directory to release/crts/ in Code Signing Tool (CST). Execute the following command to dump the SRK hash value:

```
hexdump -e '/4 "0x"' -e '/4 "%X"\n"' SRK_1_2_3_4_fuse.bin
0x20593752
0x6ACE6962
0x26E0D06C
0xFC600661
0x1240E88F
0x1209F144
0x831C8117
0x1190FD4D
```

8. Use the U-Boot fuse command to fuse the hash value to a chip.

Flash the image just signed to the board, and then boot to U-Boot command mode, and execute the following command to fuse the SRK hash value. This is the same for i.MX 8M Mini, i.MX 8M Nano, i.MX 8M Quad, and i.MX 8M Plus.

```
fuse prog -y 6 0 0x20593752 0x6ACE6962 0x26E0D06C 0xFC600661
fuse prog -y 7 0 0x1240E88F 0x1209F144 0x831C8117 0x1190FD4D
```

Now, images are signed, and the SRK hash value is fused. The chip is in open stage, and the verification failure does not block the boot process. One way to make sure that the SRK hash value is correctly fused and images are correctly signed is to check HAB events and U-Boot log. Reboot the board to U-Boot command board and execute the following command:

```
=> hab_status
```

Make sure there is no HAB EVENT reported. Before SPL invokes HAB to verify the FIT part, it first validates the CSF. Make sure there is no CSF related error as follows in the boot log.

```
Error: CSF header command not found
```

After it is confirmed that the SRK hash value is correctly fused, and signed images do not cause HAB event, execute the following command on the U-Boot console to close the chip.

```
=> fuse prog -y 1 3 0x2000000
```

This close operation is irreversible to the chips and closed chips do not boot up if HABv4 verification fails.

3.2 Configurations on TEE

3.2.1 Memory region configuration in ATF

The TEE binary is loaded to DRAM at the address of \$BBL32_BASE by SPL. By default, the load address \$BBL32_BASE is defined as 0xFE000000. It is specified during the process of generating the bootloader image with imx-mkimage. For example, you can

specify the load address as 0xFF000000 for i.MX 8QuadMax and i.MX 8QuadXPlus in `$(MY_ANDROID)/vendor/nxp-opensource/imx-mkimage` as follows:

```
diff --git a/imx8QM/soc.mak b/imx8QM/soc.mak
index 355851e..fe70191 100644
--- a/imx8QM/soc.mak
+++ b/imx8QM/soc.mak
@@ -82,7 +82,7 @@ u-boot-atf-container.img: bl31.bin u-boot-hash.bin
    fi
    if [ -f "tee.bin" ]; then \
        if [ $(shell echo $(ROLLBACK_INDEX_IN_CONTAINER)) ]; then \
            - ./$(MKIMG) -soc QM -sw_version $(ROLLBACK_INDEX_IN_CONTAINER) -rev B0 -c -ap bl31.bin a53
0x80000000 -ap u-boot-hash.bin a53 0x80020000 -ap tee.bin a53 0xFE000000 -out u-boot-atf-container.img; \
\
            + ./$(MKIMG) -soc QM -sw_version $(ROLLBACK_INDEX_IN_CONTAINER) -rev B0 -c -ap bl31.bin a53
0x80000000 -ap u-boot-hash.bin a53 0x80020000 -ap tee.bin a53 0xFF000000 -out u-boot-atf-container.img; \
\
        else \
            ./$(MKIMG) -soc QM -rev B0 -c -ap bl31.bin a53 0x80000000 -ap u-boot-hash.bin a53 0x80020000
-ap tee.bin a53 0xFE000000 -out u-boot-atf-container.img; \
    fi; \
diff --git a/imx8QX/soc.mak b/imx8QX/soc.mak
index 56422e0..d917dc3 100644
--- a/imx8QX/soc.mak
+++ b/imx8QX/soc.mak
@@ -73,7 +73,7 @@ u-boot-atf.itb: u-boot-hash.bin bl31.bin
u-boot-atf-container.img: bl31.bin u-boot-hash.bin
    if [ -f tee.bin ]; then \
        if [ $(shell echo $(ROLLBACK_INDEX_IN_CONTAINER)) ]; then \
            - ./$(MKIMG) -soc QX -sw_version $(ROLLBACK_INDEX_IN_CONTAINER) -rev B0 -c -ap bl31.bin a35
0x80000000 -ap u-boot-hash.bin a35 0x80020000 -ap tee.bin a35 0xFE000000 -out u-boot-atf-container.img; \
\
            + ./$(MKIMG) -soc QX -sw_version $(ROLLBACK_INDEX_IN_CONTAINER) -rev B0 -c -ap bl31.bin a35
0x80000000 -ap u-boot-hash.bin a35 0x80020000 -ap tee.bin a35 0xFF000000 -out u-boot-atf-container.img; \
\
        else \
            ./$(MKIMG) -soc QX -rev B0 -c -ap bl31.bin a35 0x80000000 -ap u-boot-hash.bin a35 0x80020000
-ap tee.bin a35 0xFE000000 -out u-boot-atf-container.img; \
    fi; \
```

After loading the TEE binary to DRAM, the ATF tries to kick it at the address of `$BL32_BASE` with the size of `$BL32_SIZE`, which are defined in `$(MY_ANDROID)/vendor/nxp-opensource/arm-trusted-firmware/plat/imx/$(PLAT)/include/platform_def.h`. By default, `$BL32_BASE` is defined as `0xFE000000` and `$BL32_SIZE` is `0x02000000`, but you can configure them as needed. For example, `$BL32_BASE` can be configured as `0xFF000000` and `$BL32_SIZE` can be configured as `0x03000000` for i.MX 8QuadMax and i.MX 8QuadXPlus as follows:

```
diff --git a/plat/imx/imx8qm/include/platform_def.h b/plat/imx/imx8qm/include/platform_def.h
index b305bfc..6f9f7d4 100644
--- a/plat/imx/imx8qm/include/platform_def.h
+++ b/plat/imx/imx8qm/include/platform_def.h
@@ -37,8 +37,8 @@
#define BL31_LIMIT 0x80020000

#ifdef TEE_IMX8
-#define BL32_BASE 0xfe000000
-#define BL32_SIZE 0x02000000
+#define BL32_BASE 0xff000000
+#define BL32_SIZE 0x03000000
#define BL32_SHM_SIZE 0x00400000
```

```
#define BL32_LIMIT 0x100000000
#endif
diff --git a/plat/imx/imx8qxp/include/platform_def.h b/plat/imx/imx8qxp/include/platform_def.h
index 24eacc2..cfc0717 100644
--- a/plat/imx/imx8qxp/include/platform_def.h
+++ b/plat/imx/imx8qxp/include/platform_def.h
@@ -33,8 +33,8 @@
#define BL31_LIMIT 0x80020000

#ifdef TEE_IMX8
-#define BL32_BASE 0xfe000000
-#define BL32_SIZE 0x02000000
+#define BL32_BASE 0xff000000
+#define BL32_SIZE 0x03000000
#define BL32_SHM_SIZE 0x00400000
#define BL32_LIMIT 0x100000000
#define PLAT_TEE_IMAGE_OFFSET 0x84000000
```

The following table lists the recommended \$BL32_BASE and \$BL32_SIZE for DRAM with different sizes on the i.MX 8Quad platform:

Table 4. Recommended \$BL32_BASE and \$BL32_SIZE for DRAM

DRAM Size (GB)	\$BL32_BASE	\$BL32_SIZE
6	0xFE000000	0x02000000
4	0xFE000000	0x02000000
3	0xFE000000	0x02000000
2	0xFE000000	0x02000000
1	0xBE000000	0x02000000

3.2.2 Basic file and folder construction for Trusty OS

i.MX Trusty OS provides a fully security solution for Android platform and Android Automotive platform. It also provides a set of development APIs for customer to develop their own TAs.

Trusty OS is based on LittleKernel. i.MX Trusty OS has the following basic file structure.

Table 5. Basic file structure of i.MX Trusty OS

Folder name	Folder description
trusty/device/nxp/imx8	This folder contains the script files. Most of the configurations for the build target are defined in this folder, including project configuration files. The Makefile configurations, board configurations, and modules need to be built.
trusty/hardware/nxp/app	NXP specific TA source code folder. Currently the hwcrypto TA located in this folder that provides security functions depends on the i.MX SoC hardware.
trusty/hardware/nxp/target	NXP reference board target folder. Only rules.mk for the build target in this folder, platform name, and UART information are defined in this file.
trusty/hardware/nxp/platform/imx	NXP SoC specific source codes for Trusty OS. All i.MX SoCs share these codes. It includes platform initialization codes, UART drivers, and registers map definitions.

Table continues on the next page...

Table 5. Basic file structure of i.MX Trusty OS (continued)

Folder name	Folder description
trusty/kernel/lib	Trusty OS core codes including secure monitor calls management, TIPC/QL-TIPC stack.
external/lk	LittleKernel codes, including all LittleKernel modules like arch codes, interrupt management, task management, and SMP support.
trusty/user/app	Trusty OS TAs are placed here, including AVB, Gatekeeper, and Keymaster user space source codes.

For TAs implementation, see Google Trusty OS reference webpage: <https://source.android.com/security/trusty/trusty-ref>.

3.2.3 Applying new build target in Trusty OS

By default, NXP already provides i.MX 8QuadMax/8QuadXPlus and i.MX 8M Mini/8M Quad series template in the i.MX Trusty OS. To add a new platform based on i.MX 8QuadMax/8QuadXPlus or i.MX 8M Mini/8M Quad/8M Plus, add or modify the following file or modules.

In `$(MY_TRUSTY)/trusty/device/nxp/imx8/project`, `imx8-inc.mk` contains all common configurations, such as CPU cores, modules that need to be built. The `imx8-inc.mk` can be overwritten by the build target mk files, such as `imx8qm.mk`.

For example, to add a new build target based on i.MX 8QuadMax SoC called `imx8qm-abc`, which has six CPUs and 1024 RPMB blocks, write a new `.mk` file called `imx8qm-abc.mk` in `$(MY_TRUSTY)trusty/device/nxp/imx8/project`. The content is as follows:

```
TARGET := imx8q

# imx8q/x use lpuart for UART IP
IMX_USE_LPUART := true

SMP_MAX_CPUS := 6
STORAGE_RPMB_BLOCK_COUNT := 1024
include project/imx8-inc.mk
```

In the root of Trusty OS codes, execute `$make list`. Then `imx8qm-abc` is displayed.

3.2.4 Adding unit tests in Trusty OS and adding CAAM self-tests in Trusty OS

Trusty OS supports two unit tests to test the functionality of Trusty IPC (TIPC) and CAAM. It is only for debug purpose and should not be released with the open unit tests. For i.MX 8QuadMax and i.MX 8QuadXPlus, to include these unit tests, make the following changes in `$(MY_TRUSTY)/trusty/device/nxp/imx8/project`:

```
diff --git a/project/imx8-inc.mk b/project/imx8-inc.mk
index 681a223..e7dcfdb 100644
--- a/project/imx8-inc.mk
+++ b/project/imx8-inc.mk
@@ -70,6 +70,7 @@ GLOBAL_DEFINES += APP_STORAGE_RPMB_BLOCK_COUNT=$(STORAGE_RPMB_BLOCK_COUNT)

GLOBAL_DEFINES += \
WITH_LIB_VERSION=1 \
+ WITH_CAAM_SELF_TEST=1 \

# ARM suggest to use system registers to access GICv3/v4 registers
GLOBAL_DEFINES += ARM_GIC_USE_SYSTEM_REG=1
@@ -98,6 +99,8 @@ TRUSTY_ALL_USER_TASKS := \
    trusty/user/app/keymaster \
    trusty/user/app/gatekeeper \
```

```

    trusty/user/app/storage \
+   trusty/user/app/sample/ipc-unittest/main \
+   trusty/user/app/sample/ipc-unittest/srv \

# This project requires trusty IPC
WITH_TRUSTY_IPC := true

```

Rebuild the Trusty OS and copy the output binary to `${MY_ANDROID}/vendor/nxp/fsl-proprietary/uboot-firmware/imx8q_car`. Make the following changes to build out the TIPC test binary:

```

diff --git a/imx8q/mek_8q/mek_8q_car.mk b/imx8q/mek_8q/mek_8q_car.mk
index 6acc89a..19e8e24 100644
--- a/imx8q/mek_8q/mek_8q_car.mk
+++ b/imx8q/mek_8q/mek_8q_car.mk
@@ -59,7 +59,8 @@ PRODUCT_PACKAGES += \
# Add Trusty OS backed gatekeeper and secure storage proxy
PRODUCT_PACKAGES += \
    gatekeeper.trusty \
-   storageproxyd
+   storageproxyd \
+   tipc-test

```

Rebuild the Android project, the TIPC test binary is located at `${MY_ANDROID}/out/target/product/mek_8q/data/nativetest64/vendor/tipc-test/tipc-test`. Flash the images to board, and remount and push the `tipc-test` binary to `vendor/bin` with ADB commands.

Trusty OS runs the CAAM unit test when initializing the CAAM. The following logs are displayed in U-Boot if the CAAM is initialized correctly:

```

hwcrypto: 222: Initializing
caam_drv: 728: caam hwrng test PASS!!!
caam_drv: 761: caam blob test PASS!!!
caam_drv: 843: caam gen kdf root key test PASS!!!
caam_drv: 793: caam AES enc test PASS!!!
caam_drv: 802: caam AES enc test PASS!!!
caam_drv: 830: caam hash test PASS!!!

```

If the TIPC unit test is started correctly, the following logs are displayed in U-Boot:

```

ipc-unittest-main: 2607: Welcome to IPC unittest!!!
unittest: 144: added port com.android.ipc-unittest.ctrl handle, 1001, to handleset 1000
unittest: 148: waiting forever
ipc-unittest-srv: 318: Init unittest services!!!

```

Run the following commands to test the TIPC. The correct result is as follows:

```

mek_8q:/vendor/bin # tipc-test -t connect
connect_test: repeat = 1
connect_test: done
mek_8q:/vendor/bin # tipc-test -t connect_foo
connect_foo: repeat = 1
connect_foo: done
mek_8q:/vendor/bin # tipc-test -t echo -r 100
echo_test: repeat 100: msgsz 32: variable false
echo_test: done
mek_8q:/vendor/bin # tipc-test -t echo -r 1000
echo_test: repeat 1000: msgsz 32: variable false
echo_test: done

```

3.2.5 Modifying the console port for Trusty OS

Due to different hardware board designs, the debug UART may be different. i.MX Trusty OS supports to configure a different UART port by modifying the configuration file.

To change the debug UART port, see the SoC reference manual to get the specific UART port base address. The debug UART address are defined in `trusty/hardware/nxp/target/$SOC_NAME/rules.mk`.

For example, if LPUART1 is used instead of LPUART0 for i.MX 8QuadMax board, make the following modification on `rules.mk`:

```
diff --git a/target/imx8q/rules.mk b/target/imx8q/rules.mk
index e6239e2..8ea3f37 100644
--- a/target/imx8q/rules.mk
+++ b/target/imx8q/rules.mk
@@ -25,4 +25,4 @@
PLATFORM_SOC := imx8qm
PLATFORM := imx

-CONFIG_CONSOLE_TTY_BASE := 0x5A060000
+CONFIG_CONSOLE_TTY_BASE := 0x5A070000
```

3.2.6 Configuring the related TA services

The Trusted Application (TA) is the software running in a secure context. There are several TAs running in the Trusty OS. The following figure shows their relationships.

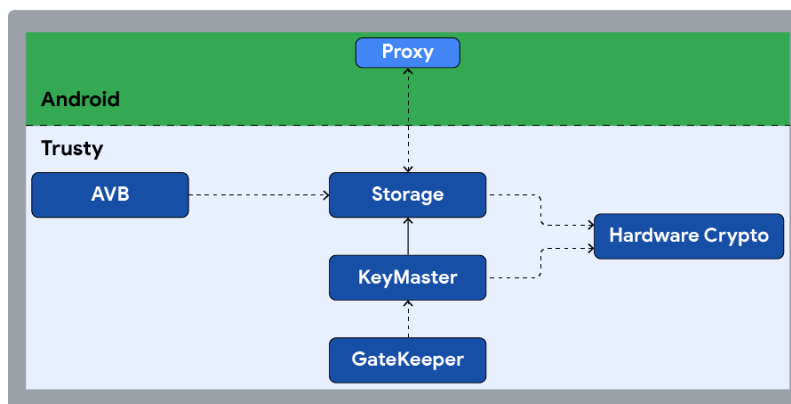

Figure 6. Relationship between TAs

- AVB TA: It provides tamper proof operations for data used during Android Verified Boot (AVB), such as rollback index, lock/unlock state, and vbmeta public key.
- Storage TA: It provides encrypted and tamper proof storage to secure applications, such as AVB TA. All operations that modify the secure storage are transactional.
- Hardware Crypto TA: It provides hardware crypto and accelerates operations based on CAAM, such as RNG generation and SHA1/SHA256 hash calculation.
- Keymaster TA: It provides all secure Keystore operations, with access to the raw key material, validating all of the access control conditions on keys.
- Gatekeeper TA: It authenticates user passwords and generates authentication tokens used to prove to the Keymaster TA that an authentication is done for a particular user at a particular point in time.

3.3 Configurations in U-Boot for security

U-Boot is loaded by SPL and verified with HAB. ATF starts U-Boot. The primary purpose of U-Boot is to load and verify Android images.

3.3.1 Overview of security features in U-Boot

Android Verified Boot (AVB) is enabled in i.MX Android images. There is an additional vbmeta image used in AVB. This vbmeta image does not contain any code that the device will execute. It is used by U-Boot to authenticate its own and other Android images. The other images to be authenticated with the vbmeta image include images for boot, dtbo, system, and vendor partitions. If there are other images containing executing code, like product, they are also authenticated based on the data in the vbmeta image. The hash value of these images is calculated and the metadata is stored in the vbmeta image. The following figure shows the relationship of these images.

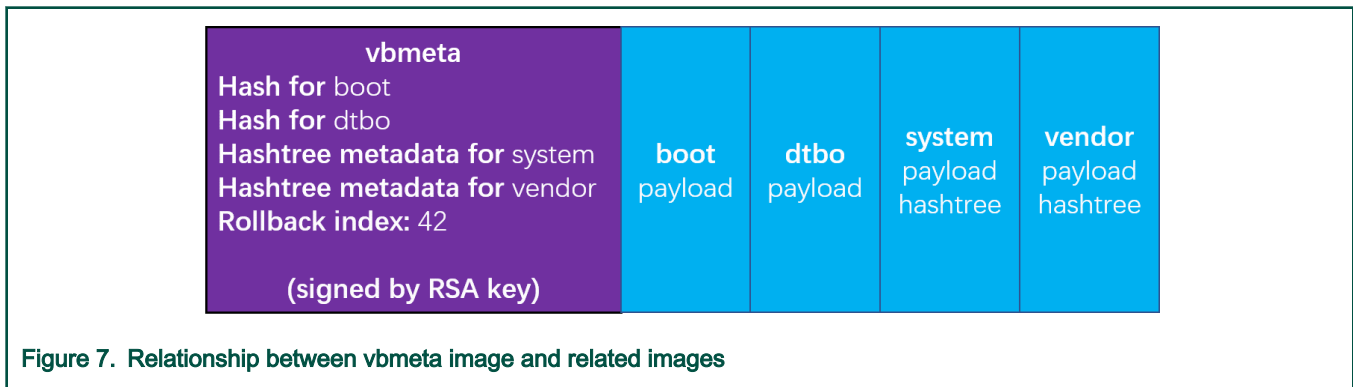

To make sure that the vbmeta image is trusted, it is signed with the RSA key, and the signature of the vbmeta image is verified at boot time before the data in it are used to verify other images.

To prevent rollback attack, there is a rollback index value stored in the vbmeta image. The value can increase with the release of images. This rollback index value in the vbmeta image is also saved in the RPMB partition of eMMC after all the images are verified as bootable. If the rollback index value in the vbmeta image is smaller than the one stored in the RPMB partition of eMMC, U-Boot does not boot with the related images. With dual bootloader enabled, SPL and U-Boot proper is not in one file, so there is another rollback index value for U-Boot proper.

To prevent the device from getting bricked during OTA, a/b slot feature is provided. Some partitions used to store images have two copies in the boot device. They are called "slot a" and "slot b". The image update process only flashes one slot. An update failure does not affect the other slot.

3.3.2 Generating and fusing the eMMC RPMB key

The RPMB partition of eMMC can be fused with the 256-bit secure key. This secure key also needs to be saved in the format that only TEE can parse, so TEE can use this key to communicate with RPMB. This 256-bit secure key is used to sign and verify data transferred between eMMC RPMB and TEE.

The RPMB key can only be programmed one time. The saved copy of RPMB key is encapsulated with CAAM, and CAAM uses the value in eFuse hardware. If the SRK hash value needs to be programmed into eFuse hardware and close the chips, do it first, and only after that can the RPMB key be programmed.

Before setting the RPMB key, it is necessary to know where the RPMB key blob encapsulated with CAAM is stored and how to change the location. This location is used when setting the RPMB key. By default, the key blob is saved in the last block of BOOT1 partition. The BOOT1 partition size of eMMC on i.MX 8QuadMax MEK and i.MX 8QuadXPlus MEK is 8 MB. It is 4 MB for BOOT1 partition of eMMC on i.MX 8M Mini EVK and i.MX 8M Nano EVK. To prevent key blob from been tampered when the system is running, BOO1 partition is set with power-on write protection when the board boots up.

The location to store the key blob may need to be changed based on the board design. Two macros are used to control the location of the key blob. These two macros are the same for i.MX 8QuadMax MEK and i.MX 8QuadXPlus MEK. Their definitions are as follows:

```
#define KEYSLOT_HWPARTITION_ID 2
#define KEYSLOT_BLKs 0x3FFF
```

While for i.MX 8M Mini EVK and i.MX 8M Nano EVK, the definition is as follows:

```
#define KEYSLOT_HWPARTITION_ID 2
#define KEYSLOT_BLKs 0x1FFF
```

"KEYSLOT_HWPARTITION_ID" represents the eMMC partition. 0 means USERDATA partition, 1 means BOOT0 partition, and 2 means BOOT1 partition. "KEYSLOT_BLKs" represents the block in which the key blob is stored.

For i.MX8QuadMax MEK, they are in below files. For other platforms, it's in other board related header files in the same folder.

```
/* Android Automotive */
${MY_ANDROIDID}/vendor/nxp-opensource/uboot-imx/include/configs/imx8qm_mek_android_auto.h
/* Standard Android */
${MY_ANDROIDID}/vendor/nxp-opensource/uboot-imx/include/configs/imx8qm_mek_android.h
```

Two ways are provided to set the RPMB key:

- Manually specify a 256-bit key and program it.

1. A file containing the key needs to be generated. In the default key file "rpmb_key_test.bin", all 256 bits are zero. It can be generated with the following commands:

```
$ touch rpmb_key.bin
$ echo -n "RPMB" > rpmb_key.bin
$ echo -n -e
'\x00\x00\x00\x00\x00\x00\x00\x00\x00\x00\x00\x00\x00\x00\x00\x00\x00\x00\x00\x00\x00\x00\x00\x00\x00\x00\x00\x00\x00\x00\x00\x00\x00\x00\x00\x00\x00\x00\x00\x00\x00\x00\x00\x00\x00\x00\x00\x00\x00\x00\x00\x00\x00\x00\x00\x00\x00\x00\x00\x00\x00\x00\x00\x00\x00\x00\x00\x00\x00\x00\x00\x00\x00\x00' >> rpmb_key.bin
```

The '\xHH' means 8-bit character whose value is the hexadecimal value 'HH'. You can replace above "00" with the key you want to set.

2. Program the key with the file just generated.
3. Make the board enter fastboot mode, and then execute the following commands on the host side:

```
$ fastboot stage rpmb_key.bin
$ fastboot oem set-rpmb-key
```

- Program a random key.

Make the board enter fastboot mode, and then execute the following commands on the host side:

```
$ fastboot oem set-rpmb-random-key
```

After the RPMB key is programmed with either of the two ways, reboot the board. The RPMB service in Trusty OS is then initialized successfully.

3.3.3 Generating AVB key to sign and verify images

The vbmeta image is signed during the time of building Android platform. By default, it is signed with a test private key as follows:

```
${MY_ANDROIDID}/device/fsl/common/security/testkey_rsa4096.pem
```

Its corresponding public key is:

```
 ${MY_ANDROID}/device/fsl/common/security/testkey_public_rsa4096.bin.
```

The default algorithm used to sign the image is "SHA256_RSA4096".

The private key can be generated with OpenSSL. For example, the following command can generate RSA-4096 private key test_rsa4096_private.pem:

```
 openssl genpkey -algorithm RSA -pkeyopt rsa_keygen_bits:4096 -outform PEM -out
 custom_rsa4096_private.pem
```

The corresponding public key can be extracted from the private key with avbtool. The avbtool can be found in `${MY_ANDROID}/external/avb`. Execute the following command to extract the public key from the private key:

```
 avbtool extract_public_key --key custom_rsa4096_private.pem --output custom_rsa4096_public.bin
```

"SHA256_RSA4094" is recommended for i.MX 8Quad and i.MX 8M devices, whose Cryptographic Acceleration and Assurance Module (CAAM) can help accelerate the hash calculation. We can keep it as default.

To use the private key just generated to sign the vbmeta image, taking i.MX 8QuadMax or i.MX 8QuadXPlus MEK as an example, make the following changes on the repository in `${MY_ANDROID}/device/fsl`. It is similar for other platforms to change the private key for vbmeta.

```
 /* Android Automotive */
 ${MY_ANDROID}/vendor/nxp-opensource/uboot-imx/include/configs/imx8qm_mek_android_auto.h
 /* Standard Android */
 ${MY_ANDROID}/vendor/nxp-opensource/uboot-imx/include/configs/imx8qm_mek_android.h
```

To enable U-Boot to verify image signature with the public key just generated, save the public key in TEE backed RPMB. Make the board enter fastboot mode, and execute the following commands:

```
 $ fastboot stage custom_rsa4096_public.bin
 $ fastboot oem set-public-key
```

`custom_rsa4096_public.bin` is the public key just generated. If there is no change made to the private key used to sign vbmeta image, you still need to store the default public key with the following commands:

```
 $ fastboot oem set-public-key
```

3.3.4 Bypass vbmeta/lock check for development purposes

Bypassing vbmeta/lock check is very convenient for development work. To unlock the device after all images are flashed, boot the board to the Android UI, enable "Developer options" in the "Settings" Application, open "OEM unlocking" under "Developer options", and reboot the board to fastboot mode. Execute the following command:

```
 $ sudo fastboot oem unlock
```

After the board is unlocked, images can be flashed with the fastboot command. To bypass vbmeta check, use fastboot to flash the vbmeta image with the "--disable-verity" option. Take i.MX 8QuadMax MEK as an example, execute the following commands:

```
 $ sudo fastboot flash vbmeta_a vbmeta-imx8qm.img --disable-verity
 $ sudo fastboot flash vbmeta_b vbmeta-imx8qm.img --disable-verity
```

3.3.5 Changing the value of the rollback index in images

There are two rollback index values if the dual-bootloader feature is enabled. One is for the image which contains U-Boot proper, and the other is for vbmeta image and other images whose hash metadata are stored in the vbmeta image. If dual-bootloader feature is not enabled, only the one for vbmeta image and other images is in use. The default value of rollback index is zero.

When a version of images is to be released to fix a bug in previous version that makes previous images under potential attacks, it is recommended to increase the rollback index values by one compared to the previous version.

In this release, some modifications are made to the Android build system. A shell script named "imx-make.sh" is provided to build U-Boot and kernel code independently from the building process of Android images. To make the build process simple and as only one command can build all images, "imx-make.sh" starts to build Android images after the U-Boot and kernel are built. To change the rollback index value for the image which contains U-Boot proper, a shell variable named "BOOTLOADER_RBINDEX" can be specified when executing the "imx-make.sh" script. To change the rollback index value for vbmeta image and other related images, a shell variable named "AVB_RBINDEX" can also be assigned a value when building the images.

As an example, the following command can be executed to change the rollback index values. Change `AVB_RBINDEX` and `BOOTLOADER_RBINDEX` to a value as needed.

```
AVB_RBINDEX=${avb_rbindex} BOOTLOADER_RBINDEX=${bootloader_rbindex} ./imx-make.sh -j4
```

Of course, if the U-Boot and kernel are already built and they do not need to be updated, "make" can be used to build vbmeta and other related images need to be updated. Change the rollback index value as follows. Change `AVB_RBINDEX` to a value as needed.

```
make -j4 AVB_RBINDEX=${avb_rbindex}
```

3.3.6 Programming the attestation key

Attestation key is programmed in U-Boot. The keystore key attestation aims to provide a way to strongly determine if an asymmetric key pair is hardware-backed, what the properties of the key are, and what constraints are applied to its usage.

Google provides the attestation "keybox", which contains private keys (RSA and ECDSA) and the corresponding certificate chains to partners from the Android Partner Front End (APFE). After retrieving the "keybox" from Google, you need to parse the "keybox", provision the keys and certificates to secure storage. Both keys and certificates should be encoded with Distinguished Encoding Rules (DER).

Two ways are provided to provision the attestation keys and certificates. One is provisioning the keys and certificates in plaintext format, and the other is provisioning the keys and certificates in AES-ECB encrypted format. Before provisioning starts, make sure the secure storage is properly initialized for Trusty OS.

1. Provision keys and certificates in plaintext format.

Fastboot commands are provided to flash the attestation keys and certificates in plaintext format to device. This way is more simple but has more risk of leaking the keys. Boot the board into fastboot mode and use the following commands.

- Set the RSA private key:

```
$ fastboot stage ${path-to-rsa-private-key}
$ fastboot oem set-rsa-atte-key
```

- Set the ECDSA private key:

```
$ fastboot stage ${path-to-ecdsa-private-key}
$ fastboot oem set-ec-atte-key
```

- Append the RSA certificate chain:

```
$ fastboot stage ${path-to-rsa-atte-cert}
$ fastboot oem append-rsa-atte-cert
```

The second command may need to be executed multiple times to append the whole certificate chain.

- Append the ECDSA certificate chain:

```
$ fastboot stage < path-to-ecdsa-cert >
$ fastboot oem append-ec-atte-cert
```

The second command may need to be executed multiple times to append the whole certificate chain.

2. Provision keys and certificates in AES-ECB encrypted format.

Fastboot commands are provided to flash AES-ECB encoded keys and certificates to device. This way is more secure, because it encrypts the keys and certificates with the MPPUBK (Manufacturing Protection Public Key, generated from CAAM module) to prevent leakage. This way can only be used on HAB CLOSED board. The workflow is as shown in the following figure.

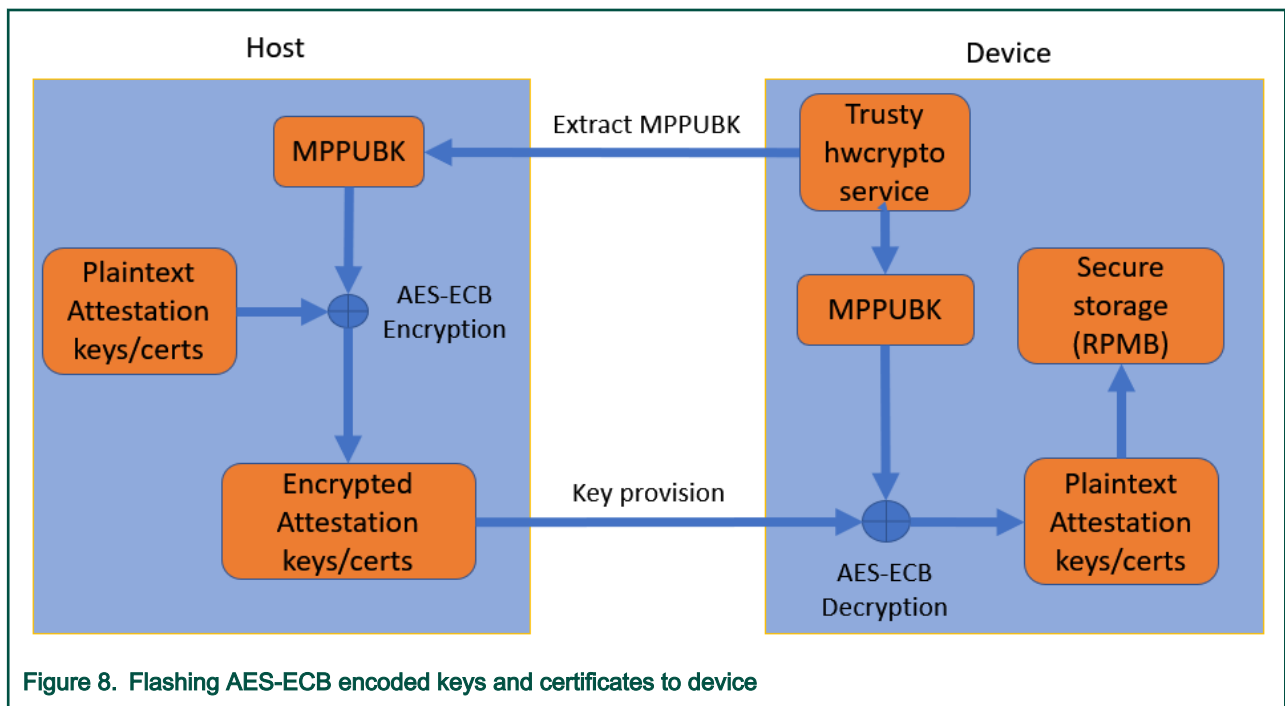

Boot the board into fastboot mode and perform the following steps:

- Get MPPUBK:

```
$ fastboot oem get-mppubk
$ fastboot get_staged mppubk.bin
```

- Encrypt the plaintext attestation keys and certificates with the MPPUBK.

The attestation keys and certificates should be encrypted in AES-ECB with the generated MPPUBK. The following is a simple encryption python scripts gen_secure_atte.py:

```
from Crypto.Cipher import AES
import struct
import argparse

parser = argparse.ArgumentParser(description='Secure Provision encrypt tool.')
parser.add_argument('key', type=file)
parser.add_argument('plaintext', type=file)
parser.add_argument('blob', type=argparse.FileType('w'))
args = parser.parse_args()
```

```

data = args.plaintext.read()
data_len = len(data)
written_len = struct.pack('I', data_len)

#AES need 16 bytes align, so pad the data it
data += '\0' * (((len(data)+15)/16 * 16) - len(data))
key2 = args.key.read()
key = key2[0:16]
magic = "!AT"
pad0 = struct.pack('B', 0)

cipher = AES.new(key, AES.MODE_ECB)
blob = cipher.encrypt(data)

args.blob.write(magic)
args.blob.write(pad0)
args.blob.write(written_len)
args.blob.write(blob)

#blob structure describe as below:
#{
# char magic[4] = "!AT";
# uint32_t len = plaintext_length
# uint8 *encrypted_data
#}

```

Encrypt the keys and the certificates on the host computer: \$ python gen_secure_atte.py mppubk.bin < path-to-plaintext-keys-or-certificates > < encrypted-keys-or-certificates >

c. Set encrypted RSA private key:

```

$ fastboot stage ${path-to-encrypted-rsa-private-key}
$ fastboot oem set-rsa-atte-key-enc

```

d. Set encrypted ECDSA private key:

```

$ fastboot stage ${path-to-encrypted-ecdsa-private-key}
$ fastboot oem set-ec-atte-key-enc

```

e. Append encrypted RSA certificate chain:

```

$ fastboot stage ${path-to-encrypted-rsa-atte-cert}
$ fastboot oem append-rsa-atte-cert-enc

```

The second command may need to be executed multiple times to append the whole certificate chain.

f. Append encrypted ECDSA certificate chain:

```

$ fastboot stage < path-to-encrypted-ecdsa-cert >
$ fastboot oem append-ec-atte-cert-enc

```

The second command may need to be executed multiple times to append the whole certificate chain.

3.3.7 Changing the way to store lock status and/or rollback index

For images with TEE enabled, lock status and rollback index values are stored in RPMB. The rollback index value for AVB is written/read by TEE into/from RPMB but the write/read process is initiated by U-Boot. For i.MX Android with dual-bootloader feature, there is a rollback index for bootloader, this rollback index value for bootloader is written/read by SPL into/from RPMB.

Rollback index values and lock status can be used for many purposes as designed by developers, not limited to the usage in i.MX Android code. At this point, it is necessary to know how the lock status and rollback index values are stored on board.

For i.MX Android with dual-bootloader feature, the rollback index value for bootloader is read from RPMB to compare with the one in the bootloader image. If the rollback index value is bigger than the one stored in RPMB and the images are verified as bootable, rollback index value in bootloader image is written into RPMB. This logic is completed in the following function:

```
static int spl_verify_rbidx(struct mmc *mmc, AvbABSlotData *slot,
                          struct spl_image_info *spl_image)
```

In the following file:

```
${MY_ANDROID}/vendor/nxp-opensource/uboot-imx/lib/avb/fsl/fsl_avb_ab_flow.c
```

For new boards just flashed with images, at their first time of boot, a default rollback index value is written in RPMB in the following function:

```
int rpmb_init(void)
```

In the following file:

```
${MY_ANDROID}/vendor/nxp-opensource/uboot-imx/lib/avb/fsl/fsl_avb_ab_flow.c
```

From the functions listed above, it is known that the rollback index value for bootloader is located by a `kblb_hdr_t` type structure variable. This structure has a magic value. A member with the type of `kblb_tag_t` is used to specify the rollback index value.

Now in i.MX Android Auto, the offset of the rollback index value for bootloader is controlled by a macro named "BOOTLOADER_RBIDX_START" as defined in the following two files respectively for i.MX 8QuadMax MEK and i.MX 8QuadXPlus MEK.

```
${MY_ANDROID}/vendor/nxp-opensource/uboot-imx/include/configs/imx8qm_mek_android_auto.h
${MY_ANDROID}/vendor/nxp-opensource/uboot-imx/include/configs/imx8qxp_mek_android_auto.h
```

The value for "BOOTLOADER_RBIDX_START" is 0x3FF000, 4KB offset from the end of the RPMB partition.

The read process of the rollback index value for AVB is initiated by U-Boot in the following function:

```
FbLockState fastboot_get_lock_stat(void)
```

In the following file:

```
${MY_ANDROID}/vendor/nxp-opensource/uboot-imx/drivers/usb/gadget/fastboot_lock_unlock.c
```

For images with TEE enabled, this function invokes the following function. It uses TIPC to communicate with TEE to get the value.

```
int trusty_read_lock_state(uint8_t *lock_state)
```

The write process of the rollback index value for AVB is initiated by U-Boot in the following function:

```
int fastboot_set_lock_stat(FbLockState lock)
```

In the following file:

```
${MY_ANDROID}/vendor/nxp-opensource/uboot-imx/drivers/usb/gadget/fastboot_lock_unlock.c
```

For images with TEE enabled, this function invokes the following function. It uses TIPC to communicate with TEE to save the value.

```
int trusty_write_lock_state(uint8_t lock_state)
```

Rollback index value for AVB is read to compare with the one in vbmeta image and the one in vbmeta image is saved into RPMB if necessary. This logic is completed in the following function:

```
AvbABFlowResult avb_flow_dual_uboot(AvbABOps* ab_ops,
    const char* const* requested_partitions,
    AvbSlotVerifyFlags flags,
    AvbHashtreeErrorMode hashtree_error_mode,
    AvbSlotVerifyData** out_data)
```

In the following file:

```
$(MY_ANDROID)/vendor/nxp-opensource/uboot-imx/lib/avb/fsl/fsl_avb_ab_flow.c
```

The following two functions are invoked to read and store the rollback index for vbmeta:

```
AvbIOResult fsl_read_rollback_index_rpmb(AvbOps* ops, size_t rollback_index_slot,
    uint64_t* out_rollback_index)

AvbIOResult fsl_write_rollback_index_rpmb(AvbOps* ops, size_t rollback_index_slot,
    uint64_t rollback_index)
```

They finally communicate with TEE to finish the work.

3.3.8 Choosing to boot a specific slot

With both slots flashed with images, a specific slot can be chosen to boot manually for development purpose. Boot the board into fastboot mode, and execute the following command to boot from "slot a" or "slot b":

```
$ sudo fastboot set_active a
$ sudo fastboot set_active b
```

3.3.9 Disabling development options in U-Boot

To facilitate development, some development options are set in U-Boot, which may bring in potential security holes. Before shipping the final products, these options must be closed.

- Boot delay

By default, the U-Boot reserves 1 second count-down to help developer stop at U-Boot and run some U-Boot commands. This can be disabled by setting `CONFIG_BOOTDELAY` to `-2`. For i.MX 8QuadMAX and i.MX 8QuadXPlus, make the following changes. Similar changes need to be made on other platforms that you are working on.

```
diff --git a/configs/imx8qm_mek_androidauto_trusty_defconfig b/configs/
imx8qm_mek_androidauto_trusty_defconfig
index 0a8c3cb..8150b2b 100644
--- a/configs/imx8qm_mek_androidauto_trusty_defconfig
+++ b/configs/imx8qm_mek_androidauto_trusty_defconfig
@@ -40,7 +40,7 @@ CONFIG_USB_GADGET_DUALSPEED=y

CONFIG_DM_GPIO=y
CONFIG_DM_PCA953X=y
-CONFIG_BOOTDELAY=1
+CONFIG_BOOTDELAY=-2
CONFIG_CMD_MMC=y
CONFIG_DM_MMC=y
CONFIG_MMC_IO_VOLTAGE=y
diff --git a/configs/imx8qxp_mek_androidauto_trusty_defconfig b/configs/
imx8qxp_mek_androidauto_trusty_defconfig
index 0611773..a424e31 100644
```



```

--- a/configs/imx8qxp_mek_androidauto_trusty_defconfig
+++ b/configs/imx8qxp_mek_androidauto_trusty_defconfig
@@ -41,7 +41,7 @@ CONFIG_USB_GADGET_DUALSPEED=y

CONFIG_DM_GPIO=y
CONFIG_DM_PCA953X=y
-CONFIG_BOOTDELAY=1
+CONFIG_BOOTDELAY=-2
CONFIG_CMD_MMC=y
CONFIG_DM_MMC=y
CONFIG_MMC_IO_VOLTAGE=y

```

- **Bootargs appending**

The bootargs may need to be changed frequently during development. NXP U-Boot supports appending the U-Boot variable `append_bootargs` to the default bootargs, which will be passed to kernel. However, this feature can be used by hackers to compromise the device and should be disabled in any formal release. To disable the bootargs appending feature, you need to disable `CONFIG_APPEND_BOOTARGS`. For i.MX 8QuadMAX and i.MX 8QuadXPlus, make the following changes. Similar changes need to be made on other platforms that you are working on.

```

diff --git a/configs/imx8qm_mek_androidauto_trusty_defconfig b/configs/
imx8qm_mek_androidauto_trusty_defconfig
index 0a8c3cb..bc6a97d 100644
--- a/configs/imx8qm_mek_androidauto_trusty_defconfig
+++ b/configs/imx8qm_mek_androidauto_trusty_defconfig
@@ -120,4 +120,3 @@ CONFIG_NOT_UUU_BUILD=y
CONFIG_SHA256=y
CONFIG_SPL_MMC_WRITE=y
CONFIG_DUAL_BOOTLOADER=y
-CONFIG_APPEND_BOOTARGS=y
diff --git a/configs/imx8qxp_mek_androidauto_trusty_defconfig b/configs/
imx8qxp_mek_androidauto_trusty_defconfig
index 0611773..e501c40 100644
--- a/configs/imx8qxp_mek_androidauto_trusty_defconfig
+++ b/configs/imx8qxp_mek_androidauto_trusty_defconfig
@@ -121,4 +121,3 @@ CONFIG_NOT_UUU_BUILD=y
CONFIG_SHA256=y
CONFIG_SPL_MMC_WRITE=y
CONFIG_DUAL_BOOTLOADER=y
-CONFIG_APPEND_BOOTARGS=y

```

3.3.10 Secure unlock

Secure unlock is designed to prevent unauthorized unlock. It requires the unlock credential. The unlock operation can only occur after a valid unlock credential is provided.

An example is provided, which generates the unlock credential with serial number and MPPUBK (Manufacturing Protection Public Key, generated from CAAM module). To enable the secure unlock feature, enable "CONFIG_SECURE_UNLOCK". For i.MX 8QuadMAX MEK and i.MX 8QuadXPlus MEK running Android Automotive, make the following changes. Similar changes need to be made on other platforms that you are working on:

```

diff --git a/configs/imx8qm_mek_androidauto_trusty_defconfig b/configs/
imx8qm_mek_androidauto_trusty_defconfig
index b18e3d5..66c9ee5 100644
--- a/configs/imx8qm_mek_androidauto_trusty_defconfig
+++ b/configs/imx8qm_mek_androidauto_trusty_defconfig
@@ -171,4 +171,4 @@ CONFIG_LIBAVB=y
CONFIG_SHA256=y
CONFIG_SPL_MMC_WRITE=y

```

```

CONFIG_DUAL_BOOTLOADER=y
-
+CONFIG_SECURE_UNLOCK=y
diff --git a/configs/imx8qxp_mek_androidauto_trusty_defconfig b/configs/
imx8qxp_mek_androidauto_trusty_defconfig
index 264dc2d..ffaf254 100644
--- a/configs/imx8qxp_mek_androidauto_trusty_defconfig
+++ b/configs/imx8qxp_mek_androidauto_trusty_defconfig
@@ -180,4 +180,4 @@ CONFIG_LIBAVB=y
CONFIG_SHA256=y
CONFIG_SPL_MMC_WRITE=y
CONFIG_DUAL_BOOTLOADER=y
-
+CONFIG_SECURE_UNLOCK=y

```

Perform the following steps to verify the secure unlock feature. These operations can only be executed on the hab closed boards:

1. Get MPPUBK:

```

$ fastboot oem get-mppubk
$ fastboot get_staged mppubk.bin

```

2. Get the serial number:

```

$ fastboot oem get-serial-number
$ fastboot get_staged serial.bin

```

3. Generate the unlock credential. Encrypt `serial.bin` with `mppubk.bin` on the host PC. For the encryption script, see [Section Programming the attestation key](#).

```

$ python gen_secure_atte.py mppubk.bin serial.bin serial-enc.bin

```

4. Verify the secure unlock feature:

```

$ fastboot stage serial-enc.bin
$ fastboot oem unlock

```

You may need to lock the device first if the device is already in unlocked state.

3.4 Configurations in Linux/Android platform for security features

3.4.1 DM-Verity relationship with vbmeta

The Device Mapper verity (DM-verity) kernel feature supports transparent integrity checking of block devices. This feature helps Android users be sure that when booting a device, it is in the same state as when it is flashed. The vbmeta image contains a kernel command line descriptor for setting up DM-verity for `system.img`, together with hashtree descriptors for `system.img` and `vendor.img`. The hash tree descriptor in the vbmeta image contains the root hash, salt and the offset of the hashtree, which are essential to do the DM-verity check for system and vendor partitions.

When the DM-verity is enabled for system and vendor partition, any operations that break the consistency of the `system.img`, `vendor.img`, and `vbmeta.img` will cause DM-verity check failure, and thus cause the system boot failure.

3.4.2 Configuration of the RSA keys for DM-verity

RSA keys are used to sign the DM_verity table to produce a table signature. When verifying a partition, the table signature is validated first. This is done against a key on your boot image in a fixed location. Keys are typically included in the `/verity_key` directory.

The 2048-bit private RSA key that is used to sign the table is generated by OpenSSL, which is included in `${MY_ANDROID}/build/target/product/security/verity_private_dev_key`.

The RSA public key used for verification needs to be in mincrypt format. Converting an OpenSSL RSA public key to mincrypt format requires some modular operations and is not simply a binary format conversion. You can convert the PEM key using the `pem2mincrypt` tool. The public key is included in `${MY_ANDROID}/build/target/product/security/verity_key`.

You can change the default RSA key using the following commands:

```
cd build/target/product/security/
openssl genrsa -out verity_private_dev_key_tem 2048
openssl pkcs8 -topk8 -inform PEM -in verity_private_dev_key_tem -out verity_private_dev_key -outform PEM
-nocrypt
pem2mincrypt verity_private_dev_key_tem verity_key
```

NOTE

- Install libssl0.9.8 using the following command:

```
$sudo apt-get install libssl0.9.8
```

- The tool `pem2mincrypt`'s source code is under <https://github.com/nelenkov/verity>.

3.4.3 Trusty OS Linux driver configuration

The Trusty OS supports to output the logs to UART or TIPC log channel. The Trusty OS Linux driver supports to carry the logs from the Trusty OS by TIPC channel. By default, this feature is enabled in the reference image.

In the Trusty OS Linux driver `trusty-log`, when it is enabled, the Trusty OS shuts down the UART output log port. The UART driver in the Trusty OS outputs characters synchronously and it costs much IO time.

The `trusty-log` driver is configured in the device tree as follows:

```
trusty-log {
    compatible = "android,trusty-log-v1";
};
```

3.4.4 Introductions of trusty based keymaster, gatekeeper, and secure storage proxy

The trusty backed keymaster HAL is a dynamically loadable library used by the keystore service to provide hardware-backed cryptographic services. It does not provide any sensitive operations in user space, or even in kernel space. All sensitive operations are delegated to the keymaster TA in the Trusty OS (secure world). The relationship is shown in the following figure.

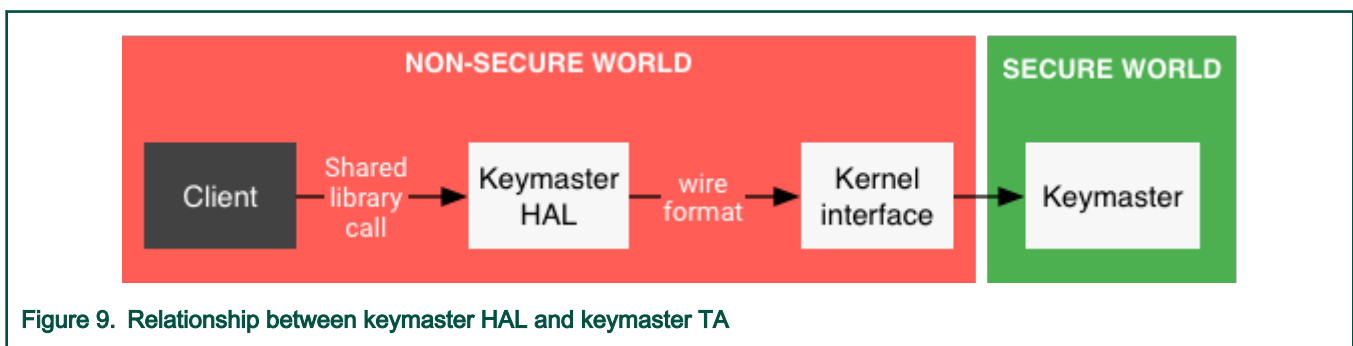

The trusty backed keymaster HAL 3.0 is designed for Android Pie 9 or later, which cannot work for Android Oreo 8.1. Instead, the Android Oreo 8.1 is running trusty backed keymaster HAL 2.0.

The Gatekeeper subsystem performs device pattern/password authentication. It enrolls and verifies passwords through an HMAC with a secret key. Additionally, the Gatekeeper throttles consecutive failed verification attempts and refuses to service requests

based on a given timeout and a given number of consecutive failed attempts. The trusty backed gatekeeper sends all critical operations to the gatekeeper TA in trusty.

The secure storage proxy is running in the Linux end to communicate with the storage TA in trusty to perform secure storage read/write operations, for example, reading/writing data from/to RPMB partition of the eMMC device.

Trusty backed keymaster, gatekeeper, and secure storage proxy all depend on secure storage, which can only be accessed by trusty, but users may not want to set the secure storage properly (like the key of RPMB), because in some instances, security is not so important and can even be neglected. In this case, both keymaster and gatekeeper fall back to software backed version, and they are chosen by the `androidboot.keystore` variable in the kernel command line.

When the trusty and associated trusted applications (such as keymaster TA and storage TA) are initialized properly, U-Boot sets `androidboot.keystore` to `trusty`, otherwise to `software`, and then passes it to the kernel through the kernel command line. The `androidboot.keystore` is translated to `ro.boot.keystore` Android property, and then the initialization program chooses the keymaster and gatekeeper version (trusty backed or software backed) and starts the secure storage proxy according to this property. The following figure shows the workflow.

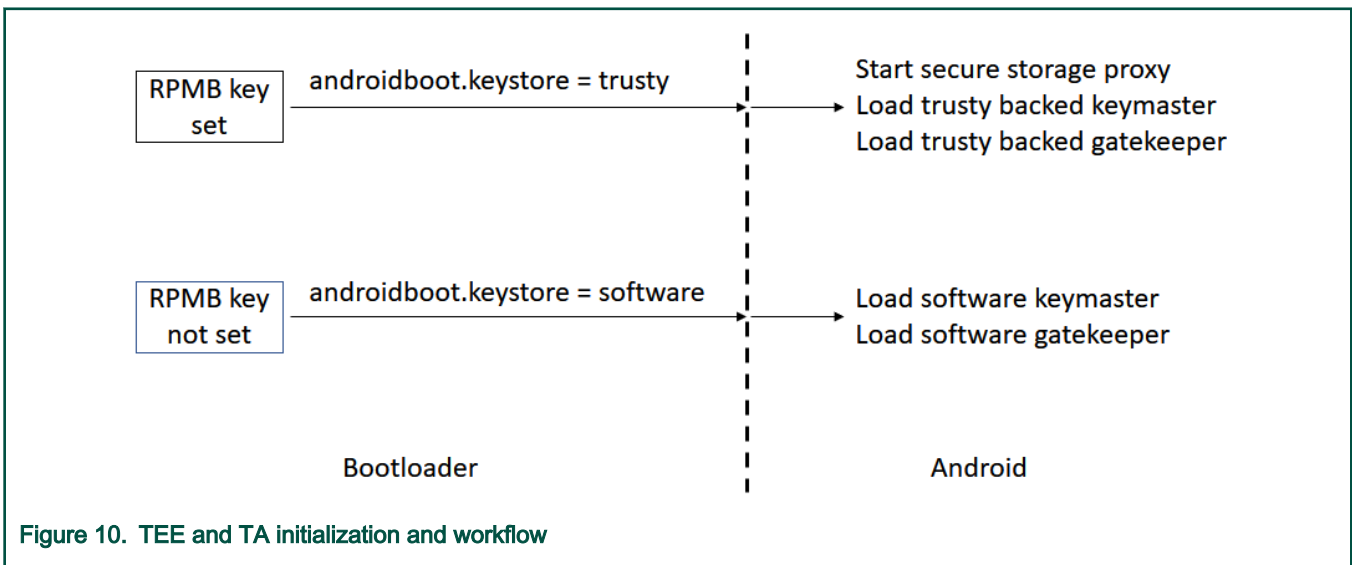

4 Revision History

Table 6. Revision history

Revision number	Date	Substantive changes
P9.0.0_1.0.0-beta	11/2018	Initial release
P9.0.0_1.0.0-ga	01/2019	i.MX 8M, i.MX 8QuadMax, i.MX 8QuadXPlus GA release.
P9.0.0_2.0.0-ga	04/2019	i.MX 8M, i.MX 8QuadMax, i.MX 8QuadXPlus GA release.
P9.0.0_2.0.0-ga	08/2019	Updated the location of the SCFW porting kit.
android-10.0.0_1.0.0	02/2020	i.MX 8M Mini, i.MX 8M Quad, i.MX 8QuadMax, and i.MX 8QuadXPlus GA release.
android-10.0.0_1.0.0	03/2020	Deleted the Android 10 image.

Table continues on the next page...

Table 6. Revision history (continued)

Revision number	Date	Substantive changes
android-10.0.0_2.0.0	05/2020	i.MX 8M Mini, i.MX 8M Nano, i.MX 8M Quad, i.MX 8QuadMax, and i.MX 8QuadXPlus GA release.

How To Reach Us

Home Page:

nxp.com

Web Support:

nxp.com/support

Information in this document is provided solely to enable system and software implementers to use NXP products. There are no express or implied copyright licenses granted hereunder to design or fabricate any integrated circuits based on the information in this document. NXP reserves the right to make changes without further notice to any products herein.

NXP makes no warranty, representation, or guarantee regarding the suitability of its products for any particular purpose, nor does NXP assume any liability arising out of the application or use of any product or circuit, and specifically disclaims any and all liability, including without limitation consequential or incidental damages. "Typical" parameters that may be provided in NXP data sheets and/or specifications can and do vary in different applications, and actual performance may vary over time. All operating parameters, including "typicals," must be validated for each customer application by customer's technical experts. NXP does not convey any license under its patent rights nor the rights of others. NXP sells products pursuant to standard terms and conditions of sale, which can be found at the following address: nxp.com/SalesTermsandConditions.

While NXP has implemented advanced security features, all products may be subject to unidentified vulnerabilities. Customers are responsible for the design and operation of their applications and products to reduce the effect of these vulnerabilities on customer's applications and products, and NXP accepts no liability for any vulnerability that is discovered. Customers should implement appropriate design and operating safeguards to minimize the risks associated with their applications and products.

NXP, the NXP logo, NXP SECURE CONNECTIONS FOR A SMARTER WORLD, COOLFLUX, EMBRACE, GREENCHIP, HITAG, I2C BUS, ICODE, JCOP, LIFE VIBES, MIFARE, MIFARE CLASSIC, MIFARE DESFire, MIFARE PLUS, MIFARE FLEX, MANTIS, MIFARE ULTRALIGHT, MIFARE4MOBILE, MIGLO, NTAG, ROADLINK, SMARTLX, SMARTMX, STARPLUG, TOPFET, TRENCHMOS, UCODE, Freescale, the Freescale logo, Altivec, C-5, CodeTEST, CodeWarrior, ColdFire, ColdFire+, C-Ware, the Energy Efficient Solutions logo, Kinetis, Layerscape, MagniV, mobileGT, PEG, PowerQUICC, Processor Expert, QoriQ, QoriQ Qonverge, Ready Play, SafeAssure, the SafeAssure logo, StarCore, Symphony, VortiQa, Vybrid, Airfast, BeeKit, BeeStack, CoreNet, Flexis, MXC, Platform in a Package, QUICC Engine, SMARTMOS, Tower, TurboLink, UMEMS, EdgeScale, EdgeLock, eIQ, and Immersive3D are trademarks of NXP B.V. All other product or service names are the property of their respective owners. AMBA, Arm, Arm7, Arm7TDMI, Arm9, Arm11, Artisan, big.LITTLE, Cordio, CoreLink, CoreSight, Cortex, DesignStart, DynamIQ, Jazelle, Keil, Mali, Mbed, Mbed Enabled, NEON, POP, RealView, SecurCore, Socrates, Thumb, TrustZone, ULINK, ULINK2, ULINK-ME, ULINK-PLUS, ULINKpro, µVision, Versatile are trademarks or registered trademarks of Arm Limited (or its subsidiaries) in the US and/or elsewhere. The related technology may be protected by any or all of patents, copyrights, designs and trade secrets. All rights reserved. Oracle and Java are registered trademarks of Oracle and/or its affiliates. The Power Architecture and Power.org word marks and the Power and Power.org logos and related marks are trademarks and service marks licensed by Power.org.

© NXP B.V. 2018-2020.

All rights reserved.

For more information, please visit: <http://www.nxp.com>

For sales office addresses, please send an email to: salesaddresses@nxp.com

Date of release: 20 May 2020

Document Identifier: ASUG

