

All rights are reserved. Reproduction in whole or in parts is prohibited without consent of the copyright owner.

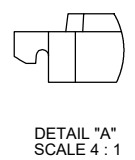
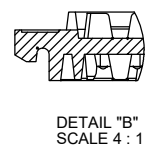
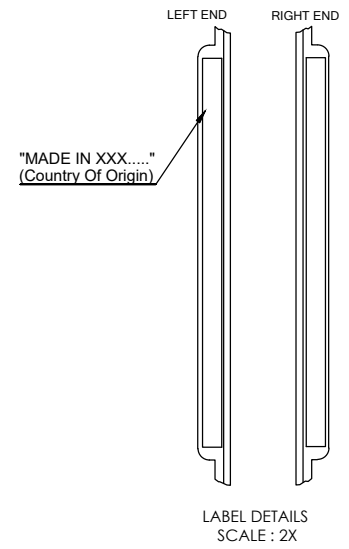
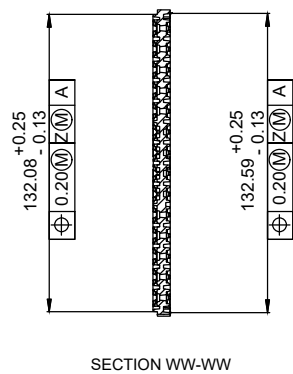
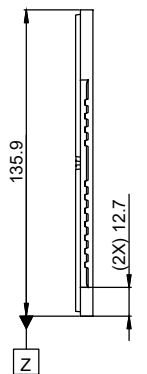
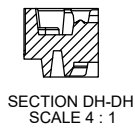
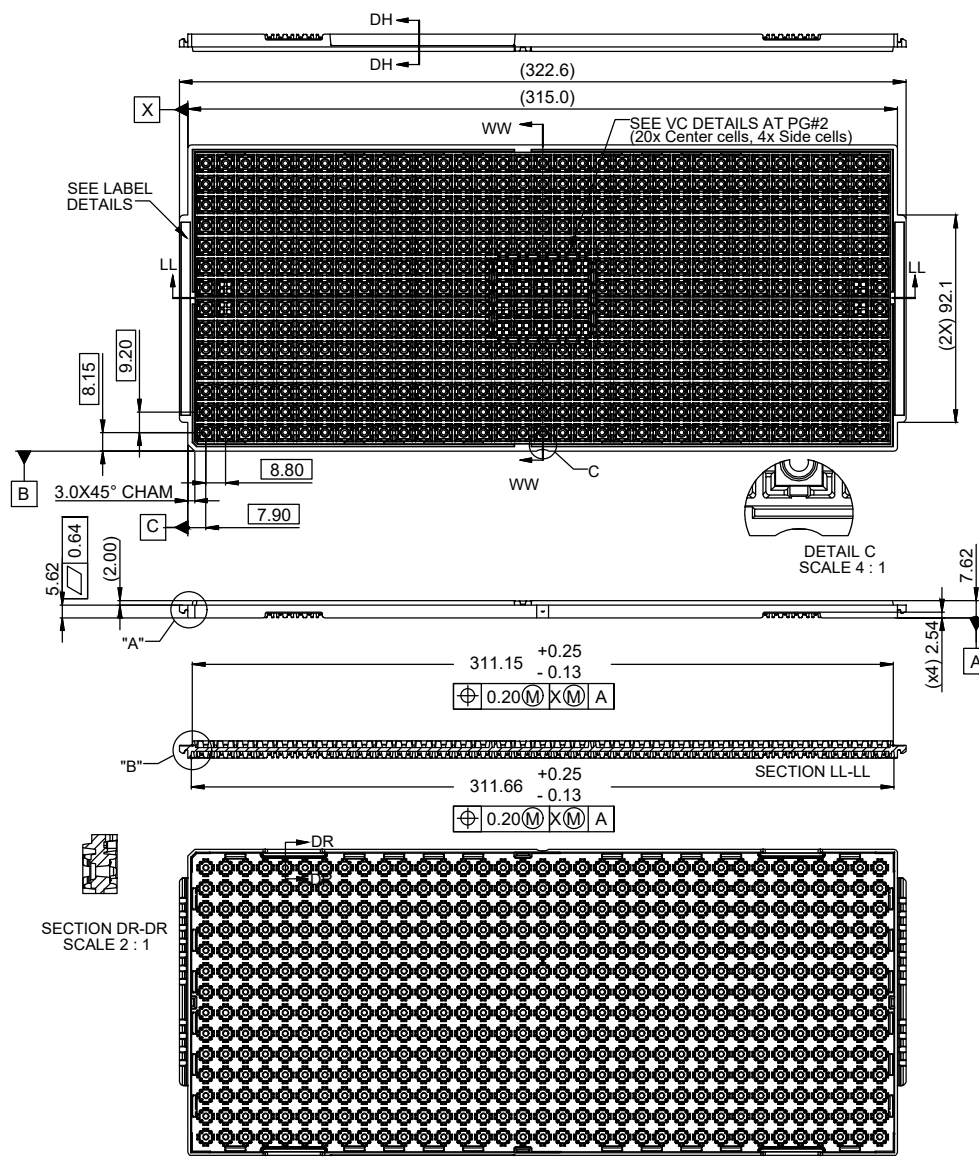

NOTES:

1. All dimensions are in mm
2. Tolerances - X.X = ±0.25
X.XX = ±0.13
3. Unless otherwise specified
ESD - Surface resistance
- 10⁴ to <10¹¹ ohms
4. Tray cavity 14x35=490
5. Tray temperature is Mid Temp (150°C)

DESCRIPTION	SMAT 12NC	PMAT 12NC	SUPPLIER P/N	SUPPLIER
		JTRAY 14x35 QFN 5x5 Mid	3422 135 02834	40505-15-1435-9/G
NAME Nicholas Ng		DATE 2/3/2022	SHEET 1 of 3	REV 0

All rights are reserved. Reproduction in whole or in parts is prohibited without consent of the copyright owner.



SIDE LOCKS (2X)

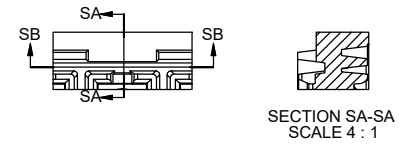

SECTION SA-SA
SCALE 4 : 1

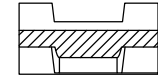

SECTION SB-SB
SCALE 4 : 1

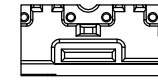

SECTION SB-SB
SCALE 4 : 1

END LOCKS (2X)

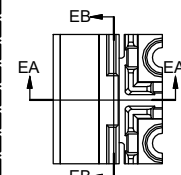

SECTION EB-EB
SCALE 4 : 1

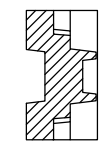

SECTION EB-EB
SCALE 4 : 1

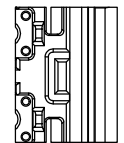

SECTION EB-EB
SCALE 4 : 1

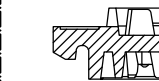

SECTION EA-EA
SCALE 4 : 1

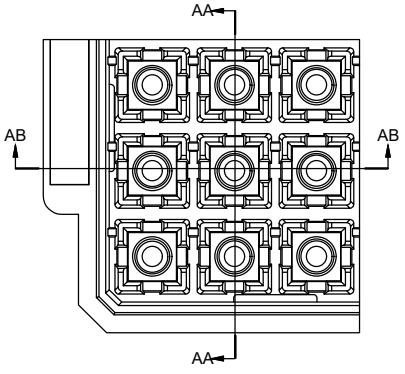

SECTION AA-AA
SCALE 4 : 1

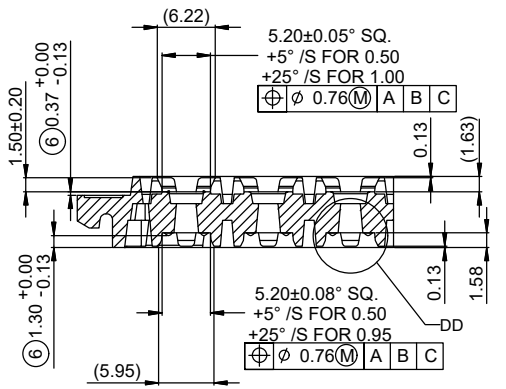
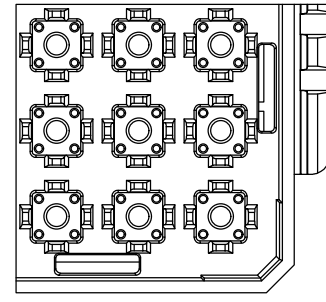
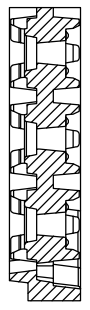

SECTION AB-AB
SCALE 4 : 1

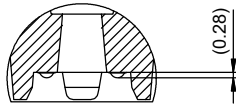

DETAIL DD
SCALE 8 : 1

"VC" DETAIL

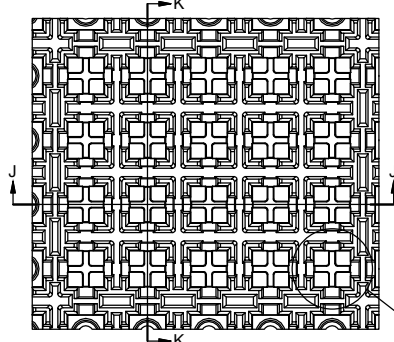

SECTION K-K
SCALE 3 : 1

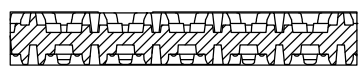
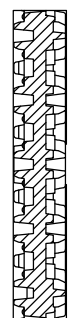

SECTION J-J
SCALE 3 : 1

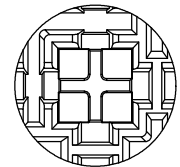

DETAIL DL
SCALE 6 : 1

DESCRIPTION	SMAT 12NC	PMAT 12NC	SUPPLIER P/N	SUPPLIER
		3422 135 02834	40505-15-1435-9/G	ITW
JTRAY 14x35 QFN 5x5 Mid	3422 135 23552			
NAME Nicholas Ng	DATE 2/3/2022	SHEET 2 of 3	REV	0



All rights are reserved. Reproduction in whole or in parts is prohibited without consent of the copyright owner.

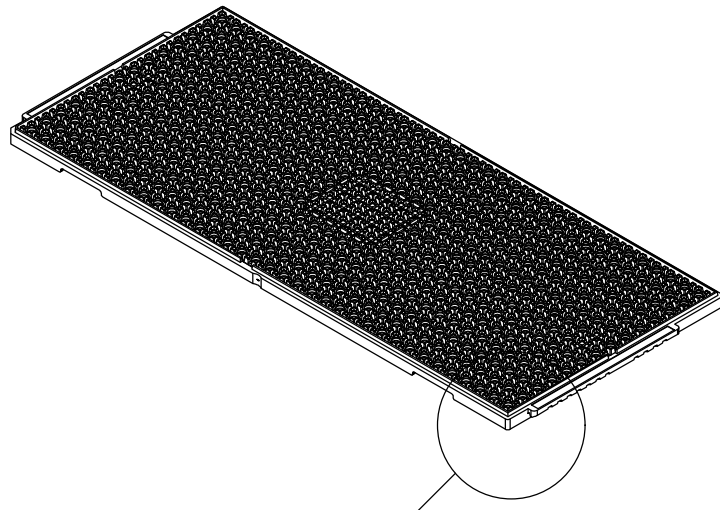

ISO-T

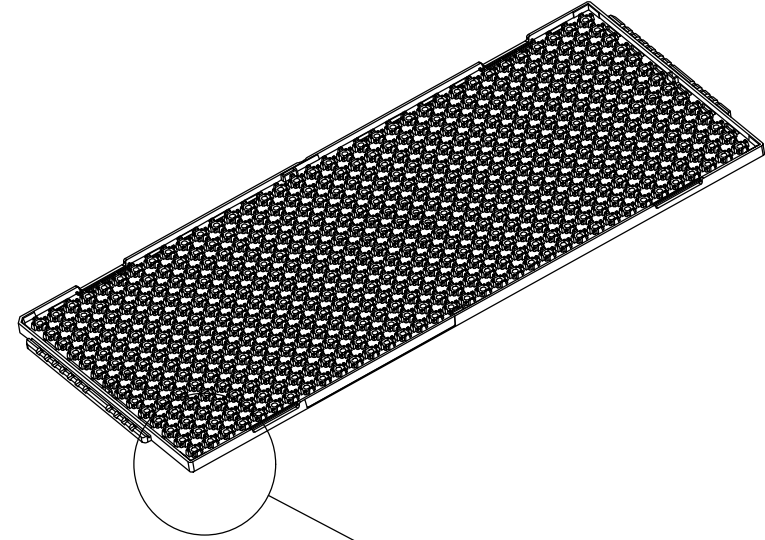

ISO-B

DETAIL ISO-T
SCALE 4 : 1

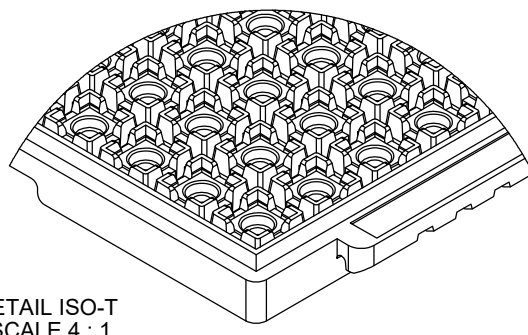

DETAIL ISO-B
SCALE 4 : 1

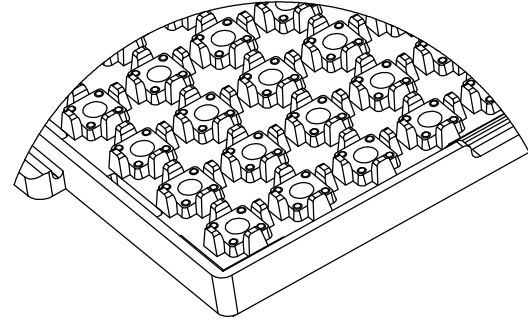

DESCRIPTION	SMAT 12NC	PMAT 12NC	SUPPLIER P/N	SUPPLIER
		JTRAY 14x35 QFN 5x5 Mid	3422 135 23552	3422 135 02834
NAME Nicholas Ng		DATE 2/3/2022	SHEET 3 of 3	REV 0