



# Flip Chip Plastic Ball Grid Array (FC-PBGA)

## Application Note

Q2 2012



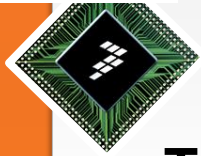

# FC-PBGA Application Note

## Table of Contents

## Slide

- 1. FC-PBGA Package Configurations 3
- 2. Printed Circuit Board Design for FC-PBGA 11
- 3. Surface Mount Assembly 16
- 4. Component Level Qualification 29
- 5. Board-Level Reliability 31
- 6. Thermal Performance 38





# FC-PBGA Package Configurations



Freescale, the Freescale logo, Altivec, C-5, CodeTEST, CodeWarrior, ColdFire, C-Ware, the Energy Efficient Solutions logo, mobileGT, PowerQUICC, QorIQ, StarCore and Symphony are trademarks of Freescale Semiconductor, Inc., Reg. U.S. Pat. & Tm. Off. BeeKit, BeeStack, ColdFire+, CoreNet, Flexis, Kinetic, MXC, Platform in a Package, Processor Expert, QorIQ Converge, Qoriva, QUICC Engine, SMARTMOS, TurboLink, VortiQa and Xtrinsic are trademarks of Freescale Semiconductor, Inc. All other product or service names are the property of their respective owners. © 2011 Freescale Semiconductor, Inc.

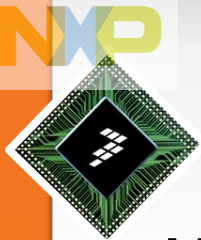

# Freescale Flip Chip Package Configurations

Many Freescale high performance products require the performance advantages of a flip chip Ball Grid Array (BGA) package. Flip chip packages are offered in bare die, flat lid and full lid configurations.

## Bare Die Configuration

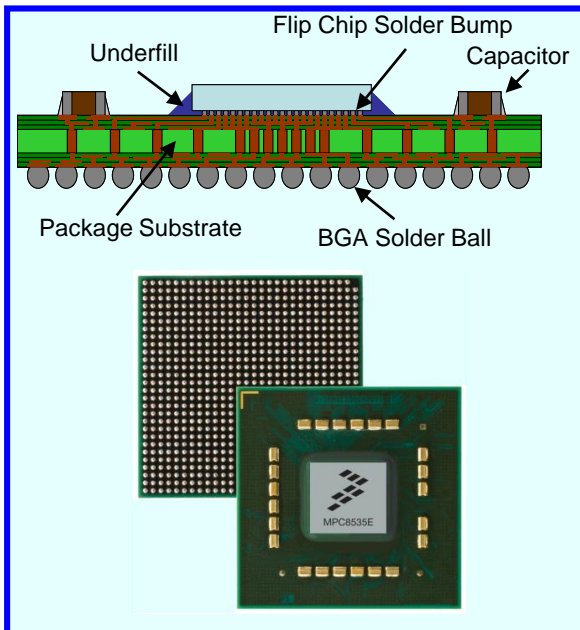

## Flat Lid Configuration

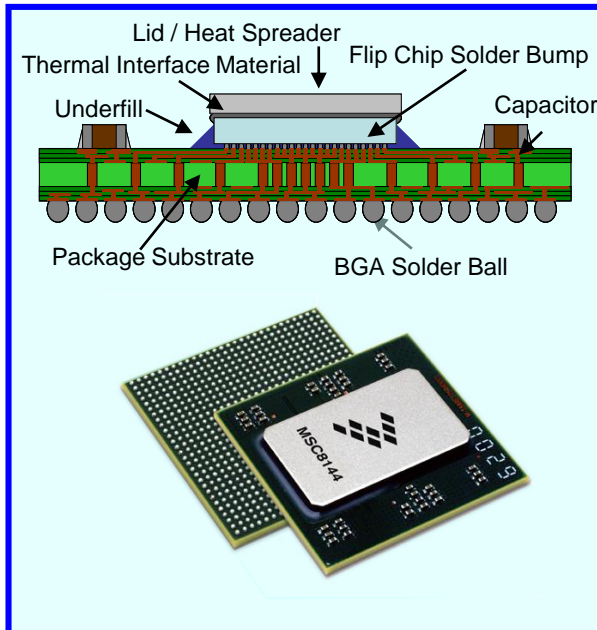

## Full Lid Configuration

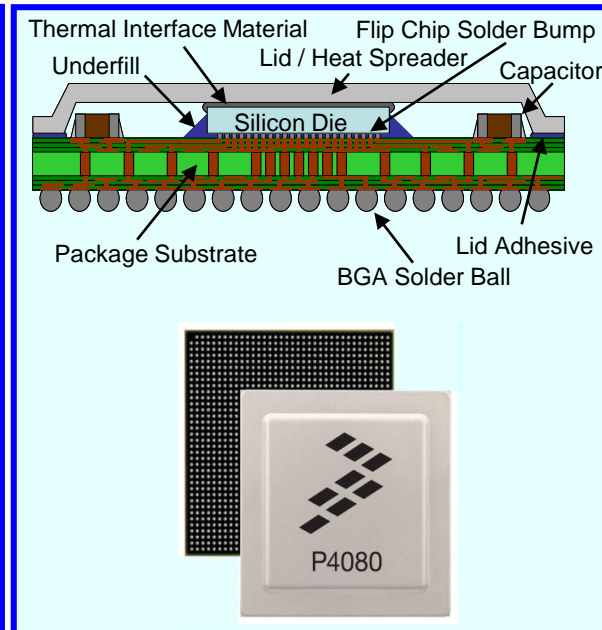

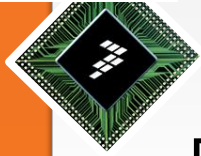

# Freescale FC-PBGA Solder Bump Construction

Freescale FC-PBGA packages feature either a high-lead solder bump soldered to the package substrate with a eutectic tin-lead solder or a lead-free bump

Typical High-Lead Solder Bump Interconnect

Typical Pb-Free Solder Bump Interconnect

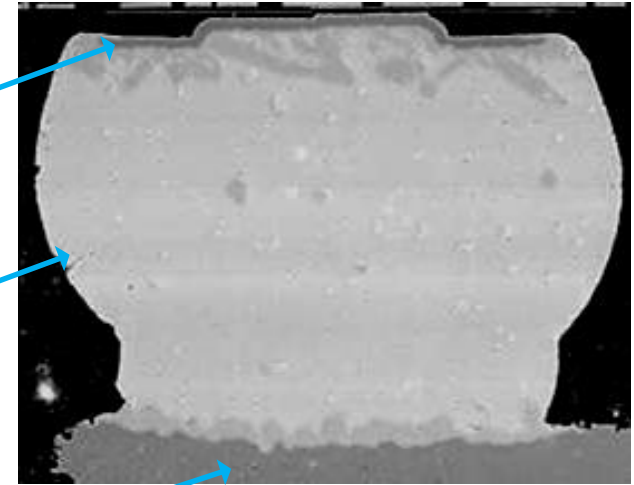
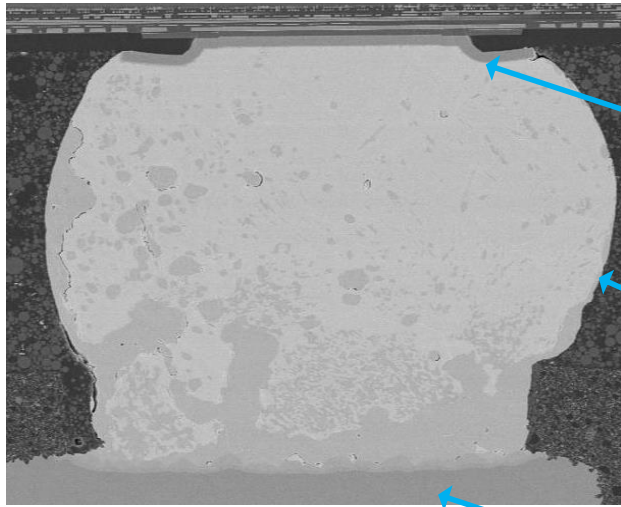

Under Bump Metallurgy (UBM)

Bump

Package Substrate Copper Pad

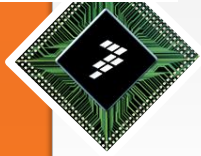

# Freescale FC-PBGA Body Sizes

- Freescale Flip-Chip PBGA body sizes range from 17x17mm to 45x45mm
- BGA sphere pitch currently ranges from 0.8 to 1.27 mm

## Freescale Flip-Chip PBGA Package Attributes

Body Size (mm)	Package I/O Count	Sphere Pitch (mm)	Sphere Array	Pkg SM Diam* (mm)
17x17	332	0.8	19x19	0.4
20x20	431	0.8	23x23	0.4
21x21	520	0.8	25x25	0.5
21x21	624	0.8	25x25	0.525
23x23	780	0.8	28x28	0.5
21x21	255	1.27	16x16	0.635
25x25	360	1.27	19x19	0.635
25x25	575	1.0	24x24	0.55
29x29	783	1.0	28x28	0.55
33x33	1023	1.0	32x32	0.55
37.5x37.5	1295	1.0	36x36	0.55
45x45	1935	1.0	44x44	0.55

\* Package BGA pads are soldermask defined. "Pkg SM Diam" is the BGA pad soldermask opening

- *Information is based on products currently in production and is subject to change.*
- *Contact Freescale or visit [www.Freescale.com](http://www.Freescale.com) for details on specific products.*

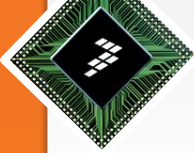

# FC-PBGA Pin A1 Location

Pin A1 location on Freescale devices may be indicated by a topside marker and/or depopulated corner sphere on the bottom-side

## Examples of Pin A1 Markers

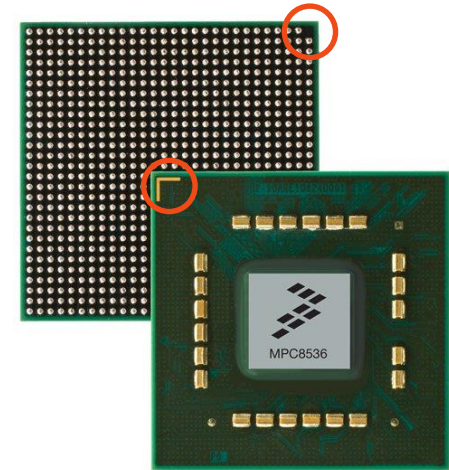
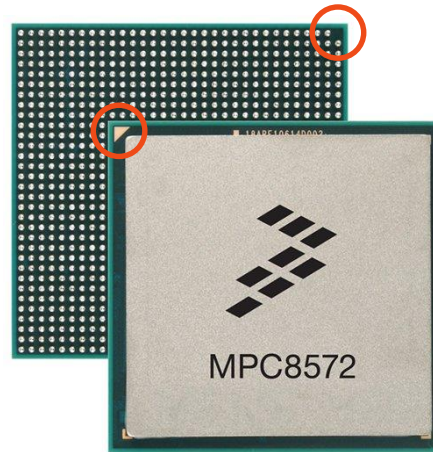
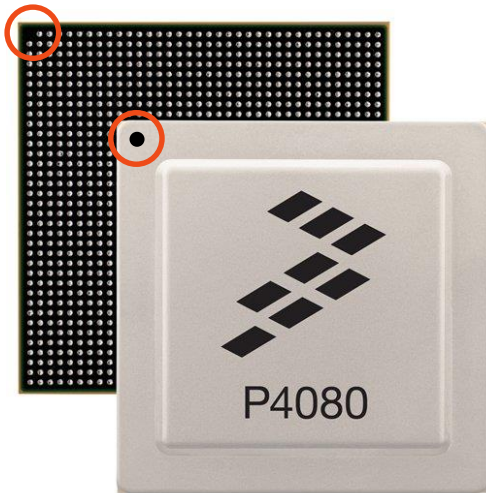

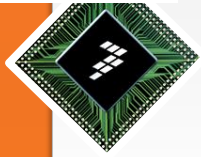

# FC-PBGA Substrate Construction

- Most FC-PBGA substrates feature High Density Interconnect (HDI) construction with Build-Up (BU) layers on both sides of glass/epoxy core.
- Construction is typically designated by the number of build-up and core copper layers (BU-C-BU)
  - Example: (3-2-3) construction is 3 build-up layers on both sides of a two layer glass/epoxy core
- See Freescale package drawings for substrate thickness specifications

## 10-Layer (4-2-4) Construction Cross-Section

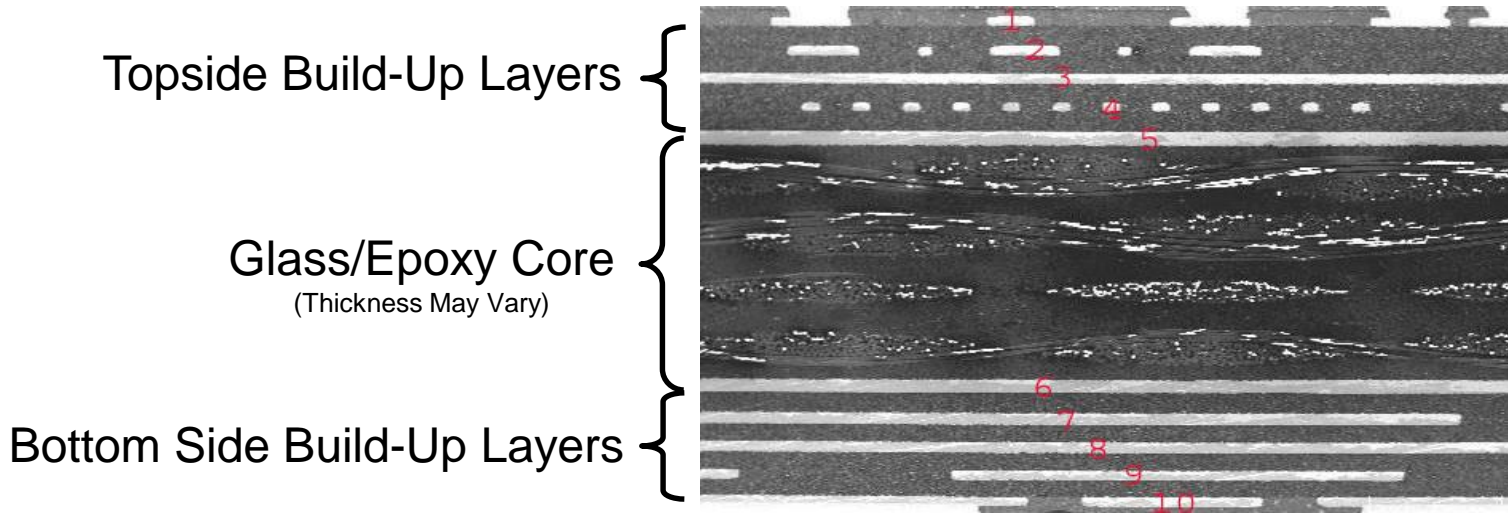



# Freescale Package Drawing Location

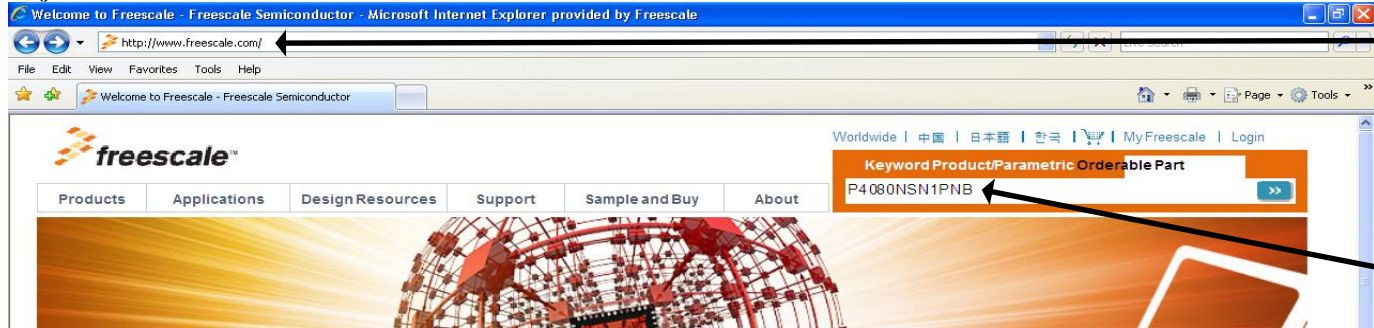

Go to :  
<http://www.freescale.com/>

Enter Part Number.  
 P4080NSN1PNB is used  
 for this example

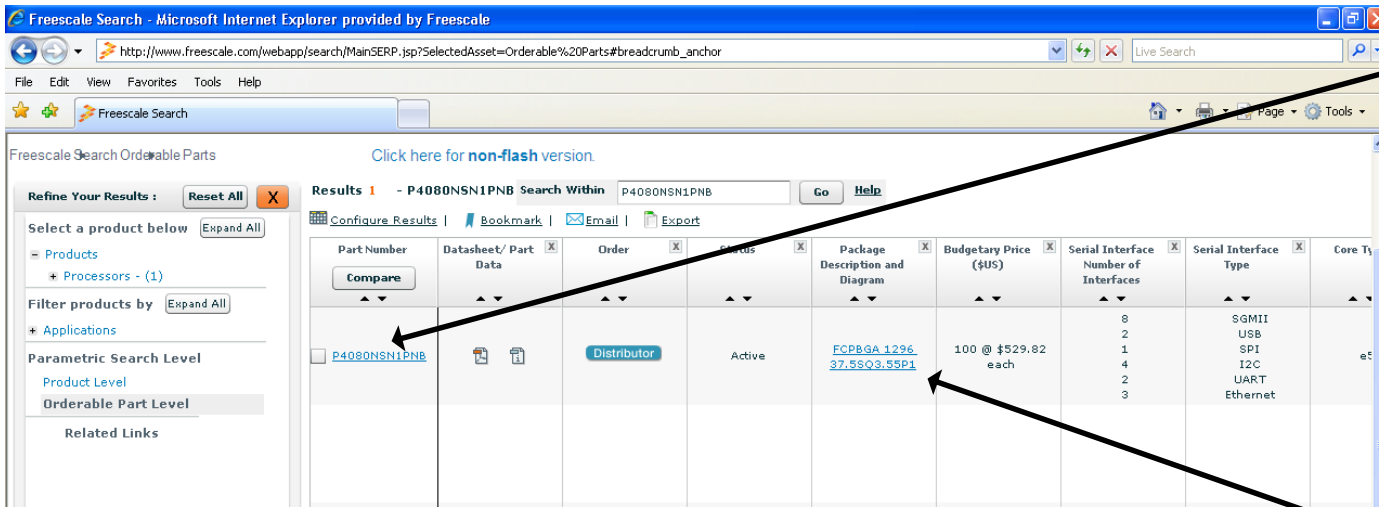

Next screen shows  
 search results for Part  
 Number  
 P4080NSN1PNB

Package drawing can at  
 found at this link (see  
 next slide)

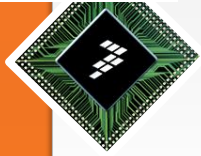

# Example 1296 Lidded FC-PBGA Package Drawing

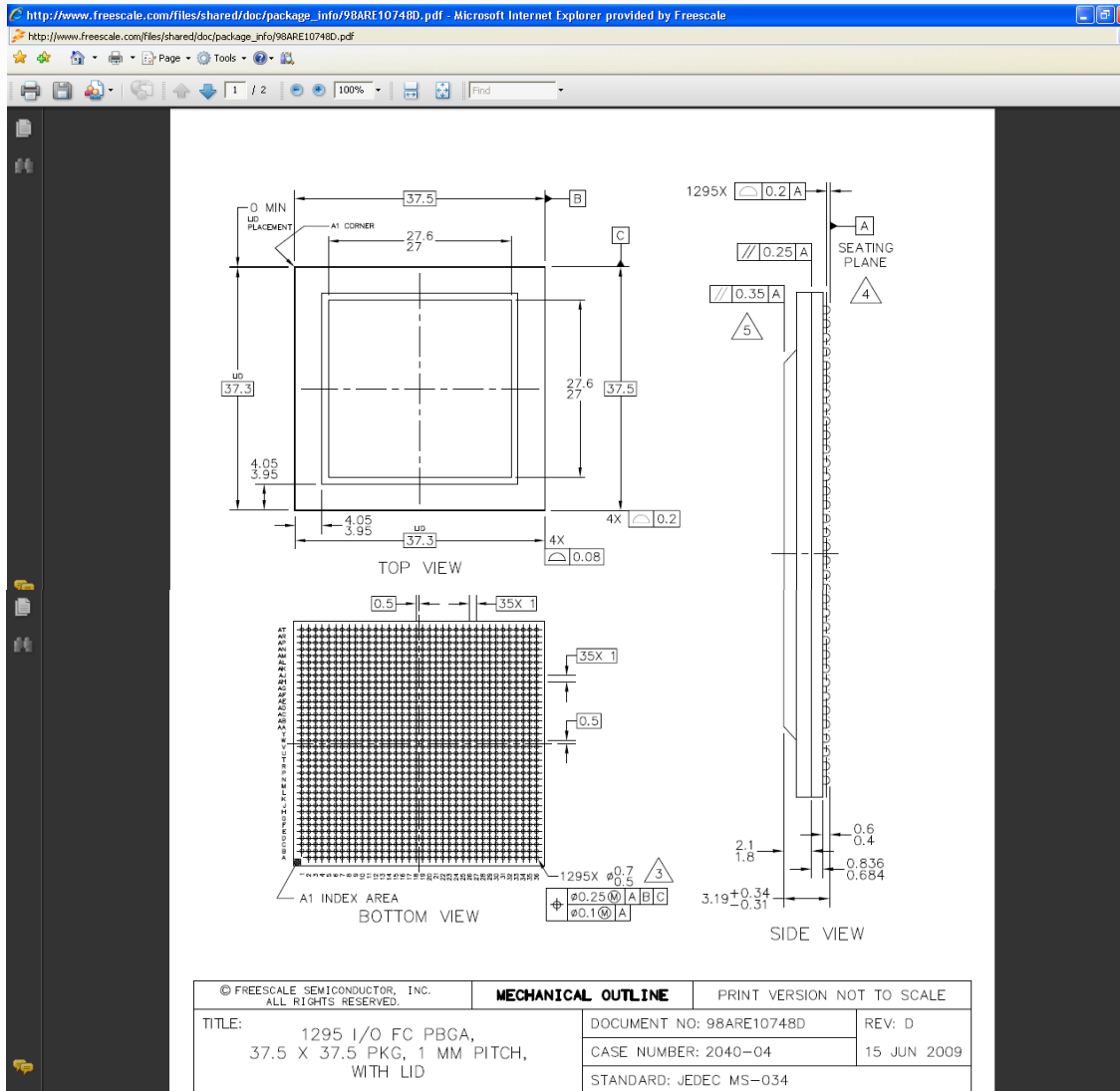



# Printed Circuit Board Design for FC-PBGA



Freescale, the Freescale logo, Altivec, C-5, CodeTEST, CodeWarrior, ColdFire, C-Ware, the Energy Efficient Solutions logo, mobileGT, PowerQUICC, QorIQ, StarCore and Symphony are trademarks of Freescale Semiconductor, Inc., Reg. U.S. Pat. & Tm. Off. BeeKit, BeeStack, ColdFire+, CoreNet, Flexis, Kinetis, MXC, Platform in a Package, Processor Expert, QorIQ Converge, Qoriva, QUICC Engine, SMARTMOS, TurboLink, VortiQa and Xtrinsic are trademarks of Freescale Semiconductor, Inc. All other product or service names are the property of their respective owners. © 2011 Freescale Semiconductor, Inc.

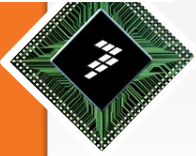

# Printed Circuit Board Pad Design for FC-PBGA

- **Solder pad diameter:**

- In general, printed circuit board (PCB) pad solderable diameter should match the package pad diameter
- See table on slide 6 for common package pad diameters
- When required for routing, motherboard pad diameter may be decreased by up to 10% versus the package pad

- **Solder pad configurations:**

- Non-Soldermask Defined (NSMD) pads:
  - Most common type of motherboard pad in the industry
  - Typically results in the most consistent solderability, especially with hot air solder leveled (HASL) surface finish
- Soldermask Defined (SMD) pads:
  - Added strength provided by the soldermask overlap
- NSMD motherboard pads recommended for most applications

**NSMD Pad**

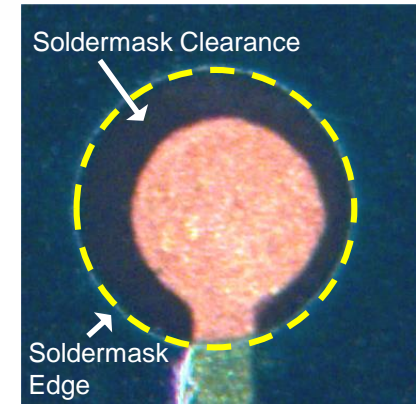

**SMD Pad**

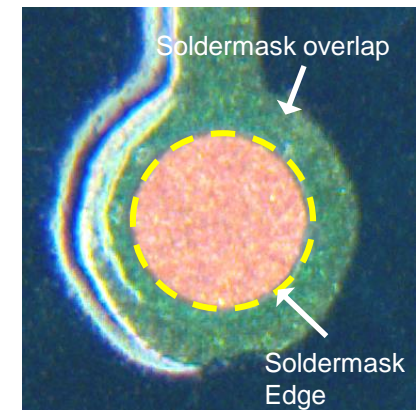

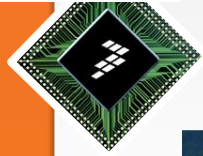

# Trade-Offs Between SMD and NSMD PCB Pads

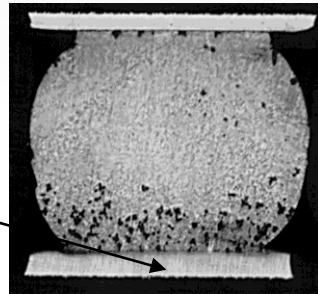

**SMD = SolderMask Defined**  
**Advantages**

1. Strongest mechanical strength
2. More copper, better heat spreading to board
3. More heat resistant - multiple reworks

**Disadvantages**

1. Potential stress point
2. Foreign matter entrapment on pad
3. Possible worse dimensional tolerance on solderable diameter versus NSMD

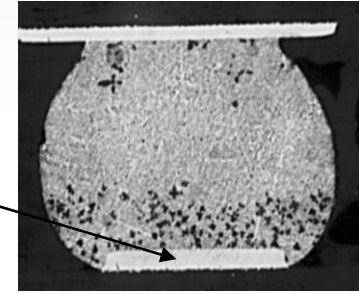
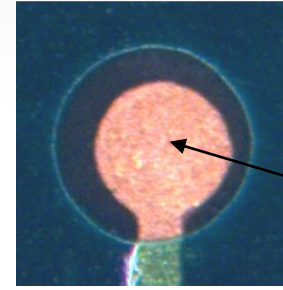

**NSMD = Non-SolderMask Defined**  
**Advantages**

1. Most common pad configuration
2. Potentially the most solderable pad since no soldermask encroachment
3. No point of stress concentration at PC board
4. More copper to copper space to route traces between pads

**Disadvantages**

1. Reduced pad to PCB adhesion strength
2. May be weak link in other mechanical testing, i.e. board bending, mechanical shock and vibration
3. Non-symmetrical joint fails at the package interface first in thermal cycling

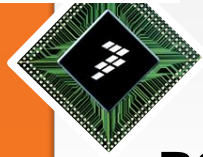

# PCB Pad Design Guidelines

- **PCB Surface Finish for FC-PBGA**
  - Surface finishes compatible with FC-PBGA include: organic solderability protectant (OSP), Hot Air Solder Leveled (HASL), electroless or electrolytic nickel/gold (NiAu) and immersion silver (Ag)
- **PCB Routing Vias for FC-PBGA**
  - For coarser BGA pitches, use thru-hole vias that are offset from the BGA PCB pad and placed interstitially between BGA pads
    - Via preferably tented with soldermask on both sides of PCB or soldermask covering the trace connecting the via and BGA pad
  - Finer pitches may require the use of via-in-pad structures:

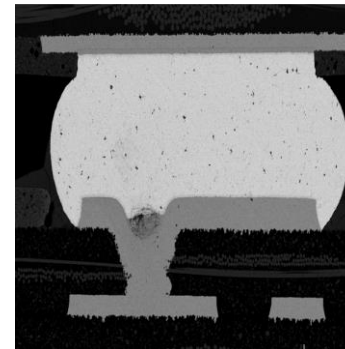
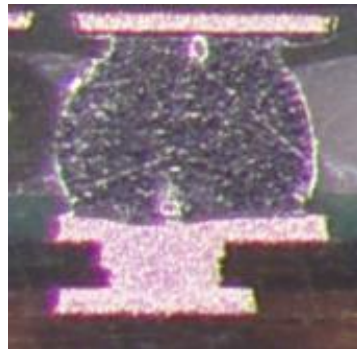
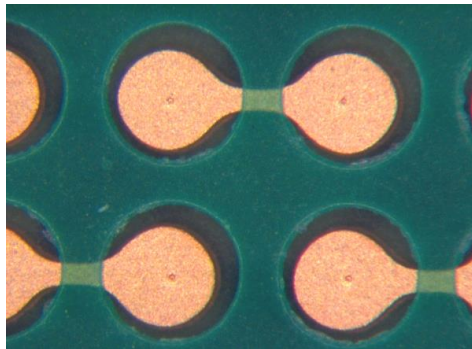

***PCB Pads for PBGA Employing MicroVia-in-Pad  
(Use of plated or otherwise filled microvias recommended)***

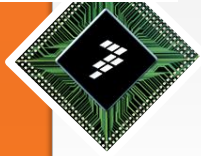

# PCB Pad Design for FC-PBGA

- Diameter of Copper Solder Pad shown below should be equal to or as much as 10% smaller than FC-PBGA package pad diameter (see Slide 6 for package diameters)

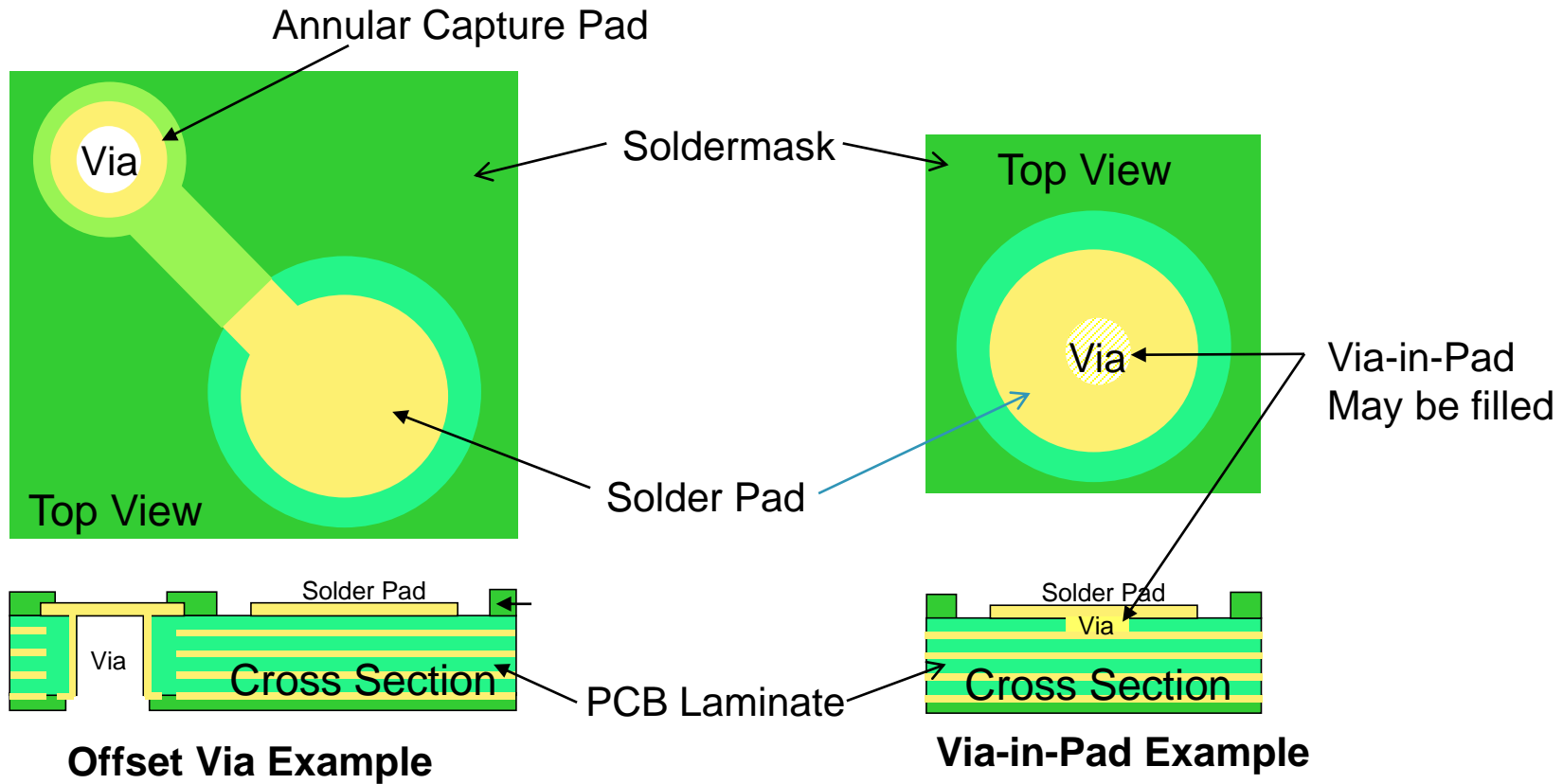



# Surface Mount Assembly



Freescale, the Freescale logo, Altivec, C-5, CodeTEST, CodeWarrior, ColdFire, C-Ware, the Energy Efficient Solutions logo, mobileGT, PowerQUICC, QorIQ, StarCore and Symphony are trademarks of Freescale Semiconductor, Inc., Reg. U.S. Pat. & Tm. Off. BeeKit, BeeStack, ColdFire+, CoreNet, Flexis, Kinetis, MXC, Platform in a Package, Processor Expert, QorIQ Converge, Qoriva, QUICC Engine, SMARTMOS, TurboLink, VortiQa and Xtrinsic are trademarks of Freescale Semiconductor, Inc. All other product or service names are the property of their respective owners. © 2011 Freescale Semiconductor, Inc.



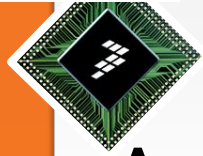

# Surface Mount Assembly

## Avoiding FC-PBGA Package Delamination

- ▶ Always follow instructions on shipping container
- ▶ Do not exceed the package peak temperature (PPT) rating shown on the shipping container label
  - Example: An MSL3 245°C device can only be out of the original vacuum sealed dry bag one week (i.e., 168 hours) maximum prior to soldering, and the peak package temperature should not exceed 245C during reflow.
- ▶ Establish strict process control and procedures to ensure safe operation conditions
- ▶ Use dry nitrogen cabinets to store devices after opening packages
- ▶ Rework boards within time allowed in room environment
  - Example: An MSL3 device must be soldered and reworked within one week of opening the vacuum sealed dry bag
- ▶ FC-PBGAs that have been out of the dry bag longer than their specified MSL rating can be baked dry at 125°C for 24 hrs. This is highly recommended prior to any rework or removal of the FC-PBGA from the PCB

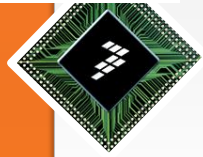

# Surface Mount Assembly

## FC-PBGA Pre-Assembly Handling

- ▶ FC-PBGAs are typically moisture sensitive and rated at MSL3 following JEDEC moisture sensitivity specifications in J-STD-020, similar to other plastic packages.
- Follow Moisture Sensitivity guidelines printed on the package labels.

JEDEC Moisture Level Table		
Level	Condition	Allowable Time Out of Dry Pack*
1	30°C / 85% RH	Unlimited
2	30°C / 60% RH	1 year
2a	30°C / 60% RH	4 weeks
3	30°C / 60% RH	168 hours
4	30°C / 60% RH	72 hours
5	30°C / 60% RH	48 hours
5a	30°C / 60% RH	24 hours
6	30°C / 60% RH	Time on Label

**\*Re-Bake required if time our of Dry-Pack exceeds allowable limits**

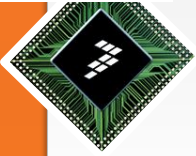

# Surface Mount Assembly

## Solder Stencils:

- For BGA the typical stencil aperture diameter should be the same size as the PCB solder pad
- Slight reductions (0.02 - 0.05 mm) of the stencil diameter to the PCB pad diameter may improve gasketing between the stencil and the PCB and help with solder paste release
- 125 to 150  $\mu\text{m}$  thick stencils have been found to give good results
- Follow the IPC-7525 *Stencil Design Guidelines*

## Solder Paste:

- Use of no clean rosin based solder paste is recommended
- For 0.65 mm BGA solder ball pitch and higher use a paste formulated with type 3 powder
- For BGA pitches below 0.65 mm type 4 powder is recommended

# Surface Mount Assembly



## FC-PBGA Solder Joint Voids

- BGA solder joint voids commonly known as “Macro” or “Process” voids are the result of solder paste flux volatiles trapped during the solidification of the molten solder during the PCB reflow assembly process
- PCB assembly process parameters as well as the type of solder paste used can have a significant impact on the quantity and size of the voids.
- Water washable solder paste typically produces larger voids than rosin based paste
- IPC-610 calls out a void criteria of 25% of joint area
  - Studies\* have shown no quality or reliability issues with voids  $\geq 25\%$

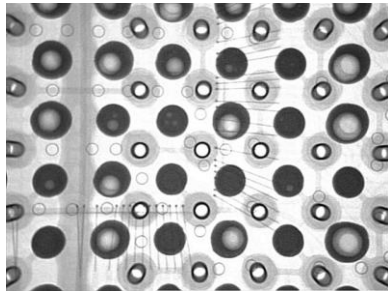

***X-Ray Showing Voids in BGA Solder Joints***

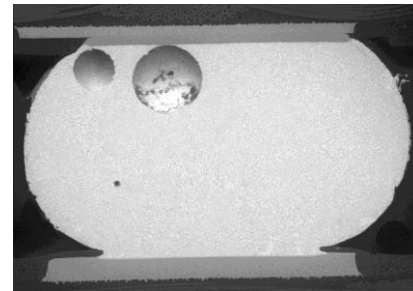

***Cross-Section of BGA Solder Joint Showing Macro Voids***

Reference: "The Effects of Solder Joint Voiding on Plastic Ball Grid Array Reliability," Donald R. Banks, et al., 1996 SMI Proceedings, pages 121-126.

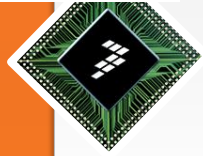

# Surface Mount Assembly

## FC-PBGA Placement

- FC-PBGAs have excellent self-centering properties which are attributed to surface tension between the applied solder on the PCB solder pad and the FC-PBGA solder sphere
- FC-PBGA solder spheres can be placed up to 50% off the PCB pad
  - Surface tension during solder reflow will center the BGA spheres to the PCB pads.
- Placement machine vision systems can be used to place the FC-PBGA by either sphere alignment or component package body alignment
- When placing by component body alignment the solder sphere location variability is typically +/- 0.075 mm, worst case
- The solder spheres of the FC-PBGA should be pushed into the printed solder paste until contacting the PCB solder pad to reduce the risk of HIP (Head in Pillow) open solder joints

# Surface Mount Assembly

## FC-PBGA Placement – Bare Die Packages

- Care should be taken to avoid damaging the exposed silicon die backside or edges when handling and placing bare die devices. A compliant tip nozzle (such as rubber), preferably with closed loop head force control should be used to pick and place exposed silicon devices
- Consult your pick and place equipment provider for pick-up tip size and material recommendations.

***Metal Pick-Up Tip May Cause  
Damage to Exposed Die***

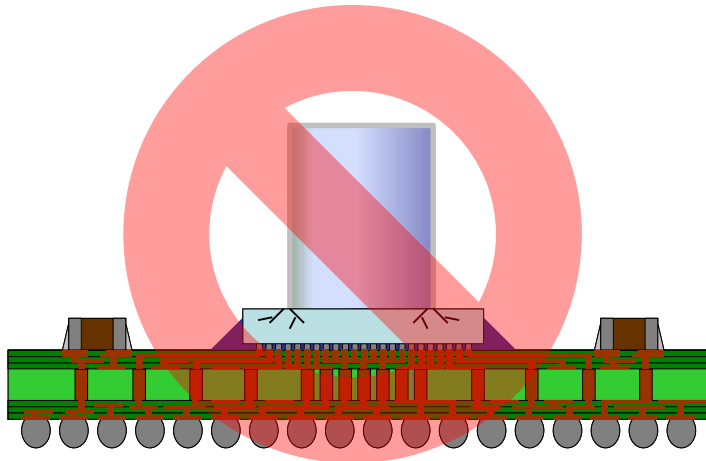

***Compliant Tip Nozzle is  
Preferred***

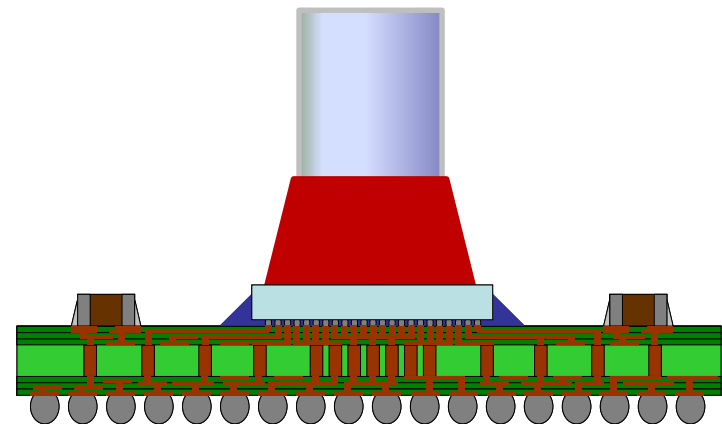

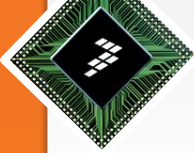

# Surface Mount Assembly

## Soldering Pb-Free BGA with Pb-Free Solder Paste - Reflow Recommendations

- Reflow preheat - Use the solder paste suppliers minimum reflow preheat recommendations to avoid over drying of the paste flux which can contribute to “Head in Pillow” (HIP) open solder joints
- Achieve a minimum solder joint temperature (SJT) of 235°C
  - Ideal peak temperature is typically 240 – 245C
- Dwell time above 217°C should be 50 – 80 seconds

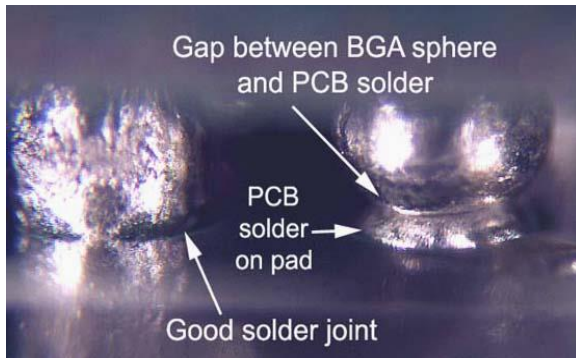

**Head In Pillow (HiP) Open Joint**

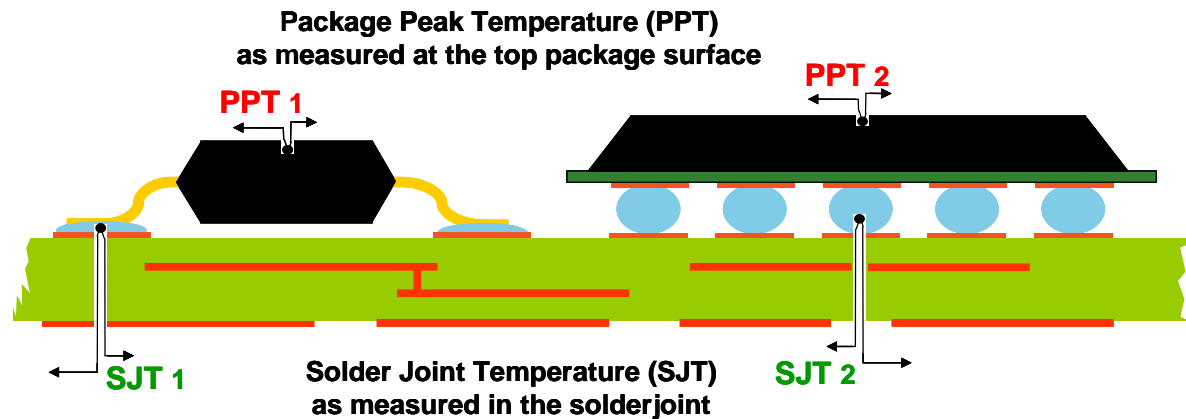

**Package Peak Temperature vs Solder Joint Temperature**

# Surface Mount Assembly

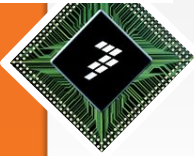

## Thermal Profiling Recommendations

- ▶ Use new, fine gauge, calibrated, welded thermocouple beads
  - ▶ 36 gage wire preferable
- ▶ Hand twisted thermocouple wires can cause inaccurate readings
  - Temperature will be taken at first good contact twist or shared with several contact points
- ▶ For FC-PBGA, embed the thermocouple which will measure the SJT (solder joint temperature) in the solder sphere using high temperature, thermally conductive, electrically insulative epoxy
- ▶ Larger FC-PBGAs can have a high thermal mass relative to other components and should be carefully profiled with one thermocouple in a corner sphere and a second thermocouple in a inner sphere on a fully populated profile PCB

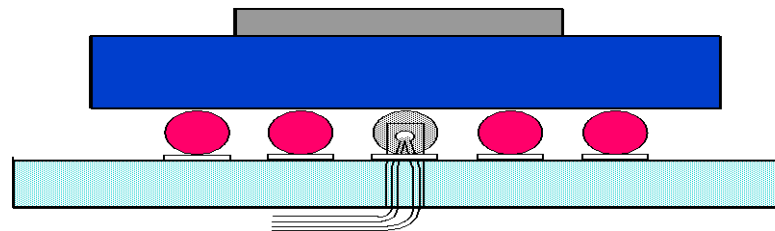



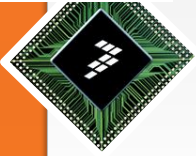

# Surface Mount Assembly

## Soldering Pb-free BGA with SnPb Solder Paste

- In some applications, it may be required that BGA with Pb-free spheres may need to be soldered using traditional SnPb soldering processes
- Such mixed alloy BGA soldering processes are not typically recommended
- A minimum solder joint temperature (SJT) of 225°C may be used to provide for complete melting of the BGA solder sphere and mixing with the SnPb solder paste
- Dwell time above the solder paste melting temperature of 183°C should still be 50 – 80 seconds
- Use the solder paste supplier's minimum reflow preheat recommendations to avoid over drying of the paste flux which can contribute to "Head in Pillow" (HIP) open solder joints
- Before board assembly verify all components on the PCB can withstand package peak temperatures (PPT) >225°C

# Surface Mount Assembly

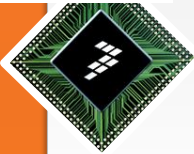

## Post Reflow Washing

- Post reflow washing with water or solvents is typically discouraged as moisture or chemicals could corrode or attack package materials
- If a water or solvent wash process is used, care must be taken to completely dry the water from the PCB and components following the wash process
  - Component should be cooler than wash fluid when entering wash process
- This is especially true with the full lid FC-PBGA configuration shown below
  - This configuration typically features venting that allows pressure equalization between the inside and outside surfaces of the lid
- During the water or solvent wash process, moisture or chemicals may seep under the lid through the vents
  - To remove this moisture a post-wash bake is strongly recommended.

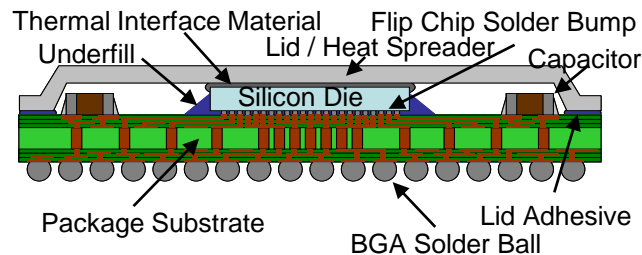

**Typical Full Lid FC-PBGA**

# Surface Mount Assembly

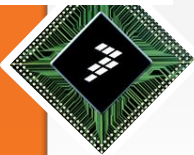

## FC-PBGA Sphere Alloys

- FC-PBGA solder spheres may be Pb-bearing or Pb-free
  - All BGA spheres should collapse to the PCB solder pad during assembly soldering
  - The amount of collapse is controlled by solder pad geometries and surface tension of the solder
  
- Pb-bearing sphere compositions may include:
  - The most common is 62Sn36Pb2Ag
  - Some may contain 63Sn37Pb
  
- Lead-free sphere compositions may include:
  - SAC387 - 95.5Sn3.8Ag0.7Cu
  - SAC405 - 95.5Sn4.0Ag0.5Cu
  - SAC305 - 96.5Sn3.0Ag0.5Cu
  - SnAg - 96.5Sn3.5Ag

**Note:**

- 1) Pb = lead, Sn = tin, Ag = silver, Cu = copper
- 2) All compositions listed are weight percent

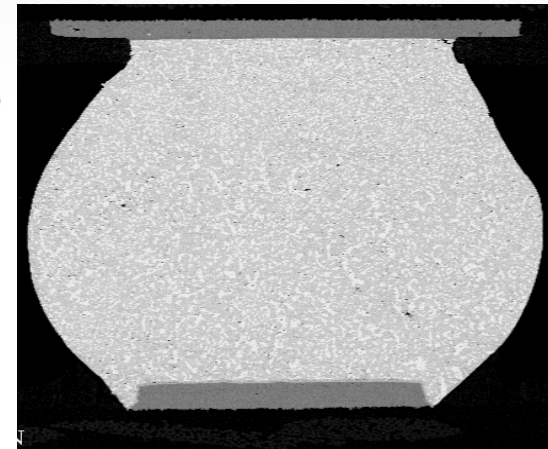

**SnPbAg PBGA Sphere**

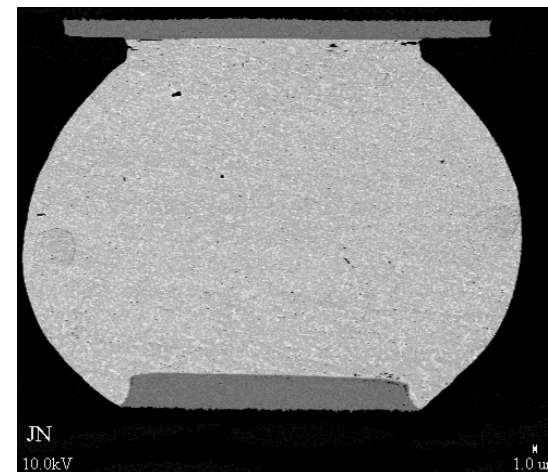

**SAC405 PBGA Sphere**

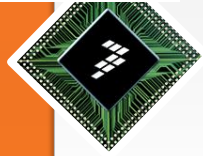

# Surface Mount Assembly

## FC-PBGA Rework

- Entire board to be reworked should be baked for at least 12 hours at 125° C or the highest temp the assembly can withstand to remove moisture which can result in FC-PBGA package delamination
- FCPBGA spheres completely melt and will solder without additional solder if flux only is applied. Solder paste is not required for FC-PBGA replacement
- The same careful temperature profiling procedures should be used for rework as is used during the original reflow process
- Preheat the entire board in an offline bake oven to minimize “oil canning” type PCB warpage under the FC-PBGA. Preheat SnPb soldered boards to a minimum of 125°C and Pb-free boards to a minimum of 150°C
- After desoldering the FC-PBGA remove residual solder from the PCB solder pads while the PCB is still hot using solder wick and a soldering iron
- Apply a small volume of no clean flux to the cleaned PCB solder pads
- Place the new BGA using a microscope or rework station that incorporates a vision system capable of viewing the BGA spheres as well as the PCB solder pads
- It is not recommended to use reballed BGAs on products due to long-term solder joint reliability concerns

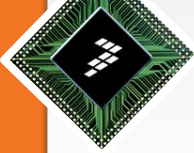

# Determining FC-PBGA Solder Sphere Alloy

- Following the instructions on slide 9, go to <http://www.freescale.com/>
- Enter the Freescale Part Number (make sure “Orderable Part” is selected)
- On the next screen, click on the link for package drawing which will open a table
- Click on “Download IPC-1752 Report” which opens the Matl Composition Report
- The solder sphere alloy including maximum allowable trace elements will be listed
- In this example the alloy is SAC305 or 96.5%Sn3.0%Ag0.5%Cu by weight

http://www.freescale.com/mc/ds/P4080NSN1PNB.pdf - Microsoft Internet Explorer provided by Freescale

http://www.freescale.com/mc/ds/P4080NSN1PNB.pdf

+P +M +S -X Capacitor, 0402		g	Other	Metals	Cupric oxide	1317-38-0	0.000075	g	1	1	58,000
+P +M +S -X Capacitor, 0402		g	Other	Metals	Manganese dioxide	1313-13-9	0.000138	g	1	1	106,000
+P +M +S -X Capacitor, 0402		g	Other	Metals	Nickel, metal and allo	7440-02-0	0.000088	g	1	1	68,000
+P +M +S -X Capacitor, 0402		g	Other	Metals	Tin, metal and alloys	7440-31-5	0.000055	g	1	1	42,000
+P +M +S -X Capacitor, 0402		g	Other	Metals	Barium titanate	12047-27-7	0.000941	g	1	1	724,000
+P +M +S -X Solder Balls - Lead	1.2821	g						g			
+P +M +S -X Solder Balls - Lead		g	Other	Metals	Antimony, metal and	7440-36-0	0.000641	g	1	1	500
+P +M +S -X Solder Balls - Lead		g	Other	Metals	Arsenic metal and all	7440-38-2	0.000385	g	1	1	300
+P +M +S -X Solder Balls - Lead		g	Other	Metals	Bismuth metal and al	7440-69-9	0.000385	g	1	1	300
+P +M +S -X Solder Balls - Lead		g	Other	Metals	Cadmium, metal and	7440-43-9	0.000026	g	1	1	20
+P +M +S -X Solder Balls - Lead		g	Other	Metals	Copper, metal and all	7440-50-8	0.006411	g	1	1	5,000
+P +M +S -X Solder Balls - Lead		g	Other	Metals	Gold, metal and alloy	7440-57-5	0.000064	g	1	1	50
+P +M +S -X Solder Balls - Lead		g	Other	Metals	Lead, metallic lead ar	7439-92-1	0.000641	g	1	1	500
+P +M +S -X Solder Balls - Lead		g	Other	Metals	Nickel, metal and allo	7440-02-0	0.000064	g	1	1	50
+P +M +S -X Solder Balls - Lead		g	Other	Metals	Silver, metal and allo	7440-22-4	0.038463	g	1	1	30,000
+P +M +S -X Solder Balls - Lead		g	Other	Metals	Tin, metal and alloys	7440-31-5	1.235021	g	1	1	963,280



# Component Level Qualification



Freescale, the Freescale logo, Altivec, C-5, CodeTEST, CodeWarrior, ColdFire, C-Ware, the Energy Efficient Solutions logo, mobileGT, PowerQUICC, QorIQ, StarCore and Symphony are trademarks of Freescale Semiconductor, Inc., Reg. U.S. Pat. & Tm. Off. BeeKit, BeeStack, ColdFire+, CoreNet, Flexis, Kinetic, MXC, Platform in a Package, Processor Expert, QorIQ Converge, Qoriva, QUICC Engine, SMARTMOS, TurboLink, VortiQa and Xtrinsic are trademarks of Freescale Semiconductor, Inc. All other product or service names are the property of their respective owners. © 2011 Freescale Semiconductor, Inc.

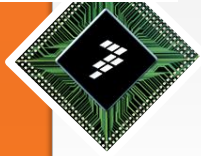

# FC-PBGA Component Level Qualification

- Flip-Chip PBGA packages are typically qualified to industrial tier levels based on JEDEC specifications
- Most Flip-Chip PBGA packages are qualified to MSL3 at peak reflow of either 245°C or 260°C
  - Products qualified to MSL3 must be soldered within 168 hours after opening dry-pack

## Typical Flip-Chip PBGA Industrial Qualification Levels

Environmental Stress	Condition	With Precondition?	Qualification Readpoint	JEDEC Reference
Moisture Preconditioning - Level 3	30 C, 60% RH, 196hrs + 3x Reflow			J-STD-020C
Air to Air Temperature Cycle (AATC)	-40 to 125 C	Yes	850 Cycles	JESD22-A104
	OR			
	-55 to 125 C	Yes	700 Cycles	
High Temperature Storage (HTS)	150 C	No	1008 Hours	JESD22-A103
Perform Either ONE of the Following:				
Temperature-Humidity Bias (THB)	85 C, 85% RH	Yes	1008 Hours	JESD22-A108
Biased Highly Accelerated Stress Test (Biased HAST)	130 C, 85% RH	Yes	96 Hours	JESD22-A110



# FC-PBGA Board Level Reliability



Freescale, the Freescale logo, AltiVec, C-5, CodeTEST, CodeWarrior, ColdFire, C-Ware, the Energy Efficient Solutions logo, mobileGT, PowerQUICC, QorIQ, StarCore and Symphony are trademarks of Freescale Semiconductor, Inc., Reg. U.S. Pat. & Tm. Off. BeeKit, BeeStack, ColdFire+, CoreNet, Flexis, Kinetic, MXC, Platform in a Package, Processor Expert, QorIQ Converge, Qoriva, QUICC Engine, SMARTMOS, TurboLink, VortiQa and Xtrinsic are trademarks of Freescale Semiconductor, Inc. All other product or service names are the property of their respective owners. © 2011 Freescale Semiconductor, Inc.





# FC-PBGA Board Level Reliability

- Board mounted thermal cycling solder-joint reliability performed per IPC-9701A
  - Printed Circuit Board
    - 0.093" thick, 8 Cu layers
    - NSMD pads, OSP finish
  - Air Temperature Cycling
    - 0/100°C, 10 minute ramps, 10 minute dwells
    - In-situ daisy chain resistance monitoring
      - 300 Ohms or greater is considered a failure
  
- Board mounted monotonic bend to failure performed per IPC-9702
  - Printed Circuit Board
    - 0.093" thick, 8 Cu layers
    - NSMD pads, OSP finish
  - Bend Test
    - Bend at strain rate of 5000 microstrain/second
    - Failure is break in strain/continuity

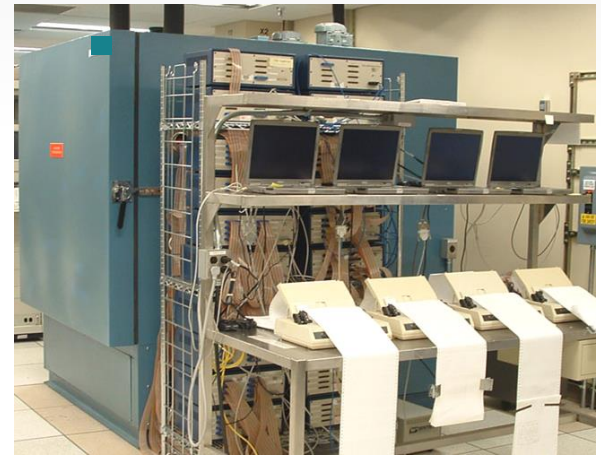

**Single Chamber Thermal Cycling**

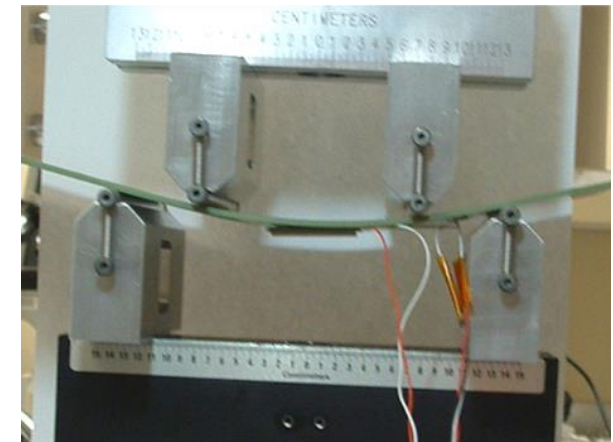

**Monotonic Bend to Failure Testing**

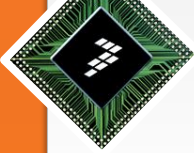

# FC-PBGA Board Level Reliability

## Example: FC-PBGA Board-Level Thermal Cycling Reliability Sphere Alloy Comparison

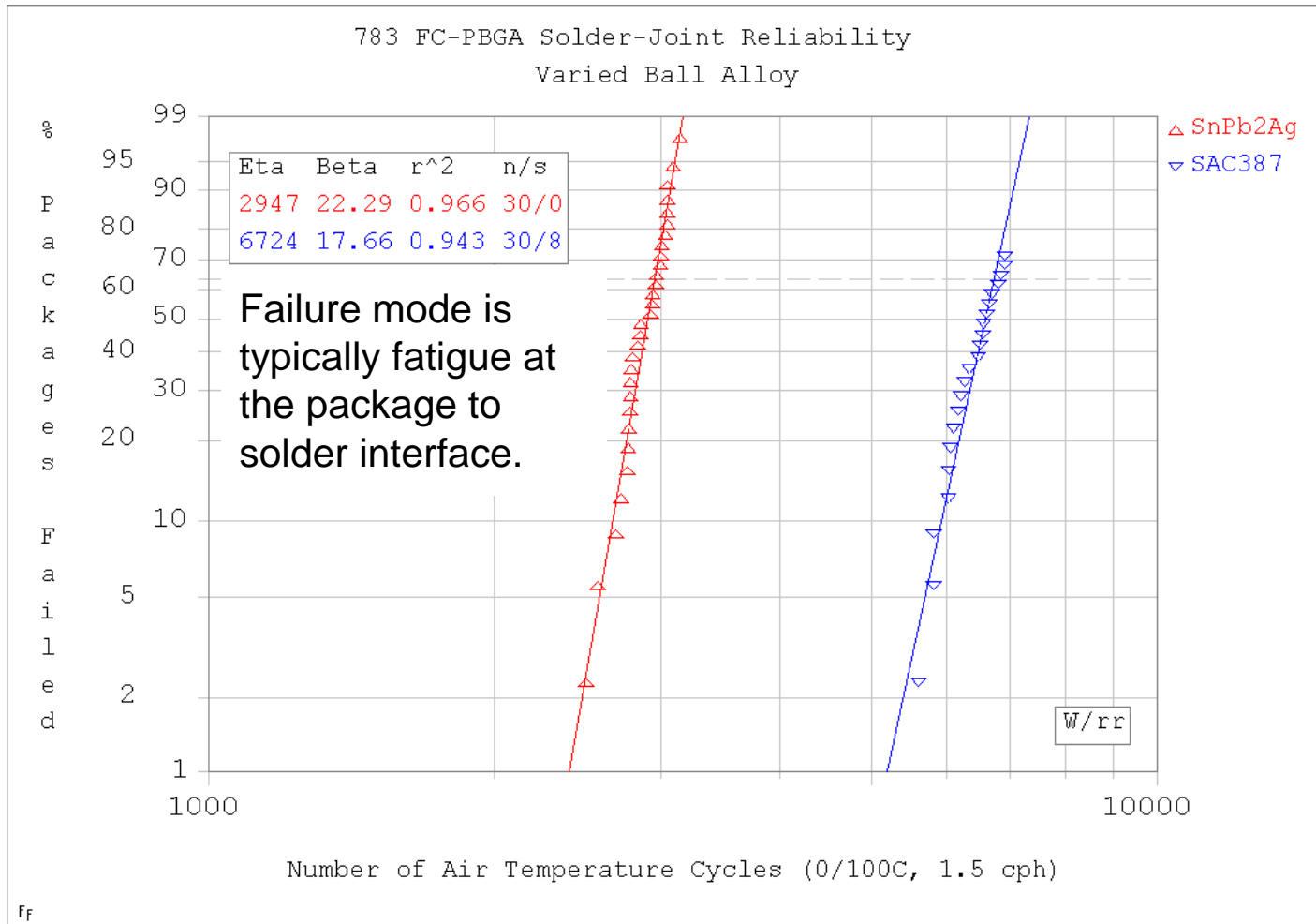

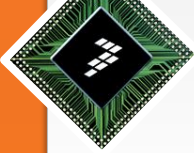

# FC-PBGA Board Level Reliability

## Example: FC-PBGA Board-Level Thermal Cycling Reliability Lid Configuration Comparison

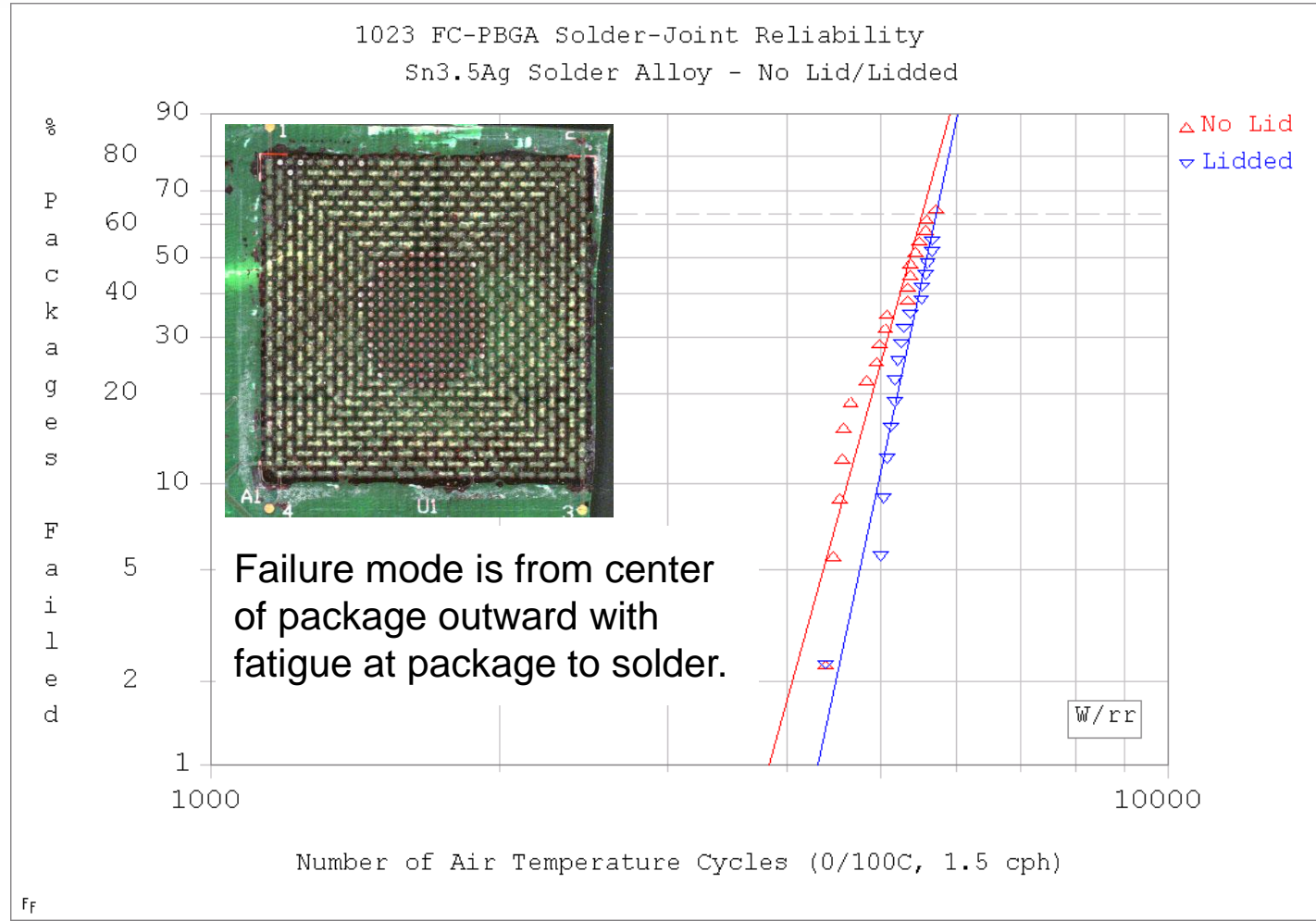

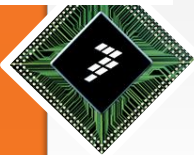

# FC-PBGA Board Level Reliability

## Example: FC-PBGA Board-Level Bend Test Reliability

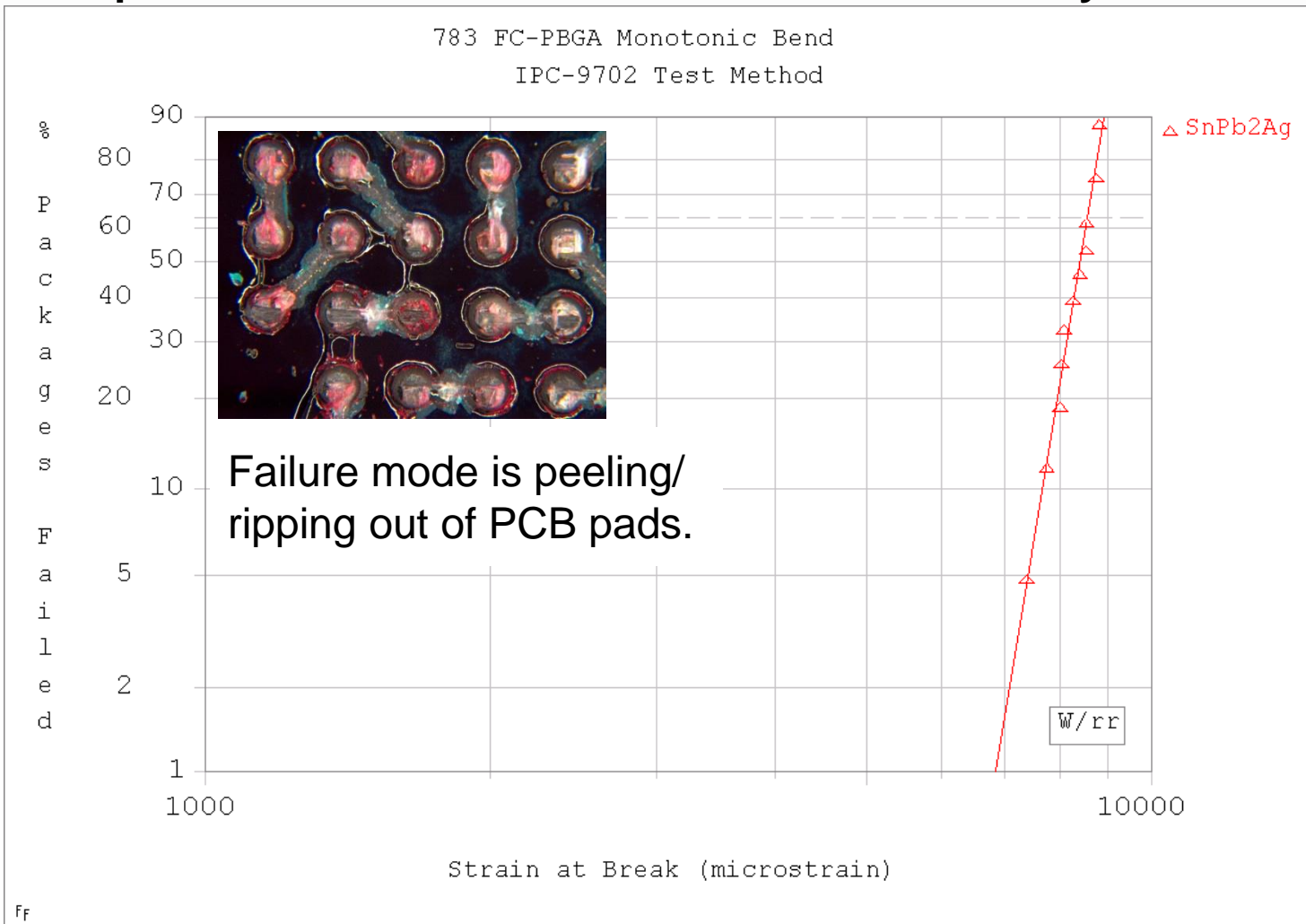

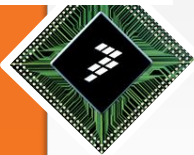

# FC-PBGA Board Level Reliability

## Example: FC-PBGA Board-Level Bend Test Reliability Lid Configuration Comparison

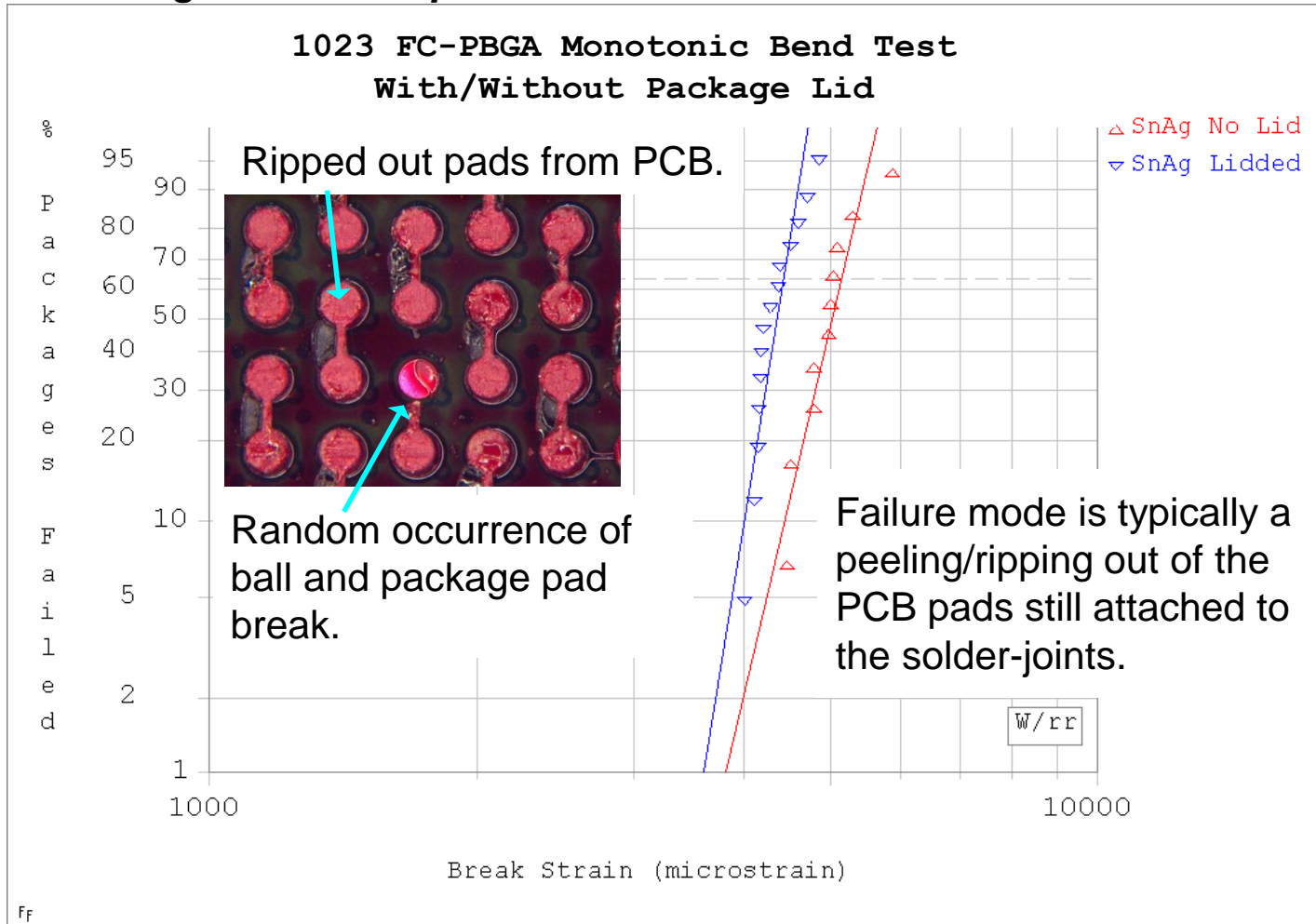

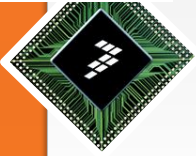

# FC-PBGA Board Level Reliability

- Freescale routinely gathers solder-joint reliability data for FC-PBGA packages
  - Data taken using IPC-9701A and IPC-9702 test methods
- Testing is by package configuration
  - For example, many Freescale products use the 783 FC-PBGA package
- Data availability
  - For packages not shown, customers may request reports from the appropriate Freescale Sales office or Freescale Applications group



# FC-PBGA Thermal Performance



Freescale, the Freescale logo, Altivec, C-5, CodeTEST, CodeWarrior, ColdFire, C-Ware, the Energy Efficient Solutions logo, mobileGT, PowerQUICC, QorIQ, StarCore and Symphony are trademarks of Freescale Semiconductor, Inc., Reg. U.S. Pat. & Tm. Off. BeeKit, BeeStack, ColdFire+, CoreNet, Flexis, Kinetic, MXC, Platform in a Package, Processor Expert, QorIQ Converge, Qoriva, QUICC Engine, SMARTMOS, TurboLink, VortiQa and Xtrinsic are trademarks of Freescale Semiconductor, Inc. All other product or service names are the property of their respective owners. © 2011 Freescale Semiconductor, Inc.

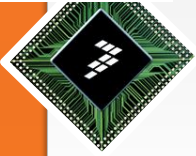

# FC-PBGA Thermal Performance

## Typical FC-PBGA Thermal Resistances in Standard JEDEC Environment:

- Example Case for 783 FC-PBGA 29x29 mm Body with Lid

Table of Thermal Resistance Data

Thermal Metric	JEDEC Test Board		Value	Unit
Junction to Ambient Natural Convection	Single layer board (1s)	$R_{\theta JA}$	18	$^{\circ}C/W$
Junction to Ambient Natural Convection	Four layer board (2s2p)	$R_{\theta JA}$	13	$^{\circ}C/W$
Junction to Ambient (@200 ft/min)	Single layer board (1s)	$R_{\theta JMA}$	12	$^{\circ}C/W$
Junction to Ambient (@200 ft/min)	Four layer board (2s2p)	$R_{\theta JMA}$	9	$^{\circ}C/W$
Junction to Board		$R_{\theta JB}$	5	$^{\circ}C/W$
Junction to Case (Top)		$R_{\theta JCtop}$	0.6	$^{\circ}C/W$

Notes:

1. Junction-to-Ambient Thermal Resistance determined per JEDEC JESD51-3 and JESD51-6. Thermal test board meets JEDEC specification for this package.
2. Junction-to-Board thermal resistance determined per JEDEC JESD51-8. Thermal test board meets JEDEC specification for the specified package.
3. Junction-to-Case at the top of the package determined using MIL-STD 883 Method 1012.1. The cold plate temperature is used for the case temperature. Reported value includes the thermal resistance of the interface layer.



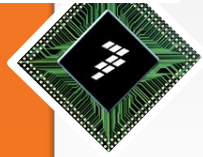

# FC-PBGA Thermal Performance

## Typical FC-PBGA Thermal Resistances in Standard JEDEC Environment:

- Example Case for 624 FC-PBGA 21x21 mm Body with No-Lid

Table of Thermal Resistance Data

Rating			No Lid	Unit
Junction to Ambient Natural Convection	Single layer board (1s)	$R_{\theta JA}$	31	°C/W
Junction to Ambient Natural Convection	Four layer board (2s2p)	$R_{\theta JA}$	22	°C/W
Junction to Ambient (@200 ft/min)	Single layer board (1s)	$R_{\theta JMA}$	24	°C/W
Junction to Ambient (@200 ft/min)	Four layer board (2s2p)	$R_{\theta JMA}$	18	°C/W
Junction to Board		$R_{\theta JB}$	12	°C/W
Junction to Case (Top)		$R_{\theta JCtop}$	< 0.1	°C/W

Notes:

1. Junction-to-Ambient Thermal Resistance determined per JEDEC JESD51-3 and JESD51-6. Thermal test board meets JEDEC specification for this package.
2. Junction-to-Board thermal resistance determined per JEDEC JESD51-8. Thermal test board meets JEDEC specification for the specified package.
3. Junction-to-Case at the top of the package determined using MIL-STD 883 Method 1012.1. The cold plate temperature is used for the case temperature. Reported value includes the thermal resistance of the interface layer.

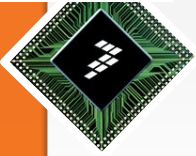

# FC-PBGA Thermal Performance

## Comparison of Lid vs. No-Lid FC-PBGA Thermal Resistances:

624 FC-PBGA 21x21mm Body Thermal Resistance\*

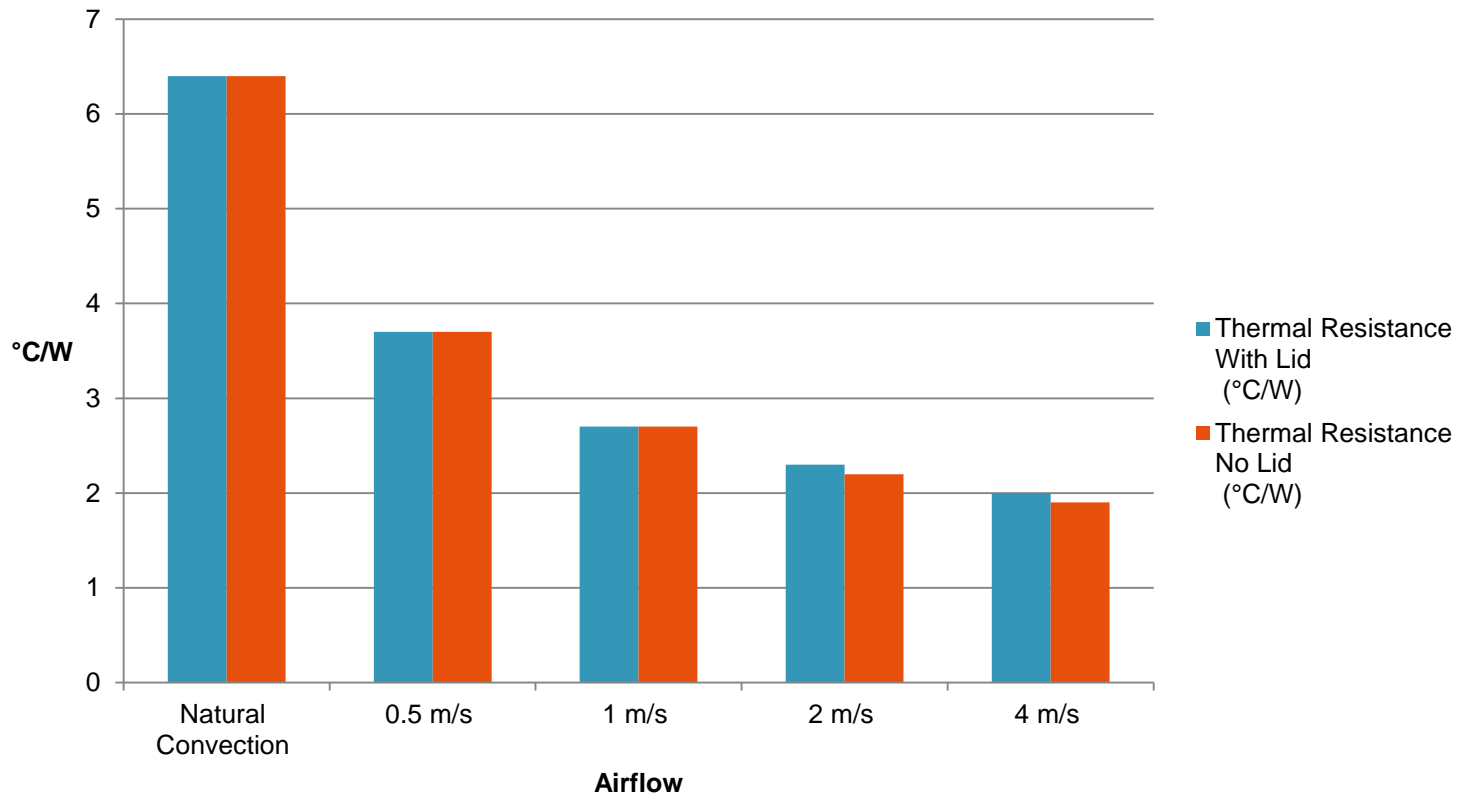

\*53 x 53 x 25 mm Pin Fin HeatSink

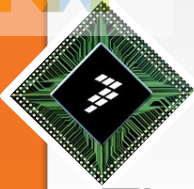

# FC-PBGA Thermal Performance

## Thermally Sinking Lid-Less Flip Chip Devices

- A uniform layer of thermal interface material must be present between the heat sink and the exposed die. Heat sink must not directly contact exposed die surface.
- Heat sink must be brought in contact with die backside thermal interface material with surface parallel to exposed die. Direct contact with die edges and corners may result in die damage
- Thermal Interface Material is not a glue and should not be relied upon exclusively for adhesion

***Application of Heatsink Non-Parallel to Die Backside May Cause Die Damage***

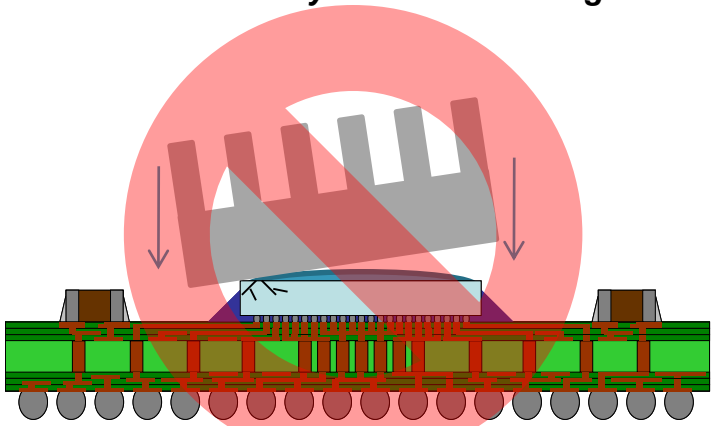

***Heatsink Surface Should be Parallel to Die BackSide Surface***

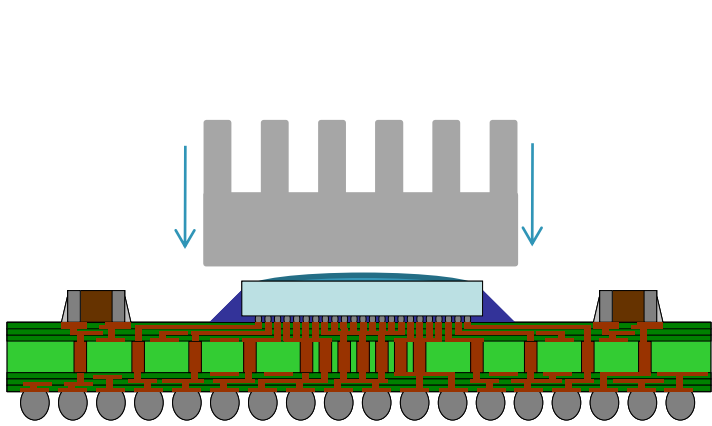

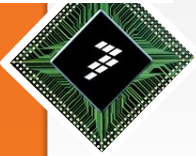

# FC-PBGA Thermal Performance

## Heat Sink Attachment

- The maximum allowable junction temperature for each product can be typically found in the hardware specification
- Depending on the application and the Freescale product involved, most applications may require a heat sink
  - The heat sink is selected by the customer
- It is recommended that heat sinks be attached to the Printed Circuit Board (PCB)
  - Clipping or attaching to the FC-PBGA substrate can result in solder ball failure
  - Backing plate may be necessary to prevent board warpage
- Maximum allowable heat sink attachment force varies by product and is typically as high as 45 Newtons (10 lb force)

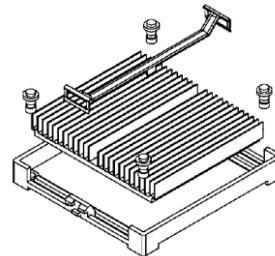

**Examples of Package Heat Sinks Available in the Industry**



# FC-PBGA Thermal Performance

## System-Level Thermal Modeling

*Example Case for 783 FC-PBGA with Full-Footed Lid in Network Server Application*

- Package: 783 29x29 mm FC-PBGA with fully footed lid
- Typical configuration considered: Four 783 FC-PBGA parts each on 3 AMC\* cards, 27 mm gap between cards
- Air speed 2 m/s
- Inlet air temperature: 55°C
- Each board uses an extruded plate fin heat sink (70×118×19 mm) to cool all FC-PBGA parts
- FC-PBGA device power is temperature dependent, power increases with temperature
  - Careful design of cooling system critical to prevent thermal runaway



Note: AMC = Advanced Mezzanine Card

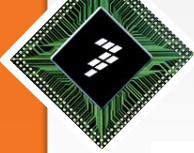

# FC-PBGA Thermal Performance

## Front View of System Thermal Model In-line Configuration, 3 In-Line AMC\* Cards

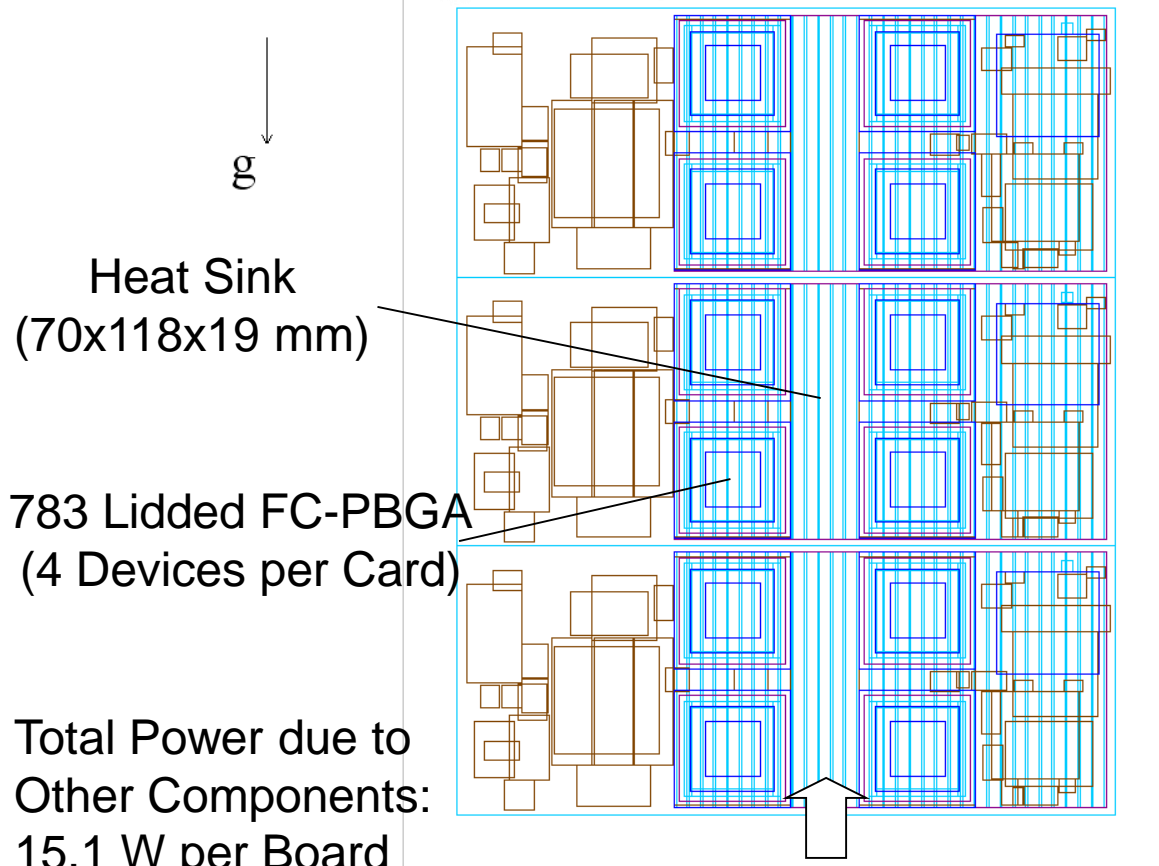

2 m/s Air Flow,  $T_{inlet} = 55^{\circ}C$

Note: AMC = Advanced Mezzanine Card

### Device Power is Temperature Dependent

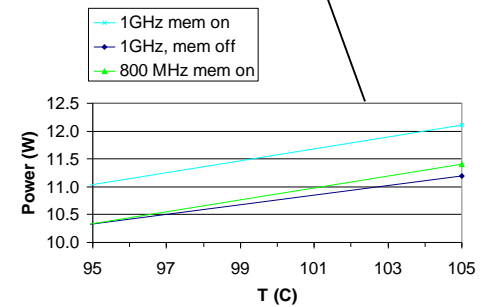



# FC-PBGA Thermal Performance

## System Thermal Model, End View

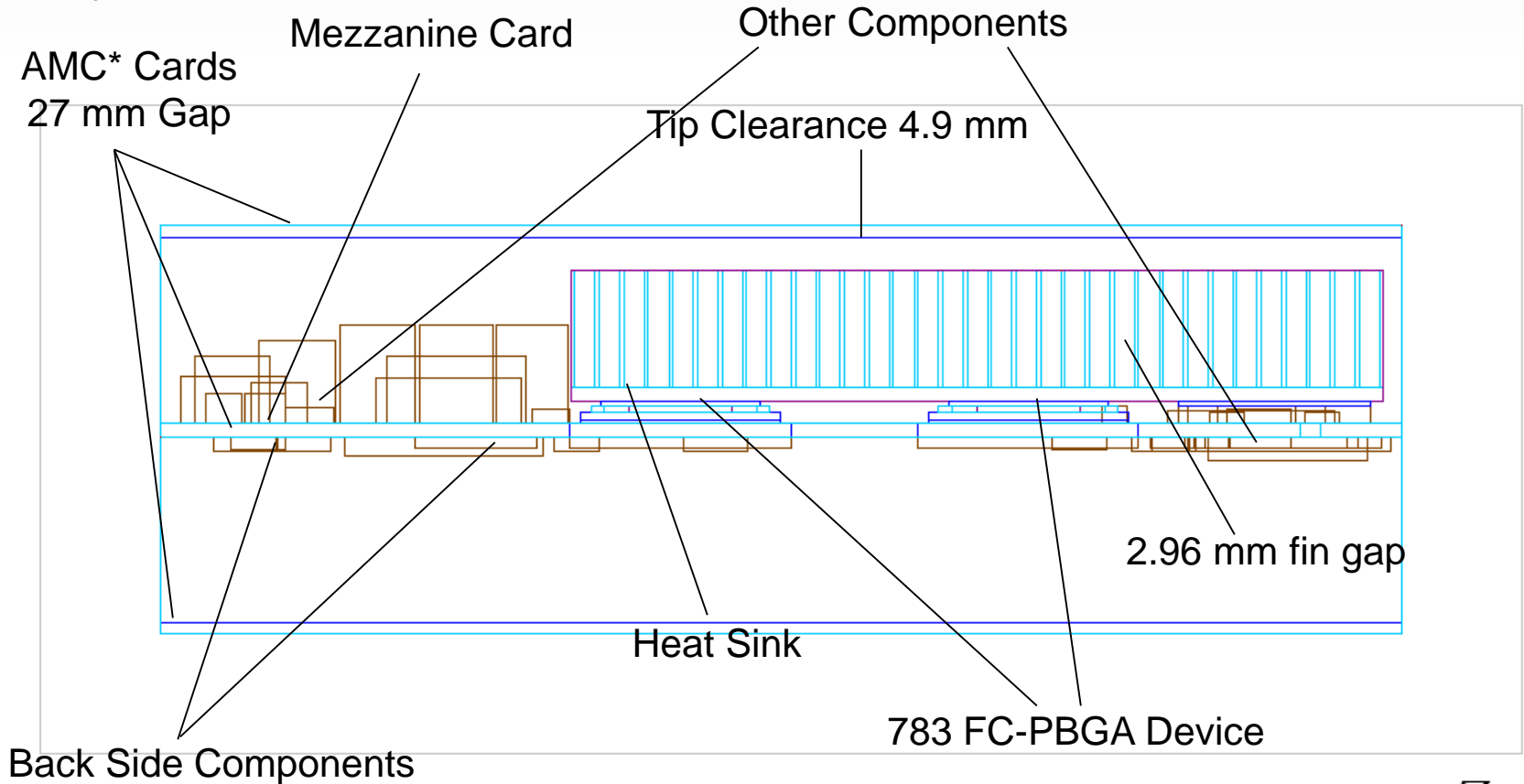

Note: AMC = Advanced Mezzanine Card

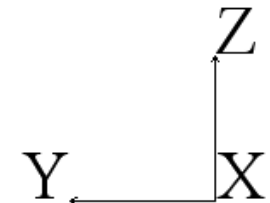

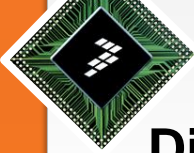

# FC-PBGA Thermal Performance

**Die Temperature Plot, In-Line Configuration  
3 Cards, 4 Parts per Card, 1Ghz, Memory On**

All parts work within 105°C junction temperature

FC-PBGA power range: 9.1-12W

Device power is temperature dependent

Total Power due to other Components: 15.1 W per Card

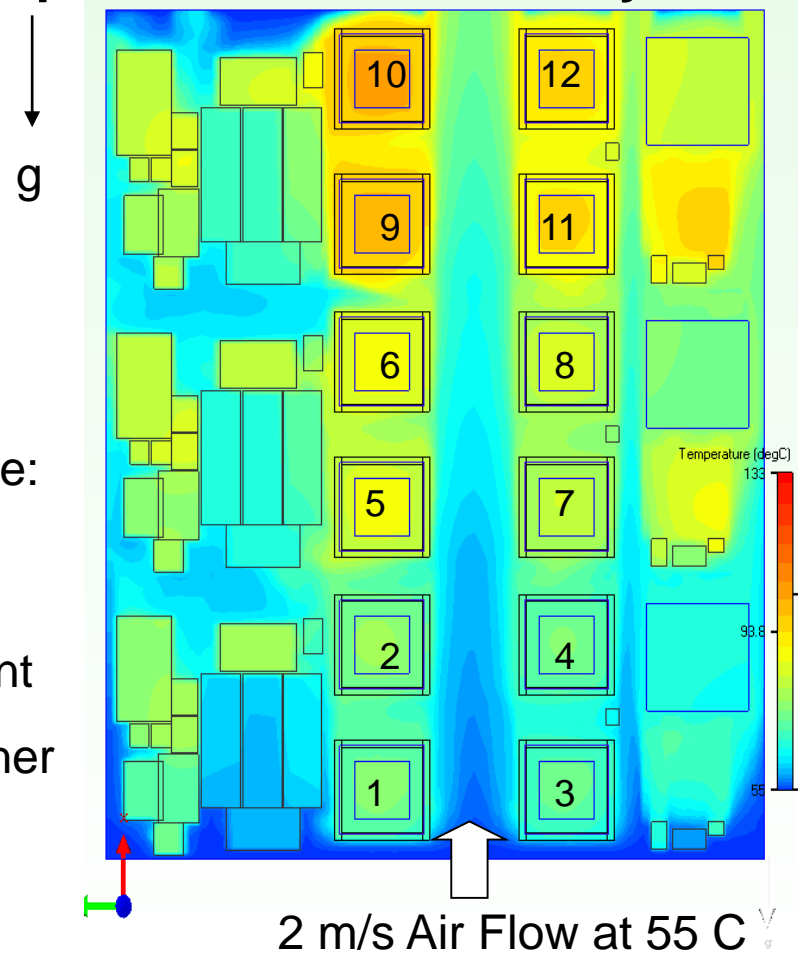

Position	T junction (C)	Power (W)
1	74.7	9.1
2	77.2	9.2
3	72.2	8.8
4	74.4	8.9
5	87.7	10.5
6	89.6	10.5
7	83.1	10.0
8	84.9	10.0
9	100.7	12.0
10	102.9	12.0
11	94.5	11.3
12	96.3	11.3





# FC-PBGA Thermal Performance

## System-Level Thermal Modeling

*Example Case for 624 FC-PBGA Non-Lidded in Netbook Application*

- Package: 624 21x21mm FC-BGA (no lid)
- Typical netbook design, including board, components, thermal management solution
- Box size: 200x130x10 mm (Approximate)
- Board size: 40x125x1.6 mm (Approximate)
- No airflow

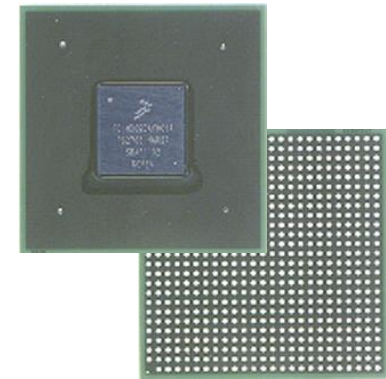

**624 FC-PBGA**

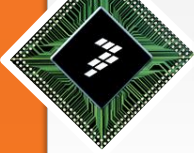

# FC-PBGA Thermal Performance

## Geometry of Simplified Thermal Model

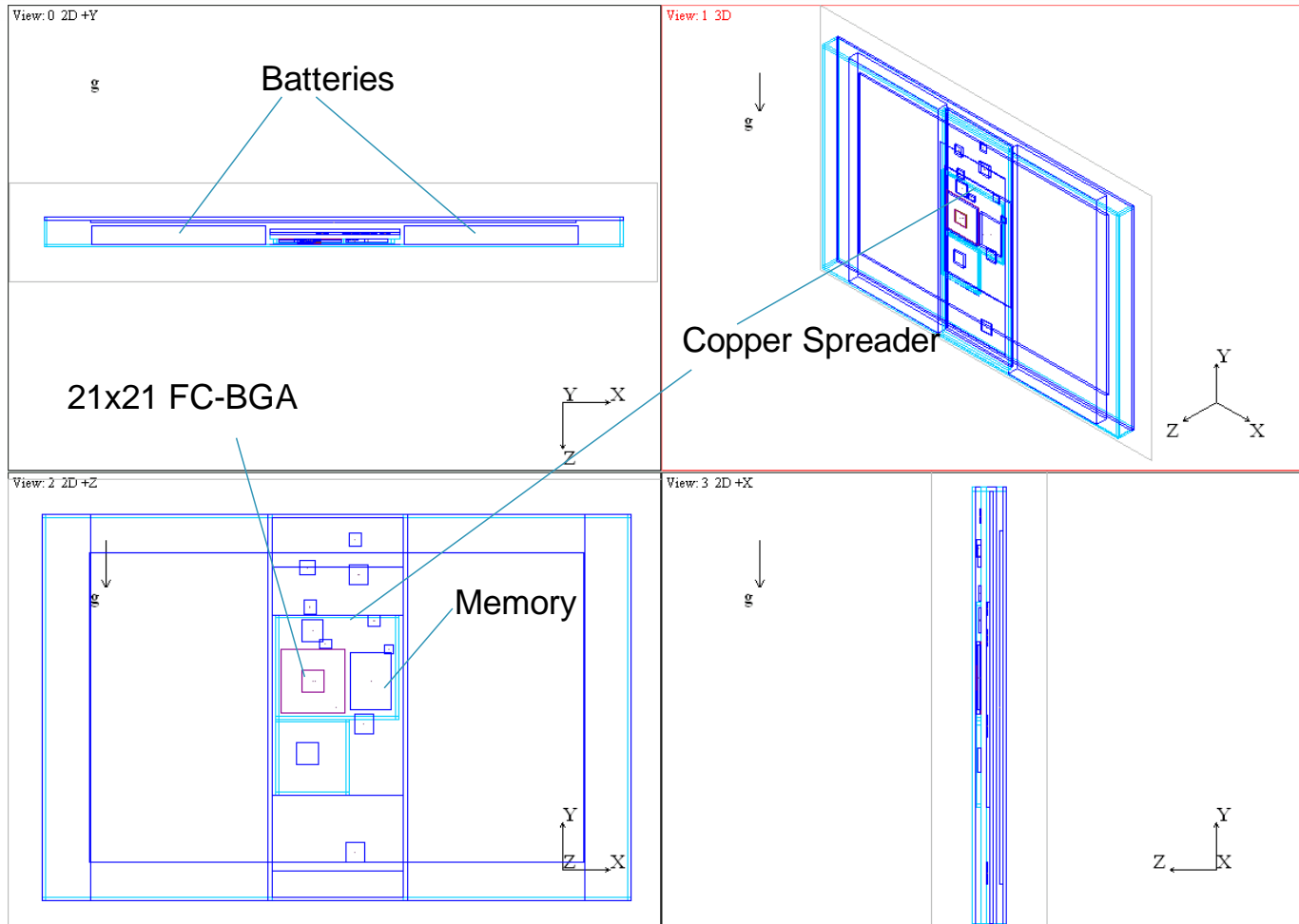

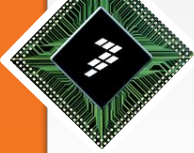

# FC-PBGA Thermal Performance

## End View

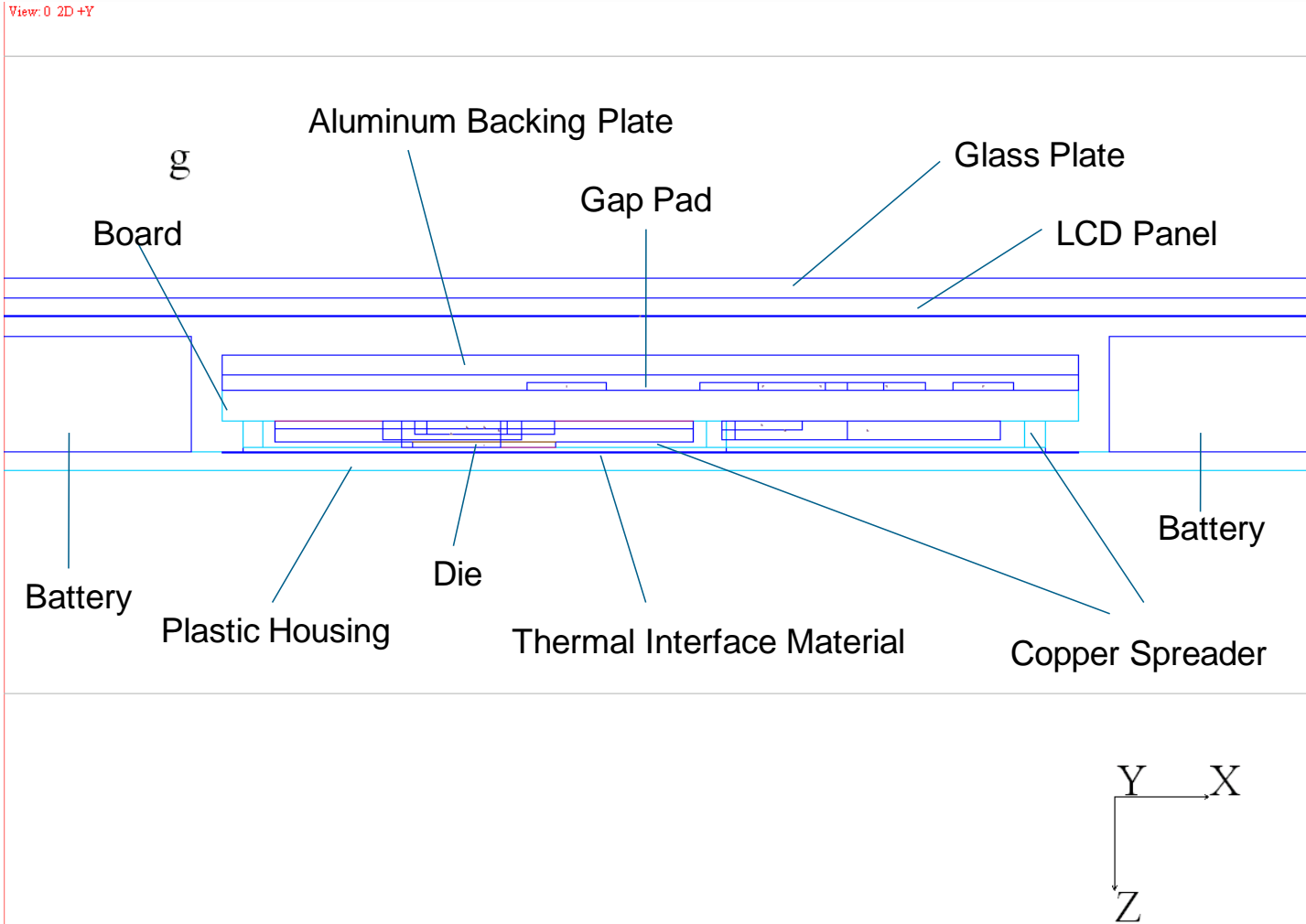

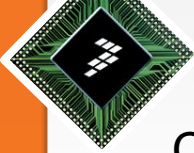

# FC-PBGA Thermal Performance

Case 1: 2GHz Configuration Power Cycle (transient profile non-linear source)

## Power Vs. Temperature:

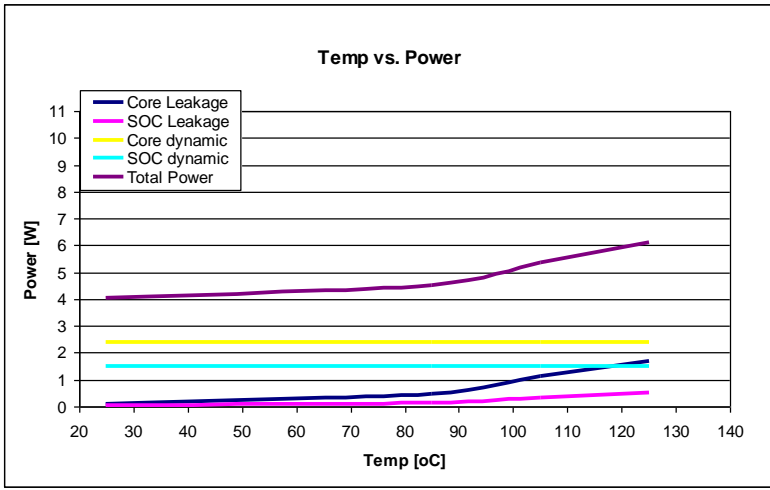

## Power Cycling Profile:

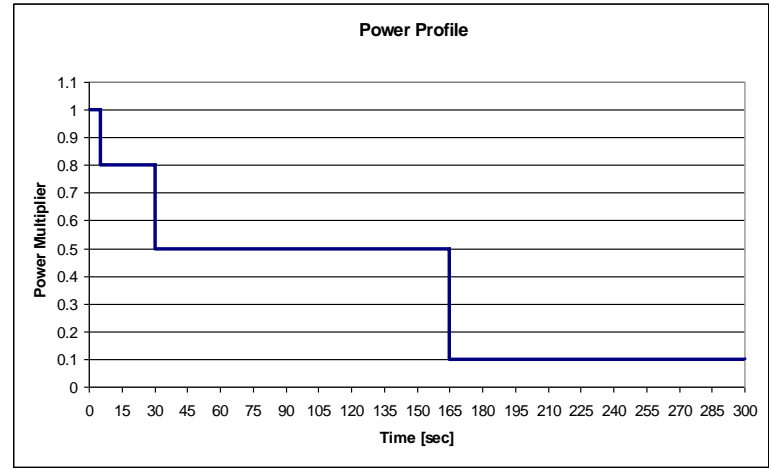

5 sec at max power  
 25 sec at of 80% of max power  
 135 sec at 50% of max power  
 135 sec at low power (10% of max power) .

### Other components:

PCB – 0.88W constant (distributed evenly over board components)

LCD – 1W constant

Memory (max power)– 0.65W

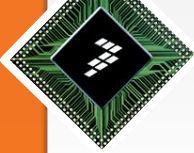

# FC-PBGA Thermal Performance

## Junction Temperature Variation with Time

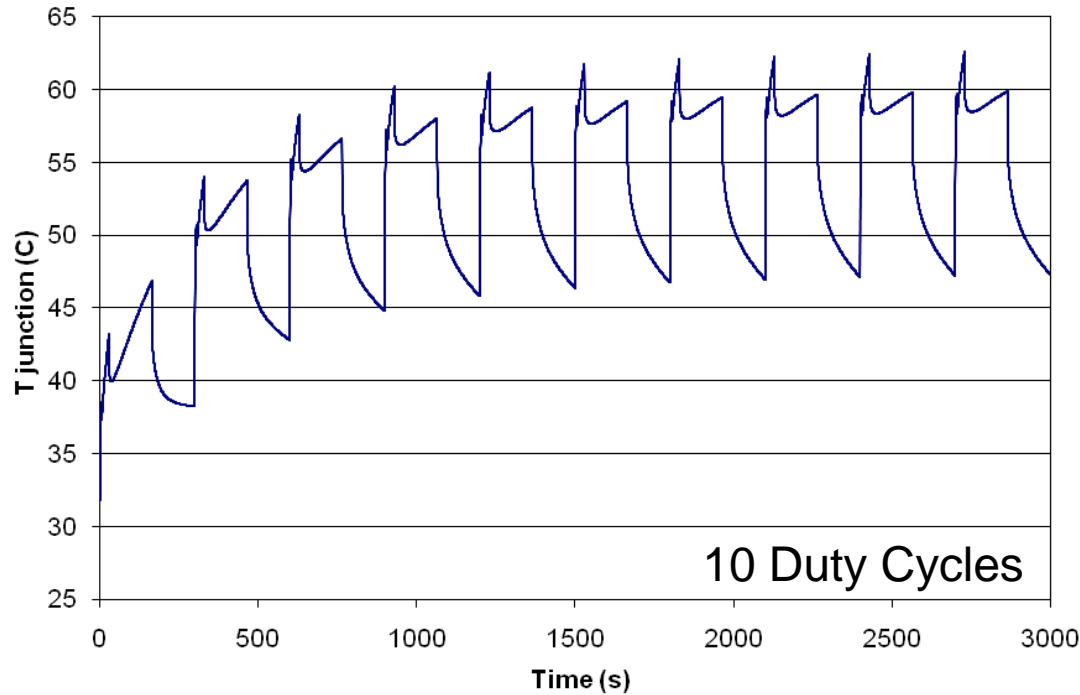

— T junction (C)

T ambient = 25 C

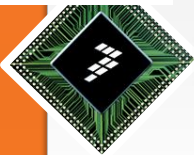

# FC-PBGA Thermal Performance

Temperature Profile, Plane through Die, Steady State Solution

$T_{\text{junction}} = 106.6 \text{ C}$

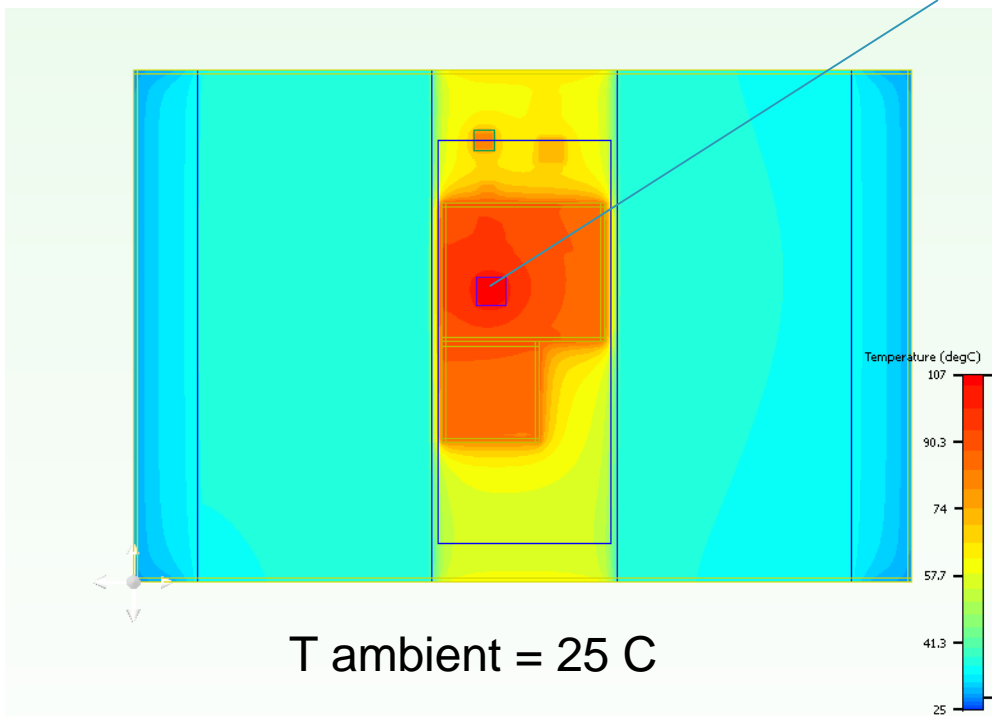

$T_{\text{ambient}} = 25 \text{ C}$

