

CodeWarrior Development Studio for Power Architecture Processors Targeting Manual



Contents

Chapter 1 Introduction.....	11
1.1 Release notes.....	11
1.2 Contents of this manual.....	11
1.3 Accompanying documentation.....	12
1.4 PowerPC Embedded Application Binary Interface.....	12
1.5 CodeWarrior Development Studio tools.....	13
1.5.1 Eclipse IDE.....	14
1.5.2 C/C++ compiler.....	14
1.5.3 Assembler.....	14
1.5.4 Linker.....	15
1.5.5 Debugger.....	15
1.5.6 Main standard libraries.....	15
1.5.7 CodeWarrior Profiling and Analysis tools.....	16
1.6 CodeWarrior IDE.....	16
1.6.1 Project files.....	17
1.6.2 Code editing.....	17
1.6.3 Compiling.....	17
1.6.4 Linking.....	17
1.6.5 Debugging.....	17
 Chapter 2 Working with Projects.....	 19
2.1 CodeWarrior Bareboard Project Wizard.....	19
2.1.1 Create a CodeWarrior Bareboard Project Page.....	20
2.1.2 Processor Page.....	21
2.1.3 Debug Target Settings Page.....	22
2.1.4 Build Settings Page.....	24
2.1.5 Configurations Page.....	26
2.1.6 Trace Configuration Page.....	28
2.2 CodeWarrior Linux Project Wizard.....	29
2.2.1 Create a CodeWarrior Linux Project Page.....	29
2.2.2 Processor Page.....	31
2.2.3 Build Settings Page.....	32
2.2.4 Linux Application Page.....	33
2.3 Creating Projects.....	34
2.3.1 Creating CodeWarrior Bareboard Application Project.....	35
2.3.2 Creating CodeWarrior Bareboard Library Project.....	37
2.3.3 Creating CodeWarrior Linux Application Project.....	39
2.4 Building projects.....	40
2.4.1 Manual-Build Mode.....	41
2.4.2 Auto-Build Mode.....	41
2.5 Importing Classic CodeWarrior Projects.....	42
2.6 Deleting Project.....	43
 Chapter 3 Build Properties.....	 45
3.1 Changing Build Properties.....	45
3.2 Restoring Build Properties.....	46
3.3 Build Properties for Power Architecture.....	46

3.3.1 CodeWarrior Build Tool Settings.....	48
3.3.1.1 PowerPC CPU.....	49
3.3.1.2 Debugging.....	50
3.3.1.3 Messages.....	50
3.3.1.4 PowerPC Linker.....	51
3.3.1.5 PowerPC Compiler.....	57
3.3.1.6 PowerPC Assembler.....	68
3.3.1.7 PowerPC Disassembler.....	70
3.3.1.8 PowerPC Preprocessor.....	72
3.3.2 GCC Build Tool Settings.....	73
3.3.2.1 Architecture.....	76
3.3.2.2 PowerPC Linker.....	76
3.3.2.3 PowerPC Compiler.....	80
3.3.2.4 PowerPC Assembler.....	86
3.3.2.5 PowerPC Preprocessor.....	87
3.3.2.6 PowerPC Disassembler.....	88

Chapter 4 Debug Configurations 91

4.1 Using Debug Configurations Dialog Box.....	91
4.1.1 Main.....	92
4.1.2 Arguments.....	97
4.1.3 Debugger.....	98
4.1.3.1 Debug.....	99
4.1.3.2 EPPC Exceptions.....	101
4.1.3.3 Download.....	102
4.1.3.4 PIC.....	104
4.1.3.5 System Call Services.....	105
4.1.3.6 Other Executables.....	107
4.1.3.7 Symbolics.....	108
4.1.3.8 OS Awareness.....	110
4.1.4 Trace and Profile.....	113
4.1.5 Source.....	114
4.1.6 Environment.....	116
4.1.7 Common.....	117
4.2 Customizing Debug Configurations.....	118
4.3 Reverting Debug Configuration Settings.....	120

Chapter 5 Working with Debugger..... 121

5.1 Debugging a CodeWarrior Project.....	121
5.2 Consistent debug control.....	122
5.3 Connection types.....	122
5.3.1 CCSSIM2 ISS.....	122
5.3.2 Ethernet TAP.....	124
5.3.3 Gigabit TAP + Trace.....	128
5.3.4 Gigabit TAP.....	133
5.3.5 Simics.....	138
5.3.6 TCF.....	140
5.3.7 USB TAP.....	141
5.3.8 CodeWarrior TAP.....	145
5.4 JTAG diagnostics tests.....	150
5.4.1 Power at probe test.....	151
5.4.2 IR scan test.....	151
5.4.3 Bypass scan test.....	151

5.4.4 Arbitrary TAP state move test.....	152
5.4.5 Reading JTAG IDCODEs test.....	152
5.5 Editing remote system configuration.....	152
5.5.1 Initialization tab.....	153
5.5.2 Memory tab.....	154
5.5.3 Advanced tab.....	155
5.6 Memory translations.....	155
5.7 CodeWarrior Command-Line Debugger.....	156
5.8 Working with Breakpoints.....	158
5.8.1 Setting Breakpoints.....	159
5.8.2 Setting Hardware Breakpoints.....	161
5.8.2.1 Using IDE to Set Hardware Breakpoints.....	161
5.8.2.2 Using Debugger Shell to Set Hardware Breakpoints.....	161
5.8.3 Removing Breakpoints.....	161
5.8.3.1 Remove Breakpoints using Marker Bar.....	161
5.8.3.2 Remove Breakpoints using Breakpoints View.....	162
5.8.4 Removing Hardware Breakpoints.....	162
5.8.4.1 Remove Hardware Breakpoints using the IDE.....	162
5.8.4.2 Remove Hardware Breakpoints using Debugger Shell.....	162
5.9 Working with Watchpoints.....	163
5.9.1 Setting Watchpoints.....	163
5.9.2 Removing Watchpoints.....	165
5.10 Working with Registers.....	165
5.10.1 Changing Bit Value of a Register.....	166
5.10.2 Viewing Register Details.....	167
5.10.2.1 Bit Fields.....	168
5.10.2.2 Changing Bit Fields.....	168
5.10.2.3 Actions.....	169
5.10.2.4 Description.....	170
5.10.3 Registers View Context Menu.....	170
5.10.4 Working with Register Groups.....	172
5.10.4.1 Adding a Register Group.....	172
5.10.4.2 Editing a Register Group.....	173
5.10.4.3 Removing a Register Group.....	173
5.10.5 Working with TLB Registers.....	173
5.10.5.1 Viewing TLB Registers in Registers View.....	174
5.10.5.2 Reading TLB Registers from Debugger Shell.....	175
5.10.5.3 Initializing TLB Registers.....	177
5.10.5.4 TLB Register Details.....	177
5.10.6 Working with IMMR.....	193
5.11 Viewing Memory.....	193
5.11.1 Adding Memory Monitor.....	194
5.12 Viewing Cache.....	196
5.12.1 Cache View.....	196
5.12.2 Cache View Toolbar Menu.....	197
5.12.3 Components of Cache View.....	199
5.12.4 Using Debugger Shell to View Caches.....	199
5.12.5 Debugger Shell Global Cache Commands.....	200
5.12.6 Debugger Shell Cache Line Commands.....	201
5.12.7 Processor-Specific Cache Features.....	201
5.13 Changing Program Counter Value.....	204
5.14 Hard Resetting.....	204
5.15 Setting Stack Depth.....	204
5.16 Import a CodeWarrior Executable file Wizard.....	204
5.16.1 Import a CodeWarrior Executable file Page.....	205

5.16.2 Import C/C++/Assembler Executable Files Page.....	205
5.16.3 Processor Page.....	206
5.16.4 Linux Application Launch Configurations Page.....	206
5.16.5 Debug Target Settings Page.....	207
5.16.6 Configurations Page.....	208
5.17 Debugging Externally Built Executable Files.....	209
5.17.1 Import an Executable File.....	209
5.17.2 Edit the Launch Configuration.....	211
5.17.3 Specify the Source Lookup Path.....	212
5.17.4 Debug the Executable File.....	214
Chapter 6 Multi-Core Debugging.....	215
6.1 Debugging Multi-Core Projects.....	215
6.1.1 Setting Launch Configurations.....	215
6.1.2 Debugging Multiple Cores.....	218
6.2 Multi-Core Debugging Commands.....	221
6.2.1 Multi-Core Commands in CodeWarrior IDE.....	221
6.2.2 Multi-Core Commands in Debugger Shell.....	222
Chapter 7 Debugging Embedded Linux Software.....	227
7.1 Debugging a Linux Application.....	227
7.1.1 Install CodeWarrior TRK on Target System.....	228
7.1.2 Start CodeWarrior TRK on Target System.....	228
7.1.2.1 TCP/IP Connections.....	228
7.1.2.2 Serial Connections.....	229
7.1.3 Create a CodeWarrior Download Launch Configuration for the Linux Application.....	230
7.1.4 Specify Console I/O Redirections for the Linux Application.....	233
7.1.5 Configure Linux Process Signal Policy.....	234
7.1.5.1 Signal Inheritance.....	234
7.1.5.2 Default Signal Policy.....	234
7.1.5.3 Modifying Signal Policy.....	234
7.1.6 Debug the Linux Application.....	236
7.2 Viewing multiple processes and threads.....	236
7.3 Debugging applications that use fork() and exec() system calls.....	237
7.4 Debugging a shared library.....	247
7.4.1 Create an example project.....	247
7.4.2 Configure the shared library build configuration.....	250
7.4.3 Configure the executable build configuration.....	250
7.4.4 Build the shared library.....	251
7.4.5 Build the executable.....	251
7.4.6 Configure the launch configuration.....	251
7.4.7 Debug the shared library.....	253
7.5 Preparing U-Boot for debugging.....	255
7.5.1 Install BSP.....	256
7.5.2 Configure U-Boot and build U-Boot images with CodeWarrior debugger support.....	257
7.5.3 Configure hardware to use U-Boot image.....	257
7.5.4 Create a CodeWarrior project to debug U-Boot.....	257
7.5.5 Specify launch configuration settings.....	258
7.5.6 Create launch configurations for U-Boot debug stages.....	260
7.6 Debugging U-Boot using NOR, NAND, SPI, and SD Card/MMC Flash Devices.....	262
7.6.1 Configuring and Building U-Boot.....	262
7.6.1.1 Writing configuration words in U-Boot code.....	264
7.6.2 Creating a CodeWarrior Project to Debug U-Boot.....	264

7.6.3	Specifying the Launch Configuration Settings.....	265
7.6.4	Debugging U-Boot using Flash Devices.....	267
7.6.4.1	Points to remember.....	267
7.6.4.2	Debugging U-Boot using NOR flash.....	268
7.6.4.3	Debugging U-Boot using SPI and SD/MMC flash.....	273
7.6.4.4	Debugging U-Boot using NAND flash.....	278
7.7	Debugging the Linux Kernel.....	283
7.7.1	Setting Up the Target Hardware.....	284
7.7.1.1	Connect USB TAP.....	285
7.7.1.2	Establish a Console Connection.....	285
7.7.2	Installing the Board Support Package (BSP).....	286
7.7.3	Configuring the Build Tool.....	287
7.7.4	Configuring the Linux Kernel.....	287
7.7.5	Creating a CodeWarrior Project using the Linux Kernel Image.....	289
7.7.5.1	Updating the Linux Kernel Image.....	290
7.7.6	Configuring the kernel project for debugging.....	290
7.7.6.1	Configuring a download kernel debug scenario.....	291
7.7.6.2	Configure an attach kernel debug scenario.....	291
7.7.6.3	Setting up RAM disk.....	294
7.7.6.4	Using Open Firmware Device Tree Initialization method.....	297
7.7.7	Debugging the kernel to download the kernel, RAM disk, and device tree.....	301
7.7.8	Debugging the kernel based on MMU initialization.....	302
7.7.8.1	Debugging the Kernel before the MMU is Enabled.....	302
7.7.8.2	Debugging the Kernel while the MMU is being Enabled.....	304
7.7.8.3	Debugging the Kernel after the MMU is Enabled.....	304
7.7.9	Debugging the kernel by attaching to a running U-Boot.....	305
7.8	Debugging Loadable Kernel Modules.....	307
7.8.1	Loadable Kernel Modules - An Introduction.....	307
7.8.2	Creating a CodeWarrior Project from the Linux Kernel Image.....	308
7.8.3	Configuring Symbolics Mappings of Modules.....	310
7.9	Debugging Hypervisor Guest Applications.....	312
7.9.1	Hypervisor - An Introduction.....	312
7.9.2	Prerequisites for Debugging a Guest Application.....	313
7.9.3	Adding CodeWarrior HyperTRK Debug Stub Support in Hypervisor for Linux Kernel Debugging.....	313
7.9.3.1	Enabling HyperTRK Debug Support Directly in Build Tool.....	314
7.9.3.2	Applying New HyperTRK Patches from CodeWarrior Install Layout.....	314
7.9.3.3	Modifying and Building HyperTRK Manually.....	314
7.9.4	Preparing Connection to P4080DS Target.....	314
7.9.5	Debugging AMP/SMP Guest Linux Kernels Running Under Hypervisor.....	315
7.9.5.1	Prerequisites for Debugging AMP/SMP Guest Linux Kernels.....	315
7.9.5.2	Creating an Attach Launch Configuration to Debug a Linux Partition after Kernel Boot.....	315
7.9.5.3	Creating a Download Launch Configuration to Debug a Linux Partition from an Entry Point or a User-Defined Function.....	318
7.10	Debugging the P4080 Embedded Hypervisor.....	320
7.10.1	Debugging Hypervisor During the Boot and Initialization Process.....	322
7.10.1.1	Debugging Hypervisor from the Entry Point.....	323
7.10.1.2	Debugging Hypervisor from Relocation till Release of Secondary Cores.....	325
7.10.1.3	Debugging Hypervisor after Release of Secondary Cores.....	326
7.10.1.4	Debugging the Hypervisor Partitions Initialization Process.....	327
7.10.1.5	Debugging the Hypervisor Partitions Image Loading Process.....	328
7.10.1.6	Debugging All Cores when Starting the Guest Applications.....	328
7.10.1.7	Debugging the Hypervisor Partition Manager.....	328
7.11	User Space Debugging with On-Chip Debug.....	329

7.11.1 Attaching Core to Debug Application.....	330
7.11.2 Debugging Application from main() Function.....	330
Chapter 8 JTAG Configuration Files.....	333
8.1 JTAG configuration file syntax.....	333
8.2 Using a JTAG configuration file to override RCW.....	334
8.3 Using a JTAG configuration file to specify multiple linked devices on a JTAG chain.....	335
8.4 Setting up a remote system to use a JTAG configuration file.....	337
Chapter 9 Target Initialization Files.....	341
9.1 Using target initialization files.....	341
9.2 Target initialization commands.....	343
9.2.1 .cfg target initialization commands.....	343
9.2.1.1 alternatePC.....	344
9.2.1.2 ANDmem.l.....	344
9.2.1.3 ANDmmr.....	345
9.2.1.4 IncorMMR.....	345
9.2.1.5 ORmem.l.....	346
9.2.1.6 reset.....	346
9.2.1.7 run.....	347
9.2.1.8 setCoreID.....	347
9.2.1.9 resetCoreID.....	347
9.2.1.10 sleep.....	347
9.2.1.11 stop.....	348
9.2.1.12 writemem.b.....	348
9.2.1.13 writemem.w.....	348
9.2.1.14 writemem.l.....	349
9.2.1.15 writemmr.....	349
9.2.1.16 writereg.....	350
9.2.1.17 writereg64.....	350
9.2.1.18 writereg128.....	351
9.2.1.19 writereg192.....	352
9.2.1.20 writespr.....	352
9.2.2 .tcl target initialization commands.....	353
Chapter 10 Memory Configuration Files.....	355
10.1 Using memory configuration files.....	355
10.2 Memory configuration commands.....	356
10.2.1 autoEnableTranslations.....	357
10.2.2 range.....	357
10.2.3 reserved.....	358
10.2.4 reservedchar.....	358
10.2.5 translate.....	359
Chapter 11 Working with Hardware Tools.....	361
11.1 Flash programmer.....	361
11.1.1 Create a flash programmer target task.....	361
11.1.2 Configure flash programmer target task.....	363
11.1.2.1 Add flash device.....	364
11.1.2.2 Specify target RAM settings.....	364
11.1.2.3 Add flash programmer actions.....	364

11.1.3 Execute flash programmer target task.....	369
11.2 Flash File to Target.....	370
11.2.1 Erasing flash device.....	371
11.2.2 Programming a file.....	372
11.3 Hardware diagnostics.....	372
11.3.1 Creating hardware diagnostics task.....	372
11.3.2 Working with Hardware Diagnostic Action editor.....	373
11.3.2.1 Action Type.....	374
11.3.2.2 Memory Access.....	374
11.3.2.3 Loop Speed.....	375
11.3.2.4 Memory Tests.....	376
11.3.3 Memory test use cases.....	379
11.3.3.1 Use Case 1: Execute host-based Scope Loop on target.....	379
11.3.3.2 Use Case 2: Execute target-based Memory Tests on target.....	379
11.4 Import/Export/Fill memory.....	380
11.4.1 Creating task for import/export/fill memory.....	380
11.4.2 Importing data into memory.....	382
11.4.3 Exporting memory to file.....	384
11.4.4 Fill memory.....	386
Chapter 12 Making a Custom MSL C Library.....	389
12.1 Source library modifications.....	389
12.1.1 Files modified.....	390
12.2 Modifications to avoid errors from GCC LD tool.....	391
12.2.1 Files modified.....	391
12.3 Software floating point emulation support.....	392
12.4 Building a custom MSL C library.....	392
Chapter 13 Debugger Limitations and Workarounds.....	395
13.1 PowerQUICC II processors.....	395
13.2 PowerQUICC II Pro processors.....	395
13.3 PowerQUICC III processors.....	396
13.4 QorIQ communications processors.....	398
13.5 T-series processors.....	399
13.6 QorIQ Qonverge processors.....	401
13.7 Generic processors.....	402
Index.....	403

Chapter 1

Introduction

This manual explains how to use CodeWarrior Development Studio tools to develop software for bareboard applications and embedded Linux[®] operating system running on Freescale Power Architecture[®] processors.

This chapter provides an overview of this manual and introduces you to the CodeWarrior development tools and development process.

The topics covered here are as follows:

- [Release notes](#) on page 11
- [Contents of this manual](#) on page 11
- [Accompanying documentation](#) on page 12
- [PowerPC Embedded Application Binary Interface](#) on page 12
- [CodeWarrior Development Studio tools](#) on page 13
- [CodeWarrior IDE](#) on page 16

1.1 Release notes

Release notes include information about new features, last-minute changes, bug fixes, incompatible elements, or other sections that may not be included in this manual.

You should read release notes before using the CodeWarrior IDE.

NOTE

The release notes for specific components of the CodeWarrior IDE are located in the `Release_Notes` folder in the CodeWarrior installation directory.

1.2 Contents of this manual

Each chapter of this manual describes a different area of software development.

The table below lists each chapter in the manual.

Table 1: Organization of this manual

Chapter	Description
Introduction on page 11	This chapter.
Working with Projects on page 19	Describes the different types of projects you can create, provides an overview of CodeWarrior project wizards.
Build Properties on page 45	Explains build properties for Power Architecture projects.
Debug Configurations on page 91	Describes the different types of launch configurations you can create, provides an overview of the debugger.

Table continues on the next page...

Table 1: Organization of this manual (continued)

Chapter	Description
Working with Debugger on page 121	Explains various aspects of CodeWarrior debugging, such as debugging a project, connection types, setting breakpoints and watchpoints, working with registers, viewing memory, viewing cache, and debugging externally built executable files.
Multi-Core Debugging on page 215	Explains multi-core debugging capabilities of CodeWarrior debugger.
Debugging Embedded Linux Software on page 227	Explains debugging activities related to embedded Linux software.
JTAG Configuration Files on page 333	Explains JTAG configuration files that pass specific configuration settings to the debugger and support chaining of multiple devices.
Target Initialization Files on page 341	Discusses how to use a target initialization file and describes <code>.cfg</code> and <code>.tcl</code> target initialization commands.
Memory Configuration Files on page 355	Discusses how to use a memory configuration file and describes memory configuration commands.
Working with Hardware Tools on page 361	Explains CodeWarrior hardware tools used for board bring-up, test, and analysis.
Making a Custom MSL C Library on page 389	Discusses how to port an MSL C library to the GNU Compiler Collection (GCC) tool to support bareboard applications that execute on the Power Architecture-based boards.
Debugger Limitations and Workarounds on page 395	Describes processor-specific CodeWarrior debugger limitations and workarounds.

1.3 Accompanying documentation

The Documentation page describes the documentation included in this version of CodeWarrior Development Studio for Power Architecture.

You can access the Documentation page by:

- Using a shortcut link that the CodeWarrior installer creates by default on the Desktop.
- Opening the `START_HERE.html` file available in the `<CWInstallDir>\PA\Help` folder.

1.4 PowerPC Embedded Application Binary Interface

The Power Architecture Embedded Application Binary Interface (PowerPC EABI) specifies data structure alignment, calling conventions, and other information about how high-level languages can be implemented on a Power Architecture processor.

The code generated by CodeWarrior for Power Architecture conforms to the PowerPC EABI.

To learn more about the PowerPC EABI:

- Information and documentation about all supported Power Architecture hardware is available here:

<http://www.freescale.com/powerarchitecture>

- *PowerPC Embedded Binary Interface, 32-Bit Implementation.*, published by Freescale Semiconductor, Inc., and available here:

http://www.freescale.com/files/32bit/doc/app_note/PPCEABI.pdf

- *System V Application Binary Interface*, available here:

http://www.freescale.com/files/archives/doc/app_note/PPCABI.pdf

The PowerPC EABI also specifies the object and symbol file format. It specifies Executable and Linkable Format (ELF) as the output file format and Debug With Arbitrary Record Formats (DWARF) as the debugging information format. For more information about those formats, see:

- *Executable and Linkable Format, Version 1.1*, published by UNIX System Laboratories.

- DWARF Debugging Standard website available at:

www.dwarfstd.org

- *DWARF Debugging Information Format, Revision: Version 1.1.0*, published by UNIX International, Programming Languages SIG, October 6, 1992 and available here:

www.nondot.org/sabre/os/files/Executables/dwarf-v1.1.0.pdf

- *DWARF Debugging Information Format, Revision: Version 2.0.0*, Industry Review Draft, published by UNIX International, Programming Languages SIG, July 27, 1993.

1.5 CodeWarrior Development Studio tools

This section talks about some important tools of CodeWarrior Development Studio.

Programming for Power Architecture processors is much like programming for any other CodeWarrior platform target. If you have not used CodeWarrior tools before, start by studying the Eclipse IDE, which is used to host the tools.

Note that CodeWarrior Development Studio for Power Architecture uses the Eclipse IDE, whose user interface is substantially different from the "classic" CodeWarrior IDE. For more details on these interface differences, see *CodeWarrior Development Studio Common Features Guide* available in the `<CWInstallDir>\PA\Help\PDF\` folder.

The following are some important tools of CodeWarrior Development Studio:

- [Eclipse IDE](#) on page 14
- [C/C++ compiler](#) on page 14
- [Assembler](#) on page 14
- [Linker](#) on page 15
- [Debugger](#) on page 15
- [Main standard libraries](#) on page 15
- [CodeWarrior Profiling and Analysis tools](#) on page 16

1.5.1 Eclipse IDE

The Eclipse Integrated Development Environment (IDE) is an open-source development environment that lets you develop and debug your software.

It controls the project manager, the source code editor, the class browser, the compilers and linkers, and the debugger. The Eclipse workspace organizes all files related to your project. This allows you to see your project at a glance and navigate easily through the source code files.

The Eclipse IDE has an extensible architecture that uses plug-in compilers and linkers to target various operating systems and microprocessors. The IDE can be hosted on Microsoft Windows, Linux, and other platforms. There are many development tools available for the IDE, including C, C++, and Java compilers for desktop and embedded processors

For more information about the Eclipse IDE, read the Eclipse documentation at:

<http://www.eclipse.org/documentation/>

1.5.2 C/C++ compiler

A C/C++ compiler compiles C and C++ statements and assembles inline assembly language statements.

The CodeWarrior Eclipse IDE for Power Architecture processors supports the following two types of C/C++ compilers:

- CodeWarrior C/C++ compiler
- GCC C/C++ compiler

Each supported compiler is ANSI-compliant. You can generate Power Architecture applications and libraries that conform to the PowerPC EABI by using the CodeWarrior/GCC compiler in conjunction with the CodeWarrior/GCC linker for Power Architecture processors.

The IDE manages the execution of the compiler. The IDE invokes the compiler if you:

- Change a source file and issue the make command.
- Select a source file in your project and issue the compile, preprocess, or precompile command.

For more information about the CodeWarrior Power Architecture C/C++ compiler and its inline assembler, see the *Power Architecture Build Tools Reference Manual* from the `<CWInstallDir>\PA\Help\PDF\` folder.

For more information about the GCC Power Architecture C/C++ compiler, see the `gcc.pdf` manual from the `<CWInstallDir>\Cross_Tools\gcc-<version>-<target>\powerpc-<[eabi]/[eabispe]/[aeabi]/[linux/libc]>\share\docs\pdf\gcc` folder.

1.5.3 Assembler

The assembler translates assembly-language source code to machine-language object files or executable programs.

The CodeWarrior Eclipse IDE for Power Architecture processors supports two types of standalone assemblers:

- CodeWarrior assembler
- GCC assembler

Either you can provide the assembly-language source code to the assembler, or the assembler can take the assembly-language source code generated by the compiler.

For more information about the CodeWarrior Power Architecture assembler, see the *Power Architecture Build Tools Reference* manual from the `<CWInstallDir>\PA\Help\PDF\` folder.

For more information about the GCC Power Architecture assembler, see the `as.pdf` manual from the `<CWInstallDir>\Cross_Tools\gcc-<version>-<target>\powerpc-<[eabi]/[eabispe]/[aeabi]/[linux/libc]>\share\docs\pdf` folder.

1.5.4 Linker

The linker generates binaries that conform to the PowerPC Embedded Application Binary Interface (EABI).

The linker combines object modules created by the compiler and/or assembler with modules in static libraries to produce a binary file in executable and linkable (ELF) format.

CodeWarrior Eclipse IDE for Power Architecture processors supports two types of linkers:

- CodeWarrior linker
- GCC linker

Among many powerful features, the linker lets you:

- Use absolute addressing
- Create multiple user-defined sections
- Generate S-Record files
- Generate PIC/PID binaries

The IDE runs the linker each time you build your project.

For more information about the CodeWarrior Power Architecture linker, see the *Power Architecture Build Tools Reference manual* from the `<CWInstallDir>\PA\Help\PDF\` folder.

For more information about the GCC Power Architecture linker, see the `ld.pdf` manual from the `<CWInstallDir>\Cross_Tools\gcc-<version>-<target>\powerpc-<[eabi]/[eabispe]/[aeabi]/[linux/libc]>\share\docs\pdf` folder.

1.5.5 Debugger

The CodeWarrior Power Architecture debugger controls the execution of your program and allows you to see what is happening internally as the program runs.

You can use the debugger to find problems in your program. The debugger can execute your program one statement at a time and suspend execution when control reaches a specified point. When the debugger stops a program, you can view the chain of function calls, examine and change the values of variables, and inspect the contents of registers.

The debugger allows you to debug your CodeWarrior project using either a simulator or target hardware.

The Power Architecture debugger communicates with the board through a monitor program (such as CodeWarrior TRK) or through a hardware probe (such as CodeWarrior TAP (over USB)).

For more information, see *CodeWarrior Development Studio Common Features Guide* and the [Working with Debugger](#) on page 121 chapter of this manual.

1.5.6 Main standard libraries

The main standard libraries (MSL) are ANSI-compliant C and C++ standard libraries that help you create applications for Power Architecture processors.

The Power Architecture versions of the MSL libraries have been customized and the runtime has been adapted for Power Architecture processor development.

For more information about MSL, see *MSL C Reference* and *MSL C++ Reference*.

1.5.7 CodeWarrior Profiling and Analysis tools

The CodeWarrior Profiling and Analysis tools allow you to monitor an application as it runs on the simulator and hardware.

This helps you understand how your application runs, as well as identify operational problems. The tools also provide the following user-friendly data viewing features:

- Simultaneously step through trace data and the corresponding source and assembly code of that trace data
- Export source line information of the performance data generated by the simulator into an Excel file
- Export the trace and function data generated by simulator and target hardware into an Excel file
- Apply multi-level filters to isolate data
- Apply multi-level searches to find specific data
- Display results in an intuitive, user friendly manner in the trace, critical code, and performance views
- Show or hide columns and also reorder the columns
- Copy and paste a cell or a line of the trace, alu-agu and performance data generated by simulator and target hardware
- Control trace collection by using start and stop tracepoints to reduce the amount of unwanted trace events in the trace buffer making the trace data easier to read
- View the value of the DPU counters in form of graphs (pie charts and bar charts) while the application is in debug mode
- Display real time cycle count for simulated targets to allow quick monitoring of evolution of application in time

For more information, see *Tracing and Analysis Tools User Guide* available in the `<CWInstallDir>\PA\Help\PDF\` folder.

1.6 CodeWarrior IDE

This section explains the CodeWarrior IDE and tells how to perform basic IDE operations.

While working with the CodeWarrior IDE, you will proceed through the development stages familiar to all programmers, such as writing code, compiling and linking, and debugging. See *CodeWarrior Development Studio Common Features Guide* for:

- Complete information on tasks, such as editing, compiling, and linking
- Basic information on debugging

The difference between the CodeWarrior development environment and traditional command-line environments is how the software, in this case the CodeWarrior IDE, helps you manage your work more effectively.

The following sections explain the CodeWarrior IDE and describe how to perform basic CodeWarrior IDE operations:

- [Project files](#) on page 17
- [Code editing](#) on page 17
- [Compiling](#) on page 17
- [Linking](#) on page 17
- [Debugging](#) on page 17

1.6.1 Project files

A CodeWarrior *project* is analogous to a set of make files, because a project can have multiple settings that are applied when building the program.

For example, you can have one project that has both a debug version and a release version of your program. You can build one or the other, or both as you wish. The different settings used to launch your program within a single project are called *launch configurations*.

The CodeWarrior IDE uses the **CodeWarrior Projects** view to list all the files in a project. A project includes files, such as source code files and libraries. You can add or remove files easily. You can assign files to one or more different build configurations within the project, so files common to multiple build configurations can be managed simply.

The CodeWarrior IDE itself manages all the interdependencies between files and tracks which files have changed since the last build.

The CodeWarrior IDE also stores the settings for the compiler and linker options for each build configuration. You can modify these settings using the IDE, or with the `#pragma` statements in your code.

1.6.2 Code editing

CodeWarrior IDE has an integral text editor designed for programmers. It handles text files in ASCII, Microsoft® Windows®, and UNIX® formats.

To edit a file in a project, double-click the file name in the **CodeWarrior Projects** view. CodeWarrior IDE opens the file in the editor associated with the file type.

The editor view has excellent navigational features that allow you to switch between related files, locate any particular function, mark any location within a file, or go to a specific line of code.

1.6.3 Compiling

A source code file is compiled if it is part of the current launch configuration.

If the file is in the configuration, select it in the **CodeWarrior Projects** view and choose **Project > Build Project** from the CodeWarrior IDE menu bar.

To automatically compile all the files in the current launch configuration after you modify them, select **Project > Build Automatically** from the CodeWarrior IDE menu bar.

1.6.4 Linking

Choose **Project > Build Project** from the CodeWarrior IDE menu bar to link object code into a final binary file.

The **Build Project** command makes the active project up-to-date and links the resulting object code into a final output file.

You can control the linker through the IDE. There is no need to specify a list of object files. The workspace tracks all the object files automatically.

You can also modify the build configuration settings to specify the name of the final output file.

1.6.5 Debugging

Choose **Run > Debug** from the CodeWarrior IDE menu bar to debug your project.

This command downloads the current project's executable to the target board and starts a debug session.

NOTE

The CodeWarrior IDE uses the settings in the launch configuration to generate debugging information and initiate communications with the target board.

You can now use the debugger to step through the program code, view and change the value of variables, set breakpoints, and much more. For more information, see *CodeWarrior Development Studio Common Features Guide* and the [Working with Debugger](#) on page 121 chapter of this manual.

Chapter 2

Working with Projects

This chapter explains how to create and build projects for Power Architecture processors using the CodeWarrior tools.

This chapter explains:

- [CodeWarrior Bareboard Project Wizard](#) on page 19
- [CodeWarrior Linux Project Wizard](#) on page 29
- [Creating projects](#) on page 34
- [Building projects](#) on page 40
- [Importing Classic CodeWarrior Projects](#) on page 42
- [Deleting Projects](#) on page 43

2.1 CodeWarrior Bareboard Project Wizard

The term bareboard refers to hardware systems that do not need an operating system to operate. The CodeWarrior Bareboard Project Wizard presents a series of pages that prompt you for the features and settings to be used when making your program.

This wizard also helps you specify other settings, such as whether the program executes on a simulator rather than actual hardware.

This section describes the various pages that the **CodeWarrior Bareboard Project Wizard** displays as it assists you in creating a bareboard project.

NOTE

The pages that the wizard presents can differ, based upon the choice of project type or execution target.

The pages of the **CodeWarrior Bareboard Project Wizard** are:

- [Create a CodeWarrior Bareboard Project Page](#) on page 20
- [Processor Page](#) on page 21
- [Debug Target Settings Page](#) on page 22
- [Build Settings Page](#) on page 24
- [Configurations Page](#) on page 26
- [Trace Configuration Page](#) on page 28

2.1.1 Create a CodeWarrior Bareboard Project Page

Use this page to specify the project name and the directory where the project files are located.

Figure 1: Create a CodeWarrior Bareboard Project page

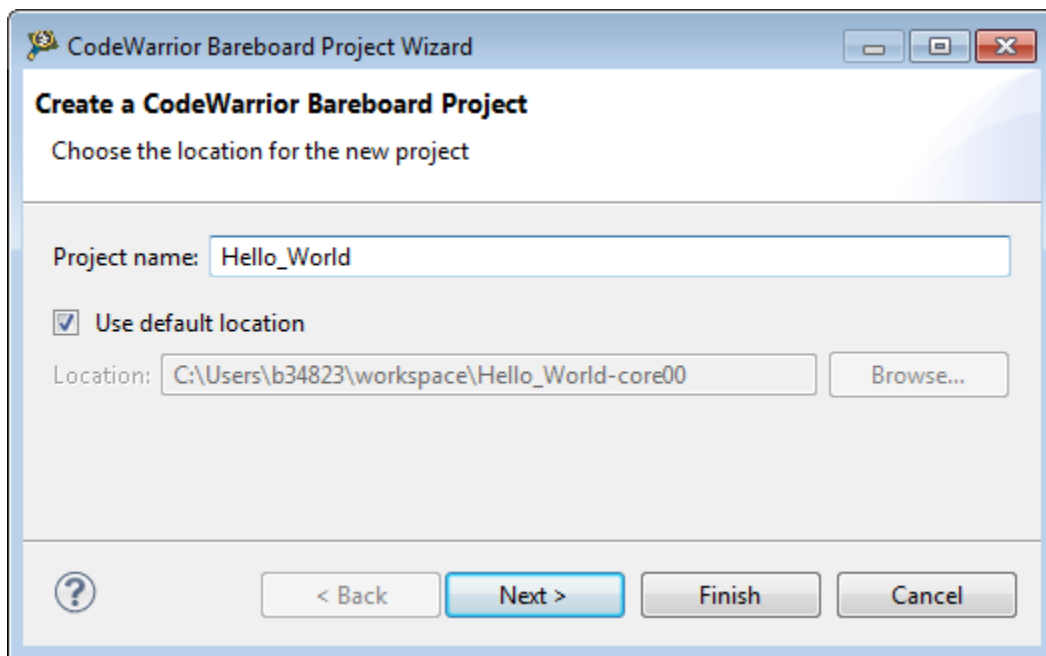

The table below describes the various options available on the **Create a CodeWarrior Bareboard Project** page.

Table 2: Create a CodeWarrior Bareboard Project page settings

Option	Description
Project name	Enter the name for the project in this text box.
Use default location	Select to choose the directory to store the files required to build the program. Use the Location option to select the desired directory.
Location	Specifies the directory that contains the project files. Use Browse to navigate to the desired directory. This option is only available when Use default location is cleared.

2.1.2 Processor Page

This page displays the target devices supported by the current installation. Use this page to specify the type of processor and the output for the new project.

Figure 2: Processor Page

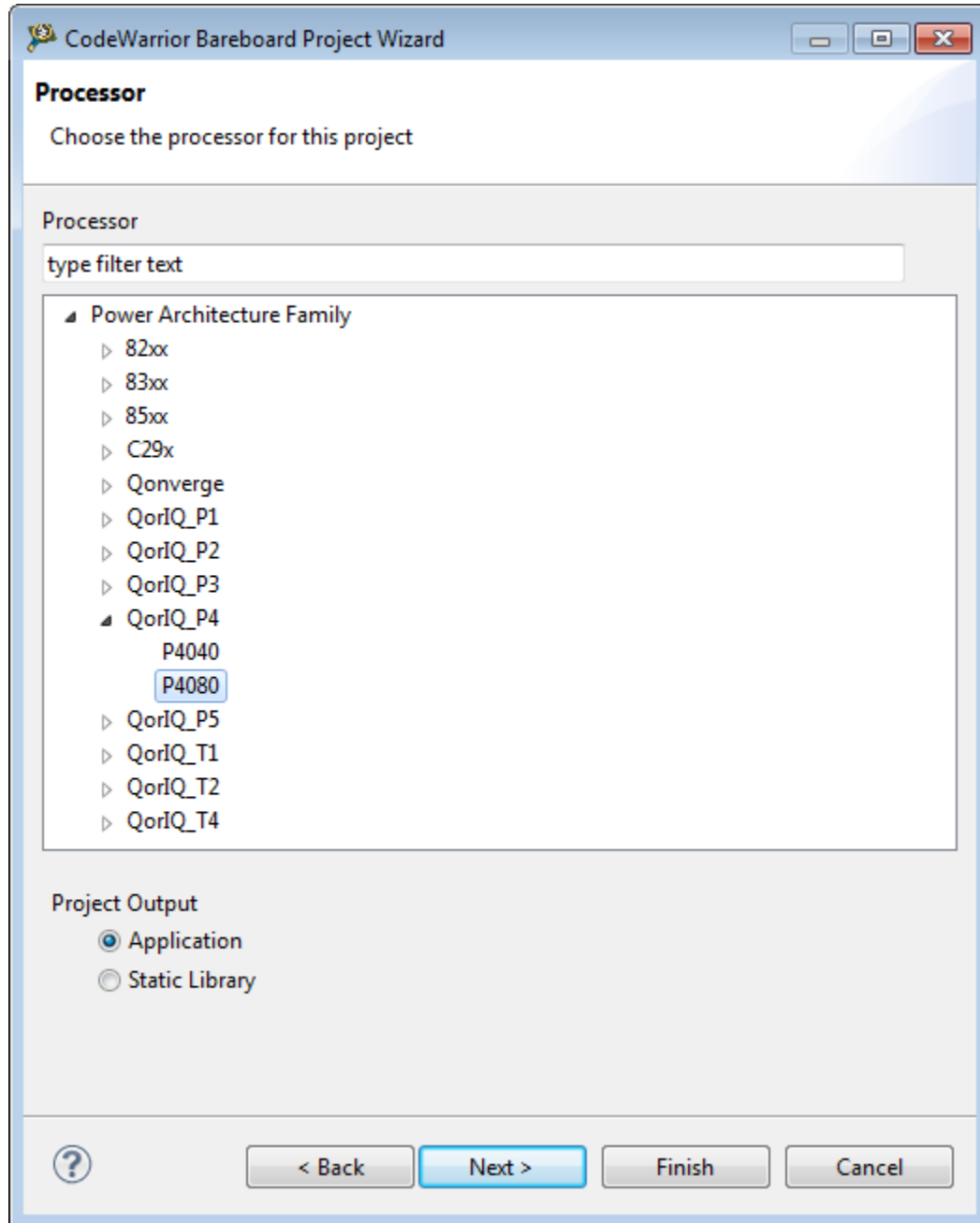

The table below describes the various options available on the **Processor** page.

Table 3: Processor Page Settings

Option	Description
Processor	Expand the processor family tree and select a supported target. The toolchain uses this choice to generate code that makes use of processor-specific features, such as multiple cores.
Project Output	Select any one of the following supported project output: <ul style="list-style-type: none">• Application: Select to create an application with ".elf" extension, that includes information related to the debug over a board.• Static Library: Select to create a library with ".a" extension, that can be included in other projects. Library files created using this option do not include board specific details.

2.1.3 Debug Target Settings Page

Use this page to select debugger connection type, board type, launch configuration type, and connection type for your project.

This page also lets you configure the connection settings for your project.

NOTE

This wizard page will prompt you to either create a new remote system configuration or select an existing one. A remote system is a system configuration that defines connection, initialization, and target parameters. The remote system explorer provides data models and frameworks to configure and manage remote systems, their connections, and their services. For more information, see *CodeWarrior Development Studio Common Features Guide* available in the `<CWInstallDir>\PA\Help\PDF\` folder, where `<CWInstallDir>` is the installation directory of your CodeWarrior software.

Figure 3: Debug Target Settings Page

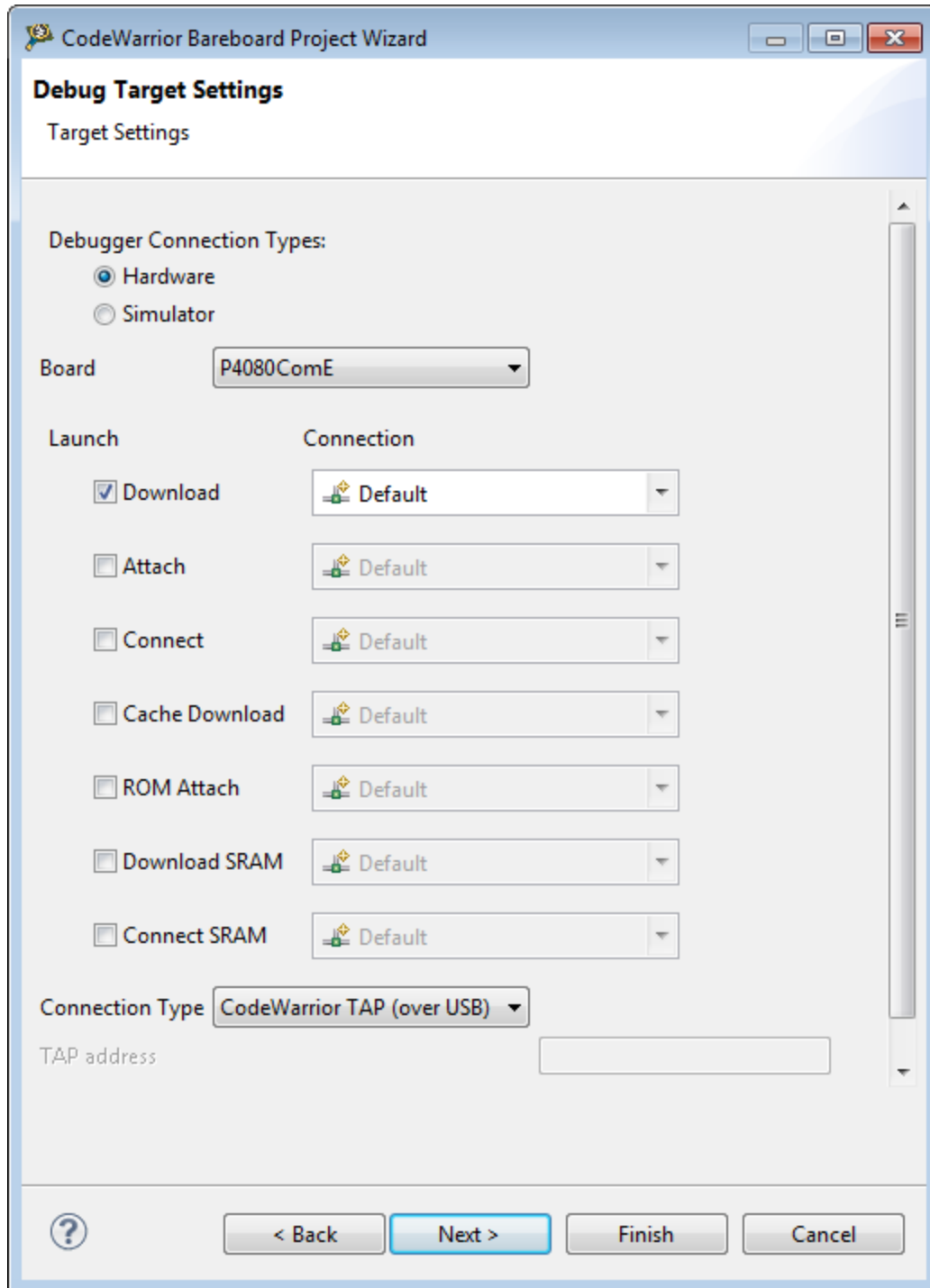

The table below describes the various options available on the **Debug Target Settings** page.

Table 4: Debug Target Settings page settings

Option	Description
Debugger Connection Types	Specifies the available target types: <ul style="list-style-type: none"> • Hardware - Select to execute the program on the target hardware available. • Simulator - Select to execute the program on a software simulator. • Emulator - Select to execute the program on a hardware emulator.
Board	Specifies the hardware supported by the selected processor.
Launch	Specifies the launch configurations and corresponding connection, supported by the selected processor.
Connection Type	Specifies the interface to communicate with the hardware. <ul style="list-style-type: none"> • CodeWarrior TAP (over USB) - Select to use the CodeWarrior TAP interface (over USB) to communicate with the hardware device. • CodeWarrior TAP (over Ethernet) - Select to use the CodeWarrior TAP interface (over Ethernet) to communicate with the hardware device. • USB TAP - Select to use the USB interface to communicate with the hardware device. • Ethernet TAP - Select to use the Ethernet interface to communicate with the target hardware. <p>For more details on CodeWarrior TAP, see <i>CodeWarrior TAP User Guide</i> available in the <code><CWInstallDir>\PA\Help\PDF\</code> folder, where <code><CWInstallDir></code> is the installation directory of your Codewarrior software.</p> <ul style="list-style-type: none"> • Gigabit TAP - Corresponds to a Gigabit TAP that includes an Aurora daughter card, which allows you to collect Nexus trace in a real-time non-intrusive fashion from the high speed serial trace port (the Aurora interface). • Gigabit TAP + Trace (JTAG over JTAG cable) - Select to use the Gigabit TAP and Trace probe to send JTAG commands over the JTAG cable. • Gigabit TAP + Trace (JTAG over Aurora cable) - Select to use the Gigabit TAP and Trace probe to send JTAG commands over the Aurora cable. <p>For more details on Gigabit TAP, see <i>Gigabit TAP Users Guide</i> available in the <code><CWInstallDir>\PA\Help\PDF\</code> folder, where <code><CWInstallDir></code> is the installation directory of your Codewarrior software.</p>
TAP address	Enter the IP address of the selected TAP device.

2.1.4 Build Settings Page

Use this page to select a programming language, toolchain, and the output project type for your project.

NOTE

The current release does not include toolchains for Linux applications by default. To add the required build tools support, you should install the corresponding service pack for the required target. For more information on installing service packs, see the *Service Pack Updater Quickstart* available in the `<CWInstallDir>\PA\` folder.

Figure 4: Build Settings Page

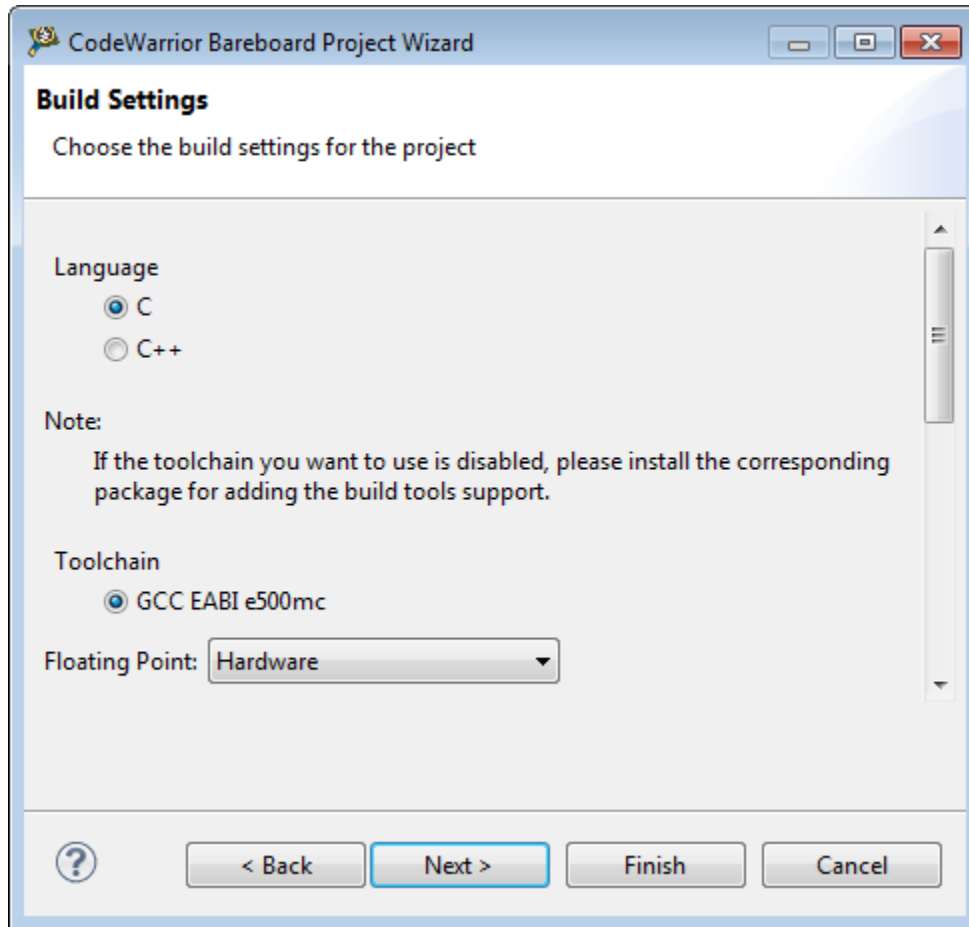

The table below describes the various options available on the **Build Settings** page.

Table 5: Build Settings Page

Option	Description
Language	Specifies the programming language used by the new project. The current installation supports the following languages: <ul style="list-style-type: none"> • C - Select to generate ANSI C-compliant startup code, and initializes global variables. • C++ - Select to generate ANSI C++ startup code, and performs global class object initialization.
Toolchain	Specifies the toolchains supported by the current installation. Selected toolchain sets up the default compiler, linker, and libraries used to build the new project. Each toolchain generates code targeted for a specific platform.
Floating Point	Specifies how the compiler handles floating-point operations, encountered in the source code.

2.1.5 Configurations Page

Use this page to specify the processing model and the processor core that executes the project.

Figure 5: Configurations Page

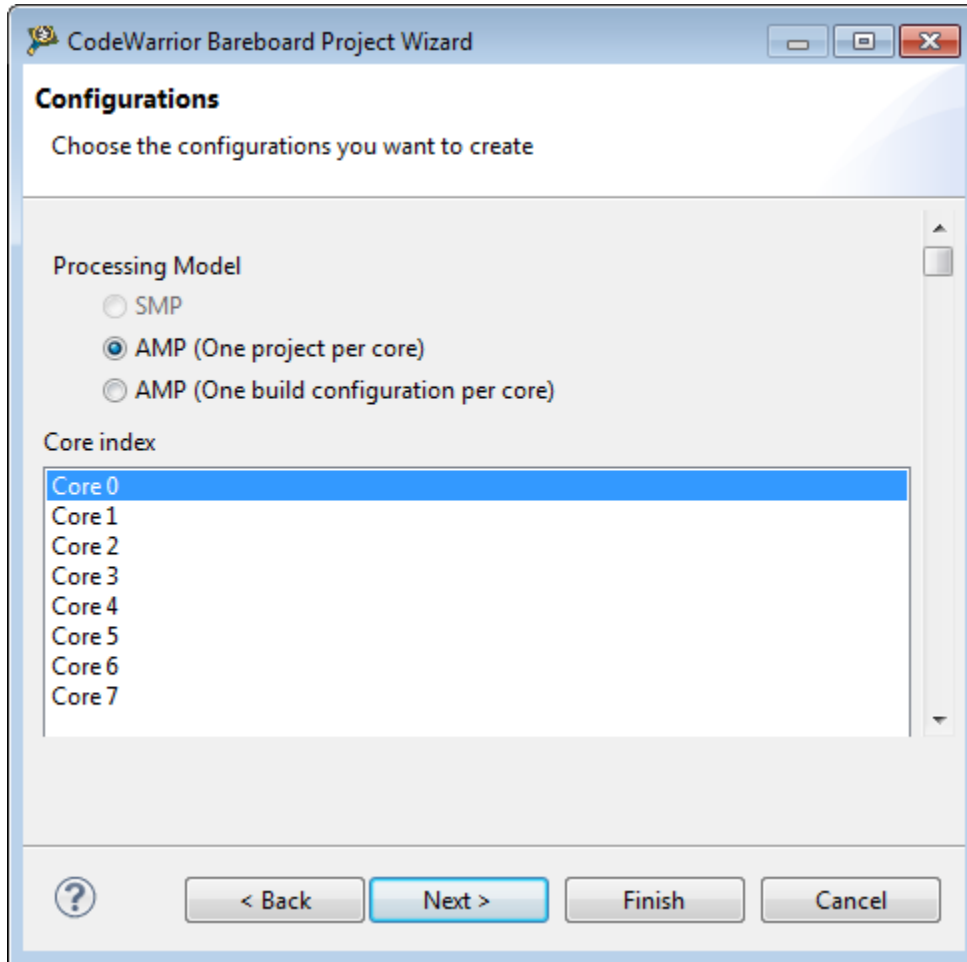

The table below describes the various options available on the **Configurations** page.

Table 6: Configurations Page Setting

Option	Description
Processing Model	<p>The current installation supports the following processing models:</p> <ul style="list-style-type: none"> • SMP - Select this option to generate a single project for the selected cores. The cores share the same interrupt vector, text, data sections and heap memory. Each core has its own, dedicated stack. A single initialization file should be executed for each core. <p style="text-align: center;">NOTE</p> <p style="text-align: center;">The SMP option is available for selection only while creating projects for some e500mc, e5500, and e6500 core targets.</p> <ul style="list-style-type: none"> • AMP (one project per core) - Select this option to generate a separate project for each selected core. The option will also set the core index for each project based on the core selection. • AMP (one build configuration per core) - Select this option to generate one project with multiple targets, each containing an lcf file for the specified core. <p style="text-align: center;">NOTE</p> <p style="text-align: center;">Selecting the AMP (One build configuration per core) option displays a checkbox, Set up build references for build configurations of all cores, just below this option. If you select the Set up build references for build configurations of all cores checkbox, then building the project for one core will automatically build the project for other cores as well. If you do not select this checkbox, then you would need to manually build the project for each core.</p>
Core Index	Select the processor core that executes the project.

2.1.6 Trace Configuration Page

Use this page to enable collection of trace and profiling data.

Figure 6: The Trace Configuration Page

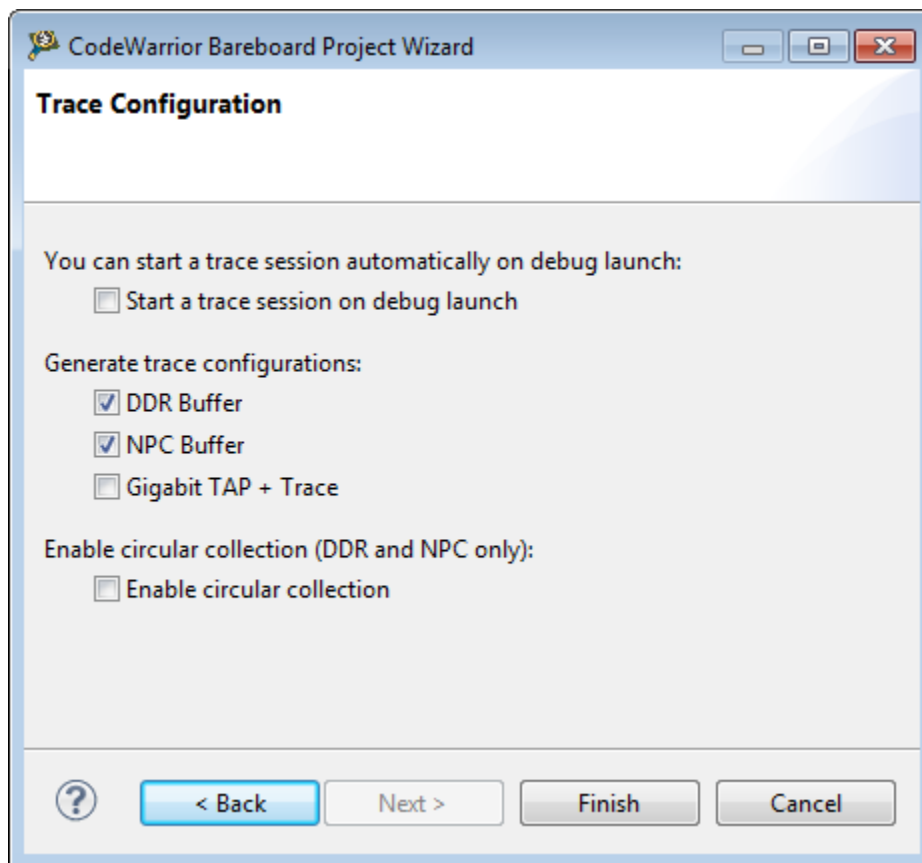

The table below describes the various options available on the **Trace Configuration** page.

Table 7: Trace Configuration Page Settings

Option	Description
Start a trace session on debug launch	Allows you to enable trace and profile for your project.
Generate trace configurations	Specifies the source used for collecting trace data. The current installation supports the following options: <ul style="list-style-type: none"> • DDR Buffer - Select to send trace to a DDR memory buffer. • NPC Buffer - Select to send trace data to a small dedicated trace buffer. • Gigabit TAP + Trace - Select to collect trace data on a GigabitTAP+Trace probe.
Enable circular collection (DDR and NPC only)	Specifies circular collection of trace data in the generated trace configurations. If selected, the trace buffer is treated as a 'circular buffer', and tracing continues even after the buffer is full by replacing the oldest entries.

2.2 CodeWarrior Linux Project Wizard

The CodeWarrior Linux Project Wizard helps you create a Linux project by displaying various pages that allow you to specify settings for your project.

NOTE

The pages that the wizard presents can differ, based upon the choice of project type or execution target.

The pages of the CodeWarrior Linux Project Wizard are:

- [Create a CodeWarrior Linux Project Page](#) on page 29
- [Processor Page](#) on page 31
- [Build Settings Page](#) on page 32
- [Linux Application Page](#) on page 33

2.2.1 Create a CodeWarrior Linux Project Page

Use this page to specify the project name and the directory where the project files are located.

Figure 7: Create a CodeWarrior Linux Project Page

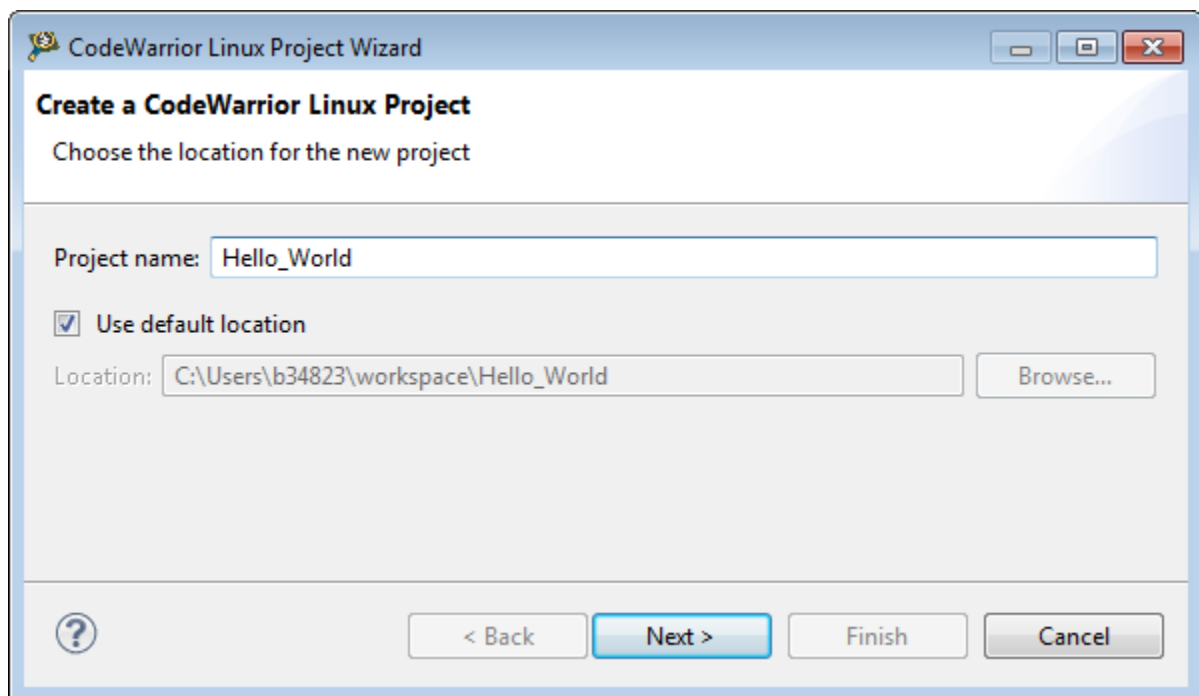

The table below describes the various options available on the **Create a CodeWarrior Linux Project** page.

Table 8: Create a CodeWarrior Linux Project Page Settings

Option	Description
Project name	Enter the name for the project in this text box.
<i>Table continues on the next page...</i>	

Table 8: Create a CodeWarrior Linux Project Page Settings (continued)

Option	Description
Use default location	Select to choose the directory to store the files required to build the program. Use the Location option to select the desired directory.
Location	Specifies the directory that contains the project files. Use Browse to navigate to the desired directory. This option is only available when Use default location is cleared. Ensure that you append the name of the project to the path to create a new location for your project.

2.2.2 Processor Page

This page displays the processors supported by the current installation. Use this page to specify the type of processor and the output for the new project.

Figure 8: Processor Page

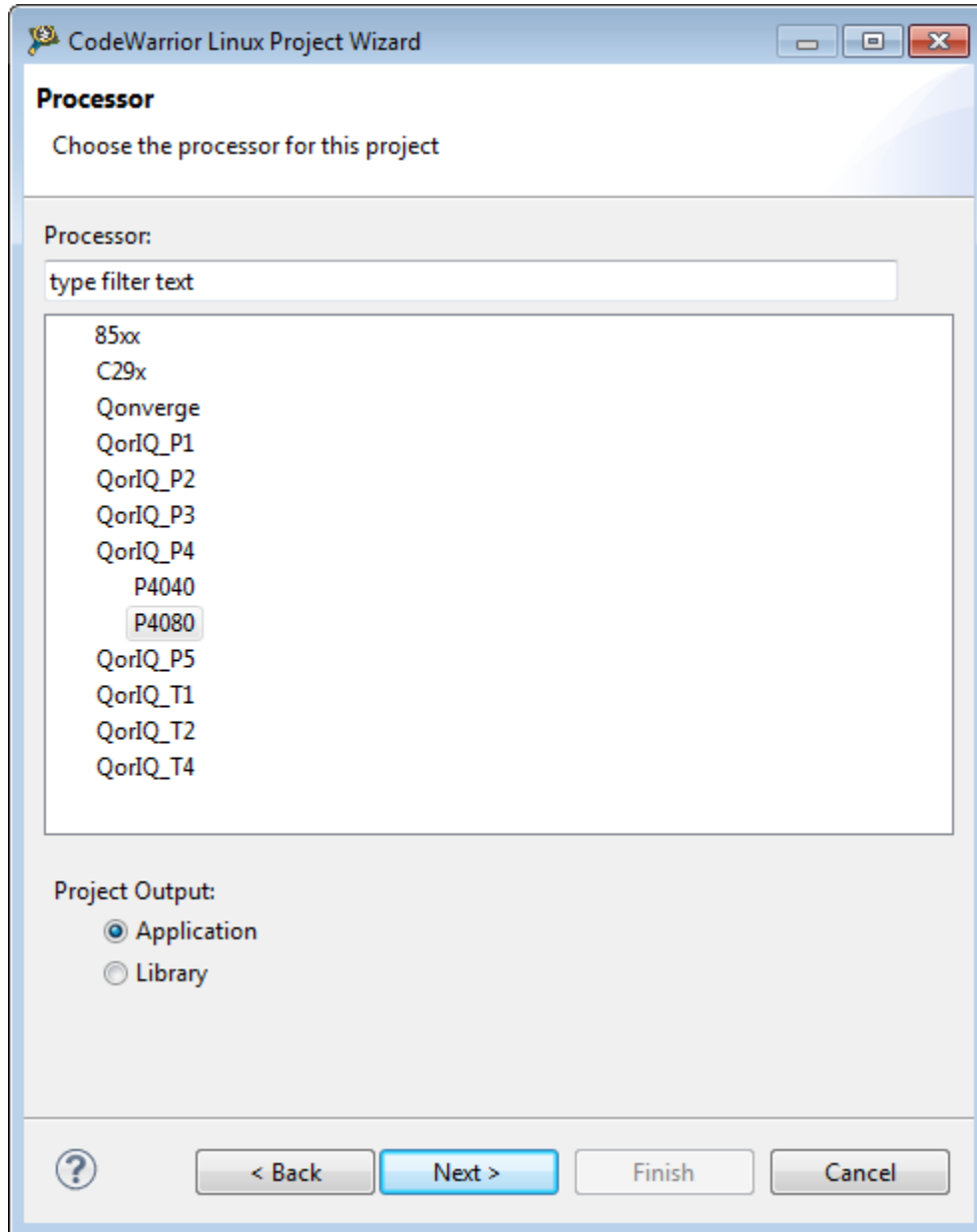

The table below describes the various options available on the **Processor** page.

Table 9: Processor Page Settings

Option	Description
Processor	Expand the processor family tree and select a supported target. The toolchain uses this choice to generate code that makes use of processor-specific features, such as multiple cores.
Project Output	Select any one of the following supported project output: <ul style="list-style-type: none"> • Application -Select to create an application with ".elf" extension, that includes information related to the debug over a board. • Library -Select to create a library with ".a" extension, that can be included in other projects. Library files created using this option do not include board specific details.

2.2.3 Build Settings Page

This page displays the toolchains supported by the current installation. Use this page to specify the toolchain for the new project.

NOTE

The current release does not include toolchains for Linux applications by default. To add the required build tools support, you should install the corresponding service pack for the required target. For more information on installing service packs, see the *Service Pack Updater Quickstart* available in the `<CWInstallDir>\PA\` folder.

Figure 9: Build Settings Page

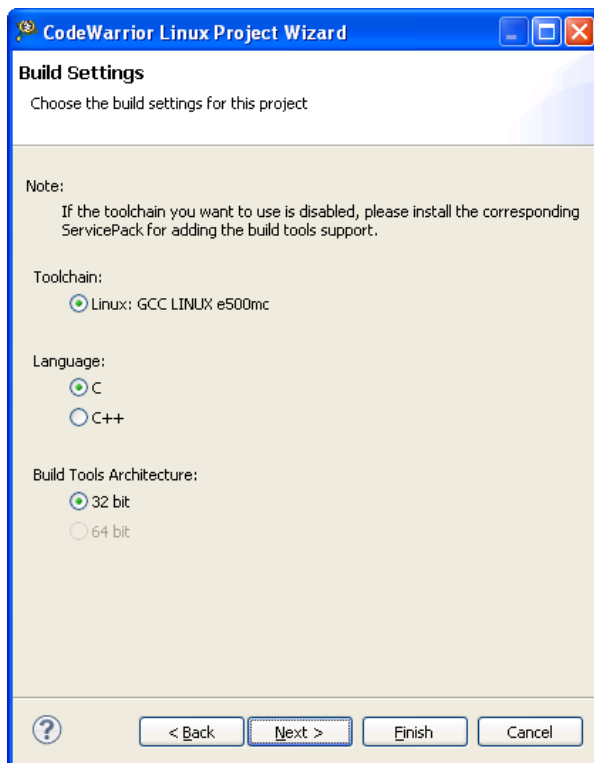

The table below describes the various options available on the **Build Settings** page.

Table 10: Build Settings Page Setting

Option	Description
Toolchain	Specifies the toolchains supported by the current installation. Selected toolchain sets up the default compiler, linker, and libraries used to build the new project. Each toolchain generates code targeted for a specific platform.
Language	Specifies the programming language used by the new project. The current installation supports the following languages: <ul style="list-style-type: none"> • C - Select to generate ANSI C-compliant startup code, and initializes global variables. • C++ - Select to generate ANSI C++ startup code, and performs global class object initialization.
Build Tools Architecture	Specifies the processor used by the new project. The current installation supports the following architectures: <ul style="list-style-type: none"> • 32 bit - 32 bit option is available by default for QorIQ_P4 processors. • 64 bit - 64 bit option is only available for QorIQ_P5 processors <p style="text-align: center;">NOTE</p> <p>For QorIQ_P4 processors, 32 bit option is selected by default and 64 bit is unavailable. But if you are using QorIQ_P5 processors, both the options are enabled.</p>

2.2.4 Linux Application Page

Use this page to specify how the debugger communicates with the host Linux system and controls your Linux application.

NOTE

The **Linux Application** page appears, in the **CodeWarrior Linux Project Wizard**, only when you add the Linux build tools support, by installing the corresponding service pack for the required target. For more information on installing service packs, see the *Service Pack Updater Quickstart* available in the `<CWInstallDir>\PA\` folder.

Figure 10: Linux Application Page

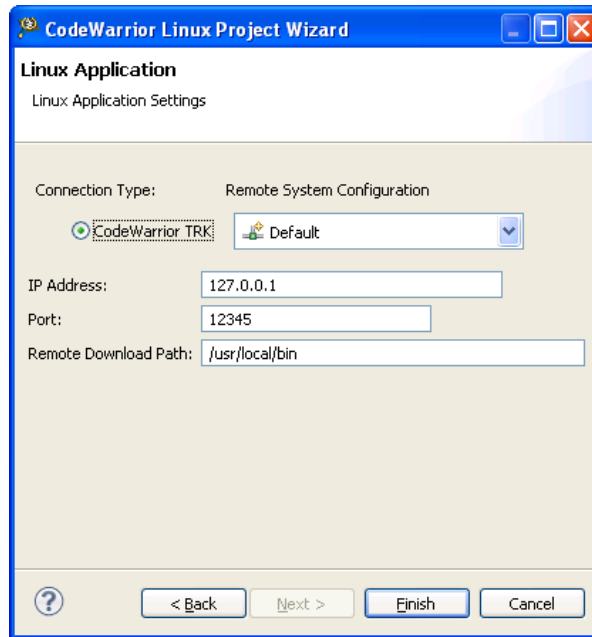

NOTE

When debugging a Linux application, you must use the **CodeWarrior TRK** to manage the communications interface between the debugger and Linux system. For details, see [Install CodeWarrior TRK on Target System](#) on page 228.

The table below describes the various options available on the **Linux Application** page.

Table 11: Linux Application Page Setting

Option	Description
CodeWarrior TRK	Select to use the CodeWarrior Target Resident Kernel (TRK) protocol, to download and control application on the Linux host system.
IP Address	Specifies the IP address of the Linux host system, the project executes on.
Port	Specifies the port number that the debugger will use to communicate to the Linux host.
Remote Download Path	Specifies the host directory into which the debugger downloads the application.

2.3 Creating projects

You can use a project creation wizard provided by CodeWarrior Development Studio to create a CodeWarrior project according to your requirements.

This section explains:

- [Creating CodeWarrior Bareboard Application Project](#) on page 35
- [Creating CodeWarrior Bareboard Library Project](#) on page 37

- [Creating CodeWarrior Linux Application Project](#) on page 39

2.3.1 Creating CodeWarrior Bareboard Application Project

You can create a CodeWarrior bareboard application project using the **CodeWarrior Bareboard Project Wizard**.

To create a CodeWarrior bareboard application project, perform these steps:

1. Select **Start > All Programs > Freescale CodeWarrior > CW for Power Architecture vnumber > CodeWarrior IDE**, where *number* is the version number of your product.

The **Workspace Launcher** dialog appears, prompting you to select a workspace to use.

NOTE

Click **Browse** to change the default location for workspace folder. You can also select the **Use this as the default and do not ask again** checkbox to set default or selected path as the default location for storing all your projects.

2. Click **OK**.

The default workspace is accepted. The CodeWarrior IDE launches and the **Welcome** page appears.

NOTE

The **Welcome** page appears only if the CodeWarrior IDE or the selected workspace is started for the first time. Otherwise, the Workbench window appears.

3. Click **Go to Workbench** from the **Welcome** page.

The workbench window appears.

4. Select **File > New > CodeWarrior Bareboard Project Wizard**, from the CodeWarrior IDE menu bar.

The **CodeWarrior Bareboard Project Wizard** launches and the **Create a CodeWarrior Bareboard Project** page appears.

5. Specify a name for the new project in the **Project name** text box.

For example, enter the project name as `Hello_World`.

6. If you do not want to create your project in the default workspace:

- a. Clear the **Use default location** checkbox.

- b. Click **Browse** and select the desired location from the **Browse For Folder** dialog.

- c. In the **Location** text box, append the location with the name of the directory in which you want to create your project. In the **Location** text box, append the location with the name of the directory in which you want to create your project.

NOTE

An existing directory cannot be specified for the project location. If created, the CodeWarrior will prompt an error message.

7. Click **Next**.

The **Processor** page appears.

8. Select the target processor for the new project, from the **Processor** list.

9. Select **Application** from the **Project Output** group, to create an application with `.elf` extension, that includes information required to debug the project.

10. Click **Next**.

The **Debug Target Settings** page appears.

11. Select a supported connection type (hardware, simulator, or emulator), from the **Debugger Connection Types** group. Your selection determines the launch configurations that you can include in your project.

12. Select the board you are targeting, from the **Board** drop-down list.

NOTE

Hardware or Simulators that supports the target processor selected on the **Processors** page are only available for selection. If you are using the Simics simulator, see <https://www.simics.net/> for latest version and installation instructions for Simics.

13. Select the launch configurations that you want to include in your project and the corresponding connection, from the **Launch** group.

14. Select the interface to communicate with the hardware, from the **Connection Type** drop-down list.

15. Enter the IP address of the TAP device in the **TAP address** text box. This option is disabled and cannot be edited, if you select **USB TAP** from the **Connection Type** drop-down list.

16. Click **Next**.

The **Build Settings** page appears.

17. Select the programming language, you want to use, from the **Language** group.

The language you select determines the libraries that are linked with your program and the contents of the main source file that the wizard generates.

18. Select the architecture type used by the new project, from the **Build Tools Architecture** group.

NOTE

For projects created for QorIQ_P5 processors, both the **32 bit** and **64 bit** options are enabled and can be selected. This option may not be available for some target processors selected on the **Processors** page.

19. Select a toolchain from the **Toolchain** group.

Selected toolchain sets up the default compiler, linker, and libraries used to build the new project. Each toolchain generates code targeted for a specific platform.

NOTE

The current release does not include toolchains for Linux applications by default. To add the required Linux build tools support, you should install the corresponding service pack for the required target. For more information on installing service packs, see the *Service Pack Updater Quickstart* available in the `<CWInstallDir>\PA\` folder.

20. Select an option from the **Floating Point** drop-down list, to prompt the compiler to handle the floating-point operations by generating instructions for the selected floating-point unit.

21. Click **Next**.

The **Configurations** page appears.

22. Select a processing model option from the **Processing Model** group.

NOTE

The SMP option is available for selection only while creating projects for some e500mc and e5500 core targets.

- Select **SMP** (One build configuration for all the cores) to generate a single project for the selected cores. The cores share the same interrupt vector, text, data sections and heap memory. Each core has its own, dedicated stack. A single initialization file should be executed for each core.
- Select **AMP (One project per core)** to generate a separate project for each selected core. The option will also set the core index for each project based on the core selection.
- Select **AMP (One build configuration per core)** to generate one project with multiple targets, each containing an `.lcf` file for the specified core.

23. Select the processor core that executes the project, from the Core index list.

24. Click **Next**.

The **Trace Configuration** page appears.

25. If you plan to collect the trace details:

- a. Select the **Start a trace session on debug launch** checkbox, to start a trace session automatically on debug launch.
- b. Select the source used for collecting trace data, from the **Generate trace configurations** group.
 - Select the **DDR Buffer** checkbox, to send the trace data to a DDR memory buffer.
 - Select the **NPC Buffer** checkbox, to send the trace data to a small dedicated trace buffer.
 - Select the **Gigabit TAP + Trace** checkbox, to collect trace data on a Gigabit TAP+Trace probe.
- c. Select the **Enable circular collection** checkbox, from the **Enable circular collection (DDR and NPC only)** group, to treat the trace buffer as a `circular buffer'. Selection of this checkbox, ensures continuation of trace collection, even after the buffer is full, by replacing the oldest entries.

26. Click **Finish**.

The wizard creates an application project according to your specifications. You can access the project from the **CodeWarrior Projects** view on the Workbench.

The new project is ready for use. You can now customize the project by adding your own source code files, changing debugger settings and adding libraries.

2.3.2 Creating CodeWarrior Bareboard Library Project

You can create a CodeWarrior bareboard library project using the **CodeWarrior Bareboard Project Wizard**.

To create a CodeWarrior bareboard library project, perform these steps:

1. Select **Start > All Programs > Freescale CodeWarrior > CW for Power Architecture v`number` > CodeWarrior IDE**, where `number` is the version number of your product.

The **Workspace Launcher** dialog appears, prompting you to select a workspace to use.

NOTE

Click **Browse** to change the default location for workspace folder. You can also select the **Use this as the default and do not ask again** checkbox to set default or selected path as the default location for storing all your projects.

2. Click **OK**.

The default workspace is accepted. The CodeWarrior IDE launches and the **Welcome** page appears.

NOTE

The **Welcome** page appears only if the CodeWarrior IDE or the selected workspace is started for the first time. Otherwise, the Workbench window appears.

3. Click **Go to Workbench**, on the **Welcome** page.

The workbench window appears.

4. Select **File > New > CodeWarrior Bareboard Project Wizard**, from the CodeWarrior IDE menu bar.

The **CodeWarrior Bareboard Project Wizard** launches and the **Create a CodeWarrior Bareboard Project** page appears.

5. Specify a name for the new project in the **Project name** text box.

For example, enter the project name as `library_project`.

6. If you do not want to create your project in the default workspace:

- a. Clear the **Use default location** checkbox.
- b. Click **Browse** and select the desired location from the **Browse For Folder** dialog.
- c. In the **Location** text box, append the location with the name of the directory in which you want to create your project.

NOTE

An existing directory cannot be specified for the project location.

7. Click **Next**.

The **Processor** page appears.

8. Select the target processor for the new project, from the **Processor** list.

9. Select **Static Library** from the **Project Output** group, to create a library with `.a` extension, that can be included in other projects. Library files created using this option do not include board specific details.

10. Click **Next**.

The **Build Settings** page appears.

11. Select the programming language, you want to use, from the **Language** group.

The language you select determines the libraries that are linked with your program and the contents of the main source file that the wizard generates.

12. Select a toolchain from the **Toolchain** group.

Selected toolchain sets up the default compiler, linker, and libraries used to build the new project. Each toolchain generates code targeted for a specific platform.

NOTE

The current release does not include toolchains for Linux applications by default. To add the required build tools support, you should install the corresponding service pack for the required target. For more information on installing service packs, see the *Service Pack Updater Quickstart* available in the `<CWInstallDir>\PA\` folder.

13. Select an option from the **Floating Point** drop-down list, to prompt the compiler to handle the floating-point operations by generating instructions for the selected floating-point unit.

14. Click **Finish**.

The wizard creates a library project according to your specifications. You can access the project from the **CodeWarrior Projects** view on the Workbench.

The new library project is ready for use. You can now customize the project to match your requirements.

2.3.3 Creating CodeWarrior Linux Application Project

You can create a CodeWarrior Linux application project using the **CodeWarrior Linux Project Wizard**.

To create a CodeWarrior Linux application project, perform these steps:

1. Select **Start > All Programs > Freescale CodeWarrior > CW for Power Architecture v $number$ > CodeWarrior IDE**, where $number$ is the version number of your product.

The **Workspace Launcher** dialog appears, prompting you to select a workspace to use.

NOTE

Click **Browse** to change the default location for workspace folder. You can also select the **Use this as the default and do not ask again** checkbox to set default or selected path as the default location for storing all your projects.

2. Click **OK**.

The default workspace is accepted. The CodeWarrior IDE launches and the **Welcome** page appears.

NOTE

The **Welcome** page appears only if the CodeWarrior IDE or the selected workspace is started for the first time. Otherwise, the Workbench window appears.

3. Click **Go to Workbench**, on the **Welcome** page.

The workbench window appears.

4. Select **File > New > CodeWarrior Linux Project Wizard**, from the CodeWarrior IDE menu bar.

The **CodeWarrior Linux Project Wizard** launches and the **Create a CodeWarrior Linux Project** page appears.

5. Specify a name for the new project in the **Project name** text box.

For example, enter the project name as `linux_project`.

6. If you do not want to create your project in the default workspace:

- a. Clear the **Use default location** checkbox.
- b. Click **Browse** and select the desired location from the **Browse For Folder** dialog.
- c. In the **Location** text box, append the location with the name of the directory in which you want to create your project.

NOTE

An existing directory cannot be specified for the project location.

7. Click **Next**.

The **Processor** page appears.

8. Select the target processor for the new project, from the **Processor** list.

9. Select **Application** from the **Project Output** group, to create an application with `.elf` extension, that includes information required to debug the project.

10. Click **Next**.

The **Build Settings** page appears.

11. Select a toolchain for Linux applications from the **Toolchain** group.

Selected toolchain sets up the default compiler, linker, and libraries used to build the new project. Each toolchain generates code targeted for a specific platform.

NOTE

The current release does not include toolchains for Linux applications by default. To add the required Linux build tools support, you should install the corresponding service pack for the required target. For more information on installing service packs, see the *Service Pack Updater Quickstart* available in the `<CWInstallDir>\PA\` folder.

12. Select the programming language, you want to use, from the **Language** group.

The language you select determines the libraries that are linked with your program and the contents of the main source file that the wizard generates.

13. Select the architecture type used by the new project, from the **Build Tools Architecture** group.

NOTE

For projects created for QorIQ_P5 processors, both the 32 bit and 64 bit options are enabled and can be selected. For all other processors, 32 bit option is selected by default and 64 bit is disabled and cannot be selected.

14. Click **Next**.

The **Linux Application** page appears.

15. Select **CodeWarrior TRK** to use the CodeWarrior Target Resident Kernel (TRK) protocol, to download and control application on the Linux host system.

NOTE

When debugging a Linux application, you must use the CodeWarrior TRK to manage the communications interface between the debugger and Linux system. For details, see [Install CodeWarrior TRK on Target System](#) on page 228.

16. Specify a **Remote System Configuration** option.

17. In the **IP Address** text box, enter the IP Address of the Linux host system, the project executes on.

18. In the **Port** text box, enter the port number that the debugger will use to communicate to the Linux host system.

19. In the **Remote Download Path** text box, enter the absolute path for the host directory, into which the debugger downloads the application.

20. Click **Finish**.

The wizard creates a CodeWarrior Linux application project according to your specifications. You can access the project from the **CodeWarrior Projects** view on the Workbench.

The new CodeWarrior Linux application project is ready for use. You can now customize the project to match your requirements.

2.4 Building projects

CodeWarrior IDE supports two modes of building projects.

These modes are:

- [Manual-Build mode](#) on page 41
- [Auto-Build mode](#) on page 41

2.4.1 Manual-Build mode

This section explains the manual mode of building projects.

In large workspaces, building the entire workspace can take a long time if users make changes with a significant impact on dependent projects. Often there are only a few projects that really matter to a user at a given time.

To build only the selected projects, and any prerequisite projects that need to be built to correctly build the selected projects, select **Project > Build Project** from the CodeWarrior IDE menu bar.

Figure 11: Project Menu- Build Project

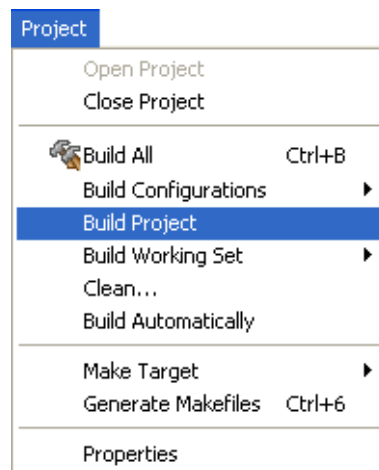

Alternatively, right-click on the selected project in the **CodeWarrior Projects** view and select **Build Project** from the context menu.

To build all projects available in the **CodeWarrior Projects** view, select **Project > Build All**.

Figure 12: Project Menu-Build All

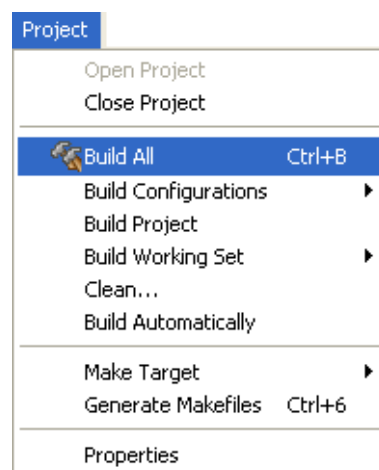

2.4.2 Auto-Build mode

This section explains the automatic mode of building projects.

CodeWarrior IDE takes care of compiling source files automatically. When auto-build is enabled, project build occurs automatically in the background every time you change files in the workspace (for example saving an editor).

To automatically build all the projects in a workspace, select **Project > Build Automatically** from the CodeWarrior IDE menu bar.

Figure 13: Project Menu-Build Automatically

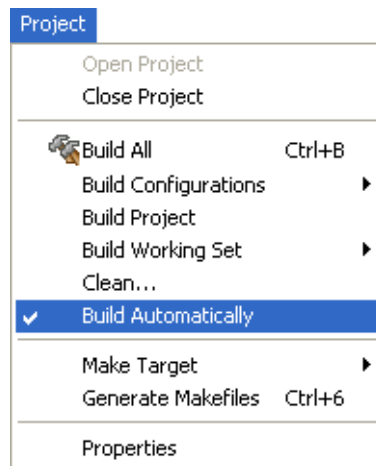

If auto-build is taking too long and is interfering with ongoing development, it can be turned off. Select **Project > Build Automatically** from the CodeWarrior IDE menu bar to disable auto-build mode.

NOTE

It is advised that you do not use the **Build Automatically** option for C/C++ development. Using this option will result in building the entire project whenever you save a change to the makefile or source files. This can take a significant amount of time for very large projects.

2.5 Importing Classic CodeWarrior Projects

The CodeWarrior Project Importer feature in Eclipse IDE helps automate the conversion of a legacy C/C++ CodeWarrior IDE project to a project supported by the latest versions of the CodeWarrior IDE.

This feature lets you:

- Select the classic CodeWarrior project
- Set targets to import
- Configure source trees and shielded folders
- Edit access paths for each target
- List files that are not found in the previous settings
- Specify the new project name and location
- List warnings or errors in the conversion process
- Open the newly created Eclipse project.

NOTE

For more information on importing classic CodeWarrior projects to the latest versions of the CodeWarrior IDE, see the CodeWarrior Common Features Guide from the `<CWInstallDir>\PA\Help\PDF\` folder.

2.6 Deleting Projects

Using the options available in CodeWarrior IDE, you can delete a project and optionally the resources linked to the project.

To delete a project, follow these steps:

1. Select the project you want to delete in the **CodeWarrior Projects** view.
2. Select **Edit > Delete**.

The **Delete Resources** dialog appears.

NOTE

Alternatively, you can also select **Delete** from the context menu that appears when you right-click the project.

3. Select the **Delete project contents on disk (cannot be undone)** option to delete the project contents permanently.

NOTE

You will not be able to restore your project using **Undo**, if you select the **Delete project contents on disk (cannot be undone)** option.

4. Click **OK**.

NOTE

In case, the **Unreferenced Remote Systems** dialog appears displaying a list of remote systems used by the deleted project, click **Remove** to delete the unreferenced remote systems. Alternatively, click **Cancel** to reuse the remote systems.

The selected project is deleted and relevant details of the project are removed from the **CodeWarrior Projects** view.

Working with Projects
Deleting Projects

Chapter 3

Build Properties

This chapter explains build properties for CodeWarrior for Power Architecture projects.

A *build configuration* is a named collection of build tools options. The set of options in a given build configuration causes the build tools to generate a final binary with specific characteristics. For example, the binary produced by a "Debug" build configuration might contain symbolic debugging information and have no optimizations, while the binary product by a "Release" build configuration might contain no symbolics and be highly optimized.

NOTE

The settings of the CodeWarrior IDE's build and launch configurations correspond to an object called a target made by the classic CodeWarrior IDE.

This chapter explains:

- [Changing Build Properties](#) on page 45
- [Restoring Build Properties](#) on page 46
- [Build Properties for Power Architecture](#) on page 46

3.1 Changing Build Properties

You can modify the build properties of a project to better suit your needs.

To change build properties of a project, perform the steps given below:

1. Start the CodeWarrior IDE.
2. In the **CodeWarrior Projects** view, select the project for which you want to modify the build properties.
3. Select **Project > Properties** from the menu bar.

The **Properties for <project>** window appears. The left pane of this window shows the build properties that apply to the current project.

4. Expand the **C/C++ Build** property.
5. Select **Settings**.
6. Use the Configuration drop-down list in the right pane to specify the launch configuration for which you want to modify the build properties.
7. Click the **Tool Settings** tab. The corresponding page appears.
8. From the list of tools on the **Tool Settings** page, select the tool for which you want to modify properties.
9. Change the settings that appear in the page.
10. Click **Apply**.

The IDE saves your new settings.

You can select other tool pages and modify their settings. When you finish, click **OK** to save your changes and close the Properties for <project> window.

3.2 Restoring Build Properties

If you had modified a build configuration of a project in the past, you can restore the build properties to have a factory-default configuration, or to revert to a last-known working build configuration.

To undo your modifications to build properties, click **Restore Defaults** at the bottom of the **Properties** window. This changes the values of the options to the absolute default of the toolchain. By default, the toolchain options are blank.

For example, when a Power Architecture project is created the Power ELF Linker panel has some values set, which are specific to the project. By selecting **Restore Defaults** the default values of settings will return to blank state of the toolchain.

3.3 Build Properties for Power Architecture

Based on different processor families, CodeWarrior for Power Architecture supports both CodeWarrior and GCC builds tools.

The build tools used in a project depend upon the processor and the build toolchain that is selected while creating a project.

The table below lists the build tools supported by different processors.

Table 12: Build Tools for Power Architecture Processor Families

Family	Processor	Build Tool
82xx	8250	CodeWarrior tools
83xx	8306	CodeWarrior tools
	8309	CodeWarrior tools
	8323	CodeWarrior tools
	8377	CodeWarrior tools
85xx	8536	CodeWarrior tools
	8548	CodeWarrior tools
	8560	CodeWarrior tools
	8568	CodeWarrior tools
	8569	CodeWarrior tools
	8572	CodeWarrior tools
C29x	C29x	CodeWarrior tools
Qonverge	B4420	GCC tools
	B4460	GCC tools
	B4860	GCC tools

Table continues on the next page...

Table 12: Build Tools for Power Architecture Processor Families (continued)

Family	Processor	Build Tool
	BSC9131	CodeWarrior/GCC tools
	BSC9132	CodeWarrior/GCC tools
	G1110	CodeWarrior/GCC tools
	G4860	GCC tools
QorIQ_P1	P1010	CodeWarrior tools
	P1011	CodeWarrior tools
	P1012	CodeWarrior tools
	P1013	CodeWarrior tools
	P1014	CodeWarrior tools
	P1015	CodeWarrior tools
	P1016	CodeWarrior tools
	P1017	CodeWarrior tools
	P1020	CodeWarrior tools
	P1021	CodeWarrior/GCC tools
	P1022	CodeWarrior tools
	P1023	CodeWarrior tools
	P1024	CodeWarrior tools
	P1025	CodeWarrior tools
QorIQ_P2	P2010	CodeWarrior tools
	P2020	CodeWarrior tools
	P2040	GCC tools
	P2041	GCC tools
QorIQ_P3	P3041	GCC tools
QorIQ_P4	P4040	GCC tools
	P4080	GCC tools
QorIQ_P5	P5010	GCC tools
	P5020	GCC tools
	P5021	GCC tools
	P5040	GCC tools
QorIQ_T1	T1013	GCC tools
	T1014	GCC tools

Table continues on the next page...

Table 12: Build Tools for Power Architecture Processor Families (continued)

Family	Processor	Build Tool
	T1020	GCC tools
	T1022	GCC tools
	T1023	GCC tools
	T1024	GCC tools
	T1040	GCC tools
	T1042	GCC tools
QorIQ_T2	T2080	GCC tools
	T2081	GCC tools
QorIQ_T4	T4160	GCC tools
	T4240	GCC tools

The following sections will help you with more details on the build tools supported by the current installation:

- [CodeWarrior Build Tool Settings](#) on page 48
- [GCC Build Tool Settings](#) on page 73

3.3.1 CodeWarrior Build Tool Settings

CodeWarrior build tools are build tools developed by Freescale.

The table below lists the CodeWarrior build tool settings specific to developing software for Power Architecture.

NOTE

For more details on CodeWarrior build tools, see the *Power Architecture Build Tools Reference Manual* available in the <CWInstallDir>\PA\Help\PDF\ folder.

Table 13: CodeWarrior Build Tool Settings for Power Architecture

Build Tool	Build Properties Panels
PowerPC CPU on page 49	
Debugging on page 50	
Messages on page 50	
PowerPC Linker on page 51	Input on page 51
	Link Order on page 53
	General on page 53
	Output on page 54
PowerPC Compiler on page 57	Preprocessor on page 58
	Input on page 58
	Warnings on page 59

Table continues on the next page...

Table 13: CodeWarrior Build Tool Settings for Power Architecture (continued)

Build Tool	Build Properties Panels
	Optimization on page 62 Processor on page 62 C/C++ Language on page 66
PowerPC Assembler on page 68	Input on page 69 General on page 70
PowerPC Disassembler on page 70	Disassembler Settings on page 71
PowerPC Preprocessor on page 72	Preprocessor Settings on page 72

3.3.1.1 PowerPC CPU

Use the **PowerPC CPU** panel to specify the Power Architecture processor family for the project.

The properties specified on this page are also used by the build tools (compiler, linker, and assembler).

The table below lists and describes the various options available on the **PowerPC CPU** panel.

Table 14: CodeWarrior Build Tool Settings - PowerPC CPU Options

Option	Explanation
Processor	Generates and links object code for a specific processor. This setting is equivalent to specifying the <code>-proc[essor]</code> <i>keyword</i> command-line option.
Floating Point	Controls floating-point code generation. This setting is equivalent to specifying the <code>-fp</code> <i>keyword</i> command-line option.
Byte Ordering	Generates object code and links an executable image to use the specified data format. This setting is equivalent to specifying the <code>-big</code> or <code>-little</code> command-line options.
Code Model	Specifies the addressing mode that the linker uses when resolving references. This setting is equivalent to specifying the <code>-model</code> <i>keyword</i> command-line option.
ABI	Chooses which ABI (Application Binary Interface) to conform to. This setting is equivalent to specifying the <code>-abi</code> <i>keyword</i> command-line option.
Tune Relocations	Ensures that references made by the linker conform to the PowerPC EABI (Embedded Application Binary Interface) or position-independent ABI (Application Binary Interface). Use this option only when you select EABI or SDA PIC/PID from the ABI drop-down list, to ensure that references in the executable image conform to these ABIs. To conform to both of these ABIs, the linker will modify relocations that do not reach the desired executable code. The linker first converts near branch instructions to far branch instructions. Then it will convert absolute branches to PC-relative branches. For branches that cannot be converted to far or PC-relative addressing, the linker will generate branch islands. To conform to the SDA PIC/PID ABI , the linker will generate the appropriate style of addressing. This setting is equivalent to specifying the <code>-tune_relocations</code> command-line option.
<i>Table continues on the next page...</i>	

Table 14: CodeWarrior Build Tool Settings - PowerPC CPU Options (continued)

Option	Explanation
Compress for PowerPC VLE (Zen)	Specifies compression of the VLE (Variable Length Encoding) code by shortening the gaps between the functions. <div style="text-align: center;"> <p>NOTE</p> <p>For Power Architecture processors that do not have the VLE capability, this option is disabled and cannot be selected.</p> </div>
Small Data	Limits the size of the largest objects in the small data section. This setting is equivalent to specifying the <code>-sdata[threshold] size</code> command-line option. The <i>size</i> value specifies the maximum size, in bytes, of all objects in the small data section (<code>.sdata</code>). The default value for <i>size</i> is 8. The linker places objects that are greater than this size in the data section (<code>.data</code>) instead.
Small Data2	Limits the size of the largest objects in the small constant data section. This setting is equivalent to specifying the <code>-sdata2[threshold] size</code> command-line option. The <i>size</i> value specifies the maximum size, in bytes, of all objects in the small constant data section (<code>.sdata2</code>). The default value for <i>size</i> is 8. The linker places constant objects that are greater than this size in the constant data section (<code>.rodata</code>) instead.

3.3.1.2 Debugging

Use the **Debugging** panel to specify the global debugging options for the project.

The table below lists and describes the various options available on the **Debugging** panel.

Table 15: CodeWarrior Build Tool Settings - Debugging Options

Option	Explanation
Generate DWARF Information	Generates DWARF 2.x conforming debugging information. This setting is equivalent to specifying the <code>-sym dwarf-2</code> command-line option.
Store Full Paths To Source Files	Stores absolute paths of the source files instead of relative paths. This setting is equivalent to specifying the <code>-sym full[path]</code> command-line option.

3.3.1.3 Messages

Use the **Messages** panel to specify the error and warning message options for the project.

The table below lists and describes the various options available on the **Messages** panel.

Table 16: CodeWarrior Build Tool Settings - Messages Options

Option	Explanation
Message Style	Controls the style used to show error and warning messages. This setting is equivalent to specifying the <code>-msgstyle keyword</code> command-line option.
Maximum Number of Errors	Specifies the maximum number of errors messages to show. This setting is equivalent to specifying the <code>-maxerrors number</code> command-line option.
Maximum Number of Warnings	Specifies the maximum number of warning messages to show. This setting is equivalent to specifying the <code>-maxwarnings number</code> command-line option.

3.3.1.4 PowerPC Linker

Use the **PowerPC Linker** panel to specify the CodeWarrior linker options that are specific to Power Architecture software development.

NOTE

The list of tools presented on the **Tool Settings** page can differ, based upon the toolchain used by the project.

The table below lists and describes the various options available on the **PowerPC Linker** panel.

Table 17: CodeWarrior Build Tool Settings - PowerPC Linker Options

Option	Explanation
Command	Specifies the location of the linker executable file
All Options	Specifies the actual command line, the linker will be called with
Expert settings: Command line pattern	Specifies the expert settings command line parameters

This section contains the following subsections:

- [Input](#) on page 51
- [Link Order](#) on page 53
- [General](#) on page 53
- [Output](#) on page 54

3.3.1.4.1 Input

Use the Input panel to specify the path to the linker command file and libraries.

The table below lists and describes the various options available on the **Input** panel.

Table 18: CodeWarrior Build Tool Settings - Input Options

Option	Explanation
No Standard Library	Uses standard system library access paths as specified by the environment variable <code>%MWLibraries%</code> to add system libraries as specified by the environment variable <code>%MWLibraryFiles%</code> at the end of link order. This setting is equivalent to specifying the <code>-nostdlib</code> command-line option.
Link Command File (.lcf)	Specifies the path of the linker-command file that the linker reads to determine how to build the output file. Alternatively, click Browse, then use the resulting dialog to specify the linker command file. This setting is equivalent to specifying the <code>-lcf filename</code> command-line option.
Code Address	Sets the run-time address of the executable code. This setting is equivalent to specifying the <code>-codeaddr addr</code> command-line option. The <code>addr</code> value is an address, in decimal or hexadecimal format. Hexadecimal values must begin with <code>0x</code> . The default is <code>65536</code> . This option is disabled and cannot be selected if you have specified the <code>.lcf</code> file in the Link Command File (.lcf) text box.





Table continues on the next page...

Table 18: CodeWarrior Build Tool Settings - Input Options (continued)

Option	Explanation
Data Address	Sets the loading address of the data. This setting is equivalent to specifying the <code>-dataaddr addr</code> command-line option. The <code>addr</code> value is an address, in decimal or hexadecimal format. Hexadecimal values must begin with <code>0x</code> . The default is the address after the code and large constant sections. This option is disabled and cannot be selected if you have specified the <code>.lcf</code> file in the Link Command File (.lcf) text box.
Small Data Address	Sets the loading address of small data. This setting is equivalent to specifying the <code>-sdataaddr addr</code> command-line option. The <code>addr</code> value is an address, in decimal or hexadecimal format. Hexadecimal values must begin with <code>0x</code> . The default is the address after the large data section. This option is disabled and cannot be selected if you have specified the <code>.lcf</code> file in the Link Command File (.lcf) text box.
Small Data 2 Address	Sets the loading address of small constant data. This setting is equivalent to specifying the <code>-sdata2addr addr</code> command-line option. The <code>addr</code> value is an address, in decimal or hexadecimal format. Hexadecimal values must begin with <code>0x</code> . The default is the address after the small data section. This option is disabled and cannot be selected if you have specified the <code>.lcf</code> file in the Link Command File (.lcf) text box.
Entry Point	Specifies the main entry point for the executable image. This setting is equivalent to specifying the <code>-m[ain] symbol</code> command-line option. The maximum length of <code>symbol</code> is 63 characters. The default is <code>_start</code> .
Library Search Paths	Use this panel to specify multiple paths that the Power Architecture linker searches for libraries. The linker searches the paths in the order shown in this list. The table that follows lists and describes the toolbar buttons that help work with the library search paths.
Library Files	Lists paths to libraries that the Power Architecture linker uses. The linker uses the libraries in the order shown in this list. The table that follows lists and describes the toolbar buttons that help work with the library file search paths.

The table below lists and describes the toolbar buttons that help work with the library search paths.

Table 19: CodeWarrior Build Tool Settings - Input Toolbar Buttons

Button	Tooltip	Description
	Add	Click to open the Add file path or the Add directory path dialog and create a file or directory path.
	Delete	Click to delete the selected file or directory. To confirm deletion, click Yes in the Confirm Delete dialog.
	Edit	Click to open the Edit file path or Edit directory path dialog and update the selected file or directory.
	Move up	Click to move the selected file search path one position higher in the list.
	Move down	Click to move the selected file search path one position lower in the list.

3.3.1.4.2 Link Order

Use the Link Order panel to control the link input order.

The table below lists and describes the various options available on the **Link Order** panel.

Table 20: CodeWarrior Build Tool Settings - Link Order Options

Option	Explanation
Customize linker input order	Allows to change the default link input order. Selecting this option enables the Link Order panel, allowing you to change the default link input order by using the Move Up and Move Down buttons on the Link Order panel toolbar.
Link Order	Shows the default link input order that you can change by selecting a link input and clicking the Move Up or Move Down button on the Link Order panel toolbar.

3.3.1.4.3 General

Use the General panel to specify the linker performance and optimization parameters.

The table below lists and describes the various options available on the **General** panel.

Table 21: CodeWarrior Build Tool Settings - General Options

Option	Explanation
Link Mode	Controls the performance of the linker. The default options are: <ul style="list-style-type: none"> • Normal - Uses little memory but may take more processing time. • Use Less RAM - Uses medium amount of memory for medium processing time. • Use More RAM - Uses lots of memory to improve processing time. This setting is equivalent to specifying the <code>-linkmode keyword</code> command-line option.
Code Merging	Code merging reduces the size of object code by removing identical functions. This option takes the following values: <ul style="list-style-type: none"> • Off - Disables code merging optimization. This is the default value. • All Functions - Controls code merging for all identical functions. • Safe Functions - Controls code merging for weak functions. This setting is equivalent to specifying the <code>-code_merging off all safe</code> command-line option.
Aggressive Merging	The code merging optimization will not remove an identical copy of a function if your program refers to its address. In this case, the compiler keeps this copied function but replaces its executable code with a branch instruction to the original function. To ignore references to function addresses, use aggressive code merging. This setting is equivalent to specifying the <code>-code_merging all,aggressive</code> or <code>-code_merging safe,aggressive</code> command-line options.
<i>Table continues on the next page...</i>	

Table 21: CodeWarrior Build Tool Settings - General Options (continued)

Option	Explanation
Merges FP Constants	Compiler pools strings of a file, when the option is checked. Deselect this option to keep individual the strings of each file. (This permits deadstripping of unused strings.) This setting is equivalent to specifying the <code>#pragma fp_constants merge pragma</code> .
Other Flags	Specify linker flags.

3.3.1.4.4 Output

Use the Output panel to specify the configuration of your final output file.

The table below lists and describes the various options available on the **Output** panel.

Table 22: CodeWarrior Build Tool Settings - Output Options

Option	Explanation
Output Type	<p>Specifies the generated output type. The default options are:</p> <ul style="list-style-type: none"> • Application • Static Library • Partial Link <p>This setting is equivalent to specifying the <code>-application, -library, -partial</code> command-line options.</p>
Optimize Partial Link	<p>Specifies the use of a linker command file, create tables for C++ static constructors, C++ static destructors, and C++ exceptions. This option also configures the linker to build an executable image, even if some symbols cannot be resolved.</p> <p style="text-align: center;">NOTE</p> <p style="text-align: center;">Select Partial Link from the Output Type list box to enable this option.</p> <p>This setting is equivalent to specifying the <code>-opt_partial</code> command-line option.</p>
Deadstrip Unused Symbols	<p>Removes unreferenced objects on a partially linked image.</p> <p style="text-align: center;">NOTE</p> <p style="text-align: center;">Select Partial Link from the Output Type list box to enable this option.</p> <p>This setting is equivalent to specifying the <code>-strip_partial</code> command-line option.</p>
<i>Table continues on the next page...</i>	

Table 22: CodeWarrior Build Tool Settings - Output Options (continued)

Option	Explanation
Require Resolved Symbols	<p>Finishes a partial link operation and issues error messages for unresolved symbols.</p> <p style="text-align: center;">NOTE</p> <p>Select Partial Link from the Output Type list box to enable this option.</p> <p>This setting is equivalent to specifying the <code>-resolved_partial</code> command-line option.</p>
Heap Size (k)	Sets the run-time size of the heap, in kilobytes. This setting is equivalent to specifying the <code>-heapsize size</code> command-line option.
Stack Size (k)	Sets the run-time size of the stack, in kilobytes. This setting is equivalent to specifying the <code>-stacksize size</code> command-line option.
Interpreter	Specifies the interpreter file used by the linker.
Generate Link Map	Generates a text file that describes the contents of the linker's output file. This setting is equivalent to specifying the <code>-map [filename]</code> command-line option.
List Closure	Controls the appearance of symbol closures in the linker map file. This setting is equivalent to specifying the <code>-listclosure</code> command-line option.
List Unused Objects	Controls the appearance of a list of unused symbols in the linker map file. This setting is equivalent to specifying the <code>-mapunused</code> command-line option.
List DWARF Objects	Controls the appearance of DWARF debugging information in the linker map file. This setting is equivalent to specifying the <code>-listdwarf</code> command-line option.
Generate Binary File	<p>Controls generation of the binary files. The default options are:</p> <ul style="list-style-type: none"> • None - Generates no binary file even if S-record generation is on. This is the default option. • One - Generates a single binary file with all the loadable code and data, even if S-record generation is off. • Multiple - Generates separate binary files for each MEMORY directive, even if S-record generation is off. <p>This setting is equivalent to specifying the <code>-genbinary keyword</code> command-line option.</p>
Generate S-Record File	Generates an S-record file. This setting is equivalent to specifying the <code>-srec</code> command-line option.
Sort S-Record	<p>Sorts the records, in ascending order, in an S-record file.</p> <p style="text-align: center;">NOTE</p> <p>Select Generate S-Record File to enable this option.</p> <p>This setting is equivalent to specifying the <code>-sortsrec</code> command-line option.</p>

Table continues on the next page...

Table 22: CodeWarrior Build Tool Settings - Output Options (continued)

Option	Explanation
Max S-Record Length	<p>Specifies the length of S-records. You can select a value from 8 to 255. The default is 26.</p> <p style="text-align: center;">NOTE</p> <p>Select Generate S-Record File to enable this option.</p> <p>This setting is equivalent to specifying the <code>-sreclength</code> command-line option.</p>
EOL Character	<p>Specifies the end-of-line style to use in an S-record file. The default options are:</p> <ul style="list-style-type: none"> • Mac - Use Mac OS®-style end-of-line format. • DOS - Use Microsoft® Windows®-style end-of-line format. This is the default choice. • UNIX - Use a UNIX-style end-of-line format. <p style="text-align: center;">NOTE</p> <p>Select Generate S-Record File to enable this option.</p> <p>This setting is equivalent to specifying the <code>-sreceol</code> <i>keyword</i> command-line option.</p>
Generate Warning Messages	<p>Turns on most warning messages issued by the build tools. This setting is equivalent to specifying the <code>-w on</code> command-line option.</p>
Heap Address	<p>Sets the run-time address of the heap. The specified address must be in decimal or hexadecimal format. Hexadecimal values must begin with <code>0x</code>. The default is <code>stack_address - (heap_size + stack_size)</code> where <code>stack_address</code> is the address of the stack, <code>heap_size</code> is the size of the heap, and <code>stack_size</code> is the size of the stack. This setting is equivalent to specifying the <code>-heapaddr</code> <i>address</i> command-line option.</p>
Stack Address	<p>Sets the run-time address of the stack. The specified address must be in decimal or hexadecimal format. Hexadecimal values must begin with <code>0x</code>. This setting is equivalent to specifying the <code>-stackaddr</code> <i>address</i> command-line option.</p>
Generate ROM Image	<p>Enables generation of a program image that may be stored in and started from ROM.</p>
ROM Image Address	<p>Generates a ROM image and specifies the image's starting address at run time.</p> <p style="text-align: center;">NOTE</p> <p>Select Generate ROM Image to enable this option.</p> <p>This setting is equivalent to specifying the <code>-romaddr</code> <i>address</i> command-line option.</p>

Table continues on the next page...

Table 22: CodeWarrior Build Tool Settings - Output Options (continued)

Option	Explanation
RAM Buffer Address of ROM Image	<p>Specifies a run-time address in which to store the executable image in RAM so that it may be transferred to flash memory.</p> <p style="text-align: center;">NOTE</p> <p>Select Generate ROM Image to enable this option.</p> <p>This option specifies information for a legacy flashing tool (some development boards that used the Power Architecture 821 processor). This tool required that the executable image must first be loaded to an area in RAM before being transferred to ROM.</p> <p style="text-align: center;">NOTE</p> <p>Do not use this option if your flash memory tool does not follow this behavior.</p> <p>This setting is equivalent to specifying the <code>-rombuffer <i>address</i></code> command-line option.</p>

3.3.1.5 PowerPC Compiler

Use the **PowerPC Compiler** panel to specify the compiler options that are specific to Power Architecture software development.

The table below lists and describes the various options available on the **PowerPC Compiler** panel.

Table 23: CodeWarrior Build Tool Settings - PowerPC Compiler Options

Option	Explanation
Command	Specifies the location of the PowerPC ELF compiler executable file that will be used to build the project.
All Options	The actual command line the compiler will be called with.
Expert settings: Command line pattern	Shows the expert settings command line parameters.

This section contains the following subsections:

- [Preprocessor](#) on page 58
- [Input](#) on page 58
- [Warnings](#) on page 59
- [Optimization](#) on page 62
- [Processor](#) on page 62
- [C/C++ Language](#) on page 66

3.3.1.5.1 Preprocessor

Use the Preprocessor panel to specify the preprocessor behavior by providing details of the file, whose contents can be used as prefix to all source files.

The table below lists and describes the various options available on the **Preprocessor** panel.

Table 24: CodeWarrior Build Tool Settings - Preprocessor Options

Option	Explanation
Prefix Files	Adds contents of a text file or precompiled header as a prefix to all source files. This setting is equivalent to specifying the <code>-prefix file</code> command-line option.
Source encoding	Specifies the default source encoding used by the compiler. The compiler automatically detects UTF-8 (Unicode Transformation Format) header or UCS-2/UCS-4 (Uniform Communications Standard) encodings regardless of setting. The default setting is <code>ascii</code> . This setting is equivalent to specifying the <code>-enc[oding] keyword</code> command-line option.
Defined Macros (-D)	Defines a specified symbol name. This setting is equivalent to specifying the <code>-D name</code> command-line option, where <code>name</code> is the symbol name to define.
Undefined Macros (-U)	Undefines the specified symbol name. This setting is equivalent to specifying the <code>-U name</code> command-line option, where <code>name</code> is the symbol name to undefine.

3.3.1.5.2 Input

Use the Input panel to specify the path and search order of the `#include` files.

The table below lists and describes the various options available on the **Input** panel.

Table 25: CodeWarrior Build Tool Settings - Input Options

Option	Explanation
Compile Only, Do Not Link	Instructs the compiler to compile but not invoke the linker to link the object code. This setting is equivalent to specifying the <code>-c</code> command-line option.
Do not use MWCIncludes variable	Restricts usage of standard system include paths as specified by the environment variable <code>%MWCIncludes%</code> . This setting is equivalent to specifying the <code>-nostdinc</code> command-line option.
Always Search User Paths	Performs a search of both the user and system paths, treating <code>#include</code> statements of the form <code>#include <xyz></code> the same as the form <code>#include "xyz"</code> . This setting is equivalent to specifying the <code>-nosyspath</code> command-line option.
User Path (-i)	Use this panel to specify multiple user paths and the order in which to search those paths. The table that follows lists and describes the toolbar buttons that help work with the file search paths. This setting is equivalent to specifying the <code>-i</code> command-line option.
User Recursive Path (-ir)	Appends a recursive access path to the current User Path list. The table that follows lists and describes the toolbar buttons that help work with the file search paths. This setting is equivalent to specifying the <code>-ir path</code> command-line option.





Table continues on the next page...

Table 25: CodeWorrior Build Tool Settings - Input Options (continued)

Option	Explanation
System Path (-I -I)	<p>Changes the build target's search order of access paths to start with the system paths list. The table that follows lists and describes the toolbar buttons that help work with the file search paths.</p> <ul style="list-style-type: none"> • The compiler can search <code>#include</code> files in several different ways. Use this panel to set the search order as follows: • For include statements of the form <code>#include "xyz"</code>, the compiler first searches user paths, then the system paths • For include statements of the form <code>#include <xyz></code>, the compiler searches only system paths <p>This setting is equivalent to specifying the <code>-I- -I path</code> command-line option.</p>
System Recursive Path (-I -ir)	<p>Appends a recursive access path to the current System Path list. The table that follows lists and describes the toolbar buttons that help work with the file search paths. This setting is equivalent to specifying the <code>-I- -ir</code> command-line option.</p>
Disable CW Extensions	<p>Controls deadstripping files. Not all third-party linkers require checking this option.</p>

The table below lists and describes the toolbar buttons that help work with the **Input** panel.

Table 26: CodeWorrior Build Tool Settings - Input Toolbar Buttons

Button	Tooltip	Description
	Add	Click to open the Add file path or the Add directory path dialog and create a file or directory path.
	Delete	Click to delete the selected file or directory. To confirm deletion, click Yes in the Confirm Delete dialog.
	Edit	Click to open the Edit file path or Edit directory path dialog and update the selected file or directory.
	Move up	Click to move the selected file search path one position higher in the list.
	Move down	Click to move the selected file search path one position lower in the list.

3.3.1.5.3 Warnings

Use the Warnings panel to control how the compiler reports the error and warning messages.

The table below lists and describes the various options available on the **Warnings** panel.

Table 27: CodeWarrior Build Tool Settings - Warnings

Option	Explanation
Treat All Warnings As Errors	Select to make all warnings into hard errors. Source code which triggers warnings will be rejected.
Illegal Pragmas	Select to issue a warning message if the compiler encounters an unrecognized pragma. This setting is equivalent to specifying the <code>pragma warn_illpragma pragma</code> and the <code>-warnings illpragmas</code> command-line option.
Possible Errors	Select to issue warning messages for common, usually-unintended logical errors: in conditional statements, using the assignment (<code>=</code>) operator instead of the equality comparison (<code>==</code>) operator, in expression statements, using the <code>==</code> operator instead of the <code>=</code> operator, placing a semicolon (<code>;</code>) immediately after a <code>do</code> , <code>while</code> , <code>if</code> , or <code>for</code> statement. This setting is equivalent to specifying the <code>warn_possunwant pragma</code> and the <code>-warnings possible</code> command-line option.
Extended Error Checking	Select to issue warning messages for common programming errors: mismatched return type in a function's definition and the return statement in the function's body, mismatched assignments to variables of enumerated types. This setting is equivalent to specifying the <code>extended_errorcheck pragma</code> and the <code>-warnings extended</code> command-line option.
Hidden virtual functions	Select to issue warning messages if you declare a non-virtual member function that prevents a virtual function, that was defined in a superclass, from being called. This setting is equivalent to specifying the <code>warn_hidevirtual pragma</code> and the <code>-warnings hidevirtual</code> command-line option.
Implicit Arithmetic Conversions	Select to issue warning messages when the compiler applies implicit conversions that may not give results you intend: assignments where the destination is not large enough to hold the result of the conversion, a signed value converted to an unsigned value, an integer or floating-point value is converted to a floating-point or integer value, respectively. This setting is equivalent to specifying the <code>warn_implicitconv pragma</code> and the <code>-warnings implicitconv</code> command-line option.
Implicit Integer To Float Conversions	Select to issue warning messages for implicit conversions from integer to floating-point values. This setting is equivalent to specifying the <code>warn_impl_i2f_conv pragma</code> and the <code>-warnings impl_int2float</code> command-line option.
Implicit Float To Integer Conversions	Select to issue warning messages for implicit conversions from floating point values to integer values. This setting is equivalent to specifying the <code>warn_impl_f2i_conv pragma</code> and the <code>-warnings impl_float2int</code> command-line option.
Implicit Signed/Unsigned Conversions	Select to issue warning messages for implicit conversions from a signed or unsigned integer value to an unsigned or signed value, respectively. This setting is equivalent to specifying the <code>warn_impl_s2u_conv pragma</code> and the <code>-warnings signedunsigned</code> command-line option.
<i>Table continues on the next page...</i>	

Table 27: CodeWarrior Build Tool Settings - Warnings (continued)

Option	Explanation
Pointer/Integral Conversions	Select to issue warning messages for implicit conversions from pointer values to integer values and from integer values to pointer values. This setting is equivalent to specifying the <code>warn_any_ptr_int_conv</code> and <code>warn_ptr_int_conv</code> pragmas and the <code>-warnings p rintconv, anyptrinconv</code> command-line option.
Unused Arguments	Select to issue warning messages for function arguments that are not referred to in a function. This setting is equivalent to specifying the <code>warn_unusedarg</code> pragma and the <code>-warnings unusedarg</code> command-line option.
Unused Variables	Select to issue warning messages for local variables that are not referred to in a function. This setting is equivalent to specifying the <code>warn_unusedvar</code> pragma and the <code>-warnings unusedvar</code> command-line option.
Missing 'return' Statement	Select to issue warning messages, if a function that is defined to return a value has no return statement. This setting is equivalent to specifying the <code>warn_missingreturn</code> pragma and the <code>-warnings missingreturn</code> command-line option.
Expression Has No Side Effect	Select to issue warning messages if a statement does not change the program's state. This setting is equivalent to specifying the <code>warn_no_side_effect</code> pragma and the <code>-warnings unusedexpr</code> command-line option.
Extra Commas	Select to issue a warning messages if a list in an enumeration terminates with a comma. The compiler ignores terminating commas in enumerations when compiling source code that conforms to the ISO/IEC 9899-1999 ("C99") standard. This setting is equivalent to specifying the <code>warn_extracomma</code> pragma and the <code>-warnings extracomma</code> command-line option.
Empty Declarations	Select to issue warning messages if a declaration has no variable name. This setting is equivalent to specifying the <code>warn_emptydecl</code> pragma and the <code>-warnings emptydecl</code> command-line option.
Inconsistent 'class' / 'struct' Usage	Select to issue warning messages if the class and struct keywords are used interchangeably in the definition and declaration of the same identifier in C++ source code. This setting is equivalent to specifying the <code>warn_structclass</code> pragma and the <code>-warnings structclass</code> command-line option.
Include File Capitalization	Select to issue warning messages if the name of the file specified in a <code>#include</code> file directive uses different letter case from a file on disk. This setting is equivalent to specifying the <code>warn_filenameecaps</code> pragma and the <code>-warnings filecaps</code> command-line option.
Check System Includes	Select to issue warning messages if the name of the file specified in a <code>#include</code> file directive uses different letter case from a file on disk. This setting is equivalent to specifying the <code>warn_filenameecaps_system</code> pragma and the <code>-warnings sysfilecaps</code> command-line option.
Pad Bytes Added	Select to issue warning messages when the compiler adjusts the alignment of components in a data structure. This setting is equivalent to specifying the <code>warn_padding</code> pragma and the <code>-warnings padding</code> command-line option.
<i>Table continues on the next page...</i>	

Table 27: CodeWarrior Build Tool Settings - Warnings (continued)

Option	Explanation
Undefined Macro in #if	Select to issue warning messages if an undefined macro appears in #if and #elif directives. This setting is equivalent to specifying the warn_undefmacro pragma and the -warnings undefmacro command-line option.
Non-Inlined Functions	Select to issue warning messages if a call to a function defined with the inline, _inline_, or _inline keywords could not be replaced with the function body. This setting is equivalent to specifying the warn_notinlined pragma and the -warnings notinlined command-line option.

3.3.1.5.4 Optimization

Use the Optimization panel to control the code optimization settings.

The table below lists and describes the various options available on the **Optimization** panel.

Table 28: CodeWarrior Build Tool Settings - Optimization Options

Option	Explanation
Optimization Level	Specifies code optimization options to apply to object code. This setting is equivalent to specifying the -opt <i>keyword</i> command-line option.
Speed vs. Size	Specifies code optimization for speed or size. This setting is equivalent to specifying the optimize_for_size on or optimize_for_size off pragmas and -opt speed or -opt size command-line option.
Inlining	Specifies inline options. Default settings are: <ul style="list-style-type: none"> • Smart - The compiler considers the functions declared with inline. • Auto Inline - Inlines small functions even if they are not declared with the inline qualifier. • Off - Turns off inlining. This setting is equivalent to specifying the -inline, -inline auto, or -inline off command-line option.
Bottom-up Inlining	Select to instruct the compiler to inline functions from the last function called to the first function in a chain of function calls. This setting is equivalent to specifying the inline_bottom_up pragma and -inline <i>bottomup</i> command-line option.

3.3.1.5.5 Processor

Use the Processor panel to control the processor-dependent code-generation settings.

The table below lists and describes the various options available on the **Processor** panel.

Table 29: CodeWarrior Build Tool Settings - Processor Options

Option	Explanation
Struct Alignment	<p>Specifies structure and array alignment. The default options are:</p> <ul style="list-style-type: none"> • PowerPC - Use conventional Power Architecture alignment. This choice is the default. • 68K - Use conventional Mac OS® 68K alignment. • 68K 4-Byte - Use Mac OS® 68K 4-byte alignment. <p>This setting is equivalent to specifying the <code>-align keyword</code> command-line option.</p>
Function Alignment	<p>Specifies alignment of functions in executable code. The default alignment is 4. However, at an optimization level 4, the alignment changes to 16. If you are using <code>-func_align 4</code> (or none) and if you are compiling for VLE, then the linker will compress gaps between VLE functions:</p> <ul style="list-style-type: none"> • If those functions are not called by a Classic PPC function • The function has an alignment greater than 4. <p style="text-align: center;">NOTE</p> <p style="text-align: center;">Compression of the gaps will only happen on files compiled by the CodeWarrior compiler.</p> <p>This setting is equivalent to specifying the <code>-func_align</code> command-line option.</p>
Relax HW IEEE	<p>Controls the use of relaxed IEEE floating point operations. This setting is equivalent to specifying the <code>-relax_ieee</code> command-line option.</p>
Use Fused Mult-Add/Sub	<p>Controls the use of fused multiply-addition instructions. This setting is equivalent to specifying the <code>-maf on off</code> command-line option.</p>
Generate FSEL Instructions	<p>Controls the use of FSEL instructions.</p> <p style="text-align: center;">NOTE</p> <p style="text-align: center;">Do not turn on this option, if the Power Architecture processor of your target platform does not have hardware floating-point capabilities, that includes fsel. This option only has an effect if Relax HW IEEE option or <code>-relax_ieee</code> command-line option is also specified. The default is <code>off</code>.</p> <p>This setting is equivalent to specifying the <code>-gen_fsel</code> command-line option.</p>

Table continues on the next page...

Table 29: CodeWarrior Build Tool Settings - Processor Options (continued)

Option	Explanation
Assume Ordered Compares	Controls the assumption of no unordered values in comparisons. This setting is equivalent to specifying the <code>-ordered-fp-compares</code> , <code>-no-ordered-fp-compares</code> command-line options.
Vector Support	<p>Specifies supported vector options. Default settings are:</p> <ul style="list-style-type: none"> • None - Turns off vectorization. • SPE - Enables the SPE vector support. This option needs to be enabled when the floating point is set to SPFP or DPFP as both SPFP and DPFP require support from the SPE vector unit. If the option is not turned on, the compiler generates a warning and automatically enables the SPE vector generation. • AltiVec - Enables the AltiVec vector support and generate AltiVec vectors and related instructions. <p>This setting is equivalent to specifying the <code>-spe_vector</code> and <code>-vector</code> <i>keyword</i> command-line options.</p>
Generate VRSAVE Instructions	Specifies generation of AltiVec vectors and instructions that use VRSAVE prologue and epilogue code. This setting is equivalent to specifying the <code>-vector novrsave</code> , <code>-vector vrsave</code> command-line options.
AltiVec Structure Moves	Controls the use of AltiVec instructions to optimize block moves. This setting is equivalent to specifying the <code>-noaltivec_move_block</code> , <code>-altivec_move_block</code> command-line options.
Make Strings ReadOnly	Places string constants in a read-only section. This setting is equivalent to specifying the <code>-readonlystrings</code> command-line options.
Merges String Constants	<p>Specifies how the compiler will place strings of a file. If this option is selected, the strings of a file will be kept as a pool; otherwise, they will be placed separately.</p> <p style="text-align: center;">NOTE</p> <p style="text-align: center;">This option is enabled only when the Make Strings ReadOnly option is selected.</p>

Table continues on the next page...

Table 29: CodeWarrior Build Tool Settings - Processor Options (continued)

Option	Explanation
Pool Data	<p>Controls the grouping of similar-sized data objects. Use this option to reduce the size of executable object code in functions that refer to many objects of the same size. These similar-sized objects do not need to be of the same type. The compiler only applies this option to a function if the function refers to at least 3 similar-sized objects. The objects must be global or static. At the beginning of the function, the compiler generates instructions to load the address of the first similar-sized object. The compiler then uses this address to generate 1 instruction for each subsequent reference to other similar-sized objects instead of the usual 2 instructions for loading an object using absolute addressing. This setting is equivalent to specifying the <code>pool_data</code> pragma and <code>-pool[data]</code> command-line option.</p>
Use Common Section	<p>Moves uninitialized data into a common section. The default is off. This setting is equivalent to specifying the <code>-common</code> command-line option.</p>
Use LMW STMW	<p>Controls the use of multiple load and store instructions for function prologues and epilogues. The default is off.</p> <p style="text-align: center;">NOTE</p> <p style="text-align: center;">This option is only available for big-endian processors. This option is not available for big-endian e500v1 and e500v2 architectures when vector and double-precision floating-point instructions are used.</p> <p>This setting is equivalent to specifying the <code>-use_lmw_stmw</code> command-line option.</p>
Inlined Assembler is Volatile	<p>Controls whether or not inline assembly statements will be optimized. This setting is equivalent to specifying the <code>-volatileasm, -novolatileasm</code> command-line options.</p>
Instruction Scheduling	<p>Controls the rearrangement of instructions to reduce the effects of instruction latency. The default is off. This setting is equivalent to specifying the <code>-schedule</code> command-line option.</p>
Peephole Optimization	<p>Specifies peephole optimization. This setting is equivalent to specifying the <code>peephole</code> pragma and the <code>-opt peep[hole]</code> command-line option.</p>
Profiler Information	<p>Controls the appearance of calls to a profiler library at the entry and exit points of each function. The default is off. This setting is equivalent to specifying the <code>-profile</code> command-line option.</p>

Table continues on the next page...

Table 29: CodeWarrior Build Tool Settings - Processor Options (continued)

Option	Explanation
Generate ISEL Instructions (e500/Zen)	<p>Controls the use of isel instructions. The default is off.</p> <p style="text-align: center;">NOTE</p> <p>If the Power Architecture processor of your target platform does not implement the Freescale ISEL APU, this option appears disabled and cannot be selected.</p> <p>This setting is equivalent to specifying the <code>-use-isel</code> command-line option.</p>
Translate PPC Asm to VLE Asm (Zen)	<p>Controls VLE code generation for inline assembly statements.</p> <p style="text-align: center;">NOTE</p> <p>If the Power Architecture processor of your target platform does not have the VLE capability, this option appears disabled and cannot be selected.</p> <p>This setting is equivalent to specifying the <code>-ppc_asm_to_vle</code> command-line option.</p>

3.3.1.5.6 C/C++ Language

Use the C/C++ Language panel to control the compiler language features and some object code storage features for the current build target.

The table below lists and describes the various options available on the **C/C++ Language** panel.

Table 30: CodeWarrior Build Tool Settings - C/C++ Language Options

Option	Explanation
Force C++ Compilation	Translates all C source files as C++ source code. This setting is equivalent to specifying the <code>cplusplus</code> pragma and <code>-lang c++</code> command-line option.
ISO C++ Template Parser	Enforces the use of ISO/IEC 14882-1998 standard for C++ to translate templates, and more careful use of the <code>typename</code> and <code>template</code> keywords. The compiler also follows stricter rules for resolving names during declaration and instantiation. This setting is equivalent to specifying the <code>parse_func_tmpl</code> pragma and <code>-iso_templates</code> command-line option.
Use Instance Manager	Reduces compile time by generating any instance of a C++ template (or non-inlined inline) function only once. This setting is equivalent to specifying the <code>-instmgr</code> command-line option.
Enable C++ Exceptions	Generates executable code for C++ exceptions. Enable this option, if you use the <code>try</code> , <code>throw</code> , and <code>catch</code> statements specified in the ISO/IEC 14882-1998 C++ standard. Otherwise, disable this setting to generate smaller and faster code. This setting is equivalent to specifying the <code>-cpp_exceptions</code> command-line option.
<i>Table continues on the next page...</i>	

Table 30: CodeWarrior Build Tool Settings - C/C++ Language Options (continued)

Option	Explanation
Enable RTTI	Allows the use of the C++ run-time type information (RTTI) capabilities, including the <code>dynamic_cast</code> and <code>typeid</code> operators. This setting is equivalent to specifying the <code>-RTTI</code> command-line option.
Enable C++ 'bool' type, 'true' and 'false' Constants	Instructs the C++ compiler to recognize the <code>bool</code> type and its true and false values specified in the ISO/IEC 14882-1998 C++ standard. This setting is equivalent to specifying the <code>-bool</code> command-line option.
Enable <code>wchar_t</code> Support	Instructs the C++ compiler to recognize the <code>wchar_t</code> data type specified in the ISO/IEC 14882-1998 C++ standard. This setting is equivalent to specifying the <code>-wchar_t</code> command-line option.
EC++ Compatibility Mode	Verifies C++ source code files for Embedded C++ source code. This setting is equivalent to specifying the <code>-dialect ec++</code> command-line option.
ANSI Strict	Recognizes source code that conforms to the ISO/IEC 9899-1990 standard for C. This setting is equivalent to specifying the <code>-ansi strict</code> command-line option.
ANSI Keywords Only	Generates an error message for all non-standard keywords. <p style="text-align: center;">NOTE</p> <p style="text-align: center;">Enable this setting only if the source code strictly adheres to the ISO standard.</p> <p>This setting is equivalent to specifying the <code>-stdkeywords</code> command-line option.</p>
Expand Trigraphs	Specifies compiler to recognize trigraph sequences. clear this option to use many common characters, that look like trigraph sequences, without including escape characters. This setting is equivalent to specifying the <code>-trigraphs</code> command-line option.
Legacy for-scoping	Generates an error message when the compiler encounters a variable scope usage that the ISO/IEC 14882-1998 C++ standard disallows, but is allowed in the C++ language specified in <i>The Annotated C++ Reference Manual ("ARM")</i> . This setting is equivalent to specifying the <code>-for_scoping</code> command-line option.
Require Prototypes	Specifies compiler to enforce the requirement of function prototypes. <p style="text-align: center;">NOTE</p> <p style="text-align: center;">The compiler generates an error message if you define a previously referenced function that does not have a prototype. The compiler generates a warning message, if you define the function before it is referenced but do not give it a prototype.</p> <p>This setting is equivalent to specifying the <code>-requireprotos</code> command-line option.</p>

Table continues on the next page...

Table 30: CodeWarrior Build Tool Settings - C/C++ Language Options (continued)

Option	Explanation
Enable C99 Extensions	Specifies compiler to recognize ISO/IEC 9899-1999 ("C99") language features. This setting is equivalent to specifying the <code>-dialect c99</code> command-line option.
Enable GCC Extensions	Specifies compiler to recognize language features of the GNU Compiler Collection (GCC) C compiler that are supported by CodeWarrior compilers. This setting is equivalent to specifying the <code>-gcc_extensions</code> command-line option.
Enum Always Int	Specifies compiler to use signed integers to represent enumerated constants. This setting is equivalent to specifying the <code>-enum</code> command-line option.
Use Unsigned Chars	Specifies compiler to treat char declarations as unsigned char declarations. This setting is equivalent to specifying the <code>-char unsigned</code> command-line option.
Pool Strings	Specifies compiler to collect all string constants into a single data section in the object code, it generates. This setting is equivalent to specifying the <code>-strings pool</code> command-line option.
Reuse	Specifies compiler to store only one copy of identical string literals. This setting is equivalent to specifying the <code>-string reuse</code> command-line option.
IPA	Specifies the Interprocedural Analysis (IPA) policy. The default values are: <ul style="list-style-type: none"> • Off - No interprocedural analysis, but still performs function-level optimization. Equivalent to the "no deferred inlining" compilation policy of older compilers. • File - Completely parse each translation unit before generating any code or data. Equivalent to the "deferred inlining" option of older compilers. Also performs an early dead code and dead data analysis in this mode. Objects with unreferenced internal linkages will be dead-stripped in the compiler rather than in the linker. This setting is equivalent to specifying the <code>-ipa</code> command-line option.
Other flags	Specify compiler flags.

3.3.1.6 PowerPC Assembler

Use the **PowerPC Assembler** panel to determine the format used for the assembly source files and the code generated by the PowerPC assembler.

The table below lists and describes the various options available on the **PowerPC Assembler** panel.

Table 31: CodeWarrior Build Tool Settings - PowerPC Assembler Options

Option	Explanation
Command	Shows the location of the assembler executable file.
All Options	Shows the actual command line the assembler will be called with.
<i>Table continues on the next page...</i>	

Table 31: CodeWarrior Build Tool Settings - PowerPC Assembler Options (continued)

Option	Explanation
Expert settings: Command line pattern	Shows the expert settings command line parameters.

This section contains the following subsections:

- [Input](#) on page 69
- [General](#) on page 70

3.3.1.6.1 Input

Use the Input panel to specify the path and search order of the `#include` files.

The table below lists and describes the various options available on the **Input** panel.

Table 32: CodeWarrior Build Tool Settings - Input Options

Option	Explanation
Always Search user Paths	Performs a search of both the user and system paths, treating <code>#include</code> statements of the form <code>#include <xyz></code> , the same as the form <code>#include "xyz"</code> . This setting is equivalent to specifying the <code>-nosyspath</code> command-line option.
User Path (-i)	Use this panel to specify multiple user paths and the order in which to search those paths. The table that follows lists and describes the toolbar buttons that help work with the file search paths. This setting is equivalent to specifying the <code>-i</code> command-line option.
User Recursive Path (-ir)	Appends a recursive access path to the current User Path list. The table that follows lists and describes the toolbar buttons that help work with the file search paths. This setting is equivalent to specifying the <code>-ir path</code> command-line option.
System Path (-I -I)	Changes the build target's search order of access paths to start with the system paths list. The table that follows lists and describes the toolbar buttons that help work with the file search paths. This setting is equivalent to specifying the <code>-I- -I path</code> command-line option.
System Recursive Path (-I- -ir)	Appends a recursive access path to the current System Path list. The table that follows lists and describes the toolbar buttons that help work with the file search paths. This setting is equivalent to specifying the <code>-I- -ir</code> command-line option.

The table below lists and describes the toolbar buttons that help work with the **Input** panel.

Table 33: CodeWarrior Build Tool Settings - Input Toolbar Buttons





Button	Tooltip	Description
	Add	Click to open the Add file path or the Add directory path dialog and create a file or directory path.
<i>Table continues on the next page...</i>		

Table 33: CodeWarrior Build Tool Settings - Input Toolbar Buttons (continued)

Button	Tooltip	Description
	Delete	Click to delete the selected file or directory. To confirm deletion, click Yes in the Confirm Delete dialog.
	Edit	Click to open the Edit file path or Edit directory path dialog and update the selected file or directory.
	Move up	Click to move the selected file search path one position higher in the list.
	Move down	Click to move the selected file search path one position lower in the list.

3.3.1.6.2 General

Use the General panel to specify the PowerPC assembler options that are specific to the Power Architecture software development.

The table below lists and describes the various options available on the **General** panel.

Table 34: CodeWarrior Build Tool Settings - General Options

Option	Explanation
Labels Must End With ':'	Specifies whether labels must end with a colon (:). Deselect this option to omit the ending colon from label names that start in the first column. This setting is equivalent to specifying the <code>.option colon off on reset</code> assembler control option.
Directives Begin With '.'	Controls period usage for directives. Select this option to ensure that each directive must start with a period. This setting is equivalent to specifying the <code>.option period off on reset</code> assembler control option.
Case Sensitive Identifier	Specifies case sensitivity for identifiers. This setting is equivalent to specifying the <code>.option case off on reset</code> assembler control option.
Allow Space In Operand Field	Controls spaces in operand fields. Deselect this option, if a space in an operand field starts with a comment. This setting is equivalent to specifying the <code>.option space off on reset</code> assembler control option.
GNU Compatible Syntax	CodeWarrior Assembler supports several GNU-format assembly language extensions. Select this option to control GNU's assembler format conflicts with that of the CodeWarrior assembler.
Generate Listing File	Controls generation of a listing file that includes files source, line numbers, relocation information, and macro expansions. Deselect this option, if no listing file is specified.
Other Flags	Specify assembler flags.

3.3.1.7 PowerPC Disassembler

Use the **PowerPC Disassembler** panel to specify the command, options, and expert settings related to the PowerPC disassembler.

The table below lists and describes the various options available on the **PowerPC Disassembler** panel.

Table 35: CodeWarrior Build Tool Settings - PowerPC Disassembler Options

Option	Explanation
Command	Shows the location of the disassembler executable file.
All options	Shows the actual command line the disassembler will be called with.
Expert settings: Command line pattern	Shows the expert settings command line parameters .

This section contains the following subsection:

- [Disassembler Settings](#) on page 71

3.3.1.7.1 Disassembler Settings

Use the Disassembler Settings panel to specify the PowerPC disassembler options that are specific to the Power Architecture software development.

The table below lists and describes the various options available on the **Disassembler** panel.

Table 36: CodeWarrior Build Tool Settings - Disassembler Options

Option	Explanation
Show Headers	Controls display of object header information This setting is equivalent to specifying the <code>-show headers noheaders</code> command-line option.
Show Symbol and String Tables	Controls display of character string and symbol tables. This setting is equivalent to specifying the <code>-show tables notables</code> command-line option.
Show Core Modules	Controls display of executable code sections. This setting is equivalent to specifying the <code>-show code nocode</code> command-line option.
Show Extended Mnemonics	Controls display of extended mnemonics. This setting is equivalent to specifying the <code>-show extended noextended</code> command-line option.
Show Source Code	Interleaves the code disassembly with C or C++ source code. This setting is equivalent to specifying the <code>-show source nosource</code> command-line option.
Only Show Operands and mnemonics	Controls display of address and op-code values. This setting is equivalent to specifying the <code>-show binary nobinary</code> command-line option.
Show Data Modules	Controls display of data sections. This setting is equivalent to specifying the <code>-show data noata</code> command-line option.
Disassemble Exception Tables	Controls display of C++ exception tables. This setting is equivalent to specifying the <code>-show xtab[les] noxtab[les]</code> or <code>-show exceptions noexceptions</code> command-line option.
<i>Table continues on the next page...</i>	

Table 36: CodeWarrior Build Tool Settings - Disassembler Options (continued)

Option	Explanation
Show DWARF Info	Controls display of debugging information. This setting is equivalent to specifying the <code>-show debug nodebug</code> or <code>-show dwarf nodwarf</code> command-line option.
Verbose	Controls display of extra information. This setting is equivalent to specifying the <code>-show detail nodetail</code> command-line option.

3.3.1.8 PowerPC Preprocessor

Use the **PowerPC Preprocessor** panel to specify the command, options, and expert settings related to the PowerPC preprocessor.

The table below lists and describes the various options available on the **PowerPC Preprocessor** panel.

Table 37: CodeWarrior Build Tool Settings - PowerPC Preprocessor Options

Option	Explanation
Command	Shows the location of the preprocessor executable file
All options	Shows the actual command line the preprocessor will be called with
Expert settings: Command line pattern	Shows the expert settings command line parameters

This section contains the following subsection:

- [Preprocessor Settings](#) on page 72

3.3.1.8.1 Preprocessor Settings

Use the Preprocessor Settings panel to specify the PowerPC preprocessor options that are specific to the Power Architecture software development.

The table below lists and describes the various options available on the **Preprocessor** panel.

Table 38: CodeWarrior Build Tool Settings - Preprocessor Options

Option	Explanation
Mode	Specifies the tool to preprocess source files. This setting is equivalent to specifying the <code>-E</code> command-line option.
Emit file change	Controls generation of file and line breaks. This setting is equivalent to specifying the <code>-ppopt [no]break</code> command-line option.
Emit #pragmas	Controls generation of <code>#pragma</code> directives. This setting is equivalent to specifying the <code>-ppopt [no]pragma</code> command-line option.
Show full path	Controls generation of full paths or just the base file name. This setting is equivalent to specifying the <code>-ppopt [no]full[path]</code> command-line option.
Keep comment	Controls generation of comments. This setting is equivalent to specifying the <code>-ppopt [no]comment</code> command-line option.

Table continues on the next page...

Table 38: CodeWarrior Build Tool Settings - Preprocessor Options (continued)

Option	Explanation
Use #line	Controls generation of #line directives. This setting is equivalent to specifying the <code>-ppopt [no]line</code> command-line option.
Keep whitespace	Controls generation of white spaces. This setting is equivalent to specifying the <code>-ppopt [no]space</code> command-line option.

3.3.2 GCC Build Tool Settings

GNU compiler collection (GCC) build tools are open source tools that you can use in your CodeWarrior projects.

In the current installation, every core or target has a separate GCC build tool attached to it. For example, projects created for e500mc bareboard use `powerpc-eabi` toolchain; whereas, projects created for e5500 or e6500 (32/64) bareboard use `powerpc-aeabi e5500` or `powerpc-aeabi e6500` toolchain.

NOTE

For more information about the GCC build tools, see documents available in the `<CWInstallDir>\Cross_Tools\gcc-<version>-<target>\powerpc-<[eabi]/[eabispe]/[aeabi]/[linux/libc]>\share\docs\pdf` folder.

For this version of CodeWarrior Development Studio for Power Architecture, the default version of GCC PowerPC toolchain (bareboard and Linux) is GCC v4.9.2 (rev1267).

NOTE

By default, GCC v4.9.x generates DWARF4. To generate an older DWARF version (DWARF2/DWARF3), use `-g` with `-gdwarf-2` or `-gdwarf-3`.

For older versions of GCC PowerPC toolchain, such as GCC v4.8.2 (rev963), or for toolchains not available in the current release by default, install the corresponding service pack by performing these steps:

1. Select **Help > Install New Software** from the CodeWarrior IDE menu bar.

The **Install** wizard launches and the **Available Software** page appears.

2. Select **FSL PA Build Tools** from the **Work with** drop-down list.

A list of PA GCC service packs is displayed in the pane below the **Work with** drop-down list.

3. Select the appropriate service pack, as shown in the figure below.

Figure 14: Selecting a service pack

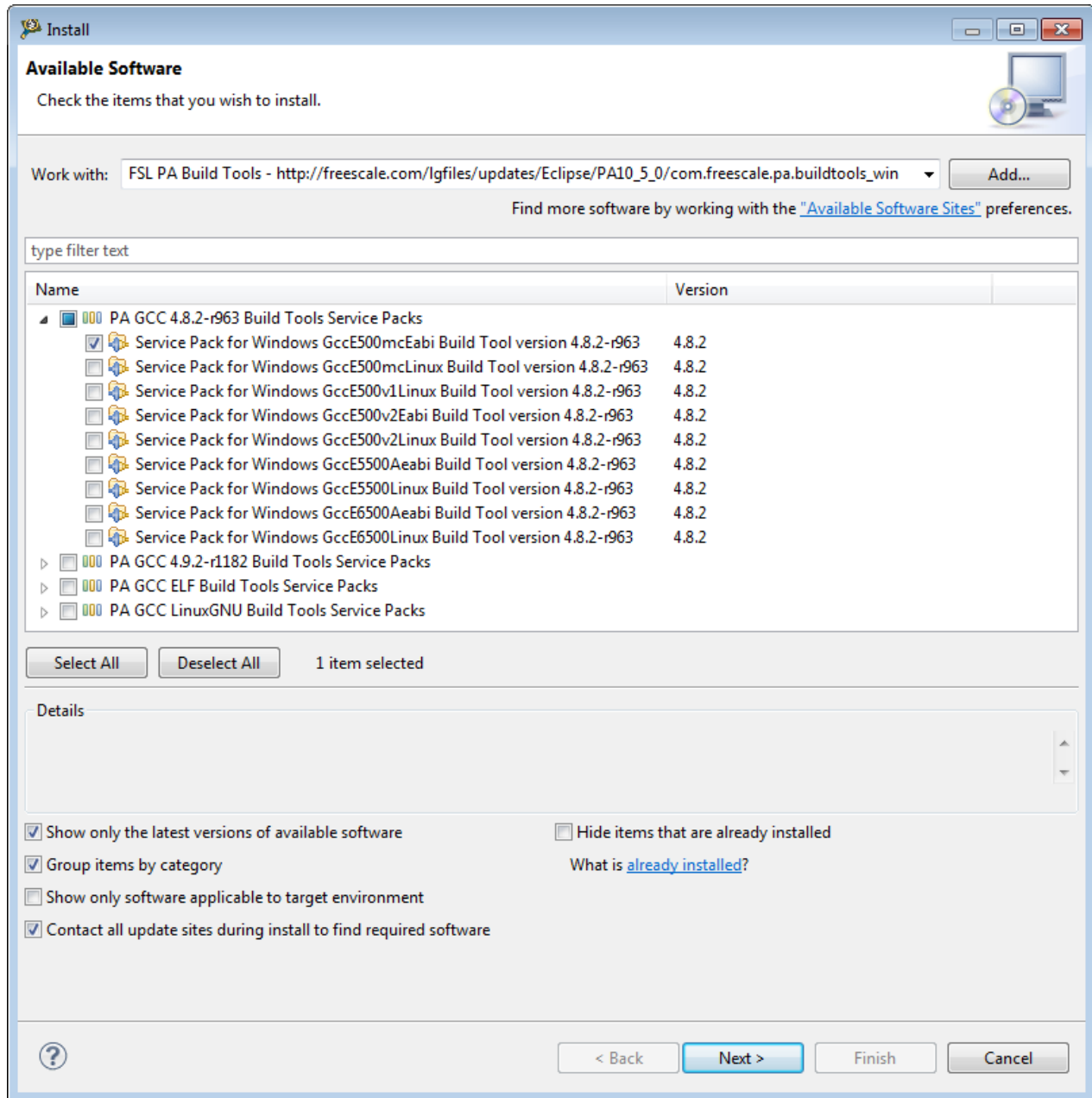

4. Click **Next** and complete the remaining wizard steps.

The service pack, along with the new toolchain, will be installed on your computer.

NOTE

For more information on service packs, see the *Service Pack Updater Quickstart* available in the `<CWInstallDir>\PA\` folder.

After installing the service pack, you need to set the new toolchain as the default toolchain to build your project with the new toolchain. To set the new toolchain as the default toolchain and to build the project, use these steps:

1. Select **Project > Properties** from the CodeWarrior IDE menu bar.

The **Properties** dialog appears.

2. In the left pane, select **C/C++ Build > Settings**.
3. In the right pane, select the **Build Tool Versions** tab.
4. Select the required toolchain version and click **Set As Default**, as shown in the figure below.

Figure 15: Setting a toolchain as default toolchain

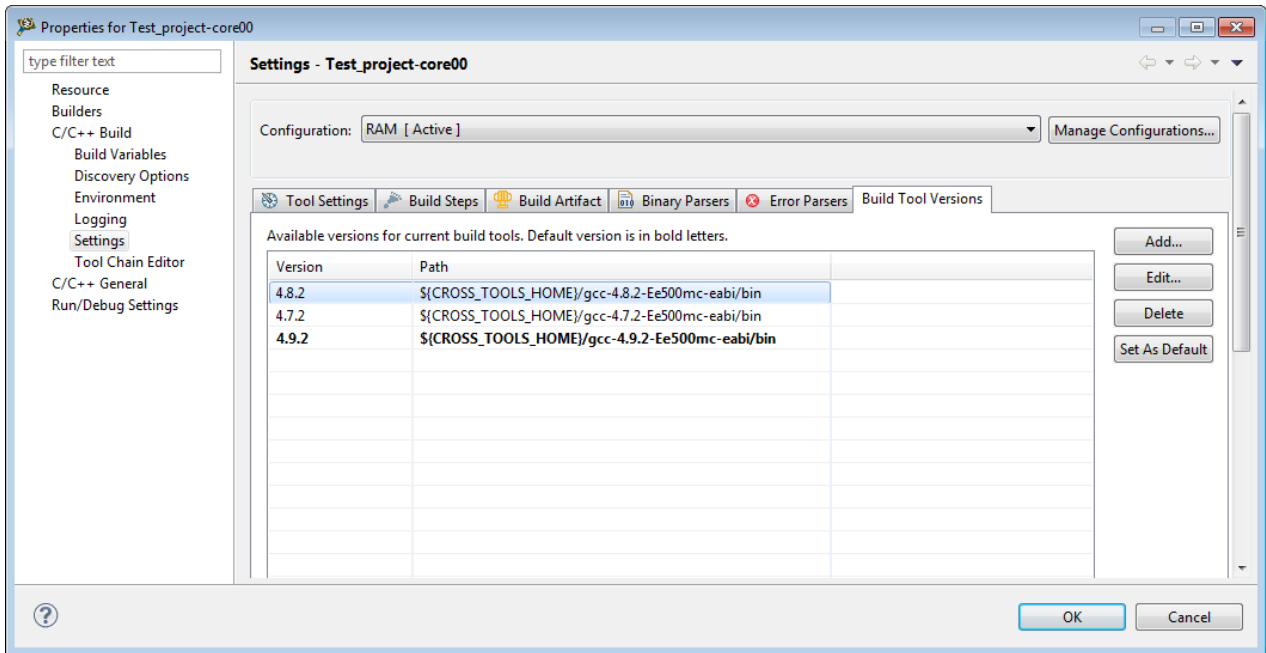

5. Click **OK**.
6. Select **Project > Build Project** from the CodeWarrior IDE menu bar.

The project is built using the new toolchain.

The table below lists the GCC build tool settings specific to developing software for Power Architecture.

Table 39: GCC Build Tool Settings for Power Architecture

Build Tool	Build Properties Panels
Architecture on page 76	
PowerPC Linker on page 76	General on page 77
	Libraries on page 77
	Miscellaneous on page 78
	Shared Library Settings on page 79
	PowerPC Environment on page 79
PowerPC Compiler on page 80	Preprocessor on page 80
	Symbols on page 81
	Includes on page 82
	Optimization on page 83

Table continues on the next page...

Table 39: GCC Build Tool Settings for Power Architecture (continued)

Build Tool	Build Properties Panels
	Debugging on page 84 Warnings on page 85 Miscellaneous on page 86
PowerPC Assembler on page 86	General on page 87
PowerPC Preprocessor on page 87	Preprocessor Settings on page 88
PowerPC Disassembler on page 88	Disassembler Settings on page 89

The CodeWarrior build tools listed in the above table share some properties panels, such as Include Search Paths. Properties specified in these panels apply to the selected build tool on the **Tool Settings** page of the **Properties for <project>** window.

3.3.2.1 Architecture

Use the **Architecture** panel to specify the Power Architecture processor family for the build.

The properties specified on this page are also used by the build tools (compiler, linker, and assembler).

The table below lists and describes the options available on the **Architecture** panel.

Table 40: Tool Settings - Architecture Options

Option	Explanation
Architecture	Specifies which architecture variant is used by the target.
Target Mode	Specifies the target environment (32-bit/64-bit mode) on which your generated code will run. This option takes the following values: <ul style="list-style-type: none"> • 32-bit: Enables 32-bit code generation • 64-bit: Enables 64-bit code generation

3.3.2.2 PowerPC Linker

Use the **PowerPC Linker** panel to specify the GCC linker options that are specific to Power Architecture software development.

NOTE

The list of tools presented on the **Tool Settings** page can differ, based upon the toolchain used by the project.

The table below lists and describes the various options available on the **PowerPC Linker** panel.

Table 41: Tool Settings - PowerPC Linker Options

Option	Description
Command	Specifies the PowerPC GCC command line driver or linker required to build the project
All options	Shows the actual command line the linker will be called with
<i>Table continues on the next page...</i>	

Table 41: Tool Settings - PowerPC Linker Options (continued)

Option	Description
Expert settings: Command line pattern	Shows the expert settings command line parameters

This section contains the following subsections:

- [General](#) on page 77
- [Libraries](#) on page 77
- [Miscellaneous](#) on page 78
- [Shared Library Settings](#) on page 79
- [PowerPC Environment](#) on page 79

3.3.2.2.1 General

Use the General panel to specify the general linker behavior.

The following table lists and describes the various options available on the **General** panel.

Table 42: Tool Settings - General Options

Option	Description
Do not use standard start files (-nostartfiles)	Specifies linker to not to use the standard system startup files when linking. The standard system libraries are used normally, unless <code>-nostdlib</code> or <code>-nodefaultlibs</code> command-line options are used. This setting is equivalent to specifying the <code>-nostartfiles</code> command-line option.
Do not use default libraries (-nodefaultlibraries)	Specifies linker to not to use the standard system libraries when linking. Only the libraries you specify will be passed to the linker. Options specifying linkage of the system libraries, such as <code>-static-libgcc</code> or <code>-shared-libgcc</code> , will be ignored. This setting is equivalent to specifying the <code>-nodefaultlibraries</code> command-line option.
No startup or default libs (-nostdlib)	Specifies linker to not to use the standard system startup files or libraries when linking. This setting is equivalent to specifying the <code>-nostdlib</code> command-line option.
Omit all symbol information (-s)	Specifies linker to remove all symbol table and relocation information from the executable. This setting is equivalent to specifying the <code>-s</code> command-line option.
No shared libraries (-static)	Specifies linker to prevent linking with the shared libraries. This setting is equivalent to specifying the <code>-static</code> command-line option.

3.3.2.2.2 Libraries

Use the Libraries panel to specify the libraries and their search paths if the libraries are available in non-standard location.





You can specify multiple additional libraries and library search paths. The following table lists and describes the various options available on the Libraries panel.

Table 43: Tool Settings - Libraries Options

Option	Explanation
Libraries	Lists the libraries that are to be passed to the linker while building the project. The Linker uses the libraries in the same order as shown in this list. The table that follows lists and describes the toolbar buttons that help work with the library file.
Library search path	Use this panel to specify multiple paths that the Power Architecture linker searches for libraries. The linker searches the paths in the order shown in this list. The table that follows lists and describes the toolbar buttons that help work with the library search paths.

The table below lists and describes the toolbar buttons that help work with the libraries.

Table 44: Tool Settings - Libraries Toolbar Buttons

Button	Tooltip	Description
	Add	Click to open the Add file path or the Add directory path dialog and add a file or directory path.
	Delete	Click to delete the selected file or directory. To confirm deletion, click Yes in the Confirm Delete dialog.
	Edit	Click to open the Edit file name or Edit directory path dialog and update the selected file or directory.
	Move up	Click to re-order the selected file or search path one position higher in the list.
	Move down	Click to re-order the selected file or search path one position lower in the list.

3.3.2.2.3 Miscellaneous

Use the Miscellaneous panel to specify linker behavior.

The following table lists and describes the various options available on the **Miscellaneous** panel.

Table 45: Tool Settings - MiscellaneousOptions

Option	Explanation
Linker flags	Specify flags to be passed to the linker.
Other options	Enter additional linker command-line options. The IDE passes these options to the linker shell during the link phase. <p style="text-align: center;">NOTE</p> <p style="text-align: center;">The IDE passes command-line options to the shell exactly as you enter them in this text box.</p>
Other objects	Add other objects or libraries that needs to be passed to the linker. These objects or libraries will be linked at the end.

3.3.2.2.4 Shared Library Settings

Use the Shared Library Settings panel to specify the path to the shared libraries.

You can specify multiple additional shared libraries and library search paths.

NOTE

The options provided on the Shared Library Settings panel are only applicable to Linux projects.

The table below lists and defines the various options available on the Shared Libraries Settings panel.

Table 46: Tool Settings - Shared Libraries Settings Options

Option	Explanation
Shared (-shared)	Controls generation of a shared object which can be linked with other objects to form an executable. This setting is equivalent to specifying the <code>-shared</code> command-line option.
Shared object name (-Wl, -soname=)	Specifies the internal <code>DT_SONAME</code> field to the specified name, when creating a shared object. When an executable is linked with a shared object which has a <code>DT_SONAME</code> field and the executable is run, the dynamic linker will attempt to load the shared object specified by the <code>DT_SONAME</code> field, rather than the using the file name given to the linker.
Import Library name (-Wl,--out-implib=)	Creates a file containing an import library corresponding to the shared object generated by the linker.
DEF file name (-Wl, --output-def=)	Creates a file containing a DEF file corresponding to the shared object generated by the linker.

3.3.2.2.5 PowerPC Environment

Use the PowerPC Environment panel to specify the configuration files used by the linker.

The following table lists and describes the various options available on the PowerPC Environment panel.

Table 47: Tool Settings - PowerPC Environment Options

Option	Explanation
Map File (-Xlinker -Map)	Prints a link map to the map specified map file. The specified file name must have a <code>.map</code> extension.
<i>Table continues on the next page...</i>	

Table 47: Tool Settings - PowerPC Environment Options (continued)

Option	Explanation
LCF File	<p>Specifies the path of the linker-command file that the linker reads to determine how to build the output file. Alternatively, click Browse, then use the resulting dialog to specify the linker command file.</p> <p style="text-align: center;">NOTE</p> <p>The specified linker script replaces the default linker script, so it must specify everything necessary to describe the output file.</p> <p>This setting is equivalent to specifying the <code>-lcf filename</code> command-line option.</p>

3.3.2.3 PowerPC Compiler

Use the **PowerPC Compiler** panel to specify the compiler options that are specific to Power Architecture software development.

NOTE

The list of tools presented on the **Tool Settings** page can differ, based upon the toolchain used by the project.

The table below lists and describes the various options available on the **PowerPC Compiler** panel.

Table 48: Tool Settings - PowerPC Compiler Options

Option	Description
Command	Specifies the PowerPC GCC command line driver or compiler required to build the source files in the project.
All options	Specifies the actual command line the compiler will be called with.
Expert settings: Command line pattern	Specifies the expert settings command line parameters.

This section contains the following subsections:

- [Preprocessor](#) on page 80
- [Symbols](#) on page 81
- [Includes](#) on page 82
- [Optimization](#) on page 83
- [Debugging](#) on page 84
- [Warnings](#) on page 85
- [Miscellaneous](#) on page 86

3.3.2.3.1 Preprocessor

Use the Preprocessor panel to specify preprocessor behavior.

You can specify whether to search system directories or preprocess only based on the options available in this panel.

The table below lists and describes the various options available on the Preprocessor panel.

Table 49: Tool Settings - Preprocessor Options

Options	Explanation
Do not search system directories (--nostdinc)	Specifies compiler to not to search the standard system directories for header files. Only the directories specified by the user with <code>-I</code> option (and the directory of the current file, if appropriate) are searched. This setting is equivalent to specifying the <code>-nostdinc</code> command-line option.
Preprocess only (-E)	Specifies command-line tool to preprocess the source files and not to run the compiler. This setting is equivalent to specifying the <code>-E</code> command-line option.

3.3.2.3.2 Symbols

Use the Symbols panel to control how the compiler structures the generated object code.

The table below lists and describes the various options available on the Symbols options.

Table 50: Tool Settings - Symbols Options

Option	Explanation
Defined symbols (-D)	<p>Specifies substitution strings that the assembler applies to all the assembly-language modules in the build target.</p> <p style="text-align: center;">NOTE</p> <p>Enter just the string portion of a substitution string. The IDE prepends the <code>-d</code> token to each string that you enter. For example, entering <code>opt1 x</code> produces this result on the command line: <code>-dopt1 x</code></p> <p style="text-align: center;">NOTE</p> <p>This option is similar to the <code>DEFINE</code> directive, but applies to all assembly-language modules in a build target.</p> <p>Use these toolbar buttons to work with the panel:</p> <ul style="list-style-type: none"> • Add - Click to specify the undefined symbols string. • Delete - Click to remove the selected string. • Edit - Click to edit an existing string. • Move up - Click to move the selected string one position higher in the list. • Move down - Click to move the selected string one position lower in the list. <p style="text-align: center;"><i>Table continues on the next page...</i></p>

Table 50: Tool Settings - Symbols Options (continued)

Option	Explanation
Undefined symbols (-U)	<p>Undefined the substitution strings you specify in this panel. Use these toolbar buttons to work with the panel:</p> <ul style="list-style-type: none"> • Add - Click to specify the undefined symbols string. • Delete - Click to remove the selected string. • Edit - Click to edit an existing string. • Move up - Click to move the selected string one position higher in the list. • Move down - Click to move the selected string one position lower in the list.

3.3.2.3.3 Includes

Use the Includes panel to specify paths to search for the #include files.

NOTE

The IDE displays an error message, if a header file is in a different directory from the referencing source file. In some instances, the IDE also displays an error message, if a header file is in the same directory as the referencing source file. For example, if you see the message `Could not open source file myfile.h`, you must add the path for `myfile.h` to this panel.

The table below lists and describes the various options available on the Includes panel.

Table 51: Tool Settings - Includes Options

Option	Explanation
Include paths (-I)	<p>Adds the directory to the list of directories to be searched for header files. Directories named by <code>-I</code> are searched before the standard system include directories. If the directory is a standard system include directory, the option is ignored to ensure that the default search order for system directories and the special treatment of system headers are not defeated. If the directory name begins with <code>=</code>, then the <code>=</code> will be replaced by the <code>sysroot</code> prefix. Use these toolbar buttons to work with the Include paths (-I) panel:</p> <ul style="list-style-type: none"> • Add - Click to open the Add directory path dialog and specify the directory search path. • Delete - Click to delete the selected directory search path. To confirm deletion, click Yes in the Confirm Delete dialog. • Edit - Click to open the Edit directory path dialog and update the selected directory search path. • Move up - Click to re-order the selected directory search path one position higher in the list. • Move down - Click to re-order the selected directory search path one position lower in the list.

Table continues on the next page...

Table 51: Tool Settings - Includes Options (continued)

Option	Explanation
Include files (-include)	<p>Process file as if <code>#include "file"</code> appeared as the first line of the primary source file. However, the first directory searched for file is the preprocessor's working directory instead of the directory containing the main source file. If not found, the preprocessor's working directory is searched for in the remainder of the <code>#include "..."</code> search chain as normal. If multiple <code>-include</code> options are specified, the files are included in the order they appear on the command line. Use these toolbar buttons to work with the Include files (-include) panel:</p> <ul style="list-style-type: none"> • Add - Click to open the Add file path dialog and specify the file. • Delete - Click to delete the selected file. To confirm deletion, click Yes in the Confirm Delete dialog. • Edit - Click to open the Edit directory path dialog and update the selected file. • Move up - Click to re-order the selected file one position higher in the list. • Move down - Click to re-order the selected file one position lower in the list.

3.3.2.3.4 Optimization

Use the Optimization panel to control compiler optimizations.

Compiler optimization can be applied in either global or non-global optimization mode. You can apply global optimization at the end of the development cycle, after compiling and optimizing all source files individually or in groups.

The table below lists and describes the various options available on the Optimization panel.

Table 52: Tool Settings - Optimization Options

Option	Explanation
Optimization Level	<p>Specifies the optimization that you want the compiler to apply to the generated object code. The default options are:</p> <ul style="list-style-type: none"> • None(-O0) - Disable optimizations. Reduce compilation time and make debugging produce the expected results. This is the default. This setting is equivalent to specifying the <code>-O0</code> command-line option. • Optimize (-O1) - Optimizing compilation takes more time, and a lot more memory for a large function. With <code>-O/-O1</code>, the compiler tries to reduce code size and execution time, without performing any optimizations that take a great deal of compilation time. This setting is equivalent to specifying the <code>-O1</code> command-line option. • Optimize more(-O2) - Optimize even more. GCC performs nearly all supported optimizations that do not involve a space-speed tradeoff. As compared to <code>-O/O1</code>, this option increases both compilation time and the performance of the generated code. This setting is equivalent to specifying the <code>-O2</code> command-line option. • Optimize most(-O3) - Turns on all optimizations specified by <code>-O2</code> and also turns on the <code>-finline-functions</code>, <code>-funswitch-loops</code>, <code>-fpredictive-commoning</code>, <code>-fgcse-after-reload</code> and <code>-ftree-vectorize</code> options. At this optimization level, the compiler generates code that is usually faster than the code generated from level 2 optimizations. This setting is equivalent to specifying the <code>-O3</code> command-line option. • Optimize for size(-Os) - Optimize for size. <code>-Os</code> enables all <code>-O2</code> optimizations that do not typically increase code size. It also performs further optimizations designed to reduce code size. This setting is equivalent to specifying the <code>-Os</code> command-line option.
Other optimization flags	Specifies individual optimization flag that can be turned ON/OFF based on the user requirements.

3.3.2.3.5 Debugging

Use the Debugging panel to set the debugging information.

The following table lists and describes the various options available on the Debugging panel.

Table 53: Tool Settings - Debugging Options

Option	Explanation
Debug Level	Specify the debug levels for the compiler. the default options are: <ul style="list-style-type: none"> • None - No Debug level. • Minimal (-g1) - Produces minimal information, enough for making backtraces in parts of the program that you don't plan to debug. This includes descriptions of functions and external variables, but no information about local variables and no line numbers. • Default (-g2) same as (-g) - The compiler generates DWARF 2.0 conforming debugging information. • Maximum (-g3) - The compiler provides maximum debugging support. Also includes extra information, such as all the macro definitions present in the program.
Other debugging flags	Specify the other debugging flags that need to be passed with the compiler
Generate prof information (-p)	Generate extra code to write profile information suitable for the analysis program <code>prof</code> . You must use this option while compiling and linking the source files.
Generate gprof information (-pg)	Generate extra code to write profile information suitable for the analysis program <code>gprof</code> . You must use this option while compiling and linking the source files.

3.3.2.3.6 Warnings

Use the Warnings panel to control how the compiler reports the error and warning messages.

The following table lists and describes the various options available on the Warnings panel.

Table 54: Tool settings - Warnings Options

Option	Explanation
Check syntax only (-fsyntax-only)	Check the code for syntax errors, but do not do anything beyond that.
Pedantic (-pedantic)	Select to issue all the mandatory diagnostics listed in the C standard. Some of them are left out by default, since they trigger frequently on harmless code.
Pedantic warnings as errors (-pedantic-errors)	Select to issue all the mandatory diagnostics, and make all mandatory diagnostics into errors. This includes mandatory diagnostics that GCC issues without <code>-pedantic</code> but treats as warnings.
Inhibit all warnings (-w)	Select to suppress all warnings, including those which GNU CPP issues by default.

Table continues on the next page...

Table 54: Tool settings - Warnings Options (continued)

Option	Explanation
All warnings (-Wall)	Select to turn on all optional warnings which are desirable for normal code. At present this is <code>-Wcomment</code> , <code>-Wtrigraphs</code> , <code>-Wmultichar</code> and a warning about integer promotion causing a change of sign in <code>#if</code> expressions. <div style="text-align: center;"> <p>NOTE</p> <p>Many of the preprocessor's warnings are on by default and have no options to control them.</p> </div>
Warnings as errors (-Werror)	Select to make all warnings into hard errors. Source code which triggers warnings will be rejected.

3.3.2.3.7 Miscellaneous

Use the Miscellaneous panel to specify compiler options.

The following table lists and describes the various options available on the Miscellaneous panel.

Table 55: Tool Settings - Miscellaneous Options

Option	Explanation
Other flags	Specify the compiler flags.
Verbose (-v)	Select to print on console the commands executed to run the stages of compilation. Also print the version number of the compiler driver program, the preprocessor and the compiler proper.
Support ANSI programs (-ansi)	Compiler strictly conforms to ANSI standard. In C mode, this is equivalent to <code>-std=c89</code> . In C++ mode, it is equivalent to <code>-std=c++98</code> .
Position Independent Code (-fPIC)	If supported for the target machine, emits position-independent code, which is suitable for dynamic linking and avoids any limit on the size of the global offset table.
Other Assembler options (-Xassembler [option])	Allows you to make GCC pass an option to the assembler. It is generally used to supply system-specific assembler options that are not recognized by GCC. To supply an option that takes an argument, use <code>-Xassembler</code> twice, first for the option and then for the argument.

3.3.2.4 PowerPC Assembler

Use **PowerPC Assembler** panel to specify the command, options, and expert settings for the build tool assembler.

The table below lists and describes the various options available on the **PowerPC Assembler** panel.

NOTE

The list of tools presented on the **Tool Settings** page can differ, based upon the toolchain used by the project.

Table 56: Tool Settings - PowerPC Assembler Options

Option	Description
Command	Specifies the PowerPC GCC command line Assembler required to build the assembly files in the project.
All options	Shows the actual command line the assembler will be called with.
Expert settings: Command line pattern	Shows the expert settings command line parameters.

This section contains the following subsection:

- [General](#) on page 87

3.3.2.4.1 General

Use the General panel to specify the assembler behavior.

The following table lists and describes the various options available on the General panel.

Table 57: Tool Settings - General

Option	Explanation
Assembler flags	Specify the flags that need to be passed with the assembler.
Include paths (-I)	<p>Add a path to the list of directories, assembler searches for files specified in <code>.include</code> directives. <code>-I</code> can be used multiple times as required to include a variety of paths. The current working directory is always searched first; followed by any <code>-I</code> directories, in the order they were specified (left to right) on the command line. Use these toolbar buttons to work with the Include paths (-I) panel:</p> <ul style="list-style-type: none"> • Add - Click to open the Add directory path dialog and specify the file search path. • Delete - Click to delete the selected file search path. To confirm deletion, click Yes in the Confirm Delete dialog. • Edit - Click to open the Edit directory path dialog and update the selected object file search path. • Move up - Click to re-order the selected file search path one position higher in the list. • Move down - Click to re-order the selected file search path one position lower in the list.
Supress warnings (-W)	Supresses warning messages.
Announce version (-v)	Prints the assembler version.

3.3.2.5 PowerPC Preprocessor

Use the **PowerPC Preprocessor** panel to specify specify the command, options, and expert settings for the preprocessor.

The table below lists and describes the various options available on the **PowerPC Preprocessor** panel.

NOTE

The list of tools presented on the **Tool Settings** page can differ, based upon the toolchain used by the project.

Table 58: Tool Settings - PowerPC Preprocessor Options

Option	Explanation
Command	Specifies the PowerPC GCC command line Pre-processor required to pre-process the source files.
All options	Shows the actual command line the preprocessor will be called with.
Expert settings: Command line pattern	Shows the expert settings command line parameters.

This section contains the following subsection:

- [Preprocessor Settings](#) on page 88

3.3.2.5.1 Preprocessor Settings

Use the Preprocessor Settings panel to specify preprocessor behavior.

The following table lists and describes the various options available on the Preprocessor Settings panel.

Table 59: Tool Settings - Preprocessor Settings Options

Option	Explanation
Handle Directives Only	When preprocessing, handle directives, but do not expand macros. This setting is equivalent to specifying the <code>-fdirectives-only</code> command-line option.
Print Header File Names	Select to print the name of each header file used. This setting is equivalent to specifying the <code>-H</code> command-line option.

3.3.2.6 PowerPC Disassembler

Use the **PowerPC Disassembler** panel to specify the command, options, and expert settings for the Power ELF disassembler.

The table below lists and describes the various options available on the **PowerPC Disassembler** panel.

Table 60: Tool Settings - PowerPC Disassembler Options

Option	Explanation
Command	Specifies the PowerPC GCC command line disassembler required to disassemble the generated object code.
All options	Shows the actual command line the disassembler will be called with.
Expert settings: Command line pattern	Shows the expert settings command line parameters.

This section contains the following subsection:

- [Disassembler Settings](#) on page 89

3.3.2.6.1 Disassembler Settings

Use the Disassembler Settings panel to specify or modify the existing settings for the disassembler.

The following table lists and describes the various options available on the Disassembler Settings panel.

Table 61: Tool Settings - Disassembler Settings Options

Option	Explanation
Disassemble All Section Content (including debug information)	Disassembles the content of all sections, not just those expected to contain instructions.
Disassemble Executable Section Content	Disassembles all executable content and send output to a file.
Intermix Source Code With Disassembly	Intermixes source code with disassembly.
Display All Header Content	Displays the contents of all headers.
Display Archive Header Information	Displays archive header information.
Display Overall File Header Content	Displays the contents of the overall file header.
Display Object Format Specific File Header Contents	Displays the file header contents and object format
Display Section Header Content	Displays the section header of the file.
Display Full Section Content	Displays the full section of the file.
Display Debug Information	Displays debug information in the object file.
Display Debug Information Using ctag Style	Displays debug information using the ctags style.
Display STABS Information	Displays any STABS information in the file, in raw form.
Display DWARF Information	Displays any DWARF information in the file.
Display Symbol Table Content	Displays the contents of the symbol tables.
Display Dynamic Symbol Table Content	Displays the contents of the dynamic symbol table.
Display Relocation Entries	Displays the relocation entries in the file.
Display Dynamic Relocation Entries	Displays the dynamic relocation entries in the file.

Build Properties
Build Properties for Power Architecture

Chapter 4

Debug Configurations

A CodeWarrior project can have multiple associated debug configurations. A debug configuration is a named collection of settings that the CodeWarrior tools use.

Debug configurations let you specify settings, such as:

- The files that belong to the debug configuration
- Behavior of the debugger and the related debugging tools

This chapter explains:

- [Using Debug Configurations Dialog Box](#) on page 91
- [Customizing Debug Configurations](#) on page 118
- [Reverting Debug Configuration Settings](#) on page 120

4.1 Using Debug Configurations Dialog Box

The **Debug Configurations** dialog allows you to specify debugger-related settings for your CodeWarrior project.

NOTE

As you modify a launch configuration's debugger settings, you create pending, or unsaved, changes to that launch configuration. To save the pending changes, you must click the **Apply** button of the **Debug Configurations** dialog, or click the **Close** button and then the **Yes** button.

Table 62: Debug Configuration Tabs

Main on page 92	
Arguments on page 97	
Debugger on page 98	Debug on page 99
	EPPC Exceptions on page 101
	Download on page 102
	PIC on page 104
	System Call Services on page 105
	Other Executables on page 107
	Symbolics on page 108
	OS Awareness on page 110
Trace and Profile on page 113	
Source on page 114	
Environment on page 116	
Common on page 117	

This section contains the following subsections:

4.1.1 Main

Use this tab to specify the project and the application you want to run or debug.

You can also specify a remote system configuration on this tab.

The remote system configuration is separated into connection and system configurations allowing you to define a single system configuration that can be referred to by multiple connection configurations. The launch configurations refer to a connection configuration, which in turn refers to a system configuration.

NOTE

The options displayed on the **Main** tab vary depending on the selected debug session type.

The following figure shows the **Main** tab.

Figure 16: Debug Configurations-Main Tab

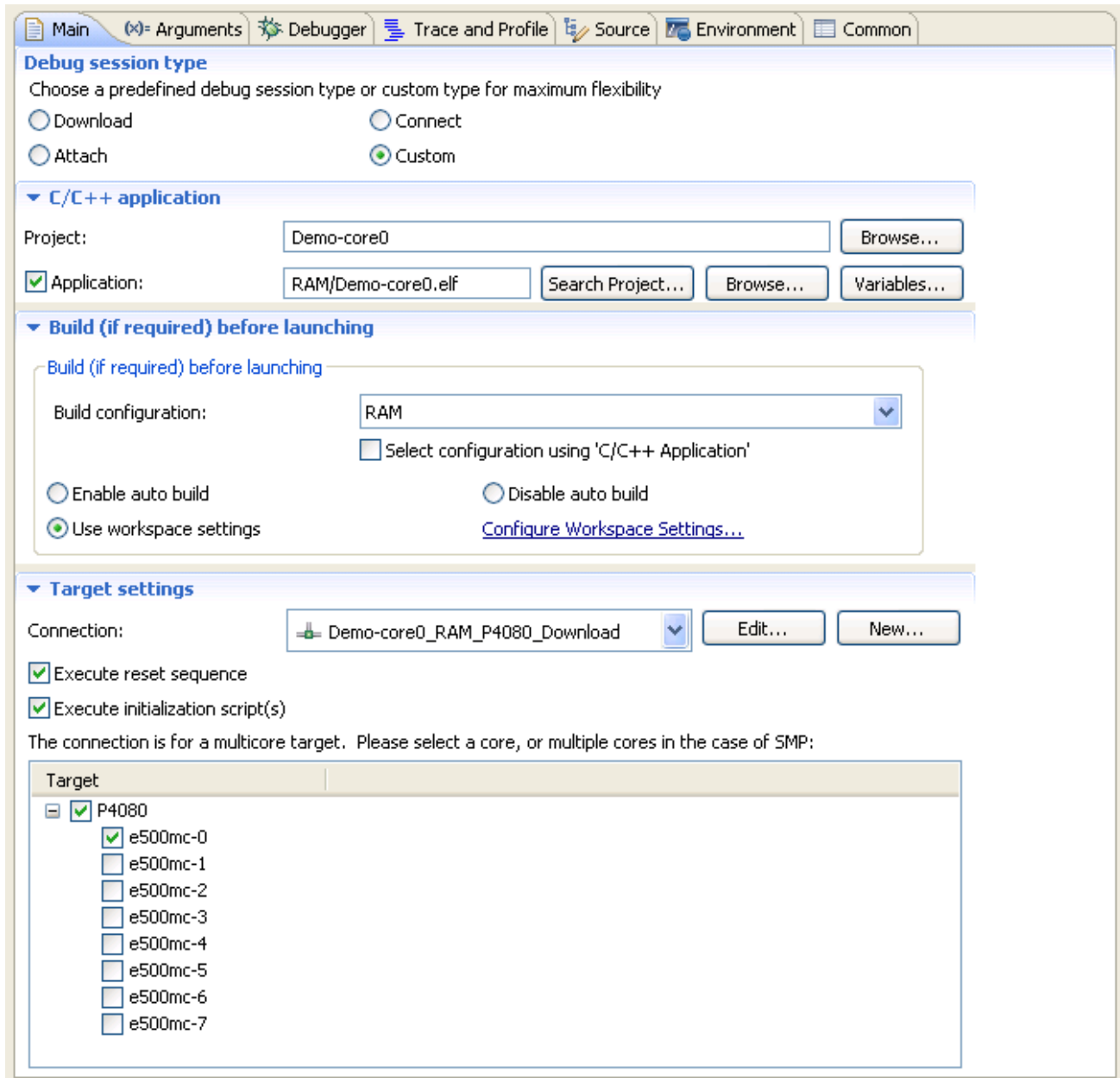

The table below describes the various options available on the **Main** page.

Table 63: Main Tab Options

Option	Description
Debug session type	<p>Specifies the options to initiate a debug session using pre-configured debug configurations. The options include:</p> <ul style="list-style-type: none"> • Download - Resets the target if the debug configuration specifies the action. Further, the command stops the target, (optionally) runs an initialization script, downloads the specified ELF file, and modifies the program counter(PC). • Attach - Assumes that code is already running on the board and therefore does not run a target initialization file. The state of the running program is undisturbed. The debugger loads symbolic debugging information for the current build target's executable. The result is that you have the same source-level debugging facilities you have in a normal debug session (the ability to view source code and variables, and so on). The function does not reset the target, even if the launch configuration specifies this action. Further, the command loads symbolics, does not stop the target, run an initialization script, download an ELF file, or modify the program counter (PC). <p style="text-align: center;">NOTE</p> <p style="text-align: center;">The debugger does not support restarting debugging sessions that you start by attaching the debugger to a process.</p> <ul style="list-style-type: none"> • Connect - Runs the target initialization file specified in the RSE configuration to set up the board before connecting to it. The Connect debug session type does not load any symbolic debugging information for the current build target's executable thereby, denying access to source-level debugging and variable display. The Connect command resets the target if the launch configuration specifies this action. Further, the command stops the target, (optionally) runs an initialization script, does not load symbolics, download an ELF file, or modify the program counter(PC). <p style="text-align: center;">NOTE</p> <p style="text-align: center;">The default debugger configuration causes the debugger to cache symbolics between sessions. However, selecting the Connect option invalidates this cache. If you must preserve the contents of the symbolics cache, and you plan to use the Connect option, clear the Cache Symbolics Between Sessions checkbox in the Symbolics page.</p> <ul style="list-style-type: none"> • Custom - Provides user an advantage to create a custom debug configuration.
<i>Table continues on the next page...</i>	

Table 63: Main Tab Options (continued)

Option	Description
C/C++ application	<p>Specifies the settings for the C/C++ application. The options include:</p> <ul style="list-style-type: none"> • Project - Specifies the name of the project associated with the selected debug launch configuration. Click Browse to select a different project. • Application - Specifies the name of the C or C++ application executable. <p style="text-align: center;">————— NOTE —————</p> <p style="text-align: center;">This option is disabled when Connect debug session type is selected.</p> <ul style="list-style-type: none"> • Search Project - Click to open the Program Selection dialog and select a binary. <p style="text-align: center;">————— NOTE —————</p> <p style="text-align: center;">This option is disabled when Connect debug session type is selected.</p> <ul style="list-style-type: none"> • Variables - Click to open the Select build variable dialog and select the build variables to be associated with the program. <p>The dialog displays an aggregation of multiple variable databases and not all these variables are suitable to be used from a build environment. Given below are the variables that should be used:</p> <p>ProjDirPath - returns the absolute path of the current project location in the file system</p> <pre>{ProjDirPath}/Source/main.c"</pre> <p>workspace_loc - returns the absolute path of a workspace resource in the file system, or the location of the workspace if no argument is specified</p> <pre>{workspace_loc:/ProjectName/Source main.c"}{workspace_loc}</pre> <p>Gnu_Make_Install_Dir - returns the absolute path of the GNU make.exe tool</p> <pre>{Gnu_Make_Install_Dir}\make.exe</pre> <p style="text-align: center;">————— NOTE —————</p> <p style="text-align: center;">This option is disabled when Connect debug session type is selected.</p>
<i>Table continues on the next page...</i>	

Table 63: Main Tab Options (continued)

Option	Description
Build (if required) before launching	<p>Controls how auto build is configured for the launch configuration. Changing this setting overrides the global workspace setting and can provide some speed improvements.</p> <p style="text-align: center;">NOTE</p> <p style="text-align: center;">These options are set to default and collapsed when Connect debug session type is selected.</p> <p>The options include:</p> <ul style="list-style-type: none"> • Build configuration - Specifies the build configuration either explicitly or use the current active configuration. • Select configuration using 'C/C++ Application' - Select/clear to enable/disable automatic selection of the configuration to be built, based on the path to the program. • Enable auto build - Enables auto build for the debug configuration which can slow down launch performance. • Disable auto build - Disables auto build for the debug configuration which may improve launch performance. No build action will be performed before starting the debug session. You have to rebuild the project manually. • Use workspace settings (default) - Uses the global auto build settings. • Configure Workspace Settings - Opens the Launching preference panel where you can change the workspace settings. It will affect all projects that do not have project specific settings.
Target settings	<p>Specifies the connection and other settings for the target. The options include:</p> <ul style="list-style-type: none"> • Connection - Specifies the applicable Remote System configuration. • Edit - Click to edit the selected Remote System configuration. • New - Click to create a new Remote System configuration for the selected project and application. • Execute reset sequence - Select to apply reset settings, specified in the target configuration, when attaching to a target. Alternatively, clear the option to ignore reset settings. <p style="text-align: center;">NOTE</p> <p style="text-align: center;">This option is not available when Attach debug session type is selected.</p> <ul style="list-style-type: none"> • Execute initialization script(s) - Select to execute the initialization script(s), specified in the target configuration, when attaching to a target. Alternatively, clear the option to ignore the initialization script(s). • Target (multicore only) - Select the core to be debugged. For SMP debugging, select all cores in the SMP group.

4.1.2 Arguments

Use this tab to specify the program arguments that an application uses and the working directory for a run or debug configuration.

Figure 17: Debug Configurations-Arguments Tab

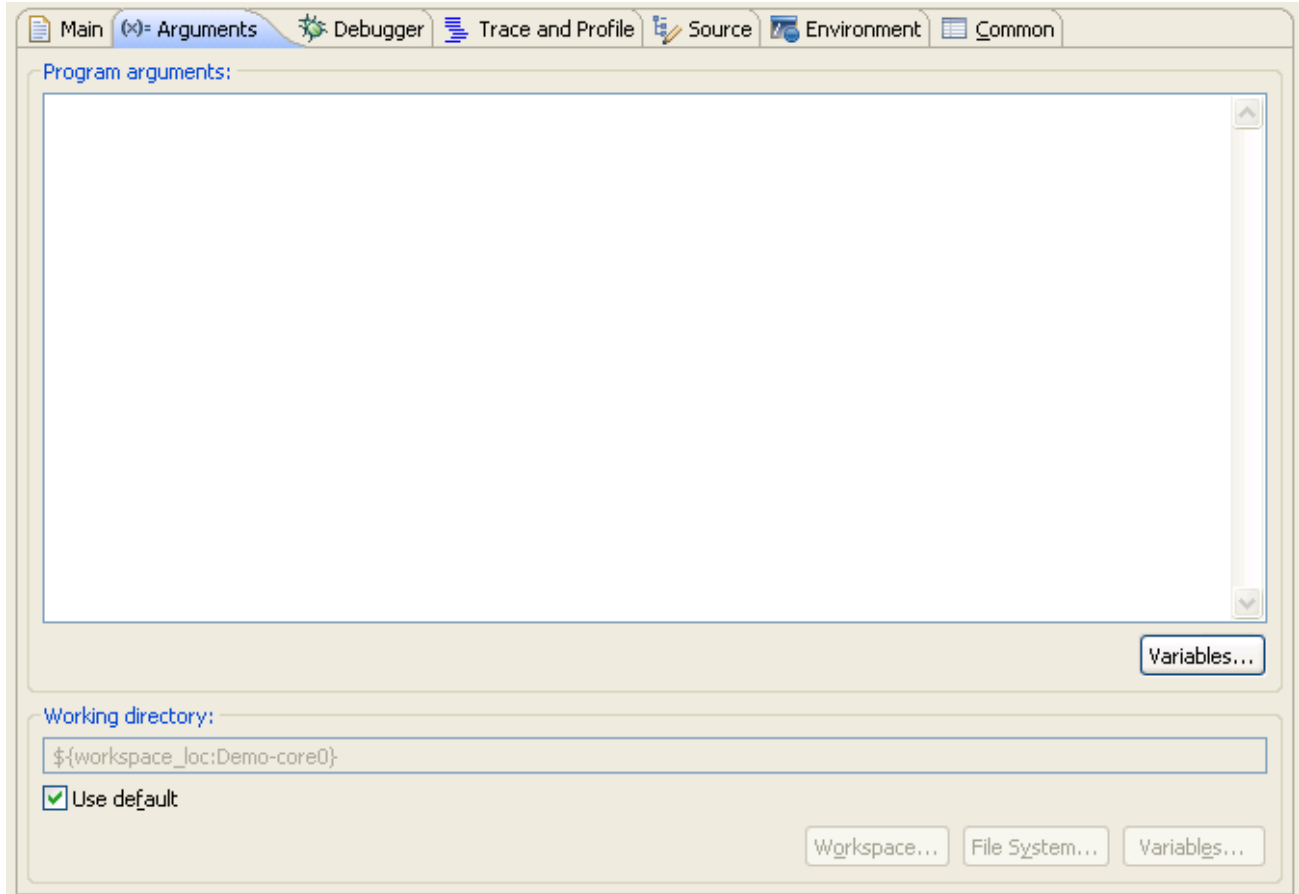

The table below lists the various options available on the **Arguments** page.

Table 64: Arguments Tab options

Option	Description
Program arguments	Specifies the arguments passed on the command line.
Variables	Click to select variables by name to include in the program arguments list.
Working Directory	Specifies the run/debug configuration working directory.
Use default	Select to specify the default run/debug configuration working directory, which is a directory within the current project directory, or clear to specify a different workspace, a file system location, or a variable. For Linux applications, the default working directory is the current directory on the process that started CodeWarrior TRK on the target. This should not be confused with the directory where the CodeWarrior TRK binary resides.

Table continues on the next page...

Table 64: Arguments Tab options (continued)

Option	Description
Workspace	Click to specify the path of, or browse to, a workspace relative working directory.
File System	Click to specify the path of, or browse to, a file system directory.
Variables	Click to specify variables by name to include in the working directory.

4.1.3 Debugger

Use this tab to configure debugger settings.

The **Debugger** tab presents different pages for specifying different settings.

NOTE

The content in the **Debugger Options** panel changes, depending on the **Debug session type** selected on the **Main** page.

Figure 18: Debug Configurations-Debugger Tab

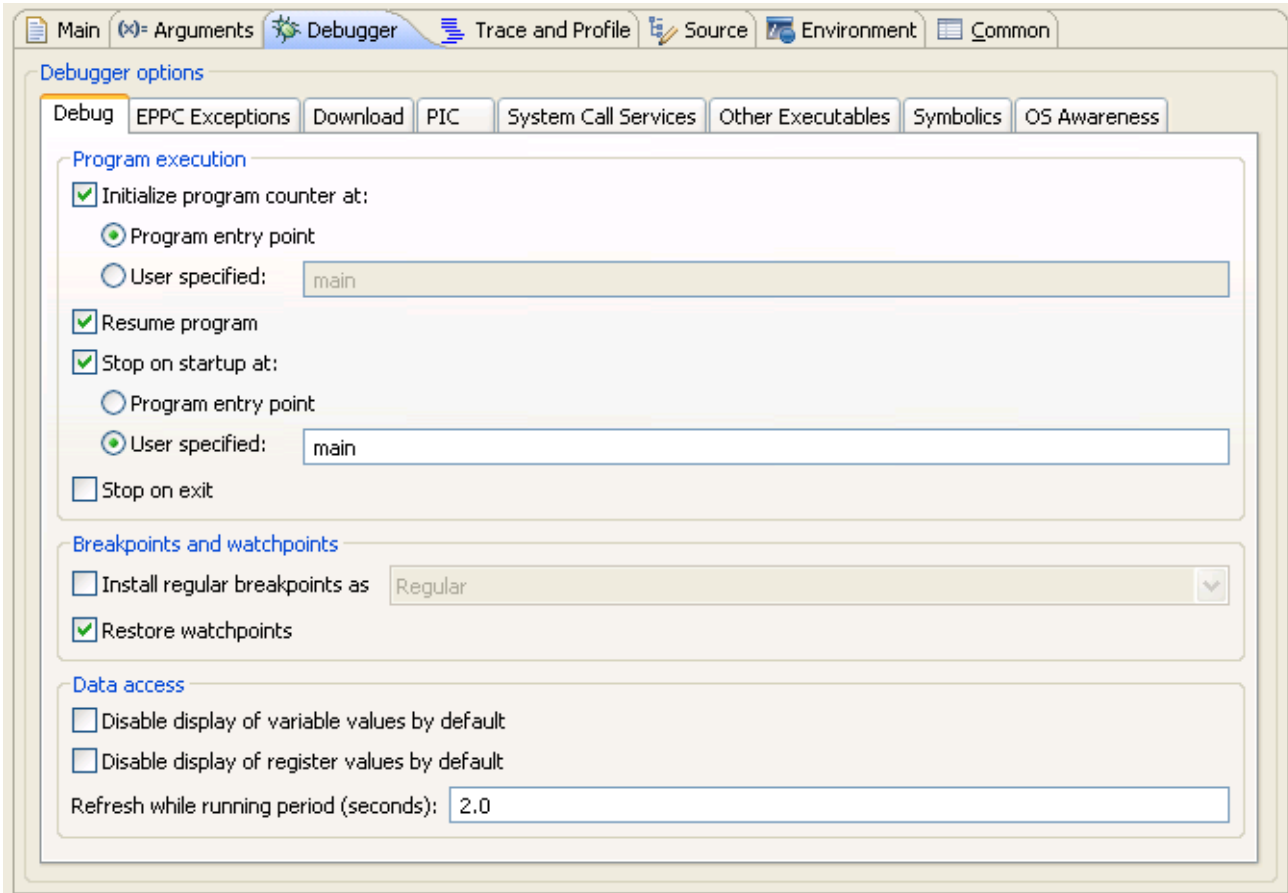

The table below lists the various options available on the **Arguments** page.

Table 65: Debugger tab options

Option	Description
Debugger Options	<p>Displays configuration options specific to the selected debugger type. See the following sections for more details:</p> <ul style="list-style-type: none"> • Debug on page 99 • EPPC Exceptions on page 101 • Download on page 102 • PIC on page 104 • System Call Services on page 105 • Other Executables on page 107 • Symbolics on page 108 • OS Awareness on page 110

This section contains the following subsections:

4.1.3.1 Debug

Use this page to specify the program execution options, Breakpoint and watchpoint options, and target access behavior.

Figure 19: Debugger Options-Debug Page

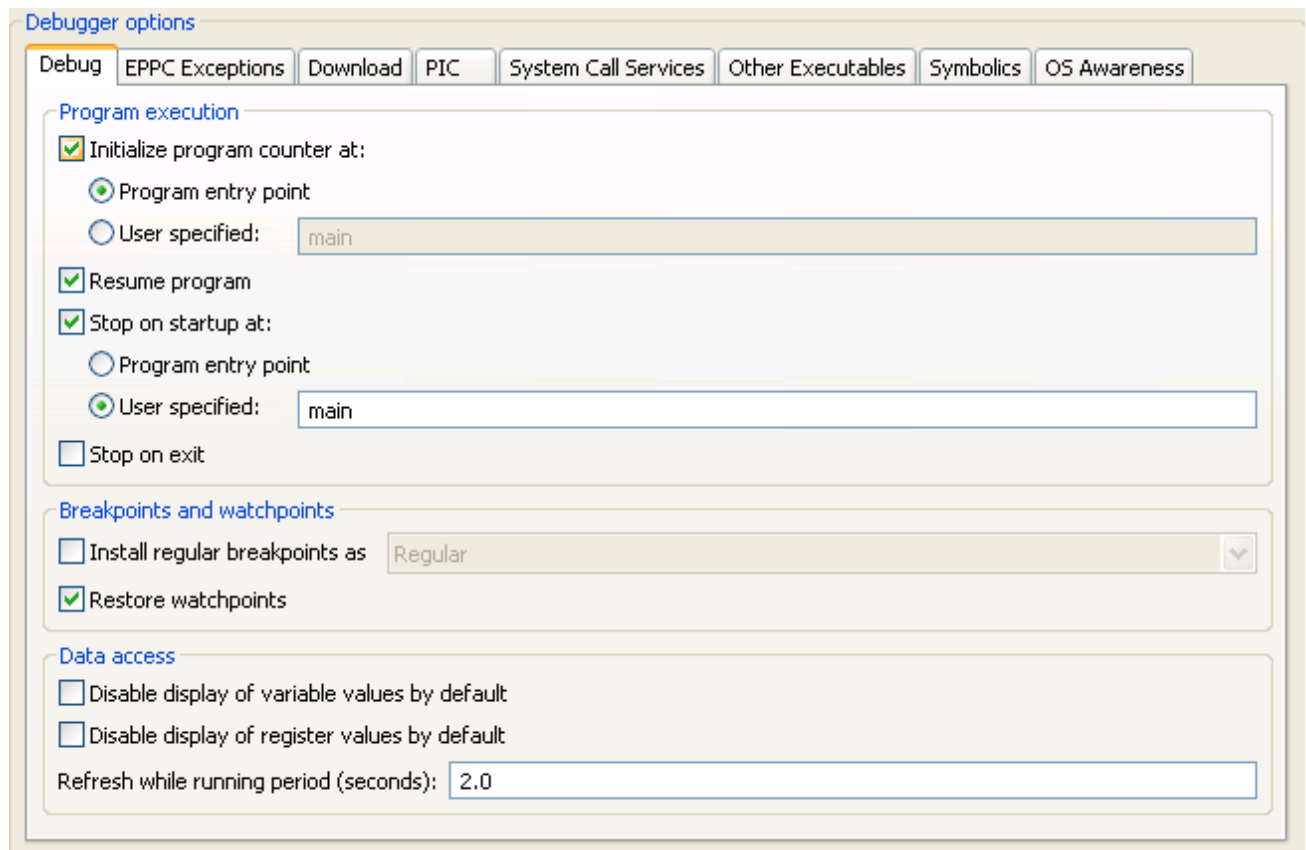

NOTE

The options displayed on the **Debug** tab varies depending on the selected launch configuration.

The table below lists the various options available on the **Debug** page.

Table 66: Debugger Options - Debug

Option	Description
Initialize program counter at	<p>Controls the initialization of program counter.</p> <ul style="list-style-type: none"> • Program entry point - Select to initialize the program counter at a specified program entry pont. • User specified - Select to initialize the program counter at a user-specified function. The default location is <code>main</code>. <p style="text-align: center;">NOTE</p> <p style="text-align: center;">Disabling this option will also disable the Resume program and Stop on startup at options.</p>
Resume program	<p>Select to resume the execution after the program counter is initialized.</p> <p style="text-align: center;">NOTE</p> <p style="text-align: center;">Disabling this option will also disable the Stop on startup at option.</p>
Stop on startup at	<p>Stops program at specified location. When cleared, the program runs until you interrupt it manually, or until it hits a breakpoint.</p> <ul style="list-style-type: none"> • Program entry point - Select to stop the debugger at a specified program entry point. • User specified - Select to stop the debugger at a user-specified function. The default location is <code>main</code>.
Stop on exit	<p>Select this option to have the debugger set a breakpoint at the code's exit point. For multicore projects, when you set this option for one project on one core, it is set for projects on the other cores. Deselect this option to prevent the debugger from setting a breakpoint at the code's exit point.</p>
Install regular breakpoints as	<p>Select this option to install breakpoints as either:</p> <ul style="list-style-type: none"> • Regular • Hardware • Software <p>Deselect this option to install breakpoints as Regular breakpoints.</p>
Restore watchpoints	<p>Select this option to restore previous watchpoints.</p>
Disable display of variable values by default	<p>Select this option to disable the display of variable values. Deselect this option to enable the display of variable values</p>

Table continues on the next page...

Table 66: Debugger Options - Debug (continued)

Option	Description
Disable display of register values by default	Select this option to disable the display of register values. Deselect this option to enable the display of register values
Refresh while running period (seconds)	Specifies the refresh period used when a view is configured to refresh, while the application is running. By default, the refresh period is set to two seconds.

4.1.3.2 EPPC Exceptions

The EPPC Exceptions page lists each of the EPPC exceptions that the CodeWarrior debugger can catch.

Use this page to specify which processor exceptions you want the debugger to catch. The EPPC Exceptions page is shown in the figure below.

NOTE

The EPPC Exceptions page currently provides options to configure projects created for PowerQUICC III and QorIQ processors based on the e500v2 core.

NOTE

The features of this page are currently not supported by this implementation.

Figure 20: Debugger Options - EPPC Exceptions page

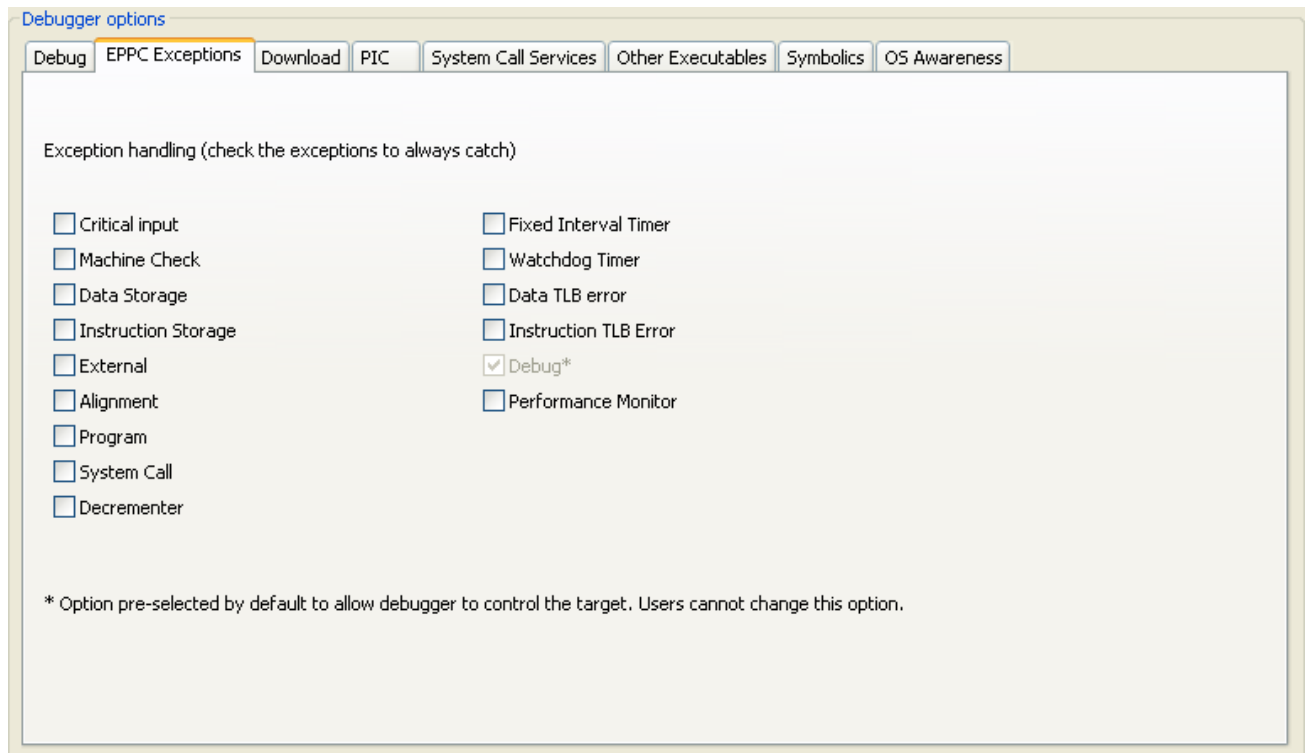

Selecting any of the checkboxes, available on the EPPC Exceptions page, configures the core to automatically halt when the corresponding exception is taken. The debugger stops at the entry point of the interrupt handler for the selected exception, allowing you to inspect the processor state and continue debugging from there.

NOTE

Catching the selected exceptions works only if the target is debugged. To ensure that the CodeWarrior debugger works properly, the debug exception is set and cannot be selected.

The table below lists the various options available on the **EPPC Exceptions** page.

Table 67: EPPC Exceptions Page Options

Option	Description
Exception handling	Select the checkboxes in this panel if you want the debugger to catch the required exceptions. By default, catching all exceptions is disabled. Only the Debug exception is caught, as the debugger uses this exception for setting breakpoints. Catching the debug exception cannot be unset.

4.1.3.3 Download

Use this page to specify which executable code sections the debugger downloads to the target, and whether the debugger should read back those sections and verify them.

NOTE

Selecting all options in the **Program Download Options** group significantly increases download time.

Initial Launch options apply to the first debugging session. Successive Runs options apply to subsequent debugging sessions.

The **Download** options control whether the debugger downloads the specified Program Section Data type to the target hardware. The **Verify** options control whether the debugger reads the specified Program Section Data type from the target hardware and compares the read data against the data written to the device.

Figure 21: Debugger Options-Download page

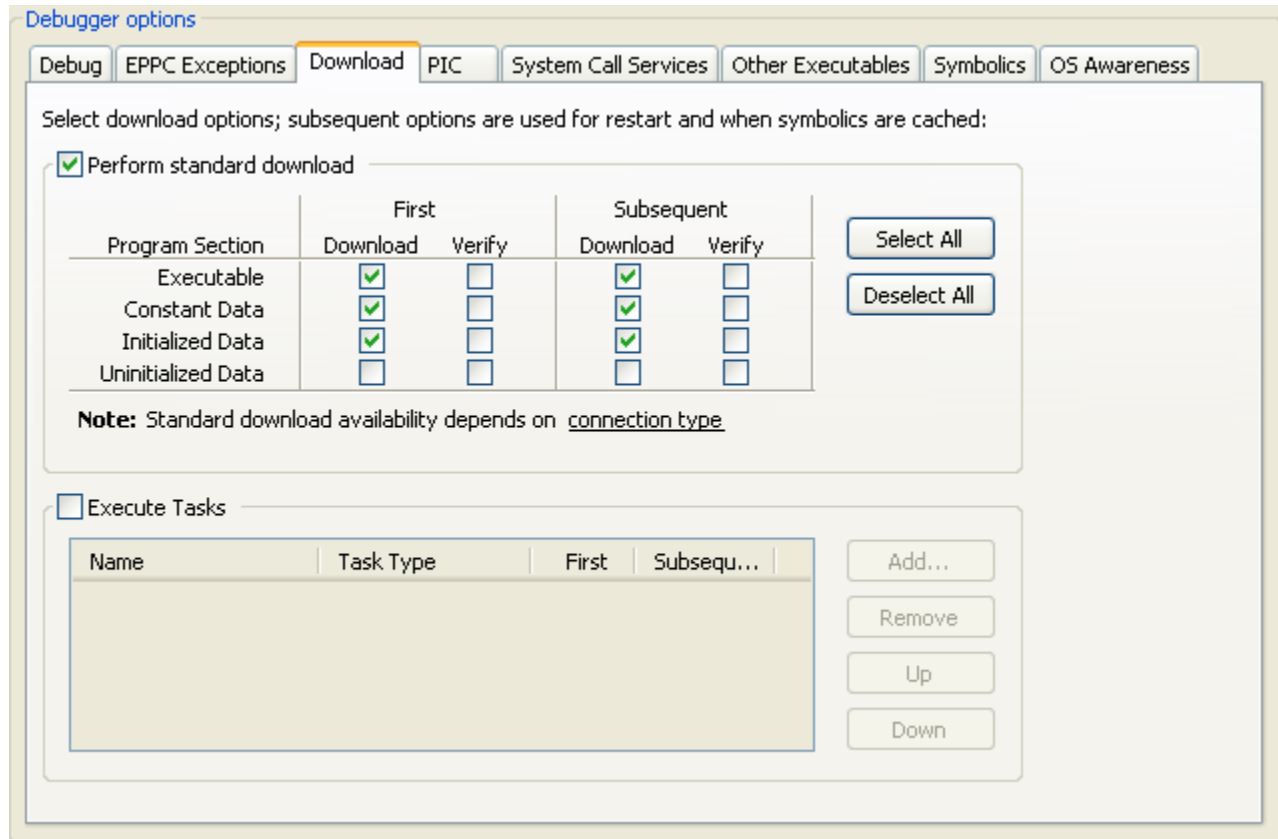

The table below lists the various options available on the Download page.

Table 68: Debugger Options - Download

Section Data Type	Explanation
Perform standard download	Controls download of the target application using memory write command.
First	Represents a group of settings that are used when an application is debugged for the first time.
Subsequent	Represents a group of settings that are used when the application is debugged subsequent times. To make these settings be used during debugging, you need to select the Cache Symbolics Between Sessions option on the Symbolics page.
Executable	Controls downloading and verification for executable sections. Select appropriate checkboxes to specify downloading and verifications, for initial launch and for successive runs.
Constant Data	Controls downloading and verification for constant-data sections. Select appropriate checkboxes to specify downloading and verifications, for initial launch and for successive runs.
Initialized Data	Controls downloading and verification for initialized-data sections. Select appropriate checkboxes to specify downloading and verifications, for initial launch and for successive runs.

Table continues on the next page...

Table 68: Debugger Options - Download (continued)

Section Data Type	Explanation
Uninitialized Data	Controls downloading and verification for uninitialized-data sections. Select appropriate checkboxes to specify downloading and verifications, for initial launch and for successive runs.
Execute Tasks	Enables the execution of target tasks.
Name	For target tasks, this is the name of the target task as seen in the Target Task view. For Debugger Shell scripts, this is the path to the CLDE script.
Task Type	Contains either Debugger Shell scripts or target tasks (such as Flash Programmer).
Add	Adds a download task that can be either a target task or Debugger shell script.
Remove	Removes the selected target task or debugger shell script.
Up	Moves the selected task up the list.
Down	Moves the selected task down the list.

4.1.3.4 PIC

Use this page to specify an alternate address at which the debugger loads the PIC module onto target memory.

Usually, Position Independent Code (PIC) is linked in such a way that the entire image starts at address 0x00000000.

Figure 22: Debugger Options-PIC page

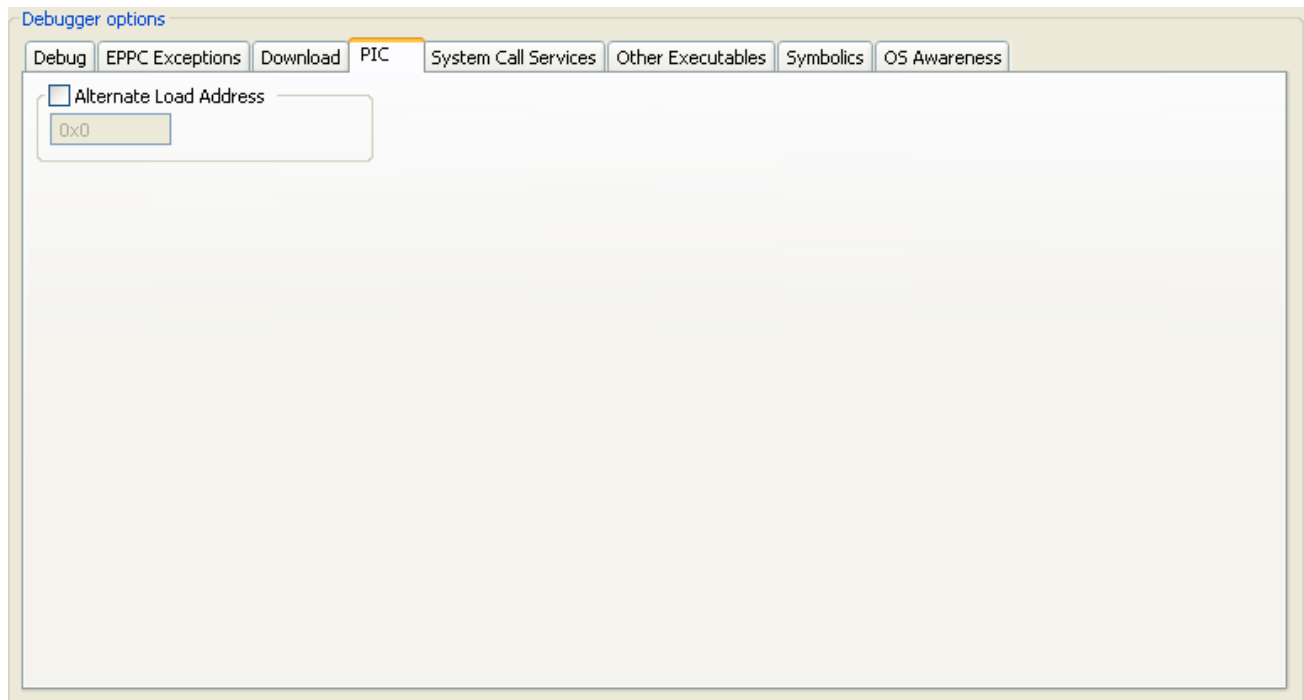

The table below lists the various options available on the **PIC** page.

Table 69: PIC Page Options

Option	Description
Alternate Load Address	Specify the starting address at which the debugger loads your program. You can also use this setting when you have an application which is built with ROM addresses and then relocates itself to RAM (such as U-Boot). Specifying a relocation address lets the debugger map the symbolic debugging information contained in the original ELF file (built for ROM addresses) to the relocated application image in RAM. Clear the checkbox to have the debugger load your program at a default starting address.

NOTE

The debugger does not verify whether your code can execute at the specified address. As a result, the PIC generation settings of the compiler, linker and your program's startup routines must correctly set any base registers and perform any required relocations.

4.1.3.5 System Call Services

Use this page to activate the debugger's support for system calls and to select options that define how the debugger handles system calls.

The CodeWarrior debugger provides system call support over JTAG. System call support lets bareboard applications use the functions of host OS service routines. This feature is useful if you do not have a board support package (BSP) for your target board.

The host debugger implements these services. Therefore, the host OS service routines are available only when you are debugging a program on a target board or simulator.

NOTE

The OS service routines provided must comply with an industry-accepted standard. The definitions of the system service functions provided are a subset of Single UNIX Specification (SUS).

Figure 23: Debugger Options-System Call Services page

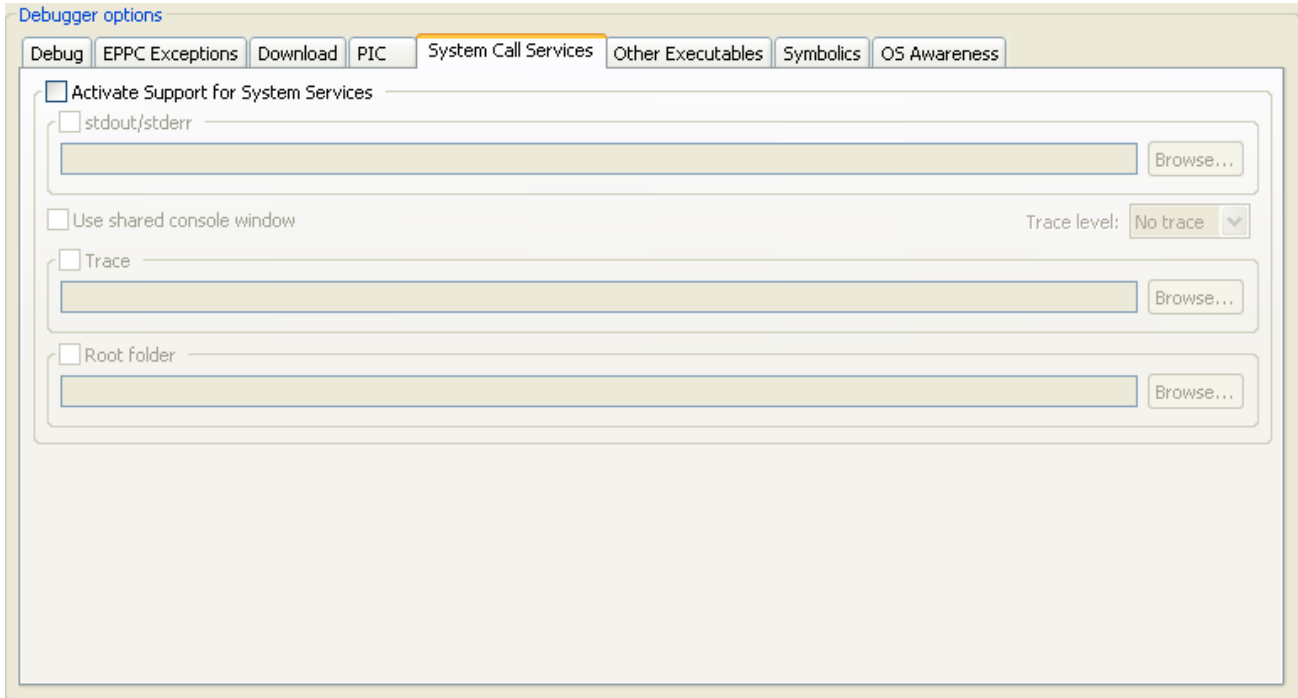

The table below lists the various options available on the **System Call Services** page.

Table 70: System Call Services Page Options

Option	Description
Activate Supportfor System Services	Select this option to enable support for system services. All the other options on the System Call Services panel are enabled only if you check this checkbox.
stdout/stderr	By default, the output written to <code>stdout</code> and <code>stderr</code> appears in a CodeWarrior IDE "console" window. To redirect console output to a file, select the <code>stdout/stderr</code> checkbox. Click Browse to display a dialog and specify the path and name of this file.
Use shared console window	Select this option if you wish to share the same console window between different debug targets. This setting is useful in multi-core or multi-target debugging.
Trace level	Use this drop-down list to specify the system call trace level. The place where the debugger displays the traced system service requests is determined by the Trace checkbox.The system call trace level options available are: <ul style="list-style-type: none"> • No Trace - system calls are not traced • Summary - the requests for system services are displayed • Detailed - the requests for system services are displayed along with the arguments/parameters of the request

Table continues on the next page...

Table 70: System Call Services Page Options (continued)

Option	Description
Trace	By default, traced system service requests appear in a CodeWarrior IDE "console" window. To log traced system service requests to a file, select the Trace checkbox. Click Browse to display a dialog and define the path and name of this file. In a Power Architecture project created using the CodeWarrior Bareboard Project Wizard, use the library <code>syscall.a</code> rather than a UART library for handling the output.
Root folder	The directory on the host system which contains the OS routines that the bareboard program uses for system calls.

4.1.3.6 Other Executables

Use this page to specify additional ELF files to download or debug in addition to the main executable file associated with the launch configuration.

Figure 24: Debugger Options-Other Executables Page

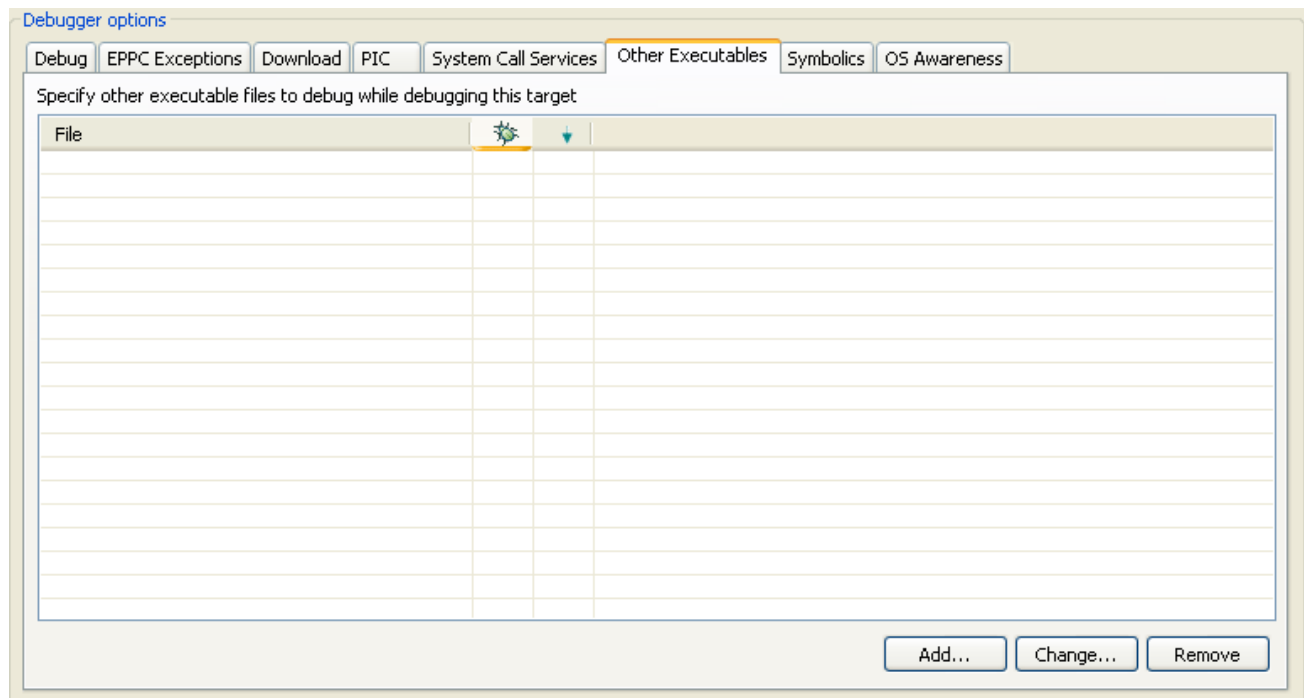



The table below lists the various options available on the **Other Executables** page.

Table 71: Debugger Options - Other Executables

Option	Description
File list	Shows files and projects that the debugger uses during each debug session.

Table continues on the next page...

Table 71: Debugger Options - Other Executables (continued)

Option	Description	
		Debug column: <ul style="list-style-type: none"> • Checked-The debugger loads symbolics for the file. • Cleared-The debugger does not load symbolics for the file.
		Download column: <ul style="list-style-type: none"> • Checked-The debugger downloads the file to the Target Device. • Cleared-The debugger does not download the file to the Target Device.
Add	Click to open the Debug Other Executable dialog, and add other executable file to debug while debugging this target. Use this dialog to specify the following settings: <ul style="list-style-type: none"> • Specify the location of the additional executable - Enter the path to the executable file that the debugger controls in addition to the current project's executable file. Alternatively, click Workspace, File System, or Variables to specify the file path. • Load symbols - Check to have the debugger load symbols for the specified file. Clear to prevent the debugger from loading the symbols. The Debug column of the File list corresponds this setting. • Download to device - Check to have the debugger download the specified file to the target device. Specify the path of the file in the Specify the remote download path text box. Clear the Download to device checkbox to prevent the debugger from downloading the file to the device. The Download column of the File list corresponds to the Download to device setting. • OK - Click to add the information that you specify in the Debug Other Executable dialog to the File list. 	
Change	Click to change the settings for the entry currently selected in the File list column. Change this information as needed, then click the OK button to update the entry in the File list.	
Remove	Click to remove the entry currently selected in the File list.	

4.1.3.7 Symbolics

Use this page to specify whether the IDE keeps symbolics in memory.

Symbolics represent an application's debugging and symbolic information. Keeping symbolics in memory, known as caching symbolics, is beneficial when you debug a large-size application.

Consider a situation in which the debugger loads symbolics for a large application, but does not download content to a hardware device and the project uses custom makefiles with several build steps to generate this application.

In such a situation, caching symbolics helps speed up the debugging process. The debugger uses the readily available cached symbolics during subsequent debugging sessions. Otherwise, the debugger spends significant time creating an in-memory representation of symbolics during subsequent debugging sessions.

NOTE

Caching symbolics provides the most benefit for large applications, where doing so speeds up application-launch time. If you debug a small application, caching symbolics does not significantly improve the launch times.

Figure 25: Debugger Options-Symbolics page

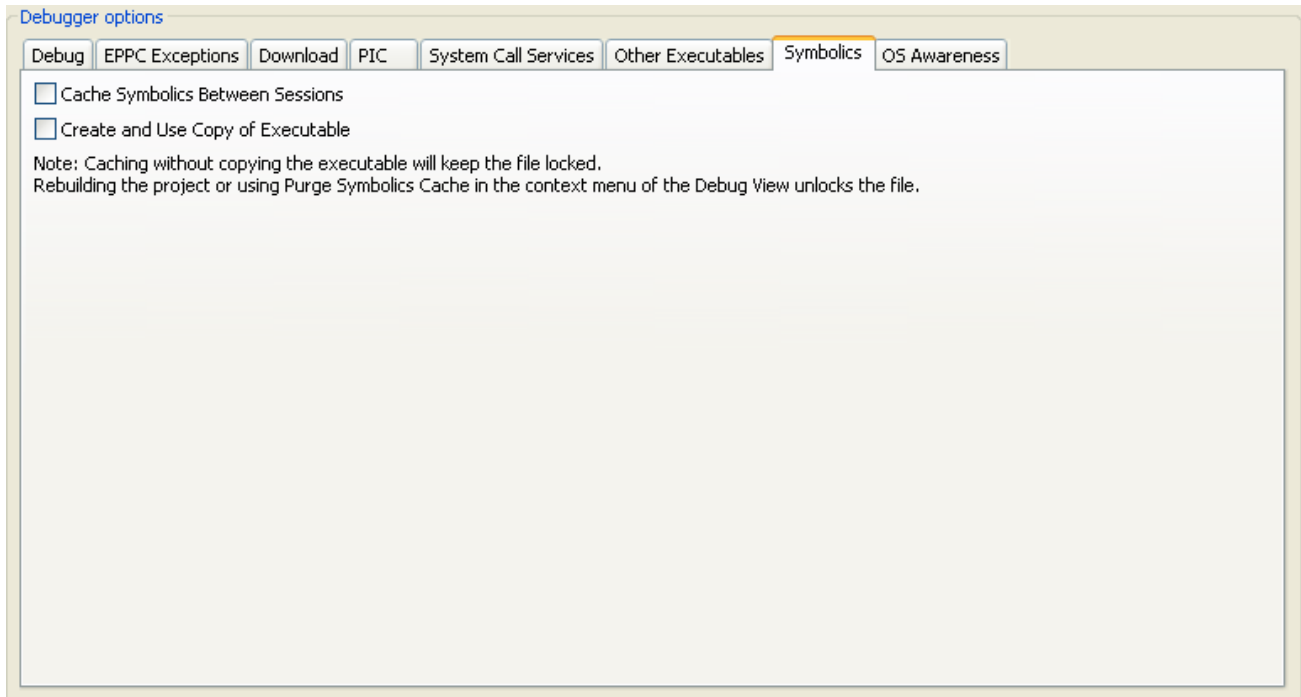

The table below lists the various options available on the **Symbolics** page.

Table 72: Debugger Options - Symbolics

Option	Description
Cache Symbolics Between Sessions	<p>Select this option to have the debugger cache symbolics between debugging sessions. If you check this checkbox and clear the Create and Use Copy of Executable checkbox, the executable file remains locked after the debugging session ends. In the Debug view, right-click the locked file and select Un-target Executables to have the debugger delete its symbolics cache and release the file lock. The IDE enables this menu command when there are currently unused cached symbolics that it can purge.</p> <p>Deselect this option so that the debugger does not cache symbolics between debugging sessions.</p>

Table continues on the next page...

Table 72: Debugger Options - Symbolics (continued)

Option	Description
Create and Use Copy of Executable	Select this option to have the debugger create and use a copy of the executable file. Using the copy helps avoid file-locking issues with the build system. If you check this checkbox, the IDE can build the executable file in the background during a debugging session. Deselect this option so that the debugger does not create and use a copy of the executable file.

4.1.3.8 OS Awareness

Use this page to specify the operating system (OS) that resides on the target device.

Figure 26: Debugger Options-OS Awareness page

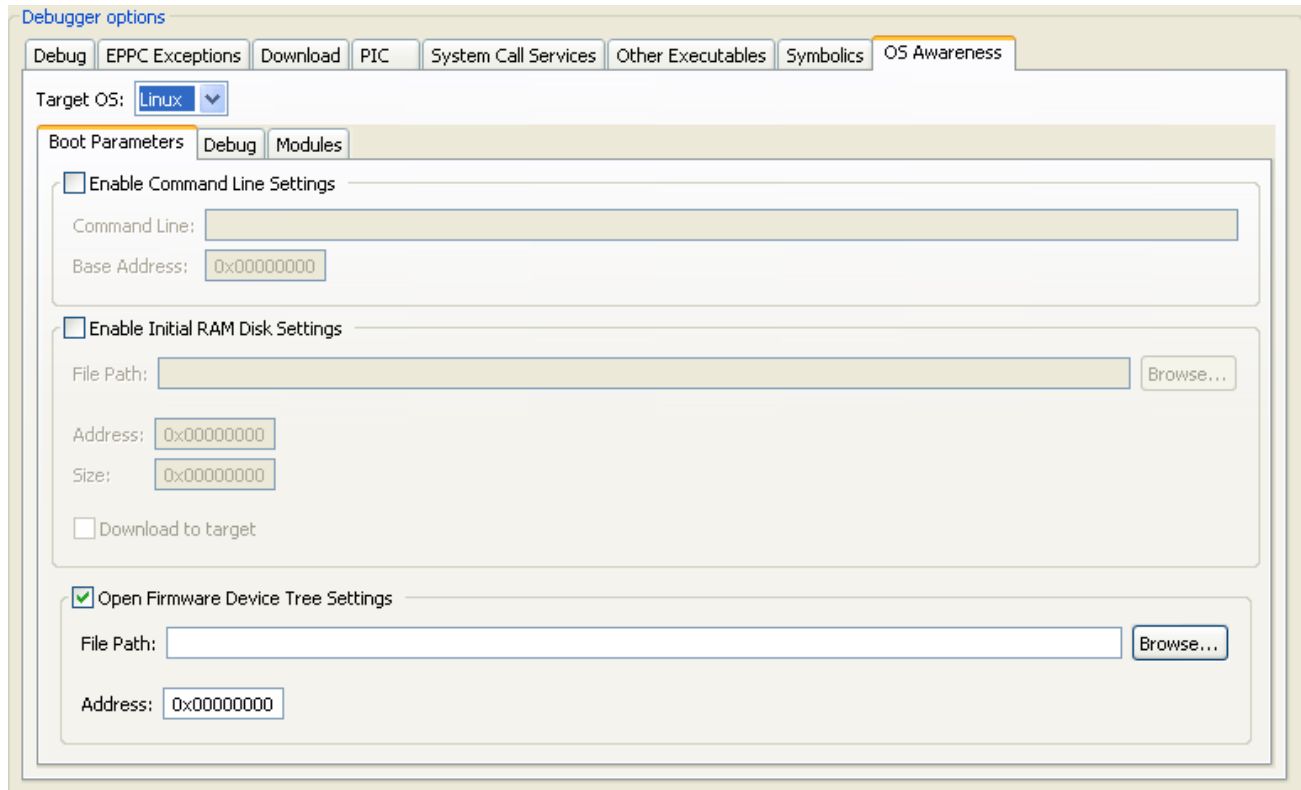

The table below lists the options available on the OS Awareness page.

Table 73: OS Awareness Page Options

Option	Description
Target OS	Use the Target OS list box to specify the OS that runs on the target device, or specify None to have the debugger use the bareboard.

Table continues on the next page...

Table 73: OS Awareness Page Options (continued)

Option	Description
<p>Boot Parameters tab</p>	<p>Enable Command Line Settings: Select this option to specify settings for regular initialization. Enter the specific command line parameters in the Command Line and Base Address text boxes.</p> <p>Enable Initial RAM Disk Settings: Select this option to specify settings for flattened device tree initialization that downloads parameters to the kernel during its initialization. You can specify a <code>.dts</code> file that contains initialization information.</p> <ul style="list-style-type: none"> • File Path: Specifies the path of the RAM disk that you transferred from the Linux machine • Address: Specifies the address specified in Linux, <code>initrd-start</code> from the dts file • Size: Specifies the size of the dts file • Download to target: Downloads the initial RAM disk settings to the target <p>Open Firmware Device Tree Settings: Select this option to load parameters to the kernel from a bootloader on Power Architecture processors</p> <ul style="list-style-type: none"> • File Path: Specifies the path to the dtb file for kernel debug • Address: Specifies the address specified in Linux, <code>initrd-start</code> from the dts file
<p><i>Table continues on the next page...</i></p>	

Table 73: OS Awareness Page Options (continued)

Option	Description
Debug tab	<p>Specifies the parameters required for Linux kernel debug.</p> <ul style="list-style-type: none"> • Enable Memory Translation: Select this option to translate memory by specifying the following values: <ul style="list-style-type: none"> • Physical Base Address: This is the CONFIG_PHYSICAL_START option of the kernel configuration • Virtual Base Address: This is the CONFIG_KERNEL_START option of the kernel configuration • Memory Size: This is the CONFIG_LOWMEM_SIZE option of the kernel configuration <p>Note: The virtual memory space should not overflow the 32-bit memory space. This indicates that the Virtual Base Address + Memory Size should not be greater than 0xFFFFFFFF. CodeWarrior displays an error when this happens.</p> <ul style="list-style-type: none"> • Enable Threaded Debugging Support: Select this option to enable support for Linux kernel threaded debugging • Update Background Threads on Stop: Select this option only if you want to update the background threads on stop. Keep this option unchecked as it may increase debug speed. • Enable Delayed Software Breakpoint Support: Select this option to enable support for delayed software breakpoints during kernel debug
Modules tab	<p>This tab allows you to add modules to the Linux kernel project and configure the module's symbolics mapping. For more information on the Modules tab, see Configuring Symbolics Mappings of Modules on page 310.</p>

4.1.4 Trace and Profile

Use this tab to configure the selected launch configuration for simulator and hardware profiling.

Figure 27: Debug Configurations-Trace and Profile Tab

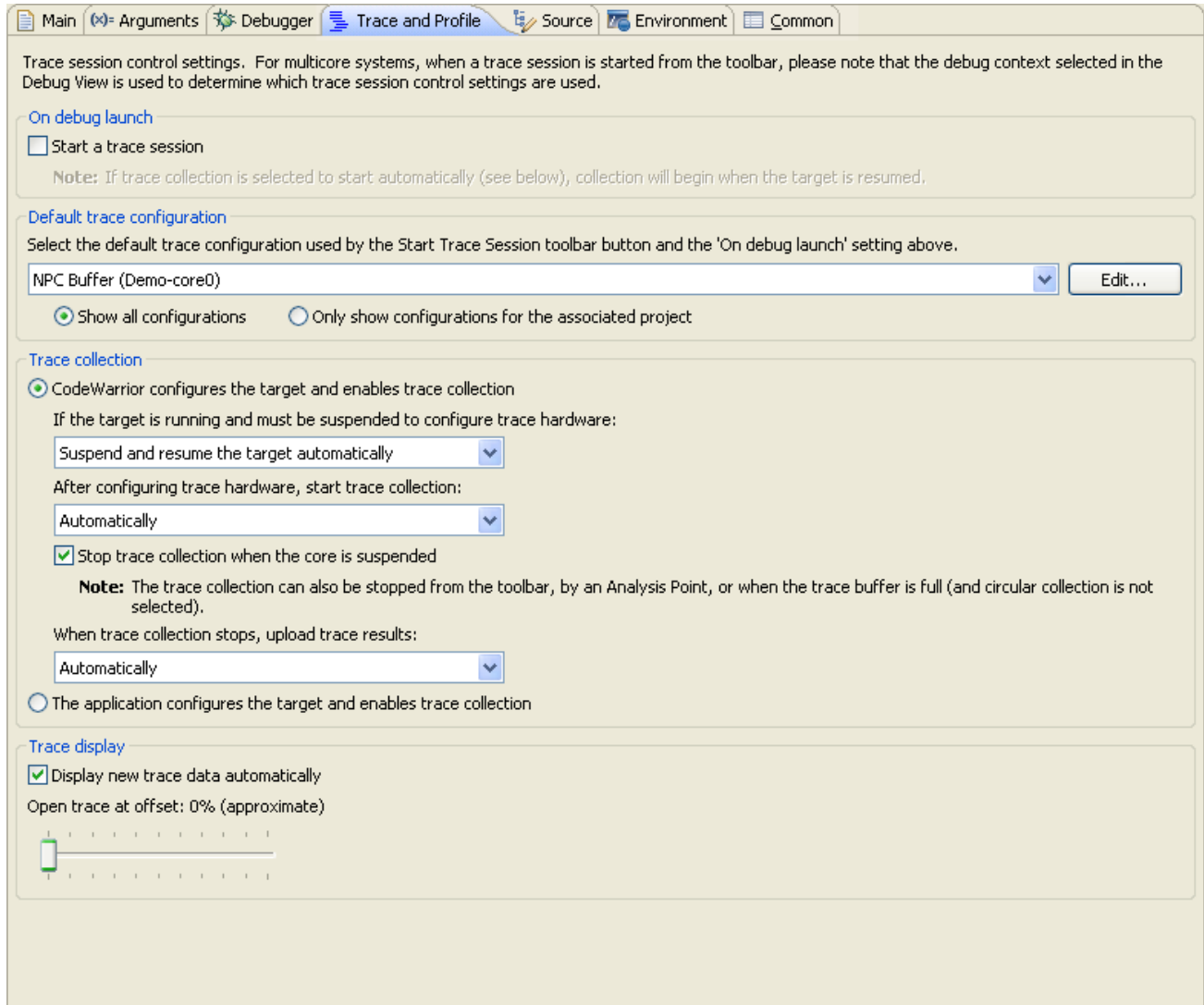

The table below lists the various options available on the **Trace and Profile** page.

Table 74: Trace and Profile Tab Options

Option	Description
Start a trace session	Select to start the trace session immediately on launch.
Default trace Configuration	Select the default trace configuration. The Show all configurations option will display all the trace configurations available in the Default trace Configuration drop-down list and the Only show configurations for the associated project option will display those configurations which are related to the selected project.
Edit	Click to modify the selected configuration.

Table continues on the next page...

Table 74: Trace and Profile Tab Options (continued)

Option	Description
Trace Collection	Select the trace collection mode.
CodeWarrior configures the target and enables trace collection	<p>Select to configure and control trace collection. If the target is running and must be suspended to configure trace hardware - Click to suspend the target to configure trace hardware.</p> <ul style="list-style-type: none"> • Suspend and resume the target automatically - Select to suspend the target automatically for trace configuration. If this option is enabled and you choose to configure trace while the target is running, the target suspends immediately while trace configuration is applied, and then resumes automatically. • Wait until the target is resumed manually - Select to suspend and resume the target for trace configuration manually. If this option is enabled and you choose to configure trace while the target is running, the configuration is changed, but not applied to the target until the target is suspended and resumed. <p>After configuring trace hardware, start trace collection - Select the option to start trace collection after configuring the trace hardware.</p> <ul style="list-style-type: none"> • Automatically - Select to start trace collection immediately after configuring trace hardware. • Manually from the toolbar or by an Analysis Point - Click to start your trace session and configure trace hardware with trace collection disabled. Trace collection will be enabled later by clicking Start Collection or by executing code at an Analysis Point <p>Stop trace collection when the core is suspended - Select to stop trace collection. When the trace collection stops, upload trace results - Select to upload trace results after the trace collection is stopped.</p> <ul style="list-style-type: none"> • Automatically - Click to save data to the <code>Trace.dat</code> file automatically after collection completes or is stopped. • Manually from the toolbar - Click to save the trace data manually to the <code>Trace.dat</code> file.
The application configures the target and enables trace collection	Click to start collecting new trace data for the trace session using your application.
Trace display	Display new trace data automatically

NOTE

For more information on Trace, see the *Tracing and Analysis Tools User Guide* available in the `<CWInstallDir>\PA\Help\PDF` folder, where `CWInstallDir` is the installation directory of your CodeWarrior software.

4.1.5 Source

Use this tab to specify the location of source files used when debugging a C application.

By default, this information is taken from the build path of your project.

Figure 28: Debug Configurations-Source tab

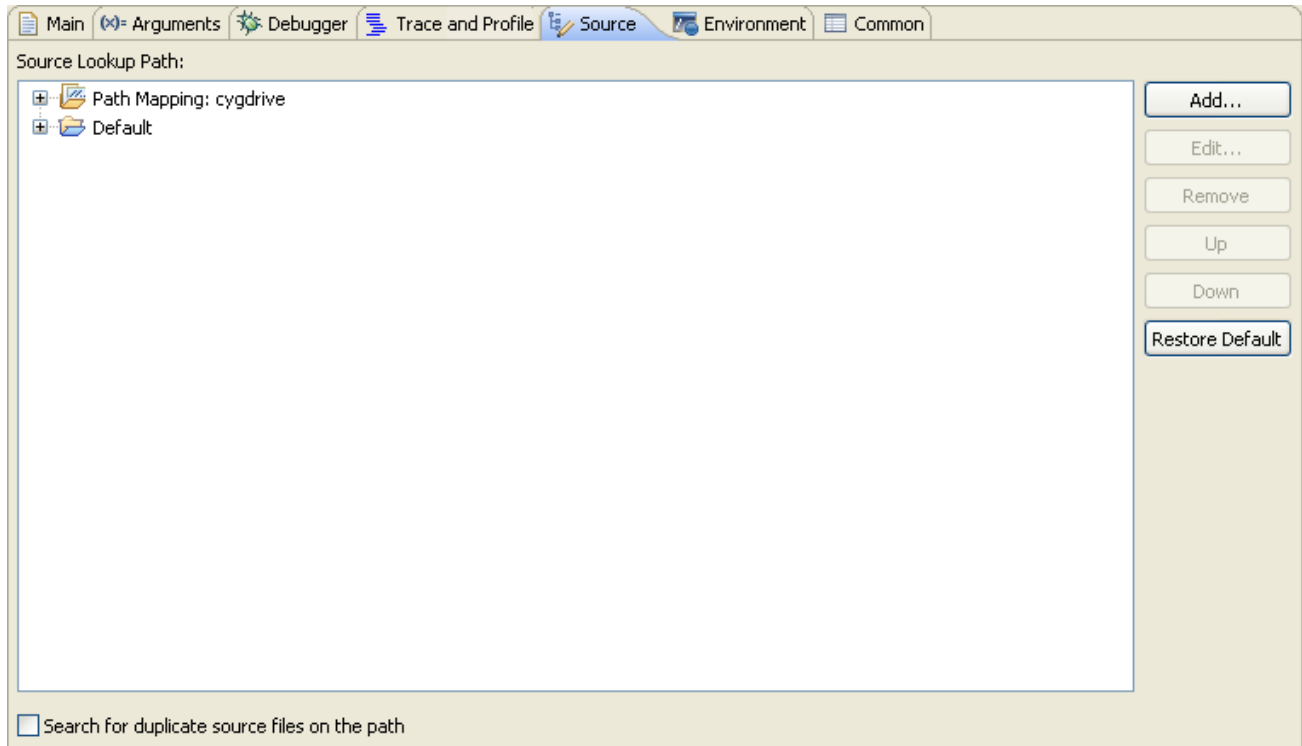

The table below lists the various options available on the **Source** page.

Table 75: Source Tab Options

Option	Description
Source Lookup Path	Lists the source paths used to load an image after connecting the debugger to the target.
Add	Click to add new source containers to the Source Lookup Path search list.
Edit	Click to modify the content of the selected source container.
Remove	Click to remove selected items from the Source Lookup Path list.
Up	Click to move selected items up the Source Lookup Path list.
Down	Click to move selected items down the Source Lookup Path list.
Restore Default	Click to restore the default source search list.
Search for duplicate source files on the path	Select to search for files with the same name on a selected path.

4.1.6 Environment

Use this tab to specify the environment variables and values to use when an application runs.

Figure 29: Debug Configuration-Environment tab

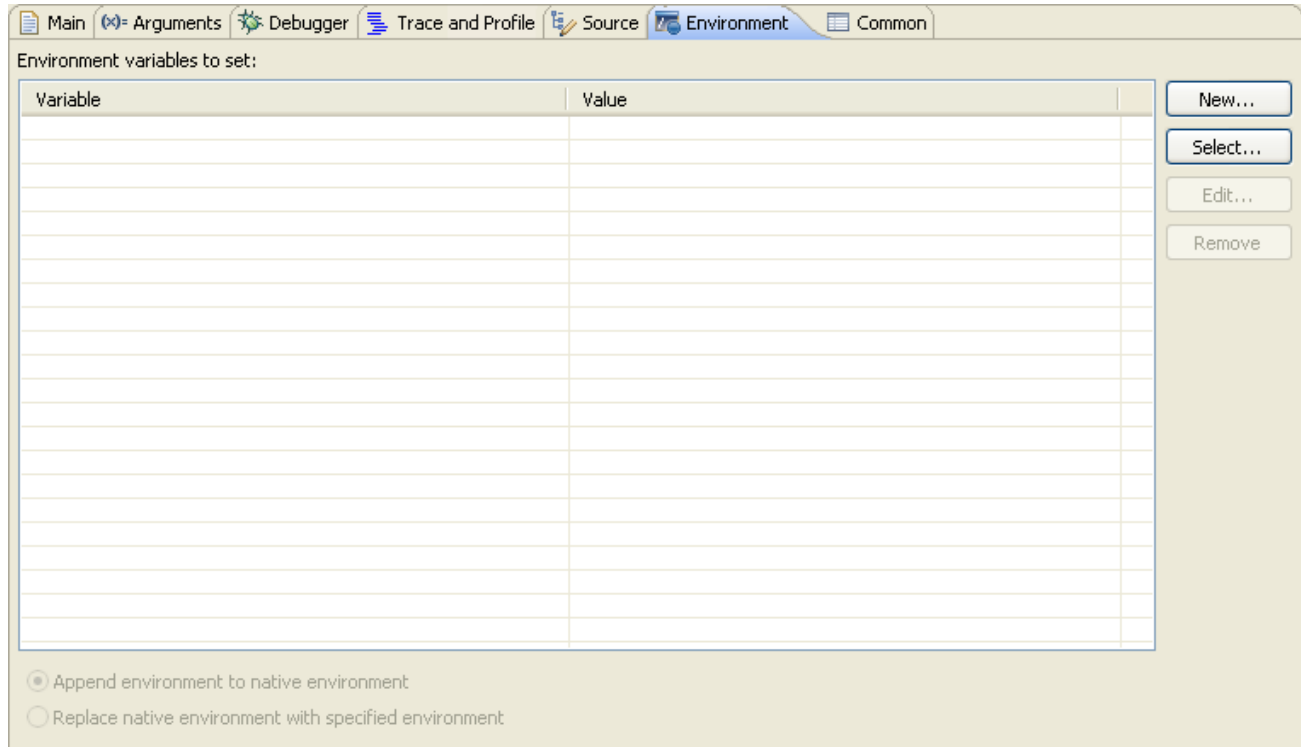

The table below lists the various options available on the **Environment** page.

Table 76: Environment Tab Options

Option	Description
Environment Variables to set	Lists the environment variable name and its value.
New	Click to create a new environment variable.
Select	Click to select an existing environment variable.
Edit	Click to modify the name and value of a selected environment variable.
Remove	Click to remove selected environment variables from the list.
Append environment to native environment	Select to append the listed environment variables to the current native environment.
Replace native environment with specified environment	Select to replace the current native environment with the specified environment set.

4.1.7 Common

Use this tab to specify the location to store your run configuration, standard input and output, and background launch options.

Figure 30: Debug Configuration-Common tab

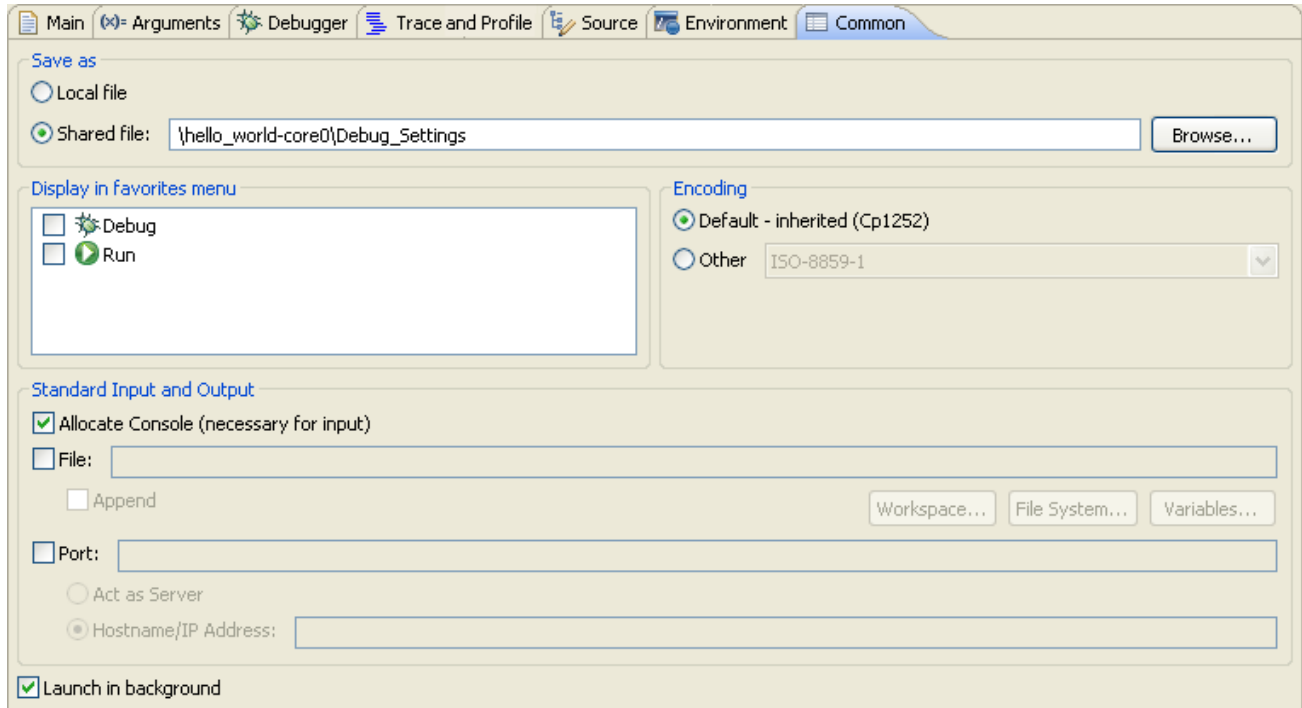

The table below lists the various options available on the **Common** page.

Table 77: Common Tab Options

Option	Description
Local file	Select to save the launch configuration locally.
Shared file	Select to specify the path of, or browse to, a workspace to store the launch configuration file, and be able to commit it to a repository.
Display in favorites menu	Select to add the configuration name to Run or Debug menus for easy selection.
Encoding	Select an encoding scheme to use for console output.
Allocate Console (necessary for input)	Select to assign a console view to receive the output. You must select this option if you want to use the host CodeWarrior to view the output of the debugged application.
File	Specify the file name to save output. For Linux applications, this option provides a way to select a host-side file to redirect the output forwarded by CodeWarrior TRK to host CodeWarrior (if redirections are specified in the Arguments tab, then this feature makes no sense because redirections are using target-side files).
Workspace	Specifies the path of, or browse to, a workspace to store the output file.

Table continues on the next page...

Table 77: Common Tab Options (continued)

Option	Description
File System	Specifies the path of, or browse to, a file system directory to store the output file.
Variables	Select variables by name to include in the output file.
Append	Select to append output. Clear to recreate file each time. Selecting this option means that the file (host-side file, in case of Linux applications) mentioned in the File text box will not be overwritten for new content. Instead, the new content will be appended to the file.
Port	Select to redirect standard output (<code>stdout</code> , <code>stderr</code>) of a process being debugged to a user specified socket. <p style="text-align: center;">NOTE</p> You can also use the <code>redirect</code> command in debugger shell to redirect standard output streams to a socket.
Act as Server	Select to redirect the output from the current process to a local server socket bound to the specified port.
Hostname/IP Address	Select to redirect the output from the current process to a server socket located on the specified host and bound to the specified port. The debugger will connect and write to this server socket via a client socket created on an ephemeral port
Launch in background	Select to launch configuration in background mode.

4.2 Customizing Debug Configurations

When you use the CodeWarrior wizard to create a new project, the wizard sets the project's launch configurations to default values. You can change the default values of your project's launch configurations, according to your program's requirements.

To modify the launch configurations:

1. Start the CodeWarrior IDE.
2. From the main menu bar of the IDE, select **Run > Debug Configurations**.

The **Debug Configurations** dialog appears. The left side of this dialog has a list of debug configurations that apply to the current application.

3. Expand the **CodeWarrior** configuration.
4. From the expanded list, select the debug configuration that you want to modify.

The following figure shows the **Debug Configurations** dialog with the settings for the debug configuration you selected.

Figure 31: CodeWarrior Debug Configuration-Main tab

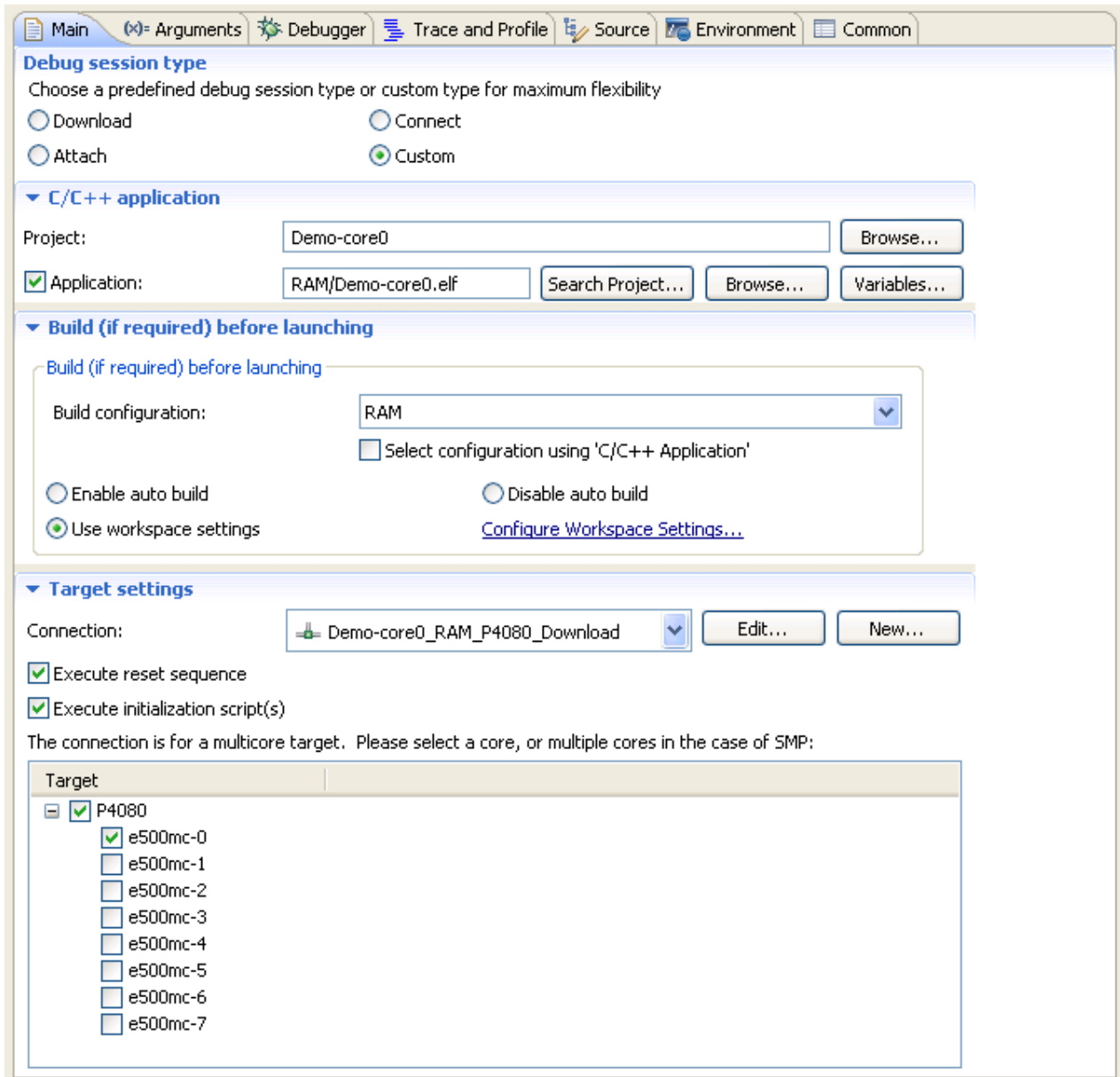

5. In the group of tabs in the upper-right side of the dialog, click a tab.
6. Change the settings on the debug configuration page as per your requirements. See [Using Debug Configurations Dialog Box](#) on page 91 for details on the various settings of this page.
7. Click **Apply** to save the new settings.

When you finish, you can click **Debug** to start a new debugging session, or click **Close** to save your changes and close the **Debug Configurations** dialog.

4.3 Reverting Debug Configuration Settings

After making some modifications in a debug configuration's settings, you can either save the pending (unsaved) changes or revert to last saved settings.

To save the pending changes, click the **Apply** button of the **Debug Configurations** dialog, or click the **Close** button and then the **Yes** button.

To undo pending changes and restore the last saved settings, click the **Revert** button at the bottom of the **Debug Configurations** dialog.

The IDE restores the last set of saved settings to all pages of the **Debug Configurations** dialog. Also, the IDE disables the **Revert** button until you make new pending changes.

Chapter 5

Working with Debugger

This chapter explains various aspects of CodeWarrior debugging, such as debugging a project, connection types, setting breakpoints and watchpoints, working with registers, viewing memory, viewing cache, and debugging externally built executable files.

NOTE

This chapter documents debugger features that are specific to CodeWarrior Development Studio for Power Architecture. For more information on debugger features that are common in all CodeWarrior products, see *CodeWarrior Development Studio Common Features Guide*.

This chapter explains:

- [Debugging a CodeWarrior project](#) on page 121
- [Consistent debug control](#) on page 122
- [Connection types](#) on page 122
- [JTAG diagnostics tests](#) on page 150
- [Editing remote system configuration](#) on page 152
- [Memory translations](#) on page 155
- [CodeWarrior Command-Line Debugger](#) on page 156
- [Working with Breakpoints](#) on page 158
- [Working with Watchpoints](#) on page 163
- [Working with Registers](#) on page 165
- [Viewing memory](#) on page 193
- [Viewing Cache](#) on page 196
- [Changing Program Counter Value](#) on page 204
- [Hard resetting](#) on page 204
- [Setting Stack Depth](#) on page 204
- [Import a CodeWarrior Executable file Wizard](#) on page 204
- [Debugging Externally Built Executable Files](#) on page 209

5.1 Debugging a CodeWarrior project

This section explains how to change the debugger settings and how to debug a CodeWarrior project.

The CodeWarrior Bareboard Project Wizard or the CodeWarrior Linux Project Wizard sets the debugger settings of a project's launch configurations to default values. You can change these default values as per your requirements.

To change the debugger settings and start debugging a CodeWarrior project, perform these steps:

1. From the CodeWarrior IDE menu bar, select **Run > Debug Configurations**. The CodeWarrior IDE uses the settings in the launch configuration to generate debugging information and initiate communications with the target board.

The **Debug Configurations** dialog appears. The left side of this dialog has a list of debug configurations that apply to the current application.

2. Expand the **CodeWarrior** configuration.
3. From the expanded list, select the debug configuration that you want to modify.
4. Click **Apply** to save the new settings.

TIP

You can click **Revert** to undo any of the unsaved changes. The CodeWarrior IDE restores the last set of saved settings to all pages of the **Debug Configurations** dialog. Also, the IDE disables **Revert** until you make new pending changes.

5. Click **Debug** to start the debugging session.

You just modified the debugger settings and initialized a debugging session.

5.2 Consistent debug control

This section describes the *consistent debug control* feature of the CodeWarrior debugger.

When you attempt to stop the target during a debugging session, the *consistent debug control* feature enables the debugger to report core's Doze and Nap low power management states.

In addition, the debugger at the same time grants you access to the system states, such as core registers, TLB registers, caches, and so on.

When you attempt to resume the debugging session, the debugger displays a warning message and puts the respective core in the same power management state (Doze or Nap, whichever is the previous one). The debugger waits for the core to exit out of Doze or Nap state to continue with the attempted operation.

5.3 Connection types

This section describes the different connection types provided by CodeWarrior debugger for connecting the target board to a computer.

The connection types supported by CodeWarrior debugger are:

- [CCSSIM2 ISS](#) on page 122
- [Ethernet TAP](#) on page 124
- [Gigabit TAP + Trace](#) on page 128
- [Gigabit TAP](#) on page 133
- [Simics](#) on page 138
- [TCF](#) on page 140
- [USB TAP](#) on page 141
- [CodeWarrior TAP](#) on page 145

5.3.1 CCSSIM2 ISS

Select this connection type to connect to simulators based on the CCSSIM2 ISS interface.

To configure the settings of the CCSSIM2 ISS connection type, perform the following steps:

1. Select **Run > Debug Configurations**.

The **Debug Configurations** dialog appears.

2. In the **Connection** group, click **Edit** next to the **Connection** drop-down list.

The **Properties for <connection launch configuration>** window appears.

3. Select **CCSSIM2 ISS** from the **Connection type** drop-down list.

The **Connection** and **Advanced** tabs display options with respect to the settings of the selected connection type.

The table below describes various options available on the **Connection** page.

Table 78: CCSSIM2 ISS - Connection Tab Options

Option		Description
CCS server	Automatic launch	Select to automatically launch the specified CCS server on the specified port.
	Server port number	Specifies the port number to launch the CCS server on.
	CCS executable	Select to specify the path of, or browse to, the executable file of the CCS server.
	Manual launch	Select to manually launch the specified CCS server on the specified port.
	Server hostname/IP	Specifies hostname or the IP address of the CCS server.
	Server port number	Specifies the port number to launch the CCS server on.
	Connect server to TAP	Select to enable the CCS server to connect to the TAP.

The table below describes the various options available on the **Advanced** page.

Table 79: CCSSIM2 ISS - Advanced Tab Options

Option		Description
Target connection lost settings	Try to reconnect	If this option is selected, the lost CCS connection between the target and host is reset. Select the Timeout checkbox to specify the time interval (in seconds) after which the connection will be lost.
	Terminate the debug session	If this option is selected, the debug session is terminated and the lost connection between JTAG and CCS server is not reset.

Table continues on the next page...

Table 79: CCSSIM2 ISS - Advanced Tab Options (continued)

Option		Description
	Ask me	This is the default setting. If the CCS connection is lost between the target and host, the user is asked if the connection needs to be reset or terminated.
Advanced CCS settings	CCS timeout	Specifies the CCS timeout period. If the target does not respond in the provided time-interval, you receive a CCS timeout error.
	Enable logging	Select to display protocol logging in console.

5.3.2 Ethernet TAP

Select this connection type when Ethernet network is used as interface to communicate with the hardware device.

To configure the settings of an **Ethernet TAP** connection type, perform the following steps:

1. Select **Run > Debug Configurations**.

The **Debug Configurations** dialog appears.

2. In the **Connection** group, click **Edit** next to the **Connection** drop-down list.

The **Properties for <connection launch configuration>** window appears.

3. Select the **Ethernet TAP** from the **Connection type** drop-down list.

The **Connection** and **Advanced** tabs display options with respect to the settings of the selected connection type.

The table below describes various options available on the **Connection** page.

Table 80: Ethernet TAP - Connection Tab Options

Option		Description
Ethernet TAP	Hostname/IP	Specifies hostname or the IP address of the TAP.
JTAG settings	JTAG clock speed (kHz)	Specifies the JTAG clock speed. By default, set to 10230 kHz.
CCS server	Automatic launch	Select to automatically launch the specified CCS server on the specified port.
	Server port number	Specifies the port number to launch the CCS server on.
	CCS executable	Click to specify the path of, or browse to, the executable file of the CCS server.

Table continues on the next page...

Table 80: Ethernet TAP - Connection Tab Options (continued)

Option		Description
	Manual launch	Select to manually launch the specified CCS server on the specified port.
	Server hostname/IP	Specifies hostname or the IP address of the CCS server.
	Server port number	Specifies the port number to launch the CCS server on.
	Connect server to TAP	Select to enable the CCS server to connect to the TAP.

The table below describes the various options available on the **Advanced** page.

Table 81: Ethernet TAP - Advanced Tab Options

Option		Description
Target connection lost settings	Try to reconnect	If this option is selected, the lost CCS connection between the target and host is reset. Select the Timeout checkbox to specify the time interval (in seconds) after which the connection will be lost.
	Terminate the debug session	If this option is selected, the debug session is terminated and the lost connection between JTAG and CCS server is not reset.
	Ask me	This is the default setting. If the CCS connection is lost between the target and host, the user is asked if the connection needs to be reset or terminated.
Advanced CCS settings	CCS timeout	Specifies the CCS timeout period. If the target does not respond in the provided time-interval, you receive a CCS timeout error.
	Enable logging	Select to display protocol logging in console.
JTAG config file		This panel displays the JTAG configuration file being used. This panel is populated only if you have selected a JTAG configuration file for your project. If a JTAG configuration file is not selected, this panel displays a None value. For more details on JTAG configuration files, see the JTAG Configuration Files on page 333 chapter.

Table continues on the next page...

Table 81: Ethernet TAP - Advanced Tab Options (continued)

Option	Description
Advanced TAP settings	Force shell download Select to force a reload of the TAP shell software.
	Disable fast download Select to disable fast download. <div style="text-align: center;"> <p>NOTE</p> <p>This option is not available for <i>e500mc</i>, <i>e5500</i>, and <i>e6500</i> core based targets.</p> </div>
	Enable JTAG diagnostics When selected, the option enables performing advanced diagnostics of the JTAG connection to be used during custom board bring-up. After the connection to the probe has been established the debugger performs the JTAG diagnostics tests (Power at probe, IR scan check, Bypass (DR) scan check, Arbitrary TAP state move, IDCODE scan check) and the result of the tests are printed to the console log and in case of an error, a CodeWarrior Alert box appears. When this option is not selected, the CodeWarrior debugger only performs a limited test while configuring the JTAG chain. It checks if the PWR pin is correctly connected and displays a Cable disconnected error if not connected properly. The connection details are provided in the CCS protocol log along with the JTAG ID and in case of an error, a CodeWarrior Alert box appears. See JTAG diagnostics tests on page 150 for more information on JTAG diagnostics tests.

Table continues on the next page...

Table 81: Ethernet TAP - Advanced Tab Options (continued)

Option		Description
	Secure debug key	<p>Select to enable the debugger to unlock the secured board with the secure debug key provided in the associated text box. If this option is not selected, you will receive a secure debug violation error when you try to debug on the locked board.</p> <p style="text-align: center;">NOTE</p> <p>If you provide a wrong key and an unlock sequence is run by the debugger with the erroneous key, the associated part will be locked until a rest occurs and you will need to reset the target to connect again. For the P1010 processor, if you have one failed attempt with a wrong key then a subsequent unlock sequence with a valid key will succeed. But, if you provide a wrong key twice, you will need to hard reset the board before the next attempt.</p>

Table continues on the next page...

Table 81: Ethernet TAP - Advanced Tab Options (continued)

Option	Description
<p>Reset Delay (ms)</p>	<p>Specifies the time in milliseconds that CodeWarrior takes to gain control of the target, after issuing a reset. The default value for this option is 200 ms. The delay needs to be increased if the debugger connection does not work reliably, after issuing the reset. This can happen for specific boards and in scenarios where the pre-boot loader (PBL) is used to perform boot image manipulation (for example, copying U-Boot from SPI flash to internal cache/SRAM during reset) that does not complete within the default reset timeout window. A good start value to test out board-specific requirements in such cases is 1000 ms; however, this value may need to be increased for very large PBL transfers.</p> <p style="text-align: center;"> NOTE Reset delay is supported for processors based on the e500mc, e5500, and e6500 cores. </p>

5.3.3 Gigabit TAP + Trace

Select this connection type when Gigabit TAP and Trace is used as interface to communicate with the hardware device.

To configure the settings of a **Gigabit TAP + Trace** connection type, perform the following steps:

1. Select **Run > Debug Configurations**.

The **Debug Configurations** dialog appears.

2. In the **Connection** group, click **Edit** next to the **Connection** drop-down list.

The **Properties for <connection launch configuration>** window appears.

3. Select the **Gigabit TAP + Trace** from the **Connection type** drop-down list.

The **Connection** and **Advanced** tabs display the options with respect to the settings of the selected connection type.

The table below describes various options available on the **Connection** page.

Table 82: Gigabit TAP + Trace - Connection Tab Options

Option		Description
Gigabit TAP + Trace	Hostname/IP	Specifies hostname or the IP address of the TAP.
	Debug connection	Specifies the type of debug connection to use. The options available are JTAG over JTAG cable connection, JTAG over Aurora cable connection, and Aurora connection.
JTAG settings	JTAG clock speed (kHz)	Specifies the JTAG clock speed. By default, set to 10230 kHz.
Aurora settings	Aurora data rate	Specifies the Aurora data rate, which refers to the frequency with which the raw data bits are transferred on the wire. The Aurora connection is used only for trace analysis.
CCS server	Automatic launch	Select to automatically launch the specified CCS server on the specified port.
	Server port number	Specifies the port number to launch the CCS server on.
	CCS executable	Select to specify the path of, or browse to, the executable file of the CCS server.
	Manual launch	Select to manually launch the specified CCS server on the specified port.
	Server hostname/IP	Specifies hostname or the IP address of the CCS server.
	Server port number	Specifies the port number to launch the CCS server on.
	Connect server to TAP	Select to enable the CCS server to connect to the TAP.

The table below describes the various options available on the **Advanced** page.

Table 83: Gigabit TAP + Trace - Advanced Tab Options

Option		Description
Target connection lost settings	Try to reconnect	If this option is selected, the lost CCS connection between the target and host is reset. Select the Timeout checkbox to specify the time interval (in seconds) after which the connection will be lost.

Table continues on the next page...

Table 83: Gigabit TAP + Trace - Advanced Tab Options (continued)

Option	Description	
	Terminate the debug session	If this option is selected, the debug session is terminated and the lost connection between JTAG and CCS server is not reset.
	Ask me	This is the default setting. If the CCS connection is lost between the target and host, the user is asked if the connection needs to be reset or terminated.
Advanced CCS settings	CCS timeout	Specifies the CCS timeout period. If the target does not respond in the provided time-interval, you receive a CCS timeout error.
	Enable logging	Select to display protocol logging in console.
JTAG config file	This panel displays the JTAG configuration file being used. This panel is populated only if you have selected a JTAG configuration file for your project. If a JTAG configuration file is not selected, this panel displays a None value. For more details on JTAG configuration files, see the JTAG Configuration Files on page 333 chapter.	
Advanced TAP settings	Force shell download	Select to force a reload of the TAP shell software.
	Disable fast download	Select to disable fast download. <p style="text-align: center;">NOTE</p> This option is not available for processors based on <i>e500mc</i> , <i>e5500</i> , and <i>e6500</i> cores.

Table continues on the next page...

Table 83: Gigabit TAP + Trace - Advanced Tab Options (continued)

Option	Description
	<p>Enable JTAG diagnostics</p> <p>When selected, the option enables performing advanced diagnostics of the JTAG connection to be used during custom board bring-up. After the connection to the probe has been established the debugger performs the JTAG diagnostics tests (Power at probe, IR scan check, Bypass (DR) scan check, Arbitrary TAP state move, IDCODE scan check) and the result of the tests are printed to the console log and in case of an error, a CodeWarrior Alert box appears. When this option is not selected, the CodeWarrior debugger only performs a limited test while configuring the JTAG chain. It checks if the PWR pin is correctly connected and displays a Cable disconnected error if not connected properly. The connection details are provided in the CCS protocol log along with the JTAG ID and in case of an error, a CodeWarrior Alert box appears. See JTAG diagnostics tests on page 150 for more information on JTAG diagnostics tests.</p>

Table continues on the next page...

Table 83: Gigabit TAP + Trace - Advanced Tab Options (continued)

Option		Description
	Secure debug key	<p>Select to enable the debugger to unlock the secured board with the secure debug key provided in the associated text box. If this option is not selected, you will receive a secure debug violation error when you try to debug on the locked board.</p> <p style="text-align: center;">NOTE</p> <p>If you provide a wrong key and an unlock sequence is run by the debugger with the erroneous key, the associated part will be locked until a rest occurs and you will need to reset the target to connect again. For the P1010 processor, if you have one failed attempt with a wrong key then a subsequent unlock sequence with a valid key will succeed. But, if you provide a wrong key twice, you will need to hard reset the board before the next attempt.</p>

Table continues on the next page...

Table 83: Gigabit TAP + Trace - Advanced Tab Options (continued)

Option	Description
	<p data-bbox="586 317 792 348">Reset Delay (ms)</p> <p data-bbox="971 317 1468 884">Specifies the time in milliseconds that CodeWarrior takes to gain control of the target, after issuing a reset. The default value for this option is 200 ms. The delay needs to be increased if the debugger connection does not work reliably, after issuing the reset. This can happen for specific boards and in scenarios where the PBL is used to perform boot image manipulation (for example, copying U-Boot from SPI flash to internal cache/ SRAM during reset) that does not complete within the default reset timeout window. A good start value to test out board-specific requirements in such cases is 1000 ms; however, this value may need to be increased for very large PBL transfers.</p> <p data-bbox="1183 919 1256 945">NOTE</p> <p data-bbox="1122 951 1317 1136">Reset delay is supported for processors based on the e500mc, e5500, and e6500 cores.</p>

5.3.4 Gigabit TAP

Select this connection type when Gigabit TAP is used as interface to communicate with the hardware device.

To configure the settings of a **Gigabit TAP** connection type, perform the following steps:

1. Select **Run > Debug Configurations**.

The **Debug Configurations** dialog appears.

2. In the **Connection** group, click **Edit** next to the **Connection** drop-down list.

The **Properties for <connection launch configuration>** window appears.

3. Select the **Gigabit TAP** from the **Connection type** drop-down list.

The **Connection** and **Advanced** tabs display options with respect to the settings of the selected connection type.

The table below describes various options available on the **Connection** page.

Table 84: Gigabit TAP - Connection Tab Options

Option		Description
Gigabit TAP	Hostname/IP	Specifies hostname or the IP address of the TAP.
JTAG settings	JTAG clock speed (kHz)	Specifies the JTAG clock speed. By default, set to 10230 kHz.
CCS server	Automatic launch	Select to automatically launch the specified CCS server on the specified port.
	Server port number	Specifies the port number to launch the CCS server on.
	CCS executable	Click to specify the path of, or browse to, the executable file of the CCS server.
	Manual launch	Select to manually launch the specified CCS server on the specified port.
	Server hostname/IP	Specifies hostname or the IP address of the CCS server.
	Server port number	Specifies the port number to launch the CCS server on.
	Connect server to TAP	Select to enable the CCS server to connect to the TAP.

The table below describes the various options available on the **Advanced** page.

Table 85: Gigabit TAP - Advanced Tab Options

Option		Description
Target connection lost settings	Try to reconnect	If this option is selected, the lost CCS connection between the target and host is reset. Select the Timeout checkbox to specify the time interval (in seconds) after which the connection will be lost.
	Terminate the debug session	If this option is selected, the debug session is terminated and the lost connection between JTAG and CCS server is not reset.
	Ask me	This is the default setting. If the CCS connection is lost between the target and host, the user is asked if the connection needs to be reset or terminated.
Advanced CCS settings	CCS timeout	Specifies the CCS timeout period. If the target does not respond in the provided time-interval, you receive a CCS timeout error.

Table continues on the next page...

Table 85: Gigabit TAP - Advanced Tab Options (continued)

Option		Description
	Enable logging	Select to display protocol logging in console.
JTAG config file		This panel displays the JTAG configuration file being used. This panel is populated only if you have selected a JTAG configuration file for your project. If a JTAG configuration file is not selected, this panel displays a None value. For more details on JTAG configuration files, see the JTAG Configuration Files on page 333 chapter.
Advanced TAP settings	Force shell download	Select to force a reload of the TAP shell software.
	Disable fast download	Select to disable fast download. <div style="text-align: center;"> <p>NOTE</p> <p>This option is not available for processors based on <i>e500mc</i>, <i>e5500</i>, and <i>e6500</i> cores.</p> </div>

Table continues on the next page...

Table 85: Gigabit TAP - Advanced Tab Options (continued)

Option	Description
	<p>Enable JTAG diagnostics</p> <p>When selected, the option enables performing advanced diagnostics of the JTAG connection to be used during custom board bring-up. After the connection to the probe has been established the debugger performs the JTAG diagnostics tests (Power at probe, IR scan check, Bypass (DR) scan check, Arbitrary TAP state move, IDCODE scan check) and the result of the tests are printed to the console log and in case of an error, a CodeWarrior Alert box appears. When this option is not selected, the CodeWarrior debugger only performs a limited test while configuring the JTAG chain. It checks if the PWR pin is correctly connected and displays a Cable disconnected error if not connected properly. The connection details are provided in the CCS protocol log along with the JTAG ID and in case of an error, a CodeWarrior Alert box appears. See JTAG diagnostics tests on page 150 for more information on JTAG diagnostics tests.</p>

Table continues on the next page...

Table 85: Gigabit TAP - Advanced Tab Options (continued)

Option		Description
	Secure debug key	<p>Select to enable the debugger to unlock the secured board with the secure debug key provided in the associated text box. If this option is not selected, you will receive a secure debug violation error when you try to debug on the locked board.</p> <p style="text-align: center;">NOTE</p> <p>If you provide a wrong key and an unlock sequence is run by the debugger with the erroneous key, the associated part will be locked until a rest occurs and you will need to reset the target to connect again. For the P1010 processor, if you have one failed attempt with a wrong key then a subsequent unlock sequence with a valid key will succeed. But, if you provide a wrong key twice, you will need to hard reset the board before the next attempt.</p>

Table continues on the next page...

Table 85: Gigabit TAP - Advanced Tab Options (continued)

Option	Description
	<p>Reset Delay (ms)</p> <p>Specifies the time in milliseconds that CodeWarrior takes to gain control of the target, after issuing a reset. The default value for this option is 200 ms. The delay needs to be increased if the debugger connection does not work reliably, after issuing the reset. This can happen for specific boards and in scenarios where the PBL is used to perform boot image manipulation (for example, copying U-Boot from SPI flash to internal cache/ SRAM during reset) that does not complete within the default reset timeout window. A good start value to test out board-specific requirements in such cases is 1000 ms; however, this value may need to be increased for very large PBL transfers.</p> <p style="text-align: center;">NOTE</p> <p style="text-align: center;">Reset delay is supported for processors based on the e500mc, e5500, and e6500 cores.</p>

5.3.5 Simics

Select this connection type when Simics simulator is used.

To configure the settings of a **Simics** connection type, perform the following steps:

1. Select **Run > Debug Configurations**.

The **Debug Configurations** dialog appears.

2. In the **Connection** group, click **Edit** next to the **Connection** drop-down list.

The **Properties for <connection launch configuration>** window appears.

3. Select **Simics** from the **Connection type** drop-down list.

The **Connection** and **Advanced** tabs display the options with respect to the settings of the selected connection type.

The table below describes various options available on the **Connection** page.

Table 86: Simics - Connection Tab Options

Option	Description
Simics settings	<p>Model startup script</p> <p>Specifies the Simics startup script.</p>

Table continues on the next page...

Table 86: Simics - Connection Tab Options (continued)

Option		Description
	Simics executable	Specifies the Simics executable file.
	CodeWarrior add-on	Specifies the Simics add-on for CodeWarrior IDE.
	Show Simics Control window	Select to allow control of the Simics environment.
CCS server	Automatic launch	Select to automatically launch the specified CCS server on the specified port.
	Server port number	Specifies the port number to launch the CCS server on.
	CCS executable	Click to specify the path of, or browse to, the executable file of the CCS server.
	Manual launch	Select to manually launch the specified CCS server on the specified port.
	Server hostname/IP	Specifies hostname or the IP address of the CCS server.
	Server port number	Specifies the port number to launch the CCS server on.

The table below describes the various options available on the **Advanced** page.

Table 87: Simics - Advanced Tab Options

Option		Description
Target connection lost settings	Try to reconnect	If this option is selected, the lost CCS connection between the target and host is reset. Select the Timeout checkbox to specify the time interval (in seconds) after which the connection will be lost.
	Terminate the debug session	If this option is selected, the debug session is terminated and the lost connection between JTAG and CCS server is not reset.
	Ask me	This is the default setting. If the CCS connection is lost between the target and host, the user is asked if the connection needs to be reset or terminated.
Advanced CCS settings	CCS timeout (seconds)	Specifies the CCS timeout period. If the target does not respond in the provided time-interval, you receive a CCS timeout error.
	Enable logging	Select to display protocol logging in console.

5.3.6 TCF

Select this connection type when Simics simulator is used.

To configure the settings of a **TCF** connection type, perform the following steps:

1. Select **Run > Debug Configurations**.

The **Debug Configurations** dialog appears.

2. In the **Connection** group, click **Edit** next to the **Connection** drop-down list.

The **Properties for <connection launch configuration>** window appears.

3. Select **TCF** from the **Connection type** drop-down list.

The **Connection** and **Advanced** tabs display the options with respect to the settings of the selected connection type.

The table below describes various options available on the **Connection** page.

Table 88: TCF - Connection Tab Options

Option		Description
Connection	Hostname/IP	Specifies hostname or IP address of the host, TCF agent runs on. 127.0.0.1 is used if the agent runs locally.
	Port	Specifies the TCP port the agent is listening on.
	Enable Logging	Select to enable logging of all ongoing TCF traffic in the Console view.
	Connection timeout	Specifies connection timeout in seconds.
Agent	Start Agent	Select to start the agent and specify the run-time properties.
	Path to executable	Specifies the path to the TCF agent executable file.
	Arguments to pass	Specifies all the command line arguments to be passed to the TCF agent while starting up.
	Redirect stdout	Select to have the standard output and standard error output redirected to the Console view in CodeWarrior IDE.

The table below describes the various options available on the **Advanced** page.

Table 89: TCF - Advanced Tab Options

Option		Description
Target connection lost settings	Try to reconnect	If this option is selected, the lost CCS connection between the target and host is reset. Select the Timeout checkbox to specify the time interval (in seconds) after which the connection will be lost.
	Terminate the debug session	If this option is selected, the debug session is terminated and the lost connection between JTAG and CCS server is not reset.
	Ask me	This is the default setting. If the CCS connection is lost between the target and host, the user is asked if the connection needs to be reset or terminated.

5.3.7 USB TAP

Select this connection type when USB TAP is used as interface to communicate with the hardware device.

To configure the settings of a **USB TAP** connection type, perform the following steps:

1. Select **Run > Debug Configurations**.

The **Debug Configurations** dialog appears.

2. In the **Connection** group, click **Edit** next to the **Connection** drop-down list.

The **Properties for <connection launch configuration>** window appears.

3. Select **USB TAP** from the **Connection type** drop-down list.

The **Connection** and **Advanced** tabs display the options with respect to the settings of the selected connection type.

4. n

The table below describes various options available on the **Connection** page.

Table 90: USB TAP - Connection Tab Options

Option		Description
USB TAP	USB serial number	Select and specify the USB serial number of the USB TAP, required only if using multiple USB TAPs.
JTAG settings	JTAG clock speed (kHz)	Specifies the JTAG clock speed. By default, set to 10230 kHz.
CCS server	Automatic launch	Select to automatically launch the specified CCS server on the specified port.
	Server port number	Specifies the port number to launch the CCS server on.

Table continues on the next page...

Table 90: USB TAP - Connection Tab Options (continued)

Option		Description
	CCS executable	Click to specify the path of, or browse to, the executable file of the CCS server.
	Manual launch	Select to manually launch the specified CCS server on the specified port.
	Server hostname/IP	Specifies hostname or the IP address of the CCS server.
	Server port number	Specifies the port number to launch the CCS server on.
	Connect server to TAP	Select to enable the CCS server to connect to the TAP.

The table below describes the various options available on the **Advanced** page.

Table 91: USB TAP - Advanced Tab Options

Option		Description
Target connection lost settings	Try to reconnect	If this option is selected, the lost CCS connection between the target and host is reset. Select the Timeout checkbox to specify the time interval (in seconds) after which the connection will be lost.
	Terminate the debug session	If this option is selected, the debug session is terminated and the lost connection between JTAG and CCS server is not reset.
	Ask me	This is the default setting. If the CCS connection is lost between the target and host, the user is asked if the connection needs to be reset or terminated.
Advanced CCS settings	CCS timeout	Specifies the CCS timeout period. If the target does not respond in the provided time-interval, you receive a CCS timeout error.
	Enable logging	Select to display protocol logging in console.

Table continues on the next page...

Table 91: USB TAP - Advanced Tab Options (continued)

Option	Description	
JTAG config file	This panel displays the JTAG configuration file being used. This panel is populated only if you have select a JTAG configuration file for your project. If a JTAG configuration file is not selected, this panel displays a None value. For more details on JTAG configuration files, see the JTAG Configuration Files on page 333 chapter.	
Advanced TAP settings	Force shell download	Select to force a reload of the TAP shell software.
	Disable fast download	Select to disable fast download. <p style="text-align: center;">NOTE</p> This option is not available for processors based on <i>e500mc</i> , <i>e5500</i> , and <i>e6500</i> cores.
	Enable JTAG diagnostics	When selected, the option enables performing advanced diagnostics of the JTAG connection to be used during custom board bring-up. After the connection to the probe has been established the debugger performs the JTAG diagnostics tests (Power at probe, IR scan check, Bypass (DR) scan check, Arbitrary TAP state move, IDCODE scan check) and the result of the tests are printed to the console log and in case of an error, a CodeWarrior Alert box appears. When this option is not selected, the CodeWarrior debugger only performs a limited test while configuring the JTAG chain. It checks if the PWR pin is correctly connected and displays a Cable disconnected error if not connected properly. The connection details are provided in the CCS protocol log along with the JTAG ID and in case of an error, a CodeWarrior Alert box appears. See JTAG diagnostics tests on page 150 for more information on JTAG diagnostics tests.

Table continues on the next page...

Table 91: USB TAP - Advanced Tab Options (continued)

Option	Description
Secure debug key	<p>Select to enable the debugger to unlock the secured board with the secure debug key provided in the associated text box. If this option is not selected, you will receive a secure debug violation error when you try to debug on the locked board.</p> <p style="text-align: center;">NOTE</p> <p>If you provide a wrong key and an unlock sequence is run by the debugger with the erroneous key, the associated part will be locked until a rest occurs and you will need to reset the target to connect again. For the P1010 processor, if you have one failed attempt with a wrong key then a subsequent unlock sequence with a valid key will succeed. But, if you provide a wrong key twice, you will need to hard reset the board before the next attempt.</p>

Table continues on the next page...

Table 91: USB TAP - Advanced Tab Options (continued)

Option	Description
	<p data-bbox="581 319 792 348">Reset Delay (ms)</p> <p data-bbox="971 319 1468 886">Specifies the time in milliseconds that CodeWarrior takes to gain control of the target, after issuing a reset. The default value for this option is 200 ms. The delay needs to be increased if the debugger connection does not work reliably, after issuing the reset. This can happen for specific boards and in scenarios where the PBL is used to perform boot image manipulation (for example, copying U-Boot from SPI flash to internal cache/ SRAM during reset) that does not complete within the default reset timeout window. A good start value to test out board-specific requirements in such cases is 1000 ms; however, this value may need to be increased for very large PBL transfers.</p> <p data-bbox="1182 919 1256 945">NOTE</p> <p data-bbox="1117 949 1318 1138">Reset delay is supported for processors based on the e500mc, e5500, and e6500 cores.</p>

5.3.8 CodeWarrior TAP

Select this connection type when either the CodeWarrior TAP is used as interface to communicate with the hardware device.

To configure the settings of a **CodeWarrior TAP** connection type, perform the following steps:

1. Select **Run > Debug Configurations**.

The **Debug Configurations** dialog appears.

2. In the **Connection** group, click **Edit** next to the **Connection** drop-down list.

The **Properties for <connection launch configuration>** window appears.

3. Select **CodeWarrior TAP** from the **Connection type** drop-down list.

The **Connection** and **Advanced** tabs display the options with respect to the settings of the selected connection type.

The table below describes various options available on the **Connection** page.

Table 92: CodeWarrior TAP - Connection Tab Options

Option		Description
CodeWarrior TAP	Hardware Connection	Specifies CodeWarrior TAP interface to communicate with the hardware device. CodeWarrior TAP supports both USB and Ethernet network interfaces.
	Hostname/IP	Specifies hostname or the IP address of the TAP. <div style="text-align: center;"> <p>NOTE</p> <p>Enabled only if Hardware Connection is set to Ethernet.</p> </div>
	Serial Number	Select and specify the USB serial number of the USB TAP; required only if using multiple CodeWarrior TAPs (over USB).
JTAG settings	JTAG clock speed (kHz)	Specifies the JTAG clock speed. By default, set to 10230 kHz.
CCS server	Automatic launch	Select to automatically launch the specified CCS server on the specified port.
	Server port number	Specifies the port number to launch the CCS server on.
	CCS executable	Click to specify the path of, or browse to, the executable file of the CCS server.
	Manual launch	Select to manually launch the specified CCS server on the specified port.
	Server hostname/IP	Specifies hostname or the IP address of the CCS server.
	Server port number	Specifies the port number to launch the CCS server on.
	Connect server to TAP	Select to enable the CCS server to connect to the CodeWarrior TAP.

The table below describes the various options available on the **Advanced** page.

Table 93: CodeWarrior TAP - Advanced Tab Options

Option		Description
Target connection lost settings	Try to reconnect	If this option is selected, the lost CCS connection between the target and host is reset. Select the Timeout checkbox to specify the time interval (in seconds) after which the connection will be lost.
	Terminate the debug session	If this option is selected, the debug session is terminated and the lost connection between JTAG and CCS server is not reset.
	Ask me	This is the default setting. If the CCS connection is lost between the target and host, the user is asked if the connection needs to be reset or terminated.
Advanced CCS settings	CCS timeout	Specifies the CCS timeout period. If the target does not respond in the provided time-interval, you receive a CCS timeout error.
	Enable logging	Select to display protocol logging in console.
JTAG config file		This panel displays the JTAG configuration file being used. This panel is populated only if you have select a JTAG configuration file for your project. If a JTAG configuration file is not selected, this panel displays a None value. For more details on JTAG configuration files, see the JTAG Configuration Files on page 333 chapter.
Advanced TAP settings	Force shell download	Select to force a reload of the TAP shell software.
	Disable fast download	Select to disable fast download. NOTE This option is not available for <i>e500mc</i> , <i>e5500</i> , and <i>e6500</i> core based targets.

Table continues on the next page...

Table 93: CodeWarrior TAP - Advanced Tab Options (continued)

Option	Description
Enable JTAG diagnostics	<p>When selected, the option enables performing advanced diagnostics of the JTAG connection to be used during custom board bring-up. After the connection to the probe has been established the debugger performs the JTAG diagnostics tests (Power at probe, IR scan check, Bypass (DR) scan check, Arbitrary TAP state move, IDCODE scan check) and the result of the tests are printed to the console log and in case of an error, a CodeWarrior Alert box appears. When this option is not selected, the CodeWarrior debugger only performs a limited test while configuring the JTAG chain. It checks if the PWR pin is correctly connected and displays a Cable disconnected error if not connected properly. The connection details are provided in the CCS protocol log along with the JTAG ID and in case of an error, a CodeWarrior Alert box appears. See JTAG diagnostics tests on page 150 for more information on JTAG diagnostics tests.</p>

Table continues on the next page...

Table 93: CodeWarrior TAP - Advanced Tab Options (continued)

Option		Description
	Secure debug key	<p>Select to enable the debugger to unlock the secured board with the secure debug key provided in the associated text box. If this option is not selected, you will receive a secure debug violation error when you try to debug on the locked board.</p> <p style="text-align: center;">NOTE</p> <p>If you provide a wrong key and an unlock sequence is run by the debugger with the erroneous key, the associated part will be locked until a rest occurs and you will need to reset the target to connect again. For the P1010 processor, if you have one failed attempt with a wrong key then a subsequent unlock sequence with a valid key will succeed. But, if you provide a wrong key twice, you will need to hard reset the board before the next attempt.</p>

Table continues on the next page...

Table 93: CodeWarrior TAP - Advanced Tab Options (continued)

Option	Description
Reset Delay (ms)	<p>Specifies the time in milliseconds that CodeWarrior takes to gain control of the target, after issuing a reset. The default value for this option is 200 ms. The delay needs to be increased if the debugger connection does not work reliably, after issuing the reset. This can happen for specific boards and in scenarios where the PBL is used to perform boot image manipulation (for example, copying U-Boot from SPI flash to internal cache/ SRAM during reset) that does not complete within the default reset timeout window. A good start value to test out board-specific requirements in such cases is 1000 ms; however, this value may need to be increased for very large PBL transfers.</p> <p style="text-align: center;">NOTE</p> <p style="text-align: center;">Reset delay is supported for processors based on the e500mc, e5500, and e6500 cores.</p>

5.4 JTAG diagnostics tests

JTAG diagnostics tests are advanced diagnostics tests performed on the JTAG connection to be used during custom board bring-up.

After connection to the probe has been established, the debugger performs JTAG diagnostics tests and prints the test results to the console log.

Five JTAG header pins (TDI, TDO, TMS, TCK, and TRST) are used in JTAG diagnostics tests. Failing of any of these pins can generate errors. Other JTAG header pins, such as HRESET are architecture-specific and not directly related to JTAG.

JTAG diagnostics tests available in CodeWarrior are:

- [Power at probe test](#) on page 151
- [IR scan test](#) on page 151
- [Bypass scan test](#) on page 151
- [Arbitrary TAP state move test](#) on page 152
- [Reading JTAG IDCODEs test](#) on page 152

5.4.1 Power at probe test

This test checks if the PWR pin is correctly connected. If not, an error message, *Error: No target power detected*, is displayed.

5.4.2 IR scan test

The IR scan test uses the TCK and TMS pins to move the target into the Shift-IR state, and then sends a long test pattern through the IR by holding TMS=0, clocking TCK, and feeding the test pattern bits in the TDI pin.

It captures the bits coming out on the TDO pin. If the connection is working correctly, the TDI bits pass through the IR shift register (instruction register) and eventually show up on the TDO pin. The test compares the TDO data it captures against the TDI test pattern it sent to see if TDO contains the test pattern. It expects to find the test pattern in the TDO, but bit-shifted to the left by some number of bits (corresponding to the IR length).

If it fails to find the test pattern, then the test reports an error, *Error testing IR scan*.

If the test fails to measure the length of the instruction register, then an error, *Error measuring IR length*, is thrown.

The error might be due to one or more of the following reasons:

- TRST stuck low: This may hold the target JTAG logic in reset, preventing any shifts to occur.
- TMS disconnected or stuck: This may prevent the target from making any JTAG state changes.
- TCK disconnected or stuck: This may prevent any state changes or clocking of data.
- TDI disconnected or stuck: This may prevent the test pattern data from getting into the target.
- TDO disconnected or stuck: This may prevent the test pattern data from getting out of the target.

If the test fails, then it is possible that there is a physical connection problem with the JTAG pins, or the JTAG frequency is too high.

5.4.3 Bypass scan test

The bypass scan test uses the TCK and TMS pins to move the target into the Shift-Bypass state, and then sends a long test pattern through the data register (DR) by holding TMS=0, clocking TCK, and feeding the test pattern bits in the TDI pin.

It captures the bits coming out on the TDO pin. If the connection is working correctly, the TDI bits pass through the DR shift register and eventually show up on TDO. The test compares the TDO data it captures against the TDI test pattern it sent to see if TDO contains the test pattern. It expects to find the test pattern in the TDO, but bit-shifted to the left by some number of bits (corresponding to the bypass length).

If the test fails to find the test pattern, then it reports an error, *Error testing bypass scan*.

If the test fails to measure the length of the data register, then an error, *Error measuring bypass length*, is thrown.

The error might be due to one or more of the following reasons:

- TRST stuck low: This would hold the target JTAG logic in reset, preventing any shifts to occur.
- TMS disconnected or stuck: This would prevent the target from making any JTAG state changes.
- TCK disconnected or stuck: This would prevent any state changes or clocking of data.
- TDI disconnected or stuck: This would prevent the test pattern data from getting into the target.
- TDO disconnected or stuck: This would prevent the test pattern data from getting out of the target.

If the test fails, then it is possible that there is a physical connection problem with the JTAG pins, or the JTAG frequency is too high.

5.4.4 Arbitrary TAP state move test

The arbitrary TAP state move test tries to exercise the TMS pin more rigorously than the other tests.

Usually, there is a little bit of TMS activity at the beginning and end of every test, but this test keeps it toggling frequently during the entire test. If other tests are passing and this test is failing, then it might be due to a signal integrity problem on the TMS pin.

Errors may occur at the first TAP state move operation (*Error performing first TAP state move*) or at the second TAP state move operation (*Error performing second TAP state move*), or the IR scan operation may fail after performing the state move operations (*Error on IR scan after state moves*).

5.4.5 Reading JTAG IDCODEs test

This test scans all JTAG IDCODEs on the JTAG chain and displays the detected JTAG IDCODEs.

If the test fails, then an error, *Failed to scan the JTAG IDCODEs on the chain*, is displayed.

The method used to scan the IDCODEs depends on a feature that is recommended by the JTAG standard, but is not mandatory. It works on most parts, but not on all parts. If the JTAG chain has a part (provided by Freescale or third party) that does not implement the recommended behavior, then the test results might be wrong and misleading, and confirming the successful completion of the test will be difficult.

5.5 Editing remote system configuration

The remote system configuration model defines the connection and system configurations where you can define a single system configuration that can be referred to by multiple connection configurations.

To edit the system configuration, perform these steps:

1. Select **Run > Debug Configurations**.

The **Debug Configurations** dialog appears.

2. In the **Connection** panel, click **Edit** next to the **Connection** drop-down list.

The **Properties for <connection launch configuration>** window appears.

3. Click **Edit** next to the **Target** drop-down list.

The **Properties for <system launch configuration>** window appears.

4. Select the appropriate system type from the **Target type** drop-down list.
5. Make the respective settings in [Initialization tab](#) on page 153, [Memory tab](#) on page 154 and [Advanced tab](#) on page 155.
6. Click **OK** to save the settings.
7. Click **OK** to close the **Properties** window.

In this section:

- [Initialization tab](#) on page 153
- [Memory tab](#) on page 154
- [Advanced tab](#) on page 155

5.5.1 Initialization tab

Use the Initialization tab to specify target initialization file for various cores.

Figure 32: USB TAP connection type - Initialization tab

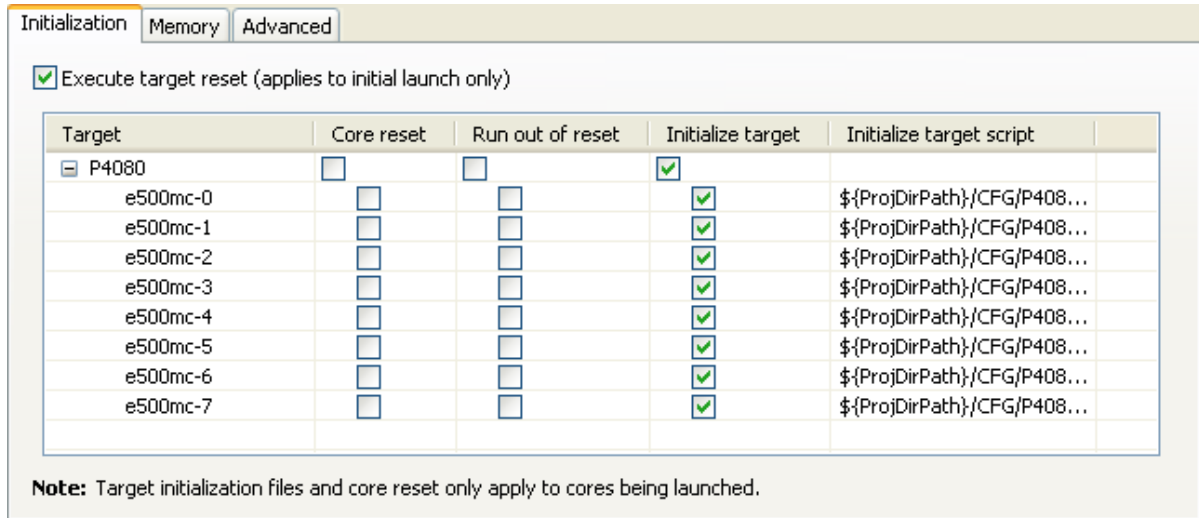

The table below lists the various options available on the **Initialization** page.

Table 94: Initialization tab options

Option	Description
Execute Target reset	Select to execute target system reset.
Core reset	Select to include the respective core for core reset operation.
Run out of reset	Select to include the respective core for run out of reset operation.
Initialize target	Click to specify a target initialization file for the respective core.
Initialize target script	Lists the path to a Debugger Shell Tcl script that runs when launching a debug session for the respective core. To edit, select a cell, then click the ellipsis (...) button to open the Target InitializationFile dialog. The settings for a group of cores can be changed all at once by editing the cell of a common ancestor node in the Target hierarchy.

5.5.2 Memory tab

Use the Memory tab to specify memory configuration file for various cores.

Figure 33: USB TAP connection type - Memory tab

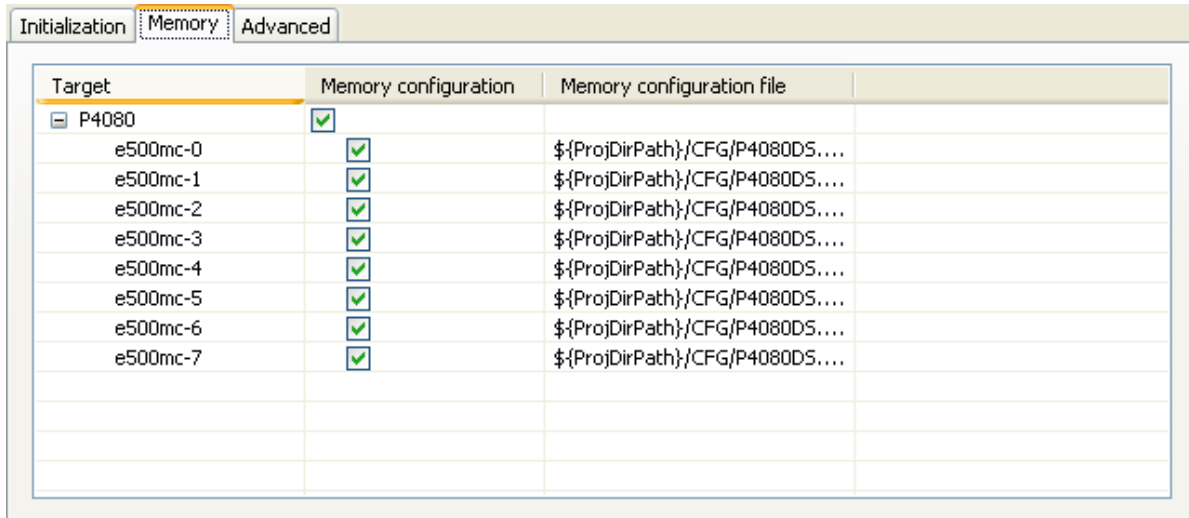
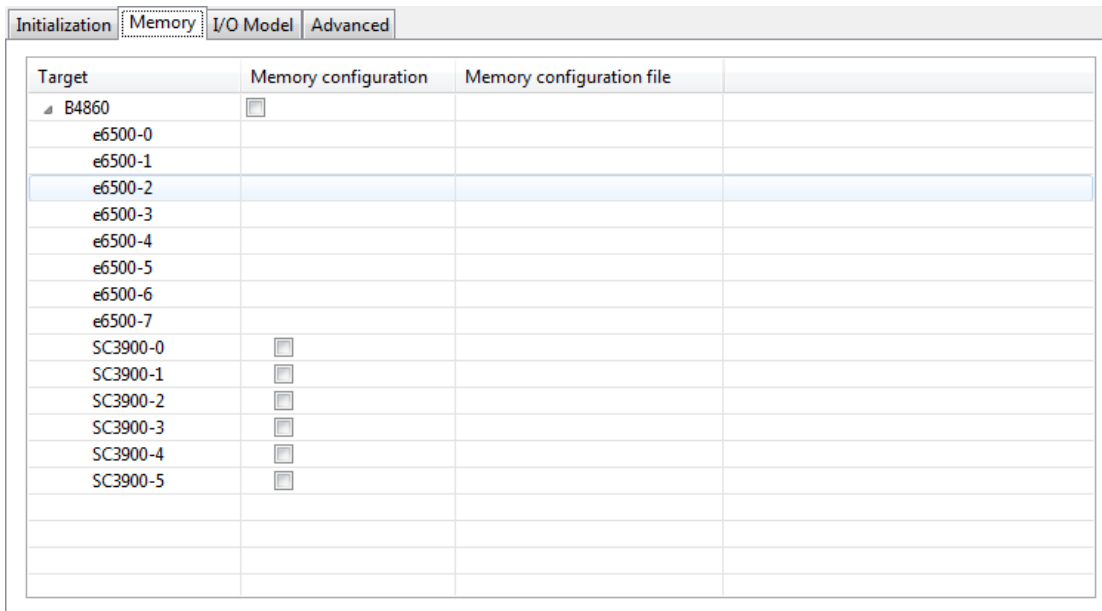

Figure 34: Memory tab



The table below lists the various options available on the **Memory** page.

Table 95: Memory tab options

Option	Description
Target	Lists the targets and the supported cores.
Memory configuration	Select to specify a memory configuration file for the respective core.

Table continues on the next page...

Table 95: Memory tab options (continued)

Option	Description
Memory configuration file	Lists the path to the memory configuration file for the respective core. To edit, select a cell, then click the ellipsis button to open the Memory Configuration File dialog. The settings for a group of cores can be changed all at once by editing the cell of a common ancestor node in the Target hierarchy.

5.5.3 Advanced tab

Use the **Advanced** tab to specify that Palladium is used to emulate the target.

Figure 35: USB TAP connection type - Advanced tab

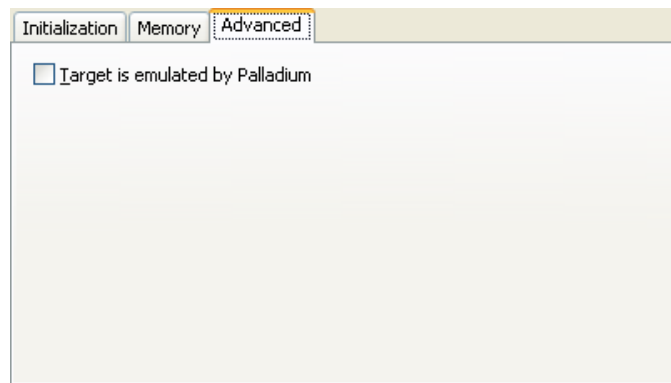

5.6 Memory translations

This section tells how to inform the CodeWarrior debugger about the Memory Management Unit (MMU) translations.

When debugging a Linux kernel, the debugger is automatically aware of the memory translations.

When debugging a bareboard system, there are two mutually exclusive ways of informing the debugger about memory translations:

- A memory configuration file containing `translate` directives can be used to instruct the debugger about memory translations. These translations are considered to be static for the duration of the debug session.
- The debugger can actively monitor the target MMU and read the currently active translations. This MMU awareness feature is activated only if there are no `translate` directives defined in the memory configuration file (or no such file is specified).

NOTE

The MMU awareness for bareboard is supported only for processors based on e500v2, e500mc, e5500, and e6500 cores.

Choose one of the two alternatives based on processor support (see Note above), the type of application being debugged (whether the translations are static or can change dynamically at runtime), and performance (note that constantly reading the MMU from the target can have a certain performance penalty on the debugger operation).

NOTE

Stationary projects in CodeWarrior are pre-configured to use a memory configuration file. To enable the debugger MMU awareness, you need to remove the `translate` directives from the memory configuration file for processors that support this feature (e500v2, e500mc, e5500, and e6500 cores).

36-Bit Physical Address Support

In general, a 32-bit processor core (including e500v2 and e500mc) has virtual memory support for 2^{32} bytes of effective address space and real memory support for 2^{36} bytes of physical address space. Therefore, only the physical address space is 36-bit wide; whereas the effective address space remains 32-bit wide.

The processor executes in the effective address space. Therefore, to have the processor use the entire 36-bit physical address space, you need to configure the MMU to translate 32-bit effective addresses to 36-bit real addresses.

When debugging a bareboard system, you can either use a memory configuration file to instruct the debugger about non 1:1 MMU translations, or let the debugger read the MMU translations automatically from the target.

TIP

A memory configuration file must not be related directly/only to the 36-bit addressing features.

For more information on memory configuration files, see the [Memory Configuration Files](#) on page 355 chapter.

5.7 CodeWarrior Command-Line Debugger

CodeWarrior supports a command-line interface that you can use to interact with CodeWarrior debugger, by issuing commands.

You can use the command-line interface together with various scripting engines, such as the Microsoft® Visual Basic® script engine, the Java™ script engine, TCL, Python, and Perl. You can even issue a command that saves your command-line activity to a log file.

You use the **Debugger Shell** view to issue command lines to the IDE. For example, you enter the command `debug` in this window to start a debugging session. The window displays the standard output and standard error streams of command-line activity.

To open the **Debugger Shell** view, follow these steps:

1. Switch the IDE to the **Debug** perspective and start a debugging session.
2. Select **Window > Show View > Other**.
The **Show View** dialog appears.
3. Expand the **Debug** group.
4. Select **Debugger Shell**.
5. Click **OK**.

The **Debugger Shell** view appears in the view stack at the bottom of the IDE.

To issue a command-line command, type the desired command at the command prompt (`%>`) in the **Debugger Shell** view, then press **Enter** or **Return**. The command-line debugger executes the specified command.

NOTE

To display a list of the commands the command-line debugger supports, type `help` at the command prompt and press **Enter**. The `help` command lists each supported command along with a brief description of each command.

Figure 36: Debugger Shell View

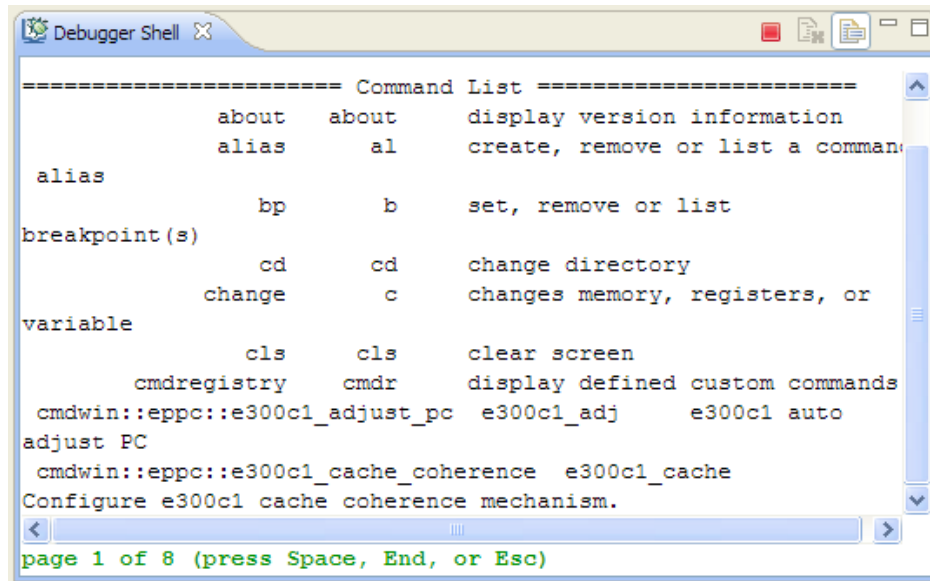

If you work with hardware as part of your project, you can use the command-line debugger to issue commands to the debugger while the hardware is running.

TIP

To view page-wise listing of the debugger shell commands, right-click in the **Debugger Shell** view and select **Paging** from the context menu. Alternatively, click the **Enable**

Paging icon  from the view toolbar.

The table below lists the instructions for common command-line debugging tasks.

Table 96: Common Command-Line Debugging Tasks

Task	Instruction	Comments
Open the Debugger Shell view	Select Windows > Show View > Other > Debugger Shell	The Debugger Shell view appears.
Use the help command	<ol style="list-style-type: none"> On the Debugger shell command prompt (%>), type <code>help</code>. Press Enter key. 	The command list for CodeWarrior appears.

Table continues on the next page...

Table 96: Common Command-Line Debugging Tasks (continued)

Task	Instruction	Comments
Enter a command.	<ol style="list-style-type: none"> 1. On the Debugger shell, type a command followed by a space. 2. Type any valid command-line options, separating each with a space. 3. Press Enter key. 	You can use shortcuts instead of complete command names, such as <code>k</code> for <code>kill</code> .
View debug command hints.	Type alias followed by a space.	The syntax for the rest of the command appears.
Review previous commands.	Press Up Arrow and Down Arrow keys.	
Clear command from the command line.	Press the Esc key.	
Stop an executing script.	Press the Esc key.	
Toggle between insert/overwrite mode.	Press the Insert key.	
Scroll up/ down a page.	Press Page Up or Page Down key.	
Scroll left/right one column.	Press Ctrl+Left Arrow or Ctrl+Right Arrow keys.	
Scroll to beginning or end of buffer.	Press Ctrl+Home or Ctrl+End keys.	

5.8 Working with Breakpoints

A breakpoint is set on an executable line of a program; if the breakpoint is enabled when you debug, the execution suspends before that line of code executes.

The different breakpoint types that you can set are listed below:

- **Software breakpoints:** The debugger sets a software breakpoint into target memory. When program execution reaches the breakpoint, the processor stops and activates the debugger. The breakpoint remains in the target memory until the user removes it.

The breakpoint can only be set in writable memory, such as SRAM or DDR. You cannot use this type of breakpoints in ROM.

- **Hardware breakpoints:** Selecting the Hardware menu option causes the debugger to use the internal processor breakpoints. These breakpoints are usually very few and can be used with all types of memories (ROM/RAM) because they are implemented by using processor registers.

TIP

You can also set breakpoint types by issuing the `bp` command in the **Debugger Shell** view.

In this section:

- [Setting Breakpoints](#) on page 159
- [Setting Hardware Breakpoints](#) on page 161
- [Removing Breakpoints](#) on page 161
- [Removing Hardware Breakpoints](#) on page 162

5.8.1 Setting Breakpoints

This section explains how to set breakpoints within a program in CodeWarrior IDE.

To set a breakpoint, perform the following steps:

1. Switch to the **Debug** perspective in CodeWarrior IDE.
2. Open the **Debug** view if it is not already open by selecting **Window > Show View > Debug**.

The **Debug** view appears, shown in the figure below.

Figure 37: Debug View

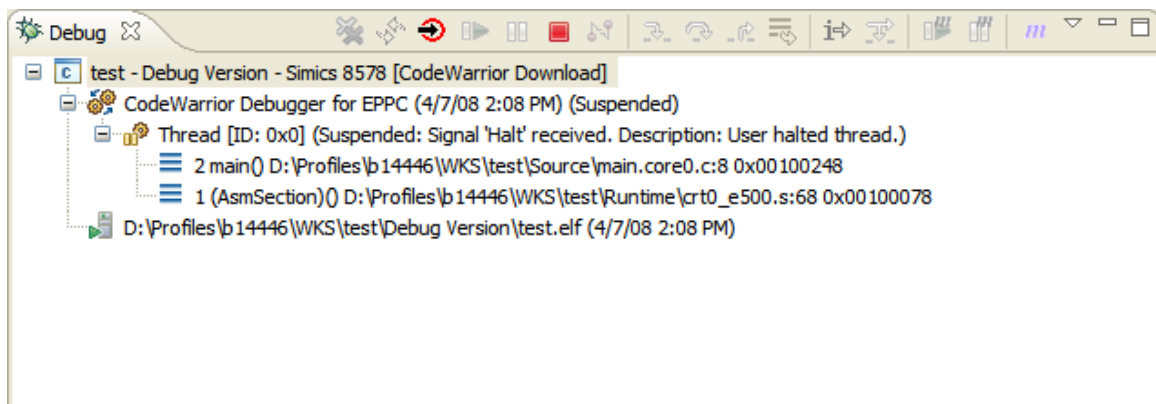

3. Expand the **Thread** group.
4. Under the **Thread** group, select the thread that has the `main()` function.

The source code appears in the Editor view (shown in the figure below). The small blue arrow to the left of the source code indicates which code statement the processor's program counter is set to execute next.

Figure 38: Editor View

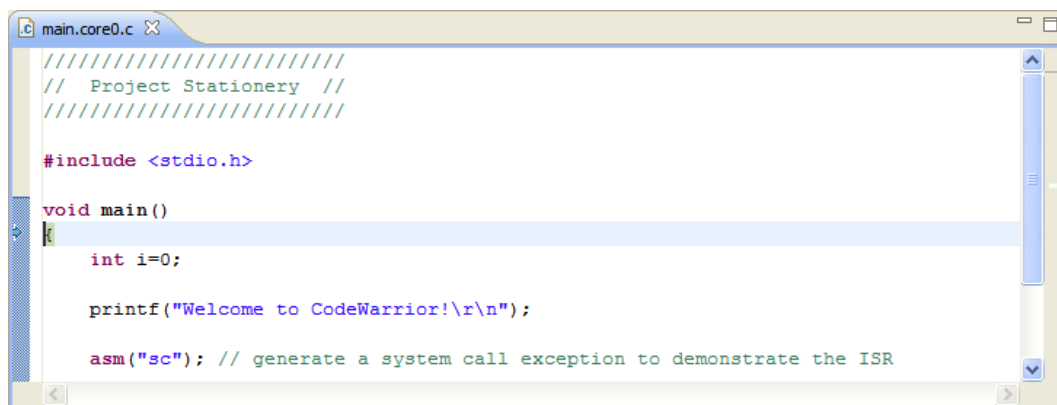

5. In the Editor view, place the cursor on the line that has this statement: `printf("Welcome to CodeWarrior!\r\n");`
6. Select **Run > Toggle Line Breakpoint**.

A blue dot appears in the marker bar to the left of the line (shown in the figure below). This dot indicates an enabled breakpoint. After the debugger installs the breakpoint, a blue checkmark appears beside the dot. The debugger installs a breakpoint by loading into the Java™ virtual machine the code in which you set that breakpoint.

TIP

An alternate way to set a breakpoint is to double-click the marker bar to the left of any source-code line. If you set the breakpoint on a line that does not have an executable statement, the debugger moves the breakpoint to the closest subsequent line that has an executable statement. The marker bar shows the installed breakpoint location. If you want to set a hardware breakpoint instead of a software breakpoint, use the `bp` command in the Debugger Shell view. You can also right-click on the marker bar to the left of any source-code line, and select Set Special Breakpoint from the context menu that appears.

Figure 39: Editor View - After Setting Breakpoints

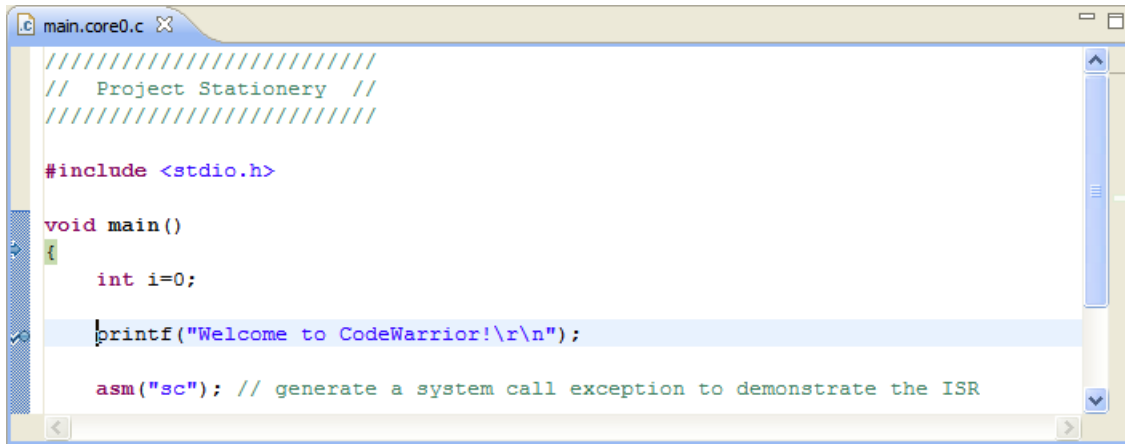

- 7. From the menu bar, select **Run > Resume**.

The debugger executes all lines up to, but not including, the line at which you set the breakpoint. The editor view highlights the line at which the debugger suspended execution (shown in the figure below). Note also that the program counter (blue arrow) is positioned here.

Figure 40: Editor View - After Reaching a Breakpoint

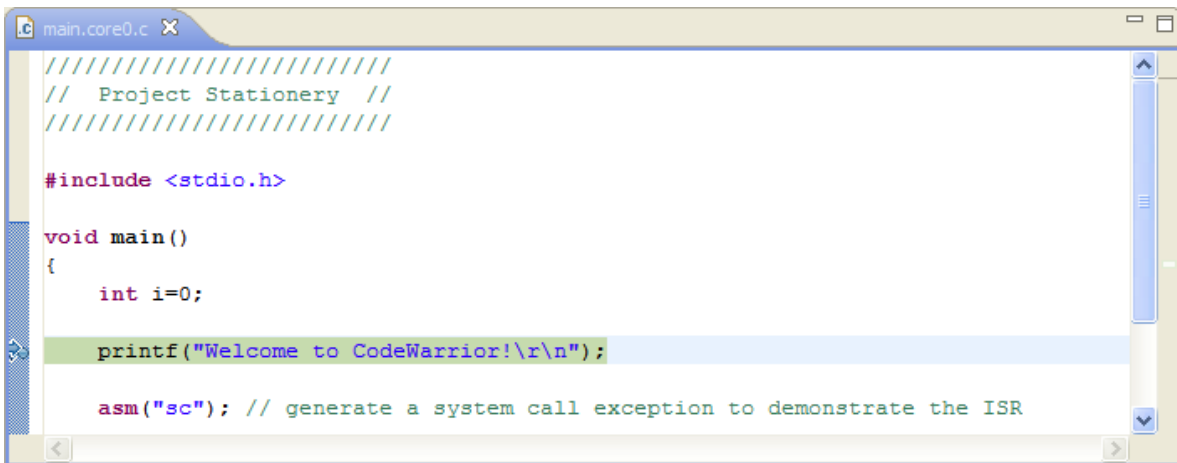

5.8.2 Setting Hardware Breakpoints

This section explains how to set hardware breakpoints within a program in CodeWarrior IDE.

There are two ways to set hardware breakpoints:

- [Using IDE to Set Hardware Breakpoints](#) on page 161
- [Using Debugger Shell to Set Hardware Breakpoints](#) on page 161

5.8.2.1 Using IDE to Set Hardware Breakpoints

This section provides the steps to set a hardware breakpoint using the CodeWarrior IDE.

Follow these steps:

1. In the CodeWarrior IDE, select **Run > Breakpoint Types > C/C++ Hardware Breakpoints**.
2. In the Editor view, click in the source line where you want to place the breakpoint.
3. Select **Run > Toggle Breakpoint**.

A hardware breakpoint appears in the marker bar on the left side of the source line.

5.8.2.2 Using Debugger Shell to Set Hardware Breakpoints

This section provides the steps to set a hardware breakpoint using the **Debugger Shell** view.

Follow these steps:

1. Open the **Debugger Shell** view.
2. Begin the command line with the text:

```
bp -hw
```

3. Complete the command line by specifying the function, address, or file at which you want to set the hardware breakpoint.

For example, to set a breakpoint for line 6 in your program, type:

```
bp -hw 6
```

4. Press the Enter key.

The debugger shell executes the command and sets the hardware breakpoint.

TIP

Enter help bp at the command-line prompt to see examples of the bp command syntax and usage.

5.8.3 Removing Breakpoints

This section explains how to remove breakpoints from a program in CodeWarrior IDE.

To remove a breakpoint from your program, you have two options:

- [Remove Breakpoints using Marker Bar](#) on page 161
- [Remove Breakpoints using Breakpoints View](#) on page 162

5.8.3.1 Remove Breakpoints using Marker Bar

This section provides the steps to remove an existing breakpoint using the marker bar.

Follow these steps:

1. Right-click the breakpoint in the marker bar.
2. Select **Toggle Breakpoint** from the menu that appears.

5.8.3.2 Remove Breakpoints using Breakpoints View

This section provides the steps to remove an existing breakpoint using the **Breakpoints** view.

Follow these steps:

1. Open the **Breakpoints** view if it is not already open by selecting **Window > Show View > Breakpoints**.
The **Breakpoints** view appears, displaying a list of breakpoints.
2. Right-click on the breakpoint you wish to remove and select **Remove** from the menu that appears.
The selected breakpoint is removed, and it disappears from the both the marker bar and the list in the view.

NOTE

To remove all of the breakpoints from the program at once, select **Remove All** from the menu.

5.8.4 Removing Hardware Breakpoints

This section explains how to remove hardware breakpoints from a program in CodeWarrior IDE.

There are two ways to remove existing hardware breakpoints:

- [Remove Hardware Breakpoints using the IDE](#) on page 162
- [Remove Hardware Breakpoints using Debugger Shell](#) on page 162

5.8.4.1 Remove Hardware Breakpoints using the IDE

This section explains how to remove a hardware breakpoint using the CodeWarrior IDE.

To remove a hardware breakpoint, follow these steps:

1. Right-click on the existing breakpoint in the marker bar.
2. Select **Toggle Breakpoint** from the menu that appears.

Alternatively, you can remove the breakpoint from the **Breakpoints** view, using the following steps:

1. Open the **Breakpoints** view if it is not already open by choosing **Window > Show View > Breakpoints**.
The **Breakpoints** view appears, displaying a list of breakpoints.
2. Right-click on the hardware breakpoint you wish to remove and select **Remove** from the menu that appears.

The selected breakpoint is removed, and it disappears from the both the marker bar and the list in the view.

5.8.4.2 Remove Hardware Breakpoints using Debugger Shell

This section explains how to remove a hardware breakpoint using the **Debugger Shell** view.

Follow these steps:

1. Open the debugger shell.
2. Begin the command line with the text:

```
bp -hw
```

3. Complete the command line by specifying the function, address, or file at which you want to remove the hardware breakpoint.

For example, to remove a breakpoint at line 6 in your program, type:

```
bp -hw 6 off
```

4. Press the **Enter** key.

The debugger shell executes the command and removes the hardware breakpoint.

5.9 Working with Watchpoints

A watchpoint is another name for a data breakpoint that you can set on an address or a range of addresses in the memory.

The debugger halts execution each time the watchpoint location is read, written, or accessed (read or written). You can set a watchpoint using the **Add Watchpoint** dialog. To open the **Add Watchpoint** dialog, use one of the following views:

- **Breakpoints** view
- **Memory** view
- **Variables** view

The debugger handles both watchpoints and breakpoints in similar manners. You can use the **Breakpoints** view to manage both watchpoints and breakpoints. It means, you can use the **Breakpoints** view to add, remove, enable, and disable both watchpoints and breakpoints. The debugger attempts to set the watchpoint if a session is in progress based on the active debugging context (the active context is the selected project in the **Debug** view).

If the debugger sets the watchpoint when no debugging session is in progress, or when re-starting a debugging session, the debugger attempts to set the watchpoint at startup as it does for breakpoints. The **Problems** view displays error messages when the debugger fails to set a watchpoint. For example, if you set watchpoints on overlapping memory ranges, or if a watchpoint falls out of execution scope, an error message appears in the Problems view. You can use this view to see additional information about the error.

The following sections explain how to set or remove watchpoints:

- [Setting Watchpoints](#) on page 163
- [Removing Watchpoints](#) on page 165

5.9.1 Setting Watchpoints

This section provides the steps to set a watchpoint for a memory range.

You can create a watchpoint for a memory range using the **Add Watchpoint** dialog. You can specify these parameters for a watchpoint:

- An address (including memory space)
- An expression that evaluates to an address
- A memory range
- An access type on which to trigger

To open the **Add Watchpoint** dialog, follow these steps:

1. Open the **Debug** perspective.

2. Click one of these tabs:

- **Breakpoints**
- **Memory**
- **Variables**

The corresponding view appears.

3. Right-click the appropriate content inside the view as mentioned in the table below.

Table 97: Opening the Add Watchpoint dialog

In the View...	Right-Click...
Breakpoints	An empty area inside the view.
Memory	The cell or range of cells on which you want to set the watchpoint.
Variables	A global variable.

NOTE

The debugger does not support setting a watchpoint on a stack variable or a register variable.

4. Select **Add Watchpoint (C/C++)** from the context menu that appears.

The **Add Watchpoint** dialog appears (shown in the figure below). The debugger sets the watchpoint according to the settings that you specify in the **Add Watchpoint** dialog. The **Breakpoints** view shows information about the newly set watchpoint. The **Problems** view shows error messages when the debugger fails to set the watchpoint.

Figure 41: Add Watchpoint Dialog Box

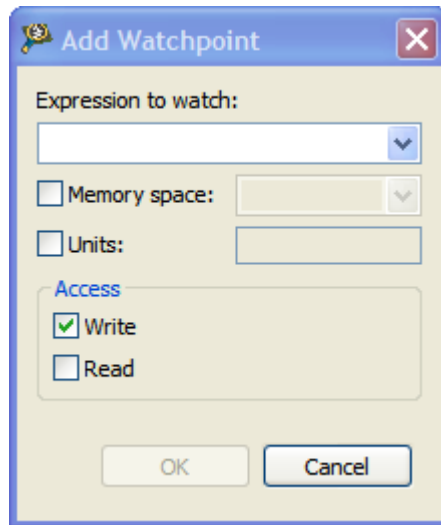

The table below describes the options available in the **Add Watchpoint** dialog.

Table 98: Add Watchpoint dialog options

Option	Description
Expression to watch	<p>Enter an expression that evaluates to an address on the target device. When the specified expression evaluates to an invalid address, the debugger halts execution and displays an error message. You can enter these types of expressions:</p> <ul style="list-style-type: none"> • An r-value, such as <code>&variable</code> • A register-based expression. Use the <code>\$</code> character to denote register names. For example, enter <code>\$SP-12</code> to have the debugger set a watchpoint on the stack pointer address minus 12 bytes. <p>The Add Watchpoint dialog does not support entering expressions that evaluate to registers.</p>
Memory space	<p>Select this option to specify an address, including memory space, at which to set the watchpoint. Use the text box to specify the address or address range on which to set the watchpoint. If a debugging session is not active, the text/list box is empty, but you can still type an address or address range.</p>
Units	<p>Enter the number of addressable units that the watchpoint monitors.</p>
Write	<p>Select this option to enable the watchpoint to monitor write activity on the specified memory space and address range. Deselect this option if you do not want the watchpoint to monitor write activity.</p>
Read	<p>Select this option to enable the watchpoint to monitor read activity on the specified memory space and address range. Deselect this option if you do not want the watchpoint to monitor read activity.</p>

5.9.2 Removing Watchpoints

This section provides the steps to remove a watchpoint.

Perform these steps:

1. Open the **Breakpoints** view if it is not already open by selecting **Window > Show View > Breakpoints**.

The **Breakpoints** view appears, displaying a list of watchpoints.

2. Right-click on the watchpoint you wish to remove and select **Remove** from the menu that appears.

The selected watchpoint is removed, and it disappears from the list in the **Breakpoints** view.

5.10 Working with Registers

Use the **Registers** view to display and modify the contents of the registers of the processor on your target board.

To display the **Registers** view, select **Window > Show View > Other > Debug > Registers**. The **Registers** view appears (shown in the figure below). The default state of the **Registers** view provides details on the processor's registers.

The **Registers** view displays categories of registers in a tree format. To display the contents of a particular category of registers, expand the tree element of the register category of interest. The figure below shows the **Registers** view with the **General Purpose Registers** tree element expanded.

TIP

You can also view and update registers by issuing the `reg`, `change`, and `display` commands in the **Debugger Shell** view.

Figure 42: Registers View

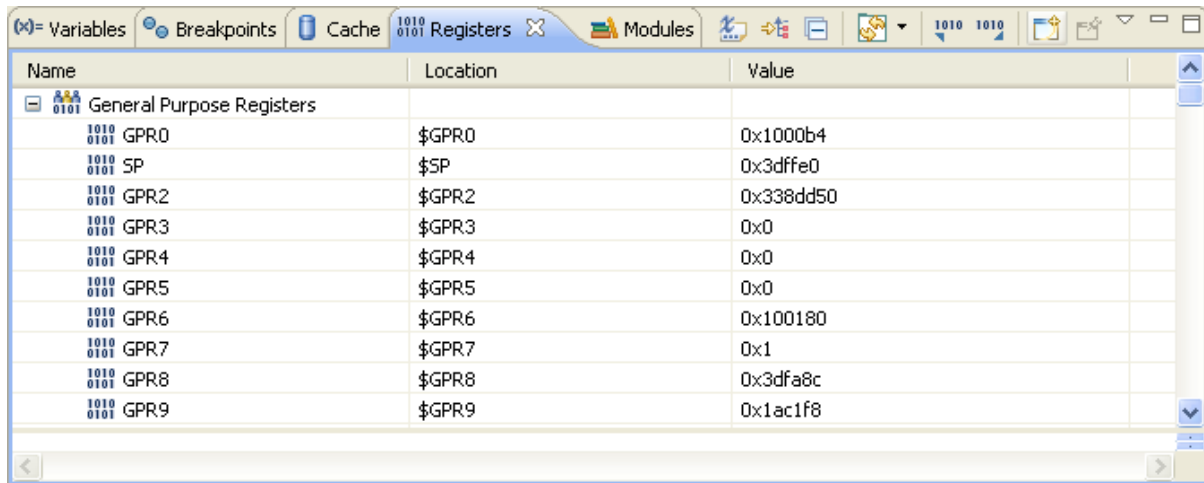

In this section:

- [Changing Bit Value of a Register](#) on page 166
- [Viewing Register Details](#) on page 167
- [Registers View Context Menu](#) on page 170
- [Working with Register Groups](#) on page 172
- [Working with TLB Registers](#) on page 173
- [Working with IMMR](#) on page 193

5.10.1 Changing Bit Value of a Register

You can change the bit value of a register in the **Registers** view.

To change a bit value in a register, first switch the IDE to the **Debug** perspective and start a debugging session. Then proceed as follows:

1. Open the **Registers** view by selecting **Window > Show View > Other > Debug > Registers**.
2. In the **Registers** view, expand the register group that contains the register with the bit value that you want to change.
3. Click the register's current bit value in the view's **Value** column.

The value becomes editable.

4. Type in the new value.
5. Press the Enter key.

The debugger updates the bit value. The bit value in the **Value** column changes to reflect your modification.

5.10.2 Viewing Register Details

This section explains how to use the **Registers** view to show the details of a register.

To open the **Registers** view, you must first start a debugging session.

To see the registers and their descriptions, follow these steps:

1. In the **Debug** perspective, click the **Registers** view tab.

The **Registers** view appears.

2. Click the **View Menu** button (the inverted triangle) on the **Registers** view toolbar.
3. Select **Layout > Vertical** or **Layout > Horizontal** to show register details.

NOTE

Selecting **Layout > Registers View Only** hides the register details.

The details of the register, selected by default in the **Registers** view, are displayed, as shown in the figure below.

Figure 43: Registers View - Register Details

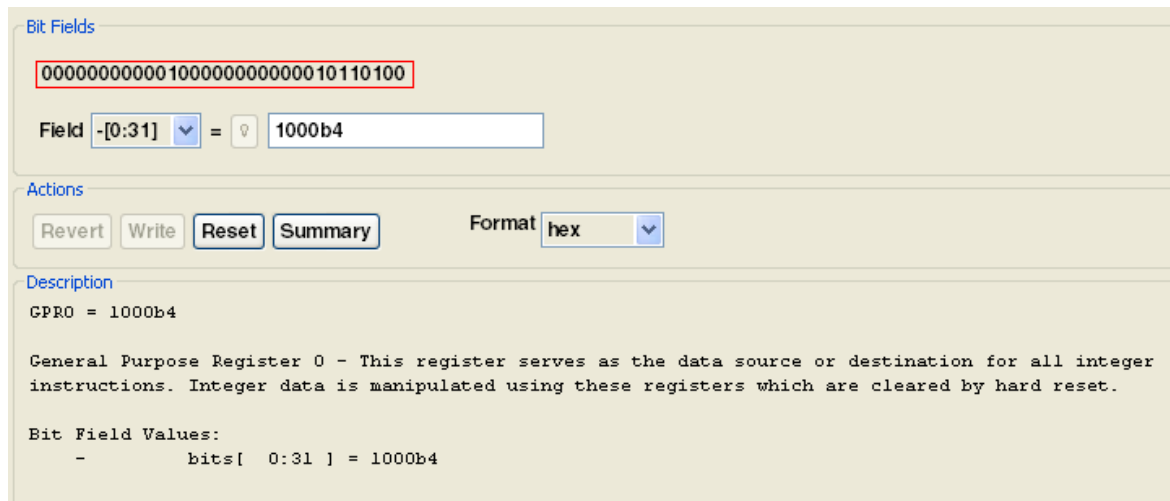

4. Expand a register group to see individual registers.
5. Select a specific register by clicking it.

The details of the selected register get displayed.

NOTE

Use the **Format** list box to change the format of data displayed for the selected register.

6. Examine register details. For example,
 - Use the **Bit Fields** group to see a graphical representation of the selected register's bit fields. You can use this graphical representation to select specific bits or bit fields.
 - Use the **Actions** group to perform operations, such as update bit field values and format the displayed register data.
 - Use the **Description** group to see an explanation of the selected register, bit field, or bit value.

TIP

To enlarge the **Registers** view, click **Maximize** on the view's toolbar. After you finish looking at the register details, click **Restore** on the view's toolbar to return the view to its previous size. Alternatively, right-click the **Registers** tab and select **Detached**. The **Registers** view becomes a floating window that you can resize. After you finish looking at the register details, right-click the **Registers** tab of the floating window and select **Detached** again. You can rearrange the re-attached view by dragging its tab to a different collection of view tabs.

In this section:

- [Bit Fields](#) on page 168
- [Changing Bit Fields](#) on page 168
- [Actions](#) on page 169
- [Description](#) on page 170

5.10.2.1 Bit Fields

The **Bit Fields** group of the **Registers** view shows a graphical representation of the selected register's bit values.

The figure below shows the **Bit Fields** group of the **Registers** view. This graphical representation shows how the register organizes bits. You can use this representation to select and change the register's bit values. Hover the cursor over each part of the graphical representation to see additional information.

Figure 44: Register Details - Bit Fields Group

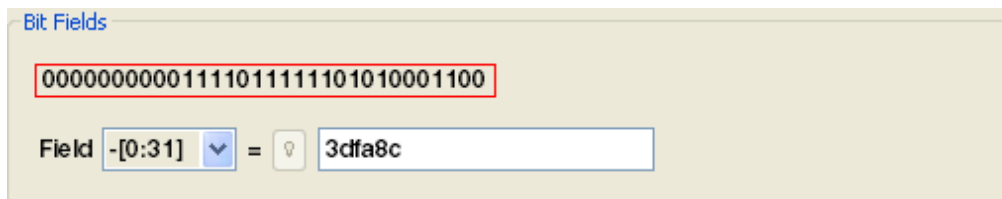

TIP

You can also view register details by issuing the `reg` command in the **Debugger Shell** view.

A bit field is either a single bit or a collection of bits within a register. Each bit field has a mnemonic name that identifies it. You can use the **Field** list box to view and select a particular bit field of the selected register. The list box shows the mnemonic name and bit-value range of each bit field. In the Bit Fields graphical representation, a box surrounds each bit field. A red box surrounds the bit field shown in the **Field** list box.

After you use the **Field** list box to select a particular bit field, you see its current value in the = text box. If you change the value shown in the text box, the **Registers** view shows the new bit field value.

5.10.2.2 Changing Bit Fields

To change a bit field in a register, you must first start a debugging session, and then open the **Registers** view.

To change a bit field, perform these steps:

1. In the **Registers** view, view register details.
2. Expand the register group that contains the bit field you want to change.
Register details appear in the **Registers** view (shown in the figure below).

Figure 45: Registers View - Register Details

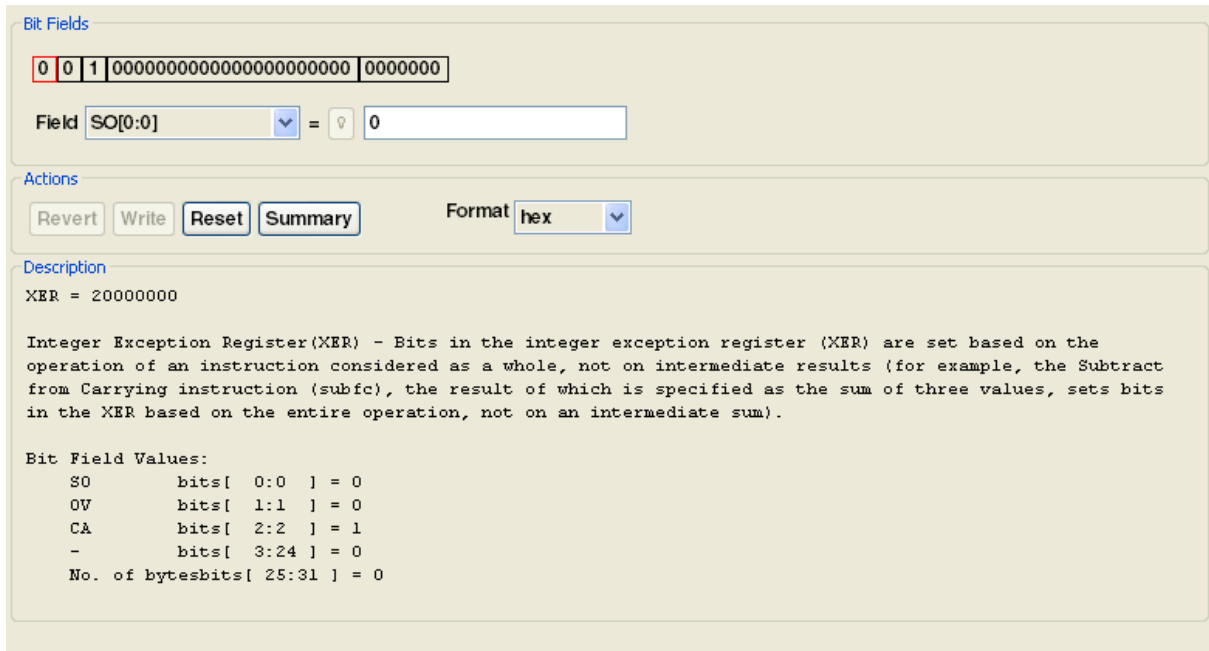

- From the expanded register group above the register details, select the name of the register that contains the bit field that you want to change.

The **Bit Fields** group displays a graphical representation of the selected bit field. The **Description** group displays explanatory information about the selected bit field and parent register.

- In the **Bit Fields** group, click the bit field that you want to change. Alternatively, use the **Field** list box to specify the bit field that you want to change.
- In the = text box, type the new value that you want to assign to the bit field.
- In the **Action** group, click **Write**.

The debugger updates the bit field value. The bit values in the **Value** column and the **Bit Fields** group change to reflect your modification.

NOTE

Click **Revert** to discard your changes and restore the original bit field value.

5.10.2.3 Actions

Use the **Actions** group of the **Registers** view to perform various operations on the selected register's bit field values.

The figure below shows the **Actions** group of the **Registers** view.

Figure 46: Register View - Actions Group

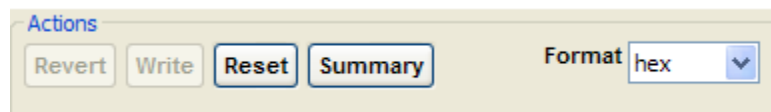

The table below lists each item in the **Actions** group and explains the purpose of each.

Table 99: Actions Group Items

Item	Description
Revert	Discard your changes to the current bit field value and restore the original value. The debugger disables this button if you have not made any changes to the bit field value.
Write	Save your changes to the current bit field value and write those changes into the register's bit field. The debugger disables this button after writing the new bit field value, or if you have not made any changes to that value.
Reset	Change each bit of the bit field value to its register-reset value. The register takes on this value after a target-device reset occurs. To confirm the bit field change, click Write. To cancel the change, click Revert .
Summary	Display Description group content in a pop-up window. Press the Esc key to close the pop-up window.
Format	Specify the data format of the displayed bit field values.

5.10.2.4 Description

The **Description** group of the **Registers** view shows explanatory information for the selected register.

The **Description** group of the **Registers** view is shown in the figure below.

Figure 47: Register View - Description Group

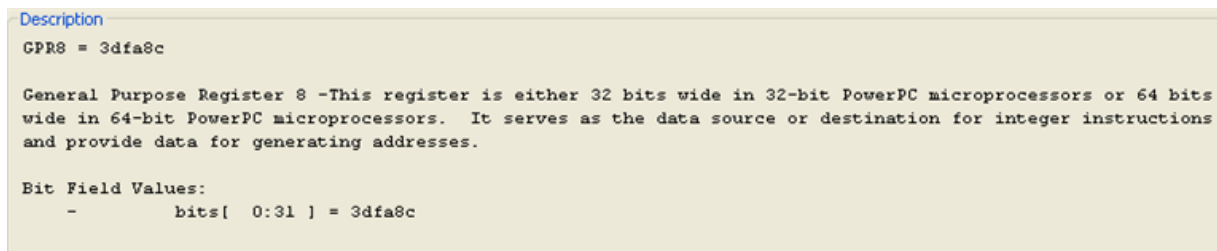

The register information covers:

- Current value
- Description
- Bit field explanations and values

Some registers have multiple modes (meaning that the register's bits can have multiple meanings, depending on the current mode). If the register you examine has multiple modes, you must select the appropriate mode.

5.10.3 Registers View Context Menu

The Registers view context menu provides you various options for working with registers.

To display the Registers view context menu, right-click a register in the **Registers** view.

The table below lists the options of the Registers view context menu.

Table 100: Registers View Context Menu Options

Option	Description
Select All	Selects the entire contents of the current register.
Copy Registers	Copies to the system clipboard the contents of the selected register.
Enable	Allows the debugger to access the selected register.
Disable	Prevents the debugger from accessing the selected register.
View Memory	Displays the corresponding memory for the selected register.
Format	Use to specify the displayed data format for the selected register: <ul style="list-style-type: none"> • Natural: Default data format • Decimal: Decimal data format • Hexadecimal: Hexadecimal data format • Binary: Binary data format • Fractional: Fractional data formats, Q0-Q31
Cast to Type	Opens a dialog that you can use to cast the selected register value to a different data type.
Restore Original Type	Reverts the selected register value to its default data type.
Find	Opens a dialog that you can use to select a particular register.
Change Value	Opens a dialog that you can use to change the current register value.
Show Details As	Allows you to specify how the debugger displays the register's contents. The options are: <ul style="list-style-type: none"> • Default Viewer: The register's contents are displayed as a hexadecimal value. • Register Details Panel: The register's values are display in a bit format, along with a description of their purpose.
Add Register Group	Opens a dialog that you can use to create a new collection of registers to display in the Registers view.
Restore Default Register Groups	Resets the custom groups of registers created using the Add Register Group option, and restores the default groups provided by the debugger as they were when CodeWarrior was installed. Note that if you select this option, all custom groupings of registers done by you are lost.
Add Watchpoint (C/C++)	Opens the Add Watchpoint dialog, proposing to set a watchpoint on an expression representing the register. The debugger sets the watchpoint according to the settings that you specify in the Add Watchpoint dialog. The Breakpoints view shows information about the newly set watchpoint. The Problems view shows error messages when the debugger fails to set the watchpoint.
Watch	Adds a new watch-expression entry to the Expressions view.

5.10.4 Working with Register Groups

This section describes different operations that can be performed on register groups.

You can perform the following operations on the register groups:

- [Adding a Register Group](#) on page 172
- [Editing a Register Group](#) on page 173
- [Removing a Register Group](#) on page 173

5.10.4.1 Adding a Register Group

You can add a custom group of registers to the default register tree structure. The default display of the **Registers** view groups the related registers into a tree structure.

To add a new register group, perform these steps:

1. Right-click in the **Registers** view.
A context menu appears.
2. Select **Add Register Group** from the context menu.

The **Register Group** dialog appears, as shown in the figure below.

Figure 48: Register Group Dialog Box

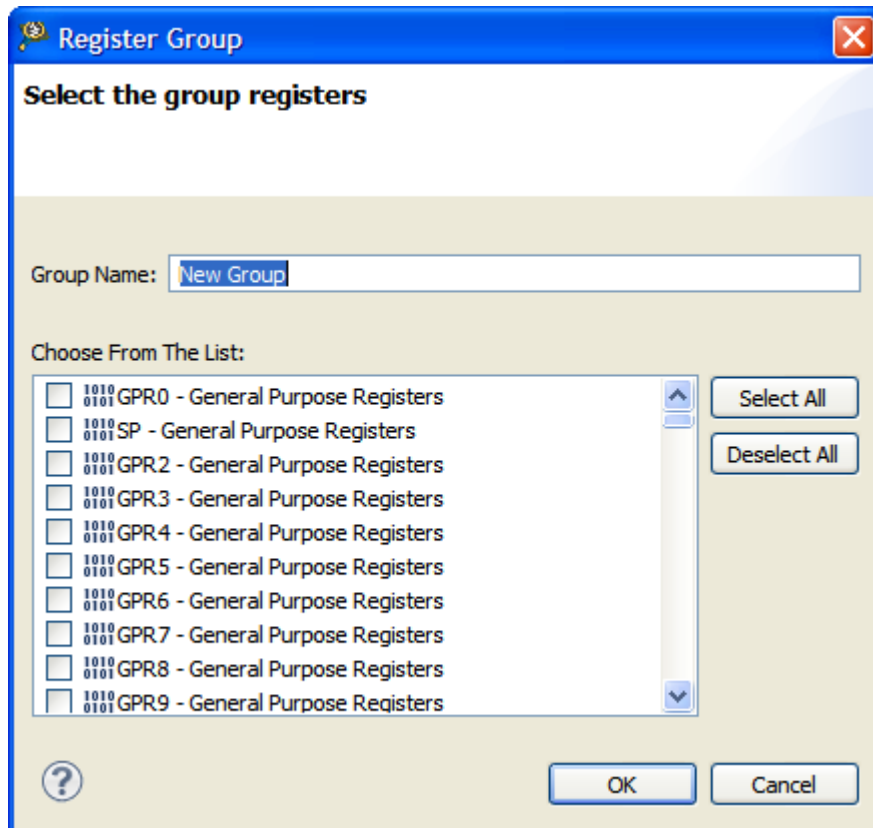

3. Enter in the **Group Name** text box a descriptive name for the new group.
4. Select the checkbox next to each register you want to appear in the new group.

TIP

Click **Select All** to check all of the checkboxes. Click **Deselect All** to clear all of the checkboxes.

5. Click **OK**.

The **Register Group** dialog closes. The new group name appears in the **Registers** view.

5.10.4.2 Editing a Register Group

In the **Registers** view, you can edit both the default register groups and the groups that you add.

To do so, use the following steps:

1. In the **Registers** view, right-click the name of the register group you want to edit.
A context menu appears.
2. Select **Edit Register Group** from the context menu.
The **Register Group** dialog appears.
3. If you wish, enter in the **Group Name** text box a new name for the group.
4. Check the checkbox next to each register you want to appear in the group.

TIP

Click **Select All** to check all of the checkboxes. Click **Deselect All** to clear all of the checkboxes.

5. Click **OK**.

The **Register Group** dialog closes. The new group name appears in the **Registers** view.

5.10.4.3 Removing a Register Group

In the **Registers** view, you can remove register groups.

To remove a register group, follow these steps:

1. In the **Registers** view, right-click the name of register group that you wish to remove.
A context menu appears.
2. Select **Remove Register Group** from the context menu.
The selected register group disappears from the **Registers** view.

5.10.5 Working with TLB Registers

This section explains how to work with translation look-aside buffer (TLB) registers.

TLB registers can be classified into the following three categories:

- TLB0: A 256-entry, 2-way (e500v1) or 512-entry, 4-way (e500v2, e500mc, e5500) or 1024-entry, 8-way (e6500) set-associative unified (for instruction and data accesses) array supporting only 4 KB pages.
- TLB1: A 16-entry (e500v1, e500v2) or 64-entry (e500mc, e5500, e6500) fully-associative unified (for instruction and data accesses) array supporting a range of variable-sized pages (VSP) page sizes.
- Real Address Translation (LRAT): An 8-element, fully associative array. LRAT registers are available only for e6500 core.

In this section:

- [Viewing TLB Registers in Registers View](#) on page 174

- [Reading TLB Registers from Debugger Shell](#) on page 175
- [Initializing TLB Registers](#) on page 177
- [TLB Register Details](#) on page 177

5.10.5.1 Viewing TLB Registers in Registers View

This section explains how to find TLB registers using the **Registers** view.

To view TLB registers in the **Registers** view, follow these steps:

1. Start the CodeWarrior IDE.
2. Open (or create) a project that targets the Power Architecture system you want to debug.
3. From the CodeWarrior IDE menu bar, select **Run > Debug**.

The IDE starts a debug session, connects to the target system, and halts the system at the program entry point.

4. Select **Window > Show View > Registers**.

The **Registers** view appears, as shown in the figure below.

Figure 49: Registers View - TLB Register Groups Displayed

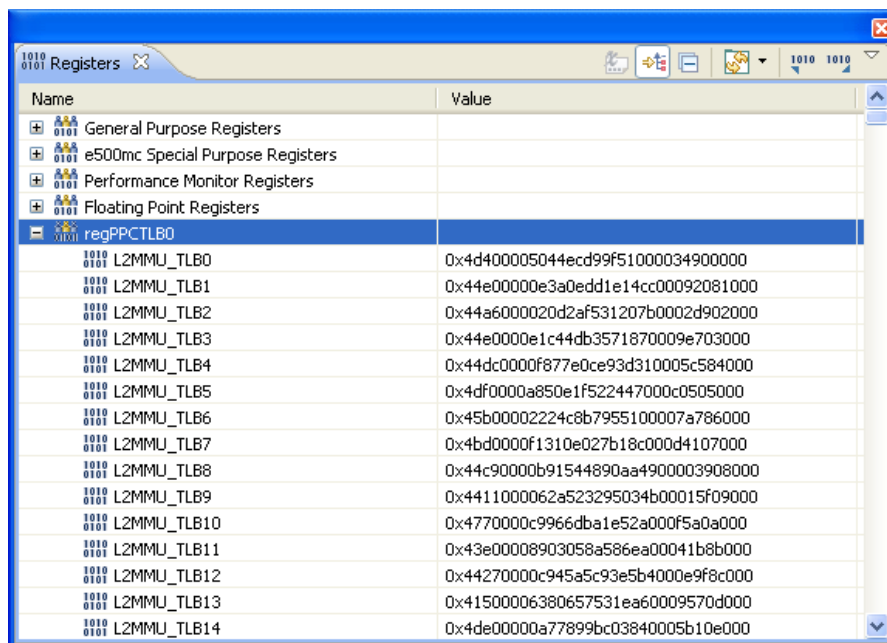

The **Registers** view shows all registers supported by the target system. The **Registers** view groups all `regPPCTLB0` registers and `regPPCTLB1` registers in the separate groups (see the figure above).

To view all of the elements of a TLB register group, double-click the group you want to view. A window appears that displays all of the elements of the selected TLB.

This window shows all of the TLB registers, and their contents. To modify TLB registers during a CodeWarrior debug session, select the TLB register you want to modify from the **Registers** view, as shown in the figure below.

Figure 50: Registers View

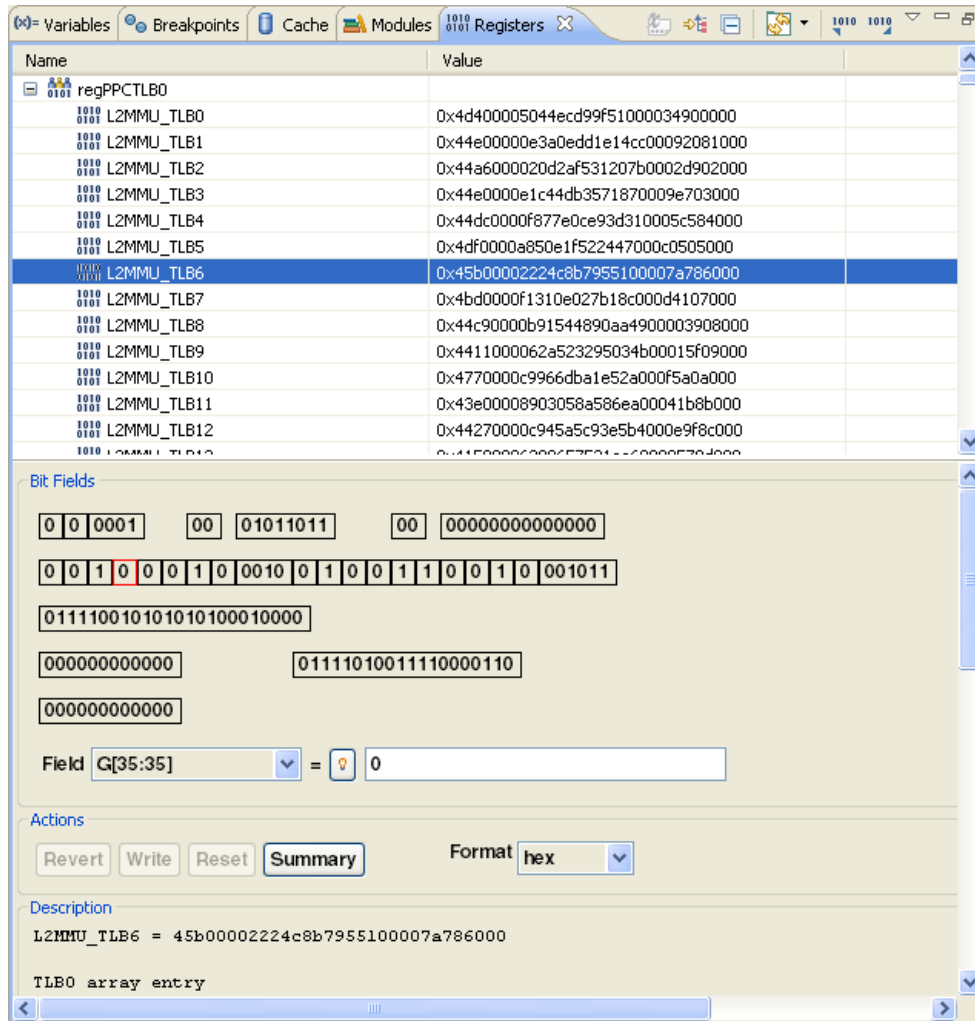

This window allows you to view register contents in different formats, and change portions of the selected register.

5.10.5.2 Reading TLB Registers from Debugger Shell

This section explains how to read TLB registers from the **Debugger Shell** view.

TLB registers are very complex, so to easily understand TLB register information, the information should be provided in a format that is easy to read and understand. The **Debugger Shell** command, `displaytlb`, extracts the meaningful information about a TLB register set and presents it in an easy to understand format. This command outputs only valid entries from the TLB register set. The `displaytlb` command is very useful when debugging a Linux kernel.

The syntax of the `displaytlb` command is as follows:

```
displaytlb [TLBSetNumber] ?[printInvalid]?
```

The command arguments are explained below:

- **TLBSetNumber**: Indicates a number representing the TLB register set that the user wants to print. Each value for this argument corresponds to one TLB register set displayed in the **Registers** view. The table below shows all the values taken by the `TLBSetNumber` argument.

Table 101: TLBSetNumber Values

TLBSetNumber Value	TLB Register Set Name
0	regPPCTLB0
1	regPPCTLB1
2	LRAT (available only for e6500 core)

- `printInvalid`: Determines whether only valid TLB register set entries will get displayed or all entries will get displayed. It is an optional argument. If no value is given to this argument, it takes the value, 0, which means only valid TLB register set entries will be displayed in the output. If a non-zero value is given to this argument, then all the TLB register set entries will get displayed in the output.

To use the `displaytlb` command, perform the following steps:

1. From the CodeWarrior IDE menu bar, select **Window > Show View > Other**.
The **Show View** dialog appears.
2. Expand the **Debug** group.
3. Select **Debugger Shell**.
4. Click **OK**.

The **Debugger Shell** view appears in the view stack at the bottom of the IDE.

5. In the **Debugger Shell** view, run the following command:

```
displaytlb 1
```

The command output is shown in the figure below.

Figure 51: Output of Running the displaytlb 1 Command for P2040DS

```
CodeWarrior Debugger Shell v1.0
%>displaytlb 1
```

ID	Effective address	Real address	SIZE	WIMGE	SRWX	URWX	TS	TID	TLPID	GS	VF	IPROT
0	0xFFFFF000-0xFFFFFFFF	0x0FFFFFF000-0x0FFFFFF000	4K	01000	111	000	0	0x0	0x0	0	0	1
1	0xFE000000-0xFEFFFFFF	0x0FE000000-0x0FEFFFFFF	16M	01010	111	000	0	0x0	0x0	0	0	1
2	0xE0000000-0xEFFFFFFF	0x0E0000000-0x0EFFFFFFF	256M	01010	111	000	0	0x0	0x0	0	0	1
3	0x80000000-0x8FFFFFFF	0x080000000-0x08FFFFFFF	1G	01010	111	000	0	0x0	0x0	0	0	1
4	0xC0000000-0xCFFFFFFF	0x0C0000000-0x0CFFFFFFF	256M	01010	111	000	0	0x0	0x0	0	0	1
5	0xD0000000-0xDFFFFFFF	0x0D0000000-0x0DFFFFFFF	256M	01010	111	000	0	0x0	0x0	0	0	1
6	0xF8000000-0xF803FFFF	0x0F8000000-0x0F803FFFF	256K	01010	111	000	0	0x0	0x0	0	0	1
7	0x00000000-0x3FFFFFFF	0x000000000-0x03FFFFFFF	1G	01000	111	000	0	0x0	0x0	0	0	1
8	0x40000000-0x7FFFFFFF	0x040000000-0x07FFFFFFF	1G	01000	111	000	0	0x0	0x0	0	0	1
9	0xF4000000-0xF40FFFFF	0x0F4000000-0x0F40FFFFF	1M	01000	111	000	0	0x0	0x0	0	0	1
10	0xF4100000-0xF41FFFFF	0x0F4100000-0x0F41FFFFF	1M	01010	111	000	0	0x0	0x0	0	0	1
11	0xF4200000-0xF42FFFFF	0x0F4200000-0x0F42FFFFF	1M	01000	111	000	0	0x0	0x0	0	0	1
12	0xF4300000-0xF43FFFFF	0x0F4300000-0x0F43FFFFF	1M	01010	111	000	0	0x0	0x0	0	0	1
13	0xF0000000-0xF03FFFFF	0x0F0000000-0x0F03FFFFF	4M	01010	111	000	0	0x0	0x0	0	0	1

5.10.5.3 Initializing TLB Registers

This section describes how to initialize TLB registers using commands.

You can use `reg`, `writereg128/writereg192` commands in the debugger initialization files to set up TLB registers at target system startup. For more details, see [writereg128](#) on page 351.

5.10.5.4 TLB Register Details

This section provides detailed information on TLB registers, categorizing the registers based on the processor core used.

This section explains the following registers:

- [e500 Registers](#) on page 178
- [e500v2 Registers](#) on page 181
- [e500mc Registers](#) on page 184
- [e5500 Registers](#) on page 187

- [e6500 Registers](#) on page 189

5.10.5.4.1 e500 Registers

This section provides information about e500 TLB0 registers, starting from L2MMU_TLB0 through L2MMU_TLB255.

Table 102: e500 TLB0 Registers (L2MMU_TLB0 through L2MMU_TLB255)

Offset Range	Field	Description																						
0 : 0	V	Valid bit for entry																						
1 : 1	TS	Translation address space (compared with AS bit of the current access)																						
2 : 5	TSIZE	<table border="0"> <tr> <td>Encoded</td> <td>Page size</td> </tr> <tr> <td>0000</td> <td>Reserved</td> </tr> <tr> <td>0001</td> <td>4 Kbyte</td> </tr> <tr> <td>0010</td> <td>16 Kbyte</td> </tr> <tr> <td>0011</td> <td>64 Kbyte</td> </tr> <tr> <td>0100</td> <td>256 Kbyte</td> </tr> <tr> <td>0101</td> <td>1 Mbyte</td> </tr> <tr> <td>0110</td> <td>4 Mbyte</td> </tr> <tr> <td>0111</td> <td>16 Mbyte</td> </tr> <tr> <td>1000</td> <td>64 Mbyte</td> </tr> <tr> <td>1001</td> <td>256 Mbyte</td> </tr> </table>	Encoded	Page size	0000	Reserved	0001	4 Kbyte	0010	16 Kbyte	0011	64 Kbyte	0100	256 Kbyte	0101	1 Mbyte	0110	4 Mbyte	0111	16 Mbyte	1000	64 Mbyte	1001	256 Mbyte
Encoded	Page size																							
0000	Reserved																							
0001	4 Kbyte																							
0010	16 Kbyte																							
0011	64 Kbyte																							
0100	256 Kbyte																							
0101	1 Mbyte																							
0110	4 Mbyte																							
0111	16 Mbyte																							
1000	64 Mbyte																							
1001	256 Mbyte																							
6 : 7	-	RESERVED																						
8 : 15	TID	Translation ID (compared with PID0, PID1, PID2 or TIDZ (all zeros))																						
16 : 17	NV	Next Victim bits used for LRU replacement algorithm.																						
18 : 31	-	RESERVED																						
32 : 36	WIMGE	Memory/cache attributes (write-through, cache-inhibit, memory coherence required, guarded, endian)																						
37 : 37	-	RESERVED																						
38 : 38	X0	Extra system attribute bits (for definition by system software)																						
39 : 39	X1	Extra system attribute bits (for definition by system software)																						
40 : 43	U0 - U3	User attribute bits, used only by software. These bits exist in the L2 MMU TLBs only (TLB1 and TLB0)																						
44 : 44	-	RESERVED																						
45 : 45	SR	Supervisor read permission bit																						
46 : 46	SW	Supervisor write permission bit																						
47 : 47	SX	Supervisor execute permission bit																						
48 : 48	UR	User read permission bit																						

Table continues on the next page...

Table 102: e500 TLB0 Registers (L2MMU_TLB0 through L2MMU_TLB255) (continued)

Offset Range	Field	Description
49 : 49	UW	User write permission bit
50 : 50	UX	User execute permission bit
51:59	-	RESERVED
60 : 63	Extended RPN	
64 : 83	RPN	Real page number
84: 95	-	RESERVED
96 : 115	EPN	Effective page number
116 : 127	-	RESERVED

The table below shows e500 TLB1 registers, starting from L2MMU_CAM0 through L2MMU_CAM15.

Table 103: e500 TLB1 Registers (L2MMU_CAM0 through L2MMU_CAM15)

Offset Range	Field	Description																						
0 : 3	TSIZE	<table border="0"> <tr> <td>Encoded</td> <td>Page size</td> </tr> <tr> <td>0000</td> <td>Reserved</td> </tr> <tr> <td>0001</td> <td>4 Kbyte</td> </tr> <tr> <td>0010</td> <td>16 Kbyte</td> </tr> <tr> <td>0011</td> <td>64 Kbyte</td> </tr> <tr> <td>0100</td> <td>256 Kbyte</td> </tr> <tr> <td>0101</td> <td>1 Mbyte</td> </tr> <tr> <td>0110</td> <td>4 Mbyte</td> </tr> <tr> <td>0111</td> <td>16 Mbyte</td> </tr> <tr> <td>1000</td> <td>64 Mbyte</td> </tr> <tr> <td>1001</td> <td>256 Mbyte</td> </tr> </table>	Encoded	Page size	0000	Reserved	0001	4 Kbyte	0010	16 Kbyte	0011	64 Kbyte	0100	256 Kbyte	0101	1 Mbyte	0110	4 Mbyte	0111	16 Mbyte	1000	64 Mbyte	1001	256 Mbyte
Encoded	Page size																							
0000	Reserved																							
0001	4 Kbyte																							
0010	16 Kbyte																							
0011	64 Kbyte																							
0100	256 Kbyte																							
0101	1 Mbyte																							
0110	4 Mbyte																							
0111	16 Mbyte																							
1000	64 Mbyte																							
1001	256 Mbyte																							
4 : 4	TS	Translation address space (compared with AS bit of the current access)																						
5 : 7	-	RESERVED																						
8 : 15	TID	Translation ID (compared with PID0, PID1, PID2 or TIDZ (all zeros))																						

Table continues on the next page...

Table 103: e500 TLB1 Registers (L2MMU_CAM0 through L2MMU_CAM15) (continued)

Offset Range	Field	Description																				
16 : 23	MASK	<table> <tr> <td>SIZE</td> <td>MASK</td> </tr> <tr> <td>4 KB</td> <td>0x0000000000</td> </tr> <tr> <td>16 KB</td> <td>0x0000000001</td> </tr> <tr> <td>64 KB</td> <td>0x0000000011</td> </tr> <tr> <td>256 KB</td> <td>0x0000000111</td> </tr> <tr> <td>1 MB</td> <td>0x0000001111</td> </tr> <tr> <td>4 MB</td> <td>0x0000011111</td> </tr> <tr> <td>16 MB</td> <td>0x0000111111</td> </tr> <tr> <td>64 MB</td> <td>0x0001111111</td> </tr> <tr> <td>256 MB</td> <td>0x0011111111</td> </tr> </table>	SIZE	MASK	4 KB	0x0000000000	16 KB	0x0000000001	64 KB	0x0000000011	256 KB	0x0000000111	1 MB	0x0000001111	4 MB	0x0000011111	16 MB	0x0000111111	64 MB	0x0001111111	256 MB	0x0011111111
SIZE	MASK																					
4 KB	0x0000000000																					
16 KB	0x0000000001																					
64 KB	0x0000000011																					
256 KB	0x0000000111																					
1 MB	0x0000001111																					
4 MB	0x0000011111																					
16 MB	0x0000111111																					
64 MB	0x0001111111																					
256 MB	0x0011111111																					
24 : 26	-	RESERVED																				
27 : 31	WIMGE	Memory/cache attributes (write-through, cache-inhibit, memory coherence required, guarded, endian)																				
32 : 32	UR	User read permission bit																				
33 : 33	UW	User write permission bit																				
34 : 34	UX	User execute permission bit																				
35 : 35	SR	Supervisor read permission bit																				
36 : 36	SW	Supervisor write permission bit																				
37 : 37	SX	Supervisor execute permission bit																				
38 : 38	X0	Extra system attribute bits (for definition by system software)																				
39 : 39	X1	Extra system attribute bits (for definition by system software)																				
40 : 43	U0 - U3	User attribute bits, used only by software. These bits exist in the L2 MMU TLBs only (TLB1 and TLB0)																				
44 : 44	IPROT	Invalidation protection (exists in TLB1 only)																				
45 : 63	-	RESERVED																				
64 : 83	RPN	Real page number																				
84 : 95	-	RESERVED																				
96 : 115	EPN	Effective page number																				
116 : 126	-	RESERVED																				
127 : 127	V	Valid bit for entry																				

5.10.5.4.2 e500v2 Registers

This section provides information about e500v2 TLB0 registers, starting from L2MMU_TLB0 through L2MMU_TLB511.

Table 104: e500v2 TLB0 Registers (L2MMU_TLB0 through L2MMU_TLB511)

Offset Range	Field	Description																										
0 : 0	V	Valid bit for entry																										
1 : 1	TS	Translation address space (compared with AS bit of the current access)																										
2 : 5	TSIZE	<table border="0"> <tr> <td>Encoded</td> <td>Page size</td> </tr> <tr> <td>0000</td> <td>Reserved</td> </tr> <tr> <td>0001</td> <td>4 Kbyte</td> </tr> <tr> <td>0010</td> <td>16 Kbyte</td> </tr> <tr> <td>0011</td> <td>64 Kbyte</td> </tr> <tr> <td>0100</td> <td>256 Kbyte</td> </tr> <tr> <td>0101</td> <td>1 Mbyte</td> </tr> <tr> <td>0110</td> <td>4 Mbyte</td> </tr> <tr> <td>0111</td> <td>16 Mbyte</td> </tr> <tr> <td>1000</td> <td>64 Mbyte</td> </tr> <tr> <td>1001</td> <td>256 Mbyte</td> </tr> <tr> <td>1010</td> <td>1 Gbyte</td> </tr> <tr> <td>1011</td> <td>4 Gbyte</td> </tr> </table>	Encoded	Page size	0000	Reserved	0001	4 Kbyte	0010	16 Kbyte	0011	64 Kbyte	0100	256 Kbyte	0101	1 Mbyte	0110	4 Mbyte	0111	16 Mbyte	1000	64 Mbyte	1001	256 Mbyte	1010	1 Gbyte	1011	4 Gbyte
Encoded	Page size																											
0000	Reserved																											
0001	4 Kbyte																											
0010	16 Kbyte																											
0011	64 Kbyte																											
0100	256 Kbyte																											
0101	1 Mbyte																											
0110	4 Mbyte																											
0111	16 Mbyte																											
1000	64 Mbyte																											
1001	256 Mbyte																											
1010	1 Gbyte																											
1011	4 Gbyte																											
6 : 7	-	RESERVED																										
8 : 15	TID	Translation ID (compared with PID0, PID1, PID2, or TIDZ (all zeros))																										
16 : 17	NV	Next Victim bits used for LRU replacement algorithm.																										
18 : 31	-	RESERVED																										
32 : 36	WIMGE	Memory/cache attributes (write-through, cache-inhibit, memory coherence required, guarded, endian)																										
37 : 37	-	RESERVED																										
38 : 38	X0	Extra system attribute bits (for definition by system software)																										
39 : 39	X1	Extra system attribute bits (for definition by system software)																										
40 : 43	U0 - U3	User attribute bits, used only by software. These bits exist in the L2 MMU TLBs only (TLB1 and TLB0)																										
44 : 44	-	RESERVED																										
45 : 45	SR	Supervisor read permission bit																										
46 : 46	SW	Supervisor write permission bit																										
47 : 47	SX	Supervisor execute permission bit																										
<i>Table continues on the next page...</i>																												

Table 104: e500v2 TLB0 Registers (L2MMU_TLB0 through L2MMU_TLB511) (continued)

Offset Range	Field	Description
48 : 48	UR	User read permission bit
49 : 49	UW	User write permission bit
50 : 50	UX	User execute permission bit
51:59	-	RESERVED
60 : 63	Extended RPN	
64 : 83	RPN	Real page number
84: 95	-	RESERVED
96 : 115	EPN	Effective page number
116 : 127	-	RESERVED

The table below shows e500v2 TLB1 registers, starting from L2MMU_CAM0 through L2MMU_CAM15.

Table 105: e500v2 TLB1 Registers (L2MMU_CAM0 through L2MMU_CAM15)

Offset Range	Field	Description																										
0 : 3	TSIZE	<table border="0"> <tr> <td>Encoded</td> <td>Page size</td> </tr> <tr> <td>0000</td> <td>Reserved</td> </tr> <tr> <td>0001</td> <td>4 Kbyte</td> </tr> <tr> <td>0010</td> <td>16 Kbyte</td> </tr> <tr> <td>0011</td> <td>64 Kbyte</td> </tr> <tr> <td>0100</td> <td>256 Kbyte</td> </tr> <tr> <td>0101</td> <td>1 Mbyte</td> </tr> <tr> <td>0110</td> <td>4 Mbyte</td> </tr> <tr> <td>0111</td> <td>16 Mbyte</td> </tr> <tr> <td>1000</td> <td>64 Mbyte</td> </tr> <tr> <td>1001</td> <td>256 Mbyte</td> </tr> <tr> <td>1010</td> <td>1 Gbyte</td> </tr> <tr> <td>1011</td> <td>4 Gbyte</td> </tr> </table>	Encoded	Page size	0000	Reserved	0001	4 Kbyte	0010	16 Kbyte	0011	64 Kbyte	0100	256 Kbyte	0101	1 Mbyte	0110	4 Mbyte	0111	16 Mbyte	1000	64 Mbyte	1001	256 Mbyte	1010	1 Gbyte	1011	4 Gbyte
Encoded	Page size																											
0000	Reserved																											
0001	4 Kbyte																											
0010	16 Kbyte																											
0011	64 Kbyte																											
0100	256 Kbyte																											
0101	1 Mbyte																											
0110	4 Mbyte																											
0111	16 Mbyte																											
1000	64 Mbyte																											
1001	256 Mbyte																											
1010	1 Gbyte																											
1011	4 Gbyte																											
4 : 4	TS	Translation address space (compared with AS bit of the current access)																										
5 : 7	-	RESERVED																										
8 : 15	TID	Translation ID (compared with PID0, PID1, PID2 or TIDZ (all zeros))																										
<i>Table continues on the next page...</i>																												

Table 105: e500v2 TLB1 Registers (L2MMU_CAM0 through L2MMU_CAM15) (continued)

Offset Range	Field	Description																								
16 : 25	MASK	<table border="0"> <tr> <td>SIZE</td> <td>MASK</td> </tr> <tr> <td>4 KB</td> <td>0x0000000000</td> </tr> <tr> <td>16 KB</td> <td>0x0000000001</td> </tr> <tr> <td>64 KB</td> <td>0x0000000011</td> </tr> <tr> <td>256 KB</td> <td>0x0000000111</td> </tr> <tr> <td>1 MB</td> <td>0x0000001111</td> </tr> <tr> <td>4 MB</td> <td>0x0000011111</td> </tr> <tr> <td>16 MB</td> <td>0x0000111111</td> </tr> <tr> <td>64 MB</td> <td>0x0001111111</td> </tr> <tr> <td>256 MB</td> <td>0x0011111111</td> </tr> <tr> <td>1 GB</td> <td>0x0111111111</td> </tr> <tr> <td>4 GB</td> <td>0x1111111111</td> </tr> </table>	SIZE	MASK	4 KB	0x0000000000	16 KB	0x0000000001	64 KB	0x0000000011	256 KB	0x0000000111	1 MB	0x0000001111	4 MB	0x0000011111	16 MB	0x0000111111	64 MB	0x0001111111	256 MB	0x0011111111	1 GB	0x0111111111	4 GB	0x1111111111
SIZE	MASK																									
4 KB	0x0000000000																									
16 KB	0x0000000001																									
64 KB	0x0000000011																									
256 KB	0x0000000111																									
1 MB	0x0000001111																									
4 MB	0x0000011111																									
16 MB	0x0000111111																									
64 MB	0x0001111111																									
256 MB	0x0011111111																									
1 GB	0x0111111111																									
4 GB	0x1111111111																									
26 : 26	-	RESERVED																								
27 : 31	WIMGE	Memory/cache attributes (write-through, cache-inhibit, memory coherence required, guarded, endian)																								
32 : 32	UR	User read permission bit																								
33 : 33	UW	User write permission bit																								
34 : 34	UX	User execute permission bit																								
35 : 35	SR	Supervisor read permission bit																								
36 : 36	SW	Supervisor write permission bit																								
37 : 37	SX	Supervisor execute permission bit																								
38 : 38	X0	Extra system attribute bits (for definition by system software)																								
39 : 39	X1	Extra system attribute bits (for definition by system software)																								
40 : 43	U0 - U3	User attribute bits, used only by software. These bits exist in the L2 MMU TLBs only (TLB1 and TLB0)																								
44 : 44	IPROT	Invalidation protection (exists in TLB1 only)																								
45 : 59	-	RESERVED																								
60 : 63	Extended RPN																									
64 : 83	RPN	Real page number																								
84 : 95	-	RESERVED																								
96 : 115	EPN	Effective page number																								
116 : 126	-	RESERVED																								

Table continues on the next page...

Table 105: e500v2 TLB1 Registers (L2MMU_CAM0 through L2MMU_CAM15) (continued)

Offset Range	Field	Description
127 : 127	V	Valid bit for entry

5.10.5.4.3 e500mc Registers

This section provides information about e500mc TLB0 registers, starting from L2MMU_TLB0 through L2MMU_TLB511.

Table 106: e500mc TLB0 Registers (L2MMU_TLB0 through L2MMU_TLB511)

Offset Range	Field	Description
0:0	V	Valid bit for entry.
1:1	TS	Translation space. Compared with MSR[IS] (instruction fetch) or MSR[DS] (memory reference) to determine if this TLB entry may be used for translation.
2:5	TSIZE	Defines the page size of the TLB entry.
6:7	Reserved	-
8:15	TID	Translation identity. Defines the process ID for this TLB entry.
16:17	NV	Next victim. Can be used to identify the next victim to be targeted for a TLB miss replacement operation for those TLBs that support the NV field.
18:31	Reserved	-
32:32	W	Write-through
33:33	I	Caching-inhibited
34:34	M	Memory coherency required
35:35	G	Guarded
36:36	E	Endianness. Determines endianness for the corresponding page.
37:37	Reserved	-
38:38	X0	Implementation-dependent page attribute. Implemented as storage.
39:39	X1	Implementation-dependent page attribute. Implemented as storage.
40:43	U0-U3	User attribute bits. These bits are associated with a TLB entry and can be used by system software.
44:44	Reserved	-
45:45	SR	Supervisor read permission bit.
46:46	SW	Supervisor write permission bit.
47:47	SX	Supervisor execute permission bit.
48:48	UR	User read permission bit.
49:49	UW	User write permission bit.

Table continues on the next page...

Table 106: e500mc TLB0 Registers (L2MMU_TLB0 through L2MMU_TLB511) (continued)

Offset Range	Field	Description
50:50	UX	User execute permission bit.
51:51	Reserved	-
52:52	GS	Translation guest space.
53:53	VF	Virtualization fault. Controls whether a DSI occurs on data accesses to the page, regardless of permission bit settings.
54:59	LPIDR	Translation logical partition ID.
60:83	RPN	Real page number
84:95	Reserved	-
96:115	EPN	Effective page number
116:127	Reserved	-

The table below shows e500mc TLB1 registers, starting from L2MMU_CAM0 through L2MMU_CAM63.

Table 107: e500mc TLB1 Registers (L2MMU_CAM0 through L2MMU_CAM63)

Offset Range	Field	Description																								
0:3	TSIZE	Defines the page size of the TLB entry.																								
4:4	TS	Translation space. Compared with MSR[IS] (instruction fetch) or MSR[DS] (memory reference) to determine if this TLB entry may be used for translation.																								
5:7	Reserved	-																								
8:15	TID	Translation identity. Defines the process ID for this TLB entry.																								
16:25	MASK	<table border="0"> <tr> <td>SIZE</td> <td>MASK</td> </tr> <tr> <td>4 KB</td> <td>0x0000000000</td> </tr> <tr> <td>16 KB</td> <td>0x0000000001</td> </tr> <tr> <td>64 KB</td> <td>0x0000000011</td> </tr> <tr> <td>256 KB</td> <td>0x0000000111</td> </tr> <tr> <td>1 MB</td> <td>0x0000001111</td> </tr> <tr> <td>4 MB</td> <td>0x0000011111</td> </tr> <tr> <td>16 MB</td> <td>0x0000111111</td> </tr> <tr> <td>64 MB</td> <td>0x0001111111</td> </tr> <tr> <td>256 MB</td> <td>0x0011111111</td> </tr> <tr> <td>1 GB</td> <td>0x0111111111</td> </tr> <tr> <td>4 GB</td> <td>0x1111111111</td> </tr> </table>	SIZE	MASK	4 KB	0x0000000000	16 KB	0x0000000001	64 KB	0x0000000011	256 KB	0x0000000111	1 MB	0x0000001111	4 MB	0x0000011111	16 MB	0x0000111111	64 MB	0x0001111111	256 MB	0x0011111111	1 GB	0x0111111111	4 GB	0x1111111111
SIZE	MASK																									
4 KB	0x0000000000																									
16 KB	0x0000000001																									
64 KB	0x0000000011																									
256 KB	0x0000000111																									
1 MB	0x0000001111																									
4 MB	0x0000011111																									
16 MB	0x0000111111																									
64 MB	0x0001111111																									
256 MB	0x0011111111																									
1 GB	0x0111111111																									
4 GB	0x1111111111																									
26:26	Reserved	-																								

Table continues on the next page...

Table 107: e500mc TLB1 Registers (L2MMU_CAM0 through L2MMU_CAM63) (continued)

Offset Range	Field	Description
27:27	W	Write-through
28:28	I	Caching-inhibited
29:29	M	Memory coherency required
30:30	G	Guarded
31:31	E	Endianness. Determines endianness for the corresponding page.
32:32	UR	User read permission bit.
33:33	UW	User write permission bit.
34:34	UX	User execute permission bit.
35:35	SR	Supervisor read permission bit.
36:36	SW	Supervisor write permission bit.
37:37	SX	Supervisor execute permission bit.
38:38	X0	Implementation-dependent page attribute. Implemented as storage.
39:39	X1	Implementation-dependent page attribute. Implemented as storage.
40:43	U0-U3	User attribute bits. These bits are associated with a TLB entry and can be used by system software.
44:44	IPROT	Invalidate protect. Set to protect this TLB entry from invalidate operations from tlbivax, tlbilx, or MMUCSR0 TLB flash invalidates.
45:51	Reserved	-
52:52	GS	Translation guest space.
53:53	VF	Virtualization fault. Controls whether a DSI occurs on data accesses to the page, regardless of permission bit settings.
54:59	LPIDR	Translation logical partition ID.
60:83	RPN	Real page number
84:95	Reserved	-
96:115	EPN	Effective page number
116:126	Reserved	-
127:127	V	Valid bit for entry.

5.10.5.4.4 e5500 Registers

This section provides information about e5500 TLB0 registers, starting from L2MMU_TLB0 through L2MMU_TLB511.

Table 108: e5500 TLB0 Registers (L2MMU_TLB0 through L2MMU_TLB511)

Offset Range	Field	Description
0:0	V	Valid bit for entry.
1:1	TS	Translation space. Compared with MSR[IS] (instruction fetch) or MSR[DS] (memory reference) to determine if this TLB entry may be used for translation.
2:5	TSIZE	Defines the page size of the TLB entry.
6:7	Reserved	-
8:15	TID	Translation identity. Defines the process ID for this TLB entry.
16:17	NV	Next victim. Can be used to identify the next victim to be targeted for a TLB miss replacement operation for those TLBs that support the NV field.
18:31	Reserved	-
32:32	W	Write-through
33:33	I	Caching-inhibited
34:34	M	Memory coherency required
35:35	G	Guarded
36:36	E	Endianness. Determines endianness for the corresponding page.
37:37	Reserved	-
38:38	X0	Implementation-dependent page attribute. Implemented as storage.
39:39	X1	Implementation-dependent page attribute. Implemented as storage.
40:43	U0-U3	User attribute bits. These bits are associated with a TLB entry and can be used by system software.
44:44	Reserved	-
45:45	SR	Supervisor read permission bit.
46:46	SW	Supervisor write permission bit.
47:47	SX	Supervisor execute permission bit.
48:48	UR	User read permission bit.
49:49	UW	User write permission bit.
50:50	UX	User execute permission bit.
51:51	Reserved	-
52:52	GS	Translation guest space.
53:53	VF	Virtualization fault. Controls whether a DSI occurs on data accesses to the page, regardless of permission bit settings.
<i>Table continues on the next page...</i>		

Table 108: e5500 TLB0 Registers (L2MMU_TLB0 through L2MMU_TLB511) (continued)

Offset Range	Field	Description
54:59	LPIDR	Translation logical partition ID.
60:91	Reserved	-
92:115	RPN	Real page number
116:127	Reserved	-
128:179	EPN	Effective page number
180:191	Reserved	-

The table below shows e5500 TLB1 registers, starting from L2MMU_CAM0 through L2MMU_CAM63.

Table 109: e5500 TLB1 Registers (L2MMU_CAM0 through L2MMU_CAM63)

Offset Range	Field	Description																								
0:3	TSIZE	Defines the page size of the TLB entry.																								
4:4	TS	Translation space. Compared with MSR[IS] (instruction fetch) or MSR[DS] (memory reference) to determine if this TLB entry may be used for translation.																								
5:7	Reserved	-																								
8:15	TID	Translation identity. Defines the process ID for this TLB entry.																								
16:25	MASK	<table border="0"> <tr> <td>SIZE</td> <td>MASK</td> </tr> <tr> <td>4 KB</td> <td>0x0000000000</td> </tr> <tr> <td>16 KB</td> <td>0x0000000001</td> </tr> <tr> <td>64 KB</td> <td>0x0000000011</td> </tr> <tr> <td>256 KB</td> <td>0x0000000111</td> </tr> <tr> <td>1 MB</td> <td>0x0000001111</td> </tr> <tr> <td>4 MB</td> <td>0x0000011111</td> </tr> <tr> <td>16 MB</td> <td>0x0000111111</td> </tr> <tr> <td>64 MB</td> <td>0x0001111111</td> </tr> <tr> <td>256 MB</td> <td>0x0011111111</td> </tr> <tr> <td>1 GB</td> <td>0x0111111111</td> </tr> <tr> <td>4 GB</td> <td>0x1111111111</td> </tr> </table>	SIZE	MASK	4 KB	0x0000000000	16 KB	0x0000000001	64 KB	0x0000000011	256 KB	0x0000000111	1 MB	0x0000001111	4 MB	0x0000011111	16 MB	0x0000111111	64 MB	0x0001111111	256 MB	0x0011111111	1 GB	0x0111111111	4 GB	0x1111111111
SIZE	MASK																									
4 KB	0x0000000000																									
16 KB	0x0000000001																									
64 KB	0x0000000011																									
256 KB	0x0000000111																									
1 MB	0x0000001111																									
4 MB	0x0000011111																									
16 MB	0x0000111111																									
64 MB	0x0001111111																									
256 MB	0x0011111111																									
1 GB	0x0111111111																									
4 GB	0x1111111111																									
26:26	Reserved	-																								
27:27	W	Write-through																								
28:28	I	Caching-inhibited																								
29:29	M	Memory coherency required																								

Table continues on the next page...

Table 109: e5500 TLB1 Registers (L2MMU_CAM0 through L2MMU_CAM63) (continued)

Offset Range	Field	Description
30:30	G	Guarded
31:31	E	Endianness. Determines endianness for the corresponding page.
32:32	UR	User read permission bit.
33:33	UW	User write permission bit.
34:34	UX	User execute permission bit.
35:35	SR	Supervisor read permission bit.
36:36	SW	Supervisor write permission bit.
37:37	SX	Supervisor execute permission bit.
38:38	X0	Implementation-dependent page attribute. Implemented as storage.
39:39	X1	Implementation-dependent page attribute. Implemented as storage.
40:43	U0-U3	User attribute bits. These bits are associated with a TLB entry and can be used by system software.
44:44	IProt	Invalidate protect. Set to protect this TLB entry from invalidate operations from tlbivax, tlbilx, or MMUCSR0 TLB flash invalidates.
45:51	Reserved	-
52:52	GS	Translation guest space.
53:53	VF	Virtualization fault. Controls whether a DSI occurs on data accesses to the page, regardless of permission bit settings.
54:59	LPIDR	Translation logical partition ID.
60:91	Reserved	-
92:115	RPN	Real page number
116:127	Reserved	-
128:179	EPN	Effective page number
180:190	Reserved	-
191:191	V	Valid bit for entry.

5.10.5.4.5 e6500 Registers

This section provides information about e6500 TLB0 registers, starting from L2MMU_TLB0 through L2MMU_TLB1023.

Table 110: e6500 TLB0 Registers (L2MMU_TLB0 through L2MMU_TLB1023)

Offset Range	Field	Description
0:0	V	Valid bit for entry.
1:1	TS	Translation address space (compared with AS bit of the current access.)
<i>Table continues on the next page...</i>		

Table 110: e6500 TLB0 Registers (L2MMU_TLB0 through L2MMU_TLB1023) (continued)

Offset Range	Field	Description
2:6	TSIZE	Encoded page size. Only present in TLB1, however software should always set page sizes for TLB0 for future compatibility.
7:9	-	Reserved
10:23	TID	Translation ID (compared with PID)
24:26	NV	
27:31	-	Reserved
32:36	WIMGE	Memory/cache attributes (write-through, cache-inhibit, memory coherence required, guarded, endian)
37:37	-	Reserved
38:38	X0	Extra system attribute bit
39:39	X1	Extra system attribute bit
40:43	U0-U3	User attribute bits, used only by software.
44:44	-	Reserved
45:45	SR	Supervisor read permission bit
46:46	SW	Supervisor write permission bit
47:47	SX	Supervisor execute permission bit
48:48	UR	User read permission bit
49:49	UW	User write permission bit
50:50	UX	User execute permission bit
51:51	-	Reserved
52:52	GS	Translation guest space
53:53	VF	Virtualization fault
54:59	LPIDR	Translation logical partition ID
60:87	-	Reserved
88:115	RPN	Real page number
116:127	-	Reserved
128:179	EPN	Effective page number
180:191	-	Reserved

The table below shows e6500 TLB1 registers, starting from L2MMU_CAM0 through L2MMU_CAM63.

Table 111: e6500 TLB1 Registers (L2MMU_CAM0 through L2MMU_CAM63)

Offset Range	Field	Description																																																										
0:4	TSIZE	<table border="0"> <tr> <td>Encoded</td> <td>Page size</td> </tr> <tr> <td>0b00010</td> <td>4 KB</td> </tr> <tr> <td>0b00011</td> <td>8 KB</td> </tr> <tr> <td>0b00100</td> <td>16 KB</td> </tr> <tr> <td>0b00101</td> <td>32 KB</td> </tr> <tr> <td>0b00110</td> <td>64 KB</td> </tr> <tr> <td>0b00111</td> <td>128 KB</td> </tr> <tr> <td>0b01000</td> <td>256 KB</td> </tr> <tr> <td>0b01001</td> <td>512 KB</td> </tr> <tr> <td>0b01010</td> <td>1 MB</td> </tr> <tr> <td>0b01011</td> <td>2 MB</td> </tr> <tr> <td>0b01100</td> <td>4 MB</td> </tr> <tr> <td>0b01101</td> <td>8 MB</td> </tr> <tr> <td>0b01110</td> <td>16 MB</td> </tr> <tr> <td>0b01111</td> <td>32 MB</td> </tr> <tr> <td>0b10000</td> <td>64 MB</td> </tr> <tr> <td>0b10001</td> <td>128 MB</td> </tr> <tr> <td>0b10010</td> <td>256 MB</td> </tr> <tr> <td>0b10011</td> <td>512 MB</td> </tr> <tr> <td>0b10100</td> <td>1 GB</td> </tr> <tr> <td>0b10101</td> <td>2 GB</td> </tr> <tr> <td>0b10110</td> <td>4 GB</td> </tr> <tr> <td>0b10111</td> <td>8 GB</td> </tr> <tr> <td>0b11000</td> <td>16 GB</td> </tr> <tr> <td>0b11001</td> <td>32 GB</td> </tr> <tr> <td>0b11010</td> <td>64 GB</td> </tr> <tr> <td>0b11011</td> <td>128 GB</td> </tr> <tr> <td>0b11100</td> <td>256 GB</td> </tr> <tr> <td>0b11101</td> <td>512 GB</td> </tr> </table>	Encoded	Page size	0b00010	4 KB	0b00011	8 KB	0b00100	16 KB	0b00101	32 KB	0b00110	64 KB	0b00111	128 KB	0b01000	256 KB	0b01001	512 KB	0b01010	1 MB	0b01011	2 MB	0b01100	4 MB	0b01101	8 MB	0b01110	16 MB	0b01111	32 MB	0b10000	64 MB	0b10001	128 MB	0b10010	256 MB	0b10011	512 MB	0b10100	1 GB	0b10101	2 GB	0b10110	4 GB	0b10111	8 GB	0b11000	16 GB	0b11001	32 GB	0b11010	64 GB	0b11011	128 GB	0b11100	256 GB	0b11101	512 GB
Encoded	Page size																																																											
0b00010	4 KB																																																											
0b00011	8 KB																																																											
0b00100	16 KB																																																											
0b00101	32 KB																																																											
0b00110	64 KB																																																											
0b00111	128 KB																																																											
0b01000	256 KB																																																											
0b01001	512 KB																																																											
0b01010	1 MB																																																											
0b01011	2 MB																																																											
0b01100	4 MB																																																											
0b01101	8 MB																																																											
0b01110	16 MB																																																											
0b01111	32 MB																																																											
0b10000	64 MB																																																											
0b10001	128 MB																																																											
0b10010	256 MB																																																											
0b10011	512 MB																																																											
0b10100	1 GB																																																											
0b10101	2 GB																																																											
0b10110	4 GB																																																											
0b10111	8 GB																																																											
0b11000	16 GB																																																											
0b11001	32 GB																																																											
0b11010	64 GB																																																											
0b11011	128 GB																																																											
0b11100	256 GB																																																											
0b11101	512 GB																																																											
5:5	Reserved																																																											
6:6	IND	Indirect bit. When set, this TLB entry is an indirect entry used to locate a page table.																																																										
7:7	TS	Translation address space (compared with AS bit of the current access.)																																																										

Table continues on the next page...

Table 111: e6500 TLB1 Registers (L2MMU_CAM0 through L2MMU_CAM63) (continued)

Offset Range	Field	Description
8:9	Reserved	
10:23	TID	Translation ID (compared with PID)
24:26	Reserved	
27:31	WIMGE	Memory/cache attributes (write-through, cache-inhibit, memory coherence required, guarded, endian)
32:32	UR	User read permission bit
33:33	UW	User write permission bit
34:34	UX	User execute permission bit
35:35	SR	Supervisor read permission bit
36:36	SW	Supervisor write permission bit
37:37	SX	Supervisor execute permission bit
38:38	X0	Extra system attribute bit
39:39	X1	Extra system attribute bit
40:43	U0-U3	User attribute bits, used only by software.
44:44	IPROT	Invalidation protection
45:51	Reserved	
52:52	GS	Translation guest space
53:53	VF	Virtualization fault
54:59	LPIDR	Translation logical partition ID
60:87	Reserved	
88:115	RPN	Real page number (depending on page size, only the bits associated with a page boundary are valid. Bits that represent offsets within a page are ignored and should be zero)
116:127	Reserved	
128:179	EPN	Effective page number (Depending on page size, only the bits associated with a page boundary are valid. Bits that represent offsets within a page are ignored and should be zero.)
180:190	Reserved	
191:191	V	Valid bit for entry.

The table below shows e6500 LRAT registers, starting from L2MMU_LRAT0 through L2MMU_LRAT7.

Table 112: e6500 LRAT Registers (L2MMU_LRAT0 through L2MMU_LRAT7)

Offset Range	Field	Description
0:4	LSIZE	Logical page size. Describes the size of the logical page of the LRAT entry. The possible values are the same as for TSIZE field from TLB0 and TLB1.
5:25	Reserved	
26:31	LPID	Logical partition ID value. Is compared with LPIDR during translation to help select an LRAT entry.
32:55	Reserved	
56:83	LRPN	Real page number
84:119	Reserved	
120:147	LPN	Logical page number. Describes the logical address of the start of the page.
148:158	Reserved	
159:159	V	LRAT valid bit

5.10.6 Working with IMMR

This section describes internal memory map register (IMMR).

Use the **Debugger Shell**: `eppc::setMMRBaseAddr` command to define the memory location of the IMMR. This information lets the CodeWarrior debugger find the IMMR register during a debug session.

NOTE

The Change IMMR command is applicable to 825x or 826x processors.

5.11 Viewing memory

This section explains how to view memory of a target processor.

The debugger allocates multiple memory spaces in the IDE for flexible control over the memory access. The number of supported memory spaces and their properties depends upon the debugged processor.

You can display and access the supported memory spaces for a target in the **Memory** and **Memory Browser** views, in the Import/Export/Fill Memory Action Task View or in the **Debugger Shell** view using the designated memory space prefix. Use the `mem -ms` command to list the supported memory spaces for a processor.

To display the **Memory** view, select **Window > Show View > Other > Debug > Memory**. The figure below shows a **Memory** view displaying physical memory address space.

Figure 52: Memory View

Address	0 - 3	4 - 7	8 - B	C - F
0100002420	480032E1	4BFFFFBD	3BDE0001	4BFFFFFC
0100002430	9421FFE0	7C0802A6	90010024	93E1001C
0100002440	93C10018	7C7E1B78	7FE000A6	67FF0200
0100002450	0x100002430	2C1E0C00	40820020	48000051
0100002460	7C641B78	3C600000	38636EA0	4CC63182
0100002470	48003291	48000020	48000035	7C641B78
0100002480	3C600000	38636ECC	7FC5F378	4CC63182
0100002490	48003271	83E1001C	83C10018	80010024
01000024A0	7C0803A6	38210020	4E800020	7C7E42A6
01000024B0	4E800020	9421FFFO	38210010	4E800020
01000024C0	9421FFFO	7C0802A6	90010014	48000015

NOTE

The **Memory** view seamlessly displays 32-bit, 36-bit, 40-bit, and 64-bit addresses depending upon the selected memory space and the target processor currently under debug process.

In this section:

- [Adding Memory Monitor](#) on page 194

5.11.1 Adding Memory Monitor

This section describes how to add memory monitor in the **Memory** view.

To display the supported memory spaces for a target in the **Memory** view, perform the following steps:

1. In the **Memory** view, click the **Add Memory Monitor** icon .

The **Monitor Memory** dialog appears (shown in the figure below).

2. Specify the address in the **Enter address or expression to monitor** drop-down list.

Figure 53: Monitor Memory Dialog Box

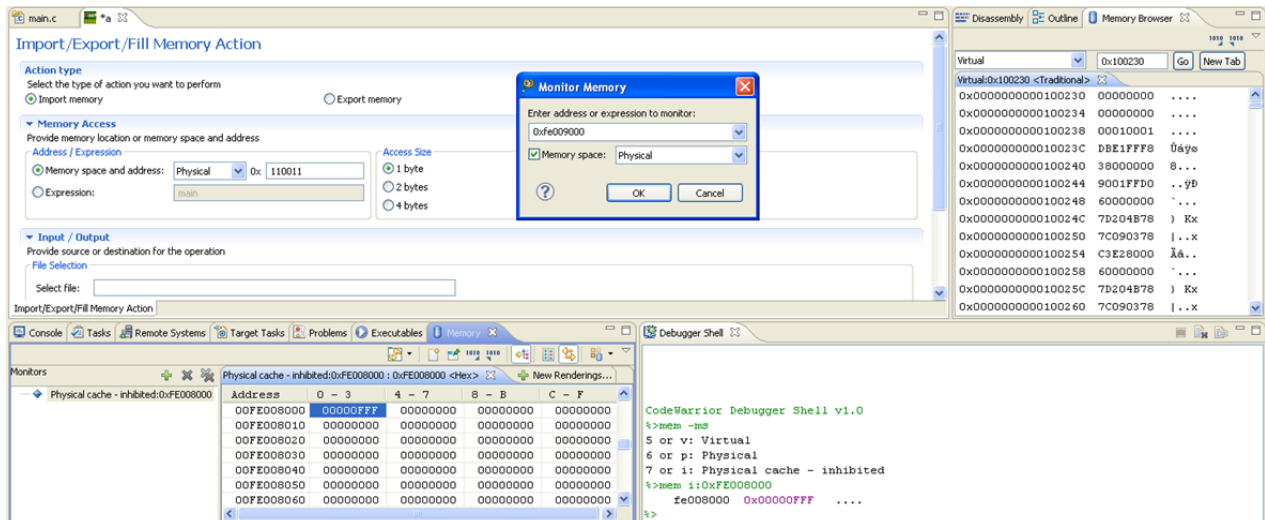

3. Select one of the supported memory spaces from the **Memory space** drop-down list.

- Virtual (v)

Indicates that the specified address space is same as the address space in which the processor executes. When you select the *Virtual* option, the debugger performs virtual to physical translations based on the MMU translations read from the target or based on the `translate` directives specified in the memory configuration file (for bareboard debugging) or the kernel awareness plug-in (for Linux debugging). In addition, the *Virtual* memory space is the one that is relevant for the Program Counter (PC) and the Stack Pointer (SP) registers. The width of the *Virtual* memory space is determined by the target processor's effective address size. For e500v2 and e500mc processors the width of the *Virtual* memory space is 32-bit. For e5500 and e6500 processors, the width of the *Virtual* memory is 64-bit. Note that the *Virtual* memory space is the default memory space in the **Disassembly** view.

- Physical (p)

Indicates that the specified address is interpreted as a physical address. The debugger does not attempt to perform virtual to physical translations, therefore it simply accesses the specified address as a physical address. When you select the *Physical* option, any translations read from the target MMU or defined in the memory configuration file or the kernel awareness plug-in are disregarded. In addition, the behavior is cache-coherent. If the data is in cache, the debugger gets it from there, otherwise the access goes to the memory. Note that a *Physical* cacheable read access can cause modified cache lines to be flushed to the memory before being accessed.

For processors based on e500v2, e500mc, e5500 cores, the width of the physical memory address space is 36-bit. The e6500 core has a 40-bit physical memory space. Older cores like e300 and e500 only support 32-bit physical addresses.

- Physical Cache Inhibited

The *Physical Cache Inhibited* option disregards the cache and accesses whatever is in the memory. This option allows you to access the data directly from the main memory, even if the data or address is available in one of the caches. The *Physical Cache Inhibited* memory space is only available on processors based on e500mc/e5500/e6500 cores.

CAUTION

The e500mc/e5500/e6500 core architecture specifies that it is a programming error to inter-mix cache-inhibited with cacheable accesses to the same memory range. If this error is encountered, it can lead to a number of problems like stale data, and un-intended corruption of neighboring locations.

Also, you should not perform a cacheable access to a memory range which is defined as cache-inhibited in the MMU.

When using the Virtual memory space, the debugger performs virtual to physical translations, and based on the MMU setup it requires the correct cacheable/cache-inhibited attribute for the particular memory range.

- For Linux debugging, CodeWarrior uses the Kernel Awareness plug-in to automatically extract the cacheable/cache-inhibited attribute from the CAM/TLB registers (1 bit of the WIMGE) or the PTE kernel structure.
- For bareboard debugging, when CodeWarrior is not configured for reading the MMU, it relies on the information available in the memory configuration file. The `translate` directives are used to inform the debugger of MMU translations and cacheable/cache-inhibited attribute (even for 1:1 translations), using the appropriate memory space, for example:

```
translate v:<v_addr> p:<p_addr> - for cacheable ranges
translate v:<v_addr> i:<p_addr> - for cache-inhibited ranges
```

- CodeWarrrior can also automatically read the translations from the target while debugging bareboard applications for most processors based on e500v2, e500mc, e5500, and e6500 cores, relieving the user from specifying the translations in the memory configuration file. For more information, see [Memory translations](#) on page 155.

5.12 Viewing Cache

This section provides detailed information on working with caches.

The CodeWarrrior debugger allows you to view and modify the instruction cache and data cache of the target system during a debug session.

In this section:

- [Cache View](#) on page 196
- [Cache View Toolbar Menu](#) on page 197
- [Components of Cache View](#) on page 199
- [Using Debugger Shell to View Caches](#) on page 199
- [Debugger Shell Global Cache Commands](#) on page 200
- [Debugger Shell Cache Line Commands](#) on page 201
- [Processor-Specific Cache Features](#) on page 201

5.12.1 Cache View

This section describes how to use the **Cache** view.

Use the **Cache** view to examine L1 cache (such as instruction cache or data cache). Also, you can use the viewer to display L2 and L3 cache for targets that support it.

To open the **Cache** view, use the following steps:

1. Start a debugging session.
2. From the CodeWarrrior IDE menu bar, select **Window > Show View > Other**.

The **Show View** dialog appears.

3. Expand the **Debug** group.
4. Select **Cache**.
5. Click **OK**.

The **Cache** view appears, as shown in the figure below.

TIP

You can use the type filter text box as a shortcut to specify the **Cache** view. Start typing cache into the text box. The **Show View** dialog shortens the list of views to those whose names match the characters you type. The list continues to shorten as you type each additional character. When the list shows just the **Cache** view, select it and click **OK** to

open that view. You can click **Clear** () to empty the text box and restore the full list of views.

Figure 54: Cache View



6. Use the **Choose a Cache** list box to specify the cache that you want to examine.

NOTE

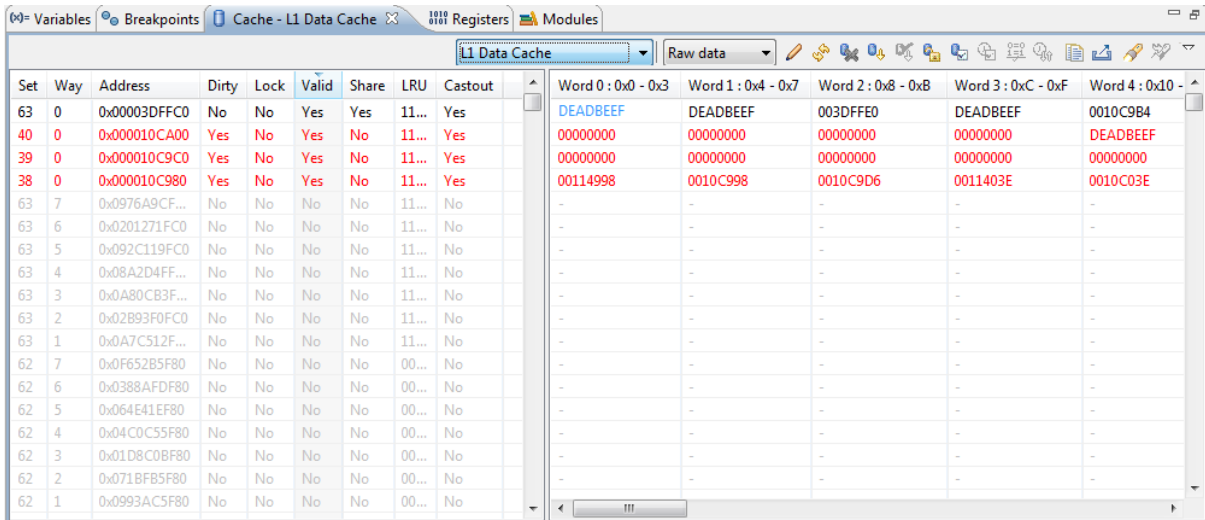
If the **Choose a Cache** list box is grayed out, the current target does not support viewing cache. If a cache line appears in red, it indicates that the line has been changed by the processor in the cache but has not been updated in the storage. This is also suggested by the **Dirty** flag that reads **Yes** in this case.

5.12.2 Cache View Toolbar Menu

Use the **Cache** view toolbar menu to configure the cache information.

To display this menu, click the **Menu** button (inverted triangle) in the **Cache** view toolbar.

TIP

The **Cache** view toolbar buttons are alternative ways to implement the control actions defined in the toolbar menu.

NOTE

Certain toolbar buttons are unavailable (grayed out) if the target hardware does not support their corresponding functions, or if a specific operation can be performed in assembly language and is not supported by the **Cache** view.

The table below describes the **Cache** view toolbar menu options.

Table 113: Cache View Toolbar Menu Options

Option	Description
Write	Commits content changes from the Cache view to the cache registers on the target hardware (if the target hardware supports doing so).
Refresh	Reads data from the target hardware and updates the Cache view display.

Table continues on the next page...

Table 113: Cache View Toolbar Menu Options (continued)

Option	Description
Invalidate	Discards the cache.
Flush	Flushes the entire contents of the cache. This option commits uncommitted data to the next level of the memory hierarchy, then invalidates the data within the cache.
Lock	Locks the cache and prevent the debugger from fetching new lines or discarding current valid lines.
Enable/Disable	Turns on/off the cache.
Disable LRU	Removes the Least Recently Used (LRU) attribute from the existing display for each cache line. This option is never activated because the function does not apply to Power Architecture processors.
Enable/Disable Parity	Turns on/off the line data parity checksum calculation.
Inverse LRU	Displays the inverse of the Least Recently Used attribute for each cache line. This option is never activated because the function does not apply to Power Architecture processors.
Copy Cache	Copies the cache contents to the system clipboard.
Export Cache	Exports the cache contents to a file.
Search	Finds an occurrence of a string in the cache lines.
Search Again	Finds the next occurrence of a string in the cache lines.
Preserve Sorting	Preserves sorting of the cache when the cache data is updated and the cache is refreshing. This option is disabled by default. If enabled, every operation that triggers cache refresh (such as step, run to breakpoint) will have to wait for cache data loading and sorting.
View Memory	Allows you to view the corresponding memory for the selected cache lines.
Lock Line	Locks the selected cache lines.
Invalidate Line	Invalidates the selected cache lines.
Flush Line	Flushes the entire contents of the selected cache lines.
Synchronize Line	Synchronizes selected cache data with memory data.
Lock Way	Locks the cache ways specified with the Lock Ways menu option. Locking a cache way means that the data contained in that way must not change. If the cache needs to discard a line, it will not discard locked lines (such as lines explicitly locked, or lines belonging to locked ways).

Table continues on the next page...

Table 113: Cache View Toolbar Menu Options (continued)

Option	Description
Unlock Way	Unlocks the cache ways specified with the Lock Ways menu option.
Lock Ways	Specifies the cache ways on which the Lock Way and Unlock Way menu options operate.

5.12.3 Components of Cache View

This section describes the components of the **Cache** view.

Below the toolbar, there are two panes in the window, separated by another vertical divider line. The pane to the left of the divider line displays the attributes for each displayed cache line. The pane to the right of the divider line displays the actual contents of each displayed cache line. You can modify information in this pane and click **Write** to apply those changes to the cache on the target board.

Above the cache line display panes are **Refresh** and **Write** and the **View As** drop-down menu. Click **Refresh** to clear the entire contents of the cache, re-read status information from the target hardware, and update the cache lines display panes. Click **Write** to commit cache content changes from this window to the cache memory on the target hardware (if the target hardware supports doing so). Select **Raw Data** or **Disassembly** from the **View As** drop-down menu to change the way the IDE displays the data in the cache line contents pane on the right side of the window.

You can perform all cache operations from assembly code in your programs. For details about assembly code, see the core documentation for the target processor. You can also perform cache operations by clicking **Menu**, shown as an inverted triangle, which opens a pull-down menu that contain actions for the **Cache** view.

5.12.4 Using Debugger Shell to View Caches

Another way to manipulate the processor's caches is by using the **Debugger Shell** view.

To display the **Debugger Shell** view, follow these steps:

1. Start a debugging session.
2. Select **Window > Show View > Other**.
The **Show View** dialog appears.
3. Expand the **Debug** group.
4. Select **Debugger Shell**.
5. Click **OK**.

The **Debugger Shell** view appears.

To display a list of the commands supported by the **Debugger Shell** view, enter this at the command prompt:

```
help -tree
```

For more information about the **Debugger Shell** support of cache commands, enter these commands at the command prompt:

```
help cmdwin::ca
```

```
help cmdwin::caln
```

The next sections describe these commands in detail.

5.12.5 Debugger Shell Global Cache Commands

The `cmdwin::ca` cache commands manage global cache operations, that is, they affect the operation of the entire cache.

For multi-core processors, these commands operate on a specific cache if an optional ID number is provided. If the ID number is absent, the command operates on the cache that was assigned as the default by the last `cmdwin::ca::default` command.

The table below lists the cache commands.

Table 114: Debugger Shell Global Cache Commands

Command	Description
<code>cmdwin::ca::default</code>	Set specified cache as default
<code>cmdwin::ca::enable</code>	Enable/disable cache
<code>cmdwin::ca::flush</code>	Flushes cache
<code>cmdwin::ca::inval</code>	Invalidates cache
<code>cmdwin::ca::lock</code>	Lock/Unlock cache
<code>cmdwin::ca::show</code>	Show the architecture of the cache

The basic format of a shell global cache command is:

```
command [<cache ID>] [on | off]
```

The optional cache ID number argument selects the cache that the command affects.

The optional on or off argument changes a cache's state.

For example, to display a particular cache's characteristics:

```
%> cmdwin::ca:show 1
```

displays the characteristics of the second processor cache.

You use the `cmd::ca::default` to assign a default cache that becomes the target of global cache commands. For example:

```
%> cmdwin::ca:default 0
```

makes the first processor cache the default cache. Subsequent global cache commands that do not specify a cache ID will affect this cache.

Other cache commands require the off or on state argument. When specifying a particular cache, the state argument follows the ID argument. For example:

```
%> cmdwin::ca:lock 2 on
```

locks the contents of the third processor cache, while:

```
%> cmdwin::ca:enable 1 off
```

disables the second processor cache.

5.12.6 Debugger Shell Cache Line Commands

The `cmdwin::caln` commands manage cache line operations, that is, they affect memory elements within a designated cache.

The table below lists these commands.

Table 115: Debugger Shell Cache Line Commands

Command	Description
<code>cmdwin::caln:get</code>	Display cache line
<code>cmdwin::caln:flush</code>	Flush cache line
<code>cmdwin::caln:inval</code>	Invalidate cache line
<code>cmdwin::caln:lock</code>	Locks/unlocks cache line
<code>cmdwin::caln:set</code>	Writes specified data to cache line

The basic format for a shell cache line command is:

```
command [<cache ID>] <line> [<count>]
```

The optional cache ID argument specifies the cache that the command affects, otherwise it affects the default cache, as set by the `cmdwin::ca::default` command.

The required line argument specifies the cache line to affect.

The optional count argument specifies the number of cache lines the command affects. The default is one line. For example:

```
%> cmdwin::caln:flush 2
```

flushes line 2 of the default cache.

The `cmdwin::caln:set` command varies from the other commands in that you must specify data words that fill the cache line. For example:

```
%> cmdwin::caln:set 2 = 0 1 1 2 3 5 8 13
```

Sets the contents of cache line two, where the first word has a value of 0, the second word has a value of 1, the third word has a value of 1, the fourth word has a value of 2, and so on.

NOTE

If the command specifies a list of data values that are less than one line's worth of words, then the values are repeated from the beginning of the list to complete the filling the cache line. If too many data words are specified for the cache line to hold, the extra values are discarded.

5.12.7 Processor-Specific Cache Features

This section lists the cache features and status flags supported by this product.

The table below lists cache features supported by P4080 QorIQ processors.

Table 116: P4080 QorIQ - Supported Cache Operations

Cache	Features	Supported Operations	Supported Status Flags
L1 data cache	<ul style="list-style-type: none"> • 32 KB size • 64 sets • 8 ways • 16 words / line 	<ul style="list-style-type: none"> • enable/disable cache • lock/unlock cache • invalidate cache • lock/unlock line • invalidate line • read/modify data • flush cache • flush line 	<ul style="list-style-type: none"> • valid • lock • shared • dirty • castout • plru
L1 instruction cache	<ul style="list-style-type: none"> • 32 KB size • 64 sets • 8 ways • 16 words / line 	<ul style="list-style-type: none"> • enable/disable cache • lock/unlock cache • invalidate cache • lock/unlock line • invalidate line • read/modify data 	<ul style="list-style-type: none"> • valid • lock • plru
L2 cache	<ul style="list-style-type: none"> • 128 KB size • 256 sets • 8 ways • 16 words / line 	<ul style="list-style-type: none"> • enable/disable cache • lock/unlock cache • invalidate cache • lock/unlock line • invalidate line • read/modify data • flush cache • flush line 	<ul style="list-style-type: none"> • valid • lock • shared • dirty • non-coherent • plru
L3 cache	<ul style="list-style-type: none"> • 2 banks • 512KB/bank • 512 sets • 32 ways • 16 words/line 	<ul style="list-style-type: none"> • enable/disable cache • lock/unlock cache • invalidate cache • lock/unlock line • invalidate line • read/modify data • flush cache • flush line 	<ul style="list-style-type: none"> • valid • locked • modified • plru

The table below lists cache features supported by PowerQUICC II processors.

Table 117: PowerQUICC II Family - Supported Cache Operations

Cache	Features	Supported Operations
L1D L1 data cache	<ul style="list-style-type: none"> • 16 KB size • 128 sets • 4 ways • 8 words / line 	<ul style="list-style-type: none"> • enable/disable cache • lock/unlock cache • invalidate cache • read/modify data
L1I L1 instruction cache	<ul style="list-style-type: none"> • 16 KB size • 128 sets • 4 ways • 8 words / line 	<ul style="list-style-type: none"> • enable/disable cache • lock/unlock cache • invalidate cache • read/modify data

The table below lists cache features supported by PowerQUICC III processors.

Table 118: PowerQUICC III Family - Supported Cache Operations

Cache	Features	Supported Operations
L1D L1 data cache	<ul style="list-style-type: none"> • 32 KB size • 128 sets • 8 ways • 8 words / line 	<ul style="list-style-type: none"> • enable/disable cache • lock/unlock cache • invalidate cache • lock/unlock line • invalidate line • read/modify data
L1I L1 instruction cache	<ul style="list-style-type: none"> • 32 KB size • 128 sets • 8 ways • 8 words / line 	<ul style="list-style-type: none"> • enable/disable cache • lock/unlock cache • invalidate cache • lock/unlock line • invalidate line • read/modify data
L2 L2 cache (data only, instruction only, unified)	<ul style="list-style-type: none"> • 256 KB/512 KB size • 1024/2048 sets • 8 ways • 8 words / line 	<ul style="list-style-type: none"> • enable/disable cache • lock/unlock cache • invalidate cache • read/modify data

5.13 Changing Program Counter Value

This section explains how to change the program counter value in the CodeWarrior IDE to make the debugger execute a specific line of code.

To change the program counter value, follow these steps:

1. Start a debugging session.
2. In the Editor view, place the cursor on the line that you want the debugger to execute next.
3. Right-click in the Editor view.

A context menu appears.

4. From the context menu, select **Move To Line**.

The CodeWarrior IDE modifies the program counter according to the specified location. The Editor view shows the new location.

5.14 Hard resetting

Use the reset hard command in the **Debugger Shell** view to send a hard reset signal to the target processor.

NOTE

The **Hard Reset** command is enabled only if the debug hardware you are using supports it.

TIP

You can also perform a hard reset by clicking **Reset** () on the **Debug** perspective toolbar.

5.15 Setting Stack Depth

This section describes how to control the depth of the call stack displayed by the debugger.

Select **Window > Preferences > C/C++ > Debug > Maximum stack crawl depth** option to set the depth of the stack to read and display. Showing all levels of calls when you are examining function calls several levels deep can sometimes make stepping through code more time consuming. Therefore, you can use this menu option to reduce the depth of calls that the debugger displays.

5.16 Import a CodeWarrior Executable file Wizard

The **Import a CodeWarrior Executable file** wizard helps you to import a CodeWarrior executable file and create a new project.

To use the **Import a CodeWarrior Executable file** wizard, perform these steps:

1. From the CodeWarrior IDE menu bar, select **File > Import**.

The **Import** wizard launches and the **Select** page appears.

2. Expand the **CodeWarrior** group.
3. Select the **CodeWarrior Executable Importer** to import a Power Architecture `.elf` file.
4. Click **Next**.

The wizard name changes to **Import a CodeWarrior Executable file** and the **Import a CodeWarrior Executable file** page appears.

The following sections describe the various pages that the wizard displays as it assists you in importing an executable (`.elf`) file:

- [Import a CodeWarrior Executable file Page](#) on page 205
- [Import C/C++/Assembler Executable Files Page](#) on page 205
- [Processor Page](#) on page 206
- [Linux Application Launch Configurations Page](#) on page 206
- [Debug Target Settings Page](#) on page 207
- [Configurations Page](#) on page 208

5.16.1 Import a CodeWarrior Executable file Page

Use the **Import a CodeWarrior Executable file** page to specify the name and location for your project.

The table below describes the options available on this page.

Table 119: Import a CodeWarrior Executable file page settings

Option	Description
Project name	Specify the name of the project. The specified name identifies the project created for debugging (but not building) the executable file.
Use default location	If you select this option, the project files required to build the program are stored in the current workspace directory of the workbench. If you clear this option, the project files are stored in the directory that you specify in the Location option.
Location	Specifies the directory that contains the project files. Use the Browse button to navigate to the desired directory. This option is only available when the Use default location option is cleared.

5.16.2 Import C/C++/Assembler Executable Files Page

Use the **Import C/C++/Assembler Executable Files** page to select an executable file or a folder to search for C/C++/assembler executable files.

The table below explains the options available on the page.

Table 120: Import C/C++/Assembler Executable Files page settings

Option	Description
File to import	Specifies the C/C++/assembler executable file. Click Browse to choose an executable file.
Copy the selected file to current project folder	Select this option to copy the executable file in the project folder.

5.16.3 Processor Page

Use the **Processor** page to specify the processor family for the imported executable file and also specify the toolchain to be used.

The table below describes the options available on the page.

Table 121: Processor page settings

Option	Description
Processor	Expand the processor family and select the appropriate target processor for the execution of the specified executable file. The toolchain uses this choice to generate code that makes use of processor-specific features, such as multiple cores. <div style="text-align: center;"> TIP You can also type the processor name in the text box. </div>
Toolchain	Chooses the compiler, linker, and libraries used to build the program. Each toolchain generates code targeted for a specific platform. These are: <ul style="list-style-type: none"> • Bareboard Application: Targets a hardware board without an operating system. • Linux Application: Targets a board running the Linux operating system.
Target OS	Select if the board runs no operation system or imports a Linux kernel project to be executed on the board. The option is applicable only for bareboard application projects.

5.16.4 Linux Application Launch Configurations Page

Use the **Linux Application Launch Configurations** page to specify how the debugger communicates with the host Linux system and controls your Linux application.

NOTE

The **Linux Application** page appears, only when select the **Linux Application** toolchain option on the **Processor** page in the **Import a CodeWarrior Executable file** wizard.

NOTE

When debugging a Linux application, you must use the **CodeWarrior TRK** to manage the communications interface between the debugger and Linux system. For details, see [Install CodeWarrior TRK on Target System](#) on page 228.

The table below lists the options available on the page.

Table 122: Linux Application Launch Configurations Page Setting

Option	Description
CodeWarrior TRK	Select to use the CodeWarrior Target Resident Kernel (TRK) protocol, to download and control application on the Linux host system.
TAP Address	Specifies the IP address of the Linux host system, the project executes on.
<i>Table continues on the next page...</i>	

Table 122: Linux Application Launch Configurations Page Setting (continued)

Option	Description
Port	Specifies the port number that the debugger will use to communicate to the Linux host.
Remote Download Path	Specifies the host directory into which the debugger downloads the application.

5.16.5 Debug Target Settings Page

Use the **Debug Target Settings** page to specify debugger connection type, board type, launch configuration type, and connection type for your project.

This page also allows you to configure connection settings for your project.

The table below describes the options available on the page.

Table 123: Debug Target Settings page settings

Option	Description
Debugger Connection Types	Specifies what target the program executes on. <ul style="list-style-type: none"> • Hardware: Select to execute the program on the hardware available for the product. • Simulator: Select to execute the program on a software simulator. • Emulator: Select to execute the program on a hardware emulator.
Board	Specifies the hardware (board) supported by the selected processor.
Launch	Specifies the launch configurations and corresponding connection configurations, supported by the selected processor.
<i>Table continues on the next page...</i>	

Table 123: Debug Target Settings page settings (continued)

Option	Description
Connection Type	<p>Specifies the interface to communicate with the hardware.</p> <ul style="list-style-type: none"> • USB TAP: Select to use the USB interface to communicate with the hardware device. • Ethernet TAP: Select to use the Ethernet interface to communicate with the target hardware. • CodeWarrior TAP (over USB): Select to use the CodeWarrior TAP interface (over USB) to communicate with the hardware device. • CodeWarrior TAP (over Ethernet): Select to use the CodeWarrior TAP interface (over Ethernet) to communicate with the hardware device. <p>For more details on CodeWarrior TAP, see the <i>CodeWarrior TAP User Guide</i> available in the <code><CWInstallDir>\Help\PDF\</code> folder.</p> <ul style="list-style-type: none"> • Gigabit TAP: Corresponds to a Gigabit TAP that includes an Aurora daughter card, which allows you to collect Nexus trace in a real-time non-intrusive fashion from the high speed serial trace port (the Aurora interface). • Gigabit TAP + Trace (JTAG over JTAG cable): Select to use the Gigabit TAP and Trace probe to send JTAG commands over the JTAG cable. • Gigabit TAP + Trace (JTAG over Aurora cable): Select to use the Gigabit TAP and Trace probe to send JTAG commands over the Aurora cable. <p>For more details on Gigabit TAP, see <i>Gigabit TAP Users Guide</i> available in the <code><CWInstallDir>\PA\Help\PDF\</code> folder.</p>
TAP address	Enter the IP address of the selected TAP device.

NOTE

The **Debug Target Settings** page may prompt you to either create a new remote system configuration or select an existing one.

A remote system is a system configuration that defines connection, initialization, and target parameters. The remote system explorer provides data models and frameworks to configure and manage remote systems, their connections, and their services. For more information, see the *CodeWarrior Development Studio Common Features Guide* available in the `<CWInstallDir>\PA\Help\PDF\` folder.

5.16.6 Configurations Page

Use the **Configurations** page to select the processor core that executes the project.

The table below lists the options available on the page.

Table 124: Configurations Page

Options	Description
Core Index	Select the processor core that executes the project.

5.17 Debugging Externally Built Executable Files

You can use the **Import a CodeWarrior Executable file** wizard to debug an externally built executable file, that is, an executable (`.elf`) file that has no associated CodeWarrior project.

For example, you can debug a `.elf` file that was generated using a different IDE.

The process of debugging an externally built executable file can be divided into the following tasks:

- [Import an Executable File](#) on page 209
- [Edit the Launch Configuration](#) on page 211
- [Specify the Source Lookup Path](#) on page 212
- [Debug Executable File](#) on page 214

5.17.1 Import an Executable File

First of all, you need to import the executable file that you want the CodeWarrior IDE to debug.

The IDE imports the executable file into a new project.

To import an externally built executable file, follow these steps:

1. From the CodeWarrior IDE menu bar, select **File > Import**.

The **Import** wizard appears.

2. Expand the **CodeWarrior** group.
3. Select **CodeWarrior Executable Importer** to import a Power Architecture `.elf` file.
4. Click **Next**.

The wizard name changes to **Import a CodeWarrior Executable file** and the **Import a CodeWarrior Executable file** page appears.

5. In the **Project name** text box, enter the name of the project. This name identifies the project that the IDE creates for debugging (but not building) the executable file.
6. Clear the **Use default location** checkbox and click **Browse** to specify a different location for the new project. By default, the **Use default location** checkbox is selected.
7. Click **Next**.

The **Import C/C++/Assembler Executable Files** page appears.

8. Click **Browse**.

The **Select file** dialog appears. Use the dialog to navigate to the executable file that you want to debug.

9. Select the required file and click **Open**.

The **Select file** dialog closes. The path to the executable file appears in the **File to import** text box.

TIP

You can also drag and drop a `.elf` file in the CodeWarrior Eclipse IDE. When you drop the `.elf` file in the IDE, the **Import a CodeWarrior Executable file** wizard appears with the `.elf` file already specified in the **Project Name** and **File to Import** text box.

10. Check the **Copy the selected file to current project folder** checkbox to copy the executable file in the current workspace.
11. Click **Next**.

The **Processor** page appears.

12. Select the processor family for the executable file.

13. Select a toolchain from the **Toolchain** group.

Selected toolchain sets up the default compiler, linker, and libraries used to build the new project. Each toolchain generates code targeted for a specific platform.

14. Select if the board runs no operation system or imports a Linux kernel project to be executed on the board. The **Target OS** options are applicable only for bareboard application projects.

15. Click **Next**.

The **Debug Target Settings** page appears.

16. Select a supported connection type, from the **Debugger Connection Types** group. Your selection determines the launch configurations that you can include in your project.

17. Select the hardware or simulator, you plan to use, from the **Board** drop-down list.

NOTE

Hardware or Simulators that supports the target processor selected on the **Processors** page are only available for selection.

18. Select the launch configurations that you want to include in your project and the corresponding connection.

19. Select the interface to communicate with the hardware, from the **Connection Type** drop-down list.

20. Enter the IP address of the TAP device in the **TAP address** text box. This option is disabled and cannot be edited, if you select **USB TAP** from the **Connection Type** drop-down list.

21. Click **Next**.

The **Configurations** page appears.

22. Select the processor core that executes the project, from the **Core index** list.

23. Click **Finish**.

The **Import a CodeWarrior Executable file** wizard ends. The project for the imported `.elf` file appears in the **CodeWarrior Projects** view. You can now open the **Debug Configurations** dialog box by selecting **Run > Debug Configurations**. The **Debug Configurations** dialog shows the current settings for the launch configuration that you just created. A remote system is created with details of all the connection, initialization, and target parameters you had set while importing the `.elf` file.

Figure 55: Debug Configurations Dialog Box - Launch Configuration for Executable File

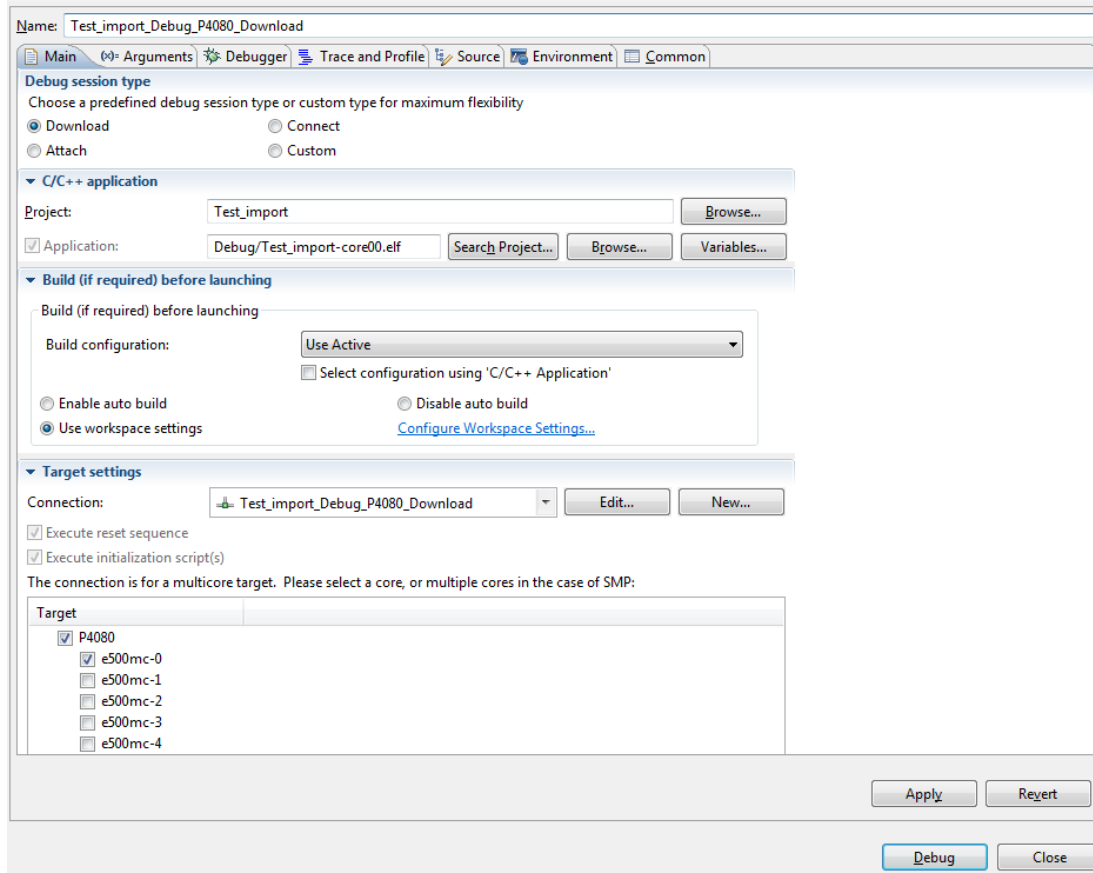

5.17.2 Edit the Launch Configuration

Using the tabs of the **Debug Configurations** dialog, you can change the launch configuration settings that you specified while importing the `.elf` file.

To edit the launch configuration for your executable file, follow these steps:

1. On the **Main** tab, click **Edit** in the **Connection** panel.
The corresponding **Connection** page appears.
2. Use the **Connection type** list box to modify the current connection type.
3. Configure the various connection options as appropriate for your executable file by using the various tabs available on the **Connection** page.

For example, specify the appropriate target processor, any initialization files, and connection protocol.

4. Click **OK** to close the **Connection** page.

NOTE

For more information on how to modify settings using the remote system explorer, see *CodeWarrior Common Features Guide* from the `<CWInstallDir>\PA\Help\PDF\` folder.

5.17.3 Specify the Source Lookup Path

Source lookup path is specified in terms of the compilation path and the local file system path.

The CodeWarrior debugger uses both these paths to debug the executable file.

The compilation path is the path to the original project that built the executable file. If the original project is from an IDE on a different computer, you need to specify the compilation path in terms of the file system on that computer.

The local file system path is the path to the project that the CodeWarrior IDE creates to debug the executable file.

To specify a source lookup path for your executable file, perform the following steps:

1. Click the **Source** tab of the **Debug Configurations** dialog.

The corresponding page appears.

Figure 56: Debug Configurations Dialog Box - Source Page

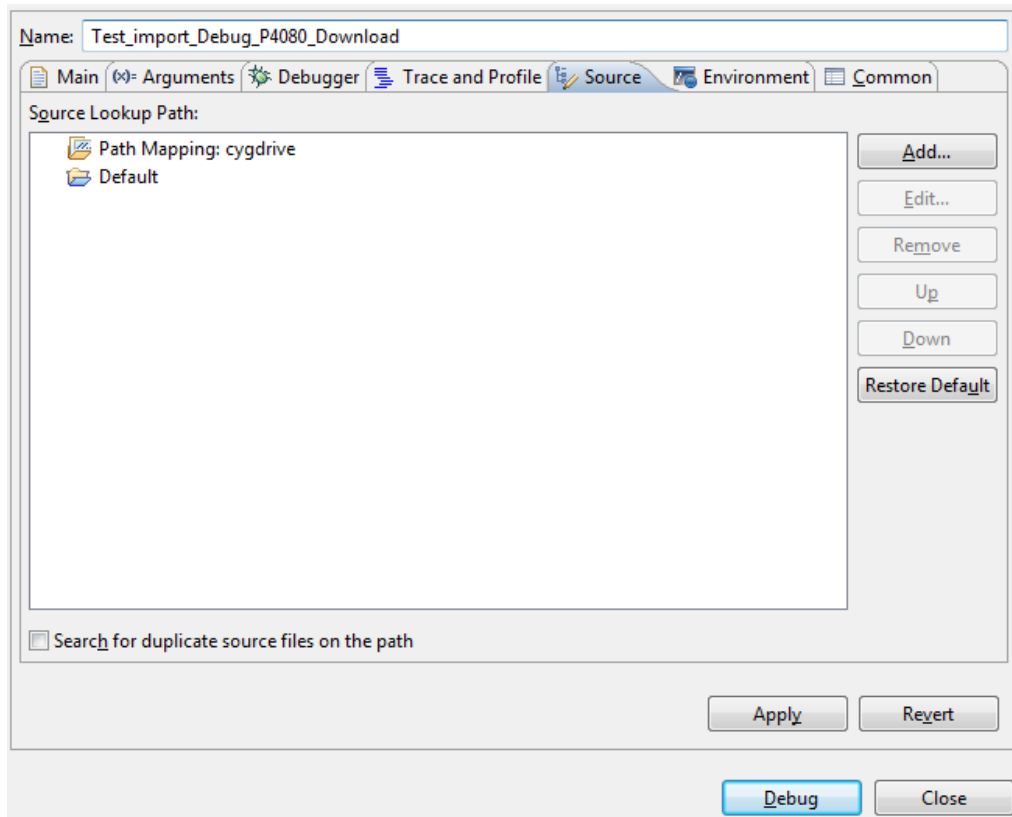

2. Click **Add**.

The **Add Source** dialog appears.

3. Select **Path Mapping** from the available list of sources.

Figure 57: Add Source Dialog Box

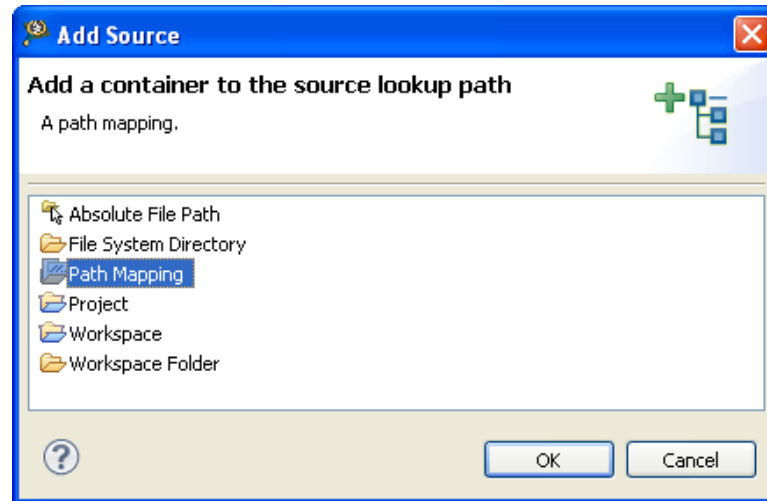

4. Click **OK**.

The **Add Source** dialog closes. The **Path Mappings** dialog appears.

5. In the **Name** text box, enter the name of the new path mapping.
6. Click **Add**.

The cursor blinks in the **Compilation path** column.

7. In the **Compilation path** column, enter the path to the parent project of the executable file, relative to the computer that generated the file.

Suppose the computer on which you debug the executable file is not the same computer that generated that executable file. On the computer that generated the executable file, the path to the parent project is `D:\workspace\originalproject`. Enter this path in the **Compilation path** text box.

TIP

You can use the IDE to discover the path to the parent project of the executable file, relative to the computer that generated the file. In the C/C++ Projects view of the C/C++ perspective, expand the project that contains the executable file that you want to debug. Next, expand the group that has the name of the executable file itself. A list of paths appears, relative to the computer that generated the file. Search this list for the names of source files used to build the executable file. The path to the parent project of one of these source files is the path you should enter in the **Compilation path** column.

8. In the **Local file system path** text box, enter the path to the parent project of the executable file, relative to your computer. Click the ellipsis button to specify the parent project.

Suppose the computer on which you debug the executable file is not the same computer that generated that executable file. On your current computer, the path to the parent project of the executable file is `C:\projects\thisproject`. Enter this path in the **Local file system path** text box.

9. Click **OK**.

The **Path Mapping** dialog closes. The mapping information now appears under the path mapping shown in the **Source Lookup Path** list of the **Source** page.

10. If needed, change the order in which the IDE searches the paths.

The IDE searches the paths in the order shown in the **Source Lookup Path** list, stopping at the first match. To change this order, select a path, then click **Up** or **Down** to change its position in the list.

11. Click **Apply**.

The IDE saves your changes.

5.17.4 Debug Executable File

You can use the CodeWarrior debugger to debug the externally built executable file.

To debug the executable file:

1. Select the project in the **CodeWarrior Projects** view.
2. Click the **Debug** button from the IDE toolbar.

The IDE switches to Debug perspective listing the debugging output.

Chapter 6

Multi-Core Debugging

This chapter explains how to use the multi-core debugging capability of the CodeWarrior debugger.

In this chapter:

- [Debugging Multi-Core Projects](#) on page 215
- [Multi-Core Debugging Commands](#) on page 221

6.1 Debugging Multi-Core Projects

This section explains how to set launch configurations and how to debug multiple cores in a multi-core project.

The CodeWarrior debugger provides the facility to debug multiple Power Architecture processors using a single debug environment. The run control operations can be operated independently or synchronously. A common debug kernel facilitates multi-core, run control debug operations for examining and debugging the interaction of the software running on the different cores on the system.

NOTE

This procedure assumes that you have already created a multi-core project, named `board_project`.

To debug a multi-core project, perform the steps given in the following sections:

- [Setting Launch Configurations](#) on page 215
- [Debugging Multiple Cores](#) on page 218

6.1.1 Setting Launch Configurations

Setting a launch configuration allows you to specify all core-specific initializations.

To set up the launch configurations, follow these steps:

1. Open the CodeWarrior project you want to debug.
2. Switch to the **Debug** perspective.
3. Select **Run > Debug Configurations**.

The **Debug Configurations** dialog appears (shown in the figure below) with a list of debug configurations that apply to the current application.

4. Expand the **CodeWarrior** tree control.
5. From the expanded list, select the debug configuration for which you want to modify the debugger settings.
For example, `board_project-core00_RAM_B4860_Download`.

Figure 58: Debug Configurations Dialog Box

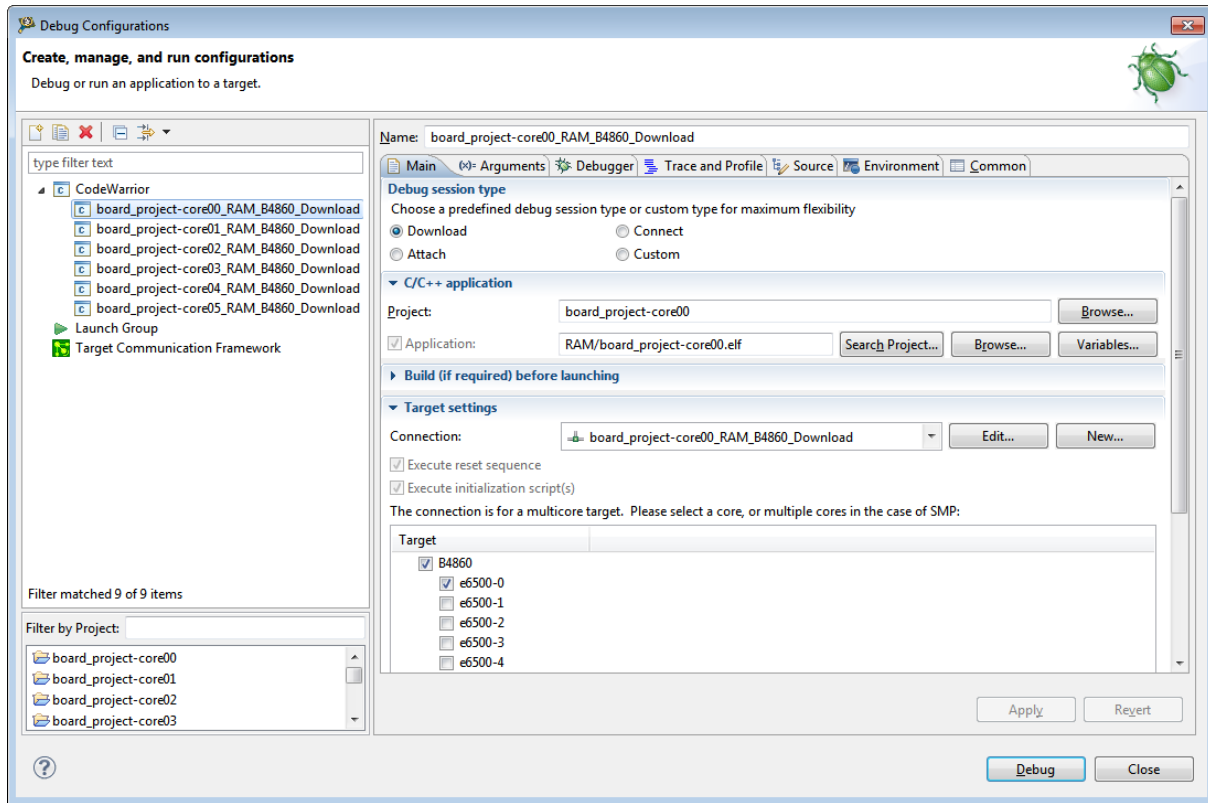

6. On the **Main** tab, select a connection from the **Connection** drop-down list.
7. Select a core from the **Target** list.
8. Click **Edit** next to the **Connection** drop-down list.
The **Properties for <connection>** dialog appears.

Figure 59: Properties for <connection> Dialog Box

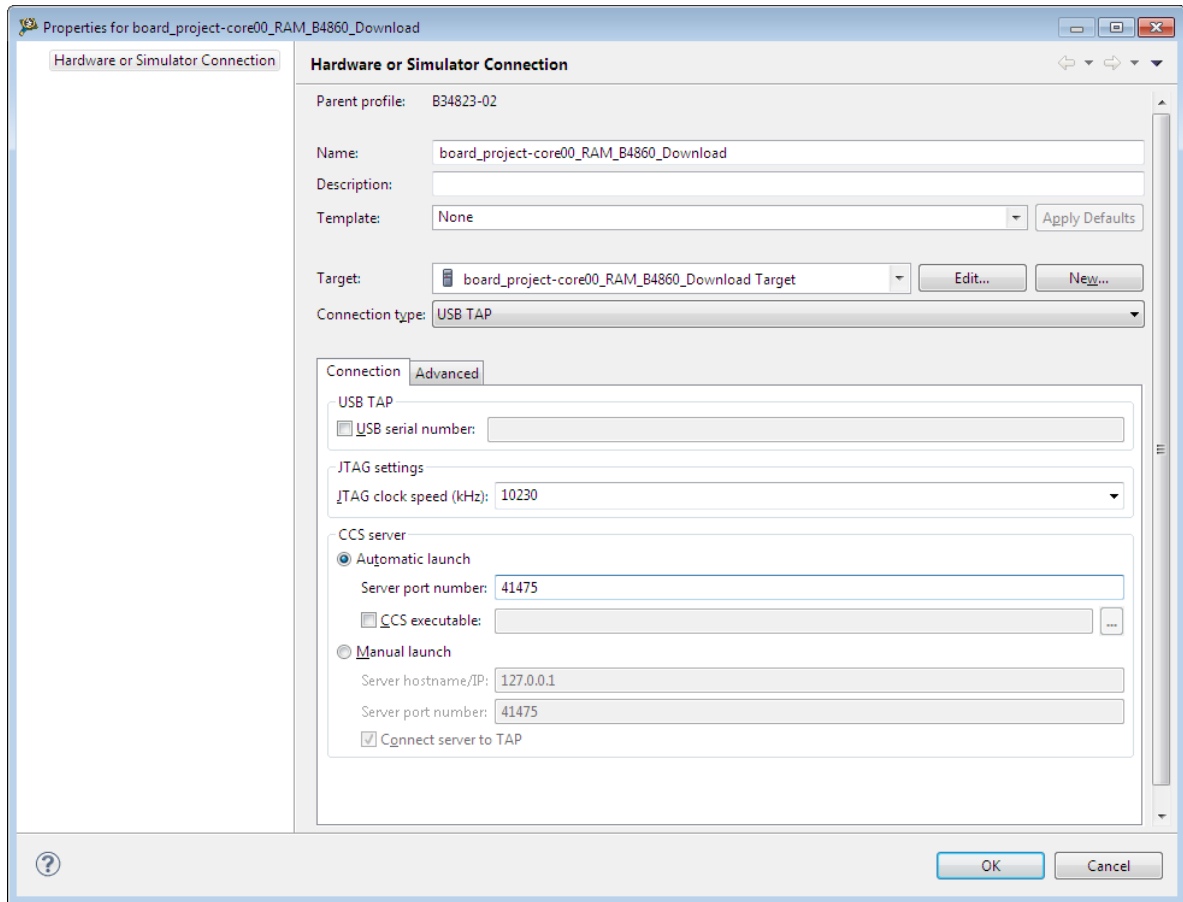

9. Select a target from the **Target** drop-down list.
10. Select the required TAP connection from the **Connection type** drop-down list. For example, **CodeWarrior TAP**.
11. On the **Connection** tab, specify the hostname/IP of the target board in the **Hostname/IP** text box.
12. Enter the JTAG clock speed in the **JTAG clock speed** text box.
13. Specify the port number of the CCS server in the **Server port number** text box.

Figure 60: Properties for <connection> Dialog Box - Connection Settings

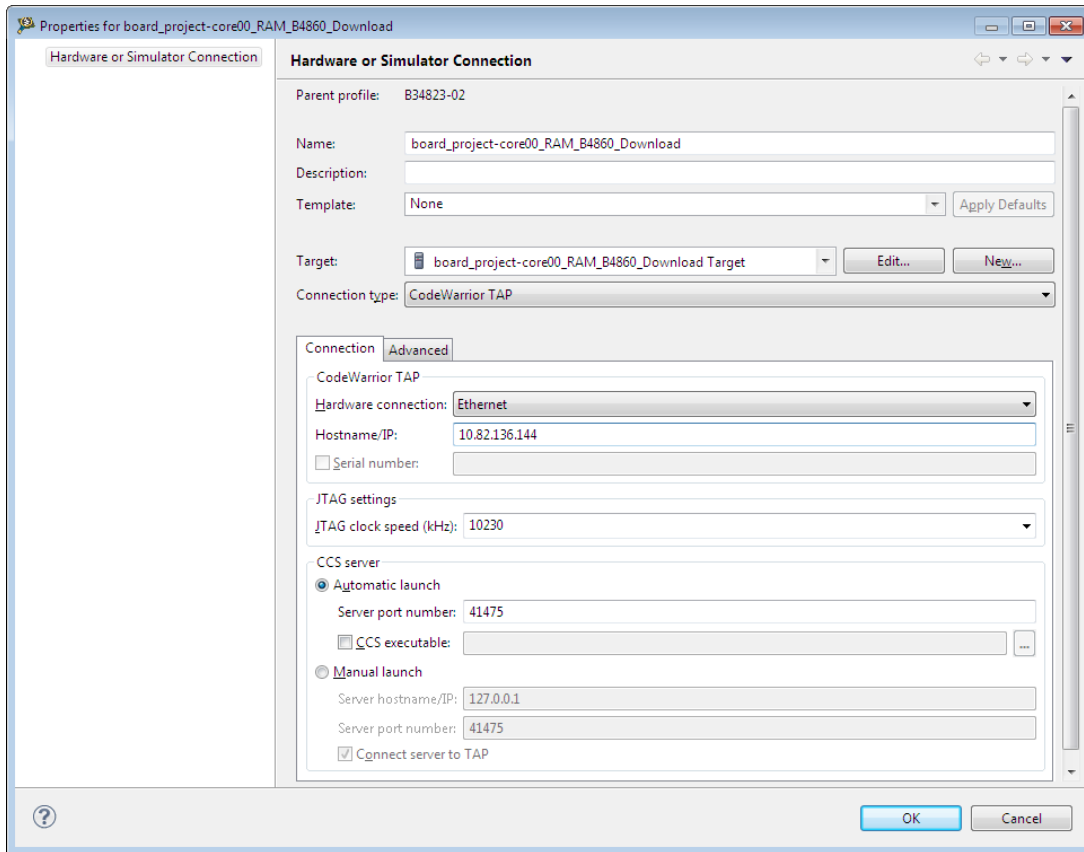

14. Click **OK**.
15. Click the **Debugger** tab in the **Debug Configurations** dialog.
The **Debugger** page appears.
16. Ensure that the **Stop on startup at** checkbox is selected and `main` is specified in the **User specified** text box.
17. Click **Apply** to save the changes.
You have successfully configured a debug configuration.
18. Similarly, configure remaining debug configurations.

NOTE

To successfully debug multiple cores, the connection settings must be identical for all debug configurations.

6.1.2 Debugging Multiple Cores

The CodeWarrior debugger enables system developers to simultaneously develop and debug applications on a system with multiple processors, within the same debug environment.

NOTE

Ensure that you have attached a debug probe to the target board and to the computer hosting the CodeWarrior IDE before performing the steps listed in this section.

To debug multiple cores, follow these steps:

1. Select a multi-core project in the **CodeWarrior Projects** view.
2. Select **Run > Debug**.

The debugger downloads core 0 and switches to the **Debug** perspective. The debugger halts execution at the first statement of `main()`. The **Debug** view displays all the threads associated with the core.

Figure 61: Multi-Core Debugging - Debug Core 0

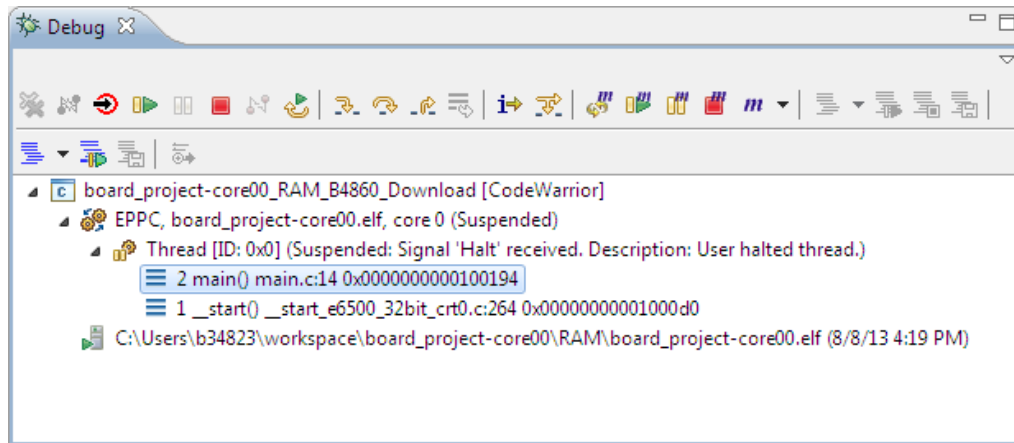

3. Download all other cores associated with the project.
4. Select a thread from core 0 in the **Debug** view.

All the views in the **Debug** perspective will be updated to display the debug session for the selected core. The figure below displays the debug session for a selected thread in core 0.

Figure 62: Viewing Debug Information for Core 0

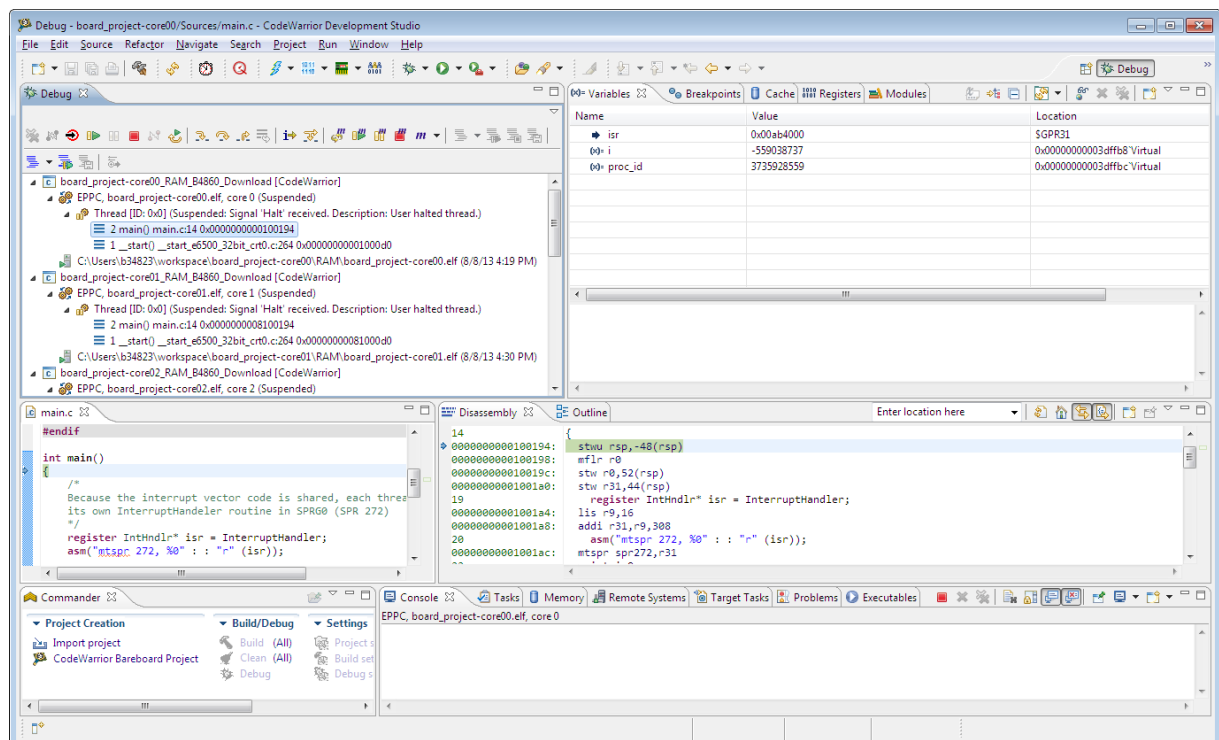

5. Select and expand the **General Purpose Registers** group.
6. Select **Run > Step Over**.

The following actions occur:

- Debugger executes the current statement and halts at the next statement.
- The program counter (PC) indicator moves to the next executable source line in the Source view.
- In the **Debug** view, the status of the program changes to (Suspended).
- Modified register values are highlighted in yellow.

7. Select **Window > New Window**.

Another instance of the **Debug** perspective opens in a new window. The figure below displays multiple instances of an active debug session.

Figure 63: Viewing Multiple Instances of Active Debug Session

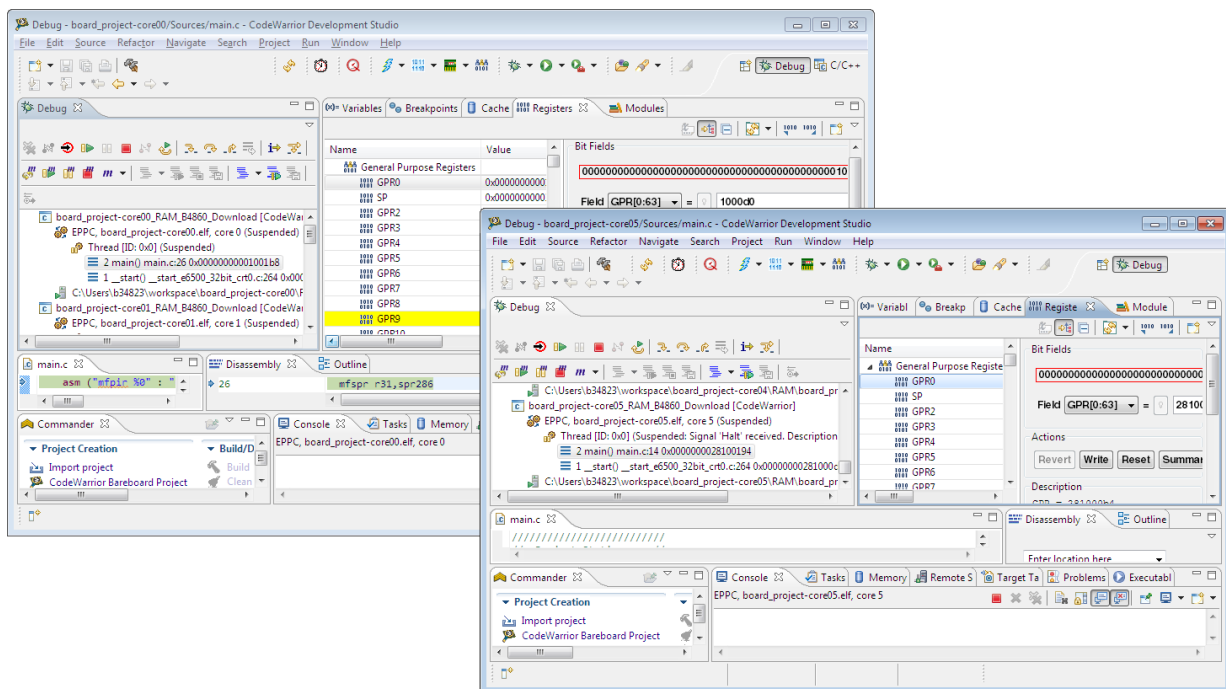

8. Select a thread from core 1 in the **Debug** view of the newly opened **Debug - <project>** window.

All the views in the **Debug** perspective will be updated to display the debug session for the selected core.

9. Select and expand the **External Debug Registers** group.

10. Select **Run > Step Over**.





The following actions occur:

- Debugger executes the current statement and halts at the next statement.
- The program counter (PC) indicator moves to the next executable source line in the Source view.

11. Issue several more **Step Over** commands and watch the register values change.

12. Select `main()` thread from core 0 again.

Notice that the register values remain unchanged. This is because the CodeWarrior debugger controls each core's execution individually.

13. With core 0 still selected, click the **Step Over**  button several times until you reach the `printf()` statement.
Debugger executes the current statement, the following statements, and halts at the `printf()` statement.
14. Switch to the other debug window.
15. Select the `main()` thread for core 1 by clicking it. Notice that the program counter icon in the Source view did not move. The debugger controls the execution of each core individually.
16. In the **Debug** view, click the **Resume**  button.
Core 1 enters an infinite loop. The status of the program changes to (Running).
17. In the **Debug** view, click the `main()` thread for core 0 and click the **Resume**  button.
Core 0 enters an infinite loop and core 1 continues to execute in its loop.
18. Select `main()` thread from core 1 and click the **Suspend**  button.
The debugger halts core 1 at the current statement and the status of the program changes to (Halted). Core 0 continues to execute.
19. Select **Run > Multicore Terminate**.
The debugger terminates the active debug session. The threads associated with each core in the **Debug** view disappear.

6.2 Multi-Core Debugging Commands

This section describes the multi-core commands available in the **Run** menu of CodeWarrior IDE and in the Debugger Shell.

If you are debugging a multi-core project, you can use single and multi-core debugging commands to debug parts of each core project.

This section contains the following subsections:

- [Multi-Core Commands in CodeWarrior IDE](#) on page 221
- [Multi-Core Commands in Debugger Shell](#) on page 222

6.2.1 Multi-Core Commands in CodeWarrior IDE

This section describes the multi-core commands in the CodeWarrior IDE.

When you start a multi-core debug session, multi-core commands are enabled on the CodeWarrior IDE **Run** menu. These commands, when issued, affect all cores simultaneously. The table below describes each menu choice. For detailed information on these commands, see *CodeWarrior Development Studio Common Features Guide*.

Table 125: Multi-Core Debugging Commands





Command	Icon	Description
Multicore Resume		Starts all cores of a multi-core system running simultaneously.

Table continues on the next page...

Table 125: Multi-Core Debugging Commands (continued)

Command	Icon	Description
Multicore Suspend		Stops execution of all cores of a multi-core system simultaneously.
Multicore Restart		Restarts all the debug sessions for all cores of a multi-core system simultaneously.
Multicore Terminate		Kills all the debug sessions for all cores of a multi-core system simultaneously.
Multicore Groups		<p>Use All Cores: If the selected debug context is a multi-core system, then all cores are used for multi-core operations.</p> <p>Disable Halt Groups: Disables breakpoint halt groups. For more information on halt groups, see "Multicore Breakpoint Halt Groups" in <i>CodeWarrior Development Studio Common Features Guide</i>.</p> <p>Limit new breakpoints to current group: If selected, all new breakpoints set during a debug session are reproduced only on cores belonging to the group of the core on which the breakpoint is set.</p> <p>Edit Target Types: Opens Target Types dialog that lets you add and remove system types.</p> <p>Edit Multicore Groups: Opens the Multicore Groups dialog to create multi-core groups. You can also use this option to modify the existing multi-core groups.</p>

NOTE

For more information about creating/modifying multi-core groups, or editing target type, see "Multicore Groups" in *CodeWarrior Development Studio Common Features Guide*.

To use the multi-core commands from the **Debug** perspective, follow these steps:

1. Start a debugging session by selecting the appropriately configured launch configuration.
2. If necessary, expand the desired core's list of active threads by clicking on the tree control in the **Debug** view.
3. Click the thread you want to use with multi-core operations.
4. From the **Run** menu, specify the multi-core operation to perform on the thread.

NOTE

The keyboard shortcut for the **Multicore Resume** operation is Alt+Shift+F8.

6.2.2 Multi-Core Commands in Debugger Shell

This section describes the multi-core commands in debugger shell.

In addition to the multicore-specific toolbar buttons and menu commands available in the **Debug** view, the **Debugger Shell** has multi-core specific commands that can control the operation of one or more processor cores at the same time. Like the menu commands, the multi-core debugger shell commands allow you to select, start, and stop a specific core. You can also restart or kill sessions executing on a particular core. The table below lists and defines the affect of each multi-core debugging command.

Table 126: Multi-Core Debugging Commands

Command	Shortcut	Description
mc::config	mc::c	List or edit multicore group options. Syntax mc::config
mc::go	mc::g	Resume multiple cores Syntax mc::go Examples mc::go Resumes the selected cores associated with the current thread context.
mc::group	mc::gr	Display or edit multicore groups Syntax group group new <type-name> [<name>] group rename <name> <group-index> <new-name>group remove <name> <group-index> ... group removeall group enable disable <index> ... all Examples mc::group Shows the defined groups, including indices for use in the mc::group rename enable remove set of commands. mc::group new 8572 Creates a new group for system type 8572. The group name will be based on the system name and will be unique. The enablement of the group elements will be all non-cores enabled, all cores disabled. mc::group rename 0 "My Group Name" Renames the group at index 0 to "My Group Name". mc::group enable 0 0.0 Enables the group at index 0 and the element at index 0.0 of the mc::group command. mc::group remove "My Group Name" Removes the group named "My Group Name". mc::group removeall Removes all groups.

Table continues on the next page...

Table 126: Multi-Core Debugging Commands (continued)

Command	Shortcut	Description
mc::kill	mc::kill	<p>Terminates the debug session for selected cores associated with the current thread context.</p> <p>Syntax</p> <pre>mc::kill</pre> <p>Examples</p> <pre>mc::kill</pre> <p>Terminates multiple cores.</p>
mc::reset	mc::reset	<p>Resets multiple cores.</p> <p>Syntax</p> <pre>mc::reset</pre>
mc::restart	mc::restart	<p>Restarts the debug session for selected cores associated with the current thread context.</p> <p>Syntax</p> <pre>mc::restart</pre> <p>Examples</p> <pre>mc::restart</pre> <p>Restarts multiple cores.</p>
mc::stop	mc::stop	<p>Stops the selected cores associated with the current thread context.</p> <p>Syntax</p> <pre>mc::stop</pre> <p>Examples</p> <pre>mc::stop</pre> <p>Suspends multiple cores.</p>

Table continues on the next page...

Table 126: Multi-Core Debugging Commands (continued)

Command	Shortcut	Description
mc::type	mc::t	<p>Shows the system types available for multicore debugging as well as type indices for use by the <code>mc::type remove</code> and <code>mc::group new</code> commands.</p> <p>Syntax</p> <pre>type type import <filename> type remove <filename> <type-index> ... type removeall</pre> <p>Examples</p> <pre>mc::type</pre> <p>Display or edit system types.</p> <pre>mc::type import 8572_jtag.txt</pre> <p>Creates a new type from the JTAG configuration file.</p> <pre>mc::type remove 8572_jtag.txt</pre> <p>Removes the type imported from the specified file.</p> <pre>mc::type removeall</pre> <p>Removes all imported types.</p>

Chapter 7

Debugging Embedded Linux Software

This chapter explains how to use the CodeWarrior Development Studio tools to debug embedded Linux[®] software for Power Architecture[®] processors.

NOTE

This chapter documents debugger features that are specific to the CodeWarrior for Power Architecture Processors product. For more information on debugger features that are in all CodeWarrior products, see *CodeWarrior Development Studio Common Features Guide* from the `<CWInstallDir>\PA\Help\PDF\` folder.

This chapter includes the following sections:

- [Debugging a Linux Application](#) on page 227
- [Viewing multiple processes and threads](#) on page 236
- [Debugging applications that use fork\(\) and exec\(\) system calls](#) on page 237
- [Debugging a shared library](#) on page 247
- [Preparing U-Boot for debugging](#) on page 255
- [Debugging U-Boot using NOR, NAND, SPI, and SD Card/MMC Flash Devices](#) on page 262
- [Debugging the Linux Kernel](#) on page 283
- [Debugging Loadable Kernel Modules](#) on page 307
- [Debugging Hypervisor Guest Applications](#) on page 312
- [Debugging the P4080 Embedded Hypervisor](#) on page 320
- [User Space Debugging with On-Chip Debug](#) on page 329

7.1 Debugging a Linux Application

This section describes CodeWarrior Target-Resident Kernel (TRK) and provides information related to using it with CodeWarrior projects.

For embedded Linux development, CodeWarrior TRK is a user-level application that resides on target embedded Linux systems and accepts connections from the CodeWarrior debugger. You use the CodeWarrior remote connections feature to download and debug applications built with CodeWarrior projects. The CodeWarrior debugger connects to CodeWarrior TRK on the remote target system through a serial or ethernet connection.

On embedded Linux systems, CodeWarrior TRK is packaged as a regular Linux application, named `apptrk`. This application runs on the remote target system along side the program you are debugging to provide application-level debug services to the CodeWarrior debugger.

To debug a Linux application using CodeWarrior TRK:

- [Install CodeWarrior TRK on Target System](#) on page 228
- [Start CodeWarrior TRK on Target System](#) on page 228
- [Create a CodeWarrior Download Launch Configuration for the Linux Application](#) on page 230
- [Specify Console I/O Redirections for the Linux Application](#) on page 233
- [Debug the Linux Application](#) on page 236

7.1.1 Install CodeWarrior TRK on Target System

This section talks about installation of CodeWarrior TRK on target system.

To connect the CodeWarrior debugger to CodeWarrior TRK, the CodeWarrior TRK binary executable file must be installed and running on the remote target system. When CodeWarrior TRK starts running on the target system, the debugger can upload your application and debug the application on the target system.

NOTE

If CodeWarrior TRK is not present on a given target system, you need to use a file transfer facility, such as Secure Copy (SCP) or File Transfer Protocol (FTP) to download the CodeWarrior TRK binary executable file, `AppTRK.elf`, to a suitable location on the file system of the target system. You also need to place the unstripped versions of the `ld.so`, `libpthread.so`, and `libthread_db.so` files in the `/lib` directory of the target system to debug shared library code or multi-threaded code with CodeWarrior TRK.

7.1.2 Start CodeWarrior TRK on Target System

This section explains how to start CodeWarrior TRK on target system.

How you start CodeWarrior TRK on the target hardware depends on the type of connection between the host computer and that target hardware:

- **Transmission Control Protocol / Internet Protocol (TCP/IP):** The host computer communicates with the target hardware over a TCP/IP connection
- **Serial cable:** A serial cable connecting the host computer to the target hardware

CodeWarrior TRK can be started as either a root user or a normal user; however, if the application to be debugged requires root permission, then you need to start CodeWarrior TRK as a root user. In other words, CodeWarrior TRK must have all the privileges required by the application that it will debug. You also need to ensure that the download directory specified in the **Remote** tab of the launch configuration matches the user privileges of the CodeWarrior TRK running on the target system.

This section contains the following subsections:

- [TCP/IP Connections](#) on page 228
- [Serial Connections](#) on page 229

7.1.2.1 TCP/IP Connections

This section explains how to start CodeWarrior TRK using a TCP/IP connection.

To start CodeWarrior TRK through a TCP/IP connection:

1. Connect to the remote target system.
 - a. On the host computer, open a new terminal window.
 - b. At the command prompt in the terminal window, enter the following command, where `IPAddress` represents the target system's IP address:

```
telnet IPAddress
```

The telnet client connects to the telnet daemon on the target system.

2. Navigate to the directory that contains the `AppTRK.elf` binary executable file.

The system changes the current working directory.

3. Type the following command (where *Port* is the listening port number optionally specified in the Connections panel of Debug window- typically 1000):

```
./AppTRK.elf :Port
```

CodeWarrior TRK starts on the target system, and listens to the specified TCP/IP port for connections from the CodeWarrior IDE.

TIP

To continue use of the terminal session after launching CodeWarrior TRK, start CodeWarrior TRK as a background process by appending the ampersand symbol (&) to the launch command. For example, to start CodeWarrior TRK as a background process listening to TCP/IP port number 6969, you would enter the following command:

```
./AppTRK.elf :6969 &
```

7.1.2.2 Serial Connections

This section explains how to launch CodeWarrior TRK using a serial connection.

To launch CodeWarrior TRK through a serial connection:

TIP

To improve your debugging experience, we recommend the host computer running the IDE have two serial ports. In an ideal scenario, you would connect one serial port of the host computer to the first serial port of the target board to monitor startup and console log messages. You would then connect another serial port of the host computer to the second serial port of the target board; the debugger would use this connection to communicate with CodeWarrior TRK on the target system.

1. Connect a serial cable between the host computer's serial port and the second serial port of the target system.
2. On the host computer, start a terminal emulation program (such as minicom).
3. Configure the terminal emulation program with baud rate, stop bit, parity, and handshake settings appropriate for the target system.
4. Connect the terminal emulator to the target system.

A command prompt appears in the terminal emulation program.

5. Boot the system. Log in as the root user.
6. Use the `cd` command at the command prompt to navigate to the directory where the CodeWarrior TRK binary executable file, `AppTRK.elf`, resides on the target system.

The system changes the current working directory.

7. Configure the serial port on which CodeWarrior TRK is going to connect.

- a. Enter this command: `stty -F /dev/ttyS1 raw`

This command configures the serial port for raw mode of operation. If you do not use raw mode, special characters sent as part of packets may be interpreted (dropped), causing the connection to break.

- b. Enter this command: `stty -F /dev/ttyS1 ispeed 115200`

The serial input speed is set to 115200 baud.

- c. Enter this command: `stty -F /dev/ttyS1 ospeed 115200`

The serial output speed is set to 115200 baud.

- d. Enter this command: `stty -F /dev/ttyS1 crtscts`

The terminal emulation program enables handshake mode

- e. Enter this command: `stty -a -F /dev/ttyS1`

The system displays the current device settings.

8. Enter the command: `./AppTRK.elf /dev/ttyS1`

CodeWarrior TRK launches on the remote target system.

7.1.3 Create a CodeWarrior Download Launch Configuration for the Linux Application

This section explains how to create a CodeWarrior download launch configuration for debugging a Linux application on target system.

To create a CodeWarrior download launch configuration, perform the following steps:

1. In the **CodeWarrior Projects** view of the **C/C++** perspective, select the name of the project that builds the Linux application.

2. Select **Run > Debug Configurations**.

The **Debug Configurations** dialog appears.

3. Select CodeWarrior on the left-hand side of the **Debug Configurations** dialog.

4. Click the **New launch configuration** toolbar button of the **Debug Configurations** dialog.

The IDE creates a new launch configuration under the **CodeWarrior** group. The settings pages for this new launch configuration appear on the right-hand side of the **Debug Configurations** dialog.

5. In the **Main** tab of the **Debug Configuration** dialog:

- a. Select **Download** from the **Debug session type** group.
- b. Click **New** next to the **Connection** drop-down list.

The **New Connection** wizard appears.

6. Expand the **CodeWarrior Application Debugging** group and select **Linux AppTRK**, as shown in the figure below.

Figure 64: Remote System - New Connection Wizard

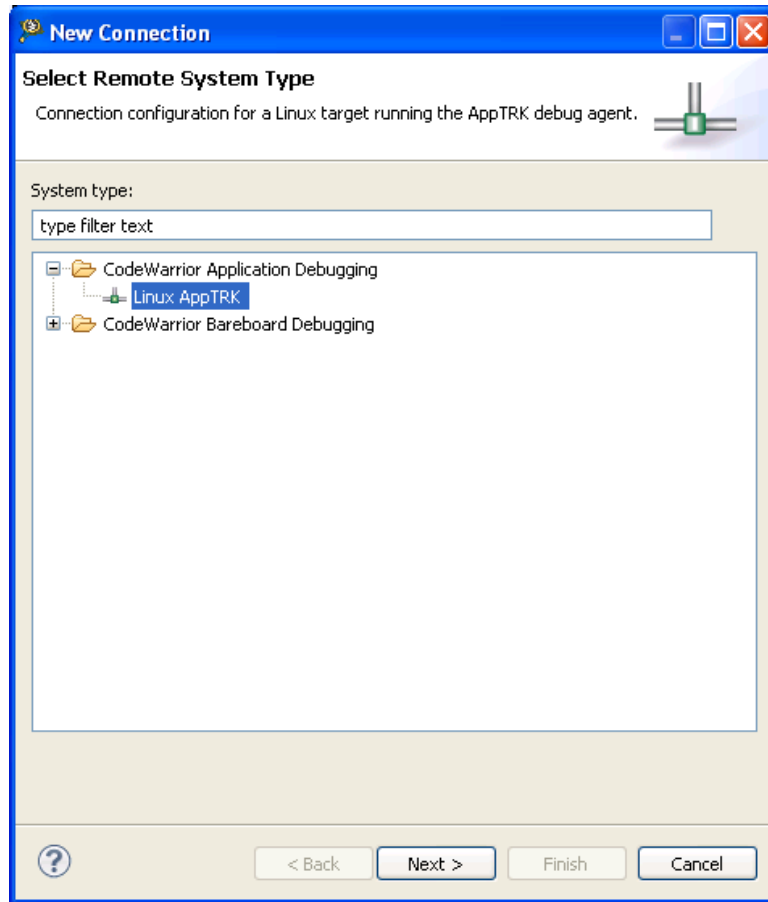

7. Click **Next**.

The **Linux AppTRK** page appears.

8. Specify the connection name, description, template and connection type on this page.

9. When you select the connection type, the corresponding Connection tab appears (shown in the figure below).

Figure 65: Remote Linux AppTRK System Connection Page

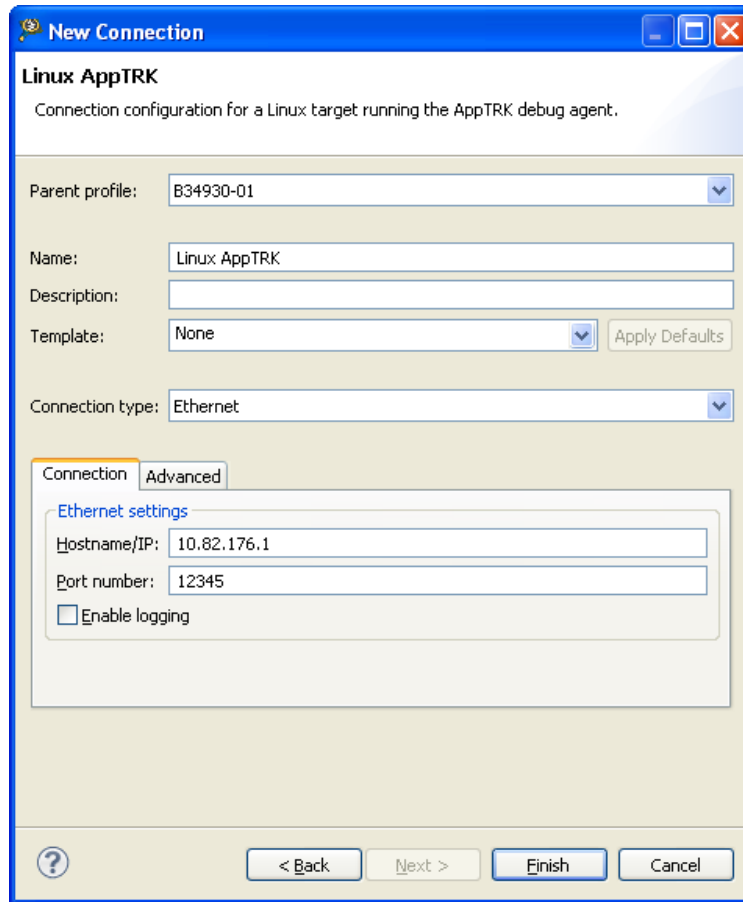

10. Specify the settings as appropriate for the connection between the host computer and the target hardware on this page.

11. Click **Finish**.

The new remote system that you just created appears in the **Connection** drop-down list.

12. Click the **Debugger** tab.

The **Debugger options** panel appears with the respective tabs.

13. On the **Debug** tab, if required, specify a function or address in the application where you want the program control to stop first in the debug session:

a. Select the **Stop on startup at** checkbox.

The IDE enables the corresponding text box.

b. Enter in the text box an address or a function inside the application.

14. Click the **Remote** tab.

The corresponding sub-page comes forward.

15. Enter in the **Remote download path** text box the path of a target-computer directory to which the Linux application, running on the target hardware, can read and write files.

NOTE

The specified directory must exist on the target system.

16.If required, specify information about other executable files to debug in addition to the Linux application:

- a. Click the **Other Executables** tab.

The corresponding sub-page appears.

- b. Use the sub-page settings to specify information about each executable file.

17.Click **Apply**.

The IDE saves the pending changes you made to the launch configuration.

You just finished creating a CodeWarrior download launch configuration that you can use to debug the Linux application.

7.1.4 Specify Console I/O Redirections for the Linux Application

CodeWarrior TRK allows you to specify I/O redirections as arguments for applications to be debugged.

This feature allows users to use a file on the target or even the target console for file descriptors, including `stdin`, `stdout`, and `stderr`. By default, the CodeWarrior TRK running on the target forwards the output of the application to the host CodeWarrior. The host CodeWarrior will be able to print the received output only if the **Allocate Console (necessary for input)** checkbox is selected in the **Common** tab of the **Debug Configurations** dialog.

NOTE

The CodeWarrior console, allocated for the debugged application, can only be used to view the output of the application running on the target; forwarding the input from a CodeWarrior console to the debugged application is not supported currently for Linux applications.

The listing below displays the syntax to specify I/O redirections for the `stdin`, `stdout`, and `stderr` file descriptors.

Figure 66: Specifying I/O Redirections

```
- '< <filename>' - stdin redirection from <filename>
- '> <filename>' - stdout redirection to <filename>
- '> <filename>' - stderr redirection to <filename>
```

To specify I/O redirections for a Linux application:

1. In the **CodeWarrior Projects** view of the C/C++ perspective, select the name of the project that builds the Linux application.

2. Select **Run > Debug Configurations**.

The **Debug Configurations** dialog appears.

3. Expand **CodeWarrior** group and select the launch configuration associated with the project.

The settings pages for the selected launch configuration appears on the right-hand side of the **Debug Configurations** dialog.

4. Click the **Arguments** tab.

5. Specify the I/O redirections in the **Program arguments** text box.

6. Click **Apply** to save the changes.

The listing below displays an example of redirections, added to the list of arguments, to forward the output to the console where CodeWarrior TRK was started.

Figure 67: Sample I/O Redirections

```
- '< /proc/self/fd/0' -> use target console for stdin (this way, stdin  
is functional and can be used - using a CW console it isn't)  
- '> /proc/self/fd/1' -> use target console for stdout  
- '2> /proc/self/fd/2' -> use target console for stderr
```

7.1.5 Configure Linux Process Signal Policy

This section explains how to control applications being debugged using signals and how to manage signals, using CodeWarrior IDE.

AppTRK and CodeWarrior can be configured to stop the application being debugged, whenever the application receives a signal. A user can send signals to the application directly from CodeWarrior, when the application resumes execution. To send a signal to an application, right-click the signal name in the **Signals** view and select **Resume With Signal** from the context menu that appears.

This section contains the following subsections:

- [Signal Inheritance](#) on page 234
- [Default Signal Policy](#) on page 234
- [Modifying Signal Policy](#) on page 234

7.1.5.1 Signal Inheritance

When a new process is forked, it inherits the signal settings from the parent process.

For example, if a process has a setting that if the SIGUSR1 signal is received, the application being debugged will be stopped, then a child process forked by this process will also inherit this setting. It will stop the application being debugged if the SIGUSR1 signal is received.

All the threads created by a process share the signal settings of that process. Signal settings cannot be configured at thread level.

7.1.5.2 Default Signal Policy

By default, the SIGINT, SIGILL, SIGTRAP, SIGSTOP, and SIGSEGV signals are caught by the debugger. The debugger stops the application being debugged if any of these signals is received.

7.1.5.3 Modifying Signal Policy

CodeWarrior IDE provides a view, Signals, which can be used to view signals and change the debugger's policy for a signal.

To open the Signals view, perform the following steps:

1. Select **Window > Show View > Other** in the CodeWarrior IDE.

The **Show View** dialog appears.

2. Select **Debug > Signals**.

The **Signals** view appears, as shown in the figure below.

Figure 68: Signals View

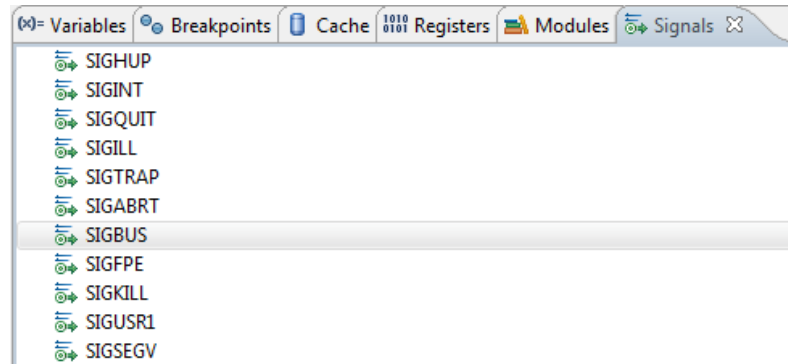

To send a signal to a stopped process or thread, right-click the signal in the **Signals** view and select **Resume With Signal**, as shown in the figure below.

Figure 69: Sending a Signal to a Process or Thread

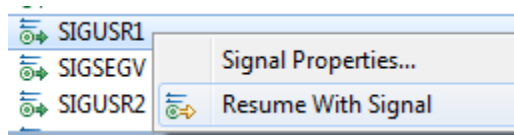

To catch a signal, perform the following steps:

1. Right-click the signal in the **Signals** view and select **Signal Properties**.
 The **Properties** for window appears (shown in the figure below).
2. Select the **Suspend the program when this signal happens** checkbox, as shown in the figure below.

Figure 70: Catching a Signal

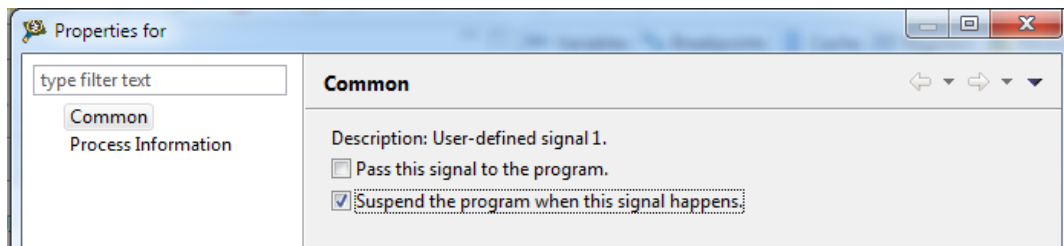

The figure below shows a child process stopped on receiving the SIGUSR1 signal.

Figure 71: A Stopped Child Process

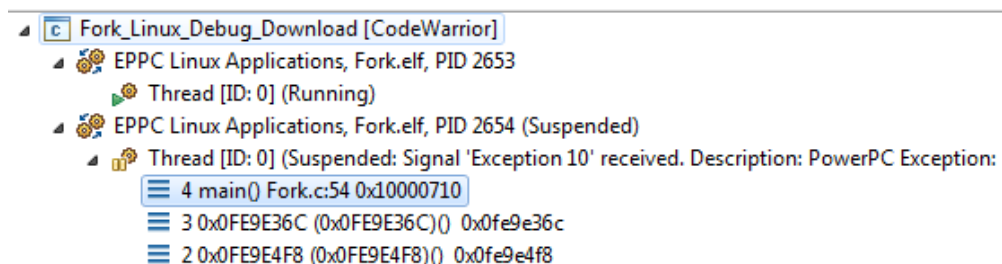

Some signals cannot be caught, but they can be passed to the debugged application. These signals have read-only properties. One such signal is SIGKILL.

7.1.6 Debug the Linux Application

You can use the CodeWarrior download launch configuration created earlier to debug the Linux application on the target system.

To debug the Linux application, perform the following steps:

1. On the left-hand side of the **Debug Configurations** dialog, ensure to select the CodeWarrior download launch configuration that you created to debug the Linux application.
2. Click **Debug** in the **Debug Configurations** dialog.

The IDE uses the selected CodeWarrior download launch configuration to start a debug session and opens the **Debug** view, as shown in the figure below.

Figure 72: Debug View - A Sample Linux Application

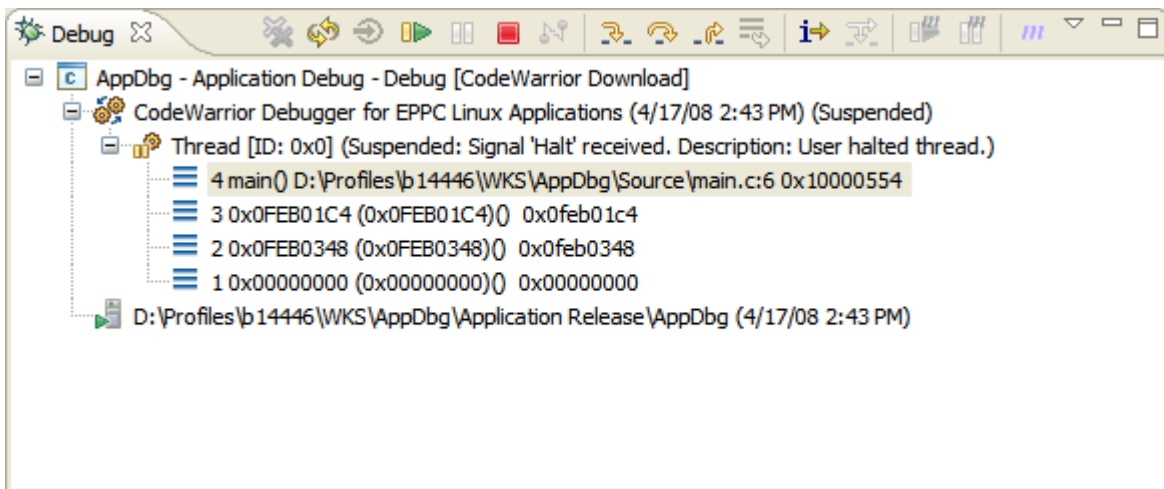

You just finished using the CodeWarrior download launch configuration to debug a Linux application.

7.2 Viewing multiple processes and threads

This section explains how to view all processes and threads on a target.

When you debug an application, the CodeWarrior debugger opens the **Debug** view. In this view, you can see only processes and threads/tasks on which debugger is attached, as shown in the figure below.

Figure 73: Debug view - processes and threads

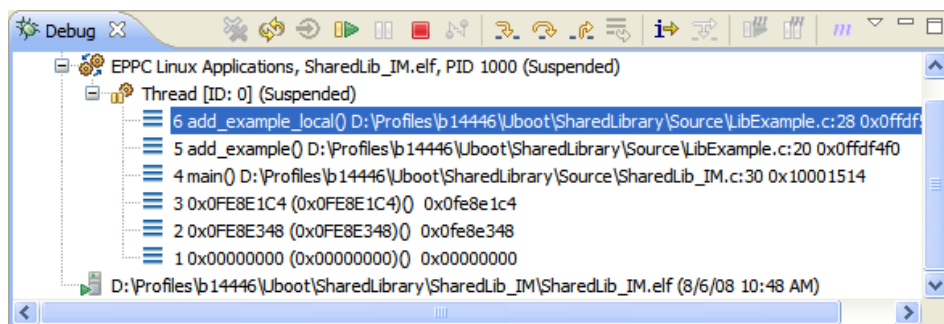

For Linux debugging, you can view all processes on a target in the **System Browser** view.

To view processes and threads in **System Browser** view:

1. Open a Linux application in the CodeWarrior IDE.
2. Select **Run > Debug**.
 The **Debug** perspective appears.
3. While the application is running, select **Window > Show View > Other**.
 The **Show View** dialog appears.
4. From the **Debug** group, select **System Browser**.
5. Click **OK**.

The **System Browser** view appears with the process and thread information (shown in the figure below).

Figure 74: System Browser view

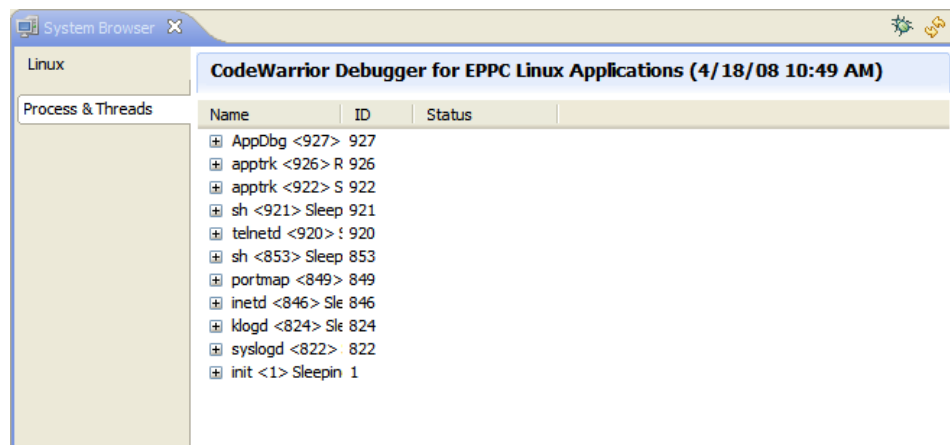

7.3 Debugging applications that use fork() and exec() system calls

This section describes how to use the CodeWarrior debugger to debug programs that contain `fork()` and `exec()` system calls.

The table below describes the `fork()` and `exec()` system calls.

Table 127: fork() and exec() Description

System Call	Description
<code>fork()</code>	This generic Linux system call creates a new process that is the exact replica of the process that creates it. This call returns 0 to the child process and returns the PID (Process ID) of the newly-created child process to the parent process.
<code>exec()</code>	This Linux system call launches a new executable in an already running process. The debugger destroys the instance of the previous executable loaded into that address space and a new instance is created.

NOTE

You can also pick up sample Linux applications from the following folder:

```
<CWInstallDir>\PA\CodeWarrior_Examples\Linux_Examples
```

For CodeWarrior debugging purposes, when applications call the `fork()` system call, the debugger instead calls the `clone()` system call with the flag `CLONE_PTRACE`. This causes:

- The operating system to attach CodeWarrior TRK to the child process
- The child process to stop with a `SIGTRAP` on return from the `clone()` system call

To make this happen, you must add a static library to your CodeWarrior project. The source code for building the static library is described later in this section.

Before you start following the steps given in this section, ensure that you have:

- Installed the BSP on Linux
- Created a TCP/IP connection between the host computer and the remote target
- Launched CodeWarrior TRK on the target system

These steps demonstrate how to use the CodeWarrior IDE to debug programs that contain `fork()` and `exec()` system calls:

1. Create a CodeWarrior project with the settings listed in the table below.

Table 128: Static Library Project Settings

Option Name	Value
Project name	Fork
Location	<workspace-dir>\Fork
Project type	Linux application
Language	C

The IDE creates a project with a debug launch configuration.

2. Create a new build configuration. Right-click on the project folder and select **Build Configurations > Manage**.

The **Fork: Manage Configurations** dialog appears.

3. Rename the default debug configuration to `Fork`.
4. Click **New** to create a new build configuration.

The **Create New Configuration** dialog appears.

5. In the **Name** field, enter the configuration name, `Fork2clone`.
6. From the **Copy settings from** options, select **Existing configuration**.
7. Click **OK**. The **Fork: Manage Configurations** dialog appears (shown in the figure below).

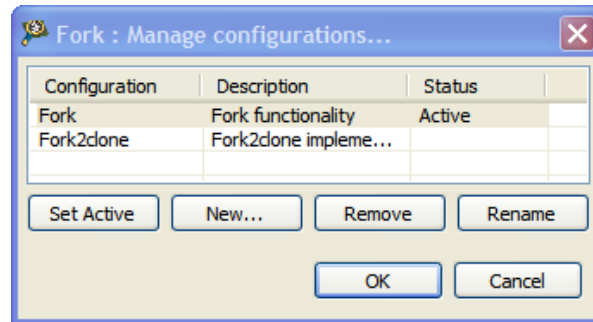

Figure 75: Fork: Manage Configurations Dialog Box



8. Activate the `Fork2clone` build configuration.
9. Build the `Fork2clone` build configuration by right-clicking it in the **CodeWarrior Projects** view and selecting **Build Project** from the context menu. The CodeWarrior IDE builds the project and stores the support library, `libfork2clone.a`, in the *Output* directory within the project directory.

NOTE

Remember to build the `Fork2clone` build configuration before the `Fork` build configuration to avoid getting a library file missing error as the `libfork2clone.a` is used in the `Fork` project.

10. To specify the linker settings and add the support library to the project.
 - a. Right-click the `Fork` build configuration in the **CodeWarrior Projects** view.
 - b. Select **Properties** from the context menu. The **Properties** window for the shared library project appears.
 - c. From the **C/C++ Build** group, select **Settings**.
 - d. On the **Tool Settings** page, from the **Power ELF Linker** container, select **Libraries**.
 - e. In the **Libraries (-l)** panel, click **Add** (). The **Enter Value** dialog appears.
 - f. Enter the library file name in the **Libraries** field.
 - g. In the **Libraries search path (-L)** panel, click **Add** (). The **Add directory path** dialog appears.
 - h. Enter the library path in the **Directory** field, as shown in the figure below.

NOTE

These settings enable the CodeWarrior IDE linker to locate the shared library `libfork2clone.a`. For detailed information on other linker command line arguments, see GNU linker manuals. You can find GNU documentation here: <http://www.gnu.org>.

Figure 76: Libraries Linker Settings - Fork Project

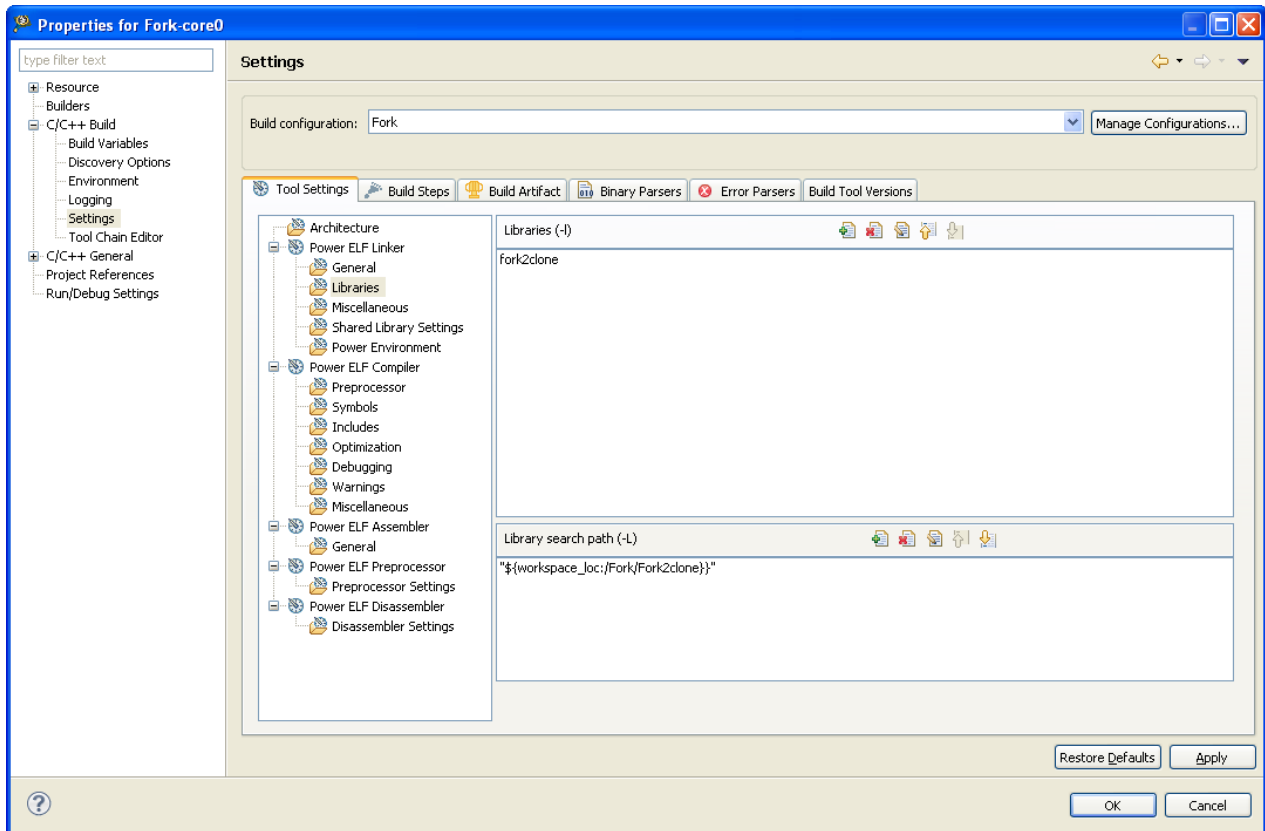

11. Remove the default main.c file from the project.
12. Add a new db_fork.c file to the project.
13. Enter the below code in the editor window of db_fork.c file.

Figure 77: Source Code for db_fork.c

```

/*
-----

User Include files

-----

*/

#include "db_fork.h"

/*
-----

Main Program

-----

*/
    
```



```
int __libc_fork(void)
{
    return( __db_fork() );
}

extern __typeof ( __libc_fork ) __fork __attribute__ ((weak, alias
("__libc_fork")));

extern __typeof ( __libc_fork ) fork __attribute__ ((weak, alias
("__libc_fork")));
```

14. Create a header file `db_fork.h` in your project directory and add the below code in the header file.

Figure 78: Source Code for db_fork.h

```
#include <asm/unistd.h>
#include <sys/syscall.h>
#include <errno.h>
#include <signal.h>
#include <sched.h>
#define __NR__db_clone __NR_clone
#define __db_fork()
syscall(__NR__db_clone, SIGCHLD | CLONE_PTRACE, 0);
```

15. Enter the below code in the editor window of `fork.c` file.

Figure 79: Source Code for fork.c

```
/*
/*
 * fork.c
 *
 */
/*-----*
System Include files
*-----*/
#include <stdio.h>
#include <unistd.h>
#include <stdlib.h>
#include <sys/ptrace.h>
```

```

#include <sys/errno.h>

#include <sys/types.h>

#include <signal.h>

#include <sched.h>

#include <fcntl.h>

#include <dlfcn.h>

/*-----*

Function Prototypes

*-----*/

int fn1(int j);

int fn2(int i);

/*-----*

Global Variables

*-----*/

int gint;

/*-----*

Main Program

*-----*/

int main(void)
{
    int pid,x;

    int shared_local;

    printf( "Fork Testing!\r\n" );

    fflush( stdout );

    gint = 5;

    shared_local =5;

    pid = fork();

    if(pid == 0)

    {

        x=0;

```

```
gint = 10;

shared_local = fn1(9);

printf("\nForked : Child");

printf("\nChild:Global=%d,Shared_Local=%d",gint,shared_local);

printf("\nChild pid = %d, parent pid =%d \n", getpid(),getppid());

fflush( stdout );

}

else

{

x=0;

gint = 12;

shared_local = fn2(11);

printf("\nForked : Parent");

printf("\nParent:Global=%d,Shared_Local=%d",gint,shared_local);

printf("\nParent pid = %d, Parent's parent pid =%d \n",

getpid(),getppid());

fflush( stdout );

}

return 0;

}

int fn1(int j)

{

j++;

return j;

}

int fn2(int i)

{

i++;

return i;

}
```

```
}

```

The code of the parent process creates a forked process (child process) when the `__db_fork` function executes. The debugger opens a separate thread window for the child process. When the child process finishes executing, the debugger closes the thread window. To debug the code of the child process, you need to set a breakpoint in the child process code. You can debug the code of the child process the same way you debug code of any other process.

16. Create another project, `Exec`, and create two new build configurations with the following settings:

Table 129: Exec Example Project Settings

Option Name	Value
Project name	Exec
Location	<workspace-dir>\Exec
Project type	Linux application
Language	C
Build configurations	<ul style="list-style-type: none"> • Exec • Exec-1

17. Add the source files `exec.c` and `exec-1.c` to the `Exec` project.

- `exec.c`: The code demonstrating `exec()` functionality
- `exec-1.c`: Generates the executable file `exec-1.elf`

As you step through the code of the `exec.elf` file, the `exec()` function call executes and a separate debugger window for the `exec-1.elf` appears. You can perform normal debug operations in this window. The debugger destroys the instance of the previous file (`exec.elf`) and creates a new instance for the `exec-1.elf` file.

18. Enter the below code in the editor window of `Exec.c` file.

Figure 80: Source Code for Exec.c

```
/** Exec.c
 *
 * Demonstrates Exec system call functionality
 */

/*-----*
 * System Include files
 *-----*/
#include <stdio.h>
#include <unistd.h>

/*-----*
 * Constant Defintions
 *-----*/
#define EXEC_1    "/tmp/Exec-1.elf"

/*-----*
 * Main Program
 *-----*/
int main(void)
{

```

```
char *argv[2];
printf("Exec Testing!\r\n" );
printf("Before exec my ID is %d\n",getpid());
printf("My parent process's ID is %d\n",getppid());
fflush( stdout );

/*Calling another program exec-1.elf*/
argv[0] = EXEC_1;
argv[1] = NULL;
printf("exec starts\n");
execv(argv[0],argv);
printf("This will not print\n");
fflush( stdout );
return 0;
}
```

19. Enter the below code in the editor window of `Exec-1.c` file.

Figure 81: Source Code for Exec-1.c

```
/** Exec-1.c *
Demonstrates Exec system call functionality */
/*-----*
System Include files
*-----*/
#include <stdio.h>
#include <unistd.h>
/*-----*
Main Program
*-----*/
int main(void) {
    printf("After exec my process ID is %d\n",getpid());
    printf("My parent process's ID is %d\n",getppid());
    printf("exec ends\n");
    fflush( stdout );
    return 0;
}
```

20. Create the build configurations for building `Exec.elf` and `Exec-1.elf` (similar to creating the build configurations for the `Fork` project).

21. Build `Exec` project.

- a. Select the `Exec` build configuration, if not selected.
- b. Select **Project > Build Project**.

The CodeWarrior IDE generates the `exec.elf`, and `exec-1.elf` executable files and places them in the project folder.

22. Specify the remote download path of the executable files to be launched by the `exec()` system call.

- a. Select **Run > Debug Configurations** to open the **Debug Configurations** dialog.
- b. In the left panel from the **CodeWarrior** group, select the `Exec` launch configuration.
- c. On the **Debugger** page, click the **Remote** tab.
- d. Type `/tmp` in the **Remote Download Path** field, as shown in the figure below. This specifies that the final executable file will be downloaded to this location on the target platform for debugging.

NOTE

In the current example, the remote download path is specified as /tmp. If you wish, you may specify an alternate remote download path for the executable file.

Figure 82: Remote Download Path - Shared Library Project

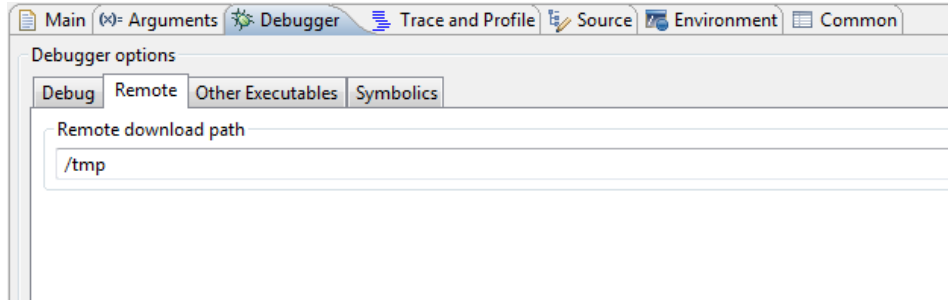

23. Specify the host-side location of the executable files to be launched by the `exec()` system call.

- a. Click the **Other Executables** tab.
- b. Click **Add**. The **Debug Other Executable** dialog appears.
- c. Click **File System**. The **Open** dialog appears.
- d. Navigate to the location of the `exec-1.elf` file in your project directory.
- e. Select the `exec-1.elf` file name.
- f. Click **Open**. The host-side location of `exec-1.elf` appears in the **Additional Executable File** text box.
- g. Select the **Load Symbols** checkbox.
- h. Select the **Download to Device** checkbox. The **Specify the remote download path** field is activated.

NOTE

If you do not want to download the selected file on the target platform, do not select the **Download to Device** checkbox.

- i. Type `/tmp` in the **Remote download path** text box. The shared library will be downloaded to this location when you debug or run the executable file.
- j. Click **OK**. The settings are saved.

24. Click **Apply** to save the settings made to the launch configuration.

25. Set breakpoints in the child and parent processes.

- a. Double-click the `fork.c` file name in the **CodeWarrior Projects** view.
- b. Set a breakpoint in the code of the child process at this line: `x=0;`
- c. Set a breakpoint in the code of the parent process.
- d. Close the `fork.c` file.

26. Select **Run > Debug**.

The debugger window appears and the `Fork` project starts debugging. As a result, the `Fork.elf` and `libfork2clone.a` files are downloaded on the target system.

27. Step over the code until you reach the line of code that calls the `fork()` system call: `pid = fork();`

When the `fork()` system call is called, the child process debugger window appears. You can now perform normal debugging operations in this window.

28. Step over the code in the child process debugger window a couple of times.
29. Next, step over the code in the parent process debugger window a couple of times.

NOTE

The console window of the parent process is shared by the child process.

30. Terminate the debug session.
31. Clear previously set breakpoints.
32. Select **Run > Debug** for `Exec` project.
33. Set a breakpoint in the `Exec.c` file on the line containing the `execv()` function call.
34. Click **Resume**. The target stops at the line where you set the breakpoint.
35. Click **Resume**. The `exec()` call is executed and the debugger stops in the `main()` function of the `Exec-1.elf` file.
36. Execute some steps in `Exec-1.c` file.
37. Terminate the debug session and remove all breakpoints.

7.4 Debugging a shared library

CodeWarrior allows you to perform source-level debugging of shared libraries.

When you debug an executable file using a shared library, you can step into the shared library code. This section demonstrates how to debug a shared library that is implicitly linked to an application.

In this section:

- [Create an example project](#) on page 247
- [Configure the shared library build configuration](#) on page 250
- [Configure the executable build configuration](#) on page 250
- [Build the shared library](#) on page 251
- [Build the executable](#) on page 251
- [Configure the launch configuration](#) on page 251
- [Debug the shared library](#) on page 253

7.4.1 Create an example project

First of all, you need to create an example Linux project that uses a shared library.

To create an example Linux project, perform the following steps:

1. In the CodeWarrior IDE, use **File > New > CodeWarrior Linux Project Wizard** to create a new Linux project with the settings given in the table below.

NOTE

Instead of creating a new Linux project, you can import an example Linux project, `SharedLibrary`, available in the `<CWInstallDir>\PA\CodeWarrior_Examples\Linux_Examples` folder as a reference. The example project can be imported as a CodeWarrior Example Project using the **File > Import** menu bar option.

Table 130: Example Project Settings

Option Name	Value
Project name	SharedLibraryExample
Location	<workspace-dir>\SharedLibraryExample
Project type	Linux application
Language	C
Build configurations	<ul style="list-style-type: none">• LibExample (generates the dynamic library needed by the launch configurations)• SharedLib_IM (used to demonstrate implicit linking with the library generated by LibExample build configuration)
Launch configurations	SharedLib_IM (launches the application that demonstrates implicit linking with a shared library)

NOTE

In the current example, only implicit library linking is mentioned; however, in the example project shipped with CodeWarrior, SharedLibrary, we have also demonstrated explicit library loading. For explicit library loading, we have used another build/launch configuration, SharedLib_EX.

2. Remove the default main.c file and add the source files (SharedLib_IM.c and LibExample.c) to your project.
3. In the CodeWarrior IDE, create a header file, LibExample.h, as depicted in the listing below.

Figure 83: Source Code for LibExample.h

```
/* LibExample.h */  
int add_example(int x,int y);  
int add_example_local(int x,int y);
```

4. Save the LibExample.h file in the project directory.
5. Enter the below code into the editor window of the SharedLib_IM.c file.

Figure 84: Source Code for SharedLib_IM.c

```
/*  
  Sharedlib_IM.c  
  
  Demonstrates implicit linking.  
  
*/  
  
// User Include files  
  
#include "LibExample.h"  
  
// function prototype declaration  
  
int temp (int, int);
```



```
// main program

int main ()
{
    int ret;

    int a, b;

    a = 10;

    b = 20;

    ret = temp (a, b);

    ret = add_example (a, b);    // step in here

    return ret;
}

int temp(int i, int j)
{
    return i + j;
}
```

6. Enter the below code into the editor window of the `LibExample.c` file.

Figure 85: Source Code for LibExample.c

```
/*
   LibExample.c
*/

// user include files#include "LibExample.h"// functions definitions

int add_example( int x, int y)
{
    int p,q;

    p=100;

    q=p+200;

    add_example_local (2, 3);    // step in here

    return x+y+q;
}

int add_example_local (int x, int y)
```

```
{  
  
    int p,q;  
  
    p = 100;  
  
    q = p + 200;  
  
    return x + y + q;  
  
}
```

7.4.2 Configure the shared library build configuration

The next action is to configure the `LibExample` build configuration, which generates `libexample.so`.

The steps are given below:

1. Select the `SharedLibraryExample` project in the **CodeWarrior Projects** view.
2. Select the `LibExample` build configuration by selecting **Project > Build Configurations > Set Active > <Build Configuration Name>**.
3. Check `LibExample.c` and `LibExample.h` in the **Build** column.



TIP

Use the CodeWarrior example project, `SharedLibrary`, as a reference to set up the build configuration settings of the `LibExample` build configuration.

7.4.3 Configure the executable build configuration

Now, you need to set up the `SharedLib_IM` build configuration.

The steps are given below:

1. Select the `SharedLibraryExample` project in the **CodeWarrior Projects** view.
2. Select the `SharedLib_IM` build configuration by selecting **Project > Build Configurations > Set Active > <Build Configuration Name>**.
3. Specify the linker settings.
 - a. Select the `SharedLib_IM` build configuration in the **CodeWarrior Projects** view.
 - b. Select **Project > Properties**. The **Properties** window for the shared library project appears.
 - c. In the **Tool settings** page, from the **Power ELF Linker** container, select **Libraries**.
 - d. In the **Libraries (-I)** panel, click **Add** (). The **Enter Value** dialog appears.
 - e. Enter the library file name, `example`, in the **Libraries** field.
 - f. In the **Libraries (-L)** panel, click **Add** (). The **Add directory path** dialog appears.
 - g. Enter the library path in the **Directory** field. The library path is the path of the `Output` directory that is used by `LibExample` build configuration.

NOTE

These settings enable the CodeWarrior IDE linker to locate the shared library, `libexample.so`. For detailed information on other linker command line arguments, see GNU linker manuals. You can find GNU documentation here: <http://www.gnu.org>.

7.4.4 Build the shared library

The next action is to build the shared library.

To build the shared library, perform the following steps:

1. Select the `SharedLibraryExample` project in the **CodeWarrior Projects** view.
2. Select the `LibExample` build configuration by selecting **Project > Build Configurations > Set Active > <Build Configuration Name>**.
3. Select **Project > Build Project**. The CodeWarrior IDE builds the project and stores the output file `libexample.so` in the *Output* directory within the project directory.

7.4.5 Build the executable

Now, you need to build the executable that uses the shared library.

To build the executable, perform the following steps:

1. Select the `SharedLibraryExample` project in the **CodeWarrior Projects** view.
2. Select the `SharedLib_IM` build configuration by selecting **Project > Build Configurations > Set Active > <Build Configuration Name>**.

TIP

You can also select a build configuration from the drop-down list that appears when you click the down arrow next to the project name in the **CodeWarrior Projects** view.

3. Select **Project > Build Project**. The CodeWarrior IDE builds the project and stores the output file `SharedLib_IM.elf` in the *Output* directory within the project directory.

7.4.6 Configure the launch configuration

The next action is to configure the `SharedLib_IM` launch configuration.

You can configure the `SharedLib_IM` launch configuration by:

1. Specifying the remote download path of the final executable file.
2. Specifying the host-side location of the executable file to be used for debugging the shared library.
3. Specifying the environment variable that enables the shared object loader to locate the shared library on the remote target at run time.

Following are complete steps of configuring a launch configuration:

1. Activate the `SharedLib_IM` launch configuration in the project.
2. Specify the remote download path of the final executable file.
 - a. Select **Run > Debug Configurations** to open the **Debug Configurations** dialog.
 - b. In the left pane from the **CodeWarrior** group, select the `SharedLib_IM` launch configuration.
 - c. On the **Debugger** page, click the **Remote** tab.
 - d. Type `/tmp` in the **Remote Download Path** field, as shown in the figure below. This specifies that the final executable file will be downloaded to this location on the target platform for debugging.

NOTE

In the current example, the remote download path is specified as `/tmp`. You can replace `/tmp` with any other directory for which CodeWarrior TRK has the necessary access permissions.

Figure 86: Remote Download Path - Shared Library Project

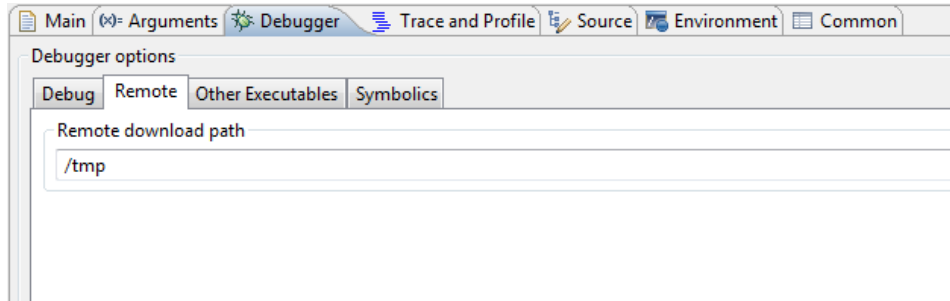

3. Specify the host-side location of the executable file to be used for debugging the shared library.
 - a. Click the **Other Executables** tab in the **Debugger** page.
 - b. Click **Add**. The **Debug Other Executable** dialog appears.
 - c. Click **Workspace**. The **Open** dialog appears.
 - d. Navigate to the location where you have stored the `libexample.so` file in your project directory.
 - e. Select the `libexample.so` file name.
 - f. Click **Open**. The host-side location of the shared library appears in the **Specify the location of the other executable** field.
 - g. Select the **Load Symbols** checkbox, so that the debugger has visibility of symbols within the library.
 - h. Select the **Download to Device** checkbox. The **Specify the remote download path** field is activated.
 - i. Type `/tmp` in the **Remote download path** text box. The shared library will be downloaded to this location when you debug or run the executable file.

The default location of shared libraries on the embedded Linux operating system is `/usr/lib`. In the current example, the remote download location of `libexample.so` is `/tmp`.
 - j. Click **OK**. The settings (shown in the figure below) are saved.

Figure 87: Debug Other Executable Dialog Box

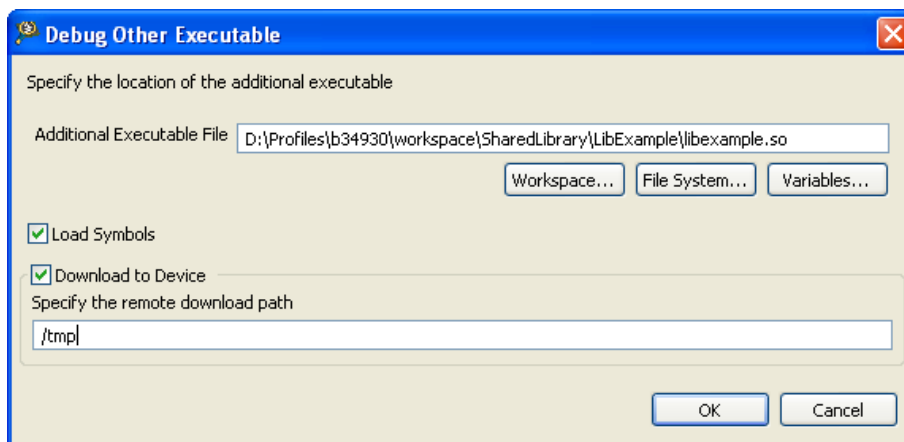

- Specify the environment variable that enables the shared object loader to locate the shared library on the remote target at run time.

At run time, the shared object loader first searches for a shared library in the path specified by the `LD_LIBRARY_PATH` environment variable's value. In this case, the value of this environment variable will be `/tmp`, which is the remote download path for the shared library you specified in the **Debug Other Executable** dialog. If you have not specified the environment variable or have assigned an incorrect value, the shared object loader searches for the shared library in the default location `/usr/lib`.

- In the Debug window, click **Environment** to open the **Environment** page.
- Click **New** to open the **New Environment Variable** dialog.
- In the **Name** field, type `LD_LIBRARY_PATH`.
- In the **Value** field, type `/tmp`.

NOTE

Ensure that you type the same remote download path in the **Value** field that you specified in the **Debug Other Executable** dialog.

- Click **OK**. The environment variable is added to the launch configuration.
- Add another environment variable with name, `AVOID_SYSTEM_PATH` and value `YES`.

NOTE

The `AVOID_SYSTEM_PATH` variable sets the launch configuration to use the library path settings you specify. By specifying the value `YES` you avoid the launch configuration from picking up any other system path.

- Click **Apply** to save the launch configuration settings. The target settings are saved (shown in the figure below).

Figure 88: Environment Variables - Shared Library Project

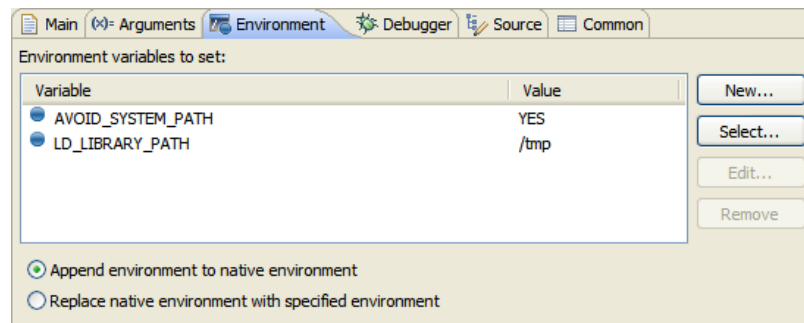

- Click **OK** to close the **Debug** view.

7.4.7 Debug the shared library

Finally, you need to debug the shared library.

In the steps that follow, you will launch the debugger. Next, you will step through the code of the executable file, `SharedLib_IM.elf`, until you reach the code that makes a call to the `add_example` function implemented in the shared library. At this point, you will step into the code of the `add_example` function to debug it.

- Activate the `SharedLib_IM` launch configuration in the project.
- Select **Run > Debug**.

The debugger starts and downloads the `SharedLib_IM.elf` and `libexample.so` files to the specified location on the remote target, one after another. The **Debug** perspective appears.

3. Click **Step Over** in the debugger window until you reach the following line of code (shown in the figure below):

```
ret=add_example(a,b)
```

TIP

Before you set breakpoints in the code of an imported shared library to step into the code, you can use the **Executables** view to navigate and check the source files of the library. For more information on the **Executables** view, open CodeWarrior Eclipse Help by selecting **Help > Help Contents** in the CodeWarrior IDE, and then select **Third Party References > C/C++ Development User Guide > Reference > C/C++ Views and Editors > Executables** view in the **Contents** pane.

Figure 89: SharedLib_IM.c - Step In Location

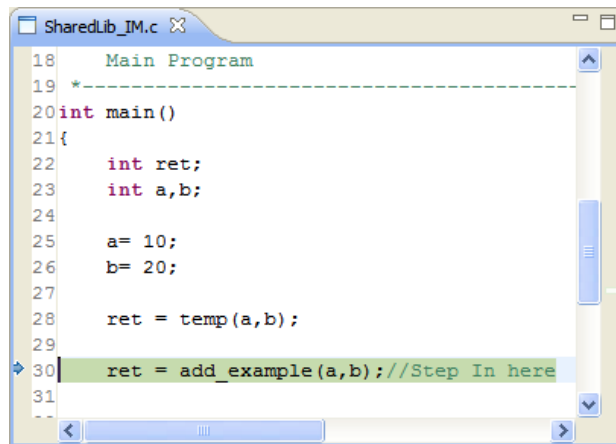

4. In the **Debug** view, click **Step Into** to step into the code of the `add_example` function.

The debugger steps into the source code of the `add_example` function in the `LibExample.c` file (shown in the figure below).

Figure 90: LibExample.c - add_example Function

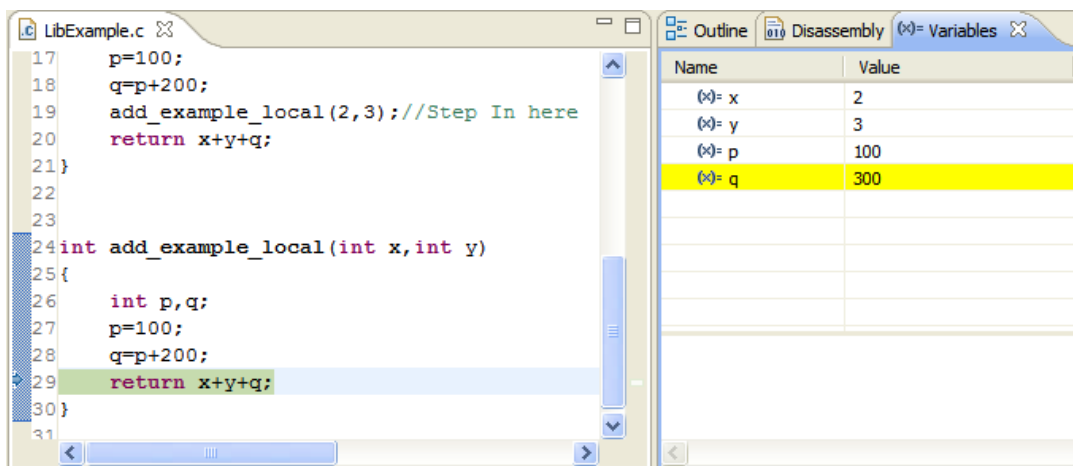

5. After stepping in, you can step through the rest of the code.

The **Debug** view shows the function calls to the `add_example` function (shown in the figure below).

Figure 91: Debug View - Shared Library Project

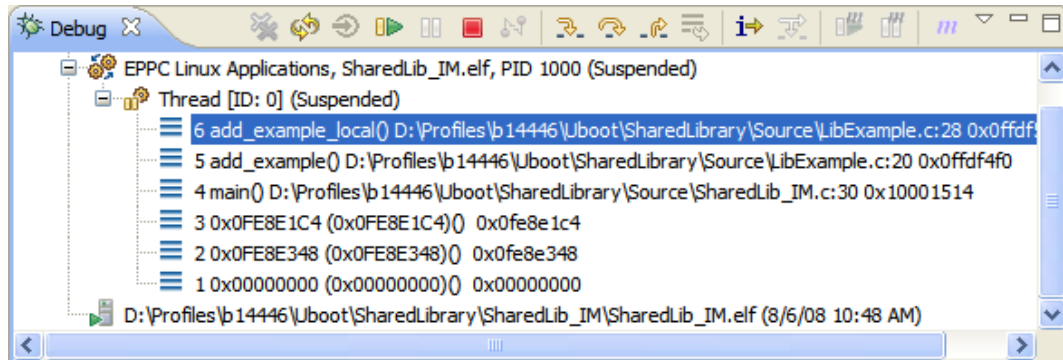

6. View the output of the program.

The rest of the code is executed and the output appears in the **Variables** view (shown in the figure below).

Figure 92: Variables View - Shared Library Project

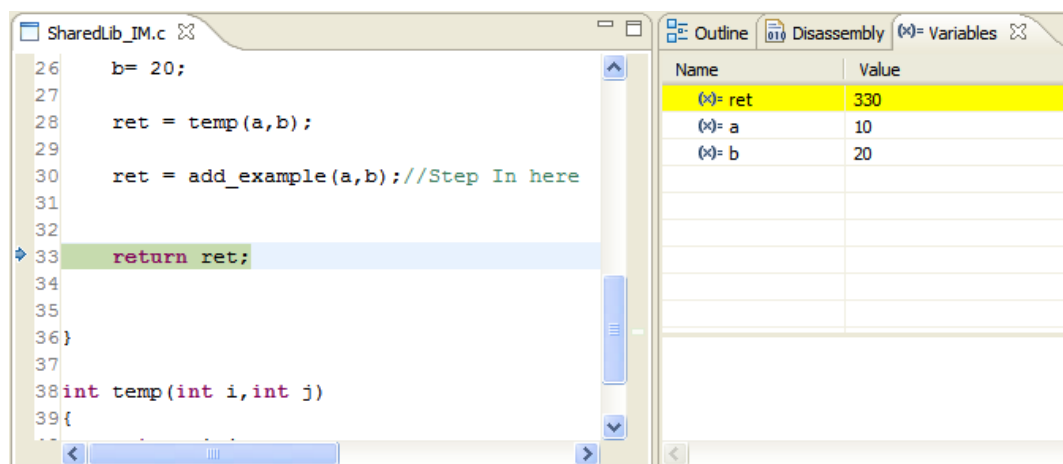

7.5 Preparing U-Boot for debugging

U-Boot resides in flash memory on target systems and boots an embedded Linux image developed for those systems.

Before debugging U-Boot on a target system, follow these steps:

1. [Install BSP](#) on page 256.
2. [Configure U-Boot and build U-Boot images with CodeWarrior debugger support](#) on page 257.
3. [Configure hardware to use U-Boot image](#) on page 257.
4. [Create a CodeWarrior project to debug U-Boot](#) on page 257
5. [Specify launch configuration settings](#) on page 258
6. [Create launch configurations for U-Boot debug stages](#) on page 260

7.5.1 Install BSP

Install the board support package (BSP) for the target system you want to debug on the Linux host computer.

NOTE

The BSP versions keep changing frequently. For different BSP versions, you might encounter build environments based on various tools. The subsequent sections will describe necessary procedures and use specific examples from real Freescale BSPs for illustration. The examples in these sections need to be adapted based on the BSP versions or build tools you are currently using.

Follow these steps to install the BSP:

1. On the Linux computer, download the BSP for your target hardware to install kernel files and Linux compiler toolchains on your system.

BSP image files for target boards are located at <http://www.freescale.com/linux>.

2. Download the BSP image file for your target board.

NOTE

You will need to log-in or register to download the BSP image file.

The downloaded image file has an `.iso` extension. For example,

```
QorIQ-DPAA-SDK-<yyyymmdd>-yocto.iso
```

3. Mount the image file to the CDROM as root, or using "sudo":

```
<sudo> mount -o loop QorIQ-DPAA-SDK-<yyyymmdd>-yocto.iso/mnt/cdrom
```

NOTE

`sudo` is a Linux utility that allows users to run applications as `root`. You need to be setup to run `sudo` commands by your system administrator to mount and install the BSPs.

4. Execute the BSP install file to install the build tool files to a directory of your choice, where you have privileges to write files:

```
/mnt/cdrom/install
```

NOTE

The BSP must be installed as a non-root user, otherwise the install will exit.

5. Answer the questions from the installation program until the file copy process begins.

You will be prompted to input the required build tool install path. Ensure you have the correct permissions for the install path.

6. Upon successful installation, you will be prompted to install the ISO for the core(s) you want to build.

For example, if you want to build the SDK for P4080, that is a e500mc core, then you have to install the ISO images for e500mc core:

```
c23174e5e3d187f43414e5b4420e8587 QorIQ-SDK-V1.2-PPCE500MC-20120603-yocto.iso.part1  
292c6e1c5e97834987fbdb5f69635a1d QorIQ-SDK-V1.2-PPCE500MC-20120603-yocto.iso.part2
```

NOTE

You can see the SDK Manual for instructions about how to build the BSP images and run different scenarios from the `iso/help/documents/pdf` location.

7.5.2 Configure U-Boot and build U-Boot images with CodeWarrior debugger support

After installing the BSP, you need to configure the BSP U-Boot package, to place debugger symbolic information in the U-Boot binary executable file, and build the U-Boot images with CodeWarrior debugger support, on the Linux host computer.

For more information on configuring the U-Boot and building U-Boot images, see the SDK User Manual available in the `iso/help/documents/pdf` folder.

7.5.3 Configure hardware to use U-Boot image

To configure the hardware to use U-Boot image, you need to burn the U-Boot image to the flash memory of the hardware.

NOTE

See the *Burning U-Boot to Flash* cheat sheet for the entire procedure for burning U-Boot to flash. To access the cheat sheets, select **Help > Cheat Sheets** from the CodeWarrior IDE menu bar.

7.5.4 Create a CodeWarrior project to debug U-Boot

Create a new CodeWarrior project to debug U-Boot on the target system.

To create a CodeWarrior project, use these steps:

1. Launch CodeWarrior IDE.
2. Select **File > Import**. The **Import** wizard appears.
3. Expand the **CodeWarrior** group and select **CodeWarrior Executable Importer**.
4. Click **Next**.

The **Import a CodeWarrior Executable file** page appears.

5. Specify a name for the project, to be imported, in the **Project name** text box.
6. If you do not want to create your project in the default workspace:
 - a. Clear the **Use default location** checkbox.
 - b. Click **Browse** and select the desired location from the **Browse For Folder** dialog.
 - c. In the **Location** text box, append the location with the name of the directory in which you want to create your project.

NOTE

An existing directory cannot be specified for the project location.

7. Click **Next**.

The **Import C/C++/Assembler Executable Files** page appears.

8. Click **Browse** next to the **Executable** field.
9. Select the U-Boot ELF file obtained after the U-Boot compilation.

NOTE

You can see the SDK Manual, for instructions about how to generate an U-Boot ELF file, from the `iso/help/documents/pdf` location.

10. Click **Open**.

11. From the **Processor** list, expand the processor family and select the required processor.

12. Select **Bareboard Application** from the **Toolchain** group.

The selected toolchain sets up the default compiler, linker, and libraries used to build the new project.

13. Select **None** from the **Target OS** list.

14. Click **Next**.

The **Debug Target Settings** page appears.

15. From the **Debugger Connection Types** list, select the required connection type.

16. Specify the settings, such as board, launch configuration, connection type, and TAP address if you are using CodeWarrior TAP (over Ethernet), Ethernet TAP, or Gigabit TAP.

17. Click **Next**.

The **Configurations** page appears.

18. From the **Core index** list, select **Core 0**.

19. Click **Finish**.

The wizard creates a CodeWarrior project to debug the U-Boot image.

You can access the project from the **CodeWarrior Projects** view on the workbench.

7.5.5 Specify launch configuration settings

Now, you need to specify the settings for the newly created Attach launch configuration in the **Debug Configuration** dialog.

To specify launch configuration settings, follow these steps:

1. Select **Run > Debug Configurations**.
2. On the **Main** tab, if you have an already existing system for the attach configuration, select it from the **Connection** drop-down list, else create a new one by following the steps given below:
 - a. Click **New**. The **New Connection** wizard appears.
 - b. Expand the **CodeWarrior Bareboard Debugging** group and select **Hardware or Simulator Connection**.
 - c. Click **Next**. The **Hardware or Simulator Connection** page appears.
 - d. Specify a name and a description for the connection.
 - e. Click **New** next to the **Target** drop-down list. The **New Connection** wizard appears.
 - f. Expand the **CodeWarrior Bareboard Debugging** group and select **Hardware or Simulator System**.
 - g. Click **Next**.
 - h. Select a processor from the **Target** type drop-down list.
 - i. On the **Initialization** tab, clear the **Execute reset** checkbox.
 - j. Select the checkbox for the respective core in the Initialize target column.
 - k. Click the ellipsis button in the **Initialize target** column.

The **Initialization target** dialog appears.

- I. Click **File System** and select the target initialization file from the following path:

```
<CWInstallDir>\PA\PA_Support\Initialization_Files
```

NOTE

If you want to use an initialization file that initializes CCSR and PIXIS before U-Boot, you can uncomment the specific lines in the `<board_name>_uboot_<numbits>.tcl` initialization file, where `<numbits>` can be 32 or 36.

- m. Based on the target you select, you may also have to specify the memory configuration file details by selecting the **Memory Configuration** checkbox on the **Memory** tab.
- n. Click the ellipsis button in the **Memory Configuration** column.

The **Memory Configuration** dialog appears.

- o. Click **File System** and select the memory configuration file from the following path:

```
<CWInstallDir>\PA\PA_Support\Initialization_Files\Memory
```

- p. Click **Finish**.
 - q. From the **Connection type** drop-down list, select the type of connection you plan to use.
The **Connection** tab appears along with the other tabs on the page.
 - r. On the **Connection** tab, specify the IP address of the TAP.
 - s. Click **Finish**.
 - t. From the **System** panel, select all the cores on which U-Boot is running.
3. Click the **Debugger** tab.
 4. On the **PIC** page, select the **Alternate Load Address** checkbox.
 5. In the text box that comes up, enter the `0xFFFF40000` address.
 6. Click the **Source** tab and verify the source mapping configuration.
 7. Click **Apply** to save the settings made to the various tabs.
 8. Click **Debug**.

The **Debug** perspective appears with the core 0 stopped at the reset vector (shown in the figure below).

NOTE

You will need to press **Reset** in the **Debug** view. Select the **Core reset** checkboxes for all cores except core 0. You will then see core 0 stopped at the reset vector.

Figure 93: Debug Perspective - U-Boot Debug

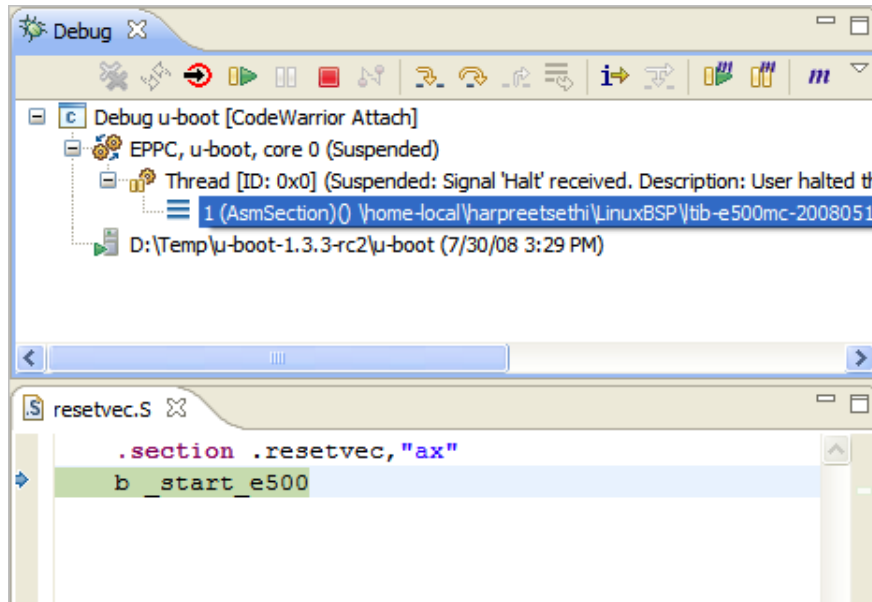

7.5.6 Create launch configurations for U-Boot debug stages

Finally, you need to create launch configurations for different U-Boot debug stages.

During a typical U-Boot start-up sequence, the target processor starts executing U-Boot in flash memory. U-Boot then enables the Memory Management Unit (MMU), and relocates itself to RAM. From the memory layout perspective, U-Boot debug has four different stages. For each of these stages, you will need a separate launch configuration. You have already configured the launch configuration settings for the first stage in the P4080 U-Boot Stage 1 launch configuration.

To create launch configurations for the remaining three stages for U-Boot debug:

NOTE

Create these launch configurations only if you are using the hardware option to debug U-Boot.

1. To open the **Remote Systems** view, select **Window > Show View > Other**.
The **Show View** dialog appears.
2. Expand the **Remote Systems** group and select **Remote Systems**.
The **Remote Systems** view appears as a tabbed view at the bottom of the workbench.
3. Select the P4080 U-Boot Stage 1 remote system from the view.
4. Right-click and from the context menu select **Copy**.
The **Copy Resource** dialog appears.
5. Select the active profile from the list. Click **OK**.
The **Duplicate Name Collision** message box appears.
6. Select the **Rename** option.
The **Rename to** text box is enabled.
7. Enter the name for the copied remote system. For example, P4080DS u-boot mem translation.

The new remote system appears in the **Remote Systems** view.

NOTE

This remote system will be used in the second stage of U-Boot debug.

8. Right-click P4080DS u-boot mem translation and select **Properties** from the context menu.

The **Properties for P4080DS u-boot mem translation** window appears.

9. On the **System** tab, select the checkbox for the respective core in the **Memory configuration** column.

10. Click the ellipsis button in the **Memory configuration file** column.

The **Memory Configuration File** dialog appears.

11. Click **File System** and select the memory configuration file from this path:

```
<CWInstallDir>\PA\PA_Support\Initialization_Files\Memory\${BoardName}_uboot_${bits}_${FlashDevice}_${stage}.mem
```

12. Click **OK**.

13. Click **OK**.

14. Select **Run > Debug Configurations** to open the **Debug Configurations** dialog.

15. Expand the **CodeWarrior Attach** group.

16. Right-click the P4080 U-Boot Stage 1 launch configuration and select **Duplicate** from the context menu that appears.

A new launch configuration appears in the **CodeWarrior Attach** group.

17. On the right-hand side, in the **Name** text box, enter an appropriate name. For example, P4080 U-Boot Stage 2.

18. On the **Main** page, in the **Remote system** panel, from the **System** drop-down list, select the P4080DS u-boot mem translation system.

19. On the **Debugger** tab, in the **PIC** page, clear the **Alternate Load Address** checkbox.

20. Duplicate the P4080 U-Boot Stage 1 launch configuration.

21. On the right-hand side in the **Name** text box, enter an appropriate name. For example, P4080 U-Boot Stage 3.

22. On the **Debugger** tab, in the **PIC** page, clear the **Alternate Load Address** checkbox.

23. Duplicate the P4080 U-Boot Stage 1 launch configuration.

24. On the right-hand side in the **Name** text box, enter an appropriate name. For example, P4080 U-Boot Stage 4.

25. On the **Debugger** tab, in the **PIC** page, select the **Alternate Load Address** checkbox.

26. In the text box that comes up, enter the address printed by U-Boot as "Now running in RAM".

You have successfully created launch configurations for all the four stages of U-Boot debug.

From a memory layout perspective, U-Boot has four different stages till you get the U-Boot prompt. CodeWarrior debug settings required to debug U-Boot in flash memory differ from the settings required to debug U-Boot in RAM.

7.6 Debugging U-Boot using NOR, NAND, SPI, and SD Card/MMC Flash Devices

U-Boot resides in flash memory on target systems and boots an embedded Linux image developed for those systems. This section shows you how to use the CodeWarrior debugger to debug the U-Boot using NOR, NAND, SPI, and SD Card/MMC flash devices.

This section explains:

- [Configuring and Building U-Boot](#) on page 262
- [Creating a CodeWarrior Project to Debug U-Boot](#) on page 264
- [Specifying the Launch Configuration Settings](#) on page 265
- [Debugging U-Boot using Flash Devices](#) on page 267

7.6.1 Configuring and Building U-Boot

This section explains how to configure and build U-Boot and how to write configuration words in the U-Boot code to create the final boot image.

See [Preparing U-Boot for debugging](#) on page 255 to install and configure the BSP. For more information on configuring the build tool and building U-Boot with CodeWarrior debugger support, see the SDK User Manual available in the `iso/help/documents/pdf` folder.

Upon successful compilation of U-Boot, the binary images for NOR and NAND flash devices are written to the flash. For the SPI and SD flash devices, write the configuration words at the beginning of the `u-boot.bin` file to create the final boot image.

See the figure below for the required eSPI/SD EEPROM data structure.

Figure 94: eSPI/SD EEPROM Data Structure

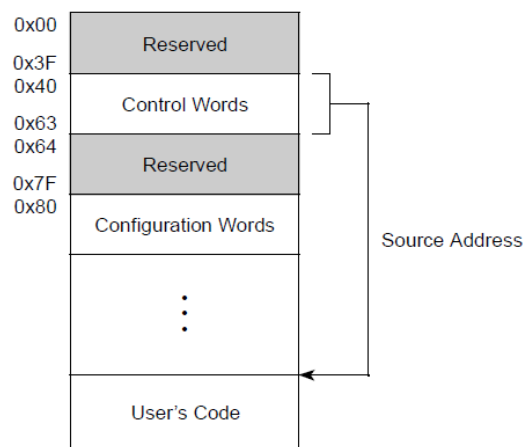

The table below describes the eSPI/SD EEPROM data structure.

Table 131: eSPI/SD EEPROM Data Structure Details

Address	Data Bits
0x00-0x3F	Reserved

Table continues on the next page...

Table 131: eSPI/SD EEPROM Data Structure Details (continued)

Address	Data Bits
0x40-0x43	BOOT signature - This location should contain the value 0x424f_4f54, which is the ASCII encoding for BOOT. The eSPI loader code searches for this signature, initially in 24-bit addressable mode. If the value at this location does not match the BOOT signature, the EEPROM is accessed again, but in 16-bit mode. If the value in this location still does not match the BOOT signature, the eSPI device does not contain a valid user code. In such a case, the eSPI loader code disables the eSPI and issues a hardware reset request of the SoC by setting RSTCR[HRESET_REQ].
0x44-0x47	Reserved
0x48-0x4B	User's code length - Number of bytes in the user's code to be copied. The value must be a multiple of 4. $4 \leq \text{User's code length} \leq 2\text{GBytes}$.
0x4C-0x4F	Reserved
0x50-0x53	Source Address - Contains the starting address of the user's code as an offset from the EEPROM starting address. In the 24-bit addressing mode, the 8 most significant bits of the source address should be written to as zero, because the EEPROM is accessed with a 3-byte (24-bit) address. In 16-bit addressing mode, the 16 most significant bits of the source address should be written as zero.
0x54-0x57	Reserved
0x58-0x5B	Target Address - Contains the target address in the system's local memory address space in which the user's code is copied. This is a 32-bit effective address. The core is configured in such a way that the 36-bit real address is equal to the target address (with 4 most significant bits zero).
0x5C-0x5F	Reserved
0x60-0x63	Execution Starting Address - Contains the jump address of the system's local memory address space into which the user's code first instruction is executed. This is a 32-bit effective address. The core is configured in such a way that the 36-bit real address is equal to this (with 4 most significant bits zero).
0x64-0x67	Reserved
0x68-0x6B	N - Number of Config Address/Data pairs. This address must be ≤ 1024 (but it is recommended to keep it as small as possible).
0x6C-0x7F	Reserved
0x80-0x83	Config Address 1
0x84-0x87	Config Data 1
0x88-0x8B	Config Address 2
0x8C-0x8F	Config Data 2
...	...
$0x80 + 8*(N-1)$	Config Address N

Table continues on the next page...

Table 131: eSPI/SD EEPROM Data Structure Details (continued)

Address	Data Bits
0x80 + 8*(N-1)+4	Config Data N (Final Config Data N optional)
~ ~ ~	~ ~ ~
User's Code	Your U-Boot code.

This section contains the following subsection:

- [Writing configuration words in U-Boot code](#) on page 264

7.6.1.1 Writing configuration words in U-Boot code

You can use the boot format tool to write the configuration words to the beginning of the U-Boot code.

The boot format tool is used only for SPI and SD flash devices.

To use the boot format tool:

1. Access the BSP folder to access the boot format tool.

NOTE

See the BSP documentation to read more about the boot format tool.

2. Issue the following commands:

```
cd boot_format  
make [all]
```

3. Issue the following command for the SPI flash device:

```
./boot_format config_XXX_ddr.dat u-boot.bin -spi spi-boot.bin
```

where `config_XXX_ddr.dat` is the appropriate DDR init file for your board.

4. For the SD flash device, you need to format your SD device to vfat:

```
/sbin/mkfs.vfat /dev/sdc1  
./boot_format config_ddr3_XXX.dat u-boot.bin -sd /dev/sdc1
```

where `/dev/sdc1` is the SD flash device.

7.6.2 Creating a CodeWarrior Project to Debug U-Boot

This section provides steps to create a CodeWarrior project for debugging U-Boot.

To create a CodeWarrior project to debug U-Boot:

1. Start the CodeWarrior IDE.
2. Select **File > Import**. The **Import** wizard appears.
3. Expand the **CodeWarrior** group and select **CodeWarrior Executable Importer**.
4. Click **Next**.

The **Import a Codewarrior Executable file** page appears.

5. Specify the project name in the **Project name** text box.
6. Click **Next**.

7. Click **Browse** next to the **Executable** text box.
 - For NOR, SPI, and SD, browse to the U-Boot folder and select the U-Boot file.
 - For NAND, browse to the U-Boot folder and select the u-boot-spl file from the nand_spl folder. You need two `.elf` files when performing U-Boot debug in NAND. To specify the second `.elf` file, see [Specifying the Launch Configuration Settings](#) on page 265.
 - Click **Open**.
 - Click **Next**.
 - From the **Processor** list, expand the processor family and select the required processor.
 - From the **Toolchain** list, select **Bareboard Application**.
 - Click **Next**.
 - From the **Debugger Connection Types** list, select the required connection type.

NOTE

Select the **Simulator** option from the **Debugger Connection Types** list if you want to use the simulator to debug U-Boot.

- Select a required launch configuration.
- From the **Core index** list, select the required core.
- Click **Next**.
- Specify connection type, and TAP address if you are using Ethernet or Gigabit TAP.

NOTE

If you are using the simulator to debug U-Boot, this page will show the simulator options.

- Click **Finish**.

The imported project appears in the **CodeWarrior Projects** view.

You just finished creating a CodeWarrior project to debug the U-Boot image.

7.6.3 Specifying the Launch Configuration Settings

You can specify settings for the launch configuration created earlier using the **Debug Configurations** dialog.

To specify settings for the newly created Attach launch configuration:

1. Select **Run > Debug Configurations**.
2. On the **Main** tab, if you have an already existing system for the attach configuration, select it from the **Connection** drop-down list, else create a new one by following the steps given below:
 - a. Click **New**. The **New Connection** wizard appears.
 - b. Expand the **CodeWarrior Bareboard Debugging** group and select **Hardware or Simulator Connection**.
 - c. Click **Next**. The **Hardware or Simulator Connection** page appears.
 - d. Specify a name and a description for the connection.
 - e. Click **New** next to the **Target** drop-down list. The **New Connection** wizard appears.
 - f. Expand the **CodeWarrior Bareboard Debugging** group and select **Hardware or Simulator System**.
 - g. From the **Target type** drop-down list, expand the **eppc** group and select the required processor.
 - h. On the **Initialization** tab, clear the **Execute system reset** checkbox.

- i. Select the checkbox for the respective core in the **Initialize target** column.
- j. Click the ellipsis button in the Initialize target script column.

The **Target Initialization File** dialog appears.

- k. Click **File System** and select the target initialization file from the following path:

```
<CWInstallDir>\PA\PA_Support\Initialization_Files\
```

NOTE

If you want to use an initialization file that initializes CCSR and PIXIS before U-Boot, you can uncomment the specific lines in the `<boardname>_uboot_<Numbits>.tcl` initialization file, where `<NumBits>` can be 32 or 36.

- l. Click **Finish**.
 - m. From the **Connection type** drop-down list, select the type of connection you want to use (Ethernet TAP, Gigabit TAP, or Simulator).
The **Connection** tab appears along with the other tabs on the page.
 - n. On the **Connection** tab, specify the IP address of the TAP if you are using a TAP or configure the Simics paths (model startup script, simics executable, and CodeWarrior add-on) if you are using Simics. For Simics, select the **Manual launch** option from the **CCS server** panel and enter the IP address of the CCS server in the **Server hostname/IP** text box.
 - o. Click **Finish**.
 - p. From the **Target** panel, select all the cores on which U-Boot is running.
3. On the **Debugger** tab, in the **Other Executables** page specify the second elf file needed to perform U-Boot debug in NAND.
 - a. Click **Add**. The **Debug Other Executable** dialog appears.
 - b. In the **Additional Executable File** text box, browse to the U-Boot folder and select the U-Boot file.
 - c. Select the **Load Symbols** checkbox.
 - d. Click **OK**.
 4. On the **Debugger** tab, in the **PIC** page, clear the **Alternate Load Address** checkbox.
 5. On the **Source** tab, specify the source mapping configuration.
 6. Click **Apply** to save the settings made to the various tabs.
 7. Click **Debug**.

The **Debug** perspective appears with the core 0 stopped at the reset vector (shown in the figure below).

NOTE

Select the **Core reset** checkboxes for all cores except core 0 and then click **Reset** in the **Debug** view. You will then see core 0 stopped at the reset vector.

Figure 95: Debug Perspective - U-Boot Debug

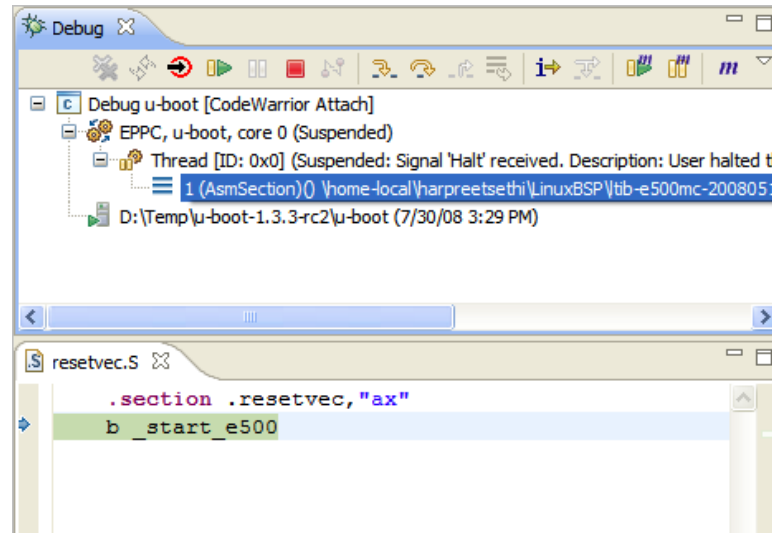

7.6.4 Debugging U-Boot using Flash Devices

This section explains how to debug U-Boot using different flash devices.

From a memory layout perspective, U-Boot has four different stages till you get the U-Boot prompt. CodeWarrior debug settings required to debug U-Boot in flash memory differ from the settings required to debug U-Boot in RAM. Each of these stages requires specific debug settings that are described in the following sections for each flash device, NOR, NAND, SPI, and SD/MMC.

- [Points to remember](#) on page 267
- [Debugging U-Boot using NOR flash](#) on page 268
- [Debugging U-Boot using SPI and SD/MMC flash](#) on page 273
- [Debugging U-Boot using NAND flash](#) on page 278

7.6.4.1 Points to remember

This section talks about some important points to remember while debugging U-Boot using a flash device.

Before debugging U-Boot, you should be aware of the board you are using, if the U-Boot was built on 32 or 36 bits, and the configuration files you will use from the layout.

Select the correct initialization and memory files used by the CodeWarrior Debugger. These configuration files have various names:

```
${BoardName}_uboot_${bits}_${FlashDevice}_${stage}.mem
```

```
${BoardName}_uboot_${bits}.tcl
```

- `BoardName` is any available board, for example, P4080DS, P2040RDB, P2010DS, and so on
- `bits` are any token from 32 or 36
- `FlashDevice` is any token from NOR, NAND, SPI, and SD
- `stage` can be any token from 1, 2, 3, 4, 1_2, 3_4, {}

NOTE

Note that the configuration files in which the stage token is missing (for example, P1024RDB_uboot_32.tcl) can be used in all debug stages.

Whenever you want to set a breakpoint, verify the following:

- A valid opcode at the debug exception interrupt vector.

In a scenario where the valid opcode is missing, when a breakpoint is hit, an exception is generated for the invalid opcode found at the debug interrupt vector memory location.

- All available support for debug.

For example, a very common error is when the code is relocated from reset space (0xfffffxxx) to flash space (0xefffxxxx) for the NOR and NAND flash devices. In such a scenario, IVPR remains at 0xffff0000 and IVOR15 at 0x0000f000. Any access to 0xffff000 (the debug exception) generates a TLB miss exception. The workaround is to set IVPR to 0xefff0000 before the U-Boot relocation.

To hit breakpoints set on a previous debug session after changing the PIC address, verify the following:

- Do not disable and enable back those breakpoints after the PIC value has been changed. Use the breakpoints relocation feature to deal with these changes
- Do not set breakpoints in Stage 4 (relocation to RAM) until you move execution there.
- Do not set breakpoints from Stage 1 to Stage 2. The Instruction Address Space (IS) and Data Address Space (DS) bits from MSR are cleared in Stage 1. So the processor will use only the TLB entries with Translation Space (TS) = 0 instead of Stage 2 where TS = 1.

7.6.4.2 Debugging U-Boot using NOR flash

This section explains how to debug U-Boot using the NOR flash device in different U-Boot debug stages.

During a typical U-Boot start-up sequence, the target processor starts executing U-Boot in flash memory. U-Boot then enables the Memory Management Unit (MMU), and relocates itself to RAM. From the memory layout perspective, U-Boot debug has four different stages.

The following sections describe four U-Boot debug stages for debugging U-Boot using the NOR flash device:

- [Debugging U-Boot before switching address space](#) on page 268
- [Debugging U-Boot in translated address space](#) on page 269
- [Debugging U-Boot after switching back to initial address space](#) on page 271
- [Debugging U-Boot in RAM](#) on page 272

7.6.4.2.1 Debugging U-Boot before switching address space

This section tells how to debug U-Boot in a NOR flash device before switching address space.

To debug U-Boot in flash before switching address space:



1. Start the CodeWarrior IDE.
2. Open the CodeWarrior U-Boot project that you created in [Creating a CodeWarrior Project to Debug U-Boot](#) on page 264.
3. Select **Run > Debug Configurations**. The **Debug Configurations** dialog appears.
4. Expand the **CodeWarrior** group and select the appropriate launch configuration.
5. Click **Debug**. The **Debug** perspective appears with the core 0 running.
6. Click **Reset** on the **Debug** view toolbar.

The **Reset** dialog appears.

7. In the **Run out of reset** column, select the checkboxes for all cores except core 0.

After the reset completes, core 0 appears stopped at the reset vector. In the **Debugger Shell** view, issue the following command to enter the PIC alternate load address:

```
setpicloadaddr 0xFFFF40000
```

8. From the **Debug** view toolbar, select the **Instruction Stepping Mode** () command.
9. From the **Debug** view toolbar, select the **Step Into** () command to step into `b _start_e500`.

The `start.s` file appears in the editor area and the disassembled code with memory addresses appears in the **Disassembly** view.

Figure 96: U-Boot Debug - Disassembly View

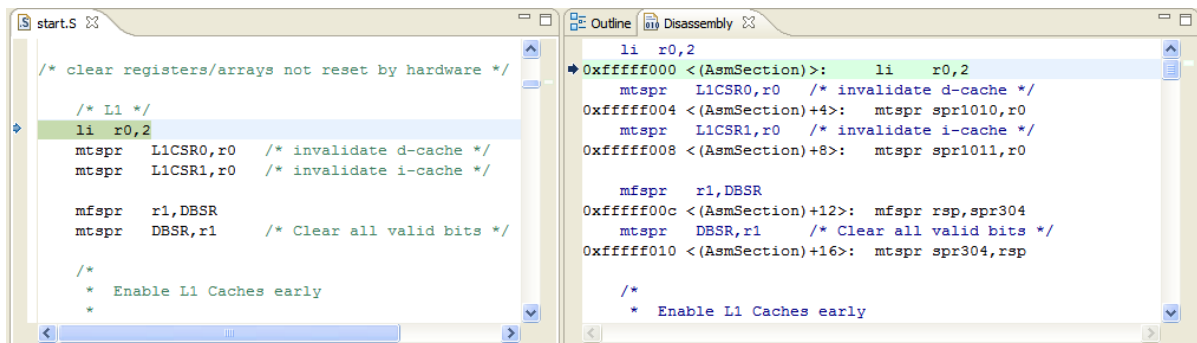

10. Move the Debug Current Instruction Pointer to `_start_e500`.

11. Deselect the **Instruction Stepping Mode** () command.

You can now do source-level debugging and set breakpoints in `start.s` until the address space switch at the `rfi` before `switch_as` (`start.s`, line 326). See [Points to remember](#) on page 267 for more details.

7.6.4.2.2 Debugging U-Boot in translated address space

This section tells how to debug U-Boot in the translated address space in a NOR flash device.

After you have reached the `rfi` call, the execution will move to the next stage. You should now use a memory configuration file for debugging in this section.

It is necessary to inspect the TLB registers to check if there are address spaces translated or to search in the CW PA10 layout (`PA\PA_Support\Initialization_Files\Memory\`) if there are memory configuration files that match your U-Boot debug scenario.

NOTE

For e500v2 cores (36-bit U-Boot debug only), due to a hardware issue (terminating the current debug session will put the core in running) another script must be executed before proceeding further with the instructions provided in this section:

1. Open **Debugger Shell** view.
2. Execute `${BoardName}_uboot_36_stage2_preparation.tcl` using the following command:

```
source /${BoardName}_uboot_36_stage2_preparation.tcl
```

To debug U-Boot in the translated address space in flash before switching back to initial address space (`start.s`, `bl cpu_init_f`, line 396):

1. Click  on the **Debug** view toolbar to terminate the current debug session.
2. Select **Run > Debug Configurations**. The **Debug Configurations** dialog appears.
3. Expand the CodeWarrior group and select the appropriate launch configuration.
4. In the **Connection** panel, click **Edit** next to the **Connection** drop-down list.
The **Properties for <connection>** dialog appears.
5. Click **Edit** next to the **Target** drop-down list.
The **Properties for <Target>** dialog appears.
6. On the **Memory** tab, select the checkbox for the respective core in the **Memory configuration** column.
7. Click the ellipsis button in the **Memory configuration file** column.
The **Memory Configuration File** dialog appears.
8. Click **File System** and select the memory configuration file from the following path:

```
<CWInstallDir>\PA\PA_Support\Initialization_Files\Memory\
```

NOTE

To select an appropriate memory configuration file, it is necessary to inspect the TLB registers and check if there are address spaces translated or if there are memory configuration files available in the CodeWarrior layout that match your U-Boot debug scenario.

9. Click **OK** to close the **Memory Configuration File** dialog.
10. Click **OK** to close the **Properties for <Target>** dialog.
11. Click **OK** to close the **Properties for <connection>** dialog.
12. Click **Debug**.

The instruction pointer is now on the `rfi` function call.

NOTE

For e500v2 cores (36-bit U-Boot debug only) a reset using `${BoardName}_uboot_36_stage2.tcl` is needed.

13. In the **Debugger Shell**, issue the following command to reset PIC load address to the location specified in `u-boot.elf`.

```
setpicloadaddr reset
```



14. From the **Debug** view toolbar, select the **Instruction Stepping Mode** () command.
15. Ensure the Debug Current Instruction Pointer is at `rfi`. From the Debug view toolbar, select the **Step Into** () command to step into `rfi`. The **Disassembly** view appears.

Figure 97: U-Boot Debug - Translated Address Space in Flash



16. Deselect the **Instruction Stepping Mode** command when the instruction pointer is at `switch_as`.

You can set breakpoints and use the Step Over, Step Into, and Step Out commands from line (`switch_as`: label) in `start.S` to line (`/* switch back to AS = 0 */`) in `start.S`. At these locations, the Instruction Address Space (IS) and Data Address Space (DS) bits from MSR are cleared, so that the processor uses only the TLB entries with TS = 0. See [Points to remember](#) on page 267 for more details.

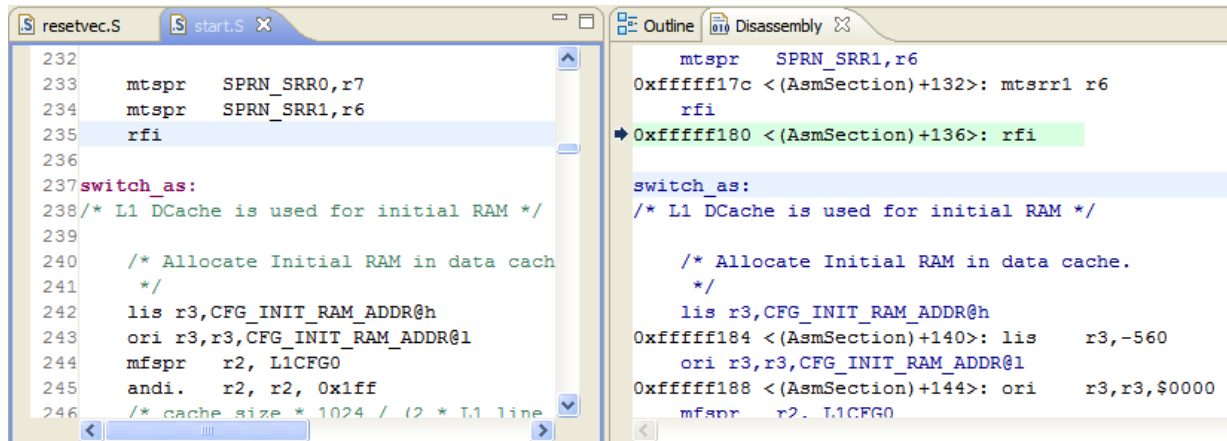
NOTE

To set breakpoints in Stage2 after `rfi` (`start.S`), you can set the Alternate Load Address by using `setpicloadaddr reset`. For low-end processors (e500v1, e500v2), set DE (Debug Enable) from MSR register using the **Debugger Shell** or the **Registers** view. You can then perform the set, resume, and remove operations on the breakpoints.

NOTE

To access breakpoints set on a previous debug session after changing the PIC address, you need to disable and enable back those breakpoints after the PIC value has been changed.

7.6.4.2.3 Debugging U-Boot after switching back to initial address space

This section tells how to debug U-Boot in a NOR flash device after switching back to initial address space.

While debugging U-Boot, when you reach the `cpu_init_f` call you are back to address space 0. You now need to remove the memory configuration file used in the previous section or set another memory configuration file for U-Boot compiled on 36 bits.

To debug U-Boot in flash after switching back to initial address space:

1. Click  on the **Debug** view toolbar to terminate the current debug session.
2. Select **Run > Debug Configurations**. The **Debug Configurations** dialog appears.
3. Expand the **CodeWarrior** group and select the appropriate launch configuration.
4. In the **Connection** panel, click **Edit** next to the **Connection** drop-down list.

The **Properties for <connection>** dialog appears.

5. Click **Edit** next to the **Target** drop-down list.

The **Properties for <Target>** dialog appears.

- On the **Memory** tab, deselect the checkbox for the respective core in the **Memory configuration** column to remove the memory configuration file you had set in the previous section.

NOTE

If required, you can set another memory configuration file for U-Boot compiled on 36 bits on the **Memory** tab.

- Click **OK** to close the **Memory Configuration File** dialog.
- Click **OK** to close the **Properties for <Target>** dialog.
- Click **OK** to close the **Properties for <connection>** dialog.
- Click **Debug**.



The instruction pointer is now on the `cpu_init_f` function call.

NOTE

For e500v2 cores (36-bit U-Boot debug only) a reset using `${BoardName}_uboot_36_stage3.tcl` is needed.

- If you used a different PIC value, in the Debugger Shell, issue the following command to reset PIC load address to the location specified in `u-boot.elf`.

```
setpicloadaddr reset
```

- From the Debug view toolbar, select the **Instruction Stepping Mode** () command.
- From the **Debug** view toolbar, select the **Step Into** () command to step into `cpu_init_f`.

You can set breakpoints and use the Step Over, Step Into, and Step Out commands from line 396 in `start.S` (`bl cpu_init_f`) to line 980 in `start.S` (`blr /* NEVER RETURNS! */`).

NOTE

To access breakpoints set on a previous debug session after changing the PIC address, you need to disable and enable back those breakpoints after the PIC value has been changed.

7.6.4.2.4 Debugging U-Boot in RAM

This section tells how to debug U-Boot in RAM using a NOR flash device.

To debug U-Boot in RAM:

- In the **Debugger Shell** view, issue the following command to reset PIC load address to RAM space:

```
setpicloadaddr 0xxxxx0000
```

NOTE

The address printed by U-Boot at line "Now running in ram" is `0xxxxx0000`. You can also see this address in the **Disassembly** view and observe the current address space you are in.



- From the **Debug** view toolbar, select the **Instruction Stepping Mode** () command.
- From the **Debug** view toolbar, select the **Step Into** () command to step into `blr`.

Figure 98: U-Boot Debug - Running in RAM



```
start.S
916   bne 5b
9176:
918
919   mr   r3,r9      /* Init Data pointer */
920   mr   r4,r10     /* Destination Address */
921   bl   board_init_r
922
923   /*
924   * Copy exception vector code to low memory
925   *
926   * r3: dest_addr
927   * r7: source address, r8: end address, r9: target address
928   */
```

4. Deselect the **Instruction Stepping Mode** command when the instruction pointer is at `in_ram`.

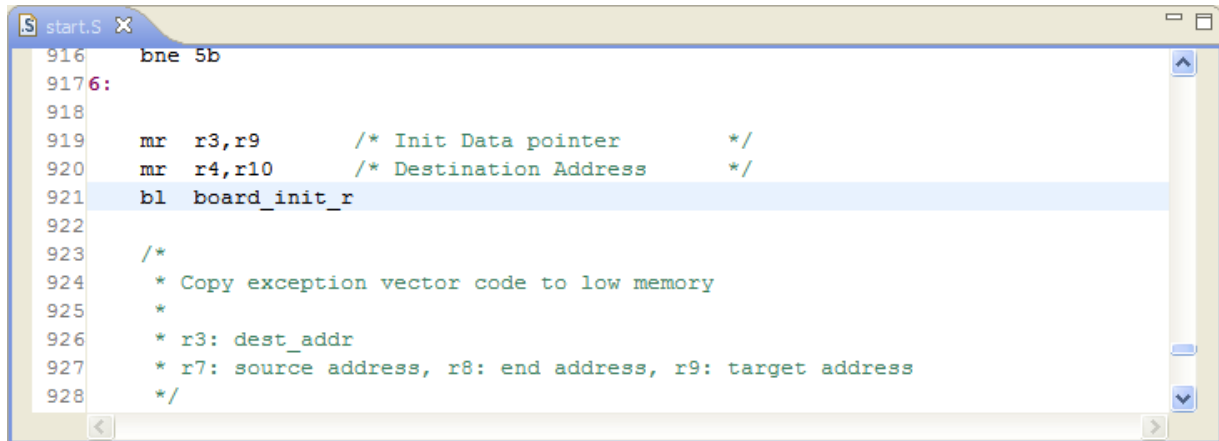
You can now do source-level debugging and set breakpoints in all RAM area, including `board_init_r`. See [Points to remember](#) on page 267 for more details.

NOTE

Before closing the debug session, change back the alternate load address to flash address space by issuing the `setpicloadaddr 0xFFFF40000` command in the **Debugger Shell**. Now, you do not need to manually set it from the **Debugger Shell** in Stage 1.

7.6.4.3 Debugging U-Boot using SPI and SD/MMC flash

This section explains how to debug U-Boot using the SPI and SD/MMC flash devices in different U-Boot debug stages.

U-Boot debug using the SPI and SD/MMC flash devices is similar. The only difference between these devices is how the final image (`u-boot.bin` and the configuration and control words) is built. For more details, see [Configuring and Building U-Boot](#) on page 262.

After the device has completed the reset sequence, if the ROM location selects the on-chip ROM eSDHC/eSPI Boot configuration, the e500 core starts to execute code from the internal on-chip ROM. The e500 core configures the eSDHC/eSPI controller, enabling it to communicate with the external SD/SPI card. The SD/SPI device should contain a specific data structure with control words, device configuration information, and initialization code. The on-chip ROM boot code uses the information from the SD/SPI card content to configure the device, and to copy the initialization code to a target memory device through the eSDHC interface. After all the code has been copied, the e500 core starts to execute the code from the target memory device. There are different ways you can utilize the eSDHC/eSPI boot feature. The simplest way is for the on-chip ROM to copy an entire operating system boot image into the system memory, and then access it to begin execution. This is the preferred way for small applications and for U-Boot application debug. After the reset sequence, all code is in RAM at 0x11000000.

The following sections describe four U-Boot debug stages for debugging U-Boot using the SPI and SD/MMC flash devices:

- [Debugging U-Boot before switching address space](#) on page 274
- [Debugging U-Boot in translated address space](#) on page 275
- [Debugging U-Boot after switching back to initial address space](#) on page 277
- [Debugging U-Boot in RAM](#) on page 278

7.6.4.3.1 Debugging U-Boot before switching address space

This section tells how to debug U-Boot in the SPI and SD/MMC flash devices before switching address space.

To debug U-Boot in flash before switching address space:

1. Start the CodeWarrior IDE.
2. Open the CodeWarrior U-Boot project that you created in [Creating a CodeWarrior Project to Debug U-Boot](#) on page 264.
3. Select **Run > Debug Configurations**. The **Debug Configurations** dialog appears.
4. From the left pane, expand the **CodeWarrior Attach** container and select the appropriate launch configuration.
5. Click **Debug**. The **Debug** perspective appears with the core 0 running.
6. Click **Reset** on the **Debug** view toolbar.

The **Reset** dialog appears.

7. In the **Run out of reset** column, select the checkboxes for all cores except core 0.

After the reset completes, core 0 appears stopped at the reset vector.

NOTE

To jump over the on-chip ROM code that performs block copy from SD EPROM and the reset sequence, you can set a hardware breakpoint at `_start_e500` by issuing the `bp -hw _start_e500` command.

8. From the **Debug** view toolbar, select the **Instruction Stepping Mode** () command.
9. From the **Debug** view toolbar, select the **Step Into** () command to step into `b _start_e500`.

The `start.s` file appears in the editor area and the disassembled code with memory addresses appears in the **Disassembly** view.

Figure 99: U-Boot Debug - Disassembly View

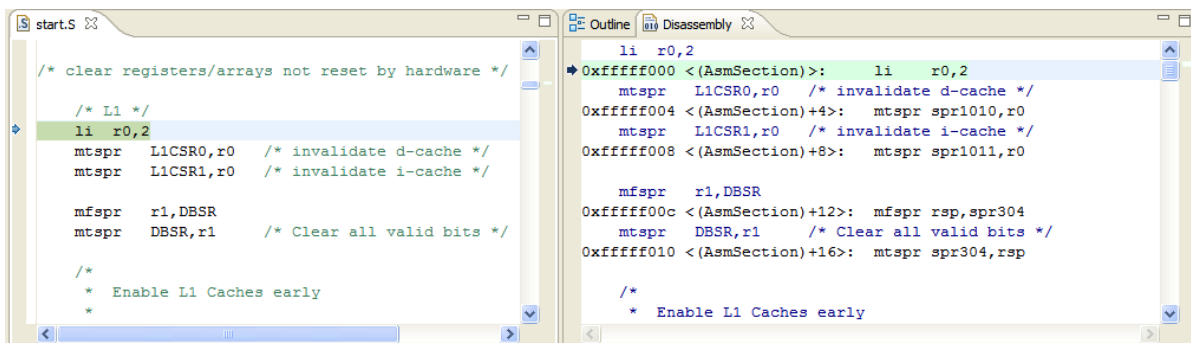

10. Move the Debug Current Instruction Pointer to `_start_e500`.

11. Deselect the **Instruction Stepping Mode** () command.

You can now do source-level debugging and set breakpoints in `start.s` until the address space switch at the `rfi` before `switch_as` (`start.s`, line 326). See [Points to remember](#) on page 267 for more details.

7.6.4.3.2 Debugging U-Boot in translated address space

This section tells how to debug U-Boot in the translated address space in the SPI and SD/MMC flash devices.

After you have reached the `rfi` call, the execution will move to the next stage. You should now use a memory configuration file for debugging in this section.

It is necessary to inspect the TLB registers to check if there are address spaces translated or to search in the CW PA10 layout (`PA\PA_Support\Initialization_Files\Memory\`) if there are memory configuration files that match your U-Boot debug scenario.

NOTE

For e500v2 cores (36-bit U-Boot debug only), due to a hardware issue (terminating the current debug session will put the core in running) another script must be executed before proceeding further with the instructions provided in this section:

1. Open **Debugger Shell** view.
2. Execute `${BoardName}_uboot_36_stage2_preparation.tcl` using the following command:

```
source /${BoardName}_uboot_36_stage2_preparation.tcl
```

To debug U-Boot in the translated address space in flash before switching back to initial address space (`start.s`, `bl cpu_init_f`, line 396):

1. Click  on the **Debug** view toolbar to terminate the current debug session.
2. Select **Run > Debug Configurations**. The **Debug Configurations** dialog appears.
3. Expand the **CodeWarrior** group and select the appropriate launch configuration.
4. In the **Connection** panel, click **Edit** next to the **Connection** drop-down list.
The **Properties for <connection>** dialog appears.
5. Click **Edit** next to the **Target** drop-down list.
The **Properties for <Target>** dialog appears.
6. On the **Memory** tab, select the checkbox for the respective core in the **Memory configuration** column.
7. Click the ellipsis button in the **Memory configuration file** column.
The **Memory Configuration File** dialog appears.
8. Click **File System** and select the memory configuration file from the following path:

```
<CWInstallDir>\PA\PA_Support\Initialization_Files\Memory\
```

NOTE

To select an appropriate memory configuration file, it is necessary to inspect the TLB registers and check if there are address spaces translated or if there are memory configuration files available in the CodeWarrior layout that match your U-Boot debug scenario.

9. Click **OK** to close the **Memory Configuration File** dialog.
10. Click **OK** to close the **Properties for <Target>** dialog.
11. Click **OK** to close the **Properties for <connection>** dialog.
12. Click **Debug**.

The instruction pointer is now on the `rfi` function call.

NOTE

For e500v2 cores (36-bit U-Boot debug only) a reset using `$ {BoardName}_uboot_36_stage2.tcl` is needed.

13. In the **Debugger Shell**, issue the following command to reset PIC load address to the location specified in `u-boot.elf`:

```
setpicloadaddr reset
```

14. From the **Debug** view toolbar, select the **Instruction Stepping Mode** () command.

15. Ensure the Debug Current Instruction Pointer is at `rfi`. From the **Debug** view toolbar, select the **Step Into** () command to step into `rfi`. The **Disassembly** view appears.

Figure 100: U-Boot Debug - Translated Address Space in Flash



16. Deselect the **Instruction Stepping Mode** command when the instruction pointer is at `switch_as`.

You can set breakpoints and use the Step Over, Step Into, and Step Out commands from line (`switch_as`: label) in `start.S` to line (`/* switch back to AS = 0 */`) in `start.S`. At these locations, the Instruction Address Space (IS) and Data Address Space (DS) bits from MSR are cleared, so that the processor uses only the TLB entries with `TS = 0`. See [Points to remember](#) on page 267 for more details.

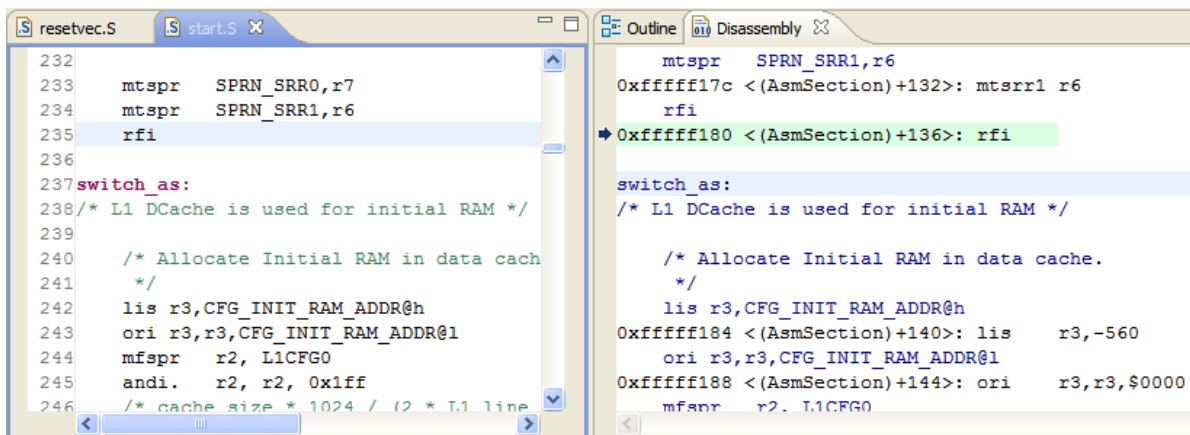
NOTE

To set breakpoints in Stage2 after `rfi` (`start.S`), you can set the Alternate Load Address by using `setpicloadaddr reset`. For low-end processors (e500v1, e500v2), set DE (Debug Enable) from MSR register via the **Debugger Shell** or the **Registers** view. You can then perform the set, resume, and remove operations on the breakpoints.

NOTE

To access breakpoints set on a previous debug session after changing the PIC address you will need to disable and enable back those breakpoints after the PIC value has been changed.

7.6.4.3.3 Debugging U-Boot after switching back to initial address space

This section tells how to debug U-Boot in the SPI and SD/MMC flash devices after switching back to initial address space.

While debugging U-Boot when you reach the `cpu_init_f` call you are back to address space 0; you now need to remove the memory configuration file used in the previous section or set another memory configuration file for U-Boot compiled on 36 bits.

To debug U-Boot in flash after switching back to initial address space:

1. Click  on the **Debug** view toolbar to terminate the current debug session.
2. Select **Run > Debug Configurations**. The **Debug Configurations** dialog appears.
3. From the left pane, in the **CodeWarrior Attach** container, select the appropriate launch configuration.
4. In the **Connection** panel, click **Edit** next to the **Connection** drop-down list.
The **Properties for <connection>** dialog appears.
5. Click **Edit** next to the **Target** drop-down list.
The **Properties for <Target>** dialog appears.
6. On the **Memory** tab, deselect the checkbox for the respective core in the **Memory configuration** column to remove the memory configuration file you had set in the previous section.

NOTE

If required, you can set another memory configuration file for U-Boot compiled on 36 bits on the **Memory** tab.

7. Click **OK** to close the **Memory Configuration File** dialog.
8. Click **OK** to close the **Properties for <Target>** dialog.
9. Click **OK** to close the **Properties for <connection>** dialog.
10. Click **Debug**.

The instruction pointer is now on the `cpu_init_f` function call.

NOTE

For e500v2 cores (36-bit U-Boot debug only) a reset using `setpicloadaddr reset` is needed.

11. If you used a different PIC value, issue the following command in the **Debugger Shell** to reset PIC load address to the location specified in `u-boot.elf`.

```
setpicloadaddr reset
```

12. From the **Debug** view toolbar, select the **Instruction Stepping Mode** () command.
13. From the **Debug** view toolbar, select the **Step Into** () command to step into `cpu_init_f`.
You can set breakpoints and use the Step Over, Step Into and Step Out commands from line 396 in `start.S` (`bl cpu_init_f`) to line 980 in `start.S` (`blr /* NEVER RETURNS! */`).

NOTE

To access breakpoints set on a previous debug session after changing the PIC address, you will need to disable and enable back those breakpoints after the PIC value has been changed.

7.6.4.3.4 Debugging U-Boot in RAM

This section tells how to debug U-Boot in RAM using the SPI and SD/MMC flash devices.

To debug U-Boot in RAM:

1. In the **Debugger Shell**, issue the following command to reset PIC load address to RAM space:
`setpicloadaddr 0xxxxx0000`

NOTE

0xxxxx0000 is the address printed by U-Boot at line "Now running in ram". You can also see this address in the **Disassembly** view and observe the current address space you are in.

2. From the **Debug** view toolbar, select the **Instruction Stepping Mode** () command.
3. From the **Debug** view toolbar, select the **Step Into** () command to step into `blr`. The **Disassembly** view appears.

Figure 101: U-Boot Debug - Running in RAM

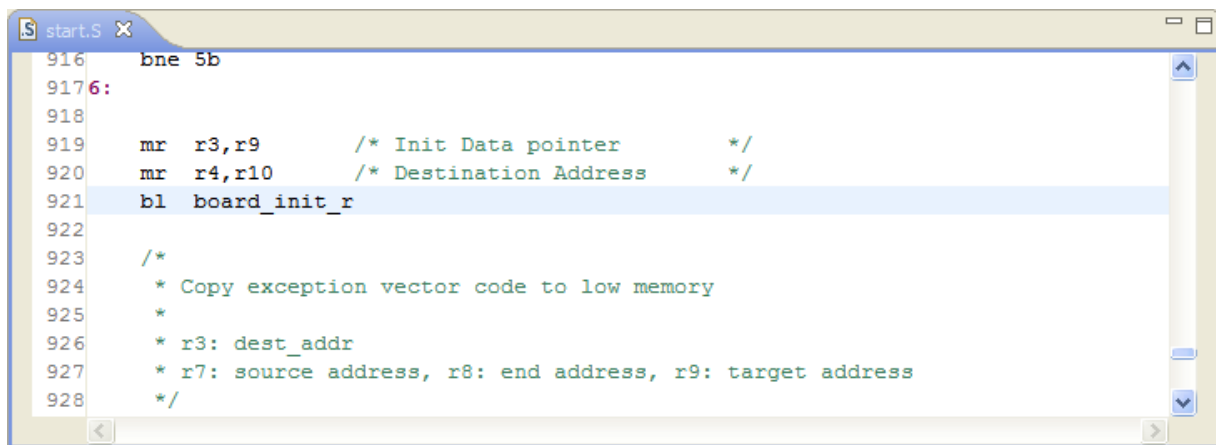

4. Deselect the **Instruction Stepping Mode** command when the instruction pointer is at `in_ram`.
You can now do source level debugging and set breakpoints in all RAM area, including `board_init_r`. See [Points to remember](#) on page 267 for more details.

NOTE

Before closing the debug session, change back the alternate load address to flash address space by issuing the `setpicloadaddr 0xFFFF40000` command in the **Debugger Shell**. Now, you do not need to manually set it from the **Debugger Shell** in Stage 1.

7.6.4.4 Debugging U-Boot using NAND flash

This section explains how to debug U-Boot using the NAND flash device in different U-Boot debug stages.

The following sections describe four U-Boot debug stages for debugging U-Boot using the NAND flash device:

- [Debugging U-Boot before switching address space](#) on page 279
- [Debugging U-Boot in translated address space](#) on page 279
- [Debugging U-Boot after switching back to initial address space](#) on page 281
- [Debugging U-Boot in RAM](#) on page 282

7.6.4.4.1 Debugging U-Boot before switching address space

This section tells how to debug U-Boot in a NAND flash device before switching address space.

To debug U-Boot in flash before switching address space:

1. Start the CodeWarrior IDE.
2. Open the CodeWarrior U-Boot project that you created in [Creating a CodeWarrior Project to Debug U-Boot](#) on page 264.
3. Select **Run > Debug Configurations**. The **Debug Configurations** dialog appears.
4. From the left pane, expand the **CodeWarrior Attach** container and select the appropriate launch configuration.
5. Click **Debug**. The **Debug** perspective appears with the core 0 running.
6. Click **Reset** on the **Debug** view toolbar.
 The **Reset** dialog appears.
7. In the **Run out of reset** column, select the checkboxes for all cores except core 0.

After the reset completes, core 0 appears stopped at the reset vector. In the **Debugger Shell** view, issue the following command to enter the PIC alternate load address:

```
setpicloadaddr 0xFFFF40000
```

8. From the **Debug** view toolbar, select the **Instruction Stepping Mode** () command.
9. From the **Debug** view toolbar, select the **Step Into** () command to step into `b _start_e500`.

The `start.s` file appears in the editor area and the disassembled code with memory addresses appear in the **Disassembly** view.

Figure 102: U-Boot Debug - Disassembly View

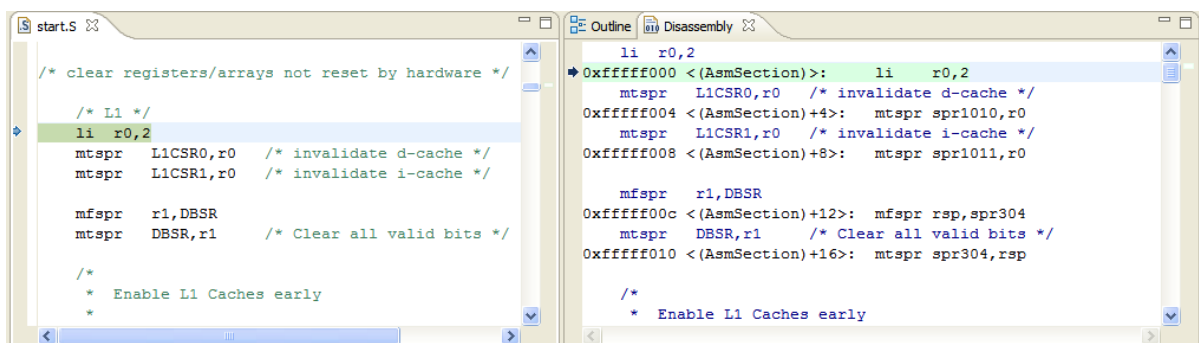

10. Move the Debug Current Instruction Pointer to `_start_e500`.

11. Deselect the **Instruction Stepping Mode** () command.

You can now do source-level debugging and set breakpoints in `start.s` until the address space switch at the `rfi` before `switch_as` (`start.s`, line 326). See [Points to remember](#) on page 267 for more details.

7.6.4.4.2 Debugging U-Boot in translated address space

This section tells how to debug U-Boot in the translated address space in a NAND flash device.

After you have reached the `rfi` call the execution moves to the next stage. You should now use a memory configuration file for debugging in this section.

It is necessary to inspect the TLB registers to check if there are address spaces translated or to search in the CW PA10 layout (*PA\PA_Support\Initialization_Files\Memory*) if there are memory configuration files that match your U-Boot debug scenario.

NOTE

For e500v2 cores (36-bit U-Boot debug only), due to a hardware issue (terminating the current debug session will put the core in running) another script must be executed before proceeding further with the instructions provided in this section:

- Open **Debugger Shell** view.
- Execute `${BoardName}_uboot_36_stage2_preparation.tcl` using the following command:

```
source /${BoardName}_uboot_36_stage2_preparation.tcl
```

To debug U-Boot in the translated address space in flash before switching back to initial address space (*start.s, bl cpu_init_f*, line 396):

1. Click  on the **Debug** view toolbar to terminate the current debug session.
2. Select **Run > Debug Configurations**. The **Debug Configurations** dialog appears.
3. From the left pane, in the **CodeWarrior Attach** container, select the appropriate launch configuration.
4. In the **Connection** panel, click **Edit** next to the **Connection** drop-down list.

The **Properties for <connection>** dialog appears.

5. Click **Edit** next to the **Target** drop-down list.

The **Properties for <Target>** dialog appears.

6. On the **Memory** tab, select the checkbox for the respective core in the **Memory configuration** column.
7. Click the ellipsis button in the **Memory configuration file** column.

The **Memory Configuration File** dialog appears.

8. Click **File System** and select the memory configuration file from the path:

```
<CWInstallDir>\PA\PA_Support\Initialization_Files\Memory\
```

NOTE

To select an appropriate memory configuration file, it is necessary to inspect the TLB registers and check if there are address spaces translated or if there are memory configuration files available in the CodeWarrior layout that match your U-Boot debug scenario.

9. Click **OK** to close the **Memory Configuration File** dialog.
10. Click **OK** to close the **Properties for <Target>** dialog.
11. Click **OK** to close the **Properties for <connection>** dialog.
12. Click **Debug**.

The instruction pointer is now on the rfi function call.

NOTE

For e500v2 cores (36-bit U-Boot debug only) a reset using `${BoardName}_uboot_36_stage2.tcl` is needed.

13. In the **Debugger Shell**, issue the following command to reset PIC load address to the location specified in `u-boot.elf`.

```
setpicloadaddr reset
```

14. From the **Debug** view toolbar, select the **Instruction Stepping Mode** () command.

15. Ensure the Debug Current Instruction Pointer is at `rfi`. From the **Debug** view toolbar, select the **Step Into** () command to step into `rfi`. The **Disassembly** view appears.

Figure 103: U-Boot Debug - Translated Address Space in Flash



16. Deselect the **Instruction Stepping Mode** command when the instruction pointer is at `switch_as`.

You can set breakpoints and use the Step Over, Step Into, and Step Out commands from line (`switch_as:` label) in `start.S` to line (`/* switch back to AS = 0 */`) in `start.S`. At these locations, the Instruction Address Space (IS) and Data Address Space (DS) bits from MSR are cleared, so the processor will use only the TLB entries with `TS = 0`. See [Points to remember](#) on page 267 for more details.

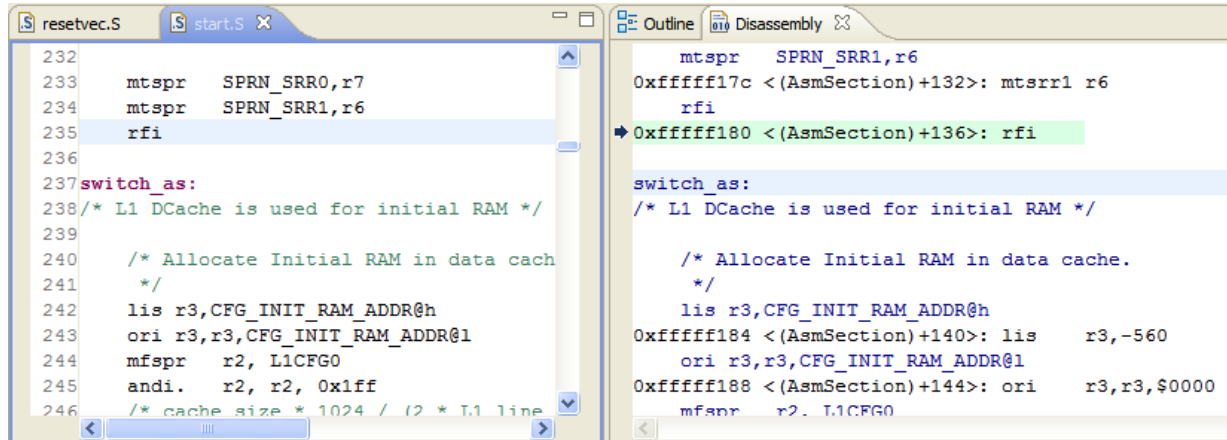
NOTE

To access breakpoints set on a previous debug session after changing the PIC address, you will need to disable and enable back those breakpoints after the PIC value was changed.

NOTE

To set breakpoints in Stage2 after `rfi` (`start.S`), you can set the Alternate Load Address by using `setpicloadaddr reset`. For low-end processors (e500v1, e500v2), set DE (Debug Enable) from MSR register using the **Debugger Shell** or the **Registers** view. You can then perform the set, resume, and remove operations on the breakpoints.

7.6.4.4.3 Debugging U-Boot after switching back to initial address space

This section tells how to debug U-Boot in a NAND flash device after switching back to initial address space.

While debugging U-Boot when you reach the `cpu_init_f` call you are back to address space 0; you now need to remove the memory configuration file used in the previous section or set another memory configuration file for U-Boot compiled on 36 bits.

To debug U-Boot in flash after switching back to initial address space:

1. Click  on the **Debug** view toolbar to terminate the current debug session.
2. Select **Run > Debug Configurations**. The **Debug Configurations** dialog appears.

3. From the left pane, in the **CodeWarrior Attach** container, select the appropriate launch configuration.
4. In the **Connection** panel, click **Edit** next to the **Connection** drop-down list.

The **Properties for <connection>** dialog appears.

5. Click **Edit** next to the **Target** drop-down list.

The **Properties for <Target>** dialog appears.

6. On the **Memory** tab, deselect the checkbox for the respective core in the **Memory configuration** column to remove the memory configuration file you had set in the previous section.

NOTE

If required, you can set another memory configuration file for U-Boot compiled on 36 bits on the Memory tab.

7. Click **OK** to close the **Memory Configuration File** dialog.
8. Click **OK** to close the **Properties for <Target>** dialog.
9. Click **OK** to close the **Properties for <connection>** dialog.
10. Click **Debug**.

The instruction pointer is now on the `cpu_init_f` function call.

NOTE

For e500v2 cores (36-bit u-boot debug only) a reset using `${BoardName}_uboot_36_stage2.tcl` is needed.

11. If you used a different PIC value, in the **Debugger Shell** view, issue the following command to reset PIC load address to the location specified in `u-boot.elf`.

```
setpicloadaddr reset
```

12. From the **Debug** view toolbar, select the **Instruction Stepping Mode** () command.

13. From the **Debug** view toolbar, select the **Step Into** () command to step into `cpu_init_f`.

You can set breakpoints and use the Step Over, Step Into and Step Out commands from line 396 in `start.S` (`bl cpu_init_f`) to line 980 in `start.S` (`blr /* NEVER RETURNS! */`).

NOTE

To access breakpoints set on a previous debug session after changing the PIC address you will need to disable and enable back those breakpoints after the PIC value was changed.

7.6.4.4 Debugging U-Boot in RAM

This section tells how to debug U-Boot in RAM using a NAND flash device.

To debug U-Boot in RAM:

1. In the **Debugger Shell** view, issue the following command to reset PIC load address to RAM space:

```
setpicloadaddr 0xxxxx0000
```

NOTE

0xxxxx0000 is the address printed by U-Boot at line "Now running in ram". You can also see this address in the **Disassembly** view and observe the current address space you are in.



2. From the **Debug** view toolbar, select the **Instruction Stepping Mode** () command.
3. From the **Debug** view toolbar, select the **Step Into** () command to step into `blr`.

Figure 104: U-Boot Debug - Running in RAM



4. Deselect the **Instruction Stepping Mode** command when the instruction pointer is at `in_ram`.
 You can now do source-level debugging and set breakpoints in all the RAM area, including `board_init_r`. See [Points to remember](#) on page 267 for more details.

NOTE

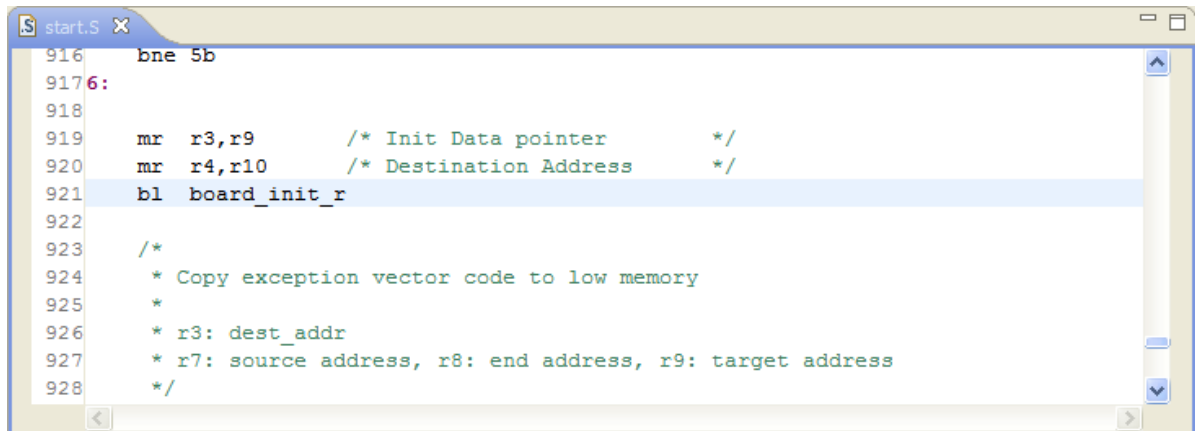
You can enter the `board_init_r`, `nand_boot`, and `uboot` functions. Beginning with the `uboot` function, the second image is relocated to RAM at `0x11000000` and you begin to execute the entire code again from RAM address space. See [Points to remember](#) on page 267 to avoid any debugging issues.

NOTE

Before closing the debug session, change back the alternate load address to flash address space by issuing the `setpicloadaddr 0xFFF40000` command in the **Debugger Shell**. Now, you do not need to manually set it from the **Debugger Shell** in Stage 1.

7.7 Debugging the Linux Kernel

This section shows you how to use the CodeWarrior debugger to debug the Linux kernel.

The Linux operating system (OS) works in two modes, *kernel mode* and *user mode*. The Linux kernel operates in kernel mode and resides at the top level of the OS memory space, or *kernel space*. The kernel performs the function of a mediator among all the currently running programs and between the programs and the hardware. The kernel manages the memory for all the programs (processes) currently running and ensures that the processes share the available memory such that each process has enough memory to function adequately. In addition, the kernel allows application programs to manipulate various hardware architectures via a common software interface.

User mode uses the memory in the lowest level of the OS memory space, called the *user space* or the application level. At the application level, a program accesses memory or other hardware through system calls to the kernel as it does not have permission to directly access these resources.

Debugging the Linux kernel involves the following major actions:

1. [Setting Up the Target Hardware](#) on page 284
2. [Installing the Board Support Package \(BSP\)](#) on page 286
3. [Configuring the Build Tool](#) on page 287
4. [Configuring the Linux Kernel](#) on page 287
5. [Creating a CodeWarrior Project using the Linux Kernel Image](#) on page 289
6. [Configuring the kernel project for debugging](#) on page 290
7. [Debugging the kernel to download the kernel, RAM disk, and device tree](#) on page 301
8. [Debugging the kernel based on MMU initialization](#) on page 302
9. [Debugging the kernel by attaching to a running U-Boot](#) on page 305

7.7.1 Setting Up the Target Hardware

Before you use the CodeWarrior IDE to debug the Linux kernel, you need to set up the target hardware.

One requirement of the setup is to have a debug probe connected between the CodeWarrior debug host and target board.

The figure below illustrates the setup required to use the IDE to debug the Linux kernel running on a Power Architecture target board.

Figure 105: Setup for Kernel Debugging Using the CodeWarrior IDE

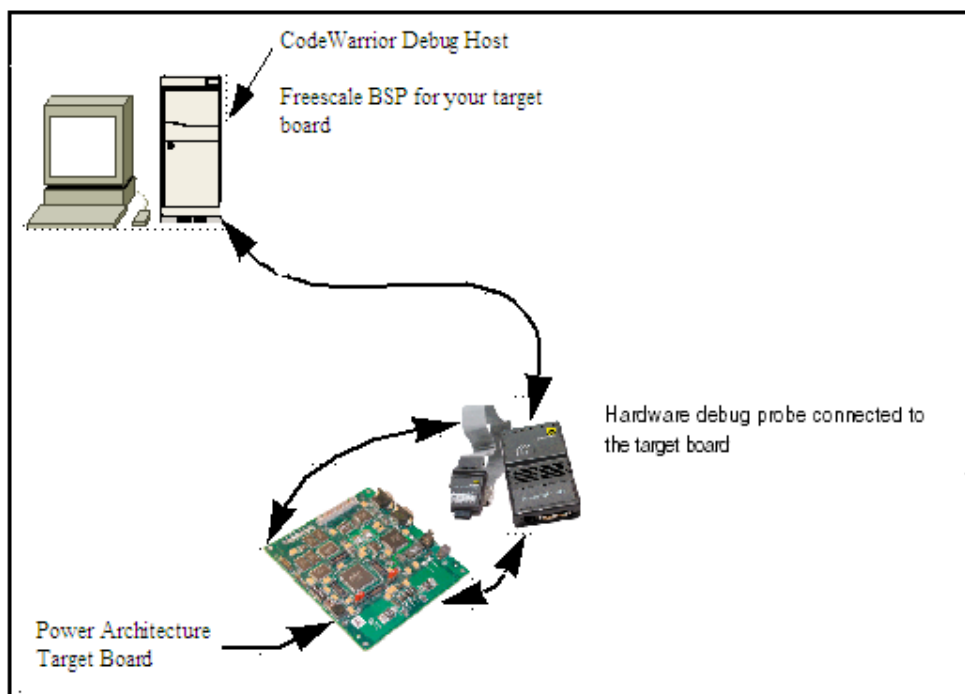

Connect the hardware debug probe between the target board and CodeWarrior debug host. Kernel debugging is possible using a Linux-hosted or Windows-hosted CodeWarrior installation. There are a variety of debug

probes. The current kernel debugging example uses the USB TAP. Connection information for other debug probes can be determined from documentation provided with the probes.

The following subsections provide the steps to set up the target hardware:

1. [Connect USB TAP](#) on page 285
2. [Establish a Console Connection](#) on page 285

7.7.1.1 Connect USB TAP

This section explains how to connect the USB TAP between the CodeWarrior debug host and target board.

To connect the USB TAP, perform these steps:

1. Ensure that the power switch on the target board is OFF.
2. Connect the square end (USB "B" connector) of the USB cable to the USB TAP.
3. Connect the rectangular end (USB "A" connector) of the USB cable to a free USB port on the host Linux machine.
4. Connect the ribbon cable coming out of the USB TAP to the 16-pin connector on the target board.
5. Connect the power supply to the USB TAP.

7.7.1.2 Establish a Console Connection

You need to establish a console connection before applying power to the target board, so that boot messages can be viewed in a terminal window.

Establishing the console connection allows you to:

- View target generated log and debug messages
- Confirm successful installation of the bootloader (U-Boot)
- Use the bootloader to boot the Linux OS
- Halt the booting of the Linux OS

The bootloader receives keyboard input through a serial port that has default settings 115,200-8-N-1.

Follow these steps to establish a console connection to the target hardware.

1. Connect a serial cable from a serial port of the CodeWarrior debug host to a serial port of the target board.
2. On the CodeWarrior debug host computer, open a terminal-emulator program of your choice (for example, `minicom` for a Linux host).
3. From the terminal-emulator program, open a console connection to the target hardware.

Use the connection settings given in the table below.

Table 132: Terminal Connection Settings

Name	Setting
Baud rate	115, 200 bits per second
Data bits	8
Parity	None
Stop bits	1
Flow control	Hardware

NOTE

See the board specific README file inside the stationery wizard project to find out more details on the serial connection settings, changing the serial port on the board, and the type of serial cable to use.

4. Test the connection by turning on the test board with the power switch and viewing the boot messages in the console connection.

7.7.2 Installing the Board Support Package (BSP)

This section describes installation of a BSP on a Linux computer.

NOTE

The BSP versions keep changing frequently. For different BSP versions, you might encounter build environments based on Itib, bitbake, or other tools. The subsequent sections will describe necessary procedures and use specific examples from real Freescale BSPs for illustration. The examples in these sections will need to be adapted based on the BSP versions or build tools you are currently using.

To install a BSP, perform the following steps:

1. On the Linux computer, download the Board Support Package (BSP) for your target hardware to install kernel files and Linux compiler toolchains on your system.

Board Support Package image files for target boards are located at <http://www.freescale.com/linux>.

2. Download the BSP image file for your target board.

NOTE

You will need to log in or register to download the BSP image file.

The downloaded image file has an `.iso` extension.

For example,

```
QorIQ-DPAA-SDK-<yyyymmdd>-yocto.iso
```

3. Mount the image file to the CDROM as root, or using "sudo":

```
<sudo> mount -o loop QorIQ-DPAA-SDK-<yyyymmdd>-yocto.iso /mnt/cdrom
```

NOTE

`sudo` is a Linux utility that allows users to run applications as `root`. You need to be setup to run `sudo` commands by your system administrator to mount the BSP image files.

4. Execute the BSP install file to install the build tool files to a directory of your choice, where you have privileges to write files:

```
/mnt/cdrom/install
```

NOTE

The BSP must be installed as a non-root user, otherwise the install will exit.

5. Answer the questions from the installation program until the file copy process begins.

You will be prompted to input the required build tool install path. Ensure you have the correct permissions for the install path.

6. Upon successful installation, you will be prompted to install the ISO for the core(s) you want to build.

For example, if you want to build the SDK for P4080, that is a e500mc core, then you have to install the ISO images for e500mc core:

```
c23174e5e3d187f43414e5b4420e8587 QorIQ-SDK-V1.2-PPCE500MC-20120603-yocto.iso.part1  
292c6e1c5e97834987fbd5f69635a1d QorIQ-SDK-V1.2-PPCE500MC-20120603-yocto.iso.part2
```

NOTE

You can see the SDK User Manual for instructions about how to build the BSP images and run different scenarios from the `iso/help/documents/pdf` location.

7.7.3 Configuring the Build Tool

After installing the BSP, you need to configure the build tool and build the Linux kernel and U-boot images for CodeWarrior debug.

For more information on configuring the build tool, see the SDK User Manual from `iso/help/documents/pdf`.

7.7.4 Configuring the Linux Kernel

After you complete the BSP configuration, configure the Linux kernel to enable CodeWarrior support.

To configure the Linux kernel, perform the following steps:

1. Launch a terminal window and navigate to the `<yocto_installtion_path>/build_<board>_release` folder.
2. Execute the following command to get a new and clean kernel tree:

```
bitbake -c configure -f virtual/kernel
```

3. Configure the Linux kernel using the various configuration options available in the kernel configuration user interface. For example, run the following command to display the kernel configuration user interface:

```
bitbake -c menuconfig virtual/kernel
```

The kernel configuration user interface appears.

4. CodeWarrior supports both SMP and non-SMP debug. To change the default settings, you can make changes by selecting the Processor support options.
5. To run a monolithic kernel, you do not need to enable loadable module support. However, during the debug phase of drivers, it is easier to debug them as loadable modules to avoid rebuilding the Linux kernel on every debug iteration. If you intend to use loadable modules, select the **Loadable module support** menu item.
6. Select the **Enable loadable module support** option.
7. Select the **Module unloading** option.

NOTE

If you want to use the `rmmod -f <mod_name>` command for kernel modules under development, select the **Forced module unloading** option.

8. Select **Exit** to return to the main configuration menu.
9. Select **Kernel hacking**.

10. Select **Include CodeWarrior kernel debugging** by pressing Y. Enabling this option allows the CodeWarrior debugger to debug the target. Select other desired configuration options for Linux kernel debug.
11. Select **Exit** to return to the main configuration menu.
12. Select the **General Setup** option.
13. Select **Configure standard kernel features (expert users)** and ensure that the **Sysctl syscall support** option is selected.
14. If you are using the Open Source Device Tree debugging method, under the **General Setup > Configure standard kernel features (expert users)** option, then select:
 - Load all symbols for debugging/ksymoops.
 - Include all symbols in kallsyms.

NOTE

These settings are optional. They aid the debugging process by providing the vmlinux symbols in `/proc/kallsyms`.

15. Select **Exit** to exit the configuration screen.
16. Select **Yes** when asked if you want to save your configuration.
17. Execute the following command to rebuild the Linux kernel:

```
bitbake virtual/kernel
```

The uncompressed Linux kernel image with debug symbols, `vmlinux.elf`, is created.

NOTE

The location of the images directory might differ based on the BSP version being used. For the correct location of where the Linux kernel images are stored, see the SDK User Manual from `iso/help/documents/pdf`.

You just created a Linux kernel image that contains symbolic debugging information.

Now, you can use this image and create a CodeWarrior project for debugging the Linux kernel. The various use cases for the Linux kernel debug scenario are:

- CodeWarrior allows you to download this Linux kernel image (`vmlinux.elf`), RAM disk, and dtb files to the target.
- You can start the Linux kernel and RAM disk manually from U-Boot. The U-Boot, the kernel, RAM disk, and dtb images are written into flash memory.
- You can download the Linux kernel and RAM disk from CodeWarrior without using U-Boot.
- You can perform an early kernel debug before the MMU is enabled or debug after the Linux kernel boots and the login prompt is shown.

The Linux kernel debug scenarios are explained in the following sections:

- [Creating a CodeWarrior Project using the Linux Kernel Image](#) on page 289
- [Configuring the kernel project for debugging](#) on page 290
- [Debugging the kernel to download the kernel, RAM disk, and device tree](#) on page 301
- [Debugging the kernel based on MMU initialization](#) on page 302
- [Debugging the kernel by attaching to a running U-Boot](#) on page 305

7.7.5 Creating a CodeWarrior Project using the Linux Kernel Image

After creating a Linux kernel image with symbolic debugging information, you need to create a CodeWarrior project using the kernel image.

To create a CodeWarrior project:

1. Start the CodeWarrior IDE from the Windows system.
2. Select **File > Import**. The **Import** wizard appears.
3. Expand the **CodeWarrior** group and select **CodeWarrior Executable Importer**.
4. Click **Next**.

The **Import a CodeWarrior executable file** page appears.

5. Specify a name for the project, to be imported, in the **Project name** text box.
6. If you do not want to create your project in the default workspace:
 - a. Clear the **Use default location** checkbox.
 - b. Click **Browse** and select the desired location from the **Browse For Folder** dialog.
 - c. In the **Location** text box, append the location with the name of the directory in which you want to create your project.

NOTE

An existing directory cannot be specified for the project location.

7. Click **Next**.

The **Import C/C++/Assembler Executable Files** page appears.

8. Click **Browse** next to the **Executable** field.
9. Select the vmlinux file obtained.
10. Click **Open**.
11. From the **Processor** list, expand the processor family and select the required processor.
12. Select the **Bareboard Application** toolchain from the **Toolchain** group.

Selected toolchain sets up the default compiler, linker, and libraries used to build the new project. Each toolchain generates code targeted for a specific platform.

13. Select the **Linux Kernel** option from the **Target OS** list.

NOTE

Selecting Linux Kernel will automatically configure the initialization file for kernel download, the default translation settings (these settings need to be adjusted according to the actual Linux kernel configuration) in the OS Awareness tab, and the startup stop function to `start_kernel`.

14. Click **Next**.

The **Debug Target Settings** page appears.

15. From the **Debugger Connection Types** list, select the required connection type.
16. Specify the settings, such as board configuration, launch configuration, connection type, and TAP address if you are using Ethernet or Gigabit TAP.
17. Click **Next**.

The **Configurations** page appears.

18. From the **Core index** list, select the required core.

19. Click **Finish**.

The wizard creates a project according to your specifications.

You can access the project from the CodeWarrior Projects view on the workbench.

7.7.5.1 Updating the Linux Kernel Image

By modifying the Linux kernel image, you can update the project you just created.

You have built a new Linux kernel image file, `vmlinux.elf`, with some changes as compared to the current `vmlinux.elf` file being used in the CodeWarrior project you created. The following subsections present two scenarios to replace the current `vmlinux.elf` file with the new `vmlinux.elf` file:

- [Cache Symbolics Between Sessions is Enabled](#) on page 290
- [Cache Symbolics Between Sessions is Disabled](#) on page 290

7.7.5.1.1 Cache Symbolics Between Sessions is Enabled

This section provides steps to replace the current `vmlinux.elf` file with the new `vmlinux.elf` file when the cache symbolics between sessions is enabled.

Follow these steps:

1. Terminate the current debug session.
2. Right-click in the Debug window.
3. From the context menu, select **Purge Symbolics Cache**. The old `vmlinux.elf` file is being used by the debugger, but after you select this option, the debugger stops using this file in the disk.
4. Copy the new `vmlinux.elf` file over the old file.

Now, when you reinitiate a debug session, the updated `vmlinux.elf` file is used for the current debug session.

7.7.5.1.2 Cache Symbolics Between Sessions is Disabled

This section provides steps to replace the current `vmlinux.elf` file with the new `vmlinux.elf` file when the cache symbolics between sessions is disabled.

Follow these steps:

1. Terminate the current debug session.
2. Copy the new `vmlinux.elf` file over the old file.

Now, when you reinitiate a debug session, the updated `vmlinux.elf` file is used for the current debug session.

7.7.6 Configuring the kernel project for debugging

After you have created a CodeWarrior project using the Linux kernel image, the next action is to configure this project for debugging.

- [Configuring a download kernel debug scenario](#) on page 291
- [Configure an attach kernel debug scenario](#) on page 291
- [Setting up RAM disk](#) on page 294
- [Using Open Firmware Device Tree Initialization method](#) on page 297

7.7.6.1 Configuring a download kernel debug scenario

This section describes how to configure a download debug scenario.

For a download debug scenario, CodeWarrior:

- Resets the target
- Runs the initialization file
- Downloads the `.elf` file to the target; from the `vmlinux.elf` file, CodeWarrior writes the binary file to the target memory
- Sets the entry point based on the information available from the `.elf` file
- Runs the target

For a download debug scenario, to boot the Linux kernel, CodeWarrior requires the RAMDISK or ROOTFS file in addition to the `vmlinux.elf` file. This file is also built along with the image files when the kernel is compiled using the build tool. CodeWarrior also requires a DTB file that specifies the resources to be used by the kernel during its execution. For a download debug scenario, you need to configure the `vmlinux.elf` file, RAMDISK or ROOTFS file, and the DTB files to be downloaded into the target memory. All these files can be found in the specific target images folder.

NOTE

The location of the images directory might differ based on the BSP version being used. For the correct location of where the kernel images are stored, see the SDK User Manual in `iso/help/documents/pdf`.

These files are specified in the Download launch configuration after you have created the CodeWarrior project with the Linux kernel image. [Table 134. Kernel Project Download Launch Configuration Settings](#) on page 309 describes the settings you need to provide in the launch configuration.

7.7.6.2 Configure an attach kernel debug scenario

This section describes how to configure an attach debug scenario.

For the attach debug scenario, CodeWarrior does not download any file on the target. The kernel is started directly from U-Boot. You need to burn the U-Boot image to the flash memory of the hardware.

NOTE

See the *Burning U-Boot to Flash* cheat sheet for the entire procedure for burning U-Boot to flash. To access the cheat sheets, select **Help > Cheat Sheets** from the CodeWarrior IDE.

After the boot process, the U-Boot console is available and the Linux kernel can be started manually from U-Boot. For this, the following files can be either written into flash memory or can be copied from U-Boot using TFTP:

- Binary kernel image file, `uImage`
- Ramdisk to be started from U-Boot, for example,

```
<target version>.rootfs.ext2.gz.u-boot
```

- dtb file, for example, `uImage-<target version>.dtb`

After the Linux boot process, the Linux login appears and you can connect to debug the kernel using the CodeWarrior Attach launch configuration. As all the files are manually loaded from U-Boot, these files must not be specified in the launch configuration.

The table below describes the settings you need to provide in the launch configuration.

To specify the launch configuration settings in CodeWarrior:

1. Select **Run > Debug Configurations**.
2. Enter the launch configuration settings, given in the table below, in the **Debug Configurations** dialog.

Table 133: Kernel Project Attach Launch Configuration Settings

Debug Window Component	Settings
Main Tab	<p>Select an appropriate system (if existing) from the Connection drop-down list or define a new system.</p> <ul style="list-style-type: none"> • To define a new system, click New. • Select Hardware or Simulator Connection from the CodeWarrior Bareboard Debugging list. Click Next. • Specify a name and a description for the connection. • Select an appropriate target (if existing) from the Target drop-down list or define a new target. • To define a new target, click New on the Hardware or Simulator Connection dialog. • Select Hardware or Simulator Target from the CodeWarrior Bareboard Debugging list. Click Next. • Specify a name and a description for the target. • Select a target from the Target type drop-down list. On the Initialization tab, ensure there are no initialization files selected. • Click Finish to create the target and close the Hardware or Simulator Target dialog. • Select the type of connection you will use from the Connection type drop-down list. • Click Finish. • Select all the cores on which Linux is running (for example, core 0 for single-core or cores 0-7 for 8-core SMP).
Debugger Tab > Debugger options > Symbolics Tab	<p>Select the Cache Symbolics between sessions checkbox. The symbolics are loaded from the elf file to the debugger for the first session only. This shows a speed improvement for <code>vmlinux.elf</code> as the size is bigger than around 100 MB.</p>
Debugger Tab > Debugger options > OS Awareness Tab	<p>Select Linux from the Target OS drop-down list.</p>
Debugger Tab > Debugger options > OS Awareness Tab > Boot Parameters	<p>Disable all settings on the Boot Parameters tab.</p> <p style="text-align: center;">NOTE</p> <p style="text-align: center;">For details on the options available on the Boot Parameters tab, see Setting up RAM disk on page 294.</p>

Table continues on the next page...

Table 133: Kernel Project Attach Launch Configuration Settings (continued)

Debug Window Component	Settings
Debugger Tab > Debugger options > OS Awareness Tab > Debug Tab	<p>Debug tab</p> <ul style="list-style-type: none"> • Select the Enable Memory Translation checkbox <p>Physical Base Address is set to value CONFIG_KERNEL_START (0x0)</p> <p>Virtual Base Address is set to value CONFIG_KERNEL_START (0xc000 0000 for 32 bits, and 0xc000 0000 0000 0000 for 64bits).</p> <ul style="list-style-type: none"> • Memory Size is the kernel space translation size. <p style="text-align: center;">NOTE</p> <p style="text-align: center;">The values shown above should be set as configured in the linux config file (.config). You can read the MMU registers to verify what you have configured and do a correction, if required.</p> <ul style="list-style-type: none"> • Select Enable Threaded Debugging Support checkbox • Select Enable Delayed Software Breakpoint Support • If required, also select Update Background Threads on Stop. When enabled, the debugger reads the entire thread list when the target is suspended. This decreases the speed. If the option is disabled, the speed is increased but the Debug window might show non-existent threads, as the list is not refreshed.

3. Click the **Source** page to specify path mappings. Path mappings are not required if the debug host is similar to the compilation host. If the two hosts are separate, the .elf file contains the paths for the compilation host. Specifying the path mappings helps establish paths from compilation host to where the sources are available to be accessed by the debugger on the debugger host. If no path mapping is specified, when you perform a debug on the specified target, a source file missing message appears (shown in the figure below).

Figure 106: Debug View When No Path Mapping is Specified

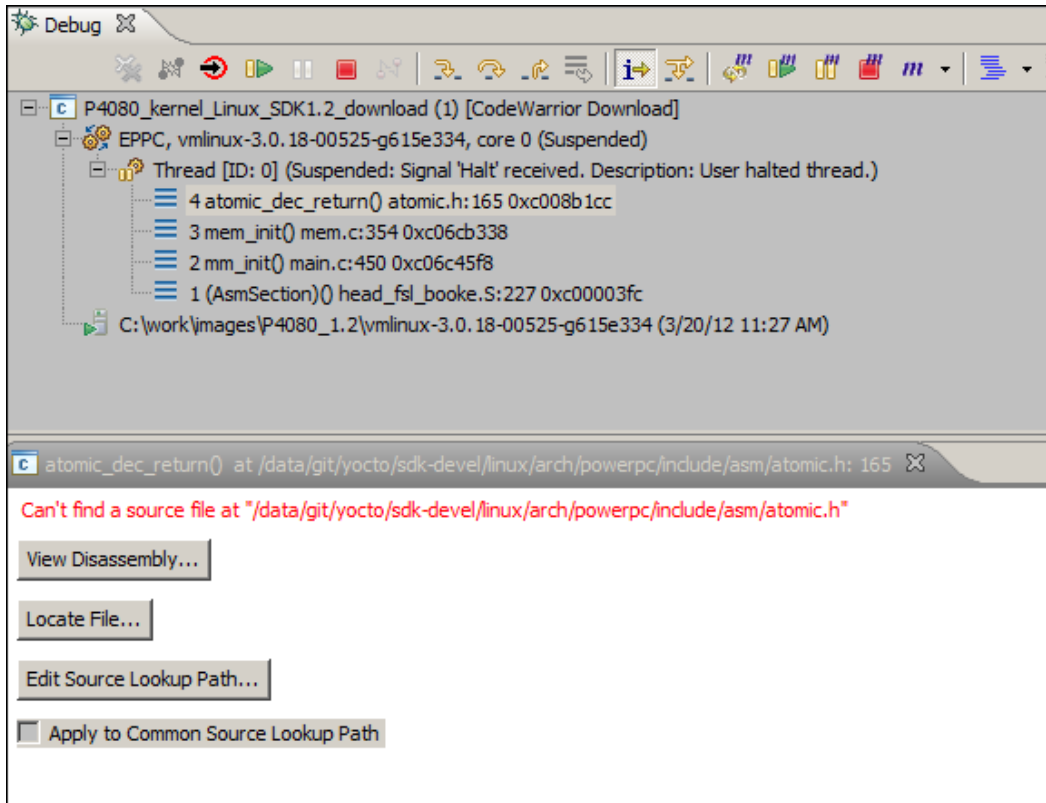

You can specify the path mappings, either by adding a new path mapping on the **Source** tab or by clicking the appropriate buttons (**Locate File**, **Edit Source Lookup Path**) that appear when a source path mapping is not found.

4. Click **Apply** to save the settings.
5. Click **Close**.

7.7.6.3 Setting up RAM disk

This section describes specifying RAM disk information that is used by the Linux kernel when it is booted.

You can specify RAM disk information in the **Boot Parameters** tab, which is present on the **OS Awareness** tab of the **Debugger** tab of the **Debug Configurations** dialog, as shown in the figure below. [Table 134. Kernel Project Download Launch Configuration Settings](#) on page 309 lists the instructions to set up the RAM disk.

Figure 107: Kernel Debug - OS Awareness Tab

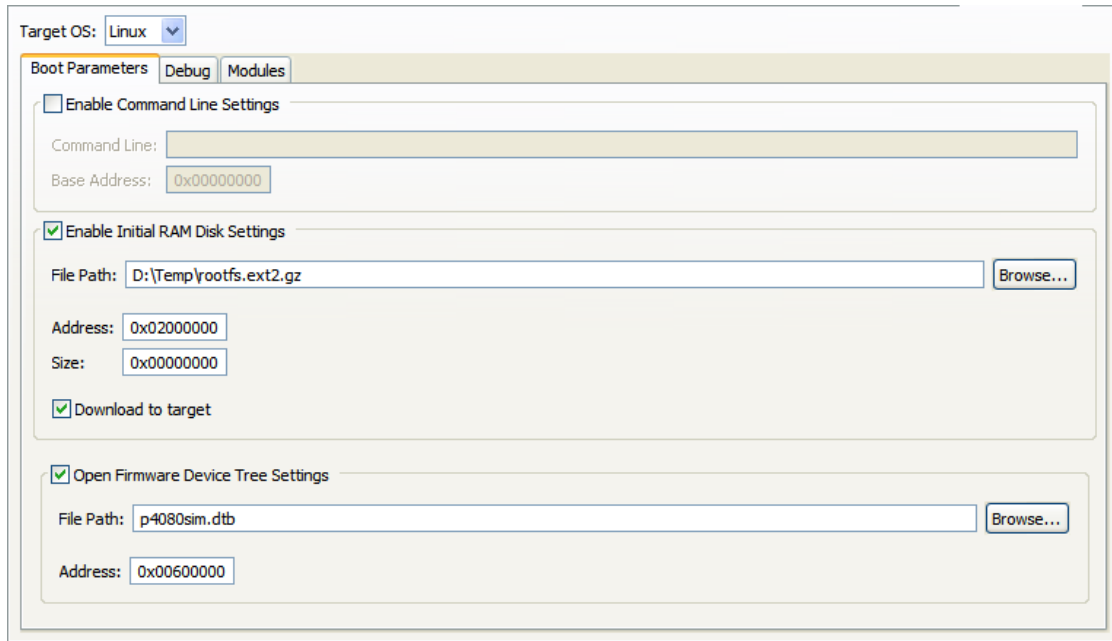

Depending on the method you choose for passing parameters to the kernel during kernel initialization, the RAM disk information can be provided in any of the following ways:

- [Flattened Device Tree Initialization](#) on page 295
- [Regular Initialization](#) on page 296

7.7.6.3.1 Flattened Device Tree Initialization

In this method, the RAM disk is set up by specifying a device tree file that contains the initialization information.

To follow the Flattened device tree initialization method:

1. Open the **Debug Configurations** dialog.
2. Select the **Debugger** tab.
3. From the **Debugger options** panel, select the **OS Awareness** tab.
4. From the **Target OS** drop-down list, select **Linux**.
5. On the **Boot Parameters** tab, select the **Enable Initial RAM Disk Settings** checkbox.

The options in this group activate.

6. In the **File Path** field, type the path of the RAM disk.

Alternatively, click **Browse** to display a dialog that you can use to select this path.

NOTE

The RAM disk is created by the build tool and not by the kernel. It contains the initial file system. For details, see the SDK User Manual in `iso/help/documents/pdf`.

7. In the **Address** text box, enter `0x02000000`, or another appropriate base address where you want the RAM disk to be written.

NOTE

Ensure that the address you specify does not cause the RAM disk to overwrite the kernel. The kernel is loaded to 0x00000000. The address you specify should be greater than the size, in bytes, of the uncompressed Linux kernel with no debug symbols.

NOTE

If you use a DTB file, ensure to use the same addresses for RAM disk and initial RAM disk (`initrd`) start value from the chosen section. The kernel must find the RAM disk at the address specified in the `.dtb` file.

8. In the **Size** text box, enter the size of the RAM disk file. To copy all the contents of the RAM disk file, enter zero (0).

9. Select the **Download to target** checkbox to download the RAM disk file to the target board.

The debugger copies the initial RAM disk to the target board only if this checkbox is checked.

NOTE

Most embedded development boards do not just use a small initial RAM disk, but a large root file system. The Download to target option works in both the cases, but for large file systems it is better to deploy the file directly to the target in the flash memory and not have it downloaded by the debugger.

7.7.6.3.2 Regular Initialization

In this method, the RAM disk is set up by passing the parameters through the command-line settings using the **Boot Parameters** tab.

To follow the regular initialization method:

1. Open the **Debug Configurations** dialog.
2. Select the **Debugger** tab.
3. From the **Debugger options** panel, select the **OS Awareness** tab.
4. From the **Target OS** drop-down list, select **Linux**.
5. On the **Boot Parameters** tab, select the **Enable Command Line Settings** checkbox.

The options in this group activate.

6. Specify the RAM disk parameters for use in the Command Line field. For example:

- You can specify the following when the regular initialization of the kernel is used:

```
root=/dev/ram rw"
```

- Sample NFS parameters:

```
"root=/dev/nfs ip=10.171.77.26  
nfsaddr=10.171.77.26:10.171.77.21  
nfsroot=/tftpboot/10.171.77.26"  
"root=/dev/nfs rw  
nfsroot=10.171.77.21:/tftpboot/10.171.77.26  
ip=10.171.77.26:10.171.77.21:10.171.77.254:255.255.255.0:8280x:eth0:off"
```

where, 10.171.77.21 is the IP address of the NFS server and 10.171.77.26 is the IP address of the target platform.

"/tftpboot/10.171.77.26" is a directory on the host computer where the target platform file system is located.

"8280x" is the host name.

- Sample flash parameters: `root=/dev/mtdblock0` or `root=/dev/mtdblock2`
(depending on your configuration)

7.7.6.4 Using Open Firmware Device Tree Initialization method

You can use the Open Firmware Device Tree Initialization method as an alternate way of loading parameters to the kernel from a bootloader on Power Architecture processors.

Since downloading the kernel with the CodeWarrior IDE emulates bootloader behavior, the IDE provides this way of passing the parameters to the kernel.

The Open Firmware Device Tree initialization method involves the following general actions:

1. [Obtain a DTS file](#) on page 297
2. [Edit DTS file](#) on page 299
3. [Compile DTS file](#) on page 300
4. [Test DTB file](#) on page 300
5. [Modify a DTS file](#) on page 300

7.7.6.4.1 Obtain a DTS file

A device tree settings (.dts) file is a text file that contains the kernel setup information and parameters.

To obtain a device tree source file that can be used with CodeWarrior:

1. Configure a TFTP server on a Linux PC.
2. Copy the Linux images on the TFTP server PC in the specific directory. The following files are needed:
 - ulimage
 - `rootfs.ex2.gz.u-boot` (if this is not present, check if the **Target Image Generation > Create a ramdisk that can be used by u-boot** option is enabled).
 - A device tree blob (DTB) obtained from the kernel sources. To convert this into a DTB, use the Device Tree Compiler (DTC) that is available in the BSP:

```
dtc -f -b 0 -S 0x3000 -R 8 -I dtb -O dts <target>.dtb > <target>.dts
```

NOTE

Standard DTS files are available along with Linux kernel source files in `<SDK_Linux_sources_root>/arch/powerpc/boot/dts`. For the exact location of where the kernel images are stored, see the SDK User Manual from `iso/help/documents/pdf`.

3. Power on the target. Wait until the uboot prompt is displayed.
4. Ensure that networking is working on the target. You need to have a network cable plugged in and set several variables (`ipaddr`, `netmask`, `serverip`, `gatewayip`), including the IP address of the TFTP server. For example,

```
ipaddr=10.171.77.230  
netmask=255.255.255.0
```

```
serverip=10.171.77.192  
gatewayip=192.168.1.1
```

5. Check that network connectivity is working by pinging the TFTP server.

```
ping $serverip
```

6. On the uboot prompt, download the DTS and configure it for the current target. For example,

```
tftp 3000000 /tftpboot/<target>.dtb  
fdt addr 0x3000000  
fdt boardsetup  
fdt print
```

7. Copy the output of this command as a DTS file.

8. Modify the memreserve statement at the beginning of the DTS file. The first parameter is the start address of the memory reserved for the RAM disk. The second parameter is the size of the RAM disk and must be modified each time the RAM disk is repackaged as you might add additional packages to the RAM disk. For example,

```
/memreserve/ 0x20000000 0x453ecc;
```

9. Modify the chosen node in the DTS file. The linux,initrd-start argument must be the start address of the RAM disk, and the linux,initrd-end value must be the end address of the RAM disk. For example,

```
chosen {  
    linux,initrd-start = <0x20000000>;  
    linux,initrd-end = <0x2453ecc>;  
    linux,stdout-path = "/soc8572@ffe00000/serial@4500";  
};
```

10. Ensure that the frequencies of the target are correct. If the DTS was generated in U-Boot as described above, the frequencies should be correct. However, if you update an existing DTS file for a new board revision, the frequencies might have changed and they need to be corrected in the DTS file.

- a. At the U-Boot prompt, inspect the current configuration.

```
bdinfo  
...  
    intfreq = 1500 MHz  
    busfreq = 600 MHz  
...
```

- b. The intfreq value from the U-Boot output must be converted to a hexadecimal value and added to the clock-frequency value of the CPU node in the DTS file. The busfreq value must be placed in the same way in the bus-frequency parameter. For example,

```
cpus {  
    PowerPC,<target>@0 {  
        ...  
        timebase-frequency = <0x47865d2>;  
        bus-frequency = <0x23c34600>;  
        clock-frequency = <0x5967f477>;  
    };  
};
```

- c. The same busfreq value is the clock frequency for the serial ports and must be updated in the DTS file also:

```
serial0: serial@4500 {
    ...
    clock-frequency = <0x23c34600>;
};
```

NOTE

If you are using hardware for kernel debugging, see [Edit DTS file](#) on page 299.

7.7.6.4.2 Edit DTS file

You need to edit the settings (.dts) file with information relevant to the current target board and kernel.

If you have a DTS file specifically designed for your target board, you should modify only the RAM disk end address and reserved memory area, in case you are using a RAM disk.

A standard .dts text file has a number of nodes which are given no value (actually <0>) or are missing nodes (for example, the /chosen branch).

When the Linux kernel is started from U-Boot with bootm, U-Boot dynamically edits the .dtb file in RAM so as to fill in the missing values and add the /chosen branch, based on the U-Boot environment variables.

The CodeWarrior IDE does not fill in the missing values and branches when it downloads the .dtb file to RAM. You must manually create and compile a separate and complete .dts file.

The following steps detail the changes that must be applied to the .dts file so the kernel boots successfully when the CodeWarrior IDE loads the .dtb file into RAM with a Linux kernel and a initial RAM disk.

1. Update the bus-frequency and clock-frequency nodes from the value KRD=>bi_busfreq
2. Update the clock-frequency nodes from the value KRD=>bi_initfreq:
3. Update the following nodes from the value KRD=>bi_tbfreq:

```
/cpus/ PowerPC,8349@0/timebase-frequency
```

4. Create the following node from the size on disk of the file entered in LKBP=>Enable Initial RAM Disk=>File Path or from the address entered in LKBP=>Enable Initial RAM Disk=>Address:

```
/memreserve/
```

5. Create the following node from LKBP=>Command Line:

```
/chosen/bootargs
```

6. Create the node:

```
linux,stdout-path
```

7. Create the following node from the address entered in LKBP=>Enable Initial RAM Disk=>Address:

```
/chosen/linux,initrd-start
```

8. Create the following node from the size on disk of the file entered in LKBP=>Enable Initial RAM Disk=>File Path and from the address entered in LKBP=>Enable Initial RAM Disk=>Address:

```
/chosen/linux,initrd-end
```

7.7.6.4.3 Compile DTS file

You can compile the settings (.dts) file to a binary (.dtb) file, if you need the binary file to set up the kernel parameters for the board.

1. Ensure that you have the DTC device tree compiler on your host machine.

If the DTC device tree compiler is missing, get the latest DTC source archive from bitshrine.org. Extract the archive, run make, and put the binary somewhere reachable by your PATH.

```
wget dtc-20070307.tar.bz2
wget dtc-20070307.tar.bz2.md5
wget dtc-20070307.tar.gz
wget dtc-20070307.tar.gz.md5
```

2. Navigate to the folder containing DTS files.

NOTE

The location of the DTS file might differ based on the BSP version being used. For the correct location of the file, see the SDK User Manual in [iso/help/documents/pdf](#).

3. Compile the .dts device tree source file for the board:

```
$ cd arch/powerpc/boot/dts
$ dtc -I dts -O dtb -V 0x10 -b 0 <target>.dts > <target>.dtb
```

NOTE

You can use the created binary (.dtb) file in the CodeWarrior IDE (in the **Boot Parameters** tab); see [Configure an attach kernel debug scenario](#) on page 291 for details.

7.7.6.4.4 Test DTB file

You can test the binary (.dtb) file outside the CodeWarrior IDE.

The steps are as follows:

1. Load the uImage, rootfs.ext2.gz.uboot, and <target>.dtb file onto the board.
2. Boot the board and verify that Linux comes up fine.

```
$ bootm <kerneladdress> <ramdiskaddress> <dtbaddress>
```

NOTE

The target board must have U-Boot present in the flash at the reset address so that U-Boot can run and set board configurations.

7.7.6.4.5 Modify a DTS file

You may need to modify a DTS file if you are using a BSP version that is not supported by a CodeWarrior DTS file or custom board.

Follow these steps to modify the DTS file:

1. Obtain a DTS file.

NOTE

The location of the DTS file might differ based on the BSP version being used. For the correct location of the file, see the SDK User Manual in [iso/help/documents/pdf](#).

2. Modify this DTS file with the information provided by U-Boot. To do this:
 - a. Check the `/proc/device-tree/` directory for the required information after kernel boot from U-Boot.
Alternatively, you may:
 - b. Enable `ft_dump_blob` call from the `u-boot/common/cmd_bootm.c` file. By default this is disabled.
 - c. Build the U-Boot and write it on the target to have this enabled when booting the kernel.
 - d. After this, configure U-Boot as described in the BSP documentation to boot the kernel and save the boot log.
 - e. Check the device tree displayed during kernel boot and accordingly modify your DTS file.

7.7.7 Debugging the kernel to download the kernel, RAM disk, and device tree

This section describes how to debug the Linux kernel using CodeWarrior IDE to download the kernel, RAM disk, and device tree.

Perform the following steps:

1. Create a project for the Linux kernel image. See [Creating a CodeWarrior Project using the Linux Kernel Image](#) on page 289.
2. Configure the launch configuration for Linux kernel debug.
 - a. Select **Run > Debug Configurations**.
The **Debug Configurations** dialog appears.
 - b. From the left pane, in the CodeWarrior group, select the appropriate launch configuration.
 - c. On the **Main** page, in the **Connection** panel, select the appropriate system from the **Connection** drop-down list.
 - d. Click **Edit**.
The **Properties for <connection>** window appears.
 - e. Click **Edit** next to the **Target** drop-down list.
The **Properties for <Target>** dialog appears.
 - f. On the **Initialization** tab, select the checkboxes for all the cores in the **Run out of reset** column.
 - g. In the **Initialize target** column, select the checkbox for core 0.
 - h. Click the ellipses button in the **Initialize target script** column.
The **Target Initialization** dialog appears.
 - i. Click **File System** and select the target initialization file from the following path:

```
<CWInstallDir>\PA\PA_Support\Initialization_Files\<Processor Family>  
\<target>_uboot_init_Linux.tcl
```

NOTE

The initialization file is automatically set when you select **Linux Kernel** as the **Target OS**, while creating a new Power Architecture project using the CodeWarrior Bareboard Project Wizard.

- j. Click **OK** to close the **Memory Configuration File** dialog.
- k. Click **OK** to close the **Properties for <Target>** dialog.

- l. Click **OK** to close the **Properties for <connection>** dialog.
- m. On the **Debug** tab of the **Debugger** tab, select an **Program execution** option, to stop the debug process at the program entry point or at a specified user function or address like `start_kernel`.
- n. On the **OS Awareness** tab of the **Debugger** tab, select **Linux** from the **Target OS** drop-down list.
- o. On the **Boot Parameters** tab of the **OS Awareness** tab:
 - i. Select the **Enable Initial RAM Disk Settings** checkbox.
The fields in that panel are enabled.
 - ii. In the **File Path** text box, enter the location of the BSP file, `rootfs.ext2.gz`.
 - iii. In the **Address** text box, enter the address where you want to add the RAM disk.
 - iv. In the **Size** text box enter 0 if you want the entire RAM disk to be downloaded.
 - v. Select the **Open Firmware Device Tree Settings** checkbox.
 - vi. In the **File Path** text box, enter the location of the device tree file.
 - vii. In the **Address** text box, enter the location in memory where you want to place the device tree.

NOTE

Ensure that the memory areas for kernel, RAM disk, and device tree do not overlap.

- p. Click **Apply** to save the settings you made to the launch configuration.
3. Click **Debug** to start debugging the kernel.

NOTE

If the kernel does not boot correctly, check the values entered in the **Boot Parameters** tab. Also ensure that you provided a valid device tree and RAM disk.

7.7.8 Debugging the kernel based on MMU initialization

This section describes how to debug the Linux kernel based on whether the MMU is disabled, being enabled, or enabled.

NOTE

You can debug the kernel on all stages from `0x0` till `start_kernel` and further, without the need of PIC changes, breakpoints at `start_kernel`, and multiple debug sessions.

Debugging the Linux kernel involves three stages with different views and functionality:

- [Debugging the Kernel before the MMU is Enabled](#) on page 302
- [Debugging the Kernel while the MMU is being Enabled](#) on page 304
- [Debugging the Kernel after the MMU is Enabled](#) on page 304

7.7.8.1 Debugging the Kernel before the MMU is Enabled

This procedure shows how to debug the kernel before the memory management unit (MMU) is initialized.

You can always debug assembly before virtual addresses are being used, without setting the alternate load address.

To debug the kernel before the MMU is enabled, follow these steps:

1. Select **Run > Debug Configurations** from the CodeWarrior menu bar to open the **Debug Configurations** dialog.
2. From the **Debugger** page, select the **PIC** tab.

3. Select the **Alternate Load Address** checkbox.
4. In the **Alternate Load Address** field, type the hexadecimal form of the memory address (for example, 0x00000000).
5. Click **Apply**. The CodeWarrior IDE saves your changes to the launch configuration.
6. Click **Debug**. The **Debug** perspective appears.
7. Set a breakpoint early in `head_fsl_booke.S`.

You can perform source level debug until the `rfi` instruction in `head_fsl_booke.S`.

Figure 108: Kernel Debug - Before MMU is Enabled

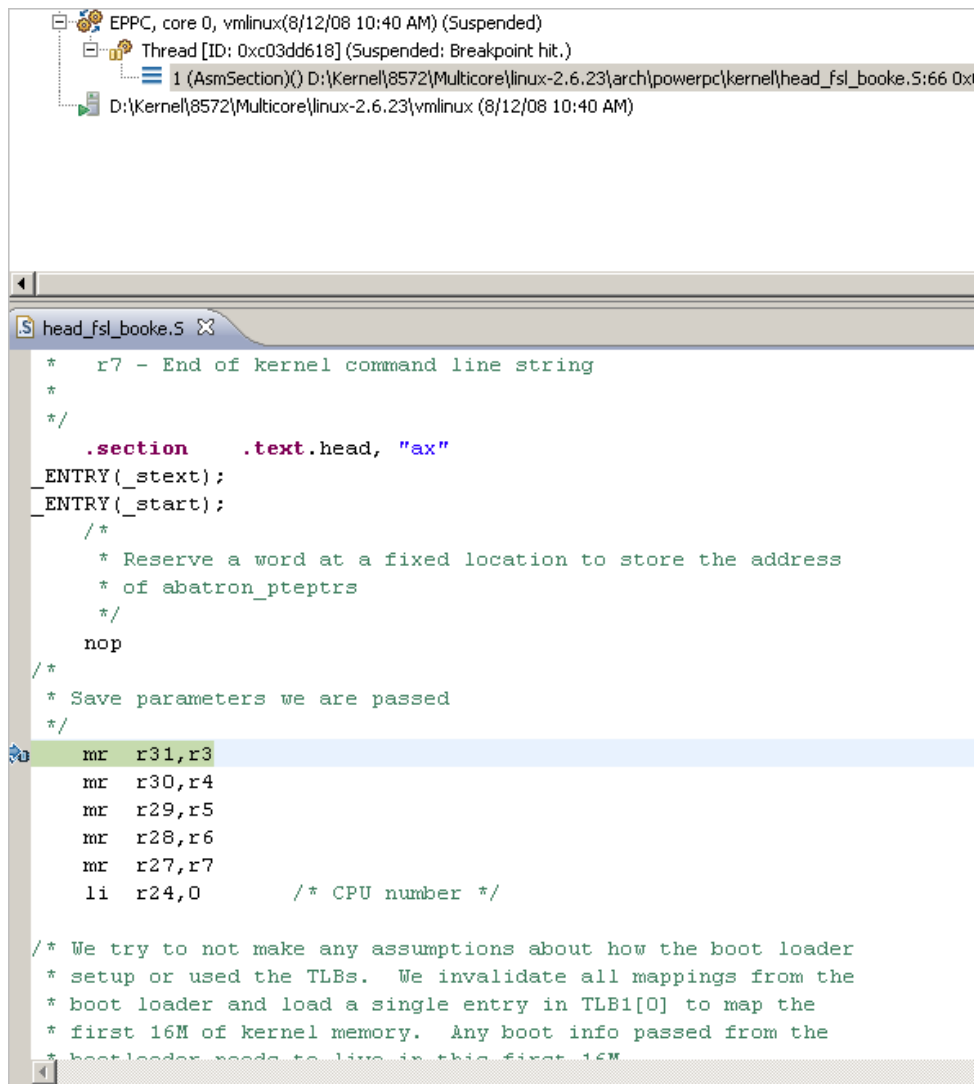

NOTE

You must stop the debug session and clear the **Alternate Load Address** checkbox in the **PIC** tab to debug after the `rfi` instruction in `head_fsl_booke.S`.

7.7.8.2 Debugging the Kernel while the MMU is being Enabled

This procedure shows how to debug the kernel while the memory management unit is being initialized.

To debug this section of code, ensure that the **Alternate Load Address** checkbox in the **PIC** tab is disabled.

7.7.8.3 Debugging the Kernel after the MMU is Enabled

This procedure shows how to debug the kernel after the memory management unit is initialized.

To debug the kernel after the MMU is enabled, follow these steps:

1. Select **Run > Debug Configurations** from the CodeWarrior menu bar to open the **DebugConfigurations** dialog.
2. From the **Debugger** tab, select the **PIC** tab.
3. Clear the **Alternate Load Address** checkbox.
4. Click **Apply**.
5. Click **Debug** to start the debug session. The **Debug** perspective appears.
6. In the editor area, set a breakpoint at `start_kernel`, after the eventpoint, in `main.c`. This will stop the debug session at `start_kernel` function (shown in the figure below).

Figure 109: Kernel Debug - After MMU is Enabled

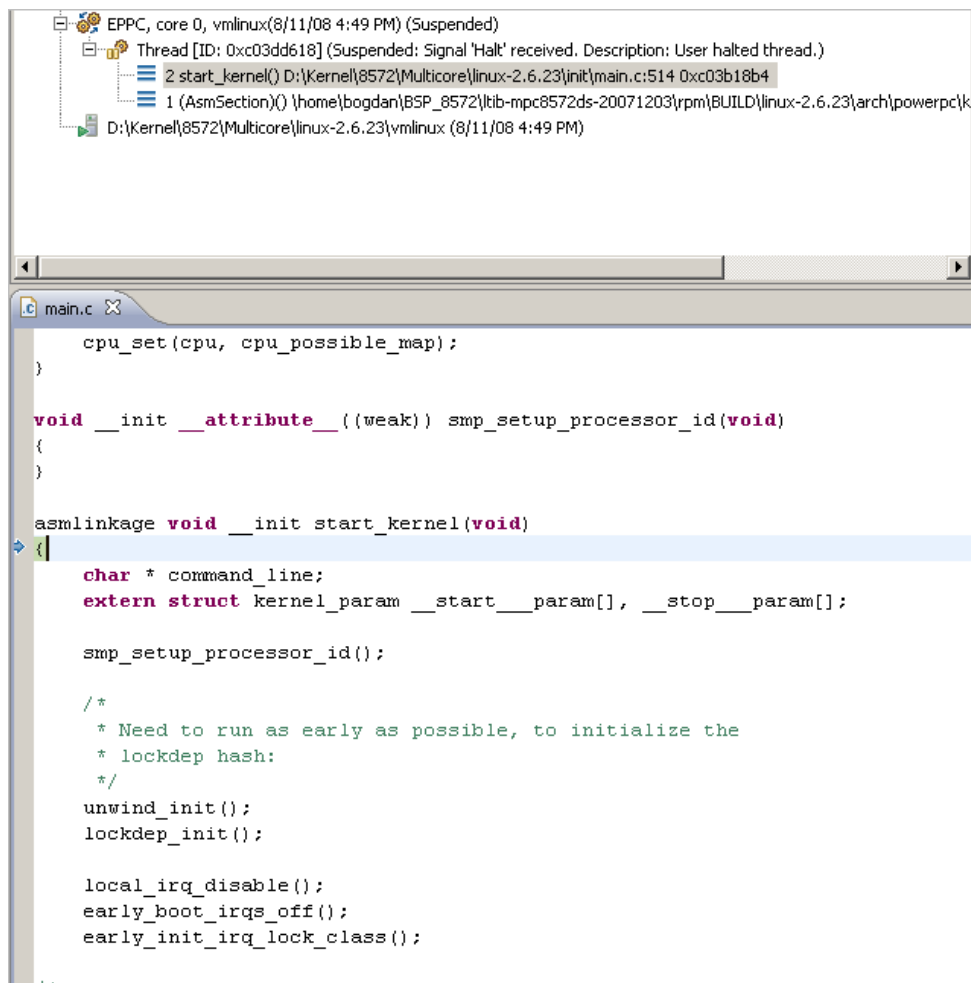

7. Click **Run**.

The debugger halts execution of the program at whatever breakpoints have been set in the project (if any breakpoints have been set).

8. Run through the rest of the code until the kernel starts to boot.

When the kernel boots, boot status messages appear in the simulator window.

NOTE

You can click Terminate to halt running of the kernel and set breakpoint/watchpoints in the debug window, as shown in the figure below.

Figure 110: Kernel Stopped by User

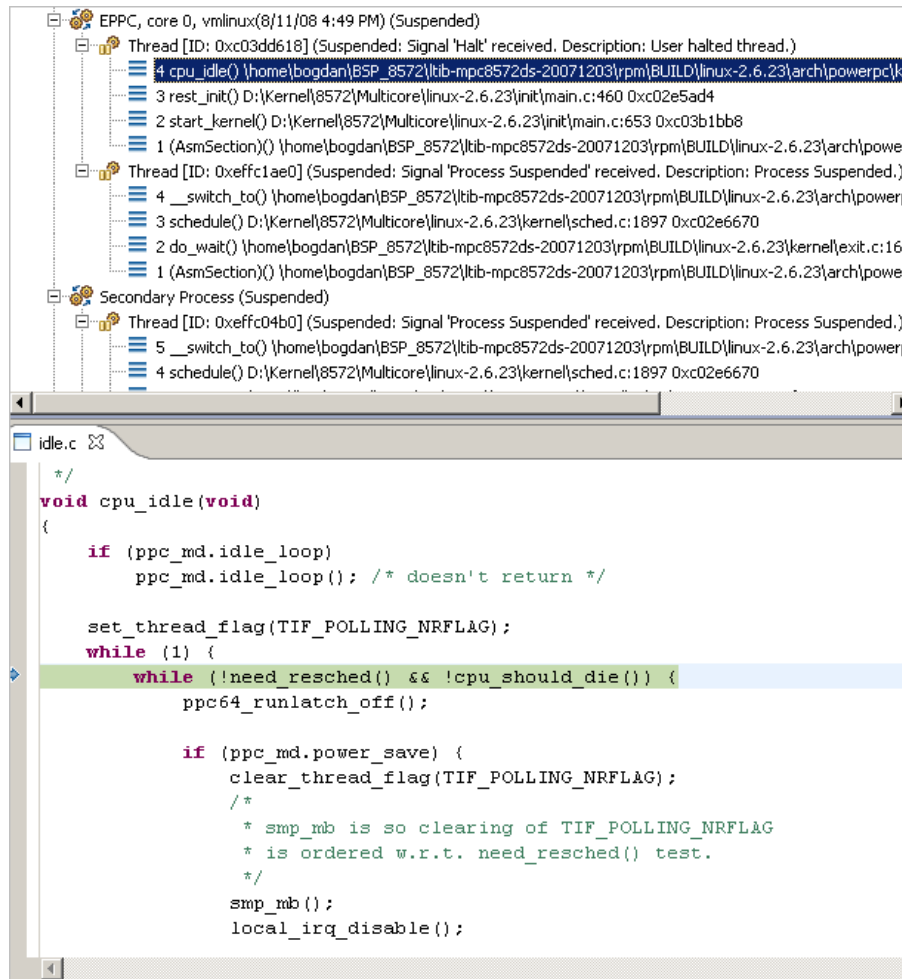

9. Continue debugging.
10. When finished, you can either:
 - a. Kill the process by selecting **Run > Terminate**.
 - b. Leave the kernel running on the hardware.

7.7.9 Debugging the kernel by attaching to a running U-Boot

This section explains how to debug the Linux kernel by attaching it to a running U-Boot.

To debug the kernel by attaching to a running U-Boot, perform the following:

1. Create a project for the Linux kernel image. For more details, see [Creating a CodeWarrior Project using the Linux Kernel Image](#) on page 289.
2. Configure the launch configuration for Linux kernel debug. For more details, see [Configure an attach kernel debug scenario](#) on page 291.
3. Select **Run > Debug Configurations**. The **Debug Configurations** dialog appears.
4. From the left pane, expand the **CodeWarrior Attach** tree and select the appropriate launch configuration.
5. From the **Debugger** tab, select the **PIC** tab.
6. Clear the **Alternate Load Address** checkbox.
7. Click **Apply**.
8. Click **Debug** to start the debug session. The **Debug** perspective appears.
9. While the U-Boot is running, attach the target.

The debugger displays a warning, in the console, as the kernel is not being executed on the target.

NOTE

For multi-core processors, only `core0` is targeted in the **Debug** view. This is normal as the secondary cores are initialized in the Linux kernel after MMU initialization. CodeWarrior will automatically add other cores, in the **Debug** view, after the kernel initializes the secondary cores.

10. Set software or hardware breakpoints for any stage (before or after MMU initialization).

To set a software breakpoint for the entry point address (for example, `address 0x0`), issue the following command in the **Debugger Shell** view.

```
bp 0x0
```

11. Using the U-boot console, load the Linux kernel, DTB file, and RAM disk/rootfs from flash or from TFTP.
12. Debug the kernel.

The debugger halts execution of the program at whatever breakpoints have been set in the project. Typical stages involved in debugging the kernel are discussed below:

a. Debugging the kernel at the entry point

The CodeWarrior debugger will stop at the kernel entry point, if any software or hardware breakpoint has been set for entry point.

NOTE

For the debugger to stop at the kernel entry point, set a breakpoint before loading the kernel from the U-boot console.

At the entry point, the MMU is not initialized and therefore debugging before MMU initialization also applies in this stage.

b. Debugging the Kernel before the MMU is enabled

Being in early debug stage, the user should set the correct PIC value, to see the source correspondence, by issuing the `setpicloadaddr 0x0` command in the **Debugger Shell** view.

Before setting a breakpoint for the stage after MMU initialization (for example, breakpoint at `start_kernel`) the correct PIC should be set, by issuing the `setpicloadaddr reset` command in the **Debugger Shell** view. This is required to ensure that the new breakpoint is set with the correct PIC for the stage after MMU initialization.

The user can set breakpoints and run/step to navigate, before MMU initialization. The correct PIC should be set by issuing the `setpicloadaddr reset` command in the **Debugger Shell** view, before the debugger enters the next stage.

c. **Debugging the Kernel after the MMU is enabled**

After the MMU is initialized, the PIC value must be reset by issuing the `setpicloadaddr reset` command in the **Debugger Shell** view. During the Linux Kernel booting, you can debug this stage directly, if no breakpoint has been set for the stage before MMU initialization. Alternatively, you can also debug this stage after run or step from the stage before initialization.

NOTE

In case of SMP, all the secondary cores are targeted and displayed in the **Debug** view.

13. When finished, you can either:

- a. Kill the process by selecting **Run > Terminate**.
- b. Leave the kernel running on the hardware.

7.8 Debugging Loadable Kernel Modules

This section explains how to use the CodeWarrior debugger to debug a loadable kernel module.

This section contains the following subsections:

- [Loadable Kernel Modules - An Introduction](#) on page 307
- [Creating a CodeWarrior Project from the Linux Kernel Image](#) on page 308
- [Configuring Symbolics Mappings of Modules](#) on page 310

7.8.1 Loadable Kernel Modules - An Introduction

The Linux kernel is a *monolithic kernel*, that is, it is a single, large program in which all the functional components of the kernel have access to all of its internal data structures and routines.

Alternatively, you may have a micro kernel structure where the functional components of the kernel are broken into pieces with a set communication mechanism between them. This makes adding new components to the kernel using the configuration process very difficult and time consuming. A more reliable and robust way to extend the kernel is to dynamically load and unload the components of the operating system using Linux *loadable kernel modules*.

A *loadable kernel module* is a binary file that you can dynamically link to the Linux kernel. You can also unlink and remove a loadable kernel module from the kernel when you no longer need it. Loadable kernel modules are used for device drivers or pseudo-device drivers, such as network drivers and file systems.

When a kernel module is loaded, it becomes a part of the kernel and has the same rights and responsibilities as regular kernel code.

Debugging a loadable kernel module consists of several general actions, performed in the following order:

1. Create a CodeWarrior Linux kernel project for the loadable kernel module to be debugged. See [Creating a CodeWarrior Project from the Linux Kernel Image](#) on page 308
2. Add the modules and configure their symbolics mapping. See [Configuring Symbolics Mappings of Modules](#) on page 310

7.8.2 Creating a CodeWarrior Project from the Linux Kernel Image

The steps in this section show how to create a CodeWarrior project from a Linux kernel image that contains symbolic debugging information.

NOTE

The following procedure assumes that you have made an archive of the Linux kernel image and transferred it to the Windows machine. For kernel modules debugging, ensure that you build the kernel with loadable module support and also make an archive for the `rootfs` directory, which contains the modules for transferring to Windows.

1. Launch CodeWarrior IDE.
2. Select **File > Import**. The Import wizard appears.
3. Expand the **CodeWarrior** group and select **CodeWarrior Executable Importer**.
4. Click **Next**.

The **Import a CodeWarrior Executable file** page appears.

5. Specify a name for the project, to be imported, in the **Project name** text box.
6. If you do not want to create your project in the default workspace:
 - a. Clear the **Use default location** checkbox.
 - b. Click **Browse** and select the desired location from the **Browse For Folder** dialog.
 - c. In the **Location** text box, append the location with the name of the directory in which you want to create your project.

NOTE

An existing directory cannot be specified for the project location.

7. Click **Next**.

The **Import C/C++/Assembler Executable Files** page appears.
8. Click **Browse** next to the **Executable** field.
9. Select the `vmlinux.elf` file.
10. Click **Open**.
11. From the **Processor** list, expand the processor family and select the required processor.
12. Select **Bareboard Application** from the **Toolchain** group.
13. Select **Linux Kernel** from the **Target OS** list.
14. Click **Next**.

The **Debug Target Settings** page appears.

15. From the **Debugger Connection Types** list, select the required connection type.
16. Specify the settings, such as board, launch configuration, connection type, and TAP address if you are using Ethernet or Gigabit TAP.
17. Click **Next**.

The **Configuration** page appears.

18. From the **Core index** list, select the required core.
19. Click **Finish**.

The wizard creates a project according to your specifications. You can access the project from the CodeWarrior Projects view on the Workbench.

20. Configure the launch configuration for linux kernel debug.

a. Select **Run > Debug Configurations**.

The Debug Configurations dialog appears.

21. Enter the launch configuration settings in the **Debug Configurations** dialog. The table below lists the launch configuration settings.

Table 134: Kernel Project Download Launch Configuration Settings

Debug Window Component	Settings
Main Tab	Select an appropriate system (if existing) from the Connection drop-down list or define a new system. <ul style="list-style-type: none"> • To define a new system, click New. • Select Hardware or Simulator Connection from the CodeWarrior Bareboard Debugging list. Click Next. • Specify a name and a description for the connection. • Select an appropriate target (if existing) from the Target drop-down list or define a new target. • To define a new target, click New on the Hardware or Simulator Connection dialog. • Select Hardware or Simulator Target from the CodeWarrior Bareboard Debugging list. Click Next. • Specify a name and a description for the target. • Select a processor from the Target type drop-down list. On the Initialization tab, ensure that there are no initialization files selected. • Click Finish to create the target and close the Hardware or Simulator Target dialog. • Select the type of connection you will use from the Connection type drop-down list. • Click Finish. • Select all the cores on which Linux is running (for example, core 0 for single-core or cores 0-7 for 8-core SMP).
Debugger Tab > Debugger options > Symbolics Tab	Select the Cache Symbolics between sessions checkbox. The symbolics are loaded from the elf file to the debugger for the first session only. This shows a speed improvement for <code>vmlinux.elf</code> as the size is bigger than around 100 MB.
Debugger Tab > Debugger options > OS Awareness Tab	Select Linux from the Target OS drop-down list.
<i>Table continues on the next page...</i>	

Table 134: Kernel Project Download Launch Configuration Settings (continued)

Debug Window Component	Settings
Debugger Tab > Debugger options > OS Awareness Tab > Boot Parameters Tab	<p>Select the Enable Initial RAM Disk Settings checkbox</p> <ul style="list-style-type: none"> • File Path: Path of the RAM disk that you transferred from the Linux machine • Address: The address specified in Linux, initrd-start from the dts file <p>Select the Download to target checkbox</p> <p>Select the Open Firmware Device Tree Settings checkbox</p> <ul style="list-style-type: none"> • File Path: Path to the <target>.dtb file • Address: 0x00600000
Debugger Tab > Debugger options > OS Awareness Tab > Debug Tab	<ul style="list-style-type: none"> • Select the Enable Memory Translation checkbox <p>Physical Base Address is set to value CONFIG_KERNEL_START (0x0)</p> <p>Virtual Base Address is set to value CONFIG_KERNEL_START (0xc000 0000 for 32 bits, and 0xC000 0000 0000 0000 for 64bits).</p> <ul style="list-style-type: none"> • Memory Size is the kernel space translation size. <p style="text-align: center;">NOTE</p> <p style="text-align: center;">The values shown above should be set as configured in the linux config file (.config). You can read the MMU registers to verify what you have configured and do a correction, if required.</p> <p>Select the Enable Threaded Debugging Support checkbox</p> <p>Select the Enable Delayed Software Breakpoint Support checkbox</p>
Debugger Tab > Debugger options > OS Awareness Tab > Modules Tab	<ul style="list-style-type: none"> • Select the Detect module loading checkbox • Click Add to insert the kernel module file. See Configuring Symbolics Mappings of Modules on page 310 • Select the Prompt for symbolics path if not found checkbox

22. Click the **Source** page to add source mappings for `rootfs` and `linux-<version>`.

23. Click **Apply** to save the settings.

7.8.3 Configuring Symbolics Mappings of Modules

You can add modules to the Linux kernel project and configure the symbolics mappings of the modules using the **Modules** tab of the **Debug Configurations** dialog.

The figure below shows the **Modules** tab of the **Debug Configurations** dialog.

Figure 111: Kernel Module Debug - Modules Tab

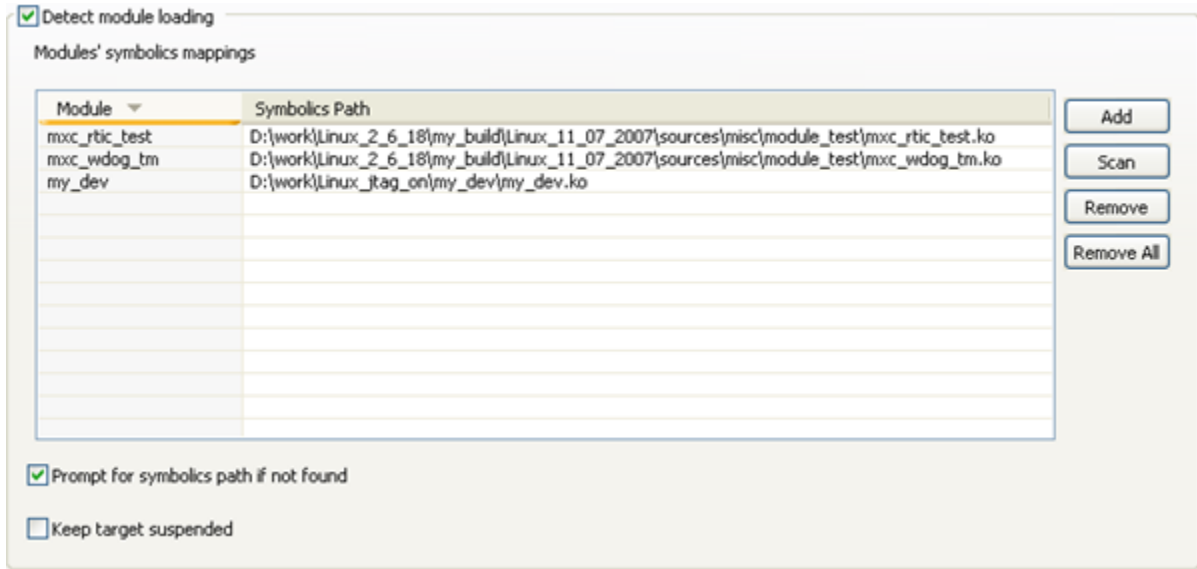

The table below describes the various options available on the **Modules** tab.

Table 135: Kernel Module Project Launch Configuration - Modules Tab Settings

Option	Description
Detect module loading	Enables the debugger to detect module load events and insert an eventpoint in the kernel. Disabling this setting delays the module loading. This is useful in scenarios where multiple modules are loaded to the kernel and not all of them need to be debugged. You can enable this setting again in the Modules dialog. The dialog is available during the Debug session from the System Browser View toolbar > Module tab.
Add	Adds a module name along with the corresponding symbolic path This option displays a dialog in the following scenarios: <ul style="list-style-type: none"> The file that you have selected is not a valid compiled kernel module If the selected module already exists in the list with the same path
Scan	Automatically searches for module files and populates the kernel module list.
Remove	Removes the selected items. This button will be enabled only if a row is selected.
Remove All	Removes all items. This button will be enabled only if the kernel list contains any entries.

Table continues on the next page...

Table 135: Kernel Module Project Launch Configuration - Modules Tab Settings (continued)

Option	Description
Prompt for symbolics path if not found	Prompts to locate the symbolics file if a mapping for it is not available in the settings A Browse dialog appears that allows you to browse for a module file containing symbolics. The debugger will add the specified symbolics to the modules' symbolics mapping.
Keep target suspended	Keeps the target suspended after the debugger loads the symbolics file for a module. This option is useful if you want to debug the module's initialization code. It allows you to set breakpoints in the module's initialization code before running it. <p style="text-align: center;">NOTE</p> This option is automatically enabled when activating the Prompt for symbolics path if not found option.

NOTE

Breakpoints are resolved each time a symbolics file is loaded and the debugger uses the modules unload events for symbolics disposal and breakpoints cleanup.

7.9 Debugging Hypervisor Guest Applications

This section shows you how to debug hypervisor guest applications.

This section explains:

- [Hypervisor - An Introduction](#) on page 312
- [Prerequisites for Debugging a Guest Application](#) on page 313
- [Adding CodeWarrior HyperTRK Debug Stub Support in Hypervisor for Linux Kernel Debugging](#) on page 313
- [Preparing Connection to P4080DS Target](#) on page 314
- [Debugging AMP/SMP Guest Linux Kernels Running Under Hypervisor](#) on page 315
- [Debugging Hypervisor During the Boot and Initialization Process](#) on page 322

7.9.1 Hypervisor - An Introduction

The embedded hypervisor is a layer of software that enables the efficient and secure partitioning of a multi-core system.

A system's CPUs, memory, and I/O devices can be divided into groupings or partitions. Each partition is capable of executing a guest operating system.

Key features of the hypervisor software architecture are summarized below-

- Partitioning: Support for partitioning of CPUs, memory, and I/O devices:
 - CPUs: Each partition is assigned one or more CPU cores in the system.

- **Memory:** Each partition has a private memory region that is only accessible to the partition that is assigned the memory. In addition, shared memory regions can be created and shared among multiple partitions.
- **I/O devices:** P4080 I/O devices may be assigned directly to a partition (Direct I/O), making the device a private resource of the partition, and providing optimal performance.
- **Protection and Isolation:** The hypervisor provides complete isolation of partitions, so that one partition cannot access the private resources of another. The P4080 PAMU (an iommu) is used by Topaz to ensure device-to-memory accesses are constrained to allowed memory regions only.
- **Sharing:** Mechanisms are provided to selectively enable partitions to share certain hardware resources (such as memory)
- **Virtualization:** Support for mechanisms that enable the sharing of certain devices among partitions such as the system interrupt controller
- **Performance:** The hypervisor software uses the features of the Freescale Embedded Hypervisor APU to provide security and isolation with very low overhead. Guest operating systems take external interrupts directly without hypervisor involvement providing very low interrupt latency.
- **Ease of migration:** The hypervisor uses a combination full emulation and para-virtualization to maintain high performance and requiring minimal guest OS changes when migrating code from an e500mc CPU to the hypervisor.

7.9.2 Prerequisites for Debugging a Guest Application

The P4080 software bundle is the prerequisite for debugging a hypervisor guest application using the CodeWarrior IDE.

The software bundle used in the current example is *P4080 Beta 2.0.2 SW Bundle*.

7.9.3 Adding CodeWarrior HyperTRK Debug Stub Support in Hypervisor for Linux Kernel Debugging

This section explains how to add CodeWarrior HyperTRK debug stub support in the hypervisor for guest LWE or Linux kernel debugging.

To add CodeWarrior HyperTRK debug stub support:

1. Download the appropriate P4080 software bundle image (the BSP in `.iso` format) to a Linux computer.
2. Mount the `.iso` image file using this command: `mount -o loop BSP-Image-Name.iso /mnt/iso`
3. Install the BSP image file according to the instructions given in the BSP documentation.
4. Add CodeWarrior HyperTRK debug support to the hypervisor image (`hv.uImage`)

You can enable the HyperTRK debug support directly in the BSP. Alternatively, you can modify and build the HyperTRK manually, and then enable it in the hypervisor.

Perform the steps given in the subsections below:

- [Enabling HyperTRK Debug Support Directly in Build Tool](#) on page 314
- [Applying New HyperTRK Patches from CodeWarrior Install Layout](#) on page 314
- [Modifying and Building HyperTRK Manually](#) on page 314

7.9.3.1 Enabling HyperTRK Debug Support Directly in Build Tool

Follow this procedure only if the `<CWInstallDir>/PA/PA_Tools/HyperTRK` directory does not contain any newer HyperTRK patches than the ones in the SW bundle.

In case the `<CWInstallDir>/PA/PA_Tools/HyperTRK` directory contains newer HyperTRK patch, see [Applying New HyperTRK Patches from CodeWarrior Install Layout](#) on page 314.

NOTE

For more details on configuring or compiling the Hypervisor, refer the SDK Manual available in the `iso/help/documents/pdf` folder.

7.9.3.2 Applying New HyperTRK Patches from CodeWarrior Install Layout

Follow this procedure to manually apply new HyperTRK patches from CodeWarrior install layout.

The `<CWInstallDir>/PA/PA_Tools/HyperTRK` directory contains new patches. To apply the new patches, see the procedures defined in the SDK manual.

7.9.3.3 Modifying and Building HyperTRK Manually

Follow this procedure only if you need to modify the HyperTRK sources.

The steps are as follows:

1. Apply the new HyperTRK patches, if any (see [Applying New HyperTRK Patches from CodeWarrior Install Layout](#) on page 314).

The hypervisor and the HyperTRK sources are extracted to this directory:

```
<BSP-Directory>/rpm/BUILD/embedded-hv-{version}
```

2. Ensure that the environment variables point to the correct compiler that BSP uses, so that it correctly builds HyperTRK and the hypervisor.

NOTE

For more details on adding new patches, modifying the HyperTRK and building the packet, see the SDK manual available in the SDK Manual available in the `iso/help/documents/pdf` folder.

7.9.4 Preparing Connection to P4080DS Target

This section explains how to debug AMP/SMP guest application on the P4080DS target board.

You must have a serial cable connected between the board UART0 and the UART0 ports of your Linux host. The debugger connects to the running `mux_server` from the Linux host and then communicates with the target board through the serial connection between the Linux host and the target board. The steps to start the `mux_server` are given below.

1. Telnet is not recommended to be used with the `mux_server`. Use `socat` instead. The syntax is:

```
socat -,raw,echo=0 tcp:<address>:<port>
```

For example:

```
socat -,raw,echo=0 tcp:rhath:9002
```

2. For the standalone P4080DS target board, which is connected with the serial cable, you can use the `Makefile` for starting the `mux_server`, and the `xtel` shipped with the SDK.
 - a. Run `make xtel_P4080DS`, if you want to automatically launch the `mux_server`, and have eight serial consoles started.
 - b. Run `make mux_server_P4080DS TARGET=/dev/ttyS0`, which will connect the `mux_server` to the `/dev/ttyS0` device using the ports from 12000 to 12015. However, in this case, you need to manually run `socat` to open the serial consoles.
 - c. If you need to change the ports, edit the tool you are using for starting the `mux_server`.
 - d. In case you are running only the `mux_server`, and not the `xtel`, you need to open the serial consoles for the hypervisor and the guest applications. To know on which port you can access the serial console of the hypervisor or the guest application, check the hypervisor device tree (the `.dts` file) that is used for starting the application.
 - Check for `stdout` nodes; for example, the hypervisor is using the `hvbc` node, which is using the muxer on channel 0. This means that the hypervisor serial console can be reached on the first port given as argument to the `mux_server`.
 - Look at the first partition, `part1`; `stdout` is using `part1_bc0`, which is using muxer channel 1. This means that the serial port will be `mux_server base_port + 1`.

The same concept applies to other partitions or other device trees as well.

7.9.5 Debugging AMP/SMP Guest Linux Kernels Running Under Hypervisor

This section describes how to debug AMP/SMP guest Linux kernels, running under the hypervisor.

This section explains:

- [Prerequisites for Debugging AMP/SMP Guest Linux Kernels](#) on page 315
- [Creating an Attach Launch Configuration to Debug a Linux Partition after Kernel Boot](#) on page 315
- [Creating a Download Launch Configuration to Debug a Linux Partition from an Entry Point or a User-Defined Function](#) on page 318

7.9.5.1 Prerequisites for Debugging AMP/SMP Guest Linux Kernels

This section provides the prerequisites for debugging AMP/SMP guest Linux kernels.

As prerequisites, ensure that:

- For Download debug session, the hypervisor loads the kernel images because CodeWarrior does not support this option.
- For Download launch configuration, the Linux partitions do not have the **no-auto-start** option set in the hypervisor DTS file. The CodeWarrior IDE resets the Linux partition and the hypervisor starts the partition, by default.
- If you want to use the Windows version of CodeWarrior, you need to transfer the Linux directory along with the `vmlinux.elf`, the associated sources, and the used `.dtb` file from the BSP directory to the Windows computer.

7.9.5.2 Creating an Attach Launch Configuration to Debug a Linux Partition after Kernel Boot

You can use an attach launch configuration to debug a Linux partition after kernel boot.

Follow these steps:

1. Import the `vmlinux.elf` file from the `BSP-Directory/linux` directory by using the PA ELF Import feature in CodeWarrior IDE
2. Create a new CodeWarrior Attach launch configuration. The steps that follow describe how to configure the required settings.
3. Select the **Main** page.
4. Click **New** in the Remote **System** group to create a new remote system

The **New Connection** wizard appears.

- a. In the **Select Remote System Type** page, expand the **CodeWarrior Bareboard Debugging** group, and select **TRK Connection**, as shown in the figure below.

Figure 112: Select Remote System Type Dialog Box

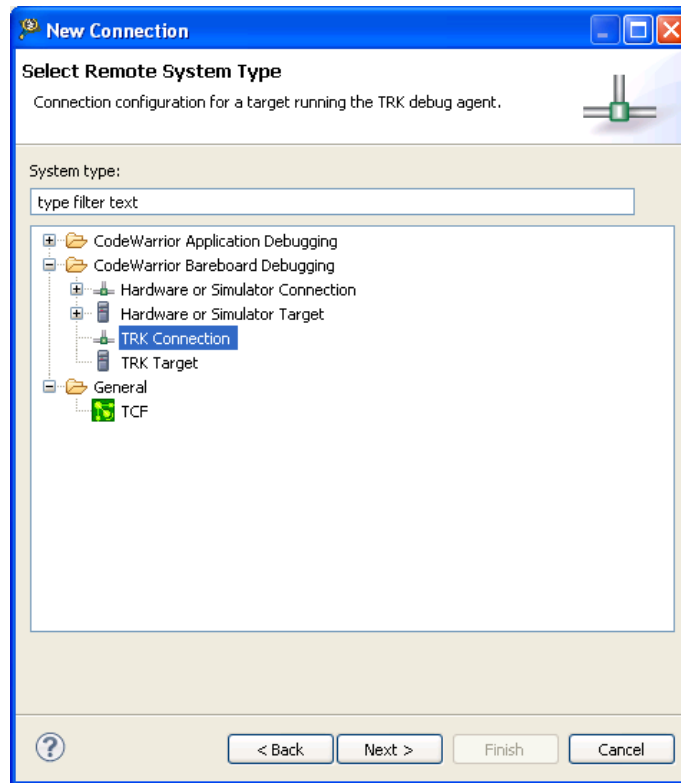

- b. Click **Next**.
The **TRK Connection** window appears.
- c. Click **Edit** next to the **Target** drop-down list.
The **Properties for <target>** window appears.
- d. Click **Edit** next to the **Target type** drop-down list
The **Target Types** dialog appears.
- e. Click **Import** and import the used hypervisor `.dtb` file.
- f. Click **OK** to close the **Target Types** dialog.
- g. Configure the following settings in the **Properties for <target>** window.
 - In the **Initialization** tab, ensure that **Execute target reset** checkbox is not selected.
 - In the **Memory** tab, do not add any memory configuration files for the debugged Linux partition cores

h. Click **OK**.

The **TRK Connection** page reappears.

i. Select **Trk Muxer** in the **Connectiontype** drop-down list.

- Select **Use existing host muxer process**, and type the IP address of the Linux host on which the `mux_server` is running.
- Alternatively, for Linux host only, you can select **Launch host muxer process** for automatically launching the muxer process. If you follow this step, you need to select the `mux_server` executable, and a TCP/IP target muxer with an IP address and a starting port on which you want to launch the `mux_server`.
- For TRK muxer ports, click **Sequence** and type the first port on which the `mux_server` started.
The channels and ports on which the debugger accesses the cores appear.
- The channels must correspond to the `trk-stub`'s mux channels added in the hypervisor `dtb` file.

j. Click **Finish**.

The **New Connection** wizard disappears and the new remote system that you just created appears in **Connection** drop-down list in the **Remote system** group.

5. Select all the cores that you want to debug from the Linux partition

NOTE

You can use the new remote system, which you just created, in other launch configurations also by selecting different cores and making other necessary adjustments.

6. Select the **Debugger** page to configure the debugger specific settings

- a. In the **Debugger** options group, select the **OS Awareness** tab
- b. Select **Linux** in the **Target OS** drop-down list. Note that it is mandatory to select Linux for the specific scenario described in this section.

The **Boot Parameters**, **Debug** and **Modules** tabs appear

In the **Boot Parameters** tab:

- Disable all the options available on this tab.

In the **Debug** tab:

- Select the **Enable Memory Translation** checkbox, and configure it according to the Linux MMU settings. For example:

Physical Base Address	0x0
Virtual Base Address	0xc0000000
Memory Size	0x20000000

- Select the **Enable Threaded Debugging Support** checkbox
- The **Update Background Threads on Stop** option is used to remove the dead threads, which were debugged at some point during the debugging session, but later, were terminated or killed. This option might cause a decrease in speed because a big amount of memory must be read at every stop.
- Do not select the **Enable Delayed Software Breakpoint Support** checkbox (see the figure below).

Figure 113: Boot Parameters, Debug, and Modules tab

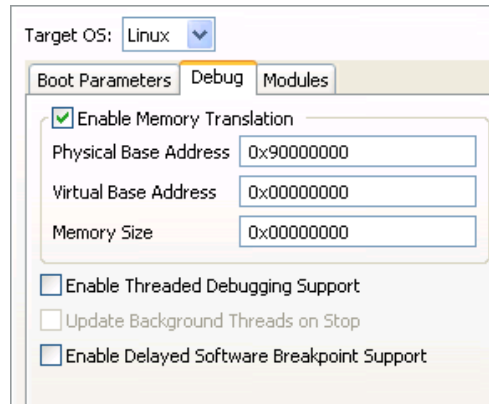

- c. Configure other options in the **Debugger options** group according to your specific requirements

You have successfully created the Attach Launch configuration. Click **Debug** and attach the configuration to the running Linux kernel.

7.9.5.3 Creating a Download Launch Configuration to Debug a Linux Partition from an Entry Point or a User-Defined Function

You can use a download launch configuration to debug a Linux partition from an entry point or a user-defined function.

Follow these steps:

1. Import the `vmlinux.elf` file from the `BSP-Directory/linux` directory by using the PA ELF Import feature in CodeWarrior IDE.
2. Create a new CodeWarrior download launch configuration. The steps that follow describe how to configure the required settings.
3. Select the **Main** page.
4. Click **New** in the **Remote system** group to create a new remote system.

The **New Connection** wizard appears.

- a. In the **Select Remote System Type** window, select **CodeWarrior Bareboard Debugging**, and then **TRK Connection**.
- b. Click **Next**.
- c. In the **TRK Connection**, click **Edit** next to the **Target** drop-down list.

The **Properties for <target>** window appears.

- d. Click **Edit** next to the **Target type** drop-down list.

The **Target Types** dialog appears.

- e. Click **Import** and import the used hypervisor `.dtb` file.
- f. Click **OK** to close the **Target Types** dialog.
- g. Configure the following settings in the **Properties for <target>** window.

- In the **Initialization** tab, select the **Execute system reset** checkbox.
- Ensure that no init files exist for the debugged Linux partition cores.
- In the **Memory** tab, do not add any memory configuration files for the debugged Linux partition cores.

h. Click **OK**.

The **TRK Connection** page reappears.

i. Select **Trk Muxer** in the **Connection** type drop-down list.

- Select **Use existing host muxer process**, and type the IP address of the Linux host on which the `mux_server` is running.
- Alternatively, for Linux host only, you can select **Launch host muxer process** for automatically launching the muxer process. If you follow this step, you need to select the `mux_server` executable, and a TCP/IP target muxer with an IP address and a starting port on which you want to launch the `mux_server`.
- For TRK muxer ports, click **Sequence** and type the first port on which the `mux_server` started.
The channels and ports on which the debugger accesses the cores appear.
- The channels must correspond to the `trk-stub`'s mux channels added in the hypervisor `.dts` file.

j. Click **Finish**.

The **New Connection** wizard disappears and the new remote system that you just created appears in **Connection** drop-down list in the **Remote system** group.

5. Select all the cores that you want to debug from the Linux partition.

NOTE

You can use the new remote system, which you just created, in other launch configurations also by selecting different cores and making other necessary adjustments.

6. Select the **Debugger** page to configure the debugger specific settings.

- a. In the **Debugger options** group, select the **OS Awareness** tab.
- b. Select **Linux** in the **Target OS** drop-down list. Note that it is mandatory to select Linux for the specific scenario described in this section.

The **Boot Parameters**, **Debug**, and **Modules** tabs appear.

In the **Boot Parameters** tab:

- Ensure that you disable all the options available on this tab.

In the **Debug** tab:

- Select the **Enable Memory Translation** checkbox, and configure it according to the Linux MMU settings. For example:

Physical Base Address	0x0
Virtual Base Address	0xc0000000
Memory Size	0x20000000

- Select the **Enable Threaded Debugging Support** checkbox.
 - The **Update Background Threads on Stop** option is used to remove the dead threads, which were debugged at some point during the debugging session, but later, were terminated or killed. This option might cause a decrease in speed because a big amount of memory must be read at every stop.
 - Do not select the **Enable Delayed Software Breakpoint Support** checkbox.
- c. In the **Debugger options** group, select the **Debug** tab.
 - d. Select the **Stop on startup at** checkbox in the **Program execution options** group.

- Select the **Program entry point** option, if you want the debugging session to start from 0x0.
 - Specify the function name in the **User specified** field, if you want the debugging session to start from a specific kernel function.
- e. In the **Debugger options** group, select the **Download** tab.

NOTE

Ensure that the **Perform standard download** checkbox is not selected. Hypervisor transfers the required kernel images for partition boot to memory.

- f. Configure other option in the **Debugger options** group according to your specific requirements.

You have successfully created the Download Launch configuration. Click **Debug** and observe the Linux partition restarting, hypervisor loading the kernel images, and the debug session stopping at the Stop on startup at point/function, if specified.

7.10 Debugging the P4080 Embedded Hypervisor

You can debug the P4080 embedded hypervisor during the boot and initialization process by using a JTAG probe and by creating an attach launch configuration.

To debug the hypervisor, perform the following steps:

1. Download the appropriate P4080 SW Bundle image (the BSP in `.iso` format) to a Linux computer.
2. Mount the `.iso` image file using this command:

```
mount -o loop BSP-Image-Name.iso /mnt/iso
```

3. Install the BSP image file according to the instructions given in the BSP documentation, *P4080_BSP_User_Manual*.

NOTE

Ensure that you are able to boot the hypervisor on the P4080 board.

4. Import the `hv.elf` file and create an Attach launch configuration.
 - a. Start the CodeWarrior IDE.
 - b. From the CodeWarrior menu bar, select **File > Import**.
 - c. The **Import** wizard appears.
 - d. Expand the **CodeWarrior** group.
 - e. Select **CodeWarrior Executable Importer** to debug a `.elf` file.
 - f. Click **Next**.

The **Import a CodeWarrior Executable** page appears.
 - g. In the **Project name** text box specify a name for the imported project.
 - h. Click **Next**.

The **Import C/C++/Assembler Executable Files** page appears.
 - i. Click **Browse** next to the **Executable** option.

The **Select file** page appears.
 - j. Select the `hv.elf` file obtained from the output folder of the package.

- k. Click **Open**.
- l. The **Select file** dialog closes. The path to the executable file appears in the **Executable** text box.
- m. Click **Next**.

The **Processors** page appears.

- n. Select the processor family, toolchain, and target operating system for the executable file.
- o. Click **Next**.
- p. Specify the debugger connection type, board, launch configuration, and connection options for the executable file.
- q. Click **Next**.

The **Debug Target Settings** page appears.

- r. Select the core index for the executable file.
- s. Click **Finish**.

The **Import a CodeWarrior Executable** window closes. The project for the imported elf file appears in the **CodeWarrior Projects** view. You can now open the **Debug Configurations** dialog box by selecting **Run > Debug Configurations**. The **Debug Configurations** dialog shows the current settings for the launch configuration that you just created. The **Debug Configurations** dialog appears.

- t. Expand the **CodeWarrior** group and select the launch configuration.
- u. In the **Connection** panel, click **Edit** next to the **Connection** drop-down list.

The **Properties for <connection launch configuration>** window appears.

- v. Select the appropriate **<Connection type>** from the drop-down list.

The **Connection** page appears.

- w. Ensure that **CCS executable** is selected in the **CCS server** panel.
- x. Specify the path of the executable file of the CCS server.
- y. Enter the IP address in the **Hostname/IP address** text box.

NOTE

Use the default port, 41475 and JTAG clock speed, 16000 kHz.

- z. In the **Advanced** tab, none of the checkbox should be selected.
- aa. Click **Edit** next to the **Target** drop-down list.

The **Properties for <system launch configuration>** window appears.
- ab. In the **Initialization** tab, clear any reset options if checked.
- ac. Clear the Initialize target options for any of the cores so that no initialization file is selected.
- ad. In the **Memory** tab, nothing should be selected because we currently do not have a memory configuration file. The file will be created later with hypervisor MMU entries.

The **Properties** window appears for the Attach launch configuration
- ae. Click **OK**. The **Properties** window closes.
- af. On the **Main** tab, in the **Connection** panel, check all the core checkboxes.
- ag. Click **Debug**.

The **Debug** view appears with the debugger attached to each core of the selected processor.

5. Create the required memory configuration file based on the hypervisor MMU entries.
 - a. In the **Debug** view, select the first core and click **Suspend**.
 - b. In the **Registers** view, expand the `regPPCTLB1` group.
 - c. Find the MMU entries corresponding to the `0x00100000` address.

NOTE

The MMU entry for this translation uses the physical address `0x7f900000` and the translation size is 1 MB.

- d. Add the following code to the memory configuration file:

```
AutoEnableTranslations    true
translate v:0x00100000 p:0x7f900000 0x00100000
```

- e. Add specific translations to access memory areas for which the translation is not 1-1.

NOTE

The memory mapped registers are accessed directly on physical memory space, no translation is required in such cases.

- f. Save the memory configuration file and add it to the attach launch configuration.
- g. Select **Run > Debug Configurations**.

The **Debug Configurations** dialog appears.
- h. Expand the **CodeWarrior** group and select the launch configuration you created.
- i. In the **Connection** panel, click **Edit** next to the **Connection** drop-down list box.

The **Properties for <connection>** window appears.
- j. In the **Memory** tab, select the created memory configuration file at the processor level.

NOTE

By default, the memory configuration files, `P4080_HV_EntryPoint.mem` and `P4080_HV.mem` needed for debugging the hypervisor, included in P4080 2.1 software bundle, are provided with the CodeWarrior layout in the `PA\PA_Support\Initialization_Files\Memory` folder. If you use a different hypervisor or use a hypervisor with different MMU entries, you need to follow the steps above.

You are now ready to debug the hypervisor at different stages.

7.10.1 Debugging Hypervisor During the Boot and Initialization Process

This section discusses the various debug scenarios while debugging hypervisor from the boot.

This section explains:

- [Debugging Hypervisor from the Entry Point](#) on page 323
- [Debugging Hypervisor from Relocation till Release of Secondary Cores](#) on page 325
- [Debugging Hypervisor after Release of Secondary Cores](#) on page 326
- [Debugging the Hypervisor Partitions Initialization Process](#) on page 327
- [Debugging the Hypervisor Partitions Image Loading Process](#) on page 328

- [Debugging All Cores when Starting the Guest Applications](#) on page 328
- [Debugging the Hypervisor Partition Manager](#) on page 328

7.10.1.1 Debugging Hypervisor from the Entry Point

In this section, you will see how the hypervisor code is debugged from the `_start` function in the `libos/lib/head.S` file until the `tlbwe` from `branch_to_reloc` from the `scr/misc.S` file, when the new text mapping is created and the initial one is removed.

To debug hypervisor from the entry point until the hypervisor relocation:

1. Download the appropriate P4080 SW Bundle image (the BSP in `.iso` format) to a Linux computer.
2. Mount the `.iso` image file using this command: `mount -o loop BSP-Image-Name.iso /mnt/iso`
3. Install the BSP image file according to the instructions given in the BSP documentation, `help/documents/pdf/BSP_User_Manual`.
4. Configure <build tool> to have U-Boot boot the hypervisor as per instructions given in the BSP documentation, `help/documents/pdf/BSP_User_Manual`.
5. Import the U-Boot file and create an Attach launch configuration.
 - a. Launch the CodeWarrior IDE.
 - b. From the main menu bar, select **File > Import**.
The **Import** wizard appears.
 - c. Expand the **CodeWarrior** group.
 - d. Select **CodeWarrior Executable Importer** to debug a `.elf` file.
 - e. Click **Next**.
The **Import a CodeWarrior Executable file** page appears.
 - f. Specify the project name for the imported project.
 - g. Click **Next**.
The **Import C/C++/Assembler Executable Files** page appears.
 - h. Click **Browse** next to the **Executable** option.
 - i. Select the `hv.elf` file.
 - j. Click **Next**.
The **Processor** page appears.
 - k. Select the processor family and toolchain for the executable file.
 - l. Click **Next**.
The **Debug Target Settings** page appears.
 - m. Specify the debugger connection type, board, launch connection, and connection type for the executable file.
 - n. Click **Next**.
The **Configurations** page appears.
 - o. Select a core index.
 - p. Click **Finish**.
The **Import a CodeWarrior Executable** window closes.

q. Select **Run > Debug Configurations**.

The **Debug Configurations** dialog appears with the specified launch configuration settings.

r. Click **Edit** near the **Connection** list box to check or edit the settings you made during the creation of the launch configuration.

The **Properties** window appears for the selected launch configuration.

s. Select the type of connection using the **Connection type** drop-down list.

The **Connection** page appears.

t. Ensure that CCS executable is selected in the CCS server panel.

u. Specify the path of the executable file of the CCS server.

v. Enter the IP address in the **Hostname/IP Address** text box.

NOTE

Use the default port, 41475 and JTAG clock speed, 16000 kHz.

w. Click **Edit** next to the **System** drop-down list.

The **System** page appears.

x. Select `P4080_HV_EntryPoint.mem` from `\CWInstall_dir\PA\PA_Support\Initialization_Files\Memory` in the Initialize target script column.

y. Click **OK**.

The **Properties** window closes.

z. On the **Main** tab, in the System panel list, ensure that `e500mc-0` is selected. Run the launch configuration.

aa. Click **Finish**.

NOTE

You can attach to all 8 cores, but for this example you will just select the first core. In the beginning the hypervisor runs from address `0x0` and uses this translation `v: 0x00100000 p:0x00000000 0x00100000` in its TLB1 MMU.

6. Open the **Debugger Shell** and set a hardware breakpoint at the entry point (`_start` function from `libos/lib/head.S`) by issuing this command:

```
bp -hw 0x0 or bp -hw libos_client_entry
```

7. Find the address of this entry point by using the elf dump file:

```
powerpc-linux-gnu-objdump -D hv > hv.objdump;
```

8. Open the generated dump and search for `_start` address (for example, `0x100000`)

NOTE

You use the `objdump` utility here because `head.S` is not present in the `hv.elf` file. To set a hardware breakpoint, you can also expand the `hv.elf` file, open the required file (if present) and set a hardware breakpoint directly at the desired function, for example, the `libos_client_entry` or any other function.

9. Boot the hypervisor at the U-Boot prompt.

The debugger stops at the specified hardware breakpoint (see the figure below). You can now debug from this location until hypervisor relocation.

Figure 114: Hypervisor Debug - Entry Point

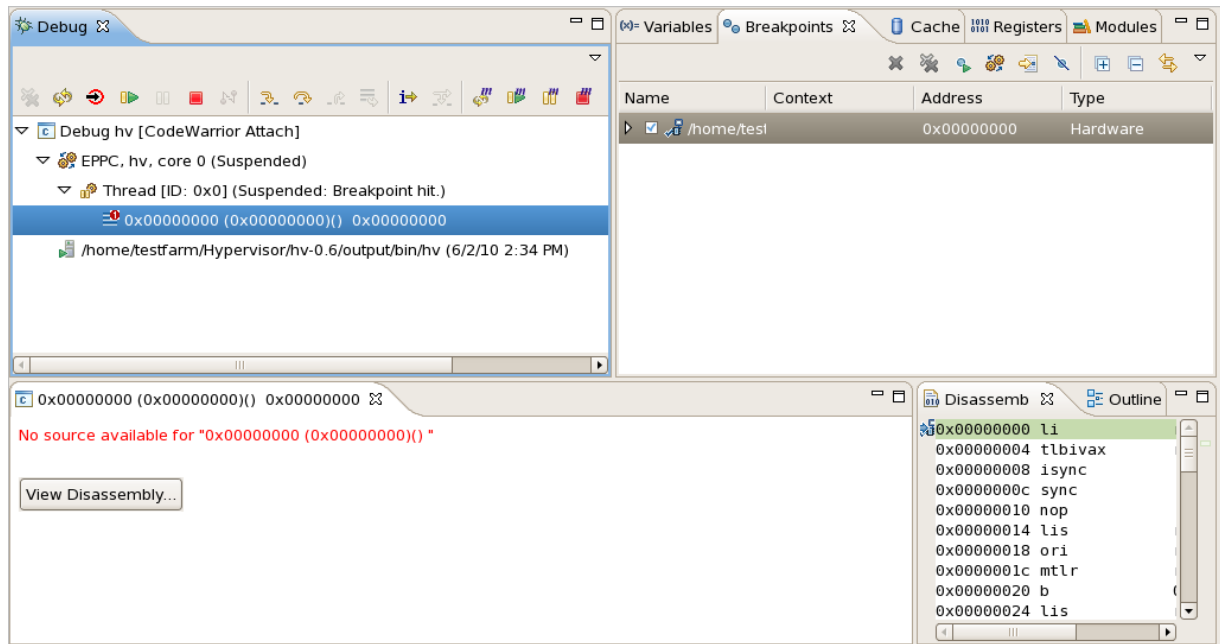

7.10.1.2 Debugging Hypervisor from Relocation till Release of Secondary Cores

After the hypervisor relocation, the MMU entry from TLB1 is changed. Therefore, to continue debugging the hypervisor, the used memory configuration file should use the new translation.

NOTE

For debugging hypervisor from relocation, use the `P4080_HV.mem` file from `\CWPAv10.0\PA\PA_Support\Initialization_Files\Memory`.

Follow these steps to debug hypervisor from relocation:

1. Select **Run > Debug Configurations**.

The **Debug Configurations** dialog appears.

2. On the left panel, from the **CodeWarrior Attach** group, select the attach launch configuration you had imported using the `hv.elf` file.
3. On the **Main** tab, in the **System** panel, select all the cores and click **Debug**.

The **Debug** perspective appears.

4. In the Editor view, open the `init.c` file and set a hardware breakpoint at the `branch_to_reloc` function call from the `init_hv_mem` function.

Figure 115: Hypervisor Debug - Setting Breakpoint

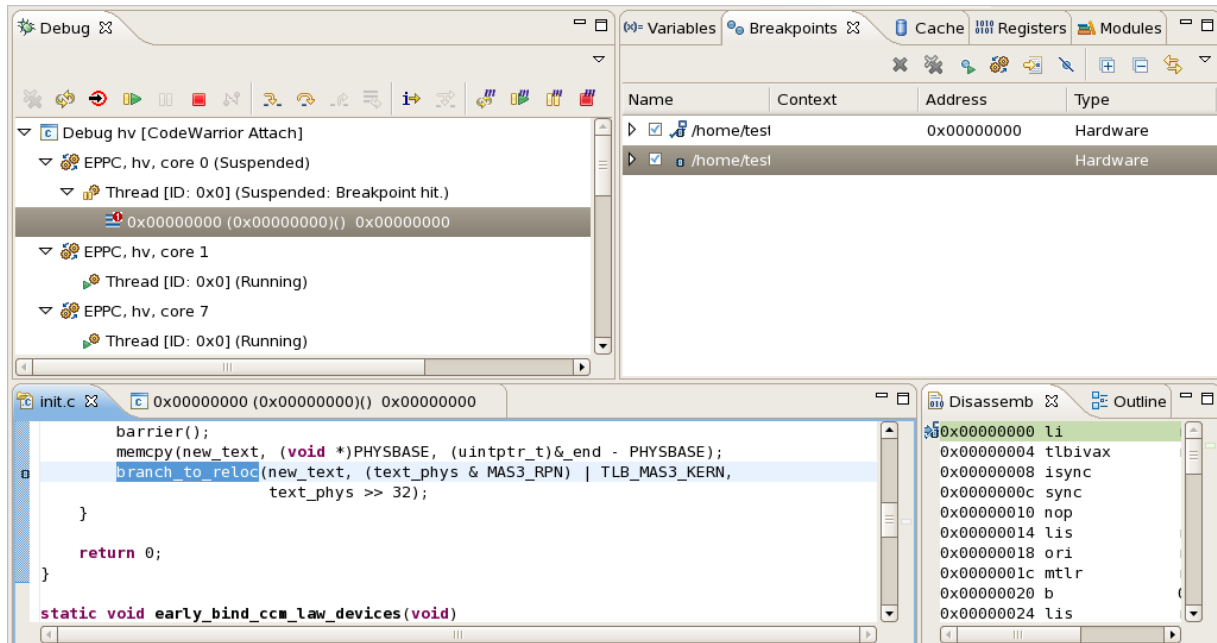

5. Debug until the secondary cores are being released from the spin table in the `release_secondary` function from `init.c` at `start_secondary_spin_table` call.

Figure 116: Hypervisor Debug - Release of Secondary Cores

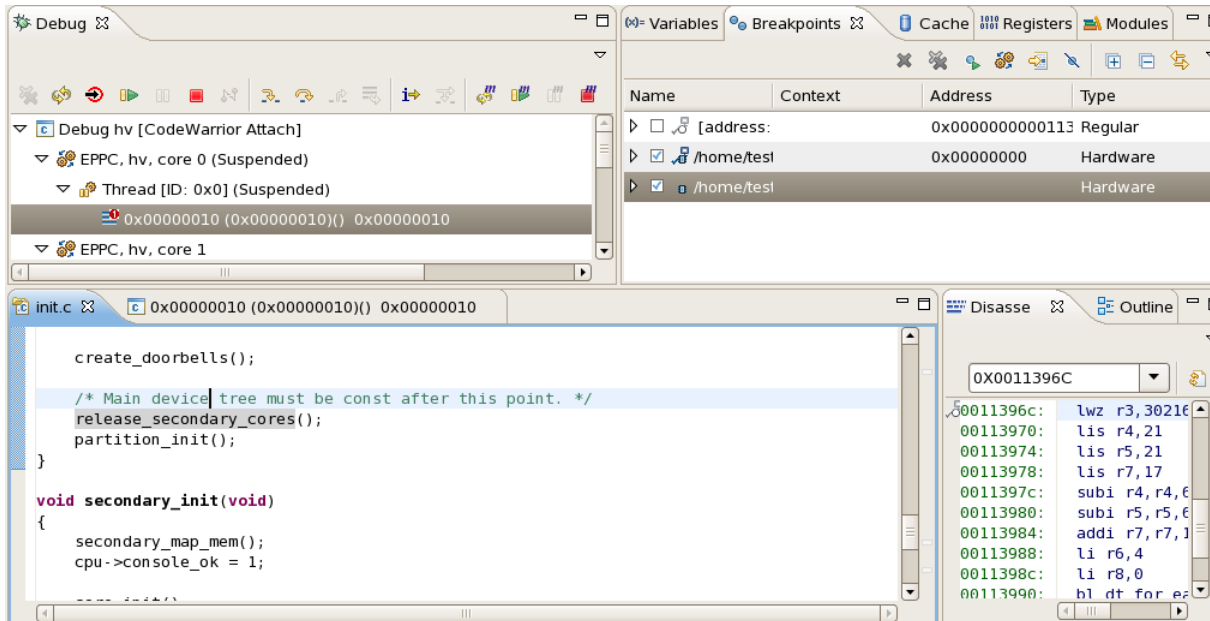

7.10.1.3 Debugging Hypervisor after Release of Secondary Cores

This section explains how to debug hypervisor after the release of secondary cores.

Follow these steps:

1. Select **Run > Debug Configurations**.

The **Debug Configurations** dialog appears.

2. On the left panel, from the **CodeWarrior Attach** group, select the attach launch configuration you had imported using the `hv.elf` file.
3. On the **Main** tab, in the **System** panel, select all the cores and click **Debug**.
The **Debug** perspective appears.
4. When the secondary cores are released, set a hardware breakpoint at the `start_secondary_spin_table` function in the `mp.c` file.
5. Boot the hypervisor.
The first core will stop at the `start_secondary_spin_table` function.

NOTE

For debugging the secondary cores, set a breakpoint either at the `secondary_start` entry point for secondary cores from `libos/lib/head.S` or at a function called by secondary cores (for example, set a breakpoint at the `secondary_init` function in the `init.c` file).

6. Find out the address of the `secondary_start` entry point by using the elf dump file:

```
powerpc-linux-gnu-objdump -D hv > hv.objdump;
```

7. Open the generated dump and search for `secondary_start` address (for example, `0x10006c`).
8. After having the translation from `0x00100000` to `0x7f900000`, add a breakpoint at `0x7f90006c`.
9. Resume the first core which was stopped at the `start_secondary_spin_table` function.
Each secondary core will stop at the specified breakpoint either at the entry point or the `secondary_init` function.
10. Debug all the cores until the `init_guest` function call from the `partition_init` function.

7.10.1.4 Debugging the Hypervisor Partitions Initialization Process

This section explains how to debug the hypervisor partition initialization process.

Follow these steps:

1. Select **Run > Debug Configurations**.
The **Debug Configurations** dialog appears.
2. On the left panel, from the **CodeWarrior Attach** group, select the attach launch configuration you had imported using the `hv.elf` file.
3. On the **Main** tab, in the **System** panel, select all the cores and click **Debug**.
The **Debug** perspective appears.
4. In the Editor view, open the `init.c` file and set a hardware breakpoint at the `partition_init` function.
5. Debug the `init_guest` function on each core.
6. Set a breakpoint in the `init_guest_primary` function for debugging each primary core of a partition.
7. Set a breakpoint in the `register_cpu_with_guest` function for the other cores of a partition.

NOTE

The secondary cores wait on a barrier in the `register_cpu_with_guest` function until the primary core of that partition allocates the `guest->gcpus` member; after this they will enter `idle_loop` from `src/misc.S`. The primary core of each partition will continue in the `init_guest_primary` function with different device-tree operations.

7.10.1.5 Debugging the Hypervisor Partitions Image Loading Process

After debugging the hypervisor partitions initialization process, the image loading process begins at the `start_load_guest` or `load_guest` function from the `guest.c` file.

Each primary boot core will set a event of this type in the `init_guest` function causing one of this functions to be called.

1. From the `start_load_guest` function, the primary core of each partition begins the process of image loading for each partition.
2. In the `start_guest_primary` function, the `load_images` function call will load the specific files for each partition.
3. Set different breakpoints in these functions for debugging the image loading process.

7.10.1.6 Debugging All Cores when Starting the Guest Applications

After the images for each partition are loaded, the primary core of each partition should take the secondary partition cores from the idle loop and start the partition.

Follow these steps to debug all cores:

1. In the `start_guest_primary_noload` function, each partition primary core sets a `gev_start` event and will wait on a barrier until all the cores from the partition become active.
2. The secondary partition cores will continue in the `start_guest_secondary` function and will wait in the while loop for different events.
3. After all the partition cores become active and they are waiting for events in the while loop, the primary core moves over the barrier, sets the partition state to running, sets the `srr1` variable to guest state and at the return from exception will start executing the guest application.
4. The other secondary cores from the partition set `srr1` to guest state and at the return from exception will start executing the guest application.
5. Set different breakpoints in these `start_guest_primary_noload` and `start_guest_secondary` functions for debugging.

7.10.1.7 Debugging the Hypervisor Partition Manager

If you want to verify the behavior of different commands on a user space, you can use `partman`, which is a Linux user space application.

For debugging the associated hypercalls routines, you will need to attach to the hypervisor with all the eight cores and set breakpoints at the required function calls.

In this section, we will take an example of issuing the partition restart command from `partman`.

1. Select **Run > Debug Configurations**.

The **Debug Configurations** dialog appears.

2. On the left panel, from the **CodeWarrior Attach** group, select the attach launch configuration you had imported using the `hv.elf` file.
3. On the **Main** tab, in the **System** panel, select all the cores and click **Debug**.

The **Debug** perspective appears.

4. In the Editor view, in the `hcalls.c` file set a breakpoint at the `hcall_partition_restart` function.

The debugger stops at this breakpoint and you can debug this hypercall handle.

7.11 User Space Debugging with On-Chip Debug

The user space on-chip debug (OCD) feature introduces the capability of debugging only one user space application per debug session, using the Linux kernel awareness debug feature.

The advantage of this feature is that the debugger functionality is not conditioned by any target services and the target serial/ethernet capabilities do not consume target resources. It works regardless of the target's processes state. The solution does not require any debugger add-on for the target board.

The Linux kernel awareness debug feature has been enhanced to accept the on-source debugging for one user space application per debug session. The limitation is multiple applications are linked and run on different virtual addresses. In real time, user space applications are linked to the same virtual address, so that only one can be debugged on the source.

A typical Linux kernel debug session (attach or download) adds the symbolics information for the user space application. The symbolic information must be added before starting the debug session. Follow these steps to add the information:

1. Select **Run > Debug Configurations**.

The **Debug Configurations** dialog appears.

2. Click the **Debugger** tab.

The **Debugger options** group appears.

3. Select the **Other Executables** tab.

4. Click **Add** to add the application elf file.

The **Debug Other Executable** dialog appears.

5. Select the **Load Symbols** checkbox and clear the **Download to Device** checkbox.

6. To download and start the application on the target board, the application should be included in the target file system (using RAM disk or rootfs). You can either include the application manually or using SDK.

- From the SDK: The application is included in the `rootfs` file from the SDK. The application will be downloaded on the target board with the rest of the file system using the RAM disk download feature. Follow all the steps from the BSP user manual (`iso/help/documents/pdf` on the BSP image) to include the application in the target file system.
- Place the application manually: You can place the application manually in the target file system by copying the application to the target, after the linux application is running on the target board using the file transfer protocol like, FTP, TFTP, or SCP. If you use NFS, copy the application on the NFS server location of the RAM disk.

7. Click **Debug**.

The debugged application processes will be presented as kernel tasks with the respective PID. If a core is terminated while running inside the application, the corresponding thread will appear in the **System Browser** view.

8. Select **Window > Show View > Other**.

The **Show View** dialog appears.

9. From the **Debug** group, select **System Browser**.

10. Click **OK**.

The **System Browser** window appears with the process and thread information.

11. Locate the particular thread among the other threads and double click on it to debug the selected thread. You can also right-click the thread and select the **Debug** option.

The selected thread appears in the **Debug** perspective for the current core.

NOTE

On multi-core systems the application can be found on any core and, if it creates multiple threads/processes, each has a separate entry in **System Browser** view.

12. Click on the thread in the **Debug** view, the program counter icon  on the marker bar points to the next statement to be executed.

13. In the **Debug** view, click **Step Into** .

The debugger executes the current statement and halts at the next statement.

14. Set the breakpoint on the appropriate function.

15. You can inspect the variables, view the Disassembly or perform any other debug capability as required.

NOTE

The Linux kernel and user space stack frames are not simultaneously supported for a thread. In a system call, the kernel stack is displayed corresponding to the kernel function (system call) called from the application.

This section contains the following subsections:

- [Attaching Core to Debug Application](#) on page 330
- [Debugging Application from main\(\) Function](#) on page 330

7.11.1 Attaching Core to Debug Application

In this section, we will take an example to attach the target to an already executed debugging application.

The steps are as follows:

1. Click **Suspend** from the debug view to suspend the debug session or **Multicore Suspend** if a multicore target is used.
2. Select **Window > Show View > Other**.

The **Show View** dialog appears.

3. From the **Debug** group, select **System Browser**.

4. Click **OK**.

The **System Browser** window appears.

5. Select and double-click on the particular thread to attach it to the target.



NOTE

If the application stack does not appear in the **Debug** view, go to **System Browser** view and attach the application.

7.11.2 Debugging Application from main() Function

In this section, we will describe the steps to debug the application from the beginning of the program, that is, from the `main()` function.

Before executing the `main()` function, the application load process must be interrupted by setting a breakpoint after the MMU setup and before the main execution. It can be performed in two steps:

1. Attach to a running instance of the application (as described above) and set the breakpoint.
 - a. Right-click the selected thread in the application stack.
The context menu appears.
 - b. Select the **Debug** option to debug the application after the application stack is displayed in the **Disassembly** view.
 - c. Click the thread in the **Debug** view.
The program counter icon  on the marker bar points to the next statement to be executed.
 - d. Set breakpoint at the stack frame under `main()`.
2. Click **Resume**  and restart the application from the console.
3. When the breakpoint is hit, set a new breakpoint on source, and repeat the above steps.

Chapter 8

JTAG Configuration Files

This chapter explains the JTAG configuration files that pass specific configuration settings to the debugger and support chaining of multiple devices.

A JTAG configuration file is a text file, specific to the CodeWarrior debugger, which describes a custom JTAG scan chain. You can specify the file in the remote system settings.

This chapter explains:

- [JTAG configuration file syntax](#) on page 333
- [Using a JTAG configuration file to override RCW](#) on page 334
- [Using a JTAG configuration file to specify multiple linked devices on a JTAG chain](#) on page 335
- [Setting up a remote system to use a JTAG configuration file](#) on page 337

8.1 JTAG configuration file syntax

This section describes the syntax of a JTAG configuration file.

You can create a JTAG configuration file that specifies the type, chain order, and various settings for the devices you want to debug. To create the JTAG configuration file, list each device on a separate line, starting with the device that is directly connected to the transmit data out (TDO) signal (Pin 1) of the 16-pin COP/JTAG debug connector on the hardware target, and conclude with a blank line.

The listing below shows the complete syntax for a JTAG configuration file.

Figure 117: JTAG Configuration File Syntax

```

cfgfile:
    '\n'

    '#' 'any other characters until end of line'

line
    cfgfile line

line:
    target

    target filter_list_or_params

target:
    target_name

    target_name = target_id

    'Generic' number number number

filter_list_or_params:
    filter_list_entity
  
```

```

    filter_list_or_params filter_list_entity

filter_list_entity:

    '(' number number ')'

    filter_name

    %

```

In the listing above, target_name represents a processor name, such as P1010, P2020, P4080, and so on.

NOTE

If a JTAG scan chain contains a processor, such as P1011, P1012, P1013, P1015, P1016, P1017, and P2010, then an additional parameter, (0x80000000 1), needs to be specified in the JTAG configuration file. An example of this parameter is given in [Using a JTAG configuration file to specify multiple linked devices on a JTAG chain](#) on page 335.

8.2 Using a JTAG configuration file to override RCW

You can use a JTAG configuration file to override reset configuration word (RCW) for a processor, such as P4080.

In the following scenarios, the JTAG configuration files are used for overriding RCW:

- Programming RCW in a target board that does not have RCW programmed already
- New board bring-up
- Recovering a board having a blank or corrupted flash

NOTE

For more information on RCW, see the reference manual for your processor.

The CodeWarrior software includes example JTAG configuration files that can be used for overriding the RCW (see the listing below). The JTAG Configuration files are available at the following location:

```
<CWInstallDir>\PA\PA_Support\Initialization_Files\jtag_chains
```

Figure 118: Sample JTAG configuration file for overriding RCW

```

# Example file to allow overriding the whole RCW or a portion of it
#
# Syntax:
#   P4080 (2 RCW_option) (RCWn value) ...
#
#   where:
#   RCW_option = 0 [RCW override disabled]
#               1 [RCW override enabled]
#               2 [Reset previous RCW override parts]
#
#   RCWn = 21000+n (n = 1 .. 16; index of RCW value)
#
#   value = 32-bit value

```

As specified in the listing above, the JTAG configuration files can be used to override a portion or the complete RCW for P4080, by specifying (index, value) pairs for some (or all) of the 16 x (32-bit words) of the RCW.

NOTE

You can use the pre-boot loader (PBL) tool to configure the various settings of the RCW and output the RCW in multiple formats, including CodeWarrior JTAG configuration files. For more information on the PBL tool, see [QCVS PBL Tool User Guide](#).

8.3 Using a JTAG configuration file to specify multiple linked devices on a JTAG chain

This section explains how to connect multiple processors through a single JTAG chain and how to describe such a JTAG chain in a JTAG configuration file.

The listing and figure below show a sample JTAG initialization file with a single core.

Figure 119: Sample JTAG Initialization File for P1010 Processor

```
# A single device in the chain
P1010
```

Figure 120: A Single Device in a JTAG Chain

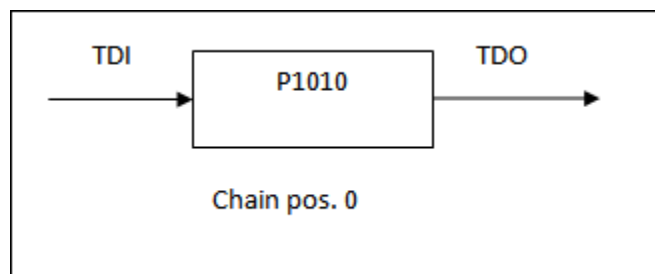

The listing and figure below show a sample JTAG initialization file with two devices in a JTAG chain.

Figure 121: Sample JTAG Initialization File for P1014 and P2020 Processors

```
# Two devices in a JTAG chain
P1014
P2020
```

Figure 122: Two Devices in a JTAG Chain

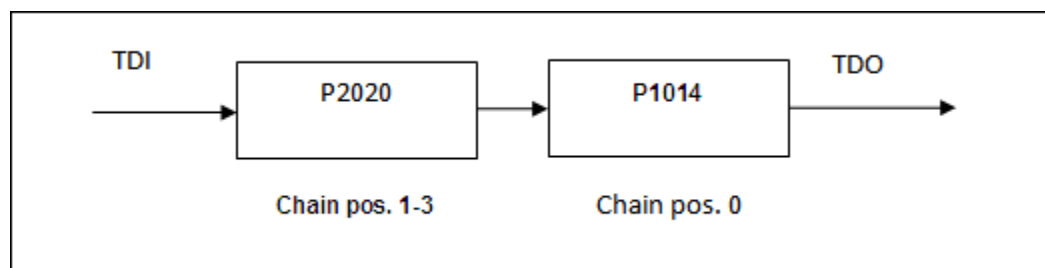

Using a JTAG configuration file to specify multiple linked devices on a JTAG chain

NOTE

The devices are enumerated in the direction starting from TDO output to TDI input.

The listing and figure below show two devices connected in a JTAG chain.

Figure 123: Sample JTAG Initialization File for P2010 and P4080 Processors

```
# Two devices in a JTAG chain
P2010 (0x80000000 1)

P4080 (2 1) (210005 0x90404000)
```

Figure 124: Two Devices in a JTAG Chain

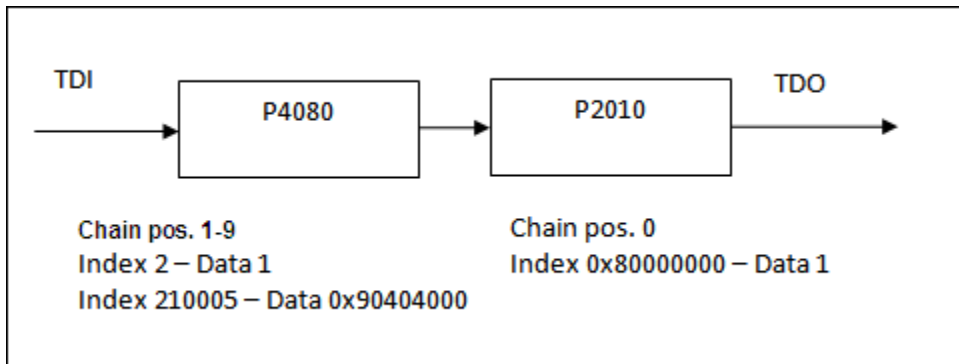

The listing and figure below show two devices connected in a JTAG chain with a filter applied for the second device.

Figure 125: Sample JTAG Initialization File for Two Devices with Filter for Second Device

```
# Two devices in a JTAG chain
8306 (1 1) (2 0x44050006) (3 0x00600000)

8309 log
```

Figure 126: Two Devices in a JTAG Chain with Filter Applied to Second Device

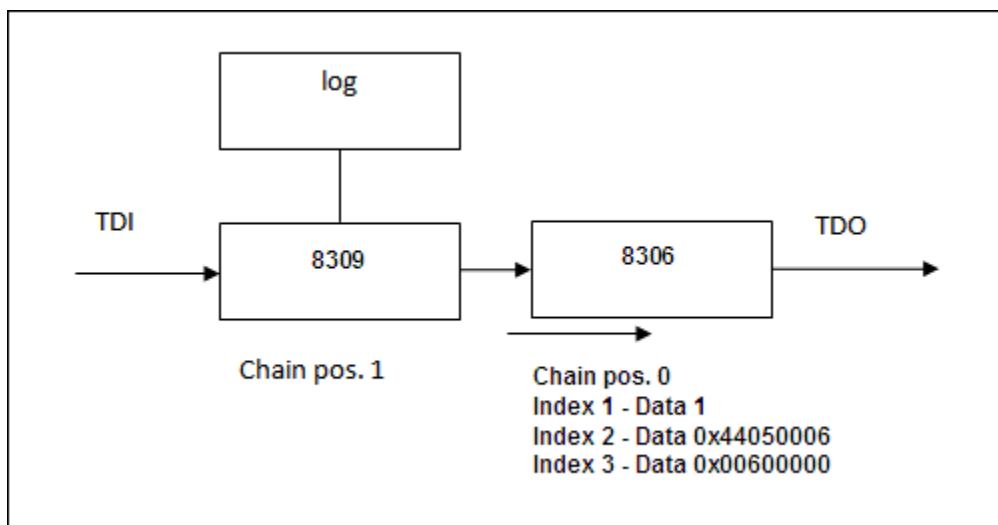

In the above example, the entry for the 8306 also includes the Hard Reset Control Word (HRCW) data that will overwrite the HRCW fetched by the 8306 upon power up or Hard Reset. The Hard Reset Control Word parameters are optional.

The CodeWarrior debugger not only supports Freescale devices but also supports non-Freescale devices in a JTAG scan chain. Each non-Freescale device used in a scan chain is declared as "Generic" and it takes the following three parameters:

- JTAG Instruction Length
- Bypass Command
- Bypass Length

The values for these three parameters are available in the device's data sheet or can be obtained from the manufacturer of the device.

The listing and figure below show a Freescale device, 8560, connected with a non-Freescale device, PLA, in a JTAG scan chain. From the PLA's data sheet, the JTAG Instruction Length = 5, the Bypass Command = 1, and the Bypass Length = 0x1F.

Figure 127: Sample JTAG Initialization File including Non-Freescale Devices

```
8560
Generic 5 1 0x1F
```

Figure 128: A Freescale Device and a Non-Freescale Device in a JTAG Chain

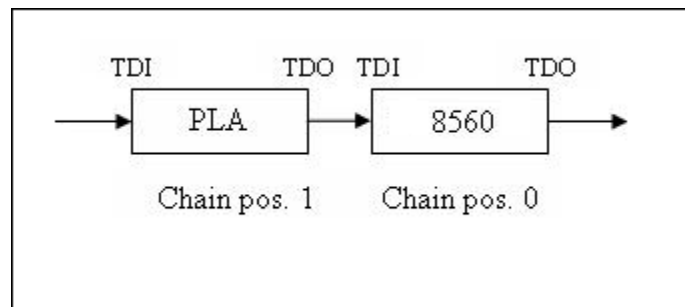

8.4 Setting up a remote system to use a JTAG configuration file

This section explains how to configure a remote system to use a JTAG configuration file.

To connect to a JTAG chain, specify these settings in the launch configurations:

1. Create a JTAG initialization file that describes the items on the JTAG chain. For more information on how to create a JTAG initialization file, see [JTAG configuration file syntax](#) on page 333 and [Using a JTAG configuration file to specify multiple linked devices on a JTAG chain](#) on page 335.

2. Open the CodeWarrior project you want to debug.

3. Select **Run > Debug Configurations**.

The **Debug Configurations** dialog appears with a list of debug configurations that apply to the current application.

4. Expand the **CodeWarrior** tree control.

5. From the expanded list, select the debug configuration for which you want to modify the debugger settings.

Setting up a remote system to use a JTAG configuration file

The **Debug** view shows the settings for the selected configuration.

6. Select a remote system from the **Connection** drop-down list.
7. Select a core from the **Target** list.
8. In the **Connection** group, click **Edit**.

The **Properties for <project>** window appears.

9. Click **Edit** next to the **Target** list.

The **Properties for <remote system>** window appears.

10. Click **Edit** next to the **Target type** drop-down list.

The **Target Types** dialog appears.

11. Click **Import**.

12. The **Import Target Type** dialog appears.

13. Select the JTAG initialization file that describes the items on the JTAG chain from this location:

```
<CWInstallDir>\PA\PA_Support\Initialization_Files\jtag_chains
```

14. Click **OK**.

The items on the JTAG chain described in the file appear in the **Target Types** dialog.

15. Click **OK**.

The selected JTAG configuration file appears on the **Advanced** tab (shown in the figure below).

Figure 129: Advanced Tab Showing the JTAG Configuration File

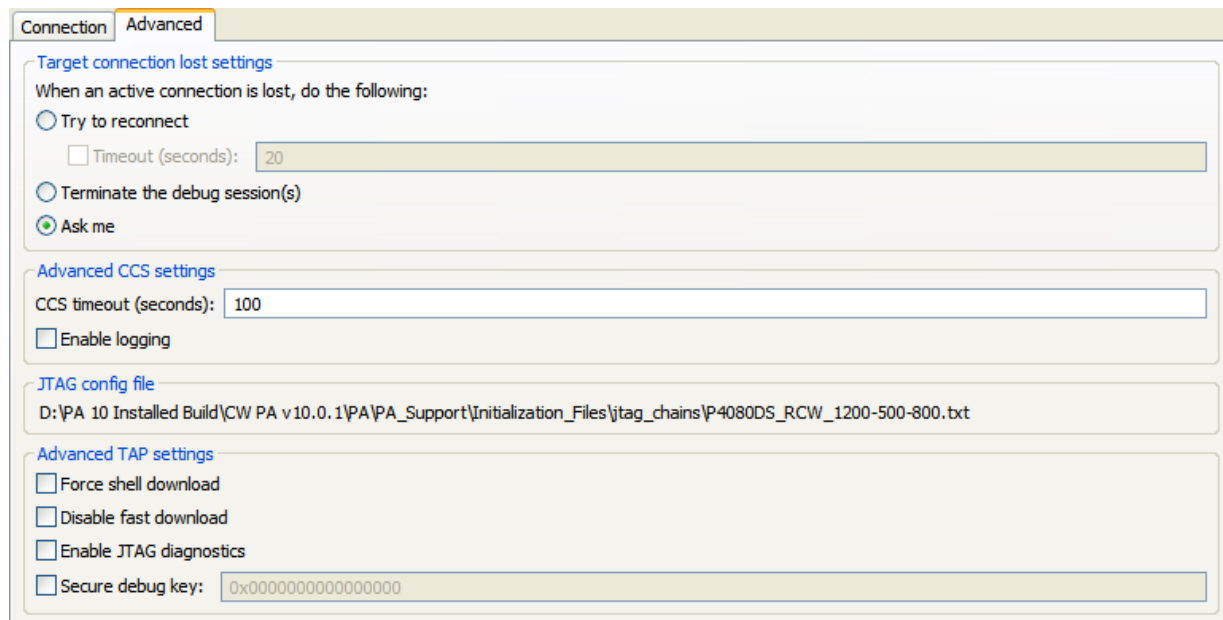

16. Click **OK**.

17. Click the **Debugger** tab.

The **Debugger** page appears.

18. Ensure that the **Stop on startup at** checkbox is selected and `main` is specified in the **User specified** text box.

19. Click **Apply** to save the changes.

You have successfully configured a debug configuration.

JTAG Configuration Files

Setting up a remote system to use a JTAG configuration file

Chapter 9

Target Initialization Files

A target initialization file is a file that contains commands that initialize registers, memory locations, and other components on a target board.

The most common use case is to have the CodeWarrior debugger execute a target initialization file immediately before the debugger downloads a bareboard binary to a target board. The commands in a target initialization file put a board in the state required to debug a bareboard program.

NOTE

The target board can be initialized either by the debugger (by using an initialization file), or by an external bootloader or OS (U-Boot, Linux). In both cases, the extra use of an initialization file is necessary for debugger-specific settings (for example, silicon workarounds needed for the debug features).

This chapter explains:

- [Using target initialization files](#) on page 341
- [Target initialization commands](#) on page 343

9.1 Using target initialization files

This section describes how to configure the CodeWarrior debugger to use a specific target initialization file.

A target initialization file contains commands that the CodeWarrior debugger executes each time the launch configuration, the initialization file is assigned to, is debugged. You can use the target initialization file for all launch configuration types (Attach, Connect and Download). The target initialization file is executed after the connection to the target is established, but before the download operation takes place.

The debugger executes the commands in the target initialization file using the target connection protocol, such as a JTAG run-control device.

NOTE

You do not need to use an initialization file if you debug using the CodeWarrior TRK debug protocol.

To instruct the CodeWarrior debugger to use a target initialization file:

1. Start the CodeWarrior IDE.
2. Open a bareboard project.
3. Select one of this project's build targets.
4. Select **Run > Debug Configurations**.
The **Debug Configurations** dialog appears.
5. Select the appropriate launch configuration from the left panel.
6. In the **Main** tab, from the **Connection** panel, click **Edit** next to the **Connection** drop-down list.
The **Properties for <Launch Configuration Name>** window appears.
7. Click **Edit** next to the **Target** drop-down list.
The **Properties for <remote system>** window appears.

- In the **Initialization** tab, select the appropriate cores checkboxes from the Initialize target column, as shown in the figure below.

Figure 130: Initialization Tab

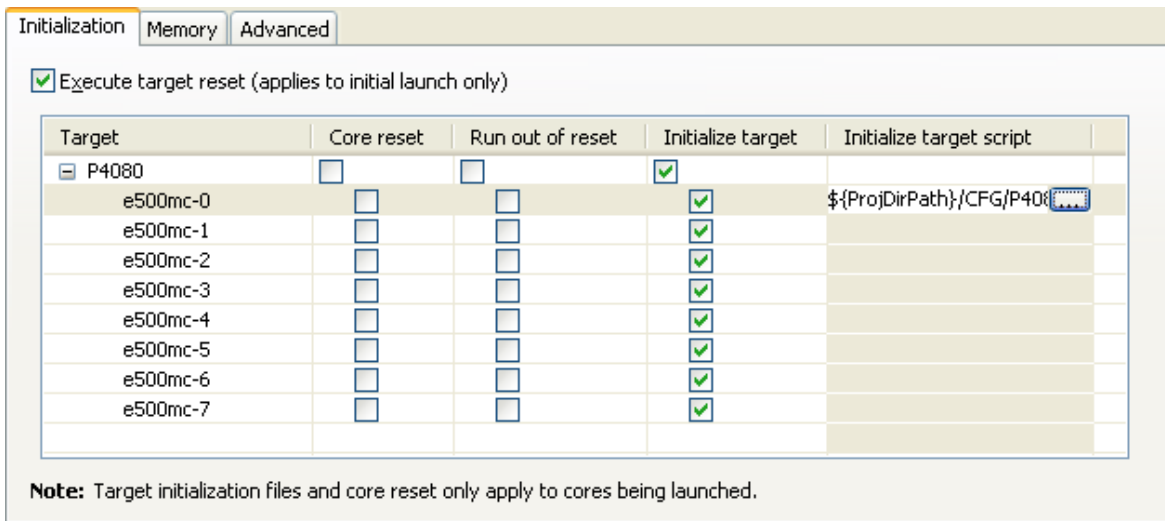

- In the **Initialize target script** column, click the ellipsis button, as shown in the figure above.

TIP

Click in the specified cell of the **Initialize target script** column for the ellipsis button to appear.

The **Target Initialization File** dialog appears, as shown in the figure below.

Figure 131: Target Initialization File Dialog Box

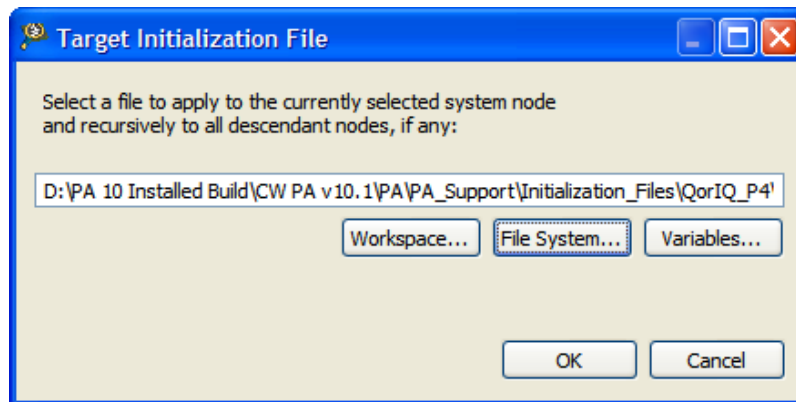

- Select the target initialization file by using the buttons provided in the dialog and click **OK**.

The target initialization files are available at the following path:

```
<CWInstallDir>\PA\PA_Support\Initialization_Files\
```

You can also write your own target initialization files. The next section documents the commands that can appear in such files.

9.2 Target initialization commands

Target initialization commands are of two types, `.cfg` commands and `.tcl` commands.

The syntax of each target initialization command follows these rules:

- Spaces and tabs (white space) are ignored
- Character case is ignored
- Unless otherwise noted, values may be specified in hexadecimal, octal, or decimal:
 - Hexadecimal values are preceded by `0x` (for example, `0xDEADBEEF`)
 - Octal values are preceded by `0` (for example, `01234567`)
 - Decimal values start with a non-zero numeric character (for example, `1234`)
- Comments start with a semicolon (`;`) or pound sign (`#`), and continue to the end of the line

This section explains:

- [.cfg target initialization commands](#) on page 343
- [.tcl target initialization commands](#) on page 353

9.2.1 .cfg target initialization commands

This section describes for each `.cfg` target initialization command a brief statement of what the command does, the command's syntax, a definition of each argument that can be passed to the command, and examples showing how to use the command.

Some commands described in this section allow access to memory-mapped register by name as well as address. Based on the processor selection in the debugger settings, these commands will accept the register names shown in the debugger's **Registers** view. There are also commands to access built-in registers of a processor core, for example, `writereg`. The names of these registers follow the architectural description for the respective processor core for general purpose and special purpose registers. Note that these names (for example, `GPR5`) might be different from names used in assembly language (for example, `r5`). You can identify the register names by looking at the debugger's **Registers** view.

NOTE

The current release does not include `.cfg` initialization files but provides backward compatibility to these files.

Listed below are the commands that can appear in a `.cfg` target initialization file:

- [alternatePC](#) on page 344
- [ANDmem.l](#) on page 344
- [ANDmmr](#) on page 345
- [IncorMMR](#) on page 345
- [ORmem.l](#) on page 346
- [reset](#) on page 346
- [run](#) on page 347
- [setCoreID](#) on page 347
- [resetCoreID](#) on page 347
- [sleep](#) on page 347

Target Initialization Files
Target initialization commands

- [stop](#) on page 348
- [writemem.b](#) on page 348
- [writemem.w](#) on page 348
- [writemem.l](#) on page 349
- [writemmr](#) on page 349
- [writereg](#) on page 350
- [writereg64](#) on page 350
- [writereg128](#) on page 351
- [writereg192](#) on page 352
- [writespr](#) on page 352

9.2.1.1 alternatePC

Sets the initial program counter (PC) register to the specified value, disregarding any entry point value read from the ELF application being debugged.

Syntax

```
alternatePC  
address
```

Arguments

address

The 32-bit address to assign to the program counter register.

This address may be specified in hexadecimal (for example, 0xABCD0000), octal (for example, 025363200000), or decimal (for example, 2882338816).

Example

This command assigns the address 0xc28737a4 to the program counter register:

```
alternatePC 0xc28737a4
```

9.2.1.2 ANDmem.l

Performs a bit AND using the 32-bit value at the specified memory address and the supplied 32-bit mask and writes the result back to the specified address.

No read/write verify is performed.

Syntax

```
ANDmem.l  
address  
mask
```

Arguments

address

The address of the 32-bit value upon which to perform the bit AND operation.

This address may be specified in hexadecimal (for example, 0xABCD0000), octal (for example, 025363200000), or decimal (for example, 2882338816).

mask

32-bit mask to use in the bit AND operation.

Example

The command below performs a bit AND operation using the 32-bit value at memory location `0xC30A0004` and the 32-bit mask `0xFFFFFFFF`. The command then writes the result back to memory location `0xC30A0004`.

```
ANDmem.l 0xC30A0004 0xFFFFFFFF
```

9.2.1.3 ANDmmr

Performs a bit AND using the contents of the specified memory-mapped register (MMR) and the supplied 32-bit mask and writes the result back to the specified register.

Syntax

```
ANDmmr  
regName  
mask
```

Arguments

regName

The name of the memory-mapped register upon which to perform a bit AND.

mask

32-bit mask to use in the bit AND operation.

Example

This command bit ANDs the contents of the `ACFG` register with the value `0x00002000`:

```
ANDmmr ACFG 0x00002000
```

9.2.1.4 IncorMMR

Performs a bitwise OR using the contents of the specified memory-mapped register (MMR) and the supplied 32-bit mask and writes the result back to the specified register.

Syntax

```
incorMMR  
regName  
mask
```

Arguments

regName

The name of the MMR register upon which to perform a bit OR.

mask

32-bit mask to use in the bit inclusive OR operation.

Example

This command bit ORs the contents of the `ACFG` register with the value `0x00002000`:

```
incorMMR ACFG 0x00002000
```

9.2.1.5 ORmem.l

Performs a bit OR using the 32-bit value at the specified memory address and the supplied 32-bit mask and writes the result back to the specified address.

No read/write verify is performed.

Syntax

```
ORmem.l  
address  
mask
```

Arguments

address

The address of the 32-bit value upon which to perform the bit OR operation.

This address may be specified in hexadecimal (for example, `0xABCD0000`), octal (for example, `025363200000`), or decimal (for example, `2882338816`).

mask

32-bit mask to use in the bit OR operation.

Example

The command below performs a bit OR operation using the 32-bit value at memory location `0xC30A0008` and the 32-bit mask `0x01000800`. The command then writes the result back to memory location `0xC30A0004`.

```
ORmem.l 0xC30A0008 0x01000800
```

9.2.1.6 reset

Resets the processor on the target board.

Syntax

```
reset  
code
```

Arguments

code

Number that defines what the debugger does after it resets the processor on the target board.

The table below describes the Post Reset Actions. Use any one of the values specified.

Table 136: Post Reset Actions

Value	Description
0	reset the target processor, then run on page 347
1	reset the target processor, then stop on page 348

9.2.1.7 run

Starts program execution at the current program counter (PC) address.

Syntax

```
run
```

9.2.1.8 setCoreID

Tells the debugger to issue all subsequent commands on the specified core index, disregarding the actual core index on which the initialization is executed.

NOTE

Ensure to reset the core index after the sequence of commands intended to execute on the other core is finished (see the [resetCoreID](#) on page 347 command).

TIP

This command can be useful in cases where you need to execute a command sequence on other cores than the current one, for example in a SMP initialization scenario.

Syntax

```
setCoreID core
```

Arguments

core

The core index on which to execute.

Example

This command tells the debugger to issue all subsequent commands on the core index 1:

```
setCoreID 1
```

9.2.1.9 resetCoreID

Tells the debugger to revert to executing commands on the current core, thus cancelling the effect of a previous `setCoreID` command.

Syntax

```
resetCoreID
```

9.2.1.10 sleep

Causes the debugger to pause the specified number of milliseconds before executing the next instruction.

Syntax

```
sleep  
milliseconds
```

Arguments

milliseconds

The number of milliseconds (in decimal) to pause the debugger.

Example

This command pauses the debugger for 10 milliseconds:

```
sleep 10
```

9.2.1.11 stop

Stops program execution and halts the processor on the target board.

Syntax

```
stop
```

9.2.1.12 writemem.b

Writes a byte (8 bits) of data to the specified memory address.

Syntax

```
writemem.b  
address  
value
```

Arguments

address

The 32-bit memory address to which to assign the supplied 8-bit value.

This address may be specified in hexadecimal (for example, `0xABCD`), octal ((for example, `0125715`), or decimal (`43981`).

value

The 8-bit value to write to the specified memory address.

This value may be specified in hexadecimal (for example, `0xFF`), octal (for example, `0377`), or decimal (for example, `255`).

Example

This command writes the byte `0x1A` to the memory location `0x0001FF00`:

```
writemem.b 0x0001FF00 0x1A
```

9.2.1.13 writemem.w

Writes a word (16 bits) of data to the specified memory address.

Syntax

```
writemem.w  
address  
value
```

Arguments

address

The 32-bit memory address to which to assign the supplied 16-bit value.

This address may be specified in hexadecimal (for example, 0xABCD0000), octal (for example, 025363200000), or decimal (for example, 2882338816).

value

The 16-bit value to write to the specified memory address.

This value may be specified in hexadecimal (for example, 0xFFFF), octal (for example, 0177777), or decimal (for example, 65535).

Example

This command writes the word 0x1234 to memory location 0x0001FF00:

```
writemem.w 0x0001FF00 0x1234
```

9.2.1.14 writemem.l

Writes a long integer (32 bits) of data to the specified memory location.

Syntax

```
writemem.l  
address  
value
```

Arguments

address

The 32-bit memory address to which to assign the supplied 32-bit value.

This address may be specified in hexadecimal (for example, 0xABCD0000), octal (for example, 025363200000), or decimal (for example, 2882338816).

value

The 32-bit value to write to the specified memory address.

This value may be specified in hexadecimal (for example, 0xFFFFABCD), octal (for example, 037777725715), or decimal (for example, 4294945741).

Example

This command writes the long integer 0x12345678 to the memory location 0x0001FF00:

```
writemem.w 0x0001FF00 0x12345678
```

9.2.1.15 writemmr

Writes a value to the specified memory-mapped register (MMR).

Syntax

```
writemmr  
regName  
value
```

Arguments

regName

The name of the memory-mapped register, the supplied value is assigned to.

NOTE

This command accepts most Power Architecture processor memory-mapped register names.

value

The value to write to the specified memory-mapped register.

This value may be specified in hexadecimal (for example, 0xFFFFABCD), octal (for example, 037777725715), or decimal (for example, 4294945741).

Example

This command writes the value 0xffffffffc3 to the SYPCR register:

```
writemmr SYPCR 0xffffffffc3
```

This command writes the value 0x0001 to the RMR register:

```
writemmr RMR 0x0001
```

This command writes the value 0x3200 to the MPTPR register:

```
writemmr MPTPR 0x3200
```

9.2.1.16 writereg

Writes the supplied data to the specified register.

Syntax

```
writereg  
regName value
```

Parameters

regName

The name of the register to which to assign the supplied value.

value

The value to write to the specified register.

This value may be specified in hexadecimal (for example, 0xFFFFABCD), octal (for example, 037777725715), or decimal (for example, 4294945741).

Example

This command writes the value 0x00001002 to the MSR register:

```
writereg MSR 0x00001002
```

9.2.1.17 writereg64

Writes the supplied 32-bit values to the specified 64-bit register.

NOTE

This command is applicable only to 64-bit Book E cores like the e5500.

Syntax

```
writereg regName value1 value2
```

Arguments

regName

The name of the 64-bit register to which to assign the supplied value.

value1, value2

The two 32-bit values that together make up the 64-bit value to assign to the specified register.

Each value may be specified in hexadecimal (for example, 0xFFFFABCD), octal

(for example, 037777725715), or decimal (for example, 4294945741).

Example

This command writes the 64-bit value 0x0123456789ABCDEF to the 64-bit GPR5 register:

```
writereg64 GPR5 0x01234567 0x89ABCDEF
```

9.2.1.18 writereg128

Writes the supplied 32-bit values to the specified TLB register.

NOTE

This command is applicable only to Book E cores, such as the e500 or e500mc variants.

Syntax

```
writereg128  
regName value1 value2 value3 value4
```

Arguments

regName

The name (or number) of the TLB register to which to assign the specified values.

TIP

Valid TLB0 register names range from L2MMU_TLB0 through L2MMU_TLB255 (L2MMU_TLB511 for e500v2 and e500mc).

TIP

Valid TLB1 register names range from L2MMU_CAM0 through L2MMU_CAM15, and L2MMU_CAM63 for e500mc.

value1, value2, value3, value4

The four 32-bit values that together make up the 128-bit value to assign to the specified TLB register.

Each value must be specified in hexadecimal (for example, 0xFFFFABCD).

Example

This command writes the values 0xA1002, 0xB1003, 0xC1004, and 0xD1005 to the L2MMU_CAM0 TLB register:

```
writereg128 L2MMU_CAM1 0x7000000A 0x1C080000 0xFE000000 0xFE000001
```

9.2.1.19 writereg192

Writes the supplied 32-bit values to the specified TLB register.

NOTE

This command is applicable only to 64-bit Book E cores, such as the e5500 variant.

Syntax

```
writereg192  
regName value1 value2 value3 value4 value5 value6
```

Arguments

regName

The name (or number) of the TLB register to which to assign the specified values.

TIP

Valid TLB0 register names range from L2MMU_TLB0 through L2MMU_TLB511.

TIP

Valid TLB1 register names range from L2MMU_CAM0 through L2MMU_CAM63.

value1, value2, value3, value4, value5, value6

The six 32-bit values that together make up the 192-bit value to assign to the specified TLB register.

Each value must be specified in hexadecimal (for example, 0xFFFFABCD).

Example

This command writes the values 0x7000000A 0x1C080000 0x00000000 0xFE000000 0x00000000 0xFE000001 to the L2MMU_CAM1 TLB register:

```
writereg192 L2MMU_CAM1 0x7000000A 0x1C080000 0x00000000 0xFE000000  
0x00000000 0xFE000001
```

9.2.1.20 writespr

Writes the specified value to the specified SPR register.

NOTE

This command is similar to the `writereg SPRxxx` command, except that `writespr` lets you specify the SPR register to modify by number (in hexadecimal, octal, or decimal).

Syntax

```
writespr  
regNumber value
```

Arguments

regNumber

The number of the SPR register to which to assign the supplied value.

This value may be specified in hexadecimal (for example, 0x27E), octal (for example, 01176), or decimal (for example, 638).

value

The value to write to the specified SPR register.

This value may be specified in hexadecimal (for example, 0xFFFFABCD), octal (for example, 037777725715), or decimal (for example, 4294945741).

Example

This command writes the value 0x0220000 to SPR register 638:

```
writespr 638 0x0220000
```

9.2.2 .tcl target initialization commands

This section describes the tool command language (TCL) - based commands that are used to initialize a target.

Similar to a .cfg initialization file, a TCL-based initialization file can contain target-specific initialization, processor core initialization, or debugger-specific initialization.

The .tcl file format offers some advantages over the .cfg file format, for example, it implements a better memory management approach, and allows you to use memory address ranges higher than 32-bit and use flow control statements. The .tcl file format is the recommended target initialization file format.

The debugger automatically executes the TCL script when you debug the launch configuration. You can also execute the script manually at any time from the Debugger Shell, by using the source command. The TCL-based target initialization is basically a debugger shell script and implicitly supports all Debugger Shell commands. For more details on the Debugger Shell commands, see *CodeWarrior Development Studio Common Features Guide*.

The table below lists the equivalent Debugger Shell commands that you can include in a TCL script for target initialization.

Table 137: .tcl target initialization commands

Target initialization commands	Debugger Shell equivalent
writereg, writereg64, writereg128, writereg192	reg OR change
writespr	reg OR change (partial equivalence - uses the register name instead of the spr number)
writemem.l	mem 32bit OR change 32bit
writemem.w	mem 16bit OR change 16bit
writemem.b	mem 8bit OR change 8bit
sleep	wait
writemmr	reg OR change
IncOrmmr	change regName [format %x [expr [reg regName %d -np] [expr mask]]] OR reg regName = [format %x [expr [reg regName %d -np] [expr mask]]]

Table continues on the next page...

Table 137: .tcl target initialization commands (continued)

Target initialization commands	Debugger Shell equivalent
ANDmmr	change regName [format %x [expr [reg regName %d -np] & [expr mask]]] Or reg regName = [format %x [expr [reg regName %d -np] [expr mask]]]
setCoreID	eppc::setcoreid
resetCoreID	eppc::setcoreid default
run	go
stop	stop
reset	reset
ANDmem.l	change address [format %x [expr [mem address %d -np] & [expr mask]]] Or mem address = [format %x [expr [mem address %d -np] & [expr mask]]]
ORmem.l	change address [format %x [expr [mem address %d -np] [expr mask]]] Or mem address = [format %x [expr [mem address %d -np] & [expr mask]]]
alternatePC	N/A

TIP

When accessing registers, for best performance you can add the register group name followed by '/' before the name of the register, for example:

```
reg "e500mc Special Purpose Registers"/MSR = 0x00002000
```

Chapter 10

Memory Configuration Files

A memory configuration file is a command file containing commands that define the rules the debugger follows when accessing a target board's memory.

NOTE

Memory configuration files do not define the memory map for the target. Instead, they define how the debugger should treat the memory map the target has already established. The actual memory map is initialized either by a target resident boot loader or by a target initialization file. For more information, see the [Target Initialization Files](#) on page 341 chapter of this manual.

If necessary, you can have the CodeWarrior debugger execute a memory configuration file immediately before the debugger downloads a bareboard binary to a target board. The memory configuration file defines the memory access rules (restrictions, translations) used each time the debugger needs to access memory on the target board.

NOTE

Assign a memory configuration file to bareboard build targets only. The memory of a board that boots embedded Linux® is already set up properly. A memory configuration file defines memory access rules for the debugger; the file has nothing to do with the OS running on a board. If needed, a memory configuration file should be in place at all times. The Linux Kernel Aware Plugin performs memory translations automatically, relieving the user from specifying them in the memory configuration file. In addition, for certain processors, the debugger can automatically read the translations from the target in a bareboard scenario, relieving the user from specifying them in the memory configuration file. For more information, see [Memory translations](#) on page 155.

This chapter explains:

- [Using memory configuration files](#) on page 355
- [Memory configuration commands](#) on page 356

10.1 Using memory configuration files

This section describes how to configure the CodeWarrior debugger to use a specific memory configuration file.

A memory configuration file contains memory access rules that the CodeWarrior debugger uses each time the build target, the configuration file is assigned to, is debugged.

You specify a memory configuration file in the **Memory** tab of the remote system configuration (shown in the figure below).

Figure 132: Specifying a memory configuration file

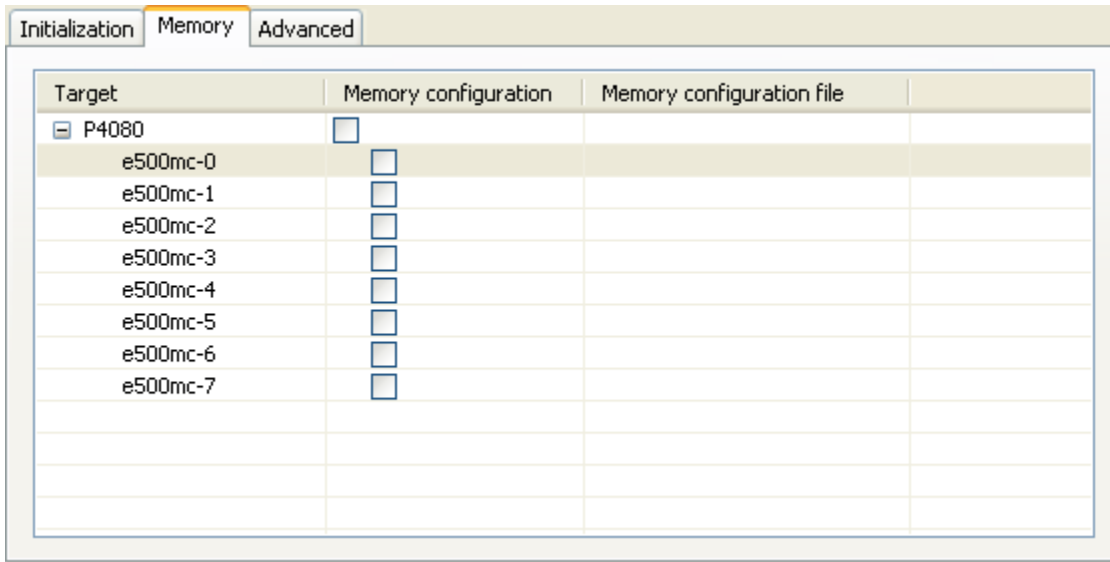

You can also write your own memory configuration files. The next section documents the commands that can appear in such files.

10.2 Memory configuration commands

This section describes for each memory configuration command a brief statement of what the command does, the command's syntax, a definition of each argument that can be passed to the command, and examples showing how to use the command.

In general, the syntax of memory configuration commands follows these rules:

- Spaces and tabs (white space) are ignored
- Character case is ignored
- Unless otherwise noted, values may be specified in hexadecimal, octal, or decimal:
 - Hexadecimal values are preceded by `0x` (for example, `0xDEADBEEF`)
 - Octal values are preceded by `0` (for example, `01234567`)
 - Decimal values start with a non-zero numeric character (for example, `1234`)
- Addresses are values that might be prefixed with the memory space command line prefix: `[<MemSP>:]<value>`. For example: `p:0x80000004` or `0x80000004`.
- Comments start with standard C and C++ comment characters, and continue to the end of the line

Listed below are the commands that can appear in a memory configuration file:

- [autoEnableTranslations](#) on page 357
- [range](#) on page 357
- [reserved](#) on page 358
- [reservedchar](#) on page 358
- [translate](#) on page 359

10.2.1 autoEnableTranslations

The `autoEnableTranslations` command configures if the translate commands are considered by the debugger or not.

Syntax

```
autoEnableTranslations enableFlag
```

Arguments

`enableFlag`

Pass true to instruct the debugger to consider the translate commands.

If this command is not present, the translations will not be considered, so this command should usually be present and have a "true" argument.

Examples

This command enables the debugger to consider the translate commands:

```
AutoEnableTranslations true
```

10.2.2 range

The `range` command sets debugger access to a block of memory.

NOTE

The `range` command must have both the `loAddress` and `hiAddress` in the same memory space.

Syntax

```
range  
loAddress hiAddress size access
```

Arguments

`loAddress`

the starting address of the memory range

`hiAddress`

the ending address of the memory range

`size`

the size, in bytes, the debug monitor or emulator uses for memory accesses

`access`

controls what type of access the debugger has to the memory block - supply one of: `Read`, `Write`, or `ReadWrite`

Examples

To set memory locations `0xFF000000` through `0xFF0000FF` to read-only with a size of 4 bytes:

```
range 0xFF000000 0xFF0000FF 4 Read
```

To set memory locations `0xFF000100` through `0xFF0001FF` to write-only with a size of 2 bytes:

```
range 0xFF000100 0xFF0001FF 2 Write
```

To set memory locations `0xFF000200` through `0xFFFFFFFF` to read and write with a size of 1 byte:

```
range 0xFF000200 0xFFFFFFFF 1 ReadWrite
```

10.2.3 reserved

The `reserved` command allows you to specify a reserved range of memory.

If the debugger attempts to read reserved memory, the resulting buffer is filled with the reserved character. If the debugger attempts to write to reserved memory, no write takes place. Note that the `reserved` command must have both the `loAddress` and `hiAddress` in the same memory space.

NOTE

For information showing how to set the reserved character, see [reservedchar](#) on page 358.

Syntax

```
reserved  
loAddress hiAddress
```

Arguments

`loAddress`

the starting address of the memory range

`hiAddress`

the ending address of the memory range

Examples

To reserve memory starting at `0xFF000024` and ending at `0xFF00002F`:

```
reserved 0xFF000024 0xFF00002F
```

10.2.4 reservedchar

The `reservedchar` command sets the reserved character for the memory configuration file.

When the debugger attempts to read a reserved or invalid memory location, it fills the buffer with this character.

Syntax

```
reservedchar rChar
```

Arguments

`rChar`

the one-byte character the debugger uses when it accesses reserved or invalid memory

Example

To set the reserved character to "x":

```
reservedchar 0x78
```

10.2.5 translate

The `translate` command lets you configure how the debugger performs virtual-to-physical memory address translations.

Typically, you use address translations to debug programs that use a memory management unit (MMU) that performs block address translations.

NOTE

Using the `translate` commands in the memory configuration file prevents the debugger from automatically reading the translations from the target MMU. For more information, see [Memory translations](#) on page 155.

Syntax

```
translate  
virtualAddress  
physicalAddress  
numBytes
```

Arguments

virtualAddress

the address of the first byte of the virtual address range to translate

physicalAddress

the address of the first byte of the physical address range to which the debugger translates virtual addresses

numBytes

the size (in bytes) of the address range to translate

Example

The following `translate` command:

- Defines a one-megabyte address range (`0x100000` bytes is one megabyte)
- Instructs the debugger to convert a virtual address in the range `0xC0000000` to `0xC0100000` to the corresponding physical address in the range `0x00000000` to `0x00100000`

```
translate v:0xC0000000 p:0x00000000 0x100000
```

Memory Configuration Files
Memory configuration commands

Chapter 11

Working with Hardware Tools

This chapter explains how to use the CodeWarrior hardware tools. Use these tools for board bring-up, test, and analysis.

In this chapter:

- [Flash programmer](#) on page 361
- [Flash File to Target](#) on page 370
- [Hardware diagnostics](#) on page 372
- [Import/Export/Fill memory](#) on page 380

11.1 Flash programmer

Flash programmer is a CodeWarrior plug-in that lets you program the flash memory of the supported target boards from within the IDE.

The flash programmer can program the flash memory of the target board with code from a CodeWarrior IDE project or a file. You can perform the following actions on a flash device using the flash programmer:

- [Erase/Blank check actions](#) on page 365
- [Program/Verify actions](#) on page 366
- [Checksum actions](#) on page 367
- [Diagnostics actions](#) on page 367
- [Dump Flash actions](#) on page 368
- [Protect/Unprotect actions](#) on page 368
- [Secure/Unsecure actions](#) on page 369

NOTE

Click the **Save** button or press **Ctrl+S** to save task settings.

The flash programmer runs as a target task in the Eclipse IDE. To program the flash memory on a target board, you need to perform the following tasks:

- [Create a flash programmer target task](#) on page 361
- [Configure flash programmer target task](#) on page 363
- [Execute flash programmer target task](#) on page 369

11.1.1 Create a flash programmer target task

You can create a flash programmer task using the **Create New Target Task** wizard.

1. Choose **Window > Show View > Other** from the CodeWarrior IDE menu bar.

The **Show View** dialog appears.

Figure 133: Show View dialog

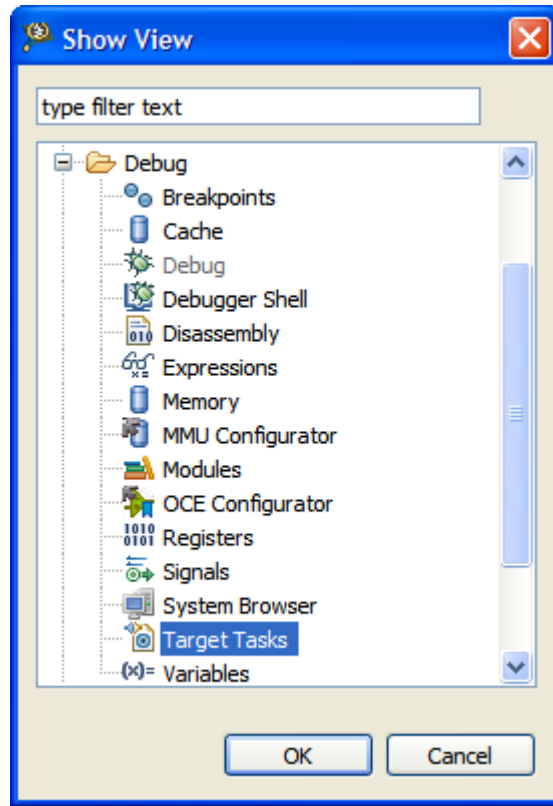

2. Expand the **Debug** group and select **Target Tasks**.
3. Click **OK**.

The **Target Tasks** view appears.

Figure 134: Target Tasks view

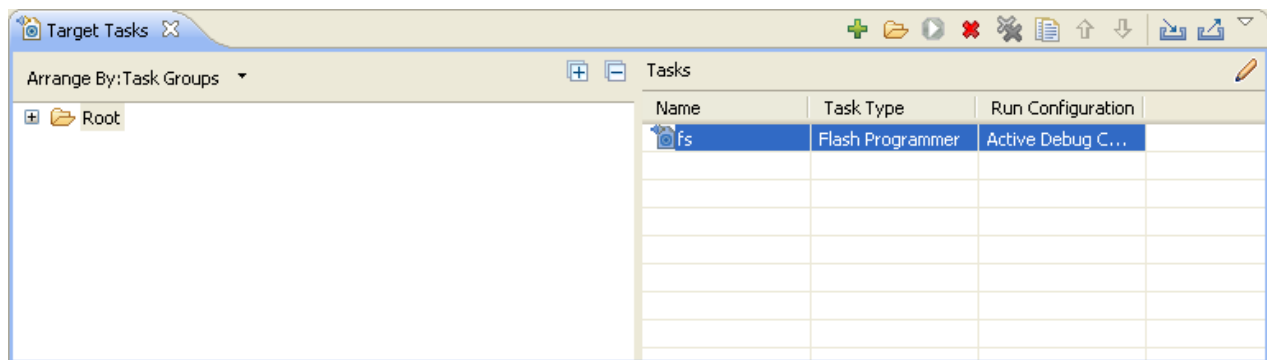

4. Click the **Create a new Target Task** button in the **Target Tasks** view toolbar.

The **Create New Target Task** wizard appears.

Figure 135: Create New Target Task window

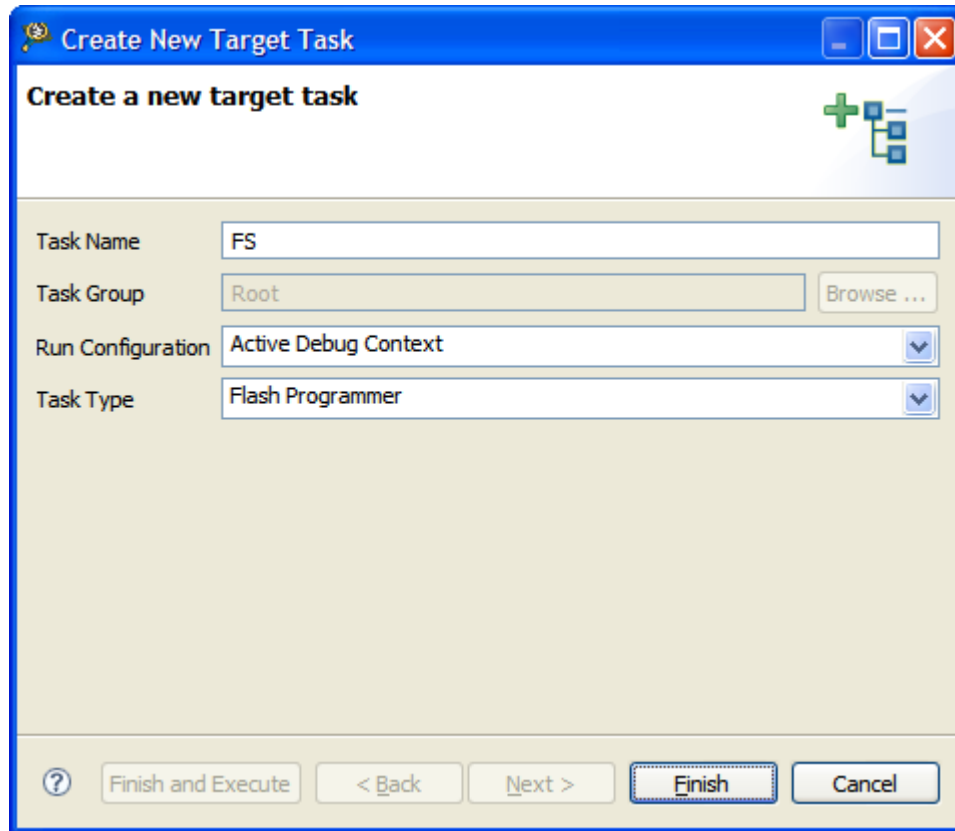

5. In the **Task Name** textbox, enter a name for the new flash programming target task.
6. Choose a launch configuration from the **Run Configuration** pop-up menu.
 - Choose **Active Debug Context** when flash programmer is used over an active debug session.
 - Choose a project-specific debug context when flash programmer is used without an active debug session.
7. Choose **Flash Programmer** from the **Task Type** pop-up menu.
8. Click **Finish**.

The target task is created and the **Flash Programmer Task** editor window appears. You use this window to configure the flash programmer target task.

- Flash Devices - Lists the devices added in the current task.
- Target RAM - Lets you specify the settings for Target RAM.
- Flash Program Actions - Displays the programmer actions to be performed on the flash devices.

11.1.2 Configure flash programmer target task

You can add flash devices, specify Target RAM settings, and add flash program actions to a flash programmer task to configure it.

This topic contains the following sub-topics:

- [Add flash device](#) on page 364
- [Specify target RAM settings](#) on page 364

- [Add flash programmer actions](#) on page 364

11.1.2.1 Add flash device

This topic explain how to add a flash device.

To add a flash device to the **Flash Devices** table:

1. Click the **Add Device** button.

The **Add Device** dialog appears.

2. Select a flash device from the device list.
3. Click the **Add Device** button.

The flash device is added to the **Flash Devices** table in the **Flash Programmer Task** editor window.

NOTE

You can select multiple flash devices to add to the **Flash Devices** table. To select multiple devices, hold down the Control key while selecting the devices.

4. Click **Done**.

The **Add Device** dialog closes and the flash device appears in the **Flash Devices** table in the **Flash Programmer Task** editor window.

NOTE

For NOR flashes, the base address indicates the location where the flash is mapped in the memory. For SPI and NAND flashes, the base address is usually 0x0.

11.1.2.2 Specify target RAM settings

The Target RAM is used by Flash Programmer to download its algorithms.

NOTE

The Target RAM memory area is not restored by flash programmer. If you are using flash programmer with Active Debug Context, it will impact your debug session.

The **Target RAM** ([Add flash device](#) on page 364) group contains fields to specify settings for the Target RAM.

- **Address** textbox: Use it to specify the address from the target memory. The **Address** textbox should contain the first address from target memory used by the flash algorithm running on a target board.
- **Size** textbox: Use it to specify the size of the target memory. The flash programmer does not modify any memory location other than the target memory buffer and the flash memory.
- **Verify Target Memory Writes** checkbox: Select this checkbox to verify all write operations to the hardware RAM during flash programming.

11.1.2.3 Add flash programmer actions

This section lists the various **Flash Programmer** actions available in the Flash Programmer Task editor window.

In the **Flash Programmer Actions** group in the Flash Programmer Task editor window ([Create a flash programmer target task](#) on page 361), you can add following actions on the flash device.

- [Erase/Blank check actions](#) on page 365
- [Program/Verify actions](#) on page 366
- [Checksum actions](#) on page 367

- [Diagnostics actions](#) on page 367
- [Dump Flash actions](#) on page 368
- [Protect/Unprotect actions](#) on page 368
- [Secure/Unsecure actions](#) on page 369

The **Flash Programmer Actions** group contains the following UI controls to work with flash programmer actions:

- **Add Action** pop-up menu
 - **Erase/Blank Check Action:** Allows you to add erase or blank check actions for a flash device.
 - **Program/Verify Action:** Allows you to add program or verify flash actions for a flash device.
 - **Checksum Action:** Allows you to add checksum actions for a flash device.
 - **Diagnostics Action:** Lets you add a diagnostics action.
 - **Dump Flash Action:** Lets you add a dump flash action.
 - **Protect/Unprotect Action:** Lets you add protect or unprotect action.
 - **Secure/Unsecure Action:** Lets you add secure or unsecure action.
- **Duplicate Action** button: Allows you to duplicate a flash program action in the **Flash Programmer Actions** table.
- **Remove Action** button: Allows you to remove a flash program action from the **Flash Programmer Actions** table.
- **Move Up** button: Allows you to move up the selected flash action in the **Flash Programmer Actions** table.
- **Move Down** button: Allows you to move down the selected flash action in the **Flash Programmer Actions** table.

NOTE

Actions can also be enabled or disabled using the **Enabled** column. The **Description** column contains the default description for the flash programmer actions. You can also edit the default description.

This section includes:

- [Erase/Blank check actions](#) on page 365
- [Program/Verify actions](#) on page 366
- [Checksum actions](#) on page 367
- [Diagnostics actions](#) on page 367
- [Dump Flash actions](#) on page 368
- [Protect/Unprotect actions](#) on page 368
- [Secure/Unsecure actions](#) on page 369
- [Duplicate action](#) on page 369
- [Remove action](#) on page 369

11.1.2.3.1 Erase/Blank check actions

The Erase action erases sectors from the flash device.

You can also use the erase action to erase the entire flash memory without selecting sectors. The blank check action verifies if the specified areas have been erased from the flash device.

NOTE

Flash Programmer will not erase a bad sector in the NAND flash. After the erase action a list of bad sectors is reported (if any).

To add an erase/blank check action:

1. Choose **Erase/Blank Check Action** from the **Add Action** pop-up menu.

The **Add Erase/Blank Check Action** dialog appears.

2. Select a sector from the **Sectors** table and click the **Add Erase Action** button to add an erase operation on the selected sector.

NOTE

Press the Control or the Shift key for selecting multiple sectors from the **Sectors** table.

3. Click the **Add Blank Check** button to add a blank check operation on the selected sector.
4. Select the **Erase All Sectors Using Chip Erase Command** checkbox to erase the entire flash memory.

NOTE

After selecting the **Erase All Sectors Using Chip Erase Command** checkbox, you need to add either erase or blank check action to erase all sectors.

5. Click **Done**.

The **Add Erase/Blank Check Action** dialog closes and the added erase/blank check actions appear in the **Flash Programmer Actions** table in the **Flash Programmer Task** editor window.

11.1.2.3.2 Program/Verify actions

The Program action allows you to program the flash device and the verify action verifies the programmed flash device.

NOTE

The program action will abort and fail if it is performed in a bad block for NAND flashes.

To add a program/verify action:

1. Choose **Program/Verify Action** from the **Add Action** pop-up menu.

The **Add Program/Verify Action** dialog appears.

2. Select the file to be written to the flash device.
3. Select the **Use File from Launch Configuration** checkbox to use the file from the launch (run) configuration associated with the task.
4. Specify the file name in the **File** textbox. You can use **Workspace**, **File System**, or **Variables** buttons to select the desired file.
5. Choose a file type from the **File Type** pop-up menu. You can select any one of the following file types:
 - Auto - Detects the file type automatically.
 - Elf - Specifies executable in ELF format.
 - Srec - Specifies files in Motorola S-record format.
 - Binary - Specifies binary files.
6. Select the **Erase sectors before program** checkbox to erase sectors before program.
7. [Optional] Select the **Verify after program** checkbox to verify after the program.

NOTE

The **Verify after program** checkbox is available only with the processors supporting it.

8. Select the **Restricted To Address in this Range** checkbox to specify a memory range. The write action is permitted only in the specified address range. In the **Start** textbox, specify the start address of the memory range sector and in the **End** textbox, specify the end address of the memory range.
9. Select the **Apply Address Offset** checkbox and set the memory address in the **Address** textbox. Value is added to the start address of the file to be programmed or verified.
10. Click the **Add Program Action** button to add a program action on the flash device.
11. Click the **Add Verify Action** button to add a verify action on the flash device.
12. Click **Done**.

The **Add Program/Verify Action** dialog closes and the added program/verify actions appear in the **Flash Programmer Actions** table in the **Flash Programmer Task** editor window.

11.1.2.3.3 Checksum actions

The checksum can be computed over host file, target file, memory range or entire flash memory.

To add a checksum action:

1. Choose **Checksum Action** from the **Add Action** pop-up menu.
The **Add Checksum Action** dialog appears.
2. Select the file for checksum action.
3. Select the **Use File from Launch Configuration** checkbox to use the file from the launch (run) configuration associated with the task.
4. Specify the filename in the **File** textbox. You can use the **Workspace**, **File System**, or **Variables** buttons to select the desired file.
5. Choose the file type from the **File Type** pop-up menu.
6. Select an option from the **Compute Checksum Over** options. The checksum can be computed over the host file, the target file, the memory range, or the entire flash memory.
7. Specify the memory range in the **Restricted To Addresses in this Range** group. The checksum action is permitted only in the specified address range. In the **Start** textbox, specify the start address of the memory range sector and in the **End** textbox, specify the end address of the memory range.
8. Select the **Apply Address Offset** checkbox and set the memory address in the **Address** textbox. Value is added to the start address of the file to be programmed or verified.
9. Click the **Add Checksum Action** button.
10. Click **Done**.

The **Add Checksum Action** dialog closes and the added checksum actions appear in the **Flash Programmer Actions** table in the **Flash Programmer Task** editor window.

11.1.2.3.4 Diagnostics actions

The diagnostics action generates the diagnostic information for a selected flash device.

NOTE

Flash Programmer will report bad blocks, if they are present in the NAND flash.

To add a diagnostics action:

1. Choose **Diagnostics** from the **Add Action** pop-up menu.
The **Add Diagnostics Action** dialog appears.
2. Select a device to perform the diagnostics action.
3. Click the **Add Diagnostics Action** button to add diagnostic action on the selected flash device.

NOTE

Select the **Perform Full Diagnostics** checkbox to perform full diagnostics on a flash device.

4. Click **Done**.

The **Add Diagnostics Action** dialog closes and the added diagnostics action appears in the **Flash Programmer Actions** table in the **Flash Programmer Task** editor window.

11.1.2.3.5 Dump Flash actions

The dump flash action allows you to dump selected sectors of a flash device or the entire flash device.

To add a dump flash action:

1. Choose **Dump Flash Action** from the **Add Action** pop-up menu.
The **Add Dump Flash Action** dialog appears.
2. Specify the file name in the **File** textbox. The flash is dumped in this selected file.
3. Choose the file type from the **File Type** pop-up menu. You can choose any one of the following file types:
 - Srec: Saves files in Motorola S-record format.
 - Binary: Saves files in binary file format.
4. Specify the memory range for which you want to add dump flash action.
 - Enter the start address of the range in the **Start** textbox.
 - Enter the end address of the range in the **End** textbox.
5. Click the **Add Dump Flash Action** button to add a dump flash action.
6. Click **Done**.

The **Add Dump Flash Action** dialog closes and the added dump flash action appear in the **Flash Programmer Actions** table in the **Flash Programmer Task** editor window.

11.1.2.3.6 Protect/Unprotect actions

The protect/unprotect actions allow you to change the protection of a sector in the flash device.

To add a protect/unprotect action:

1. Choose the **Protect/Unprotect Action** from the **Add Action** pop-up menu.
The **Add Protect/Unprotect Action** dialog appears.
2. Select a sector from the **Sectors** table and click the **Add Protect Action** button to add a protect operation on the selected sector.

NOTE

Press the Control or Shift key for selecting multiple sectors from the **Sectors** table.

3. Click the **Add Unprotect Action** button to add an unprotect action on the selected sector.
4. Select the **All Device** checkbox to add action on full device.

5. Click **Done**.

The **Add Protect/Unprotect Action** dialog closes and the added protect or unprotect actions appear in the **Flash Programmer Actions** table in the **Flash Programmer Task** editor window.

11.1.2.3.7 Secure/Unsecure actions

The secure/unsecure actions help you change the security of a flash device.

NOTE

The Secure/Unsecure flash actions are not supported for StarCore devices.

To add a secure/unsecure action:

1. Choose the **Secure/Unsecure Action** from the **Add Action** pop-up menu.
The **Add Secure/UnSecure Action** dialog appears.
2. Select a device from the **Flash Devices** table.
3. Click the **Add Secure Action** button to add Secure action on the selected flash device.
 - a. Enter password in the **Password** textbox.
 - b. Choose the password format from the **Format** pop-up menu.
4. Click the **Add Unsecure Action** button to add an unprotect action on the selected sector.
5. Click **Done**.

The **Add Secure/UnSecure Action** dialog closes and the added secure or unsecure action appears in the **Flash Programmer Actions** table in the **Flash Programmer Task** editor window.

11.1.2.3.8 Duplicate action

You can duplicate a flash programmer action from the **Flash Programmer Actions** table.

1. Select the action in the **Flash Programmer Actions** table.
2. Click the **Duplicate Action** button.

The selected action is copied in the **Flash Programmer Action** table.

11.1.2.3.9 Remove action

You can remove a flash programmer action from the **Flash Programmer Actions** table.

1. Select the action in the **Flash Programmer Actions** table.
2. Click the **Remove Action** button.

The selected action is removed from the **Flash Programmer Action** table.

11.1.3 Execute flash programmer target task

You can execute the flash programmer tasks using the **Target Tasks** view.

To execute the configured flash programmer target task, select a target task and click the **Execute** button in the **Target Tasks** view toolbar. Alternatively, right-click on a target task and choose **Execute** from the shortcut menu.

Figure 136: Execute target task

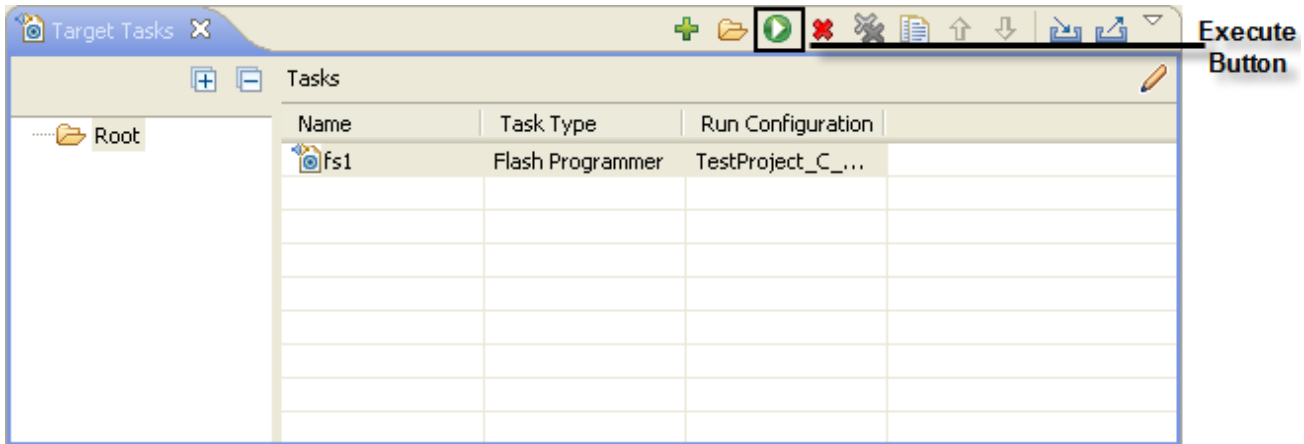

NOTE

You can use predefined target tasks for supported boards. To load a predefined target task, right-click in the **Target Tasks** view and choose **Import Target Task** from the shortcut menu. To save your custom tasks, right-click in the **Target Tasks** view and then choose **Export Target Task** from the shortcut menu.

You can check the results of flash batch actions in the **Console** view. The green color indicates the success and the red color indicates the failure of the task.

Figure 137: Console view

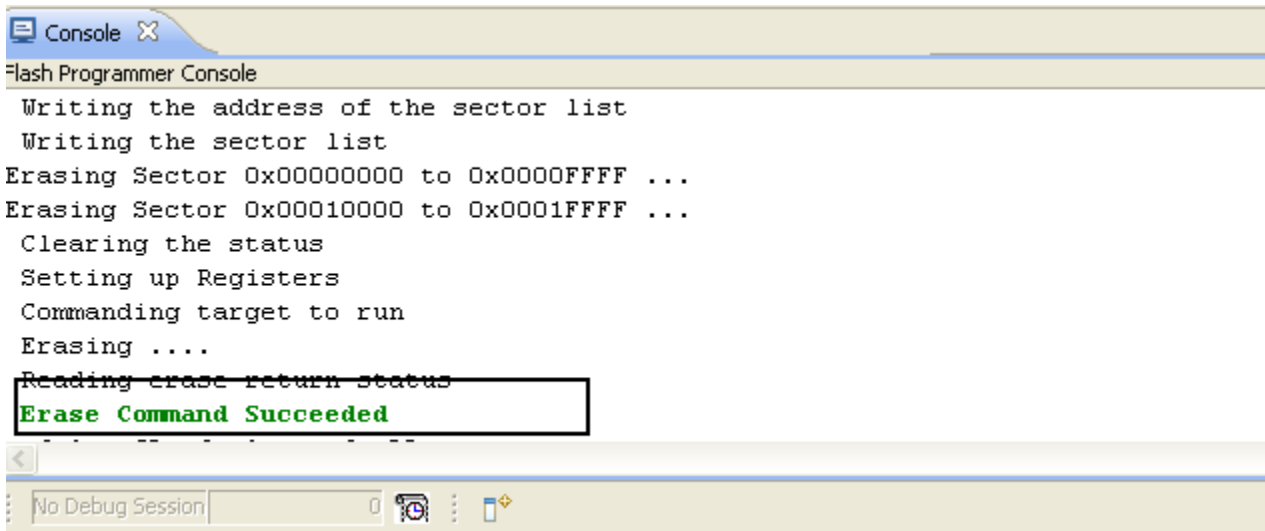

11.2 Flash File to Target

You can use the **Flash File to Target** feature to perform flash operations such as erasing a flash device or programming a file.

You do not need any project for using **Flash File to Target** feature, only a valid **Remote System** is required.

To open the **Flash File to Target** dialog, click the **Flash Programmer** button on the IDE toolbar.

- **Connection** pop-up menu- Lists all run configurations defined in Eclipse. If a connection to the target has already been made the control becomes inactive and contains the text Active Debug Configuration.
- **Flash Configuration File** pop-up menu - Lists predefined target tasks for the processor selected in the Launch Configuration and tasks added by user with the **Browse** button. The items in this pop-up menu are updated based on the processor selected in the launch configuration. For more information on launch configurations, see product's *Targeting Manual*.
 - **Unprotect flash memory before erase** checkbox - Select to unprotect flash memory before erasing the flash device. This feature allows you to unprotect the flash memory from **Flash File To Target** dialog.
- **File to Flash** group - Allows selecting the file to be programmed on the flash device and the location.
 - **File** textbox - Used for specifying the filename. You can use the **Workspace**, **File System**, or **Variables** buttons to select the desired file.
 - **Offset:0x** textbox - Used for specifying offset location for a file. If no offset is specified the default value of zero is used. The offset is always added to the start address of the file. If the file does not contain address information then zero is considered as start address.
- **Save as Target Task** - Select to enable **Task Name** textbox.
 - **Task Name** textbox - Lets you to save the specified settings as a Flash target task. Use the testbox to specify the name of the target task.
- **Erase Whole Device** button - Erases the flash device. In case you have multiple flash blocks on the device, all blocks are erased. If you want to selectively erase or program blocks, use the [Flash programmer](#) on page 361 feature.
- **Erase and Program** button - Erases the sectors that are occupied with data and then programs the file. If the flash device can not be accessed at sector level then the flash device is completely erased.

This feature helps you perform these basic flash operations:

- [Erasing flash device](#) on page 371
- [Programming a file](#) on page 372

11.2.1 Erasing flash device

This topic explains how to erase a flash device.

To erase a flash device, follow these steps:

1. Click the **Flash Programmer** button on the IDE toolbar.

The **Flash File to Target** dialog appears.

2. Choose a connection from the **Connection** pop-up menu.

NOTE

If a connection is already established with the target, this control is disabled.

The **Flash Configuration File** pop-up menu is updated with the supported configurations for the processor from the launch configuration.

3. Choose a flash configuration from the **Flash Configuration File** pop-up menu.
4. Select the **Unprotect flash memory before erase** checkbox to unprotect flash memory before erasing the flash device.
5. Click the **Erase Whole Device** button.

11.2.2 Programming a file

This topic explains how to program a file using Falsh programmer.

1. Click the **Flash Programmer** button on the IDE toolbar.

The **Flash File to Target** dialog appears.

2. Choose a connection from the **Connection** pop-up menu.

NOTE

If a connection is already established with the target, this control is disabled.

The **Flash Configuration File** pop-up menu is updated with the supported configurations for the processor from the launch configuration.

3. Choose a flash configuration from the **Flash Configuration File** pop-up menu.
4. Select the **Unprotect flash memory before erase** checkbox to unprotect flash memory before erasing the flash device.
5. Type the file name in the **File** textbox. You can use the **Workspace**, **File System**, or **Variables** buttons to select the desired file.
6. Type the offset location in the **Offset** textbox.
7. Click the **Erase and Program** button.

11.3 Hardware diagnostics

The **Hardware Diagnostics** utility lets you run a series of diagnostic tests that determine if the basic hardware is functional.

These tests include:

- **Memory read/write:** This test only makes a read or write access to the memory to read or write a byte, word (2 bytes) and long word (4 bytes) to or from the memory. For this task, the user needs to set the options in the **Memory Access** group.
- **Scope loop:** This test makes read and write accesses to memory in a loop at the target address. The time between accesses is given by the loop speed settings. The loop can only be stopped by the user, which cancels the test. For this type of test, the user needs to set the memory access settings and the loop speed.
- **Memory tests:** This test requires the user to set the access size and target address from the access settings group and the settings present in the **Memory Tests** group.

This topic contains the following sub-topics:

- [Creating hardware diagnostics task](#) on page 372
- [Working with Hardware Diagnostic Action editor](#) on page 373
- [Memory test use cases](#) on page 379

11.3.1 Creating hardware diagnostics task

You can create a hardware diagnostic task using the **Create New Target Task** wizard.

To create a task for hardware diagnostics:

1. Choose **Window > Show View > Other** from the IDE menu bar.

The **Show View** dialog appears.

2. Expand the **Debug** group and select **Target Tasks**.
3. Click **OK**.
4. Click the **Create a new Target Task** button on the **Target Tasks** view toolbar. Alternatively, right-click in the **Target Tasks** view and choose **New Task** from the shortcut menu.

The **Create a New Target Task** wizard appears.

5. Type name for the new task in the **Task Name** textbox.
6. Choose a launch configuration from the **Run Configuration** pop-up menu.

NOTE

If the task does not successfully launch the configuration that you specify, the **Execute** button on the **Target Tasks** view toolbar stays unavailable.

7. Choose **Hardware Diagnostic** from the **Task Type** pop-up menu.
8. Click **Finish**.

A new hardware diagnostic task is created in the **Target Tasks** view.

NOTE

You can perform various actions on a hardware diagnostic task, such as renaming, deleting, or executing the task, using the shortcut menu that appears on right-clicking the task in the **Target tasks** view.

11.3.2 Working with Hardware Diagnostic Action editor

The **Hardware Diagnostic Action** editor is used to configure a hardware diagnostic task.

To open the **Hardware Diagnostic Action** editor for a particular task, double-click the task in the **Target Tasks** view.

The following figure shows the **Hardware Diagnostics Action** editor.

Figure 138: Hardware Diagnostics Action editor

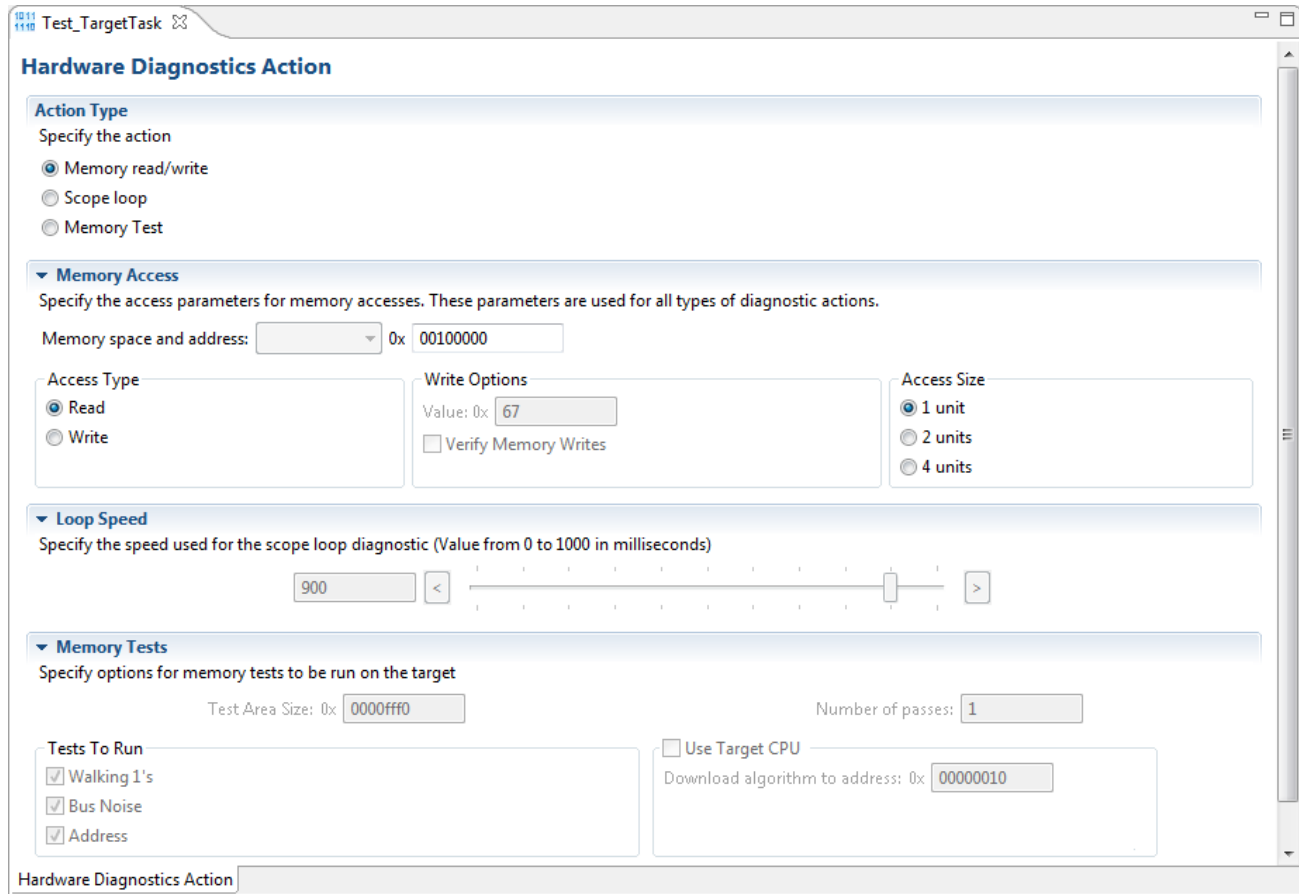

The **Hardware Diagnostics Action** editor window includes the following groups:

- [Action Type](#) on page 374
- [Memory Access](#) on page 374
- [Loop Speed](#) on page 375
- [Memory Tests](#) on page 376

11.3.2.1 Action Type

The **Action Type** group in the **Hardware Diagnostics Action** editor window is used for selecting the action type.

You can choose any one of the following actions:

- Memory read/write - Enables the options in the **Memory Access** group.
- Scope loop - Enables the options in the **Memory Access** and the **Loop Speed** groups.
- Memory test - Enables the access size and target address from the access settings group and the settings present in the **Memory Tests** group.

11.3.2.2 Memory Access

The **Memory Access** pane configures diagnostic tests for performing memory reads and writes over the remote connection interface.

The table below lists and describes the items in the pane.

Table 138: Memory Access Pane Items

Item	Description
Read	Select to have the hardware diagnostic tools perform read tests.
Write	Select to have the hardware diagnostic tools perform write tests.
1 unit	Select to have the hardware diagnostic tools perform one memory unit access size operations.
2 units	Select to have the hardware diagnostic tools perform two memory units access size operations.
4 units	Select to have the hardware diagnostic tools perform four memory units access size operations.
Target Address	Specify the address of an area in RAM that the hardware diagnostic tools should analyze. The tools must be able to access this starting address through the remote connection (after the hardware initializes).
Value	Specify the value that the hardware diagnostic tools write during testing. Select the Write option to enable this textbox.
Verify Memory Writes	Select the checkbox to verify success of each data write to the memory.

11.3.2.3 Loop Speed

The **Loop Speed** pane configures diagnostic tests for performing repeated memory reads and writes over the remote connection interface.

The tests repeat until you stop them. By performing repeated read and write operations, you can use a scope analyzer or logic analyzer to debug the hardware device. After the first 1000 operations, the **Status** shows the estimated time between operations.

NOTE

For all values of **Speed**, the time between operations depends heavily on the processing speed of the host computer.

For **Read** operations, the Scope Loop test has an additional feature. During the first read operation, the hardware diagnostic tools store the value read from the hardware. For all successive read operations, the hardware diagnostic tools compare the read value to the stored value from the first read operation. If the Scope Loop test determines that the value read from the hardware is not stable, the diagnostic tools report the number of times that the read value differs from the first read value. Following table lists and describes the items in Loop Speed pane.

Table 139: Loop Speed Pane Items

Item	Description
Set Loop Speed	Enter a numeric value between 0 to 1000 in the textbox to adjust the speed. You can also move the slider to adjust the speed at which the hardware diagnostic tools repeat successive read and write operations. Lower speeds increase the delay between successive operations. Higher speeds decrease the delay between successive operations.

11.3.2.4 Memory Tests

The **Memory Tests** pane lets you perform three hardware tests, Walking Ones, Bus Noise, and Address.

You can specify any combination of tests and number of passes to perform. For each pass, the hardware diagnostic tools performs the tests in turn, until all passes are complete. The tools compare memory test failures and display them in a log window after all passes are complete. Errors resulting from memory test failures do not stop the testing process; however, fatal errors immediately stop the testing process.

The following table explains the items in the **Memory Tests** pane.

Table 140: Memory Tests pane items

Item	Explanation
Walking 1's	Select the checkbox to have the hardware diagnostic tools perform the Walking Ones on page 377 test. Deselect to have the diagnostic tools skip the Walking Ones on page 377 test.
Address	Select to have the hardware diagnostic tools perform the Address on page 377 test. Deselect to have the diagnostic tools skip the Address on page 377 test.
Bus Noise	Select to have the hardware diagnostic tools perform the Bus noise on page 378 test. Deselect to have the diagnostic tools skip the Bus noise on page 378 test.
Test Area Size	Specify the size of memory to be tested. This setting along with Target Address defines the memory range being tested.
Number of Passes	Enter the number of times that you want to repeat the specified tests.
Use Target CPU	Select to have the hardware diagnostic tools download the test code to the hardware device. Deselect to have the hardware diagnostic tools execute the test code through the remote connection interface. Execution performance improves greatly if you execute the test code on the hardware CPU, but requires that the hardware has enough stability and robustness to execute the test code. NOTE The option is not applicable for CodeWarrior StarCore devices.
Download Algorithm to Address	Specify the address where the test driver is downloaded in case the Use target CPU is selected. NOTE The option is not applicable for CodeWarrior StarCore devices.

This section includes:

- [Walking Ones](#) on page 377
- [Address](#) on page 377
- [Bus noise](#) on page 378
- [Address lines](#) on page 378
- [Data lines](#) on page 378

11.3.2.4.1 Walking Ones

This section provides details on the Walking Ones test.

This test detects these memory faults:

- **Address Line:** The board or chip address lines are shorting or stuck at 0 or 1. Either condition could result in errors when the hardware reads and writes to the memory location. Because this error occurs on an address line, the data may end up in the wrong location on a write operation, or the hardware may access the wrong data on a read operation.
- **Data Line:** The board or chip data lines are shorting or stuck at 0 or 1. Either condition could result in corrupted values as the hardware transfers data to or from memory.
- **Retention:** The contents of a memory location change over time. The effect is that the memory fails to retain its contents over time.

The Walking Ones test includes four sub-tests:

- **Walking Ones:** This subtest first initializes memory to all zeros. Then the subtest writes, reads, and verifies bits, with each bit successively set from the least significant bit (LSB) to the most significant bit (MSB). The subtest configures bits such that by the time it sets the MSB, all bits are set to a value of 1. This pattern repeats for each location within the memory range that you specify. For example, the values for a byte-based Walking Ones subtest occur in this order:

```
0x01, 0x03, 0x07, 0x0F, 0x1F, 0x3F, 0x7F, 0xFF
```

- **Ones Retention:** This subtest immediately follows the Walking Ones subtest. The Walking Ones subtest should leave each memory location with all bits set to 1. The Ones Retention subtest verifies that each location has all bits set to 1.
- **Walking Zeros:** This subtest first initializes memory to all ones. Then the subtest writes, reads, and verifies bits, with each bit successively set from the LSB to the MSB. The subtest configures bits such that by the time it sets the MSB, all bits are set to a value of 0. This pattern repeats for each location within the memory range that you specify. For example, the values for a byte-based Walking Zeros subtest occur in this order:

```
0xFE, 0xFC, 0xF8, 0xF0, 0xE0, 0xC0, 0x80, 0x00
```

- **Zeros Retention:** This subtest immediately follows the Walking Zeros subtest. The Walking Zeros subtest should leave each memory location with all bits set to 0. The Zeros Retention subtest verifies that each location has all bits set to 0.

11.3.2.4.2 Address

This section provides details on the Address test. This test detects memory aliasing.

Memory aliasing exists when a physical memory block repeats one or more times in a logical memory space. Without knowing about this condition, you might conclude that there is much more physical memory than what actually exists.

The address test uses a simplistic technique to detect memory aliasing. The test writes sequentially increasing data values (starting at one and increasing by one) to each successive memory location. The maximum data value is a prime number and its specific value depends on the addressing mode so as to not overflow the memory location.

The test uses a prime number of elements to avoid coinciding with binary math boundaries:

- For byte mode, the maximum prime number is 28-5 or 251.
- For word mode, the maximum prime number is 216-15 or 65521.

- For long word mode, the maximum prime number is 232-5 or 4294967291.

If the test reaches the maximum value, the value rolls over to 1 and starts incrementing again. This sequential pattern repeats throughout the memory under test. Then the test reads back the resulting memory and verifies it against the written patterns. Any deviation from the written order could indicate a memory aliasing condition.

11.3.2.4.3 Bus noise

This test stresses on the memory system by causing many bits to flip from one memory access to the next (both addresses and data values).

Bus noise occurs when many bits change consecutively from one memory access to another. This condition can occur on both address and data lines.

11.3.2.4.4 Address lines

This section provides details on the Address lines test.

To force bit flips in address lines, the test uses three approaches:

- Sequential- This approach works sequentially through all of the memory under test, from lowest address to highest address. This sequential approach results in an average number of bit flips from one access to the next.
- Full Range Converging- This approach works from the fringes of the memory range toward the middle of the memory range. Memory access proceeds in this pattern, where + *number* and - *number* indicate the next item location (the specific increment or decrement depends on byte, word, or long word address mode):
 - the lowest address
 - the highest address
 - (the lowest address) + 1
 - (the highest address) - 1
 - (the lowest address) + 2
 - (the highest address) - 2
- Maximum Invert Convergence- This approach uses calculated end point addresses to maximize the number of bits flipping from one access to the next. This approach involves identifying address end points such that the values have the maximum inverted bits relative to one another. Specifically, the test identifies the lowest address with all 0x5 values in the least significant nibbles and the highest address with all 0xA values in the least significant nibbles. After the test identifies these end points, memory access alternates between low address and high address, working towards the center of the memory under test. Accessing memory in this manner, the test achieves the maximum number of bits flips from one access to the next.

11.3.2.4.5 Data lines

This section provides details on the Data Lines test.

To force bit flips in data lines, the test uses two sets of static data, a pseudo-random set and a fixed-pattern set. Each set contains 31 elements—a prime number. The test uses a prime number of elements to avoid coinciding with binary math boundaries. The sets are unique to each addressing mode so as to occupy the full range of bits.

- The test uses the pseudo-random data set to stress the data lines in a repeatable but pattern-less fashion.
- The test uses the fixed-pattern set to force significant numbers of data bits to flip from one access to the next.

The sub-tests execute similarly in that each subtest iterates through static data, writing values to memory. The test combines the three address line approaches with the two data sets to produce six unique sub-tests:

- Sequential with Random Data
- Sequential with Fixed Pattern Data
- Full Range Converging with Random Data
- Full Range Converging with Fixed Pattern Data
- Maximum Invert Convergence with Random Data
- Maximum Invert Convergence with Fixed Pattern Data

11.3.3 Memory test use cases

Memory tests are the complex tests that can be executed in two modes: Host based and Target based depending upon the selection made for the **Use Target CPU** checkbox.

The memory read /write and scope loop tests are host based tests. The host machine issues read and write action to the memory through the connection protocol. For example **CCS**.

- **Selected:** Target Based
- **Deselected:** Host Based

The **Host Based** tests are slower than the **Target Based** tests.

This section explains the following use case scenerios:

- [Use Case 1: Execute host-based Scope Loop on target](#) on page 379
- [Use Case 2: Execute target-based Memory Tests on target](#) on page 379

11.3.3.1 Use Case 1: Execute host-based Scope Loop on target

This use case scenerio explains the steps required to execute the host based scope loop on the target.

Perform the following steps:

1. Select **Scope loop** in the **Action Type**.
2. Set **Memory Access** settings from the **Memory Access** section.
3. Set the speed used for the scope loop diagnostic from the **Loop Speed** section.
4. Save the settings.
5. Press **Execute** to execute the action.

11.3.3.2 Use Case 2: Execute target-based Memory Tests on target

This use case scenerio explains the steps required to execute the target based memory test on the target.

Perform the following steps:

1. Select **Memory Test** in the **Action Type**.
2. Specify **Target Address** and **Access Size** settings from the **Memory Access** section.
3. Specify the following settings for **Memory Tests** section:
 - **Test Area Size:** The tested memory region is computed from **Target Address** until **Target Address + Test Area Size**.
 - **Tests to Run:** Select tests to run on the target.
 - **Number of passes:** Specify number of times a test will be executed.
 - **Use Target CPU:** set the Address to which the test driver (algorithm) is to be downloaded.
4. Save the settings.

5. Press **Execute** to execute the action.

11.4 Import/Export/Fill memory

The **Import/Export/Fill Memory** utility lets you export memory contents to a file and import data from a file into memory.

The utility also supports filling memory with a user provided data pattern.

This section explain the following topics:

- [Creating task for import/export/fill memory](#) on page 380
- [Importing data into memory](#) on page 382
- [Exporting memory to file](#) on page 384
- [Fill memory](#) on page 386

11.4.1 Creating task for import/export/fill memory

You can use the **Import/Export/Fill Memory** utility to perform various tasks on memory.

The utility can be accessed from the **Target Tasks** view.

To open the **Target Tasks** view:

1. Choose **Window > Show View > Other** from the **IDE** menu bar.

The **Show View** dialog appears.

2. Expand the **Debug** group.
3. Select **Target Tasks**.
4. Click **OK**.

The first time it opens, the **Target Tasks** view contains no tasks. You must create a task to use the **Import/Export/Fill Memory** utility.

To create a task:

1. Click the **Create a new Target Task** button on the toolbar of the **Target Tasks** view. Alternatively, right-click the left-hand list of tasks and choose **New Task** from the shortcut menu that appears.

The **Create a New Target Task** page appears.

Figure 139: Create New Target Task Window

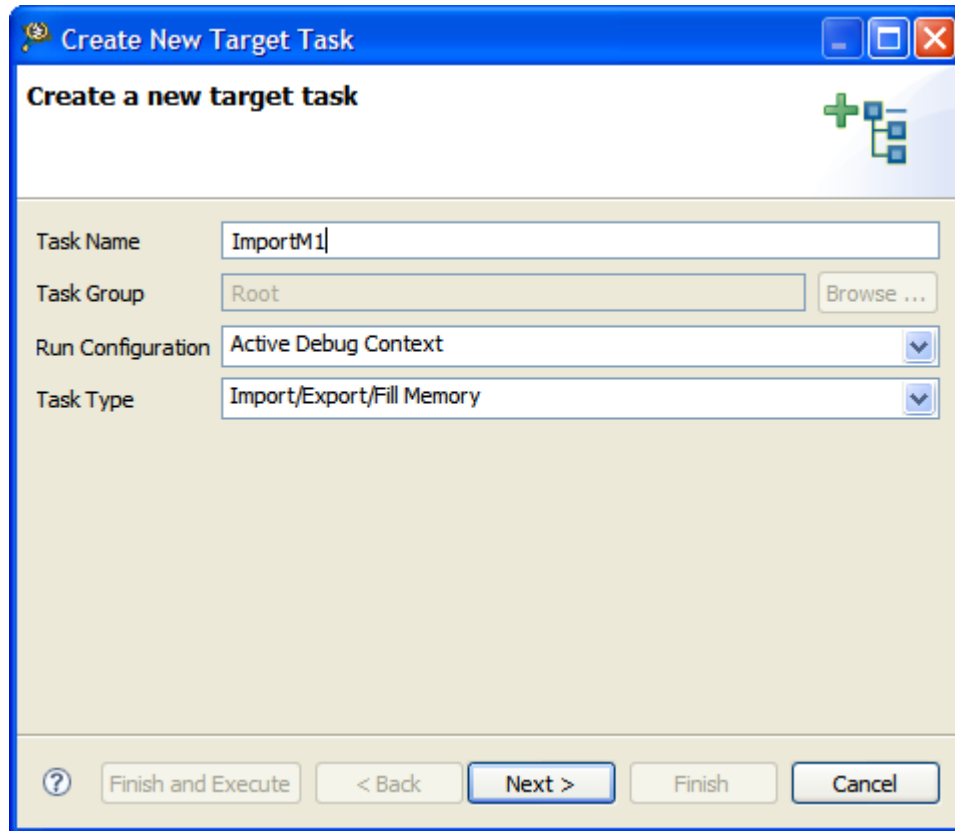

2. In the **Task Name** textbox, enter a name for the new task.
3. Use the **Run Configuration** pop-up menu to specify the configuration that the task launches and uses to connect to the target.

NOTE

If the task does not successfully launch the configuration that you specify, the **Execute** button of the **Target Tasks** view toolbar stays unavailable.

4. Use the **Task Type** pop-up menu to specify **Import/Export/Fill Memory**.
5. Click **Finish**.

The **Import/Export/Fill Memory** target task is created and it appears in the **Import/Export/Fill Memory Action** editor.

Figure 140: Import/Export Memory Action editor

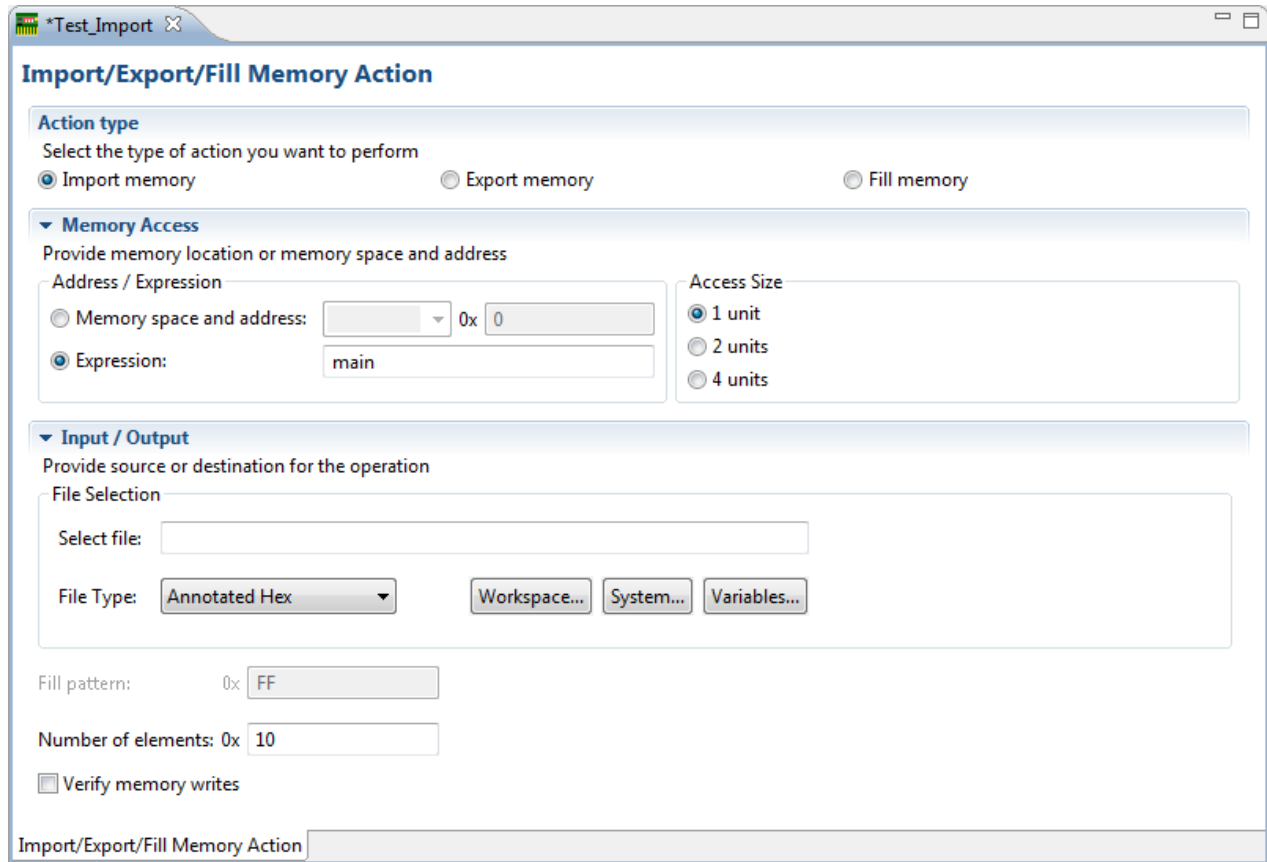

11.4.2 Importing data into memory

You can import the encoded data from a user specified file, decode it, and copy it into a user specified memory range.

Select the **Import memory** option from the **Import/Export/Fill Memory Action** editor to import data into memory.

Figure 141: Import/Export Memory Action editor - Importing data into memory

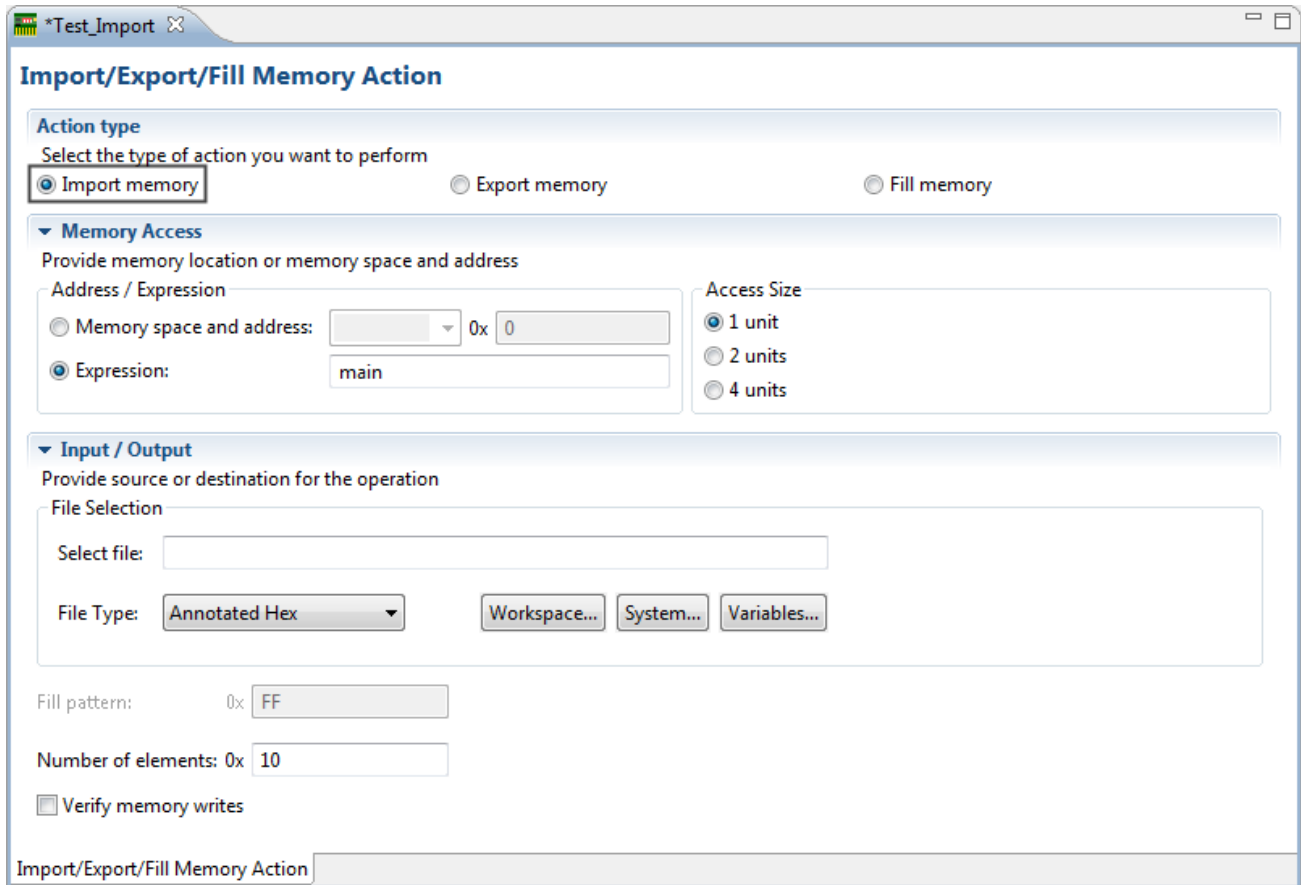

The following table explains the import memory options.

Table 141: Controls used for importing data into memory

Item	Explanation
Memory space and address	Enter the literal address and memory space on which the data transfer is performed. The Literal address field allows only decimal and hexadecimal values.
Expression	Enter the memory address or expression at which the data transfer starts.
Access Size	Denotes the number of addressable units of memory that the debugger accesses in transferring one data element. The default values shown are 1, 2, and 4 units. When target information is available, this list shall be filtered to display the access sizes that are supported by the target.
Select file	Enter the path to the file that contains the data to be imported. Click the Workspace button to select a file from the current project workspace. Click the System button to select a file from the file system the standard File Open dialog. Click the Variables button to select a build variable.

Table continues on the next page...

Table 141: Controls used for importing data into memory (continued)

Item	Explanation
File Type	Defines the format in which the imported data is encoded. By default, the following file types are supported: <ul style="list-style-type: none">• Signed decimal Text• Unsigned decimal Text• Motorola S-Record format• Hex Text• Annotated Hex Text• Raw Binary
Number of Elements	Enter the total number of elements to be transferred.
Verify Memory Writes	Select the checkbox to verify success of each data write to the memory.

11.4.3 Exporting memory to file

You can read data from a user specified memory range, encode it in a user specified format, and store this encoded data in a user specified output file.

Select the **Export memory** option from the **Import/Export/Fill Memory Action** editor to export memory to a file.

Figure 142: Exporting memory

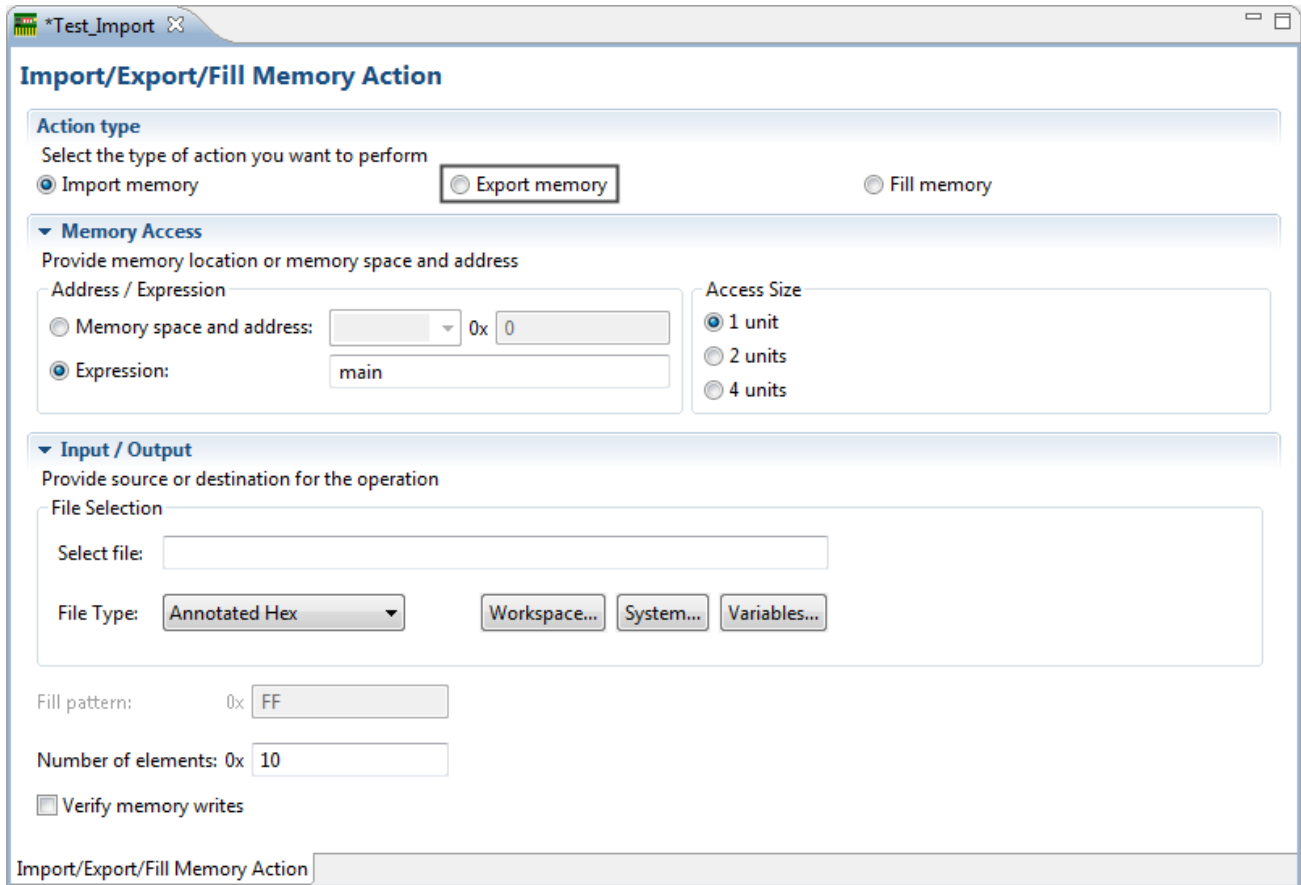

The following table explains the export memory options.

Table 142: Controls used for exporting data from memory into file

Item	Explanation
Memory space and address	Enter the literal address and memory space on which the data transfer is performed. The Literal address field allows only decimal and hexadecimal values.
Expression	Enter the memory address or expression at which the data transfer starts.
Access Size	Denotes the number of addressable units of memory that the debugger accesses in transferring one data element. The default values shown are 1, 2, and 4 units. When target information is available, this list shall be filtered to display the access sizes that are supported by the target.
Select file	Enter the path of the file to write data. Click the Workspace button to select a file from the current project workspace. Click the System button to select a file from the file system the standard File Open dialog. Click the Variables button to select a build variable.

Table continues on the next page...

Table 142: Controls used for exporting data from memory into file (continued)

Item	Explanation
File Type	Defines the format in which encoded data is exported. By default, the following file types are supported: <ul style="list-style-type: none"> • Signed decimal Text • Unsigned decimal Text • Motorola S-Record format • Hex Text • Annotated Hex Text • Raw Binary
Number of Elements	Enter the total number of elements to be transferred.

11.4.4 Fill memory

You can fill a user specified memory range with a user specified data pattern.

Select the **Fill memory** option from the **Import/Export/Fill Memory Action** editor window to fill memory.

Figure 143: Fill memory

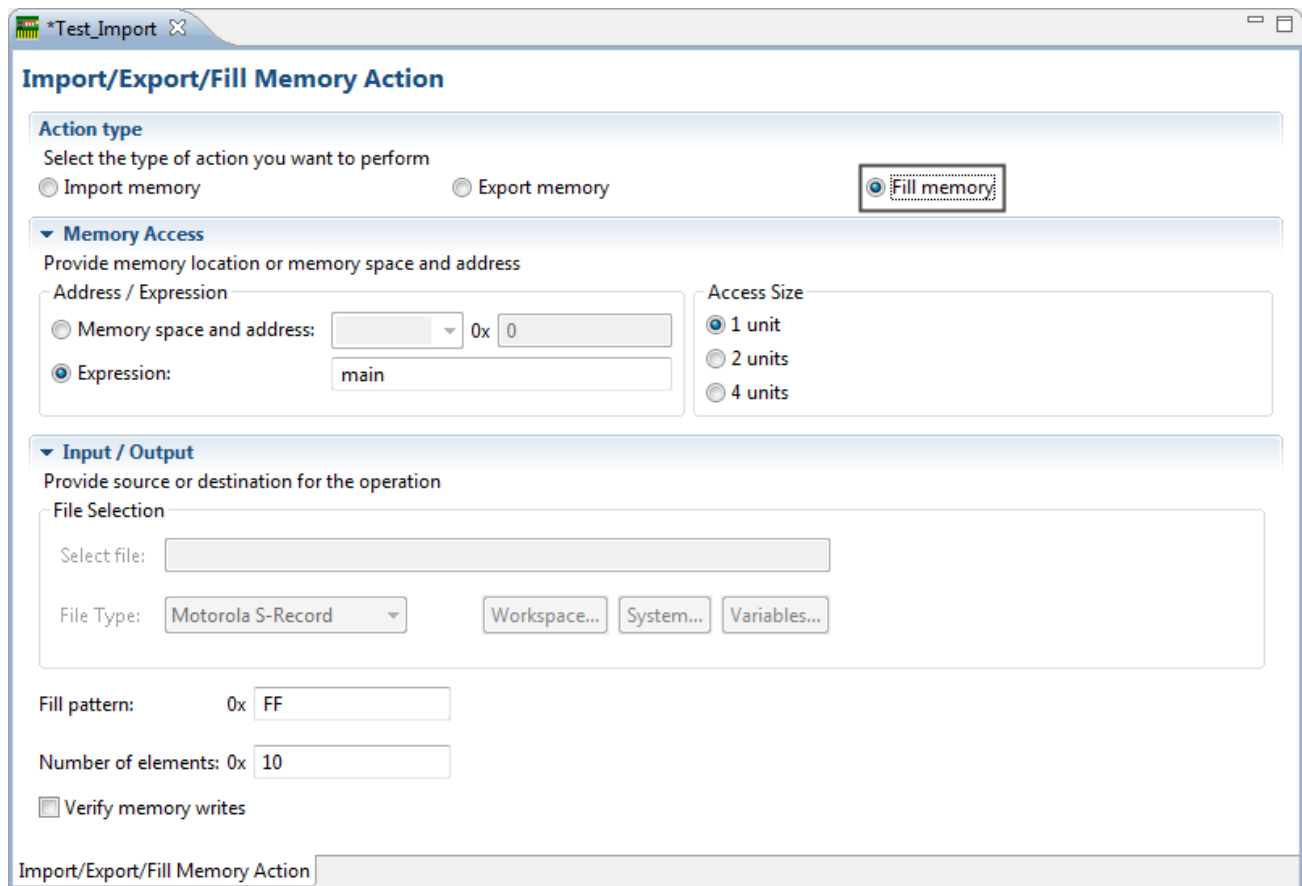

The following table explains the fill memory options.

Table 143: Controls used for filling memory with data pattern

Item	Explanation
Memory space and address	Enter the literal address and memory space on which the fill operation is performed. The Literal address field allows only decimal and hexadecimal values.
Expression	Enter the memory address or expression at which the fill operation starts.
Access Size	Denotes the number of addressable units of memory that the debugger accesses in modifying one data element. The default values shown are 1, 2, and 4 units. When target information is available, this list shall be filtered to display the access sizes that are supported by the target.
Fill Pattern	Denotes the sequence of bytes, ordered from low to high memory mirrored in the target. The field accept only hexadecimal values. If the width of the pattern exceeds the access size, an error message.
Number of Elements	Enter the total number of elements to be modified.
Verify Memory Writes	Select the checkbox to verify success of each data write to the memory.

Chapter 12

Making a Custom MSL C Library

This chapter describes porting a main standard libraries (MSL) C library to the GNU compiler collection (GCC) tool to support bareboard applications that execute on the Power Architecture - based boards.

NOTE

If you target P10*0 or P20*0 bareboard application using CodeWarrior toolchain, you use Embedded Warrior Library (EWL) instead of MSL. The CodeWarrior stationery wizard is already setup to automatically configure the correct library and toolchain depending on the target processor selected. For more information on EWL, see *EWL C Reference*.

Occasionally you must create bareboard applications that, while invoking the services of the MSL C Library, must execute on new Power Architecture-based boards. You can manage this by using the GCC tool to customize the MSL C library for the new board's hardware configuration.

The location of the customized library installation must differ from the existing MSL libraries to ensure that it does not affect the creation of new projects for the Linux operating system. Otherwise, every time you run the wizard to create a new bareboard application, the CodeWarrior IDE would automatically use the customized C library.

NOTE

The custom MSL C Library discussed in this chapter is already installed as a part of the CodeWarrior installation process and can be located under the `..\PA\PA_Support\MSL` directory.

This chapter explains:

- [Source library modifications](#) on page 389
- [Modifications to avoid errors from GCC LD tool](#) on page 391
- [Software floating point emulation support](#) on page 392
- [Building a custom MSL C library](#) on page 392

12.1 Source library modifications

This section describes the modifications done to the existing MSL C library sources to make them compatible with the GCC compiler.

The existing MSL C library sources, when built with GCC compiler, generate error messages due to language syntax and implementation differences. To overcome these errors, some modifications to the existing library sources are necessary. The modifications handled by the conditional directive `_GCCPORT_` are summarized below:

- CodeWarrior directives, such as `_option`, `_has_intrinsic`, `_has_feature`, and `_supports` are treated as macros to the equivalent GCC directives. Therefore, `_has_intrinsic`, `_has_feature` and `_supports` have been set to `false`. Equivalent GCC options are used to replace the various capabilities provided by the `_option` directive.
- The `declspec` keyword has been replaced with `_attribute_`.
- The `_MSL_INLINE_` declaration becomes `_inline` under CodeWarrior. To avoid multiple definition errors generated by the GCC linker, replace `_inline` with `_attribute_((weak))`.

- For function definitions under CodeWarrior, the function attribute `_MSL_CANT_THROW` follows the function name. For instance, `isalnum(int c) _MSL_CANT_THROW{.....}`. To avoid an error message under GCC, the function attribute must be moved before the function name. For instance, `_MSL_CANT_THROW isalnum(int c) {.....}`.
- GCC does not allow pointer arithmetic unless it results in a lvalue. Otherwise, the compiler issues an error. For example, `l1 = *((++((int*)(left)))`;
is an error in GCC. To overcome this error, split the pointer arithmetic by introducing temporary pointers of the appropriate type.
- In the `math_api.h` file, certain function definitions are located under a conditional statement, `#if _MSL_USE_INLINE`. If this condition is not set, the code for these functions is not generated. The result is a linker error for all the function definitions that fall under this conditional statement. To prevent the error, enable the declaration `_GCCPORT_`.
- GCC requires explicit declarations of global arrays. For instance, `static const mem_size fix_pool_sizes[] = {4, 12, 20, 36, 52, max_fix_pool_size}`;
is an invalid declaration under GCC, although `max_fix_pool_size` is a globally initialized variable. To prevent this error, replace the variable `max_fix_pool_size` with an exact value. So, the code becomes:

```
static const mem_size fix_pool_sizes[] = {4, 12, 20, 36, 52, 6};
```
- In CodeWarrior, the variables, `_heap_addr`, `_heap_end`, `_stack_addr`, and `_stack_end`, are initialized by preference panels. To work with GCC, you provide the definitions of these variables through a linker command file (LCF), `gccport.lcf`.
- The GCC definitions `va_list`, `va_start`, `va_end`, `va_arg`, and `va_copy` replace/override the CodeWarrior definitions.
- The `nofralloc` directive is not available in GCC. The functions requiring such a directive have been rewritten in the assembly.

This section contains the following subsection:

- [Files modified](#) on page 390

12.1.1 Files modified

This section describes the source library files modified to make a custom MSL C library.

A new file, `msl_c_directives_to_gcc.h`, has been added to the MSL C library sources. This file is used as a prefix to build all the libraries. This header file maps the features of CodeWarrior tools and maps them to the features of the GCC tools.

Following files from the MSL C Library are modified:

- `ansi_parms.h`
- `cctype.h`
- `cinttypes.h`
- `cmath.h`
- `cwctype.h`
- `math_api.h`
- `wstdio.h`
- `alloc.c`
- `math_api.c`

- `math_double.c`
- `math_float.c`
- `math_fma.c`
- `math_longdouble.c`
- `mem_funcs.c`
- `string.c`
- `fminmaxdim.c`
- `math_sun.c`
- `ansi_prefix.`
- `PPCEABI.bare.h`
- `stdarg.EPPC.h`
- `math_ppc.c`

12.2 Modifications to avoid errors from GCC LD tool

This section talks about modifications done to avoid getting errors from the GCC linker load (LD) tool.

The GCC LD tool throws errors for the `_rom_copy_info` and `_bss_init_info` symbols when used with the run-time libraries built with CodeWarrior. This is because the CodeWarrior linker stores the symbols internally and so they are not available for the GCC LD. To overcome this problem, a new LCF file, `gccport.lcf`, which contains the symbols required by the GCC LD, has been introduced, without changing the MSL C library sources. The modifications are summarized below:

- The call to `_rom_copy_info` from `_init_data` has been commented out.
- The stack is always aligned to 16 bytes.
- Two new symbols, `_fsl_bss_start` and `_fsl_bss_end`, have been introduced in the `_ppc_eabi_linker.h` file. The values of these symbols are set by the `gccport.lcf` file.

This section contains the following subsection:

- [Files modified](#) on page 391

12.2.1 Files modified

This section describes the files modified to avoid getting errors from the GCC LD tool.

The `gccport.lcf` file provides definitions for the following symbols:

- `_stack_addr`
- `_stack_end`
- `_heap_addr`
- `_heap_end`
- `_SDA_BASE_`
- `_SDA2_BASE_`
- `_fsl_bss_start`
- `_fsl_bss_end`

Following files are modified:

- `_start.c`
- `_ppc_eabi_linker.h`

12.3 Software floating point emulation support

This section tells how to access the emulation functions needed by the GCC compiler.

The GCC compiler generates calls to the emulation functions found in the `libgcc.a` archive. You can access this archive from the following path:

```
/opt/freescale/gcc-4.9.2-Ee500v2-eabispe/lib/gcc/powerpc-eabispe/4.9.2/nof/libgcc.a
```

12.4 Building a custom MSL C library

A custom MSL C library can be built with the makefile, `MSL_C.EPPC.GNU.mak`, which was derived from the MSL C For ARM implementation.

To build a custom MSL C library:

1. Change directory to `$(CWInstallDir)/PA_Support/MSL/MSL_C/PPC_EABI/Project`
2. Invoke make as follows:

```
$> make -f MSL_C.EPPC.GNU.mak TARGETS= MSL_C_LINUXABI_bare_N_UC
```

The make file generates `MSL_C_LINUXABI_bare_N_UC.a` in the `$(CWInstallDir)/PA_Support/MSL/MSL_C/PPC_EABI/Lib` folder.

NOTE

Change the environment variable of `$(CWInstallDir)/GCC` accordingly. Some developers use an underscore to change the name of the GCC built library so that it is different from the library built by the CodeWarrior tools.

3. CodeWarrior run-time libraries built with CodeWarrior are provided as Build Runtime Libraries.

NOTE

The `_start.o` and `_ppc_eabi_init.o` files are to be included individually. Otherwise, the linker won't be able to locate the `_start` function in `_start.o` file.

4. Reuse the pre-built `libgcc.a` archive.
5. To build an application:
 - a. Use the below files:
 - The MSL header files
 - The `gccport.lcf` linker command file
 - b. Set up the definitions for `_GCCPORT_`, `_POWERPC_`, `_PPC_EABI_`, and `_MWERKS_`
 - c. Use the following compiler options to build the libraries, with the appropriate processor and compiler settings, and to specify the include files:

- `-nostdinc`
- `$(INCLUDE) -include msl_c_directives_to_gcc.h`
- `-fno-builtin`
- `-mcpu=e500mc -c`

NOTE

`$(INCLUDE)` denotes the path of the MSL header files.

6. With the program's object file generated, invoke the linker with the following options:

- `-nostdlib`
- `-nostartfiles`
- `-nostdlib`
- `-static`
- `-T gccport.lcf`
- `-e _start`

7. And link it with the following files:

- a. `_start.o`
- b. `_ppc_eabi_init.o`
- c. `syscall.a`
- d. `MSL_C_PPCEABI_bare_N_UC.a`
- e. `Runtime.PPCEABI.N.UC.a`

8. Use the `gccport.lcf` file as an input to the linker. The generated ELF file can be run on Simics.

Making a Custom MSL C Library
Building a custom MSL C library

Chapter 13

Debugger Limitations and Workarounds

This chapter describes processor-specific CodeWarrior debugger limitations and workarounds. The chapter includes the following sections:

- [PowerQUICC II processors](#) on page 395
- [PowerQUICC II Pro processors](#) on page 395
- [PowerQUICC III processors](#) on page 396
- [QorIQ communications processors](#) on page 398
- [T-series processors](#) on page 399
- [QorIQ Qonverge processors](#) on page 401
- [Generic processors](#) on page 402

13.1 PowerQUICC II processors

This section talks about the limitations and workarounds of the CodeWarrior debugger for the PowerQUICC II processors.

The PowerQUICC II processor family includes G2: 8250 processors.

Working with watchpoints

G2 cores do not support watchpoints.

Working with hardware breakpoints

G2 cores implement one address instruction breakpoint (hardware breakpoint) that can be used in a debug session.

Working with memory-mapped registers

For G2 cores, you must provide the internal memory map base address before the CodeWarrior debugger can access the internal memory-mapped registers (MMR). There are two ways to provide this address:

- Use the `setMMRBaseAddr` command in a target initialization file.
- During a debug session, in the Debugger Shell issue this command: `cmdwin::eppc::setMMRBaseAddr.`

13.2 PowerQUICC II Pro processors

This section talks about the limitations and workarounds of the CodeWarrior debugger for the PowerQUICC II Pro processors.

The PowerQUICC II Pro processor family includes these processors:

- e300c2: 8323
- e300c3: 8306 and 8309
- e300c4: 8377

Single-stepping exception generating instructions (e300c2-c4 cores)

When single-stepping a branch instruction (for example, `blr`) to an address for which the translation is unavailable, an I-TLB miss exception is generated. However, the run-control stops the target while being in an incomplete state. The PC points to the requested address instead of the I-TLB interrupt vector, the SRR0 and SRR1 do not contain the values of PC and MSR at the time of the exception, just the IMISS register is updated correctly. The further execution is not possible because of the incomplete state. The user has to manually adjust the aforementioned registers to their intended values: $PC \leq \text{I-TLB miss vector address (0x1100)}$, $SRR0 \leq \text{the value of PC at the time of the exception}$, $SRR1 \leq \text{the interrupt-specific information and MSR bit values}$.

Working with watchpoints

- Resuming execution after a watchpoint is hit: When a target is under the debugger's control and a watchpoint (data breakpoint) condition is met, the core stops execution at the instruction that generated the data access. This instruction is called the watchpoint hit instruction. Unfortunately, when an e300 core hits a watchpoint, the debugger cannot determine the circumstances under which the target stopped because these cores do not update the necessary status registers. As a result, it is impossible to resume (run or step) the target after a watchpoint has been hit because the debugger cannot temporarily disable the watchpoint generated by the hit instruction. As a result, for an e300 core, you must manually disable a watchpoint before you can resume execution from the watchpoint hit instruction.
- 64-bit alignment: The e300 core implements two data address registers. The CodeWarrior debugger uses both registers to place a single watchpoint on a variable or memory range. Any watchpoint set on a variable or memory address is equivalent to a watchpoint set on an aligned address and a range of 64-bit multiple. This limitation stems from the e300 cores' data breakpoints implementation.

Working with hardware breakpoints

The e300 core implements two address instruction breakpoints (hardware breakpoints) that can be used in a debug session.

Working with memory-mapped registers

e300 cores have an internal memory-mapped registers base address register (IMMRBAR). This is a memory-mapped register that relocates with the whole internal memory map.

Further, the debugger uses the special purpose memory base address register (MBAR) to store the base address of the internal memory-mapped registers.

Each time the location of the internal memory map changes, you must maintain the correspondence between the IMMRBAR and MBAR registers.

13.3 PowerQUICC III processors

This section describes the limitations and workarounds of the CodeWarrior debugger for the PowerQUICC III processors.

The PowerQUICC III processor family includes these processors:

- e500: 8560
- e500v2: 8536, 8548, 8568, 8569, 8572, C29x, and G1110

MMU configuration through JTAG

For e500 cores, the debugger is able to read the L2 MMU TLBs registers without using dedicated processor instructions. For e500v2 cores, the debugger can read and write the L2 MMU TLB registers. You can access these registers from the debugger's **Registers** View or using commands in a target initialization script or the Debugger Shell.

For more information on the TLB register structure, see the `README.txt` file that is included in the default CodeWarrior project for each supported target board.

Reset workaround

To put the e500 and e500v2 cores in debug mode at reset, you must ensure that the core is running. The target initialization file sets a hardware breakpoint at the reset address. The core is stopped at the reset address to be put in the debug mode.

Working with breakpoints

For e500 and e500v2 cores, the debugger implements software and hardware breakpoints by using debug exceptions and the corresponding interrupt handler. Therefore, MSR[DE] bit must remain set to allow debug interrupts to be taken. When a debug exception is encountered, the target is expected to stop at the debug exception handler pointed by `IVPR+IVOR15`.

However, for e500 and e500v2 cores, there is a chance that the first few instructions of the debug exception handler are fetched and even executed before processor halts.

As a result, the core must be able to fetch and execute valid instructions from the interrupt handler location pointed by `IVPR+IVOR15` without raising a TLB miss exception or any other exception. Also, the first few instructions of the debug interrupt handler must not perform any Load or Store operations that would corrupt the application's context if executed. If any of these conditions is not satisfied, the breakpoints will not work.

Working with watchpoints

The e500 and e500v2 cores implement two data address compare registers. The CodeWarrior debugger uses both these registers to place a single watchpoint on any variable or memory range. The variable or memory range is 1-byte aligned.

Working with hardware breakpoints

The e500 core implements two address instruction breakpoints (hardware breakpoints) that can be used in a debug session.

Debugging interrupt handlers

The e500v2 debug support in CodeWarrior relies on Debug Interrupt functionality. Due to interrupt priority levels, debugging Machine Check interrupt handlers is not possible. Also, debugging Critical interrupt handlers is supported only in the range after the prolog saves the values of CSSR0 and CSRR1 registers, and before the epilogue restores the aforementioned registers. Otherwise, hitting a breakpoint outside of this range will result in CSRR registers being overwritten, thus causing incorrect return address for the interrupt.

Using memory configuration files for bareboard debugging

When debugging bareboard applications, CodeWarrior needs to be informed of the actual MMU configuration regarding translated areas. For example:

```
// Translate virtual address to corresponding physical cacheable (p:) address
translate v:0xFE000000 p:0xFFE00000 0x00100000
```

NOTE

For e500v2 cores, the debugger can also automatically read the translations from the target MMU. To have this behavior, all `translate` directives need to be removed from the memory configuration file. For more information, see [Memory translations](#) on page 155.

13.4 QorIQ communications processors

This section talks about the limitations and workarounds of the CodeWarrior debugger for the QorIQ communications processors.

The QorIQ processor family includes the following processors:

- e500v2: P1010/11/12/13/14/15/16/17, P1020/21/22/23/24/25, and P2020/10
- e500mc: P2041/0, P3041, and P4080/40
- e5500: P5010, P5020, P5021, and P5040

NOTE

For e500v2 processors, see [PowerQUICC III processors](#) on page 396. All the information from [PowerQUICC III processors](#) on page 396 related to e500v2 cores also applies to QorIQ processors based on e500v2 core.

MMU configuration through JTAG

For e500mc and e5500 cores, the debugger is able to read and write the L2 MMU TLBs registers without using dedicated processor instructions. You can access these registers from the debugger's **Registers** view or using commands in a target initialization script.

For more information on the TLB register structure, see the `README.txt` file that is included in the default CodeWarrior project for each supported target board.

Using memory configuration files for bareboard debugging

For e500mc and e5500 cores, it is critical to use the correct cacheable or cache-inhibited attribute for physical memory accesses. Failing to do so can lead to unreliable memory access (stale data, data corruption). For more information, see [Viewing memory](#) on page 193.

When debugging bareboard applications, CodeWarrior needs to be informed of the actual MMU configuration regarding translated areas and cacheable/cache-inhibited attribute of the memory ranges. For example:

```
// Translate virtual addresses to corresponding physical cacheable (p:) or cache-
inhibited (i:) addresses
translate v:0x00000000 p:0x00000000 0x80000000
translate v:0xE0000000 i:0xE0000000 0x10000000
translate v:0xF4000000 p:0xF4000000 0x00100000
translate v:0xF4100000 i:0xF4100000 0x00100000
translate v:0xF4200000 p:0xF4200000 0x00100000
translate v:0xF4300000 i:0xF4300000 0x00100000
translate v:0xFE000000 i:0xFE000000 0x01000000
translate v:0xFFFFF000 i:0xFFFFF000 0x00001000
```

See [translate](#) on page 359 for more information on the `translate` command.

NOTE

The debugger can also automatically read the translations from the target MMU. To have this behavior, all `translate` directives need to be removed from the memory configuration file. For more information, see [Memory translations](#) on page 155.

Working with software breakpoints

For e500mc and e5500 cores, the debugger implements software breakpoints by using the dedicated debug notify halt (dnh) instruction. When the dnh opcode is encountered, the target stops without taking an exception.

Working with watchpoints

The e500mc and e5500 cores implement two data address compare registers. The CodeWarrior debugger uses both these registers to place a single watchpoint on any variable or memory range. The variable or memory range is 1-byte aligned.

Working with hardware breakpoints

The e500mc and e5500 cores implement two address instruction breakpoints (hardware breakpoints) that can be used in a debug session.

Cross triggering

The cross triggering (halt groups) functionality is only available when debugging e500mc, e5500, and e6500 processors through a JTAG connection.

Individual hardware breakpoints and watchpoints halt contexts are not working on current e500mc, e5500, and e6500 processors. The workaround is to enable all halt contexts for a group (SW BP + HW BP + WP), thus defining a general debug stop halt group.

The number of multicore groups that can be defined depends on the actual configuration of the halt contexts defined for each group. Each defined group consumes internal EPU resources. There is not a simple formula to estimate in advance the number of available groups. The groups will be configured in the same order as they are defined. In case of running out of resources, an error will be shown.

The cross triggering functionality is "edge-based" rather than "state-based", which means that only transitions from running to stopped state will be considered as triggers. This has the downside that if any core from the group is already halted when a trigger is happening on another running core, the cross trigger will not activate for the group. To work around this limitation, it is advisable to control the group synchronously by using the multicore commands (Multicore Run and Multicore Suspend).

Maintaining core time base synchronization

For e500mc and e5500 processors, the `CTBHLTCRL` register in RCPM block is modified by the debugger unconditionally on any connection to the target and after any Reset action, to enable correct time base handling during multi-core debugging, specifically during Linux kernel debugging. Changing the register value set by the debugger can cause the target software behave unexpectedly during debug sessions, if the target software relies on time base synchronization.

P2020 ComExpress (Linux kernel debug)

Linux kernel debug using download launch configuration is not supported. The workaround is to use Linux kernel debug with attach configuration. For early boot debug, set a hardware breakpoint at address 0 (debugger shell: `bp -hw 0x0`) then start the kernel from u-boot console. After the breakpoint is hit, the kernel can be debugged from the entry point.

13.5 T-series processors

This section describes the limitations and workarounds of the CodeWarrior debugger for the T-series processors.

The T-series processor family includes the following processors:

- e5500: T1013, T1014, T1020, T1022, T1023, T1024, T1040, and T1042
- e6500: T2080, T2081, T4160, and T4240

NOTE

For e5500 processors, see [QorIQ communications processors](#) on page 398. All the information from [QorIQ communications processors](#) on page 398 related to e5500 cores also applies to T-series processors based on e5500 core.

MMU configuration through JTAG

For e6500 cores, the debugger is able to read and write the L2 MMU TLB and LRAT registers without using dedicated processor instructions. You can access these registers from the debugger's Registers View or using commands in a target initialization script or Debugger Shell.

For more information on the TLB register structure, see the `README.txt` file that is included in the default CodeWarrior project for each supported target board.

Using memory configuration files for bareboard debugging

For e6500 cores, it is critical to use the correct cacheable or cache-inhibited attribute for physical memory accesses. Failing to do so can lead to unreliable memory access (stale data, data corruption). For more information, see [Viewing memory](#) on page 193.

When debugging bareboard applications, CodeWarrior needs to be informed of the actual MMU configuration regarding translated areas and cacheable/cache-inhibited attribute of the memory ranges. For example:

```
// Translate virtual addresses to corresponding physical cacheable (p:) or cache-
inhibited (i:) addresses
translate v:0x00000000 p:0x00000000 0x80000000
translate v:0xE0000000 i:0xE0000000 0x10000000
translate v:0xF4000000 p:0xF4000000 0x00100000
translate v:0xF4100000 i:0xF4100000 0x00100000
translate v:0xF4200000 p:0xF4200000 0x00100000
translate v:0xF4300000 i:0xF4300000 0x00100000
translate v:0xFE000000 i:0xFE000000 0x01000000
translate v:0xFFFFF000 i:0xFFFFF000 0x00001000
```

See [translate](#) on page 359 for more information on the `translate` command.

NOTE

The debugger can also automatically read the translations from the target MMU. To have this behavior, all `translate` directives need to be removed from the memory configuration file. For more information, see [Memory translations](#) on page 155.

For more information, see [Viewing memory](#) on page 193.

Working with software breakpoints

For e6500 cores, the debugger implements software breakpoints by using the dedicated debug notify halt (dnh) instruction. When the dnh opcode is encountered, the target stops without taking an exception.

Working with watchpoints

The e6500 cores implement two data address compare registers. The CodeWarrior debugger uses both these registers to place a single watchpoint on any variable or memory range. The variable or memory range is 1-byte aligned.

As opposed to hardware, simulators are not usually limited by the available comparator resources and allow a much higher number of watchpoints (1024).

Working with hardware breakpoints

The e6500 cores implement eight address instruction breakpoints (hardware breakpoints) that can be used in a debug session.

As opposed to hardware, simulators are not usually limited by the available comparator resources and allow a much higher number of hardware breakpoints(1024).

Thread representation of multi-threaded processor

The e6500 core is multi-threaded implementation of the resources for embedded processors defined by the Power ISA. The core supports the simultaneous execution of two threads. CodeWarrior shows each thread as a separate core, thus "core(2n)" corresponds to thread#0 of the physical core#n, "core(2n+1)" corresponds to thread#1 of physical core#n.

Individual thread control

For e6500 multi-threaded processors, the `EDBCR0 [DIS_CTH]` register is modified by the debugger unconditionally on any connection to the target and after any Reset action, to disable cross-thread halt to allow individual thread control during multi-threaded debugging. Changing the register value set by the debugger can cause the debugger behave unexpectedly.

Maintaining thread time base synchronization

For e6500 processors, the `TTBHLTCR` register in RCPM block is modified by the debugger unconditionally on any connection to the target and after any Reset action, to enable correct time base handling during multi-core debugging, specifically during Linux kernel debugging. Changing the register value set by the debugger can cause the target software behave unexpectedly during debug sessions, if the target software relies on time base synchronization.

13.6 QorIQ Qonverge processors

This section talks about the limitations and workarounds of the CodeWarrior debugger for the QorIQ Qonverge processors.

The Qonverge processor family includes the following processors:

- e500v2: BSC9131 and BSC9132
- e6500: B4420, B4460, B4860, and G4860

NOTE

For e500v2 processors, see [PowerQUICC III processors](#) on page 396. All the information from [PowerQUICC III processors](#) on page 396 related to e500v2 cores also applies to Qonverge processors based on e500v2 core. Similarly, for e6500 processors, see [T-series processors](#) on page 399.

Choosing appropriate target type

Qonverge processors bundle together the cores of different architectures, for example, BSC9131 includes a Power e500v2 core and a StarCore SC3850 core. The JTAG topology can be configured to either include cores of both architectures in the same daisy-chain, or to access only the Power cores on the JTAG port.

To distinguish between the two modes in which the processor can be configured, the debugger uses two different target types (and consequently two sets of launch configurations referencing the two different systems). For example, the BSC9131 target type/debug configuration is used when the processor/board is configured for both the PA and the SC cores in chained mode (Dual TAP mode on Power Architecture JTAG port) and BSC9131PA target type/debug configuration is used when the processor/board is configured only for the PA core on the Power Architecture JTAG port (Single TAP modes).

Preventing debug halt requests caused by cross triggering cores

For BSC9132 processors, the Halted to Halt Request Mask register, `GUTS_HALTED_TO_HALT_REQ_MASK_REG`, is modified by the debugger unconditionally on any connection

to the target and after any Reset action, to prevent debug halt requests caused by cross triggering cores. Changing the register value set by the debugger can cause the debugger behave unexpectedly.

13.7 Generic processors

This section talks about the limitations and workarounds of the CodeWarrior debugger for generic Power Architecture processors.

Working with uninitialized stack

Debugging while the stack is not initialized can cause uninitialized memory accesses errors. This situation occurs when the debugger tries to construct the stack trace.

To avoid this problem, stop the debugger from constructing a stack trace by adding a command to your target initialization file that sets the stack pointer (SP) register to an unaligned address.

For example, you could put this command in your target initialization file:

```
writereg SP 0x0x0000000F
```

Secure debug

If the processor is in the Secure Debug mode and if the unlock key is not provided, then a popup is displayed requesting the unlock key. If a wrong unlock key is provided in the Debugger settings, and an unlock sequence is initiated by the debugger, you will receive a Secure debug violation error and the connection to the target will fail.

For the P4080 processor, after this error is encountered, you will not be able to successfully unlock the processor even with a correct key. In such a scenario, the board should be hard reset first.

For the P1010 processor, if you have one failed attempt with a wrong key then a subsequent unlock sequence with a valid key will succeed. But, if you provide a wrong key twice, you will need to hard reset the board before the next attempt.

Hypervisor debug

Kernel download over Hypervisor does not work correctly. For example the kernel is not stopped at entry point or the kernel module information is incorrect. The workaround is to use the attach configuration. If you want to debug early phases of the kernel initialization, after attach, set a hardware breakpoint at address `0x0` or at any kernel function (for example, `start_kernel`). Then, in the Hypervisor console restart the partition (for example, partition 1) with the following commands:

```
stop 1  
start load 1
```

This is equivalent to download with stop at entry point.

Stepping in interrupt handler

An error sometimes occurs when stepping in an interrupt handler. The workaround to avoid this problem is to use the default memory configuration file.

Index

.cfg target initialization commands [343](#)
 .tcl target initialization commands [353](#)

A

Accompanying documentation [12](#)
 Action Type [374](#)
 Actions [169](#)
 Add flash device [364](#)
 Add Flash Programmer Actions [364](#)
 Adding a Register Group [172](#)
 Adding CodeWarrior HyperTRK Debug Stub Support in Hypervisor for Linux Kernel Debugging [313](#)
 Adding Memory Monitor [194](#)
 Address [377](#)
 Address lines [378](#)
 Advanced tab [155](#)
 alternatePC [344](#)
 ANDmem.l [344](#)
 ANDmmr [345](#)
 Applying New HyperTRK Patches from CodeWarrior Install Layout [314](#)
 Arbitrary TAP state move test [152](#)
 Architecture [76](#)
 Arguments [97](#)
 Assembler [14](#)
 Attaching Core to the Debug Application [330](#)
 Auto-Build Mode [41](#)
 autoEnableTranslations [357](#)

B

Bit Fields [168](#)
 Build Properties [45](#)
 Build Properties for Power Architecture [46](#)
 Build Settings Page [24](#), [32](#)
 Build the executable [251](#)
 Build the shared library [251](#)
 Building a custom MSL C library [392](#)
 Building Projects [40](#)
 Bus noise [378](#)
 Bypass scan test [151](#)

C

C/C++ compiler [14](#)
 C/C++ Language [66](#)
 Cache Symbolics Between Sessions is Disabled [290](#)
 Cache Symbolics Between Sessions is Enabled [290](#)
 Cache View [196](#)
 Cache View Toolbar Menu [197](#)
 CCSSIM2 ISS [122](#)

Changing Bit Fields [168](#)
 Changing Bit Value of a Register [166](#)
 Changing Build Properties [45](#)
 Changing Program Counter Value [204](#)
 Checksum actions [367](#)
 Code editing [17](#)
 CodeWarrior Bareboard Project Wizard [19](#)
 CodeWarrior Build Tool Settings [48](#)
 CodeWarrior Command-Line Debugger [156](#)
 CodeWarrior Development Studio tools [13](#)
 CodeWarrior IDE [16](#)
 CodeWarrior Linux Project Wizard [29](#)
 CodeWarrior Profiling and Analysis tools [16](#)
 CodeWarrior TAP [145](#)
 Common [117](#)
 Compiling [17](#)
 Compiling the DTS file [300](#)
 Components of Cache View [199](#)
 Configurations Page [26](#), [208](#)
 Configure flash programmer target task [363](#)
 Configure hardware to use U-Boot image [257](#)
 Configure Linux Process Signal Policy [234](#)
 Configure the executable build configuration [250](#)
 Configure the launch configuration [251](#)
 Configure the shared library build configuration [250](#)
 Configure U-Boot and build U-Boot images with CodeWarrior debugger support [257](#)
 Configuring a Download Kernel Debug Scenario [291](#)
 Configuring an Attach Kernel Debug Scenario [291](#)
 Configuring and Building U-Boot [262](#)
 Configuring the Build Tool [287](#)
 Configuring the kernel project for debugging [290](#)
 Configuring the Linux Kernel [287](#)
 Configuring the Modules' Symbolics Mapping [310](#)
 Connection types [122](#)
 Consistent debug control [122](#)
 Contents of this manual [11](#)
 Create a CodeWarrior Bareboard Project Page [20](#)
 Create a CodeWarrior Download Launch Configuration for the Linux Application [230](#)
 Create a CodeWarrior Linux Project Page [29](#)
 Create a CodeWarrior project to debug U-Boot [257](#)
 Create a flash programmer target task [361](#)
 Create an example project [247](#)
 Create launch configurations for U-Boot debug stages [260](#)
 Creating a CodeWarrior Project from the Linux Kernel Image [308](#)
 Creating a CodeWarrior Project to Debug U-Boot [264](#)
 Creating a CodeWarrior Project using the Linux Kernel Image [289](#)

Creating a Download Launch Configuration to Debug a Linux Partition from an Entry Point or a User-Defined Function [318](#)
 Creating an Attach Launch Configuration to Debug a Linux Partition after Kernel Boot [315](#)
 Creating CodeWarrior Bareboard Library Project [37](#)
 Creating CodeWarrior Bareboard Project [35](#)
 Creating CodeWarrior Linux Application Project [39](#)
 Creating hardware diagnostics task [372](#)
 Creating Projects [34](#)
 Creating task for import/export/fill memory [380](#)
 Customizing Debug Configurations [118](#)

D

Data lines [378](#)
 Debug [99](#)
 Debug Configurations [91](#)
 Debug Target Settings Page [22](#), [207](#)
 Debug the Executable File [214](#)
 Debug the Linux Application [236](#)
 Debug the shared library [253](#)
 Debugger [15](#), [98](#)
 Debugger Limitations and Workarounds [395](#)
 Debugger Shell Cache Line Commands [201](#)
 Debugger Shell Global Cache Commands [200](#)
 Debugging [17](#), [50](#), [84](#)
 Debugging a CodeWarrior project [121](#)
 Debugging a Linux Application [227](#)
 Debugging a shared library [247](#)
 Debugging All Cores when Starting the Guest Applications [328](#)
 Debugging AMP/SMP Guest Linux Kernels Running Under Hypervisor [315](#)
 Debugging applications that use fork() and exec() system calls [237](#)
 Debugging Embedded Linux Software [227](#)
 Debugging Externally Built Executable Files [209](#)
 Debugging Hypervisor after Release of Secondary Cores [326](#)
 Debugging Hypervisor During the Boot and Initialization Process [322](#)
 Debugging Hypervisor from Relocation Till Release of Secondary Cores [325](#)
 Debugging Hypervisor from the Entry Point [323](#)
 Debugging Hypervisor Guest Applications [312](#)
 Debugging Loadable Kernel Modules [307](#)
 Debugging Multi-Core Projects [215](#)
 Debugging Multiple Cores [218](#)
 Debugging the Application from the main() Function [330](#)
 Debugging the Hypervisor Partition Manager [328](#)
 Debugging the Hypervisor Partitions Image Loading Process [328](#)
 Debugging the Hypervisor Partitions Initialization Process [327](#)

Debugging the Kernel after the MMU is Enabled [304](#)
 Debugging the kernel based on MMU initialization [302](#)
 Debugging the Kernel before the MMU is Enabled [302](#)
 Debugging the kernel by attaching to a running U-Boot [305](#)
 Debugging the kernel to download the kernel, RAM disk, and device tree [301](#)
 Debugging the Kernel while the MMU is being Enabled [304](#)
 Debugging the Linux Kernel [283](#)
 Debugging the P4080 Embedded Hypervisor [320](#)
 Debugging U-Boot after switching back to initial address space [271](#), [277](#), [281](#)
 Debugging U-Boot before switching address space [268](#), [274](#), [279](#)
 Debugging U-Boot in RAM [272](#), [278](#), [282](#)
 Debugging U-Boot in translated address space [269](#), [275](#), [279](#)
 Debugging U-Boot using Flash Devices [267](#)
 Debugging U-Boot using NAND flash [278](#)
 Debugging U-Boot using NOR flash [268](#)
 Debugging U-Boot using NOR, NAND, SPI, and SD Card/MMC Flash Devices [262](#)
 Debugging U-Boot using SPI and SD/MMC flash [273](#)
 Default Signal Policy [234](#)
 Deleting Projects [43](#)
 Description [170](#)
 Diagnostics actions [367](#)
 Disassembler Settings [71](#), [89](#)
 Download [102](#)
 Dump Flash actions [368](#)
 Duplicate action [369](#)

E

e500 Registers [178](#)
 e500mc Registers [184](#)
 e500v2 Registers [181](#)
 e5500 Registers [187](#)
 e6500 Registers [189](#)
 Eclipse IDE [14](#)
 Edit the Launch Configuration [211](#)
 Editing a Register Group [173](#)
 Editing remote system configuration [152](#)
 Editing the DTS File [299](#)
 Enabling HyperTRK Debug Support Directly in Build Tool [314](#)
 Environment [116](#)
 EPPC Exceptions [101](#)
 Erase/Blank check actions [365](#)
 Erasing flash device [371](#)
 Establishing a Console Connection [285](#)
 Ethernet TAP [124](#)
 Execute flash programmer target task [369](#)
 Execute host-based Scope Loop on target [379](#)
 Execute target-based Memory Tests on target [379](#)
 Exporting memory to file [384](#)

F

Files modified [390, 391](#)
 Fill Memory [386](#)
 Flash File to Target [370](#)
 Flash programmer [361](#)
 Flattened Device Tree Initialization [295](#)

G

GCC Build Tool Settings [73](#)
 General [53, 70, 77, 87](#)
 Generic processors [402](#)
 Gigabit TAP [133](#)
 Gigabit TAP + Trace [128](#)

H

Hard resetting [204](#)
 Hardware diagnostics [372](#)
 Hypervisor - An Introduction [312](#)

I

Import a CodeWarrior Executable file Page [205](#)
 Import a CodeWarrior Executable file Wizard [204](#)
 Import an Executable File [209](#)
 Import C/C++/Assembler Executable Files Page [205](#)
 Import/Export/Fill memory [380](#)
 Importing Classic CodeWarrior Projects [42](#)
 Importing data into memory [382](#)
 Includes [82](#)
 IncoMMR [345](#)
 Initialization tab [153](#)
 Initializing TLB Registers [177](#)
 Input [51, 58, 69](#)
 Install BSP [256](#)
 Install CodeWarrior TRK on Target System [228](#)
 Installing the Board Support Package (BSP) [286](#)
 Introduction [11](#)
 IR scan test [151](#)

J

JTAG configuration file syntax [333](#)
 JTAG Configuration Files [333](#)
 JTAG diagnostics tests [150](#)

L

Libraries [77](#)
 Link Order [53](#)
 Linker [15](#)
 Linking [17](#)
 Linux Application Launch Configurations Page [206](#)
 Linux Application Page [33](#)

Loadable Kernel Modules - An Introduction [307](#)
 Loop Speed [375](#)

M

Main [92](#)
 Main standard libraries [15](#)
 Making a Custom MSL C Library [389](#)
 Manual-Build Mode [41](#)
 Memory Access [374](#)
 Memory configuration commands [356](#)
 Memory Configuration Files [355](#)
 Memory tab [154](#)
 Memory test use cases [379](#)
 Memory Tests [376](#)
 Memory translations [155](#)
 Messages [50](#)
 Miscellaneous [78, 86](#)
 Modifications to avoid errors from GCC LD tool [391](#)
 Modifying a DTS file [300](#)
 Modifying and Building the HyperTRK Manually [314](#)
 Modifying Signal Policy [234](#)
 Multi-Core Commands in CodeWarrior IDE [221](#)
 Multi-Core Commands in Debugger Shell [222](#)
 Multi-Core Debugging [215](#)
 Multi-Core Debugging Commands [221](#)

O

Obtaining a DTS File [297](#)
 Optimization [62, 83](#)
 ORmem.I [346](#)
 OS Awareness [110](#)
 Other Executables [107](#)
 Output [54](#)

P

PIC [104](#)
 Points to remember [267](#)
 Power at probe test [151](#)
 PowerPC Assembler [68, 86](#)
 PowerPC Compiler [57, 80](#)
 PowerPC CPU [49](#)
 PowerPC Disassembler [70, 88](#)
 PowerPC Embedded Application Binary Interface [12](#)
 PowerPC Environment [79](#)
 PowerPC Linker [51, 76](#)
 PowerPC Preprocessor [72, 87](#)
 PowerQUICC II Pro processors [395](#)
 PowerQUICC II processors [395](#)
 PowerQUICC III processors [396](#)
 Preparing Connection to P4080DS Target [314](#)
 Preparing U-Boot for debugging [255](#)
 Preprocessor [58, 80](#)

Preprocessor Settings [72, 88](#)
 Prerequisites [315](#)
 Prerequisites for Debugging a Guest Application [313](#)
 Processor [62](#)
 Processor Page [21, 31, 206](#)
 Processor-Specific Cache Features [201](#)
 Program/Verify actions [366](#)
 Programming file [372](#)
 Project files [17](#)
 Protect/Unprotect actions [368](#)

Q

QorIQ communications processors [398](#)
 QorIQ Qonverge processors [401](#)

R

range [357](#)
 Reading JTAG IDCODEs test [152](#)
 Reading TLB Registers from Debugger Shell [175](#)
 Registers View Context Menu [170](#)
 Regular Initialization [296](#)
 Release notes [11](#)
 Remove action [369](#)
 Remove Breakpoints using Breakpoints View [162](#)
 Remove Breakpoints using Marker Bar [161](#)
 Remove Hardware Breakpoints using Debugger Shell [162](#)
 Remove Hardware Breakpoints using the IDE [162](#)
 Removing a Register Group [173](#)
 Removing Breakpoints [161](#)
 Removing Hardware Breakpoints [162](#)
 Removing Watchpoints [165](#)
 reserved [358](#)
 reservedchar [358](#)
 reset [346](#)
 resetCoreID [347](#)
 Restoring Build Properties [46](#)
 Reverting Debug Configuration Settings [120](#)
 run [347](#)

S

Secure/Unsecure actions [369](#)
 Serial Connections [229](#)
 setCoreID [347](#)
 Setting Breakpoints [159](#)
 Setting Hardware Breakpoints [161](#)
 Setting Launch Configurations [215](#)
 Setting Stack Depth [204](#)
 Setting up a remote system to use a JTAG configuration file [337](#)
 Setting up RAM disk [294](#)
 Setting Up the Target Hardware [284](#)
 Setting Watchpoints [163](#)

Shared Library Settings [79](#)
 Signal Inheritance [234](#)
 Simics [138](#)
 sleep [347](#)
 Software floating point emulation support [392](#)
 Source [114](#)
 Source library modifications [389](#)
 Specify Console I/O Redirections for the Linux Application [233](#)
 Specify launch configuration settings [258](#)
 Specify target RAM settings [364](#)
 Specify the Source Lookup Path [212](#)
 Specifying the Launch Configuration Settings [265](#)
 Start CodeWarrior TRK on Target System [228](#)
 stop [348](#)
 Symbolics [108](#)
 Symbols [81](#)
 System Call Services [105](#)

T

T-series processors [399](#)
 Target initialization commands [343](#)
 Target Initialization Files [341](#)
 TCF [140](#)
 TCP/IP Connections [228](#)
 Testing a DTB File [300](#)
 TLB Register Details [177](#)
 Trace and Profile [113](#)
 Trace Configuration Page [28](#)
 translate [359](#)

U

Updating the Linux Kernel Image [290](#)
 USB TAP [141](#)
 USB TAP Connections [285](#)
 User Space Debugging with On-Chip Debug [329](#)
 Using a JTAG configuration file to override RCW [334](#)
 Using a JTAG configuration file to specify multiple linked devices on a JTAG chain [335](#)
 Using Debug Configurations Dialog Box [91](#)
 Using Debugger Shell to Set Hardware Breakpoints [161](#)
 Using Debugger Shell to View Caches [199](#)
 Using IDE to Set Hardware Breakpoints [161](#)
 Using memory configuration files [355](#)
 Using Open Firmware Device Tree Initialization method [297](#)
 Using target initialization files [341](#)

V

Viewing Cache [196](#)
 Viewing memory [193](#)
 Viewing multiple processes and threads [236](#)

Viewing Register Details [167](#)
Viewing TLB Registers in Registers view [174](#)

W

Walking Ones [377](#)
Warnings [59](#), [85](#)
Working with Breakpoints [158](#)
Working with Debugger [121](#)
Working with Hardware Diagnostic Action editor [373](#)
Working with Hardware Tools [361](#)
Working with IMMR [193](#)
Working with Projects [19](#)
Working with Register Groups [172](#)
Working with Registers [165](#)
Working with TLB Registers [173](#)
Working with Watchpoints [163](#)
writemem.b [348](#)
writemem.l [349](#)
writemem.w [348](#)
writemmr [349](#)
writereg [350](#)
writereg128 [351](#)
writereg192 [352](#)
writereg64 [350](#)
writespr [352](#)
Writing configuration words in U-Boot code [264](#)

How To Reach Us

Home Page:

freescale.com

Web Support:

freescale.com/support

Information in this document is provided solely to enable system and software implementers to use Freescale products. There are no express or implied copyright licenses granted hereunder to design or fabricate any integrated circuits based on the information in this document. Freescale reserves the right to make changes without further notice to any products herein.

Freescale makes no warranty, representation, or guarantee regarding the suitability of its products for any particular purpose, nor does Freescale assume any liability arising out of the application or use of any product or circuit, and specifically disclaims any and all liability, including without limitation consequential or incidental damages. "Typical" parameters that may be provided in Freescale data sheets and/or specifications can and do vary in different applications, and actual performance may vary over time. All operating parameters, including "typicals," must be validated for each customer application by customer's technical experts. Freescale does not convey any license under its patent rights nor the rights of others. Freescale sells products pursuant to standard terms and conditions of sale, which can be found at the following address: freescale.com/SalesTermsandConditions.

Freescale, the Freescale logo, CodeWarrior, QorIQ, QorIQ Converge, and StarCore are trademarks of Freescale Semiconductor, Inc., Reg. U.S. Pat. & Tm. Off. All other product or service names are the property of their respective owners. The Power Architecture and Power.org word marks and the Power and Power.org logos and related marks are trademarks and service marks licensed by Power.org.

© 2008-2016 Freescale Semiconductor, Inc.

CWPADBGUG
Rev. 10.5.1
01/2016

