



MCUXpresso IDE User Guide

Rev. 10.0 — 21 March, 2017

User guide



21 March, 2017

Copyright © 2017 NXP Semiconductors

All rights reserved.

1. Introduction to MCUXpresso IDE	1
1.1. MCUXpresso IDE Overview of Features	1
1.1.1. Summary of Features	1
1.1.2. Supported Debug Probes	3
1.1.3. Development Boards	3
2. IDE Overview	6
2.1. Documentation and Help	6
2.2. Workspaces	6
2.3. Perspectives and Views	7
2.4. Major Components of the Develop Perspective	8
3. Debug Solutions Overview	10
3.1. A note about Launch Configuration files	11
3.2. LinkServer Debug Connections	13
3.3. LinkServer Debug Operation	14
3.4. LinkServer Global and Live Global Variables	15
3.5. LinkServer Troubleshooting	18
3.5.1. Debug Log	18
3.5.2. Flash Programming	19
3.5.3. LinkServer executables	19
3.6. P&E Debug Connections	20
3.7. P&E Debug Operation	20
3.7.1. P&E Differences from LinkServer Debug	20
3.7.2. P&E Micro Software Updates	21
3.8. SEGGER Debug Connections	21
3.8.1. SEGGER software installation	21
3.9. SEGGER Debug Operation	22
3.9.1. SEGGER Differences from LinkServer Debug	22
3.10. SEGGER Troubleshooting	23
4. SDKs and Pre-Installed Part Support Overview	25
4.1. Pre-installed Part Support	25
4.2. SDK Part Support	25
4.2.1. Important notes for SDK users	26
4.2.2. Differences in Pre-installed and SDK part handling	27
4.3. Viewing Pre-installed Part Support	27
4.4. Installing an SDK	28
4.4.1. Advanced Use: SDK Importing and Configuration	30
5. Creating New Projects using SDKs	32
5.1. New Project Wizard	32
5.1.1. SDK New Project Wizard: Basic Project Creation and Settings	34
5.1.2. SDK New Project Wizard: Advanced Project Settings	36
5.2. SDK Build Project	38
6. Importing Example Projects (from SDKs)	40
6.1. SDK Example Import Wizard	41
6.1.1. SDK Example Import Wizard: Basic Selection	41
6.1.2. SDK Example Import Wizard: Advanced options	44
6.1.3. SDK Example Import Wizard: Import from XML fragment	45
7. Creating New Projects using Pre-Installed Part Support	47
7.1. New Project Wizard	47
7.2. Creating a Project	48
7.2.1. Selecting the Wizard Type	49
7.2.2. Configuring the Project	50
7.3. Wizard Options	50
7.3.1. LPCOpen Library Project Selection	50
7.3.2. CMSIS-CORE Selection	51
7.3.3. CMSIS DSP Library Selection	52
7.3.4. Peripheral Driver Selection	52
7.3.5. Enable use of Floating Point Hardware	52

- 7.3.6. Code Read Protect 52
- 7.3.7. Enable use of `romdivide` Library 52
- 7.3.8. Disable Watchdog 52
- 7.3.9. LPC1102 ISP Pin 53
- 7.3.10. Redlib Printf Options 53
- 7.3.11. Project Created 53
- 8. Importing Example Projects (from the file system) 54
 - 8.1. Code Bundles for LPC800 Family devices 54
 - 8.2. LPCOpen Software Drivers and Examples 54
 - 8.3. Importing an Example Project 55
 - 8.3.1. Importing Examples for the LPCXpresso4337 Development Board 56
 - 8.4. Exporting Projects 57
 - 8.5. Building Projects 58
 - 8.5.1. Build Configurations 58
- 9. Debugging a Project 59
 - 9.1. Debugging overview 59
 - 9.1.1. Debug Probe Selection Dialog 60
 - 9.1.2. Controlling Execution 62
- 10. LinkServer Flash Support 64
 - 10.1. Default vs Per-Region Flash drivers 64
 - 10.2. Special case Flash drivers for LPC MCUs 64
 - 10.2.1. LPC18xx / LPC43xx Internal Flash Drivers 64
 - 10.2.2. SPIFI Flash Drivers 65
 - 10.3. Configuring projects to span multiple flash devices 65
 - 10.4. Kinetis Flash Drivers 65
 - 10.5. Using the LinkServer flash programmer 66
 - 10.5.1. The GUI flash programmer 67
 - 10.5.2. The command line flash programmer 70
- 11. C/C++ Library Support 72
 - 11.1. Overview of Redlib, Newlib and NewlibNano 72
 - 11.1.1. Redlib extensions to C90 72
 - 11.1.2. Newlib vs NewlibNano 72
 - 11.2. Library variants 73
 - 11.3. Switching the selected C library 74
 - 11.3.1. Manually switching 74
 - 11.4. What is Semihosting? 75
 - 11.4.1. Background to Semihosting 75
 - 11.4.2. Semihosting implementation 75
 - 11.4.3. Semihosting Performance 75
 - 11.4.4. Important notes about using semihosting 75
 - 11.4.5. Semihosting Specification 76
 - 11.5. Use of printf 76
 - 11.5.1. Redlib printf variants 76
 - 11.5.2. NewlibNano printf variants 76
 - 11.5.3. Newlib printf variants 77
 - 11.5.4. Printf when using LPCOpen 77
 - 11.5.5. Printf when using SDK 77
 - 11.5.6. Retargeting printf/scanf 77
 - 11.5.7. How to use ITM Printf 78
 - 11.6. itoa() and uitoa() 79
 - 11.6.1. Redlib 79
 - 11.6.2. Newlib/NewlibNano 80
 - 11.7. Libraries and linker scripts 80
- 12. Memory Configuration and Linker Scripts 82
 - 12.1. Introduction 82
 - 12.2. Managed Linker Script Overview 82
 - 12.3. How are managed linker scripts generated? 83

12.4. Default image layout	84
12.5. Examining the layout of the generated image	85
12.5.1. Linker --print-memory-usage	85
12.5.2. arm-none-eabi-size	85
12.5.3. Linker Map files	86
12.5.4. Symbol Viewer	86
12.6. Other options affecting the generated image	87
12.6.1. LPC MCUs – Code Read Protection	87
12.6.2. Kinetis MCUs – Flash Config blocks	88
12.6.3. Placement of USB data	89
12.7. Modifying the generated linker script / memory layout	90
12.8. Using the Memory Configuration Editor	90
12.8.1. Editing a Memory Configuration	91
12.8.2. Device specific vs Default Flash Drivers	94
12.8.3. Restoring a Memory Configuration	95
12.8.4. Copying Memory Configurations	95
12.9. More advanced heap/stack placement	95
12.9.1. MCUXpresso style heap and stack	96
12.9.2. LPCXpresso style heap and stack	97
12.9.3. Reserving RAM for IAP Flash Programming	97
12.9.4. Stack checking	98
12.9.5. Heap Checking	99
12.9.6. Placement of specific code/data items	99
12.10. Freemaker Linker Script Templates	103
12.10.1. Basics	103
12.10.2. Reference	104
12.11. Freemaker Linker Script Template Examples	108
12.11.1. Relocating code from FLASH to RAM	108
12.11.2. Configuring projects to span multiple flash devices	110
12.12. Disabling managed linker scripts	111
13. Multicore Projects	113
13.1. LPC43xx Multicore Projects	113
13.2. LPC541xx Multicore Projects	113
14. Appendix	114
14.1. Quick Settings	114
14.2. Launch Configurations	114
14.2.1. Editing a Launch Configuration	116
14.3. How do I switch between Debug and Release builds?	117
14.3.1. Changing the build configuration of a single project	117
14.3.2. Changing the build configuration of multiple projects	118
14.4. Editing Hints and Tips	118
14.4.1. Multiple views onto the same file	118
14.4.2. Viewing two edited files at once	118
14.4.3. Source folding	118
14.4.4. Editor templates and Code completion	119
14.4.5. Brace matching	119
14.4.6. Syntax coloring	119
14.4.7. Comment/uncomment block	119
14.4.8. Format code	120
14.4.9. Correct Indentation	120
14.4.10. Insert spaces for tabs in editor	120
14.4.11. Replacing tabs with spaces	120
14.5. Hardware Floating Point Support	120
14.5.1. Floating Point Variants	121
14.5.2. Floating point use – Preinstalled MCUs	121
14.5.3. Floating point use – SDK installed MCUs	122
14.5.4. Modifying floating point configuration for an existing project	122

- 14.5.5. Do all Cortex-M4 MCUs provide floating point in hardware? 122
- 14.5.6. Why do I get a hard fault when my code executes a floating point operation? 122
- 14.6. LinkServer Scripts 122
 - 14.6.1. Debugging code from RAM 125
- 14.7. The Console View 126
 - 14.7.1. Console types 126
 - 14.7.2. Copying the contents of a console 127
 - 14.7.3. Relocating and duplicating the Console view 128
- 14.8. Using and troubleshooting LPC-Link2 129
 - 14.8.1. LPC-Link2 hardware 129
 - 14.8.2. Softloaded vs Pre-programmed probe firmware 129
 - 14.8.3. LPC-Link2 firmware variants 130
 - 14.8.4. Manually booting LPC-Link2 131
 - 14.8.5. LPC-Link2 windows drivers 133
 - 14.8.6. LPC-Link2 failing to enumerate 133
 - 14.8.7. Troubleshooting LPC-Link2 135
- 14.9. Make fails with Virtual Alloc pointer is null error 135
- 14.10. Creating bin and hex files 136
 - 14.10.1. Simple conversion within the IDE 136
 - 14.10.2. From the command line 136
 - 14.10.3. Automatically converting the file during a build 137
 - 14.10.4. Binary files and checksums 137
- 14.11. Post-build (and Pre-build) steps 137
 - 14.11.1. 138

1. Introduction to MCUXpresso IDE

MCUXpresso IDE is a low-cost microcontroller (MCU) development platform ecosystem from NXP, which provides an end-to-end solution enabling engineers to develop embedded applications from initial evaluation to final production.

The MCUXpresso platform ecosystem includes:

- The MCUXpresso IDE, a software development environment for creating applications for NXP's ARM Cortex-M based MCUs including "LPC" and "Kinetis" ranges.
- MCUXpresso SDKs, each offering a package of device support and example software extending the capability and park knowledge of MCUXpresso IDE.
- MCUXpresso Config Tools, an integrated suite of configuration tools comprising of SDK Builder, Pins Tool and Clock Tool.
- The range of LPCXpresso development boards, each of which includes a built-in "LPC-Link", "LPC-Link2", or CMSIS-DAP debug probe. These boards are developed in collaboration with Embedded Artists.
- The range of Tower and Freedom Development boards, most of which include an Open SDA debug circuit supporting a range of firmware options.
- The standalone "LPC-Link2" debug probe.

This guide is intended as an introduction to using MCUXpresso IDE. It assumes that you have some knowledge of MCUs and software development for embedded systems.

Note: MCUXpresso IDE is built on top of much of the technology contained within the LPCXpresso IDE. This means that for users familiar with LPCXpresso IDE, the new MCUXpresso IDE will look relatively familiar.

1.1 MCUXpresso IDE Overview of Features

The MCUXpresso IDE is a fully featured software development environment for NXP's ARM-based MCUs, and includes all the tools necessary to develop high-quality embedded software applications in a timely and cost effective fashion.

MCUXpresso IDE is based on the Eclipse IDE and includes the industry standard ARM GNU toolchain. It brings developers an easy-to-use and unlimited code size development environment for NXP MCUs based on Cortex-M cores (LPC and Kinetis). This new IDE combines the best of the widely popular LPCXpresso and Kinetis Design Studio IDEs, providing a common platform for all NXP Cortex-M microcontrollers. With full-featured free (code size unlimited) and affordable professional editions, MCUXpresso IDE provides an intuitive and powerful interface with profiling, power measurement on supported boards, GNU tool integration and library, multicore capable debugger, trace functionality and more. MCUXpresso IDE debug connections support Freedom, Tower®, LPCXpresso and your custom development boards with industry- leading open-source and commercial debug probes including LPC-Link2, P&E and SEGGER.

The fully featured debugger supports both SWD and JTAG debugging, and features direct download to on-chip flash.

For the latest details on new features and functionality, please visit:

<http://www.nxp.com/mcuxpresso/ide>

1.1.1 Summary of Features

Complete C/C++ integrated development environment

- Latest Eclipse-based IDE with many ease-of-use enhancements
 - Eclipse Neon (v4.6) and CDT (v9.1)
- The IDE installs with Eclipse Plugins offering
 - Git, FreeRTOS and support for P&E Micro debug probes
- The IDE can be further enhanced with many other Eclipse plugins
- Command-line tools included for integration into build, test, and manufacturing systems

Industry standard GNU toolchain (v5 update 3) including:

- C and C++ compilers, assembler, and linker
- Converters for SREC, HEX, and binary

Advanced project wizards

- Simple creation of preconfigured applications for specific MCUs
 - Extendable with MCUXpresso SDKs
- Device-specific support for NXP's ARM-based MCUs (including LPC and Kinetis)
- Automatic generation of linker scripts for correct placement of code and data into flash and RAM
 - Extended support for flexible placement of heap and stack
- Automatic generation of MCU-specific startup and device initialization code
- No assembler required with Cortex-M MCUs

Advanced multicore support

- Provision for creating linked projects for each core in multicore MCUs
- Debugging of multicore projects within a single IDE instance, with the ability to link various debug views to specific cores

Fully featured native debugger supporting JTAG and SWD connection via LinkServer

- Built-in optimized flash programming for internal and SPI flash
- High-level and instruction-level debug
- Views of CPU registers and on-chip peripherals
- Support for multiple devices on the JTAG scan-chain

Full install and integration of 3rd party debug solutions from:

- P&E Micro
- SEGGER J-Link

Library support

- Redlib: a small-footprint embedded C library
 - RedLib-nf: a smaller footprint library offering reduced printf support
- Newlib: a complete C and C++ library
- NewlibNano: a new small-footprint C and C++ library, based on Newlib
- LPCOpen MCU software libraries
- Cortex Microcontroller Software Interface Standard (CMSIS) libraries and source code
- Extendable support per device via MCUXpresso SDKs

LinkServer Trace functionality

- Instruction trace via Embedded Trace Buffer (ETB) on certain Cortex-M3/M4 based MCUs or via Micro Trace Buffer (MTB) on Cortex-M0+ based MCUs
 - Providing a snapshot of application execution with linkage back to source, disassembly and profile

- SWO Trace on Cortex-M3/M4 based MCUs when debugging via LPC-Link2, providing functionality including:
 - Profile tracing
 - Interrupt tracing
 - Datawatch tracing
 - Printf over ITM

LinkServer Power Measurement

- On LPCXpresso boards, sample power usage at adjustable rates of up to 200 ksp/s; average power usage display option
- Explore detailed plots of collected data in the IDE
- Export data for analysis with other tools

1.1.2 Supported Debug Probes

MCUXpresso IDE installs with built in support for 3 debug solutions:

- **Native LinkServer** (including CMSIS-DAP) as also used in LPCXpresso IDE
 - this supports a variety of debug probes including OpenSDA programmed with CMSIS-DAP firmware, LPC-Link2 etc.
 - <https://community.nxp.com/message/630896>
- **P&E Micro**
 - this supports a variety of debug probes including OpenSDA programmed with P&E compatible firmware and MultiLink and Cyclone probes
 - <http://www.pemicro.com/>
- **SEGGER J-Link**
 - this supports a variety of debug probes including OpenSDA programmed with J-Link compatible firmware and J-Link debug probes
 - <https://www.segger.com/>

This support includes the installation of all necessary drivers and supporting software.

Please see Debug Solutions Overview Chapter [10] for more details.

Note: Kinetis Freedom and Tower boards typically provide an onboard OpenSDA debug circuit. This can be programmed with a range of debug firmware including:

- mBed CMSIS-DAP – supported by LinkServer connections
- DAP-Link – supported by LinkServer connections (DAP-Link is preferred to mBed CMSIS-DAP when available)
- J-Link – supported by SEGGER J-Link connections
- P&E – supported by P&E connections

The default firmware can be changed if required, for details of the procedure and range of supported firmware options please information visit: <http://www.nxp.com/opensda>

1.1.3 Development Boards

NXP Development board come in 3 families:

LPCXpresso Boards for LPC

The range of LPCXpresso boards that work seamlessly with the MCUXpresso IDE. These boards provide practical and easy-to-use development hardware to use as a starting point for your LPC Cortex-M MCU based projects.

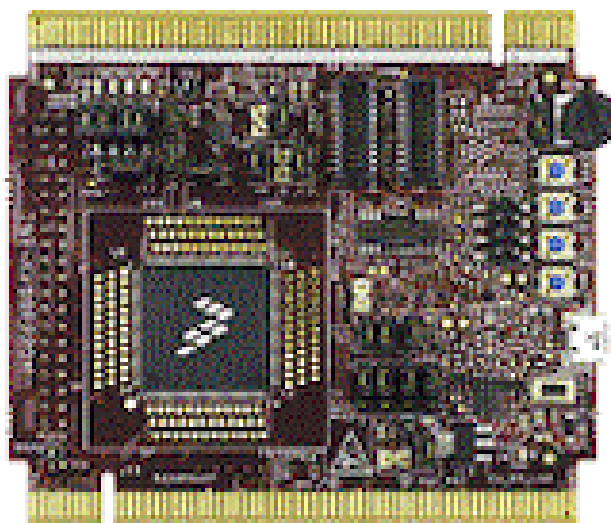

Figure 1.3. Tower (TWR-KV58F220M)

For more information, visit: http://www.nxp.com/pages/:TOWER_HOME

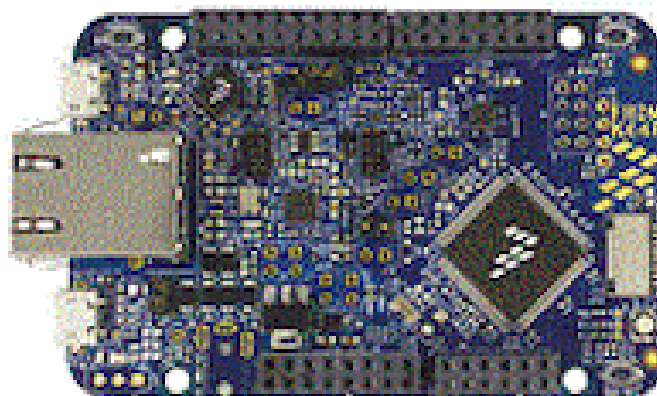

Figure 1.4. Freedom (FRDM-K64F)

For more information, visit: <http://www.nxp.com/pages/:FREDEVPLA>

2. IDE Overview

The following chapter provides a high level overview of the features offered by the IDE itself.

2.1 Documentation and Help

The MCUXpresso IDE is based on the Eclipse IDE framework, and many of the core features are described well in generic Eclipse documentation and in the help files to be found on the MCUXpresso IDE's **Help -> Help Contents** menu. That also provides access to the MCUXpresso IDE User Guide (this document), as well as the documentation for the compiler, linker, and other underlying tools.

MCUXpresso IDE documentation comprises a suite of documents including:

- MCUXpresso IDE Installation Guide
- MCUXpresso IDE User Guide
- MCUXpresso IDE LinkServer SWO Trace Guide
- MCUXpresso IDE LinkServer Instruction Trace Guide
- MCUXpresso IDE LinkServer Power Measurement Guide
- MCUXpresso IDE FreeRTOS Debug Guide

To obtain assistance on using MCUXpresso IDE, visit: <http://www.nxp.com/mcuxpresso/ide>

Related web links can be found at *Help -> Additional resources* as shown below:

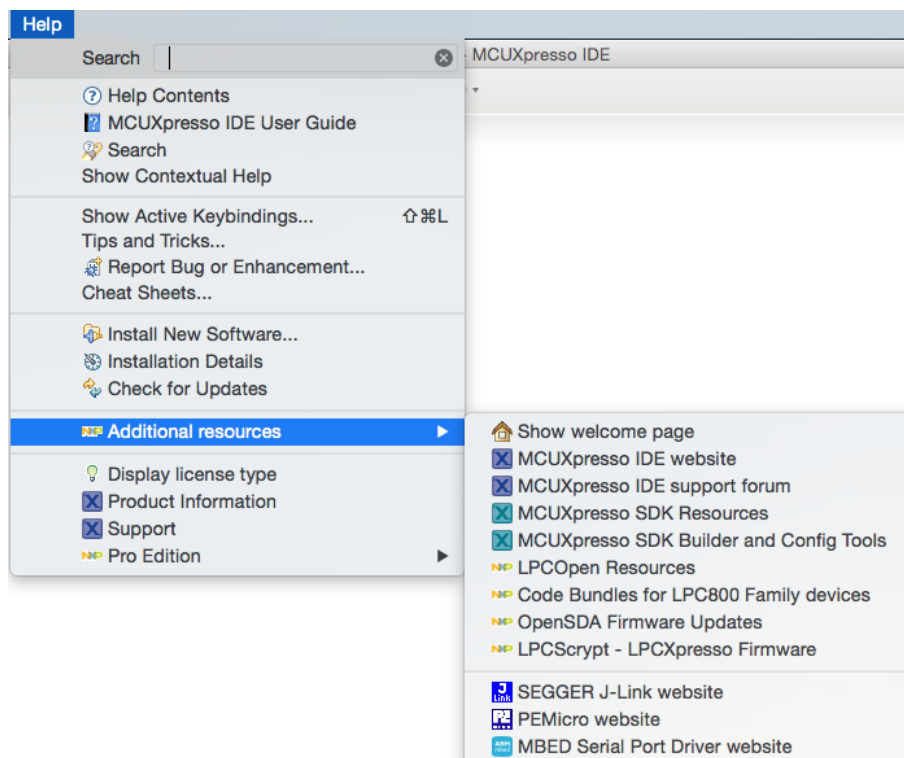

2.2 Workspaces

When you first launch MCUXpresso IDE, you will be asked to select a Workspace, as shown in Figure 2.1.

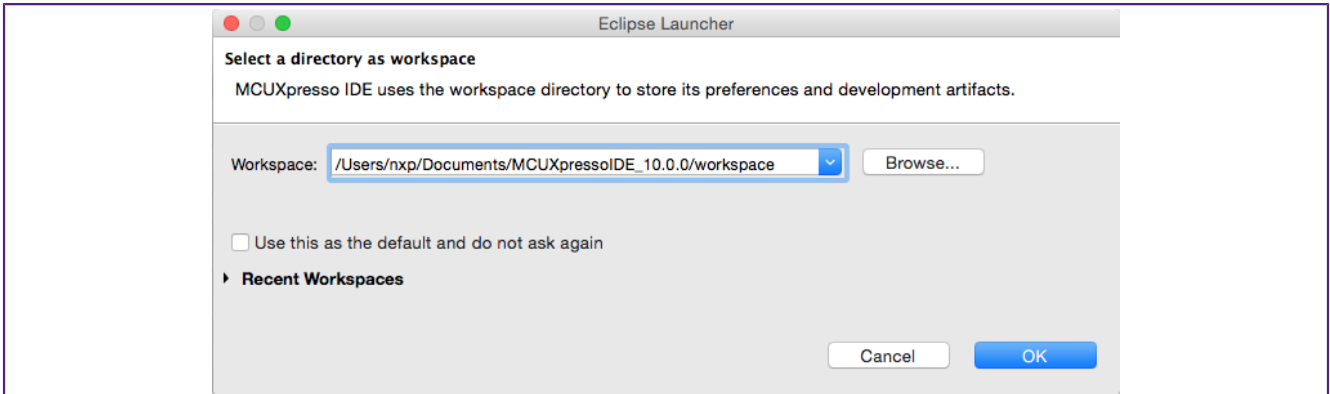

Figure 2.1. Workspace selection

A Workspace is simply a directory used to store projects. MCUXpresso IDE can only access a single Workspace at a time, although it is possible to run multiple instances in parallel — with each instance accessing a different Workspace.

If you tick the **Use this as the default and do not ask again** option, then MCUXpresso IDE will always start up with the chosen Workspace opened; otherwise, you will always be prompted to choose a Workspace.

You may change the Workspace that MCUXpresso IDE is using, via the **File -> Switch Workspace** option.

2.3 Perspectives and Views

The overall layout of the main MCUXpresso IDE window is known as a Perspective. Within each Perspective are many sub-windows, called Views. A View displays a set of data in the IDE environment. For example, this data might be source code, hex dumps, disassembly, or memory contents. Views can be opened, moved, docked, and closed, and the layout of the currently displayed Views can be saved and restored.

Typically, the MCUXpresso IDE operates using the single **Develop Perspective**, under which both code development and debug sessions operate as shown in Figure 2.3. This single perspective simplifies the Eclipse environment, but at the cost of slightly reducing the amount of information displayed on screen.

Alternatively, the MCUXpresso IDE can operate in a “dual Perspective” mode such that the **C/C++ Perspective** is used for developing and navigating around your code and the **Debug Perspective** is used when debugging your application.

You can manually switch between Perspectives using the Perspective icons in the top right of the MCUXpresso IDE window, as shown in Figure 2.2.

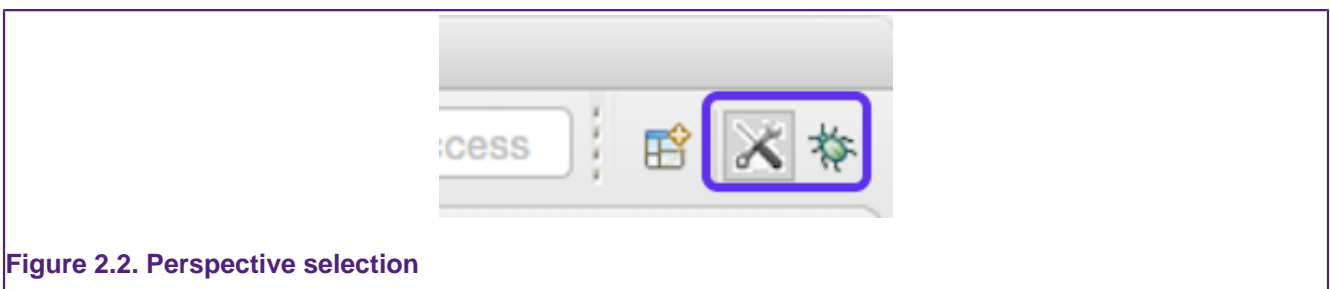

Figure 2.2. Perspective selection

All Views in a Perspective can also be rearranged to match your specific requirements by dragging and dropping. If a View is accidentally closed, it can be restored by selecting it from the

Window -> Show View dialog. The default layout for a perspective can be restored at any time via **Window -> Perspective -> Reset Perspective**.

2.4 Major Components of the Develop Perspective

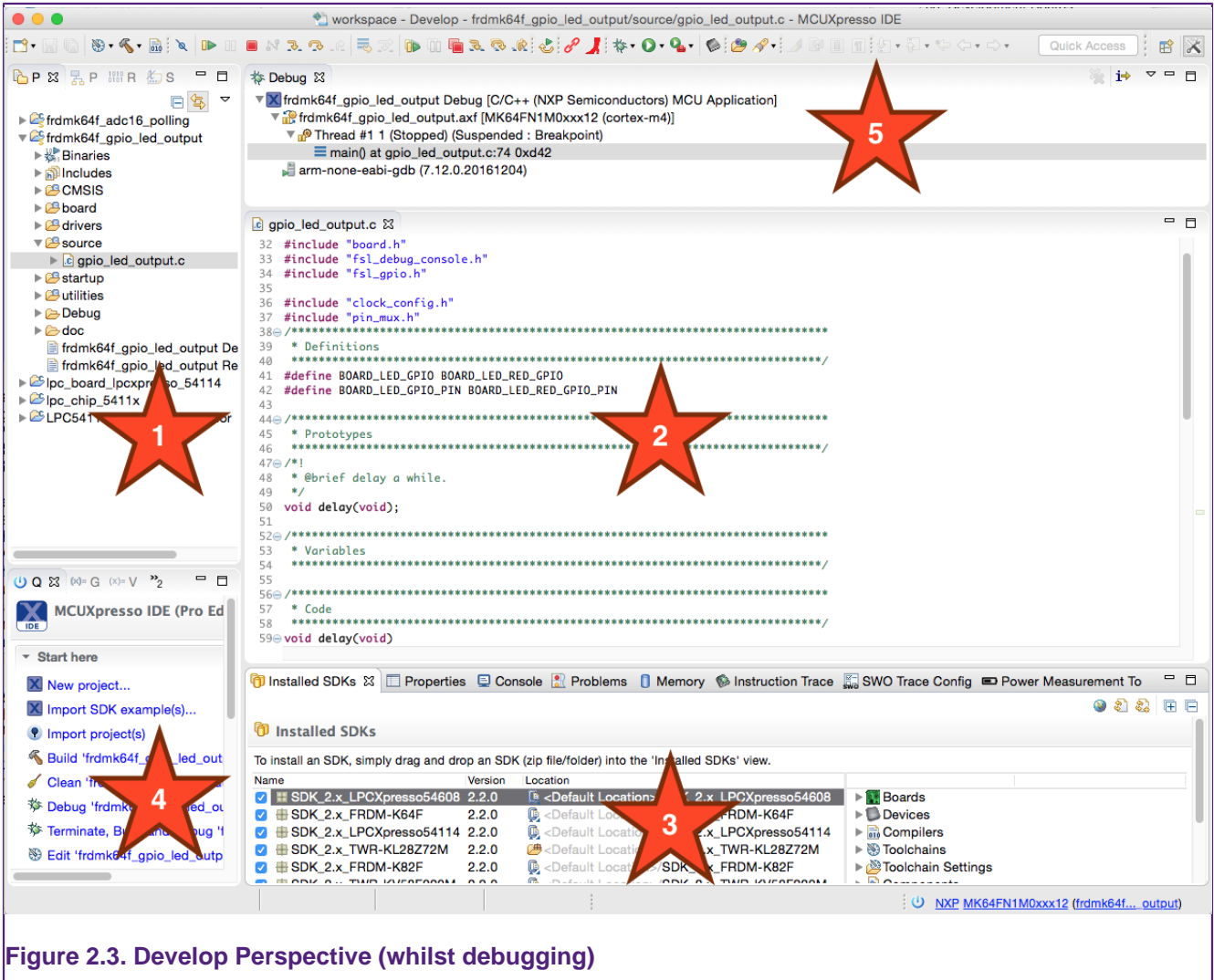

Figure 2.3. Develop Perspective (whilst debugging)

1. Project Explorer / Peripherals / Registers Views
 - The **Project Explorer** gives you a view of all the projects in your current Workspace.
 - When debugging, the **Peripherals** view allows you to display the registers within Peripherals.
 - When debugging, the **Registers** view allows you to display the registers within the CPU of your MCU.
 - Not visible here is the **Symbol Viewer**; this view displays symbolic information from a referenced .axf file.
2. Editor
 - Centrally located is the **Editor**, which allows modification and saving of source code. When debugging, this is where you can see the code you are executing and can step from line to line. By pressing the 'i->' icon at the top of the Debug view, you can switch to stepping by assembly instruction. Clicking in the left margin will set and delete breakpoints.
3. Console / Installed SDKs / Problems / Trace Views / Power Measurement
 - On the lower right are the Console, Installed SDK and Problems Views etc. The Console View displays status information on compiling and debugging, as well as semihosted program output.

- The Installed SDK view enabled the management of installed SDKs. New SDKs can be added using drag and drop. Other SDK management features are also provided from this view including unzip, explore and delete.
 - The Problems View (available by changing tabs) shows all compiler errors and warnings and will allow easy navigation to the error location in the Editor View.
 - Sitting in parallel with the Console View are the various Views that make up the Trace functionality of MCUXpresso IDE. For more information on Trace functionality, please see the MCUXpresso IDE SWO Trace Guide and/or the MCUXpresso IDE Instruction Trace Guide.
 - The SWO trace Views allow you to gather and display runtime information using the SWO/SWV technology that is part of Cortex-M3/M4 based parts.
 - On some MCUs, you can also view instruction trace data downloaded from the MCU's Embedded Trace Buffer (ETB) or Micro Trace Buffer (MTB).
 - Sitting in parallel with the Console View is the Power Measurement View, a dedicated trace View capable of displaying real-time target power usage. For more information please see the MCUXpresso IDE Power Measurement Guide.
4. Quickstart / Variables / Breakpoints / Outline Views
- On the lower left of the window, the **Quickstart Panel View** has fast links to commonly used features. From here you can find various wizards including New Project, Import from SDK and Import from File System plus options such as Build, Debug, and Import.
 - Sitting in parallel to the Quickstart Panel, the **Global Variables** View allows you to see and edit the values of Global variables. Variables can be monitored while the target is running using the LinkServer Live Variables feature.
 - Sitting in parallel to the Quickstart Panel, the **Variables** View allows you to see and edit the values of local variables.
 - Sitting in parallel to the Quickstart Panel, the **Breakpoints** View allows you to see and modify currently set breakpoints.
 - Sitting in parallel to the Quickstart Panel, the **Outline** View allows you to quickly find components of the source file with input focus within the editor.
5. Debug View
- The Debug View appears when you are debugging your application. This shows you the stack trace. In the “stopped” state, you can click on any function and inspect its local variables in the Variables tab (which is located parallel to the **Quickstart Panel View**).

3. Debug Solutions Overview

MCUXpresso IDE installs with built-in support for 3 debug solutions; comprising the Native LinkServer (including CMSIS-DAP) [13] as used in LPCXpresso IDE. Plus support for both P&E Micro [20] and SEGGER J-Link. [21]

This support includes the installation of all necessary drivers and supporting software.

The rest of this chapter discusses these different Debug solutions. For general information on debugging please see the chapter Debugging a Project [59]

Note: Within MCUXpresso IDE, the debug solution used has no impact on project setting or build configuration. Debug operations for basic debug are also identical.

To perform a debug operation:

1. select a project within the MCUXpresso IDE Project View
2. click **Debug** from within the MCUXpresso IDE **QuickStart** View
 - A probe discovery operation is automatically performed to display the available debug connections, including LinkServer, P&E and J-Link compatible probes.
3. select the required debug probe and click **OK**
 - A project launch configuration is automatically created containing debug chain specific configurations
 - Launch configurations [11] are stored within a project and are different for each of the supported debug solutions

From this point onwards, the low level debug operations are controlled by one of the above debug solutions.

However, from the users point of view, most common debug operations within the IDE will appear the same (or broadly similar), for example:

- Automatic inheritance of part knowledge
- Automatic downloading of generated image to target flash memory
- Setting breakpoints and watchpoints
- Stepping (single, step in step out etc.)
- Viewing and editing local variables, registers, peripherals, memory
- Viewing disassembly
- Semihosted IO

It is important to note that advanced operations such as the handling of launch configuration features will be very different for each debug solution.

Furthermore, advanced debug features and capabilities may vary between solutions and even similar features may appear quite different within the IDE.

MCUXpresso IDE documentation will only describe the advanced features provided by native LinkServer debug connection. These include:

- Flash programming
 - please see the chapter Introduction to LinkServer Flash Drivers [64]
- Instruction Trace
 - please see LinkServer Instruction Trace Guide
- Live Global Variable display

- described later in this chapter
- Power Measurement
 - please see LinkServer Power Measurement Guide
- FreeRTOS Debug
 - please see FreeRTOS Debug Guide
- SWO Trace (Profiling, Interrupts, Data Watch) - LPC-Link2 Only
 - please see LinkServer SWO Trace Guide

P&E Micro and SEGGER debug solutions also provide a number of advanced features, details can be found at their respective web sites.

3.1 A note about Launch Configuration files

The debug properties of a project in MCUXpresso IDE are held locally within each project in **.launch** files (known as launch configuration files).

Launch configuration files are different for each debug solution (LinkServer, SEGGER, P&E) and contain the properties of the debug connection (SWD/JTAG, and various other configurations etc.) and can also include a debug probe identifier for automatic debug probe matching.

If a project has not yet been debugged, for example a newly imported or created project, then the project will not have a launch configuration associated with it.

When the user first tries to debug a project, MCUXpresso IDE will perform a **Debug Probe Discovery** operation and present the user with a list of debug probes found. **Note:** The Debug Solutions searched can be filtered from this dialogue as highlighted, removing options that are not required will speed up this process.

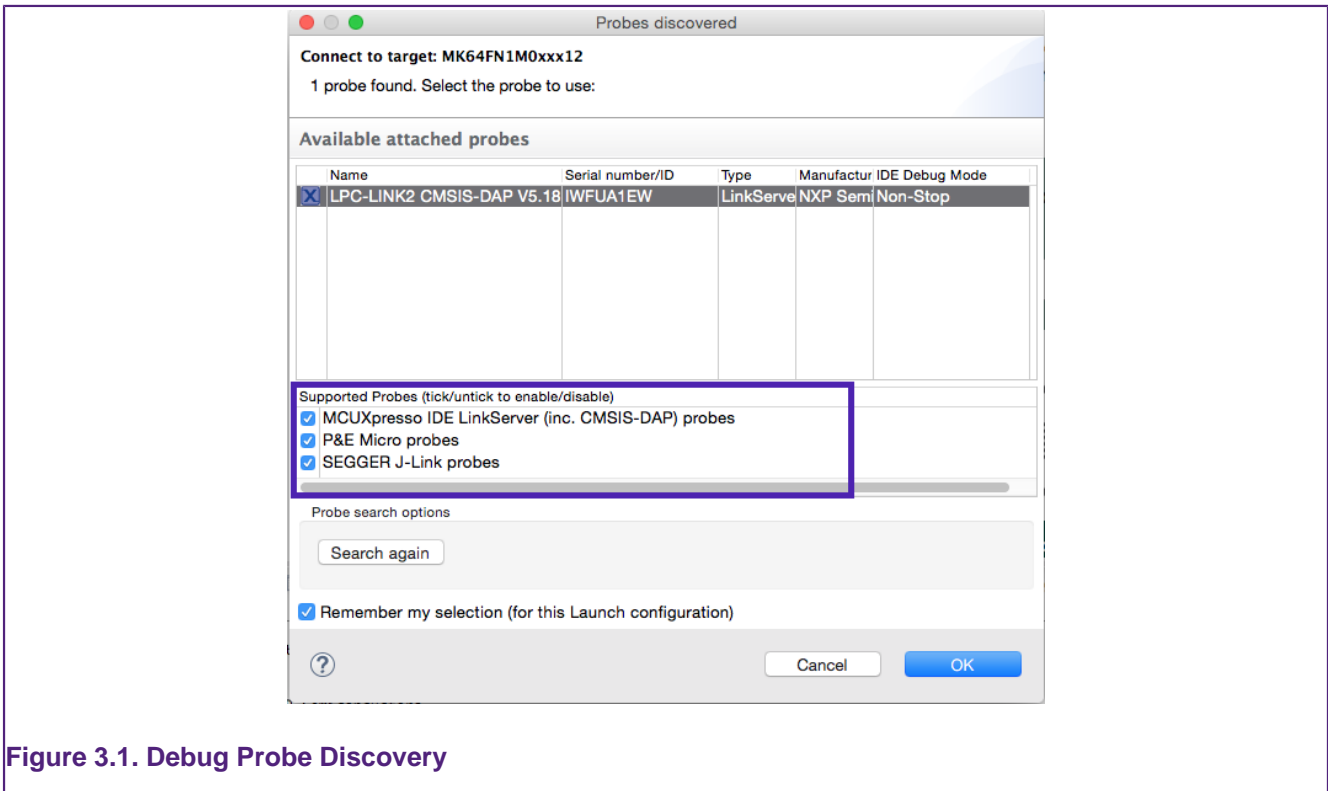

Figure 3.1. Debug Probe Discovery

Once the debug probe is selected and the user clicks 'OK', the IDE will automatically create a default launch configuration file for that debug probe (as shown below).

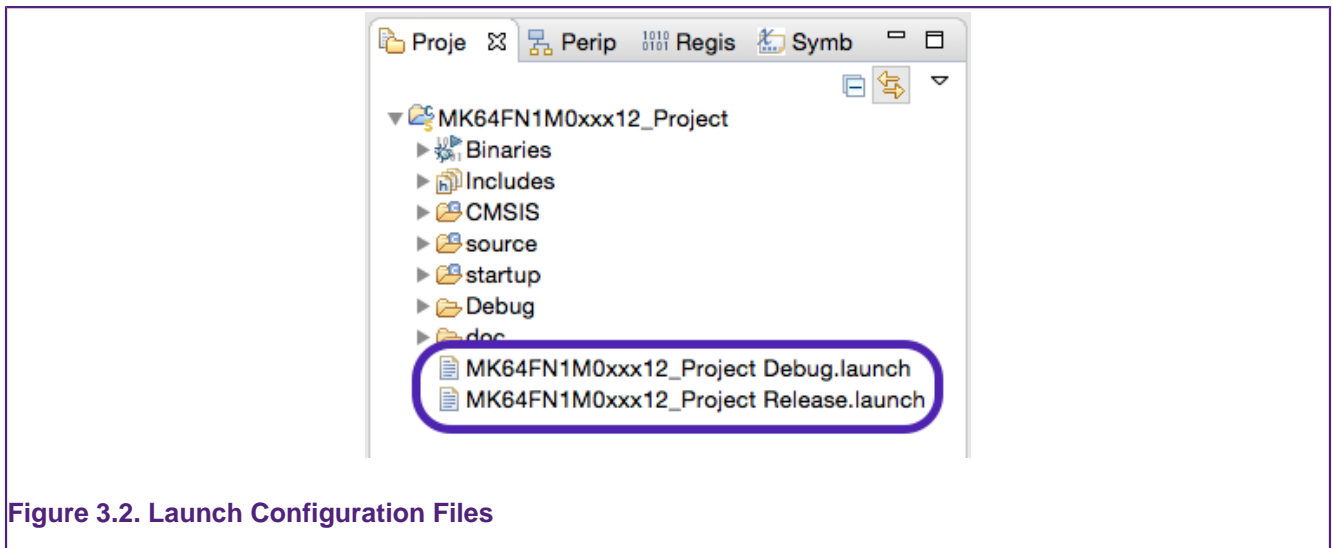

Figure 3.2. Launch Configuration Files

Note: a launch configuration will be created for each project build configuration.

For most debug operations, these files will not require any attention and can essentially be ignored. However, if changes are required, these files should not be edited manually, rather their properties should be explored within the IDE.

One way to do this is as follows:

Select the Project (with a launch configuration file) within the 'Project Explorer' pane, then Right click on the Project and select: *Launch Configurations -> Edit Current*

To view the configuration items, be sure to select the *Debugger* tab as shown below:

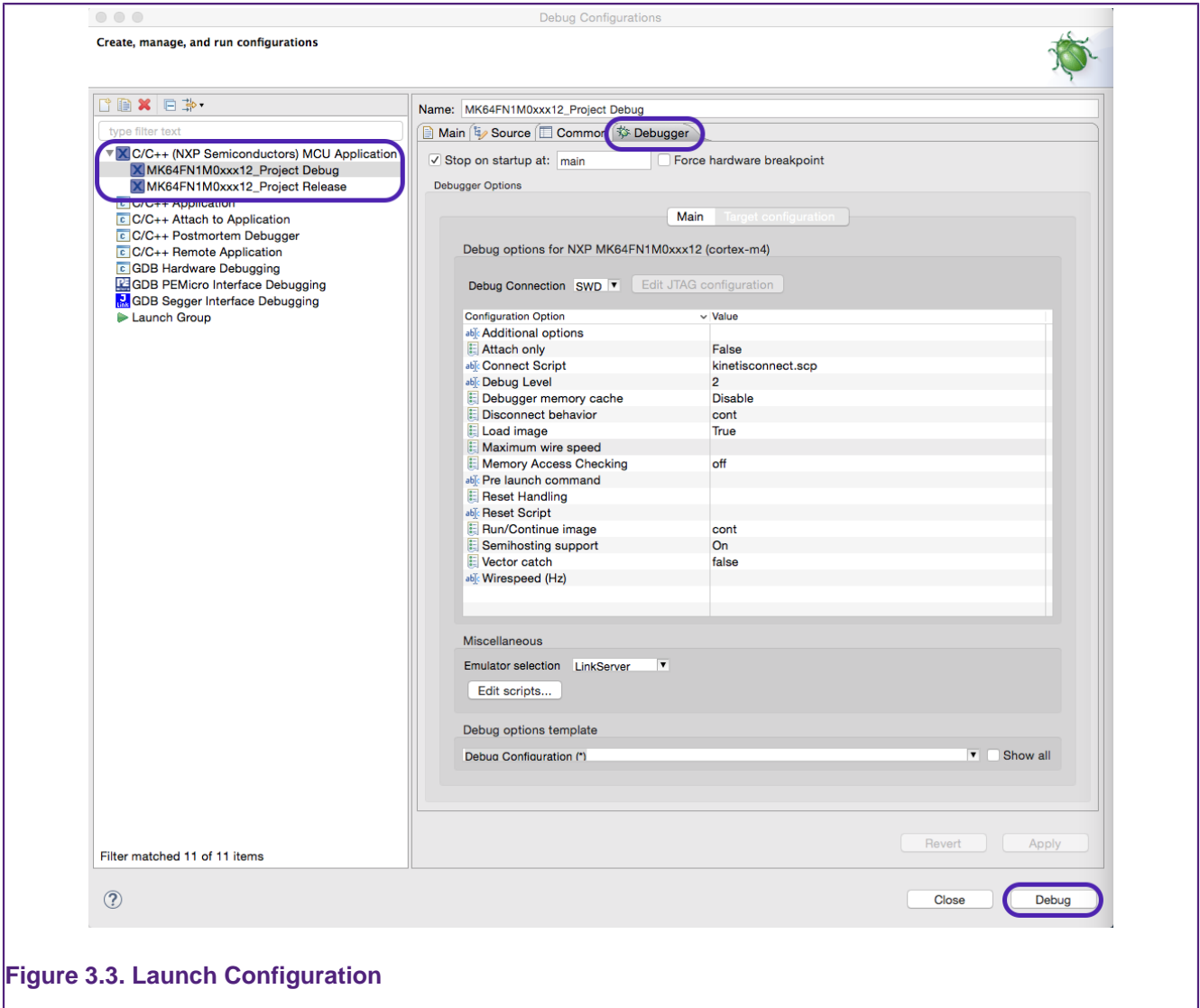

Figure 3.3. Launch Configuration

Some debug solutions support advanced operations (such as recovering of badly programmed parts) from this view.

Note: Once a launch configuration file has been created, it will be used for the projects future debug operations. If you wish to use the project with a different debug probe, then simply delete the existing launch configuration and allow a new one to be automatically used on the next debug operation.

Note: When exporting project to share with others, launch configurations should usually be deleted before export (along with other IDE generated folders such as build configuration folders (Debug/Release if present)).

For further information please see the section Launch Configurations [114]

3.2 LinkServer Debug Connections

MCUXpresso IDE's native debug connection (known as LinkServer) supports debug operation through the following debug probes:

- LPC-Link2 with CMSIS-DAP firmware
- LPCXpresso V2/V3 Boards incorporating LPC-Link2 with CMSIS-DAP firmware

- CMSIS-DAP firmware installed onto onboard debug probe hardware (as shipped by default on LPCXpresso MAX and CD boards)
 - For more information on LPCXpresso boards see: <http://www.nxp.com/lpcxpressoboards>
- CMSIS-DAP firmware installed onto onboard OpenSDA debug probe hardware (as shipped by default on certain Kinetis FRDM and TWR boards)
 - Known as DAP-Link and mBed CMSIS-DAP: <http://www.nxp.com/opensda>
 - Additional driver may be required:
 - <https://developer.mbed.org/handbook/Windows-serial-configuration>
- Other CMSIS-DAP probes such as Keil uLINK with CMSIS-DAP firmware: <http://www2.keil.com/mdk5/ulink>
- Legacy RedProbe+ and LPC-Link
- RDB1768 development board built-in debug connector (RDB-Link)
- RDB4078 development board built-in debug connector

Note: MCUXpresso IDE will automatically try to softload the latest CMSIS-DAP firmware onto LPC-Link2 or LPCXpresso V2/V3 boards. For this to occur, the DFU link on these boards must be set correctly. Please refer to the boards documentation for details.

3.3 LinkServer Debug Operation

When the user first tries to debug a project, MCUXpresso IDE will perform a Debug Probe Discovery operation and present the user with a list of debug probes found.

Note: To perform a debug operation within MCUXpresso IDE, select the project to debug within the 'Project Explorer' view and the click Debug from the **QuickStart** View.

For LinkServer compatible debug probes, you can select from Non-Stop (the default) or All-Stop IDE debug mode.

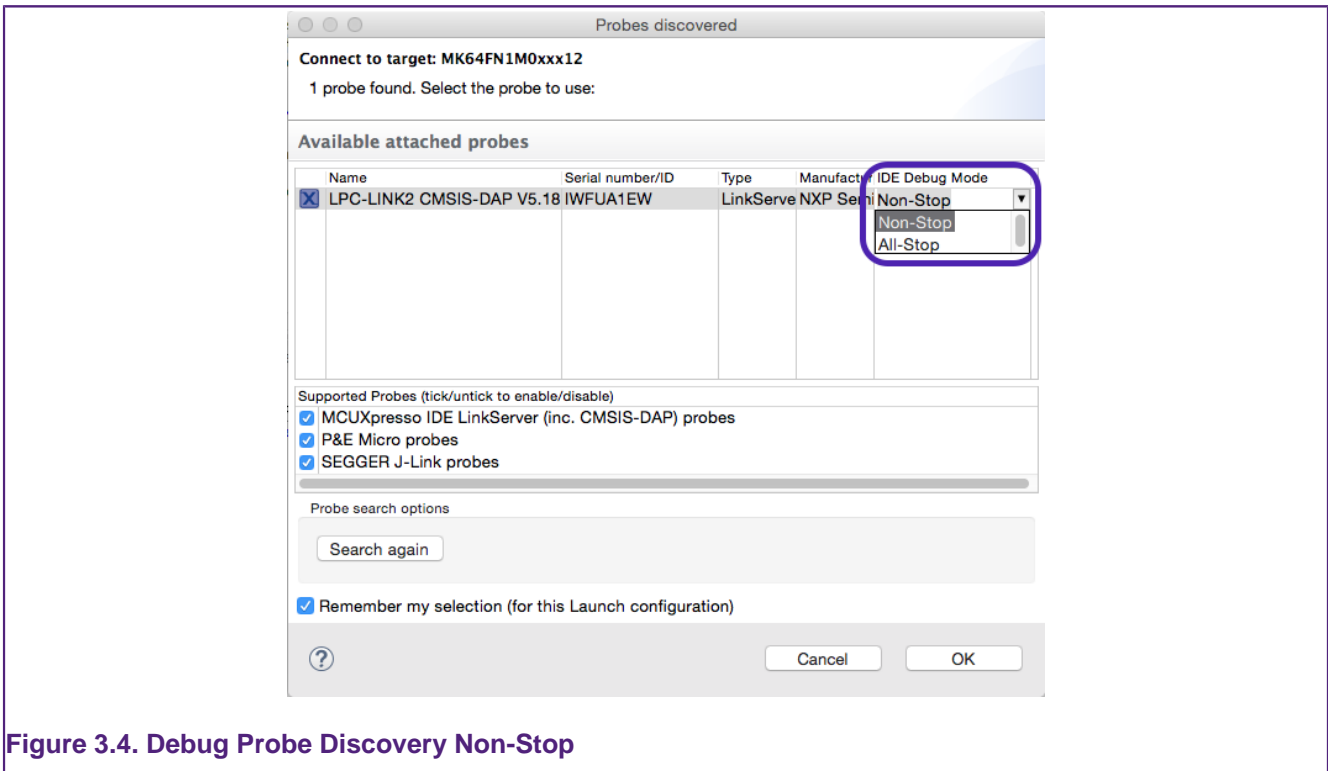

Figure 3.4. Debug Probe Discovery Non-Stop

Note: If 'Remember My Selection' is left ticked, then the probe details will be stored within the launch configuration file, and this probe will be automatically selected on subsequent debug operations for this project.

Non-Stop uses GDB's "non-stop mode" and allows data to be read from the target while an application is running. Currently this mechanism is used to support the Live Variables feature within the New Global Variables view.

3.4 LinkServer Global and Live Global Variables

MCUXpresso IDE provides a new Global Variables view for displaying the values of global variables! This replaces the use of the "Expressions" view for displaying such variables, as used in LPCXpresso IDE (and KDS). This view defaults to be located within the **QuickStart** panel.

This view can be populated from a selection of a projects global variables. Simply click the "Add global" button to launch a dialogue:

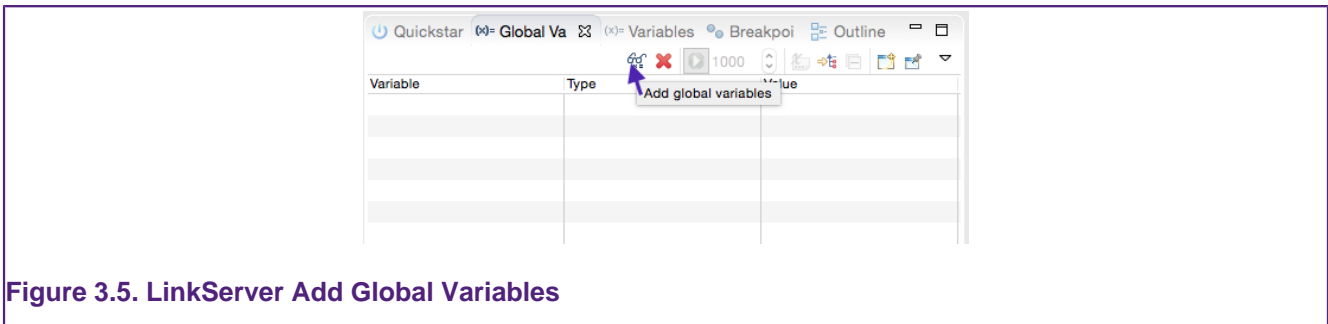

Figure 3.5. LinkServer Add Global Variables

This will then display a list of the global variables available in the image being debugged. Select the ones of interest via their checkboxes and click OK :

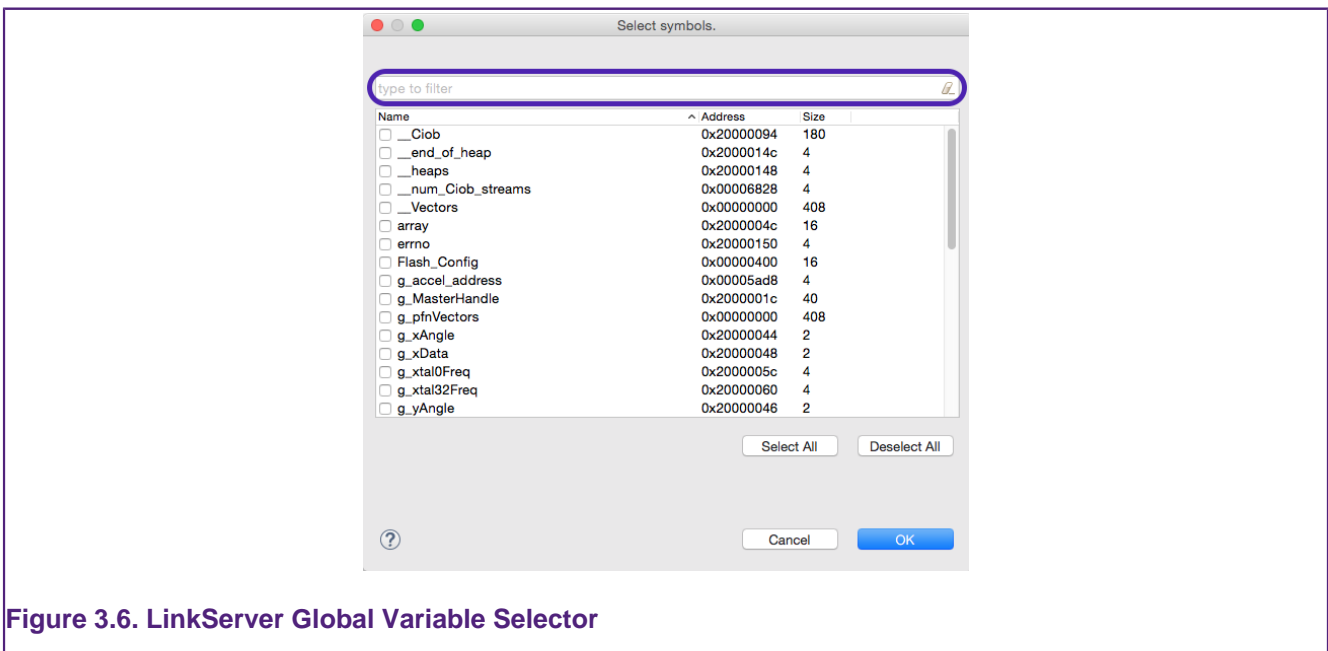

Figure 3.6. LinkServer Global Variable Selector

Note: to simplify the selection of a variable, this dialogue supports the option to filter (highlighted) and sorts on each column.

Once selected, the chosen variables will be remembered for that occurrence of the dialogue.

For "All-Stop" debug connections, the Global Variables view will be updated whenever the target is paused.

For "Non-Stop" debug connections, variables can be selected to be updated while the target is running. These are known as " **Live Variables**".

For variables to be “Live”:

- the target must be running
- the enable/disable (run) button clicked.

Once done, the display will update at the frequency selected (selectable from 500 ms to 10 s).

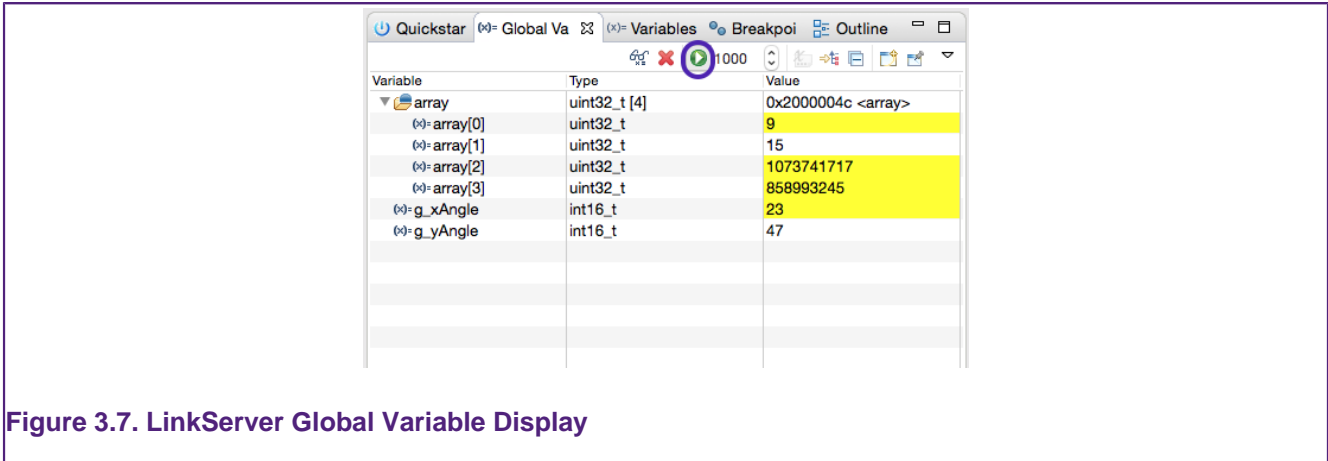

Figure 3.7. LinkServer Global Variable Display

Live Variables like normal Globals can also be edited in place. Simply click on the variable value and edit the contents. During the edit operation, the display will not update. This mechanism provides a powerful way of interacting with a running target without impacting on any other aspect of system performance.

MCUXpresso IDE defaults to the selection of “Non-Stop” mode when a probe discovery operation is performed.

Note: If you wish to have some global variables ‘Live’ and others not, then this can be achieved by spawning a second Globals display via the ‘New View’ button and populating this without enabling the ‘run’ feature for that view.

The usefulness of **Live Variables** reduces as the number monitored increases, and ultimately there will be a limit as to how many variables can be updated at the selected frequency. However, complex list of variables can be monitored if required. For example:

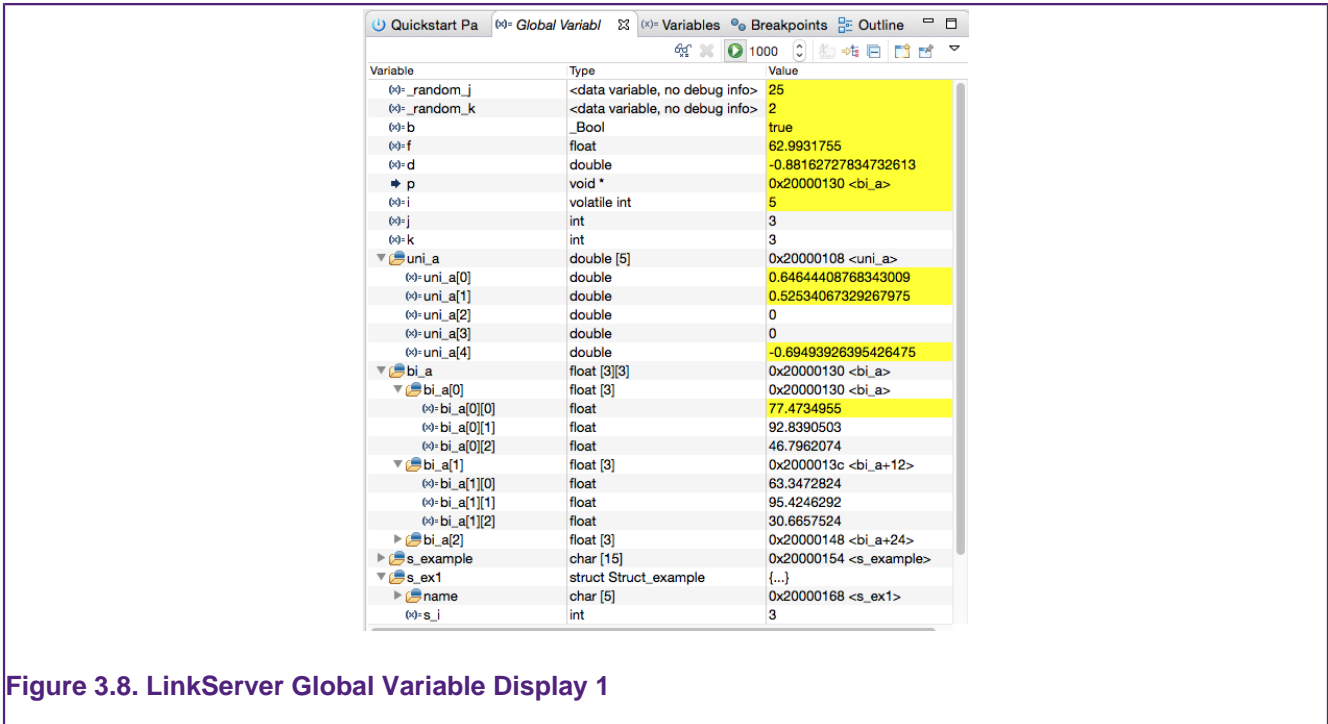

Figure 3.8. LinkServer Global Variable Display 1

MCUXpresso IDE defaults to the selection of “Non-Stop” mode when a probe discovery operation is performed. This can be disabled from an MCUXpresso IDE Preference via:

Preferences -> Debug Options (Misc)

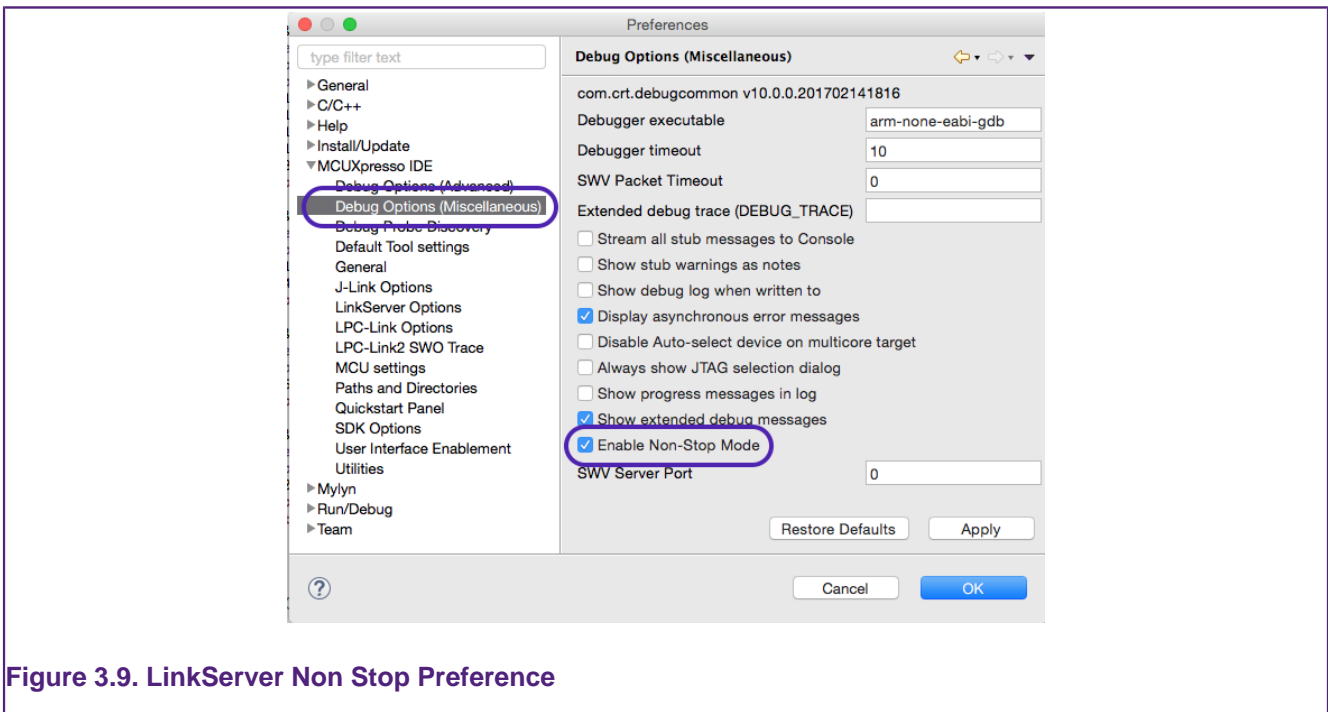

Figure 3.9. LinkServer Non Stop Preference

For a given project, the Non-Stop mode option is stored within the project’s launch configuration. For projects that already have launch configurations, these will need to be deleted before proceeding.

3.5 LinkServer Troubleshooting

3.5.1 Debug Log

On occasion, it can be useful to explore the operations of a debug session in more detail. The steps are logged into a file known as the Debug log. This log will be displayed when a Debug operation begins, but by default, will be replaced by another view when execution starts. The debug log is a standard log within the IDE's Console view. To display this log, select the Console and then click to view the various options (as below):

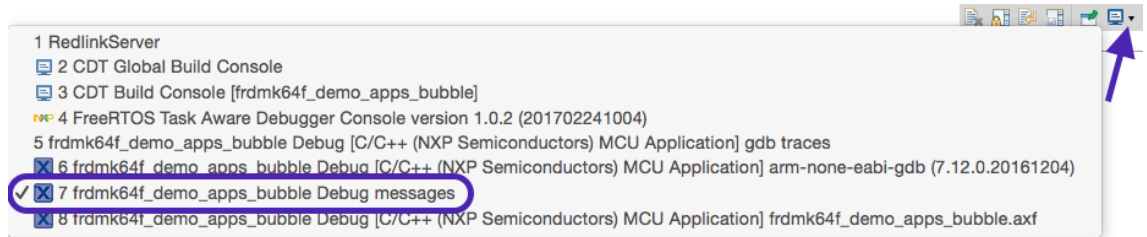

The debug log displays a large amount of information which can be useful in tracking down issues.

In the example debug log below, you can see that an initial Script file has been run. Connect scripts are required for debugging certain parts and are automatically added to launch configuration files by the IDE if required.

Further down in this log you will see the selection of flash driver (FTFE_4K), the identification of the part being debugged K64, and also the speed of flash programming (81.97 KB/sec).

```

MCUXpresso RedlinkMulti Driver v10.0 (Feb 16 2017 18:37:08 - crt_emu_cm_redlink
build 175)
Reconnected to existing redlink server (PID -1)
Connecting to core 0 (probe handle 1, PID -1) gave 'OK'
===== SCRIPT: kinetisconnect.scp =====
Kinetis Connect Script
DpID = 2BA01477
Assert NRESET
Reset pin state: 00
Power up Debug
MDM-AP APID: 0x001C0000
MDM-AP System Reset/Hold Reset/Debug Request
MDM-AP Control: 0x0000001C
MDM-AP Status (Flash Ready) : 0x00000032
Part is not secured
MDM-AP Control: 0x00000014
Release NRESET
Reset pin state: 01
MDM-AP Control (Debug Request): 0x00000004
MDM-AP Status: 0x0001003A
MDM-AP Core Halted
===== END SCRIPT =====
Probe Firmware: LPC-LINK2 CMSIS-DAP V5.181 (NXP Semiconductors)
Serial Number: IWFUA1EW
VID:PID: 1FC9:0090
USB Path: USB_1fc9_0090_14131100_ff00
Probe(0): Connected&Reset. DpID: 2BA01477. CpuID: 410FC240. Info: <None>
Debug protocol: SWD. RTCK: Disabled. Vector catch: Disabled.
    
```



```

Inspected v.2 On chip Kinetis Flash memory module FTFE_4K.cfx
Image 'Kinetis SemiGeneric Jan 13 2017 16:14:07'
Opening flash driver FTFE_4K.cfx
flash variant 'K 64 FTFE Generic 4K' detected (1MB = 256*4K at 0x0)
Closing flash driver FTFE_4K.cfx
NXP: MK64FN1M0xxx12
( 65) Chip Setup Complete
Connected: was_reset=true. was_stopped=true
MCUXpressoPro Full License - Unlimited
Awaiting telnet connection on port 3330 ...
GDB nonstop mode enabled
Opening flash driver FTFE_4K.cfx (already resident)
Writing 10744 bytes to address 0x00000000 in Flash
Erased/Wrote page 0-2 with 10744 bytes in 128msec
Closing flash driver FTFE_4K.cfx
Flash Write Done
Flash Program Summary: 10744 bytes in 0.13 seconds (81.97 KB/sec)
Stopped: Breakpoint #1

```

3.5.2 Flash Programming

Most debug operation begin with a flash programming operation, if this should fail, then the debug operation will be aborted.

Flash programming common operations:

1. Mass Erase: a mass erase will reset all the bytes in flash (usually to 0xff). Such an operation may clear any internal low level structuring such as protection of flash areas (from programming).
2. Sector Erase: internally flash devices are divided into a number of sectors, where a sector is the smallest size of flash that can be erased in a single operation. A sector will be larger than a page (see below). Sectors are usually the same size for the whole flash device, however this is not always the case. A sector base address will be aligned on a boundary that is a multiple of its size.
3. Page Program: internally flash devices are divided into a number of pages, where a page is the smallest size of flash that can be programmed in a single operation. A page will be smaller than a sector. A page base addresses will be aligned on a boundary that is a multiple of its size.

A programming operation comprises repeated operations of sector erase followed by a set of program page operations; until the sector is fully programmed or there is no more data to program.

One of the common problems when programming Kinetis parts relates to their use of flash configuration block at offset 0x400. For more information please see: Kinetis MCUs Flash Configuration Block [88] . Flash sector sizes on Kinetis MCUs range from 1KB to 8KB, therefore the first Sector Erase performed will clear the value of this block to all 0xFFs, if this is not followed by a successful program operation and the part is reset, then it will likely report as 'Secured' and subsequent debugging will not be possible until the part is recovered.

Such an event can occur if a debug operation is accidentally performed to the 'wrong board' and a wrong flash programmer is invoked.

To Recover a 'locked' part please see the section LinkServer GUI flash programmer [67]

3.5.3 LinkServer executables

LinkServer debug operations rely on 3 main debug executables.

- **arm-none-eabi-gdb** – this is a version of GDB built to target ARM based MCUs
- **crt_emu_cm_redlink** – this executable (known as the debug stub) communicates with GDB and passes low level commands to the LinkServer executable (also known as redlink server)
- **redlinkserv** – this is the LinkServer executable and takes stub operations and communicates directly with the ARM Cortex debug hardware via the debug probe.

If a debug operation fails, or a crash occurs, it is possible that one or more of these processes will fail to shut down. Therefore, if the IDE has no active debug connection but is experiencing problems making a new debug connection, ensure that none of these executables is running.

3.6 P&E Debug Connections

P&E Micro software and drivers are automatically installed when MCUXpresso IDE installs.

There is no need to perform any additional setup to use P&E Micro debug connections.

Currently we have tested using:

- Multilink Universal (FX)
- Cyclone Universal (FX) (USB and Ethernet)
- P&E firmware installed into onboard OpenSDA debug probe hardware (as shipped by default on certain Kinetis FRDM and TWR boards)

3.7 P&E Debug Operation

The process to debug via a P&E compatible debug probe is exactly the same as for a native LinkServer (CMSIS-DAP) compatible debug probe. Simply select the project via the 'Project Explorer' view then click Debug from the **QuickStart** panel and select the P&E debug probe from the Probe Discovery Dialogue.

If more than one debug probe is presented, select the required probe and then click 'OK' to start the debug session. At this point, the projects launch configuration files will be created. **Note:** P&E Launch configuration files will contain the string 'PE'.

MCUXpresso IDE stores the probe information, along with its serial number in the projects launch configuration. This mechanism is used to match any attached probe when an existing launcher configuration already exists.

Note: If the project already had a launch configuration, this will be selected and used. If they are no longer appropriate for the intended connection, simply delete the files and allow new launch configuration files to be created.

Important Note: Low level debug operations via P&E debug probes are supported by P&E software. This includes, Part Support handling, Flash Programming, and many other features. If problems are encountered, P&E Micro maintain a range of support forums at <http://www.pemicro.com/forums/>

3.7.1 P&E Differences from LinkServer Debug

MCUXpresso IDE core technology is intended to provide a seamless environment for code development and debug.

When used with P&E debug probes, the debug environment is provided by the P&E debug server. This debug server does not 100% match the features provided by native LinkServer connections. However basic debug operations will be very similar to LinkServer debug.

Note: LinkServer advanced features such as Instruction Trace, SWO Trace, Power Measurement, Live Global Variables etc. will not be available via a P&E debug connection.

3.7.2 P&E Micro Software Updates

P&E Micro support within MCUXpresso IDE is via an Eclipse Plugin. The P&E update site is automatically added to the list of Available Software Update sites.

To check whether an update is available, please select:

Help -> Check for Updates

Any available updates from P&E will then be listed for selection and installation.

3.8 SEGGER Debug Connections

SEGGER J-Link software and documentation pack is installed automatically with the MCUXpresso IDE Installation for each host platform. No user setup is required to use the SEGGER debug solution within MCUXpresso IDE.

Currently we have tested using:

- J-Link debug probes (USB and Ethernet)
- J-Link firmware installed into onboard OpenSDA debug probe hardware (as shipped by default on certain Kinetis FRDM and TWR boards)

3.8.1 SEGGER software installation

Unlike other debug solutions supplied with MCUXpresso IDE, the SEGGER software installation is not integrated into the IDE installation, rather it is a separate SEGGER J-Link installation on your host.

The installation location will be similar to:

On Windows: C:/Program Files (x86)/SEGGER/JLink_V614/jLinkGDBServerCL.exe
 On Mac: /Applications/SEGGER/JLink_V614/JLinkGDBServer

MCUXpressoIDE automatically locates the required executable and it is remembered as a Workspace preference. This can be viewed or edited within the MCUXpresso IDE preferences as below.

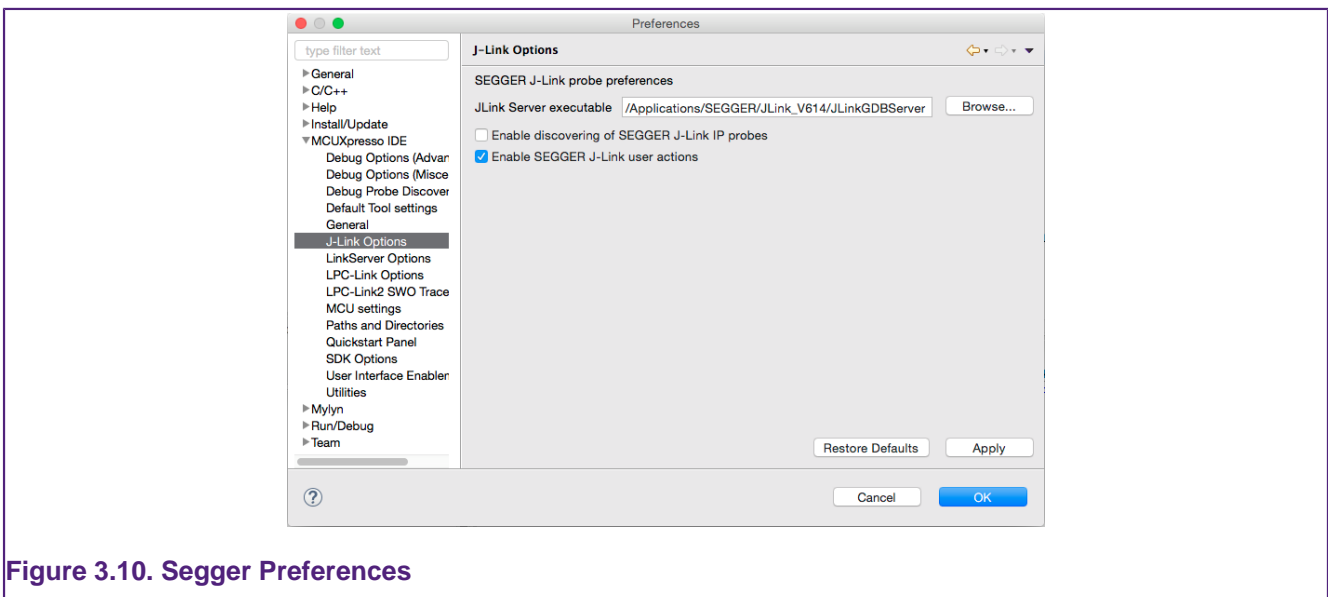

Figure 3.10. Segger Preferences

Note: this preference also provides the option to enable scanning for SEGGER IP probes (when a probe discovery operation is performed). By default, this option is disabled.

From time to time, SEGGER may release later versions of their software, which the user could choose to manually install.

MCUXpresso IDE will continue to use the SEGGER installation path as referenced in a projects workspace unless the required executable cannot be found (for example, the referenced installation has been deleted). If this occurs:

1. The IDE will automatically search for the latest installation it can find. If this is successful, the Workspace preference will automatically be updated
2. If a SEGGER installation cannot be found, the user will be prompted to located an installation

To force a particular workspace to update to use a newer installation location simply click the *Restore Default* button.

To permanently select a particular SEGGER installation version, the location of the SEGGER GDB Server can be stored in an environment variable.

For example, under Windows you could set:

```
MCUX_SEGGER_SERVER="C:/Program Files (x86)/SEGGER/JLink_V612i/jLinkGDBServerCL.exe"
```

This location will then be used, overriding any workspace preference that maybe set.

SEGGER software un-installation

If MCUXpresso IDE is uninstalled, it will not remove the SEGGER J-Link installation. If this is required, then the user must manually uninstall the SEGGER J-Link tools.

Note: If for any reason MCUXpresso IDE cannot locate the SEGGER J-Link software, then the IDE will prompt the user to either manually locate an installation or disable the further use of the SEGGER debug solution.

3.9 SEGGER Debug Operation

The process to debug via a J-Link debug probe is exactly the same as for a native LinkServer (CMSIS-DAP) compatible debug probe. Simply select the project via the 'Project Explorer' view then click Debug from the **QuickStart** Panel and select the Segger Probe from the Probe Discovery Dialogue.

If more than one debug probe is presented, select the required probe and then click 'OK' to start the debug session. At this point, the projects launch configuration files will be created.

Note: If the project already had a launch configuration, this will be selected and used. If an existing launch configuration file is no longer appropriate for the intended connection, simply delete the files and allow new launch configuration files to be created.

Important Note: Low level debug operations via SEGGER debug probes are supported by SEGGER software. This includes, Part Support handling, Flash Programming, and many other features. If problems are encountered, SEGGER's provide a range of support forums at <http://forum.segger.com/>

3.9.1 SEGGER Differences from LinkServer Debug

MCUXpresso IDE core technology is intended to provide a seamless environment for code development and debug. When used with SEGGER debug probes, the debug environment is provided by the SEGGER debug server. This debug server does not 100% match the features provided by native LinkServer connections. However basic debug operations will be very similar to LinkServer debug.

Note: LinkServer features such as Instruction Trace, SWO Trace, Power Measurement, Live Global Variables etc. will not be available via a SEGGER debug connection.

3.10 SEGGER Troubleshooting

When a debug operation to a SEGGER debug probe is performed, the SEGGER GDB server is called with a set of arguments provided by the launch configuration file. The command and resulting output is logged within the IDE Segger Debug Console. The console can be viewed as below:

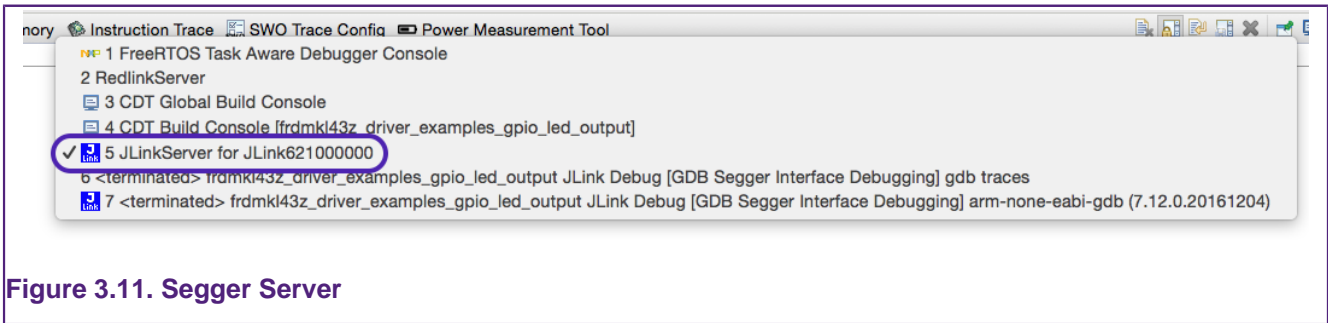

Figure 3.11. Segger Server

The command can be copied and called independently of the IDE to start a debug session and explore connection issues.

Below is the shortened output of a successful debug session to a Kinetis KL43 Freedom Board.

```

Executing Server: /Applications/SEGGER/JLink_V614/JLinkGDBServer -nosilent
-swoport 2332 -select USB=621000000 -telnetport 2333 -endian little -noir
-speed auto -port 2331 -vd -device MKL43Z256xxx4 -if SWD -nohalt -reportuseraction
bc..
SEGGER J-Link GDB Server V6.14 Command Line Version
bc..
JLinkARM.dll V6.14 (DLL compiled Feb 23 2017 17:31:36)
bc..
-----GDB Server start settings-----
GDBInit file:           none
GDB Server Listening port: 2331
SWO raw output listening port: 2332
Terminal I/O port:     2333
Accept remote connection: yes
Generate logfile:      off
Verify download:       on
Init regs on start:    off
Silent mode:           off
Single run mode:       off
Target connection timeout: 0 ms
-----J-Link related settings-----
J-Link Host interface:  USB
J-Link script:         none
J-Link settings file:  none
-----Target related settings-----
Target device:         MKL43Z256xxx4
Target interface:      SWD
Target interface speed: auto
Target endian:         little
bc..
Connecting to J-Link...
    
```

```
J-Link is connected.
Device "MKL43Z256XXX4" selected.
Firmware: J-Link OpenSDA compiled Nov 16 2016 09:42:59
Hardware: V1.00
S/N: 621000000
Checking target voltage...
Target voltage: 3.30 V
Listening on TCP/IP port 2331
...
Connected to target
Waiting for GDB connection...Connected to 127.0.0.1
Reading all registers
...Target halted (PC = 0x00000150)
Read 4 bytes @ address 0x00000150 (Data = 0x46C0E7FE)
Resetting target
Semi-hosting enabled (Handle on BKPT)
Downloading 6940 bytes @ address 0x00000000 - Verified OK
J-Link: Flash download: Flash programming performed for 1 range (7168 bytes)
J-Link: Flash download: Total time needed: 0.480s (Prepare: 0.081s, Compare: 0.024s,
Erase: 0.105s, Program: 0.238s, Verify: 0.023s, Restore: 0.007s)
Writing register (PC = 0x00010000)
Read 4 bytes @ address 0x00000100 (Data = 0xB672B510)
Read 2 bytes @ address 0x00000414 (Data = 0xF000)
Read 2 bytes @ address 0x00000414 (Data = 0xF000)
Read 2 bytes @ address 0x00000414 (Data = 0xF000)
Setting breakpoint @ address 0x00000414, Size = 2, BPHandle = 0x0001
Starting target CPU...
...Breakpoint reached @ address 0x00000414
Reading all registers
Read 4 bytes @ address 0x00000414 (Data = 0xF816F000)
Removing breakpoint @ address 0x00000414, Size = 2
```

4. SDKs and Pre-Installed Part Support Overview

To support a particular MCU (or family of MCUs), a number of elements are required. These break down into:

- Startup code
 - This code will handle specific features required by the MCU
- Memory Map knowledge
 - The addresses and sizes of all memory regions
- Peripheral knowledge
 - Detailed information allowing the MCUs peripherals registers to be viewed and edited
- Flash Drivers
 - Routines to program the MCU's on and off chip flash devices as efficiently as possible
- Debug capabilities
 - Knowledge of the MCU debug interfaces and features (e.g. SWO, ETB)
- Example Code
 - Code to demonstrate the features of the particular MCU and supporting drivers

MCUXpresso IDE uses these data elements for populating its wizards, and for built in intelligence features, such as the automatic generation of linker scripts etc.

MCUXpresso IDE delivers its part support through an extensible scheme.

4.1 Pre-installed Part Support

Firstly the IDE installs with an enhanced version of the part support as provided with LPCXpresso IDE v 8.2.2. This provides support for the majority of LPC parts 'out of the box'. This is known as pre-installed part support.

Example code for these pre-installed parts is provided by sophisticated LPCOpen packages (and Code Bundles). Each of these contains code libraries to support the MCU features, LPCXpresso boards (and some other popular ones), plus a large number of code examples and drivers. Version of these are installed by default at:

```
<install dir>/ide/Examples/LPCOpen  
<install dir>/ide/Examples/CodeBundles
```

Further information can be founds at:

<http://www.nxp.com/lpcopen>

<http://www.nxp.com/LPC800-Code-Bundles>

4.2 SDK Part Support

Secondly, MCUXpresso IDE's part support can be extended using freely available MCUXpresso SDK2.x packages. These can be installed via a simple 'drag and drop' and automatically extend the IDE with new part knowledge and examples.

SDKs for MCUXpresso IDE can be generated and downloaded as required using the SDK Builder on the MCUXpresso Config Tools website at:

<http://mcuxpresso.nxp.com/>

Support for Kinetis devices is delivered by SDK2.x packages, in addition this mechanism will be used to offer support for new LPC MCUs from NXP such as the LPC54608J512.

Once an SDK has been installed, the included part support becomes available through the New Project Wizard and also the SDK example import Wizard.

4.2.1 Important notes for SDK users

Only SDKs created for MCUXpresso IDE can be used

Only SDKs built specifically for **MCUXpresso IDE** are compatible with MCUXpresso IDE. SDKs created for any other toolchain will not work! Therefore, when requesting an SDK be sure that MCUXpresso IDE is specified as the Toolchain.

Shared Part Support handling

Each SDK package will contain part support for one or more MCUs, therefore it is possible to have two (or more) SDK packages containing the same part support. For example, a user might request a Tower K64 SDK and later a Freedom K64 SDK that both target the same MK64FN1M0xxx12 MCU. If both SDKs are installed into the IDE, both sets of examples and board drivers will be available, but the IDE will select the most up to date version of part support specified within these SDKs. This means the various wizards and dialogues will only ever present a single instance of an MCU, but may offer a variety of compatible boards and examples. **Note:** If a board is selected (from one SDK) and part support is provided by another SDK, a message will be displayed within the project wizard to show this has occurred but no user action is required.

If two SDKs with matching part support are installed, and the SDK providing part support later deleted, then part support will automatically be used from the remaining SDK.

Building a Fat SDK

An SDK can be generated for a selected part (processor type/MCU) or a board. If just a part is selected, then the generated SDK will contain both part support and also board support data for the closest matching development board.

Therefore, to obtain an SDK with both Freedom and Tower board support for say the Kinetis MK64... part, simply select the part and the board support will be added automatically.

If a part is chosen that has no directly matching board, say the Kinetis MK63... then the generated SDK will contain:

- part support for the requested part i.e. MK63...
- part support for the recommended closest matching part that has an associated development board i.e. MK64...
- board support packages for the above part i.e. Freedom and/or Tower MK64...

Uninstallation Considerations

MCUXpresso IDE allows SDKs to be installed and uninstalled as required (although for most users there is little benefit in uninstalling an SDK). However, since the SDK provides part support to the IDE, if an SDK is uninstalled, part support will also be removed. Any existing project built using part support from an uninstalled SDK will no longer build or debug. Such a situation can be remedied by re-installing the missing SDK. **Note:** if there is another SDK installed capable of providing the 'missing' part support, then this will automatically be used.

Sharing Projects

If a project built using part support from an SDK and is then exported – for example to share the project with a colleague who also uses MCUXpresso IDE, then the colleague must also install an SDK providing part support for the project's MCU. **Note:** it is recommended that any required SDKs are installed before a project requiring SDK part support is imported. However, if this is not done, simply select the imported project in the project explorer and right click and select: *C/C++ Build -> MCU settings* ensure the correct MCU is selected and click **Refresh MCU Cache**. Please see the section Importing Example Projects [54]

4.2.2 Differences in Pre-installed and SDK part handling

Since SDKs bundle part (MCU) and board support into a single package, MCUXpresso IDE is able to provide linkage between SDK installed MCUs and their related boards when creating or importing projects.

For pre-installed parts, the board support libraries are provided within LPCOpen packages and Code Bundles. It is the responsibility of user to match an MCU with its related LPCOpen board and chip library when creating or importing projects.

Creating and importing project using Pre-Installed and SDK part support is described in the following chapters.

4.3 Viewing Pre-installed Part Support

When MCUXpresso IDE is installed, it will contain pre-installed part support for most LPC based MCUs.

To explore the range of pre-installed MCUs simply click 'New project' in the **QuickStart panel**. This will open a page similar to the image below:

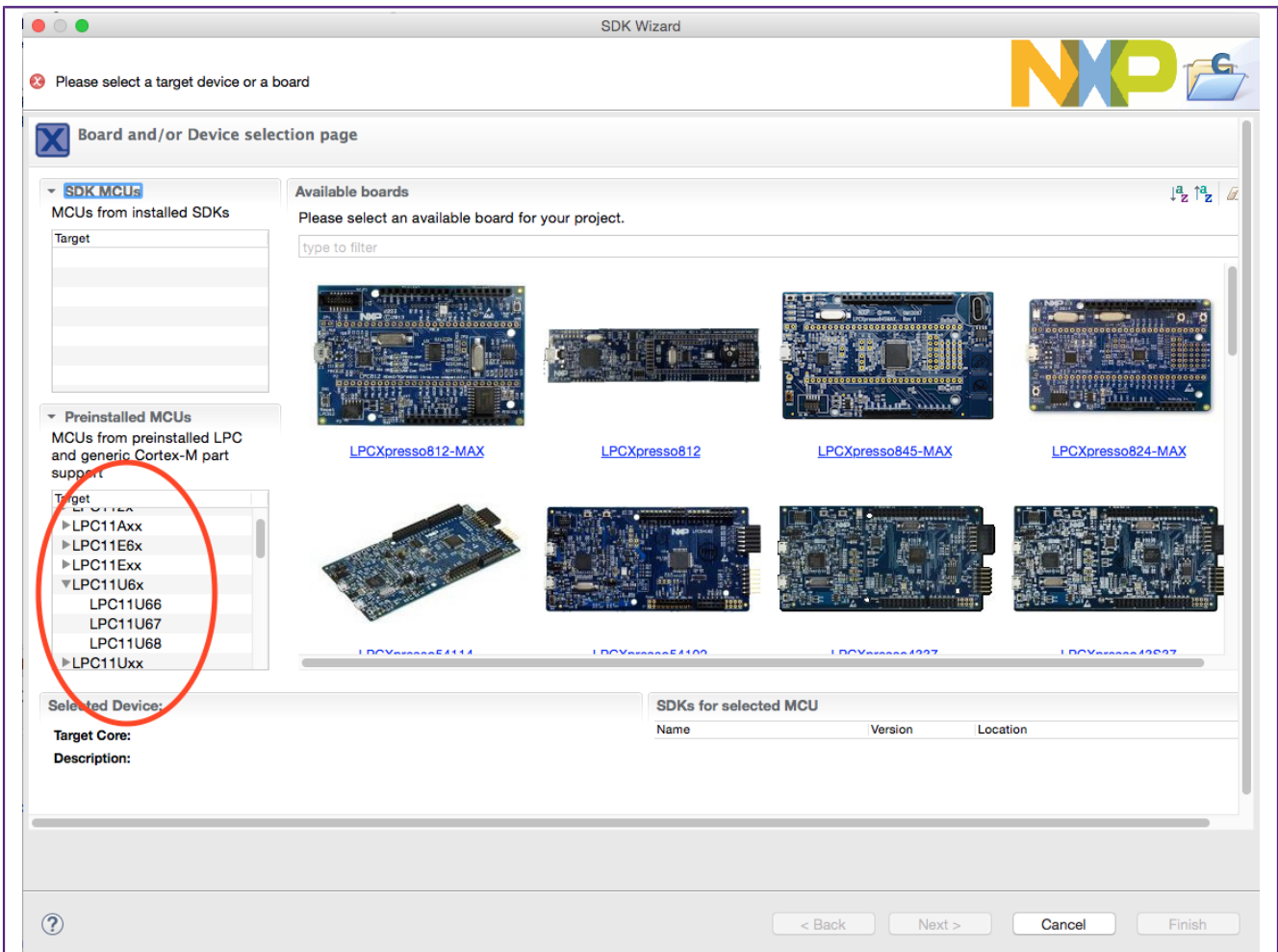

Figure 4.1. New Project Wizard

The list of pre-installed parts is presented on the bottom left of this window.

You will also see a range of related development boards indicating whether a matching LPCOpen Library or Code Bundle is available.

For creating project with Pre-Installed part support please see: Creating Projects with Pre-Installed part support) [47]

If you intend to work on an MCU that is not available from the range of Pre-Installed parts for example a Kinetis MCU then you must first extend the part support of MCUXpresso IDE with the required SDK.

4.4 Installing an SDK

The process to follow is simple, first download the SDK package, then install this into MCUXpresso IDE.

The easiest way to do this is to switch to the “Installed SDKs” view within the MCUXpresso IDE console view (highlighted below).

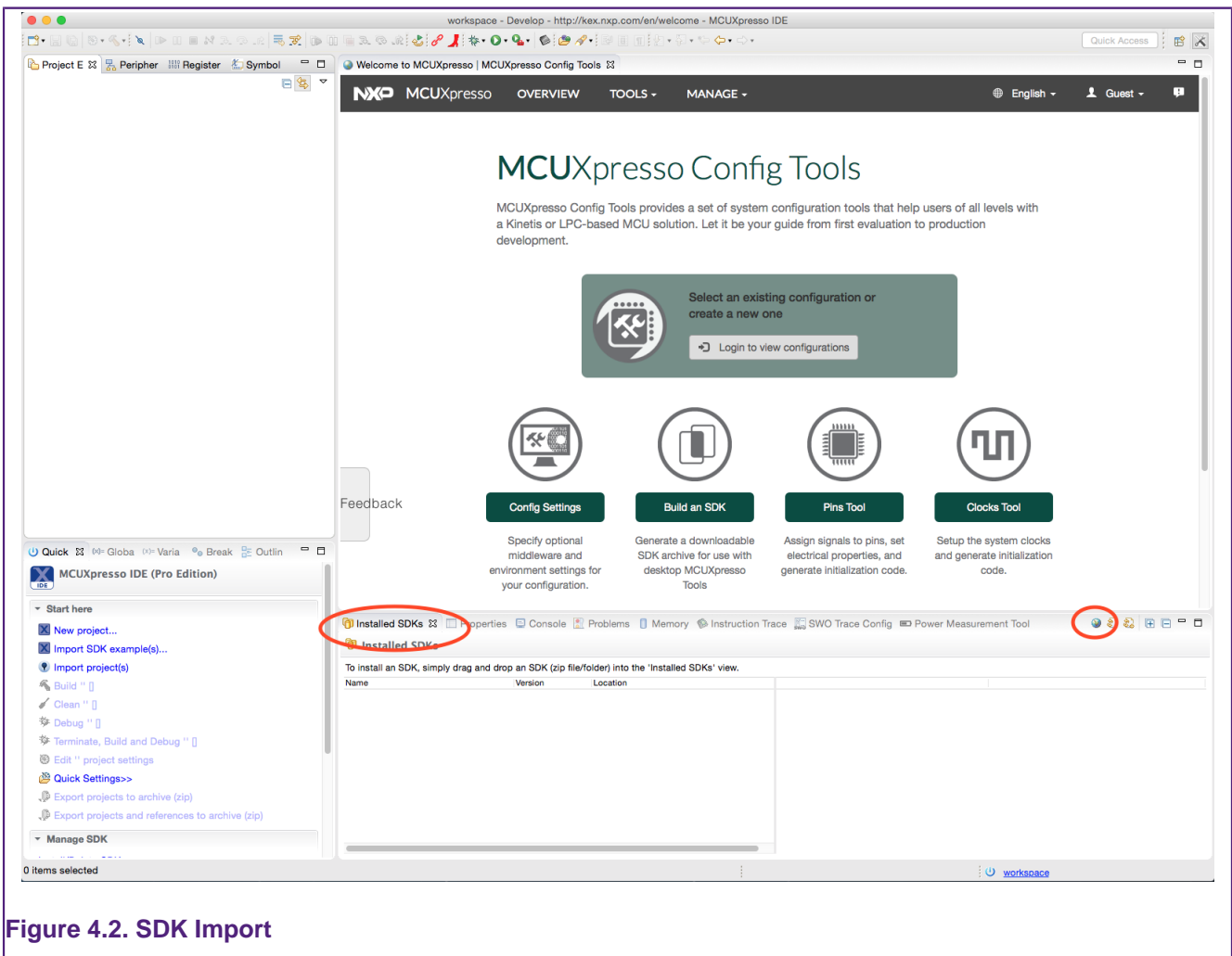

Figure 4.2. SDK Import

SDKs are free to download (login is required); MCUXpresso IDE offers a link to the SDK portal from the Installed SDK Console view (as indicated above). If required, the necessary SDK can be downloaded onto the host machine.

To install the SDK, simply open a Windows Explorer / filer onto the directory containing the SDK package(s), then select the ZIP file(s) and drag them into the “Installed SDKs” view.

You will then be prompted with a dialog asking you to confirm the import – click OK. The SDK or SDKs will then be automatically installed into MCUXpresso IDE part support repository.

Notes:

- MCUXpresso IDE can import an SDK as a zipped package or unzipped folder. Typically importing as a zipped package is expected.
 - The main consequence of leaving SDKs zipped is that you will not be able to create (or import projects) into a workspace with linked references back to the SDK source files.
- When an SDK is imported via drag and drop, required files are copied and the original file/folder is unaffected. This also installs imported data into a default location allowing imported SDKs to be shared among different IDE instances/installations and workspaces.

Once complete the “Installed SDKs” view will update to show you the package(s) that you have just installed.

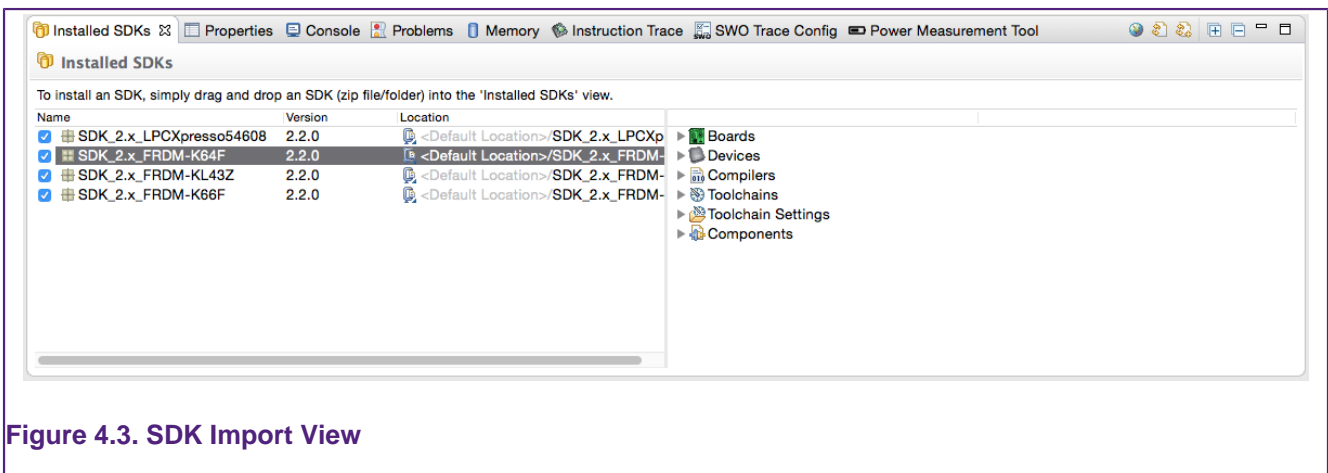
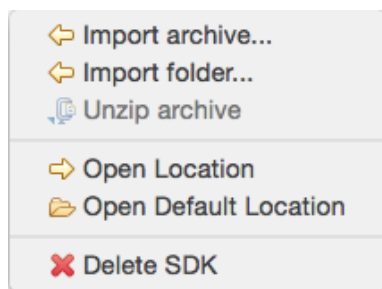

Figure 4.3. SDK Import View

The display will show whether the SDKs are stored as zipped folders or not. MCUXpresso IDE offers the option to unzip an archive in place via a right click option onto the selected SDK (as below).



Note: Unzipping an SDK may take some time and is generally not needed unless you wish to make use of referenced files or perform many example imports (where some speed improvement will be seen).

Once an SDK has been unzipped, its icon will be updated to reflect that it is now stored internally as a folder.

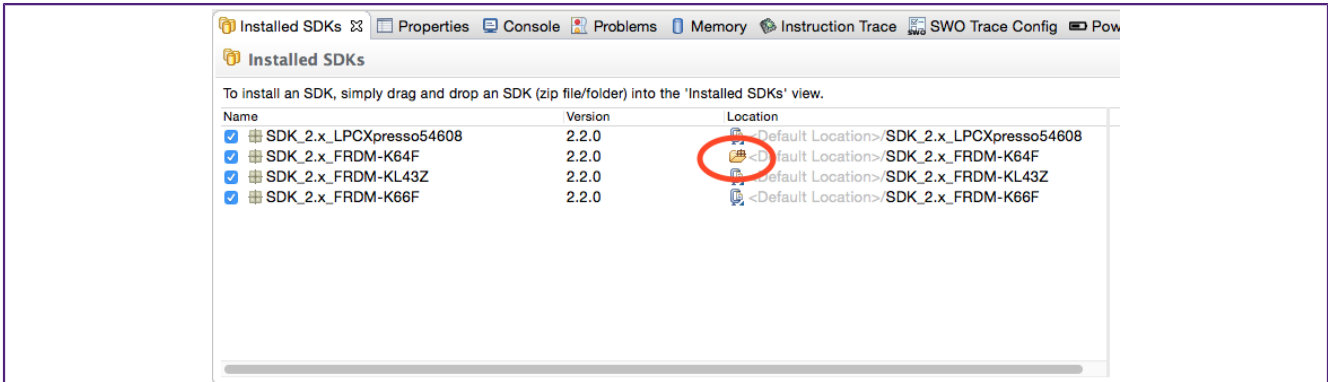

Figure 4.4. SDK Unzipped

You can explore each of the SDKs within the “Installed SDKs” view to examine its contents as below:

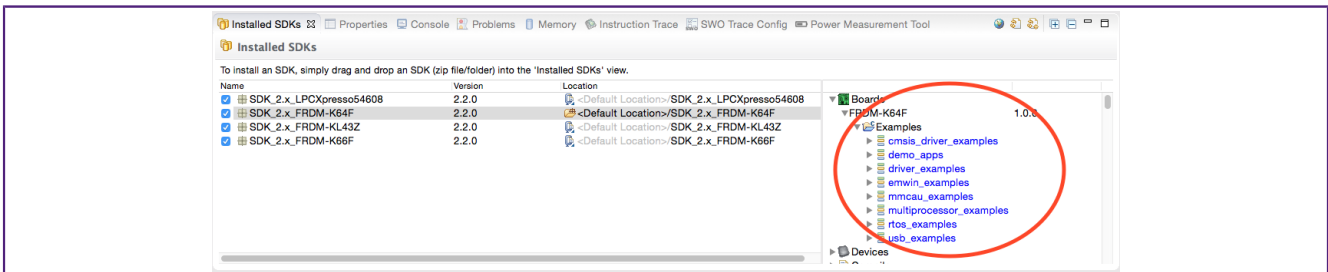

Figure 4.5. SDK Explore

4.4.1 Advanced Use: SDK Importing and Configuration

Although using the “Installed SDKs” view offers the most straight forward way of importing SDKs, MCUXpresso IDE also provides additional capabilities for importing and configuring its SDK usage.

If you go to *Preferences->MCUXpresso IDE->SDK Options* then the following window will appear:

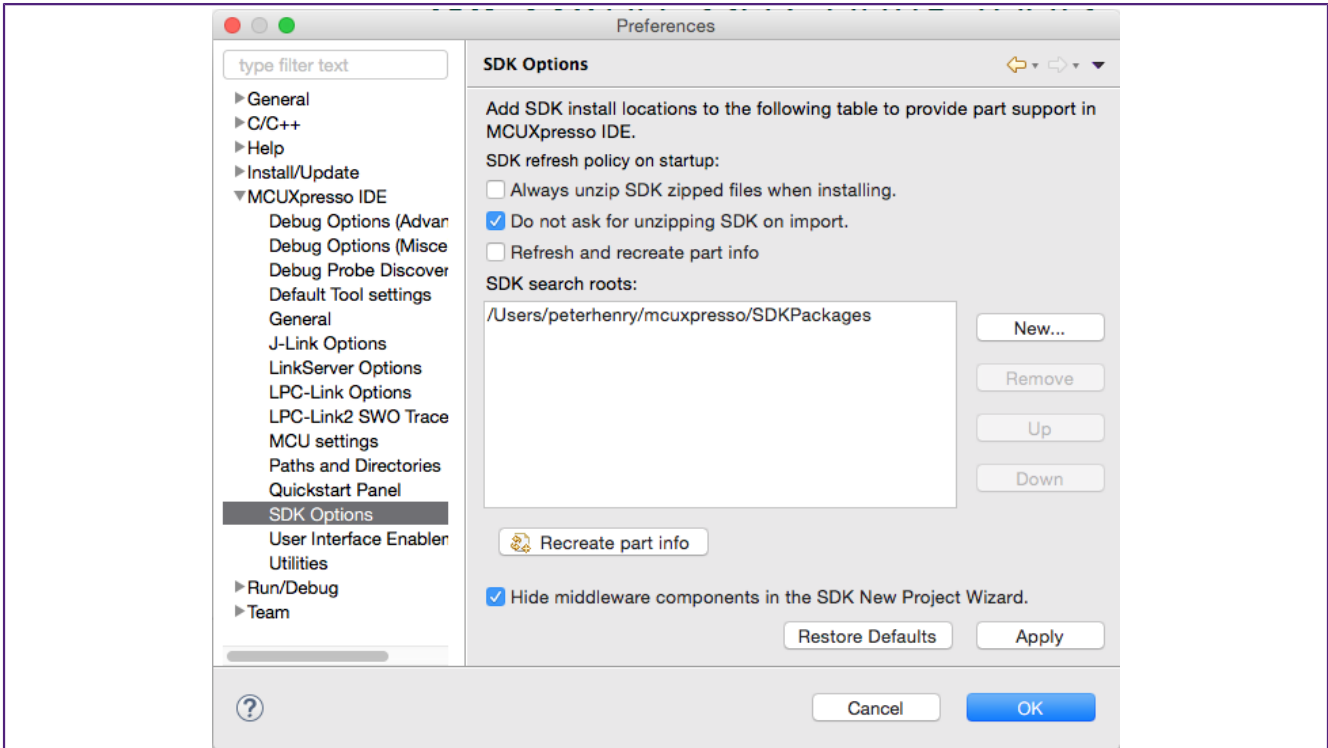

Figure 4.6. SDK Preferences

From here you can add paths to other folders where you have stored or plan to store SDK folders/zips. Those SDKs will appear in the Installed SDKs View along with those from the default location.

The main differences between having SDKs in the default location or leaving them in other folders are:

- “Delete SDK” function is disabled when using non-default locations
 - since these SDKs are not imported, they may be original files
- The knowledge of the SDKs and their part support is per-workspace

The order of the SDKs in the SDK location list may be important on occasion: if you have multiple SDKs for the same part in various locations, you can choose which to load by reordering. If multiple SDK are found, a warning is displayed into the Installed SDK view.

5. Creating New Projects using SDKs

For creating project with Pre-Installed part support please see: Creating Projects with Pre-Installed part support [47]

From the **QuickStart** Panel in the bottom left of the MCUXpresso IDE window there are two options:

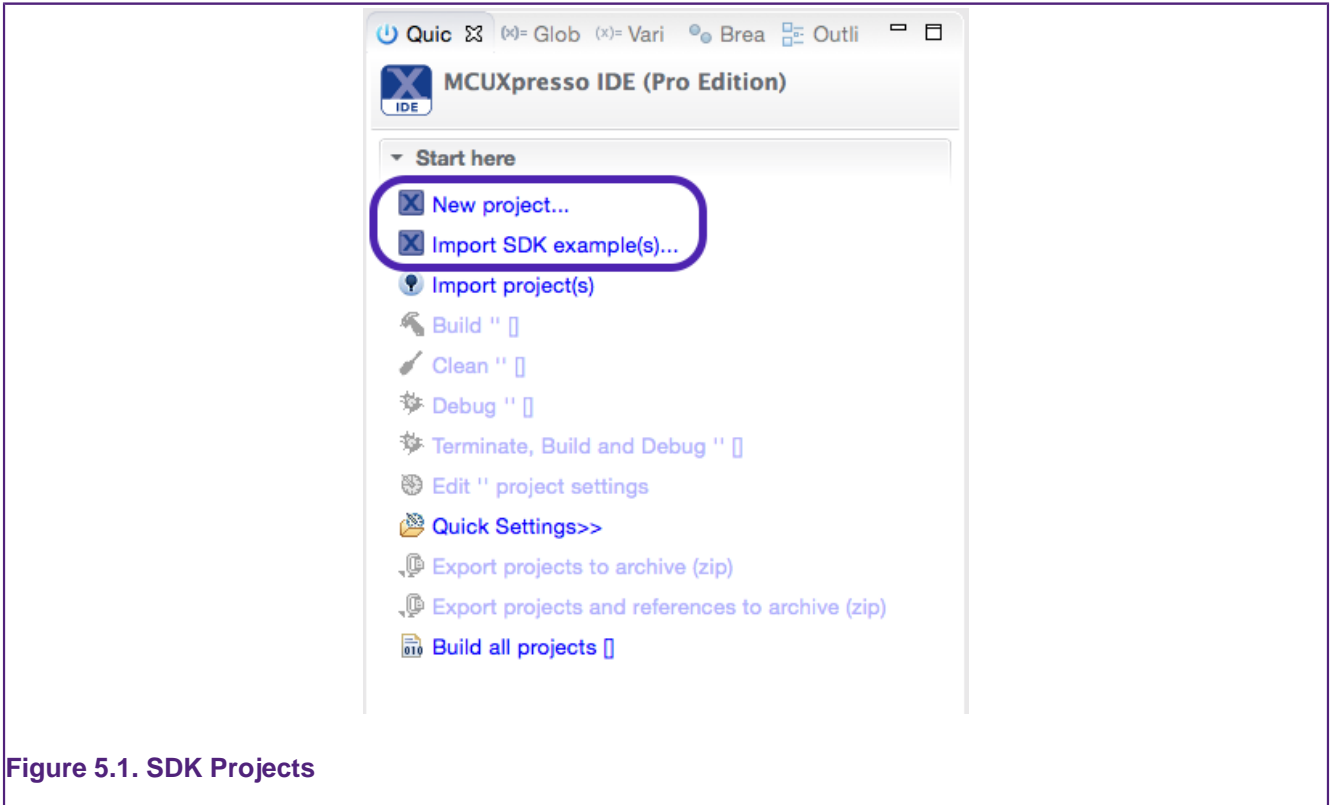

Figure 5.1. SDK Projects

The first will invoke the **New Project Wizard**, that guides the user in creating new projects from the installed SDKs (and also from pre-installed part support – which will be discussed in a later chapter).

The second option invokes the **SDK Import Wizard** that guides the user to import SDK example projects from installed SDKs.

This option will be explored in the next chapter.

Click New project to launch the New Project Wizard.

5.1 New Project Wizard

The New Project Wizard will begin by opening the “Board and/or device selection” page, this page is populated with a range of features described below:

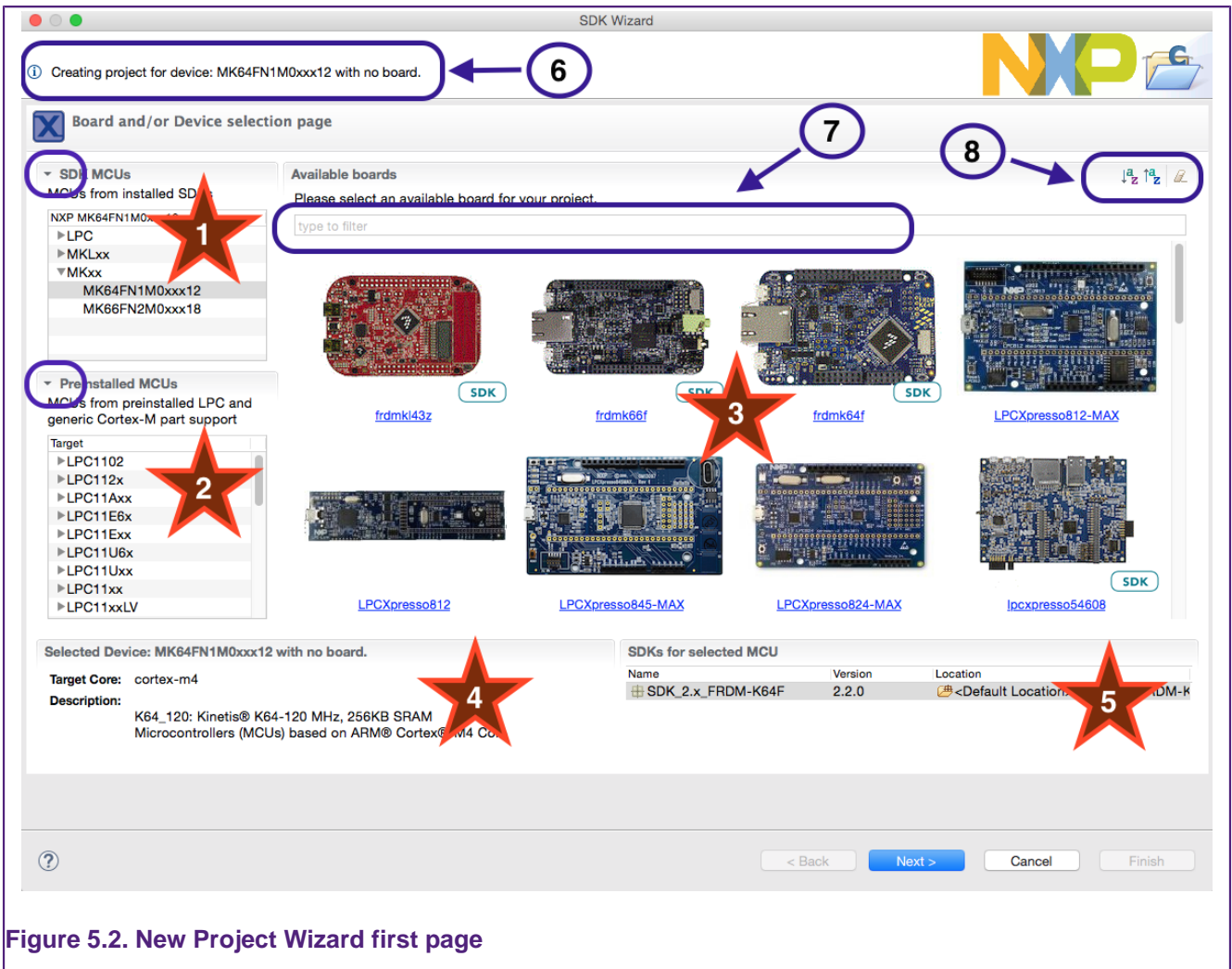

Figure 5.2. New Project Wizard first page

1. A display of all parts (MCUs) installed via SDKs. Click to select the MCU and filter the available matching boards. SDK part support can be hidden by clicking on the triangle (highlighted in the blue oval)
2. A display of all pre-installed parts (these are all LPC or Generic M parts). Click to select the MCU and filter the available matching boards (if any). Pre-Installed part support can be hidden by clicking on the triangle (highlighted in blue)
3. A display of all boards from both SDKs or matching LPCOpen packages. Click to select the board and its associated MCU.
 - Boards from SDK packages will have 'SDK' superimposed onto their image.
4. Some description relating to the users selection
5. A display to show the matching SDK for a chosen MCU or Board. If more than one matching SDK is installed, the user can select the SDK to use from this list
6. Any Warning, Error or Information related to the current selection
7. An input field to filter the available boards e.g. enter '64' to see matching MK64... Freedom or Tower boards available
8. 3 options: to Sort boards from A-Z, Z-A or clear any filter made through the input field or a select click. **Note:** once a project has been created, the filter settings will be remembered the next time the Wizard is entered (unless cleared by an external event such as the installation of a new SDK).

This page provides a number of ways of quickly selecting the target for the project that you want to create.

In this description, we are going to create a project for a Freedom MK64xxx board (The required SDK has already been imported).

First, to reduce the number of boards displayed, we can simply type '64' into the filter (7). Now only boards with MCUs matching '64' will be displayed.

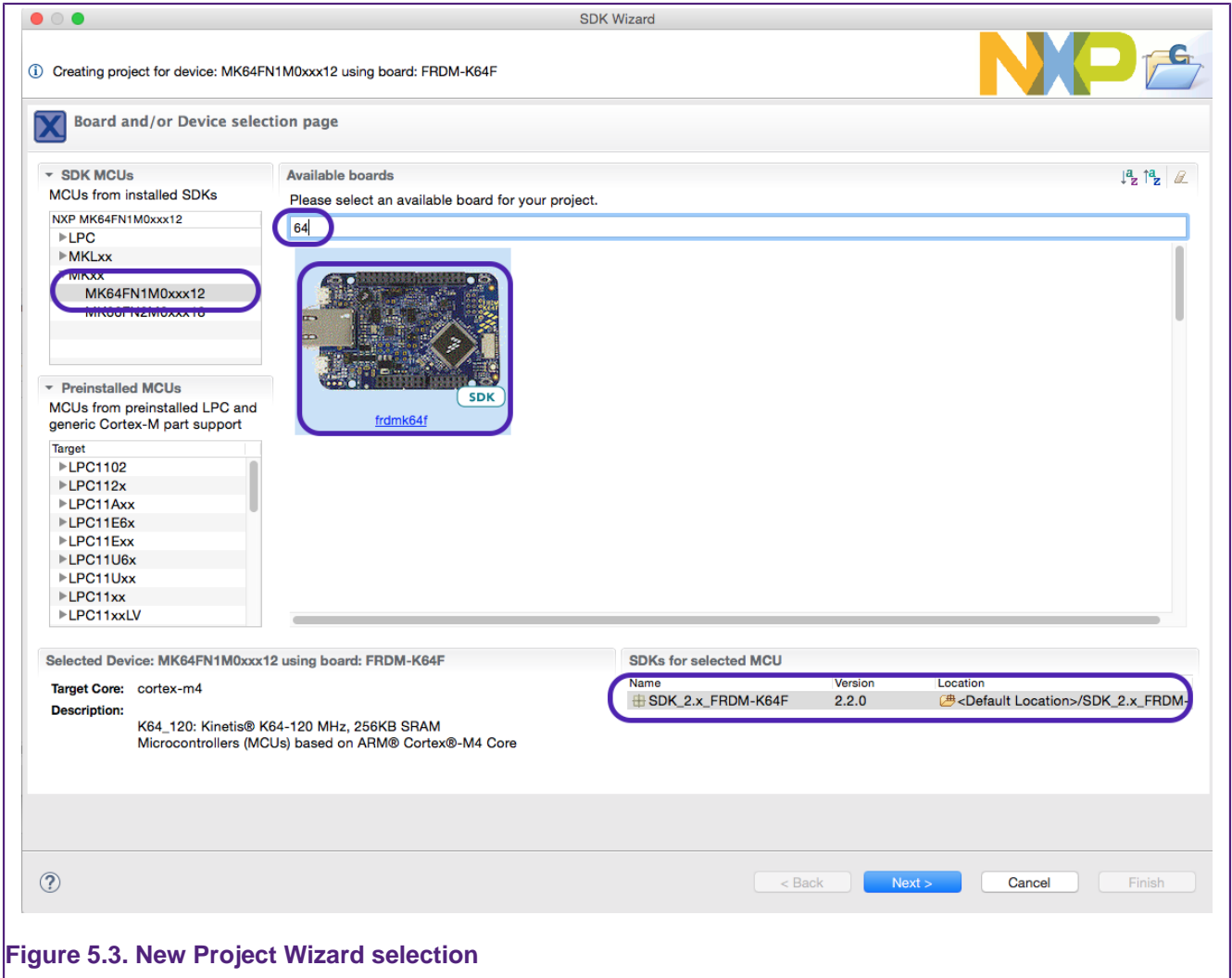

Figure 5.3. New Project Wizard selection

When the (SDK) board is selected, you can see highlighted in the above figure that the matching MCU (part) and SDK are also selected automatically.

With a chosen board selected, now click 'Next'...

5.1.1 SDK New Project Wizard: Basic Project Creation and Settings

The SDK New Project Wizard consists of two pages offering basic and advanced configuration options. Each of these pages is preconfigured with default options (the default options offered on the advanced page may be set based on user settings from the basic page).

Therefore, to create a simple 'Hello World' C project for the Freedom MK64... board we selected, all that is required is simply click 'Finish'.

Note: The project will be given a default name based on the MCU name. If this name matches a project within the workspace e.g. the wizard has previously been used to generate a project with the default name, then the error field will show a name clash and the 'next' and 'finish' buttons will be 'greyed out'. To change the new project's name; the blank 'Project Name Suffix' field can be used to quickly create a unique name but retain the original prefix.

This will create a project in the chosen workspace taking all the default Wizard options for our board.

However, the wizard offers the flexibility to select/change many build, library and source code options. These options and the components of this first Wizard page are described below.

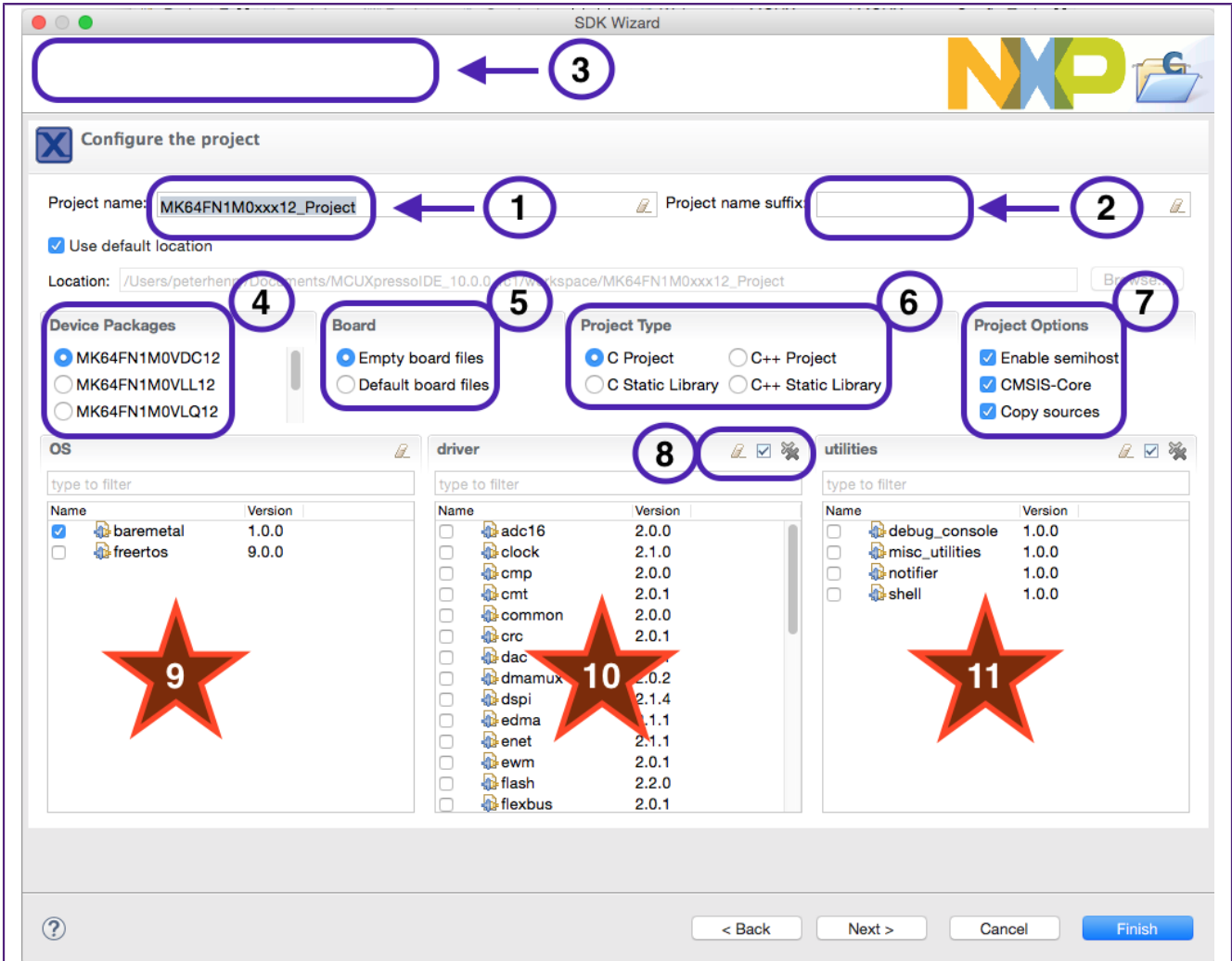

Figure 5.4. New Project Wizard basic SDK settings

1. Project Name: The default project name prefix is automatically selected based on the part selected on the previous screen
2. Project Suffix: An optional suffix to append to a project name can be entered here
3. Error and Warnings: Any error or warning will be displayed here. The 'Next' option will not be available until any error is handled – for example, a project name has been selected that matches an existing project name in your workspace. The suffix field (2) allows a convenient way of updating a project name
4. MCU Package: The device package can be selected from the range contained with the SDK. The package relates to the actual device packaging and typically has no meaning for project creation
5. Board files: This field allows the automatic selection of a default set of board support files, else empty files will be created. If a part rather than a board had been selected on the previous screen, these options will not be displayed.
 - if you intend to use board specific features such as output over UART, you should ensure Default board files are selected

6. Project Type: C or C++ projects or libraries can be selected. Selecting 'C' will automatically select RedLib libraries, selecting C++ will select NewlibNano libraries. See C/C++ Library Support [72]
7. Project Options:
 - Enable Semihost: will cause the Semihosted variant of the chosen library to be selected. For C projects this will default to be Redlib Semihost-nf. Semihosting allows IO operations such as printf and scanf to be emulated by the debug environment.
 - CMSIS-Core: will cause a CMSIS folder containing a variety of support code such as Clock Setup, header files to be created. It is recommended to leave this options ticked
 - Copy Sources: For zipped SDKs, this option will be ticked and greyed out. For unzipped SDKs, projects can be created that use linked references back to the original SDK folder. This feature is recommended for 'Power Users' only
8. Each set of components support a filter and check boxes for selection. These icons allow filters to be cleared, all check boxes to be set, all check boxes to be cleared
9. OS: This provides the option to pull in and link against Operating System resources such as FreeRTOS.
10. driver: enables the selection of supporting driver software components to support the MCU peripheral set.
11. utilities: a range of optional supporting utilities.
 - For example select the debug_console to make use of the SDK Debug Console handling of IO
 - Selecting this option will cause the wizard to substitute the (SDK) PRINTF() macro for C Library printf() within the generated code
 - the debug console option relies on the OpenSDA debug probe communicating to the host via VCOM over USB.

Finally, if there is no error condition displayed, 'Finish' can be selected to finish the wizard, alternatively, select 'Next' to proceed to the Advanced options page (described next).

5.1.2 SDK New Project Wizard: Advanced Project Settings

The advanced configuration page will take certain default options based on settings from the first configure project page, for example a C project will pre-select Redlib, where as a C++ project will pre-select NewlibNano.

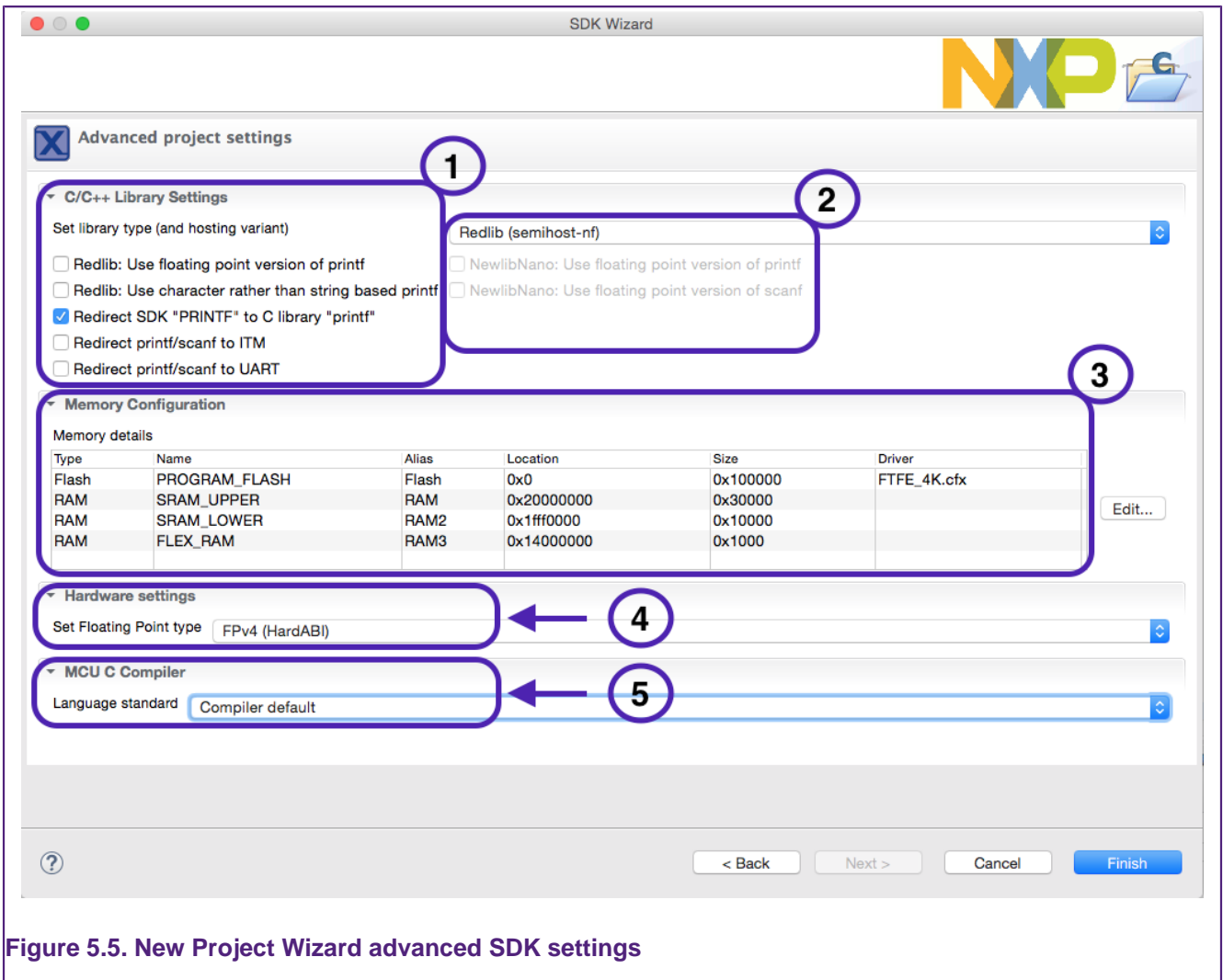

Figure 5.5. New Project Wizard advanced SDK settings

- This panel allows options to be set related to Input/Output. **Note** if a C++ project was selected on the previous page, then the Redlib options will be Greyed out. See C/C++ Library Support [72]
 - Redlib Floating Point printf: If this option is ticked, floating point support for printf will automatically be linked in. This will allow printf to support the printing out of floating point variables at the expense of larger library support code.
 - Redlib use Character printf: selecting this option will avoid heap usage and reduce code size but make printf operations slower
 - Redirect SDK "PRINTF": many SDK examples use a PRINTF macro, selecting this option causes redirection to C library IO rather than options provided by the SDK debug console
 - Redirect printf/scanf to ITM: causes a C file 'retarget_itm.c' to be pulled into your project. This then enables printf/scanf I/O to be sent over the SWO channel. The benefit of this is that I/O operations can be performed with little performance penalty. Furthermore, these routines do not require debugger support and for example could be used to generate logging that would effectively go to Null unless debug tools were attached. Note: not available on Cortex M0 and M0+ parts
 - Redirect printf/scanf to UART: Sets the define SDK_DEBUGCONSOLE_UART causing the C libraries printf functions to re-direct to the SDKs debug console UART code
- This panel allows the selection of various library variants. See C/C++ Library Support [72]



3. Memory Configuration: This panel shows the Flash and RAM memory layout for the MCU project being created. The pre-selected LinkServer flash driver is also shown. **Note:** this flash driver will only be used for LinkServer (CMSIS-DAP) debug connections.

- Clicking Edit invokes the IDE’s memory configuration editor. From this dialogue, the project’s default memory setting and hence automatically generated linker settings can be changed. See Memory Configuration and Linker Scripts [82]

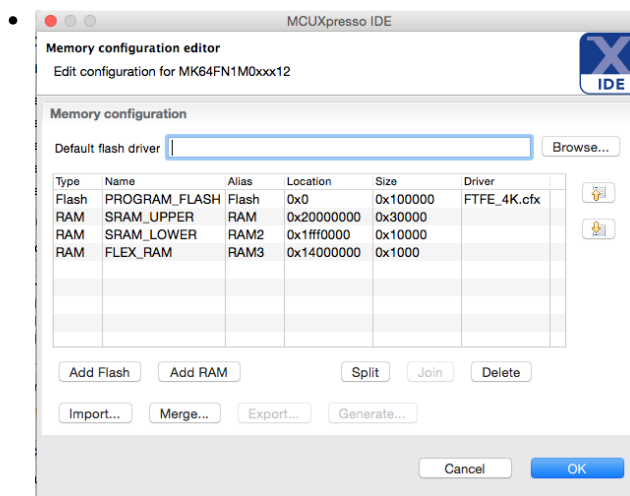

4. Hardware Settings: from this drop down you can set options such as the type of floating point support available/required. This will default to an appropriate value for your MCU.

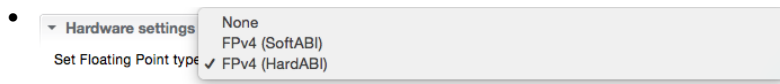

5. MCU C Compiler: from this drop down you can set various compiler options that can be set for the GNU C/C++ compiler.

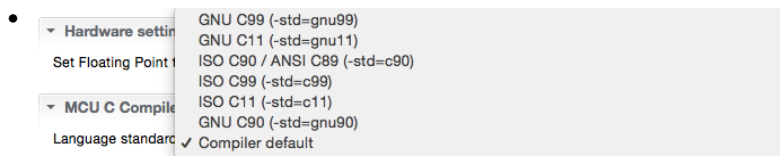

5.2 SDK Build Project

To build a project created by the SDK New Project Wizard, simply select the project in the ‘Project Explorer’ view, then go to the ‘QuickStart’ Panel and click on the **build button** to build the project. This will build the project for the default projects ‘Debug’ configuration.

Note: MCUXpresso IDE projects are created with two build configurations, Debug and Release (more can be added if required). These differ in the default level of compiler optimisation. Debug projects default to None (-O0), and Release projects default to (-Os). For more information on switching between build configurations, see How do I switch between Debug and Release builds? [117]

The build log will be displayed in the console view as below.

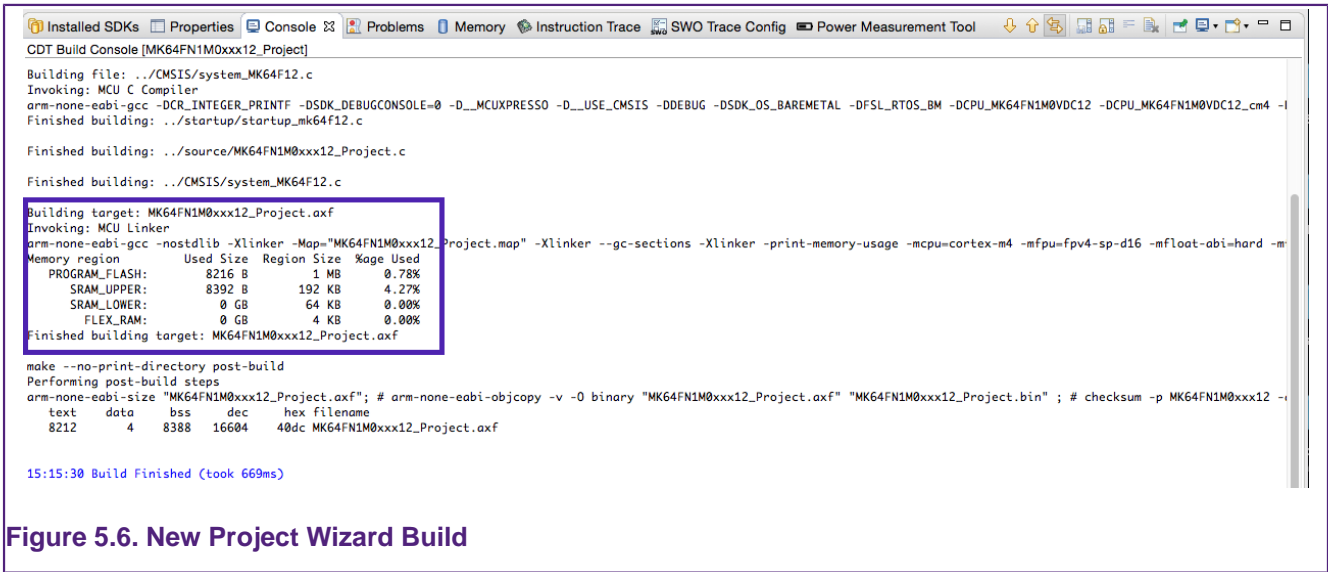

Figure 5.6. New Project Wizard Build

The projects memory usage as highlighted above is shown below:

Memory region	Used Size	Region Size	%age Used
PROGRAM_FLASH:	8216 B	1 MB	0.78%
SRAM_UPPER:	8392 B	192 KB	4.27%
SRAM_LOWER:	0 GB	64 KB	0.00%
FLEX_RAM:	0 GB	4 KB	0.00%

Finished building target: MK64FN1M0xxx12_Project.axf

By default, the application will build and link against the first flash memory found within the devices memory configuration. For most MCUs there will only be 1 flash device available. In this case our project requires 8216 bytes of Flash memory storage, 0.78% of the available Flash storage.

RAM will be used for global variable, the heap and the stack. MCUXpresso IDE provides a flexible scheme to reserve memory for Stack and Heap. The above example build has reserved 4KB each for the stack and the heap. Please See Memory Configuration and Linker Scripts[82] for detailed information.

6. Importing Example Projects (from SDKs)

In addition to drivers and part support, SDKs also deliver many example projects for the target MCU.

To import examples from an installed SDK, go to the **QuickStart** panel and select **Import SDK example(s)**.

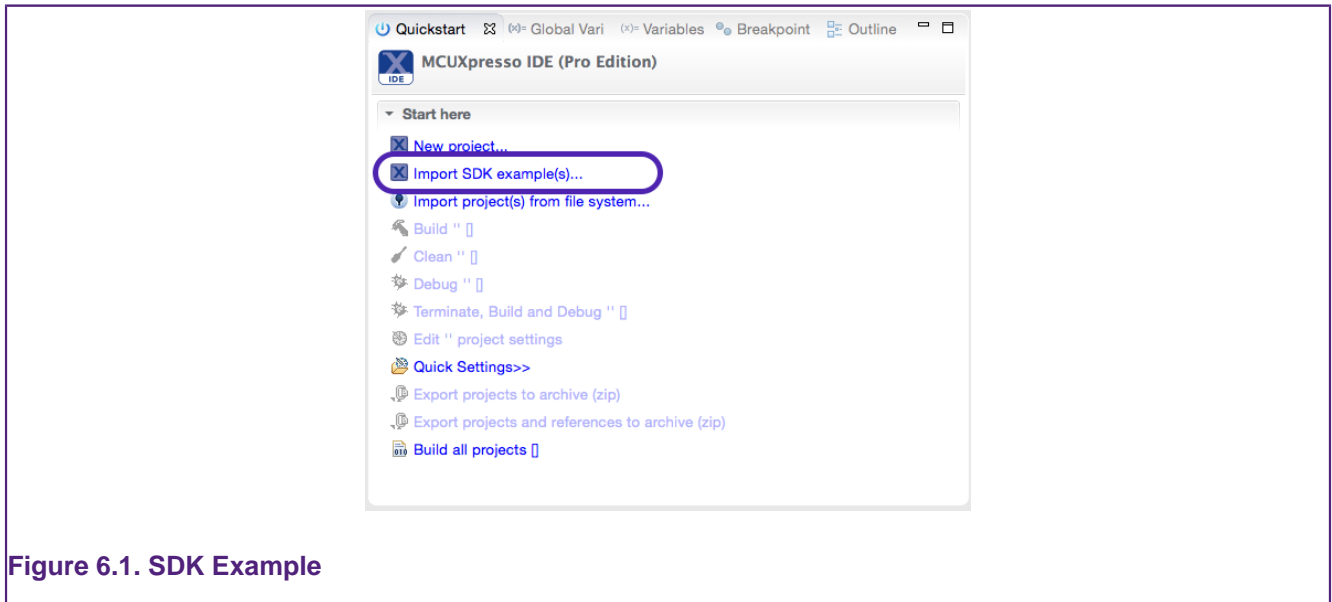

Figure 6.1. SDK Example

This option invokes the **SDK Import Wizard** that guides the user to import SDK example projects from installed SDKs.

Like the New Project wizard, this will initially launch a page allowing MCU/board selection. However now, only SDK supported parts and boards will be presented.

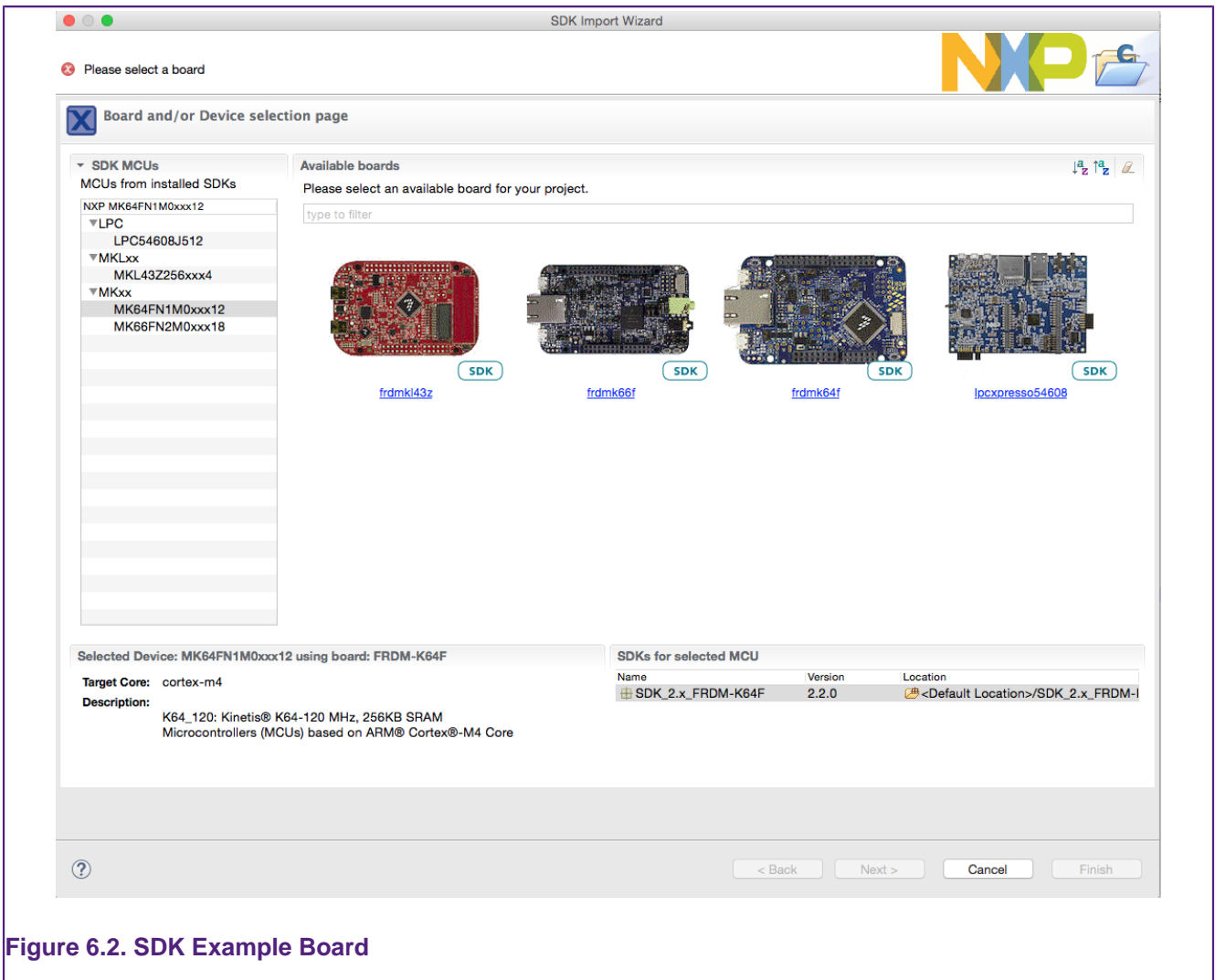

Figure 6.2. SDK Example Board

6.1 SDK Example Import Wizard

Selection and filtering work in the same way as for the New Project Wizard [32] but note, examples are created for particular development boards, therefore a board must be selected to move to the 'Next' page of the wizard.

6.1.1 SDK Example Import Wizard: Basic Selection

The SDK Example Import Wizard consists of two pages offering basic and advanced configuration and selection options. The second configuration page is only available when a single example is selected for import. This is because examples may set specific options, and therefore changing settings globally is not sensible.

The first page offers all the available examples in various categories. These can be expanded to view the underlying hierarchical structure. The various settings and options are explained below: **Note:** The project will be given a default name based on the MCU name, Board name and Example name. If this name matches a project within the workspace e.g. the wizard has previously been used to generate an example with the default name, then the error field will show a name clash and the 'next' and 'finish' buttons will be greyed out. To change the new example name, the blank 'Project Name Suffix' field can be used to quickly create a unique name but retain the original prefix e.g. add '1'.

MCUXpresso IDE will create a project with common default settings for your chosen MCU and board. However, the wizard offers the flexibility to select/change many build, library and source code options. These options and the components of this first Wizard page are described below.

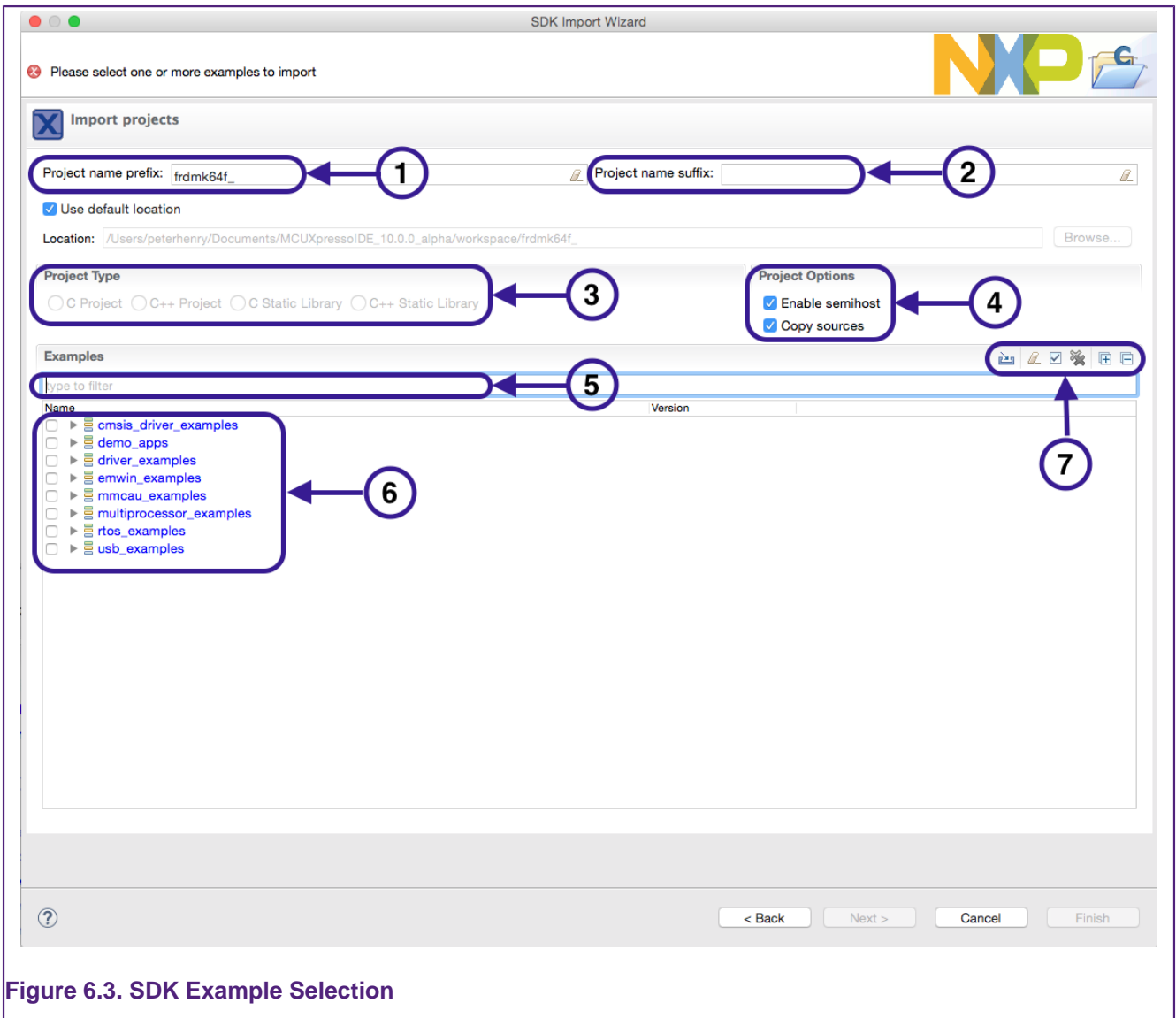

Figure 6.3. SDK Example Selection

1. Project Name: A project name is automatically created with a name of the form: *prefix_SDK example path_example name_suffix*.
2. Project Suffix: An optional suffix to append to a project name can be entered here. This is particularly useful if you are repeating an import of one or more projects since an entry here can make all auto generated names unique for the current workspace... Note: Changing the default name of Imported SDK **MultiCore examples** may cause linkage to fail.
3. Project Type: These will be set by the pre-set type of the example being imported. If more than one example is imported, then these options will appear greyed out.
4. Project Options: 'Enable semihost' check this box to create projects with semihosting support (options and libraries). 'Copy sources' For unzipped SDKs, you can untick this option to create project containing source links to the original SDK files. This option should only be unticked with care, since editing linked example source will overwrite the original files!
5. Examples Filter: Enter text into this field to select matches for example 'LED', 'bubble' will select common examples from the set. This filter is case insensitive.
6. Examples: The example list broken into categories. **Note** for some parts there will be many potential examples to import

7. Various options:

- Opens a filer window to allow an example to be imported from an XML description. This is intended as a developer feature and is described in more detail below.
- Clear any existing filter
- Select (tick) all Examples
- Clear all ticked examples
- Open the example structure
- Close the example structure

Finally, if there is no error condition displayed, 'Finish' can be selected to finish the wizard, alternatively if only one example has been selected the option to select 'Next' to proceed to the Advanced options page is available (described in the next section).

Note: SDKs may contain many examples, 185 is indicated for the FRDM MK64 SDK example shown below. Importing many examples will take time ... Consider that each example may consist of many files and associated description XML. A single example import may only take a few seconds, but this time is repeated for each additional example. Furthermore, the operation of the IDE maybe impacted by a large number of project in a single workspace, therefore it is suggested that example imports be limited to sensible numbers.

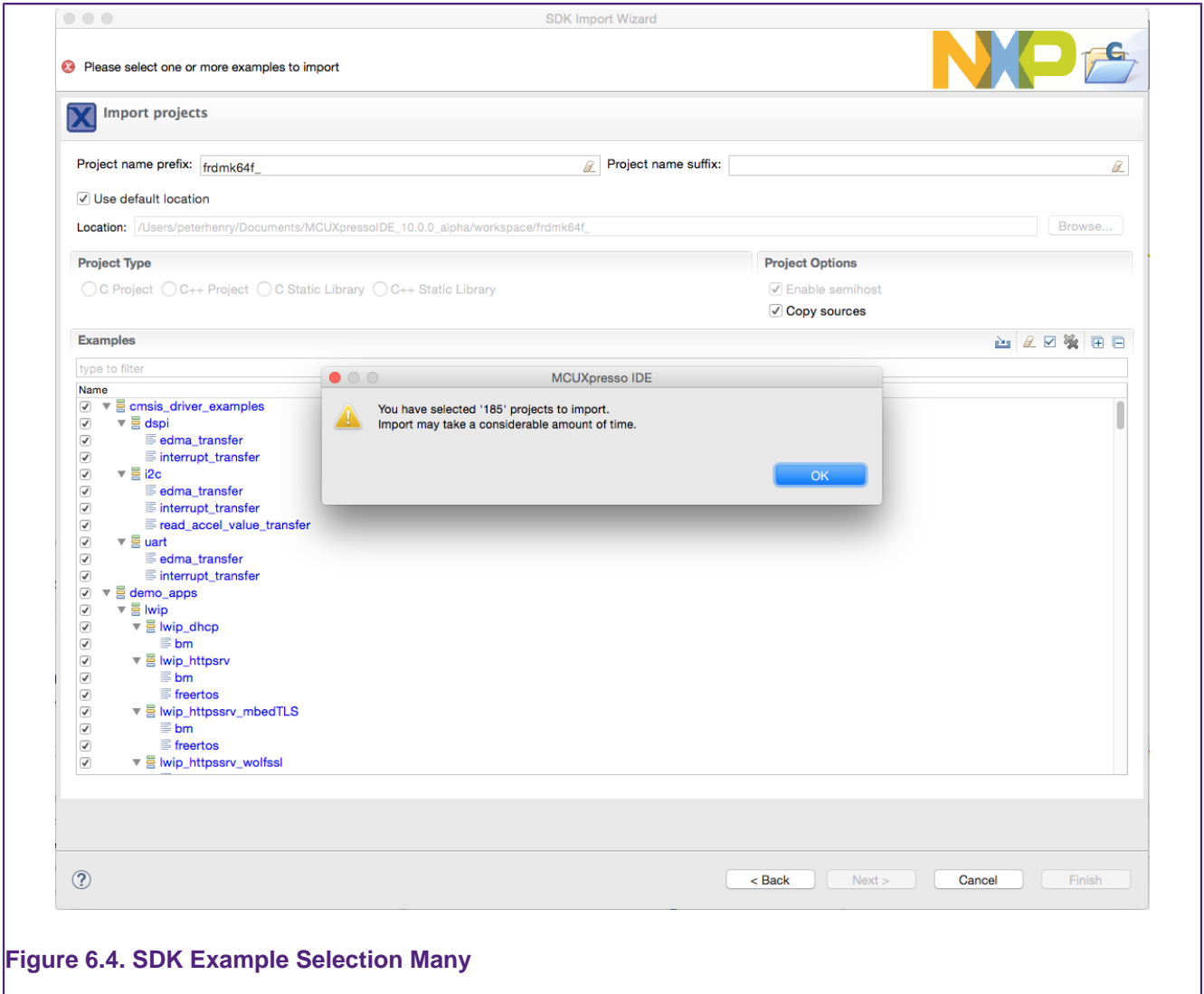

Figure 6.4. SDK Example Selection Many

6.1.2 SDK Example Import Wizard: Advanced options

The advanced configuration page (shown below) will take certain default options based on the example's selected, for example a C project will pre-select Redlib libraries, where as a C++ project will pre-select NewlibNano.

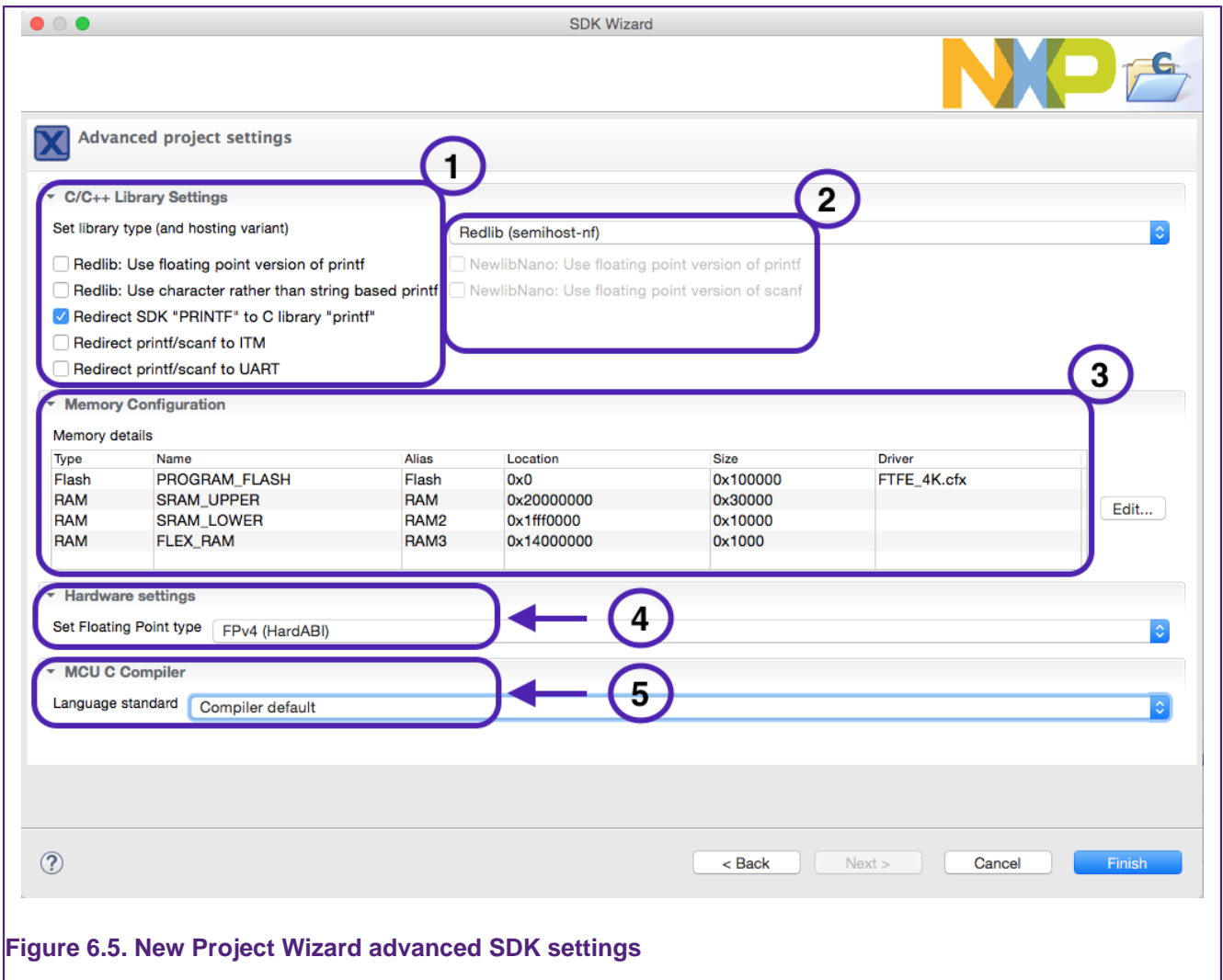

Figure 6.5. New Project Wizard advanced SDK settings

These settings closely match those in SDK New Project Wizard description. Therefore See SDK New Project Wizard:Advanced Options [36] for a description of these options. **Note:** Changing these advanced options may prevent an example from building or executing.

6.1.3 SDK Example Import Wizard: Import from XML fragment

This option works in conjunction with the 'Project Explorer' -> Tools -> Generate Example XML (and is also used to import project created by the MCUXpresso Config Tools Project Generator).

The functionality here is to merge existing sources within a selectable board package framework.

To create an XML "fragment" for an existing project in your workspace, right click on the project in the 'Project Explorer' (or just in the 'Project Explorer' view with no project selected) and choose Tools->Generate examples.xml file

The selected project or all the projects in the workspace (if no projects are selected) will be converted into a fragment within a new folder created in the workspace itself:

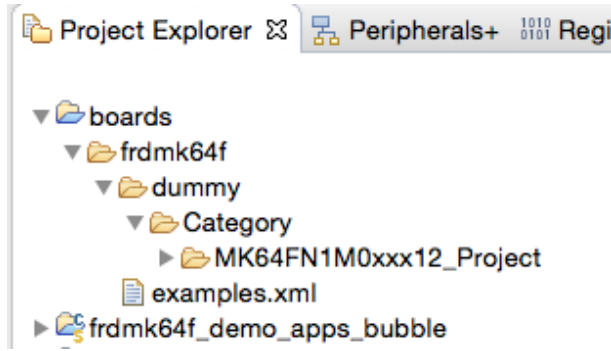

To create a project from a fragment, click on “Import SDK examples...” in the **QuickStart** Panel view:

Then select a board and then click on the button “Import from XML...” (highlighted below and described in the previous section). You will see the examples definitions from the external fragment in list of examples as shown and selected below.

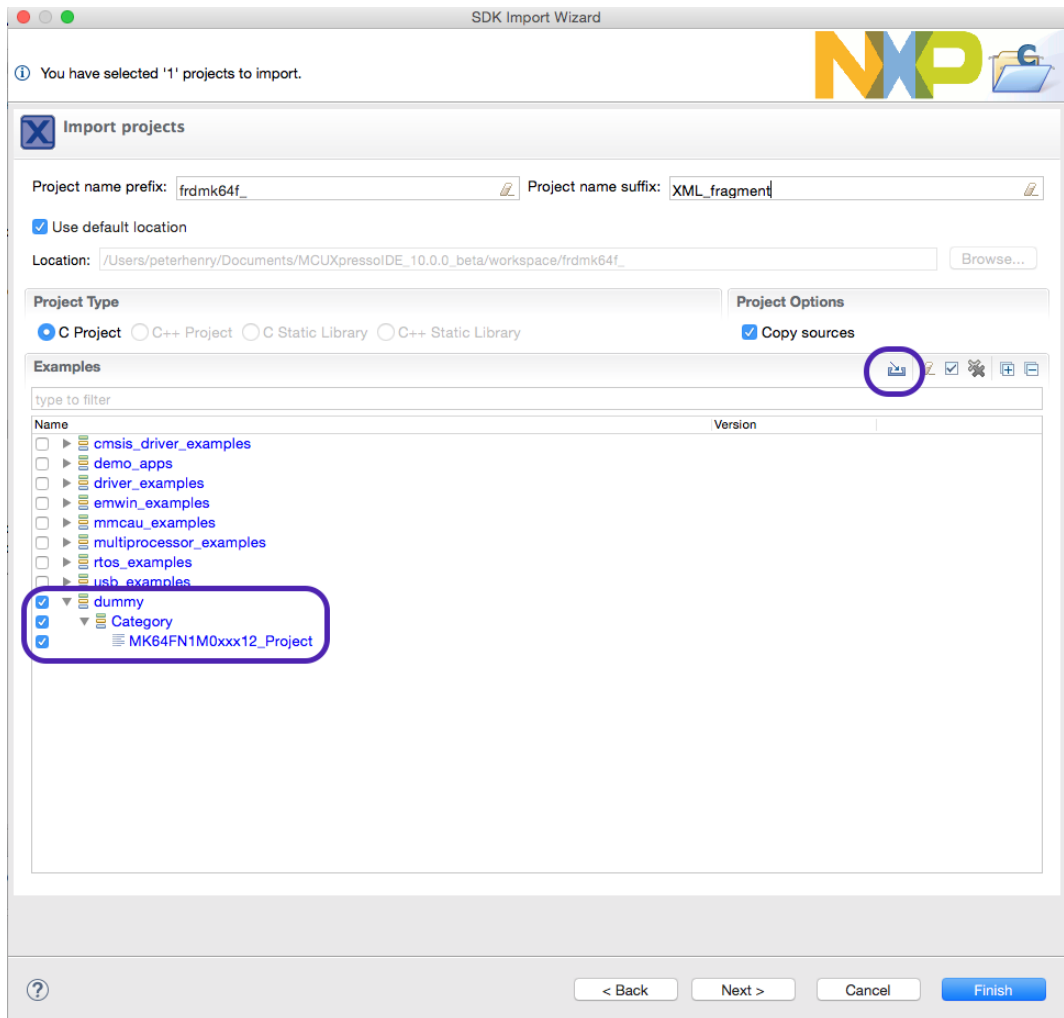

Select the external examples you want to re-create and click on “Finish”. The project(s) will be created in the workspace.

7. Creating New Projects using Pre-Installed Part Support

For Creating project using SDKs please see Creating New Projects using SDKs [32]

To explore the range of pre-installed parts/MCUs simply click 'New project' in the **QuickStart panel**. This will open a page similar to the image below:

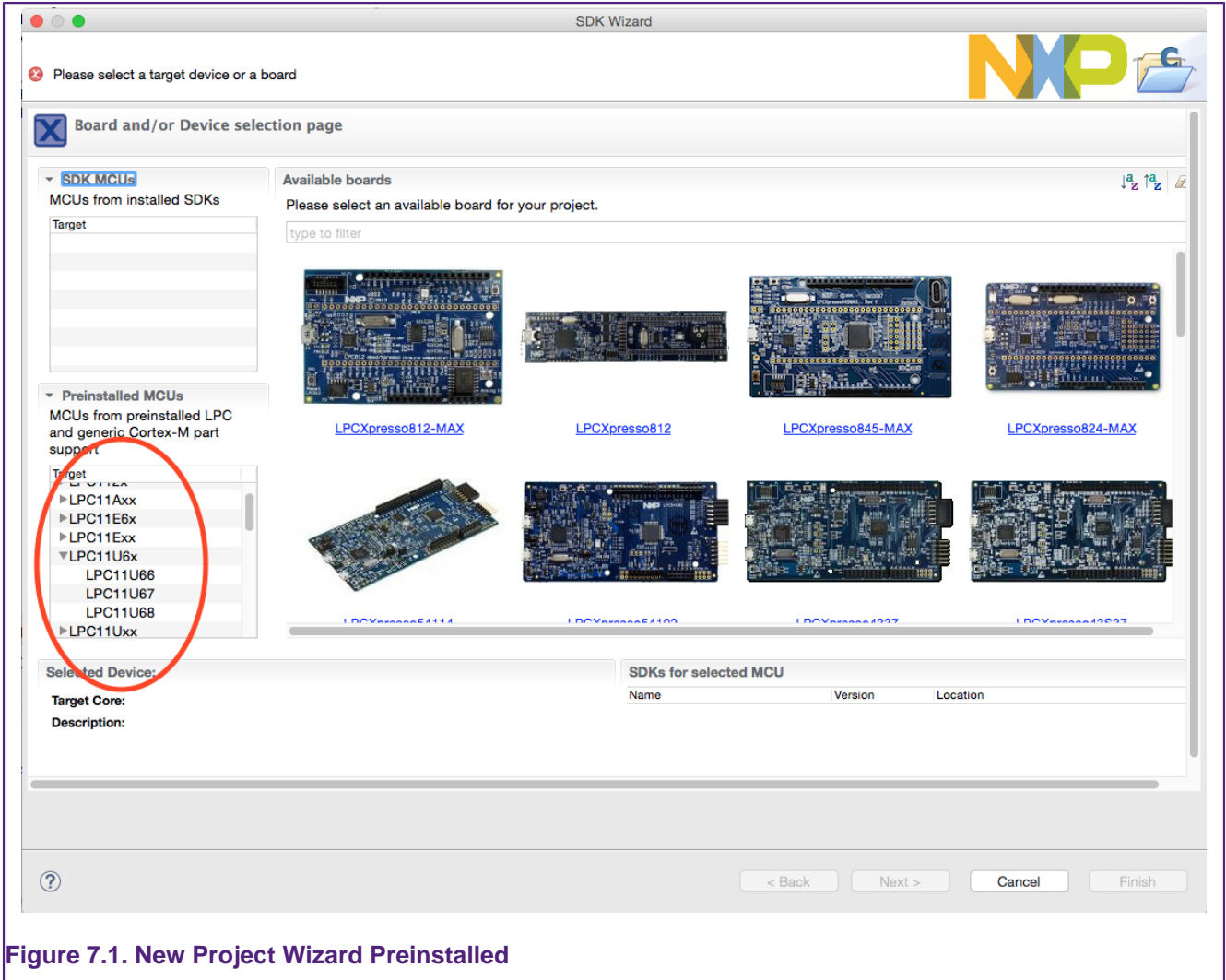

Figure 7.1. New Project Wizard Preinstalled

The list of pre-installed parts is presented on the bottom left of this window.

You will also see a range of related development boards indicating whether a matching LPCOpen Library is available.

For details of this page see: New Project Wizard details [32]

7.1 New Project Wizard

This wizard page provides a number of ways of quickly selecting the target for the project that you want to create.

In this description, we are going to create a project for an LPC4337 MCU (for this MCU an LPCOpen project exists), so we can locate the MCU using the board filter.

To reduce the number of boards displayed, we can simply type '4337' into the filter. Now only boards with MCUs matching '4337' will be displayed.

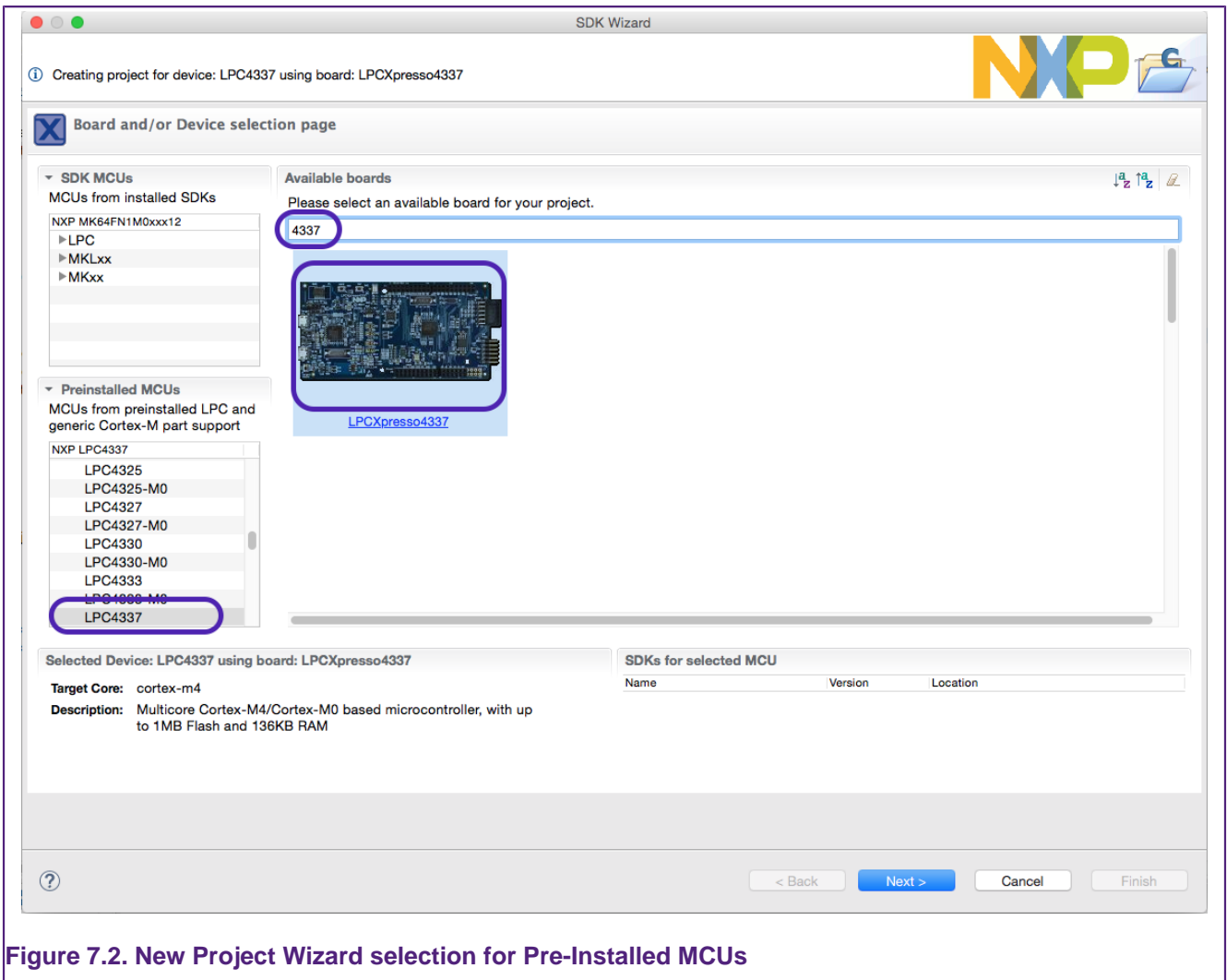

Figure 7.2. New Project Wizard selection for Pre-Installed MCUs

When the board is selected, you can see highlighted in the above figure that the matching MCU (part) is selected automatically.

Note: if no matching board is available, the required MCU can be selected from the list of Pre-Installed MCUs.

Note: Boards added to MCUXpresso IDE from SDKs will have an ‘SDK’ graphic superimposed on the board image. Boards without the SDK graphic indicate that a matching LPCOpen package is available for that board and associated MCU.

LPCOpen is described in section LPCOpen Software Drivers and Examples [54]

With a chosen board selected, now click ‘Next’...

The wizards for Pre-Installed MCUs are very similar to those featured in LPCXpresso IDE.

7.2 Creating a Project

The MCUXpresso IDE includes many project templates to allow the rapid creation of correctly configured projects for specific MCUs.

This New Project wizard supports 2 types of projects:

- Those targeting LPCOpen libraries
- Standalone projects

In addition, certain MCUs like the LPC4337 support multiple core internally, for these MCUs, Multicore options will also be presented (as below):

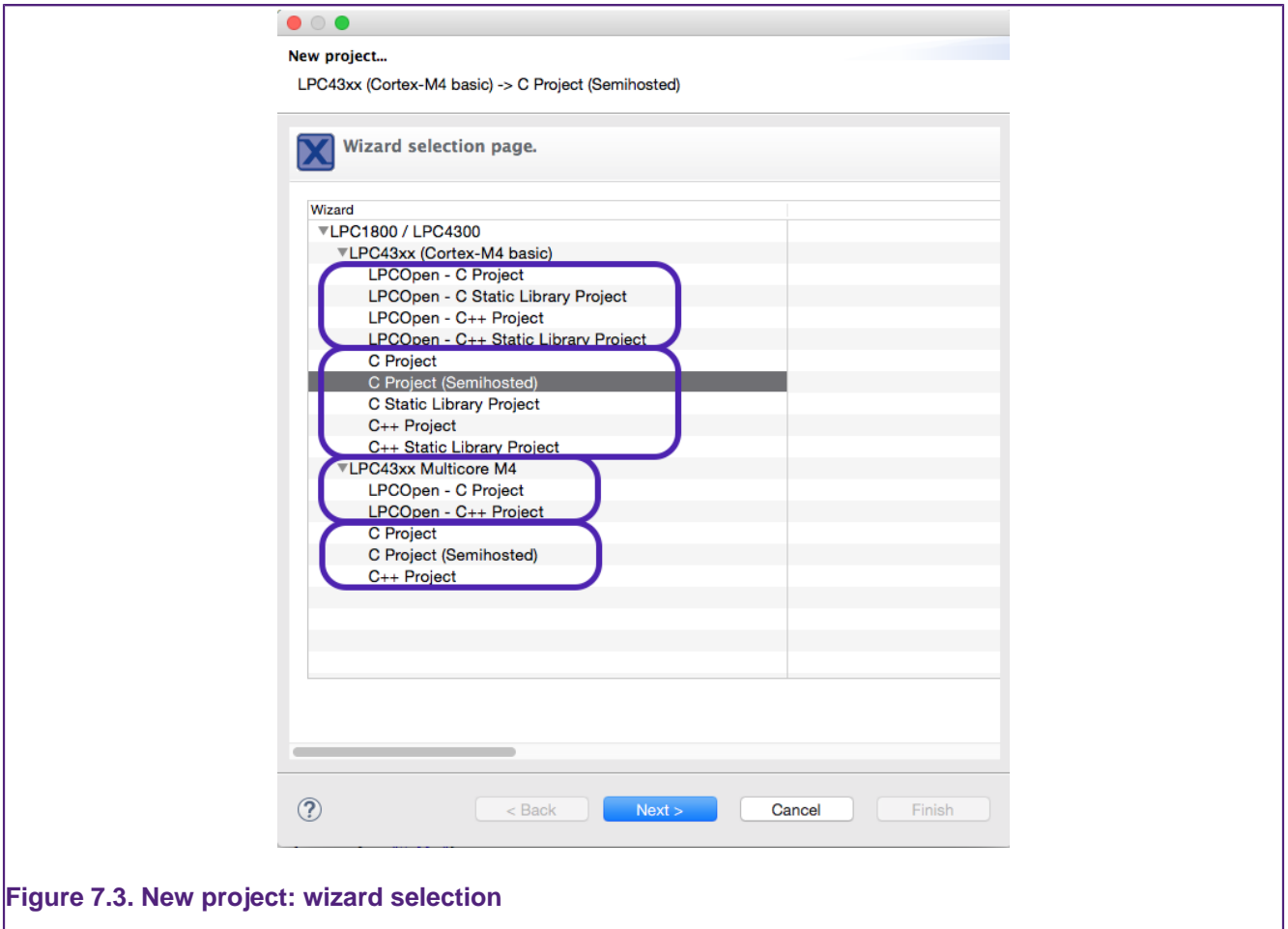

Figure 7.3. New project: wizard selection

You can now select the type of project that you wish to create (see below for details of Wizard types).

In this case, we will show the steps in creating a simple C ‘Hello World’ example project.

7.2.1 Selecting the Wizard Type

For most MCU families the MCUXpresso IDE provides wizards for two forms of project: LPCOpen and non-LPCOpen. For more details on LPCOpen, see Software drivers and examples[54]. For both kinds, the main wizards available are:

C Project

- Creates a simple C project, with the `main()` routine consisting of an infinite `while(1)` loop that increments a counter.
- For LPCOpen projects, code will also be included to initialize the board and enable a LED.

C++ Project

- Creates a simple C++ project, with the `main()` routine consisting of an infinite `while(1)` loop that increments a counter.
- For LPCOpen projects, code will also be included to initialize the board and enable a LED.

C Static Library Project

- Creates a simple static library project, containing a source directory and, optionally, a directory to contain include files. The project will also contain a “liblinks.xml” file, which can be used by the smart update wizard on the context-sensitive menu to create links from application projects to this library project. For more details, please see the FAQ at

<https://community.nxp.com/message/630594>

C++ Static Library Project

- Creates a simple (C++) static library project, like that produced by the C Static Library Project wizard, but with the tools set up to build C++ rather than C code.

The non-LPCOpen wizard families also include a further wizard:

Semihosting C Project

- Creates a simple “Hello World” project, with the `main()` routine containing a `printf()` call, which will cause the text to be displayed within the Console View of the MCUXpresso IDE. This is implemented using “semihosting” functionality. See the section on Semihosting [75] for more information.

7.2.2 Configuring the Project

Once you have selected the appropriate project wizard, you will be able to enter the name of your new project, this must be unique for the current workspace.

Finally you will be presented with one or more “Options” pages that provide the ability to set a number of project-specific options. The choices presented will depend upon which MCU you are targeting and the specific wizard you selected, and may also change between versions of the MCUXpresso IDE. **Note** that if you have any doubts over any of the options, then we would normally recommend leaving them set to their default values.

The following sections detail some of the options that you may see when running through a wizard.

7.3 Wizard Options

7.3.1 LPCOpen Library Project Selection

When creating an LPCOpen-based project, the first option page that you will see is the LPCOpen library selection page.

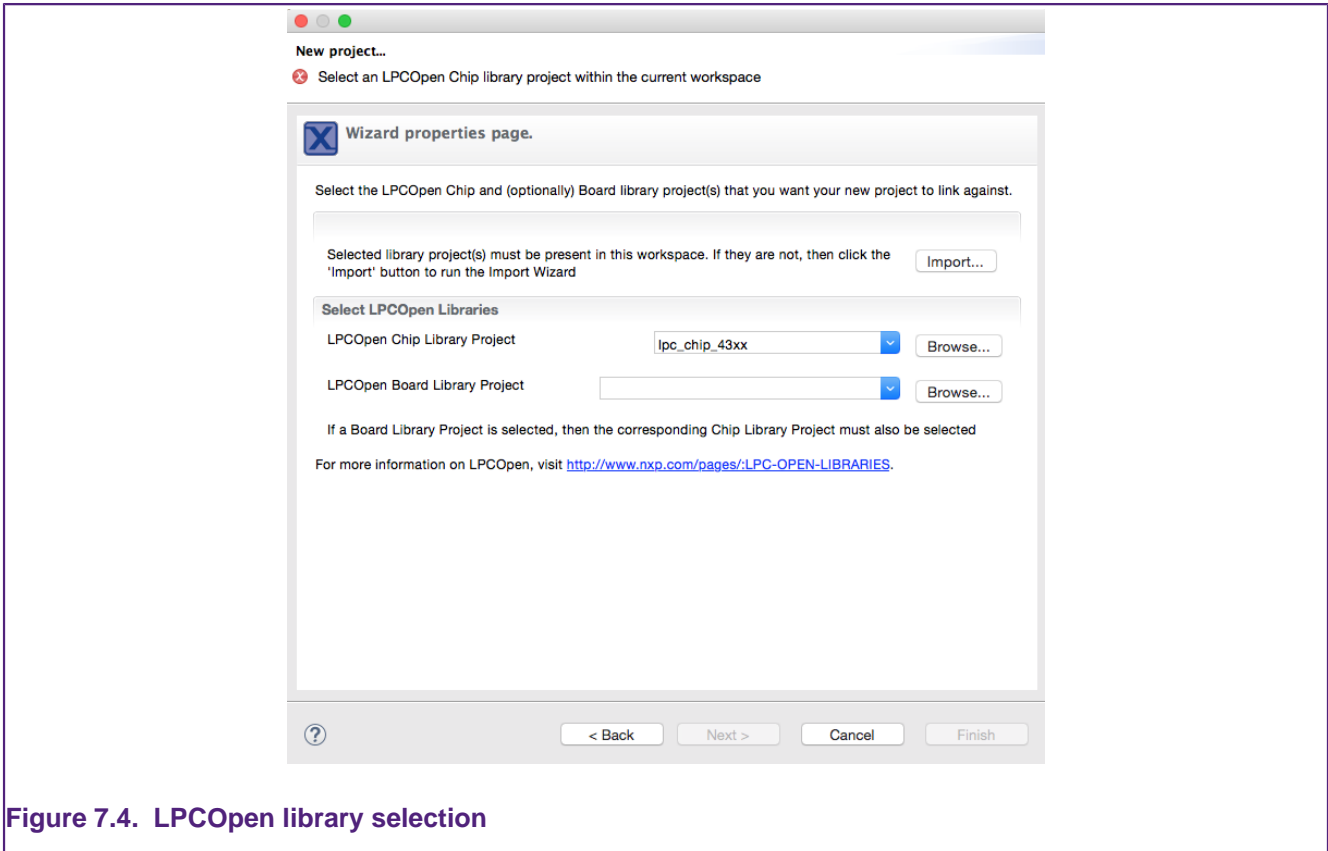

Figure 7.4. LPCOpen library selection

This page allows you to run the “Import wizard” to download the LPCOpen bundle for your target MCU/board from <http://www.nxp.com/lpcopen> and import it into your Workspace, if you have not already done so.

You will then need to select the LPCOpen Chip library for your MCU using the Workspace browser (and for some MCUs an appropriate value will also be available from the dropdown next to the Browse button). **Note** that the wizard will not allow you to continue until you have selected a library project that exists within the Workspace.

Finally, you can optionally select the LPCOpen Board library for the board that your MCU is fitted to, using the Workspace browser (and again, in some cases an appropriate value may also be available from the dropdown next to the Browse button). Although selection of a board library is optional, it is recommended that you do this in most cases.

7.3.2 CMSIS-CORE Selection

For backwards compatibility reasons, the non-LPCOpen wizards for many parts provide the ability to link a new project with a CMSIS-CORE library project. The CMSIS-CORE portion of ARM’s **Cortex Microcontroller Software Interface Standard** (or **CMSIS**) provides a defined way of accessing MCU peripheral registers, as well as code for initializing an MCU and accessing various aspects of functionality of the Cortex CPU itself. The MCUXpresso IDE typically provides support for CMSIS through the provision of CMSIS library projects. CMSIS-CORE library projects can be found in the Examples directory of your MCUXpresso IDE installation.

Generally, if you wish to use CMSIS-CORE library projects, you should use `CMSIS_CORE_<partfamily>` (these projects use components from ARM’s CMSIS v3.20 specification). The MCUXpresso IDE does in some cases provide libraries based on early versions of the CMSIS specification with names such as `CMSISv1p30_<partfamily>`, but these are not recommended for use in new projects.

The CMSIS library option within the MCUXpresso IDE allows you to select which (if any) CMSIS-CORE library you want to link to from the project you are creating. **Note** that you will need to import the appropriate CMSIS-CORE library project into the workspace before the wizard will allow you to continue.

For more information on CMSIS and its support in the MCUXpresso IDE, please see the FAQ at <https://community.nxp.com/message/630589>

Note: The use of LPCOpen instead of CMSIS-CORE library projects is recommended in most cases for new projects. (In fact LPCOpen actually builds on top of many aspects of CMSIS-CORE.) For more details see Software drivers and examples [54]

7.3.3 CMSIS DSP Library Selection

ARM's **Cortex Microcontroller Software Interface Standard** (or **CMSIS**) specification also provides a definition and implementation of a DSP library. The MCUXpresso IDE provides prebuilt library projects for the CMSIS DSP library for Cortex-M0/M0+, Cortex-M3 and Cortex-M4 parts, although a source version of it is also provided within the MCUXpresso IDE Examples.

Note: The CMSIS DSP library can be used with both LPCOpen and non-LPCOpen projects.

7.3.4 Peripheral Driver Selection

For some parts, one or more peripheral driver library projects may be available for the target MCU from within the Examples area of your MCUXpresso IDE installation. The non-LPCOpen wizards allow you to create appropriate links to such library projects when creating a new project. You will need to ensure that you have imported such libraries from the Examples before selecting them in the wizard.

Note: The use of LPCOpen rather than these peripheral driver projects is recommended in most cases for new projects.

7.3.5 Enable use of Floating Point Hardware

Certain MCUs may include a hardware floating point unit (for example NXP LPC32xx, LPC407x_8x, and LPC43xx parts). This option will set appropriate build options so that code is built to use the hardware floating point unit and will also cause startup code to enable the unit to be included.

7.3.6 Code Read Protect

NXP's Cortex based LPC MCUs provide a "Code Read Protect" (CRP) mechanism to prevent certain types of access to internal flash memory by external tools when a specific memory location in the internal flash contains a specific value. The MCUXpresso IDE provides support for setting this memory location. See the section on Code Read Protection [87] for more information.

7.3.7 Enable use of `romdivide` Library

Certain NXP Cortex-M0 based MCUs, such as LPC11Axx, LPC11Exx, LPC11Uxx, and LPC12xx, include optimized code in ROM to carry out divide operations. This option enables the use of these Romdivide library functions. For more details see the FAQ at

<https://community.nxp.com/message/630743>

7.3.8 Disable Watchdog

Unlike most MCUs, NXP's LPC12xx MCUs enable the watchdog timer by default at reset. This option disables that default behavior. For more details, please see the FAQ at

<https://community.nxp.com/message/630654>

7.3.9 LPC1102 ISP Pin

The provision of a pin to trigger entry to NXP's ISP bootloader at reset is not hardwired on the LPC1102, unlike other NXP MCUs. This option allows the generation of default code for providing an ISP pin. For more information, please see NXP's application note, AN11015, "Adding ISP to LPC1102 systems".

7.3.10 Redlib Printf Options

The "Semihosting C Project" wizard for some parts provides two options for configuring the implementation of printf family functions that will get pulled in from the Redlib C library:

- Use non-floating-point version of printf
 - If your application does not pass floating point numbers to `printf()` family functions, you can select a non-floating-point variant of printf. This will help to reduce the code size of your application.
 - For MCUs where the wizard does not provide this option, you can cause the same effect by adding the symbol `CR_INTEGER_PRINTF` to the project properties.
- Use character- rather than string-based printf
 - By default `printf()` and `puts()` make use of `malloc()` to provide a temporary buffer on the heap in order to generate the string to be displayed. Enable this option to switch to using "character-by-character" versions of these functions (which do not require additional heap space). This can be useful, for example, if you are retargeting `printf()` to write out over a UART – since in this case it is pointless creating a temporary buffer to store the whole string, only to print it out over the UART one character at a time.
 - For MCUs where the wizard does not provide this option, you can cause the same effect by adding the symbol `CR_PRINTF_CHAR` to the project properties.

Note: if you only require the display of fixed strings, then using `puts()` rather than `printf()` will noticeably reduce the code size of your application.

For more information see C/C++ Library Support [72]

7.3.11 Project Created

Having selected the appropriate options, you can then click on the Finish button, and the wizard will create your project for you, together with appropriate startup code and a simple `main.c` file. Build options for the project will be configured appropriately for the MCU that you selected in the project wizard.

You should then be able to build and debug your project, as described in Section 8.5 and Chapter 9.

8. Importing Example Projects (from the file system)

MCUXpresso IDE supports two schemes for importing examples:

- From SDKs – see the **QuickStart** Panel -> Import SDK example(s). See Importing Examples Projects (from SDK) [40]
- From the filing system – see the **QuickStart** Panel -> Import project(s) from file System
 - this option is discussed below:

Note: This option can also be used to import projects exported from MCUXpresso IDE. See Exporting Projects [57]

MCUXpresso IDE installs with a large number of example projects for pre-installed parts, that can be imported directly into a workspace: These are located at:

```
<install_dir>\ide\Examples
```

and consist of:

- CMSIS-DSPLIB
 - a suite of common signal processing functions for use on Cortex-M processor based devices.
- CodeBundles for LPC800 family
 - which consist of software examples to teach users how to program the peripherals at a basic level.
- FlashDrivers
 - example projects to create flash driver used by LinkServer
- Legacy
 - a range of historic examples and drivers including CMSIS / Peripheral Driver Library
- LPCOpen
 - High quality board and chip support libraries for LPC MCUs, plus example projects

8.1 Code Bundles for LPC800 Family devices

The LPC800 Family of MCUs are ideal for customers who want to make the transition from 8 and 16-bit MCUs to the Cortex M0/M0+. For this purpose, we've created Code Bundles which consist of software examples to teach users how to program the peripherals at a basic level. The examples provide register level peripheral access, and direct correspondence to the memory map in the MCU User Manual. Examples are concise and accurate explanations are provided within the readmes and source file comments. Code Bundles for LPC800 family devices are made available at the time of the series product launch, ready for use with a range of tools including MCUXpresso IDE.

More information on code bundles together with latest downloads can be found at:

<https://www.nxp.com/LPC800-Code-Bundles>

8.2 LPCOpen Software Drivers and Examples

LPCOpen is an extensive collection of free software libraries (drivers and middleware) and example programs that enable developers to create multifunctional products based on LPC microcontrollers. Access to LPCOpen is free to all LPC developers.

Amongst the features of LPCOpen are:

- MCU peripheral device drivers with meaningful examples
- Common APIs across device families
- Commonly needed third party and open source software ports
- Support for Keil, IAR and LPCXpresso/MCUXpresso IDE toolchains

LPCOpen is thoroughly tested and maintained. The latest LPCOpen software now available provides:

- MCU family-specific download package
- Support for USB ROM drivers
- Improved code organization and drivers (efficiency, features)
- Improved support for the MCUXpresso IDE

CMSIS / Peripheral Driver Library / code bundle software packages are still available, from within your MCUXpresso IDE install directory in `ide\Examples\Legacy`. But generally, these should only be used for existing development work. When starting a new evaluation or product development, we would recommend the use of LPCOpen if available.

More information on LPCOpen together with package downloads can be found at:

<http://www.nxp.com/lpcopen>

8.3 Importing an Example Project

To import an example project from the file system, locate the **QuickStart** panel and select 'Import projects from Filesystem'

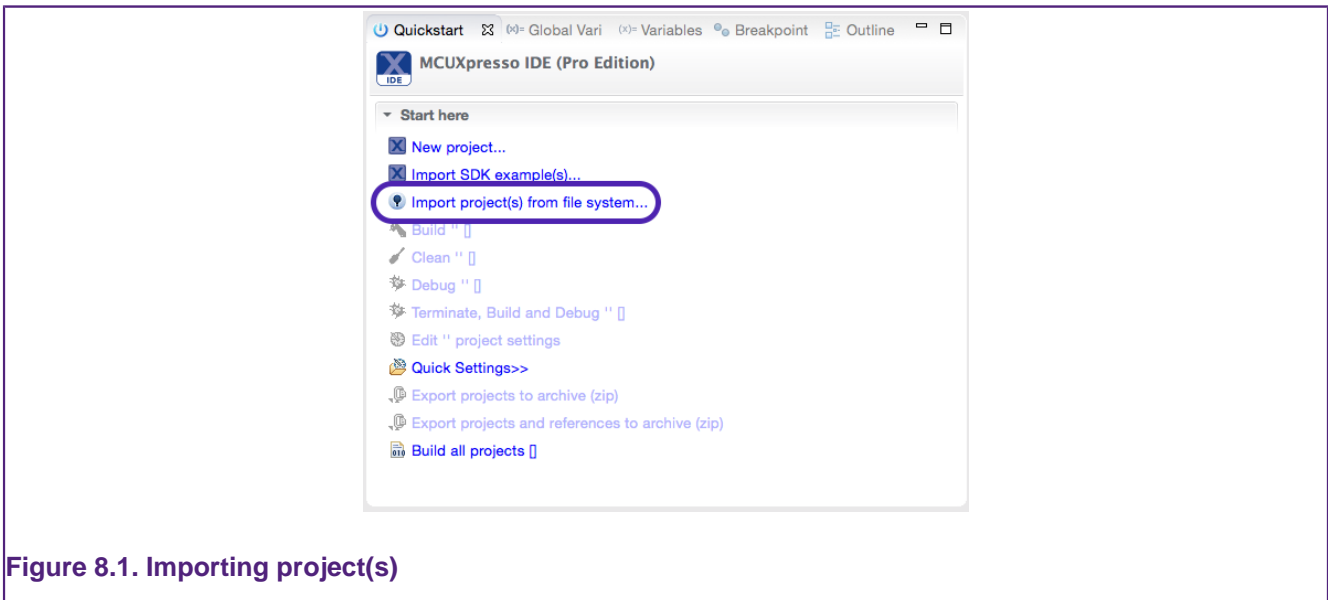

Figure 8.1. Importing project(s)

From here you can browse the file system.

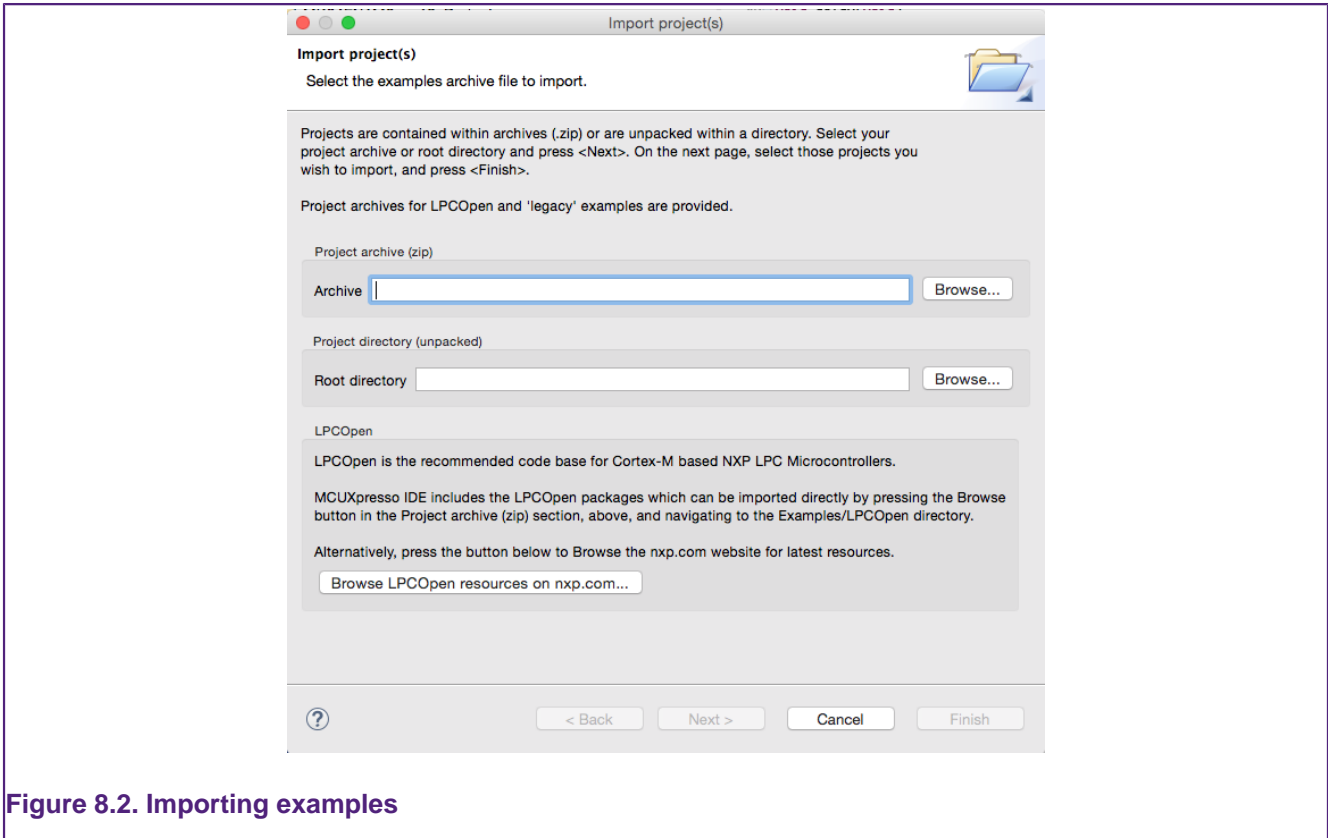

Figure 8.2. Importing examples

- **Browse** to locate Examples stored in zip archive files on your local system. These could be archives that you have previously downloaded (for example LPCOpen packages from <http://www.nxp.com/lpcopen> or the supplied, but deprecated, sample code located within the Examples/Legacy subdirectory of your MCUXpresso IDE installation).
- **Browse** to locate projects stored in directory form on your local system (for example, you can use this to import projects from a different Workspace into the current Workspace).
- **Browse LPCOpen resources** to visit <http://www.nxp.com/lpcopen> and download an appropriate LPCOpen package for your target MCU. This option will automatically open a web browser onto a suitable links page.

To demonstrate how to use the Import Project(s) functionality, we will now import the LPCOpen examples for the LPCXpresso4337 development board.

8.3.1 Importing Examples for the LPCXpresso4337 Development Board

First of all, assuming that you have not previously downloaded the appropriate LPCOpen package, click on **Browse LPCOpen Resources**, which will open a web browser window. Click on **LPC4300 Series**, and then locate **NXP LPCXpresso4337**, and then download **2.xx** version for LPCXpresso Tookchain (LPCOpen packages created for LPCXpresso IDE are compatible with MCUXpresso IDE).

Note: LPCOpen Packages for the LPC4337 are pre-installed and located at:

```
<install_dir>\ide\Examples\LPCOpen\...
```

Once the package has downloaded, return to the Import Project(s) dialog and click on the **Browse** button next to **Project archive (zip)**; then locate the LPCOpen LPCXpresso4337 package archive previously downloaded. Select the archive, click **Open** and then click **Next**. You will then be presented with a list of projects within the archive, as shown in Figure 8.3.

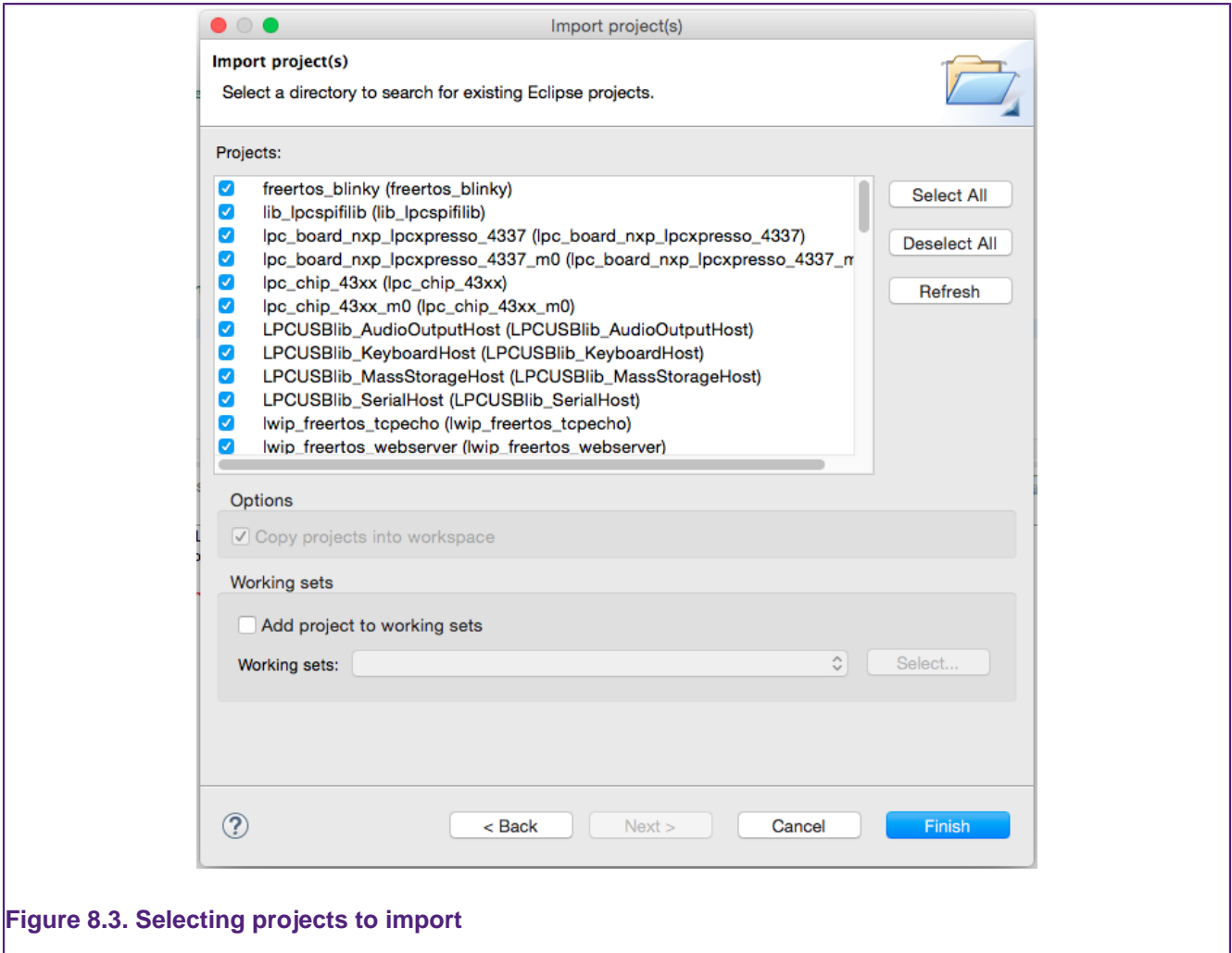

Figure 8.3. Selecting projects to import

Select the projects you want to import and then click **Finish**. The examples will be imported into your Workspace.

Note: generally, it is a good idea to leave all projects selected when doing an import from a zip archive file of examples. This is certainly true the first time you import an example set, when you will not necessarily be aware of any dependencies between projects. In most cases, an archive of projects will contain one or more library projects, which are used by the actual application projects within the examples. If you do not import these library projects, then the application projects will fail to build.

8.4 Exporting Projects

MCUXpresso IDE provides the following export options from the **QuickStart** panel:

- Export project(s) to archive (zip)
- Export project(s) and references to archive (zip)
 - choose this option to export project(s) and automatically also export referenced libraries

To export one or more projects, first select the project(s) in the **Project Explorer** then from the **QuickStart** Panel -> Export project(s) to archive (zip). This will launch a filer window. Simply select the destination and enter a name for the archive to be exported then click 'OK'.

8.5 Building Projects

Building the projects in a workspace is a simple case of using the **Quickstart Panel** to “Build all projects”. Alternatively, a single project can be selected in the ‘Project Explorer’ View and built. **Note** that building a single project may also trigger a build of any associated library projects.

8.5.1 Build Configurations

By default, each project will be created with two different “build configurations”: **Debug** and **Release**. Each build configuration will contain a distinct set of build options. Thus a **Debug** build will typically compile its code with optimizations disabled (`-O0`) and **Release** will compile its code optimizing for minimum code size (`-Os`). The currently selected build configuration for a project will be displayed after its name in the **QuickStart Panel**’s Build/Clean/Debug options.

For more information on switching between build configurations, see [How do I switch between Debug and Release builds? \[117\]](#)

9. Debugging a Project

This chapter shows how a simple debug session should be performed on an example application/project. The details below are common to all supported debug solutions. Refer to the chapter Debug Solutions Overview [10] for more details of supported debug solutions and management of debug operations.

9.1 Debugging overview

The debug chain usually starts with a debug probe USB connection to the host computer (although IP probes from P&E and SEGGER are also supported). Some debug probes such as LPC-Link2 or SEGGER J-Link *Plus* are separate physical devices, however many LPCXpresso, Freedom and Tower boards also incorporate a built in debug probe.

Note: If a separate debug probe is used, you must ensure that the appropriate cables are used to connect the probe to the target, and that the target is powered.

Note: Some LPCXpresso development boards have two USB connectors fitted. Make sure that you have connected the lower connector marked DFU-Link.

Note: Many Freedom and Tower boards also have two USB connectors fitted. Make sure that you have connected to the one marked 'OpenSDA' - this is usually (but not always) marked on the board. If in doubt, the debug processor used on these designs is a Kinetis K20 MCU, it is approximately 6mm square. The USB nearest this MCU will be the OpenSDA connection.

To start debugging a project on your target MCU, simply highlight the appropriate project in the 'Project Explorer', and then in the **Quickstart Panel** click on **Debug 'Project Name'**, as in Figure 9.1, alternatively click the blue bug icon  to perform the same action.

Note: The green bug icon should not be used because this invokes the standard Eclipse debug operation and so skips certain essential MCUXpresso IDE debug steps.

By default, this operation will first build the project and (assuming there is no build error), launch a debug probe discovery operation (see next section).

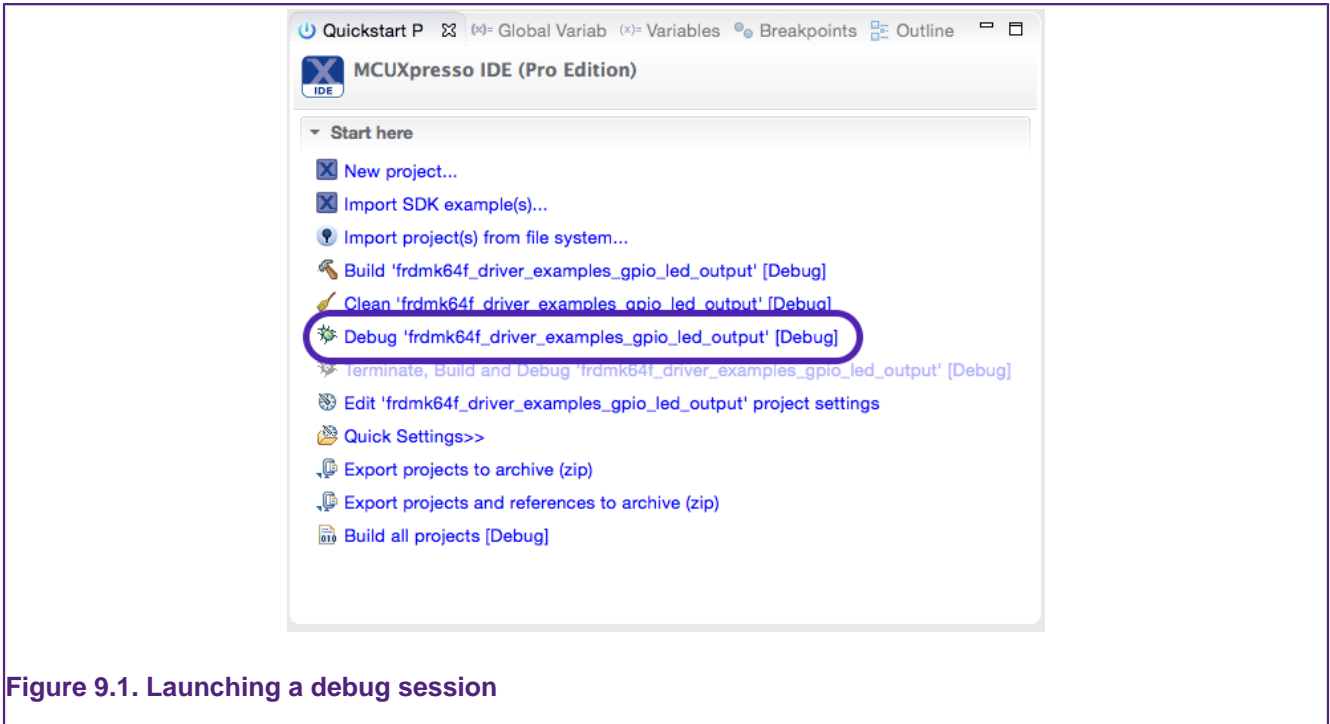

Figure 9.1. Launching a debug session

Note: Previously debugged projects will contain launch configuration files. Please see the section A note about Launch Configuration files [11] for more information.

Once a debug probe has been selected (and 'OK' clicked) the binary contents of the .axf file will automatically be downloaded to the target via the debug probe connection. Typically, projects are built to target MCU flash memory, and in these cases, a suitable flash driver will automatically be selected to perform the flash programming operation. Next a default breakpoint will be set on the first instruction in `main()`, the application will be started (by simulating a processor reset), and code will be executed until the default breakpoint is hit.

9.1.1 Debug Probe Selection Dialog

The first time you debug a project, the Debug Probe Discovery Dialogue will be displayed. This will show all supported probes that are attached to your computer. In the example shown in Figure 9.2, a LinkServer (LPC-Link2), a P&E Micro Multilink and also a J-Link (OpenSDA) probe have been found.

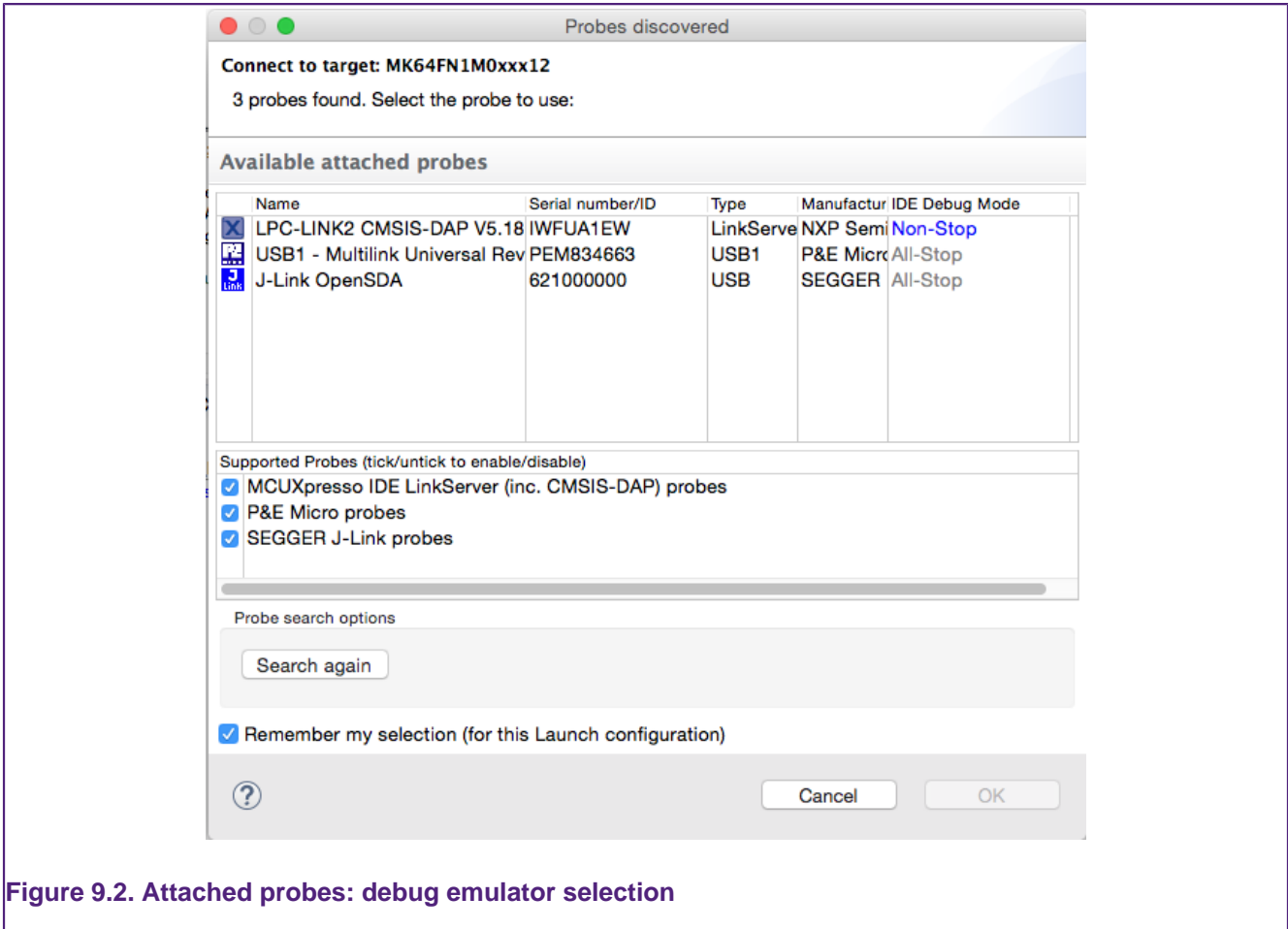

Figure 9.2. Attached probes: debug emulator selection

MCUXpresso IDE supports unique debug probe association.

Debug probes can return an ID (Serial number) that is used to associate a particular debug probe with a particular project. Some debug probes will always return the same ID, however debug probes such as the LPC-Link2 will return a unique ID for each probe – in our example **IWFUA1EW**.

For any future debug sessions, the stored probe selection will be automatically used to match the project being debugged with the previously used debug probe. This greatly simplifies the case where multiple debug probes are being used.

However, if a debug operation is performed and the previously remembered debug probe cannot be found, then a debug probe discovery operation will be performed for within the same family e.g. LinkServer, P&E or SEGGER.

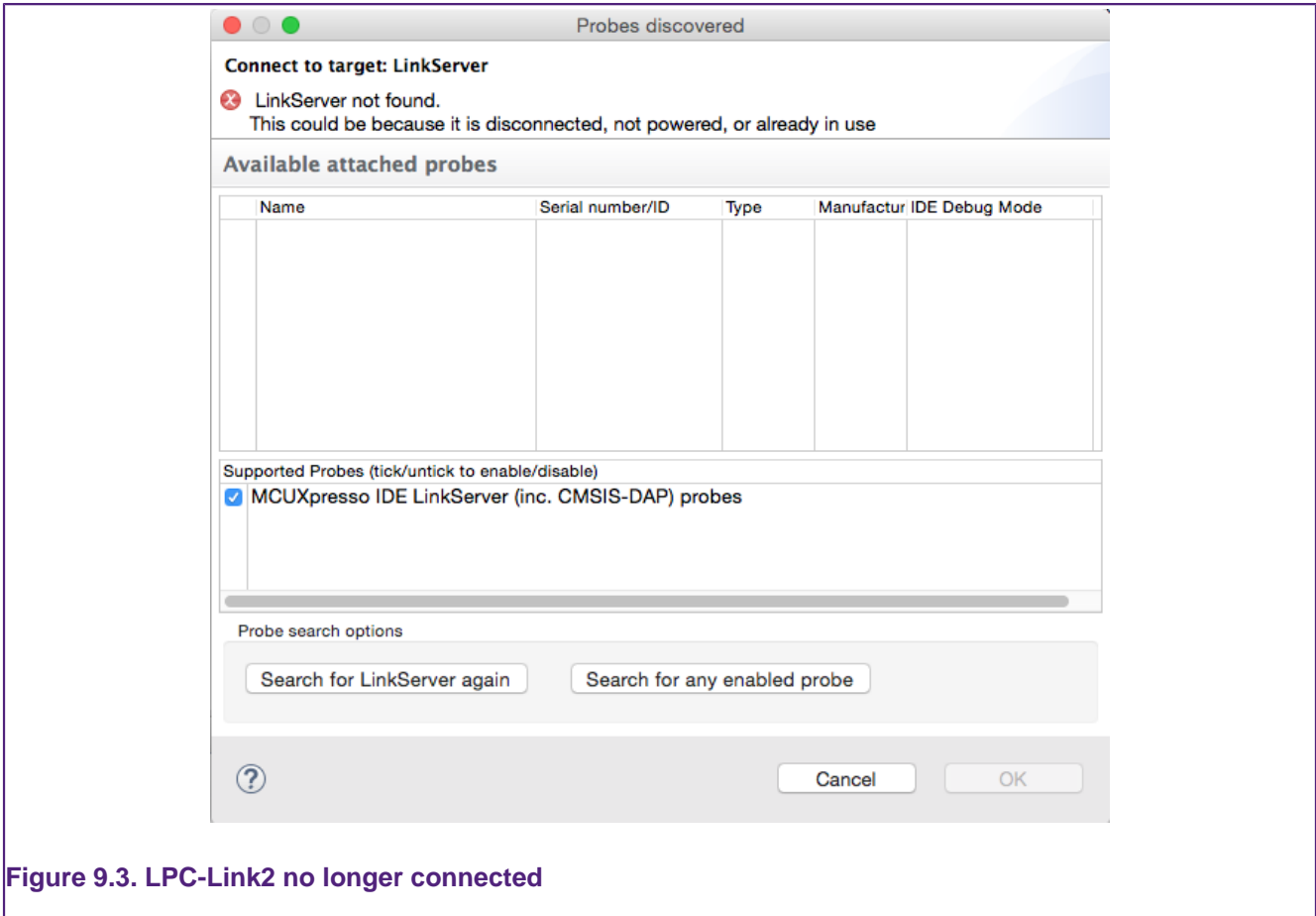

Figure 9.3. LPC-Link2 no longer connected

This might have been because you had forgotten to connect the probe, in which case simply connect it to your computer and select **Search again**. If you are using a different debug probe from the same family of debug probes, simply select the new probe and this will replace the previously selected probe.

Notes:

- The “Remember my selection” option is enabled by default in the Debug Emulator Selection Dialog, and will cause the selected probe to be stored in the launch configuration for the current configuration (typically Debug or Release) of the current project. You can thus remove the probe selection at any time by simply deleting the launch configuration.
- You will need to select a probe for each project that you debug within a Workspace (as well as for each configuration within a project).
- If you wish to debug a project using a different family of debug probe, then the simplest option is to delete the launch configuration files associated with the project and start a debug operation. Please see the section A note about Launch Configuration files [11] for more information.

9.1.2 Controlling Execution

When you have started a debug session a default breakpoint is set on the first instruction in `main()`, the application is started (by simulating a processor reset), and code is executed until the default breakpoint is hit.

Program execution can now be controlled using the common debug control buttons, as listed in Table 9.1, which are displayed on the global toolbar. The call stack is shown in the Debug View, as in Figure 9.4.

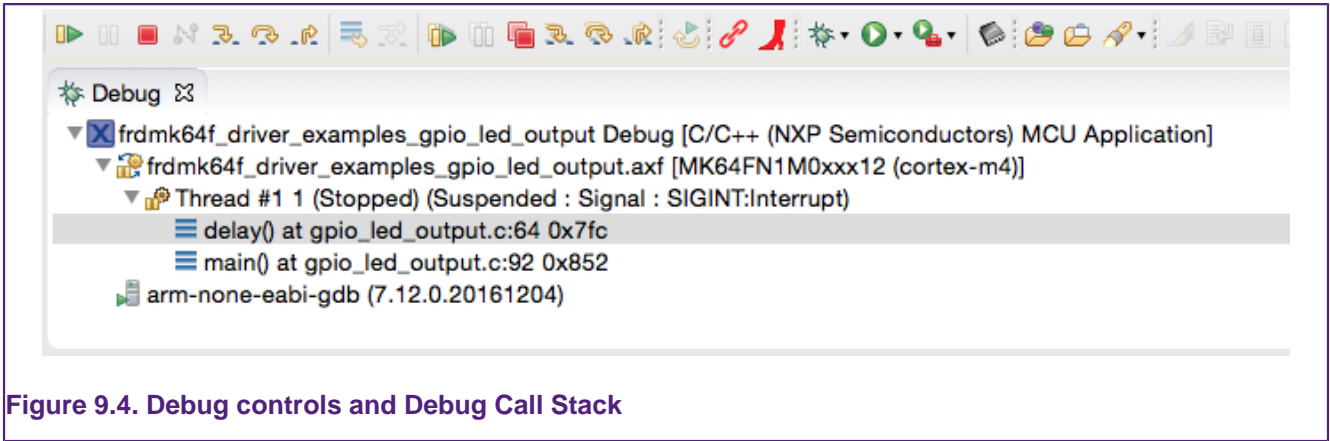

Figure 9.4. Debug controls and Debug Call Stack

Table 9.1. Program execution controls

Button	Description	Keyboard Shortcut
	Restart program execution (from reset)	
	Run/Resume the program	F8
	Pause Execution of the running program	
	Terminate the debug Session	Ctrl + F2
	Run, Pause, Terminate all debug sessions	
	Step over a C/C++ line	F6
	Step into a function	F5
	Return from a function	F7
	Step in, over, out all debug sessions	
	Show disassembled instructions	

Note: The debug controls for ‘all’ debug sessions will perform identically to their single session counterparts if only one debug session exists.

Note: Typically a user will only have a single active debug session. However if there is more than one debug session, the active session can be chosen by clicking within the debug call stack within the debug pane.

Setting a breakpoint

To set a breakpoint, simply double-click on the left margin area of the line on which you wish to set the breakpoint (before the line number).

Restarting the application

If you hit a breakpoint or pause execution and want to start execution of the application from the beginning again, you can do this using the **Restart** button.

Stopping debugging

To stop debugging just press the **Stop** button.

If you are debugging using the **Debug Perspective**, then to switch back to the **C/C++ Perspective** when you stop your debug session, just click on the **C/C++** tab in the upper right area of the MCUXpresso IDE (as shown in Figure 2.2).

10. LinkServer Flash Support

MCUXpresso IDE's LinkServer based debug connections makes use of a RAM loadable flash driver mechanism. Such a flash driver contains the knowledge required to program the internal flash on a particular MCU (or potentially, family of MCUs). This knowledge may be either prebuilt into the driver, or some of it may be determined by the driver as it starts up (typically known as a "generic" flash driver).

At the time the debug connection is started from within the MCUXpresso IDE, the LinkServer debug session running on the host will typically download a flash driver into RAM on the target MCU. It will then communicate with the downloaded flash driver via the debug probe in order to program the required code and data into the flash memory.

In addition, the loadable flash driver mechanism also provides the ability to produce flash drivers which can be used to program external flash memory (for instance via the SPIFI flash memory interface on LPC18x, LPC40xx, LPC43xx and LPC5460x families). The sources for some of these drivers is provided in the Examples/Flashdrivers subdirectory within the MCUXpresso IDE installation directory.

LinkServer flash drivers have a .cfx file extension. For Preinstalled MCUs, the flash driver used for each part/family will be located in the /bin/Flash subdirectory of the MCUXpresso IDE installation. For SDK installed MCUs, the flash driver will generally be supplied within the SDK, though versions are also provided in the /bin/Flash subdirectory too.

10.1 Default vs Per-Region Flash drivers

By default, for legacy reasons, Preinstalled MCUs are configured to use what is called a "Default" flash driver. This means that this flash driver will be used for all Flash memory blocks that are defined for that MCU (i.e. as displayed in the Memory Configuration Editor).

For most users, there is never any need to change the automatically selected flash driver for the MCU being debugged.

However, MCUXpresso IDE also supports the creation and programming of projects that span multiple flash devices. In order to allow this to work, flash drivers can also be specified per-region.

For example, this allows a project based on an LPC43xx device with internal flash to also make use of external SPIFI flash device. This is achieved by removing the default flash driver from the memory configuration and instead explicitly specifying the flash driver to use for each flash memory block (per-region flash drivers). A typical use case could be to create an application to run from the MCU's internal flash that makes use of static constant data (e.g. for graphics) stored in external SPIFI device.

Note: SDK installed MCUs are always defined using Per-Region flash drivers.

10.2 Special case Flash drivers for LPC MCUs

For most projects, the selection of a flash driver is automatically performed by the Project wizard, however for some MCUs some user intervention may be required.

10.2.1 LPC18xx / LPC43xx Internal Flash Drivers

A number of LPC18/43 parts provide dual banks of internal flash, with bank A starting at address 0x1A000000, and bank B starting at address 0x1B000000.

```
* LPC18x3/LPC43x3 : Flash = 2x 256KB (512 KB total)
* LPC18x5/LPC43x5 : Flash = 2x 384KB (768 KB total)
* LPC18x7/LPC43x7 : Flash = 2x 512KB ( 1 MB total)
```

When you create a new project using the New Project Wizard for one of these parts, an appropriate default flash driver (from *LPC18x3_43x3_2x256_BootA.cfx* / *LPC18x5_43x5_2x384_BootA.cfx* / *LPC18x7_43x7_2x512_BootA.cfx*) will be selected which after programming the part will also configure it to boot from Bank A flash.

If you wish to boot from Bank B flash instead, then you will need to manually configure the project to use the corresponding “BootB” flash driver (*LPC18x3_43x3_2x256_BootB.cfx* / *LPC18x5_43x5_2x384_BootB.cfx* / *LPC18x7_43x7_2x512_BootB.cfx*). This can be done by selecting the appropriate driver file in the “Flash driver” field of the Memory Configuration Editor. **Note:** you will also need to delete Flash Bank A from the list of available memories (or at least reorder so that Flash Bank B is first).

10.2.2 SPIFI Flash Drivers

A number of LPC parts provide support for external SPIFI flash, usually in addition to internal flash. Programming these flash memories provides a number of challenges because the size of memory (if present) is unknown, and the actual memory device is also unknown. These issues are handled using *Generic Drivers* which can interrogate the memory device to find its size and programming requirements.

At the time of writing, these LPC devices comprise:

Table 10.1. SPIFI details

LPC Part	SPIFI Address	Bootable	Flash Driver
LPC18xx/LPC43xx	0x14000000	Yes	LPC18_43_SPIFI_GENERIC.cfx
LPC40xx	0x28000000	No	LPC40xx_SPIFI_GENERIC.cfx
LPC5460x	0x10000000	No	LPC546x_SPIFI_GENERIC.cfx

During a programming operation, the flash driver will interrogate the SPIFI flash device to identify its configuration. If the device is recognised, its size and name will be reported in the MCUXpresso IDE Debug log - as below:

```

...
Inspected v.2 External Flash Device on SPI using SPIFI lib LPC18_43_SPIFI_GENERIC.cfx
Image 'LPC18/43 Generic SPIFI Mar 7 2017 13:14:25'
Opening flash driver LPC18_43_SPIFI_GENERIC.cfx
flash variant 'MX25L8035E' detected (1MB = 16*64K at 0x14000000)
...
    
```

Note: Although the flash driver reports the size and location of the SPIFI device, the IDE's view of the world is determined by the project memory configuration settings. It remains the users responsibility to ensure these setting match the actual device in use.

10.3 Configuring projects to span multiple flash devices

<https://community.nxp.com/thread/388979>

10.4 Kinetis Flash Drivers

Kinetis MCUs make use of a range of generic drivers, which are supplied as part of the SDK part support package. When a project is created or imported, the appropriate flash driver is automatically selected and associated with the project.

Kinetis flash drivers follow a simple naming convention i.e. **FTFx_nK_xx** where:

- FTFx is the flash module name of the MCU, where x can take the value E, A or L
- nK represents the flash sector size the flash device supports, where n can take the value 1, 2, 4, 8

- a sector size is the smallest amount of flash that can be erased on that device
- xx is an optional suffix for special case drivers e.g. __Tiny for use on parts with a small quantity of RAM

So for example a K64F MCU's flash driver will be called *FTFE_4K*, because the K64F MCU uses the FTFE flash module type and support a 4KB flash sector size.

When a debug session is started that programs data into flash memory, the IDE's debug log file will report the flash driver used and parameters it has read from the MCU. Below we can see the driver identified a K64 part and the size of the internal Flash available. It also reports the programming speed achieved when programming this device. These logs can be useful when problems are encountered.

Note: when the flash driver starts up, it will interrogate the MCU and report a number of data items. However, due to the nature of internal registers with the MCU, these many not exactly match the MCU being debugged.

```

Probe Firmware: LPC-LINK2 CMSIS-DAP V5.181 (NXP Semiconductors)
Serial Number: IWFUA1EW
VID:PID: 1FC9:0090
USB Path: USB_lfc9_0090_14131100_ff00
Probe(0): Connected&Reset. DpID: 2BA01477. CpuID: 410FC240. Info: <None>
Debug protocol: SWD. RTCK: Disabled. Vector catch: Disabled.
Inspected v.2 On chip Kinetis Flash memory module FTFE_4K.cfx
Image 'Kinetis SemiGeneric Feb 17 2017 17:24:02'
Opening flash driver FTFE_4K.cfx
flash variant 'K64 FTFE Generic 4K' detected (1MB = 256*4K at 0x0)
Closing flash driver FTFE_4K.cfx
NXP: MK64FN1M0xxx12
Connected: was_reset=true. was_stopped=true
MCUXpressoPro Full License - Unlimited
Awaiting telnet connection on port 3331 ...
GDB nonstop mode enabled
Opening flash driver FTFE_4K.cfx (already resident)
Writing 26732 bytes to address 0x00000000 in Flash
Erased/Wrote page 0-6 with 26732 bytes in 285msec
Closing flash driver FTFE_4K.cfx
Flash Write Done
Flash Program Summary: 26732 bytes in 0.28 seconds (91.60 KB/sec)
    
```

Flash drivers for a number of Kinetis MCUs are listed below:

```

K64F  FTFE_4K (1MB)
K22F  FTFA_2K (512KB)
KL43  FTFA_1K (256KB)
KL27  FTFA_1K (64KB)
K40   FTFL_2K (256KB)
    
```

10.5 Using the LinkServer flash programmer

As well as supporting the programming of flash when starting a debug session, the flash programming capabilities of LinkServer can also be accessed directly, both via the GUI and from the command line. This might be useful, for instance, in carrying out small production runs.

10.5.1 The GUI flash programmer

The flash programming utility, which is invoked automatically when you launch a debug session, can also be accessed at other times within the MCUXpresso IDE environment by clicking on the “Program Flash” icon on the toolbar at the top of the IDE window....



This button provides access to 3 distinct flash programming operations:

1. Programming an .axf or .bin file
2. Flash Mass Erase
3. Kinetis Flash Recovery

The behaviour of these 3 operations can be modified by a common set of self describing check boxes.

Before clicking on the “Program Flash” icon, ensure that you have a project selected in the Project Explorer pane which is configured for the MCU that you are going to program. This will ensure that appropriate configuration options for the flash programmer are set correctly. Alternatively, you can directly select a .bin or .axf file within a project, the flash programming tool will then also pick up the appropriate filename.

Note: These features are for LinkServer connections only so only LinkServer compatible debug probes will be used. Each use of the GUI flash programmer will be preceded by a Debug Probe Discovery process.

Programming an .axf or .bin file

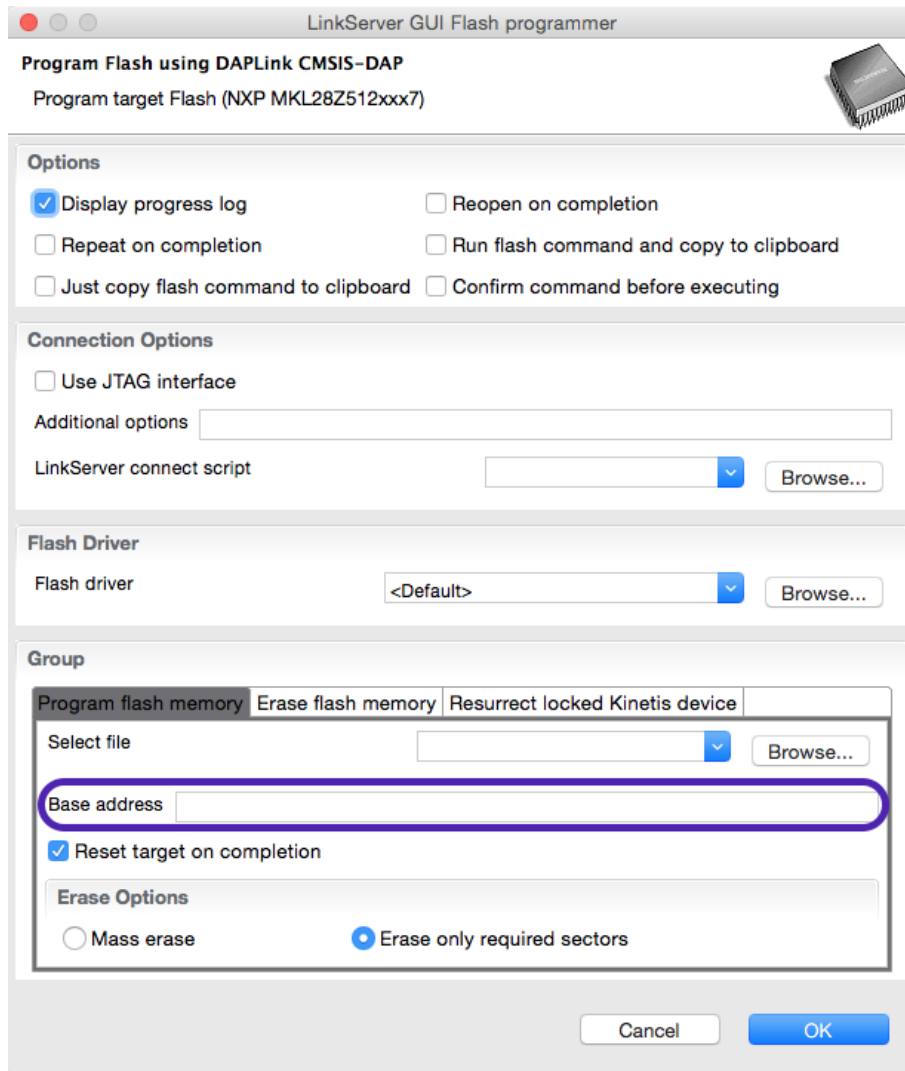

From this view you can select a .axf or .bin file to be programmed. Note: for a bin file you must also provide an appropriate base address. The utility will inherit the flash driver from the projects configuration or alternatively a different flash driver can be selected.

Flash Mass Erase

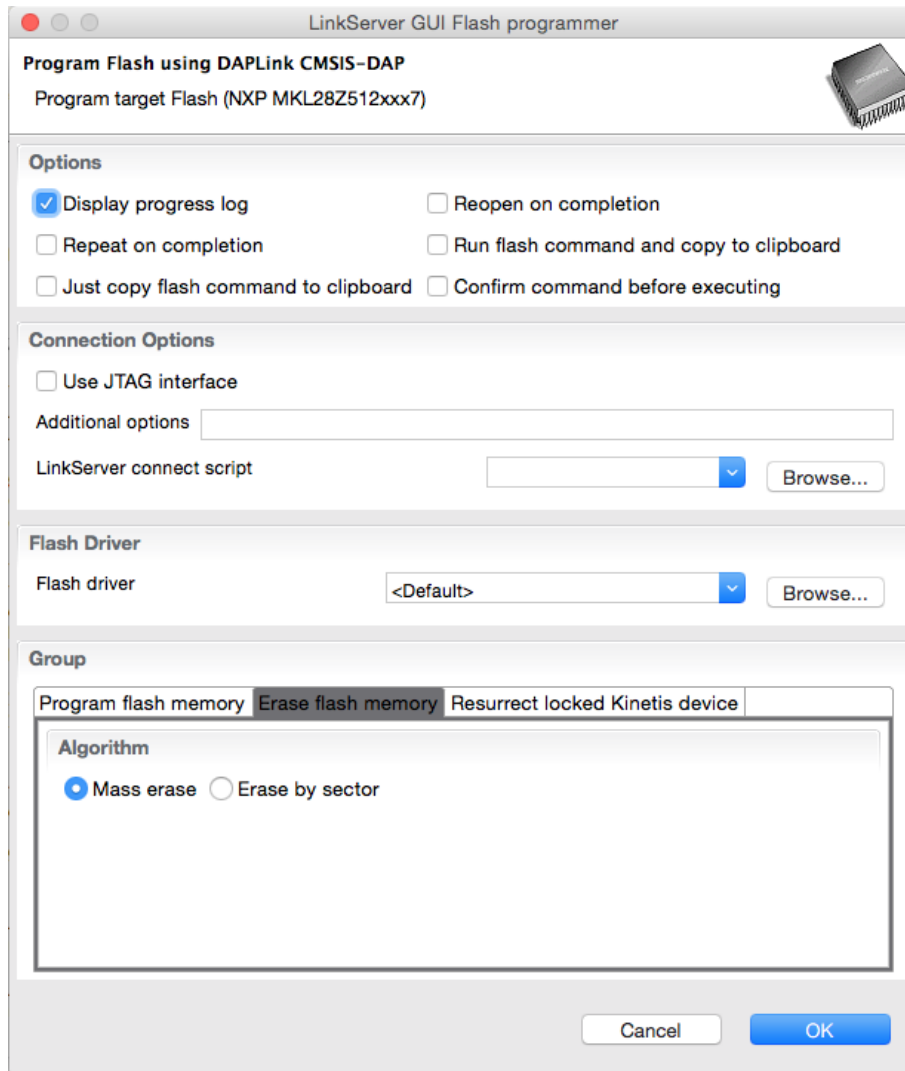

On occasion it can be useful to completely erase the memory on a flash device. The utility will inherit the flash driver from the projects configuration or alternatively a different flash driver can be selected. The mass erase option with the flash driver will be used to perform the erase operation.

Kinetis Flash Recovery

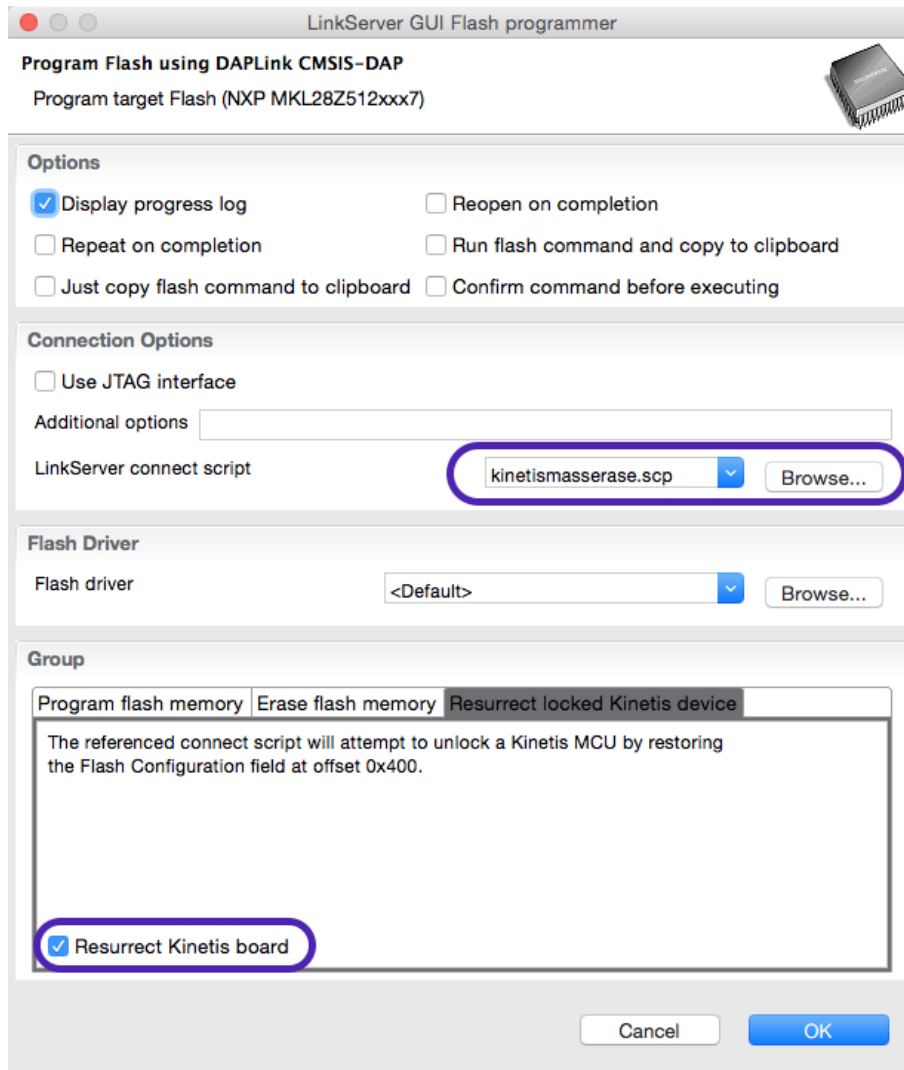

This operation is designed to recover Kinetis MCUs whose flash devices have become ‘secured’. A secured MCU cannot be programmed by a normal flash programming operation.

Should this occur, simply check the box labeled ‘Resurrect Kinetis Board’, this will populate the *Connect Script* field with a *kinetismasserase.scp* script and click ‘OK’. This will cause a script to be run that will attempt to recover the flash device.

Note: Should this process fail to recover the part, an alternate script called *kinetisunlock.scp* may be successful. This alternate script must be manually selected via the *Connect Script Browse* button.

10.5.2 The command line flash programmer

Flash programming is usually invoked automatically when you launch a debug session from within the MCUXpresso IDE, but can also be accessed directly using a command line utility. This can be useful for things like programming the flash for devices with limited production runs.

The MCUXpresso IDE flash programming stubs are located at:

```
<install_dir>/ide/bin/
```

To run a flash programming operation from the command line, the correct flash utility stub for your part should be called with appropriate options. For example:

```
crt_emu_cm_redlink -flash-load-exec "LPC11U68_App.axf" -vendor=NXP -pLPC11U68
```

Note: A simple way of finding the correct command and options, is to use the GUI flash programmer described above, the completion dialog shows the exact command line invoked by the GUI.

The flash programming utility takes the following options:

```
crt_emu_cm_redlink -ptarget -vendor=NXP -flash-load[-exec] "filename" [-load-base=base_address] [-flash-driver=driver]
```

- *target* is the target chip name. For example LPC1343, LPC1114/301, LPC1768 etc.
- *filename* is the file to flash program. It may be an executable (axf) or a binary (bin) file. If using a binary file, the *base_address* also must be specified.
- *base_address* is the address where the binary file will be written. It should be specified as a hex value with a leading 0x.
- *flashdriver* for parts with external flash, a flash driver can be specified, see LPC18 / LPC43 External Flash Drivers for more information.
 - *-flash-load* will leave the processor in a stopped state.
 - *-flash-load-exec* will start execution of application as soon as download has completed.

11. C/C++ Library Support

MCUXpresso IDE ships with three different C/C++ library families. This provides the maximum possible flexibility in balancing code size and library functionality.

11.1 Overview of Redlib, Newlib and NewlibNano

- **Redlib** Our own (non-GNU) ISO C90 standard C library, with some C99 extensions.
- **Newlib** GNU C/C++ library
- **NewlibNano** a version of the GNU C/C++ library optimized for embedded.

By default, MCUXpresso IDE will use Redlib for C projects, NewlibNano for SDK C++ projects, and Newlib for C++ projects for preinstalled MCUs.

Newlib provides complete C99 and C++ library support at the expense of a larger (in some cases, much larger) code size in your application.

NewlibNano was produced as part of ARM's "GNU Tools for ARM Embedded Processors" initiative in order to provide a version of Newlib focused on code size. Using NewlibNano can help dramatically reduce the size of your application compared to using the standard version of Newlib – for both C and C++ projects.

If you need a smaller application size and don't need the additional functionality of the C99 or C++ libraries, we recommend the use of Redlib, which can often produce much smaller applications.

11.1.1 Redlib extensions to C90

Although Redlib is basically a C90 standard C library, it does implement a number of extensions, including some from the C99 specification. These include:

- Single precision math functions
 - Single precision implementations of some of the math.h functions such as `sinf()` and `cosf()` are provided.
- `stdbool.h`
 - An implementation of the C99 `stdbool.h` header is provided.
- `itoa`
 - `itoa()` is non-standard library function which is provided in many other toolchains to convert an integer to a string. To ease porting, an implementation of this function is provided, accessible via `stdlib.h`. More details can be found later in this chapter.

11.1.2 Newlib vs NewlibNano

Differences between Newlib and NewlibNano include:

- NewlibNano is optimized for size.
- The `printf` and `scanf` family of routines have been re-implemented in NewlibNano to remove a direct dependency on the floating-point input/output handling code. Projects that need to handle floating-point values using these functions must now explicitly request the feature during linking.
- The `printf` and `scanf` family of routines in NewlibNano support only conversion specifiers defined in C89 standard. This provides a good balance between small memory footprint and full feature formatted input/output.
- NewlibNano removes the now redundant integer-only implementations of the `printf/scanf` family of routines (`iprntf/iscanf`, etc). These functions now alias the standard routines.
- In NewlibNano, only unwritten buffered data is flushed on exit. Open streams are not closed.

- In NewlibNano, the dynamic memory allocator has been re-implemented

11.2 Library variants

Each C library family is provided in a number of different variants : None, Nohost and Nohost-nf, Semihost and Semihost-nf (Redlib only). These variants each provide a different set of 'stubs' that form the very bottom of the C library and include certain low-level functions used by other functions in the library.

Each variant has a differing set of these stubs, and hence provides differing levels of functionality:

- **Semihost**
 - This library variant provides implementation of all functions, including file I/O. The file I/O will be directed through the debugger and will be performed on the host system (semihosting). For example, printf/scanf will use the debugger console window and fread/fwrite will operate on files on the host system. **Note:** emulated I/O is relatively slow and can only be used when debugging.
- **Semihost-nf (no files)**
 - Redlib only. Similar to Semihost, but only provides support for the 3 standard built-in streams – stdin, stdout, stderr. This reduces the memory overhead required for the data structures used by streams, but means that the user application cannot open and use files, though generally this is not a problem for embedded applications.
- **Nohost and Nohost-nf**
 - This library variant provides the string and memory handling functions and some file-based I/O functions. However, it assumes that you have no debugging host system, thus any file I/O will do nothing. However, it is possible for the user to provide their own implementations of some of these I/O functions, for example to redirect output to the UART.
- **None**
 - This has literally no stub and has the smallest memory footprint. It excludes low-level functions for all file-based I/O and some string and memory handling functions.

In many embedded microcontroller applications it is possible to use the None variant by careful use of the C library, for instance avoiding calls to printf().

If you are using the wrong library variant, then you will see build errors of the form:

- Linker error "Undefined reference to 'xxx' "

For example for a project linking against Redlib(None) but using printf() :

```
... libcr_c.a(fpprintf.o): In function `printf':
fpprintf.c:(.text.printf+0x38): undefined reference to `__sys_write'
fpprintf.c:(.text.printf+0x4c): undefined reference to `__Ciob'
... libcr_c.a(deferredlazyseek.o): In function `__flsbuf':
deferredlazyseek.c:(.text.__flsbuf+0x88): undefined reference to `__sys_istty'
... libcr_c.a(writebuf.o): In function `_Cwritebuf':
writebuf.c:(.text._Cwritebuf+0x16): undefined reference to `__sys_flen'
writebuf.c:(.text._Cwritebuf+0x26): undefined reference to `__sys_seek'
writebuf.c:(.text._Cwritebuf+0x3c): undefined reference to `__sys_write'
... libcr_c.a(alloc.o): In function `_Csys_alloc':
alloc.c:(.text._Csys_alloc+0xe): undefined reference to `__sys_write'
alloc.c:(.text._Csys_alloc+0x12): undefined reference to `__sys_appexit'
... libcr_c.a(fseek.o): In function `fseek':
fseek.c:(.text.fseek+0x16): undefined reference to `__sys_istty'
fseek.c:(.text.fseek+0x3a): undefined reference to `__sys_flen'
```

Or if linking against NewlibNano(None):

```

... libc_nano.a(lib_a-writer.o): In function `_write_r':
writer.c:(.text._write_r+0x10): undefined reference to `_write'
... libc_nano.a(lib_a-closer.o): In function `_close_r':
closer.c:(.text._close_r+0xc): undefined reference to `_close'
... libc_nano.a(lib_a-lseekr.o): In function `_lseek_r':
lseekr.c:(.text._lseek_r+0x10): undefined reference to `_lseek'
... libc_nano.a(lib_a-readr.o): In function `_read_r':
readr.c:(.text._read_r+0x10): undefined reference to `_read'
... libc_nano.a(lib_a-fstatr.o): In function `_fstat_r':
fstatr.c:(.text._fstat_r+0xe): undefined reference to `_fstat'
... libc_nano.a(lib_a-isatty.o): In function `_isatty_r':
isatty.c:(.text._isatty_r+0xc): undefined reference to `_isatty'

```

In such cases, simply change the library hosting being used (as described below), or remove the call to the triggering C library function.

11.3 Switching the selected C library

Normally the library variant used by a project is set up when the project is first created by the New Project Wizard. However it is quite simple to switch the selected C library between Redlib, Newlib and NewlibNano, as well as switching the library variant in use.

To switch, highlight the project in the Project Explorer view and go to:

Quickstart -> Quick Settings -> Set library/header type

and select the required library and variant.

11.3.1 Manually switching

Alternatively, you can make the required changes to your project properties manually as follows...

When switching between Newlib(Nano) and Redlib libraries you must also switch the headers (since the 2 libraries use different header files). To do this:

1. Select the project in Project Explorer
2. Right-click and select Properties
3. Expand C/C++ Build and select Settings
4. In the Tools settings tab, select Miscellaneous under MCU C Compiler. **Note:** Redlib is not available for C++ projects
5. In Library headers, select Newlib or Redlib
6. In the Tools setting tab, select Architecture & Headers under MCU Assembler
7. In Library headers, select Newlib or Redlib

Repeat the above sequence for all Build Configurations (typically Debug and Release).

To then change the libraries actually being linked with (assuming you are using Managed linker scripts):

1. Select the project in Project Explorer
2. Right-click and select Properties
3. Expand C/C++ Build and select Settings
4. In the Tools settings tab, select Managed Linker Script under MCU Linker
5. In the Library drop-down, select the Newlib, NewlibNano or Redlib library variant that you require (None, Nohost, Semihost, Semihost-nf).

Again repeat the above sequence for all Build Configurations (typically Debug and Release).
Note: Redlib is not available for C++ projects.

11.4 What is Semihosting?

Semihosting is a term to describe application I/O via the debug probe. For this to operate, library code and debug support are required.

11.4.1 Background to Semihosting

When creating a new embedded application, it can sometimes be useful during the early stages of development to be able to output debug status messages to indicate what is happening as your application executes.

Traditionally, this might be done by piping the messages over, a serial cable connected to a terminal program running on your PC. The MCUXpresso IDE offers an alternative to this scheme, called semihosting. Semihosting provides a mechanism for code running on the target board to use the facilities of the PC running the IDE. The most common example of this is for the strings passed to a printf being displayed in the IDE's console view.

The term "semihosting" was originally termed by ARM in the early 1990s, and basically indicates that part of the functionality is carried out by the host (the PC with the debug tools running on it), and partly by the target (your board). The original intention was to provide I/O in a target environment where no real peripheral-based I/O was available at all.

11.4.2 Semihosting implementation

The way it is actually implemented by the tools depends upon which target CPU you are running on. With Cortex-M based MCUs, the bottom level of the C library contains a special BKPT instruction. The execution of this is trapped by the debug tools which determine what operation is being requested – in the case of a printf, for example, this will effectively be a "write character to stdout". The debug tools will then read the character from the memory of the target board – and display it in the console window within the IDE.

Semihosting also provides support for a number of other I/O operations (though this relies upon your debug probe also supporting them)... For example it provides the ability for scanf to read its input from the IDE console. It also allows file operations, such that fopen can open a file on your PC's hard drive, and fscanf can then be used to read from that file.

11.4.3 Semihosting Performance

It is fair to say that the semihosting mechanism does not provide a high performance I/O system. Each time a semihosting operation takes place, the processor is basically stopped whilst the data transfer takes place. The time this takes depends somewhat on the target CPU, the debug probe being used, the PC hardware and the PC operating system. But it takes a definite period of time, which may make your code appear to run more slowly.

11.4.4 Important notes about using semihosting

When you have linked with the semihosting library, your application will no longer work standalone – it will only work when connected to the debugger.

Semihosting operations cause the CPU to drop into "debug state", which means that for the duration of the data transfer between the target and the host PC no code (including interrupts) will get executed on the target. Thus if your application uses interrupts, then it is normally advisable to avoid the use of semihosting whilst interrupts are active – and certainly within interrupt handlers

themselves. If you still need to use `printf`, then you can retarget the bottom level of the C library to use an alternative communication channel, such as a UART or the Cortex-M CPU's ITM channel.

11.4.5 Semihosting Specification

The semihosting mechanism used within MCUXpresso IDE is based on the specification contained in the following document available from ARM's website... => ARM Developer Suite (ADS) v1.2 Debug Target Guide, Chapter 5. Semihosting

11.5 Use of `printf`

By default, the output from `printf()` (and `puts()`) will be displayed in the debugger console via the semihosting mechanism. This provides a very easy way of getting basic status information out from your application running on your target.

For `printf()` to work like this, you must ensure that you are linking with a "semihost" or "semihost-nf" library variant.

Note that if you only require the display of fixed strings, then using `puts()` rather than `printf()` will noticeably reduce the code size of your application.

11.5.1 Redlib `printf` variants

Redlib provides the following two variants of `printf`. Many of the MCUXpresso New project wizards provide options to select which of these to use when you create a new project.

Character vs String output

By default `printf()` and `puts()` functions will output the generated string at once, so that a single semihosted operation can output the string to the console of the debugger. Note that these versions of `printf()` / `puts()` make use of `malloc()` to provide a temporary buffer on the heap in order to generate the string to be displayed.

It is possible to switch to using "character-by-character" versions of these functions (which do not require additional heap space) by specifying the build define "CR_PRINTF_CHAR" (which should be set at the project level). This can be useful, for example, if you are retargeting `printf()` to write out over a UART (as detailed below)- as in this case it is pointless creating a temporary buffer to store the whole string, only to then print it out over the UART one character at a time

Integer only vs full `printf` (including floating point)

The `printf()` routine incorporated into Redlib is much smaller than that in Newlib. Thus if code size is an issue, then always try to use Redlib if possible. In addition if your application does not pass floating point numbers to `printf`, you can also select a "integer only" (non-floating point compatible) variant of `printf`. This will reduce code size further.

To enable the "integer only" `printf` from Redlib, define the symbol "CR_INTEGER_PRINTF" (at the project level). This is done by default for projects created from the SDK new project wizard.

11.5.2 NewlibNano `printf` variants

By default, NewlibNano uses non-floating point variants of the `printf` and `scanf` family of functions, which can help to dramatically reduce the size of your image if only integer values are used by such functions.

If your codebase does require floating point variants of `printf/scanf`, then these can be enabled by going to:

Project -> Properties -> C/C++ Build -> Settings -> MCU Linker -> Managed Linker Script and selecting the " Enable printf/scanf float" tick box.

11.5.3 Newlib printf variants

Newlib provides an "iprintf" function which implements integer only printf

11.5.4 Printf when using LPCOpen

If you are building your application against LPCOpen, you may find that printf output does not get displayed in the MCUXpresso IDE's debug console by default. This is due to many LPCOpen board library projects by default redirecting printf to a UART output.

If you want to direct printf output to the debug console instead, then you will need to modify your projects so that:

1. Your main application project is linked against the "semihost" variant of the C library, and
2. You disable the LPCOpen board library's redirection of printf output by either:
 - locating the source file board.c within the LPCOpen board library and comment out the line: `#include "retarget.h`, or
 - locating the file board.h and enable the line: `#define DEBUG_SEMIHOSTING`

11.5.5 Printf when using SDK

The MCUXpresso SDK codebase provides its own printf style functionality through the macro PRINTF. This is set up in the header file fsl_debug_console.h such that it can either point to the printf function provided by the C library itself, or can be directly to the SDK function pseudo-printf function : DbgConsole_Printf() . This will typically cause the output to be sent out via a UART (which may be connected to an onboard debug probe which will send it back to the host over a USB VCOM channel). This is controlled by the macro **SDK_DEBUGCONSOLE** thus:

- If `SDK_DEBUGCONSOLE == 0`
 - PRINTF is directed to C library printf()
- If `SDK_DEBUGCONSOLE == 1`
 - PRINTF is directed to SDK DbgConsole_Printf()

The Advanced page of the SDK new project wizard and Import SDK examples wizard offer the option to configure a project so that PRINTF is directed to C library printf() by setting **SDK_DEBUGCONSOLE** appropriately.

In addition if PRINTF is being directed to the C library printf(), then if **SDK_DEBUGCONSOLE_UART** is also defined, then printf output will still be directed to the UART. Again the Advanced page of the SDK new project wizard and Import SDK examples wizard offer an option to control this.

11.5.6 Retargeting printf/scanf

By default, the printf function outputs text to the debug console using the "semihosting" mechanism.

In some circumstances, this output mechanism may not be suitable for your application. Instead, you may want printf to output via an alternative communication channel such as a UART or – on Cortex-M3/M4 – the ITM channel of SWO Trace. In such cases you can retarget the appropriate portion of the bottom level of the library.

The section "How to use ITM Printf" below provides an example of how this can be done.

Note: when retargeting these functions, you can typically link against the "nohost" variant of the C Library, rather than the "semihost" one.

Redlib

To retarget Redlib's `printf()`, you need to provide your own implementations of the function `__sys_write()`:

```
int __sys_write(int iFileHandle, char *pcBuffer, int iLength)
```

Function returns number of unwritten bytes if error, otherwise 0 for success

Similarly if you want to retarget `scanf()`, you need to provide your own implementations of the function `__sys_readc()`:

```
int __sys_readc(void)
```

Function returns character read

Note: these two functions effectively map directly onto the underlying “semihosting” operations.

Newlib / NewlibNano

To retarget `printf()`, you will need to provide your own implementation of the Newlib system function `_write()`:

```
int _write(int iFileHandle, char *pcBuffer, int iLength)
```

Function returns number of unwritten bytes if error, otherwise 0 for success

To retarget `scanf()`, you will need to provide your own implementation of the Newlib system function `_read()`:

```
int _read(int iFileHandle, char *pcBuffer, int iLength)
```

Function returns number of characters read, stored in `pcBuffer`

More information on the Newlib system calls can be found at: <https://sourceware.org/newlib/libc.html#Syscalls>

11.5.7 How to use ITM Printf

ITM Printf is a scheme to achieve application IO via a debug probe without the usual semihosting penalties.

ITM Overview

As part of the Cortex-M3/M4 SWO Trace functionality available when using an LPC-Link2 (with NXP's CMSIS-DAP firmware), MCUXpresso IDE provides the ability to make use of the ITM : The Instrumentation Trace Macrocell (ITM) block provides a mechanism for sending data from your target to the debugger via the SWO trace stream. This communication is achieved through a memory-mapped register interface. Data written to any of 32 stimulus registers is forwarded to the SWO stream. Unlike other SWO functionality, using the ITM stimulus ports requires changes to your code and so should not be considered non-intrusive.

Printf operations can be carried out directly by writing to the ITM stimulus port. However the stimulus port is output only. And therefore `scanf` functionality is achieved via a special global variable, which allows the debugger to send characters from the console to the target (using

the trace interface). The debugger writes data to the global variable named ITM_RxBuffer to be picked up by scanf.

Note: MCUXpresso IDE currently only supports ITM via stimulus port 0.

Note: For more information on SWO Trace, please see the MCUXpresso IDE LinkServer SWO Trace Guide.

ITM printf with SDK

The Advanced page of the SDK new project wizard and Import SDK examples wizard offer the option to configure a project so as to redirect printf/scanf to ITM. Selecting this option will cause the file retarget_itm.c to be generated in your project to carry out the redirection.

ITM printf with LPCOpen

To use this functionality with an LPCOpen project you need to: Include the file retarget_itm.c in your project – available from the Examples subdirectory of your IDE installation. Ensure you are using a semihost, semihost-nf, or nohost C library variant. Then simply add calls to printf and scanf to your code.

If you just linking against the LPCOpen Chip library, then this is all you need to do. However if you are also linking against an LPCOpen board library then you will likely see build errors of the form:

```
../src/retarget.h:224: multiple definition of `__sys_write'
../src/retarget.h:240: multiple definition of `__sys_readc'
```

locating the file board.h and enable the line: `#define DEBUG_SEMIHOSTING`, or locating the source file board.c within the LPCOpen board library and comment out the line: `#include "retarget.h"`

11.6 itoa() and uitoa()

itoa() is non-standard library function which is provided in many other toolchains to convert an integer to a string.

11.6.1 Redlib

To ease porting, the MCUXpresso IDE provides two variants of this function in the Redlib C library....

```
char * itoa(int value, char *vstring, unsigned int base);
char * uitoa(unsigned int value, char *vstring, unsigned int base);
```

which can be accessed via the system header....

```
#include <stdlib.h>
```

itoa() converts an integer value to a null-terminated string using the specified base and stores the result in the array pointed to by the vstring parameter. Base can take any value between 2 and 16; where 2 = binary, 8 = octal, 10 = decimal and 16 = hexadecimal.

If base is 10 and the value is negative, then the resulting string is preceded with a minus sign (-). With any other base, value is always considered unsigned. The return value to the function is a pointer to the resulting null-terminated string, the same as parameter vstring.

uitoa() is similar but treats the input value as unsigned in all cases.

Note: the caller is responsible for reserving space for the output character array – the recommended length is 33, which is long enough to contain any possible value regardless of the base used.

Example invocations

```
char vstring [33];
itoa (value,vstring,10); // convert to decimal
itoa (value,vstring,16); // convert to hexadecimal
itoa (value,vstring,8); // convert to octal
```

Standards compliance

As noted above, itoa() / uitoa() are not standard C library functions. A standard-compliant alternative for some cases may be to use sprintf() - though this is likely to cause an increase in the size of your application image:

```
sprintf(vstring,"%d",value); // convert to decimal
sprintf(vstring,"%x",value); // convert to hexadecimal
sprintf(vstring,"%o",value); // convert to octal
```

11.6.2 Newlib/NewlibNano

Newlib and NewlibNano now also provide similar functionality though with slightly different naming - **itoa()** and **utoa()**.

11.7 Libraries and linker scripts

When using the managed linker script mechanism, as described in the chapter “Memory configuration and Linker Script Generation”, then the appropriate settings to link against the required library family and variant will be handled automatically.

However if you are not using the managed linker script mechanism, then you will need to define which library files to use in your linker script. To do this, add one of the following entries before the SECTION line in your linker script:

- Redlib (None), add
 - [C project only]: GROUP (libcr_c.a libcr_eabihelpers.a)
- Redlib (Nohost), add
 - [C projects only]: GROUP (libcr_nohost.a libcr_c.a libcr_eabihelpers.a)
- Redlib (Semihost-nf), add
 - [C projects only]: GROUP (libcr_semihost_nf.a libcr_c.a libcr_eabihelpers.a)
- Redlib (Semihost), add
 - [C projects only]: GROUP (libcr_semihost.a libcr_c.a libcr_eabihelpers.a)
- NewlibNano (None), add
 - [C projects]: GROUP (libgcc.a libc_nano.a libm.a libcr_newlib_none.a)
 - [C++ projects]: GROUP (libgcc.a libc_nano.a libstdc++_nano.a libm.a libcr_newlib_none.a)
- NewlibNano (Nohost), add
 - [C projects]: GROUP (libgcc.a libc_nano.a libm.a libcr_newlib_nohost.a)
 - [C++ projects]: GROUP (libgcc.a libc_nano.a libstdc++_nano.a libm.a libcr_newlib_nohost.a)
- NewlibNano (Semihost), add

- [C projects]: GROUP (libgcc.a libc_nano.a libm.a libcr_newlib_semihost.a)
- [C++ projects]: GROUP (libgcc.a libc_nano.a libstdc++_nano.a libm.a libcr_newlib_semihost.a)
- Newlib (None), add
 - [C projects]: GROUP (libgcc.a libc.a libm.a libcr_newlib_none.a)
 - [C++ projects]: GROUP (libgcc.a libc.a libstdc++.a libm.a libcr_newlib_none.a)
- Newlib (Nohost), add
 - [C projects]: GROUP (libgcc.a libc.a libm.a libcr_newlib_nohost.a)
 - [C++ projects]: GROUP (libgcc.a libc.a libstdc++.a libm.a libcr_newlib_nohost.a)
- Newlib (Semihost), add
 - [C projects]: GROUP (libgcc.a libc.a libm.a libcr_newlib_semihost.a)
 - [C++ projects]: GROUP (libgcc.a libc.a libstdc++.a libm.a libcr_newlib_semihost.a)

In addition, if using NewlibNano, then tick box method of enabling printf/scanf floating point support in the Linker pages of Project Properties will also not be available. In such cases, you can enabling floating point support manually by going to:

Project -> Properties -> C/C++ Build -> Settings -> MCU Linker -> Miscellaneous

and entering `-u _printf_float` and/or `-u _scanf_float` into the "Linker flags" box.

A further alternative is to put an explicit reference to the required support function into your project codebase itself. One way to do this is to add a statement such as:

```
asm ("global _printf_float");
```

to one (or more) of the C source files in your project.

12. Memory Configuration and Linker Scripts

12.1 Introduction

A key part of the core technology within MCUXpresso IDE is the principle of a default defined memory map for each MCU. For devices with internal flash, this will also specify a flash driver to be used to program that flash memory (for use with LinkServer “native” debug probes).

For pre-installed MCUs, the definition of the memory map is contained within the MCU part knowledge that is built into the product. For MCUs installed into MCUXpresso IDE from an SDK, the definition of the memory map is loaded from manifest file within the SDK structure.

But in both cases, the defined memory map is used by the MCUXpresso IDE to drive the “managed linker script” mechanism. This auto-generates a linker script to place the code and data from your project appropriately in memory, as well as being made available to the debugger.

A projects memory map can be viewed and modified by the user to add, remove (split/join) or reorder blocks using the Memory Configuration Editor. For example, if a project targets an MCU that supports external flash (e.g. SPIFI), then its memory map can be easily extended to define the SPIFI memory region (base and size). In addition, an appropriate flash driver can be associated with the newly defined region.

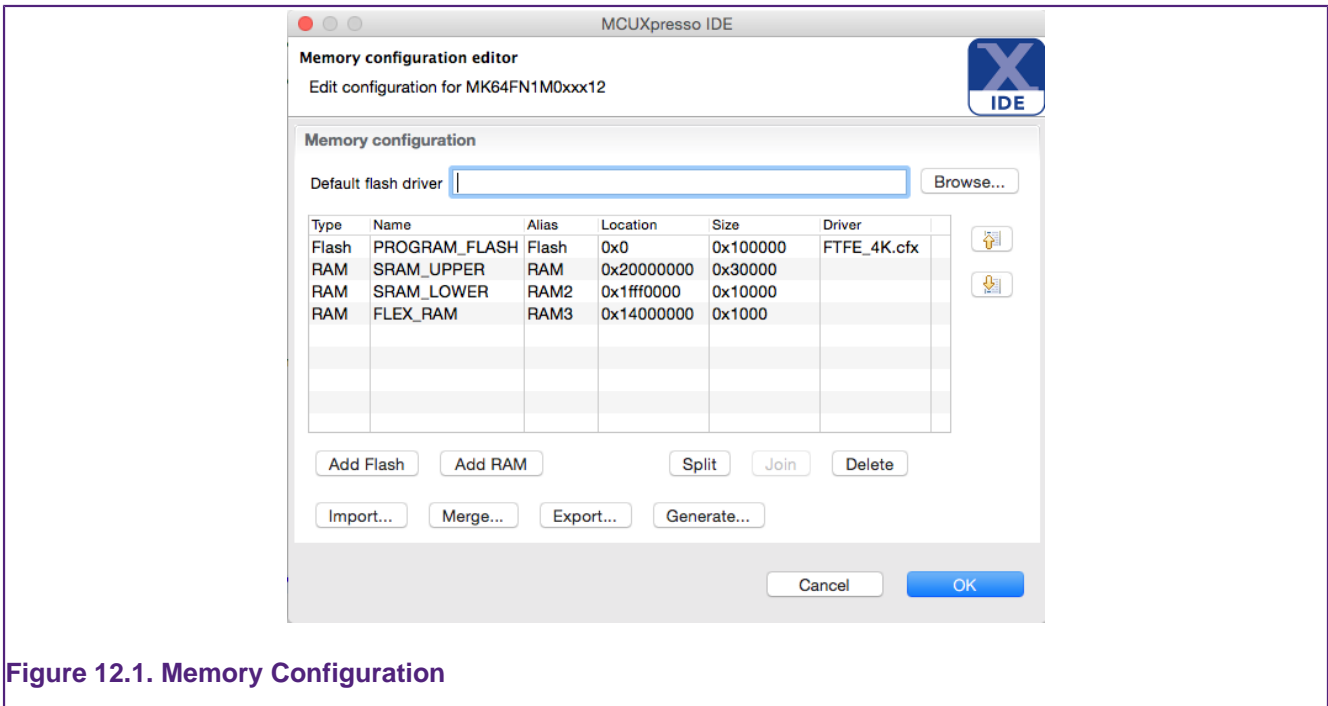

Figure 12.1. Memory Configuration

12.2 Managed Linker Script Overview

By default, the use of “managed linker scripts” is enabled for projects. This mechanism allows the MCUXpresso IDE to automatically create a script for each build configuration that is suitable for the MCU selected for the project, and the C libraries being used. It will create (and at times modify) three linker script files for each build configuration of your project:

```
<projname>_<buildconfig>_lib.ld
<projname>_<buildconfig>_mem.ld
<projname>_<buildconfig>_ld
```

This set of hierarchical files are used to define the C libraries being used, the memory map of the system and the way your code and data is placed into the memory map. These files will be located in the build configuration subdirectories of your project (typically – Debug and Release).

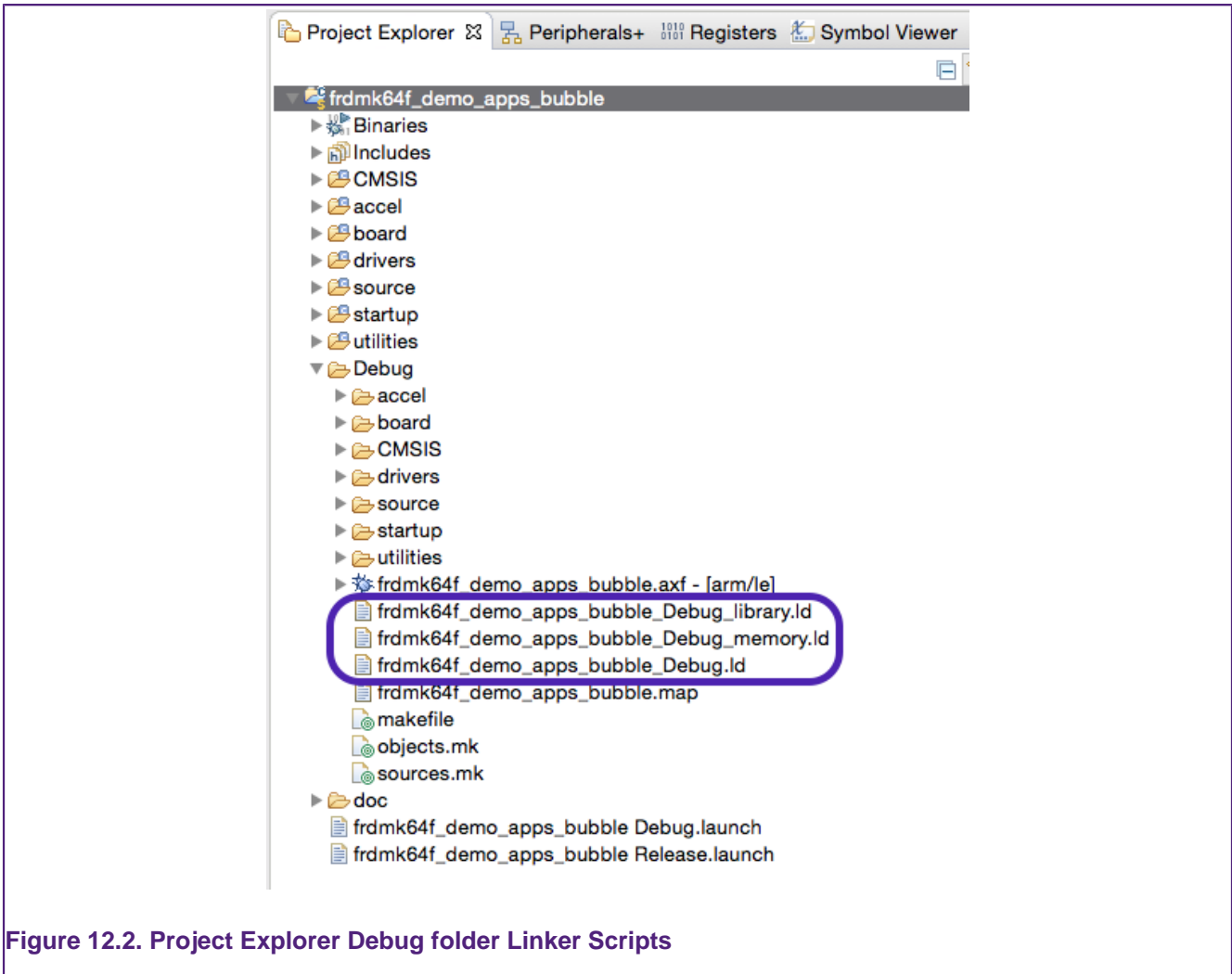

Figure 12.2. Project Explorer Debug folder Linker Scripts

The managed linker script mechanism also automatically takes into account memory map changes made in Memory Configuration Editor as well as other configuration changes, such as C/C++ library setting.

12.3 How are managed linker scripts generated?

The MCUXpresso IDE passes a set of parameters into the linker script generator (based on the “Freemarker” scripting engine) to create an appropriate linker script for your project. This generator uses a set of conditionally parsed template files, each of which control different aspects of the generated linker script.

It is possible to modify certain aspects of the generated linker script by providing one or more modified template files locally within \linkscripts subdirectory of project directory structure. Any such templates that you provide locally will then override the default ones built into MCUXpresso. A full set of the default linker templates (.ldt) files are provided inside *Wizards\linker* subdirectory of your IDE install.

12.4 Default image layout

Code and initial values of initialised data items are placed into first bank of flash (as show in memory configuration editor). During startup, the MCUXpresso IDE startup code copies the data into the first bank of RAM (as show in memory configuration editor), and zero initializes the BSS data directly after this in memory. This process uses a global section table generated into the image from the linker script.

Other RAM blocks can also have data items placed into them under user control, and the startup code will also initialize these automatically. See later in this chapter for more details.

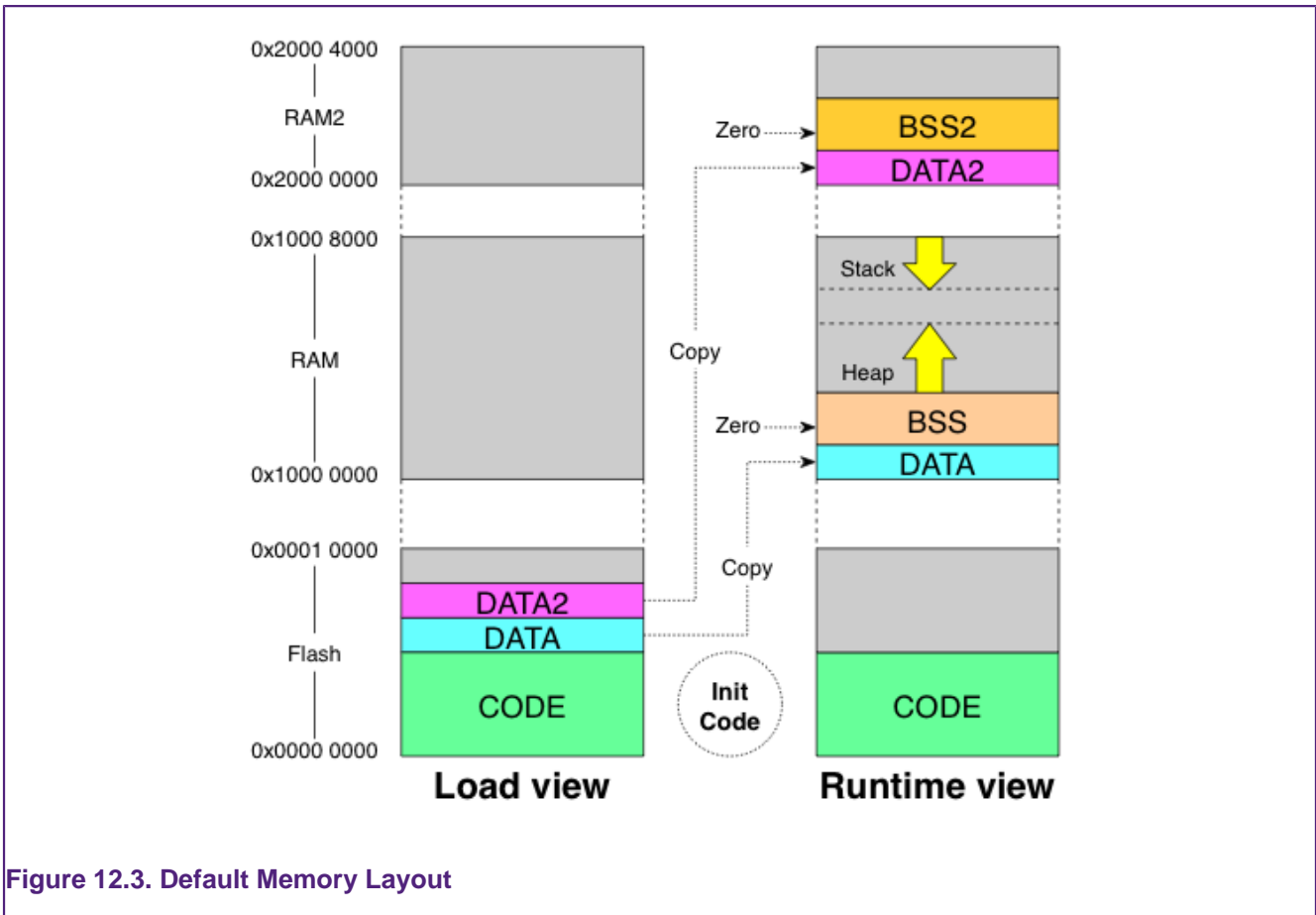

Figure 12.3. Default Memory Layout

Note: The above memory layout is simply the default used by the IDE’s managed linker script mechanism. There are a number of mechanisms that can be used to modify the layout according to the requirements of your actual project – such as simply editing the order of the RAM banks in the Memory Configuration Editor. These various methods are described later in this chapter.

The default memory layout will also locate the heap and stack in the first RAM bank, such that:

- the heap is located directly after the BSS data, growing upwards through memory
- the stack located at the end of the first RAM bank, growing down towards the heap

Again this heap and stack placement is a default and it is very easy to modify the locations for a particular project, as will be described later in this chapter.

Note: When you import a project, you may find that the defaults have already been modified. Check the Project Properties to confirm the exact details.

12.5 Examining the layout of the generated image

Looking at the size of the AXF file generated by building your project on disk does not provide any information as to how much Flash/RAM space your application will occupy when downloaded to your MCU. The AXF file contains a lot more information than just the binary code of your application, for example the debug data used to provide source level information when debugging, that is never downloaded to your MCU.

Looking at the size of the AXF file generated by building your project on disk does not provide any information as to how much Flash/RAM space your application will occupy when downloaded to your MCU. The AXF file contains a lot more information than just the binary code of your application, for example the debug data used to provide source level information when debugging, that is never downloaded to your MCU.

12.5.1 Linker --print-memory-usage

MCUXpresso IDE projects use the --print-memory-usage option on the link step of a build to display memory usage information in the build console of the following form:

Memory region	Used Size	Region Size	%age Used
PROGRAM_FLASH:	26764 B	1 MB	2.55%
SRAM_UPPER:	8532 B	192 KB	4.34%
SRAM_LOWER:	0 GB	64 KB	0.00%
FLEX_RAM:	0 GB	4 KB	0.00%
Finished building target: frdmk64f_demo_apps_bubble.axf			

The memory regions displayed here will match up to the memory banks displayed in the memory configuration editor when the managed linker script mechanism is being used.

By default, the application will build and link against the first flash memory found within the devices memory configuration. For most MCUs there will only be 1 flash device available. In this case our project requires 26764 bytes of Flash memory storage, 2.55% of the available Flash storage.

RAM will be used for global variable, the heap and the stack. MCUXpresso IDE provides a flexible scheme to reserve memory for Stack and Heap. This build has reserved 4KB each for the stack and the heap contributing 8KB to the overall 8532 bytes reported.

If using the LPCXpresso style of heap and stack placement (described later in this chapter), the RAM consumption provided by this is only that of your global data. It will not include any memory consumed by your stack and heap when your application is actually executing.

12.5.2 arm-none-eabi-size

In addition, a post-build step will normally invoke the arm-none-eabi-size utility to provide this information in a slightly different form....

text	data	bss	dec	hex	filename
2624	524	32	3180	c6c	LPCXpresso1768_systick_twinkle.axf

- **text** - shows the code and read-only data in your application (in decimal)
- **data** - shows the read-write data in your application (in decimal)
- **bss** - show the zero initialized ('bss' and 'common') data in your application (in decimal)
- **dec** - total of 'text' + 'data' + 'bss' (in decimal)
- **hex** - hexadecimal equivalent of 'dec'

Typically:

- the flash consumption of your application will then be text + data
- the RAM consumption of your application will then be data + bss

Again if using the LPCXpresso style of heap and stack placement (described later in this chapter), the RAM consumption will not include any memory consumed by your stack and heap when your application is actually executing.

You can also manually run the `arm-none-eabi-size` utility on both your final application image, or on individual object files within your build directory by right clicking on the file in Project Explorer and selecting the Binary Utilities -> Size option.

12.5.3 Linker Map files

The linker option “-map” option, which is enabled by default by the project wizard when a new project is created, allows you to analyse in more detail the contents of your application image. When you do a build, this will cause a file called *projectname.map* to be created in the Debug (or Release) subdirectory, which can be loaded into the editor view. This contains a large amount of information, including:

- A list of archive members (library objects) included with details
- A list of discarded input sections (because they are unused and the linker option `--gc-sections` is enabled).
- The location, size and type of all code, data and bss items that have been placed in the image

12.5.4 Symbol Viewer

The Symbol Viewer provides a simple way of displaying the symbols in an object, library archive or executable. By default, this is located in the top left of the MCUXpresso IDE window, in parallel with the Project Explorer view.

Viewing Symbols in the Viewer

To open an image in the Symbol Viewer, either highlight it in the Project Explorer Views and use the context sensitive menu ‘Tools->View Symbols’ menu, or use the Browse button on the Toolbar within the Symbol Viewer windows itself

The Symbol Viewer can display object files (.o), libraries (.lib) and executables (.axf or .elf)

The image will be processed and displayed in the Symbol Viewer as shown in the next section.

It is possible to open multiple Symbol Viewers by pressing the ‘Green +’ icon in the toolbar. The symbols for different images can then be displayed simultaneously.

Using the Symbol Viewer

When first opening a file, the viewer will display the sections found in the file (e.g. .text, .bss etc). Expanding a section will show the symbols within that section. Clicking on the symbol name will open the source file in an editor window at the symbol definition (if source is available).

The columns of the symbol viewer show information about the symbols:

- **Symbol Name:**
- **Address:** The address (or value) of the Symbol
- **Size:** The size of the symbol, in bytes. For functions this would be the size of the function. For variables, this would be the size occupied by the variable
- **Flags:** The type of the Symbol. Typically this would be Local or Global and Function or Object (data variable)

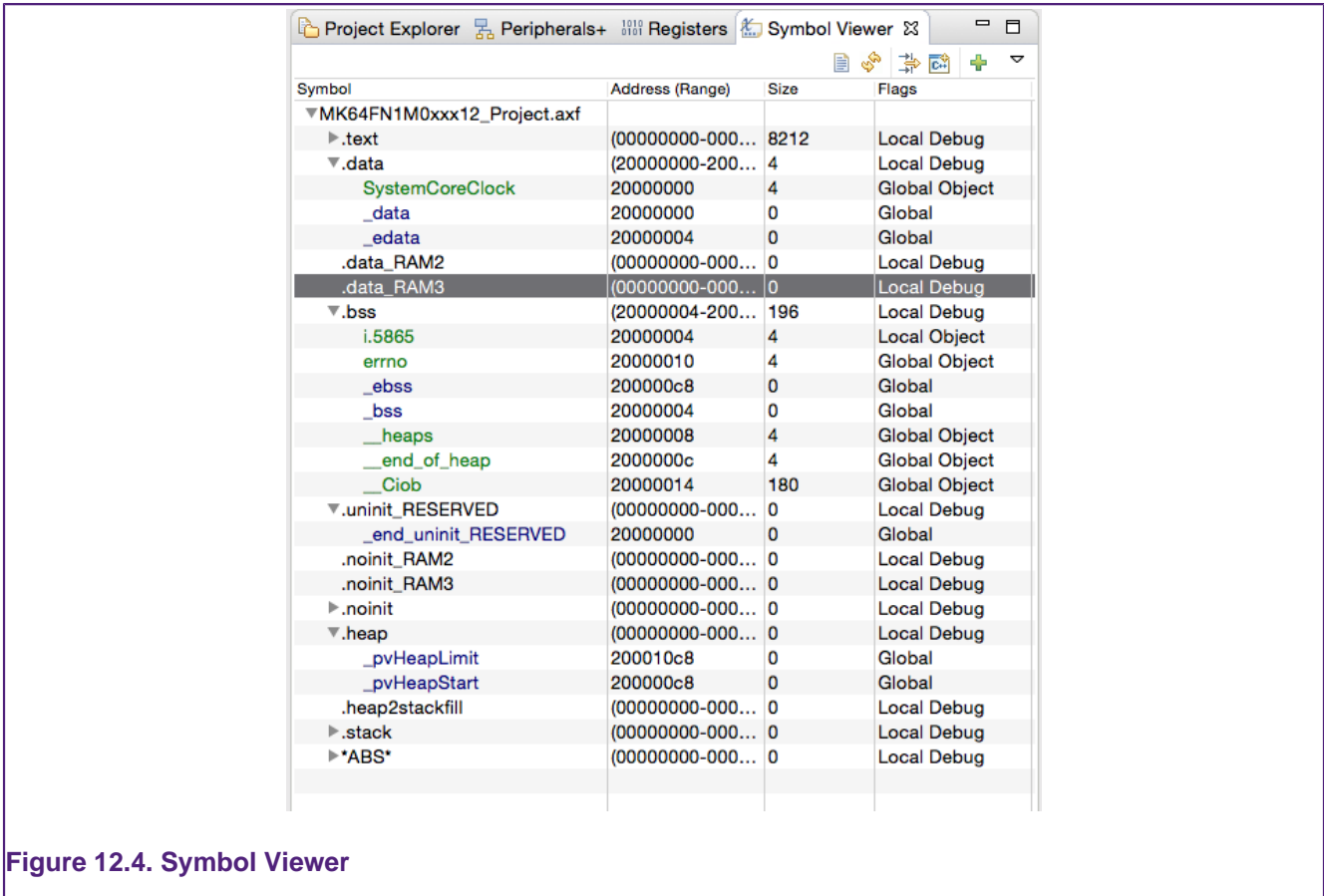

Figure 12.4. Symbol Viewer

Note: The symbols displayed are a snapshot of the symbols for a particular build, therefore these should be refreshed when a new build is performed. This can easily be done using the Reload icon in the Symbol Viewer window.

Other utilities

The arm-none-eabi-nm utility is effectively a command line version of the Symbol Browser. But it can sometime be useful when looking at the size of your application, as it can produce some of the information provided in the linker map file but in a more concise form. For example:

```
arm-none-eabi-nm -S --size-sort -s project.axf
```

produces a list of all the symbols in an image, their sizes and their addresses, listed in size order. For more information on this utility, please see the GNU binutils documentation.

Note: you can run arm-none-eabi-nm as a post-build step, or else open a command shell using the status bar shortcuts (at the bottom of the IDE window).

12.6 Other options affecting the generated image

12.6.1 LPC MCUs – Code Read Protection

Most of NXP's LPC Cortex-M based MCUs which have internal flash memory contain "Code Read Protection" (CRP) support. This mechanism uses one of a number of known values being placed in a specific location in flash memory to provide a number of levels of protection. When the MCU boots, this specific location in flash memory is read and depending upon its value, the MCU may prevent access to the flash memory by external devices. This location is typically at

0x2FC though for LPC18xx/43xx parts with internal flash, the CRP location is at an offset of 0x2FC from the start of the flash bank being used.

CRP : Preinstalled MCUs

Support for setting up the CRP memory location is provided via a combination of the Project Wizard, a header file and a number of macros. This support allows specific values to be easily placed into the CRP memory location, based on the user's requirements.

The New Project wizard contains an option to allow linker support for placing a CRP word to be enabled when you create a new project. This is typically enabled by default. This wizard option actually then controls the "Enable CRP" checkbox of the Project Properties linker Target tab.

In addition the wizard will create a file, 'crp.c' which defines the 'CRP_WORD' variable which will contain the required CRP value. A set of possible values are provided by the NXP/crp.h header file that this then includes. Thus for example 'crp.c' will typically contain:

```
#include <NXP/crp.h>
__CRP const unsigned int CRP_WORD = CRP_NO_CRP ;
```

which is then placed at the correct location in Flash by the linker script generated by the managed linker script mechanism:

```
. = 0x000002FC ;
KEEP(*(.crp))
```

Note: the value CRP_NO_CRP ensures that the flash memory is fully accessible. When you reach the stage of your project where you want to protect your image, you will need to modify the CRP word to contain an appropriate value.

Important Note: You should take particular care when modifying the value placed in the CRP word, as some CRP settings can disable some or all means of access to your MCU (including debug). Before making use of CRP, you are strongly advised to refer to the User Manual for the LPC MCU that you are using.

CRP : MCUs installed by Importing an SDK

The support for CRP in LPC parts imported into MCUXpresso IDE from an SDK, is generally similar to the Preinstalled MCUs. However rather than having a separate crp.c file, the CRP_WORD variable definition is generally found within the startup code.

12.6.2 Kinetis MCUs – Flash Config blocks

Kinetis MCUs provides an alternative means of protecting the user's image in Flash using the Flash Configuration Block. The Flash Configuration Field is generally located at addresses 0x400-0x40F and unlike the LPC CRP mechanism only specific values give access, whereas any other values are likely to lock the part.

The value of the Flash Configuration block for a project is provided by the following structure which will be found in the startup code:

```
__attribute__((used,section(".FlashConfig"))) const struct {
    unsigned int word1;
    unsigned int word2;
    unsigned int word3;
    unsigned int word4;
} Flash_Config = {0xFFFFFFFF, 0xFFFFFFFF, 0xFFFFFFFF, 0xFFFFFFFF};
```

which is then placed appropriately by the linker script generated by the managed linker script mechanism.

```

/* Kinetis Flash Configuration data */
. = 0x400 ;
PROVIDE(__FLASH_CONFIG_START__ = .) ;
KEEP(*(.FlashConfig))
PROVIDE(__FLASH_CONFIG_END__ = .) ;
ASSERT(!(__FLASH_CONFIG_START__ == __FLASH_CONFIG_END__),
"Linker Flash Config Support Enabled, but no .FlashConfig
section provided within application");
/* End of Kinetis Flash Configuration data */
    
```

Important Note: The support for placing the Flash Configuration Block can be disabled by unchecking a checkbox of the Project Properties linker Target tab. However this is generally not advisable as it is very likely to result in a locked MCU.

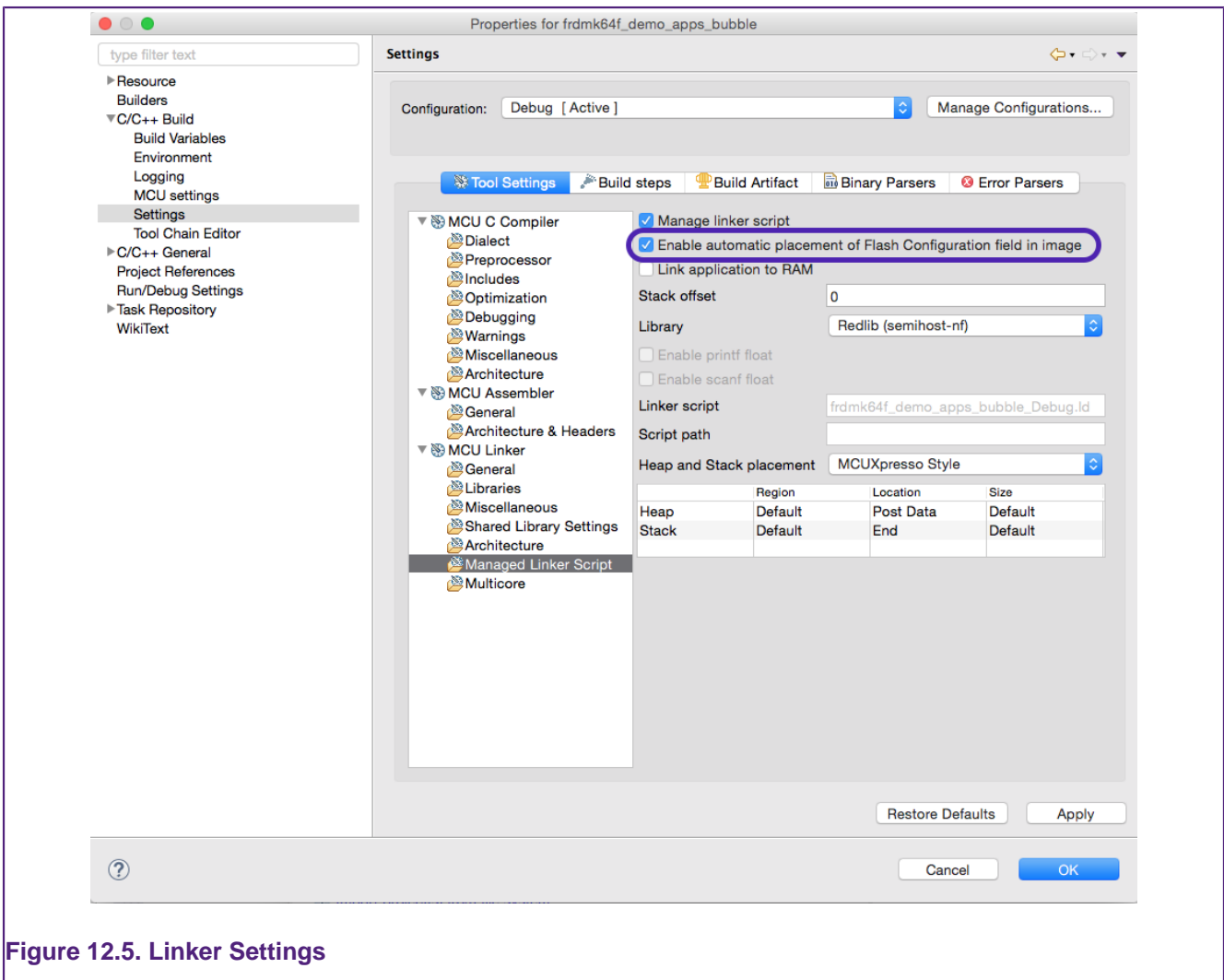

Figure 12.5. Linker Settings

12.6.3 Placement of USB data

For MCUs where part support is imported from an SDK, the managed linker script mechanism supports the automatic placement of USB global data (as used by the SDK USB Drivers), including for parts with dedicated USB_RAM (small or large variants).

12.7 Modifying the generated linker script / memory layout

The linker script generated by the managed linker script mechanism will be suitable for use, as is, for many applications. However in some circumstances you may need to make changes. MCUXpresso IDE provides a number of mechanisms to allow you to do this whilst still being able to use the managed linker script mechanism. These include:

- Changing the layout and order of memory using the Memory Configuration Editor
- Changing the size and location of the stack and heap using the Heap and Stack Editor
- Decorating the definitions of variables and functions in your source code with macros from the *cr_section_macros.h* to cause them to be placed into different memory blocks
- Providing project specific versions of Freemaker linker script templates to change particular aspects of how the managed linker script mechanism creates the final linker script

The following sections describe these in more detail.

12.8 Using the Memory Configuration Editor

The Memory Editor is accessed via the MCU settings dialog, which can be found at

Project Properties -> C/C++ Build -> MCU settings

This lists the memory details for the selected MCU, and will, by default, display the memory regions that have been defined by the MCUXpresso IDE itself.

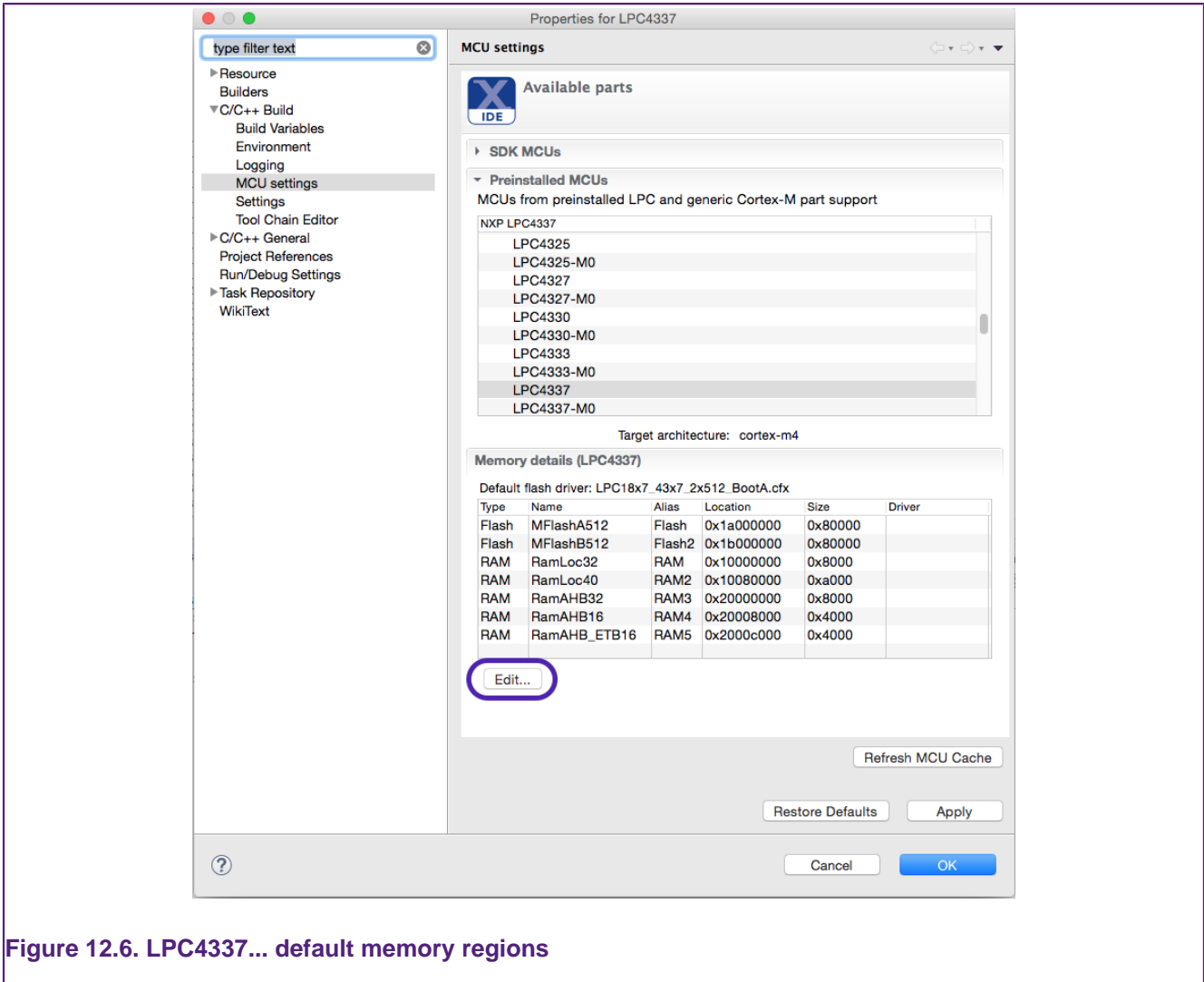

Figure 12.6. LPC4337... default memory regions

12.8.1 Editing a Memory Configuration

In the example below, we will show how the default memory configuration for an LPC4337... can be changed. Selecting the **Edit...** button will launch the **Memory configuration editor** dialog — see Figure 12.7.

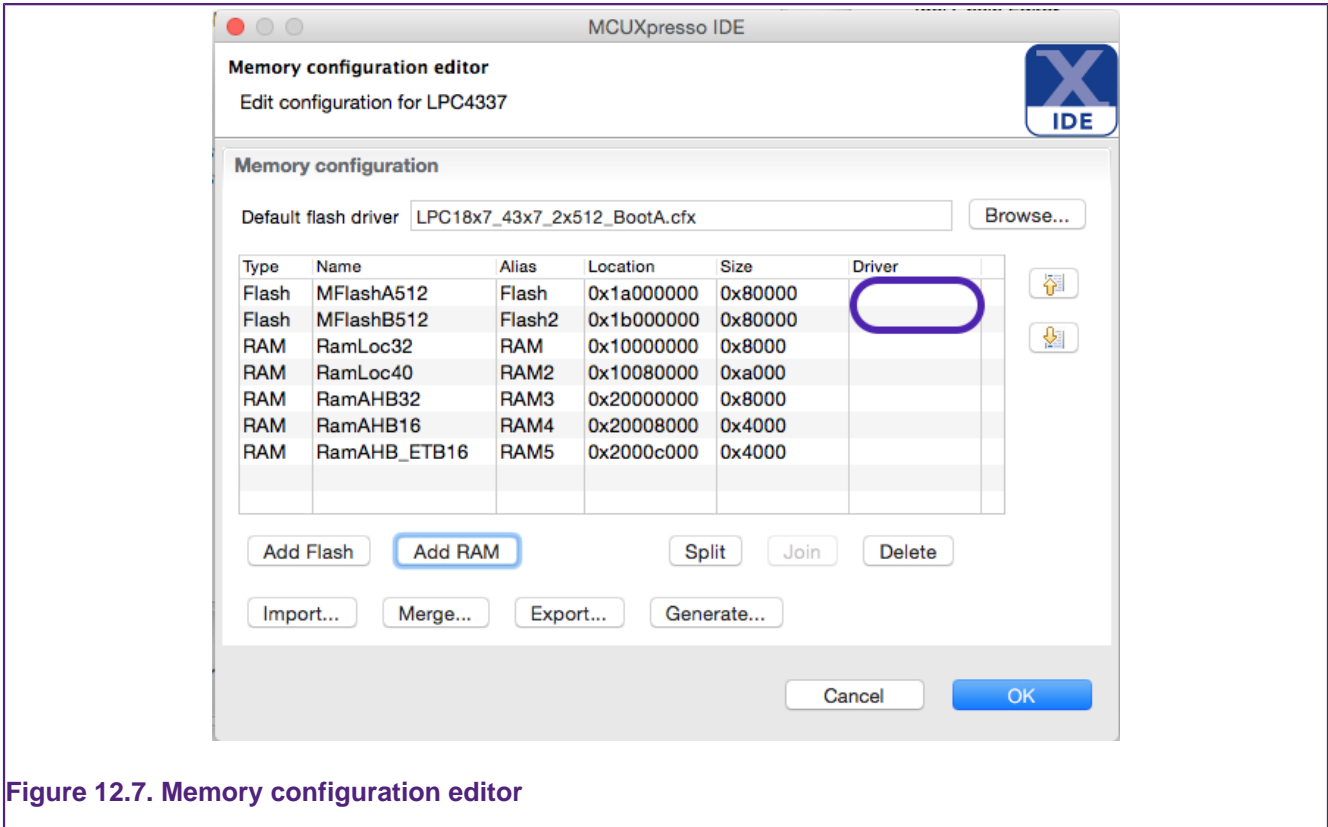

Figure 12.7. Memory configuration editor

Known blocks of memory, with their type, base location, and size are displayed. Entries can be created, deleted, etc by using the provided buttons.

For simplicity, the **additional** memory regions are given sequential aliases, starting from 2, so RAM2, RAM3 etc (as well as using their “formal” region name – for example RamAHB32).

Table 12.1. Memory editor controls

Button	Details
Add Flash	Add a new memory block of the appropriate type.
Add RAM	Add a new memory block of the appropriate type.
Split	Split the selected memory block into two equal halves.
Join	Join the selected memory block with the following block (if the two are contiguous).
Delete	Delete the selected memory block.
Import	Import a memory configuration that has been exported from another project, overwriting the existing configuration.
Merge	Import a partial memory configuration from a file, merging it with the existing memory configuration. This allows you, for example, to add an external flash bank definition to an existing project.
Export	Export a memory configuration for use in another project.
Up / Down	Reorder memory blocks. This is important: if there is no flash block, then code will be placed in the first RAM block, and data will be placed in the block following the one used for the code (regardless of whether the code block was RAM or Flash).
Generate	Generates local part support for the selected MCU.
Driver	Highlighted in blue, shows the selection of a per-flash region flash driver. Click this field to see a drop down of all available drivers. Please see: Introduction to LinkServer Flash Drivers [64]
Browse(Flash driver)	Select the appropriate driver for programming the flash memory specified in the memory configuration. This is only required when the flash memory is external to the MCU. Flash drivers for external flash must have a “.cfx” file extension and must be located in the ide\bin\flash subdirectory of the MCUXpresso IDE installation.

The name, location, and size of this new region can be edited in place. **Note** that when entering the size of the region, you can enter full values in decimal or in hex (by prefixing with `0x`), or by specifying the size in kilobytes or megabytes. For example:

- To enter a region size of 32KB, enter `32768`, `0x8000` or `32k`.
- To enter a region size of 1MB, enter `0x100000` or `1m`.

Note: memory regions must be located on four-byte boundaries, and be a multiple of four bytes in size.

The screenshot below shows the dialog after the “Add Flash” button has been clicked. Use the highlighted up/down buttons to move this region to be top in the list.

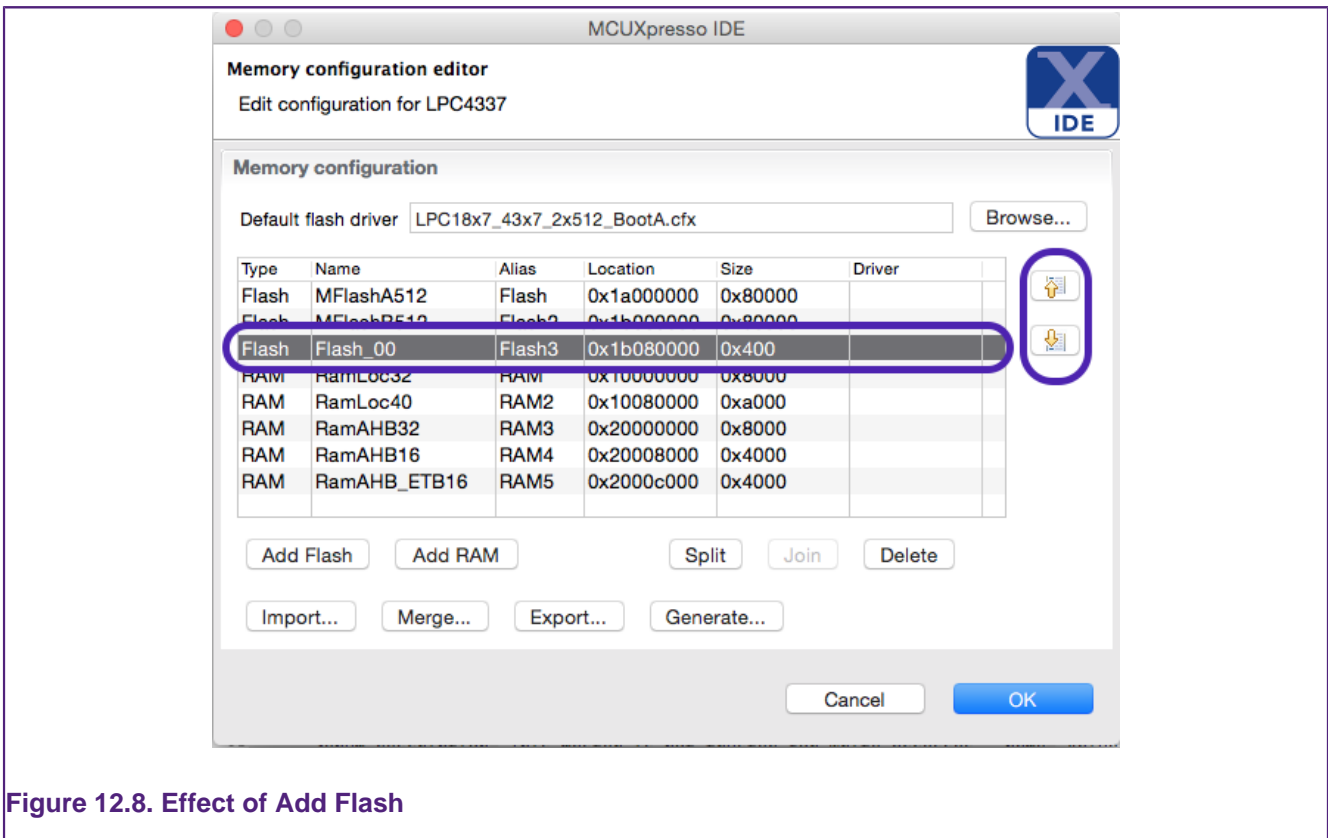

Figure 12.8. Effect of Add Flash

After updating the new memory configuration, click **OK** to return to the MCU settings dialog, which will be updated to reflect the new configuration.

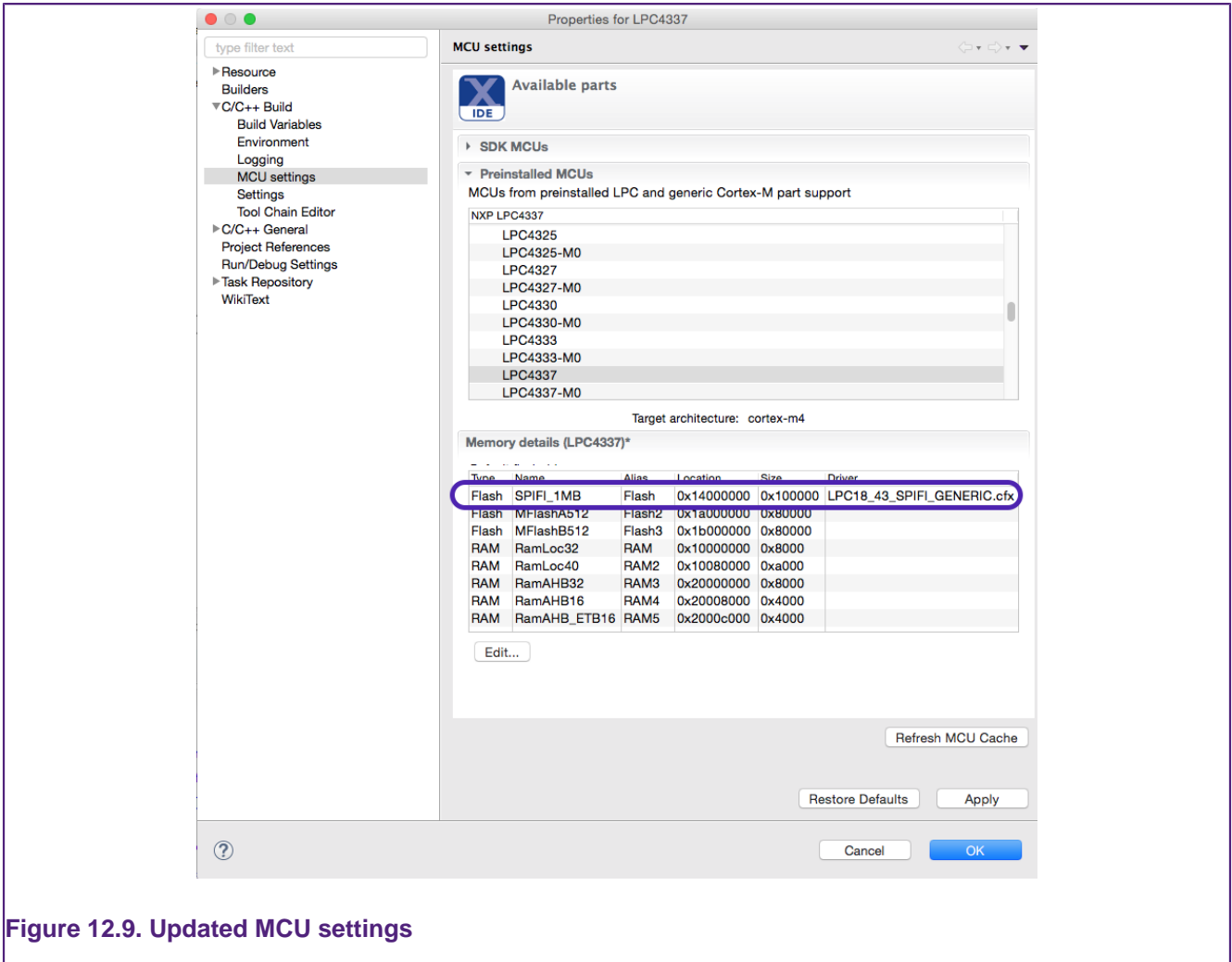

Figure 12.9. Updated MCU settings

Here you can see that the region has been named SPIFI_1MB, and the default flash driver has been deleted and the Generic SPIFI driver selected for the newly created SPIFI_1MB region.

MCUXpresso IDE provides extended support for the creation and programming of projects that span multiple flash devices. In addition to a single default flash driver, per region flash drivers can also be specified (as above). Using this scheme projects can be created that span flash regions and can be programmed in a single 'debug' operation.

Note: that once the memory details have been modified, the selected MCU as displayed on the "Status Bar" (at the bottom of the IDE window) will be displayed with an asterisk (*) next to it. This provides an indication that the MCU memory configuration settings for the selected project have been modified.

12.8.2 Device specific vs Default Flash Drivers

When a project is configured to use additional flash devices via the Memory Configuration Editor, the flash driver to be used for programming that flash device has to be specified in the Driver column. Typically for a SPIFI device, this should be:

- *LPC18_43_SPIFI_GENERIC.cfx* (for *LPC18/LPC43* series MCUs)
- *LPC40xx_SPIFI_GENERIC.cfx* (for *LPC407x/8x* MCUs)
- *LPC5460x_SPIFI_GENERIC.cfx* (for *LPC5460x* MCUs).

12.8.3 Restoring a Memory Configuration

To restore the memory configuration of a project back to the default settings, simply reselect the MCU type, or use the “Restore Defaults” button, on the MCU Settings properties page.

12.8.4 Copying Memory Configurations

Memory configurations can be exported for import into another project. Use the Export and Import buttons for this purpose.

MCUXpresso IDE provides a standard memory layout for each known MCU. In addition, the MCUXpresso IDE supports the editing of the target memory layout used for a project. This allows for the details of external flash to be defined or for the layout of internal RAM to be reconfigured. Also, it allows a flash driver to be allocated for use with parts with no internal flash, but where an external flash part is connected.

12.9 More advanced heap/stack placement

MCUXpresso IDE provides two models of heap/stack placement. The first of these is the “LPCXpresso Style”, which is the mechanism provided by the previous generation LPCXpresso IDE. This is the default model used for projects created for Preinstalled MCUs. The second model is the “MCUXpresso style”. This is the default model used for projects created for MCUs imported from SDKs.

The heap/stack placement model being used for a particular project/build configuration can be modified by right clicking on the project and selecting:

```
Project Properties -> C/C++ Build -> Settings -> MCU Linker -> Managed Linker Scripts
```

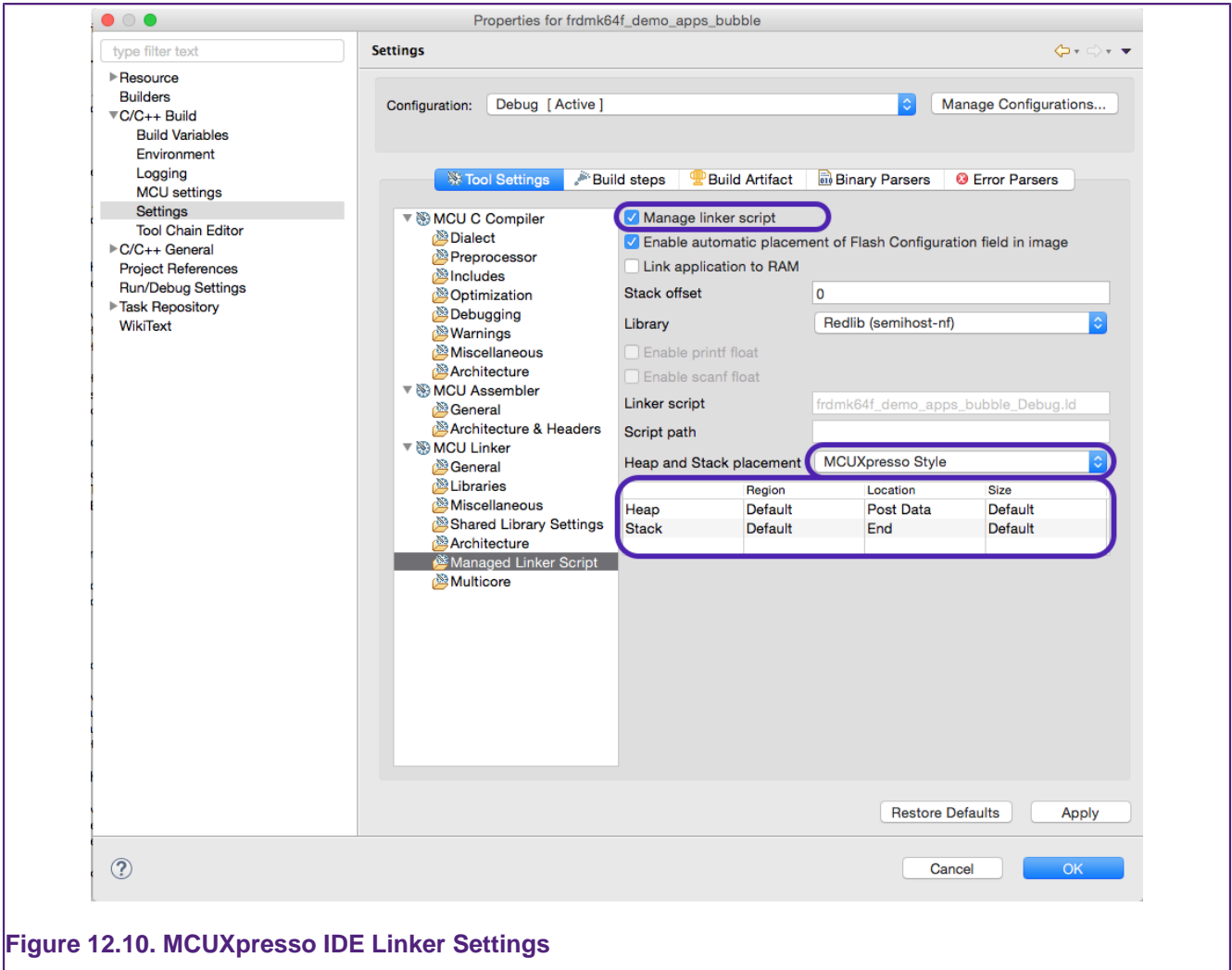

Figure 12.10. MCUXpresso IDE Linker Settings

In the dialogue above, highlights show the managed linker script option along with the selection of the MCUXpresso Style scheme.

12.9.1 MCUXpresso style heap and stack

By default the heap and stack are placed in the “default” memory region (i.e. the first RAM block displayed in the memory configuration area), with the heap placed after the application’s data and the stack rooted at the top of this block.

However, using the Heap and Stack editor in Project Properties, it is very simple to individually change the stack and heap locations (both the memory block used, and the location within that block), and also the size of the memory to be used by each of them.

Region

- Default : Place into first RAM bank as shown in Memory Configuration Editor
- List of memory regions, and aliases, as show in Memory Configuration Editor

Location

- Start : Place at start of specified RAM bank.
- Post Data : Place after any data in specified RAM bank. Default for heap.
- End : Place at end of specified RAM bank. Default for stack.

Size

- Default: 1/16th of the memory region size, up to a maximum of 4KB (and a minimum of 128bytes). Hovering the cursor over the field will show the current value that will be used.
- Value : Specify exact required size. Must be a multiple of 4. Note that when entering the size of the region, you can enter full values in decimal or in hex (by prefixing with 0x), or by specifying the size in Kilobytes (or Megabytes). For example:
 - To enter a size of 32KB, enter 32768, 0x8000 or 32k.

Note: The MCUXpresso style of setting heap and stack has the advantage over the LPCXpresso style described below in that the memory allocated for heap/stack usage is also taken into account in the image size information displayed in the Build console when your project is built.

12.9.2 LPCXpresso style heap and stack

By default the heap and stack are still placed in the “default” memory region (i.e. the first RAM block displayed in the memory configuration area), with the heap placed after the application’s data and the stack rooted at the top of this block.

To relocate the stack or heap, or provide a maximum extent of the heap, then the linker “--defsym” option can be used to define one or more of the following symbols:

```
__user_stack_top
__user_heap_base
_pvHeapLimit
```

To do this, use the `__MCU Linker – Miscellaneous – Other Options_` box in Project Properties.

For example:

--defsym=__user_stack_top=__top_RAM2

- Locate the stack at the top of the second RAM bank (as listed in the memory configuration editor)
- Note : The symbol `__top_RAM2` is defined in the project by the managed linker script mechanism at:

```
<projname>_<buildconfig>_mem.ld
```

--defsym=__user_heap_base=__end_bss_RAM2

- Locate the start of the heap in the second RAM bank, after any data that has been placed there

--defsym=_pvHeapLimit=__end_bss_RAM2+0x8000

- Locate the end of the heap in the second RAM bank, offset by 32KB from the end of any data that has been placed there

--defsym=_pvHeapLimit=0x10004000

- Locate the end of the heap at the absolute address 0x10004000

12.9.3 Reserving RAM for IAP Flash Programming

The IAP flash programming routines available in NXP’s LPC MCUs generally make use of some of the onchip RAM when executed. For example on the LPC1343 the top 32 bytes of onchip RAM are used. Thus if you are calling the IAP routines from your own application, you need to ensure that this memory is not used by your main application – which typically means by the stack.

However, with the managed linker script mechanism, it is easy to modify the start position of the stack (remember that stacks grow down) to avoid this clash with the IAP routines. To do this go to:

Project Properties -> C/C++ Build -> Settings -> MCU Linker -> Manager Linker Script

and modify the value in the “Stack Offset” field from 0 to 32. This will work whether you are using LPCXpresso style or MCUXpresso style of heap/stack placement.

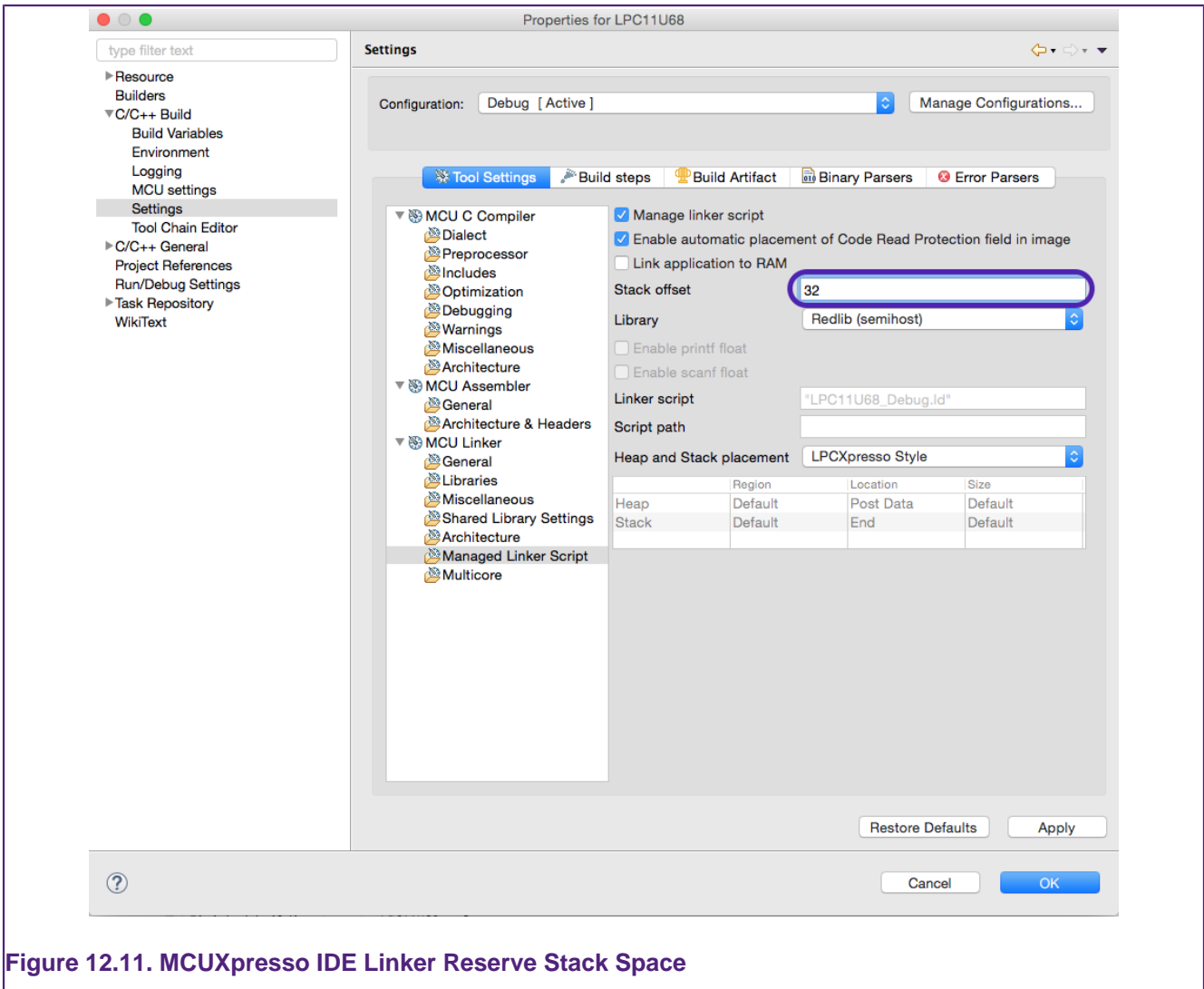

Figure 12.11. MCUXpresso IDE Linker Reserve Stack Space

The value you enter in this field must be a multiple of 4.

You are also advised to check the documentation for the actual MCU that you are using to confirm the amount of memory required by the IAP routines.

12.9.4 Stack checking

Although, as described above, it is possible to define a size of memory to be used for the stack, Cortex-M CPUs have no support for hardware stack checking. Thus if you want to automatically detect if the stack exceeds the memory set aside for it – other mechanisms must be used. For example:

- Locate stack to fall off start of memory block and trigger fault
- Include code that sets the stack to a known value, and periodically checks whether the lowest address has been overwritten.
- When debugging, set a watchpoint on the lowest address the stack is allowed to reach
- Use the Memory Protection Unit (MPU) to detect overflow, on parts which implement one

12.9.5 Heap Checking

By default, the heap used by the malloc() family of routines grows upwards from the end of the user data in RAM up towards the stack – a “one region memory model”.

When a new block of memory is requested, the memory allocation function _sbrk() will make a call to the following function to check for heap overflow:

```
unsigned __check_heap_overflow (void * new_end_of_heap)
```

This should return:

- **1** - If the heap will overflow
- **0** - If the heap is still OK

If 1 is returned, Redlib’s malloc() will set errno to ENOMEM and return a null pointer to the caller

The default version of **__check_heap_overflow()** built into the MCUXpresso IDE supplied C libraries carry out no checking unless the symbol “_pvHeapLimit” has been created in your image, to mark the end location of the heap.

This symbol will have been created automatically if you are using the MCUXpresso style of heap and stack placement described earlier in this chapter. Or alternatively if using the LPCXpresso style of heap and stack placements, you can use the --defsym option to set this.

If you wish to use a different means of heap overflow checking, then you can find a reference implementation of **__check_heap_overflow()** in the file **_cr_check_heap.c** that can be found in the Examples subdirectory of your IDE installation.

This file also provides functionality to allow simple heap overflow checking to be done by looking to see if the heap has reached the current location of the stack point, which of course assumes that the heap and stack are in the same region. This check is not enabled by default implementation within the C library as it can break in some circumstances – for example when the heap is being managed by an RTOS.

12.9.6 Placement of specific code/data items

It is possible to make small changes to the placement of specific code/data items within the final image without modifying the Freemaker linker script templates. Such placement can be controlled via macros provided in an MCUXpresso IDE supplied header file which can be pulled into your project using:

```
#include <cr_section_macros.h>
```

Placing data into different RAM blocks

Many MCUs provide more than one bank of RAM. By default the managed linker script mechanism will place all of the application data and bss (as well as the heap and stack) into the first bank of RAM.

However it is also possible to place specific data or bss items into any of the defined banks for the target MCU, as displayed in the Memory Configuration Editor, by decorating their definitions in your source code with macros from the cr_section_macros.h MCUXpresso IDE supplied header file

For simplicity, the **additional** memory regions are named sequentially, starting from 2, so RAM2, RAM3 etc (as well as using their “formal” region name – for example RamAHB32).

For example, the LPC1768 has a second bank of RAM at address 0x2007c000. The managed linker script mechanism creates a data (and equivalent bss) load section for this region thus:

```
.data_RAM2 : ALIGN(4)
{
    FILL(0xff)
    *(.data.$RAM2*)
    *(.data.$RamAHB32*)
} > RamAHB32 AT>MFlash512
```

To place data into this section, you can use the `__DATA` macro, thus:

```
// create an initialised 1k buffer in RAM2
__DATA(RAM2) char data_buffer[1024];
```

Or the `__BSS` macro:

```
// create a zero-init buffer in RAM2
__BSS(RAM2) char bss_buffer[128];
```

In some cases you might need a finer level of granularity than just placing a variable into a specific memory bank, and rather need to place it at a specific address. In such a case you could then edit the predefined memory layout for your particular project using the “Memory Configuration Editor” to divide up (and rename) the existing banks of RAM. This then allows you to provide a specific named block of RAM into which to place the variable that you need at a specific address, again by using the attribute macros provided by the “`cr_section_macros.h`” header file.

Noinit Memory Sections

Normally global variables in an application will end up in either a “.data” (initialized) or “.bss” (zero-initialized) data section within your linked application. Then when your application starts executing, the startup code will automatically copy the initial values of “.data” sections from Flash to RAM, and zero-initialize “.bss” data sections directly in RAM.

MCUXpresso IDE’s managed linker script mechanism also supports the use of “.noinit” data within your application. Such data is similar to “.bss” except that it will not get zero-initialized during startup.

Note: Great care must be taken when using “.noinit” data such that your application code makes no assumptions about the initial value of such data. This normally means that your application code will need to explicitly set up such data before using it – otherwise the initial value of such a global variable will basically be random (i.e. it will depend upon the value that happens to be in RAM when your system powers up).

One common example of using such .noinit data items is in defining the frame buffer stored in SDRAM in applications which use an onchip LCD controller (for example NXP LPC178x and LPC408x parts).

Making global variables noinit

The linker script generated by the MCUXpresso IDE managed linker script mechanism will contain a section for each RAM memory block to contain “.noinit” items, as well as the “.data” and “.bss” items. Note that for a particular RAM memory block, all “.data” items will be placed first, followed by “.bss” items, and then “.noinit” items.

However, normally for a particular RAM memory block where you are going to be put “.noinit” items, you would actually be making all of the data placed into that RAM “.noinit”.

The “cr_section_macros.h” header file then defines macros which can be used to place global variables into the appropriate “.noinit” section. First of all include this header file:

```
#include <cr_section_macros.h>
```

The `__NOINIT` macro can then be used thus:

```
// create a 128 byte noinit buffer in RAM2
__NOINIT(RAM2) char noinit_buffer[128];
```

And if you want “.noinit” items placed into the default RAM bank, then you can use the `__NOINIT_DEF` macro thus:

```
// create a noinit integer variable in the main block of RAM
__NOINIT_DEF int noinit_var ;
```

Placing code/rodata into different FLASH blocks

Most MCUs only have one bank of Flash memory. But with some parts more than one bank may be available – and in such cases, by default, the managed linker script mechanism will still place all of the application code and rodata (consts) into the first bank of flash (as displayed in the Memory Configuration Editor).

For example:

- most of the LPC18 and LPC43xx parts containing internal flash (such as LPC1857 and LPC4357) actually provide dual banks of flash.
- some MCUs have the ability to access external flash (typically SPIFI) as well as their built-in internal flash (e.g. LPC18xx, LPC40xx, LPC43xx, LPC546xx).

However it is also possible to place specific functions or rodata items into the second (or even third) bank of Flash. This placement is controlled via macros provided in the “cr_section_macros.h” header file.

For simplicity, the **additional** Flash region can be referenced as Flash2 (as well as using its “formal” region name – for example MFlashB512 – which will vary depending upon part).

First of all include this header file:

```
#include <cr_section_macros.h>
```

Then, for example, to place a rodata item into this section, you can use the `__RODATA` macro, thus:

```
__RODATA(Flash2) const int roarray[] = {10,20,30,40,50};
```

Or to place a function into it you can use `__TEXT` macro:

```
__TEXT(Flash2) void systick_delay(uint32_t delayTicks) {
:
}
```

In addition the `__RODATA_EXT` and `__TEXT_EXT` macros can be used to place functions/rodata into a more specifically named section, for example:

```
__TEXT_EXT(Flash2,systick_delay) void systick_delay(uint32_t delayTicks) {
:
}
```

will be placed into the section “.text.\$Flash2.systick_delay” rather than “.text.\$Flash2”.

Placing specific functions into RAM blocks

In most modern MCUs with built-in flash memory, code is normally executed directly from flash memory. Various techniques, such as prefetch buffering are used to ensure that code will execute with minimal or zero wait states, even a higher clock frequencies. Please see the documentation for the MCU that you are using for more details.

However it is also possible to place specific functions into any of the defined banks of RAM for the target MCU, as displayed in:

Project -> Properties -> C/C++ Build -> MCU settings

and sometimes there can be advantages in relocating small, time critical functions so that they run out of RAM instead of flash.

For simplicity, the **additional** memory regions are named sequentially, starting from 2, (as well as using their “formal” region name – for example RamAHB32). So for a device with 3 RAM regions, alias names RAM, RAM2 and RAM3 will be available.

This placement is controlled via macros provided in a header file which can be pulled into your project using:

```
#include <cr_section_macros.h>
```

The macro `__RAMFUNC` can be used to locate a function into a specific RAM region.

For example, to place a function into the main RAM region, use:

```
__RAMFUNC(RAM) void fooRAM(void) {...}
```

To place a function into the RAM2 region, use:

```
__RAMFUNC(RAM2) void fooRAM2(void) {...}
```

Alternatively, RAM can be selected by formal name (as listed in the memory configuration editor), for example:

```
__RAMFUNC(RamAHB32) void HandlerRAM(void) {...}
```

In order to initialize RAM based code (and data) into specified RAM banks, the managed linker script mechanism will create a “Global Section Table” in your image, directly after the vector table. This contains the addresses and lengths of each of the data (and bss) sections, so that the startup code can then perform the necessary initialization (copy code/data from Flash to RAM).

Long branch veneers and debugging

Due to the distance in the memory map between flash memory and RAM, you will typically require a “long branch veneer” between the function in RAM and the calling function in flash. The linker can automatically generate such a veneer for direct function calls, or you can effectively generate your own by using a call via a function pointer.

One point to note is that debugging code with a linker generated veneer can sometimes cause problems. This veneer will not have any source level debug information associated with it, so that if you try to step in to a call to your code in RAM, typically the debugger will step over it instead.

You can work around this by single stepping at the instruction level, setting a breakpoint in your RAM code, or by changing the function call from a direct one to a call via a function pointer.

Reducing Code Size when support for LPC CRP or Kinetis Flash Config Block is enabled

One of the consequences of the way that LPC CRP and Kinetis Flash Configuration Blocks work is that the memory between the CPU's vector table and the CRP word/ Flash Config Block is often left largely unused. This can typically increase the size of the application image by several hundred bytes (depending upon the MCU being used).

However this unused space can easily be reclaimed by choosing one or more functions to be placed into this unused memory. To do this, you simply need to decorate their definitions with the macro `__AFTER_VECTORS` which is supplied in the "cr_section_macros.h" header file

Obviously in order to do this effectively, you need to identify functions which will occupy as much of this unused memory as possible. The best way to do this is to look at the linker map file.

MCUXpresso IDE startup code already uses this macro to place the various initialization functions and default exception handlers that it contains into this space, thus reducing the 'default' unused space. But you can also place additional functions there by decorating their definitions with the macro, for example

```
__AFTER_VECTORS void myStartupFunction(void);
```

Note you will get a link error if the `__AFTER_VECTORS` space grows beyond the CRP/Flash Configuration Block (when this support is enabled):

```
myproj_Debug.ld:98 cannot move location counter backwards (from 00000334
to 000002fc)
collect2: ld returned 1 exit status
make: *** [myproj.axf] Error 1
```

In this case, you will need to remove the `__AFTER_VECTORS` macro from the definition of one or more of your functions.

12.10 Freemaker Linker Script Templates

By default, MCUXpresso IDE projects use a managed linker script mechanism which automatically generates a linker script file without user intervention – allowing the project code and data to be laid out in memory based on the IDE's knowledge of the memory layout of the target MCU.

However sometimes the linker script generated in this way may not provide exactly the memory layout required. MCUXpresso IDE therefore provides a highly flexible and powerful linker script template mechanism to allow the user to change the content of the linker script generated by the managed linker script mechanism

12.10.1 Basics

FreeMarker is a template engine: a generic tool to generate text output (HTML web pages, e-mails, configuration files, source code, etc.) based on templates and changing data. Built

into MCUXpresso IDE are a set of templates that are processed by the Freemarker template engine to create the linker script. Templates are written in the FreeMarker Template Language (FTL), which is a simple, specialized language, not a full-blown programming language like PHP. Full documentation for Freemarker can be found at :<http://freemarker.org/docs/index.html>:<http://freemarker.org/docs/index.html> .

MCUXpresso IDE automatically invokes Freemarker, passing it a data model that describes the memory layout of the target together with a 'root' template that is processed to create the linker script. This root template, #include's further 'component' templates. This structure allows a linker script to be broken down into various components, and allows a user to provide their own templates for a component, instead of having to (re-)write the whole template. For example, component templates are provided for text, data and bss sections, allowing the user to provide a different implementations as necessary, but leaving the other parts of the linker script untouched.

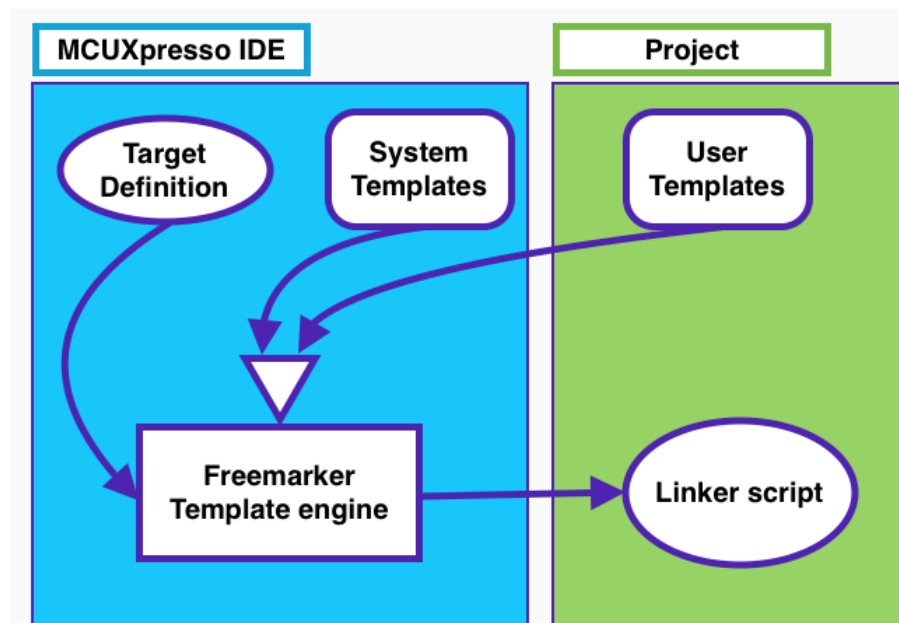

12.10.2 Reference

Freemarker reads input files, copying text and processing Freemarker directives and 'variables', and writes an output file. As used by the MCUXpresso IDE managed linker script mechanism, the input files describe the various components of a linker script which, together with variables defined by the IDE, are used to generate a complete linker script. Any of the component template input files may be overridden by providing a local version in the project.

The component template input files are provided as a hierarchy, shown below, where each file #include's those files nested below. This allows for individual components of the linker script to be overridden without having to supply the entire linker script, increasing flexibility, while maintaining the benefits of Managed Linker Scripts.

Linker script template hierarchy

linkscript.ldt (top level)

- user.ldt (an empty file designed to be overridden by users that is included in linkscript, memory and library templates)
- user_linkscript.ldt (an empty file designed to be overridden by users that is included in linkscript only)
- linkscript_common.ldt (root for main content)
 - header.ldt (the header for scripts)

- listvars.ldt (a script to output a list of all predefined variables available to the template)
- includes.ldt (includes the memory and library scripts)
- section_top.ldt (top of the linker script SECTION directive)
- text_section.ldt (text sections for each secondary flash)
 - text_section_multicore.ldt (text sections for multicore targets)
 - text.ldt (for inserting *text)
 - rodata.ldt (for inserting rodata)
- main_text_section.ldt (the primary text section)
 - global_section_table.ldt (the global section table)
 - crp.ldt (the CRP information)
 - main_text.ldt (for inserting *text)
 - main_rodata.ldt (read-only data)
 - cpp_info.ldt (additional C++ requirements)
- exdata.ldt (the exdata sections)
- end_text.ldt (end of text marker)
- usb_ram_section.ldt (placement of SDK USB data structures)
- stack_heap_sdk_start.ldt (placement of MCUXpresso style heap/stack)
- data_section.ldt (data sections for secondary ram)
 - data_section_multicore.ldt (data sections for multicore targets)
 - data.ldt (for inserting *data)
- mtb_default_section.ldt (special section for MTB (cortex-m0+ targets))
- uninit_reserved_section.ldt (uninitialised data)
- main_data_section.ldt (primary data section)
 - main_data.ldt (for inserting *data)
- bss_section.ldt (secondary bss sections)
 - bss.ldt (for inserting *bss)
- main_bss_section.ldt (primary bss section)
 - main_bss.ldt (for inserting *bss)
- noinit_section.ldt (no-init data)
- noinit_noload_section.ldt (no-load data)
- stack_heap_sdk_postdata.ldt (placement of MCUXpresso style heap/stack)
- stack_heap_sdk_end.ldt (placement of MCUXpresso style heap/stack)
- stack_heap.ldt (define the stack and heap)
- checksum.ldt (create the LPC checksum)
- section_tail.ldt (immediately before the send of linker SECTION directive)

library.ldt (the standard libraries used in the application)

- user.ldt (an empty file designed to be overridden by users that is included in linkscript, memory and library templates)
- user_library.ldt (an empty file designed to be overridden by users that is included in library only)

memory.ldt (the memory map)

- user.ldt (an empty file designed to be overridden by users that is included in linkscript, memory and library templates)
- user_memory.ldt (an empty file designed to be overridden by users that is included in memory only)

Linker script search paths

Whenever a linker script template is used, LPCXpresso will search in the following locations, in the order shown:

- *project/linkscripts*
- the searchPath global variable

- The searchPath can be set in a script by using the syntax `<#global searchPath="c:/windows/path;d:/another/windows/path">`

each directory to search is separated by a semicolon ';'

- `mcuxpresso_install_dir/ide/Data/Linkscripts`
 - linker templates can be placed in this directory to override the default templates for an entire installation
- MCUXpresso IDE internally provided templates (not directly visible to users)

Thus, a project can simply override any template by simply creating a linkscript directory within the project and placing the appropriate template in there. Using the special syntax "super@" an overridden template can reference a file from the next level of the search path

e.g. `<#include "super@user.ldt">`

Linker script templates

Copies of the default linker script templates used within MCUXpresso IDE can be found in the Wizards/linker directory within the MCUXpresso IDE install.

Predefined variables (macros)

List (sequence) variables (used in `#list`)

- `libraries[]`
 - list of the libraries to be included in the "lib" script
 - for example (Redlib nohost)

```
libraries[0]=libcr_c.a
libraries[1]=libcr_eabihelpers.a
```

- `configMemory[]`
 - list of each memory region defined in the memory map for the project. Each entry has the following fields defined
 - name – the name of the memory region
 - alias – the alias of the memory region
 - location – the base address of the memory
 - size – the size of the memory region
 - sizek – the printable size of the memory region in k or M
 - mcuPattern
 - defaultRAM – boolean indicating if this is the default RAM region
 - defaultFlash – boolean indication if this is the default Flash region
 - RAM – boolean indicating if this is RAM
 - flash – boolean indicating if this is Flash
 - for example

```
configMemory[0]= name=MFlashA512 alias=Flash location=0x1a000000
size=0x80000 sizek=512K bytes mcuPattern=Flash flash=true RAM=false
defaultFlash=true defaultRAM=false
```

```
configMemory[2]= name=RamLoc32 alias=RAM location=0x10000000
size=0x8000 sizek=32K bytes mcuPattern=RAM flash=false RAM=true
defaultFlash=false defaultRAM=true
```

- `slaves[]`

- list of the slaves in a Multicore project. This variable is only defined in Multicore projects. Each entry has the following fields defined
 - name – name of the slave
 - enabled – boolean indicating if this slave is enabled
 - objPath – path to the object file for the slave image
 - linkSection – name of the section this slave is to be linked in
 - runtimeSection
 - textSection – name of the text section
 - textSectionNormalized – normalized name of the text section
 - dataStartSymbol – name of the Symbol defining the start of the data
 - dataEndSymbol – name of the Symbol defining the end of the data
- for example

```
slaves[0] = name=M0APP objectPath=${workspace_loc:/MCB4357_Blinky_DualM0/Debug
/MCB4357_Blinky_DualM0.axf.o}linkSection=Flash2 runtimeSection= textSection=
.core_m0app textSectionNormalized=.core_m0appdata StartSymbol=__start_data
dataEndSymbol=__end_data enabled=true;</notextile>
```

Simple variables:

- CODE – name of the memory region to place the default code (text) section
- CRP_ADDRESS – location of the Code Read Protect value
- DATA – name of the memory region to place the default data section
- LINK_TO_RAM – value of the “Link to RAM” linker option
- STACK_OFFSET – value of the Stack Offset linker option
- FLASHn – defined for each FLASH memory
- RAMn – defined for each RAM memory
- basename – internal name of the process
- bss_align – alignment for .bss sections
- buildConfig – the name of the configuration being built
- chipFamily – the chip family
- chipName – name of the target chip
- data_align – alignment for .data section
- date – date string
- heap_symbol – name of the symbol used to define the heap
- isCppProject – boolean indicating if this is a C++ project
- isSlave – boolean indicating if this target is a slave – true iff is a slave core in a multicore system
- library_include – name of the library include file
- libtype – C library type
- memory_include – name of the memory include file
- mtb_supported – boolean indicating if mtb is supported for this target
- numCores – number of cores in this target
- procName – the name of the target processor
- project – the name of the project
- script – name of the script file
- slaveName – is the name of the slave (only present for slaves)
- stack_section – the name of the section where the stack is to be placed
- start_symbol – the name of the start symbol (entry point)
- scriptType – the type of script being generated (one of “script”, “memory”, or “library”)
- text_align – alignment for .text section
- version – product version string
- workspace_loc – workspace directory
- year – the year (extracted from the date)

Extended variables

Two 'extended' variables are available:

environment

- The environment variable makes the host Operating System environment variables available. For example, the Path variable is available as `${environment["Path"]}`. Note that environment variables are case sensitive.

systemProperties

- The Java system properties are available through the systemProperties variable. For example the "os.name" system property is available as `${systemProperties["os.name"]}`. Note that the system properties are case sensitive.

Outputting variables

A list of all predefined variables and their values can be output to the generated linker script by setting the Preference: *MCUXpresso IDE -> Default Tool settings -> ...* and list predefined variables in the script

A list of extended variables and their values can be output to the generated linker script by creating a *linkscripts/user.ldt* file in the project with the content

```
<#assign listvarsext=true>
```

(This is likely to be used less often, hence the slightly longer winded method of specifying the option)

12.11 Freemaker Linker Script Template Examples

The use of Freemaker linker script templates allows more wide ranging changes to be made to the generated link script than is possible using the *cr_section_macros.h* macros. The following examples provide some examples of this.

12.11.1 Relocating code from FLASH to RAM

If you have specific functions in your code base that you wish to place into a particular block of RAM, then the simplest way to do this is to decorate the function definition using the macro `__RAMFUNC` described earlier in this chapter.

However once you want to relocate more than a few functions, or when you don't have direct access to the source code, this becomes impractical. In such case the use of Freemaker linker script templates will be a better approach. The following sections provide a number of such examples.

Relocating particular objects into RAM

In some cases, it may be required to relocate all of the functions (and rodata) from a given object file in your project into RAM. This can be achieved by providing three linker script template files into a linkscripts folder within your project. For example if it was required that all code/rodata from the files *foo.c* and *bar.c* were relocated into RAM, then this could be achieved using the following linker script templates:

```
main_text.ldt
(EXCLUDE_FILE(*foo.o *bar.o) .text*)
```

```
main_rodata.ldt
*(EXCLUDE_FILE(*foo.o *bar.o) .rodata)
*(EXCLUDE_FILE(*foo.o *bar.o) .rodata.*)
*(EXCLUDE_FILE(*foo.o *bar.o) .constdata)
*(EXCLUDE_FILE(*foo.o *bar.o) .constdata.*)
. = ALIGN(${text_align});
```

```
main_data.ldt
*foo.o(.text*)
*foo.o(.rodata .rodata.* .constdata .constdata.*)
*bar.o(.text*)
*bar.o(.rodata .rodata.* .constdata .constdata.*)
. = ALIGN(${text_align});
*(.data*)
```

What each of these EXCLUDE_FILE lines (in main_text.ldt and main_rodata.ldt) is doing in pulling in all of the sections of a particular type (for example .text), except for the ones from the named object files. Then in main_data.ldt, we specify explicitly that the text and rodata sections should be pulled in from the named object files. Note that with the GNU linker, LD, the first match found in the final generated linker script is always used, which is why the EXCLUDE_FILE keyword is used in the first two template files.

Note: EXCLUDE_FILE only acts on the closest input section specified, which is why we have 4 separate EXCLUDE_FILE lines in the main_rodata.ldt file rather than just a single combined EXCLUDE_LINE.

Once you have built your project using the above linker script template files, then you can check the generated .ld file to see the actual linker script produced, together with the linker map file to confirm where the code and rodata have been placed.

Relocating particular libraries into RAM

In some cases, it may be required to relocate all of the functions (and rodata) from a given library in your project into RAM. One example of this might be if you are using a flashless LPC43xx MCU with an external SPIFI flash device being used to store and execute your main code from, but you need to actually update some data that you are also storing in the SPIFI flash. In this case, the code used to update the SPIFI flash cannot run from SPIFI flash.

This can be achieved by providing three linker script template files into a linkscripts folder within your project. For example if it was required that all code/rodata from the library MYLIBRARYPROJ were relocated into RAM, then this could be achieved using the following linker script templates:

```
main_text.ldt
*(EXCLUDE_FILE(*libMYLIBRARYPROJ.a:) .text*)
```

```
main_rodata.ldt
*(EXCLUDE_FILE(*libMYLIBRARYPROJ.a:) .rodata)
*(EXCLUDE_FILE(*libMYLIBRARYPROJ.a:) .rodata.*)
*(EXCLUDE_FILE(*libMYLIBRARYPROJ.a:) .constdata)
*(EXCLUDE_FILE(*libMYLIBRARYPROJ.a:) .constdata.*)
. = ALIGN(${text_align});
```

```
main_data.ldt
```

```

*libMYLIBRARYPROJ.a:(.text*)
*libMYLIBRARYPROJ.a:(.rodata .rodata.* .constdata .constdata.*)
. = ALIGN(${text_align});
*(.data*)

```

Relocating majority of application into RAM

In some situations, you may wish to run the bulk of your application code from RAM – typically just leaving startup code and the vector table in Flash. This can be achieved by providing three linker script template files into a linkscripts folder within your project:

```

main_text.ldt
*startup*.o (.text.*)
*(.text.main)
*(.text.__main)

```

```

main_rodata.ldt
*startup*.o (.rodata .rodata.* .constdata .constdata.*)
. = ALIGN(${text_align});

```

```

main_data.ldt
*(.text*)
*(.rodata .rodata.* .constdata .constdata.*)
. = ALIGN(${text_align});
*(.data*)

```

The above linker template scripts will cause the main body of the code to be relocated into the main (first) RAM bank of the target MCU, which by default will also contain data/bss, as well as the stack and heap.

If the MCU being targeted has more than one RAM bank, then the main body of the code could be relocated into another RAM bank instead. For example, if you wanted to relocate the code into the second RAM bank, then this could be done by providing the following data.ldt file instead of the main_data.ldt above:

```

data.ldt
<#if memory.alias=="RAM2">
*(.text*)
*(.rodata .rodata.* .constdata .constdata.*)
. = ALIGN(${text_align});
</#if>
*(.data.${memory.alias}*)
*(.data.${memory.name}*)

```

Note: memory.alias value is taken from the Alias column of the Memory Configuration Editor.

12.11.2 Configuring projects to span multiple flash devices

Most MCUs only have one bank of Flash memory. But with some parts more than one bank may be available – and in such cases, by default, the managed linker script mechanism will still place all of the application code and rodata (consts) into the first bank of flash (as displayed in the Memory Configuration Editor)..

For example

- most of the LPC18 and LPC43xx parts containing internal flash (such as LPC1857 and LPC4357) actually provide dual banks of flash.
- some MCUs have the ability to access external flash (typically SPIFI) as well as their built-in internal flash (e.g. LPC18xx, LPC40xx, LPC43xx, LPC546xx).

The macros provided in the “cr_section_macros.h” header file provide some ability to control the placement of specific functions or rodata items into the second (or even third) bank of Flash. However the use of Freemarker linkers script templates allow this to be done in a much more powerful and flexible way.

One typical use case for this is a project which stores its main code and data in internal flash, but additional rodata (for example graphics data for displaying on an LCD) in the external SPIFI flash.

For instance, consider an example project where such rodata is all contained in a set of specific files, which we therefore want to place into the external flash device. One very simple way to do this is to place such source files into a separate source folder within your project. You can then supply linker script templates to place the code and rodata from these files into the appropriate flash.

For example, for a project using the LPC4337 with two internal flash banks, plus external SPIFI flash, if the source folder used for this purpose were called ‘spifidata’, then placing the following files into a ‘linkscripts’ directory within your project would have the desired effect:

```
text.ldt
<#if memory.alias=="Flash3">
  *spifidata/*(.text*)
</#if>
*(.text_${memory.alias}*) /* for compatibility with previous releases */
*(.text_${memory.name}*) /* for compatibility with previous releases */
*(.text.${memory.alias}*)
*(.text.${memory.name}*)
```

```
rodata.ldt
<#if memory.alias=="Flash3">
  *spifidata/*(.rodata*)
</#if>
*(rodata.${memory.alias}*)
*(rodata.${memory.name}*)
```

Note: the check of the memory.alias being Flash3 is to prevent the code/rodata items from ending up in the BankB flash bank (which is Flash2 by default).

12.12 Disabling managed linker scripts

It is possible to disable the managed linker script mechanism if required and provide your own linker scripts, but this is not recommended for most users. In most circumstance, the facilities provided by the managed linker script mechanism, and its underlying Freemarker template mechanism should allow you to avoid the need for writing your own linker scripts. But if you do wish to do this, then untick the appropriate option at:

Properties -> C/C++ Build -> Settings -> MCU Linker -> Managed Linker Script

And then in the field *Script Path* provide the name and path (relative to the current build directory) of your own, manually maintained linker script.

In such cases you can either create your own linker script from scratch, or you can use the managed linker scripts as a starting point. One very important point though is that you are advised

not to simply modify the managed linker scripts in place, but instead to copy them to another location and modify them there. This will prevent any chance of the tools accidentally overwriting them if at some point in the future you turn the managed make script mechanism back on.

Note: if your linker script includes additional files (as the managed linker scripts do), then you will also need to include the relative path information in the include inside the top level script file.

For more details of writing your own linker scripts, please see the GNU Llinker (ld) documentation:

Help -> Help Contents -> Tools (Compilers, Debugger, Utilities) -> GNU Linker

There is also a good introduction to linker scripts available in Building Bare-Metal ARM Systems with GNU: Part 3 at:

<http://www.embedded.com/design/mcus-processors-and-socs/4026080/Building-Bare-Metal-ARM-Systems-with-GNU-Part-3>

13. Multicore Projects

13.1 LPC43xx Multicore Projects

The LPC43xx family of MCUs contain a Cortex-M4 “master” core and one or more Cortex-M0 “slave” cores. After a power-on or Reset, the master core boots and is then responsible for booting the slave core(s). However, this relationship only applies to the booting process; after boot, your application may treat any of the cores as the master or a slave.

The MCUXpresso IDE allows for the easy creation of “linked” projects that support the targeting of LPC43xx Multicore MCUs. For more information on creating and using such multicore projects, please see the FAQ at

<https://community.nxp.com/message/637967>

13.2 LPC541xx Multicore Projects

Some members of the LPC541xx family of MCUs contain a Cortex-M4 core and a Cortex-M0+ core (with the Cortex-M4 being the master, and the M0+ the slave). After a power-on or Reset, the master core boots and is then responsible for booting the slave core. However, this relationship only applies to the booting process; after boot, your application may treat either of the cores as the master or the slave.

The MCUXpresso IDE allows for the easy creation of “linked” projects that support the targeting of LPC541xx Multicore MCUs. For more information on creating and using such multicore projects, please see the FAQ at

<https://community.nxp.com/message/630715>

14. Appendix

14.1 Quick Settings

MCUXpresso IDE provides quick access to a range of project settings via the QuickStart Panel as shown below:

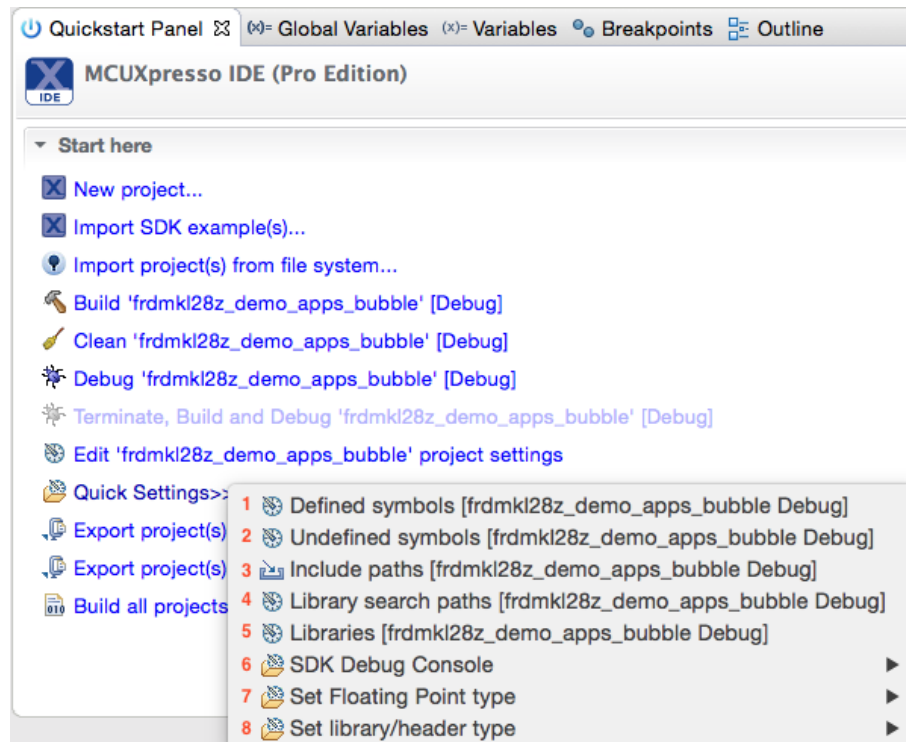

Note: These settings apply to the selected project's default build configuration only and simplify access to commonly used settings normally accessed from *Properties -> C/C++ Build -> Settings*

1. Defined symbols – select to edit the (-D) symbols
2. Undefined symbols – select to edit the (-U) symbols
3. Include paths – select to edit the (-I) the include paths
4. Library search paths – select to edit the (-L) the library
5. Libraries – select to edit the (-l) the linker libraries search
6. SDK BUILD Console – select the SDK BUILD Console's PRINTF output to be via UART or to redirect via the C libraries printf function
 - selecting printf will increase the size of the project binary compared to UART output
 - for semihosted printf output to generated, the project must be linked against a suitable library.
 - for more information see the section on Semihosting and the use of printf [75]
7. Set Floating Point type – select to switch between the available Floating Point options
 - for more information see the section on Hardware Floating Point Support [120]
8. Set Library/Header type – select to switch the current C/C++ Library
 - for more information see the section on C/C++ Library Support [72]

14.2 Launch Configurations

Within each MCUXpresso IDE project, there will be a “launch configuration file” for each build variant, which is used to store the settings for a debug connection for that build configuration.

These will be created in the root directory of a project the first time that you launch a debug session for that project and are typically called

```
{projname} Debug.launch
{projname} Release.launch
```

Normally, there is no need to touch the launch configurations, as the default settings created by the tools will be suitable. However, in some circumstances, you may need to modify them – typically under direction from an FAQ. In such cases, the best way to do this is via the “Launch Configurations” entry on the context sensitive menu available from the Project Explorer view...

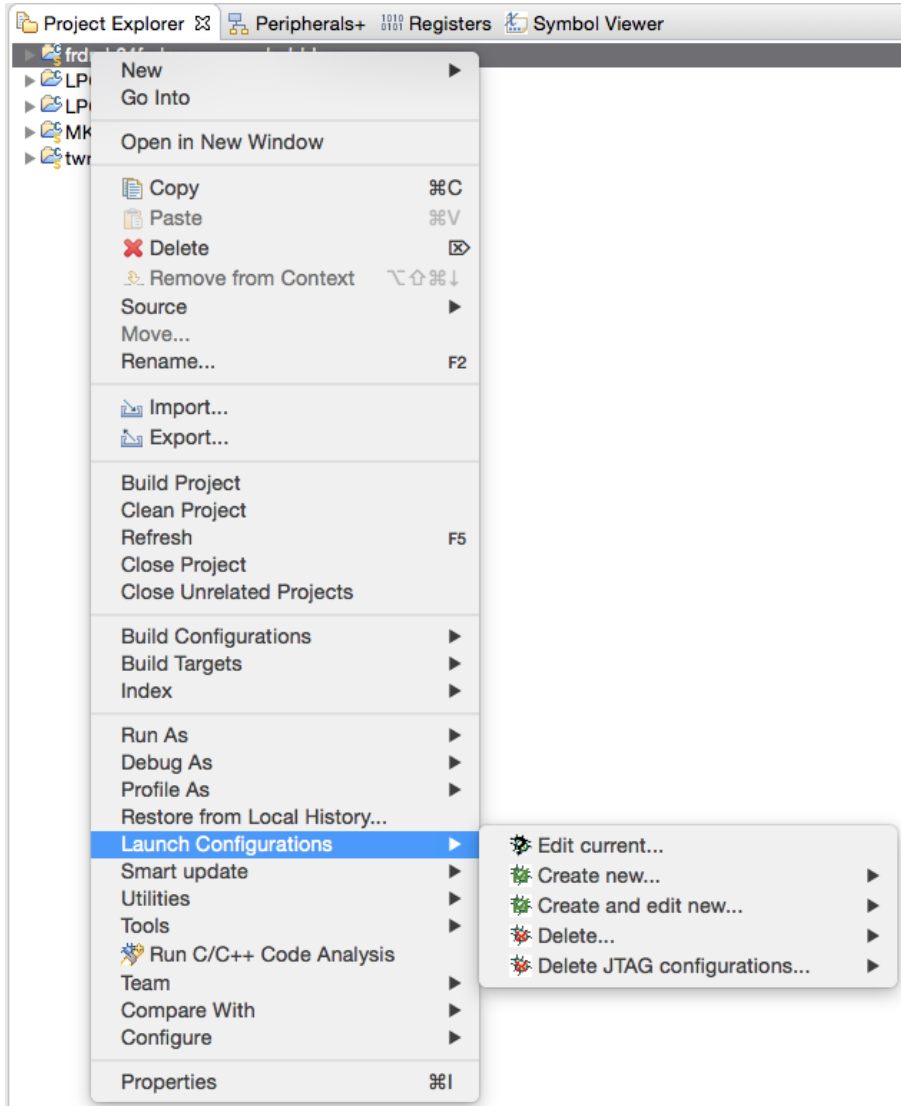

A number of options are available here:

Edit current

- Allows various debug settings to be modified
- We do not recommend this for normal use unless you are explicitly instructed.

Create New

- Creates launch configurations for the selected project, if they do not already exist.

- Normally you will not need this option as it is carried out automatically the first time that you debug your project. However if you Delete your launch configuration and want to then edit a new default launch configuration before debugging, then you will need to use this option to do so.

Create and Edit New

- Allows new launch configurations to be created and immediately opened for editing.

Delete Current

- Allows the launch configurations for the selected project (or projects) to be deleted.
- This can be useful as it allows you to put the debug connection settings back to the default after making modifications for some reason, or if you are moving your project to a new version of the tools, and want to ensure that your debug settings are correct for this version of the tools.

Delete JTAG Configuration

- Allows the JTAG configuration files for the selected project (or projects) to be deleted. These files are stored in the Debug/Release subdirectories.

14.2.1 Editing a Launch Configuration

WARNING: - Modifying the default settings for a launch configuration can prevent a successful debug connection from being made. Make changes with care!

After selecting the “Edit current” or “Create and Open New” launch configuration menu entry, you will then see a new dialog box pop up, which looks like the following...

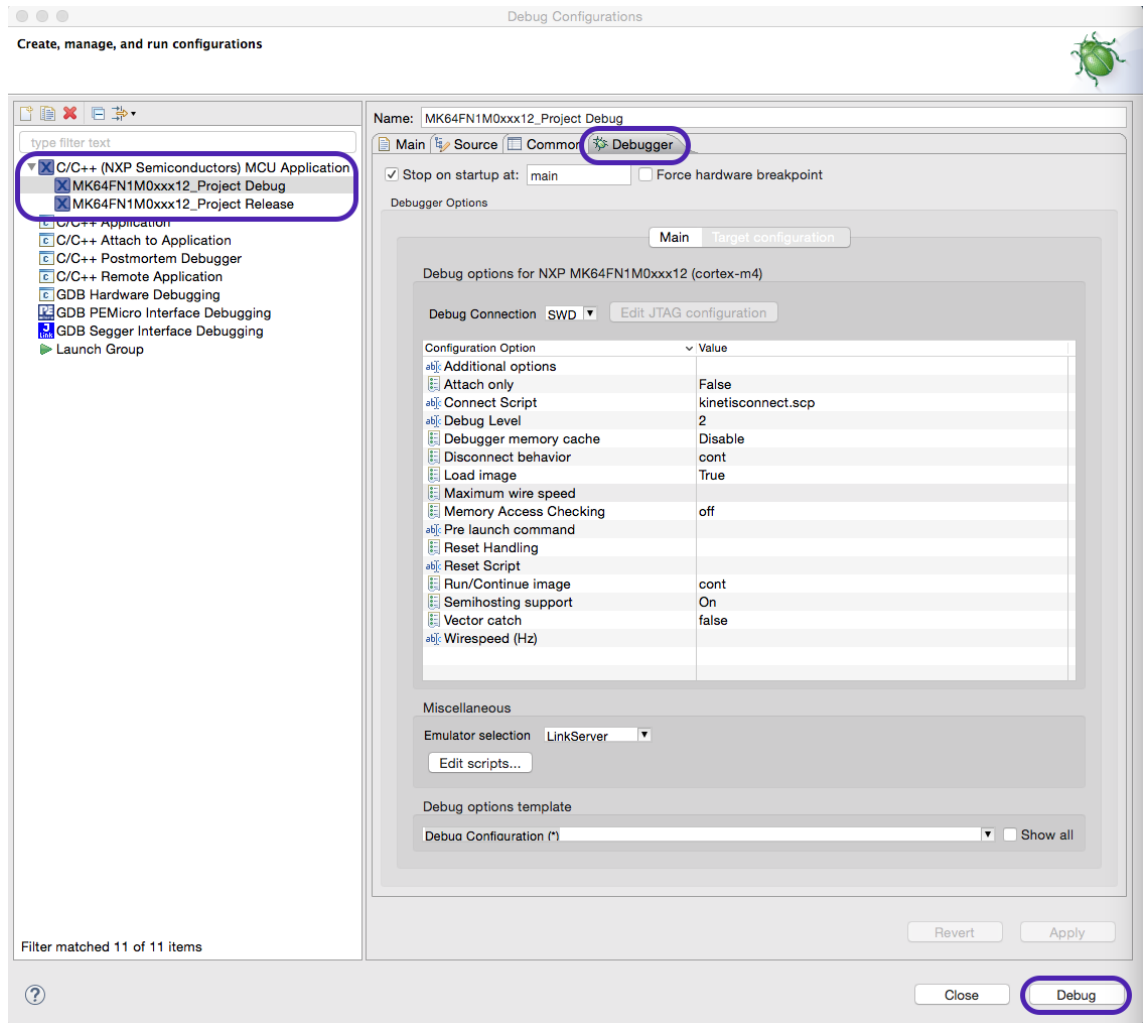

Most settings that you may need to modify can be found in the Debugger tab, in the Target configuration sub-tab (as shown in the above screenshot).

Some examples of modifications that you may need to make in particular circumstances are:

- Changing the initial breakpoint on debug startup
 - When the debugger starts, it automatically sets an initial (temporary) breakpoint on the first statement in main(). If desired, you can change where this initial breakpoint is set, or even remove it completely.
- Modifying the Debugger connect behavior
 - via a Connect Script e.g. kinetisconnect.scp
- Connecting to a target via JTAG rather than SWD
 - if supported by the target, you can edit the Debug type
- Connecting to a running system
 - set Attach only to True

14.3 How do I switch between Debug and Release builds?

14.3.1 Changing the build configuration of a single project

You can switch between Debug and Release build configurations by selecting the project you want to change the build configuration of in the Project Explorer view, then using one of the below methods:

- Select the menu item **Project->Build Configuration->Set Active** and select **Release** or **Debug** as necessary
- Use the drop down arrow next to the 'sundial' (Manage configurations for the current project) icon on the main toolbar (next to the 'hammer' icon) and select **Release** or **Debug** as necessary. Alternatively you can use the drop down next to the 'hammer' icon to change the current configuration and then immediately trigger a build.

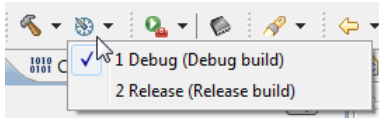

- Right click in the Project Explorer view to display the context sensitive menu and select **Build Configurations->Set Active** entry.

14.3.2 Changing the build configuration of multiple projects

It is also possible to set the build configuration of multiple projects at once. This may be necessary if you have a main application project linked with a library project, or you have linked projects for a multicore MCU such as an LPC43xx or LPC541xx (one project for the master Cortex-M4 CPU and another for a slave Cortex-M0/M0+ CPU).

To do this, you first of all you need to select the projects that you wish to change the build configuration for in the Project Explorer view – by clicking to select the first project, then use shift-click or control-click to select additional projects as appropriate. If you want to change all projects, then you can simply use Ctrl-A to select all of them.

Note it is important that when you select multiple projects, you should ensure that none of the selected projects are opened out – in other words, when you selected the projects, you must not have been able to see any of the files or the directory structure within them. If you do not do this, then some methods for changing the build configuration will not be available.

Once the required projects are selected, you then need to simply change the build configuration as you would do for a single project.

14.4 Editing Hints and Tips

The editor view within Eclipse, which sits under the MCUXpresso IDE, provides a large number of powerful features for editing your source files.

14.4.1 Multiple views onto the same file

The **Window -> Editor** menu provides several ways of looking at the same file in parallel.

- **Clone** : two editor views onto the same file
- **Toggle Split Editor** : splits the view onto the current file into two (either horizontally or vertically)

14.4.2 Viewing two edited files at once

To see more than one file at the same time, simply to click one the file tabs that you have open in the editor view, and then keep the mouse button held down and you should just be able to drag that file tab across to the right. After you've moved to the side, or below, slightly, and outline should be appear showing you where that tab will be placed once you let go of the mouse button.

14.4.3 Source folding

Within the editor view, functions, structures etc may be folded to show the structure and hide the detail.

To enable folding, right click in the margin of the editor view to bring up the context sensitive menu, then select **Folding->Enable Folding**

You can then click on the + or - icon that now appear in the margin next to each function, structure, etc, to expand or collapse it, or use the **Folding->Expand all** and **Folding->Collapse all** options from the context sensitive menu

Various settings for Folding can also be controlled through **Window -> Preferences -> C/C++ -> Editor -> Folding**

14.4.4 Editor templates and Code completion

Within the editor, a number of related pieces of functionality allow you to enter code quickly and easily.

First of all, templates are fragments of code that can be inserted in a semi-automatic manner to ease the entering of repetitive code – such as blocks of code for C code structures such as for loops, if-then-else statements and so on.

Secondly, the indexing of your source code that is done by default by the tools, allows for auto completion of function and variable names. This is known as “content assist”.

- Ctrl-Space at any point will list available editor template, function names etc
- Ctrl-Shift-Space will display function parameters
- Alt-/ for word completion (press multiple times to cycle through multiple options).

In addition, the predefined templates are user extensible via **Window -> Preferences -> C/C++ -> Editor -> Templates**

14.4.5 Brace matching

The editor can highlight corresponding open and closing braces in a couple of ways.

First of all, if you place the cursor immediately to the right of a brace (either an opening or closing brace), then the editor will display a rectangle around the corresponding brace.

Secondly, if you double click immediately to the right of a brace, then the editor will automatically highlight all of the text between this brace and the corresponding one.

14.4.6 Syntax coloring

Syntax Coloring specifies how your source code is rendered in the editor view, with different colors used for different elements of your source code. The settings used can be modified in:

- Window -> Preferences -> C/C++ -> Editor -> Syntax Coloring*

Note that general text editor settings such as the background color can be configured in:

Window -> Preferences -> General -> Text Editors

Fonts may be configured in:

Window -> Preferences -> General -> Appearance -> Colors and Fonts

14.4.7 Comment/uncomment block

The editor offers a number of ways of comment in or out one or more lines of text. These can be accessed using the Source entry of the editor context-sensitive menu, or using the following keyboard shortcuts...

- Select the line(s) to comment, then hit Ctrl-/ to comment out using // at the start of the line, or uncomment if the line is currently commented out.
- Select the line(s) to comment, then hit Ctrl-Shift-/ to block comment out (placing /* at the start and */ at the end).
- To remove a block comment, hit Ctrl-Shift-\\.

14.4.8 Format code

The editor can format your code to match the coding standards in use (**Window -> Preferences -> C/C++ -> Code Style**). This can automatically deal with layout elements such as indentation and where braces are placed. This can be carried out on the currently selected text using the Source->Format entry of the editor context-sensitive menu, or using the keyboard shortcuts Ctrl-Shift-F. If no text is selected, then the format will take place on the whole of the current file.

14.4.9 Correct Indentation

As you enter code in the editor, it will attempt to automatically indent your code appropriately, based on the code standards in use, and also the layout of the preceding text. However in some circumstances, for example after manually laying text out, you may end up with incorrect indentation.

This can usually be corrected using the Source->Correct Indentation entry of the editor context-sensitive menu, or using the keyboard shortcuts Ctrl-I.

Alternatively use the “Format code” option which will fix other layout issues in addition to indentation.

14.4.10 Insert spaces for tabs in editor

You can configure the IDE so that when editing a file, pressing the TAB key inserts spaces instead of tab characters. To do this go to

Window -> Preferences -> General -> Editors -> Text Editors

and tick the “Insert spaces for tabs” box. If you tick “Show white-space characters” you can see whether a tab character or space characters are being inserted when you press the TAB key

14.4.11 Replacing tabs with spaces

To replace existing tabs with spaces throughout the file, open the Code Style preferences:

Window -> Preferences -> C/C++ -> Code Style

- Select a Code Style profile and then select Edit...
- Choose the Indentation tab
- For the Tab policy, select Spaces only
- Apply the changes.
 - Note. If the Code Style has not been edited before, the Profile must be renamed before the change can be applied.
- The new style will be applied when the source is next formatted using Source -> Format

14.5 Hardware Floating Point Support

Most ARM-based systems – including those based on Cortex-M0, M0+ and M3, have historically not implemented any form of floating point in hardware. This means that any floating point

operations contained in your code will be converted into calls to library functions that then implement the required operations in software.

However many Cortex-M4 based MCUs do incorporate a single precision floating point hardware unit. Note that the optional Cortex-M4 floating point unit implements single precision operations (C/C++ float) only. Thus if your code makes use of double precision floating point (C/C++ double), then any such floating point operations contained in your code will still be converted into calls to library functions that then implement the required operations in software.

Similarly, Cortex-M7 based MCUs may incorporate a single precision or double precision floating point hardware unit.

14.5.1 Floating Point Variants

When a hardware floating point unit is implemented, ARM define that it may be used in one of two modes.

SoftABI

- Single precision floating point operations are implemented in hardware and hence provide a large performance increase over code that uses traditional floating point library calls, but when calls are made between functions any floating point parameters are passed in ARM (integer) registers or on the stack.
- SoftABI is the 'most compatible' as it allows code that is not built with hardware floating point usage enabled to be linked with code that is built using software floating point library calls.

HardABI

- Single precision floating point operations are implemented in hardware, and floating point registers are used when passing floating point parameters to functions.

HardABI will provide the highest absolute floating point performance, but is the 'least compatible' as it means that all of the code base for a project (including all library code) must be built for HardABI.

14.5.2 Floating point use – Preinstalled MCUs

When targeting preinstalled MCUs, MCUXpresso IDE generally assumes that when Cortex-M4 hardware floating point is being used, then the SoftABI will be used. Thus generally this is the mode that example code (including for example LPCOpen chip and board libraries) are compiled for. This is done as it ensures that components will tend to work out of the box with each other.

When you use a project wizard for a Cortex-M4 where a hardware floating point unit may be implemented, there will be an option to enable the use of the hardware within the wizard's options. This will default to SoftABI – for compatibility reasons.

Selecting this option will make the appropriate changes to the compiler, assembler and linker settings to cause SoftABI code to be generated. It will also typically enable code within the startup code generated by the wizard that will turn the floating point unit on.

You can also select the use of HardABI in the wizards. Again this will cause appropriate tool settings to be used. But if you use this, you must ensure that any library projects used by your application project are also configured to use HardABI. If such projects already exist, then you can manually modify the compiler/assembler/linker settings in Project Properties to select HardABI.

Warning : Creating a project that uses HardABI when linked library projects have not been configured and built with this option will result in link time errors.

14.5.3 Floating point use – SDK installed MCUs

When targeting SDK installed MCUs, MCUXpresso IDE generally assumes that when hardware floating point is available, then the HardABI will be used. This will generally work without problem as generally projects for such MCUs contain all required code (with no use of library projects).

However it is still possible to switch to using SoftABI using the “Advanced Properties settings” page of the |New project” and “Import SDK examples” wizards.

14.5.4 Modifying floating point configuration for an existing project

If you wish to change the floating point ABI for an existing project (for example to change it from using SoftABI to HardABI), then go to:

Quickstart -> Quick Settings -> Set Floating Point type

and choose the required option.

Alternatively you can configure the settings manually by going to:

Project -> Properties -> C/C++ Build -> Settings -> Tool Settings

and changing the setting in **ALL** of the following entries:

- MCU C Compiler -> Architecture -> Floating point
- MCU Assembler -> Architecture & Headers -> Floating point
- MCU Linker -> Architecture -> Floating point

Note: For C++ projects, you will also need to modify the setting for the MCU C++ Compiler.

Warning: Remember to change the setting for all associated projects, otherwise linker errors may result.

14.5.5 Do all Cortex-M4 MCUs provide floating point in hardware?

Not all Cortex-M4 based MCUs implement floating point in hardware, so please check the documentation provided for your specific MCU to confirm.

In particular with some MCU families, some specific MCUs may not provide hardware floating point, even though most of the members of the family do (for example the LPC407x_8x). Thus it is a good idea to double check the documentation, even if the project wizard in the MCUXpresso IDE for the family that you are targeting suggests that hardware floating point is available.

14.5.6 Why do I get a hard fault when my code executes a floating point operation?

If you are getting a hard fault when your application tries to execute a floating point operation, then you are almost certainly not enabling the floating point unit. This is normally done in the LPCOpen or SDK initialisation code, or else in the startup file that MCUXpresso IDE generates. But if there are configuration issues with your project, then you can run into problems.

For more information, please see the Cortex-M4 Technical Reference Manual, available on the ARM website.

14.6 LinkServer Scripts

LinkServer debug connections offer additional functionality through the use of scripts. There are two ‘flavours’ of Redlink scripts – Reset and Connect. Connect scripts are used when establishing

a connection to the target; Reset scripts are used when resetting a target (to start it running, for example).

LinkServer scripts are written in a simple version of the BASIC programming language. In this variant of BASIC, 26 variables are available (%a thru %z). On entry to the script some variable have assigned values:

```
%a is the PC
%b is the SP
%c is the XPSR
```

On exit from the script %a is loaded into the PC and %b is loaded into the SP, thus providing a way for the script to change the startup behavior of the application.

They offer functionality as shown below:

Generic BASIC like functions that only work inside scripts

```
GOTO 'LineNumber'
IF 'relation' THEN 'statement'
REPEAT : Start of a repeat block
UNTIL 'relation' : End with condition of repeat block
BREAKREPEATTO 'LineNumber' : Premature end of a repeat loop
GOSUB 'LineNumber'
RETURN
TIME : Returns a 10ms incrementing count from the host
```

Generic BASIC like functions

```
PEEK8{[THIS] | ['ProbeIndex' 'CoreIndex']} 'Address'
PEEK16{[THIS] | ['ProbeIndex' 'CoreIndex']} 'Address'
PEEK32{[THIS] | ['ProbeIndex' 'CoreIndex']} 'Address'
POKE8{[THIS] | ['ProbeIndex' 'CoreIndex']} 'Address' 'Data'
POKE16{[THIS] | ['ProbeIndex' 'CoreIndex']} 'Address' 'Data'
POKE32{[THIS] | ['ProbeIndex' 'CoreIndex']} 'Address' 'Data'
QPOKE32{[THIS] | ['ProbeIndex' 'CoreIndex']} 'Address' 'Data'
QSTARTTRANSFERS{[THIS] | ['ProbeIndex' 'CoreIndex']}
MEMSAVE{[THIS] | ['ProbeIndex' 'CoreIndex']} 'FileName' 'Byte StartAddress' 'Length in Bytes'
MEMLOAD{[THIS] | ['ProbeIndex' 'CoreIndex']} 'Byte StartAddress' 'LengthLimit in Bytes'
MEMDUMP{[THIS] | ['ProbeIndex' 'CoreIndex']} 'Byte StartAddress' 'Length in Bytes'
EXIT: Exit the server
LIST: Lists the script
NEW: Erases script from memory
RENUMBER: Renumbers in increments of 10
LOAD 'FILENAME': Loads a script from current directory
SAVE 'FILENAME': Saves a script to current directory
```

Probe related functions

```
PROBELIST : Creates and then returns an indexed list of the probes attached
PROBENUM : Returns the number of probes attached
PROBEOPENBYINDEX 'ProbeIndex' : Returns a unique probe handle
PROBECLOSE 'ProbeHandle'
PROBECLOSEBYINDEX 'ProbeIndex' : Returns an error code
PROBETIME 'ProbeIndex' : Returns time from firmware in the probe
```

```

PROBESTATUS : Returns an indexed summary of the status of the probes connected to the system
PROBEVERSION 'ProbeIndex': Returns version information about probe firmware
PROBEISOPEN 'ProbeIndex'
PROBEHASJTAG 'ProbeIndex'
PROBEHASSWD 'ProbeIndex'
PROBEHASSWV 'ProbeIndex'
PROBEHASETM 'ProbeIndex'
PROBEDIAGNOSTICS 'ProbeIndex' : Return counts of responses from probe

```

Core/TAP related functions

```

CORELIST 'ProbeIndex': Returns list of TAPs/Cores found connected to specified probe
CORECONFIG{[THIS] | ['ProbeIndex']}: Configures the scanchain
CORESCONFIGURED 'ProbeIndex'
COREREADID 'ProbeIndex' 'CoreIndex'

```

Wire related functions

```

WIRESWDCONNECT{[THIS] | ['ProbeIndex']}: Returns the DPID
WIREJTAGCONNECT{[THIS] | ['ProbeIndex']}:
WIRETIMEDRESET 'ProbeIndex' 'TimeIn_ms': pulls reset and returns the end state of the wire
WIREHOLDRESET 'ProbeIndex' 'State' : pulls reset and returns the end state of the wire
WIRESTATUS 'ProbeIndex' : Returns the status of the wire connection on the probe specified
WIRESPEED 'ProbeIndex' 'SpeedInHz': Requests a particular wire speed
WIREGETSPEED 'ProbeIndex' : Returns the current wire speed
WIRESETIDLECYCLES 'ProbeIndex' 'Cycles': Requests a specific number of idle cycles between debug transactions
WIREGETIDLECYCLES 'ProbeIndex' : Returns the current number of debug idle cycles WIREISCONNECTED 'ProbeIndex'
WIREGETPROTOCOL 'ProbeIndex'
SELECTPROBECORE 'ProbeIndex' 'CoreIndex' : sets up for use with following commands
THIS : displays the current Probe, Core pair

```

Cortex-M related functions

```

CMINITAPDP{[THIS] | ['ProbeIndex' 'CoreIndex']}: Initialize a CMx core ready for debug connections
CMWRITEDP{[THIS] | ['ProbeIndex' 'CoreIndex']} 'REG' 'DATA': returns zero on success
CMWRITEAP{[THIS] | ['ProbeIndex' 'CoreIndex']} 'REG' 'DATA': returns zero on success
CMREADDP{[THIS] | ['ProbeIndex' 'CoreIndex']} 'REG': returns data
CMREADAP{[THIS] | ['ProbeIndex' 'CoreIndex']} 'REG': returns data (note this deals with RDBUF on AP reads)
CMCLEARERRORS{[THIS] | ['ProbeIndex' 'CoreIndex']}
CMHALT{[THIS] | ['ProbeIndex' 'CoreIndex']}
CMRUN{[THIS] | ['ProbeIndex' 'CoreIndex']}
CMREGS{[THIS] | ['ProbeIndex' 'CoreIndex']}
CMWRITEREG{[THIS] | ['ProbeIndex' 'CoreIndex']} 'RegNumber' 'Value'
CMREADREG{[THIS] | ['ProbeIndex' 'CoreIndex']} 'RegNumber'
CMWATCHLIST{[THIS] | ['ProbeIndex' 'CoreIndex']}
CMWATCHSET{[THIS] | ['ProbeIndex' 'CoreIndex']} 'DWTIndex' 'Address' ['R|W|R|W']
CMWATCHCLEAR{[THIS] | ['ProbeIndex' 'CoreIndex']} 'DWTIndex'
CMBREAKLIST{[THIS] | ['ProbeIndex' 'CoreIndex']} : List the hardware breakpoints
CMBREAKSET{[THIS] | ['ProbeIndex' 'CoreIndex']} 'Address' : Set an FPB
CMBREAKCLEAR{[THIS] | ['ProbeIndex' 'CoreIndex']} ['Address'] : Clear an FPB
CMSYSRESETREQ{[THIS] | ['ProbeIndex' 'CoreIndex']} : System reset request

```

```

CMVCTRESETREQ{[THIS] | ['ProbeIndex' 'CoreIndex']} : Core reset request
CMRESETVECTORCATCHSET{[THIS] | ['ProbeIndex' 'CoreIndex']} : Enable reset vector catch
CMRESETVECTORCATCHCLEAR{[THIS] | ['ProbeIndex' 'CoreIndex']} : Disable reset vector catch

```

Scripts can be specified within a LinkServer launch configuration to be run before a connection and/or before a reset.

14.6.1 Debugging code from RAM

MCUs will have well defined boot strategies from reset, typically they will boot from code in internal flash.

On occasion it can be useful to run and debug code directly from RAM. Since an MCU will not boot from RAM a scheme is needed to take control of the debuggers reset mechanism. This can be achieved the use of a LinkServer reset script.

Within MCUXpresso IDE, certain precreated scripts are located at:

```
{install dir}/bin/Scripts
```

Contained in this directory is a script called *kinetisRamReset.scp* (see below).

```

10 REM Kinetis K64F Internal RAM (@ 0x20000000) reset script
20 REM Connect script is passed PC/SP from the vector table in the image by the debugger
30 REM For the simple use case we pass them back to the debugger with the location of the
45 REM reset context.
40 REM
50 REM Syntax here is that '~' commands a hex output, all integer variables are a% to z%
70 REM Find the probe index
80 p% = probefirstfound
90 REM Set the 'this' probe and core
100 selectprobecore p% 0
110 REM NOTE!! Vector table presumed RAM location is address 0x20000000
120 REM The script passes the SP (%b) and PC (%a) back to the debugger as the reset context.
130 b% = peek32 this 0x20000000
140 a% = peek32 this 0x20000004
150 print "Vector table SP/PC is the reset context."
160 print "PC = "; ~a%
170 print "SP = "; ~b%
180 print "XPSR = "; ~c%
190 end

```

This reset script makes an assumption that the user intends to run code from RAM at 0x20000000 – this is the value of the SRAM_Upper RAM block on Kinetis parts.

Note: To build a project to link against RAM, you can simply delete any flash entries within the projects memory configuration. If the MCUXpresso IDEs default linker settings are used then project will link to the first RAM block in the list. For many Kinetis parts, this address will match the expected address within the script. For some parts (for example KLxx) however, the first RAM block may take a different value. This problem can be resolved by editing the script or modifying the projects RAM addresses.

For users if LPC parts, the RAM addresses will be different but the principal remains the same. Within the *Scripts* directory, you will find an RAM reset script for the LPC18LPC43 parts, this script is identical to the one above apart from the assumed RAM address.

Finally, to use the script, simply edit the projects launch configuration for the 'Reset Script' entry, browse to the appropriate 'RAMReset.scp' script. For information about launch configurations please see the section "Launch Configuration Files::#launchconfig

Note: When executing code from RAM, the projects Vector table will also be located at the start of the RAM block. Cortex M MCUs can locate their vector table using an internal register called *VTOR* (the vector table offset register). Typically this register will be set automatically by a projects startup or init code. However, if execution fails when an interrupt occurs, check that this register is set the the correct value.

14.7 The Console View

The Console View contains a number of different consoles providing textual information about the operation of various parts of MCUXpresso IDE. It is located by default in the bottom right of the Debug Perspective, in parallel with a number of other views – including the “Installed SDKs” view.

The actual consoles available within the Console view will depend upon what operations are currently taking place – in particular a number of consoles will only become available once a debug session is started.

The currently displayed console will provide a local toolbar, with icons to do things like copying the contents of the console or clearing its contents.

To see the list of currently available consoles, and, if required, change to a different one..

1. Switch to the Console View
2. Using the toolbar within the Console View click on the drop-down arrow next to the **Display Selected Console** icon (which looks like a small monitor)
3. Select the require console from the drop down list

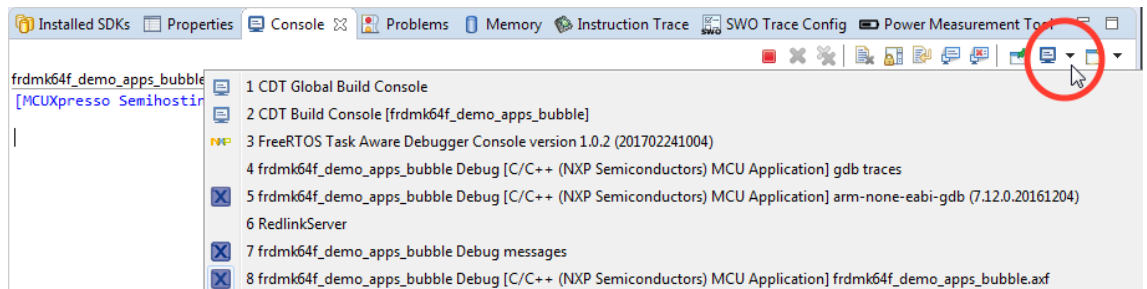

14.7.1 Console types

Consoles you will typically see include the following...

Build Console and Global Build Console

The Build Console (sometimes referred to as the *Build Log*) is used by the MCUXpresso IDE build tools (compiler, linker, etc) to display output generated when building your project. In fact MCUXpresso IDE has two build consoles – one of which records the output from building the current project, and the second a global build console which will record the output from building all projects.

By default, the number of lines stored in the Build Console is limited to 500 lines. You can increase this to any reasonable number as follows:

1. Select the **Windows->Preferences** menu option

2. Now choose **C/C++ -> Build -> Console**
3. Increase the "**Limit Console out (number of lines)**" to a larger number, for instance 5000.

Note: This setting, like most within the MCUXpresso IDE is saved as part of your workspace. Thus you will need to make this change each time you create a new workspace.

Other options that can be set in Preferences include whether the console is cleared before a build, whether it should be opened when a build starts, and whether to bring the console to the top when building.

Once your build has completed, then if you have any build errors displayed in the console, clicking on them will, by default, cause the appropriate source file to be opened at the appropriate place for you to fix the error.

FreeRTOS Task Aware Debugger Console

This console displays status about the FreeRTOS TAD views. For more details, please see the *MCUXpresso IDE FreeRTOS Debug Guide*.

gdb traces and arm-none-eabi-gdb Consoles

These consoles give access to the GDB command line debugger, that sits underneath the MCUXpresso IDE's graphical debugging front end.

RedlinkServer Console

This console gives access to the server application that sits at the bottom of the debug stack when using a debug probe connected via the MCUXpresso IDE's native "LinkServer" debugging mechanism.

Debug messages Console

The Debug Messages Console (sometimes referred to as the *Debug Log*) is used by the debug driver to display additional information that may be helpful in understanding connection issues when debugging your target MCU.

Semihosting Console

This console, generally displayed with *.axf*, allows semihosted output from the application running on the MCU target to be displayed, and potentially for input to be sent down to the target.

14.7.2 Copying the contents of a console

Occasionally, you may wish to copy out the contents of a console. For instance, the MCUXpresso IDE support team may ask you to provide the details of your Build Console in a forum thread. To do this:

1. Clean, then build your project.
2. Select the appropriate Build Console as above:
3. Select the contents (e.g. Ctrl-A)
4. Copy to the clipboard (e.g. Ctrl-C).
5. Paste from clipboard into forum thread (e.g. Ctrl-V). If there is a large amount of text in the build console, it is advisable to paste it into a text file, which can be ZIPed if appropriate.

Note that some console will provide a button in their local toolbar to copy or save out their contents.

14.7.3 Relocating and duplicating the Console view

By default the Console View is positioned in parallel with a number of other views. This can mean, if a console is being regularly updated with new output (for instance the view displaying semihosted output from the application running on the target MCU), then by default this may cause the console to keep jumping to the foreground – hence hiding other views that you are using (for instance one of the SWO Trace views)

To avoid this you may wish to relocate the Console. To do this ...

1. Click and hold down on the Console View
2. Continue to hold down, and drag the cursor to the location you want Console view to be displayed
3. Then release the mouse click, and the Console view will be placed at the required position

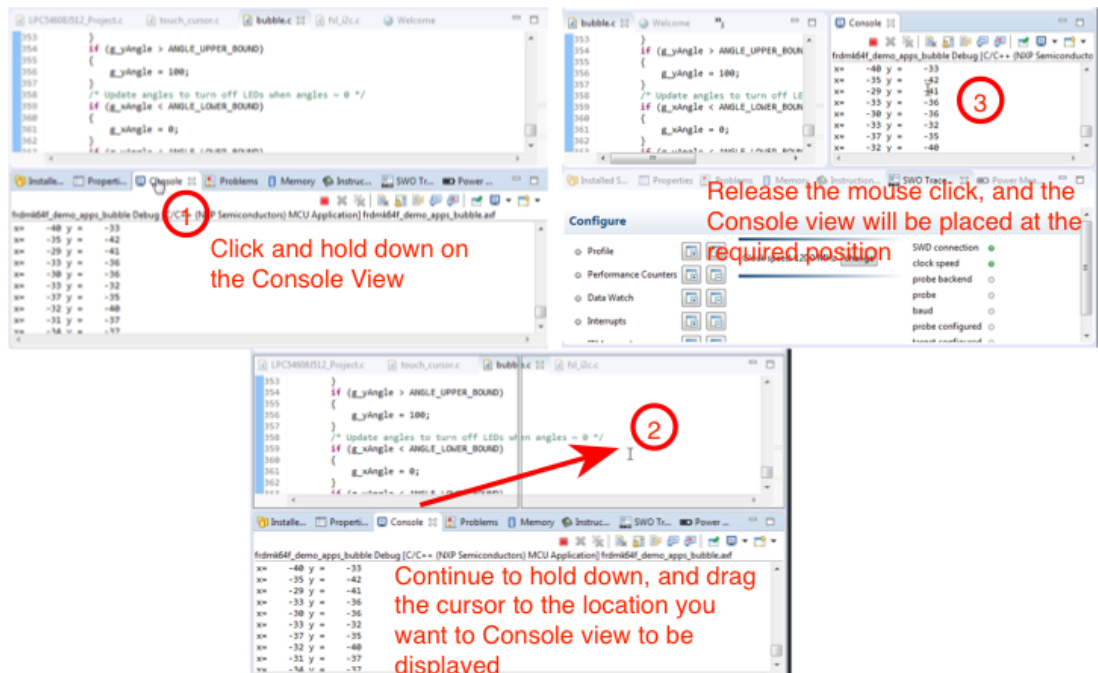

Another alternative is to spawn a duplicate instance of the Console view. This allows multiple consoles to be visible at the same time. To do this use the Open Console button on the Console view local toolbar

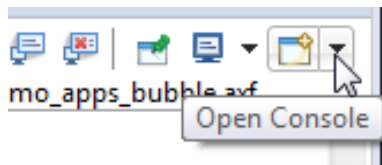

and then select "New Console View"

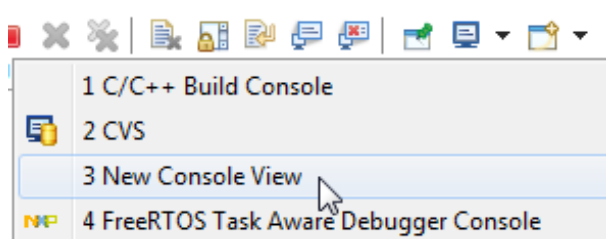

This will then display a second console view, which can be drag'n'dropped to a new location within in the Perspective, as shown for the single Console view case described above.

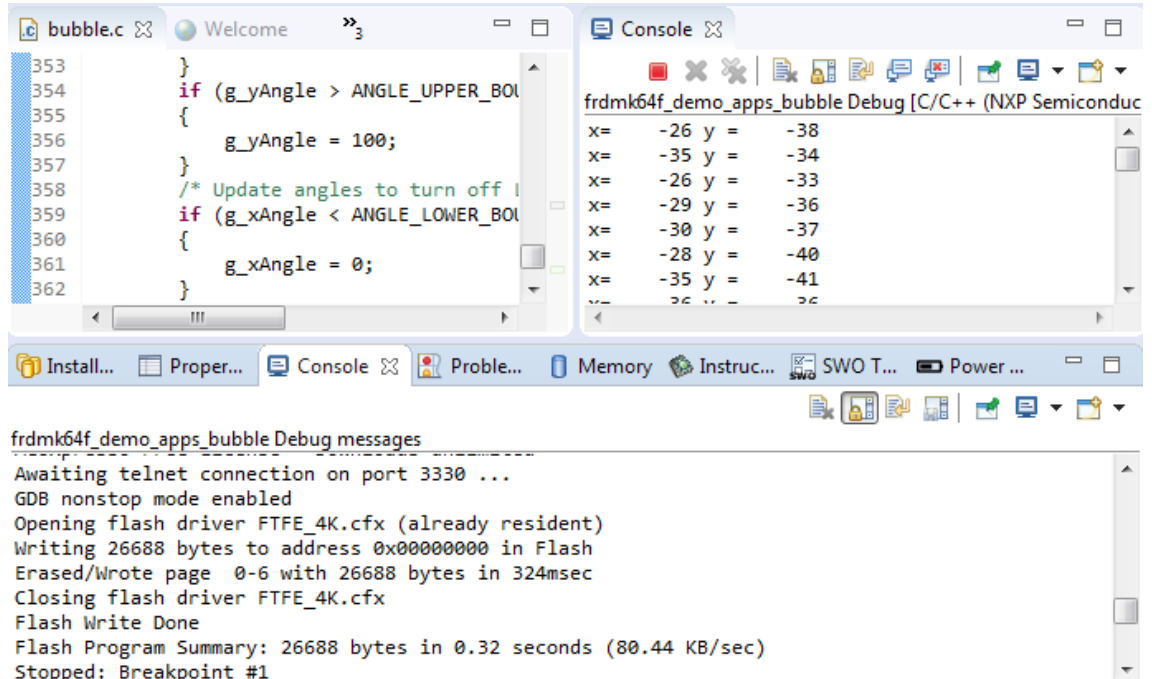

Having opened a second console view, select which console you want displayed in it, and then use the “Pin Console” button to ensure that it does not switch to one of the other consoles when output is displayed.

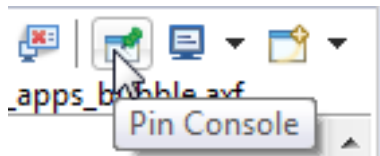

14.8 Using and troubleshooting LPC-Link2

14.8.1 LPC-Link2 hardware

LPC-Link2 is a powerful, low cost debug probe design from NXP Semiconductors based on the LPC43xx MCU. It has been implemented into a number of different systems, including:

- The standalone LPC-Link2 debug probe
- The debug probe built into the range of LPCXpresso V2/V3 boards.

For more details, see <http://www.nxp.com/lpcxpresso-boards>

14.8.2 Softloaded vs Pre-programmed probe firmware

One thing that most LPC-Link2 implementation offer is the ability to either softload the debug probe firmware (using USB DFU functionality) or to have the debug probe firmware pre-programmed into flash.

Programming the firmware into flash has some advantages, including:

- Allows the use of the LPC-Link2 with toolchains that, unlike MCUXpresso IDE, do not support softloading of the probe firmware.

- Better supports the use of LPC-Link2 as a small production run programmer
- Allows the LPC-Link2 to be used with SEGGER J-Link firmware as an alternative to the normal CMSIS-DAP firmware. Note that J-Link firmware does have some restrictions in its use, and is only currently compatible with LPC MCUs (and not Kinetis MCUs). For more details please visit <http://www.segger.com>
- Avoids issues that the reenumeration of the LPC-Link2 can sometimes trigger as the firmware softloads (particularly where virtual machines are in use).

The recommended way to program the firmware into the flash of LPC-Link2 is NXP's LPCScript flash programming tool. For more details, see <http://www.nxp.com/lpcscript>

However when used with MCUXpresso IDE, softloading the probe firmware is the recommended method of using LPC-Link2 in most circumstances.

This ensures that the firmware version matching the MCUXpresso IDE version can automatically be loaded when the first debug session is started (so normally the latest version). It also allows different probe firmware variants to be softloaded, depending on current user requirements.

For this to work, you need to make sure that the probe hardware is configured to allow DFU booting. To do this:

- For standalone LPC-Link2: remove the link from header JP1 (nearest USB)
- For LPCXpresso V2/V3: add a link to the header "DFU link"

14.8.3 LPC-Link2 firmware variants

As well as providing debug probe functionality, NXP's CMSIS-DAP firmware for LPC-Link2 by default also includes bridge channels to provide:

- Support for SWO Trace capture from the MCUXpresso IDE
- Support for Power Measurement from the MCUXpresso IDE (certain LPCXpresso V3 boards only)
- Support for a UART VCOM port connected to the target processor (LPCXpresso V2/V3 boards only)
- Support for a LPCSIO bridge that provides communication to I2C and SPI slave devices (LPCXpresso V3 boards only)

However two other variants of the CMSIS-DAP firmware are provided that remove some of these bridge channels.

- **"Non Bridged"**: This version of firmware provides debug features only – removing the bridged channels such as trace, power measurement and VCOM. By removing the requirement for these channels, USB bandwidth is reduced, therefore this firmware may be preferable if multiple debug probes are to be used concurrently. The non-bridged build will also provide an increase in download and general debug performance.
- **"VCOM Only"**: This version of firmware provides only debug and VCOM features. The removal of the other bridges allows better VCOM performance (though generally the bridged firmware provides more than good enough VCOM performance).

A particular workspace can be switched to softload a different firmware variant via **Preferences – MCUXpresso IDE – LinkServer Options – LPC-Link2 boot type**.

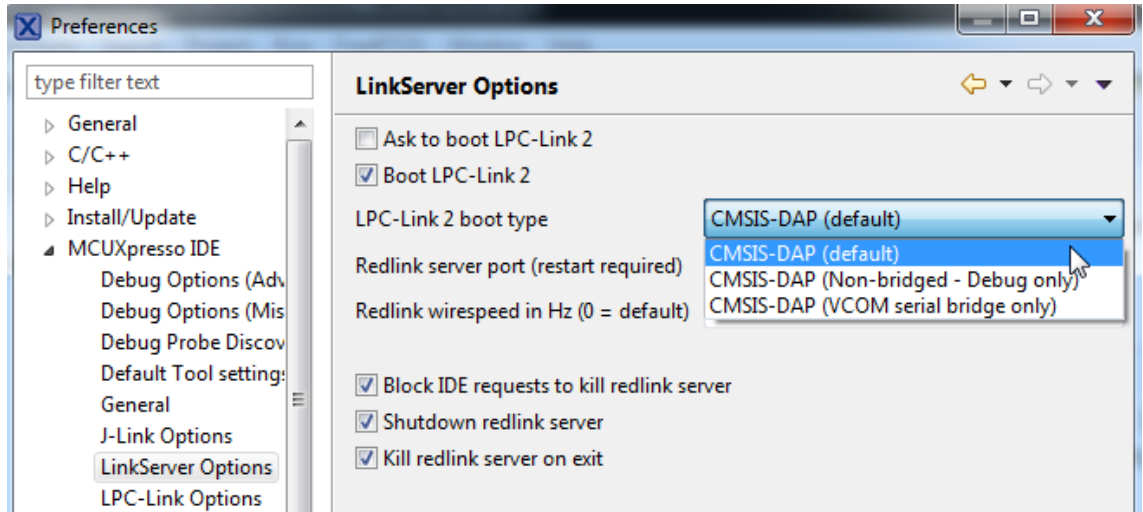

Note: If a mix of bridged and unbridged debug probes is required, then it is recommended that these probes are pre-programmed with the required debug firmware. This can easily be done via LPCScript.

14.8.4 Manually booting LPC-Link2

The recommended way to use LPC-Link2 with the MCUXpresso IDE is to allow the GUI to boot and softload a debug firmware image at the start of a debug session.

Normally, LPC-Link2 is booted automatically (when configured to operate in DFU mode), however under certain circumstances – such as when troubleshooting issues, or using the LinkServer command line flash utility, you may need to boot it manually.

LPC-Link2 USB Details

The standard utilities to explore USB devices on MCUXpresso IDE supported host platforms are:

- Windows – Device Manager
 - MCUXpressoIDE also provides a listusb utility in:
 - `{install_dir}\ide\bin\Scripts`
- Linux – terminal command: `lsusb`
- Mac OS X – terminal command: `system_profiler SPUSBDataType`

Before boot, LPC-Link2 appears as a USB device with details:

```
Device VendorID/ProductID: 0x1FC9/0x000C (NXP Semiconductors)
```

and will appear in Windows -> Devices and Printers, as below:



After boot, LPC-Link2 will by default appear as a USB device with details:

```
Device VendorID/ProductID: 0x1FC9/0x0090
```

and will appear in Windows -> Devices and Printers similar to below:

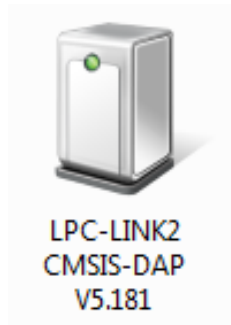

Note: Text details will vary depending on version number and which probe firmware variant is booted.

Booting from the command line

MCUXpresso IDE provides a boot script for all supported platforms. To make use of this script first of all connect the LPC-Link2 to your PC then enter the commands into a DOS command prompt (or equivalent):

```
cd {install_dir}\ide\bin
boot_link2
```

This will invoke the dfu-util utility to download the probe firmware into the RAM of the LPC-Link2's LPC43xx MCU and then reenumerate the probe.

Booting from the GUI

It is also possible to manually boot LPC-Link2 from the MCUXpresso IDE GUI, which may be a more convenient solution than using the command line. To do this, first of all connect the LPC-Link2 to your PC, then locate the red Boot icon on the Toolbar:

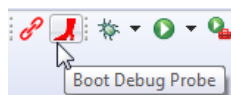

and then click OK in the dialog displayed :

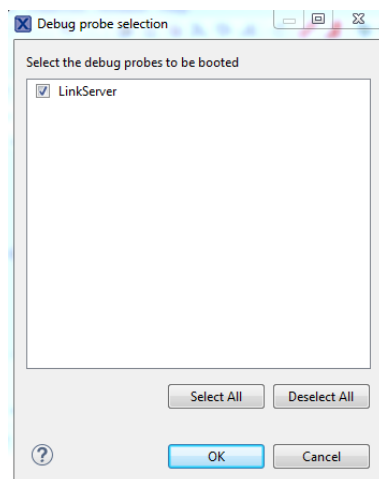

14.8.5 LPC-Link2 windows drivers

The drivers for LPC-Link2 are installed as part of the main MCUXpresso IDE installation process.

- **Note:*** One thing to be aware of is that the first time you debug using a particular LPC-Link2 on a particular PC, the drivers will need to be loaded. This first time can take a variable period of time depending upon your PC and operating system version. This may mean that the first debug attempt fails, as the IDE may time out waiting for the booted LPC-Link2 to appear. In such as case, a second debug attempt should complete successfully. Otherwise, try booting the LPC-Link2 manually and checking the drivers load correctly.

If you need to reinstall the drivers, then the installer can be found at:

```
C:\npx\{install_dir}\Drivers\lpc_driver_installer.exe
```

14.8.6 LPC-Link2 failing to enumerate

On some systems, after booting LPC-Link2 with CMSIS-DAP firmware, the booted debug probe does not enumerate correctly and the MCUXpresso IDE (or other toolchain) is unable to see the debug probe. This problem is normally caused by an old, obsolete, version of the VCOM driver being found by Windows instead of the the correct driver. To see if this is the cause of a problem on your computer, find the version number of the LPC-Link2 VCOM driver. The obsolete driver version is 1.0.0.0.

To find the version number of the LPC-Link2 VCOM driver

If you are using a soft-booted LPC-Link2 debug probe, start by booting your LPC-Link2, as described in Manually booting LPC-Link2 [131]. If your LPC-Link2 debug probe is booting from an image preprogrammed into the flash, you can skip this step.

Once your LPC-Link2 has booted, find the device in Device Manager and look at the driver version number.

- Open the Windows Device Manager
- Expand the “Ports (COM and LPT)” section
- Right-click on “LPC-LinkII UCom Port”, and select Properties
- Click on the Driver tab of the Properties dialog

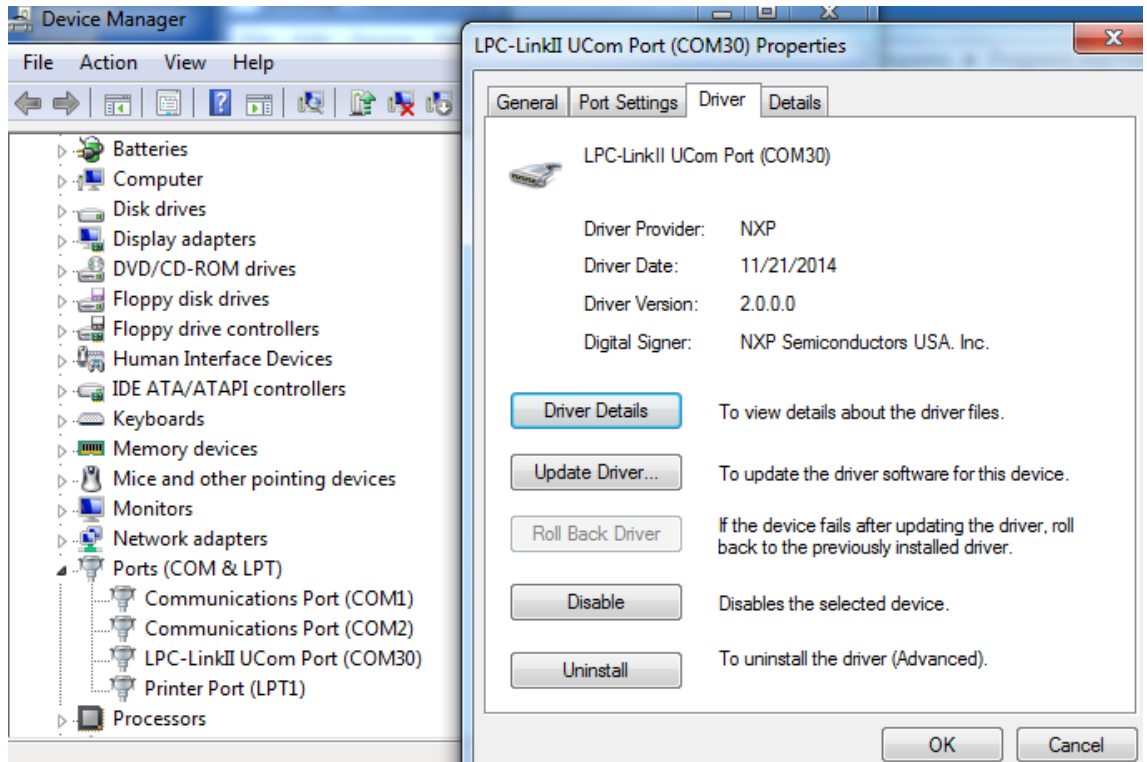

Note that this image shows the current correct version of the driver (2.0.0.0).

Removing the obsolete 1.0.0.0 LPC-LinkII UCOM driver

To remove the obsolete driver, perform the following actions:

1. In Device Manager, right-click on the LPC-LinkII UCOM device and select Uninstall
2. If there is an option to delete the driver software, make sure it is checked, and press OK
3. Select the menu item Action->Scan for hardware changes
4. In Windows Control Panel, select Add/Remove program or Uninstall a program option
5. Find the LPC Driver Installer, right-click on choose Uninstall
6. Let the uninstaller complete
7. Switch back to the Device Manager and Scan for hardware changes again
8. If the LPC-LinkII UCOM driver version is still present, Uninstall it again (steps 1 through 3) and repeat until the LPC-LinkII UCOM driver no longer appears
9. Now run the lpc_driver_installer.exe found in the MCUXpresso IDE “Drivers” directory

Note: A reboot is recommended after running the lpc_driver_installer.exe installer.

Now manually reboot the probe again (if softloading) and check **Windows – Devices and Printers** to see if the device now appears correctly as an LPC-Link2 CMSIS-DAP Vx.xxx.

If this fails to correct the problem, there is one final thing to try:

- Open a Command Prompt as the Administrative user and run the following commands

```
cd %temp%
pnputil -e >devices.txt
notepad devices.txt
```

- Search devices.txt for an entry similar to this, and note down the Published name (oemXX.inf)

```
Published name :          oem38.inf
Driver package provider : NXP
Class :                 Ports (COM & LPT)
Driver date and version : 09/12/2013 1.0.0.0
Signer name :           NXP Semiconductors USA. Inc.
```

- Using the name notes above, run the following command (replacing XX with the number found above)

```
pnputil -f -d oemXX.inf
```

14.8.7 Troubleshooting LPC-Link2

If you have been able to use LPC-Link2 in a debug session but now see issues such as “No compatible emulator available” or “Priority 0 connection to this core already taken” when trying to perform a debug operation ...

- Ensure you have shut down any previous debug session
 - You must close a debug session (press the Red ‘terminate’ button) before starting another debug session
- It is possible that the debug driver is still running in the background. Use the task manager or equivalent to kill any tasks called:
 - redlinkserv
 - arm-none-eabi_gdb*
 - crt_emu_*

If your host has never worked with LPC-Link2, then the following may help to identify the problem:

- Try manually booting your LPC-Link2 (as per [Manually booting LPC-Link2](#), and ensure that the drivers have installed correctly.
- Try a different USB cable!
- Try a different USB port. If your host has USB3 and USB2, then try a USB2 port
 - there are know issues with motherboard USB3 firmware, ensure your host is using the latest driver from the manufacturer. Note, this is not referencing the host OS driver but the motherboard firmware of the USB port
- If using a USB hub, first try a direct connection to the host computer
- If using a USB hub, try using one with a separate power supply – rather than relying on the supply over USB from your PC.
- Try completely removing and re-installing the host device driver. See also [LPC-Link2 fails to enumerate \[133\]](#) above.
- If using Windows 8.1 or later, then sometimes the Windows USB power settings can cause problems. For more details use your favourite search engine to search for “windows 8 usb power settings” or similar.

14.9 Make fails with Virtual Alloc pointer is null error

Very rarely, building a project on Windows may result in an error similar to this:

```
0 [main] us 0 init_cheap: VirtualAlloc pointer is null, Win32 error 487
AllocationBase 0x0, BaseAddress 0x71110000, RegionSize 0x350000, State 0x10000
\msys\bin\make.exe: *** Couldn't reserve space for cygwin's heap, Win32 error 0
```

This is a problem that affects a tiny minority of customers, and depends on what other applications they are running at the same time. This is caused by a feature in the MSYS binaries that we use to provide the the build environment for the MCUXpresso IDE on Windows.

If this happens, you can replace the file `ide\msys\bin\msys-1.0.dll` within your MCUXpresso IDE install directory with the `msys-1.0-alternate.dll` file in the same directory (i.e. do a rename)

Note that this does not fix the problem, rather it moves DLL base address. Unfortunately, it is possible the error may occur with this replacement DLL too, again depending on what other applications are running. In which case you will need to revert to the original DLL again.

14.10 Creating bin and hex files

When building a project, the MCUXpresso IDE tools create an ARM executable format (AXF) file – which is actually standard ELF/DWARF file. This file can be programmed directly down to your target using the MCUXpresso IDE debug functionality, but it may also be converted into a variety of formats suitable for use in other external tools.

14.10.1 Simple conversion within the IDE

The simplest way to create a one-off binary or hex file is to open up the Debug (or Release) folder in Project Explorer right click on the .axf file, and "Binary Utilities->Create binary" (or Create hex).

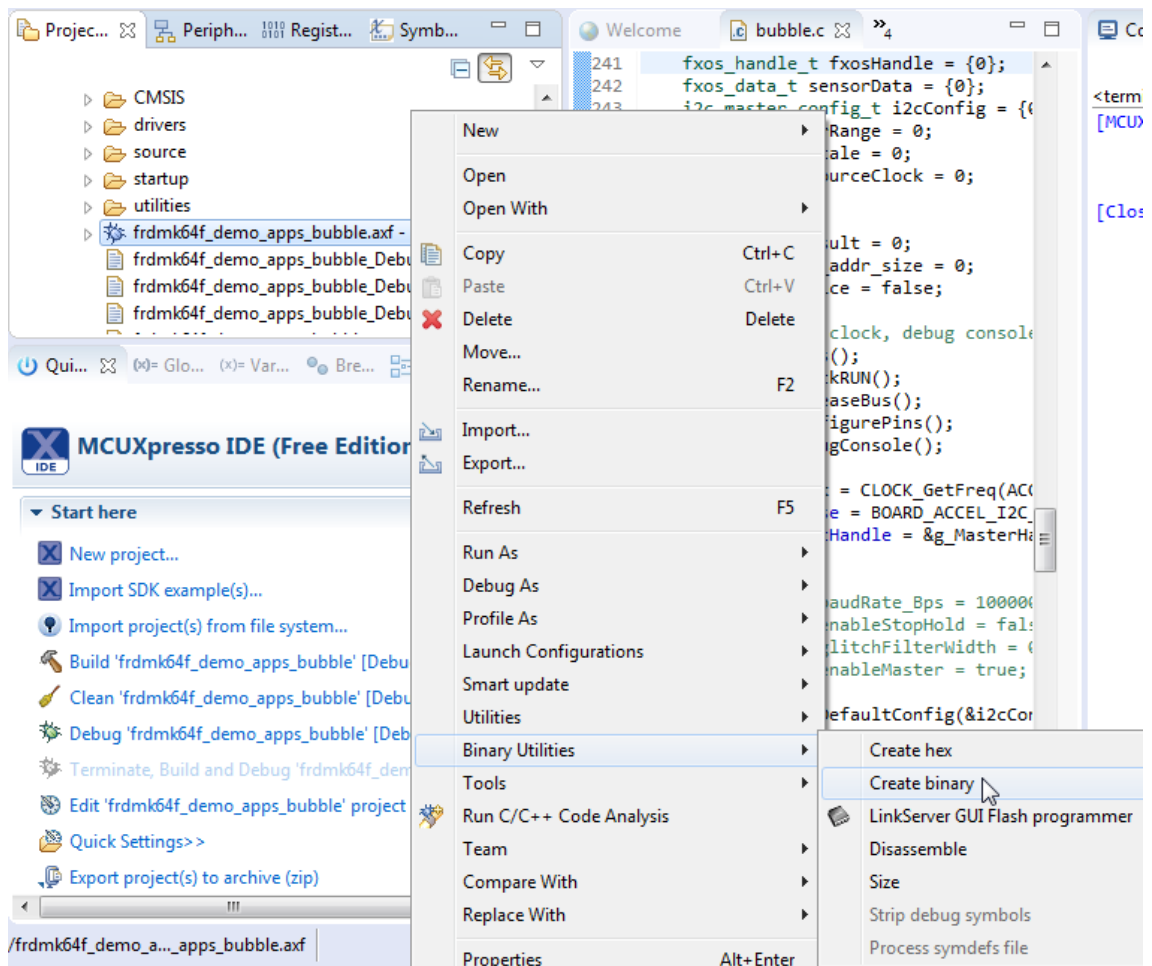

You can also change the options used to create a binary or hex file in this way on the "Windows->Preferences->MCUXpresso IDE ->Utilites" preference page.

14.10.2 From the command line

The above "Binary Utilities" option within the IDE GUI is simply invoking the command line objcopy tool (arm-none-eabi-objcopy). Objcopy can convert into the following formats:

- srec (Motorola S record format)
- binary
- ihex (Intel hex)
- tekhex

For example, to convert example.axf into binary format, use the following command:

```
arm-none-eabi-objcopy -O binary example.axf example.bin
```

If you ctrl-click on the project name on the right hand side of the bottom bar of the IDE, this will launch a command prompt in the project directory with appropriate tool paths set up. You can also use the Project Explorer right-click “Utilities->Open command prompt here” option to do this.

All you need to do before running the objcopy command is change into the directory of the required Build configuration.

14.10.3 Automatically converting the file during a build

Objcopy may be used to automatically convert an axf file during a build. To do this, create an appropriate Post-build step

14.10.4 Binary files and checksums

When creating a binary file for most LPC MCUs, you also need to ensure that you apply a checksum to it – so that the LPC bootloader sees the image as being valid. Generally the linker script will do this if the managed linker script mechanism is used. Otherwise the “checksum” utility found in the \ide\bin subdirectory of your MCUXpresso IDE installation can be used.

14.11 Post-build (and Pre-build) steps

It is sometimes useful to be able to automatically post-process your linked application, typically to run one or more of the GNU ‘binutils’ on the generated AXF file.

For example, any application project that you create using the Project wizard will have least one such “post-build step” - typically to display the size of your application.

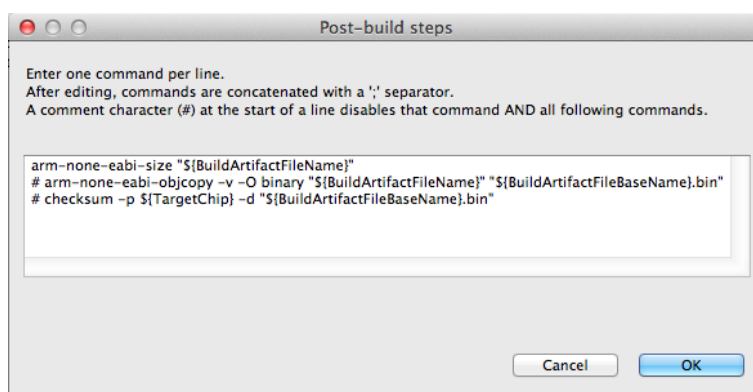

Note: Additional commands may also be listed (for example to create a binary and to run a checksum command), but be commented out by use of a # character and hence not executed. Any commands following a comment #command will be ignored.

Adding addition steps is very simple. In the below example we are going to carry out three post-link steps:

- displaying the size of the application

- generate an interleaved C / assembler listing
- create a hex version of the application image

To do this:

- Open the Project properties. There are a number of ways of doing this. For example, make sure the Project is highlighted in the Project Explorer view then open the menu “Project -> Properties”.
- In the left-hand list of the Properties window, open “C/C++ Build” and select “Settings”.
- Select the “Build steps” tab
- In the “Post-build steps - Command” field, click 'Edit...'
 - Paste in the lines below and click 'OK'

```
arm-none-eabi-size ${BuildArtifactFileName};  
arm-none-eabi-objdump -S ${BuildArtifactFileName} > ${BuildArtifactFileName}.lss;  
arm-none-eabi-objcopy -O ihex ${BuildArtifactFileName} ${BuildArtifactFileName}.hex;
```

- Click apply
- Repeat for your other Build Configurations (Debug/Release)

Next time you do a build, this set of post-build steps will now run, displaying the application size in the console, creating you an interleaved C/assembler listing file called *.lss* and a hex file called *hex*.

Note: Pre-build steps can be added to a project in exactly the same way if required.

Temporarily removing post-build steps

If you want to temporarily remove a step from your post-build process, rather than deleting it completely – move that entry to the end of the line and pre-fix it with a “#” (hash) character. This acts as a comment, causing the rest of the post-build steps to be ignored.