

DWG NAME : <DWG NAME>	COMPANY NAME : Bit Mapper Integration Technologies Pvt.Ltd.	
DATE : Tuesday, August 23, 2011	TITLE : MB OLED R1	
DESIGNED : SAYALI	PCB NO. B-SA-1113-R1-B01	
CHECKED : <CHECKED>	SIZE : 128mm X 99mm	REV : 000
DRAWN : JIGAR	CUSTOMER : BEL MACHILIPATNAM	SHEET : 1 of 6

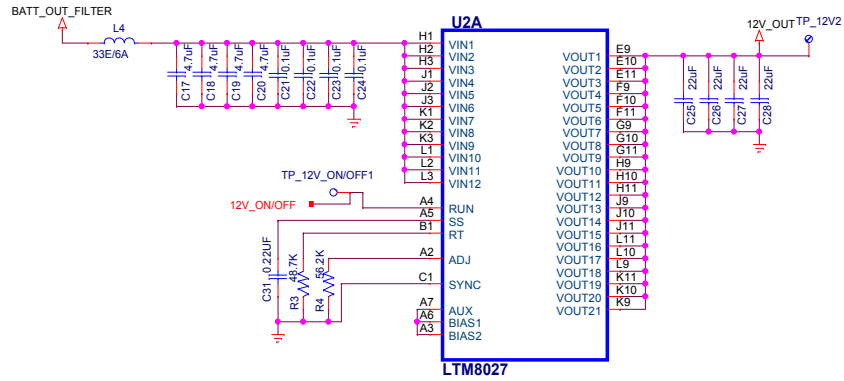

LTM8027

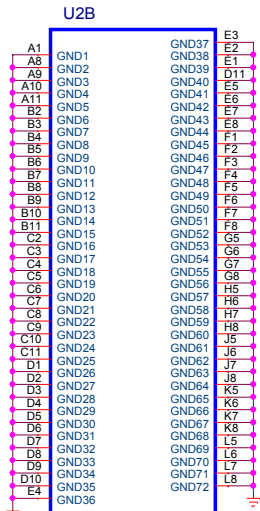

LTM8027

Manufacturer's Part No. = LTM8027IV#PBF

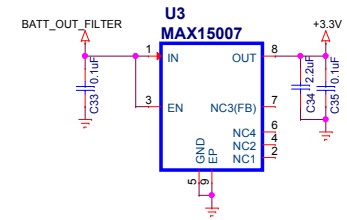
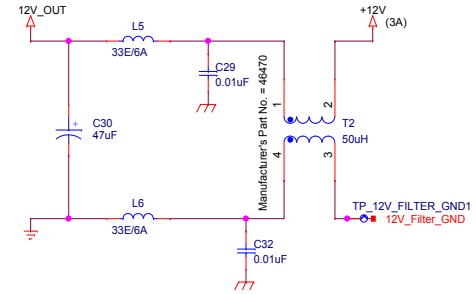

Manufacturer's Part No. = MAX15007AASA+

DWG NAME : <DWG NAME>	COMPANY NAME : Bit Mapper Integration Technologies Pvt.Ltd.	
DATE : Tuesday, August 23, 2011	TITLE : MB OLED R1	
DESIGNED : SAYALI	PCB NO. B-SA-1113-R1-B01	
CHECKED : <CHECKED>	SIZE : 128mm X 99mm	REV : 000
DRAWN : JGAR	CUSTOMER : BEL MACHILIPATNA	SHEET : 2 of 6

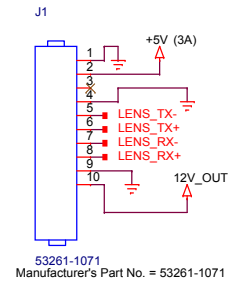
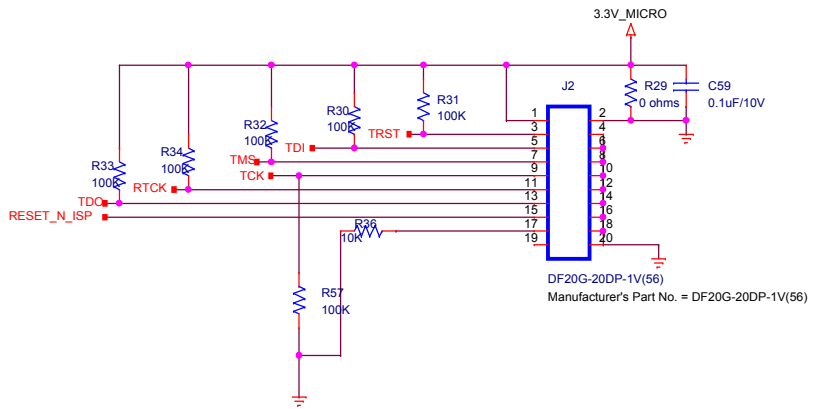

INPUT CONNECTOR

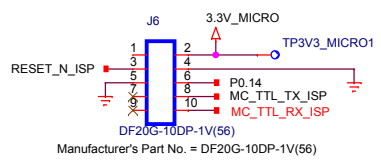
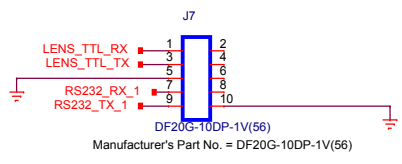
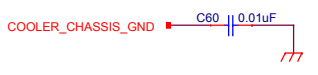
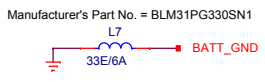
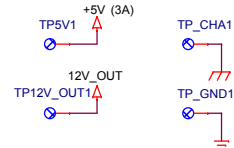
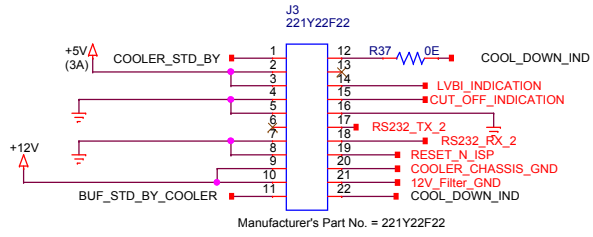
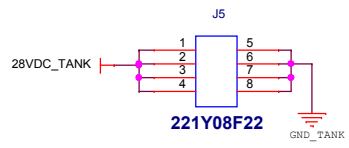

DWG NAME : <DWG NAME>	COMPANY NAME : Bit Mapper Integration Technologies Pvt.Ltd.	
DATE : Wednesday, August 24, 2016	TITLE : MB OLED R1	
DESIGNED : SAYALI	PCB NO. B-SA-1113-R1-B01	
CHECKED : <CHECKED>	SIZE : 128mm X 99mm	REV. : 000
DRAWN : JIGAR	CUSTOMER : BEL MACHILIPATNAM	SHEET : 4 of 6

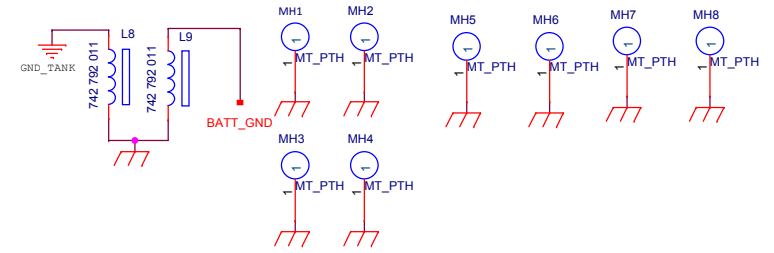

FILTER CIRCUIT

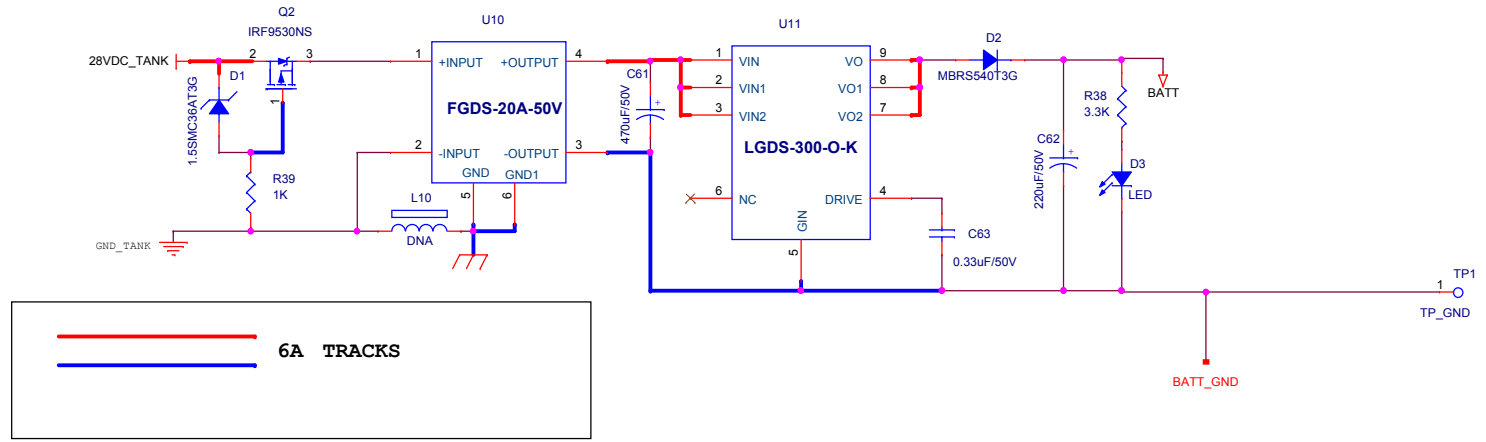

DWG NAME : <DWG NAME>	COMPANY NAME : Bit Mapper Integration Technologies Pvt.Ltd.	
DATE : Saturday, August 20, 2022	TITLE : MB OLED R1	
DESIGNED : SAYALI	PCB NO. B-SA-1113-R1-B01	
CHECKED : <CHECKED>	SIZE : 128mm X 99mm	REV. : 000
DRAWN : JIGAR	CUSTOMER : BEL MACHILIPATNAM	SHEET : 5 of 6