i.MX 6ULL Applications Processor Reference Manual

Document Number: IMX6ULLRM
Rev. 1, 11/2017





Contents

Section number	Title	Page
----------------	-------	------

Chapter 1 Introduction

1.1	About This Document.....	159
1.1.1	Audience.....	159
1.1.2	Organization.....	159
1.1.3	Suggested Reading.....	160
1.1.3.1	General Information.....	160
1.1.3.2	Related Documentation.....	160
1.1.4	Conventions.....	160
1.1.5	Register Access.....	162
1.1.5.1	Register Diagram Field Access Type Legend.....	162
1.1.5.2	Register Macro Usage.....	163
1.1.6	Signal Conventions.....	164
1.1.7	Acronyms and Abbreviations.....	164
1.2	Introduction.....	167
1.3	Target Applications.....	167
1.4	Features.....	167
1.5	Architectural Overview.....	171
1.5.1	Simplified Block Diagram.....	171
1.5.2	Architectural Partitioning.....	172
1.5.3	Endianness Support.....	174
1.5.4	Memory Interfaces.....	174

Chapter 2 Memory Maps

2.1	Memory system overview.....	175
2.2	ARM Platform Memory Map.....	175
2.3	DMA memory map.....	181

Chapter 3

Section number	Title	Page
Interrupts and DMA Events		
3.1	Overview.....	183
3.2	Cortex A7 interrupts.....	183
3.3	SDMA event mapping.....	188
Chapter 4 External Signals and Pin Multiplexing		
4.1	Overview.....	191
4.1.1	Muxing Options.....	191
Chapter 5 Fusemap		
5.1	Boot Fusemap.....	215
5.2	Lock Fusemap.....	226
5.3	Fusemap Descriptions Table.....	227
Chapter 6 External Memory Controllers		
6.1	Overview.....	235
6.2	Multi-mode DDR controller (MMDC) overview and feature summary.....	235
6.3	EIM-PSRAM/NOR flash controller overview.....	236
6.3.1	EIM features.....	236
6.3.2	EIM boot scenarios.....	237
6.3.3	EIM boot configuration.....	237
6.3.4	OneNAND requirements.....	238
Chapter 7 System Debug		
7.1	Overview.....	239
7.2	Chip and ARM Platform Debug Architecture.....	239
7.2.1	Debug Features.....	240
7.2.2	Debug system components.....	240
7.2.2.1	AMBA Trace Bus (ATB).....	241
7.2.2.2	ATB replicator.....	241

Section number	Title	Page
7.2.2.3	Embedded Cross Triggering.....	241
7.2.2.3.1	Cross-Trigger Matrix (CTM).....	242
7.2.2.3.2	Cross-Trigger Interface (CTI).....	243
7.2.2.4	Debug Access Port (DAP).....	243
7.2.3	Chip-Specific SJC Features.....	244
7.2.3.1	JTAG Disable Mode.....	244
7.2.3.2	JTAG ID.....	244
7.2.4	System JTAG Controller - SJC.....	244
7.2.5	System JTAG controller main features.....	245
7.2.6	SJC TAP Port.....	245
7.2.7	SJC main blocks.....	245
7.3	Smart DMA (SDMA) core.....	246
7.3.1	SDMA On Chip Emulation Module (OnCE) Feature Summary.....	246
7.3.1.1	Other SDMA Debug Functionality.....	247
7.3.1.2	SDMA ROM Patching.....	248
7.4	Miscellaneous.....	248
7.4.1	Clock/Reset/Power.....	248
7.5	Supported tools.....	248

Chapter 8 System Boot

8.1	Overview.....	249
8.2	Boot modes.....	250
8.2.1	Boot mode pin settings.....	251
8.2.2	High-level boot sequence.....	251
8.2.3	Boot From Fuses mode (BOOT_MODE[1:0] = 00b).....	252
8.2.4	Serial Downloader.....	253
8.2.5	Internal Boot mode (BOOT_MODE[1:0] = 0b10).....	255
8.2.6	Boot security settings.....	255
8.3	Device configuration.....	256

Section number	Title	Page
8.3.1	Boot eFUSE descriptions.....	256
8.3.2	GPIO boot overrides.....	258
8.3.3	Device Configuration Data (DCD).....	259
8.4	Device initialization.....	259
8.4.1	Internal ROM/RAM memory map.....	260
8.4.2	Boot block activation	260
8.4.3	Clocks at boot time.....	261
8.4.4	Enabling MMU and caches.....	263
8.4.5	Exception handling.....	264
8.4.6	Interrupt handling during boot.....	264
8.4.7	Persistent bits.....	264
8.5	Boot devices (internal boot).....	265
8.5.1	NOR flash/OneNAND using EIM interface.....	266
8.5.1.1	NOR flash boot operation.....	266
8.5.1.2	OneNAND flash boot operation.....	267
8.5.1.3	IOMUX configuration for EIM devices.....	268
8.5.2	NAND flash.....	269
8.5.2.1	NAND eFUSE configuration.....	269
8.5.2.2	NAND flash boot flow and Boot Control Blocks (BCB).....	271
8.5.2.3	Firmware configuration block.....	275
8.5.2.4	Discovered Bad Block Table (DBBT).....	278
8.5.2.5	Bad block handling in ROM.....	278
8.5.2.6	Read-retry handling in the ROM.....	279
8.5.2.7	Toggle mode DDR NAND boot.....	281
8.5.2.7.1	GPMI and BCH clocks configuration.....	281
8.5.2.7.2	Setup DMA for DDR transfers.....	282
8.5.2.7.3	Reconfigure timing and speed using values in FCB.....	282
8.5.2.8	Typical NAND page organization.....	283
8.5.2.8.1	BCH ECC page organization.....	283

Section number	Title	Page
	8.5.2.8.2 Metadata.....	284
	8.5.2.9 IOMUX configuration for NAND.....	284
8.5.3	Expansion device.....	285
	8.5.3.1 Expansion device eFUSE configuration.....	285
	8.5.3.2 MMC and eMMC boot.....	288
	8.5.3.3 SD, eSD, and SDXC.....	297
	8.5.3.4 IOMUX configuration for SD/MMC.....	297
	8.5.3.5 Redundant boot support for expansion device.....	298
8.5.4	Serial ROM through SPI.....	300
	8.5.4.1 Serial ROM eFUSE configuration.....	300
	8.5.4.2 ECSPi boot.....	301
	8.5.4.2.1 ECSPi IOMUX pin configuration.....	302
8.6	QuadSPI serial flash memory boot.....	303
	8.6.1 QuadSPI eFUSE configuration.....	303
	8.6.2 QuadSPI serial flash BOOT operation.....	303
	8.6.3 QuadSPI configuration parameters.....	304
	8.6.4 IOMUX configuration for QSPI devices.....	307
	8.6.5 QuadSPI boot flow chart.....	308
8.7	Program image.....	309
	8.7.1 Image Vector Table and Boot Data.....	309
	8.7.1.1 Image vector table structure.....	310
	8.7.1.2 Boot data structure.....	311
	8.7.2 Device Configuration Data (DCD).....	311
	8.7.2.1 Write data command.....	312
	8.7.2.2 Check data command.....	314
	8.7.2.3 NOP command.....	315
	8.7.2.4 Unlock command.....	316
8.8	Plugin image.....	316
8.9	Serial Downloader.....	317

Section number	Title	Page
8.9.1	USB.....	320
8.9.1.1	USB configuration details.....	320
8.9.1.2	IOMUX configuration for USB.....	321
8.9.2	UART.....	321
8.9.2.1	UART configuration details.....	321
8.9.2.2	UART eFUSE configuration.....	322
8.9.2.3	IOMUX configuration for UART.....	322
8.9.3	Serial Download Protocol (SDP).....	322
8.9.3.1	SDP commands.....	323
8.9.3.1.1	READ_REGISTER.....	323
8.9.3.1.2	WRITE_REGISTER.....	324
8.9.3.1.3	WRITE_FILE.....	325
8.9.3.1.4	ERROR_STATUS.....	326
8.9.3.1.5	DCD_WRITE.....	326
8.9.3.1.6	SKIP_DCD_HEADER.....	327
8.9.3.1.7	JUMP_ADDRESS.....	328
8.10	Recovery devices.....	329
8.11	USB low-power boot.....	329
8.12	SD/MMC manufacture mode.....	331
8.13	High-Assurance Boot (HAB).....	332
8.13.1	HAB API vector table addresses.....	333

Chapter 9 Multimedia

9.1	Display and graphics subsystem.....	335
9.1.1	Electrophoretic Display Controller.....	336
9.1.2	PiXel Processing Pipeline (PXP).....	337
9.1.3	LCD Interface (LCDIF).....	337
9.1.4	CMOS Sensor Interface (CSI).....	337
9.2	Audio subsystem.....	338

Section number	Title	Page
9.2.1	Audio Subsystem Module Overview.....	338
9.2.2	Medium Quality Sound (MQS).....	340
9.2.3	Synchronous Audio Interface (SAI).....	340
9.2.4	Enhanced Serial Audio Interface (ESAI).....	340
9.2.5	Sony/Philips Digital Interface (SPDIF).....	341
9.2.6	Asynchronous Sample Rate Converter (ASRC).....	342

Chapter 10 Clock and Power Management

10.1	Introduction.....	345
10.2	Device Power Management Architecture Components.....	345
10.2.1	Centralized components of clock generation and management.....	346
10.2.2	Centralized components of power generation, distribution and management.....	347
10.2.3	Reset generation and distribution system.....	347
10.2.4	Power and clock management framework.....	347
10.3	Clock Management.....	348
10.3.1	Centralized components of clock management system.....	348
10.3.2	Clock generation.....	350
10.3.2.1	Crystal Oscillator (XTALOSC)	351
10.3.2.2	Low Voltage Differential Signaling (LVDS) I/O ports.....	351
10.3.2.3	PLLs.....	351
10.3.2.3.1	General PLL Control and Status Functions.....	352
10.3.2.4	CCM	354
10.3.2.5	Low Power Clock Gating unit (LPCG).....	354
10.3.3	Peripheral components of clock management system.....	355
10.3.3.1	Interface and functional clock.....	355
10.3.3.2	Block level clock management.....	356
10.3.3.2.1	Master clock protocol.....	356
10.3.3.2.2	Slave clock protocol.....	357
10.3.3.3	Clock Domain(s).....	357

Section number	Title	Page
10.3.3.4	Domain level clock management.....	357
10.3.3.5	Domain dependencies.....	357
10.4	Power management.....	358
10.4.1	Centralized Components of Power Management System.....	358
10.4.1.1	Integrated PMU.....	359
10.4.1.1.1	Digital LDO Regulators.....	361
10.4.1.1.2	Analog LDO regulators.....	362
10.4.1.1.3	USB LDO.....	362
10.4.1.1.4	SNVS regulator.....	362
10.4.1.2	GPC - General Power Controller.....	363
10.4.1.3	SRC - System reset Controller.....	363
10.4.1.4	Power domain(s).....	364
10.4.1.4.1	Power distribution	364
10.4.1.4.2	Domain Memory and domain logic state retention in case of Power Gating.....	365
10.4.1.4.3	Power Gating Domain Management.....	366
10.4.1.4.3.1	ARM Core Platform.....	366
10.4.1.4.3.2	SOC_PD.....	367
10.4.1.4.3.3	SoC.....	367
10.4.1.4.4	Power Gating domain dependencies.....	368
10.4.1.5	Voltage domains.....	368
10.4.1.6	Voltage domain management.....	369
10.4.1.6.1	Dynamic.....	369
10.4.1.6.1.1	Voltage Scaling.....	369
10.4.1.6.2	Static	369
10.4.1.6.2.1	Standby Leakage reduction (SLR).....	369
10.4.1.6.2.2	ANALOG PHYs IPs.....	370
10.4.1.7	System domains layout.....	370
10.4.2	Power management techniques.....	372
10.4.2.1	Power saving techniques.....	373

Section number	Title	Page
10.4.2.2	Thermal-aware power management.....	374
10.4.2.3	Peripheral Power management.....	374
10.4.2.3.1	Main memory power management.....	374
10.4.2.3.2	Video-Graphics system power management.....	375
10.4.2.3.3	IO power reduction.....	375
10.4.3	Examples of External Power Supply Interface.....	376
10.5	ONOFF (Button).....	378

Chapter 11 System Security

11.1	Overview.....	381
11.2	Central Security Unit (CSU).....	382
11.2.1	CSU Overview.....	382
11.2.2	CSU Features.....	382
11.2.3	CSU Functional Description.....	382
11.2.3.1	CSU Peripheral Access Policy.....	383
11.3	Secure Non-Volatile Storage (SNVS).....	384
11.3.1	SNVS Overview.....	384
11.3.2	Tamper Detection.....	384
11.4	Data Co-Processor (DCP).....	385
11.5	High-Assurance Boot (HAB).....	385
11.6	System JTAG Controller (SJC).....	386

Chapter 12 ARM Cortex A7 Platform (CA7)

12.1	Overview.....	387
12.2	External Signals.....	388
12.3	Clocks.....	388
12.4	Platform Configuration.....	388
12.5	Low-Power and Performance.....	389

Chapter 13 Analog-to-Digital Converter (ADC)

Section number	Title	Page
13.1	Overview.....	391
13.1.1	Features.....	391
13.1.2	ADC I/F block diagram.....	392
13.1.3	ADC block diagram.....	392
13.1.4	ADC module interface.....	393
13.1.5	Modes of Operation.....	394
13.2	External Signals.....	394
13.3	Functional Description.....	396
13.3.1	Clock Select and Divide Control.....	397
13.3.2	Voltage Reference Selection	398
13.3.3	Conversion Control.....	398
13.3.3.1	Initiating Conversions.....	399
13.3.3.2	Completing Conversions.....	399
13.3.3.3	Aborting Conversions.....	400
13.3.3.4	Power Control.....	401
13.3.3.5	Sample Time and Total Conversion Time.....	401
13.3.3.6	Conversion Time Examples.....	403
13.3.3.6.1	Typical conversion time configuration.....	403
13.3.3.6.2	Long conversion time configuration.....	404
13.3.3.6.3	Short conversion time configuration.....	404
13.3.3.7	Hardware Average Function.....	405
13.3.4	Automatic Compare Function.....	405
13.3.5	Calibration Function.....	406
13.3.6	User Defined Offset Function	408
13.3.7	MCU Wait Mode Operation.....	408
13.3.8	MCU Stop Mode Operation.....	409
13.3.8.1	Stop Mode With ADACK Disabled.....	409
13.3.8.2	Stop Mode With ADACK Enabled.....	409
13.4	Initialization Information.....	410

Section number	Title	Page
13.4.1	ADC Module Initialization Example.....	410
13.4.1.1	Initialization Sequence.....	410
13.4.1.2	Pseudo-Code Example.....	411
13.5	Application Information.....	412
13.5.1	Sources of Error.....	412
13.5.1.1	Sampling Error.....	412
13.5.1.2	Pin Leakage Error.....	413
13.5.1.3	Noise-Induced Errors.....	413
13.5.1.4	Code Width and Quantization Error.....	414
13.5.1.5	Linearity Errors.....	414
13.5.1.6	Code Jitter, Non-Monotonicity, and Missing Codes.....	415
13.6	Memory map and register definition.....	416
13.6.1	Control register (ADCx_HC0).....	417
13.6.2	Status register (ADCx_HS).....	418
13.6.3	Data result register (ADCx_R0).....	419
13.6.4	Configuration register (ADCx_CFG).....	420
13.6.5	General control register (ADCx_GC).....	422
13.6.6	General status register (ADCx_GS).....	424
13.6.7	Compare value register (ADCx_CV).....	425
13.6.8	Offset correction value register (ADCx_OFS).....	426
13.6.9	Calibration value register (ADCx_CAL).....	427
13.7	Memory map and register definition.....	427
13.7.1	Control register for hardware triggers (ADCx_HC0).....	429
13.7.2	Control register for hardware triggers (ADCx_HCn).....	430
13.7.3	Status register for HW triggers (ADCx_HS).....	432
13.7.4	Data result register for HW triggers (ADCx_R0).....	433
13.7.5	Data result register for HW triggers (ADCx_Rn).....	434
13.7.6	Configuration register (ADCx_CFG).....	435
13.7.7	General control register (ADCx_GC).....	437

Section number	Title	Page
13.7.8	General status register (ADCx_GS).....	439
13.7.9	Compare value register (ADCx_CV).....	440
13.7.10	Offset correction value register (ADCx_OFS).....	441
13.7.11	Calibration value register (ADCx_CAL).....	442

Chapter 14 AHB to IP Bridge (AIPSTZ)

14.1	Overview.....	443
14.1.1	Features.....	443
14.2	Clocks.....	443
14.3	Functional Description.....	444
14.4	Access Protections.....	445
14.5	Access Support.....	445
14.6	Initialization Information.....	446
14.6.1	Security Block.....	446
14.7	AIPSTZ Memory Map/Register Definition.....	447
14.7.1	Master Privilege Registers (AIPSTZx_MPR).....	449
14.7.2	Off-Platform Peripheral Access Control Registers (AIPSTZx_OPACR).....	451
14.7.3	Off-Platform Peripheral Access Control Registers (AIPSTZx_OPACR1).....	454
14.7.4	Off-Platform Peripheral Access Control Registers (AIPSTZx_OPACR2).....	457
14.7.5	Off-Platform Peripheral Access Control Registers (AIPSTZx_OPACR3).....	460
14.7.6	Off-Platform Peripheral Access Control Registers (AIPSTZx_OPACR4).....	463

Chapter 15 AHB-to-APBH Bridge with DMA (APBH-Bridge-DMA)

15.1	Overview.....	465
15.2	Clocks.....	466
15.3	APBH DMA.....	467
15.4	NAND Read Status Polling Example.....	472
15.5	APBH Memory Map/Register Definition.....	474
15.5.1	AHB to APBH Bridge Control and Status Register 0 (APBH_CTRL0n).....	480

Section number	Title	Page
15.5.2	AHB to APBH Bridge Control and Status Register 1 (APBH_CTRL1n).....	481
15.5.3	AHB to APBH Bridge Control and Status Register 2 (APBH_CTRL2n).....	485
15.5.4	AHB to APBH Bridge Channel Register (APBH_CHANNEL_CTRLn).....	490
15.5.5	AHB to APBH DMA Device Assignment Register (APBH_DEVSEL).....	491
15.5.6	AHB to APBH DMA burst size (APBH_DMA_BURST_SIZE).....	492
15.5.7	AHB to APBH DMA Debug Register (APBH_DEBUG).....	493
15.5.8	APBH DMA Channel n Current Command Address Register (APBH_CHn_CURCMDAR).....	494
15.5.9	APBH DMA Channel n Next Command Address Register (APBH_CHn_NXTCMDAR).....	495
15.5.10	APBH DMA Channel n Command Register (APBH_CHn_CMD).....	495
15.5.11	APBH DMA Channel n Buffer Address Register (APBH_CHn_BAR).....	497
15.5.12	APBH DMA Channel n Semaphore Register (APBH_CHn_SEMA).....	498
15.5.13	AHB to APBH DMA Channel n Debug Information (APBH_CHn_DEBUG1).....	499
15.5.14	AHB to APBH DMA Channel n Debug Information (APBH_CHn_DEBUG2).....	502
15.5.15	APBH Bridge Version Register (APBH_VERSION).....	503

Chapter 16 Asynchronous Sample Rate Converter (ASRC)

16.1	Overview.....	505
16.1.1	Features.....	507
16.1.2	Modes of Operation.....	508
16.1.2.1	Data Transfer Schemes.....	508
16.1.2.1.1	Data Input Modes.....	508
16.1.2.1.2	Data Output Modes.....	510
16.1.2.2	Word Alignment Supported	511
16.1.2.2.1	Input Data Alignment Modes	511
16.1.2.2.2	Output Data Alignment Modes	511
16.2	Clocks.....	512
16.3	Interrupts.....	512
16.4	DMA requests.....	513
16.5	Functional Description.....	513

Section number	Title	Page
16.5.1	Algorithm Description.....	513
16.5.1.1	Signal processing flow.....	513
16.5.1.2	Operation of the Filter.....	517
16.5.1.2.1	Support of Physical Clocks.....	517
16.6	Startup Procedure.....	519
16.7	ASRC Memory Map/Register Definition.....	523
16.7.1	ASRC Control Register (ASRC_ASRCCTR).....	526
16.7.2	ASRC Interrupt Enable Register (ASRC_ASRIER).....	529
16.7.3	ASRC Channel Number Configuration Register (ASRC_ASRCNCR).....	530
16.7.4	ASRC Filter Configuration Status Register (ASRC_ASRCFG).....	532
16.7.5	ASRC Clock Source Register (ASRC_ASRCSTR).....	534
16.7.6	ASRC Clock Divider Register 1 (ASRC_ASRCDR1).....	537
16.7.7	ASRC Clock Divider Register 2 (ASRC_ASRCDR2).....	538
16.7.8	ASRC Status Register (ASRC_ASRSTR).....	539
16.7.9	ASRC Parameter Register n (ASRC_ASRPMn).....	542
16.7.10	ASRC ASRC Task Queue FIFO Register 1 (ASRC_ASRTFR1).....	543
16.7.11	ASRC Channel Counter Register (ASRC_ASRCR).....	544
16.7.12	ASRC Data Input Register for Pair x (ASRC_ASRDIn).....	545
16.7.13	ASRC Data Output Register for Pair x (ASRC_ASRDO).....	545
16.7.14	ASRC Ideal Ratio for Pair A-High Part (ASRC_ASRIDRHA).....	546
16.7.15	ASRC Ideal Ratio for Pair A -Low Part (ASRC_ASRIDRLA).....	546
16.7.16	ASRC Ideal Ratio for Pair B-High Part (ASRC_ASRIDRHB).....	547
16.7.17	ASRC Ideal Ratio for Pair B-Low Part (ASRC_ASRIDRLB).....	547
16.7.18	ASRC Ideal Ratio for Pair C-High Part (ASRC_ASRIDRHC).....	548
16.7.19	ASRC Ideal Ratio for Pair C-Low Part (ASRC_ASRIDRLC).....	548
16.7.20	ASRC 76 kHz Period in terms of ASRC processing clock (ASRC_ASR76K).....	549
16.7.21	ASRC 56 kHz Period in terms of ASRC processing clock (ASRC_ASR56K).....	550
16.7.22	ASRC Misc Control Register for Pair A (ASRC_ASRMCRA).....	551
16.7.23	ASRC FIFO Status Register for Pair A (ASRC_ASRFSTA).....	553

Section number	Title	Page
16.7.24	ASRC Misc Control Register for Pair B (ASRC_ASRMCRB).....	554
16.7.25	ASRC FIFO Status Register for Pair B (ASRC_ASRFSTB).....	556
16.7.26	ASRC Misc Control Register for Pair C (ASRC_ASRMCRB).....	557
16.7.27	ASRC FIFO Status Register for Pair C (ASRC_ASRFSTC).....	559
16.7.28	ASRC Misc Control Register 1 for Pair X (ASRC_ASRMCR1n).....	560

Chapter 17 40-BIT Correcting ECC Accelerator (BCH)

17.1	Overview.....	563
17.2	Operation.....	565
17.2.1	BCH Limitations and Assumptions.....	566
17.2.2	Flash Page Layout.....	567
17.2.3	Determining the ECC layout for a device.....	569
17.2.3.1	4K+218 flash, 10 bytes metadata, 512 byte data blocks, separate metadata, Assuming GF(213).....	569
17.2.3.2	4K+128 flash, 10 bytes metadata, 1024 byte data blocks, separate metadata, assuming GF(213) for data and GF(214) for metadata.....	570
17.2.4	Data Buffers in System Memory.....	570
17.3	Memory to Memory (Loopback) Operation.....	572
17.4	Programming the BCH/GPMI Interfaces.....	573
17.4.1	BCH Encoding for NAND Writes.....	573
17.4.1.1	DMA Structure Code Example.....	576
17.4.1.2	Using the BCH Encoder.....	581
17.4.2	BCH Decoding for NAND Reads.....	582
17.4.2.1	DMA Structure Code Example.....	586
17.4.2.2	Using the Decoder.....	589
17.4.3	Interrupts.....	591
17.5	Behavior During Reset.....	592
17.6	BCH Memory Map/Register Definition.....	593
17.6.1	Hardware BCH ECC Accelerator Control Register (BCH_CTRLn).....	597
17.6.2	Hardware ECC Accelerator Status Register 0 (BCH_STATUS0n).....	599

Section number	Title	Page
17.6.3	Hardware ECC Accelerator Mode Register (BCH_MODE <i>n</i>).....	601
17.6.4	Hardware BCH ECC Loopback Encode Buffer Register (BCH_ENCODEPTR <i>n</i>).....	602
17.6.5	Hardware BCH ECC Loopback Data Buffer Register (BCH_DATAPTR <i>n</i>).....	602
17.6.6	Hardware BCH ECC Loopback Metadata Buffer Register (BCH_METAPTR <i>n</i>).....	603
17.6.7	Hardware ECC Accelerator Layout Select Register (BCH_LAYOUTSELECT <i>n</i>).....	603
17.6.8	Hardware BCH ECC Flash 0 Layout 0 Register (BCH_FLASH0LAYOUT0 <i>n</i>).....	604
17.6.9	Hardware BCH ECC Flash 0 Layout 1 Register (BCH_FLASH0LAYOUT1 <i>n</i>).....	606
17.6.10	Hardware BCH ECC Flash 1 Layout 0 Register (BCH_FLASH1LAYOUT0 <i>n</i>).....	607
17.6.11	Hardware BCH ECC Flash 1 Layout 1 Register (BCH_FLASH1LAYOUT1 <i>n</i>).....	609
17.6.12	Hardware BCH ECC Flash 2 Layout 0 Register (BCH_FLASH2LAYOUT0 <i>n</i>).....	610
17.6.13	Hardware BCH ECC Flash 2 Layout 1 Register (BCH_FLASH2LAYOUT1 <i>n</i>).....	612
17.6.14	Hardware BCH ECC Flash 3 Layout 0 Register (BCH_FLASH3LAYOUT0 <i>n</i>).....	613
17.6.15	Hardware BCH ECC Flash 3 Layout 1 Register (BCH_FLASH3LAYOUT1 <i>n</i>).....	615
17.6.16	Hardware BCH ECC Debug Register0 (BCH_DEBUG0 <i>n</i>).....	616
17.6.17	KES Debug Read Register (BCH_DBGKESREAD <i>n</i>).....	618
17.6.18	Chien Search Debug Read Register (BCH_DBGCSFEREAD <i>n</i>).....	619
17.6.19	Syndrome Generator Debug Read Register (BCH_DBGSYNDGENREAD <i>n</i>).....	619
17.6.20	Bus Master and ECC Controller Debug Read Register (BCH_DBGAHBMREAD <i>n</i>).....	620
17.6.21	Block Name Register (BCH_BLOCKNAME <i>n</i>).....	620
17.6.22	BCH Version Register (BCH_VERSION <i>n</i>).....	621
17.6.23	Hardware BCH ECC Debug Register 1 (BCH_DEBUG1 <i>n</i>).....	622

Chapter 18 Clock Controller Module (CCM)

18.1	Overview.....	625
18.1.1	Features.....	625
18.1.2	CCM Block Diagram.....	626
18.2	External Signals.....	628
18.3	CCM Clock Tree.....	628
18.4	System Clocks.....	630

Section number	Title	Page
18.5	Functional Description.....	643
18.5.1	Clock Generation.....	643
18.5.1.1	External Low Frequency Clock - CKIL	643
	18.5.1.1.1 CKIL synchronizing to IPG_CLK.....	644
18.5.1.2	External High Frequency Clock - CKIH and internal oscillator.....	644
18.5.1.3	PLL reference clock.....	644
	18.5.1.3.1 ARM PLL.....	644
	18.5.1.3.2 USB PLLs.....	645
	18.5.1.3.3 System PLL.....	645
	18.5.1.3.4 Audio / Video PLL.....	645
	18.5.1.3.5 Ethernet PLL.....	646
18.5.1.4	Phase Fractional Dividers (PFD).....	646
18.5.1.5	CCM internal clock generation.....	646
	18.5.1.5.1 Clock Switcher.....	647
	18.5.1.5.2 PLL bypass procedure.....	649
	18.5.1.5.3 PLL clock change.....	649
	18.5.1.5.4 Clock Root Generator.....	649
	18.5.1.5.5 Initial values controlled by the System JTAG Controller (SJC).....	651
	18.5.1.5.6 Divider change handshake.....	651
18.5.1.6	Disabling / Enabling PLLs.....	651
18.5.1.7	Clock Switching Multiplexers.....	652
18.5.1.8	Low Power Clock Gating module (LPCG).....	653
18.5.1.9	MMDC handshake.....	654
18.5.2	DVFS support.....	655
18.5.3	Power modes.....	655
	18.5.3.1 RUN mode.....	655
	18.5.3.2 WAIT mode.....	656
	18.5.3.2.1 Entering WAIT mode	656
	18.5.3.2.2 Exiting WAIT mode	656

Section number	Title	Page
18.5.3.3	STOP mode.....	657
18.5.3.3.1	Entering STOP mode	657
18.5.3.3.2	Exiting STOP mode.....	657
18.6	CCM Memory Map/Register Definition.....	658
18.6.1	CCM Control Register (CCM_CCR).....	660
18.6.2	CCM Control Divider Register (CCM_CCDR).....	661
18.6.3	CCM Status Register (CCM_CSR).....	663
18.6.4	CCM Clock Switcher Register (CCM_CCSR).....	664
18.6.5	CCM Arm Clock Root Register (CCM_CACRR).....	665
18.6.6	CCM Bus Clock Divider Register (CCM_CBCDR).....	666
18.6.7	CCM Bus Clock Multiplexer Register (CCM_CBCMR).....	669
18.6.8	CCM Serial Clock Multiplexer Register 1 (CCM_CSCMR1).....	670
18.6.9	CCM Serial Clock Multiplexer Register 2 (CCM_CSCMR2).....	673
18.6.10	CCM Serial Clock Divider Register 1 (CCM_CSCDR1).....	674
18.6.11	CCM SAI1 Clock Divider Register (CCM_CS1CDR).....	676
18.6.12	CCM SAI2 Clock Divider Register (CCM_CS2CDR).....	678
18.6.13	CCM D1 Clock Divider Register (CCM_CDCDR).....	680
18.6.14	CCM HSC Clock Divider Register (CCM_CHSCCDR).....	681
18.6.15	CCM Serial Clock Divider Register 2 (CCM_CSCDR2).....	682
18.6.16	CCM Serial Clock Divider Register 3 (CCM_CSCDR3).....	684
18.6.17	CCM Divider Handshake In-Process Register (CCM_CDHIPR).....	685
18.6.18	CCM Low Power Control Register (CCM_CLPCR).....	688
18.6.19	CCM Interrupt Status Register (CCM_CISR).....	690
18.6.20	CCM Interrupt Mask Register (CCM_CIMR).....	693
18.6.21	CCM Clock Output Source Register (CCM_CCOSR).....	695
18.6.22	CCM General Purpose Register (CCM_CGPR).....	697
18.6.23	CCM Clock Gating Register 0 (CCM_CCGR0).....	698
18.6.24	CCM Clock Gating Register 1 (CCM_CCGR1).....	700
18.6.25	CCM Clock Gating Register 2 (CCM_CCGR2).....	702

Section number	Title	Page
18.6.26	CCM Clock Gating Register 3 (CCM_CCGR3).....	703
18.6.27	CCM Clock Gating Register 4 (CCM_CCGR4).....	704
18.6.28	CCM Clock Gating Register 5 (CCM_CCGR5).....	706
18.6.29	CCM Clock Gating Register 6 (CCM_CCGR6).....	707
18.6.30	CCM Module Enable Override Register (CCM_CMEOR).....	709
18.7	CCM Analog Memory Map/Register Definition.....	710
18.7.1	Analog ARM PLL control Register (CCM_ANALOG_PLL_ARMn).....	714
18.7.2	Analog USB1 480MHz PLL Control Register (CCM_ANALOG_PLL_USB1n).....	716
18.7.3	Analog USB2 480MHz PLL Control Register (CCM_ANALOG_PLL_USB2n).....	718
18.7.4	Analog System PLL Control Register (CCM_ANALOG_PLL_SYSn).....	720
18.7.5	528MHz System PLL Spread Spectrum Register (CCM_ANALOG_PLL_SYS_SS).....	722
18.7.6	Numerator of 528MHz System PLL Fractional Loop Divider Register (CCM_ANALOG_PLL_SYS_NUM).....	722
18.7.7	Denominator of 528MHz System PLL Fractional Loop Divider Register (CCM_ANALOG_PLL_SYS_DENOM).....	723
18.7.8	Analog Audio PLL control Register (CCM_ANALOG_PLL_AUDIOn).....	724
18.7.9	Numerator of Audio PLL Fractional Loop Divider Register (CCM_ANALOG_PLL_AUDIO_NUM)..	726
18.7.10	Denominator of Audio PLL Fractional Loop Divider Register (CCM_ANALOG_PLL_AUDIO_DENOM).....	727
18.7.11	Analog Video PLL control Register (CCM_ANALOG_PLL_VIDEOn).....	728
18.7.12	Numerator of Video PLL Fractional Loop Divider Register (CCM_ANALOG_PLL_VIDEO_NUM)...	730
18.7.13	Denominator of Video PLL Fractional Loop Divider Register (CCM_ANALOG_PLL_VIDEO_DENOM).....	731
18.7.14	Analog ENET PLL Control Register (CCM_ANALOG_PLL_ENETn).....	732
18.7.15	480MHz Clock (PLL3) Phase Fractional Divider Control Register (CCM_ANALOG_PFD_480n).....	734
18.7.16	528MHz Clock (PLL2) Phase Fractional Divider Control Register (CCM_ANALOG_PFD_528n).....	736
18.7.17	Miscellaneous Register 0 (CCM_ANALOG_MISC0n).....	739
18.7.18	Miscellaneous Register 1 (CCM_ANALOG_MISC1n).....	743
18.7.19	Miscellaneous Register 2 (CCM_ANALOG_MISC2n).....	746

Chapter 19

Section number	Title	Page
CMOS Sensor Interface (CSI)		
19.1	Overview.....	751
19.2	External Signals.....	752
19.3	Clocks.....	754
19.4	Principles of Operation.....	754
19.4.1	Data Transfer with the Embedded DMA Controllers.....	756
19.4.2	Gated Clock Mode.....	757
19.4.3	Non-Gated Clock Mode.....	757
19.4.4	CCIR656 Interlace Mode.....	758
19.4.5	CCIR656 Progressive Mode.....	760
19.4.6	Error Correction for CCIR656 Coding.....	761
19.4.7	Deinterlacer.....	761
19.5	Interrupt Generation.....	762
19.5.1	Start Of Frame Interrupt (SOF_INT).....	762
19.5.2	End Of Frame Interrupt (EOF_INT).....	762
19.5.3	Change Of Field Interrupt (COF_INT).....	762
19.5.4	CCIR Error Interrupt (ECC_INT).....	763
19.5.5	RxFIFO Full Interrupt (RxFF_INT).....	763
19.5.6	Statistic FIFO Full Interrupt (STATFF_INT).....	763
19.5.7	RxFIFO Overrun Interrupt (RFF_OR_INT).....	763
19.5.8	Statistic FIFO Overrun Interrupt (SFF_OR_INT).....	763
19.5.9	Frame Buffer1 DMA Transfer Done Interrupt (DMA_TSF_DONE_FB1).....	764
19.5.10	Frame Buffer2 DMA Transfer Done Interrupt (DMA_TSF_DONE_FB2).....	764
19.5.11	Statistic FIFO DMA Transfer Done Interrupt (DMA_TSF_DONE_SFF).....	764
19.5.12	AHB Bus Response Error Interrupt (HRESP_ERR_INT).....	764
19.5.13	DMA Field 0 Transfer Done Interrupt (DMA_FIELD0_DONE).....	764
19.5.14	DMA Field 1 Transfer Done Interrupt (DMA_FIELD1_DONE).....	764
19.5.15	Base Address Change Error Interrupt (BASEADDR_CHANGE_ERROR).....	765
19.6	Data Packing Style.....	765

Section number	Title	Page
19.6.1	RX FIFO Path.....	766
19.6.1.1	Bayer Data.....	766
19.6.1.2	RGB565 Data.....	766
19.6.1.3	RGB888 Data.....	767
19.6.2	STAT FIFO Path.....	769
19.7	CSI Memory Map/Register Definition.....	769
19.7.1	CSI Control Register 1 (CSI_CSICR1).....	771
19.7.2	CSI Control Register 2 (CSI_CSICR2).....	775
19.7.3	CSI Control Register 3 (CSI_CSICR3).....	777
19.7.4	CSI Statistic FIFO Register (CSI_CSISTATFIFO).....	779
19.7.5	CSI RX FIFO Register (CSI_CSIRFIFO).....	780
19.7.6	CSI RX Count Register (CSI_CSIRXCNT).....	780
19.7.7	CSI Status Register (CSI_CSISR).....	781
19.7.8	CSI DMA Start Address Register - for STATFIFO (CSI_CSIDMASA_STATFIFO).....	784
19.7.9	CSI DMA Transfer Size Register - for STATFIFO (CSI_CSIDMATS_STATFIFO).....	784
19.7.10	CSI DMA Start Address Register - for Frame Buffer1 (CSI_CSIDMASA_FB1).....	785
19.7.11	CSI DMA Transfer Size Register - for Frame Buffer2 (CSI_CSIDMASA_FB2).....	786
19.7.12	CSI Frame Buffer Parameter Register (CSI_CSIFBUF_PARA).....	786
19.7.13	CSI Image Parameter Register (CSI_CSIIMAG_PARA).....	787
19.7.14	CSI Control Register 18 (CSI_CSICR18).....	788
19.7.15	CSI Control Register 19 (CSI_CSICR19).....	790

Chapter 20 Enhanced Configurable SPI (ECSPI)

20.1	Overview.....	791
20.1.1	Features.....	792
20.1.2	Modes and Operations.....	792
20.2	External Signals.....	793
20.3	Clocks.....	794
20.4	Functional Description.....	794

Section number	Title	Page
20.4.1	Master Mode.....	795
20.4.2	Slave Mode.....	795
20.4.3	Low Power Modes.....	795
20.4.4	Operations.....	795
20.4.4.1	Typical Master Mode.....	795
20.4.4.1.1	Master Mode with SPI_RDY.....	796
20.4.4.1.2	Master Mode with Wait States.....	798
20.4.4.1.3	Master Mode with SS_CTL[3:0] Control.....	798
20.4.4.1.4	Master Mode with Phase Control.....	799
20.4.4.2	Typical Slave Mode.....	800
20.4.5	Reset.....	801
20.4.6	Interrupts.....	801
20.4.7	DMA	802
20.4.8	Byte Order.....	803
20.5	Initialization.....	804
20.6	Applications.....	804
20.7	ECSPI Memory Map/Register Definition.....	805
20.7.1	Receive Data Register (ECSPi _x _RXDATA).....	806
20.7.2	Transmit Data Register (ECSPi _x _TXDATA).....	807
20.7.3	Control Register (ECSPi _x _CONREG).....	807
20.7.4	Config Register (ECSPi _x _CONFIGREG).....	810
20.7.5	Interrupt Control Register (ECSPi _x _INTREG).....	812
20.7.6	DMA Control Register (ECSPi _x _DMAREG).....	813
20.7.7	Status Register (ECSPi _x _STATREG).....	815
20.7.8	Sample Period Control Register (ECSPi _x _PERIODREG).....	816
20.7.9	Test Control Register (ECSPi _x _TESTREG).....	818
20.7.10	Message Data Register (ECSPi _x _MSGDATA).....	819

Chapter 21 External Interface Module (EIM)

Section number	Title	Page
21.1	Overview.....	821
21.1.1	Features.....	823
21.1.2	Modes of Operation.....	823
21.1.2.1	Asynchronous Mode.....	824
21.1.2.2	Asynchronous Page Read Mode.....	824
21.1.2.3	Multiplexed Address/Data Mode.....	824
21.1.2.4	Burst Clock Mode.....	825
21.1.2.5	Low Power Modes.....	825
21.1.2.6	Boot Mode.....	826
21.2	External Signals.....	826
21.2.1	Other Important Block I/O Signals Internal to the SoC.....	826
21.3	Clocks.....	826
21.4	Chip Select Memory Map.....	827
21.5	Functional Description.....	828
21.5.1	Bus Sizing Configuration.....	828
21.5.1.1	8 BIT PORT SUPPORT.....	828
21.5.1.1.1	MOTOROLA 68000.....	828
21.5.1.1.2	INTEL 386.....	829
21.5.2	EIM Operational Modes.....	829
21.5.3	Burst Mode (Synchronous) Memory Operation.....	829
21.5.4	Burst Clock Divisor (BCD).....	830
21.5.5	Burst Clock Start (BCS).....	831
21.5.6	Multiplexed Address/Data Mode Support.....	831
21.5.7	Mixed Master/Memory Burst Modes Support.....	831
21.5.8	AXI (Master) Bus Cycles Support.....	832
21.5.9	WAIT_B Signal, RWSC and WWSC bit fields Usage.....	834
21.5.10	IPS Register Interface.....	835
21.5.11	MRS Set for PSRAM.....	835
21.5.12	EIM Access Termination	835

Section number	Title	Page
21.5.13	Error Conditions.....	835
21.5.14	DTACK Mode.....	836
21.5.15	EIM_GRANT / EIM_BUSY Handshake Description.....	837
21.5.16	LPMD / LPACK Handshake Description.....	837
21.5.17	Endianness.....	837
21.5.18	Strobe Signal Use.....	838
21.6	Initialization Information.....	839
21.6.1	Booting from EIM.....	839
21.7	Typical Application.....	839
21.7.1	Access to Intel Sibley Flash.....	840
21.7.1.1	Intel Sibley Flash Asynchronous Mode Configuration.....	840
21.7.1.2	Intel Sibley Flash Synchronous Mode Configuration.....	840
21.7.1.3	Intel Sibley Flash Utility.....	840
21.7.2	Access to MDOC Device.....	841
21.7.2.1	MDOC Device Boot.....	841
21.7.2.2	MDOC Device Asynchronous Mode Configuration.....	841
21.7.2.3	MDOC Device Utility.....	841
21.7.3	Access to Micron PSRAM	841
21.7.3.1	Micron PSRAM Asynchronous Mode Configuration.....	842
21.7.3.2	Micron PSRAM Synchronous Mode Configuration.....	842
21.7.4	Access to Samsung OneNAND	842
21.7.4.1	Samsung OneNAND Boot.....	842
21.7.4.2	Samsung OneNAND Asynchronous Mode Configuration.....	843
21.7.4.3	Samsung OneNAND Synchronous Mode Configuration.....	843
21.7.4.4	Samsung OneNAND Utility.....	843
21.7.5	Access to Samsung UtRAM	844
21.7.5.1	Samsung UtRAM Asynchronous Mode Configuration.....	844
21.7.5.2	Samsung UtRAM Synchronous Mode Configuration.....	844
21.7.6	Access to Spansion Flash	844

Section number	Title	Page
21.7.6.1	Spansion Flash Asynchronous Mode Configuration.....	844
21.7.6.2	Spansion Flash Synchronous Mode Configuration.....	845
21.7.6.3	Spansion Flash Utility.....	845
21.7.7	8 bit support.....	846
21.8	External Bus Timing Diagrams.....	847
21.8.1	Asynchronous Read Memory Accesses Timing Diagram.....	847
21.8.2	Asynchronous Write Memory Accesses Timing Diagram.....	848
21.8.3	Asynchronous Read/Write Memory Accesses Timing Diagram.....	849
21.8.4	Asynchronous Read/Write Using RAL, WAL and CSREC.....	851
21.8.5	Consecutive Asynchronous Write Memory Accesses Timing Diagram.....	852
21.8.6	Consecutive Asynchronous Read Memory Accesses Timing Diagram.....	855
21.8.7	Burst (Synchronous Mode) Read Memory Accesses Timing Diagram - BCD=0.....	857
21.8.8	Burst (Synchronous Mode) Read Memory Accesses Timing Diagram - BCD=1.....	858
21.8.9	Burst (Synchronous Mode) Write Memory Access Timing - BCD=1.....	859
21.8.10	Asynchronous Page Mode Access.....	861
21.8.11	DTACK Mode - AXI Single Access.....	861
21.8.12	DTACK Mode - AXI Single Write Access.....	864
21.8.13	DTACK Mode - AXI Burst Access.....	865
21.9	EIM Memory Map/Register Definition.....	866
21.9.1	Chip Select n General Configuration Register 1 (EIM_CSnGCR1).....	869
21.9.2	Chip Select n General Configuration Register 2 (EIM_CSnGCR2).....	873
21.9.3	Chip Select n Read Configuration Register 1 (EIM_CSnRCR1).....	875
21.9.4	Chip Select n Read Configuration Register 2 (EIM_CSnRCR2).....	877
21.9.5	Chip Select n Write Configuration Register 1 (EIM_CSnWCR1).....	879
21.9.6	Chip Select n Write Configuration Register 2 (EIM_CSnWCR2).....	882
21.9.7	EIM Configuration Register (EIM_WCR).....	883

Chapter 22

10/100-Mbps Ethernet MAC (ENET)

22.1	Introduction.....	885
------	-------------------	-----

Section number	Title	Page
22.2	Overview.....	885
22.2.1	Features.....	886
22.2.1.1	Ethernet MAC features.....	886
22.2.1.2	IP protocol performance optimization features.....	887
22.2.1.3	IEEE 1588 features.....	888
22.2.2	Block diagram.....	888
22.3	External Signals.....	889
22.4	Clocks.....	898
22.5	Memory map/register definition.....	899
22.5.1	Interrupt Event Register (ENETx_EIR).....	908
22.5.2	Interrupt Mask Register (ENETx_EIMR).....	911
22.5.3	Receive Descriptor Active Register (ENETx_RDAR).....	914
22.5.4	Transmit Descriptor Active Register (ENETx_TDAR).....	915
22.5.5	Ethernet Control Register (ENETx_ECR).....	916
22.5.6	MII Management Frame Register (ENETx_MMFR).....	918
22.5.7	MII Speed Control Register (ENETx_MSCR).....	918
22.5.8	MIB Control Register (ENETx_MIBC).....	921
22.5.9	Receive Control Register (ENETx_RCR).....	922
22.5.10	Transmit Control Register (ENETx_TCR).....	925
22.5.11	Physical Address Lower Register (ENETx_PALR).....	927
22.5.12	Physical Address Upper Register (ENETx_PAUR).....	927
22.5.13	Opcode/Pause Duration Register (ENETx_OPD).....	928
22.5.14	Transmit Interrupt Coalescing Register (ENETx_TXIC).....	928
22.5.15	Receive Interrupt Coalescing Register (ENETx_RXIC).....	929
22.5.16	Descriptor Individual Upper Address Register (ENETx_IAUR).....	930
22.5.17	Descriptor Individual Lower Address Register (ENETx_IALR).....	931
22.5.18	Descriptor Group Upper Address Register (ENETx_GAUR).....	931
22.5.19	Descriptor Group Lower Address Register (ENETx_GALR).....	932
22.5.20	Transmit FIFO Watermark Register (ENETx_TFWR).....	932

Section number	Title	Page
22.5.21	Receive Descriptor Ring Start Register (ENETx_RDSR).....	933
22.5.22	Transmit Buffer Descriptor Ring Start Register (ENETx_TDSR).....	934
22.5.23	Maximum Receive Buffer Size Register (ENETx_MRBR).....	935
22.5.24	Receive FIFO Section Full Threshold (ENETx_RSFL).....	936
22.5.25	Receive FIFO Section Empty Threshold (ENETx_RSEM).....	936
22.5.26	Receive FIFO Almost Empty Threshold (ENETx_RAEM).....	937
22.5.27	Receive FIFO Almost Full Threshold (ENETx_RAFL).....	937
22.5.28	Transmit FIFO Section Empty Threshold (ENETx_TSEM).....	938
22.5.29	Transmit FIFO Almost Empty Threshold (ENETx_TAEM).....	938
22.5.30	Transmit FIFO Almost Full Threshold (ENETx_TAFL).....	939
22.5.31	Transmit Inter-Packet Gap (ENETx_TIPG).....	939
22.5.32	Frame Truncation Length (ENETx_FTRL).....	940
22.5.33	Transmit Accelerator Function Configuration (ENETx_TACC).....	940
22.5.34	Receive Accelerator Function Configuration (ENETx_RACC).....	941
22.5.35	Reserved Statistic Register (ENETx_RMON_T_DROP).....	942
22.5.36	Tx Packet Count Statistic Register (ENETx_RMON_T_PACKETS).....	943
22.5.37	Tx Broadcast Packets Statistic Register (ENETx_RMON_T_BC_PKT).....	943
22.5.38	Tx Multicast Packets Statistic Register (ENETx_RMON_T_MC_PKT).....	944
22.5.39	Tx Packets with CRC/Align Error Statistic Register (ENETx_RMON_T_CRC_ALIGN).....	944
22.5.40	Tx Packets Less Than Bytes and Good CRC Statistic Register (ENETx_RMON_T_UNDERSIZE).....	944
22.5.41	Tx Packets GT MAX_FL bytes and Good CRC Statistic Register (ENETx_RMON_T_OVERSIZE).....	945
22.5.42	Tx Packets Less Than 64 Bytes and Bad CRC Statistic Register (ENETx_RMON_T_FRAG).....	945
22.5.43	Tx Packets Greater Than MAX_FL bytes and Bad CRC Statistic Register (ENETx_RMON_T_JAB).....	946
22.5.44	Tx Collision Count Statistic Register (ENETx_RMON_T_COL).....	946
22.5.45	Tx 64-Byte Packets Statistic Register (ENETx_RMON_T_P64).....	947
22.5.46	Tx 65- to 127-byte Packets Statistic Register (ENETx_RMON_T_P65TO127).....	947
22.5.47	Tx 128- to 255-byte Packets Statistic Register (ENETx_RMON_T_P128TO255).....	948
22.5.48	Tx 256- to 511-byte Packets Statistic Register (ENETx_RMON_T_P256TO511).....	948
22.5.49	Tx 512- to 1023-byte Packets Statistic Register (ENETx_RMON_T_P512TO1023).....	949

Section number	Title	Page
22.5.50	Tx 1024- to 2047-byte Packets Statistic Register (ENETx_RMON_T_P1024TO2047).....	949
22.5.51	Tx Packets Greater Than 2048 Bytes Statistic Register (ENETx_RMON_T_P_GTE2048).....	950
22.5.52	Tx Octets Statistic Register (ENETx_RMON_T_OCTETS).....	950
22.5.53	Reserved Statistic Register (ENETx_IEEE_T_DROP).....	950
22.5.54	Frames Transmitted OK Statistic Register (ENETx_IEEE_T_FRAME_OK).....	951
22.5.55	Frames Transmitted with Single Collision Statistic Register (ENETx_IEEE_T_1COL).....	951
22.5.56	Frames Transmitted with Multiple Collisions Statistic Register (ENETx_IEEE_T_MCOL).....	952
22.5.57	Frames Transmitted after Deferral Delay Statistic Register (ENETx_IEEE_T_DEF).....	952
22.5.58	Frames Transmitted with Late Collision Statistic Register (ENETx_IEEE_T_LCOL).....	952
22.5.59	Frames Transmitted with Excessive Collisions Statistic Register (ENETx_IEEE_T_EXCOL).....	953
22.5.60	Frames Transmitted with Tx FIFO Underrun Statistic Register (ENETx_IEEE_T_MACERR).....	953
22.5.61	Frames Transmitted with Carrier Sense Error Statistic Register (ENETx_IEEE_T_CSERR).....	954
22.5.62	Reserved Statistic Register (ENETx_IEEE_T_SQE).....	954
22.5.63	Flow Control Pause Frames Transmitted Statistic Register (ENETx_IEEE_T_FDXFC).....	954
22.5.64	Octet Count for Frames Transmitted w/o Error Statistic Register (ENETx_IEEE_T_OCTETS_OK).....	955
22.5.65	Rx Packet Count Statistic Register (ENETx_RMON_R_PACKETS).....	955
22.5.66	Rx Broadcast Packets Statistic Register (ENETx_RMON_R_BC_PKT).....	956
22.5.67	Rx Multicast Packets Statistic Register (ENETx_RMON_R_MC_PKT).....	956
22.5.68	Rx Packets with CRC/Align Error Statistic Register (ENETx_RMON_R_CRC_ALIGN).....	956
22.5.69	Rx Packets with Less Than 64 Bytes and Good CRC Statistic Register (ENETx_RMON_R_UNDERSIZE).....	957
22.5.70	Rx Packets Greater Than MAX_FL and Good CRC Statistic Register (ENETx_RMON_R_OVERSIZE).....	957
22.5.71	Rx Packets Less Than 64 Bytes and Bad CRC Statistic Register (ENETx_RMON_R_FRAG).....	958
22.5.72	Rx Packets Greater Than MAX_FL Bytes and Bad CRC Statistic Register (ENETx_RMON_R_JAB).....	958
22.5.73	Reserved Statistic Register (ENETx_RMON_R_RESVD_0).....	958
22.5.74	Rx 64-Byte Packets Statistic Register (ENETx_RMON_R_P64).....	959
22.5.75	Rx 65- to 127-Byte Packets Statistic Register (ENETx_RMON_R_P65TO127).....	959
22.5.76	Rx 128- to 255-Byte Packets Statistic Register (ENETx_RMON_R_P128TO255).....	960

Section number	Title	Page
22.5.77	Rx 256- to 511-Byte Packets Statistic Register (ENETx_RMON_R_P256TO511).....	960
22.5.78	Rx 512- to 1023-Byte Packets Statistic Register (ENETx_RMON_R_P512TO1023).....	960
22.5.79	Rx 1024- to 2047-Byte Packets Statistic Register (ENETx_RMON_R_P1024TO2047).....	961
22.5.80	Rx Packets Greater than 2048 Bytes Statistic Register (ENETx_RMON_R_P_GTE2048).....	961
22.5.81	Rx Octets Statistic Register (ENETx_RMON_R_OCTETS).....	962
22.5.82	Frames not Counted Correctly Statistic Register (ENETx_IEEE_R_DROP).....	962
22.5.83	Frames Received OK Statistic Register (ENETx_IEEE_R_FRAME_OK).....	962
22.5.84	Frames Received with CRC Error Statistic Register (ENETx_IEEE_R_CRC).....	963
22.5.85	Frames Received with Alignment Error Statistic Register (ENETx_IEEE_R_ALIGN).....	963
22.5.86	Receive FIFO Overflow Count Statistic Register (ENETx_IEEE_R_MACERR).....	964
22.5.87	Flow Control Pause Frames Received Statistic Register (ENETx_IEEE_R_FDXFC).....	964
22.5.88	Octet Count for Frames Received without Error Statistic Register (ENETx_IEEE_R_OCTETS_OK)...	964
22.5.89	Adjustable Timer Control Register (ENETx_ATCR).....	965
22.5.90	Timer Value Register (ENETx_ATVR).....	967
22.5.91	Timer Offset Register (ENETx_ATOFF).....	967
22.5.92	Timer Period Register (ENETx_ATPER).....	967
22.5.93	Timer Correction Register (ENETx_ATCOR).....	968
22.5.94	Time-Stamping Clock Period Register (ENETx_ATINC).....	969
22.5.95	Timestamp of Last Transmitted Frame (ENETx_ATSTMP).....	969
22.5.96	Timer Global Status Register (ENETx_TGSR).....	970
22.5.97	Timer Control Status Register (ENETx_TCSR n).....	971
22.5.98	Timer Compare Capture Register (ENETx_TCCR n).....	972
22.6	Functional description.....	973
22.6.1	Ethernet MAC frame formats.....	973
22.6.1.1	Pause Frames.....	975
22.6.1.2	Magic packets.....	975
22.6.2	IP and higher layers frame format.....	976
22.6.2.1	Ethernet types.....	976
22.6.2.2	IPv4 datagram format.....	976

Section number	Title	Page
22.6.2.3	IPv6 datagram format.....	977
22.6.2.4	Internet Control Message Protocol (ICMP) datagram format.....	978
22.6.2.5	User Datagram Protocol (UDP) datagram format.....	979
22.6.2.6	TCP datagram format.....	979
22.6.3	IEEE 1588 message formats.....	980
22.6.3.1	Transport encapsulation.....	980
22.6.3.1.1	UDP/IP.....	980
22.6.3.1.2	Native Ethernet (PTPv2).....	981
22.6.3.2	PTP header.....	981
22.6.3.2.1	PTPv1 header.....	982
22.6.3.2.2	PTPv2 header.....	982
22.6.4	MAC receive.....	984
22.6.4.1	Collision detection in half-duplex mode.....	985
22.6.4.2	Preamble processing.....	985
22.6.4.3	MAC address check.....	986
22.6.4.3.1	Unicast address check.....	986
22.6.4.3.2	Multicast and unicast address resolution.....	986
22.6.4.3.3	Broadcast address reject.....	987
22.6.4.3.4	Miss-bit implementation.....	987
22.6.4.4	Frame length/type verification: payload length check.....	988
22.6.4.5	Frame length/type verification: frame length check.....	988
22.6.4.6	VLAN frames processing.....	988
22.6.4.7	Pause frame termination.....	988
22.6.4.8	CRC check.....	989
22.6.4.9	Frame padding removal.....	989
22.6.5	MAC transmit.....	990
22.6.5.1	Frame payload padding.....	991
22.6.5.2	MAC address insertion.....	991
22.6.5.3	CRC-32 generation.....	991

Section number	Title	Page
22.6.5.4	Inter-packet gap (IPG).....	992
22.6.5.5	Collision detection and handling — half-duplex operation only.....	992
22.6.6	Full-duplex flow control operation.....	994
22.6.6.1	Remote device congestion.....	994
22.6.6.2	Local device/FIFO congestion.....	995
22.6.7	Magic packet detection.....	996
22.6.7.1	Sleep mode.....	996
22.6.7.2	Magic packet detection.....	996
22.6.7.3	Wakeup.....	996
22.6.8	IP accelerator functions.....	997
22.6.8.1	Checksum calculation.....	997
22.6.8.2	Additional padding processing.....	998
22.6.8.3	32-bit Ethernet payload alignment.....	998
22.6.8.3.1	Receive processing.....	999
22.6.8.3.2	Transmit processing.....	999
22.6.8.4	Received frame discard.....	999
22.6.8.5	IPv4 fragments.....	1000
22.6.8.6	IPv6 support.....	1000
22.6.8.6.1	Receive processing.....	1000
22.6.8.6.2	Transmit processing.....	1001
22.6.9	Resets and stop controls.....	1001
22.6.9.1	Hardware reset.....	1001
22.6.9.2	Soft reset.....	1001
22.6.9.3	Hardware freeze.....	1002
22.6.9.4	Graceful stop.....	1002
22.6.9.4.1	Graceful transmit stop (GTS).....	1003
22.6.9.4.2	Graceful receive stop (GRS).....	1003
22.6.9.4.3	Graceful stop interrupt (GRA).....	1004
22.6.10	IEEE 1588 functions.....	1004

Section number	Title	Page
22.6.10.1	Adjustable timer module.....	1005
22.6.10.1.1	Adjustable timer implementation.....	1005
22.6.10.2	Transmit timestamping.....	1007
22.6.10.3	Receive timestamping.....	1007
22.6.10.4	Time synchronization.....	1007
22.6.10.5	Input Capture and Output Compare.....	1008
22.6.10.5.1	Input capture.....	1008
22.6.10.5.2	Output compare.....	1008
22.6.10.5.3	DMA requests.....	1008
22.6.11	FIFO thresholds.....	1008
22.6.11.1	Receive FIFO.....	1009
22.6.11.2	Transmit FIFO.....	1010
22.6.12	Loopback options.....	1011
22.6.13	Legacy buffer descriptors.....	1012
22.6.13.1	Legacy receive buffer descriptor.....	1012
22.6.13.2	Legacy transmit buffer descriptor.....	1012
22.6.14	Enhanced buffer descriptors.....	1013
22.6.14.1	Enhanced receive buffer descriptor.....	1013
22.6.14.2	Enhanced transmit buffer descriptor.....	1017
22.6.15	Client FIFO application interface.....	1019
22.6.15.1	Data structure description.....	1020
22.6.15.2	Data structure examples.....	1021
22.6.15.3	Frame status.....	1022
22.6.16	FIFO protection.....	1022
22.6.16.1	Transmit FIFO underflow.....	1023
22.6.16.2	Transmit FIFO overflow.....	1023
22.6.16.3	Receive FIFO overflow.....	1024
22.6.17	PHY management interface.....	1025
22.6.17.1	MDIO clause 22 frame format.....	1025

Section number	Title	Page
22.6.17.2	MDIO clause 45 frame format.....	1026
22.6.17.3	MDIO clock generation.....	1027
22.6.17.4	MDIO operation.....	1027
22.6.18	Ethernet interfaces.....	1028
22.6.18.1	RMII interface.....	1028
22.6.18.2	MII Interface — transmit.....	1029
22.6.18.2.1	Transmit with collision — half-duplex.....	1030
22.6.18.3	MII interface — receive.....	1031
22.6.19	Interrupt coalescence.....	1032
22.6.19.1	Interrupt coalescence setup.....	1032
22.6.19.2	Updating the frame count threshold on-the-fly.....	1033
22.6.19.3	Updating the timer threshold on-the-fly.....	1033

Chapter 23 Electrophoretic Display Controller (EPDC)

23.1	Overview	1035
23.1.1	EPDC Block Diagram.....	1036
23.2	External Signals.....	1037
23.3	Programming Model.....	1037
23.3.1	Assumptions.....	1037
23.3.2	Register Space (Write/Set/Clear/Toggle).....	1038
23.3.3	Interrupts.....	1039
23.3.3.1	Interrupt Sources.....	1039
23.3.3.2	Enabling/Masking Interrupts.....	1039
23.3.3.3	Handling/Clearing Interrupts.....	1039
23.3.4	Controller Setup.....	1040
23.3.4.1	Memory Requirements.....	1040
23.3.4.2	Panel Architecture Configuration.....	1041
23.3.4.3	TFT Panel Timing Configuration	1043
23.3.4.4	Source Driver and Pixel Clock Configuration.....	1049

Section number	Title	Page
23.3.4.5	Initializing the Display.....	1050
23.3.4.5.1	Reset/Clocks and Buffer Preparation.....	1050
23.3.4.5.2	Performing an Initialization Display Update.....	1051
23.3.5	Update Buffer Analysis Functions.....	1051
23.3.6	Waveform Mode Selection (AUTOWV).....	1052
23.3.7	Panel Interface Generator (Pigeon Mode).....	1053
23.3.8	Display Update Programming.....	1057
23.3.8.1	Initiating a Display Update.....	1057
23.3.8.2	Update Processing and Collisions.....	1058
23.3.8.3	Multiple Update Flow.....	1062
23.3.9	Architectural Clock Gating (Low Power Mode).....	1065
23.3.10	Performance Tuning and Considerations.....	1067
23.3.10.1	Memory and Bus Bandwidth Requirements.....	1067
23.3.10.2	Pixel Latency FIFO.....	1068
23.3.10.3	Basic Watermarking Control.....	1068
23.3.10.4	Update/Refresh Tuning (VSCAN_HOLDOFF).....	1069
23.3.10.5	System-Level Arbitration Control.....	1069
23.4	EPDC Memory Map/Register Definition.....	1071
23.4.1	EPDC Control Register (EPDC_CTRL n).....	1080
23.4.2	EPDC Working Buffer Address for TCE (EPDC_WB_ADDR_TCE).....	1082
23.4.3	EPDC Waveform Address Pointer (EPDC_WVADDR).....	1082
23.4.4	EPDC Working Buffer Address (EPDC_WB_ADDR).....	1083
23.4.5	EPDC Screen Resolution (EPDC_RES).....	1083
23.4.6	EPDC Format Control Register (EPDC_FORMAT n).....	1084
23.4.7	Working Buffer Field Setting (EPDC_WB_FIELD0).....	1086
23.4.8	Working Buffer Field Setting (EPDC_WB_FIELD1).....	1087
23.4.9	Working Buffer Field Setting (EPDC_WB_FIELD2).....	1088
23.4.10	Working Buffer Field Setting (EPDC_WB_FIELD3).....	1089
23.4.11	EPDC FIFO control register (EPDC_FIFOCTRL n).....	1089

Section number	Title	Page
23.4.12	EPDC Update Region Address (EPDC_UPD_ADDR).....	1090
23.4.13	EPDC Update Region Stride (EPDC_UPD_STRIDE).....	1091
23.4.14	EPDC Update Command Co-ordinate (EPDC_UPD_CORD).....	1092
23.4.15	EPDC Update Command Size (EPDC_UPD_SIZE).....	1092
23.4.16	EPDC Update Command Control (EPDC_UPD_CTRL n).....	1093
23.4.17	EPDC Update Fixed Pixel Control (EPDC_UPD_FIXED n).....	1094
23.4.18	EPDC Temperature Register (EPDC_TEMP).....	1095
23.4.19	Waveform Mode Lookup Table Control Register. (EPDC_AUTOWV_LUT).....	1095
23.4.20	EPDC LUT Standby Register for LUT 31~0 (EPDC_LUT_STANDBY1 n).....	1096
23.4.21	EPDC LUT Standby Register for LUT 63~32 (EPDC_LUT_STANDBY2 n).....	1096
23.4.22	EPDC Timing Control Engine Control Register (EPDC_TCE_CTRL n).....	1096
23.4.23	EPDC Timing Control Engine Source-Driver Config Register (EPDC_TCE_SDCFG n).....	1099
23.4.24	EPDC Timing Control Engine Gate-Driver Config Register (EPDC_TCE_GDCFG n).....	1100
23.4.25	EPDC Timing Control Engine Horizontal Timing Register 1 (EPDC_TCE_HSCAN1 n).....	1101
23.4.26	EPDC Timing Control Engine Horizontal Timing Register 2 (EPDC_TCE_HSCAN2 n).....	1101
23.4.27	EPDC Timing Control Engine Vertical Timing Register (EPDC_TCE_VSCAN n).....	1102
23.4.28	EPDC Timing Control Engine OE timing control Register (EPDC_TCE_OE n).....	1102
23.4.29	EPDC Timing Control Engine Driver Polarity Register (EPDC_TCE_POLARITY n).....	1103
23.4.30	EPDC Timing Control Engine Timing Register 1 (EPDC_TCE_TIMING1 n).....	1104
23.4.31	EPDC Timing Control Engine Timing Register 2 (EPDC_TCE_TIMING2 n).....	1105
23.4.32	EPDC Timing Control Engine Timing Register 3 (EPDC_TCE_TIMING3 n).....	1106
23.4.33	EPDC Pigeon Mode Control Register 0 (EPDC_PIGEON_CTRL0 n).....	1106
23.4.34	EPDC Pigeon Mode Control Register 1 (EPDC_PIGEON_CTRL1 n).....	1107
23.4.35	EPDC IRQ Mask Register for LUT 0~31 (EPDC_IRQ_MASK1 n).....	1107
23.4.36	EPDC IRQ Mask Register for LUT 32~63 (EPDC_IRQ_MASK2 n).....	1108
23.4.37	EPDC Interrupt Register for LUT 0~31 (EPDC_IRQ1 n).....	1108
23.4.38	EPDC Interrupt Register for LUT 32~63 (EPDC_IRQ2 n).....	1108
23.4.39	EPDC IRQ Mask Register (EPDC_IRQ_MASK n).....	1109
23.4.40	EPDC Interrupt Register (EPDC_IRQ n).....	1110

Section number	Title	Page
23.4.41	EPDC Status Register - LUTs (EPDC_STATUS_LUTS1n).....	1111
23.4.42	EPDC Status Register - LUTs (EPDC_STATUS_LUTS2n).....	1112
23.4.43	EPDC Status Register - Next Available LUT (EPDC_STATUS_NEXTLUT).....	1112
23.4.44	EPDC LUT Collision Status (EPDC_STATUS_COL1n).....	1114
23.4.45	EPDC LUT Collision Status (EPDC_STATUS_COL2n).....	1114
23.4.46	EPDC General Status Register (EPDC_STATUSn).....	1115
23.4.47	EPDC Collision Region Co-ordinate (EPDC_UPD_COL_CORD).....	1116
23.4.48	EPDC Collision Region Size (EPDC_UPD_COL_SIZE).....	1117
23.4.49	1-level Histogram Parameter Register. (EPDC_HIST1_PARAM).....	1117
23.4.50	2-level Histogram Parameter Register. (EPDC_HIST2_PARAM).....	1118
23.4.51	4-level Histogram Parameter Register. (EPDC_HIST4_PARAM).....	1119
23.4.52	8-level Histogram Parameter 0 Register. (EPDC_HIST8_PARAM0).....	1119
23.4.53	8-level Histogram Parameter 1 Register. (EPDC_HIST8_PARAM1).....	1120
23.4.54	16-level Histogram Parameter 0 Register. (EPDC_HIST16_PARAM0).....	1121
23.4.55	16-level Histogram Parameter Register. (EPDC_HIST16_PARAM1).....	1122
23.4.56	16-level Histogram Parameter Register. (EPDC_HIST16_PARAM2).....	1122
23.4.57	16-level Histogram Parameter Register. (EPDC_HIST16_PARAM3).....	1123
23.4.58	EPDC General Purpose I/O Debug register (EPDC_GPIOn).....	1124
23.4.59	EPDC Version Register (EPDC_VERSION).....	1125
23.4.60	Panel Interface Signal Generator Register 0_0 (EPDC_PIGEON_0_0).....	1126
23.4.61	Panel Interface Signal Generator Register 0_1 (EPDC_PIGEON_0_1).....	1127
23.4.62	Panel Interface Signal Generator Register 0_1 (EPDC_PIGEON_0_2).....	1127
23.4.63	Panel Interface Signal Generator Register 1_0 (EPDC_PIGEON_1_0).....	1128
23.4.64	Panel Interface Signal Generator Register 1_1 (EPDC_PIGEON_1_1).....	1129
23.4.65	Panel Interface Signal Generator Register 1_1 (EPDC_PIGEON_1_2).....	1130
23.4.66	Panel Interface Signal Generator Register 2_0 (EPDC_PIGEON_2_0).....	1130
23.4.67	Panel Interface Signal Generator Register 2_1 (EPDC_PIGEON_2_1).....	1132
23.4.68	Panel Interface Signal Generator Register 2_1 (EPDC_PIGEON_2_2).....	1132
23.4.69	Panel Interface Signal Generator Register 3_0 (EPDC_PIGEON_3_0).....	1133

Section number	Title	Page
23.4.70	Panel Interface Signal Generator Register 3_1 (EPDC_PIGEON_3_1).....	1134
23.4.71	Panel Interface Signal Generator Register 3_1 (EPDC_PIGEON_3_2).....	1134
23.4.72	Panel Interface Signal Generator Register 4_0 (EPDC_PIGEON_4_0).....	1135
23.4.73	Panel Interface Signal Generator Register 4_1 (EPDC_PIGEON_4_1).....	1136
23.4.74	Panel Interface Signal Generator Register 4_1 (EPDC_PIGEON_4_2).....	1137
23.4.75	Panel Interface Signal Generator Register 5_0 (EPDC_PIGEON_5_0).....	1137
23.4.76	Panel Interface Signal Generator Register 5_1 (EPDC_PIGEON_5_1).....	1139
23.4.77	Panel Interface Signal Generator Register 5_1 (EPDC_PIGEON_5_2).....	1139
23.4.78	Panel Interface Signal Generator Register 6_0 (EPDC_PIGEON_6_0).....	1140
23.4.79	Panel Interface Signal Generator Register 6_1 (EPDC_PIGEON_6_1).....	1141
23.4.80	Panel Interface Signal Generator Register 6_1 (EPDC_PIGEON_6_2).....	1141
23.4.81	Panel Interface Signal Generator Register 7_0 (EPDC_PIGEON_7_0).....	1142
23.4.82	Panel Interface Signal Generator Register 7_1 (EPDC_PIGEON_7_1).....	1143
23.4.83	Panel Interface Signal Generator Register 7_1 (EPDC_PIGEON_7_2).....	1144
23.4.84	Panel Interface Signal Generator Register 8_0 (EPDC_PIGEON_8_0).....	1144
23.4.85	Panel Interface Signal Generator Register 8_1 (EPDC_PIGEON_8_1).....	1146
23.4.86	Panel Interface Signal Generator Register 8_1 (EPDC_PIGEON_8_2).....	1146
23.4.87	Panel Interface Signal Generator Register 9_0 (EPDC_PIGEON_9_0).....	1147
23.4.88	Panel Interface Signal Generator Register 9_1 (EPDC_PIGEON_9_1).....	1148
23.4.89	Panel Interface Signal Generator Register 9_1 (EPDC_PIGEON_9_2).....	1148
23.4.90	Panel Interface Signal Generator Register 10_0 (EPDC_PIGEON_10_0).....	1149
23.4.91	Panel Interface Signal Generator Register 10_1 (EPDC_PIGEON_10_1).....	1150
23.4.92	Panel Interface Signal Generator Register 10_1 (EPDC_PIGEON_10_2).....	1151
23.4.93	Panel Interface Signal Generator Register 11_0 (EPDC_PIGEON_11_0).....	1151
23.4.94	Panel Interface Signal Generator Register 11_1 (EPDC_PIGEON_11_1).....	1153
23.4.95	Panel Interface Signal Generator Register 11_1 (EPDC_PIGEON_11_2).....	1153
23.4.96	Panel Interface Signal Generator Register 12_0 (EPDC_PIGEON_12_0).....	1154
23.4.97	Panel Interface Signal Generator Register 12_1 (EPDC_PIGEON_12_1).....	1155
23.4.98	Panel Interface Signal Generator Register 12_1 (EPDC_PIGEON_12_2).....	1155

Section number	Title	Page
23.4.99	Panel Interface Signal Generator Register 13_0 (EPDC_PIGEON_13_0).....	1156
23.4.100	Panel Interface Signal Generator Register 13_1 (EPDC_PIGEON_13_1).....	1157
23.4.101	Panel Interface Signal Generator Register 13_1 (EPDC_PIGEON_13_2).....	1158
23.4.102	Panel Interface Signal Generator Register 14_0 (EPDC_PIGEON_14_0).....	1158
23.4.103	Panel Interface Signal Generator Register 14_1 (EPDC_PIGEON_14_1).....	1160
23.4.104	Panel Interface Signal Generator Register 14_1 (EPDC_PIGEON_14_2).....	1160
23.4.105	Panel Interface Signal Generator Register 15_0 (EPDC_PIGEON_15_0).....	1161
23.4.106	Panel Interface Signal Generator Register 15_1 (EPDC_PIGEON_15_1).....	1162
23.4.107	Panel Interface Signal Generator Register 15_1 (EPDC_PIGEON_15_2).....	1162
23.4.108	Panel Interface Signal Generator Register 16_0 (EPDC_PIGEON_16_0).....	1163
23.4.109	Panel Interface Signal Generator Register 16_1 (EPDC_PIGEON_16_1).....	1164
23.4.110	Panel Interface Signal Generator Register 16_1 (EPDC_PIGEON_16_2).....	1165

Chapter 24 Enhanced Periodic Interrupt Timer (EPIT)

24.1	Overview.....	1167
24.1.1	EPIT features.....	1167
24.1.2	EPIT modes and operations.....	1168
24.2	External signals.....	1168
24.3	Clocks.....	1168
24.4	Functional Description.....	1170
24.4.1	Operating modes.....	1170
24.4.1.1	Operating in set-and-forget mode.....	1170
24.4.1.2	Operating in free-running mode.....	1170
24.4.2	Operations.....	1171
24.4.3	Compare Event.....	1171
24.4.3.1	Counter Value Overwrite.....	1172
24.4.3.2	Low-Power Mode Behavior.....	1173
24.4.3.3	Debug Mode Behavior.....	1173
24.5	Initialization/ Application Information.....	1173

Section number	Title	Page
24.5.1	Change of Clock Source.....	1173
24.6	EPIT Memory Map/Register Definition.....	1174
24.6.1	Control register (EPITx_CR).....	1174
24.6.2	Status register (EPITx_SR).....	1177
24.6.3	Load register (EPITx_LR).....	1177
24.6.4	Compare register (EPITx_CMPR).....	1178
24.6.5	Counter register (EPITx_CNR).....	1178

Chapter 25 Enhanced Serial Audio Interface (ESAI)

25.1	Overview.....	1179
25.1.1	Features.....	1181
25.1.2	Modes of Operation.....	1181
25.1.2.1	Normal/Network/On-Demand Mode Selection.....	1181
25.1.2.2	Synchronous/Asynchronous Operating Modes.....	1182
25.1.2.3	Frame Sync Selection.....	1182
25.1.2.4	Shift Direction Selection.....	1183
25.2	External Signals.....	1184
25.2.1	Serial Transmit 0 Data Pin.....	1184
25.2.2	Serial Transmit 1 Data Pin.....	1184
25.2.3	Serial Transmit 2/Receive 3 Data Pin.....	1184
25.2.4	Serial Transmit 3/Receive 2 Data Pin.....	1185
25.2.5	Serial Transmit 4/Receive 1 Data Pin.....	1185
25.2.6	Serial Transmit 5/Receive 0 Data Pin.....	1186
25.2.7	Receiver Serial Clock.....	1186
25.2.8	Transmitter Serial Clock.....	1188
25.2.9	Frame Sync for Receiver.....	1189
25.2.10	Frame Sync for Transmitter.....	1190
25.2.11	High Frequency Clock for Transmitter.....	1190
25.2.12	High Frequency Clock for Receiver.....	1190

Section number	Title	Page
25.2.13	Serial I/O Flags.....	1191
25.3	Clocks.....	1192
25.4	Functional Description.....	1192
25.4.1	ESAI After Reset.....	1192
25.4.2	ESAI Interrupt Requests.....	1193
25.4.3	ESAI DMA Requests from the FIFOs.....	1194
25.4.4	ESAI Transmit and Receive Shift Registers.....	1194
25.4.4.1	ESAI Transmit Shift Registers.....	1195
25.4.4.2	ESAI Receive Shift Registers.....	1198
25.5	Initialization Information.....	1198
25.5.1	ESAI Initialization.....	1198
25.5.2	ESAI Initialization Examples.....	1199
25.5.2.1	Initializing the ESAI using Personal Reset.....	1199
25.5.2.2	Initializing the ESAI Transmitter Section.....	1200
25.5.2.3	Initializing the ESAI Receiver Section.....	1200
25.6	ESAI Memory Map/Register Definition.....	1201
25.6.1	ESAI Transmit Data Register (ESAI_ETDR).....	1203
25.6.2	ESAI Receive Data Register (ESAI_ERDR).....	1203
25.6.3	ESAI Control Register (ESAI_ECR).....	1204
25.6.4	ESAI Status Register (ESAI_ESR).....	1205
25.6.5	Transmit FIFO Configuration Register (ESAI_TFCR).....	1206
25.6.6	Transmit FIFO Status Register (ESAI_TFSR).....	1208
25.6.7	Receive FIFO Configuration Register (ESAI_RFCR).....	1209
25.6.8	Receive FIFO Status Register (ESAI_RFSR).....	1211
25.6.9	Transmit Data Register n (ESAI_TXn).....	1212
25.6.10	ESAI Transmit Slot Register (ESAI_TSR).....	1212
25.6.11	Receive Data Register n (ESAI_RXn).....	1213
25.6.12	Serial Audio Interface Status Register (ESAI_SAISR).....	1214
25.6.13	Serial Audio Interface Control Register (ESAI_SAICR).....	1216

Section number	Title	Page
25.6.14	Transmit Control Register (ESAI_TCR).....	1219
25.6.15	Transmit Clock Control Register (ESAI_TCCR).....	1227
25.6.16	Receive Control Register (ESAI_RCR).....	1231
25.6.17	Receive Clock Control Register (ESAI_RCCR).....	1235
25.6.18	Transmit Slot Mask Register A (ESAI_TSMA).....	1238
25.6.19	Transmit Slot Mask Register B (ESAI_TSMB).....	1239
25.6.20	Receive Slot Mask Register A (ESAI_RSMA).....	1240
25.6.21	Receive Slot Mask Register B (ESAI_RSMB).....	1241
25.6.22	Port C Direction Register (ESAI_PPRC).....	1242
25.6.23	Port C Control Register (ESAI_PCRC).....	1242

Chapter 26 Flexible Controller Area Network (FLEXCAN)

26.1	Overview.....	1245
26.1.1	Block Diagram.....	1245
26.1.2	FLEXCAN Module Features.....	1247
26.1.3	Modes of Operation.....	1248
26.2	External Signals.....	1249
26.3	Clocks.....	1250
26.4	Message Buffer Structure.....	1250
26.5	Rx FIFO Structure.....	1254
26.6	Functional Description.....	1258
26.6.1	Functional Overview.....	1258
26.6.2	Transmit Process.....	1258
26.6.3	Arbitration process.....	1259
26.6.3.1	Lowest Mailbox number first.....	1260
26.6.3.2	Highest Mailbox priority first.....	1260
26.6.3.2.1	Local Priority disabled.....	1260
26.6.3.2.2	Local Priority enabled.....	1261
26.6.4	Receive Process.....	1262

Section number	Title	Page
26.6.5	Matching Process.....	1264
26.6.6	Move Process.....	1268
26.6.6.1	Move-in.....	1269
26.6.6.2	Move-out.....	1270
26.6.7	Data Coherence.....	1270
26.6.7.1	Transmission Abort Mechanism.....	1270
26.6.7.2	Message Buffer Inactivation.....	1271
26.6.7.3	Message Buffer Lock Mechanism.....	1272
26.6.8	Rx FIFO.....	1273
26.6.9	CAN Protocol Related Features.....	1275
26.6.9.1	Remote Frames.....	1275
26.6.9.2	Overload Frames.....	1276
26.6.9.3	Time Stamp.....	1276
26.6.9.4	Protocol Timing.....	1276
26.6.9.5	Arbitration and Matching Timing.....	1279
26.6.10	Modes of Operation Details.....	1281
26.6.10.1	Freeze Mode.....	1281
26.6.10.2	Module Disable Mode.....	1282
26.6.10.3	Stop Mode.....	1283
26.6.11	Interrupts.....	1284
26.7	Initialization/Application Information.....	1284
26.7.1	FLEXCAN Initialization Sequence.....	1285
26.8	FLEXCAN Memory Map/Register Definition.....	1286
26.8.1	Module Configuration Register (FLEXCAN _x _MCR).....	1293
26.8.2	Control 1 Register (FLEXCAN _x _CTRL1).....	1298
26.8.3	Free Running Timer Register (FLEXCAN _x _TIMER).....	1301
26.8.4	Rx Mailboxes Global Mask Register (FLEXCAN _x _RXMGMASK).....	1301
26.8.5	Rx Buffer 14 Mask Register (FLEXCAN _x _RX14MASK).....	1302
26.8.6	Rx Buffer 15 Mask Register (FLEXCAN _x _RX15MASK).....	1303

Section number	Title	Page
26.8.7	Error Counter Register (FLEXCAN _x _ECR).....	1304
26.8.8	Error and Status 1 Register (FLEXCAN _x _ESR1).....	1305
26.8.9	Interrupt Masks 2 Register (FLEXCAN _x _IMASK2).....	1309
26.8.10	Interrupt Masks 1 Register (FLEXCAN _x _IMASK1).....	1309
26.8.11	Interrupt Flags 2 Register (FLEXCAN _x _IFLAG2).....	1310
26.8.12	Interrupt Flags 1 Register (FLEXCAN _x _IFLAG1).....	1310
26.8.13	Control 2 Register (FLEXCAN _x _CTRL2).....	1312
26.8.14	Error and Status 2 Register (FLEXCAN _x _ESR2).....	1318
26.8.15	CRC Register (FLEXCAN _x _CRCR).....	1320
26.8.16	Rx FIFO Global Mask Register (FLEXCAN _x _RXFGMASK).....	1321
26.8.17	Rx FIFO Information Register (FLEXCAN _x _RXFIR).....	1322
26.8.18	Rx Individual Mask Registers (FLEXCAN _x _RXIMR _n).....	1323
26.8.19	Glitch Filter Width Registers (FLEXCAN _x _GFWR).....	1323

Chapter 27 General Power Controller (GPC)

27.1	Overview.....	1325
27.2	Clocks.....	1325
27.3	Power Gating Control (PGC).....	1325
27.3.1	Overview.....	1327
27.3.1.1	Features.....	1328
27.4	GPC Interrupt Controller (INTC).....	1328
27.4.1	Interrupt Controller features.....	1328
27.5	GPC Memory Map/Register Definition.....	1329
27.5.1	GPC Interface control register (GPC_CNTR).....	1329
27.5.2	GPC Power Gating Register (GPC_PGR).....	1331
27.5.3	IRQ masking register 1 (GPC_IMR1).....	1332
27.5.4	IRQ masking register 2 (GPC_IMR2).....	1332
27.5.5	IRQ masking register 3 (GPC_IMR3).....	1332
27.5.6	IRQ masking register 4 (GPC_IMR4).....	1333

Section number	Title	Page
27.5.7	IRQ status resister 1 (GPC_ISR1).....	1333
27.5.8	IRQ status resister 2 (GPC_ISR2).....	1334
27.5.9	IRQ status resister 3 (GPC_ISR3).....	1334
27.5.10	IRQ status resister 4 (GPC_ISR4).....	1335
27.6	PGC Memory Map/Register Definition.....	1335
27.6.1	PGC Mega Control Register (PGC_MEGA_CTRL).....	1336
27.6.2	PGC Mega Power Up Sequence Control Register (PGC_MEGA_PUPSCR).....	1337
27.6.3	PGC Mega Pull Down Sequence Control Register (PGC_MEGA_PDNSCR).....	1337
27.6.4	PGC Mega Power Gating Controller Status Register (PGC_MEGA_SR).....	1338
27.6.5	PGC CPU Control Register (PGC_CPU_CTRL).....	1339
27.6.6	PGC CPU Power Up Sequence Control Register (PGC_CPU_PUPSCR).....	1339
27.6.7	PGC CPU Pull Down Sequence Control Register (PGC_CPU_PDNSCR).....	1340
27.6.8	PGC CPU Power Gating Controller Status Register (PGC_CPU_SR).....	1341

Chapter 28

General Purpose Input/Output (GPIO)

28.1	Overview.....	1343
28.1.1	Block Diagram.....	1345
28.1.2	Features.....	1346
28.2	External Signals.....	1346
28.3	Clocks.....	1350
28.4	GPIO Functional Description.....	1350
28.4.1	GPIO Function.....	1351
28.4.2	GPIO pad structure.....	1351
28.4.2.1	Input Driver.....	1351
28.4.2.1.1	Schmitt trigger.....	1352
28.4.2.1.2	Input keeper.....	1353
28.4.2.2	Output Driver.....	1353
28.4.2.2.1	Drive strength.....	1353
28.4.2.2.2	Output keeper.....	1354

Section number	Title	Page
28.4.2.2.3	PU / PD / Keeper Logic.....	1354
28.4.2.2.4	Open drain.....	1354
28.4.3	GPIO Programming.....	1355
28.4.3.1	GPIO Read Mode.....	1355
28.4.3.2	GPIO Write Mode.....	1356
28.4.4	Interrupt Control Unit.....	1356
28.5	GPIO Memory Map/Register Definition.....	1356
28.5.1	GPIO data register (GPIOx_DR).....	1358
28.5.2	GPIO direction register (GPIOx_GDIR).....	1359
28.5.3	GPIO pad status register (GPIOx_PSR).....	1359
28.5.4	GPIO interrupt configuration register1 (GPIOx_ICR1).....	1360
28.5.5	GPIO interrupt configuration register2 (GPIOx_ICR2).....	1364
28.5.6	GPIO interrupt mask register (GPIOx_IMR).....	1367
28.5.7	GPIO interrupt status register (GPIOx_ISR).....	1368
28.5.8	GPIO edge select register (GPIOx_EDGE_SEL).....	1369

Chapter 29 General Purpose Media Interface (GPMI)

29.1	Overview.....	1371
29.2	External Signals.....	1372
29.3	Clocks.....	1373
29.4	GPMI NAND Mode.....	1374
29.4.1	Multiple NAND Support.....	1374
29.4.2	GPMI NAND Timing and Clocking.....	1375
29.4.3	Basic NAND Timing.....	1375
29.4.3.1	NAND Asynchronous Timing.....	1375
29.4.3.2	NAND Asynchronous EDO Mode Timing.....	1377
29.4.3.3	NAND ONFI Source Synchronous Mode Timing.....	1380
29.4.3.4	NAND Toggle Mode Timing.....	1385
29.4.4	Hardware BCH Interface.....	1393

Section number	Title	Page
29.5	Behavior During Reset.....	1394
29.6	GPMI Memory Map/Register Definition.....	1394
29.6.1	GPMI Control Register 0 Description (GPMI_CTRL0n).....	1396
29.6.2	GPMI Compare Register Description (GPMI_COMPARE).....	1398
29.6.3	GPMI Integrated ECC Control Register Description (GPMI_ECCCTRLn).....	1399
29.6.4	GPMI Integrated ECC Transfer Count Register Description (GPMI_ECCCOUNT).....	1400
29.6.5	GPMI Payload Address Register Description (GPMI_PAYLOAD).....	1400
29.6.6	GPMI Auxiliary Address Register Description (GPMI_AUXILIARY).....	1401
29.6.7	GPMI Control Register 1 Description (GPMI_CTRL1n).....	1402
29.6.8	GPMI Timing Register 0 Description (GPMI_TIMING0).....	1404
29.6.9	GPMI Timing Register 1 Description (GPMI_TIMING1).....	1405
29.6.10	GPMI Timing Register 2 Description (GPMI_TIMING2).....	1406
29.6.11	GPMI DMA Data Transfer Register Description (GPMI_DATA).....	1407
29.6.12	GPMI Status Register Description (GPMI_STAT).....	1407
29.6.13	GPMI Debug Information Register Description (GPMI_DEBUG).....	1410
29.6.14	GPMI Version Register Description (GPMI_VERSION).....	1410
29.6.15	GPMI Debug2 Information Register Description (GPMI_DEBUG2).....	1411
29.6.16	GPMI Debug3 Information Register Description (GPMI_DEBUG3).....	1414
29.6.17	GPMI Double Rate Read DLL Control Register Description (GPMI_READ_DDR_DLL_CTRL).....	1414
29.6.18	GPMI Double Rate Write DLL Control Register Description (GPMI_WRITE_DDR_DLL_CTRL).....	1416
29.6.19	GPMI Double Rate Read DLL Status Register Description (GPMI_READ_DDR_DLL_STS).....	1418
29.6.20	GPMI Double Rate Write DLL Status Register Description (GPMI_WRITE_DDR_DLL_STS).....	1419

Chapter 30 General Purpose Timer (GPT)

30.1	Overview.....	1421
30.1.1	Features.....	1423
30.1.2	Modes and Operation.....	1423
30.2	External Signals.....	1423
30.2.1	External Clock Input	1425

Section number	Title	Page
30.2.2	Input Capture Trigger Signals	1425
30.2.3	Output Compare Signals.....	1425
30.3	Clocks.....	1425
30.4	Functional Description.....	1427
30.4.1	Operating Modes.....	1427
30.4.1.1	Restart Mode.....	1427
30.4.1.2	Free-Run Mode.....	1428
30.4.2	Operation.....	1428
30.4.2.1	Input Capture.....	1429
30.4.2.2	Output Compare.....	1430
30.4.2.3	Interrupts.....	1430
30.4.2.4	Low Power Mode Behavior.....	1431
30.4.2.5	Debug Mode Behavior.....	1431
30.5	Initialization/ Application Information	1432
30.5.1	Selecting the Clock Source	1432
30.6	GPT Memory Map/Register Definition.....	1432
30.6.1	GPT Control Register (GPTx_CR).....	1434
30.6.2	GPT Prescaler Register (GPTx_PR).....	1438
30.6.3	GPT Status Register (GPTx_SR).....	1439
30.6.4	GPT Interrupt Register (GPTx_IR).....	1440
30.6.5	GPT Output Compare Register 1 (GPTx_OCR1).....	1441
30.6.6	GPT Output Compare Register 2 (GPTx_OCR2).....	1442
30.6.7	GPT Output Compare Register 3 (GPTx_OCR3).....	1442
30.6.8	GPT Input Capture Register 1 (GPTx_ICR1).....	1443
30.6.9	GPT Input Capture Register 2 (GPTx_ICR2).....	1443
30.6.10	GPT Counter Register (GPTx_CNT).....	1444

Chapter 31 I2C Controller (I2C)

31.1	Overview.....	1445
------	---------------	------

Section number	Title	Page
31.1.1	Features.....	1447
31.1.2	Modes and operations.....	1448
31.2	External Signals.....	1448
31.3	Clocks.....	1449
31.4	Functional description.....	1449
31.4.1	I2C system configuration.....	1450
31.4.2	Arbitration procedure.....	1450
31.4.3	Clock synchronization.....	1450
31.4.4	Handshaking.....	1451
31.4.5	Clock stretching.....	1451
31.4.6	Peripheral bus accesses.....	1452
31.4.7	Generation of transfer error on IP bus.....	1452
31.4.8	Reset.....	1452
31.4.9	Interrupts.....	1452
31.4.10	Byte order.....	1452
31.5	Initialization.....	1453
31.5.1	Initialization sequence.....	1453
31.5.2	Generation of Start.....	1453
31.5.3	Post-transfer software response.....	1453
31.5.4	Generation of Stop.....	1454
31.5.5	Generation of Repeated Start.....	1454
31.5.6	Slave mode.....	1455
31.5.7	Arbitration lost.....	1455
31.6	Software restriction.....	1461
31.7	I2C Memory Map/Register Definition.....	1462
31.7.1	I2C Address Register (I2Cx_IADR).....	1463
31.7.2	I2C Frequency Divider Register (I2Cx_IFDR).....	1463
31.7.3	I2C Control Register (I2Cx_I2CR).....	1465
31.7.4	I2C Status Register (I2Cx_I2SR).....	1466

Section number	Title	Page
31.7.5	I2C Data I/O Register (I2Cx_I2DR).....	1468

Chapter 32 IOMUX Controller (IOMUXC)

32.1	Overview.....	1469
32.1.1	Features.....	1470
32.2	Clocks.....	1471
32.3	Functional description.....	1471
32.3.1	ALT6 and ALT7 extended muxing modes.....	1472
32.3.2	SW Loopback through SION bit.....	1473
32.3.3	Daisy chain - multi pads driving same module input pin.....	1473
32.4	IOMUXC GPR Memory Map/Register Definition.....	1474
32.4.1	GPR0 General Purpose Register (IOMUXC_GPR_GPR0).....	1475
32.4.2	GPR1 General Purpose Register (IOMUXC_GPR_GPR1).....	1478
32.4.3	GPR2 General Purpose Register (IOMUXC_GPR_GPR2).....	1481
32.4.4	GPR3 General Purpose Register (IOMUXC_GPR_GPR3).....	1484
32.4.5	GPR4 General Purpose Register (IOMUXC_GPR_GPR4).....	1487
32.4.6	GPR5 General Purpose Register (IOMUXC_GPR_GPR5).....	1490
32.4.7	GPR9 General Purpose Register (IOMUXC_GPR_GPR9).....	1493
32.4.8	GPR10 General Purpose Register (IOMUXC_GPR_GPR10).....	1494
32.4.9	GPR14 General Purpose Register (IOMUXC_GPR_GPR14).....	1495
32.5	IOMUXC SNVS Memory Map/Register Definition.....	1495
32.5.1	SW_MUX_CTL_PAD_BOOT_MODE0 SW MUX Control Register (IOMUXC_SNVS_SW_MUX_CTL_PAD_BOOT_MODE0).....	1497
32.5.2	SW_MUX_CTL_PAD_BOOT_MODE1 SW MUX Control Register (IOMUXC_SNVS_SW_MUX_CTL_PAD_BOOT_MODE1).....	1498
32.5.3	SW_MUX_CTL_PAD_SNVS_TAMPER0 SW MUX Control Register (IOMUXC_SNVS_SW_MUX_CTL_PAD_SNVS_TAMPER0).....	1499
32.5.4	SW_MUX_CTL_PAD_SNVS_TAMPER1 SW MUX Control Register (IOMUXC_SNVS_SW_MUX_CTL_PAD_SNVS_TAMPER1).....	1500

Section number	Title	Page
32.5.5	SW_MUX_CTL_PAD_SNVS_TAMPER2 SW MUX Control Register (IOMUXC_SNVS_SW_MUX_CTL_PAD_SNVS_TAMPER2).....	1501
32.5.6	SW_MUX_CTL_PAD_SNVS_TAMPER3 SW MUX Control Register (IOMUXC_SNVS_SW_MUX_CTL_PAD_SNVS_TAMPER3).....	1502
32.5.7	SW_MUX_CTL_PAD_SNVS_TAMPER4 SW MUX Control Register (IOMUXC_SNVS_SW_MUX_CTL_PAD_SNVS_TAMPER4).....	1503
32.5.8	SW_MUX_CTL_PAD_SNVS_TAMPER5 SW MUX Control Register (IOMUXC_SNVS_SW_MUX_CTL_PAD_SNVS_TAMPER5).....	1504
32.5.9	SW_MUX_CTL_PAD_SNVS_TAMPER6 SW MUX Control Register (IOMUXC_SNVS_SW_MUX_CTL_PAD_SNVS_TAMPER6).....	1505
32.5.10	SW_MUX_CTL_PAD_SNVS_TAMPER7 SW MUX Control Register (IOMUXC_SNVS_SW_MUX_CTL_PAD_SNVS_TAMPER7).....	1506
32.5.11	SW_MUX_CTL_PAD_SNVS_TAMPER8 SW MUX Control Register (IOMUXC_SNVS_SW_MUX_CTL_PAD_SNVS_TAMPER8).....	1507
32.5.12	SW_MUX_CTL_PAD_SNVS_TAMPER9 SW MUX Control Register (IOMUXC_SNVS_SW_MUX_CTL_PAD_SNVS_TAMPER9).....	1508
32.5.13	SW_PAD_CTL_PAD_TEST_MODE SW PAD Control Register (IOMUXC_SNVS_SW_PAD_CTL_PAD_TEST_MODE).....	1509
32.5.14	SW_PAD_CTL_PAD_POR_B SW PAD Control Register (IOMUXC_SNVS_SW_PAD_CTL_PAD_POR_B).....	1511
32.5.15	SW_PAD_CTL_PAD_ONOFF SW PAD Control Register (IOMUXC_SNVS_SW_PAD_CTL_PAD_ONOFF).....	1513
32.5.16	SW_PAD_CTL_PAD_SNVS_PMIC_ON_REQ SW PAD Control Register (IOMUXC_SNVS_SW_PAD_CTL_PAD_SNVS_PMIC_ON_REQ).....	1515
32.5.17	SW_PAD_CTL_PAD_CCM_PMIC_STBY_REQ SW PAD Control Register (IOMUXC_SNVS_SW_PAD_CTL_PAD_CCM_PMIC_STBY_REQ).....	1517
32.5.18	SW_PAD_CTL_PAD_BOOT_MODE0 SW PAD Control Register (IOMUXC_SNVS_SW_PAD_CTL_PAD_BOOT_MODE0).....	1519
32.5.19	SW_PAD_CTL_PAD_BOOT_MODE1 SW PAD Control Register (IOMUXC_SNVS_SW_PAD_CTL_PAD_BOOT_MODE1).....	1521
32.5.20	SW_PAD_CTL_PAD_SNVS_TAMPER0 SW PAD Control Register (IOMUXC_SNVS_SW_PAD_CTL_PAD_SNVS_TAMPER0).....	1523

Section number	Title	Page
32.5.21	SW_PAD_CTL_PAD_SNVS_TAMPER1 SW PAD Control Register (IOMUXC_SNVS_SW_PAD_CTL_PAD_SNVS_TAMPER1).....	1525
32.5.22	SW_PAD_CTL_PAD_SNVS_TAMPER2 SW PAD Control Register (IOMUXC_SNVS_SW_PAD_CTL_PAD_SNVS_TAMPER2).....	1527
32.5.23	SW_PAD_CTL_PAD_SNVS_TAMPER3 SW PAD Control Register (IOMUXC_SNVS_SW_PAD_CTL_PAD_SNVS_TAMPER3).....	1529
32.5.24	SW_PAD_CTL_PAD_SNVS_TAMPER4 SW PAD Control Register (IOMUXC_SNVS_SW_PAD_CTL_PAD_SNVS_TAMPER4).....	1531
32.5.25	SW_PAD_CTL_PAD_SNVS_TAMPER5 SW PAD Control Register (IOMUXC_SNVS_SW_PAD_CTL_PAD_SNVS_TAMPER5).....	1533
32.5.26	SW_PAD_CTL_PAD_SNVS_TAMPER6 SW PAD Control Register (IOMUXC_SNVS_SW_PAD_CTL_PAD_SNVS_TAMPER6).....	1535
32.5.27	SW_PAD_CTL_PAD_SNVS_TAMPER7 SW PAD Control Register (IOMUXC_SNVS_SW_PAD_CTL_PAD_SNVS_TAMPER7).....	1537
32.5.28	SW_PAD_CTL_PAD_SNVS_TAMPER8 SW PAD Control Register (IOMUXC_SNVS_SW_PAD_CTL_PAD_SNVS_TAMPER8).....	1539
32.5.29	SW_PAD_CTL_PAD_SNVS_TAMPER9 SW PAD Control Register (IOMUXC_SNVS_SW_PAD_CTL_PAD_SNVS_TAMPER9).....	1541
32.6	IOMUXC Memory Map/Register Definition.....	1542
32.6.1	SW_MUX_CTL_PAD_JTAG_MOD SW MUX Control Register (IOMUXC_SW_MUX_CTL_PAD_JTAG_MOD).....	1562
32.6.2	SW_MUX_CTL_PAD_JTAG_TMS SW MUX Control Register (IOMUXC_SW_MUX_CTL_PAD_JTAG_TMS).....	1563
32.6.3	SW_MUX_CTL_PAD_JTAG_TDO SW MUX Control Register (IOMUXC_SW_MUX_CTL_PAD_JTAG_TDO).....	1564
32.6.4	SW_MUX_CTL_PAD_JTAG_TDI SW MUX Control Register (IOMUXC_SW_MUX_CTL_PAD_JTAG_TDI).....	1565
32.6.5	SW_MUX_CTL_PAD_JTAG_TCK SW MUX Control Register (IOMUXC_SW_MUX_CTL_PAD_JTAG_TCK).....	1566
32.6.6	SW_MUX_CTL_PAD_JTAG_TRST_B SW MUX Control Register (IOMUXC_SW_MUX_CTL_PAD_JTAG_TRST_B).....	1567
32.6.7	SW_MUX_CTL_PAD_GPIO1_IO00 SW MUX Control Register (IOMUXC_SW_MUX_CTL_PAD_GPIO1_IO00).....	1568

Section number	Title	Page
32.6.8	SW_MUX_CTL_PAD_GPIO1_IO01 SW MUX Control Register (IOMUXC_SW_MUX_CTL_PAD_GPIO1_IO01).....	1569
32.6.9	SW_MUX_CTL_PAD_GPIO1_IO02 SW MUX Control Register (IOMUXC_SW_MUX_CTL_PAD_GPIO1_IO02).....	1570
32.6.10	SW_MUX_CTL_PAD_GPIO1_IO03 SW MUX Control Register (IOMUXC_SW_MUX_CTL_PAD_GPIO1_IO03).....	1571
32.6.11	SW_MUX_CTL_PAD_GPIO1_IO04 SW MUX Control Register (IOMUXC_SW_MUX_CTL_PAD_GPIO1_IO04).....	1572
32.6.12	SW_MUX_CTL_PAD_GPIO1_IO05 SW MUX Control Register (IOMUXC_SW_MUX_CTL_PAD_GPIO1_IO05).....	1573
32.6.13	SW_MUX_CTL_PAD_GPIO1_IO06 SW MUX Control Register (IOMUXC_SW_MUX_CTL_PAD_GPIO1_IO06).....	1574
32.6.14	SW_MUX_CTL_PAD_GPIO1_IO07 SW MUX Control Register (IOMUXC_SW_MUX_CTL_PAD_GPIO1_IO07).....	1575
32.6.15	SW_MUX_CTL_PAD_GPIO1_IO08 SW MUX Control Register (IOMUXC_SW_MUX_CTL_PAD_GPIO1_IO08).....	1576
32.6.16	SW_MUX_CTL_PAD_GPIO1_IO09 SW MUX Control Register (IOMUXC_SW_MUX_CTL_PAD_GPIO1_IO09).....	1577
32.6.17	SW_MUX_CTL_PAD_UART1_TX_DATA SW MUX Control Register (IOMUXC_SW_MUX_CTL_PAD_UART1_TX_DATA).....	1578
32.6.18	SW_MUX_CTL_PAD_UART1_RX_DATA SW MUX Control Register (IOMUXC_SW_MUX_CTL_PAD_UART1_RX_DATA).....	1579
32.6.19	SW_MUX_CTL_PAD_UART1_CTS_B SW MUX Control Register (IOMUXC_SW_MUX_CTL_PAD_UART1_CTS_B).....	1580
32.6.20	SW_MUX_CTL_PAD_UART1_RTS_B SW MUX Control Register (IOMUXC_SW_MUX_CTL_PAD_UART1_RTS_B).....	1581
32.6.21	SW_MUX_CTL_PAD_UART2_TX_DATA SW MUX Control Register (IOMUXC_SW_MUX_CTL_PAD_UART2_TX_DATA).....	1582
32.6.22	SW_MUX_CTL_PAD_UART2_RX_DATA SW MUX Control Register (IOMUXC_SW_MUX_CTL_PAD_UART2_RX_DATA).....	1583
32.6.23	SW_MUX_CTL_PAD_UART2_CTS_B SW MUX Control Register (IOMUXC_SW_MUX_CTL_PAD_UART2_CTS_B).....	1584

Section number	Title	Page
32.6.24	SW_MUX_CTL_PAD_UART2_RTS_B SW MUX Control Register (IOMUXC_SW_MUX_CTL_PAD_UART2_RTS_B).....	1585
32.6.25	SW_MUX_CTL_PAD_UART3_TX_DATA SW MUX Control Register (IOMUXC_SW_MUX_CTL_PAD_UART3_TX_DATA).....	1586
32.6.26	SW_MUX_CTL_PAD_UART3_RX_DATA SW MUX Control Register (IOMUXC_SW_MUX_CTL_PAD_UART3_RX_DATA).....	1587
32.6.27	SW_MUX_CTL_PAD_UART3_CTS_B SW MUX Control Register (IOMUXC_SW_MUX_CTL_PAD_UART3_CTS_B).....	1588
32.6.28	SW_MUX_CTL_PAD_UART3_RTS_B SW MUX Control Register (IOMUXC_SW_MUX_CTL_PAD_UART3_RTS_B).....	1589
32.6.29	SW_MUX_CTL_PAD_UART4_TX_DATA SW MUX Control Register (IOMUXC_SW_MUX_CTL_PAD_UART4_TX_DATA).....	1590
32.6.30	SW_MUX_CTL_PAD_UART4_RX_DATA SW MUX Control Register (IOMUXC_SW_MUX_CTL_PAD_UART4_RX_DATA).....	1591
32.6.31	SW_MUX_CTL_PAD_UART5_TX_DATA SW MUX Control Register (IOMUXC_SW_MUX_CTL_PAD_UART5_TX_DATA).....	1592
32.6.32	SW_MUX_CTL_PAD_UART5_RX_DATA SW MUX Control Register (IOMUXC_SW_MUX_CTL_PAD_UART5_RX_DATA).....	1593
32.6.33	SW_MUX_CTL_PAD_ENET1_RX_DATA0 SW MUX Control Register (IOMUXC_SW_MUX_CTL_PAD_ENET1_RX_DATA0).....	1594
32.6.34	SW_MUX_CTL_PAD_ENET1_RX_DATA1 SW MUX Control Register (IOMUXC_SW_MUX_CTL_PAD_ENET1_RX_DATA1).....	1595
32.6.35	SW_MUX_CTL_PAD_ENET1_RX_EN SW MUX Control Register (IOMUXC_SW_MUX_CTL_PAD_ENET1_RX_EN).....	1596
32.6.36	SW_MUX_CTL_PAD_ENET1_TX_DATA0 SW MUX Control Register (IOMUXC_SW_MUX_CTL_PAD_ENET1_TX_DATA0).....	1597
32.6.37	SW_MUX_CTL_PAD_ENET1_TX_DATA1 SW MUX Control Register (IOMUXC_SW_MUX_CTL_PAD_ENET1_TX_DATA1).....	1598
32.6.38	SW_MUX_CTL_PAD_ENET1_TX_EN SW MUX Control Register (IOMUXC_SW_MUX_CTL_PAD_ENET1_TX_EN).....	1599
32.6.39	SW_MUX_CTL_PAD_ENET1_TX_CLK SW MUX Control Register (IOMUXC_SW_MUX_CTL_PAD_ENET1_TX_CLK).....	1600

Section number	Title	Page
32.6.40	SW_MUX_CTL_PAD_ENET1_RX_ER SW MUX Control Register (IOMUXC_SW_MUX_CTL_PAD_ENET1_RX_ER).....	1601
32.6.41	SW_MUX_CTL_PAD_ENET2_RX_DATA0 SW MUX Control Register (IOMUXC_SW_MUX_CTL_PAD_ENET2_RX_DATA0).....	1602
32.6.42	SW_MUX_CTL_PAD_ENET2_RX_DATA1 SW MUX Control Register (IOMUXC_SW_MUX_CTL_PAD_ENET2_RX_DATA1).....	1603
32.6.43	SW_MUX_CTL_PAD_ENET2_RX_EN SW MUX Control Register (IOMUXC_SW_MUX_CTL_PAD_ENET2_RX_EN).....	1604
32.6.44	SW_MUX_CTL_PAD_ENET2_TX_DATA0 SW MUX Control Register (IOMUXC_SW_MUX_CTL_PAD_ENET2_TX_DATA0).....	1605
32.6.45	SW_MUX_CTL_PAD_ENET2_TX_DATA1 SW MUX Control Register (IOMUXC_SW_MUX_CTL_PAD_ENET2_TX_DATA1).....	1606
32.6.46	SW_MUX_CTL_PAD_ENET2_TX_EN SW MUX Control Register (IOMUXC_SW_MUX_CTL_PAD_ENET2_TX_EN).....	1607
32.6.47	SW_MUX_CTL_PAD_ENET2_TX_CLK SW MUX Control Register (IOMUXC_SW_MUX_CTL_PAD_ENET2_TX_CLK).....	1608
32.6.48	SW_MUX_CTL_PAD_ENET2_RX_ER SW MUX Control Register (IOMUXC_SW_MUX_CTL_PAD_ENET2_RX_ER).....	1609
32.6.49	SW_MUX_CTL_PAD_LCD_CLK SW MUX Control Register (IOMUXC_SW_MUX_CTL_PAD_LCD_CLK).....	1610
32.6.50	SW_MUX_CTL_PAD_LCD_ENABLE SW MUX Control Register (IOMUXC_SW_MUX_CTL_PAD_LCD_ENABLE).....	1611
32.6.51	SW_MUX_CTL_PAD_LCD_HSYNC SW MUX Control Register (IOMUXC_SW_MUX_CTL_PAD_LCD_HSYNC).....	1612
32.6.52	SW_MUX_CTL_PAD_LCD_VSYNC SW MUX Control Register (IOMUXC_SW_MUX_CTL_PAD_LCD_VSYNC).....	1613
32.6.53	SW_MUX_CTL_PAD_LCD_RESET SW MUX Control Register (IOMUXC_SW_MUX_CTL_PAD_LCD_RESET).....	1614
32.6.54	SW_MUX_CTL_PAD_LCD_DATA00 SW MUX Control Register (IOMUXC_SW_MUX_CTL_PAD_LCD_DATA00).....	1615
32.6.55	SW_MUX_CTL_PAD_LCD_DATA01 SW MUX Control Register (IOMUXC_SW_MUX_CTL_PAD_LCD_DATA01).....	1616

Section number	Title	Page
32.6.56	SW_MUX_CTL_PAD_LCD_DATA02 SW MUX Control Register (IOMUXC_SW_MUX_CTL_PAD_LCD_DATA02).....	1617
32.6.57	SW_MUX_CTL_PAD_LCD_DATA03 SW MUX Control Register (IOMUXC_SW_MUX_CTL_PAD_LCD_DATA03).....	1618
32.6.58	SW_MUX_CTL_PAD_LCD_DATA04 SW MUX Control Register (IOMUXC_SW_MUX_CTL_PAD_LCD_DATA04).....	1619
32.6.59	SW_MUX_CTL_PAD_LCD_DATA05 SW MUX Control Register (IOMUXC_SW_MUX_CTL_PAD_LCD_DATA05).....	1620
32.6.60	SW_MUX_CTL_PAD_LCD_DATA06 SW MUX Control Register (IOMUXC_SW_MUX_CTL_PAD_LCD_DATA06).....	1621
32.6.61	SW_MUX_CTL_PAD_LCD_DATA07 SW MUX Control Register (IOMUXC_SW_MUX_CTL_PAD_LCD_DATA07).....	1622
32.6.62	SW_MUX_CTL_PAD_LCD_DATA08 SW MUX Control Register (IOMUXC_SW_MUX_CTL_PAD_LCD_DATA08).....	1623
32.6.63	SW_MUX_CTL_PAD_LCD_DATA09 SW MUX Control Register (IOMUXC_SW_MUX_CTL_PAD_LCD_DATA09).....	1624
32.6.64	SW_MUX_CTL_PAD_LCD_DATA10 SW MUX Control Register (IOMUXC_SW_MUX_CTL_PAD_LCD_DATA10).....	1625
32.6.65	SW_MUX_CTL_PAD_LCD_DATA11 SW MUX Control Register (IOMUXC_SW_MUX_CTL_PAD_LCD_DATA11).....	1626
32.6.66	SW_MUX_CTL_PAD_LCD_DATA12 SW MUX Control Register (IOMUXC_SW_MUX_CTL_PAD_LCD_DATA12).....	1627
32.6.67	SW_MUX_CTL_PAD_LCD_DATA13 SW MUX Control Register (IOMUXC_SW_MUX_CTL_PAD_LCD_DATA13).....	1628
32.6.68	SW_MUX_CTL_PAD_LCD_DATA14 SW MUX Control Register (IOMUXC_SW_MUX_CTL_PAD_LCD_DATA14).....	1629
32.6.69	SW_MUX_CTL_PAD_LCD_DATA15 SW MUX Control Register (IOMUXC_SW_MUX_CTL_PAD_LCD_DATA15).....	1630
32.6.70	SW_MUX_CTL_PAD_LCD_DATA16 SW MUX Control Register (IOMUXC_SW_MUX_CTL_PAD_LCD_DATA16).....	1631
32.6.71	SW_MUX_CTL_PAD_LCD_DATA17 SW MUX Control Register (IOMUXC_SW_MUX_CTL_PAD_LCD_DATA17).....	1632

Section number	Title	Page
32.6.72	SW_MUX_CTL_PAD_LCD_DATA18 SW MUX Control Register (IOMUXC_SW_MUX_CTL_PAD_LCD_DATA18).....	1633
32.6.73	SW_MUX_CTL_PAD_LCD_DATA19 SW MUX Control Register (IOMUXC_SW_MUX_CTL_PAD_LCD_DATA19).....	1634
32.6.74	SW_MUX_CTL_PAD_LCD_DATA20 SW MUX Control Register (IOMUXC_SW_MUX_CTL_PAD_LCD_DATA20).....	1635
32.6.75	SW_MUX_CTL_PAD_LCD_DATA21 SW MUX Control Register (IOMUXC_SW_MUX_CTL_PAD_LCD_DATA21).....	1636
32.6.76	SW_MUX_CTL_PAD_LCD_DATA22 SW MUX Control Register (IOMUXC_SW_MUX_CTL_PAD_LCD_DATA22).....	1637
32.6.77	SW_MUX_CTL_PAD_LCD_DATA23 SW MUX Control Register (IOMUXC_SW_MUX_CTL_PAD_LCD_DATA23).....	1638
32.6.78	SW_MUX_CTL_PAD_NAND_RE_B SW MUX Control Register (IOMUXC_SW_MUX_CTL_PAD_NAND_RE_B).....	1639
32.6.79	SW_MUX_CTL_PAD_NAND_WE_B SW MUX Control Register (IOMUXC_SW_MUX_CTL_PAD_NAND_WE_B).....	1640
32.6.80	SW_MUX_CTL_PAD_NAND_DATA00 SW MUX Control Register (IOMUXC_SW_MUX_CTL_PAD_NAND_DATA00).....	1641
32.6.81	SW_MUX_CTL_PAD_NAND_DATA01 SW MUX Control Register (IOMUXC_SW_MUX_CTL_PAD_NAND_DATA01).....	1642
32.6.82	SW_MUX_CTL_PAD_NAND_DATA02 SW MUX Control Register (IOMUXC_SW_MUX_CTL_PAD_NAND_DATA02).....	1643
32.6.83	SW_MUX_CTL_PAD_NAND_DATA03 SW MUX Control Register (IOMUXC_SW_MUX_CTL_PAD_NAND_DATA03).....	1644
32.6.84	SW_MUX_CTL_PAD_NAND_DATA04 SW MUX Control Register (IOMUXC_SW_MUX_CTL_PAD_NAND_DATA04).....	1645
32.6.85	SW_MUX_CTL_PAD_NAND_DATA05 SW MUX Control Register (IOMUXC_SW_MUX_CTL_PAD_NAND_DATA05).....	1646
32.6.86	SW_MUX_CTL_PAD_NAND_DATA06 SW MUX Control Register (IOMUXC_SW_MUX_CTL_PAD_NAND_DATA06).....	1647
32.6.87	SW_MUX_CTL_PAD_NAND_DATA07 SW MUX Control Register (IOMUXC_SW_MUX_CTL_PAD_NAND_DATA07).....	1648

Section number	Title	Page
32.6.88	SW_MUX_CTL_PAD_NAND_ALE SW MUX Control Register (IOMUXC_SW_MUX_CTL_PAD_NAND_ALE).....	1649
32.6.89	SW_MUX_CTL_PAD_NAND_WP_B SW MUX Control Register (IOMUXC_SW_MUX_CTL_PAD_NAND_WP_B).....	1650
32.6.90	SW_MUX_CTL_PAD_NAND_READY_B SW MUX Control Register (IOMUXC_SW_MUX_CTL_PAD_NAND_READY_B).....	1651
32.6.91	SW_MUX_CTL_PAD_NAND_CE0_B SW MUX Control Register (IOMUXC_SW_MUX_CTL_PAD_NAND_CE0_B).....	1652
32.6.92	SW_MUX_CTL_PAD_NAND_CE1_B SW MUX Control Register (IOMUXC_SW_MUX_CTL_PAD_NAND_CE1_B).....	1653
32.6.93	SW_MUX_CTL_PAD_NAND_CLE SW MUX Control Register (IOMUXC_SW_MUX_CTL_PAD_NAND_CLE).....	1654
32.6.94	SW_MUX_CTL_PAD_NAND_DQS SW MUX Control Register (IOMUXC_SW_MUX_CTL_PAD_NAND_DQS).....	1655
32.6.95	SW_MUX_CTL_PAD_SD1_CMD SW MUX Control Register (IOMUXC_SW_MUX_CTL_PAD_SD1_CMD).....	1656
32.6.96	SW_MUX_CTL_PAD_SD1_CLK SW MUX Control Register (IOMUXC_SW_MUX_CTL_PAD_SD1_CLK).....	1657
32.6.97	SW_MUX_CTL_PAD_SD1_DATA0 SW MUX Control Register (IOMUXC_SW_MUX_CTL_PAD_SD1_DATA0).....	1658
32.6.98	SW_MUX_CTL_PAD_SD1_DATA1 SW MUX Control Register (IOMUXC_SW_MUX_CTL_PAD_SD1_DATA1).....	1659
32.6.99	SW_MUX_CTL_PAD_SD1_DATA2 SW MUX Control Register (IOMUXC_SW_MUX_CTL_PAD_SD1_DATA2).....	1660
32.6.100	SW_MUX_CTL_PAD_SD1_DATA3 SW MUX Control Register (IOMUXC_SW_MUX_CTL_PAD_SD1_DATA3).....	1661
32.6.101	SW_MUX_CTL_PAD_CSI_MCLK SW MUX Control Register (IOMUXC_SW_MUX_CTL_PAD_CSI_MCLK).....	1662
32.6.102	SW_MUX_CTL_PAD_CSI_PIXCLK SW MUX Control Register (IOMUXC_SW_MUX_CTL_PAD_CSI_PIXCLK).....	1663
32.6.103	SW_MUX_CTL_PAD_CSI_VSYNC SW MUX Control Register (IOMUXC_SW_MUX_CTL_PAD_CSI_VSYNC).....	1664

Section number	Title	Page
32.6.104	SW_MUX_CTL_PAD_CSI_HSYNC SW MUX Control Register (IOMUXC_SW_MUX_CTL_PAD_CSI_HSYNC).....	1665
32.6.105	SW_MUX_CTL_PAD_CSI_DATA00 SW MUX Control Register (IOMUXC_SW_MUX_CTL_PAD_CSI_DATA00).....	1666
32.6.106	SW_MUX_CTL_PAD_CSI_DATA01 SW MUX Control Register (IOMUXC_SW_MUX_CTL_PAD_CSI_DATA01).....	1667
32.6.107	SW_MUX_CTL_PAD_CSI_DATA02 SW MUX Control Register (IOMUXC_SW_MUX_CTL_PAD_CSI_DATA02).....	1668
32.6.108	SW_MUX_CTL_PAD_CSI_DATA03 SW MUX Control Register (IOMUXC_SW_MUX_CTL_PAD_CSI_DATA03).....	1669
32.6.109	SW_MUX_CTL_PAD_CSI_DATA04 SW MUX Control Register (IOMUXC_SW_MUX_CTL_PAD_CSI_DATA04).....	1670
32.6.110	SW_MUX_CTL_PAD_CSI_DATA05 SW MUX Control Register (IOMUXC_SW_MUX_CTL_PAD_CSI_DATA05).....	1671
32.6.111	SW_MUX_CTL_PAD_CSI_DATA06 SW MUX Control Register (IOMUXC_SW_MUX_CTL_PAD_CSI_DATA06).....	1672
32.6.112	SW_MUX_CTL_PAD_CSI_DATA07 SW MUX Control Register (IOMUXC_SW_MUX_CTL_PAD_CSI_DATA07).....	1673
32.6.113	SW_PAD_CTL_PAD_DRAM_ADDR00 SW PAD Control Register (IOMUXC_SW_PAD_CTL_PAD_DRAM_ADDR00).....	1674
32.6.114	SW_PAD_CTL_PAD_DRAM_ADDR01 SW PAD Control Register (IOMUXC_SW_PAD_CTL_PAD_DRAM_ADDR01).....	1677
32.6.115	SW_PAD_CTL_PAD_DRAM_ADDR02 SW PAD Control Register (IOMUXC_SW_PAD_CTL_PAD_DRAM_ADDR02).....	1680
32.6.116	SW_PAD_CTL_PAD_DRAM_ADDR03 SW PAD Control Register (IOMUXC_SW_PAD_CTL_PAD_DRAM_ADDR03).....	1683
32.6.117	SW_PAD_CTL_PAD_DRAM_ADDR04 SW PAD Control Register (IOMUXC_SW_PAD_CTL_PAD_DRAM_ADDR04).....	1686
32.6.118	SW_PAD_CTL_PAD_DRAM_ADDR05 SW PAD Control Register (IOMUXC_SW_PAD_CTL_PAD_DRAM_ADDR05).....	1689
32.6.119	SW_PAD_CTL_PAD_DRAM_ADDR06 SW PAD Control Register (IOMUXC_SW_PAD_CTL_PAD_DRAM_ADDR06).....	1692

Section number	Title	Page
32.6.120	SW_PAD_CTL_PAD_DRAM_ADDR07 SW PAD Control Register (IOMUXC_SW_PAD_CTL_PAD_DRAM_ADDR07).....	1695
32.6.121	SW_PAD_CTL_PAD_DRAM_ADDR08 SW PAD Control Register (IOMUXC_SW_PAD_CTL_PAD_DRAM_ADDR08).....	1698
32.6.122	SW_PAD_CTL_PAD_DRAM_ADDR09 SW PAD Control Register (IOMUXC_SW_PAD_CTL_PAD_DRAM_ADDR09).....	1701
32.6.123	SW_PAD_CTL_PAD_DRAM_ADDR10 SW PAD Control Register (IOMUXC_SW_PAD_CTL_PAD_DRAM_ADDR10).....	1704
32.6.124	SW_PAD_CTL_PAD_DRAM_ADDR11 SW PAD Control Register (IOMUXC_SW_PAD_CTL_PAD_DRAM_ADDR11).....	1707
32.6.125	SW_PAD_CTL_PAD_DRAM_ADDR12 SW PAD Control Register (IOMUXC_SW_PAD_CTL_PAD_DRAM_ADDR12).....	1710
32.6.126	SW_PAD_CTL_PAD_DRAM_ADDR13 SW PAD Control Register (IOMUXC_SW_PAD_CTL_PAD_DRAM_ADDR13).....	1713
32.6.127	SW_PAD_CTL_PAD_DRAM_ADDR14 SW PAD Control Register (IOMUXC_SW_PAD_CTL_PAD_DRAM_ADDR14).....	1716
32.6.128	SW_PAD_CTL_PAD_DRAM_ADDR15 SW PAD Control Register (IOMUXC_SW_PAD_CTL_PAD_DRAM_ADDR15).....	1719
32.6.129	SW_PAD_CTL_PAD_DRAM_DQM0 SW PAD Control Register (IOMUXC_SW_PAD_CTL_PAD_DRAM_DQM0).....	1722
32.6.130	SW_PAD_CTL_PAD_DRAM_DQM1 SW PAD Control Register (IOMUXC_SW_PAD_CTL_PAD_DRAM_DQM1).....	1725
32.6.131	SW_PAD_CTL_PAD_DRAM_RAS_B SW PAD Control Register (IOMUXC_SW_PAD_CTL_PAD_DRAM_RAS_B).....	1728
32.6.132	SW_PAD_CTL_PAD_DRAM_CAS_B SW PAD Control Register (IOMUXC_SW_PAD_CTL_PAD_DRAM_CAS_B).....	1731
32.6.133	SW_PAD_CTL_PAD_DRAM_CS0_B SW PAD Control Register (IOMUXC_SW_PAD_CTL_PAD_DRAM_CS0_B).....	1734
32.6.134	SW_PAD_CTL_PAD_DRAM_CS1_B SW PAD Control Register (IOMUXC_SW_PAD_CTL_PAD_DRAM_CS1_B).....	1737
32.6.135	SW_PAD_CTL_PAD_DRAM_SDWE_B SW PAD Control Register (IOMUXC_SW_PAD_CTL_PAD_DRAM_SDWE_B).....	1740

Section number	Title	Page
32.6.136	SW_PAD_CTL_PAD_DRAM_ODT0 SW PAD Control Register (IOMUXC_SW_PAD_CTL_PAD_DRAM_ODT0).....	1743
32.6.137	SW_PAD_CTL_PAD_DRAM_ODT1 SW PAD Control Register (IOMUXC_SW_PAD_CTL_PAD_DRAM_ODT1).....	1746
32.6.138	SW_PAD_CTL_PAD_DRAM_SDBA0 SW PAD Control Register (IOMUXC_SW_PAD_CTL_PAD_DRAM_SDBA0).....	1749
32.6.139	SW_PAD_CTL_PAD_DRAM_SDBA1 SW PAD Control Register (IOMUXC_SW_PAD_CTL_PAD_DRAM_SDBA1).....	1752
32.6.140	SW_PAD_CTL_PAD_DRAM_SDBA2 SW PAD Control Register (IOMUXC_SW_PAD_CTL_PAD_DRAM_SDBA2).....	1755
32.6.141	SW_PAD_CTL_PAD_DRAM_SDCKE0 SW PAD Control Register (IOMUXC_SW_PAD_CTL_PAD_DRAM_SDCKE0).....	1758
32.6.142	SW_PAD_CTL_PAD_DRAM_SDCKE1 SW PAD Control Register (IOMUXC_SW_PAD_CTL_PAD_DRAM_SDCKE1).....	1761
32.6.143	SW_PAD_CTL_PAD_DRAM_SDCLK0_P SW PAD Control Register (IOMUXC_SW_PAD_CTL_PAD_DRAM_SDCLK0_P).....	1764
32.6.144	SW_PAD_CTL_PAD_DRAM_SDQS0_P SW PAD Control Register (IOMUXC_SW_PAD_CTL_PAD_DRAM_SDQS0_P).....	1767
32.6.145	SW_PAD_CTL_PAD_DRAM_SDQS1_P SW PAD Control Register (IOMUXC_SW_PAD_CTL_PAD_DRAM_SDQS1_P).....	1770
32.6.146	SW_PAD_CTL_PAD_DRAM_RESET SW PAD Control Register (IOMUXC_SW_PAD_CTL_PAD_DRAM_RESET).....	1773
32.6.147	SW_PAD_CTL_PAD_JTAG_MOD SW PAD Control Register (IOMUXC_SW_PAD_CTL_PAD_JTAG_MOD).....	1775
32.6.148	SW_PAD_CTL_PAD_JTAG_TMS SW PAD Control Register (IOMUXC_SW_PAD_CTL_PAD_JTAG_TMS).....	1777
32.6.149	SW_PAD_CTL_PAD_JTAG_TDO SW PAD Control Register (IOMUXC_SW_PAD_CTL_PAD_JTAG_TDO).....	1779
32.6.150	SW_PAD_CTL_PAD_JTAG_TDI SW PAD Control Register (IOMUXC_SW_PAD_CTL_PAD_JTAG_TDI).....	1781
32.6.151	SW_PAD_CTL_PAD_JTAG_TCK SW PAD Control Register (IOMUXC_SW_PAD_CTL_PAD_JTAG_TCK).....	1783

Section number	Title	Page
32.6.152	SW_PAD_CTL_PAD_JTAG_TRST_B SW PAD Control Register (IOMUXC_SW_PAD_CTL_PAD_JTAG_TRST_B).....	1785
32.6.153	SW_PAD_CTL_PAD_GPIO1_IO00 SW PAD Control Register (IOMUXC_SW_PAD_CTL_PAD_GPIO1_IO00).....	1787
32.6.154	SW_PAD_CTL_PAD_GPIO1_IO01 SW PAD Control Register (IOMUXC_SW_PAD_CTL_PAD_GPIO1_IO01).....	1789
32.6.155	SW_PAD_CTL_PAD_GPIO1_IO02 SW PAD Control Register (IOMUXC_SW_PAD_CTL_PAD_GPIO1_IO02).....	1791
32.6.156	SW_PAD_CTL_PAD_GPIO1_IO03 SW PAD Control Register (IOMUXC_SW_PAD_CTL_PAD_GPIO1_IO03).....	1793
32.6.157	SW_PAD_CTL_PAD_GPIO1_IO04 SW PAD Control Register (IOMUXC_SW_PAD_CTL_PAD_GPIO1_IO04).....	1795
32.6.158	SW_PAD_CTL_PAD_GPIO1_IO05 SW PAD Control Register (IOMUXC_SW_PAD_CTL_PAD_GPIO1_IO05).....	1797
32.6.159	SW_PAD_CTL_PAD_GPIO1_IO06 SW PAD Control Register (IOMUXC_SW_PAD_CTL_PAD_GPIO1_IO06).....	1799
32.6.160	SW_PAD_CTL_PAD_GPIO1_IO07 SW PAD Control Register (IOMUXC_SW_PAD_CTL_PAD_GPIO1_IO07).....	1801
32.6.161	SW_PAD_CTL_PAD_GPIO1_IO08 SW PAD Control Register (IOMUXC_SW_PAD_CTL_PAD_GPIO1_IO08).....	1803
32.6.162	SW_PAD_CTL_PAD_GPIO1_IO09 SW PAD Control Register (IOMUXC_SW_PAD_CTL_PAD_GPIO1_IO09).....	1805
32.6.163	SW_PAD_CTL_PAD_UART1_TX_DATA SW PAD Control Register (IOMUXC_SW_PAD_CTL_PAD_UART1_TX_DATA).....	1807
32.6.164	SW_PAD_CTL_PAD_UART1_RX_DATA SW PAD Control Register (IOMUXC_SW_PAD_CTL_PAD_UART1_RX_DATA).....	1809
32.6.165	SW_PAD_CTL_PAD_UART1_CTS_B SW PAD Control Register (IOMUXC_SW_PAD_CTL_PAD_UART1_CTS_B).....	1811
32.6.166	SW_PAD_CTL_PAD_UART1_RTS_B SW PAD Control Register (IOMUXC_SW_PAD_CTL_PAD_UART1_RTS_B).....	1813
32.6.167	SW_PAD_CTL_PAD_UART2_TX_DATA SW PAD Control Register (IOMUXC_SW_PAD_CTL_PAD_UART2_TX_DATA).....	1815

Section number	Title	Page
32.6.168	SW_PAD_CTL_PAD_UART2_RX_DATA SW PAD Control Register (IOMUXC_SW_PAD_CTL_PAD_UART2_RX_DATA).....	1817
32.6.169	SW_PAD_CTL_PAD_UART2_CTS_B SW PAD Control Register (IOMUXC_SW_PAD_CTL_PAD_UART2_CTS_B).....	1819
32.6.170	SW_PAD_CTL_PAD_UART2_RTS_B SW PAD Control Register (IOMUXC_SW_PAD_CTL_PAD_UART2_RTS_B).....	1821
32.6.171	SW_PAD_CTL_PAD_UART3_TX_DATA SW PAD Control Register (IOMUXC_SW_PAD_CTL_PAD_UART3_TX_DATA).....	1823
32.6.172	SW_PAD_CTL_PAD_UART3_RX_DATA SW PAD Control Register (IOMUXC_SW_PAD_CTL_PAD_UART3_RX_DATA).....	1825
32.6.173	SW_PAD_CTL_PAD_UART3_CTS_B SW PAD Control Register (IOMUXC_SW_PAD_CTL_PAD_UART3_CTS_B).....	1827
32.6.174	SW_PAD_CTL_PAD_UART3_RTS_B SW PAD Control Register (IOMUXC_SW_PAD_CTL_PAD_UART3_RTS_B).....	1829
32.6.175	SW_PAD_CTL_PAD_UART4_TX_DATA SW PAD Control Register (IOMUXC_SW_PAD_CTL_PAD_UART4_TX_DATA).....	1831
32.6.176	SW_PAD_CTL_PAD_UART4_RX_DATA SW PAD Control Register (IOMUXC_SW_PAD_CTL_PAD_UART4_RX_DATA).....	1833
32.6.177	SW_PAD_CTL_PAD_UART5_TX_DATA SW PAD Control Register (IOMUXC_SW_PAD_CTL_PAD_UART5_TX_DATA).....	1835
32.6.178	SW_PAD_CTL_PAD_UART5_RX_DATA SW PAD Control Register (IOMUXC_SW_PAD_CTL_PAD_UART5_RX_DATA).....	1837
32.6.179	SW_PAD_CTL_PAD_ENET1_RX_DATA0 SW PAD Control Register (IOMUXC_SW_PAD_CTL_PAD_ENET1_RX_DATA0).....	1839
32.6.180	SW_PAD_CTL_PAD_ENET1_RX_DATA1 SW PAD Control Register (IOMUXC_SW_PAD_CTL_PAD_ENET1_RX_DATA1).....	1841
32.6.181	SW_PAD_CTL_PAD_ENET1_RX_EN SW PAD Control Register (IOMUXC_SW_PAD_CTL_PAD_ENET1_RX_EN).....	1843
32.6.182	SW_PAD_CTL_PAD_ENET1_TX_DATA0 SW PAD Control Register (IOMUXC_SW_PAD_CTL_PAD_ENET1_TX_DATA0).....	1845
32.6.183	SW_PAD_CTL_PAD_ENET1_TX_DATA1 SW PAD Control Register (IOMUXC_SW_PAD_CTL_PAD_ENET1_TX_DATA1).....	1847

Section number	Title	Page
32.6.184	SW_PAD_CTL_PAD_ENET1_TX_EN SW PAD Control Register (IOMUXC_SW_PAD_CTL_PAD_ENET1_TX_EN).....	1849
32.6.185	SW_PAD_CTL_PAD_ENET1_TX_CLK SW PAD Control Register (IOMUXC_SW_PAD_CTL_PAD_ENET1_TX_CLK).....	1851
32.6.186	SW_PAD_CTL_PAD_ENET1_RX_ER SW PAD Control Register (IOMUXC_SW_PAD_CTL_PAD_ENET1_RX_ER).....	1853
32.6.187	SW_PAD_CTL_PAD_ENET2_RX_DATA0 SW PAD Control Register (IOMUXC_SW_PAD_CTL_PAD_ENET2_RX_DATA0).....	1855
32.6.188	SW_PAD_CTL_PAD_ENET2_RX_DATA1 SW PAD Control Register (IOMUXC_SW_PAD_CTL_PAD_ENET2_RX_DATA1).....	1857
32.6.189	SW_PAD_CTL_PAD_ENET2_RX_EN SW PAD Control Register (IOMUXC_SW_PAD_CTL_PAD_ENET2_RX_EN).....	1859
32.6.190	SW_PAD_CTL_PAD_ENET2_TX_DATA0 SW PAD Control Register (IOMUXC_SW_PAD_CTL_PAD_ENET2_TX_DATA0).....	1861
32.6.191	SW_PAD_CTL_PAD_ENET2_TX_DATA1 SW PAD Control Register (IOMUXC_SW_PAD_CTL_PAD_ENET2_TX_DATA1).....	1863
32.6.192	SW_PAD_CTL_PAD_ENET2_TX_EN SW PAD Control Register (IOMUXC_SW_PAD_CTL_PAD_ENET2_TX_EN).....	1865
32.6.193	SW_PAD_CTL_PAD_ENET2_TX_CLK SW PAD Control Register (IOMUXC_SW_PAD_CTL_PAD_ENET2_TX_CLK).....	1867
32.6.194	SW_PAD_CTL_PAD_ENET2_RX_ER SW PAD Control Register (IOMUXC_SW_PAD_CTL_PAD_ENET2_RX_ER).....	1869
32.6.195	SW_PAD_CTL_PAD_LCD_CLK SW PAD Control Register (IOMUXC_SW_PAD_CTL_PAD_LCD_CLK).....	1871
32.6.196	SW_PAD_CTL_PAD_LCD_ENABLE SW PAD Control Register (IOMUXC_SW_PAD_CTL_PAD_LCD_ENABLE).....	1873
32.6.197	SW_PAD_CTL_PAD_LCD_HSYNC SW PAD Control Register (IOMUXC_SW_PAD_CTL_PAD_LCD_HSYNC).....	1875
32.6.198	SW_PAD_CTL_PAD_LCD_VSYNC SW PAD Control Register (IOMUXC_SW_PAD_CTL_PAD_LCD_VSYNC).....	1877
32.6.199	SW_PAD_CTL_PAD_LCD_RESET SW PAD Control Register (IOMUXC_SW_PAD_CTL_PAD_LCD_RESET).....	1879

Section number	Title	Page
32.6.200	SW_PAD_CTL_PAD_LCD_DATA00 SW PAD Control Register (IOMUXC_SW_PAD_CTL_PAD_LCD_DATA00).....	1881
32.6.201	SW_PAD_CTL_PAD_LCD_DATA01 SW PAD Control Register (IOMUXC_SW_PAD_CTL_PAD_LCD_DATA01).....	1883
32.6.202	SW_PAD_CTL_PAD_LCD_DATA02 SW PAD Control Register (IOMUXC_SW_PAD_CTL_PAD_LCD_DATA02).....	1885
32.6.203	SW_PAD_CTL_PAD_LCD_DATA03 SW PAD Control Register (IOMUXC_SW_PAD_CTL_PAD_LCD_DATA03).....	1887
32.6.204	SW_PAD_CTL_PAD_LCD_DATA04 SW PAD Control Register (IOMUXC_SW_PAD_CTL_PAD_LCD_DATA04).....	1889
32.6.205	SW_PAD_CTL_PAD_LCD_DATA05 SW PAD Control Register (IOMUXC_SW_PAD_CTL_PAD_LCD_DATA05).....	1891
32.6.206	SW_PAD_CTL_PAD_LCD_DATA06 SW PAD Control Register (IOMUXC_SW_PAD_CTL_PAD_LCD_DATA06).....	1893
32.6.207	SW_PAD_CTL_PAD_LCD_DATA07 SW PAD Control Register (IOMUXC_SW_PAD_CTL_PAD_LCD_DATA07).....	1895
32.6.208	SW_PAD_CTL_PAD_LCD_DATA08 SW PAD Control Register (IOMUXC_SW_PAD_CTL_PAD_LCD_DATA08).....	1897
32.6.209	SW_PAD_CTL_PAD_LCD_DATA09 SW PAD Control Register (IOMUXC_SW_PAD_CTL_PAD_LCD_DATA09).....	1899
32.6.210	SW_PAD_CTL_PAD_LCD_DATA10 SW PAD Control Register (IOMUXC_SW_PAD_CTL_PAD_LCD_DATA10).....	1901
32.6.211	SW_PAD_CTL_PAD_LCD_DATA11 SW PAD Control Register (IOMUXC_SW_PAD_CTL_PAD_LCD_DATA11).....	1903
32.6.212	SW_PAD_CTL_PAD_LCD_DATA12 SW PAD Control Register (IOMUXC_SW_PAD_CTL_PAD_LCD_DATA12).....	1905
32.6.213	SW_PAD_CTL_PAD_LCD_DATA13 SW PAD Control Register (IOMUXC_SW_PAD_CTL_PAD_LCD_DATA13).....	1907
32.6.214	SW_PAD_CTL_PAD_LCD_DATA14 SW PAD Control Register (IOMUXC_SW_PAD_CTL_PAD_LCD_DATA14).....	1909
32.6.215	SW_PAD_CTL_PAD_LCD_DATA15 SW PAD Control Register (IOMUXC_SW_PAD_CTL_PAD_LCD_DATA15).....	1911

Section number	Title	Page
32.6.216	SW_PAD_CTL_PAD_LCD_DATA16 SW PAD Control Register (IOMUXC_SW_PAD_CTL_PAD_LCD_DATA16).....	1913
32.6.217	SW_PAD_CTL_PAD_LCD_DATA17 SW PAD Control Register (IOMUXC_SW_PAD_CTL_PAD_LCD_DATA17).....	1915
32.6.218	SW_PAD_CTL_PAD_LCD_DATA18 SW PAD Control Register (IOMUXC_SW_PAD_CTL_PAD_LCD_DATA18).....	1917
32.6.219	SW_PAD_CTL_PAD_LCD_DATA19 SW PAD Control Register (IOMUXC_SW_PAD_CTL_PAD_LCD_DATA19).....	1919
32.6.220	SW_PAD_CTL_PAD_LCD_DATA20 SW PAD Control Register (IOMUXC_SW_PAD_CTL_PAD_LCD_DATA20).....	1921
32.6.221	SW_PAD_CTL_PAD_LCD_DATA21 SW PAD Control Register (IOMUXC_SW_PAD_CTL_PAD_LCD_DATA21).....	1923
32.6.222	SW_PAD_CTL_PAD_LCD_DATA22 SW PAD Control Register (IOMUXC_SW_PAD_CTL_PAD_LCD_DATA22).....	1925
32.6.223	SW_PAD_CTL_PAD_LCD_DATA23 SW PAD Control Register (IOMUXC_SW_PAD_CTL_PAD_LCD_DATA23).....	1927
32.6.224	SW_PAD_CTL_PAD_NAND_RE_B SW PAD Control Register (IOMUXC_SW_PAD_CTL_PAD_NAND_RE_B).....	1929
32.6.225	SW_PAD_CTL_PAD_NAND_WE_B SW PAD Control Register (IOMUXC_SW_PAD_CTL_PAD_NAND_WE_B).....	1931
32.6.226	SW_PAD_CTL_PAD_NAND_DATA00 SW PAD Control Register (IOMUXC_SW_PAD_CTL_PAD_NAND_DATA00).....	1933
32.6.227	SW_PAD_CTL_PAD_NAND_DATA01 SW PAD Control Register (IOMUXC_SW_PAD_CTL_PAD_NAND_DATA01).....	1935
32.6.228	SW_PAD_CTL_PAD_NAND_DATA02 SW PAD Control Register (IOMUXC_SW_PAD_CTL_PAD_NAND_DATA02).....	1937
32.6.229	SW_PAD_CTL_PAD_NAND_DATA03 SW PAD Control Register (IOMUXC_SW_PAD_CTL_PAD_NAND_DATA03).....	1939
32.6.230	SW_PAD_CTL_PAD_NAND_DATA04 SW PAD Control Register (IOMUXC_SW_PAD_CTL_PAD_NAND_DATA04).....	1941
32.6.231	SW_PAD_CTL_PAD_NAND_DATA05 SW PAD Control Register (IOMUXC_SW_PAD_CTL_PAD_NAND_DATA05).....	1943

Section number	Title	Page
32.6.232	SW_PAD_CTL_PAD_NAND_DATA06 SW PAD Control Register (IOMUXC_SW_PAD_CTL_PAD_NAND_DATA06).....	1945
32.6.233	SW_PAD_CTL_PAD_NAND_DATA07 SW PAD Control Register (IOMUXC_SW_PAD_CTL_PAD_NAND_DATA07).....	1947
32.6.234	SW_PAD_CTL_PAD_NAND_ALE SW PAD Control Register (IOMUXC_SW_PAD_CTL_PAD_NAND_ALE).....	1949
32.6.235	SW_PAD_CTL_PAD_NAND_WP_B SW PAD Control Register (IOMUXC_SW_PAD_CTL_PAD_NAND_WP_B).....	1951
32.6.236	SW_PAD_CTL_PAD_NAND_READY_B SW PAD Control Register (IOMUXC_SW_PAD_CTL_PAD_NAND_READY_B).....	1953
32.6.237	SW_PAD_CTL_PAD_NAND_CE0_B SW PAD Control Register (IOMUXC_SW_PAD_CTL_PAD_NAND_CE0_B).....	1955
32.6.238	SW_PAD_CTL_PAD_NAND_CE1_B SW PAD Control Register (IOMUXC_SW_PAD_CTL_PAD_NAND_CE1_B).....	1957
32.6.239	SW_PAD_CTL_PAD_NAND_CLE SW PAD Control Register (IOMUXC_SW_PAD_CTL_PAD_NAND_CLE).....	1959
32.6.240	SW_PAD_CTL_PAD_NAND_DQS SW PAD Control Register (IOMUXC_SW_PAD_CTL_PAD_NAND_DQS).....	1961
32.6.241	SW_PAD_CTL_PAD_SD1_CMD SW PAD Control Register (IOMUXC_SW_PAD_CTL_PAD_SD1_CMD).....	1963
32.6.242	SW_PAD_CTL_PAD_SD1_CLK SW PAD Control Register (IOMUXC_SW_PAD_CTL_PAD_SD1_CLK).....	1965
32.6.243	SW_PAD_CTL_PAD_SD1_DATA0 SW PAD Control Register (IOMUXC_SW_PAD_CTL_PAD_SD1_DATA0).....	1967
32.6.244	SW_PAD_CTL_PAD_SD1_DATA1 SW PAD Control Register (IOMUXC_SW_PAD_CTL_PAD_SD1_DATA1).....	1969
32.6.245	SW_PAD_CTL_PAD_SD1_DATA2 SW PAD Control Register (IOMUXC_SW_PAD_CTL_PAD_SD1_DATA2).....	1971
32.6.246	SW_PAD_CTL_PAD_SD1_DATA3 SW PAD Control Register (IOMUXC_SW_PAD_CTL_PAD_SD1_DATA3).....	1973
32.6.247	SW_PAD_CTL_PAD_CSI_MCLK SW PAD Control Register (IOMUXC_SW_PAD_CTL_PAD_CSI_MCLK).....	1975

Section number	Title	Page
32.6.248	SW_PAD_CTL_PAD_CSI_PIXCLK SW PAD Control Register (IOMUXC_SW_PAD_CTL_PAD_CSI_PIXCLK).....	1977
32.6.249	SW_PAD_CTL_PAD_CSI_VSYNC SW PAD Control Register (IOMUXC_SW_PAD_CTL_PAD_CSI_VSYNC).....	1979
32.6.250	SW_PAD_CTL_PAD_CSI_HSYNC SW PAD Control Register (IOMUXC_SW_PAD_CTL_PAD_CSI_HSYNC).....	1981
32.6.251	SW_PAD_CTL_PAD_CSI_DATA00 SW PAD Control Register (IOMUXC_SW_PAD_CTL_PAD_CSI_DATA00).....	1983
32.6.252	SW_PAD_CTL_PAD_CSI_DATA01 SW PAD Control Register (IOMUXC_SW_PAD_CTL_PAD_CSI_DATA01).....	1985
32.6.253	SW_PAD_CTL_PAD_CSI_DATA02 SW PAD Control Register (IOMUXC_SW_PAD_CTL_PAD_CSI_DATA02).....	1987
32.6.254	SW_PAD_CTL_PAD_CSI_DATA03 SW PAD Control Register (IOMUXC_SW_PAD_CTL_PAD_CSI_DATA03).....	1989
32.6.255	SW_PAD_CTL_PAD_CSI_DATA04 SW PAD Control Register (IOMUXC_SW_PAD_CTL_PAD_CSI_DATA04).....	1991
32.6.256	SW_PAD_CTL_PAD_CSI_DATA05 SW PAD Control Register (IOMUXC_SW_PAD_CTL_PAD_CSI_DATA05).....	1993
32.6.257	SW_PAD_CTL_PAD_CSI_DATA06 SW PAD Control Register (IOMUXC_SW_PAD_CTL_PAD_CSI_DATA06).....	1995
32.6.258	SW_PAD_CTL_PAD_CSI_DATA07 SW PAD Control Register (IOMUXC_SW_PAD_CTL_PAD_CSI_DATA07).....	1997
32.6.259	SW_PAD_CTL_GRP_ADDDS SW GRP Register (IOMUXC_SW_PAD_CTL_GRP_ADDDS).....	1998
32.6.260	SW_PAD_CTL_GRP_DDRMODE_CTL SW GRP Register (IOMUXC_SW_PAD_CTL_GRP_DDRMODE_CTL).....	1999
32.6.261	SW_PAD_CTL_GRP_B0DS SW GRP Register (IOMUXC_SW_PAD_CTL_GRP_B0DS).....	2000
32.6.262	SW_PAD_CTL_GRP_DDRPK SW GRP Register (IOMUXC_SW_PAD_CTL_GRP_DDRPK).....	2001
32.6.263	SW_PAD_CTL_GRP_CTLDS SW GRP Register (IOMUXC_SW_PAD_CTL_GRP_CTLDS).....	2001
32.6.264	SW_PAD_CTL_GRP_B1DS SW GRP Register (IOMUXC_SW_PAD_CTL_GRP_B1DS).....	2002
32.6.265	SW_PAD_CTL_GRP_DDRHYS SW GRP Register (IOMUXC_SW_PAD_CTL_GRP_DDRHYS)....	2003
32.6.266	SW_PAD_CTL_GRP_DDRPKE SW GRP Register (IOMUXC_SW_PAD_CTL_GRP_DDRPKE).....	2004

Section number	Title	Page
32.6.267	SW_PAD_CTL_GRP_DDRMODE SW GRP Register (IOMUXC_SW_PAD_CTL_GRP_DDRMODE).....	2005
32.6.268	SW_PAD_CTL_GRP_DDR_TYPE SW GRP Register (IOMUXC_SW_PAD_CTL_GRP_DDR_TYPE).....	2006
32.6.269	USB_OTG1_ID_SELECT_INPUT DAISY Register (IOMUXC_ANATOP_USB_OTG_ID_SELECT_INPUT).....	2007
32.6.270	USB_OTG2_ID_SELECT_INPUT DAISY Register (IOMUXC_USB_OTG2_ID_SELECT_INPUT).	2007
32.6.271	CCM_PMIC_READY_SELECT_INPUT DAISY Register (IOMUXC_CCM_PMIC_READY_SELECT_INPUT).....	2008
32.6.272	CSI_DATA02_SELECT_INPUT DAISY Register (IOMUXC_CSI_DATA02_SELECT_INPUT).....	2009
32.6.273	CSI_DATA03_SELECT_INPUT DAISY Register (IOMUXC_CSI_DATA03_SELECT_INPUT).....	2010
32.6.274	CSI_DATA05_SELECT_INPUT DAISY Register (IOMUXC_CSI_DATA05_SELECT_INPUT).....	2011
32.6.275	CSI_DATA00_SELECT_INPUT DAISY Register (IOMUXC_CSI_DATA00_SELECT_INPUT).....	2012
32.6.276	CSI_DATA01_SELECT_INPUT DAISY Register (IOMUXC_CSI_DATA01_SELECT_INPUT).....	2013
32.6.277	CSI_DATA04_SELECT_INPUT DAISY Register (IOMUXC_CSI_DATA04_SELECT_INPUT).....	2014
32.6.278	CSI_DATA06_SELECT_INPUT DAISY Register (IOMUXC_CSI_DATA06_SELECT_INPUT).....	2015
32.6.279	CSI_DATA07_SELECT_INPUT DAISY Register (IOMUXC_CSI_DATA07_SELECT_INPUT).....	2016
32.6.280	CSI_DATA08_SELECT_INPUT DAISY Register (IOMUXC_CSI_DATA08_SELECT_INPUT).....	2017
32.6.281	CSI_DATA09_SELECT_INPUT DAISY Register (IOMUXC_CSI_DATA09_SELECT_INPUT).....	2018
32.6.282	CSI_DATA10_SELECT_INPUT DAISY Register (IOMUXC_CSI_DATA10_SELECT_INPUT).....	2019
32.6.283	CSI_DATA11_SELECT_INPUT DAISY Register (IOMUXC_CSI_DATA11_SELECT_INPUT).....	2020
32.6.284	CSI_DATA12_SELECT_INPUT DAISY Register (IOMUXC_CSI_DATA12_SELECT_INPUT).....	2021
32.6.285	CSI_DATA13_SELECT_INPUT DAISY Register (IOMUXC_CSI_DATA13_SELECT_INPUT).....	2022
32.6.286	CSI_DATA14_SELECT_INPUT DAISY Register (IOMUXC_CSI_DATA14_SELECT_INPUT).....	2023
32.6.287	CSI_DATA15_SELECT_INPUT DAISY Register (IOMUXC_CSI_DATA15_SELECT_INPUT).....	2024
32.6.288	CSI_DATA16_SELECT_INPUT DAISY Register (IOMUXC_CSI_DATA16_SELECT_INPUT).....	2025
32.6.289	CSI_DATA17_SELECT_INPUT DAISY Register (IOMUXC_CSI_DATA17_SELECT_INPUT).....	2026
32.6.290	CSI_DATA18_SELECT_INPUT DAISY Register (IOMUXC_CSI_DATA18_SELECT_INPUT).....	2027
32.6.291	CSI_DATA19_SELECT_INPUT DAISY Register (IOMUXC_CSI_DATA19_SELECT_INPUT).....	2028
32.6.292	CSI_DATA20_SELECT_INPUT DAISY Register (IOMUXC_CSI_DATA20_SELECT_INPUT).....	2029

Section number	Title	Page
32.6.293	CSI_DATA21_SELECT_INPUT DAISY Register (IOMUXC_CSI_DATA21_SELECT_INPUT).....	2030
32.6.294	CSI_DATA22_SELECT_INPUT DAISY Register (IOMUXC_CSI_DATA22_SELECT_INPUT).....	2031
32.6.295	CSI_DATA23_SELECT_INPUT DAISY Register (IOMUXC_CSI_DATA23_SELECT_INPUT).....	2032
32.6.296	CSI_HSYNC_SELECT_INPUT DAISY Register (IOMUXC_CSI_HSYNC_SELECT_INPUT).....	2033
32.6.297	CSI_PIXCLK_SELECT_INPUT DAISY Register (IOMUXC_CSI_PIXCLK_SELECT_INPUT).....	2034
32.6.298	CSI_VSYNC_SELECT_INPUT DAISY Register (IOMUXC_CSI_VSYNC_SELECT_INPUT).....	2035
32.6.299	CSI_FIELD_SELECT_INPUT DAISY Register (IOMUXC_CSI_FIELD_SELECT_INPUT).....	2036
32.6.300	ECSPI1_SCLK_SELECT_INPUT DAISY Register (IOMUXC_ECSP11_SCLK_SELECT_INPUT)...	2037
32.6.301	ECSPI1_MISO_SELECT_INPUT DAISY Register (IOMUXC_ECSP11_MISO_SELECT_INPUT)....	2038
32.6.302	ECSPI1_MOSI_SELECT_INPUT DAISY Register (IOMUXC_ECSP11_MOSI_SELECT_INPUT)....	2039
32.6.303	ECSPI1_SS0_B_SELECT_INPUT DAISY Register (IOMUXC_ECSP11_SS0_B_SELECT_INPUT).	2040
32.6.304	ECSPI2_SCLK_SELECT_INPUT DAISY Register (IOMUXC_ECSP12_SCLK_SELECT_INPUT)...	2041
32.6.305	ECSPI2_MISO_SELECT_INPUT DAISY Register (IOMUXC_ECSP12_MISO_SELECT_INPUT)....	2042
32.6.306	ECSPI2_MOSI_SELECT_INPUT DAISY Register (IOMUXC_ECSP12_MOSI_SELECT_INPUT)....	2043
32.6.307	ECSPI2_SS0_B_SELECT_INPUT DAISY Register (IOMUXC_ECSP12_SS0_B_SELECT_INPUT).	2044
32.6.308	ECSPI3_SCLK_SELECT_INPUT DAISY Register (IOMUXC_ECSP13_SCLK_SELECT_INPUT)...	2045
32.6.309	ECSPI3_MISO_SELECT_INPUT DAISY Register (IOMUXC_ECSP13_MISO_SELECT_INPUT)....	2046
32.6.310	ECSPI3_MOSI_SELECT_INPUT DAISY Register (IOMUXC_ECSP13_MOSI_SELECT_INPUT)....	2047
32.6.311	ECSPI3_SS0_B_SELECT_INPUT DAISY Register (IOMUXC_ECSP13_SS0_B_SELECT_INPUT).	2048
32.6.312	ECSPI4_SCLK_SELECT_INPUT DAISY Register (IOMUXC_ECSP14_SCLK_SELECT_INPUT)...	2049
32.6.313	ECSPI4_MISO_SELECT_INPUT DAISY Register (IOMUXC_ECSP14_MISO_SELECT_INPUT)....	2050
32.6.314	ECSPI4_MOSI_SELECT_INPUT DAISY Register (IOMUXC_ECSP14_MOSI_SELECT_INPUT)....	2051
32.6.315	ECSPI4_SS0_B_SELECT_INPUT DAISY Register (IOMUXC_ECSP14_SS0_B_SELECT_INPUT).	2052
32.6.316	ENET1_REF_CLK1_SELECT_INPUT DAISY Register (IOMUXC_ENET1_REF_CLK1_SELECT_INPUT).....	2052
32.6.317	ENET1_MAC0_MDIO_SELECT_INPUT DAISY Register (IOMUXC_ENET1_MAC0_MDIO_SELECT_INPUT).....	2053
32.6.318	ENET2_REF_CLK2_SELECT_INPUT DAISY Register (IOMUXC_ENET2_REF_CLK2_SELECT_INPUT).....	2054

Section number	Title	Page
32.6.319	ENET2_MAC0_MDIO_SELECT_INPUT DAISY Register (IOMUXC_ENET2_MAC0_MDIO_SELECT_INPUT).....	2055
32.6.320	FLEXCAN1_RX_SELECT_INPUT DAISY Register (IOMUXC_FLEXCAN1_RX_SELECT_INPUT).....	2055
32.6.321	FLEXCAN2_RX_SELECT_INPUT DAISY Register (IOMUXC_FLEXCAN2_RX_SELECT_INPUT).....	2056
32.6.322	GPT1_CAPTURE1_SELECT_INPUT DAISY Register (IOMUXC_GPT1_CAPTURE1_SELECT_INPUT).....	2057
32.6.323	GPT1_CAPTURE2_SELECT_INPUT DAISY Register (IOMUXC_GPT1_CAPTURE2_SELECT_INPUT).....	2058
32.6.324	GPT1_CLK_SELECT_INPUT DAISY Register (IOMUXC_GPT1_CLK_SELECT_INPUT).....	2059
32.6.325	GPT2_CAPTURE1_SELECT_INPUT DAISY Register (IOMUXC_GPT2_CAPTURE1_SELECT_INPUT).....	2060
32.6.326	GPT2_CAPTURE2_SELECT_INPUT DAISY Register (IOMUXC_GPT2_CAPTURE2_SELECT_INPUT).....	2061
32.6.327	GPT2_CLK_SELECT_INPUT DAISY Register (IOMUXC_GPT2_CLK_SELECT_INPUT).....	2062
32.6.328	I2C1_SCL_SELECT_INPUT DAISY Register (IOMUXC_I2C1_SCL_SELECT_INPUT).....	2062
32.6.329	I2C1_SDA_SELECT_INPUT DAISY Register (IOMUXC_I2C1_SDA_SELECT_INPUT).....	2063
32.6.330	I2C2_SCL_SELECT_INPUT DAISY Register (IOMUXC_I2C2_SCL_SELECT_INPUT).....	2064
32.6.331	I2C2_SDA_SELECT_INPUT DAISY Register (IOMUXC_I2C2_SDA_SELECT_INPUT).....	2064
32.6.332	I2C3_SCL_SELECT_INPUT DAISY Register (IOMUXC_I2C3_SCL_SELECT_INPUT).....	2065
32.6.333	I2C3_SDA_SELECT_INPUT DAISY Register (IOMUXC_I2C3_SDA_SELECT_INPUT).....	2066
32.6.334	I2C4_SCL_SELECT_INPUT DAISY Register (IOMUXC_I2C4_SCL_SELECT_INPUT).....	2066
32.6.335	I2C4_SDA_SELECT_INPUT DAISY Register (IOMUXC_I2C4_SDA_SELECT_INPUT).....	2067
32.6.336	KPP_COL0_SELECT_INPUT DAISY Register (IOMUXC_KPP_COL0_SELECT_INPUT).....	2068
32.6.337	KPP_COL1_SELECT_INPUT DAISY Register (IOMUXC_KPP_COL1_SELECT_INPUT).....	2069
32.6.338	KPP_COL2_SELECT_INPUT DAISY Register (IOMUXC_KPP_COL2_SELECT_INPUT).....	2070
32.6.339	KPP_ROW0_SELECT_INPUT DAISY Register (IOMUXC_KPP_ROW0_SELECT_INPUT).....	2071
32.6.340	KPP_ROW1_SELECT_INPUT DAISY Register (IOMUXC_KPP_ROW1_SELECT_INPUT).....	2072
32.6.341	KPP_ROW2_SELECT_INPUT DAISY Register (IOMUXC_KPP_ROW2_SELECT_INPUT).....	2073
32.6.342	LCD_BUSY_SELECT_INPUT DAISY Register (IOMUXC_LCD_BUSY_SELECT_INPUT).....	2074

Section number	Title	Page
32.6.343	SAI1_MCLK_SELECT_INPUT DAISY Register (IOMUXC_SAI1_MCLK_SELECT_INPUT).....	2075
32.6.344	SAI1_RX_DATA_SELECT_INPUT DAISY Register (IOMUXC_SAI1_RX_DATA_SELECT_INPUT).....	2076
32.6.345	SAI1_TX_BCLK_SELECT_INPUT DAISY Register (IOMUXC_SAI1_TX_BCLK_SELECT_INPUT).....	2077
32.6.346	SAI1_TX_SYNC_SELECT_INPUT DAISY Register (IOMUXC_SAI1_TX_SYNC_SELECT_INPUT).....	2078
32.6.347	SAI2_MCLK_SELECT_INPUT DAISY Register (IOMUXC_SAI2_MCLK_SELECT_INPUT).....	2079
32.6.348	SAI2_RX_DATA_SELECT_INPUT DAISY Register (IOMUXC_SAI2_RX_DATA_SELECT_INPUT).....	2080
32.6.349	SAI2_TX_BCLK_SELECT_INPUT DAISY Register (IOMUXC_SAI2_TX_BCLK_SELECT_INPUT).....	2081
32.6.350	SAI2_TX_SYNC_SELECT_INPUT DAISY Register (IOMUXC_SAI2_TX_SYNC_SELECT_INPUT).....	2082
32.6.351	SAI3_MCLK_SELECT_INPUT DAISY Register (IOMUXC_SAI3_MCLK_SELECT_INPUT).....	2083
32.6.352	SAI3_RX_DATA_SELECT_INPUT DAISY Register (IOMUXC_SAI3_RX_DATA_SELECT_INPUT).....	2084
32.6.353	SAI3_TX_BCLK_SELECT_INPUT DAISY Register (IOMUXC_SAI3_TX_BCLK_SELECT_INPUT).....	2085
32.6.354	SAI3_TX_SYNC_SELECT_INPUT DAISY Register (IOMUXC_SAI3_TX_SYNC_SELECT_INPUT).....	2086
32.6.355	SDMA_EVENTS0_SELECT_INPUT DAISY Register (IOMUXC_SDMA_EVENTS0_SELECT_INPUT).....	2086
32.6.356	SDMA_EVENTS1_SELECT_INPUT DAISY Register (IOMUXC_SDMA_EVENTS1_SELECT_INPUT).....	2087
32.6.357	SPDIF_IN_SELECT_INPUT DAISY Register (IOMUXC_SPDIF_IN_SELECT_INPUT).....	2088
32.6.358	SPDIF_EXT_CLK_SELECT_INPUT DAISY Register (IOMUXC_SPDIF_EXT_CLK_SELECT_INPUT).....	2089
32.6.359	UART1_RTS_B_SELECT_INPUT DAISY Register (IOMUXC_UART1_RTS_B_SELECT_INPUT)	2089
32.6.360	UART1_RX_DATA_SELECT_INPUT DAISY Register (IOMUXC_UART1_RX_DATA_SELECT_INPUT).....	2090
32.6.361	UART2_RTS_B_SELECT_INPUT DAISY Register (IOMUXC_UART2_RTS_B_SELECT_INPUT)	2091

Section number	Title	Page
32.6.362	UART2_RX_DATA_SELECT_INPUT DAISY Register (IOMUXC_UART2_RX_DATA_SELECT_INPUT).....	2091
32.6.363	UART3_RTS_B_SELECT_INPUT DAISY Register (IOMUXC_UART3_RTS_B_SELECT_INPUT)	2092
32.6.364	UART3_RX_DATA_SELECT_INPUT DAISY Register (IOMUXC_UART3_RX_DATA_SELECT_INPUT).....	2093
32.6.365	UART4_RTS_B_SELECT_INPUT DAISY Register (IOMUXC_UART4_RTS_B_SELECT_INPUT)	2093
32.6.366	UART4_RX_DATA_SELECT_INPUT DAISY Register (IOMUXC_UART4_RX_DATA_SELECT_INPUT).....	2094
32.6.367	UART5_RTS_B_SELECT_INPUT DAISY Register (IOMUXC_UART5_RTS_B_SELECT_INPUT)	2095
32.6.368	UART5_RX_DATA_SELECT_INPUT DAISY Register (IOMUXC_UART5_RX_DATA_SELECT_INPUT).....	2095
32.6.369	UART6_RTS_B_SELECT_INPUT DAISY Register (IOMUXC_UART6_RTS_B_SELECT_INPUT)	2096
32.6.370	UART6_RX_DATA_SELECT_INPUT DAISY Register (IOMUXC_UART6_RX_DATA_SELECT_INPUT).....	2097
32.6.371	UART7_RTS_B_SELECT_INPUT DAISY Register (IOMUXC_UART7_RTS_B_SELECT_INPUT)	2097
32.6.372	UART7_RX_DATA_SELECT_INPUT DAISY Register (IOMUXC_UART7_RX_DATA_SELECT_INPUT).....	2098
32.6.373	UART8_RTS_B_SELECT_INPUT DAISY Register (IOMUXC_UART8_RTS_B_SELECT_INPUT)	2099
32.6.374	UART8_RX_DATA_SELECT_INPUT DAISY Register (IOMUXC_UART8_RX_DATA_SELECT_INPUT).....	2099
32.6.375	USB_OTG2_OC_SELECT_INPUT DAISY Register (IOMUXC_USB_OTG2_OC_SELECT_INPUT).....	2100
32.6.376	USB_OTG_OC_SELECT_INPUT DAISY Register (IOMUXC_USB_OTG_OC_SELECT_INPUT)..	2101
32.6.377	USDHC1_CD_B_SELECT_INPUT DAISY Register (IOMUXC_USDHC1_CD_B_SELECT_INPUT).....	2101
32.6.378	USDHC1_WP_SELECT_INPUT DAISY Register (IOMUXC_USDHC1_WP_SELECT_INPUT).....	2102
32.6.379	USDHC2_CLK_SELECT_INPUT DAISY Register (IOMUXC_USDHC2_CLK_SELECT_INPUT)..	2103
32.6.380	USDHC2_CD_B_SELECT_INPUT DAISY Register (IOMUXC_USDHC2_CD_B_SELECT_INPUT).....	2103
32.6.381	USDHC2_CMD_SELECT_INPUT DAISY Register (IOMUXC_USDHC2_CMD_SELECT_INPUT)	2104
32.6.382	USDHC2_DATA0_SELECT_INPUT DAISY Register (IOMUXC_USDHC2_DATA0_SELECT_INPUT).....	2105

Section number	Title	Page
32.6.383	USDHC2_DATA1_SELECT_INPUT DAISY Register (IOMUXC_USDHC2_DATA1_SELECT_INPUT).....	2105
32.6.384	USDHC2_DATA2_SELECT_INPUT DAISY Register (IOMUXC_USDHC2_DATA2_SELECT_INPUT).....	2106
32.6.385	USDHC2_DATA3_SELECT_INPUT DAISY Register (IOMUXC_USDHC2_DATA3_SELECT_INPUT).....	2107
32.6.386	USDHC2_DATA4_SELECT_INPUT DAISY Register (IOMUXC_USDHC2_DATA4_SELECT_INPUT).....	2107
32.6.387	USDHC2_DATA5_SELECT_INPUT DAISY Register (IOMUXC_USDHC2_DATA5_SELECT_INPUT).....	2108
32.6.388	USDHC2_DATA6_SELECT_INPUT DAISY Register (IOMUXC_USDHC2_DATA6_SELECT_INPUT).....	2109
32.6.389	USDHC2_DATA7_SELECT_INPUT DAISY Register (IOMUXC_USDHC2_DATA7_SELECT_INPUT).....	2109
32.6.390	USDHC2_WP_SELECT_INPUT DAISY Register (IOMUXC_USDHC2_WP_SELECT_INPUT).....	2110

Chapter 33 Keypad Port (KPP)

33.1	Overview	2111
33.1.1	Features.....	2113
33.1.2	Modes and Operations.....	2113
33.2	Clocks.....	2113
33.3	External Signals.....	2113
33.3.1	Input Pins.....	2114
33.3.2	Output Pins.....	2115
33.3.3	Generation of Transfer Error Signal on Peripheral Bus.....	2115
33.4	Functional Description.....	2115
33.4.1	Keypad Matrix Construction.....	2116
33.4.2	Keypad Port Configuration.....	2116
33.4.3	Keypad Matrix Scanning.....	2116
33.4.4	Keypad Standby.....	2117
33.4.5	Glitch Suppression on Keypad Inputs.....	2117

Section number	Title	Page
33.4.6	Multiple Key Closures.....	2118
33.4.6.1	Ghost Key Problem and Correction.....	2120
33.4.7	3-Point Contact Keys Support.....	2122
33.5	Initialization/Application Information.....	2123
33.5.1	Typical Keypad Configuration and Scanning Sequence.....	2123
33.5.2	Key Press Interrupt Scanning Sequence.....	2124
33.5.3	Additional Comments.....	2124
33.6	KPP Memory Map/Register Definition.....	2124
33.6.1	Keypad Control Register (KPP_KPCR).....	2125
33.6.2	Keypad Status Register (KPP_KPSR).....	2126
33.6.3	Keypad Data Direction Register (KPP_KDDR).....	2127
33.6.4	Keypad Data Register (KPP_KPDR).....	2128

Chapter 34 Enhanced LCD Interface (eLCDIF)

34.1	Overview.....	2131
34.2	External Signals.....	2131
34.3	Clocks.....	2132
34.4	Functional Description.....	2133
34.4.1	Bus Interface Mechanisms.....	2134
34.4.1.1	Bus Master Operation in Write/Display Modes.....	2135
34.4.1.2	System Bus Master Performance.....	2135
34.4.2	Write Data Path.....	2136
34.4.3	Read Data Path.....	2143
34.4.4	eLCDIF Interrupts.....	2148
34.4.5	Initializing the eLCDIF.....	2148
34.4.5.1	Write Modes.....	2148
34.4.5.2	MPU Read Mode.....	2149
34.4.6	MPU Interface.....	2150
34.4.6.1	Code Example to Initialize the eLCDIF in MPU Write Mode.....	2152

Section number	Title	Page
34.4.7	VSYNC Interface.....	2152
34.4.7.1	Code Example to Initialize eLCDIF in VSYNC Mode.....	2153
34.4.8	DOTCLK Interface.....	2154
34.4.8.1	Code Example.....	2156
34.4.9	CSI HANDSHAKE INTERFACE.....	2156
34.4.10	Alpha Blending Interface.....	2157
34.4.11	ITU-R BT.656 Digital Video Interface (DVI).....	2157
34.4.12	eLCDIF Pin Usage by Interface Mode.....	2159
34.5	Behavior During Reset.....	2165
34.6	eLCDIF Memory Map/Register Definition.....	2165
34.6.1	eLCDIF General Control Register (LCDIF_CTRL <i>n</i>).....	2168
34.6.2	eLCDIF General Control1 Register (LCDIF_CTRL1 <i>n</i>).....	2171
34.6.3	eLCDIF General Control2 Register (LCDIF_CTRL2 <i>n</i>).....	2173
34.6.4	eLCDIF Horizontal and Vertical Valid Data Count Register (LCDIF_TRANSFER_COUNT).....	2176
34.6.5	LCD Interface Current Buffer Address Register (LCDIF_CUR_BUF).....	2176
34.6.6	LCD Interface Next Buffer Address Register (LCDIF_NEXT_BUF).....	2177
34.6.7	LCD Interface Timing Register (LCDIF_TIMING).....	2177
34.6.8	eLCDIF VSYNC Mode and Dotclk Mode Control Register0 (LCDIF_VDCTRL0 <i>n</i>).....	2178
34.6.9	eLCDIF VSYNC Mode and Dotclk Mode Control Register1 (LCDIF_VDCTRL1).....	2180
34.6.10	LCDIF VSYNC Mode and Dotclk Mode Control Register2 (LCDIF_VDCTRL2).....	2180
34.6.11	eLCDIF VSYNC Mode and Dotclk Mode Control Register3 (LCDIF_VDCTRL3).....	2181
34.6.12	eLCDIF VSYNC Mode and Dotclk Mode Control Register4 (LCDIF_VDCTRL4).....	2182
34.6.13	Digital Video Interface Control0 Register (LCDIF_DVICTRL0).....	2183
34.6.14	Digital Video Interface Control1 Register (LCDIF_DVICTRL1).....	2183
34.6.15	Digital Video Interface Control2 Register (LCDIF_DVICTRL2).....	2184
34.6.16	Digital Video Interface Control3 Register (LCDIF_DVICTRL3).....	2185
34.6.17	Digital Video Interface Control4 Register (LCDIF_DVICTRL4).....	2186
34.6.18	RGB to YCbCr 4:2:2 CSC Coefficient0 Register (LCDIF_CSC_COEFF0).....	2187
34.6.19	RGB to YCbCr 4:2:2 CSC Coefficient1 Register (LCDIF_CSC_COEFF1).....	2188

Section number	Title	Page
34.6.20	RGB to YCbCr 4:2:2 CSC Coefficient2 Register (LCDIF_CSC_COEFF2).....	2189
34.6.21	RGB to YCbCr 4:2:2 CSC Coefficient3 Register (LCDIF_CSC_COEFF3).....	2189
34.6.22	RGB to YCbCr 4:2:2 CSC Coefficient4 Register (LCDIF_CSC_COEFF4).....	2190
34.6.23	RGB to YCbCr 4:2:2 CSC Offset Register (LCDIF_CSC_OFFSET).....	2191
34.6.24	RGB to YCbCr 4:2:2 CSC Limit Register (LCDIF_CSC_LIMIT).....	2191
34.6.25	LCD Interface Data Register (LCDIF_DATA).....	2192
34.6.26	Bus Master Error Status Register (LCDIF_BM_ERROR_STAT).....	2193
34.6.27	CRC Status Register (LCDIF_CRC_STAT).....	2193
34.6.28	LCD Interface Status Register (LCDIF_STAT).....	2194
34.6.29	eLCDIF Threshold Register (LCDIF_THRES).....	2196
34.6.30	eLCDIF AS Buffer Control Register (LCDIF_AS_CTRL).....	2197
34.6.31	Alpha Surface Buffer Pointer (LCDIF_AS_BUF).....	2199
34.6.32	LCDIF_AS_NEXT_BUF.....	2200
34.6.33	eLCDIF Overlay Color Key Low (LCDIF_AS_CLRKEYLOW).....	2200
34.6.34	eLCDIF Overlay Color Key High (LCDIF_AS_CLRKEYHIGH).....	2201
34.6.35	LCD working insync mode with CSI for VSYNC delay (LCDIF_SYNC_DELAY).....	2201

Chapter 35 Multi Mode DDR Controller (MMDC)

35.1	Overview.....	2203
35.1.1	MMDC feature summary.....	2204
35.2	External Signals.....	2206
35.3	Clocks.....	2207
35.4	Functional Description.....	2207
35.4.1	Write/Read data flow.....	2207
35.4.1.1	Write data flow.....	2207
35.4.1.2	Read data flow.....	2208
35.4.2	MMDC initialization	2208
35.4.3	Configuring the MMDC registers.....	2210
35.4.4	MMDC Address Space.....	2210

Section number	Title	Page
35.4.4.1	Address decoding	2210
35.4.4.2	Chip select settings.....	2213
35.4.4.2.1	Creating 4 Gbyte address space with 2 Gbyte CS density.....	2213
35.4.4.2.2	Creating 2 Gbyte address spaces with 1 Gbyte CS density.....	2213
35.4.4.3	Translation of AXI accesses to DDR accessess.....	2214
35.4.4.3.1	Example 1.....	2214
35.4.4.3.2	Example 2.....	2215
35.4.4.3.3	Example 3.....	2216
35.4.4.3.4	Example 4.....	2216
35.4.4.3.5	Example 5.....	2217
35.4.4.4	Address mirroring	2218
35.4.5	LPDDR2 and DDR3 pin mux mapping.....	2218
35.4.6	Power Saving and Clock Frequency Change modes.....	2219
35.4.6.1	Power saving general.....	2220
35.4.6.2	Self refresh and Frequency change entry/exit.....	2221
35.4.7	Reset	2222
35.4.7.1	Hard reset.....	2222
35.4.7.2	Warm reset.....	2222
35.4.7.3	Software reset	2223
35.4.8	Refresh Scheme.....	2224
35.4.9	Burst Length options towards DDR.....	2224
35.4.10	Exclusive accesses handling.....	2225
35.4.11	AXI Error Handling.....	2226
35.5	Performance.....	2226
35.5.1	Arbitration and reordering mechanism.....	2226
35.5.1.1	Arbitration General.....	2226
35.5.1.2	Real time channel mode.....	2227
35.5.1.3	Dynamic scoring mode (Arbitration Winning Conditions).....	2227
35.5.1.4	Guarding (aging) mechanism.....	2228

Section number	Title	Page
35.5.2	Prediction mechanism.....	2229
35.5.3	Special Optimization for accesses towards DDR3.....	2229
35.6	MMDC Debug	2230
35.6.1	Hardware debug monitor.....	2230
35.6.2	Step By Step (SBS) software monitor.....	2231
35.7	MMDC Profiling.....	2231
35.8	LPDDR2 Refresh Rate Update and Timing Derating.....	2232
35.9	DLL Switching.....	2233
35.9.1	DLL Off mode.....	2233
35.10	ODT Configuration	2235
35.11	Calibration Process.....	2236
35.11.1	Delay-line.....	2237
35.11.2	ZQ calibration	2237
35.11.2.1	ZQ automatic (hardware) calibration process.....	2238
35.11.2.1.1	ZQ automatic Pull-up calibration.....	2239
35.11.2.1.2	ZQ automatic Pull-down calibration.....	2239
35.11.2.2	ZQ software calibration process.....	2239
35.11.2.3	ZQ calibration commands	2240
35.11.3	Read DQS Gating Calibration.....	2240
35.11.3.1	Hardware DQS Gating Calibration.....	2240
35.11.3.1.1	Hardware DQS Calibration with MPR.....	2241
35.11.3.1.2	Hardware DQS Calibration with pre-defined value.....	2241
35.11.3.2	SW read DQS gating Calibration.....	2244
35.11.3.2.1	SW read Calibration with MPR.....	2244
35.11.3.2.2	SW read Calibration with pre-defined value.....	2244
35.11.4	Read Calibration.....	2246
35.11.4.1	Hardware (automatic) Read Calibration.....	2247
35.11.4.1.1	Hardware (automatic) Calibration with MPR/DQ Calibration.....	2247
35.11.4.1.2	Hardware (automatic) Calibration with pre-defined value.....	2247

Section number	Title	Page
35.11.4.2	SW Read Calibration.....	2249
35.11.4.2.1	Calibration with MPR/DQ calibration.....	2249
35.11.4.2.2	Calibration with pre-defined value.....	2249
35.11.5	Write Calibration.....	2251
35.11.5.1	HW (automatic) Write Calibration.....	2251
35.11.5.2	SW Write Calibration.....	2253
35.11.6	Write leveling Calibration.....	2254
35.11.6.1	Hardware Write Leveling Calibration.....	2255
35.11.6.2	SW Write Leveling Calibration.....	2256
35.11.7	Write fine tuning.....	2257
35.11.8	Read fine tuning.....	2258
35.11.9	ZQ Fine Tuning.....	2258
35.11.10	Duty cycle adjustment.....	2258
35.12	MMDC Memory Map/Register Definition.....	2258
35.12.1	MMDC Core Control Register (MMDC_MDCTL).....	2263
35.12.2	MMDC Core Power Down Control Register (MMDC_MDPDC).....	2264
35.12.3	MMDC Core ODT Timing Control Register (MMDC_MDOTC).....	2267
35.12.4	MMDC Core Timing Configuration Register 0 (MMDC_MDCFG0).....	2269
35.12.5	MMDC Core Timing Configuration Register 1 (MMDC_MDCFG1).....	2270
35.12.6	MMDC Core Timing Configuration Register 2 (MMDC_MDCFG2).....	2273
35.12.7	MMDC Core Miscellaneous Register (MMDC_MDMISC).....	2275
35.12.8	MMDC Core Special Command Register (MMDC_MDSCR).....	2278
35.12.9	MMDC Core Refresh Control Register (MMDC_MDREF).....	2281
35.12.10	MMDC Core Read/Write Command Delay Register (MMDC_MDRWD).....	2283
35.12.11	MMDC Core Out of Reset Delays Register (MMDC_MDOR).....	2285
35.12.12	MMDC Core MRR Data Register (MMDC_MDMRR).....	2286
35.12.13	MMDC Core Timing Configuration Register 3 (MMDC_MDCFG3LP).....	2287
35.12.14	MMDC Core MR4 Derating Register (MMDC_MDMR4).....	2289
35.12.15	MMDC Core Address Space Partition Register (MMDC_MDASP).....	2291

Section number	Title	Page
35.12.16	MMDC Core AXI Reordering Control Register (MMDC_MAARCR).....	2292
35.12.17	MMDC Core Power Saving Control and Status Register (MMDC_MAPSR).....	2294
35.12.18	MMDC Core Exclusive ID Monitor Register0 (MMDC_MAEXIDR0).....	2296
35.12.19	MMDC Core Exclusive ID Monitor Register1 (MMDC_MAEXIDR1).....	2297
35.12.20	MMDC Core Debug and Profiling Control Register 0 (MMDC_MADPCR0).....	2298
35.12.21	MMDC Core Debug and Profiling Control Register 1 (MMDC_MADPCR1).....	2299
35.12.22	MMDC Core Debug and Profiling Status Register 0 (MMDC_MADPSR0).....	2300
35.12.23	MMDC Core Debug and Profiling Status Register 1 (MMDC_MADPSR1).....	2300
35.12.24	MMDC Core Debug and Profiling Status Register 2 (MMDC_MADPSR2).....	2301
35.12.25	MMDC Core Debug and Profiling Status Register 3 (MMDC_MADPSR3).....	2301
35.12.26	MMDC Core Debug and Profiling Status Register 4 (MMDC_MADPSR4).....	2302
35.12.27	MMDC Core Debug and Profiling Status Register 5 (MMDC_MADPSR5).....	2302
35.12.28	MMDC Core Step By Step Address Register (MMDC_MASBS0).....	2303
35.12.29	MMDC Core Step By Step Address Attributes Register (MMDC_MASBS1).....	2303
35.12.30	MMDC Core General Purpose Register (MMDC_MAGENP).....	2304
35.12.31	MMDC PHY ZQ HW control register (MMDC_MPZQHWCTRL).....	2305
35.12.32	MMDC PHY ZQ SW control register (MMDC_MPZQSWCTRL).....	2308
35.12.33	MMDC PHY Write Leveling Configuration and Error Status Register (MMDC_MPWLGCR).....	2310
35.12.34	MMDC PHY Write Leveling Delay Control Register 0 (MMDC_MPWLDECTRL0).....	2313
35.12.35	MMDC PHY Write Leveling Delay Control Register 1 (MMDC_MPWLDECTRL1).....	2315
35.12.36	MMDC PHY Write Leveling delay-line Status Register (MMDC_MPWLDLST).....	2318
35.12.37	MMDC PHY ODT control register (MMDC_MPODTCTRL).....	2319
35.12.38	MMDC PHY Read DQ Byte0 Delay Register (MMDC_MPRDDQBY0DL).....	2321
35.12.39	MMDC PHY Read DQ Byte1 Delay Register (MMDC_MPRDDQBY1DL).....	2324
35.12.40	MMDC PHY Write DQ Byte0 Delay Register (MMDC_MPWRDQBY0DL).....	2327
35.12.41	MMDC PHY Write DQ Byte1 Delay Register (MMDC_MPWRDQBY1DL).....	2329
35.12.42	MMDC PHY Write DQ Byte2 Delay Register (MMDC_MPWRDQBY2DL).....	2331
35.12.43	MMDC PHY Write DQ Byte3 Delay Register (MMDC_MPWRDQBY3DL).....	2333
35.12.44	MMDC PHY Read DQS Gating Control Register 0 (MMDC_MPDGCTRL0).....	2336

Section number	Title	Page
35.12.45	MMDC PHY Read DQS Gating Control Register 1 (MMDC_MPDGCTRL1).....	2338
35.12.46	MMDC PHY Read DQS Gating delay-line Status Register (MMDC_MPDGDLST0).....	2340
35.12.47	MMDC PHY Read delay-lines Configuration Register (MMDC_MPRDDLCTL).....	2342
35.12.48	MMDC PHY Read delay-lines Status Register (MMDC_MPRDDLST).....	2344
35.12.49	MMDC PHY Write delay-lines Configuration Register (MMDC_MPWRDLCTL).....	2346
35.12.50	MMDC PHY Write delay-lines Status Register (MMDC_MPWRDLST).....	2348
35.12.51	MMDC PHY CK Control Register (MMDC_MPSDCTRL).....	2349
35.12.52	MMDC ZQ LPDDR2 HW Control Register (MMDC_MPZQLP2CTL).....	2350
35.12.53	MMDC PHY Read Delay HW Calibration Control Register (MMDC_MPRDDLHWCTL).....	2352
35.12.54	MMDC PHY Write Delay HW Calibration Control Register (MMDC_MPWRDLHWCTL).....	2355
35.12.55	MMDC PHY Read Delay HW Calibration Status Register 0 (MMDC_MPRDDLHWST0).....	2357
35.12.56	MMDC PHY Write Delay HW Calibration Status Register 0 (MMDC_MPWRDLHWST0).....	2358
35.12.57	MMDC PHY Write Leveling HW Error Register (MMDC_MPWLHWERR).....	2359
35.12.58	MMDC PHY Read DQS Gating HW Status Register 0 (MMDC_MPDGHWST0).....	2359
35.12.59	MMDC PHY Read DQS Gating HW Status Register 1 (MMDC_MPDGHWST1).....	2360
35.12.60	MMDC PHY Read DQS Gating HW Status Register 2 (MMDC_MPDGHWST2).....	2360
35.12.61	MMDC PHY Read DQS Gating HW Status Register 3 (MMDC_MPDGHWST3).....	2361
35.12.62	MMDC PHY Pre-defined Compare Register 1 (MMDC_MPPDCMPR1).....	2361
35.12.63	MMDC PHY Pre-defined Compare and CA delay-line Configuration Register (MMDC_MPPDCMPR2).....	2363
35.12.64	MMDC PHY SW Dummy Access Register (MMDC_MPSWDAR0).....	2366
35.12.65	MMDC PHY SW Dummy Read Data Register 0 (MMDC_MPSWDRDR0).....	2368
35.12.66	MMDC PHY SW Dummy Read Data Register 1 (MMDC_MPSWDRDR1).....	2368
35.12.67	MMDC PHY SW Dummy Read Data Register 2 (MMDC_MPSWDRDR2).....	2369
35.12.68	MMDC PHY SW Dummy Read Data Register 3 (MMDC_MPSWDRDR3).....	2369
35.12.69	MMDC PHY SW Dummy Read Data Register 4 (MMDC_MPSWDRDR4).....	2369
35.12.70	MMDC PHY SW Dummy Read Data Register 5 (MMDC_MPSWDRDR5).....	2370
35.12.71	MMDC PHY SW Dummy Read Data Register 6 (MMDC_MPSWDRDR6).....	2370
35.12.72	MMDC PHY SW Dummy Read Data Register 7 (MMDC_MPSWDRDR7).....	2371

Section number	Title	Page
35.12.73	MMDC PHY Measure Unit Register (MMDC_MPMUR0).....	2371
35.12.74	MMDC Write CA delay-line controller (MMDC_MPWRCADL).....	2372
35.12.75	MMDC Duty Cycle Control Register (MMDC_MPDCCR).....	2374

Chapter 36 Medium Quality Sound (MQS)

36.1	Overview.....	2377
36.1.1	Block Diagram.....	2377
36.2	External Signals.....	2378
36.3	Interface Signals.....	2379
36.4	Programming Considerations.....	2379
36.4.1	Usage Model.....	2380

Chapter 37 On-Chip OTP Controller (OCOTP_CTRL)

37.1	Overview.....	2381
37.1.1	Features.....	2381
37.2	Clocks.....	2381
37.3	Top-Level Symbol and Functional Overview.....	2382
37.3.1	Operation.....	2382
37.3.1.1	Shadow Register Reload.....	2383
37.3.1.2	Fuse and Shadow Register Read.....	2383
37.3.1.3	Fuse and Shadow Register Writes.....	2383
37.3.1.4	Write Postamble.....	2385
37.3.2	Fuse Shadow Memory Footprint.....	2385
37.3.3	OTP Read/Write Timing Parameters.....	2387
37.3.4	Hardware Visible Fuses.....	2387
37.3.5	Behavior During Reset.....	2387
37.3.6	Secure JTAG control.....	2387
37.4	Fuse Map.....	2388
37.5	OCOTP Memory Map/Register Definition.....	2388

Section number	Title	Page
37.5.1	OTP Controller Control Register (OCOTP_CTRL n).....	2392
37.5.2	OTP Controller Timing Register (OCOTP_TIMING).....	2394
37.5.3	OTP Controller Write Data Register (OCOTP_DATA).....	2394
37.5.4	OTP Controller Read Control Register (OCOTP_READ_CTRL).....	2395
37.5.5	OTP Controller Read Fuse Data Register (OCOTP_READ_FUSE_DATA).....	2396
37.5.6	Sticky bit Register (OCOTP_SW_STICKY).....	2396
37.5.7	Software Controllable Signals Register (OCOTP_SCS n).....	2397
37.5.8	OTP Controller CRC Test Address (OCOTP_CRC_ADDR).....	2398
37.5.9	OTP Controller CRC Value Register (OCOTP_CRC_VALUE).....	2399
37.5.10	OTP Controller Version Register (OCOTP_VERSION).....	2400
37.5.11	OTP Controller Timing Register 2 (OCOTP_TIMING2).....	2400
37.5.12	Value of OTP Bank0 Word0 (Lock controls) (OCOTP_LOCK).....	2401
37.5.13	Value of OTP Bank0 Word1 (Configuration and Manufacturing Info.) (OCOTP_CFG0).....	2404
37.5.14	Value of OTP Bank0 Word2 (Configuration and Manufacturing Info.) (OCOTP_CFG1).....	2405
37.5.15	Value of OTP Bank0 Word3 (Configuration and Manufacturing Info.) (OCOTP_CFG2).....	2405
37.5.16	Value of OTP Bank0 Word4 (Configuration and Manufacturing Info.) (OCOTP_CFG3).....	2406
37.5.17	Value of OTP Bank0 Word5 (Configuration and Manufacturing Info.) (OCOTP_CFG4).....	2406
37.5.18	Value of OTP Bank0 Word6 (Configuration and Manufacturing Info.) (OCOTP_CFG5).....	2407
37.5.19	Value of OTP Bank0 Word7 (Configuration and Manufacturing Info.) (OCOTP_CFG6).....	2407
37.5.20	Value of OTP Bank1 Word0 (Memory Related Info.) (OCOTP_MEM0).....	2408
37.5.21	Value of OTP Bank1 Word1 (Memory Related Info.) (OCOTP_MEM1).....	2408
37.5.22	Value of OTP Bank1 Word2 (Memory Related Info.) (OCOTP_MEM2).....	2409
37.5.23	Value of OTP Bank1 Word3 (Memory Related Info.) (OCOTP_MEM3).....	2409
37.5.24	Value of OTP Bank1 Word4 (Memory Related Info.) (OCOTP_MEM4).....	2410
37.5.25	Value of OTP Bank1 Word5 (Memory Related Info.) (OCOTP_ANA0).....	2410
37.5.26	Value of OTP Bank1 Word6 (General Purpose Customer Defined Info.) (OCOTP_ANA1).....	2411
37.5.27	Value of OTP Bank1 Word7 (General Purpose Customer Defined Info.) (OCOTP_ANA2).....	2411
37.5.28	Value of OTP Bank2 Word0 (OTPMK Key) (OCOTP_OTPMK0).....	2412
37.5.29	Value of OTP Bank2 Word1 (OTPMK Key) (OCOTP_OTPMK1).....	2412

Section number	Title	Page
37.5.30	Value of OTP Bank2 Word2 (OTPMK Key) (OCOTP_OTPMK2).....	2413
37.5.31	Value of OTP Bank2 Word3 (OTPMK Key) (OCOTP_OTPMK3).....	2413
37.5.32	Value of OTP Bank2 Word4 (OTPMK Key) (OCOTP_OTPMK4).....	2414
37.5.33	Value of OTP Bank2 Word5 (OTPMK Key) (OCOTP_OTPMK5).....	2414
37.5.34	Value of OTP Bank2 Word6 (OTPMK Key) (OCOTP_OTPMK6).....	2415
37.5.35	Value of OTP Bank2 Word7 (OTPMK Key) (OCOTP_OTPMK7).....	2415
37.5.36	Shadow Register for OTP Bank3 Word0 (SRK Hash) (OCOTP_SRK0).....	2416
37.5.37	Shadow Register for OTP Bank3 Word1 (SRK Hash) (OCOTP_SRK1).....	2416
37.5.38	Shadow Register for OTP Bank3 Word2 (SRK Hash) (OCOTP_SRK2).....	2417
37.5.39	Shadow Register for OTP Bank3 Word3 (SRK Hash) (OCOTP_SRK3).....	2417
37.5.40	Shadow Register for OTP Bank3 Word4 (SRK Hash) (OCOTP_SRK4).....	2418
37.5.41	Shadow Register for OTP Bank3 Word5 (SRK Hash) (OCOTP_SRK5).....	2418
37.5.42	Shadow Register for OTP Bank3 Word6 (SRK Hash) (OCOTP_SRK6).....	2419
37.5.43	Shadow Register for OTP Bank3 Word7 (SRK Hash) (OCOTP_SRK7).....	2419
37.5.44	Value of OTP Bank4 Word0 (Secure JTAG Response Field) (OCOTP_SJC_RESP0).....	2420
37.5.45	Value of OTP Bank4 Word1 (Secure JTAG Response Field) (OCOTP_SJC_RESP1).....	2420
37.5.46	Value of OTP Bank4 Word2 (MAC Address) (OCOTP_MAC0).....	2421
37.5.47	Value of OTP Bank4 Word3 (MAC Address) (OCOTP_MAC1).....	2421
37.5.48	Value of OTP Bank4 Word4 (MAC Address) (OCOTP_RESERVED) (OCOTP_MAC).....	2421
37.5.49	Value of OTP Bank4 Word5 (CRC Key) (OCOTP_CRC).....	2422
37.5.50	Value of OTP Bank4 Word6 (General Purpose Customer Defined Info) (OCOTP_GP1).....	2422
37.5.51	Value of OTP Bank4 Word7 (General Purpose Customer Defined Info) (OCOTP_GP2).....	2423
37.5.52	Value of OTP Bank5 Word0 (SW GP) (OCOTP_SW_GP0).....	2423
37.5.53	Value of OTP Bank5 Word1 (SW GP) (OCOTP_SW_GP1).....	2424
37.5.54	Value of OTP Bank5 Word2 (SW GP) (OCOTP_SW_GP2).....	2424
37.5.55	Value of OTP Bank5 Word3 (SW GP) (OCOTP_SW_GP3).....	2424
37.5.56	Value of OTP Bank5 Word4 (SW GP) (OCOTP_SW_GP4).....	2425
37.5.57	Value of OTP Bank5 Word5 (Misc Conf) (OCOTP_MISC_CONF).....	2425
37.5.58	Value of OTP Bank5 Word6 (Field Return) (OCOTP_FIELD_RETURN).....	2426

Section number	Title	Page
37.5.59	Value of OTP Bank5 Word7 (SRK Revoke) (OCOTP_SRK_REVOKE).....	2426
37.5.60	Value of OTP Bank6 Word0 (ROM Patch) (OCOTP_ROM_PATCH0).....	2427
37.5.61	Value of OTP Bank6 Word1 (ROM Patch) (OCOTP_ROM_PATCH1).....	2427
37.5.62	Value of OTP Bank6 Word2 (ROM Patch) (OCOTP_ROM_PATCH2).....	2427
37.5.63	Value of OTP Bank6 Word3 (ROM Patch) (OCOTP_ROM_PATCH3).....	2428
37.5.64	Value of OTP Bank6 Word4 (ROM Patch) (OCOTP_ROM_PATCH4).....	2428
37.5.65	Value of OTP Bank6 Word5 (ROM Patch) (OCOTP_ROM_PATCH5).....	2429
37.5.66	Value of OTP Bank6 Word6 (ROM Patch) (OCOTP_ROM_PATCH6).....	2429
37.5.67	Value of OTP Bank6 Word7 (ROM Patch) (OCOTP_ROM_PATCH7).....	2430
37.5.68	Value of OTP Bank7 Word0 (General Purpose Customer Defined Info) (OCOTP_GP3_0).....	2430
37.5.69	Value of OTP Bank7 Word1 (General Purpose Customer Defined Info) (OCOTP_GP3_1).....	2430
37.5.70	Value of OTP Bank7 Word2 (General Purpose Customer Defined Info) (OCOTP_GP3_2).....	2431
37.5.71	Value of OTP Bank7 Word3 (General Purpose Customer Defined Info) (OCOTP_GP3_3).....	2431
37.5.72	Value of OTP Bank8 Word4 (General Purpose Customer Defined Info) (OCOTP_GP4_0).....	2432
37.5.73	Value of OTP Bank7 Word5 (General Purpose Customer Defined Info) (OCOTP_GP4_1).....	2432
37.5.74	Value of OTP Bank7 Word6 (General Purpose Customer Defined Info) (OCOTP_GP4_2).....	2433
37.5.75	Value of OTP Bank7 Word7 (General Purpose Customer Defined Info) (OCOTP_GP4_3).....	2433

Chapter 38

On-Chip RAM Memory Controller (OCRAM)

38.1	Overview.....	2435
38.2	Basic Functions.....	2436
38.2.1	Read/Write Arbitration.....	2436
38.3	Advanced Features.....	2437
38.3.1	Read Data Wait State.....	2437
38.3.2	Read Address Pipeline.....	2437
38.3.3	Write Data Pipeline.....	2438
38.3.4	Write Address Pipeline.....	2438
38.4	Programmable Registers.....	2439

Chapter 39

Section number	Title	Page
Power Management Unit (PMU)		
39.1	Overview.....	2441
39.2	Digital LDO Regulators.....	2443
39.3	Analog LDO Regulators.....	2444
39.3.1	LDO 1P1.....	2444
39.3.2	LDO 2P5.....	2444
39.3.3	Low Power Operation.....	2445
39.4	USB LDO Regulator.....	2446
39.5	SNVS Regulator.....	2446
39.6	PMU Memory Map/Register Definition.....	2446
39.6.1	Regulator 1P1 Register (PMU_REG_1P1n).....	2449
39.6.2	Regulator 3P0 Register (PMU_REG_3P0n).....	2452
39.6.3	Regulator 2P5 Register (PMU_REG_2P5n).....	2454
39.6.4	Digital Regulator Core Register (PMU_REG_COREn).....	2456
39.6.5	Miscellaneous Register 0 (PMU_MISC0n).....	2458
39.6.6	Miscellaneous Register 1 (PMU_MISC1n).....	2462
39.6.7	Miscellaneous Control Register (PMU_MISC2n).....	2464
39.6.8	Low Power Control Register (PMU_LOWPWR_CTRLn).....	2469

Chapter 40 Pulse Width Modulation (PWM)

40.1	Overview.....	2473
40.2	External Signals.....	2474
40.3	Clocks.....	2476
40.4	Functional Description.....	2477
40.4.1	Operation.....	2477
40.4.1.1	FIFO.....	2478
40.4.1.2	Rollover and Compare Event.....	2478
40.4.1.3	Low Power Mode Behavior.....	2479
40.4.1.4	Debug Mode Behavior.....	2479

Section number	Title	Page
40.5	Enable Sequence for the PWM.....	2479
40.6	Disable Sequence for the PWM.....	2479
40.7	PWM Memory Map/Register Definition.....	2480
40.7.1	PWM Control Register (PWMx_PWMCR).....	2482
40.7.2	PWM Status Register (PWMx_PWMSR).....	2484
40.7.3	PWM Interrupt Register (PWMx_PWMIR).....	2485
40.7.4	PWM Sample Register (PWMx_PWMSAR).....	2486
40.7.5	PWM Period Register (PWMx_PWMPR).....	2487
40.7.6	PWM Counter Register (PWMx_PWMCNR).....	2488

Chapter 41 Pixel Pipeline (PXP)

41.1	Overview.....	2489
41.2	Clocks.....	2490
41.3	Top-level architecture.....	2490
41.3.1	Processing Details.....	2493
41.3.2	Scaling Operation.....	2494
41.3.3	Decimation Image Scaling.....	2495
41.3.4	Bilinear Image Scaling Filter	2497
41.3.5	YUV 4:2:2 Image Scaling.....	2499
41.3.6	YUV 4:2:0 Image Scaling.....	2500
41.3.7	RGB/YUV444 Image Scaling.....	2502
41.3.8	Color Space Conversion (CSC).....	2502
41.3.9	CSC1 Operation.....	2503
41.3.10	YUV versus YCbCr Support.....	2504
41.3.11	CSC2 operation.....	2504
41.3.12	Alpha Blending/Color Key	2504
41.3.13	Alpha Blend.....	2505
41.3.13.1	Normal Alpha Blend.....	2505
41.3.13.2	Porter-Duff Alpha Blend.....	2506

Section number	Title	Page
41.3.14	Color Key.....	2506
41.3.15	LUT.....	2507
41.3.16	Lookup Modes.....	2507
41.3.17	DIRECT_Y8.....	2508
41.3.18	DIRECT_RGB444.....	2508
41.3.19	DIRECT_RGB454.....	2508
41.3.20	CACHE_RGB565.....	2508
41.3.21	Output Modes.....	2510
41.3.22	Y8	2510
41.3.23	RGBW4444CFA.....	2511
	41.3.23.1 CFA Correction.....	2511
41.3.24	RGB888.....	2512
41.3.25	Rotation.....	2512
41.3.26	Output Buffer.....	2515
41.3.27	Address calculator.....	2515
41.3.28	Block size selection.....	2515
41.3.29	Interlaced Video Support.....	2515
41.3.30	LCDIF Handshake.....	2516
41.3.31	LCDIF Abort.....	2519
41.3.32	Theory of Operation.....	2519
41.3.33	Pixel Handling.....	2520
41.3.34	Output Buffer Composition.....	2520
41.3.35	PS Image Processing.....	2521
41.3.36	Letterboxing.....	2522
41.3.37	Clipping source images.....	2522
41.3.38	Color Key Processing.....	2524
41.3.39	In Place Processing (PS buffer is destination buffer).....	2526
41.3.40	Alpha Surface (AS) Processing.....	2526
41.3.41	Alpha Handling.....	2526

Section number	Title	Page
41.3.42	Color Key Processing (AS_CTRL).....	2526
41.4	Output Image Processing.....	2527
41.4.1	Output Image Size.....	2527
41.4.2	Output Format.....	2527
41.4.3	Rotation/Flip operations.....	2527
41.5	Queuing PXP transactions.....	2528
41.6	Error Handling.....	2528
41.6.1	Known PXP Limitations/Issues.....	2529
41.7	Dither Engine Block.....	2529
41.7.1	Top Level Connections.....	2530
41.7.2	Dither Engine Design.....	2530
41.7.3	Pipelined Data Flow.....	2534
41.7.4	Initialization of Dedicated Memories.....	2534
41.7.5	Register Configuration Interface.....	2535
41.8	Waveform Engines.....	2535
41.8.1	Overview.....	2535
41.8.2	Functionality.....	2536
41.9	PXP Store Engine Block Description.....	2537
41.9.1	Overview.....	2537
41.9.2	Top-Level Architecture.....	2537
41.9.3	Store Engine Design.....	2538
	41.9.3.1 Input Data Source.....	2539
	41.9.3.2 Store data shift operation.....	2539
	41.9.3.3 Data Packing.....	2540
	41.9.3.4 Data Store Format.....	2541
	41.9.3.5 Output Format Modes.....	2542
	41.9.3.6 Limitations.....	2545
41.10	Histogram.....	2545
41.10.1	Basic Operation.....	2545

Section number	Title	Page
41.10.2	Mask Functionality.....	2546
41.10.3	Collision use-case Example.....	2547
41.11	PXP Memory Map/Register Definition.....	2548
41.11.1	Control Register 0 (PXP_HW_PXP_CTRLn).....	2573
41.11.2	Status Register (PXP_HW_PXP_STATn).....	2576
41.11.3	Output Buffer Control Register (PXP_HW_PXP_OUT_CTRLn).....	2578
41.11.4	Output Frame Buffer Pointer (PXP_HW_PXP_OUT_BUF).....	2579
41.11.5	Output Frame Buffer Pointer #2 (PXP_HW_PXP_OUT_BUF2).....	2579
41.11.6	Output Buffer Pitch (PXP_HW_PXP_OUT_PITCH).....	2580
41.11.7	Output Surface Lower Right Coordinate (PXP_HW_PXP_OUT_LRC).....	2580
41.11.8	Processed Surface Upper Left Coordinate (PXP_HW_PXP_OUT_PS_ULC).....	2581
41.11.9	Processed Surface Lower Right Coordinate (PXP_HW_PXP_OUT_PS_LRC).....	2582
41.11.10	Alpha Surface Upper Left Coordinate (PXP_HW_PXP_OUT_AS_ULC).....	2583
41.11.11	Alpha Surface Lower Right Coordinate (PXP_HW_PXP_OUT_AS_LRC).....	2583
41.11.12	Processed Surface (PS) Control Register (PXP_HW_PXP_PS_CTRLn).....	2584
41.11.13	PS Input Buffer Address (PXP_HW_PXP_PS_BUF).....	2585
41.11.14	PS U/Cb or 2 Plane UV Input Buffer Address (PXP_HW_PXP_PS_UBUF).....	2585
41.11.15	PS V/Cr Input Buffer Address (PXP_HW_PXP_PS_VBUF).....	2586
41.11.16	Processed Surface Pitch (PXP_HW_PXP_PS_PITCH).....	2586
41.11.17	PS Background Color (PXP_HW_PXP_PS_BACKGROUND_0).....	2587
41.11.18	PS Scale Factor Register (PXP_HW_PXP_PS_SCALE).....	2588
41.11.19	PS Scale Offset Register (PXP_HW_PXP_PS_OFFSET).....	2589
41.11.20	PS Color Key Low (PXP_HW_PXP_PS_CLRKEYLOW_0).....	2590
41.11.21	PS Color Key High (PXP_HW_PXP_PS_CLRKEYHIGH_0).....	2590
41.11.22	Alpha Surface Control (PXP_HW_PXP_AS_CTRL).....	2591
41.11.23	Alpha Surface Buffer Pointer (PXP_HW_PXP_AS_BUF).....	2592
41.11.24	Alpha Surface Pitch (PXP_HW_PXP_AS_PITCH).....	2592
41.11.25	Overlay Color Key Low (PXP_HW_PXP_AS_CLRKEYLOW_0).....	2593
41.11.26	Overlay Color Key High (PXP_HW_PXP_AS_CLRKEYHIGH_0).....	2594

Section number	Title	Page
41.11.27	Color Space Conversion Coefficient Register 0 (PXP_HW_PXP_CSC1_COEF0).....	2595
41.11.28	Color Space Conversion Coefficient Register 1 (PXP_HW_PXP_CSC1_COEF1).....	2596
41.11.29	Color Space Conversion Coefficient Register 2 (PXP_HW_PXP_CSC1_COEF2).....	2597
41.11.30	Color Space Conversion Control Register. (PXP_HW_PXP_CSC2_CTRL).....	2598
41.11.31	Color Space Conversion Coefficient Register 0 (PXP_HW_PXP_CSC2_COEF0).....	2598
41.11.32	Color Space Conversion Coefficient Register 1 (PXP_HW_PXP_CSC2_COEF1).....	2599
41.11.33	Color Space Conversion Coefficient Register 2 (PXP_HW_PXP_CSC2_COEF2).....	2600
41.11.34	Color Space Conversion Coefficient Register 3 (PXP_HW_PXP_CSC2_COEF3).....	2600
41.11.35	Color Space Conversion Coefficient Register 4 (PXP_HW_PXP_CSC2_COEF4).....	2601
41.11.36	Color Space Conversion Coefficient Register 5 (PXP_HW_PXP_CSC2_COEF5).....	2601
41.11.37	Lookup Table Control Register. (PXP_HW_PXP_LUT_CTRL).....	2602
41.11.38	Lookup Table Control Register. (PXP_HW_PXP_LUT_ADDR).....	2604
41.11.39	Lookup Table Data Register. (PXP_HW_PXP_LUT_DATA).....	2605
41.11.40	Lookup Table External Memory Address Register. (PXP_HW_PXP_LUT_EXTMEM).....	2605
41.11.41	Color Filter Array Register. (PXP_HW_PXP_CFA).....	2606
41.11.42	PXP Alpha Engine A Control Register. (PXP_HW_PXP_ALPHA_A_CTRL).....	2607
41.11.43	PS Background Color 1 (PXP_HW_PXP_PS_BACKGROUND_1).....	2608
41.11.44	PS Color Key Low 1 (PXP_HW_PXP_PS_CLRKEYLOW_1).....	2609
41.11.45	PS Color Key High 1 (PXP_HW_PXP_PS_CLRKEYHIGH_1).....	2609
41.11.46	Overlay Color Key Low (PXP_HW_PXP_AS_CLRKEYLOW_1).....	2610
41.11.47	Overlay Color Key High (PXP_HW_PXP_AS_CLRKEYHIGH_1).....	2611
41.11.48	Control Register 2 (PXP_HW_PXP_CTRL2n).....	2612
41.11.49	PXP Power Control Register. (PXP_HW_PXP_POWER_REG0).....	2613
41.11.50	PXP Power Control Register 1. (PXP_HW_PXP_POWER_REG1).....	2614
41.11.51	This register helps decide the data path gthrough the PXP. (PXP_HW_PXP_DATA_PATH_CTRL0n)	2615
41.11.52	This register helps decide the data path gthrough the PXP. (PXP_HW_PXP_DATA_PATH_CTRL1n)	2616
41.11.53	Initialize memory buffer control Register (PXP_HW_PXP_INIT_MEM_CTRLn).....	2617
41.11.54	Write data Register (PXP_HW_PXP_INIT_MEM_DATA).....	2618
41.11.55	Write data Register (PXP_HW_PXP_INIT_MEM_DATA_HIGH).....	2618

Section number	Title	Page
41.11.56	PXP IRQ Mask Register (PXP_HW_PXP_IRQ_MASK n).....	2619
41.11.57	PXP Interrupt Register (PXP_HW_PXP_IRQ n).....	2620
41.11.58	PXP NEXT Buffer Enable select Register (PXP_HW_PXP_NEXT_EN n).....	2621
41.11.59	Next Frame Pointer (PXP_HW_PXP_NEXT).....	2622
41.11.60	Debug Control Register (PXP_HW_PXP_DEBUGCTRL).....	2623
41.11.61	Debug Register (PXP_HW_PXP_DEBUG).....	2624
41.11.62	Version Register (PXP_HW_PXP_VERSION).....	2624
41.11.63	This register defines the control bits for the pxp store_engine sub-block. (PXP_HW_PXP_DITHER_STORE_SIZE_CH0).....	2625
41.11.64	Fetch engine Control for WFE B Register (PXP_HW_PXP_WFB_FETCH_CTRL n).....	2625
41.11.65	This register defines the control bits for the pxp wfb fetch sub-block. (PXP_HW_PXP_WFB_FETCH_BUF1_ADDR).....	2627
41.11.66	This register defines the control bits for the pxp wfb fetch sub-block. (PXP_HW_PXP_WFB_FETCH_BUF1_PITCH).....	2628
41.11.67	This register defines the control bits for the pxp wfb fetch sub-block. (PXP_HW_PXP_WFB_FETCH_BUF1_SIZE).....	2628
41.11.68	This register defines the control bits for the pxp wfb fetch sub-block. (PXP_HW_PXP_WFB_FETCH_BUF2_ADDR).....	2629
41.11.69	This register defines the control bits for the pxp wfb fetch sub-block. (PXP_HW_PXP_WFB_FETCH_BUF2_PITCH).....	2629
41.11.70	This register defines the control bits for the pxp wfb fetch sub-block. (PXP_HW_PXP_WFB_FETCH_BUF2_SIZE).....	2630
41.11.71	This register defines the control bits for the pxp wfb fetch sub-block. (PXP_HW_PXP_WFB_ARRAY_PIXEL0_MASK).....	2630
41.11.72	This register defines the control bits for the pxp wfb fetch sub-block. (PXP_HW_PXP_WFB_ARRAY_PIXEL1_MASK).....	2632
41.11.73	This register defines the control bits for the pxp wfb fetch sub-block. (PXP_HW_PXP_WFB_ARRAY_PIXEL2_MASK).....	2633
41.11.74	This register defines the control bits for the pxp wfb fetch sub-block. (PXP_HW_PXP_WFB_ARRAY_PIXEL3_MASK).....	2634
41.11.75	This register defines the control bits for the pxp wfb fetch sub-block. (PXP_HW_PXP_WFB_ARRAY_PIXEL4_MASK).....	2636

Section number	Title	Page
41.11.76	This register defines the control bits for the pxp wfb fetch sub-block. (PXP_HW_PXP_WFB_ARRAY_PIXEL5_MASK).....	2637
41.11.77	This register defines the control bits for the pxp wfb fetch sub-block. (PXP_HW_PXP_WFB_ARRAY_PIXEL6_MASK).....	2638
41.11.78	This register defines the control bits for the pxp wfb fetch sub-block. (PXP_HW_PXP_WFB_ARRAY_PIXEL7_MASK).....	2640
41.11.79	This register defines the control bits for the pxp wfb fetch sub-block. (PXP_HW_PXP_WFB_ARRAY_FLAG0_MASK).....	2641
41.11.80	This register defines the control bits for the pxp wfb fetch sub-block. (PXP_HW_PXP_WFB_ARRAY_FLAG1_MASK).....	2642
41.11.81	This register defines the control bits for the pxp wfb fetch sub-block. (PXP_HW_PXP_WFB_ARRAY_FLAG2_MASK).....	2644
41.11.82	This register defines the control bits for the pxp wfb fetch sub-block. (PXP_HW_PXP_WFB_ARRAY_FLAG3_MASK).....	2645
41.11.83	This register defines the control bits for the pxp wfb fetch sub-block. (PXP_HW_PXP_WFB_ARRAY_FLAG4_MASK).....	2646
41.11.84	This register defines the control bits for the pxp wfb fetch sub-block. (PXP_HW_PXP_WFB_ARRAY_FLAG5_MASK).....	2648
41.11.85	This register defines the control bits for the pxp wfb fetch sub-block. (PXP_HW_PXP_WFB_ARRAY_FLAG6_MASK).....	2649
41.11.86	This register defines the control bits for the pxp wfb fetch sub-block. (PXP_HW_PXP_WFB_ARRAY_FLAG7_MASK).....	2650
41.11.87	This register defines the control bits for the pxp wfa fetch sub-block. (PXP_HW_PXP_WFB_FETCH_BUF1_CORD).....	2651
41.11.88	This register defines the control bits for the pxp wfa fetch sub-block. (PXP_HW_PXP_WFB_FETCH_BUF2_CORD).....	2652
41.11.89	This register defines the control bits for the pxp wfa fetch sub-block. (PXP_HW_PXP_WFB_ARRAY_FLAG8_MASK).....	2653
41.11.90	This register defines the control bits for the pxp wfa fetch sub-block. (PXP_HW_PXP_WFB_ARRAY_FLAG9_MASK).....	2654
41.11.91	This register defines the control bits for the pxp wfa fetch sub-block. (PXP_HW_PXP_WFB_ARRAY_FLAG10_MASK).....	2655

Section number	Title	Page
41.11.92	This register defines the control bits for the pxp wfa fetch sub-block. (PXP_HW_PXP_WFB_ARRAY_FLAG11_MASK).....	2657
41.11.93	This register defines the control bits for the pxp wfa fetch sub-block. (PXP_HW_PXP_WFB_ARRAY_FLAG12_MASK).....	2658
41.11.94	This register defines the control bits for the pxp wfa fetch sub-block. (PXP_HW_PXP_WFB_ARRAY_FLAG13_MASK).....	2659
41.11.95	This register defines the control bits for the pxp wfa fetch sub-block. (PXP_HW_PXP_WFB_ARRAY_FLAG14_MASK).....	2661
41.11.96	This register defines the control bits for the pxp wfa fetch sub-block. (PXP_HW_PXP_WFB_ARRAY_FLAG15_MASK).....	2662
41.11.97	This register defines software define pixels for wfb fetch sub-block. (PXP_HW_PXP_WFB_ARRAY_REG0).....	2663
41.11.98	This register defines software define pixels for wfb fetch sub-block. (PXP_HW_PXP_WFB_ARRAY_REG1).....	2664
41.11.99	This register defines software define pixels for wfb fetch sub-block. (PXP_HW_PXP_WFB_ARRAY_REG2).....	2665
41.11.100	Store engine Control Channel 0 Register (PXP_HW_PXP_WFE_B_STORE_CTRL_CH0n).....	2666
41.11.101	Store engine Control Channel 1 Register (PXP_HW_PXP_WFE_B_STORE_CTRL_CH1n).....	2668
41.11.102	Store engine status Channel 0 Register (PXP_HW_PXP_WFE_B_STORE_STATUS_CH0).....	2669
41.11.103	Store engine status Channel 1 Register (PXP_HW_PXP_WFE_B_STORE_STATUS_CH1).....	2670
41.11.104	This register defines the control bits for the pxp store_engine sub-block. (PXP_HW_PXP_WFE_B_STORE_SIZE_CH0).....	2670
41.11.105	This register defines the control bits for the pxp store_engine sub-block. (PXP_HW_PXP_WFE_B_STORE_SIZE_CH1).....	2671
41.11.106	This register defines the control bits for the pxp store_engine sub-block. (PXP_HW_PXP_WFE_B_STORE_PITCH).....	2671
41.11.107	This register defines the control bits for the pxp store_engine sub-block. (PXP_HW_PXP_WFE_B_STORE_SHIFT_CTRL_CH0n).....	2672
41.11.108	This register defines the control bits for the pxp store_engine sub-block. (PXP_HW_PXP_WFE_B_STORE_SHIFT_CTRL_CH1n).....	2673
41.11.109	This register defines the control bits for the pxp store_engine sub-block. (PXP_HW_PXP_WFE_B_STORE_ADDR_0_CH0).....	2674

Section number	Title	Page
41.11.110	This register defines the control bits for the pxp store_engine sub-block. (PXP_HW_PXP_WFE_B_STORE_ADDR_1_CH0).....	2674
41.11.111	This register defines the control bits for the pxp store_engine sub-block. (PXP_HW_PXP_WFE_B_STORE_FILL_DATA_CH0).....	2675
41.11.112	This register defines the control bits for the pxp store_engine sub-block. (PXP_HW_PXP_WFE_B_STORE_ADDR_0_CH1).....	2675
41.11.113	This register defines the control bits for the pxp store_engine sub-block. (PXP_HW_PXP_WFE_B_STORE_ADDR_1_CH1).....	2676
41.11.114	This register defines the control bits for the pxp store_engine sub-block. (PXP_HW_PXP_WFE_B_STORE_D_MASK0_H_CH0).....	2676
41.11.115	This register defines the control bits for the pxp store_engine sub-block. (PXP_HW_PXP_WFE_B_STORE_D_MASK0_L_CH0).....	2677
41.11.116	This register defines the control bits for the pxp store_engine sub-block. (PXP_HW_PXP_WFE_B_STORE_D_MASK1_H_CH0).....	2677
41.11.117	This register defines the control bits for the pxp store_engine sub-block. (PXP_HW_PXP_WFE_B_STORE_D_MASK1_L_CH0).....	2678
41.11.118	This register defines the control bits for the pxp store_engine sub-block. (PXP_HW_PXP_WFE_B_STORE_D_MASK2_H_CH0).....	2678
41.11.119	This register defines the control bits for the pxp store_engine sub-block. (PXP_HW_PXP_WFE_B_STORE_D_MASK2_L_CH0).....	2679
41.11.120	This register defines the control bits for the pxp store_engine sub-block. (PXP_HW_PXP_WFE_B_STORE_D_MASK3_H_CH0).....	2679
41.11.121	This register defines the control bits for the pxp store_engine sub-block. (PXP_HW_PXP_WFE_B_STORE_D_MASK3_L_CH0).....	2680
41.11.122	This register defines the control bits for the pxp store_engine sub-block. (PXP_HW_PXP_WFE_B_STORE_D_MASK4_H_CH0).....	2680
41.11.123	This register defines the control bits for the pxp store_engine sub-block. (PXP_HW_PXP_WFE_B_STORE_D_MASK4_L_CH0).....	2681
41.11.124	This register defines the control bits for the pxp store_engine sub-block. (PXP_HW_PXP_WFE_B_STORE_D_MASK5_H_CH0).....	2681
41.11.125	This register defines the control bits for the pxp store_engine sub-block. (PXP_HW_PXP_WFE_B_STORE_D_MASK5_L_CH0).....	2682

Section number	Title	Page
41.11.126	This register defines the control bits for the pxp store_engine sub-block. (PXP_HW_PXP_WFE_B_STORE_D_MASK6_H_CH0).....	2682
41.11.127	This register defines the control bits for the pxp store_engine sub-block. (PXP_HW_PXP_WFE_B_STORE_D_MASK6_L_CH0).....	2683
41.11.128	This register defines the control bits for the pxp store_engine sub-block. (PXP_HW_PXP_WFE_B_STORE_D_MASK7_H_CH0).....	2683
41.11.129	This register defines the control bits for the pxp store_engine sub-block. (PXP_HW_PXP_WFE_B_STORE_D_MASK7_L_CH0).....	2684
41.11.130	This register defines the control bits for the pxp store_engine sub-block. (PXP_HW_PXP_WFE_B_STORE_D_SHIFT_L_CH0).....	2684
41.11.131	This register defines the control bits for the pxp store_engine sub-block. (PXP_HW_PXP_WFE_B_STORE_D_SHIFT_H_CH0).....	2686
41.11.132	This register defines the control bits for the pxp store_engine sub-block. (PXP_HW_PXP_WFE_B_STORE_F_SHIFT_L_CH0).....	2687
41.11.133	This register defines the control bits for the pxp store_engine sub-block. (PXP_HW_PXP_WFE_B_STORE_F_SHIFT_H_CH0).....	2689
41.11.134	This register defines the control bits for the pxp store_engine sub-block. (PXP_HW_PXP_WFE_B_STORE_F_MASK_L_CH0).....	2690
41.11.135	This register defines the control bits for the pxp store_engine sub-block. (PXP_HW_PXP_WFE_B_STORE_F_MASK_H_CH0).....	2691
41.11.136	This register holds the debug bits for the prefetch engine for WFE B. (PXP_HW_PXP_FETCH_WFE_B_DEBUG).....	2691
41.11.137	Dither Control Register 0 (PXP_HW_PXP_DITHER_CTRL n).....	2693
41.11.138	Final stage lookup value Register (PXP_HW_PXP_DITHER_FINAL_LUT_DATA0 n).....	2695
41.11.139	Final stage lookup value Register (PXP_HW_PXP_DITHER_FINAL_LUT_DATA1 n).....	2695
41.11.140	Final stage lookup value Register (PXP_HW_PXP_DITHER_FINAL_LUT_DATA2 n).....	2696
41.11.141	Final stage lookup value Register (PXP_HW_PXP_DITHER_FINAL_LUT_DATA3 n).....	2696
41.11.142	This register defines the control bits for the pxp wfe sub-block (PXP_HW_PXP_WFE_B_CTRL n).....	2697
41.11.143	This register defines the control bits for the pxp wfe sub-block (PXP_HW_PXP_WFE_B_DIMENSIONS).....	2698
41.11.144	This register defines the control bits for the pxp wfe sub-block (PXP_HW_PXP_WFE_B_OFFSET)...	2698

Section number	Title	Page
41.11.145	This register defines the control bits for the pxp wfe sub-block (PXP_HW_PXP_WFE_B_SW_DATA_REGS).....	2699
41.11.146	This register defines the control bits for the pxp wfe sub-block (PXP_HW_PXP_WFE_B_SW_FLAG_REGS).....	2700
41.11.147	This register defines the control bits for the pxp wfe sub-block (PXP_HW_PXP_WFE_B_STAGE1_MUX0n).....	2701
41.11.148	This register defines the control bits for the pxp wfe sub-block (PXP_HW_PXP_WFE_B_STAGE1_MUX1n).....	2702
41.11.149	This register defines the control bits for the pxp wfe sub-block (PXP_HW_PXP_WFE_B_STAGE1_MUX2n).....	2703
41.11.150	This register defines the control bits for the pxp wfe sub-block (PXP_HW_PXP_WFE_B_STAGE1_MUX3n).....	2704
41.11.151	This register defines the control bits for the pxp wfe sub-block (PXP_HW_PXP_WFE_B_STAGE1_MUX4n).....	2705
41.11.152	This register defines the control bits for the pxp wfe sub-block (PXP_HW_PXP_WFE_B_STAGE1_MUX5n).....	2706
41.11.153	This register defines the control bits for the pxp wfe sub-block (PXP_HW_PXP_WFE_B_STAGE1_MUX6n).....	2707
41.11.154	This register defines the control bits for the pxp wfe sub-block (PXP_HW_PXP_WFE_B_STAGE1_MUX7n).....	2708
41.11.155	This register defines the control bits for the pxp wfe sub-block (PXP_HW_PXP_WFE_B_STAGE1_MUX8n).....	2709
41.11.156	This register defines the control bits for the pxp wfe sub-block (PXP_HW_PXP_WFE_B_STAGE2_MUX0n).....	2709
41.11.157	This register defines the control bits for the pxp wfe sub-block (PXP_HW_PXP_WFE_B_STAGE2_MUX1n).....	2710
41.11.158	This register defines the control bits for the pxp wfe sub-block (PXP_HW_PXP_WFE_B_STAGE2_MUX2n).....	2711
41.11.159	This register defines the control bits for the pxp wfe sub-block (PXP_HW_PXP_WFE_B_STAGE2_MUX3n).....	2712
41.11.160	This register defines the control bits for the pxp wfe sub-block (PXP_HW_PXP_WFE_B_STAGE2_MUX4n).....	2713

Section number	Title	Page
41.11.161	This register defines the control bits for the pxp wfe sub-block (PXP_HW_PXP_WFE_B_STAGE2_MUX5n).....	2714
41.11.162	This register defines the control bits for the pxp wfe sub-block (PXP_HW_PXP_WFE_B_STAGE2_MUX6n).....	2715
41.11.163	This register defines the control bits for the pxp wfe sub-block (PXP_HW_PXP_WFE_B_STAGE2_MUX7n).....	2716
41.11.164	This register defines the control bits for the pxp wfe sub-block (PXP_HW_PXP_WFE_B_STAGE2_MUX8n).....	2717
41.11.165	This register defines the control bits for the pxp wfe sub-block (PXP_HW_PXP_WFE_B_STAGE2_MUX9n).....	2718
41.11.166	This register defines the control bits for the pxp wfe sub-block (PXP_HW_PXP_WFE_B_STAGE2_MUX10n).....	2719
41.11.167	This register defines the control bits for the pxp wfe sub-block (PXP_HW_PXP_WFE_B_STAGE2_MUX11n).....	2720
41.11.168	This register defines the control bits for the pxp wfe sub-block (PXP_HW_PXP_WFE_B_STAGE2_MUX12n).....	2721
41.11.169	This register defines the control bits for the pxp wfe sub-block (PXP_HW_PXP_WFE_B_STAGE3_MUX0n).....	2721
41.11.170	This register defines the control bits for the pxp wfe sub-block (PXP_HW_PXP_WFE_B_STAGE3_MUX1n).....	2722
41.11.171	This register defines the control bits for the pxp wfe sub-block (PXP_HW_PXP_WFE_B_STAGE3_MUX2n).....	2723
41.11.172	This register defines the control bits for the pxp wfe sub-block (PXP_HW_PXP_WFE_B_STAGE3_MUX3n).....	2724
41.11.173	This register defines the control bits for the pxp wfe sub-block (PXP_HW_PXP_WFE_B_STAGE3_MUX4n).....	2725
41.11.174	This register defines the control bits for the pxp wfe sub-block (PXP_HW_PXP_WFE_B_STAGE3_MUX5n).....	2726
41.11.175	This register defines the control bits for the pxp wfe sub-block (PXP_HW_PXP_WFE_B_STAGE3_MUX6n).....	2727
41.11.176	This register defines the control bits for the pxp wfe sub-block (PXP_HW_PXP_WFE_B_STAGE3_MUX7n).....	2728

Section number	Title	Page
41.11.177	This register defines the control bits for the pxp wfe sub-block (PXP_HW_PXP_WFE_B_STAGE3_MUX8n).....	2729
41.11.178	This register defines the control bits for the pxp wfe sub-block (PXP_HW_PXP_WFE_B_STAGE3_MUX9n).....	2730
41.11.179	This register defines the control bits for the pxp wfe sub-block (PXP_HW_PXP_WFE_B_STAGE3_MUX10n).....	2731
41.11.180	This register defines the control bits for the pxp wfe sub-block (PXP_HW_PXP_WFE_B_STG1_5X8_OUT0_0).....	2732
41.11.181	This register defines the control bits for the pxp wfe sub-block (PXP_HW_PXP_WFE_B_STG1_5X8_OUT0_1).....	2732
41.11.182	This register defines the control bits for the pxp wfe sub-block (PXP_HW_PXP_WFE_B_STG1_5X8_OUT0_2).....	2733
41.11.183	This register defines the control bits for the pxp wfe sub-block (PXP_HW_PXP_WFE_B_STG1_5X8_OUT0_3).....	2734
41.11.184	This register defines the control bits for the pxp wfe sub-block (PXP_HW_PXP_WFE_B_STG1_5X8_OUT0_4).....	2734
41.11.185	This register defines the control bits for the pxp wfe sub-block (PXP_HW_PXP_WFE_B_STG1_5X8_OUT0_5).....	2735
41.11.186	This register defines the control bits for the pxp wfe sub-block (PXP_HW_PXP_WFE_B_STG1_5X8_OUT0_6).....	2736
41.11.187	This register defines the control bits for the pxp wfe sub-block (PXP_HW_PXP_WFE_B_STG1_5X8_OUT0_7).....	2736
41.11.188	This register defines the control bits for the pxp wfe sub-block (PXP_HW_PXP_WFE_B_STG1_5X8_OUT1_0).....	2737
41.11.189	This register defines the control bits for the pxp wfe sub-block (PXP_HW_PXP_WFE_B_STG1_5X8_OUT1_1).....	2738
41.11.190	This register defines the control bits for the pxp wfe sub-block (PXP_HW_PXP_WFE_B_STG1_5X8_OUT1_2).....	2738
41.11.191	This register defines the control bits for the pxp wfe sub-block (PXP_HW_PXP_WFE_B_STG1_5X8_OUT1_3).....	2739
41.11.192	This register defines the control bits for the pxp wfe sub-block (PXP_HW_PXP_WFE_B_STG1_5X8_OUT1_4).....	2740

Section number	Title	Page
41.11.193	This register defines the control bits for the pxp wfe sub-block (PXP_HW_PXP_WFE_B_STG1_5X8_OUT1_5).....	2740
41.11.194	This register defines the control bits for the pxp wfe sub-block (PXP_HW_PXP_WFE_B_STG1_5X8_OUT1_6).....	2741
41.11.195	This register defines the control bits for the pxp wfe sub-block (PXP_HW_PXP_WFE_B_STG1_5X8_OUT1_7).....	2742
41.11.196	Each set mask bit enables one of the corresponding flag input bits. There is one mask per 5x8 LUT. (PXP_HW_PXP_WFE_B_STAGE1_5X8_MASKS_0).....	2742
41.11.197	This register defines the output values (new flag) for the 5x1 LUTs in stage 1. (PXP_HW_PXP_WFE_B_STG1_5X1_OUT0).....	2743
41.11.198	Each set mask bit enables one of the corresponding flag input bits. There is one mask per 5x1 LUT. (PXP_HW_PXP_WFE_B_STG1_5X1_MASKS).....	2745
41.11.199	This register defines the output values (new flag) for the 8x1 LUTs in stage 1. (PXP_HW_PXP_WFE_B_STG1_8X1_OUT0_0).....	2746
41.11.200	This register defines the output values (new flag) for the 8x1 LUTs in stage 1. (PXP_HW_PXP_WFE_B_STG1_8X1_OUT0_1).....	2748
41.11.201	This register defines the output values (new flag) for the 8x1 LUTs in stage 1. (PXP_HW_PXP_WFE_B_STG1_8X1_OUT0_2).....	2750
41.11.202	This register defines the output values (new flag) for the 8x1 LUTs in stage 1. (PXP_HW_PXP_WFE_B_STG1_8X1_OUT0_3).....	2752
41.11.203	This register defines the output values (new flag) for the 8x1 LUTs in stage 1. (PXP_HW_PXP_WFE_B_STG1_8X1_OUT0_4).....	2754
41.11.204	This register defines the output values (new flag) for the 8x1 LUTs in stage 1. (PXP_HW_PXP_WFE_B_STG1_8X1_OUT0_5).....	2756
41.11.205	This register defines the output values (new flag) for the 8x1 LUTs in stage 1. (PXP_HW_PXP_WFE_B_STG1_8X1_OUT0_6).....	2758
41.11.206	This register defines the output values (new flag) for the 8x1 LUTs in stage 1. (PXP_HW_PXP_WFE_B_STG1_8X1_OUT0_7).....	2760
41.11.207	This register defines the output values (new flag) for the 8x1 LUTs in stage 1. (PXP_HW_PXP_WFE_B_STG1_8X1_OUT1_0).....	2762
41.11.208	This register defines the output values (new flag) for the 8x1 LUTs in stage 1. (PXP_HW_PXP_WFE_B_STG1_8X1_OUT1_1).....	2764

Section number	Title	Page
41.11.209	This register defines the output values (new flag) for the 8x1 LUTs in stage 1. (PXP_HW_PXP_WFE_B_STG1_8X1_OUT1_2).....	2766
41.11.210	This register defines the output values (new flag) for the 8x1 LUTs in stage 1. (PXP_HW_PXP_WFE_B_STG1_8X1_OUT1_3).....	2768
41.11.211	This register defines the output values (new flag) for the 8x1 LUTs in stage 1. (PXP_HW_PXP_WFE_B_STG1_8X1_OUT1_4).....	2770
41.11.212	This register defines the output values (new flag) for the 8x1 LUTs in stage 1. (PXP_HW_PXP_WFE_B_STG1_8X1_OUT1_5).....	2772
41.11.213	This register defines the output values (new flag) for the 8x1 LUTs in stage 1. (PXP_HW_PXP_WFE_B_STG1_8X1_OUT1_6).....	2774
41.11.214	This register defines the output values (new flag) for the 8x1 LUTs in stage 1. (PXP_HW_PXP_WFE_B_STG1_8X1_OUT1_7).....	2776
41.11.215	This register defines the output values (new flag) for the 8x1 LUTs in stage 1. (PXP_HW_PXP_WFE_B_STG1_8X1_OUT2_0).....	2778
41.11.216	This register defines the output values (new flag) for the 8x1 LUTs in stage 1. (PXP_HW_PXP_WFE_B_STG1_8X1_OUT2_1).....	2780
41.11.217	This register defines the output values (new flag) for the 8x1 LUTs in stage 1. (PXP_HW_PXP_WFE_B_STG1_8X1_OUT2_2).....	2782
41.11.218	This register defines the output values (new flag) for the 8x1 LUTs in stage 1. (PXP_HW_PXP_WFE_B_STG1_8X1_OUT2_3).....	2784
41.11.219	This register defines the output values (new flag) for the 8x1 LUTs in stage 1. (PXP_HW_PXP_WFE_B_STG1_8X1_OUT2_4).....	2786
41.11.220	This register defines the output values (new flag) for the 8x1 LUTs in stage 1. (PXP_HW_PXP_WFE_B_STG1_8X1_OUT2_5).....	2788
41.11.221	This register defines the output values (new flag) for the 8x1 LUTs in stage 1. (PXP_HW_PXP_WFE_B_STG1_8X1_OUT2_6).....	2790
41.11.222	This register defines the output values (new flag) for the 8x1 LUTs in stage 1. (PXP_HW_PXP_WFE_B_STG1_8X1_OUT2_7).....	2792
41.11.223	This register defines the output values (new flag) for the 8x1 LUTs in stage 1. (PXP_HW_PXP_WFE_B_STG1_8X1_OUT3_0).....	2794
41.11.224	This register defines the output values (new flag) for the 8x1 LUTs in stage 1. (PXP_HW_PXP_WFE_B_STG1_8X1_OUT3_1).....	2796

Section number	Title	Page
41.11.225	This register defines the output values (new flag) for the 8x1 LUTs in stage 1. (PXP_HW_PXP_WFE_B_STG1_8X1_OUT3_2).....	2798
41.11.226	This register defines the output values (new flag) for the 8x1 LUTs in stage 1. (PXP_HW_PXP_WFE_B_STG1_8X1_OUT3_3).....	2800
41.11.227	This register defines the output values (new flag) for the 8x1 LUTs in stage 1. (PXP_HW_PXP_WFE_B_STG1_8X1_OUT3_4).....	2802
41.11.228	This register defines the output values (new flag) for the 8x1 LUTs in stage 1. (PXP_HW_PXP_WFE_B_STG1_8X1_OUT3_5).....	2804
41.11.229	This register defines the output values (new flag) for the 8x1 LUTs in stage 1. (PXP_HW_PXP_WFE_B_STG1_8X1_OUT3_6).....	2806
41.11.230	This register defines the output values (new flag) for the 8x1 LUTs in stage 1. (PXP_HW_PXP_WFE_B_STG1_8X1_OUT3_7).....	2808
41.11.231	This register defines the output values (new flag) for the 8x1 LUTs in stage 1. (PXP_HW_PXP_WFE_B_STG1_8X1_OUT4_0).....	2810
41.11.232	This register defines the output values (new flag) for the 8x1 LUTs in stage 1. (PXP_HW_PXP_WFE_B_STG1_8X1_OUT4_1).....	2812
41.11.233	This register defines the output values (new flag) for the 8x1 LUTs in stage 1. (PXP_HW_PXP_WFE_B_STG1_8X1_OUT4_2).....	2814
41.11.234	This register defines the output values (new flag) for the 8x1 LUTs in stage 1. (PXP_HW_PXP_WFE_B_STG1_8X1_OUT4_3).....	2816
41.11.235	This register defines the output values (new flag) for the 8x1 LUTs in stage 1. (PXP_HW_PXP_WFE_B_STG1_8X1_OUT4_4).....	2818
41.11.236	This register defines the output values (new flag) for the 8x1 LUTs in stage 1. (PXP_HW_PXP_WFE_B_STG1_8X1_OUT4_5).....	2820
41.11.237	This register defines the output values (new flag) for the 8x1 LUTs in stage 1. (PXP_HW_PXP_WFE_B_STG1_8X1_OUT4_6).....	2822
41.11.238	This register defines the output values (new flag) for the 8x1 LUTs in stage 1. (PXP_HW_PXP_WFE_B_STG1_8X1_OUT4_7).....	2824
41.11.239	This register defines the control bits for the pxp wfe sub-block (PXP_HW_PXP_WFE_B_STG2_5X6_OUT0_0).....	2826
41.11.240	This register defines the control bits for the pxp wfe sub-block (PXP_HW_PXP_WFE_B_STG2_5X6_OUT0_1).....	2827

Section number	Title	Page
41.11.241	This register defines the control bits for the pxp wfe sub-block (PXP_HW_PXP_WFE_B_STG2_5X6_OUT0_2).....	2828
41.11.242	This register defines the control bits for the pxp wfe sub-block (PXP_HW_PXP_WFE_B_STG2_5X6_OUT0_3).....	2829
41.11.243	This register defines the control bits for the pxp wfe sub-block (PXP_HW_PXP_WFE_B_STG2_5X6_OUT0_4).....	2830
41.11.244	This register defines the control bits for the pxp wfe sub-block (PXP_HW_PXP_WFE_B_STG2_5X6_OUT0_5).....	2831
41.11.245	This register defines the control bits for the pxp wfe sub-block (PXP_HW_PXP_WFE_B_STG2_5X6_OUT0_6).....	2832
41.11.246	This register defines the control bits for the pxp wfe sub-block (PXP_HW_PXP_WFE_B_STG2_5X6_OUT0_7).....	2833
41.11.247	This register defines the control bits for the pxp wfe sub-block (PXP_HW_PXP_WFE_B_STG2_5X6_OUT1_0).....	2834
41.11.248	This register defines the control bits for the pxp wfe sub-block (PXP_HW_PXP_WFE_B_STG2_5X6_OUT1_1).....	2835
41.11.249	This register defines the control bits for the pxp wfe sub-block (PXP_HW_PXP_WFE_B_STG2_5X6_OUT1_2).....	2836
41.11.250	This register defines the control bits for the pxp wfe sub-block (PXP_HW_PXP_WFE_B_STG2_5X6_OUT1_3).....	2837
41.11.251	This register defines the control bits for the pxp wfe sub-block (PXP_HW_PXP_WFE_B_STG2_5X6_OUT1_4).....	2838
41.11.252	This register defines the control bits for the pxp wfe sub-block (PXP_HW_PXP_WFE_B_STG2_5X6_OUT1_5).....	2839
41.11.253	This register defines the control bits for the pxp wfe sub-block (PXP_HW_PXP_WFE_B_STG2_5X6_OUT1_6).....	2840
41.11.254	This register defines the control bits for the pxp wfe sub-block (PXP_HW_PXP_WFE_B_STG2_5X6_OUT1_7).....	2841
41.11.255	This register defines the control bits for the pxp wfe sub-block (PXP_HW_PXP_WFE_B_STG2_5X6_OUT2_0).....	2842
41.11.256	This register defines the control bits for the pxp wfe sub-block (PXP_HW_PXP_WFE_B_STG2_5X6_OUT2_1).....	2843

Section number	Title	Page
41.11.257	This register defines the control bits for the pxp wfe sub-block (PXP_HW_PXP_WFE_B_STG2_5X6_OUT2_2).....	2844
41.11.258	This register defines the control bits for the pxp wfe sub-block (PXP_HW_PXP_WFE_B_STG2_5X6_OUT2_3).....	2845
41.11.259	This register defines the control bits for the pxp wfe sub-block (PXP_HW_PXP_WFE_B_STG2_5X6_OUT2_4).....	2846
41.11.260	This register defines the control bits for the pxp wfe sub-block (PXP_HW_PXP_WFE_B_STG2_5X6_OUT2_5).....	2847
41.11.261	This register defines the control bits for the pxp wfe sub-block (PXP_HW_PXP_WFE_B_STG2_5X6_OUT2_6).....	2848
41.11.262	This register defines the control bits for the pxp wfe sub-block (PXP_HW_PXP_WFE_B_STG2_5X6_OUT2_7).....	2849
41.11.263	This register defines the control bits for the pxp wfe sub-block (PXP_HW_PXP_WFE_B_STG2_5X6_OUT3_0).....	2850
41.11.264	This register defines the control bits for the pxp wfe sub-block (PXP_HW_PXP_WFE_B_STG2_5X6_OUT3_1).....	2851
41.11.265	This register defines the control bits for the pxp wfe sub-block (PXP_HW_PXP_WFE_B_STG2_5X6_OUT3_2).....	2852
41.11.266	This register defines the control bits for the pxp wfe sub-block (PXP_HW_PXP_WFE_B_STG2_5X6_OUT3_3).....	2853
41.11.267	This register defines the control bits for the pxp wfe sub-block (PXP_HW_PXP_WFE_B_STG2_5X6_OUT3_4).....	2854
41.11.268	This register defines the control bits for the pxp wfe sub-block (PXP_HW_PXP_WFE_B_STG2_5X6_OUT3_5).....	2855
41.11.269	This register defines the control bits for the pxp wfe sub-block (PXP_HW_PXP_WFE_B_STG2_5X6_OUT3_6).....	2856
41.11.270	This register defines the control bits for the pxp wfe sub-block (PXP_HW_PXP_WFE_B_STG2_5X6_OUT3_7).....	2857
41.11.271	Each set mask bit enables one of the corresponding flag input bits. There is one mask per 5x6 LUT. (PXP_HW_PXP_WFE_B_STAGE2_5X6_MASKS_0).....	2858
41.11.272	Each Address specifies the MUX position in the MUX array. There is one MUXADDR per 5x6 LUT. (PXP_HW_PXP_WFE_B_STAGE2_5X6_ADDR_0).....	2859

Section number	Title	Page
41.11.273	This register defines the output values (new flag) for the 5x1 LUTs in stage 2. (PXP_HW_PXP_WFE_B_STG2_5X1_OUT0).....	2860
41.11.274	This register defines the output values (new flag) for the 5x1 LUTs in stage 2. (PXP_HW_PXP_WFE_B_STG2_5X1_OUT1).....	2862
41.11.275	This register defines the output values (new flag) for the 5x1 LUTs in stage 2. (PXP_HW_PXP_WFE_B_STG2_5X1_OUT2).....	2864
41.11.276	This register defines the output values (new flag) for the 5x1 LUTs in stage 2. (PXP_HW_PXP_WFE_B_STG2_5X1_OUT3).....	2866
41.11.277	Each set mask bit enables one of the corresponding flag input bits. There is one mask per 5x1 LUT. (PXP_HW_PXP_WFE_B_STG2_5X1_MASKS).....	2868
41.11.278	This register defines the output values (new flag) for the 8x1 LUTs in stage 3. (PXP_HW_PXP_WFE_B_STG3_F8X1_OUT0_0).....	2869
41.11.279	This register defines the output values (new flag) for the 8x1 LUTs in stage 3. (PXP_HW_PXP_WFE_B_STG3_F8X1_OUT0_1).....	2871
41.11.280	This register defines the output values (new flag) for the 8x1 LUTs in stage 3. (PXP_HW_PXP_WFE_B_STG3_F8X1_OUT0_2).....	2873
41.11.281	This register defines the output values (new flag) for the 8x1 LUTs in stage 3. (PXP_HW_PXP_WFE_B_STG3_F8X1_OUT0_3).....	2875
41.11.282	This register defines the output values (new flag) for the 8x1 LUTs in stage 3. (PXP_HW_PXP_WFE_B_STG3_F8X1_OUT0_4).....	2877
41.11.283	This register defines the output values (new flag) for the 8x1 LUTs in stage 3. (PXP_HW_PXP_WFE_B_STG3_F8X1_OUT0_5).....	2879
41.11.284	This register defines the output values (new flag) for the 8x1 LUTs in stage 3. (PXP_HW_PXP_WFE_B_STG3_F8X1_OUT0_6).....	2881
41.11.285	This register defines the output values (new flag) for the 8x1 LUTs in stage 3. (PXP_HW_PXP_WFE_B_STG3_F8X1_OUT0_7).....	2883
41.11.286	This register defines the output values (new flag) for the 8x1 LUTs in stage 3. (PXP_HW_PXP_WFE_B_STG3_F8X1_OUT1_0).....	2885
41.11.287	This register defines the output values (new flag) for the 8x1 LUTs in stage 3. (PXP_HW_PXP_WFE_B_STG3_F8X1_OUT1_1).....	2887
41.11.288	This register defines the output values (new flag) for the 8x1 LUTs in stage 3. (PXP_HW_PXP_WFE_B_STG3_F8X1_OUT1_2).....	2889

Section number	Title	Page
41.11.289	This register defines the output values (new flag) for the 8x1 LUTs in stage 3. (PXP_HW_PXP_WFE_B_STG3_F8X1_OUT1_3).....	2891
41.11.290	This register defines the output values (new flag) for the 8x1 LUTs in stage 3. (PXP_HW_PXP_WFE_B_STG3_F8X1_OUT1_4).....	2893
41.11.291	This register defines the output values (new flag) for the 8x1 LUTs in stage 3. (PXP_HW_PXP_WFE_B_STG3_F8X1_OUT1_5).....	2895
41.11.292	This register defines the output values (new flag) for the 8x1 LUTs in stage 3. (PXP_HW_PXP_WFE_B_STG3_F8X1_OUT1_6).....	2897
41.11.293	This register defines the output values (new flag) for the 8x1 LUTs in stage 3. (PXP_HW_PXP_WFE_B_STG3_F8X1_OUT1_7).....	2899
41.11.294	This register defines the output values (new flag) for the 8x1 LUTs in stage 3. (PXP_HW_PXP_WFE_B_STG3_F8X1_OUT2_0).....	2901
41.11.295	This register defines the output values (new flag) for the 8x1 LUTs in stage 3. (PXP_HW_PXP_WFE_B_STG3_F8X1_OUT2_1).....	2903
41.11.296	This register defines the output values (new flag) for the 8x1 LUTs in stage 3. (PXP_HW_PXP_WFE_B_STG3_F8X1_OUT2_2).....	2905
41.11.297	This register defines the output values (new flag) for the 8x1 LUTs in stage 3. (PXP_HW_PXP_WFE_B_STG3_F8X1_OUT2_3).....	2907
41.11.298	This register defines the output values (new flag) for the 8x1 LUTs in stage 3. (PXP_HW_PXP_WFE_B_STG3_F8X1_OUT2_4).....	2909
41.11.299	This register defines the output values (new flag) for the 8x1 LUTs in stage 3. (PXP_HW_PXP_WFE_B_STG3_F8X1_OUT2_5).....	2911
41.11.300	This register defines the output values (new flag) for the 8x1 LUTs in stage 3. (PXP_HW_PXP_WFE_B_STG3_F8X1_OUT2_6).....	2913
41.11.301	This register defines the output values (new flag) for the 8x1 LUTs in stage 3. (PXP_HW_PXP_WFE_B_STG3_F8X1_OUT2_7).....	2915
41.11.302	This register defines the output values (new flag) for the 8x1 LUTs in stage 3. (PXP_HW_PXP_WFE_B_STG3_F8X1_OUT3_0).....	2917
41.11.303	This register defines the output values (new flag) for the 8x1 LUTs in stage 3. (PXP_HW_PXP_WFE_B_STG3_F8X1_OUT3_1).....	2919
41.11.304	This register defines the output values (new flag) for the 8x1 LUTs in stage 3. (PXP_HW_PXP_WFE_B_STG3_F8X1_OUT3_2).....	2921

Section number	Title	Page
41.11.305	This register defines the output values (new flag) for the 8x1 LUTs in stage 3. (PXP_HW_PXP_WFE_B_STG3_F8X1_OUT3_3).....	2923
41.11.306	This register defines the output values (new flag) for the 8x1 LUTs in stage 3. (PXP_HW_PXP_WFE_B_STG3_F8X1_OUT3_4).....	2925
41.11.307	This register defines the output values (new flag) for the 8x1 LUTs in stage 3. (PXP_HW_PXP_WFE_B_STG3_F8X1_OUT3_5).....	2927
41.11.308	This register defines the output values (new flag) for the 8x1 LUTs in stage 3. (PXP_HW_PXP_WFE_B_STG3_F8X1_OUT3_6).....	2929
41.11.309	This register defines the output values (new flag) for the 8x1 LUTs in stage 3. (PXP_HW_PXP_WFE_B_STG3_F8X1_OUT3_7).....	2931
41.11.310	Each set mask bit enables one of the corresponding flag input bits. There is one mask per 8x1 LUT. (PXP_HW_PXP_WFE_B_STG3_F8X1_MASKS).....	2933
41.11.311	This register defines the control bits for the pxp alu sub-block. (PXP_HW_PXP_ALU_B_CTRLn).....	2934
41.11.312	This register defines the size of the buffer to be processed by the alu engine. (PXP_HW_PXP_ALU_B_BUF_SIZE).....	2935
41.11.313	This register defines the Entry Address for the Instruction Memory of the ALU. (PXP_HW_PXP_ALU_B_INST_ENTRY).....	2936
41.11.314	This register defines the parameter used by SW running on ALU. (PXP_HW_PXP_ALU_B_PARAM).....	2936
41.11.315	This register defines the hw configuration options for the alu core. (PXP_HW_PXP_ALU_B_CONFIG).....	2937
41.11.316	This register defines the hw configuration options for the LUT (PXP_HW_PXP_ALU_B_LUT_CONFIGn).....	2937
41.11.317	This register defines the lower 32-bit data for the LUT (PXP_HW_PXP_ALU_B_LUT_DATA0).....	2938
41.11.318	This register defines the higher 32-bit data for the LUT (PXP_HW_PXP_ALU_B_LUT_DATA1).....	2938
41.11.319	This register is used for debugging alu block (PXP_HW_PXP_ALU_B_DBG).....	2939
41.11.320	Histogram Control Register. (PXP_HW_PXP_HIST_A_CTRL).....	2940
41.11.321	Histogram Pixel Mask Register. (PXP_HW_PXP_HIST_A_MASK).....	2941
41.11.322	Histogram Pixel Buffer Size Register. (PXP_HW_PXP_HIST_A_BUF_SIZE).....	2942
41.11.323	Total Number of Pixels Used by Histogram Engine. (PXP_HW_PXP_HIST_A_TOTAL_PIXEL).....	2942
41.11.324	The X Coordinate Offset for Active Area. (PXP_HW_PXP_HIST_A_ACTIVE_AREA_X).....	2943
41.11.325	The Y Coordinate Offset for Active Area. (PXP_HW_PXP_HIST_A_ACTIVE_AREA_Y).....	2943

Section number	Title	Page
41.11.326	Histogram Result Based on RAW Pixel Value. (PXP_HW_PXP_HIST_A_RAW_STAT0).....	2944
41.11.327	Histogram Result Based on RAW Pixel Value. (PXP_HW_PXP_HIST_A_RAW_STAT1).....	2944
41.11.328	Histogram Control Register. (PXP_HW_PXP_HIST_B_CTRL).....	2945
41.11.329	Histogram Pixel Mask Register. (PXP_HW_PXP_HIST_B_MASK).....	2946
41.11.330	Histogram Pixel Buffer Size Register. (PXP_HW_PXP_HIST_B_BUF_SIZE).....	2947
41.11.331	Total Number of Pixels Used by Histogram Engine. (PXP_HW_PXP_HIST_B_TOTAL_PIXEL).....	2948
41.11.332	The X Coordinate Offset for Active Area. (PXP_HW_PXP_HIST_B_ACTIVE_AREA_X).....	2948
41.11.333	The Y Coordinate Offset for Active Area. (PXP_HW_PXP_HIST_B_ACTIVE_AREA_Y).....	2949
41.11.334	Histogram Result Based on RAW Pixel Value. (PXP_HW_PXP_HIST_B_RAW_STAT0).....	2949
41.11.335	Histogram Result Based on RAW Pixel Value. (PXP_HW_PXP_HIST_B_RAW_STAT1).....	2950
41.11.336	2-level Histogram Parameter Register. (PXP_HW_PXP_HIST2_PARAM).....	2950
41.11.337	4-level Histogram Parameter Register. (PXP_HW_PXP_HIST4_PARAM).....	2951
41.11.338	8-level Histogram Parameter 0 Register. (PXP_HW_PXP_HIST8_PARAM0).....	2951
41.11.339	8-level Histogram Parameter 1 Register. (PXP_HW_PXP_HIST8_PARAM1).....	2952
41.11.340	16-level Histogram Parameter 0 Register. (PXP_HW_PXP_HIST16_PARAM0).....	2953
41.11.341	16-level Histogram Parameter 1 Register. (PXP_HW_PXP_HIST16_PARAM1).....	2954
41.11.342	16-level Histogram Parameter 2 Register. (PXP_HW_PXP_HIST16_PARAM2).....	2954
41.11.343	16-level Histogram Parameter 3 Register. (PXP_HW_PXP_HIST16_PARAM3).....	2955
41.11.344	32-level Histogram Parameter 0 Register. (PXP_HW_PXP_HIST32_PARAM0).....	2956
41.11.345	32-level Histogram Parameter 1 Register. (PXP_HW_PXP_HIST32_PARAM1).....	2957
41.11.346	32-level Histogram Parameter 2 Register. (PXP_HW_PXP_HIST32_PARAM2).....	2957
41.11.347	32-level Histogram Parameter 3 Register. (PXP_HW_PXP_HIST32_PARAM3).....	2958
41.11.348	32-level Histogram Parameter 0 Register. (PXP_HW_PXP_HIST32_PARAM4).....	2959
41.11.349	32-level Histogram Parameter 1 Register. (PXP_HW_PXP_HIST32_PARAM5).....	2960
41.11.350	32-level Histogram Parameter 2 Register. (PXP_HW_PXP_HIST32_PARAM6).....	2960
41.11.351	32-level Histogram Parameter 3 Register. (PXP_HW_PXP_HIST32_PARAM7).....	2961
41.11.352	This register defines the pxp subblock handshake signals ready mux on top level. (PXP_HW_PXP_HANDSHAKE_READY_MUX0).....	2962

Section number	Title	Page
41.11.353	This register defines the pxp subblock handshake signals done mux on top level. (PXP_HW_PXP_HANDSHAKE_DONE_MUX0).....	2962

Chapter 42

Quad Serial Peripheral Interface (QuadSPI)

42.1	Overview.....	2965
42.1.1	Features.....	2967
42.1.2	QuadSPI Modes of Operation.....	2968
42.1.2.1	Normal Mode.....	2968
42.1.2.2	Module Disable Mode.....	2968
42.1.3	Acronyms and Abbreviations.....	2968
42.1.4	Glossary for QuadSPI module.....	2969
42.2	External Signals.....	2970
42.2.1	Driving External Signals.....	2971
42.3	Memory Map and Register Definition.....	2973
42.3.1	Register Write Access.....	2973
42.3.2	Serial Flash Address Assignment.....	2974
42.3.3	AMBA Bus Register Memory Map.....	2975
42.3.4	AHB Bus Register Memory Map Descriptions.....	2976
42.3.4.1	AHB Bus Access Considerations.....	2976
42.3.4.2	Memory Mapped Serial Flash Data - Individual Flash Mode on Flash A.....	2977
42.3.4.3	Memory Mapped Serial Flash Data - Individual Flash Mode on Flash B.....	2977
42.3.4.4	Parallel Flash Mode.....	2978
42.4	Interrupt Signals.....	2980
42.5	Functional Description.....	2980
42.5.1	Serial Flash Access Schemes.....	2980
42.5.2	Modes of Operation.....	2981
42.5.3	Normal Mode.....	2982
42.5.3.1	Programmable Sequence Engine.....	2982
42.5.3.2	Flexible AHB buffers.....	2984

Section number	Title	Page
42.5.3.3	Suspend-Abort Mechanism.....	2986
42.5.3.4	Look-up Table.....	2987
42.5.3.5	Issuing SFM Commands.....	2988
42.5.3.6	Flash Programming.....	2990
42.5.3.7	Flash Read.....	2990
42.5.3.8	Byte Ordering of Serial Flash Read Data.....	2995
42.5.3.9	Normal Mode Interrupt and DMA Requests.....	2998
42.5.3.10	TX Buffer Operation.....	3000
42.5.3.11	Address scheme.....	3000
42.6	Initialization/Application Information.....	3001
42.6.1	Power Up and Reset.....	3001
42.6.2	Available Status/Flag Information.....	3002
42.6.2.1	IP Commands.....	3002
42.6.2.2	AHB Commands.....	3002
42.6.2.3	Overview of Error Flags.....	3003
42.6.2.4	IP Bus and AHB Access Command Collisions.....	3004
42.6.3	Exclusive Access to Serial Flash for AHB Commands.....	3004
42.6.3.1	RX Buffer Read via QSPI_ARDB Registers.....	3005
42.6.3.2	RX Buffer Read via QSPI_RBDR Registers.....	3005
42.6.4	Command Arbitration	3005
42.6.5	Flash Device Selection.....	3006
42.6.6	DMA Usage.....	3007
42.6.6.1	DMA Usage in Normal Mode.....	3007
42.6.6.1.1	Bandwidth considerations.....	3007
42.6.7	Parallel mode.....	3009
42.7	Byte Ordering - Endianness.....	3011
42.7.1	Programming Flash Data.....	3012
42.7.2	Reading Flash Data into the RX Buffer.....	3013
42.7.2.1	Readout of the RX Buffer via QSPI_RBDRn.....	3013

Section number	Title	Page
42.7.2.2	Readout of the RX Buffer via ARDBn.....	3013
42.7.3	Reading Flash Data into the AHB Buffer.....	3014
42.7.3.1	Readout of the AHB Buffer via Memory Mapped Read.....	3014
42.8	Serial Flash Devices.....	3014
42.8.1	Example Sequences.....	3014
42.8.1.1	Fast Read Sequence (Macronix/Numonyx/Spansion/Winbond).....	3015
42.8.1.2	Fast Dual I/O DT Read Sequence (Macronix).....	3015
42.8.1.3	Fast Read Quad Output (Winbond).....	3016
42.8.1.4	4 x I/O Read Enhance Performance Mode (XIP) (Macronix).....	3016
42.8.1.5	Dual Command Page Program (Numonyx).....	3017
42.8.1.6	Sector Erase (Macronix/Spansion/Numonyx).....	3017
42.8.1.7	Read Status Register (Macronix/Spansion/Numonyx/Winbond).....	3017
42.8.2	Dual Die Flashes.....	3018
42.8.3	Boot initialization sequence.....	3018
42.9	Sampling of Serial Flash Input Data.....	3019
42.9.1	Internal Sampling of Serial Flash Input Data.....	3019
42.9.2	DDR Mode.....	3022
42.10	Serial Flash Data Input Timing.....	3022
42.10.1	Input timing in SDR mode with internal sampling.....	3024
42.10.2	Input timing in DDR mode with internal sampling.....	3024
42.10.3	Input timing in SDR mode with loopback DQS sampling.....	3025
42.10.4	Input timing in DDR mode with loopback DQS sampling.....	3026
42.10.5	Input timing in SDR mode with flash DQS sampling.....	3027
42.10.6	Input timing in DDR mode with flash DQS sampling.....	3028
42.10.7	Data Strobe Signal functionality.....	3029
42.11	Output timing in SDR mode.....	3029
42.12	Output timing in DDR mode.....	3030
42.13	AHB RX Data Buffer (QSPI_ARDB0 to QSPI_ARDB31).....	3031
42.13.1	AHB RX Data Buffer (QSPI_ARDB0 to QSPI_ARDB31).....	3031

Section number	Title	Page
42.13.1.1	AHB RX Data Buffer register (ARDB n).....	3031
42.14	Peripheral Bus Register Descriptions.....	3033
42.14.1	Module Configuration Register (QuadSPI_MCR).....	3039
42.14.2	IP Configuration Register (QuadSPI_IPCR).....	3042
42.14.3	Flash Configuration Register (QuadSPI_FLSHCR).....	3043
42.14.4	Buffer0 Configuration Register (QuadSPI_BUF0CR).....	3043
42.14.5	Buffer1 Configuration Register (QuadSPI_BUF1CR).....	3044
42.14.6	Buffer2 Configuration Register (QuadSPI_BUF2CR).....	3045
42.14.7	Buffer3 Configuration Register (QuadSPI_BUF3CR).....	3046
42.14.8	Buffer Generic Configuration Register (QuadSPI_BFGENCR).....	3047
42.14.9	Buffer0 Top Index Register (QuadSPI_BUF0IND).....	3047
42.14.10	Buffer1 Top Index Register (QuadSPI_BUF1IND).....	3048
42.14.11	Buffer2 Top Index Register (QuadSPI_BUF2IND).....	3049
42.14.12	Serial Flash Address Register (QuadSPI_SFAR).....	3050
42.14.13	Sampling Register (QuadSPI_SMPR).....	3050
42.14.14	RX Buffer Status Register (QuadSPI_RBSR).....	3051
42.14.15	RX Buffer Control Register (QuadSPI_RBCT).....	3052
42.14.16	TX Buffer Status Register (QuadSPI_TBSR).....	3053
42.14.17	TX Buffer Data Register (QuadSPI_TBDR).....	3053
42.14.18	Status Register (QuadSPI_SR).....	3055
42.14.19	Flag Register (QuadSPI_FR).....	3058
42.14.20	Interrupt and DMA Request Select and Enable Register (QuadSPI_RSER).....	3061
42.14.21	Sequence Suspend Status Register (QuadSPI_SPNDST).....	3064
42.14.22	Sequence Pointer Clear Register (QuadSPI_SPTRCLR).....	3066
42.14.23	Serial Flash A1 Top Address (QuadSPI_SFA1AD).....	3066
42.14.24	Serial Flash A2 Top Address (QuadSPI_SFA2AD).....	3067
42.14.25	Serial Flash B1 Top Address (QuadSPI_SFB1AD).....	3067
42.14.26	Serial Flash B2 Top Address (QuadSPI_SFB2AD).....	3068
42.14.27	RX Buffer Data Register (QuadSPI_RBDR n).....	3068

Section number	Title	Page
42.14.28	LUT Key Register (QuadSPI_LUTKEY).....	3069
42.14.29	LUT Lock Configuration Register (QuadSPI_LCKCR).....	3070
42.14.30	Look-up Table register (QuadSPI_LUT0).....	3071
42.14.31	Look-up Table register (QuadSPI_LUT1).....	3072
42.14.32	Look-up Table register (QuadSPI_LUTn).....	3073

Chapter 43 ROM Controller with Patch (ROMC)

43.1	Overview.....	3075
43.1.1	Features.....	3076
43.1.2	Modes of Operation.....	3076
43.1.2.1	Low Power Mode.....	3077
43.2	Clocks.....	3077
43.3	Memory Map.....	3077
43.3.1	ROM Memory Map in detail.....	3077
43.4	Functional Description.....	3078
43.4.1	ROM Controller (ROMC) Functional Description.....	3078
43.4.1.1	Functionality overview.....	3078
43.4.2	ROMC Functional Description.....	3078
43.4.2.1	ROMC Disabling.....	3079
43.4.2.2	ROMC Event Priority.....	3079
43.4.2.3	Data Fixing.....	3079
43.4.2.4	Opcode Patching.....	3080
43.4.2.4.1	Typical Software Response to Opcode Patch.....	3081
43.4.2.5	External Boot Feature.....	3082
43.4.2.6	Alternate Masters and ROMC.....	3083
43.5	ROMCP Memory Map/Register Definition.....	3083
43.5.1	ROMC Data Registers (ROMC_ROMPATCHnD).....	3084
43.5.2	ROMC Control Register (ROMC_ROMPATCHCNTL).....	3085
43.5.3	ROMC Enable Register High (ROMC_ROMPATCHENH).....	3086

Section number	Title	Page
43.5.4	ROMC Enable Register Low (ROMC_ROMPATCHENL).....	3086
43.5.5	ROMC Address Registers (ROMC_ROMPATCHnA).....	3087
43.5.6	ROMC Status Register (ROMC_ROMPATCHSR).....	3088

Chapter 44 Random Number Generator (RNGB)

44.1	Introduction.....	3091
44.1.1	Block diagram.....	3091
44.1.2	Features.....	3092
44.2	Modes of operation.....	3092
44.2.1	Self-test mode.....	3092
44.2.2	Seed-generation mode.....	3092
44.2.3	Random number generation mode.....	3093
44.3	Memory map/register definition.....	3093
44.3.1	RNGB version ID register (RNG_VER).....	3094
44.3.2	RNGB command register (RNG_CMD).....	3094
44.3.3	RNGB control register (RNG_CR).....	3096
44.3.4	RNGB status register (RNG_SR).....	3098
44.3.5	RNGB error status register (RNG_ESR).....	3100
44.3.6	RNGB Output FIFO (RNG_OUT).....	3102
44.4	Functional description.....	3102
44.4.1	Pseudo-Random Number Generator (PRNG).....	3102
44.4.2	True Random Number Generator (TRNG).....	3103
44.4.3	Resets.....	3103
44.4.3.1	Power-on/hardware reset.....	3103
44.4.3.2	Software reset.....	3103
44.4.4	RNG interrupts.....	3104
44.5	Initialization/application information.....	3104
44.5.1	Manual seeding.....	3105
44.5.2	Automatic seeding.....	3105

Section number	Title	Page
Chapter 45		
Synchronous Audio Interface (SAI)		
45.1	Overview.....	3107
45.1.1	Features.....	3107
45.1.2	Block diagram.....	3107
45.1.3	Modes of operation.....	3108
45.1.3.1	Run mode.....	3108
45.1.3.2	Stop mode.....	3108
45.2	External Signals.....	3108
45.3	Functional description.....	3110
45.3.1	SAI clocking.....	3111
45.3.1.1	Audio master clock.....	3111
45.3.1.2	Bit clock.....	3112
45.3.1.3	Bus clock.....	3112
45.3.2	SAI resets.....	3113
45.3.2.1	Software reset.....	3113
45.3.2.2	FIFO reset.....	3113
45.3.3	Synchronous modes.....	3114
45.3.3.1	Synchronous mode.....	3114
45.3.4	Frame sync configuration.....	3114
45.3.5	Data FIFO.....	3115
45.3.5.1	Data alignment.....	3115
45.3.5.2	FIFO pointers.....	3116
45.3.6	Word mask register.....	3117
45.3.7	Interrupts and DMA requests.....	3117
45.3.7.1	FIFO request flag.....	3117
45.3.7.2	FIFO warning flag.....	3118
45.3.7.3	FIFO error flag.....	3118
45.3.7.4	Sync error flag.....	3118

Section number	Title	Page
45.3.7.5	Word start flag.....	3119
45.4	Memory map and register definition.....	3119
45.4.1	SAI Transmit Control Register (I2Sx_TCSR).....	3122
45.4.2	SAI Transmit Configuration 1 Register (I2Sx_TCR1).....	3125
45.4.3	SAI Transmit Configuration 2 Register (I2Sx_TCR2).....	3125
45.4.4	SAI Transmit Configuration 3 Register (I2Sx_TCR3).....	3127
45.4.5	SAI Transmit Configuration 4 Register (I2Sx_TCR4).....	3128
45.4.6	SAI Transmit Configuration 5 Register (I2Sx_TCR5).....	3129
45.4.7	SAI Transmit Data Register (I2Sx_TDR n).....	3130
45.4.8	SAI Transmit FIFO Register (I2Sx_TFR n).....	3131
45.4.9	SAI Transmit Mask Register (I2Sx_TMR).....	3131
45.4.10	SAI Receive Control Register (I2Sx_RCSR).....	3132
45.4.11	SAI Receive Configuration 1 Register (I2Sx_RCR1).....	3135
45.4.12	SAI Receive Configuration 2 Register (I2Sx_RCR2).....	3136
45.4.13	SAI Receive Configuration 3 Register (I2Sx_RCR3).....	3137
45.4.14	SAI Receive Configuration 4 Register (I2Sx_RCR4).....	3138
45.4.15	SAI Receive Configuration 5 Register (I2Sx_RCR5).....	3140
45.4.16	SAI Receive Data Register (I2Sx_RDR n).....	3140
45.4.17	SAI Receive FIFO Register (I2Sx_RFR n).....	3141
45.4.18	SAI Receive Mask Register (I2Sx_RMR).....	3141
45.4.19	SAI MCLK Control Register (I2Sx_MCR).....	3142

Chapter 46 Smart Direct Memory Access Controller (SDMA)

46.1	Overview.....	3145
46.1.1	Block Diagram.....	3145
46.1.2	Features.....	3147
46.2	External Signals.....	3149
46.3	Clocks.....	3149
46.4	Functional Description.....	3149

Section number	Title	Page
46.4.1	SDMA Core.....	3150
46.4.1.1	SDMA Core Structure.....	3151
46.4.1.2	Program Control Unit (PCU).....	3154
46.4.1.2.1	Instruction Types.....	3154
46.4.1.2.2	PCU States.....	3155
46.4.1.3	SDMA Core Memory.....	3158
46.4.2	Scheduler.....	3158
46.4.2.1	Primary Functions.....	3158
46.4.2.2	Channels and DMA Requests.....	3159
46.4.2.2.1	Channels.....	3159
46.4.2.2.2	DMA Requests.....	3159
46.4.2.2.3	Mapping from DMA Requests to Channels and Priorities.....	3159
46.4.2.3	Scheduler Functional Description.....	3159
46.4.2.3.1	Scheduler Overview.....	3159
46.4.2.3.2	DMA Requests Scanning.....	3160
46.4.2.3.3	Mapping DMA Requests to Pending Channels.....	3161
46.4.2.3.4	Channel Overflow.....	3164
46.4.2.3.5	Runnable Channels Evaluation.....	3164
46.4.2.3.6	Next Channel Decision Tree.....	3166
46.4.2.3.7	Scheduler State Diagram.....	3168
46.4.2.3.8	Scheduler Pipeline Timing Diagram.....	3170
46.4.2.3.9	Channel-DMA Request Mapping.....	3170
46.4.2.3.10	Examples: How to Start a Channel.....	3170
46.4.2.4	Context Switching.....	3171
46.4.2.4.1	Context Switch Modes.....	3172
46.4.2.4.2	Context Switch Procedure.....	3172
46.4.2.4.3	Context Map in Memory.....	3174
46.4.3	Functional Units.....	3174
46.4.3.1	Burst DMA Unit.....	3174

Section number	Title	Page
46.4.3.1.1	Burst DMA Structure.....	3175
46.4.3.1.2	Burst DMA Registers.....	3176
46.4.3.1.3	Burst DMA Data Transfers.....	3177
46.4.3.1.3.1	Data Retrieval from the Arm platform Memory.....	3177
46.4.3.1.3.2	Storing Data Into the Arm platform Memory.....	3177
46.4.3.1.3.3	Transferring Data Between Two Arm platform Memory Locations-Burst DMA Unit.....	3178
46.4.3.2	Peripheral DMA Unit.....	3178
46.4.3.2.1	Peripheral DMA Structure.....	3179
46.4.3.2.2	Peripheral DMA Registers.....	3180
46.4.3.2.3	Peripheral DMA Data Transfers.....	3181
46.4.3.2.3.1	Data Retrieval from the Arm platform Memory or Peripheral.....	3181
46.4.3.2.3.2	Storing Data into the Arm platform Memory or Peripheral...	3181
46.4.3.2.3.3	Transferring Data Between Two Arm platform Memory Locations-Peripheral DMA Unit.....	3182
46.4.4	SDMA Security Support.....	3182
46.4.4.1	Locked Mode.....	3182
46.4.5	OnCE and PCU Debug States.....	3183
46.4.6	SDMA Clocks and Low Power Modes.....	3185
46.4.6.1	Clock Gating and Low Power Modes.....	3186
46.4.6.1.1	Coarse Clock Gating.....	3186
46.4.6.1.2	Refined Clock Gating.....	3187
46.4.6.1.3	Low Power Modes and User Control.....	3187
46.4.6.1.3.1	SLEEP Mode.....	3188
46.4.6.1.3.2	RUN Mode.....	3188
46.4.6.1.3.3	DEBUG Mode.....	3189
46.4.6.1.4	Stop Mode Response.....	3189
46.4.6.2	Reset.....	3189
46.4.7	Software Interface.....	3189

Section number	Title	Page
46.4.8	Initialization Information.....	3190
46.4.8.1	Hardware Reset.....	3190
46.4.8.2	Channel Script Execution.....	3191
46.4.8.3	Initialization and Script Execution Setup Sequence.....	3191
46.4.9	SDMA Programming Model.....	3192
46.4.9.1	State and Registers Per Channel.....	3192
46.4.9.2	General Purpose Registers.....	3193
46.4.9.3	Functional Unit State.....	3193
46.4.9.3.1	Program Counter Register (PC).....	3193
46.4.9.3.2	Flags.....	3193
46.4.9.3.3	Return Program Counter (RPC).....	3194
46.4.9.3.4	Loop Mode Start Program Counter (SPC).....	3194
46.4.9.3.5	Loop Mode End Program Counter (EPC).....	3194
46.4.9.4	Context Switching-Programming.....	3195
46.4.9.5	Address Space.....	3196
46.4.9.5.1	Instruction Memory Map.....	3197
46.4.9.5.2	Data Memory Map.....	3197
46.4.10	SDMA Initialization.....	3199
46.4.10.1	Hardware Reset-SDMA.....	3199
46.4.10.2	Standard Boot Sequence.....	3199
46.4.10.3	User-Defined Boot Sequence.....	3200
46.4.10.4	Script Loading and Context Initialization.....	3200
46.4.11	Instruction Description.....	3201
46.4.11.1	Scheduling Instructions.....	3201
46.4.11.2	Conditional Branch Instructions.....	3201
46.4.11.3	Unconditional Jump Instructions.....	3202
46.4.11.4	Subroutine Return Instructions.....	3202
46.4.11.5	Loop Instruction.....	3202
46.4.11.6	Miscellaneous Instructions.....	3203

Section number	Title	Page
46.4.11.7	Logic Instructions.....	3203
46.4.11.8	Arithmetic Instructions.....	3203
46.4.11.9	Compare Instructions.....	3204
46.4.11.10	Test Instructions.....	3204
46.4.11.11	Byte Permutation Instructions.....	3204
46.4.11.12	Bit Shift Instructions.....	3205
46.4.11.13	Bit Manipulation Instructions.....	3205
46.4.11.14	SDMA Memory Access Instructions.....	3205
46.4.11.15	Functional Unit Instructions.....	3206
46.4.11.16	Illegal Instructions.....	3206
46.4.11.17	Debug Instructions.....	3206
46.4.12	Functional Units Programming Model.....	3207
46.4.12.1	Burst DMA Unit Programming.....	3208
46.4.12.1.1	Memory Source Address Register (MSA).....	3208
46.4.12.1.2	Memory Destination Address Register (MDA).....	3209
46.4.12.1.3	Memory Data Buffer Register (MD).....	3209
46.4.12.1.4	State Register (MS).....	3210
46.4.12.1.5	Burst DMA Write (stf).....	3211
46.4.12.1.6	Burst DMA Read (ldf).....	3214
46.4.12.1.7	Prefetch/Flush and Auto-Flush Management-Burst DMA Unit.....	3215
46.4.12.1.8	Data Alignment and Endianness-Burst DMA Unit.....	3217
46.4.12.1.8.1	Burst DMA in Read Mode.....	3217
46.4.12.1.8.2	Burst DMA in Write Mode.....	3218
46.4.12.1.8.3	Endianness-Burst DMA Unit.....	3219
46.4.12.1.9	Burst DMA Unit Copy Mode.....	3220
46.4.12.1.10	Burst DMA Unit Error Management.....	3221
46.4.12.1.11	Conditional Yielding-Burst DMA Unit.....	3222
46.4.12.2	Peripheral DMA Unit Programming.....	3223
46.4.12.2.1	Peripheral Source Address Register (PSA).....	3224

Section number	Title	Page
46.4.12.2.2	Peripheral Destination Address Register (PDA).....	3225
46.4.12.2.3	Peripheral Data Register (PD).....	3225
46.4.12.2.4	Peripheral State Register (PS).....	3226
46.4.12.2.5	Peripheral DMA Write (stf)-Write Mode.....	3227
46.4.12.2.6	Peripheral DMA Read (ldf)-Read Mode.....	3230
46.4.12.2.7	Peripheral DMA Unit Copy Mode.....	3231
46.4.12.2.8	Error Management.....	3232
46.4.12.2.8.1	Immediate Errors.....	3232
46.4.12.2.8.2	Data Transfer Errors.....	3232
46.4.12.2.8.3	Read Error (First Phase).....	3233
46.4.12.2.8.4	Write Error and Read Error (Second Phase).....	3233
46.4.12.2.8.5	Copy Mode Errors.....	3234
46.4.12.2.8.6	Error Check Example.....	3234
46.4.12.2.9	Peripheral DMA Unit Prefetch/Flush Management.....	3235
46.4.12.3	OnCE and Real-Time Debug.....	3235
46.4.12.3.1	Memory and Register Access.....	3235
46.4.12.3.2	Hardware Breakpoints.....	3236
46.4.12.3.3	Watchpoints.....	3236
46.4.12.3.4	Software Breakpoints.....	3236
46.4.12.3.5	Core Control.....	3236
46.4.13	The OnCE Controller.....	3236
46.4.13.1	OnCE Commands.....	3237
46.4.13.2	Sending Commands to the OnCE Controller.....	3238
46.4.13.2.1	Using the JTAG Interface.....	3238
46.4.13.2.2	Using the Arm platform.....	3238
46.4.13.2.3	Conflicts Between the JTAG and the Arm platform Accesses.....	3240
46.4.13.3	Executing a Command from the OnCE.....	3240
46.4.13.3.1	Nature of the Commands.....	3240
46.4.13.3.2	Execution Request.....	3241

Section number	Title	Page
	46.4.13.3.3 Command Execution.....	3241
46.4.13.4	Registers Descriptions.....	3243
	46.4.13.4.1 Event Cell Counter Register (ECOUNT).....	3243
	46.4.13.4.2 Event Cell Address Registers (EAA or EAB).....	3243
	46.4.13.4.3 Event Cell Address Mask Register (EAM).....	3244
	46.4.13.4.4 Event Cell Data Register (ED).....	3244
	46.4.13.4.5 Event Cell Data Mask Register (EDM).....	3244
	46.4.13.4.6 Real Time Buffer Register (RTB).....	3244
	46.4.13.4.7 Event Control Register (ECTL).....	3245
	46.4.13.4.8 Trace Buffer (TB).....	3245
	46.4.13.4.9 OnCE Status Register (OSTAT).....	3245
46.4.13.5	JTAG Interface Requirements.....	3246
	46.4.13.5.1 TCK Speed Limitation.....	3246
	46.4.13.5.2 Synchronization Implementation.....	3246
	46.4.13.5.3 JTAG Controller Start-Up Recommended Procedure.....	3248
46.4.14	Using the OnCE.....	3248
	46.4.14.1 Activating Clocks in Debug Mode.....	3248
	46.4.14.2 Getting the Current Status.....	3248
	46.4.14.3 Methods of Entering Debug Mode.....	3249
	46.4.14.3.1 External Debug Request During Reset.....	3249
	46.4.14.3.2 Debug Request During Normal Activity.....	3249
	46.4.14.3.3 Software Breakpoint Instruction.....	3249
	46.4.14.3.4 Event Detection Unit Matching Condition.....	3249
	46.4.14.4 Executing Instructions in Debug Mode.....	3250
	46.4.14.5 Command Sequences Examples.....	3250
	46.4.14.5.1 Getting the SDMA Status.....	3250
	46.4.14.5.2 Saving the Context.....	3251
	46.4.14.5.3 Restoring the Context.....	3252
	46.4.14.5.4 Accessing the Memory.....	3253

Section number	Title	Page
46.4.14.5.5	Resuming Program Execution.....	3254
46.4.14.5.6	Single Stepping in RAM.....	3254
46.4.14.5.7	Single Stepping in ROM.....	3255
46.4.14.6	OnCE Event Detection Unit.....	3255
46.4.14.7	Clock Gating and Reset.....	3256
46.4.14.7.1	Clocks.....	3256
46.4.14.7.2	Resets.....	3257
46.4.14.8	Real Time Features.....	3257
46.4.14.8.1	Trace Buffer.....	3257
46.4.14.8.2	Real Time Buffer.....	3259
46.4.14.8.3	Emulation Pin.....	3259
46.4.14.8.4	Real-Time Debug Outputs.....	3259
46.5	Instruction Set.....	3263
46.5.1	Instruction Encoding.....	3263
46.5.2	SDMA Instruction Set.....	3265
46.5.2.1	ADD (Addition).....	3266
46.5.2.2	ADDI (Add with Immediate Value).....	3267
46.5.2.3	AND (Logical AND).....	3268
46.5.2.4	ANDI (Logical AND with Immediate Value).....	3269
46.5.2.5	ANDN (Logical AND NOT).....	3270
46.5.2.6	ANDNI (Logical AND with Negated Immediate Value).....	3271
46.5.2.7	ASR1 (Arithmetic Shift Right by 1 Bit).....	3272
46.5.2.8	BCLR1I (Bit Clear Immediate).....	3273
46.5.2.9	BDF (Conditional Branch if Destination Fault).....	3274
46.5.2.10	BF (Conditional Branch if False).....	3275
46.5.2.11	BSETI (Bit Set Immediate).....	3276
46.5.2.12	BSF (Conditional Branch if Source Fault).....	3277
46.5.2.13	BT (Conditional Branch if True).....	3278
46.5.2.14	BTSTI (Bit Test immediate).....	3279

Section number	Title	Page
46.5.2.15	CLRF (Clear Arm platform flags).....	3280
46.5.2.16	CMPEQ (Compare for Equal).....	3281
46.5.2.17	CMPEQI (Compare with Immediate for Equal).....	3282
46.5.2.18	CMPHS (Compare for Higher or Same).....	3283
46.5.2.19	CMPLT (Compare for Less Than).....	3284
46.5.2.20	cpShReg (Update Context of PCU Registers and Flag).....	3285
46.5.2.21	DONE (DONE, Yield)	3285
46.5.2.22	ILLEGAL (ILLEGAL Instruction).....	3287
46.5.2.23	JMP (Unconditional Jump Immediate).....	3288
46.5.2.24	JMPR (Unconditional Jump).....	3288
46.5.2.25	JSR (Unconditional Jump to Subroutine Immediate).....	3289
46.5.2.26	JSRR (Unconditional Jump to Subroutine).....	3290
46.5.2.27	LD (Load Register).....	3291
46.5.2.28	LDF (Load Register from Functional Unit).....	3292
46.5.2.29	LDI (Load Register with Immediate Value).....	3294
46.5.2.30	LDRPC (Load from RPC to Register).....	3295
46.5.2.31	LOOP (Hardware Loop).....	3296
46.5.2.32	LSL1 (Logical Shift Left by 1 Bit).....	3298
46.5.2.33	LSR1 (Logical Shift Right by 1 Bit).....	3299
46.5.2.34	MOV (Logical Move).....	3300
46.5.2.35	NOTIFY (Notify to Arm platform).....	3301
46.5.2.36	OR (Logical OR).....	3302
46.5.2.37	ORI (Logical OR with Immediate Value).....	3303
46.5.2.38	RET (Return from Subroutine).....	3304
46.5.2.39	REVB (Reverse Byte Order).....	3305
46.5.2.40	Reverse Low Order Bytes(REVBLO).....	3305
46.5.2.41	ROR1 (Rotate Right by 1 Bit).....	3306
46.5.2.42	RORB (Rotate Right by 1 Byte).....	3307
46.5.2.43	SOFTBKPT (Software Breakpoint).....	3308

Section number	Title	Page
46.5.2.44	ST (Store Register).....	3308
46.5.2.45	STF (Store Register in Functional Unit).....	3310
46.5.2.46	SUB (Subtract).....	3313
46.5.2.47	SUBI (Subtract with Immediate).....	3314
46.5.2.48	TST (Test with Zero).....	3315
46.5.2.49	TSTI (Test Immediate).....	3316
46.5.2.50	XOR (Logical Exclusive OR).....	3317
46.5.2.51	XORI (Exclusive OR with Immediate).....	3318
46.5.2.52	YIELD, YIELDGE (DONE, Yield).....	3319
46.6	Software Restrictions.....	3319
46.6.1	Unsupported Burst DMA Access Sequence.....	3319
46.7	Application Notes.....	3320
46.7.1	Data Structures for Boot Code and Channel Scripts.....	3320
46.7.1.1	Buffer Descriptor Format.....	3321
46.7.1.2	Buffer Descriptor Commands for Bootload scripts.....	3324
46.7.1.3	Example of Buffer Descriptors for Channel 0.....	3325
46.7.1.4	Channel Context.....	3328
46.7.2	Typical Data Transfer Supported by SDMA DMA Units.....	3328
46.7.2.1	External Memory to External Memory.....	3329
46.7.2.2	Peripheral to Peripheral Transfer.....	3330
46.7.2.2.1	Source and Destination Target Have the Same Data Path Width.....	3330
46.7.2.2.2	Source and Destination Target Have a Different Data Path Width.....	3331
46.7.2.3	Transfer Between Peripheral and External Memory.....	3332
46.7.2.3.1	Peripheral to External Memory Transfer.....	3332
46.7.2.3.2	External Memory to Peripheral Transfer.....	3334
46.7.2.4	Transfer Between External Memory and Internal Memory.....	3335
46.7.2.4.1	Internal Memory to Internal Memory.....	3335
46.7.2.4.2	Transfer Between Peripheral and Internal Memory.....	3335
46.8	Arm Platform Memory Map and Control Register Definitions.....	3335

Section number	Title	Page
46.8.1	Arm platform Channel 0 Pointer (SDMAARM_MC0PTR).....	3341
46.8.2	Channel Interrupts (SDMAARM_INTR).....	3341
46.8.3	Channel Stop/Channel Status (SDMAARM_STOP_STAT).....	3341
46.8.4	Channel Start (SDMAARM_HSTART).....	3342
46.8.5	Channel Event Override (SDMAARM_EVTOVR).....	3342
46.8.6	Channel BP Override (SDMAARM_DSPOVR).....	3343
46.8.7	Channel Arm platform Override (SDMAARM_HOSTOVR).....	3343
46.8.8	Channel Event Pending (SDMAARM_EVTPEND).....	3343
46.8.9	Reset Register (SDMAARM_RESET).....	3344
46.8.10	DMA Request Error Register (SDMAARM_EVTERR).....	3345
46.8.11	Channel Arm platform Interrupt Mask (SDMAARM_INTRMASK).....	3345
46.8.12	Schedule Status (SDMAARM_PSW).....	3346
46.8.13	DMA Request Error Register (SDMAARM_EVTERRDBG).....	3346
46.8.14	Configuration Register (SDMAARM_CONFIG).....	3347
46.8.15	SDMA LOCK (SDMAARM_SDMA_LOCK).....	3348
46.8.16	OnCE Enable (SDMAARM_ONCE_ENB).....	3349
46.8.17	OnCE Data Register (SDMAARM_ONCE_DATA).....	3350
46.8.18	OnCE Instruction Register (SDMAARM_ONCE_INSTR).....	3350
46.8.19	OnCE Status Register (SDMAARM_ONCE_STAT).....	3350
46.8.20	OnCE Command Register (SDMAARM_ONCE_CMD).....	3352
46.8.21	Illegal Instruction Trap Address (SDMAARM_ILLINSTADDR).....	3353
46.8.22	Channel 0 Boot Address (SDMAARM_CHN0ADDR).....	3353
46.8.23	DMA Requests (SDMAARM_EVT_MIRROR).....	3354
46.8.24	DMA Requests 2 (SDMAARM_EVT_MIRROR2).....	3354
46.8.25	Cross-Trigger Events Configuration Register 1 (SDMAARM_XTRIG_CONF1).....	3355
46.8.26	Cross-Trigger Events Configuration Register 2 (SDMAARM_XTRIG_CONF2).....	3357
46.8.27	Channel Priority Registers (SDMAARM_SDMA_CHNPRI n).....	3358
46.8.28	Channel Enable RAM (SDMAARM_CHNENBL n).....	3358
46.9	BP Memory Map and Control Register Definitions.....	3359

Section number	Title	Page
46.9.1	Channel 0 Pointer (SDMABP_DC0PTR).....	3359
46.9.2	Channel Interrupts (SDMABP_INTR).....	3360
46.9.3	Channel Stop/Channel Status (SDMABP_STOP_STAT).....	3360
46.9.4	Channel Start (SDMABP_DSTART).....	3361
46.9.5	DMA Request Error Register (SDMABP_EVTERR).....	3361
46.9.6	Channel DSP Interrupt Mask (SDMABP_INTRMASK).....	3362
46.9.7	DMA Request Error Register (SDMABP_EVTERRDBG).....	3362
46.10	SDMA Internal (Core) Memory Map and Internal Register Definitions.....	3362
46.10.1	Arm platform Channel 0 Pointer (SDMACORE_MC0PTR).....	3364
46.10.2	Current Channel Pointer (SDMACORE_CCPtr).....	3364
46.10.3	Current Channel Register (SDMACORE_CCR).....	3364
46.10.4	Highest Pending Channel Register (SDMACORE_NCR).....	3365
46.10.5	External DMA Requests Mirror (SDMACORE_EVENTS).....	3366
46.10.6	Current Channel Priority (SDMACORE_CCPRI).....	3367
46.10.7	Next Channel Priority (SDMACORE_NCPRI).....	3367
46.10.8	OnCE Event Cell Counter (SDMACORE_ECOUNTER).....	3368
46.10.9	OnCE Event Cell Control Register (SDMACORE_ECTL).....	3368
46.10.10	OnCE Event Address Register A (SDMACORE_EAA).....	3370
46.10.11	OnCE Event Cell Address Register B (SDMACORE_EAB).....	3370
46.10.12	OnCE Event Cell Address Mask (SDMACORE_EAM).....	3370
46.10.13	OnCE Event Cell Data Register (SDMACORE_ED).....	3371
46.10.14	OnCE Event Cell Data Mask (SDMACORE_EDM).....	3371
46.10.15	OnCE Real-Time Buffer (SDMACORE_RTb).....	3372
46.10.16	OnCE Trace Buffer (SDMACORE_TB).....	3372
46.10.17	OnCE Status (SDMACORE_OSTAT).....	3373
46.10.18	Channel 0 Boot Address (SDMACORE_MCHN0ADDR).....	3375
46.10.19	ENDIAN Status Register (SDMACORE_ENDIANNESs).....	3376
46.10.20	Lock Status Register (SDMACORE_SDMA_LOCK).....	3377
46.10.21	External DMA Requests Mirror #2 (SDMACORE_EVENTS2).....	3378

Section number	Title	Page
46.11	SDMA Peripheral Registers.....	3378

Chapter 47 System JTAG Controller (SJC)

47.1	Overview.....	3379
47.1.1	Features.....	3380
47.1.2	Modes of Operation.....	3381
47.2	External Signals.....	3383
47.2.1	External Signal Overview.....	3384
47.2.2	TAP Controller.....	3385
47.2.3	Accessing ExtraDebug Registers.....	3387
47.3	TAP Selection Block (TSB).....	3389
47.3.1	Select Mode Using Software.....	3389
47.4	Boundary Scan Register (BSR)	3390
47.5	SoC JTAG Instruction Register (SJIR)	3391
47.5.1	ID_CODE Instruction (IDCODE)	3391
47.5.2	SAMPLE/PRELOAD Instruction	3393
47.5.3	EXTEST Instruction.....	3393
47.5.4	HIGHZ Instruction.....	3394
47.5.5	BYPASS Instruction	3394
47.5.6	ENABLE_ExtraDebug Instruction	3394
47.5.7	ENTER_DEBUG instruction	3395
47.5.8	TAP Select Instruction	3395
47.5.9	EXTEST_PULSE instruction	3396
47.5.10	EXTEST_TRAIN instruction.....	3396
47.6	Security.....	3396
47.6.1	JTAG Security Modes	3397
47.6.1.1	Mode 1: No Debug - Maximum Security.....	3397
47.6.1.2	Mode 2: Secure JTAG - High Security	3398
47.6.1.2.1	Challenge/Response Mechanism in System JTAG Mode.....	3398

Section number	Title	Page
47.6.1.3	Mode 3: JTAG Enabled - Low Security	3399
47.6.2	Software Enabled JTAG.....	3399
47.6.3	Kill Trace.....	3400
47.6.4	SJC Disable Fuse	3401
47.7	Functional Description.....	3402
47.7.1	Static Core Debug.....	3402
47.7.2	Reset Mechanism.....	3402
47.8	Initialization/Application Information.....	3403
47.9	SJC Memory Map/Register Definition.....	3404
47.9.1	General Purpose Unsecured Status Register 1 (SJC_GPUSR1).....	3405
47.9.2	General Purpose Unsecured Status Register 2 (SJC_GPUSR2).....	3407
47.9.3	General Purpose Unsecured Status Register 3 (SJC_GPUSR3).....	3407
47.9.4	General Purpose Secured Status Register (SJC_GPSSR).....	3408
47.9.5	Debug Control Register (SJC_DCR).....	3409
47.9.6	Security Status Register (SJC_SSR).....	3411
47.9.7	General Purpose Clocks Control Register (SJC_GPCCR).....	3414

Chapter 48 Secure Non-Volatile Storage (SNVS)

48.1	SNVS overview.....	3415
48.1.1	SNVS features.....	3415
48.1.2	Modes of operation.....	3415
48.2	SNVS structure.....	3416
48.2.1	SNVS_HP (high-power domain).....	3417
48.2.2	Non-secure real-time counter.....	3418
48.2.2.1	Calibrating the time counter.....	3418
48.2.2.2	Time counter alarm.....	3419
48.2.2.3	Periodic interrupt.....	3419
48.3	SNVS_LP (low-power domain).....	3419
48.3.1	Behavior during system power down.....	3420

Section number	Title	Page
48.3.2	Monotonic Counter (MC).....	3420
48.4	SNVS reset and system powerup.....	3421
48.4.1	PMIC interface.....	3421
48.5	SNVS interrupts and alarms.....	3422
48.6	Programming guidelines.....	3423
48.6.1	RTC control bits setting.....	3423
48.6.2	RTC value read.....	3424
48.6.3	General initialization guidelines.....	3424
48.7	SNVS memory map/register definition.....	3425
48.7.1	SNVS_HP Lock register (SNVS_HPLR).....	3427
48.7.2	SNVS_HP Command register (SNVS_HPCOMR).....	3429
48.7.3	SNVS_HP Control register (SNVS_HPCR).....	3431
48.7.4	SNVS_HP Status register (SNVS_HPSR).....	3434
48.7.5	SNVS_HP Real-Time Counter MSB Register (SNVS_HPRTCMBR).....	3436
48.7.6	SNVS_HP Real-Time Counter LSB Register (SNVS_HPRTCLR).....	3437
48.7.7	SNVS_HP Time Alarm MSB Register (SNVS_HPTAMR).....	3437
48.7.8	SNVS_HP Time Alarm LSB Register (SNVS_HPTALR).....	3438
48.7.9	SNVS_LP Lock Register (SNVS_LPLR).....	3439
48.7.10	SNVS_LP Control Register (SNVS_LPCR).....	3441
48.7.11	SNVS_LP Status Register (SNVS_LPSR).....	3444
48.7.12	SNVS_LP Secure Monotonic Counter MSB Register (SNVS_LPSMCMR).....	3446
48.7.13	SNVS_LP Secure Monotonic Counter LSB Register (SNVS_LPSMCLR).....	3447
48.7.14	SNVS_LP General-Purpose Register (SNVS_LPGPR).....	3447
48.7.15	SNVS_HP Version ID Register 1 (SNVS_HPVIDR1).....	3448
48.7.16	SNVS_HP Version ID Register 2 (SNVS_HPVIDR2).....	3448

Chapter 49

Shared Peripheral Bus Arbiter (SPBA)

49.1	Overview.....	3451
49.1.1	Features.....	3452

Section number	Title	Page
49.1.2	Modes of operation.....	3453
49.2	Clocks.....	3453
49.3	Functional description.....	3454
49.3.1	Masters arbitration.....	3454
49.4	Resource ownership control.....	3457
49.4.1	Access control	3457
49.4.1.1	Peripheral access.....	3457
49.4.1.2	Peripheral Right Register access.....	3458
49.4.2	Owner election.....	3459
49.4.3	Ending ownership.....	3459
49.4.3.1	Software Controlled Ownership Ending.....	3459
49.4.4	The Un-owned State.....	3460
49.5	SPBA Memory Map/Register Definition.....	3460
49.5.1	Peripheral Rights Register (SPBA_PRRn).....	3462

Chapter 50 Sony/Philips Digital Interface (SPDIF)

50.1	Overview	3465
50.2	External Signals.....	3467
50.3	Clocks.....	3467
50.4	Functional Description.....	3467
50.4.1	SPDIF Receiver.....	3469
50.4.1.1	Audio Data Reception.....	3469
50.4.1.1.1	Application Note.....	3471
50.4.1.2	Channel Status Reception.....	3472
50.4.1.2.1	Channel Status Interrupt.....	3472
50.4.1.3	User Bit Reception.....	3472
50.4.1.4	Validity Flag Reception.....	3474
50.4.1.5	SPDIF Receiver Interrupt Exception Definition.....	3475
50.4.1.6	Standards Compliance.....	3475

Section number	Title	Page
50.4.1.7	SPDIF PLOCK Detection and Rxclk Output.....	3476
50.4.1.8	Measuring Frequency of SPDIF_RxClk.....	3476
50.4.2	SPDIF Transmitter.....	3477
50.4.2.1	Audio Data Transmission.....	3477
50.4.2.2	Channel Status Transmission.....	3478
50.4.2.3	Validity Flag Transmission.....	3478
50.5	SPDIF Memory Map/Register Definition.....	3478
50.5.1	SPDIF Configuration Register (SPDIF_SCR).....	3480
50.5.2	CDText Control Register (SPDIF_SRC_D).....	3482
50.5.3	PhaseConfig Register (SPDIF_SRPC).....	3483
50.5.4	InterruptEn Register (SPDIF_SIE).....	3484
50.5.5	InterruptStat Register (SPDIF_SIS).....	3486
50.5.6	InterruptClear Register (SPDIF_SIC).....	3488
50.5.7	SPDIFRxLeft Register (SPDIF_SRL).....	3489
50.5.8	SPDIFRxRight Register (SPDIF_SRR).....	3490
50.5.9	SPDIFRxChannel_h Register (SPDIF_SRC_SH).....	3490
50.5.10	SPDIFRxChannel_l Register (SPDIF_SRC_SL).....	3491
50.5.11	UchannelRx Register (SPDIF_SRU).....	3491
50.5.12	QchannelRx Register (SPDIF_SRQ).....	3492
50.5.13	SPDIFTxLeft Register (SPDIF_STL).....	3492
50.5.14	SPDIFTxRight Register (SPDIF_STR).....	3493
50.5.15	SPDIFTxChannelCons_h Register (SPDIF_STCSCH).....	3493
50.5.16	SPDIFTxChannelCons_l Register (SPDIF_STCSCL).....	3494
50.5.17	FreqMeas Register (SPDIF_SRFM).....	3494
50.5.18	SPDIFTxCik Register (SPDIF_STC).....	3495

Chapter 51 System Reset Controller (SRC)

51.1	SRC Overview.....	3497
51.1.1	Features.....	3497

Section number	Title	Page
51.2	External Signals.....	3497
51.3	Clocks.....	3498
51.4	Top-level resets, power-up sequence and external supply integration.....	3499
51.4.1	Reset and Power-up Flow.....	3499
51.4.2	Finite-State Machine (FSM).....	3502
51.4.3	Power mode transitions.....	3503
51.5	Power-On Reset and power sequencing.....	3504
51.5.1	External POR using SRC_POR_B.....	3504
51.5.2	Internal POR.....	3505
51.6	Functional Description.....	3505
51.6.1	Reset Control.....	3505
51.6.1.1	Reset inputs and outputs.....	3505
51.6.1.2	Reset Handling.....	3507
51.6.1.2.1	Reset Qualification.....	3507
51.6.1.2.2	Reset Sequence and De-Assertion.....	3508
51.6.1.2.3	POR (SRC_POR_B).....	3508
51.6.1.2.4	COLD RESET.....	3509
51.6.1.2.5	WARM RESET.....	3510
51.6.2	Parallel Reset Requests.....	3511
51.6.3	Boot Mode Control.....	3512
51.6.3.1	BOOT_MODE Pin Latching.....	3512
51.7	SRC Memory Map/Register Definition.....	3513
51.7.1	SRC Control Register (SRC_SCR).....	3514
51.7.2	SRC Boot Mode Register 1 (SRC_SBMR1).....	3517
51.7.3	SRC Reset Status Register (SRC_SRSR).....	3517
51.7.4	SRC Interrupt Status Register (SRC_SISR).....	3520
51.7.5	SRC Boot Mode Register 2 (SRC_SBMR2).....	3522
51.7.6	SRC General Purpose Register 1 (SRC_GPR1).....	3523
51.7.7	SRC General Purpose Register 2 (SRC_GPR2).....	3524

Section number	Title	Page
51.7.8	SRC General Purpose Register 3 (SRC_GPR3).....	3524
51.7.9	SRC General Purpose Register 4 (SRC_GPR4).....	3525
51.7.10	SRC General Purpose Register 5 (SRC_GPR5).....	3525
51.7.11	SRC General Purpose Register 6 (SRC_GPR6).....	3526
51.7.12	SRC General Purpose Register 7 (SRC_GPR7).....	3526
51.7.13	SRC General Purpose Register 8 (SRC_GPR8).....	3527
51.7.14	SRC General Purpose Register 9 (SRC_GPR9).....	3527
51.7.15	SRC General Purpose Register 10 (SRC_GPR10).....	3528

Chapter 52 Temperature Monitor (TEMPMON)

52.1	Overview.....	3529
52.2	Software Usage Guidelines.....	3530
52.3	TEMPMON Memory Map/Register Definition.....	3532
52.3.1	Tempensor Control Register 0 (TEMPMON_TEMPSENSE0n).....	3533
52.3.2	Tempensor Control Register 1 (TEMPMON_TEMPSENSE1n).....	3535
52.3.3	Tempensor Control Register 2 (TEMPMON_TEMPSENSE2n).....	3536

Chapter 53 Touch Screen Controller (TSC)

53.1	Overview.....	3537
53.1.1	Features.....	3538
53.2	Functional Description.....	3539
53.2.1	Operating modes.....	3539
53.2.1.1	Idle.....	3539
53.2.1.2	Pre-charge.....	3539
53.2.1.3	Detection.....	3539
53.2.1.4	Measurement.....	3540
53.2.1.5	Data valid check.....	3540
53.2.1.6	Interrupt.....	3540
53.2.1.7	Reset.....	3540

Section number	Title	Page
53.2.1.8	Debug mode.....	3540
53.2.2	Configuration.....	3541
53.2.2.1	TSC configurations.....	3541
53.2.2.2	TSC-ADC-TSC analogue configuration.....	3541
53.2.2.3	TSC, TSC analogue and ADC connection.....	3542
53.2.2.4	TSC and GPIO.....	3542
53.2.2.5	ADC-TSC co-working.....	3543
53.3	TSC Memory Map/Register Definition.....	3544
53.3.1	PS Input Buffer Address (TSC_BASIC_SETTING).....	3545
53.3.2	PS Input Buffer Address (TSC_PS_INPUT_BUFFER_ADDR).....	3546
53.3.3	Flow Control (TSC_FLOW_CONTROL).....	3547
53.3.4	Measure Value (TSC_MEASURE_VALUE).....	3548
53.3.5	Interrupt Enable (TSC_INT_EN).....	3549
53.3.6	Interrupt Signal Enable (TSC_INT_SIG_EN).....	3550
53.3.7	Interrupt Status (TSC_INT_STATUS).....	3551
53.3.8	TSC_DEBUG_MODE.....	3553
53.3.9	TSC_DEBUG_MODE2.....	3555

Chapter 54 TrustZone Address Space Controller (TZASC)

54.1	Overview.....	3559
54.2	Clocks.....	3560
54.3	Address Mapping in various memory mapping modes.....	3560

Chapter 55 Universal Asynchronous Receiver/Transmitter (UART)

55.1	Overview.....	3561
55.1.1	Features.....	3562
55.1.2	Modes of operation.....	3563
55.2	External Signals.....	3563
55.2.1	Detailed Signal Descriptions.....	3568

Section number	Title	Page
55.2.1.1	Interrupt Signals.....	3568
55.2.1.1.1	interrupt_uart - UART Interrupt.....	3568
55.2.1.2	DMA Request Signals.....	3568
55.2.1.2.1	dma_req_rx - Receiver DMA Request.....	3568
55.2.1.2.2	dma_req_tx - Transmitter DMA Request.....	3568
55.2.1.3	Special Signals.....	3568
55.2.1.3.1	stop_req - Stop Mode.....	3568
55.2.1.3.2	doze_req - Doze Mode.....	3569
55.2.1.3.3	debug_req - Debug Mode.....	3569
55.3	Clocks.....	3569
55.4	Functional Description.....	3569
55.4.1	Interrupts and DMA Requests.....	3569
55.4.2	Clocks.....	3570
55.4.2.1	Clock requirements.....	3571
55.4.2.2	Maximum Baud Rate.....	3571
55.4.2.3	Clocking in Low-Power Modes.....	3571
55.4.3	General UART Definitions.....	3572
55.4.3.1	RTS_B - UART Request To Send.....	3573
55.4.3.2	RTS Edge Triggered Interrupt.....	3573
55.4.3.3	DTR_B - Data Terminal Ready	3574
55.4.3.4	DSR_B - Data Set Ready.....	3575
55.4.3.5	DTR_B/DSR_B Edge Triggered Interrupt.....	3575
55.4.3.6	DCD_B - Data Carrier Detect.....	3575
55.4.3.7	RI_B - Ring Indicator.....	3576
55.4.3.8	CTS_B - Clear To Send.....	3576
55.4.3.9	Programmable CTS_B Deassertion.....	3576
55.4.3.10	TX_DATA - UART Transmit.....	3576
55.4.3.11	RX_DATA - UART Receive.....	3577
55.4.4	Transmitter.....	3579

Section number	Title	Page
55.4.4.1	Transmitter FIFO Empty Interrupt Suppression.....	3579
55.4.4.2	Transmitting a Break Condition.....	3581
55.4.5	Receiver.....	3581
55.4.5.1	Idle Line Detect.....	3582
55.4.5.2	Aging Character Detect.....	3583
55.4.5.3	Receiver Wake.....	3584
55.4.5.4	Receiving a BREAK Condition.....	3585
55.4.5.5	Vote Logic.....	3585
55.4.5.6	Baud Rate Automatic Detection Logic.....	3587
55.4.5.6.1	Baud Rate Automatic Detection Protocol.....	3588
55.4.5.6.2	New Baud Rate Determination.....	3588
55.4.5.6.2.1	New Autobaud Counter Stopped bit and Interrupt.....	3589
55.4.6	Escape Sequence Detection.....	3589
55.5	Binary Rate Multiplier (BRM).....	3591
55.6	Infrared Interface.....	3593
55.6.1	Generalities-Infrared.....	3593
55.6.2	Inverted Transmission and Reception bits (INVT & INVR).....	3594
55.6.3	InfraRed Special Case (IRSC) Bit.....	3594
55.6.4	IrDA interrupt.....	3595
55.6.5	Conclusion about IrDA.....	3596
55.6.6	Programming IrDA Interface.....	3597
55.6.6.1	High Speed.....	3597
55.6.6.2	Low Speed.....	3597
55.7	9-bit RS-485 Mode.....	3598
55.7.1	Generalities.....	3598
55.7.2	Transmit 9-bit RS-485 frames.....	3599
55.7.3	Receive 9-bit RS-485 frames.....	3599
55.7.3.1	RS-485 Slave Address Normal Detect Mode.....	3599
55.7.3.2	RS-485 Slave Address Automatic Detect Mode.....	3600

Section number	Title	Page
55.8	Low Power Modes.....	3600
55.8.1	UART Operation in System Doze Mode.....	3601
55.8.2	UART Operation in System Stop Mode.....	3601
55.8.3	Power Saving Method in UART.....	3602
55.9	UART Operation in System Debug State.....	3602
55.10	Reset.....	3603
55.10.1	Hardware reset.....	3603
55.10.2	Software reset.....	3603
55.11	Transfer Error.....	3603
55.12	Functional Timing.....	3604
55.12.1	IrDA Mode.....	3604
55.13	Initialization.....	3604
55.13.1	Programming the UART in RS-232 mode.....	3604
55.13.2	Programming the UART in 9-bit RS-485 mode.....	3606
55.14	References.....	3607
55.15	UART Memory Map/Register Definition.....	3608
55.15.1	UART Receiver Register (UARTx_URXD).....	3615
55.15.2	UART Transmitter Register (UARTx_UTXD).....	3617
55.15.3	UART Control Register 1 (UARTx_UCR1).....	3618
55.15.4	UART Control Register 2 (UARTx_UCR2).....	3620
55.15.5	UART Control Register 3 (UARTx_UCR3).....	3623
55.15.6	UART Control Register 4 (UARTx_UCR4).....	3625
55.15.7	UART FIFO Control Register (UARTx_UFCR).....	3627
55.15.8	UART Status Register 1 (UARTx_USR1).....	3629
55.15.9	UART Status Register 2 (UARTx_USR2).....	3632
55.15.10	UART Escape Character Register (UARTx_UESC).....	3634
55.15.11	UART Escape Timer Register (UARTx_UTIM).....	3635
55.15.12	UART BRM Incremental Register (UARTx_UBIR).....	3635
55.15.13	UART BRM Modulator Register (UARTx_UBMR).....	3636

Section number	Title	Page
55.15.14	UART Baud Rate Count Register (UARTx_UBRC).....	3636
55.15.15	UART One Millisecond Register (UARTx_ONEMS).....	3637
55.15.16	UART Test Register (UARTx_UTS).....	3638
55.15.17	UART RS-485 Mode Control Register (UARTx_UMCR).....	3639

Chapter 56 Universal Serial Bus Controller (USB)

56.1	Overview.....	3641
56.1.1	Features.....	3641
56.1.2	Modes of Operation.....	3642
56.1.2.1	Normal Mode.....	3642
56.1.2.2	Low-Power Mode.....	3643
56.2	External Signals.....	3643
56.3	Functional Description.....	3644
56.3.1	USB 2.0 Controller Core 0.....	3644
56.3.1.1	Host Mode.....	3644
56.3.1.2	Peripheral (Device) Mode.....	3645
56.3.2	USB 2.0 Controller Core 1.....	3645
56.3.3	USB Power Control.....	3645
56.3.3.1	Entering Low Power Suspend Mode.....	3645
56.3.3.2	Wake-Up Events.....	3646
56.3.3.2.1	Host Mode Events.....	3646
56.3.4	Interrupts.....	3647
56.3.4.1	USB Core Interrupts.....	3647
56.3.4.2	USB Wake-Up Interrupts.....	3647
56.4	USB Operation Model.....	3647
56.4.1	Register Interface.....	3648
56.4.1.1	Configuration, Control and Status Register Set.....	3648
56.4.1.2	Identification Registers.....	3650
56.4.1.3	OTG Operations.....	3650

Section number	Title	Page
	56.4.1.3.1 Register Bits.....	3651
56.4.2	Host Data Structures.....	3652
56.4.2.1	Periodic Frame List.....	3652
56.4.2.2	Asynchronous List Queue Head Pointer.....	3654
56.4.2.3	Isochronous (High-Speed) Transfer Descriptor (iTd).....	3655
	56.4.2.3.1 Next Link Pointer.....	3656
	56.4.2.3.2 iTD Transaction Status and Control List.....	3657
	56.4.2.3.3 iTD Buffer Page Pointer List (Plus).....	3658
56.4.2.4	Split Transaction Isochronous Transfer Descriptor (siTD).....	3660
	56.4.2.4.1 Next Link Pointer.....	3660
	56.4.2.4.2 siTD Endpoint Capabilities/Characteristics.....	3661
	56.4.2.4.3 siTD Transfer State.....	3662
	56.4.2.4.4 siTD Buffer Pointer List (plus).....	3663
	56.4.2.4.5 siTD Back Link Pointer.....	3664
56.4.2.5	Queue element transfer descriptor (qTD).....	3664
	56.4.2.5.1 Next qTD Pointer.....	3665
	56.4.2.5.2 Alternate Next qTD Pointer.....	3666
	56.4.2.5.3 qTD Token.....	3666
	56.4.2.5.4 qTD Buffer Page Pointer List.....	3669
56.4.2.6	Queue Head.....	3670
	56.4.2.6.1 Queue Head Horizontal Link Pointer.....	3670
	56.4.2.6.2 Queue Head Endpoint Capabilities/Characteristics.....	3671
	56.4.2.6.3 Transfer Overlay-Queue Head.....	3673
56.4.2.7	Periodic Frame Span Traversal Node (FSTN).....	3674
	56.4.2.7.1 FSTN Normal Path Pointer	3675
	56.4.2.7.2 FSTN Back Path Link Pointer	3675
56.4.3	Host Operational Model	3676
56.4.3.1	Host Controller Initialization	3676
56.4.3.2	Port Routing and Control.....	3678

Section number	Title	Page
56.4.3.2.1	Port Routing Control through EHCI Configured (CF) Bit	3680
56.4.3.2.2	Port Routing Control through PortOwner and Disconnect Event	3681
56.4.3.2.3	Example Port Routing State Machine	3683
56.4.3.2.3.1	EHCI HC Owner	3683
56.4.3.2.3.2	Companion HC Owner	3684
56.4.3.2.4	Port Power	3684
56.4.3.2.5	Port Reporting Over-Current	3685
56.4.3.3	Suspend/Resume-Host Operational Model	3686
56.4.3.3.1	Port Suspend/Resume	3686
56.4.3.4	Schedule Traversal Rules.....	3689
56.4.3.4.1	Example - Preserving Micro-Frame Integrity	3691
56.4.3.4.1.1	Transaction Fit - A Best-Fit Approximation Algorithm	3691
56.4.3.5	Periodic Schedule Frame Boundaries vs Bus Frame Boundaries	3693
56.4.3.6	Periodic Schedule	3696
56.4.3.7	Managing Isochronous Transfers Using iTDs	3698
56.4.3.7.1	Host Controller Operational Model for iTDs	3698
56.4.3.7.2	Software Operational Model for iTDs	3700
56.4.3.7.2.1	Periodic scheduling threshold.....	3702
56.4.3.8	Asynchronous Schedule	3703
56.4.3.8.1	Adding Queue Heads to Asynchronous Schedule.....	3704
56.4.3.8.2	Removing Queue Heads from Asynchronous Schedule	3705
56.4.3.8.3	Empty Asynchronous Schedule Detection	3707
56.4.3.8.4	Restarting Asynchronous Schedule Before EOF	3708
56.4.3.8.4.1	Example Method for Restarting Asynchronous Schedule Traversal	3709
56.4.3.8.4.2	Async Sched Not Active	3710
56.4.3.8.4.3	Async Sched Active	3710
56.4.3.8.4.4	Async Sched Sleeping	3711
56.4.3.8.4.5	Example Derivation for AsyncSchedSleepTime.....	3711

Section number	Title	Page
56.4.3.8.5	Asynchronous schedule traversal: Start Event.....	3711
56.4.3.8.6	Reclamation Status Bit (USBSTS Register).....	3712
56.4.3.9	Operational Model for Nak Counter.....	3712
56.4.3.9.1	Nak Count Reload Control	3714
56.4.3.9.1.1	Wait for List Head	3715
56.4.3.9.1.2	Do Reload	3715
56.4.3.9.1.3	Wait for Start Event	3715
56.4.3.10	Managing Control/Bulk/Interrupt Transfers through Queue Heads.....	3716
56.4.3.10.1	Fetch Queue Head	3718
56.4.3.10.2	Advance Queue	3718
56.4.3.10.3	Execute Transaction	3719
56.4.3.10.3.1	Interrupt Transfer Pre-condition Criteria	3720
56.4.3.10.3.2	Asynchronous Transfer Pre-operations and Pre-condition Criteria	3720
56.4.3.10.3.3	Transfer Type Independent Pre-operations.....	3720
56.4.3.10.3.4	Halting a Queue Head	3723
56.4.3.10.3.5	Asynchronous Schedule Park Mode	3724
56.4.3.10.4	Write Back qTD	3726
56.4.3.10.5	Follow Queue Head Horizontal Pointer	3726
56.4.3.10.6	Buffer Pointer List Use for Data Streaming with qTDs	3727
56.4.3.10.7	Adding Interrupt Queue Heads to the Periodic Schedule	3729
56.4.3.10.8	Managing Transfer Complete Interrupts from Queue Heads	3729
56.4.3.11	Ping Control.....	3730
56.4.3.12	Split Transactions.....	3731
56.4.3.12.1	Split Transactions for Asynchronous Transfers	3732
56.4.3.12.1.1	Asynchronous - Do Start Split.....	3733
56.4.3.12.1.2	Asynchronous - Do Complete Split	3733
56.4.3.12.2	Split Transaction Interrupt	3734
56.4.3.12.2.1	Split Transaction Scheduling Mechanisms for Interrupt	3735

Section number	Title	Page
56.4.3.12.2.2	Host Controller Operational Model for FSTNs.....	3738
56.4.3.12.2.3	Software Operational Model for FSTNs.....	3741
56.4.3.12.2.4	Tracking Split Transaction Progress for Interrupt Transfers .	3742
56.4.3.12.2.5	Split Transaction Execution State Machine for Interrupt.....	3743
56.4.3.12.2.6	Rebalancing the periodic schedule	3749
56.4.3.12.3	Split Transaction Isochronous	3750
56.4.3.12.3.1	Split Transaction Scheduling Mechanisms for Isochronous .	3750
56.4.3.12.3.2	Tracking Split Transaction Progress for Isochronous Transfers.....	3755
56.4.3.12.3.3	Split Transaction Execution State Machine for Isochronous	3757
56.4.3.12.3.4	Periodic Isochronous - Do Start Split	3758
56.4.3.12.3.5	Periodic Isochronous - Do Complete Split	3760
56.4.3.12.3.6	Complete-Split for Scheduling Boundary Cases 2a, 2b	3763
56.4.3.12.3.7	Split Transaction for Isochronous - Processing Examples.....	3765
56.4.3.13	Host Controller Pause.....	3767
56.4.3.14	Port Test Modes -Host Operational Model.....	3768
56.4.3.15	Interrupts-Host Operational Model.....	3768
56.4.3.15.1	Transfer/Transaction Based Interrupts	3770
56.4.3.15.1.1	Transaction Error	3770
56.4.3.15.1.2	Serial Bus Babble.....	3770
56.4.3.15.1.3	Data Buffer Error	3771
56.4.3.15.1.4	USB Interrupt (Interrupt on Completion (IOC))	3772
56.4.3.15.1.5	Short Packet.....	3772
56.4.3.15.2	Host Controller Event Interrupts	3772
56.4.3.15.2.1	Port Change Events	3773
56.4.3.15.2.2	Frame List Rollover	3773
56.4.3.15.2.3	Interrupt on Async Advance	3773
56.4.3.15.2.4	Host System Error	3773
56.4.4	EHCI Deviation.....	3774

Section number	Title	Page
56.4.4.1	Embedded Transaction Translator Function.....	3775
56.4.4.1.1	Capability Registers.....	3775
56.4.4.1.2	Operational Registers.....	3776
56.4.4.1.3	Discovery-EHCI Deviation.....	3776
56.4.4.1.4	Data Structures.....	3776
56.4.4.1.5	Operational Model.....	3777
56.4.4.1.5.1	Micro- frame Pipeline.....	3777
56.4.4.1.5.2	Split State Machines.....	3778
56.4.4.1.5.3	Asynchronous Transaction Scheduling and Buffer Management.....	3779
56.4.4.1.5.4	Periodic Transaction Scheduling and Buffer Management....	3779
56.4.4.1.5.5	Multiple Transaction Translators.....	3780
56.4.4.2	Device Operation.....	3780
56.4.4.2.1	USB_USBMODE Register.....	3780
56.4.4.2.2	Non-Zero Fields the Register File.....	3780
56.4.4.2.3	SOF Interrupt.....	3781
56.4.4.3	Embedded Design Interface.....	3781
56.4.4.3.1	Frame Adjust Register.....	3781
56.4.4.4	Miscellaneous variations from EHCI.....	3781
56.4.4.4.1	Programmable Physical Interface Behaviour.....	3781
56.4.4.4.2	Discovery.....	3781
56.4.4.4.2.1	Port Reset.....	3781
56.4.4.4.2.2	Port Speed Detection.....	3782
56.4.4.4.3	Port Test Mode.....	3782
56.4.5	Device Data Structures.....	3782
56.4.5.1	Endpoint Queue Head (dQH).....	3784
56.4.5.1.1	Endpoint Capabilities/Characteristics.....	3785
56.4.5.1.2	Transfer Overlay-Endpoint Queue Head.....	3785
56.4.5.1.3	Current dTD Pointer.....	3786

Section number	Title	Page
	56.4.5.1.4 Set-up Buffer.....	3786
56.4.5.2	Endpoint Transfer Descriptor (dTD).....	3786
56.4.6	Device Operational Model.....	3788
56.4.6.1	Device Controller Initialization.....	3789
56.4.6.2	Port State and Control.....	3790
	56.4.6.2.1 Bus Reset.....	3792
	56.4.6.2.2 Suspend/Resume.....	3793
	56.4.6.2.2.1 Suspend.....	3793
	56.4.6.2.2.2 Resume.....	3794
56.4.6.3	Managing Endpoints.....	3794
	56.4.6.3.1 Endpoint Initialization.....	3795
	56.4.6.3.2 Stalling.....	3796
	56.4.6.3.3 Data Toggle	3797
	56.4.6.3.3.1 Data Toggle Reset.....	3797
	56.4.6.3.3.2 Data Toggle Inhibit.....	3797
	56.4.6.3.3.3 Priming Transmit Endpoints.....	3797
	56.4.6.3.3.4 Priming Receive Endpoints.....	3798
56.4.6.4	Operational Model For Packet Transfers.....	3798
	56.4.6.4.1 Interrupt/Bulk Endpoint Operational Model.....	3799
	56.4.6.4.1.1 Interrupt/Bulk Endpoint Bus Response Matrix.....	3801
	56.4.6.4.2 Control Endpoint Operation Model.....	3801
	56.4.6.4.2.1 Setup Phase.....	3801
	56.4.6.4.2.2 Data Phase.....	3802
	56.4.6.4.2.3 Status Phase.....	3803
	56.4.6.4.2.4 Control Endpoint Bus Response Matrix.....	3803
	56.4.6.4.3 Isochronous Endpoint Operational Model.....	3804
	56.4.6.4.3.1 Isochronous Pipe Synchronization.....	3806
	56.4.6.4.3.2 Isochronous Endpoint Bus Response Matrix.....	3806
56.4.6.5	Managing Queue Heads.....	3806

Section number	Title	Page
56.4.6.5.1	Queue Head Initialization.....	3807
56.4.6.5.2	Operational Model For Setup Transfers.....	3808
56.4.6.6	Managing Transfers with Transfer Descriptors.....	3809
56.4.6.6.1	Software Link Pointers.....	3809
56.4.6.6.2	Building a Transfer Descriptor.....	3809
56.4.6.6.3	Executing A Transfer Descriptor.....	3810
56.4.6.6.4	Transfer Completion.....	3811
56.4.6.6.5	Flushing/De-priming an Endpoint.....	3811
56.4.6.6.6	Device Error Matrix.....	3812
56.4.6.7	Servicing Interrupts.....	3813
56.4.6.7.1	High-Frequency Interrupts.....	3813
56.4.6.7.2	Low-Frequency Interrupts.....	3813
56.4.6.7.3	Error Interrupts.....	3813
56.5	USB Non-Core Memory Map/Register Definition.....	3814
56.5.1	USB OTG1 Control Register (USBNC_USB_OTG1_CTRL).....	3816
56.5.2	USB OTG2 Control Register (USBNC_USB_OTG2_CTRL).....	3819
56.5.3	OTG1 UTMI PHY Control 0 Register (USBNC_USB_OTG1_PHY_CTRL_0).....	3822
56.5.4	OTG2 UTMI PHY Control 0 Register (USBNC_USB_OTG2_PHY_CTRL_0).....	3823
56.6	USB Core Memory Map/Register Definition.....	3823
56.6.1	Identification register (USB_nID).....	3828
56.6.2	Hardware General (USB_nHWGENERAL).....	3828
56.6.3	Host Hardware Parameters (USB_nHWHOST).....	3830
56.6.4	Device Hardware Parameters (USB_nHWDEVICE).....	3831
56.6.5	TX Buffer Hardware Parameters (USB_nHWTXBUF).....	3831
56.6.6	RX Buffer Hardware Parameters (USB_nHWRXBUF).....	3832
56.6.7	General Purpose Timer #0 Load (USB_nGPTIMER0LD).....	3833
56.6.8	General Purpose Timer #0 Controller (USB_nGPTIMER0CTRL).....	3833
56.6.9	General Purpose Timer #1 Load (USB_nGPTIMER1LD).....	3835
56.6.10	General Purpose Timer #1 Controller (USB_nGPTIMER1CTRL).....	3835

Section number	Title	Page
56.6.11	System Bus Config (USB_nSBUSCFG).....	3836
56.6.12	Capability Registers Length (USB_nCAPLENGTH).....	3837
56.6.13	Host Controller Interface Version (USB_nHCIVERSION).....	3838
56.6.14	Host Controller Structural Parameters (USB_nHCSPARAMS).....	3838
56.6.15	Host Controller Capability Parameters (USB_nHCCPARAMS).....	3840
56.6.16	Device Controller Interface Version (USB_nDCIVERSION).....	3842
56.6.17	Device Controller Capability Parameters (USB_nDCCPARAMS).....	3843
56.6.18	USB Command Register (USB_nUSBCMD).....	3844
56.6.19	USB Status Register (USB_nUSBSTS).....	3848
56.6.20	Interrupt Enable Register (USB_nUSBINTR).....	3852
56.6.21	USB Frame Index (USB_nFRINDEX).....	3854
56.6.22	Frame List Base Address (USB_nPERIODICLISTBASE).....	3855
56.6.23	Device Address (USB_nDEVICEADDR).....	3855
56.6.24	Next Asynch. Address (USB_nASYNCLISTADDR).....	3856
56.6.25	Endpoint List Address (USB_nENDPTLISTADDR).....	3857
56.6.26	Programmable Burst Size (USB_nBURSTSIZE).....	3857
56.6.27	TX FIFO Fill Tuning (USB_nTXFILLTUNING).....	3858
56.6.28	Endpoint NAK (USB_nENDPTNAK).....	3860
56.6.29	Endpoint NAK Enable (USB_nENDPTNAKEN).....	3860
56.6.30	Configure Flag Register (USB_nCONFIGFLAG).....	3861
56.6.31	Port Status & Control (USB_nPORTSC1).....	3861
56.6.32	On-The-Go Status & control (USB_nOTGSC).....	3868
56.6.33	USB Device Mode (USB_nUSBMODE).....	3872
56.6.34	Endpoint Setup Status (USB_nENDPTSETUPSTAT).....	3873
56.6.35	Endpoint Prime (USB_nENDPTPRIME).....	3874
56.6.36	Endpoint Flush (USB_nENDPTFLUSH).....	3875
56.6.37	Endpoint Status (USB_nENDPTSTAT).....	3875
56.6.38	Endpoint Complete (USB_nENDPTCOMPLETE).....	3876
56.6.39	Endpoint Control0 (USB_nENDPTCTRL0).....	3877

Section number	Title	Page
56.6.40	Endpoint Control 1 (USB_nENDPTCTRL1).....	3879
56.6.41	Endpoint Control 2 (USB_nENDPTCTRL2).....	3882
56.6.42	Endpoint Control 3 (USB_nENDPTCTRL3).....	3884
56.6.43	Endpoint Control 4 (USB_nENDPTCTRL4).....	3887
56.6.44	Endpoint Control 5 (USB_nENDPTCTRL5).....	3890
56.6.45	Endpoint Control 6 (USB_nENDPTCTRL6).....	3893
56.6.46	Endpoint Control 7 (USB_nENDPTCTRL7).....	3896

Chapter 57

Universal Serial Bus 2.0 Integrated PHY (USB-PHY)

57.1	USB PHY Overview.....	3901
57.2	Operation.....	3901
57.2.1	UTMI.....	3901
57.2.2	Digital Transmitter.....	3902
57.2.3	Digital Receiver.....	3902
57.2.4	Analog Receiver.....	3902
57.2.4.1	HS Differential Receiver.....	3903
57.2.4.2	Squelch Detector.....	3904
57.2.4.3	LS/FS Differential Receiver.....	3904
57.2.4.4	HS Disconnect Detector.....	3904
57.2.4.5	USB Plugged-In Detector.....	3904
57.2.4.6	Single-Ended USB_DP Receiver.....	3905
57.2.4.7	Single-Ended USB_DN Receiver.....	3905
57.2.4.8	9X Oversample Module.....	3905
57.2.5	Analog Transmitter.....	3905
57.2.5.1	Switchable High-Speed 45Ω Termination Resistors.....	3905
57.2.5.2	Low-Speed/Full-Speed Differential Driver.....	3906
57.2.5.3	High-Speed Differential Driver.....	3906
57.2.5.4	Switchable 1.5KΩ USB_DP Pullup Resistor.....	3906
57.2.5.5	Switchable 15KΩ USB_DP Pulldown Resistor.....	3906

Section number	Title	Page
57.2.6	Recommended Register Configuration for USB Certification.....	3908
57.2.7	Charger detection.....	3908
57.2.7.1	Charger detect control table.....	3908
57.2.7.2	Data pin contact detector.....	3908
57.2.7.3	Charger detector.....	3909
57.2.7.4	Charger detection software flow.....	3909
57.2.7.5	Dead Battery Protect.....	3911
57.3	USB PHY Memory Map/Register Definition.....	3911
57.3.1	USB PHY Power-Down Register (USBPHY _x _PWD _n).....	3914
57.3.2	USB PHY Transmitter Control Register (USBPHY _x _TX _n).....	3916
57.3.3	USB PHY Receiver Control Register (USBPHY _x _RX _n).....	3917
57.3.4	USB PHY General Control Register (USBPHY _x _CTRL _n).....	3919
57.3.5	USB PHY Status Register (USBPHY _x _STATUS).....	3922
57.3.6	USB PHY Debug Register (USBPHY _x _DEBUG _n).....	3924
57.3.7	UTMI Debug Status Register 0 (USBPHY _x _DEBUG0_STATUS).....	3926
57.3.8	UTMI Debug Status Register 1 (USBPHY _x _DEBUG1 _n).....	3927
57.3.9	UTMI RTL Version (USBPHY _x _VERSION).....	3928
57.4	USB Analog Memory Map/Register Definition.....	3928
57.4.1	USB VBUS Detect Register (USB_ANALOG_USB1_VBUS_DETECT _n).....	3930
57.4.2	USB Charger Detect Register (USB_ANALOG_USB1_CHRG_DETECT _n).....	3931
57.4.3	USB VBUS Detect Status Register (USB_ANALOG_USB1_VBUS_DETECT_STAT).....	3933
57.4.4	USB Charger Detect Status Register (USB_ANALOG_USB1_CHRG_DETECT_STAT).....	3935
57.4.5	USB Misc Register (USB_ANALOG_USB1_MISC _n).....	3936
57.4.6	USB VBUS Detect Register (USB_ANALOG_USB2_VBUS_DETECT _n).....	3937
57.4.7	USB Charger Detect Register (USB_ANALOG_USB2_CHRG_DETECT _n).....	3939
57.4.8	USB VBUS Detect Status Register (USB_ANALOG_USB2_VBUS_DETECT_STAT).....	3941
57.4.9	USB Charger Detect Status Register (USB_ANALOG_USB2_CHRG_DETECT_STAT).....	3943
57.4.10	USB Misc Register (USB_ANALOG_USB2_MISC _n).....	3944
57.4.11	Chip Silicon Version (USB_ANALOG_DIGPROG).....	3945

Chapter 58

Ultra Secured Digital Host Controller (uSDHC)

58.1	Overview.....	3947
58.1.1	Features.....	3950
58.1.2	Modes and Operations.....	3951
58.1.2.1	Data Transfer Modes.....	3951
58.2	External Signals.....	3951
58.2.1	Signals Overview.....	3953
58.3	Clocks.....	3954
58.4	Functional Description.....	3954
58.4.1	Data Buffer.....	3954
58.4.1.1	Write Operation Sequence.....	3957
58.4.1.2	Read Operation Sequence.....	3957
58.4.1.3	Data Buffer and Block Size.....	3958
58.4.1.4	Dividing Large Data Transfer.....	3959
58.4.1.5	External DMA Request.....	3960
58.4.2	DMA AHB Interface.....	3961
58.4.2.1	Internal DMA Request.....	3962
58.4.2.2	DMA Burst Length.....	3963
58.4.2.3	AHB Master Interface.....	3963
58.4.2.4	ADMA Engine.....	3963
58.4.2.4.1	ADMA Concept and Descriptor Format.....	3964
58.4.2.4.2	ADMA Interrupt.....	3968
58.4.2.4.3	ADMA Error.....	3969
58.4.3	Register Bank with IP Bus Interface.....	3969
58.4.3.1	SD Protocol Unit.....	3970
58.4.3.2	SD control misc.....	3971
58.4.3.3	SD Clock control.....	3971
58.4.3.4	Command control.....	3971

Section number	Title	Page
58.4.3.5	Data control.....	3972
58.4.4	Clock & Reset Manager.....	3972
58.4.5	Clock Generator.....	3973
58.4.6	SDIO Card Interrupt.....	3973
58.4.6.1	Interrupts in 1-bit Mode.....	3973
58.4.6.2	Interrupt in 4-bit Mode.....	3973
58.4.6.3	Card Interrupt Handling.....	3974
58.4.7	Card Insertion and Removal Detection.....	3975
58.4.8	Power Management and Wake Up Events.....	3976
58.4.8.1	Setting Wake Up Events.....	3977
58.4.9	MMC fast boot.....	3977
58.4.9.1	Boot operation.....	3977
58.4.9.2	Alternative boot operation.....	3978
58.5	Initialization/Application of uSDHC.....	3979
58.5.1	Command Send & Response Receive Basic Operation.....	3979
58.5.2	Card Identification Mode.....	3980
58.5.2.1	Card Detect.....	3980
58.5.2.2	Reset.....	3981
58.5.2.3	Voltage Validation.....	3982
58.5.2.4	Card Registry.....	3984
58.5.3	Card Access.....	3985
58.5.3.1	Block Write.....	3985
58.5.3.1.1	Normal Write.....	3985
58.5.3.1.2	DDR Write.....	3987
58.5.3.1.3	Write with Pause.....	3987
58.5.3.2	Block Read.....	3989
58.5.3.2.1	Normal Read.....	3989
58.5.3.2.2	DDR Read.....	3990
58.5.3.2.3	Read with Pause.....	3990

Section number	Title	Page
	58.5.3.2.4 DLL (Delay Line) in Read Path.....	3991
58.5.3.3	Suspend Resume.....	3993
	58.5.3.3.1 Suspend.....	3993
	58.5.3.3.2 Resume.....	3994
58.5.3.4	ADMA Usage.....	3994
58.5.3.5	Transfer Error.....	3995
	58.5.3.5.1 CRC Error.....	3995
	58.5.3.5.2 Internal DMA Error.....	3995
	58.5.3.5.3 Transfer ADMA Error.....	3996
	58.5.3.5.4 Auto CMD12 Error.....	3996
58.5.3.6	Card Interrupt.....	3997
58.5.4	Switch Function.....	3997
	58.5.4.1 Query, Enable and Disable SDIO High Speed Mode.....	3998
	58.5.4.2 Query, Enable and Disable SD High Speed Mode/SDR50/SDR104/DDR50.....	3998
	58.5.4.3 Query, Enable and Disable MMC High Speed Mode.....	3999
	58.5.4.4 Set MMC Bus Width.....	3999
58.5.5	ADMA Operation.....	3999
	58.5.5.1 ADMA1 Operation.....	4000
	58.5.5.2 ADMA2 Operation.....	4000
58.5.6	Fast Boot Operation.....	4001
	58.5.6.1 Normal fast boot flow	4001
	58.5.6.2 Alternative fast boot flow.....	4002
	58.5.6.3 Fast boot application case (in DMA mode).....	4002
58.6	Commands for MMC/SD/SDIO.....	4004
58.7	Software Restrictions.....	4009
	58.7.1 Initialization Active.....	4009
	58.7.2 Software Polling Procedure.....	4010
	58.7.3 Suspend Operation.....	4010
	58.7.4 Data Length Setting.....	4010

Section number	Title	Page
58.7.5	(A)DMA Address Setting.....	4010
58.7.6	Data Port Access.....	4011
58.7.7	Change Clock Frequency.....	4011
58.7.8	Multi-block Read.....	4011
58.8	uSDHC Memory Map/Register Definition.....	4011
58.8.1	DMA System Address (uSDHCx_DS_ADDR).....	4014
58.8.2	Block Attributes (uSDHCx_BLK_ATT).....	4015
58.8.3	Command Argument (uSDHCx_CMD_ARG).....	4017
58.8.4	Command Transfer Type (uSDHCx_CMD_XFR_TYP).....	4017
58.8.5	Command Response0 (uSDHCx_CMD_RSP0).....	4021
58.8.6	Command Response1 (uSDHCx_CMD_RSP1).....	4021
58.8.7	Command Response2 (uSDHCx_CMD_RSP2).....	4022
58.8.8	Command Response3 (uSDHCx_CMD_RSP3).....	4022
58.8.9	Data Buffer Access Port (uSDHCx_DATA_BUFF_ACC_PORT).....	4024
58.8.10	Present State (uSDHCx_PRES_STATE).....	4024
58.8.11	Protocol Control (uSDHCx_PROT_CTRL).....	4030
58.8.12	System Control (uSDHCx_SYS_CTRL).....	4035
58.8.13	Interrupt Status (uSDHCx_INT_STATUS).....	4038
58.8.14	Interrupt Status Enable (uSDHCx_INT_STATUS_EN).....	4044
58.8.15	Interrupt Signal Enable (uSDHCx_INT_SIGNAL_EN).....	4047
58.8.16	Auto CMD12 Error Status (uSDHCx_AUTOCMD12_ERR_STATUS).....	4050
58.8.17	Host Controller Capabilities (uSDHCx_HOST_CTRL_CAP).....	4053
58.8.18	Watermark Level (uSDHCx_WTMK_LVL).....	4056
58.8.19	Mixer Control (uSDHCx_MIX_CTRL).....	4057
58.8.20	Force Event (uSDHCx_FORCE_EVENT).....	4059
58.8.21	ADMA Error Status Register (uSDHCx_ADMA_ERR_STATUS).....	4062
58.8.22	ADMA System Address (uSDHCx_ADMA_SYS_ADDR).....	4064
58.8.23	DLL (Delay Line) Control (uSDHCx_DLL_CTRL).....	4065
58.8.24	DLL Status (uSDHCx_DLL_STATUS).....	4067

Section number	Title	Page
58.8.25	CLK Tuning Control and Status (uSDHCx_CLK_TUNE_CTRL_STATUS).....	4068
58.8.26	Vendor Specific Register (uSDHCx_VEND_SPEC).....	4070
58.8.27	MMC Boot Register (uSDHCx_MMC_BOOT).....	4073
58.8.28	Vendor Specific 2 Register (uSDHCx_VEND_SPEC2).....	4074
58.8.29	Tuning Control Register (uSDHCx_TUNING_CTRL).....	4076

Chapter 59 Watchdog Timer (WDOG)

59.1	Overview.....	4079
59.1.1	Features.....	4080
59.2	External signals.....	4081
59.3	Clocks.....	4081
59.4	Watchdog mechanism and system integration.....	4082
59.5	Functional description.....	4083
59.5.1	Timeout event.....	4083
59.5.1.1	Servicing WDOG to reload the counter.....	4084
59.5.2	Interrupt event	4084
59.5.3	Power-down counter event.....	4084
59.5.4	Low power modes.....	4085
59.5.4.1	STOP and DOZE mode.....	4085
59.5.4.2	WAIT mode.....	4085
59.5.5	Debug mode.....	4086
59.5.6	Operations.....	4086
59.5.6.1	Watchdog reset generation.....	4086
59.5.6.2	WDOG_B generation.....	4086
59.5.7	Reset.....	4088
59.5.8	Interrupt.....	4089
59.5.9	Flow Diagrams.....	4089
59.6	Initialization.....	4091
59.7	WDOG Memory Map/Register Definition.....	4092

Section number	Title	Page
59.7.1	Watchdog Control Register (WDOG _x _WCR).....	4093
59.7.2	Watchdog Service Register (WDOG _x _WSR).....	4094
59.7.3	Watchdog Reset Status Register (WDOG _x _WRSR).....	4095
59.7.4	Watchdog Interrupt Control Register (WDOG _x _WICR).....	4096
59.7.5	Watchdog Miscellaneous Control Register (WDOG _x _WMCR).....	4097

Chapter 60 Crystal Oscillator (XTALOSC)

60.1	Overview.....	4099
60.2	External Signals.....	4099
60.3	Crystal Oscillator 24 MHz.....	4100
60.3.1	Oscillator Configuration (24 MHz).....	4100
60.3.2	RC Oscillator (24 MHz).....	4101
60.3.3	Crystal Frequency Detection(24 MHz).....	4102
60.4	Crystal Oscillator 32 kHz.....	4102
60.4.1	Oscillator Configuration (32 kHz).....	4102
60.4.2	Bypass Configuration (32 kHz).....	4103
60.5	XTALOSC 24MHz Memory Map/Register Definition.....	4104
60.5.1	Miscellaneous Register 0 (XTALOSC24M_MISC0 _n).....	4106
60.5.2	XTAL OSC (LP) Control Register (XTALOSC24M_LOWPOWER_CTRL _n).....	4110
60.5.3	XTAL OSC Configuration 0 Register (XTALOSC24M_OSC_CONFIG0 _n).....	4113
60.5.4	XTAL OSC Configuration 1 Register (XTALOSC24M_OSC_CONFIG1 _n).....	4114
60.5.5	XTAL OSC Configuration 2 Register (XTALOSC24M_OSC_CONFIG2 _n).....	4115



Chapter 1

Introduction

1.1 About This Document

The i.MX 6ULL application processors are NXP's latest additions to a growing family of real-time processing products offering high-performance processing optimized for lowest power consumption.

The i.MX 6ULL processors feature NXP's advanced implementation of the ARM[®]Cortex[®]-A7 core.

The processors can be interfaced with DDR3, DDR3L LPDDR2 (single channel) DRAM memory devices.

These products are suitable for applications such as:

- eReaders
- General embedded devices
- Industrial devices

1.1.1 Audience

This manual is intended for the board-level product designers and product software developers. This manual assumes that the reader has a background in computer engineering and/or software engineering and understands the concepts of the digital system design, microprocessor architecture, Input/Output (I/O) devices, industry standard communication, and device interface protocols.

1.1.2 Organization

This document covers the chip at a system level and provides an architectural overview. It also covers the system memory map, system-level interrupt events, external pins and pin multiplexing, external memory, system debug, system boot, multimedia subsystem, power management, and system security.

1.1.3 Suggested Reading

This section lists the additional resources that provide background for the information in this manual, as well as general information about the architecture.

1.1.3.1 General Information

The following documentation provides useful background information about the ARM Cortex processor.

For information about the ARM Cortex processor see:

- <http://infocenter.arm.com>

1.1.3.2 Related Documentation

NXP documentation is available from the sources listed on the back cover of this manual; the document order numbers are included in parentheses for ease in ordering.

For a current list of documentation, refer to <http://www.nxp.com>.

1.1.4 Conventions

This document uses the following notational conventions:

cleared / set

When a bit has a value of zero, it is said to be cleared; when it has a value of one, it is said to be set.

mnemonics

Instruction mnemonics are shown in lowercase bold.

italics

Italics indicate variable command parameters, for example, **bcctrx**.

The book titles in the text are set in italics.

15

An integer in decimal.

0x

the prefix to denote a hexadecimal number.

0b

The prefix to denote a binary number. Binary values of 0 and 1 are written without a prefix.

n'H4000CA00

The n-bit hexadecimal number.

BLK_REG_NAME

The register names are all uppercase. The block mnemonic is prepended with an underscore delimiter (_).

BLK_REG[FIELD]

The fields within registers appear in brackets. For example, ESR[RLS] refers to the Receive Last Slot field of the ESAI Status Register.

BLK_REG[*n*]

The bit number *n* within the BLK.REG register.

BLK_REG[*l:r*]

The register bit ranges. The ranges are indicated by the left-most bit number *l* and the right-most bit number *r*, separated by a colon (:). For example, ESR[15:0] refers to the lower half word in the ESAI Status Register.

x, U

In some contexts, such as signal encodings, an unitalicized x indicates a "don't care" or "uninitialized". The binary value can be 1 or 0.

x

An italicized *x* indicates an alphanumeric variable.

n, m

Italicized *n* or *m* represent integer variables.

!

Binary logic operator NOT.

&&

Binary logic operator AND.

||

Binary logic operator OR.

^ or <O+>

Binary logic operator XOR. For example, A <O+> B.

|

Bit-wise OR. For example, 0b0001 | 0b1000 yields the value of 0b1001.

&

Bit-wise AND. For example, 0b0001 and 0b1000 yields the value of 0b0000.

{A,B}

Concatenation, where the n -bit value A is prepended to the m -bit value B to form an $(n+m)$ -bit value. For example, {0, REG m [14:0]} yeilds a 16-bit value with 0 in the most significant bit.

- or grey fill

Indicates a reserved bit field in a register. Although these bits can be written to with ones or zeros, they always read zeros.

>>

Shift right logical one position.

<<

Shift left logical one position.

<=

Assignment.

=

Compare equal.

!=

Compare not equal.

>

Greater than.

<

Less than.

1.1.5 Register Access

1.1.5.1 Register Diagram Field Access Type Legend

This figure provides the interpretation of the notation used in the register diagrams for a number of common field access types:

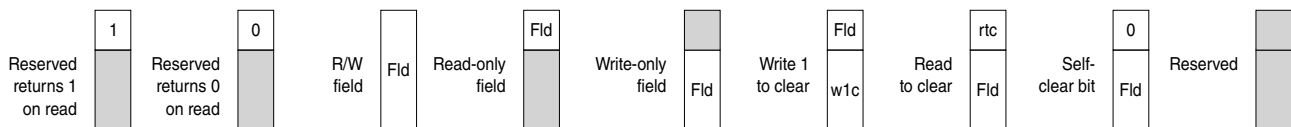

Figure 1-1. Register Field Conventions

NOTE

For reserved register fields, the software should mask off the data in the field after a read (the software can't rely on the contents of data read from a reserved field) and always write all zeros.

1.1.5.2 Register Macro Usage

A common operation is to update one field without disturbing the contents of the remaining fields in the register. Normally, this requires a read-modify-write (RMW) operation, where the CPU reads the register, modifies the target field, then writes the results back to the register. This is an expensive operation in terms of CPU cycles, because of the initial register read.

To address this issue, some hardware registers are implemented as a group, including registers that can be used to either set, clear, or toggle (SCT) individual bits of the primary register. When writing to an SCT register, all the bits set to 1 perform the associated operation on the primary register, while the bits set to 0 are not affected. The SCT registers always read back 0, and should be considered write-only. The SCT registers are not implemented if the primary register is read-only.

With this architecture, it is possible to update one or more fields using only register writes. First, all bits of the target fields are cleared by a write to the associated clear register, then the desired value of the target fields is written to the set register. This sequence of two writes is referred to as a clear-set (CS) operation.

A CS operation does have one potential drawback. Whenever a field is modified, the hardware sees a value of 0 before the final value is written. For most fields, passing through the 0 state is not a problem. Nonetheless, this behavior is something to consider when using a CS operation.

Also, a CS operation is not required for fields that are one-bit wide. While the CS operation works in this case, it is more efficient to simply set or clear the target bit (that is, one write instead of two). A simple set or clear operation is also atomic, while a CS operation is not.

Note that not all macros for set, clear, or toggle (SCT) are atomic. For registers that do not provide hardware support for this functionality, these macros are implemented as a sequence of read-modify-write operations. When an atomic operation is required, the developer should pay attention to this detail, because unexpected behavior might result if an interrupt occurs in the middle of the critical section comprising the update sequence.

A set of SCT registers is offered for registers in many modules on this device, as described in this manual. In a module memory map table, the suffix `_SET`, `_CLR`, or `_TOG` is added to the base name of the register. For example, the `CCM_ANALOG_PLL_ARM` register has three other registers called `CCM_ANALOG_PLL_ARM_SET`, `CCM_ANALOG_PLL_ARM_CLR`, and `CCM_ANALOG_PLL_ARM_TOG`.

In the sub-section that describes one of these sets of registers, a short-hand convention is used to denote that a register has the SCT register set. There is an italicized *n* appended to the end of the short register name. Using the above example, the name used for this register is CCM_ANALOG_PLL_ARM*n*. When you see this designation, there is a SCT register set associated with the register, and you can verify this by checking it in the memory map table. The address offset for each of these registers is given in the form of the following example:

Address: 20C_8000h base + 0h offset + (4d × i), where i=0d to 3d

In this example, the address for each of the base registers and their three SCT registers can be calculated as:

Register	Address
CCM_ANALOG_PLL_ARM	20C_8000h
CCM_ANALOG_PLL_ARM_SET	20C_8004h
CCM_ANALOG_PLL_ARM_CLR	20c_8008h
CCM_ANALOG_PLL_ARM_TOG	20C_800Ch

1.1.6 Signal Conventions

_b, _B

When appended to a signal name, this indicates that a signal is active-low.

NEG_ACTIVE

Overbar also denotes a negative active signal.

UPPERCASE

Package pin names, Block I/O signals.

lowercase

Lowercase is used to indicate internal signals.

1.1.7 Acronyms and Abbreviations

The table below contains acronyms and abbreviations used in this document.

Acronyms and Abbreviated Terms

Term	Meaning
ADC	Analog-to-Digital Converter
AHB	Advanced High-performance Bus
AIPS	Arm IP Bus
ALU	Arithmetic Logic Unit

Table continues on the next page...

Term	Meaning
AMBA	Advanced Microcontroller Bus Architecture
APB	Advanced Peripheral Bus
ASRC	Asynchronous Sample Rate Converter
AXI	Advanced eXtensible Interface
BEE	Bus Encrypt Engine
BIST	Built-In Self Test
CA/CM	Arm Cortex-A/Cortex-M
CAAM	Cryptographic Acceleration and Assurance Module
CAN	Controller Area Network
CCM	Clock Controller Module
CPU	Central Processing Unit
CSI	CMOS Sensor Interface
CSU	Central Security Unit
CTI	Cross Trigger Interface
DAP	Debug Access Port
DDR	Double data rate
DMA	Direct memory access
DPLL	Digital phase-locked loop
DRAM	Dynamic random access memory
ECC	Error correcting codes
ECSPi	Enhanced Configurable SPI
EIM	External Interface Module
ENET	Ethernet
EPIT	Enhanced Periodic Interrupt Timer
EPROM	Erasable Programmable Read-Only Memory
ETF	Embedded Trace FIFO
ETM	Embedded Trace Macrocell
FIFO	First-In-First-Out
GIC	General Interrupt Controller
GPC	General Power Controller
GPIO	General-Purpose I/O
GPR	General-Purpose Register
GPS	Global Positioning System
GPT	General-Purpose Timer
GPU	Graphics Processing Unit
GPV	Global Programmers View
HAB	High-Assurance Boot
I2C or I ² C	Inter-Integrated Circuit
IC	Integrated Circuit
IEEE	Institute of Electrical and Electronics Engineers
IOMUX	Input-Output Multiplexer

Table continues on the next page...

About This Document

Term	Meaning
IP	Intellectual Property
IrDA	Infrared Data Association
JTAG	Joint Test Action Group (a serial bus protocol usually used for test purposes)
LCD	Liquid Crystal Display
LDO	Low-Dropout
LIFO	Last-In-First-Out
LRU	Least-Recently Used
LSB	Least-Significant Byte
LUT	Look-Up Table
LVDS	Low Voltage Differential Signaling
MAC	Medium Access Control
MMC	Multimedia Card
MMDC	Multi Mode DDR Controller
MSB	Most-Significant Byte
MT/s	Mega Transfers per second
OCRAM	On-Chip Random-Access Memory
OCOTP	On-Chip One-Time Programmable Controller
PCI	Peripheral Component Interconnect
PCMCIA	Personal Computer Memory Card International Association
PGC	Power Gating Controller
PIC	Programmable Interrupt Controller
PMU	Power Management Unit
POR	Power-On Reset
PSRAM	Pseudo-Static Random Access Memory
PWM	Pulse Width Modulation
PXP	Pixel Pipeline
QoS	Quality of Service
R2D	Radians to Degrees
RISC	Reduced Instruction Set Computing
ROM	Read-Only Memory
ROMCP	ROM Controller with Patch
RTOS	Real-Time Operating System
Rx	Receive
SAI	Synchronous Audio Interface
SCU	Snoop Control Unit
SD	Secure Digital
SDIO	Secure Digital Input/Output
SDLC	Synchronous Data Link Control
SDMA	Smart DMA
SIM	Subscriber Identification Module
SNVS	Secure Non-Volatile Storage

Table continues on the next page...

Term	Meaning
SoC	System-on-Chip
SPBA	Shared Peripheral Bus Arbiter
SPDIF	Sony Phillips Digital Interface
SPI	Serial Peripheral Interface
SRAM	Static Random-Access Memory
SRC	System Reset Controller
TFT	Thin-Film Transistor
TPIU	Trace Port Interface
TSGEN	Time Stamp Generator
Tx	Transmit
TZASC	TrustZone Address Space Controller
UART	Universal Asynchronous Receiver/Transmitter
USB	Universal Serial Bus
USDHC	Ultra Secured Digital Host Controller
WDOG	Watchdog
WLAN	Wireless Local Area Network
WXGA	Wide Extended Graphics Array

1.2 Introduction

This chapter introduces the architecture of the i.MX 6ULL Multimedia Applications Processors. The i.MX 6ULL processors represent NXP's latest achievement in integrated multimedia applications processors.

It is part of a growing i.MX family of multimedia-focused products, offering high-performance processing optimized for the lowest power consumption.

1.3 Target Applications

The architecture's flexibility enables it to be used in a wide variety of general embedded applications. The i.MX 6ULL processor provides all interfaces necessary to connect peripherals such as WLAN, Bluetooth™, GPS, camera sensors, and multiple displays.

1.4 Features

The i.MX 6ULL processors are based on ARM®Cortex®-A7 MPCore™ Platform, which has these features:

Features

- Single ARM Cortex-A7 MPCore (with TrustZone) with:
 - 32 KB L1 instruction cache
 - 32 KB L1 data cache
 - Cortex-A7 NEON MPE (Media Processing Engine) co-processor

The ARM Cortex-A7 MPCore complex includes:

- General Interrupt Controller (GIC) with 128 interrupts support
- Global Timer
- Snoop Control Unit (SCU)
- 128 KB unified I/D L2 cache
- Single Master AXI (128-bit) bus interface output of L2 cache
- NEON MPE co-processor
 - SIMD Media Processing Architecture
 - NEON register file with 32x32-bit, 32x64-bit, and 16x128-bit general-purpose registers
 - NEON Integer execute pipeline (ALU, Shift, MAC)
 - NEON dual, single-precision floating-point execute pipeline (FADD, FMUL)
 - NEON load/store and permute pipeline
 - Supports single- and double-precision add, subtract, multiply, divide, multiply and accumulate, and square root operations, as described in the ARM VFPv4 architecture.
 - Provides conversions between 16-bit, 32-bit, and 64-bit floating-point formats and ARM integer word formats.

The target frequency of the core is 528 MHz non-overdrive and overdrive to 800 MHz for industrial processor and 900 MHz for consumer processor over the specified temperature range.

The i.MX 6ULL processors support high-volume, cost-effective handheld DRAM, NOR flash, and SD memory card standards.

The memory system consists of these components:

- Level 1 cache—32 KB instruction, 32 KB data cache
- Level 2 cache—unified instruction and data (128 KB)
- On-Chip Memory:
 - Boot ROM, including High-Assurance Boot (HAB, 96 KB)
 - Internal fast access RAM (OCRAM, 128 KB)
- External memory interfaces:
 - 16-bit LP-DDR2, 16-bit DDR3-400, and LV-DDR3-400
 - 8-bit NAND-flash, including support for Raw MLC/TLC, 2 KB, 4 KB, and 8 KB page size, BA-NAND, PBA-NAND, LBA-NAND, OneNAND™, and others
 - BCH ECC up to 40 bits
 - 16-bit NOR flash

- 16-bit PSRAM, Cellular RAM
- Dual-channel/single-channel QuadSPI flash

The i.MX 6ULL processor enables these interfaces to external devices (some of them are muxed and not available simultaneously):

Displays:

- LCDIF—supports one parallel 24-bit LCD display with up to WXGA (1366 x 768) resolution at 60 Hz
- EPDC—supports direct-driver for E-Ink EPD panels with resolution up to 2048 x 1536 at 106 Hz (or 4096 x 4096 at 20 Hz)
 - Supports up to 64 LUT for concurrent updates
 - Supports Auto-Waveform selection based on both the input image and current panel content
 - Supports collision detection
 - Supports both the PVI panels and LGD GIP panels

Camera sensors:

- One parallel camera port (up to 24-bit and 66 MHz)

Expansion cards: four MMC/SD/SDIO card ports that support:

- 1-bit or 4-bit transfer mode specifications for the SD and SDIO cards up to UHS-I SDR-104 mode (104 MB/s max)
- 1-bit, 4-bit, or 8-bit transfer mode specifications for the MMC cards up to 52 MHz in both the SDR and DDR modes (104 MB/s max)
- Compatible with SD, miniSD, SDIO, miniSDIO, SD Combo, MMC and MMC RS, embedded MMC, and embedded SD cards.
- Host-clock frequency variable from 32 kHz to 52 MHz
- Up to 200 Mbit/s data transfer for SD/SDIO cards using four parallel data lines
- Up to 416 Mbit/s data transfer for MMC cards using eight parallel data lines
- Up to 832 Mbit/s data transfer for MMC/SD cards using eight parallel data lines in the DDR mode

USB:

- Two High-Speed (HS) USB 2.0 OTG (up to 480 Mbit/s), with integrated HS USB PHY

Miscellaneous IPs and interfaces:

- Three I²S/SAI/AC97, each operating at up to 1.4 Mbit/s
- ESAI
- Eight UARTs (each operating at up to 5.0 Mbit/s) that provide the RS232 interface and support 9-bit RS485 multidrop mode. Eight UARTs that support the 4-wire mode.

Features

- Four eCSPI (enhanced CSPI), three of them support up to 52 M-bit/s, one can be of low speed
- Four I²Cs supporting 400 kbit/s
- Dual-megabit Ethernet controller (IEEE1588-compliant), 10/100 Mbit/s
- Eight Pulse Width Modulators (PWM)
- System JTAG Controller (SJC)
- GPIO with interrupt capabilities
- 8x8 Key Pad Port (KPP)
- Sony Philips Digital Interface (SPDIF), Rx and Tx
- Two Controller Area Network (FlexCAN), 1 Mbit/s each
- Three Watchdog timers (WDOG)
- Asynchronous Sample Rate Converter (ASRC)
- Medium Quality Sound (MQS)

The i.MX 6ULL processors integrate the advanced Power Management Unit (PMU) and these controllers:

- The PMU includes multiple LDO supplies for on-chip resources
- Temperature Sensor to monitor the die temperature
- DVFS to support low-power modes
- Software State Retention and Power Gating for ARM and MPE
- Multiple power modes
- Flexible clock-gating control scheme

The use of hardware accelerators is a key factor in obtaining high performance at low power consumption levels, while keeping the CPU core relatively free for performing other tasks.

The i.MX 6ULL processors incorporate this hardware accelerator:

- Pixel Processing Pipeline (PXP)

The security functions are enabled and accelerated by this hardware:

- ARM TrustZone including the TZ architecture (separation of interrupts, memory mapping, and so on)
- SJC—System JTAG Controller—protects the JTAG from debug port attacks by regulating or blocking the access to the system debug features.
- SNVS—Secure Non-Volatile Storage, including Secure Real-Time Clock.
- CSU—Central Security Unit—an enhancement for the IC Identification Module (IIM). It is configured during boot and by the eFUSES, and determines the security level operation mode and the TZ policy.
- RNGB—True Random Number Generation
- A-HAB—Advanced High-Assurance Boot—HABv4 with these new embedded enhancements: SHA-256, 2048-bit RSA key, version control mechanism, warm boot, CSU, and TZ initialization.

NOTE

The actual feature set depends on the part number.

1.5 Architectural Overview

This section contains details about the chip architecture.

1.5.1 Simplified Block Diagram

A high-level block diagram is shown in the following figure. This diagram provides a view of the chip's major sub-systems (processor domains, shared peripherals domain, and memories) and logical connectivity.

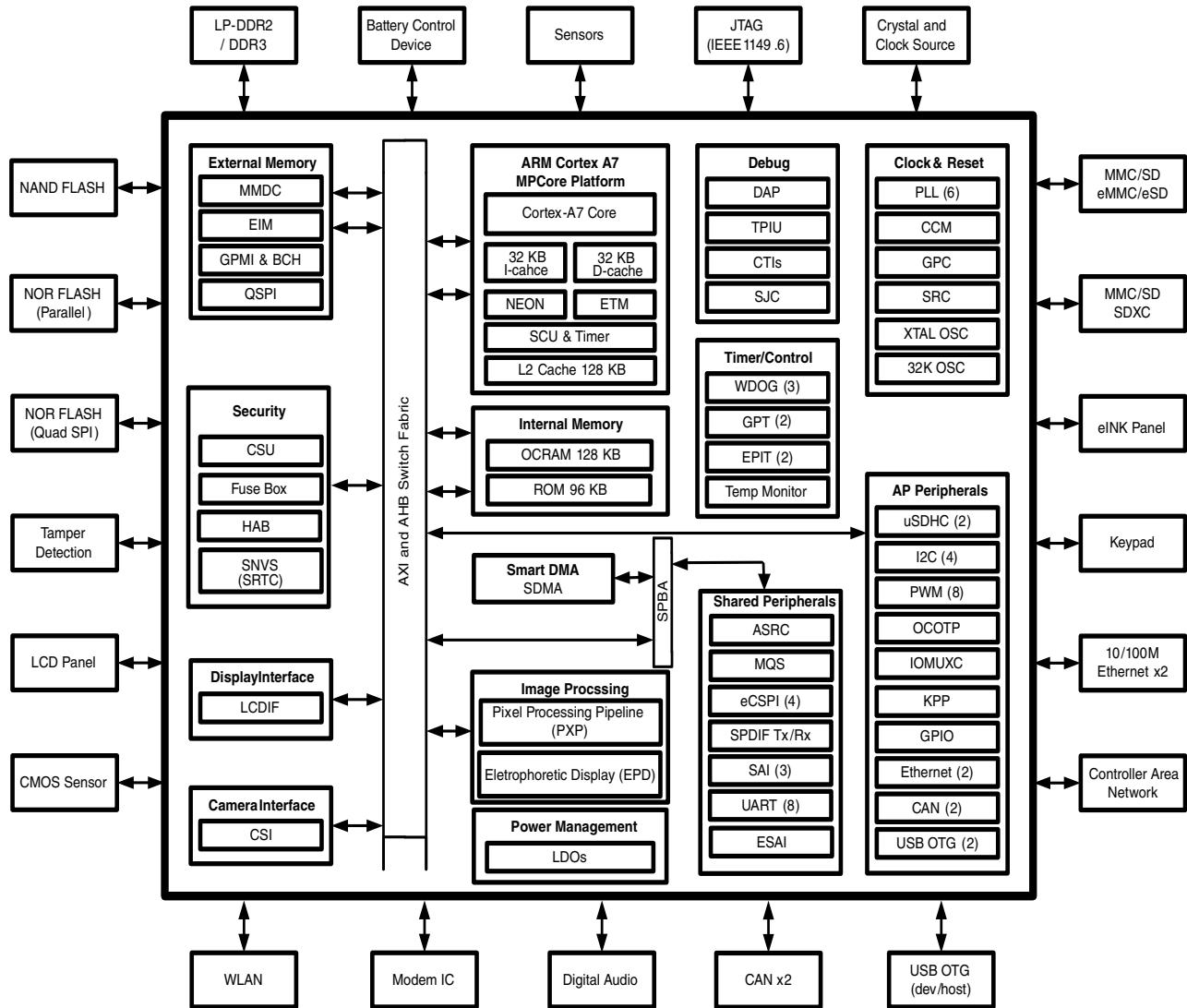

Figure 1-2. Simplified block diagram

1.5.2 Architectural Partitioning

Architecture supports processing-intensive tasks in the following ways:

- ARM Cortex A7 MPCore™ Platform provides hardware features for:
 - Operating System
 - User applications (including control over hardware accelerators and non-accelerated functions)
 - TrustZone applications

- Smart DMA enables data transfer between non-mastering peripherals and external or internal memories
- System Control is supported via:
 - Clock Control Module (CCM)
 - XTALOSC- 24 MHz Crystal oscillator source support
 - OSC32KHz - 32.768 Hz Crystal oscillator source support
 - System Reset Controller (SRC)
 - General Power Controller (GPC)
 - Temperature Sensor for monitoring and alarming on high temperature situations.
- Multimedia is supported with:
 - Audio
 - Audio codecs are provided by SW, which runs on ARM core, supporting (but not limited to) MP3, WMA, AAC, HE-AAC and Pro10
 - SPDIF Tx/Rx
 - Audio sample rate conversion accelerator (ASRC)
 - ESAI
 - Video
 - Display/graphics
 - Pixel Pipeline (PXP)
 - LCD interface (LCDIF)
 - CMOS sensor interface
 - EPDC
- Security is supported by:
 - High Assurance Boot (HAB4) System
 - ARM TrustZone (TZ) Trusted Execution environment
 - Peripheral access policy control, using Central Security Unit (CSU)
 - DCP and SNVS security architecture, providing:
 - Security State Controller
 - Encryption and Hashing functions, Random Number Generator (RNGB)
 - Security Violation/Tamper Detection & Reporting
 - System JTAG controller (SJC)
 - Secure Real Time Clock (SRTC)
 - TrustZone Watchdog (TZ WDOG)
- Connectivity peripherals, timers and External Memory Interfaces:
 - Embedded DMAs
 - 3.3V IO voltage for seamless integration
 - Two USB 2.0 ports, including two PHYs: 2x HS-USB (OTG)
 - Nand-Flash (MLC up to 40-bit ECC) and NOR Flash memory interface via GPMI Nand-Flash controller

- Timers: 2xEPIT, GPT and two Watch Dog timers (one of which is used for TZ), in addition to the timers and watchdog timers integrated within the ARM Cortex A7 MPCore™ platform.
- Miscellaneous connectivity support - FLEXCAN, MMC/SD, I2C, SPI, UART, PWM and Keypad interface

1.5.3 Endianness Support

The chip supports only the Little Endian mode.

1.5.4 Memory Interfaces

The chip DDR controller supports these memory interfaces:

The EIM block provides an interface for SRAM and PSRAM, and a 16/8-bit NOR flash. All EIM pins are muxed on other interfaces.

Chapter 2

Memory Maps

2.1 Memory system overview

This section introduces the memory architecture of the chip.

2.2 ARM Platform Memory Map

The chip memory map has been provided in the following tables.

Table 2-1. System memory map

Start address	End address	Size	Description
8000_0000	FFFF_FFFF	2048 MB	MMDC—x16 DDR Controller.
7000_0000	7FFF_FFFF	256 MB	Reserved
6000_0000	6FFF_FFFF	256 MB	QSPI1 Memory
5800_0000	5FFF_FFFF	128 MB	EIM Aliased
5000_0000	57FF_FFFF	128 MB	EIM (NOR/SRAM)
1000_0000	4FFF_FFFF	1024 MB	Reserved
0E00_0000	0FFF_FFFF	32 MB	Reserved
0C00_0000	0DFF_FFFF	32 MB	QSPI1 Rx Buffer
0900_0000	0BFF_FFFF	48 MB	Reserved
0800_0000	08FF_FFFF	16 MB	Reserved
02C0_0000	07FF_FFFF	84 MB	Reserved
0230_0000	02BF_FFFF	9 MB	Reserved
0220_0000	022F_FFFF	1 MB	Table 2-4 AIPS-3. See IP listing on the separate map.
0210_0000	021F_FFFF	1 MB	Table 2-3 AIPS-2. See the IP listing on the separate map.
0200_0000	020F_FFFF	1 MB	Table 2-2 AIPS-1. See the IP listing on the separate map.
0181_0000	01FF_FFFF	8128 KB	Reserved
0180_C000	0180_FFFF	16 KB	Reserved

Table continues on the next page...

Table 2-1. System memory map (continued)

Start address	End address	Size	Description
0180_8000	0180_BFFF	16 KB	BCH
0180_6000	0180_7FFF	8 KB	GPMI
0180_4000	0180_5FFF	32 KB	APBH DMA
0180_0000	0180_3FFF	16 KB	Reserved
0120_0000	017F_FFFF	6 MB	Reserved
0110_0000	011F_FFFF	1 MB	Reserved
0100_0000	010F_FFFF	1 MB	Reserved
00F0_0000	00FF_FFFF	1 MB	Reserved
00E0_0000	00EF_FFFF	1 MB	(per_m) configuration port
00D0_0000	00DF_FFFF	1 MB	(cpu) configuration port
00C0_0000	00CF_FFFF	1 MB	GPV_1 PL301
00B0_0000	00BF_FFFF	1 MB	GPV_0 PL301 configuration port
00A0_8000	00AF_FFFF	992 KB	Reserved
00A0_0000	00A0_7FFF	32 KB	ARM Peripherals: GIC400 Only visible to ARM core(s)
009C_0000	009F_FFFF	256 KB	Reserved
0098_0000	009B_FFFF	256 KB	Reserved
0092_0000	0097_FFFF	384 KB	OCRAM aliased
0090_0000	0091_FFFF	128 KB	OCRAM 128 KB
008F_8000	008F_FFFF	32 KB	Reserved
007F_8000	008F_7FFF	1 MB	Reserved
0010_0000	0010_7FFF	32 KB	Reserved
0001_8000	000F_FFFF	928 KB	Reserved
0001_7000	0001_7FFF	4 KB	Boot ROM—Protected 4 KB area
0000_0000	0001_6FFF	92 KB	Boot ROM (ROMCP)

The table below shows the ARM IP Bus (AIPS) detailed memory map.

Table 2-2. AIPS-1 memory map

Start Address	End Address	Region	NIC Port	Size
020F_C000	020F_FFFF	AIPS-1	PWM8	16 KB
020F_8000	020F_BFFF		PWM7	16 KB
020F_4000	020F_7FFF		PWM6	16 KB
020F_0000	020F_3FFF		PWM5	16 KB
020E_C000	020E_FFFF		SDMA	16 KB
020E_8000	020E_BFFF		GPT2	16 KB
020E_4000	020E_7FFF		IOMUXC_GPR	16 KB
020E_0000	020E_3FFF		IOMUXC	16 KB
020D_C000	020D_FFFF		GPC	16 KB

Table continues on the next page...

Table 2-2. AIPS-1 memory map (continued)

Start Address	End Address	Region	NIC Port	Size	
020D_8000	020D_BFFF	AIPS-1	SRC	16 KB	
020D_4000	020D_7FFF		EPIT2	16 KB	
020D_0000	020D_3FFF		EPIT1	16 KB	
020C_C000	020C_FFFF		SNVS_HP	16 KB	
020C_8000	020C_8FFF		ANALOG_DIG	16 KB	
020C_4000	020C_7FFF		CCM	16 KB	
020C_0000	020C_3FFF		WDOG2	16 KB	
020B_C000	020B_FFFF		WDOG1	16 KB	
020B_8000	020B_BFFF		KPP	16 KB	
020B_4000	020B_7FFF		ENET2	16 KB	
020B_0000	020B_3FFF		SNVS_LP	16 KB	
020A_C000	020A_FFFF		GPIO5	16 KB	
020A_8000	020A_BFFF		GPIO4	16 KB	
020A_4000	020A_7FFF		GPIO3	16 KB	
020A_0000	020A_3FFF		GPIO2	16 KB	
0209_C000	0209_FFFF		GPIO1	16 KB	
0209_8000	0209_BFFF		GPT1	16 KB	
0209_4000	0209_7FFF		CAN2	16 KB	
0209_0000	0209_3FFF		CAN1	16 KB	
0208_C000	0208_FFFF		PWM4	16 KB	
0208_8000	0208_BFFF		PWM3	16 KB	
0208_4000	0208_7FFF		PWM2	16 KB	
0208_0000	0208_3FFF		PWM1	16 KB	
0207_C000	0207_FFFF			AIPS-1 Configuration	16 KB
0204_8000	0207_BFFF		AIPS-1 Glob. Module enable	Reserved	208 KB
0204_4000	0204_7FFF			Reserved	16 KB
0204_0000	0204_3FFF			TOUCH_CTRL	16 KB
0203_C000	0203_FFFF	AIPS-1 (via SPBA) Glob,Module ENABLE	SPBA	16 KB	
0203_8000	0203_BFFF		Reserved for SDMA internal registers	16 KB	
0203_4000	0203_7FFF		ASRC	16 KB	
0203_0000	0203_3FFF		SAI3	16 KB	
0202_C000	0202_FFFF		SAI2	16 KB	
0202_8000	0202_BFFF		SAI1	16 KB	
0202_4000	0202_7FFF		ESAI	16 KB	
0202_0000	0202_3FFF		UART1	16 KB	
0201_C000	0201_FFFF		Reserved for SDMA internal registers	16 KB	
0201_8000	0201_BFFF		UART7	16 KB	
0201_4000	0201_7FFF		eCSPI4	16 KB	

Table continues on the next page...

Table 2-2. AIPS-1 memory map (continued)

Start Address	End Address	Region	NIC Port	Size
0201_0000	0201_3FFF		eCSPI3	16 KB
0200_C000	0200_FFFF		eCSPI2	16 KB
0200_8000	0200_BFFF		eCSPI1	16 KB
0200_4000	0200_7FFF		SPDIF	16 KB
0200_0000	0200_3FFF		Reserved for SDMA internal registers	16 KB

The table below shows the AIPS-2 detailed memory map.

Table 2-3. AIPS-2 memory map

Start Address	End Address	Region	Allocation	Size
021F_C000	021F_FFFF	AIPS-2	UART6	16 KB
021F_8000	021F_BFFF		I2C4	16 KB
021F_4000	021F_7FFF		UART5	16 KB
021F_0000	021F_3FFF		UART4	16 KB
021E_C000	021E_FFFF		UART3	16 KB
021E_8000	021E_BFFF		UART2	16 KB
021E_4000	021E_7FFF		WDOG3	16 KB
021E_0000	021E_3FFF		QSPI	16 KB
021D_C000	021D_FFFF		System Counter_CTRL	16 KB
021D_8000	021D_BFFF		System Counter_CMP	16 KB
021D_4000	021D_7FFF		System Counter_RD	16 KB
021D_0000	021D_3FFF		TZASC	16 KB
021C_C000	021C_FFFF		PXP	16 KB
021C_8000	021C_BFFF		LCDIF	16 KB
021C_4000	021C_7FFF		CSI	16 KB
021C_0000	021C_3FFF		CSU	16 KB
021B_C000	021B_FFFF	AIPS-2	OCOTP_CTRL	16 KB
021B_8000	021B_BFFF		EIM	16 KB
021B_4000	021B_7FFF		Reserved	16 KB
021B_0000	021B_3FFF		MMDC	16 KB
021A_C000	021A_FFFF		ROMCP	16 KB
021A_8000	021A_BFFF		I2C3	16 KB
021A_4000	021A_7FFF		I2C2	16 KB
021A_0000	021A_3FFF		I2C1	16 KB
0219_C000	0219_FFFF		ADC2	16 KB
0219_8000	0219_BFFF		ADC1	16 KB
0219_4000	0219_7FFF	uSDHC2	16 KB	
0219_0000	0219_3FFF	uSDHC1	16 KB	

Table continues on the next page...

Table 2-3. AIPS-2 memory map (continued)

Start Address	End Address	Region	Allocation	Size
0218_C000	0218_FFFF		Reserved	16 KB
0218_8000	0218_BFFF		ENET1	16 KB
0218_4000	0218_7FFF		USBO2 (USB)	16 KB
0218_0000	0218_3FFF		USBO2 (pl301)	16 KB
0217_C000	0217_FFFF		AIPS-2 configuration	16 KB
0214_0000	0217_BFFF		Reserved	240 KB

The table below shows the AIPS-3 detailed memory map.

Table 2-4. AIPS-3 memory map

Start Address	End Address	Region	Allocation	Size
022F_C000	022F_FFFF	AIPS-3	Reserved	16 KB
022F_8000	022F_BFFF		Reserved	16 KB
022F_4000	022F_7FFF		Reserved	16 KB
022F_0000	022F_3FFF		Reserved	16 KB
022E_C000	022E_FFFF		Reserved	16 KB
022E_8000	022E_BFFF		Reserved	16 KB
022E_4000	022E_7FFF		Reserved	16 KB
022E_0000	022E_3FFF		Reserved	16 KB
022D_C000	022D_FFFF		Reserved	16 KB
022D_8000	022D_BFFF		Reserved	16 KB
022D_4000	022D_7FFF		Reserved	16 KB
022D_0000	022D_3FFF		Reserved	16 KB
022C_C000	022C_FFFF		Reserved	16 KB
022C_8000	022C_BFFF		Reserved	16 KB
022C_4000	022C_7FFF		Reserved	16 KB
022C_0000	022C_3FFF		Reserved	16 KB
022B_C000	022B_FFFF		Reserved	16 KB
022B_8000	022B_BFFF		Reserved	16 KB
022B_4000	022B_7FFF		Reserved	16 KB
022B_0000	022B_3FFF		Reserved	16 KB
022A_C000	022A_FFFF		Reserved	16 KB
022A_8000	022A_BFFF		Reserved	16 KB
022A_4000	022A_7FFF		Reserved	16 KB
022A_0000	022A_3FFF		Reserved	16 KB
0229_C000	0229_FFFF		Reserved	16 KB
0229_8000	0229_BFFF		Reserved	16 KB
0229_4000	0229_7FFF		SNVS_GPR	16 KB
0229_0000	0229_3FFF		IOMUXC_SNVS	16 KB

Table continues on the next page...

Table 2-4. AIPS-3 memory map (continued)

Start Address	End Address	Region	Allocation	Size
0228_C000	0228_FFFF		EPDC	16 KB
0228_8000	0228_BFFF		UART8	16 KB
0228_4000	0228_7FFF		RNGB	16 KB
0228_0000	0228_3FFF		DCP	16 KB
0227_C000	0227_FFFF		AIPS-3 Configuration	16 KB
0224_0000	0227_BFFF		Reserved	240 KB
0220_0000	0223_FFFF		Reserved	256 KB

The table below shows the Debug Access Port (DAP) detailed memory map.

Table 2-5. DAP memory map

Start Address	End Address	Region	Allocation	Size
0213_F000	0213_FFFF	CA7_DAP	Reserved	4 KB
0213_E000	0213_EFFF		Reserved	4 KB
0213_D000	0213_DFFF		Reserved	4 KB
0213_C000	0213_CFFF		ETM0	4 KB
0213_B000	0213_BFFF		Reserved	4 KB
0213_A000	0213_AFFF		Reserved	4 KB
0213_9000	0213_9FFF		Reserved	4 KB
0213_8000	0213_8FFF		CTI0	4 KB
0213_7000	0213_7FFF		Reserved	4 KB
0213_6000	0213_6FFF		Reserved	4 KB
0213_5000	0213_5FFF		Reserved	4 KB
0213_4000	0213_4FFF		Reserved	4 KB
0213_3000	0213_3FFF		Reserved	4 KB
0213_2000	0213_2FFF		Reserved	4 KB
0213_1000	0213_1FFF		CPU0 PMU	4 KB
0213_0000	0213_0FFF		CPU0 Debug	4 KB
0212_1000	0212_FFFF		Reserved	60 KB
0212_0000	0212_0FFF		CA7 ROM Table	4 KB
0212_8000	0212_FFFF		Reserved	96 KB
0210_7000	0210_7FFF		Reserved	4 KB
0210_6000	0210_6FFF		Reserved	4 KB
0210_5000	0210_5FFF		Reserved	4 KB
0210_4000	0210_4FFF		TSGEN	4 KB
0210_3000	0210_3FFF		TPIU	4 KB
0210_2000	0210_2FFF		CTI	4 KB
0210_1000	0210_1FFF		ETF	4 KB
0210_0000	0210_0FFF		DAP ROM Table	4 KB

NOTE

Accessing the reserved memory regions can result in unpredictable behavior.

2.3 DMA memory map

The Smart DMA memory map is shown in the following table.

Table 2-6. SDMA peripheral memory map

Peripheral	Base address	Size
Reserved for SDMA internal memory	0x0000	4 KB
SPDIF	0x1000	4 KB
eCSPI1	0x2000	4 KB
eCSPI2	0x3000	4 KB
eCSPI3	0x4000	4 KB
eCSPI4	0x5000	4 KB
UART7	0x6000	4 KB
Reserved for SDMA internal registers	0x7000	4 KB
UART1	0x8000	4 KB
ESAI	0x9000	4 KB
SAI1	0xA000	4 KB
SAI2	0xB000	4 KB
SAI3	0xC000	4 KB
ASRC	0xD000	4 KB
Reserved	0xE000	4 KB
SPBA Registers	0xF000	4 KB

NOTE

Accessing the reserved memory regions can result in an unpredictable behavior.

Chapter 3

Interrupts and DMA Events

3.1 Overview

This section describes the assignments of interrupts from the ARM domain in [Cortex A7 interrupts](#) and from the DMA events in [SDMA event mapping](#).

3.2 Cortex A7 interrupts

The Global Interrupt Controller (GIC) collects up to 128 interrupt requests from all chip sources and provides an interface to the Cortex A7 CPU. The first 32 interrupts are private to the CPUs' interface. These interrupts are not included in the table below. All interrupts besides those private to the CPU are hooked up to the GPC.

Each interrupt can be configured as a normal or a secure interrupt. Software force registers and software priority masking are also supported. This table describes the ARM Cortex A7 interrupt sources:

Table 3-1. ARM Cortex A7 domain interrupt summary

IRQ	Interrupt Source	LOGIC	Interrupt Description
0	boot	-	Used to notify cores on exception condition while boot
1	ca7_platform	-	DAP
2	sdma	-	AND of all 48 SDMA interrupts (events) from all the channels
3	tsc	-	TSC interrupt
4	snvs_lp_wrapper	OR	ON-OFF button press shorter than 5 secs (pulse event)
	snvs_hp_wrapper		ON-OFF button press shorter than 5 secs (pulse event)
5	lcdif	-	LCDIF Sync Interrupt
6	rngb	-	RNGB Interrupt
7	csi	-	CSI interrupt
8	pxp	-	PXP interrupt
9	sctr	-	SCTR compare interrupt

Table continues on the next page...

Table 3-1. ARM Cortex A7 domain interrupt summary (continued)

IRQ	Interrupt Source	LOGIC	Interrupt Description
10	sctr	-	SCTR compare interrupt
11	wdog3	-	Watchdog Timer reset
12	-	-	Reserved
13	apbhdma	OR	GPMI operation channel 0 description complete interrupt
			GPMI operation channel 1 description complete interrupt
			GPMI operation channel 2 description complete interrupt
			GPMI operation channel 3 description complete interrupt
14	weim	-	WEIM interrupt
15	bch	-	BCH operation complete interrupt
16	gpmi	-	GPMI operation TIMEOUT ERROR interrupt
17	uart6	-	UART-6 ORed interrupt
18	pxp	-	PXP interrupt
19	snvs_hp_wrapper	-	SRTC Consolidated Interrupt. Non TZ.
20	snvs_hp_wrapper	-	SRTC Security Interrupt. TZ.
21	csu	-	CSU Interrupt Request 1. Indicates to the processor that one or more alarm inputs were asserted
22	usdhc1	-	uSDHC1 Enhanced SDHC Interrupt Request
23	usdhc2	-	uSDHC2 Enhanced SDHC Interrupt Request
24	sai3	-	SAI interrupt
25	sai3	-	SAI interrupt
26	uart1	-	UART-1 ORed interrupt
27	uart2	-	UART-2 ORed interrupt
28	uart3	-	UART-3 ORed interrupt
29	uart4	-	UART-4 ORed interrupt
30	uart5	-	UART-5 ORed interrupt
31	ecspi1	-	eCSPI1 interrupt request line to the core.
32	ecspi2	-	eCSPI2 interrupt request line to the core.
33	ecspi3	-	eCSPI3 interrupt request line to the core.
34	ecspi4	-	eCSPI4 interrupt request line to the core.
35	i2c4	-	I2C-4 Interrupt
36	i2c1	-	I2C-1 Interrupt
37	i2c2	-	I2C-2 Interrupt
38	i2c3	-	I2C-3 Interrupt
39	uart7	-	UART-7 ORed interrupt
40	uart8	-	UART-8 ORed interrupt
41	-	-	Reserved
42	usb	-	USBO2 USB OTG2
43	usb	-	USBO2 USB OTG1
44	anatop	-	USBPHY (UTMI0), Interrupt
45	anatop	-	USBPHY (UTMI1), Interrupt

Table continues on the next page...

Table 3-1. ARM Cortex A7 domain interrupt summary (continued)

IRQ	Interrupt Source	LOGIC	Interrupt Description
46	dcp	-	DCP Interrupt
47	dcp	-	DCP Interrupt
48	dcp	-	DCP Interrupt
49	tempsensor	OR	TempSensor low
			TempSensor high
			TempSensor panic
50	asrc	-	ASRC- Interrupt for core
51	esai	-	ESAI interrupt
52	spdif	OR	SPDIF Rx interrupt
	spdif		SPDIF Tx interrupt
53	-	-	Reserved
54	pmu	-	Brown-out event on either the 1.1, 2.5 or 3.0 regulators.
55	gpt1	-	OR of GPT1 Rollover interrupt line, Input Capture 1 & 2 lines, Output Compare 1,2 &3 Interrupt lines
56	epit1	-	EPIT1 output compare interrupt
57	epit2	-	EPIT2 output compare interrupt
58	gpio1	-	Active HIGH Interrupt from INT7 from GPIO
59	gpio1	-	Active HIGH Interrupt from INT6 from GPIO
60	gpio1	-	Active HIGH Interrupt from INT5 from GPIO
61	gpio1	-	Active HIGH Interrupt from INT4 from GPIO
62	gpio1	-	Active HIGH Interrupt from INT3 from GPIO
63	gpio1	-	Active HIGH Interrupt from INT2 from GPIO
64	gpio1	-	Active HIGH Interrupt from INT1 from GPIO
65	gpio1	-	Active HIGH Interrupt from INT0 from GPIO
66	gpio1	-	Combined interrupt indication for GPIO1 signal 0 throughout 15
67	gpio1	-	Combined interrupt indication for GPIO1 signal 16 throughout 31
68	gpio2	-	Combined interrupt indication for GPIO2 signal 0 throughout 15
69	gpio2	-	Combined interrupt indication for GPIO2 signal 16 throughout 31
70	gpio3	-	Combined interrupt indication for GPIO3 signal 0 throughout 15
71	gpio3	-	Combined interrupt indication for GPIO3 signal 16 throughout 31
72	gpio4	-	Combined interrupt indication for GPIO4 signal 0 throughout 15
73	gpio4	-	Combined interrupt indication for GPIO4 signal 16 throughout 31
74	gpio5	-	Combined interrupt indication for GPIO5 signal 0 throughout 15

Table continues on the next page...

Table 3-1. ARM Cortex A7 domain interrupt summary (continued)

IRQ	Interrupt Source	LOGIC	Interrupt Description
75	gpio5	-	Combined interrupt indication for GPIO5 signal 16 throughout 31
76	can1	-	IPI compare interrupt
77	can2	-	IPI compare interrupt
78	-	-	Reserved
79	-	-	Reserved
80	wdog1	-	Watchdog Timer reset
81	wdog2	-	Watchdog Timer reset
82	kpp	-	Keypad Interrupt
83	pwm1	-	Cumulative interrupt line. OR of Rollover Interrupt line, Compare Interrupt line and FIFO Waterlevel crossing interrupt line
84	pwm2	-	Cumulative interrupt line. OR of Rollover Interrupt line, Compare Interrupt line and FIFO Waterlevel crossing interrupt line
85	pwm3	-	Cumulative interrupt line. OR of Rollover Interrupt line, Compare Interrupt line and FIFO Waterlevel crossing interrupt line
86	pwm4	-	Cumulative interrupt line. OR of Rollover Interrupt line, Compare Interrupt line and FIFO Waterlevel crossing interrupt line
87	ccm	-	CCM, Interrupt Request 1
88	ccm	-	CCM, Interrupt Request 2
89	gpc	-	GPC, Interrupt Request 1
90	-	-	Reserved
91	src	-	SRC interrupt request
92	-	-	Reserved
93	-	-	Reserved
94	ca7_platform	-	Performance Unit Interrupts from ca7_mx6ul (internally: nPMUIRQ[0])
95	ca7_platform	-	CTI trigger outputs (internal: nCTIIRQ[0])
96	src	-	Combined CPU wdog interrupts (4x) out of SRC.
97	sai1	OR	SAI interrupt SAI interrupt SAI interrupt SAI interrupt
98	sai2	OR	SAI interrupt SAI interrupt SAI interrupt SAI interrupt
99	-	-	Reserved
100	adc1	OR	ADC1 interrupt

Table continues on the next page...

Table 3-1. ARM Cortex A7 domain interrupt summary (continued)

IRQ	Interrupt Source	LOGIC	Interrupt Description
			ADC1 interrupt
101	adc2	OR	ADC2 interrupt
			ADC2 interrupt
102	-	-	Reserved
103	-	-	Reserved
104	sjc	-	SJC Interrupt from General Purpose register.
105	caam_wrapper	-	CAAM interrupt queue for JQ0
106	caam_wrapper	-	CAAM interrupt queue for JQ1
107	qspi	-	QuadSPI interrupt
108	tzasc	-	TZASC #1 (PL380) interrupt
109	gpt2	-	OR of GPT2 Rollover interrupt line, Input Capture 1 & 2 lines, Output Compare 1,2 &3 Interrupt lines
110	can1	-	Combined interrupt of ini_int_busoff, ini_int_error, ipi_int_mbor, ipi_int_rxwarning, ipi_int_txwarning and ipi_int_wakein.
111	can2	-	Combined interrupt of ini_int_busoff, ini_int_error, ipi_int_mbor, ipi_int_rxwarning, ipi_int_txwarning and ipi_int_wakein.
112	epdc	-	epdc interrupt
113	-	-	Reserved
114	pwm5	-	Cumulative interrupt line. OR of Rollover Interrupt line, Compare Interrupt line and FIFO Waterlevel crossing interrupt line
115	pwm6	-	Cumulative interrupt line. OR of Rollover Interrupt line, Compare Interrupt line and FIFO Waterlevel crossing interrupt line
116	pwm7	-	Cumulative interrupt line. OR of Rollover Interrupt line, Compare Interrupt line and FIFO Waterlevel crossing interrupt line
117	pwm8	-	Cumulative interrupt line. OR of Rollover Interrupt line, Compare Interrupt line and FIFO Waterlevel crossing interrupt line
118	enet1	OR	MAC 0 Periodic Timer Overflow
			MAC 0 Time Stamp Available
			MAC 0 Payload Receive Error
			MAC 0 Transmit FIFO Underrun
			MAC 0 Collision Retry Limit
			MAC 0 Late Collision
			MAC 0 Ethernet Bus Error
			MAC 0 MII Data Transfer Done
			MAC 0 Receive Buffer Done
			MAC 0 Receive Frame Done
			MAC 0 Transmit Buffer Done

Table continues on the next page...

Table 3-1. ARM Cortex A7 domain interrupt summary (continued)

IRQ	Interrupt Source	LOGIC	Interrupt Description
			MAC 0 Transmit Frame Done
			MAC 0 Graceful Stop
			MAC 0 Babbling Transmit Error
			MAC 0 Babbling Receive Error
			MAC 0 Wakeup Request (sync)
119	enet1	-	MAC 0 1588 Timer Interrupt – synchronous
120	enet2	OR	MAC 0 Periodic Timer Overflow
			MAC 0 Time Stamp Available
			MAC 0 Payload Receive Error
			MAC 0 Transmit FIFO Underrun
			MAC 0 Collision Retry Limit
			MAC 0 Late Collision
			MAC 0 Ethernet Bus Error
			MAC 0 MII Data Transfer Done
			MAC 0 Receive Buffer Done
			MAC 0 Receive Frame Done
			MAC 0 Transmit Buffer Done
			MAC 0 Transmit Frame Done
			MAC 0 Graceful Stop
			MAC 0 Babbling Transmit Error
			MAC 0 Babbling Receive Error
			MAC 0 Wakeup Request (sync)
121	enet2	-	MAC 0 1588 Timer Interrupt – synchronous
122	-	-	Reserved
123	-	-	Reserved
124	-	-	Reserved
125	-	-	Reserved
126	-	-	Reserved
127	pmu	-	Brown out event on either the core, gpu or soc regulators

3.3 SDMA event mapping

This table shows the DMA request signals for the peripherals in the chip:

Table 3-2. SDMA event mapping

Event Number	DMA Source	Description
0	UART6 / ESAI	UAR6 Rx FIFO; ESAI Rx FIFO DMA request
1	ADC1	ADC1 DMA request
2	EPIT2 / PXP	EPIT2 DMA request; PXP DMA Event
3	eCSPI1	eCSPI1 Rx request
4	eCSPI1	eCSPI1 Tx request
5	eCSPI2	eCSPI2 Rx request
6	eCSPI2	eCSPI2 Tx request
7	eCSPI3 / I2C1	eCSPI3 Rx request; I2C1 DMA event
8	eCSPI3 / I2C2	eCSPI3 Tx request; I2C2 DMA event
9	eCSPI4 / I2C3	eCSPI4 Rx request; I2C3 DMA event
10	eCSPI4 / I2C4	eCSPI4 Tx request; I2C4 DMA event
11	QSPI	QSPI DMA RX request
12	QSPI	QSPI DMA TX request
13	ADC2 / TSC	ADC2 DMA request; TSC interrupt
14	Mux_bottom	external DMA pad #1
15	Mux_bottom	external DMA pad #2
16	EPIT1 / CSI	EPIT1 DMA request: CSI DMA Event
17	ASRC	ASRC DMA1 request (Pair A input Request)
18	ASRC	ASRC DMA2 request (Pair B input Request)
19	ASRC	ASRC DMA3 request (Pair C input Request)
20	ASRC	ASRC DMA4 request (Pair A output Request)
21	ASRC	ASRC DMA5 request (Pair B output Request)
22	ASRC	ASRC DMA6 request (Pair C output Request)
23	GPT1	GPT1 counter event
24	GPT2 / LCDIF	GPT2 counter event; LCDIF DMA Event
25	UART1	UART1 Rx FIFO
26	UART1	UART1 Tx FIFO
27	UART2	UART2 Rx FIFO
28	UART2	UART2 Tx FIFO
29	UART3	UART3 Rx FIFO
30	UART3	UART3 Tx FIFO
31	UART4	UART4 Rx FIFO
32	UART4	UART4 Tx FIFO
33	UART5	UART5 Rx FIFO
34	UART5 / EPDC	UART5 Tx FIFO; EPDC DMA request
35	SAI1	SAI1 Rx FIFO
36	SAI1	SAI1 Tx FIFO
37	SAI2	SAI2 Rx FIFO
38	SAI2	SAI2 Tx FIFO

Table continues on the next page...

Table 3-2. SDMA event mapping (continued)

Event Number	DMA Source	Description
39	SAI3	SAI3 Rx FIFO
40	SAI3	SAI3 Rx FIFO
41	SPDIF	SPDIF Rx DMA request
42	SPDIF	SPDIF Tx DMA request
43	UART7 / ENET1	UART7 Rx FIFO; ENET1 1588 Event0 out
44	UART7 / ENET1	UART7 Tx FIFO; ENET1 1588 Event1 out
45	UART8 / ENET2	UART8 Rx FIFO; ENET2 1588 Event0 out
46	UART8 / ENET2	UART8 Tx FIFO; ENET2 1588 Event1 out
47	UART6 / ESAI	UART6 Tx FIFO; ESAI Tx FIFO DMA request

As shown in the table, some of the events are the output of a mux of two signals or triggers. The selection of this mux is controlled by the general-purpose registers in IOMUXC.

Chapter 4

External Signals and Pin Multiplexing

4.1 Overview

The chip contains a limited number of pins, most of which have multiple signal options. These signal-to-pin and pin-to-signal options are selected by the input-output multiplexer called IOMUX. The IOMUX is also used to configure other pin characteristics, such as voltage level, drive strength, and hysteresis.

The muxing options table lists the external signals grouped by the module instance, the muxing options for each signal, and the registers used to route the signal to the chosen pad.

4.1.1 Muxing Options

Instance	Port	Pad	Mode
ARM_PLATFORM	EVENTI	LCD_RESET	ALT2
	EVENTO	LCD_DATA18	ALT2
	TRACE0	LCD_DATA00	ALT2
	TRACE1	LCD_DATA01	ALT2
	TRACE2	LCD_DATA02	ALT2
	TRACE3	LCD_DATA03	ALT2
	TRACE4	LCD_DATA04	ALT2
	TRACE5	LCD_DATA05	ALT2
	TRACE6	LCD_DATA06	ALT2
	TRACE7	LCD_DATA07	ALT2
	TRACE8	LCD_DATA08	ALT2
	TRACE9	LCD_DATA09	ALT2
	TRACE10	LCD_DATA10	ALT2
	TRACE11	LCD_DATA11	ALT2
TRACE12	LCD_DATA12	ALT2	

Table continues on the next page...

Overview

Instance	Port	Pad	Mode
	TRACE13	LCD_DATA13	ALT2
	TRACE14	LCD_DATA14	ALT2
	TRACE15	LCD_DATA15	ALT2
	TRACE_CLK	LCD_DATA16	ALT2
	TRACE_CTL	LCD_DATA17	ALT2
CCM	CLKO1	JTAG_TMS	ALT3
		SD1_DATA2	ALT6
	CLKO2	JTAG_TDO	ALT3
		SD1_DATA3	ALT6
	PMIC_READY	GPIO1_IO08	ALT6
		JTAG_MOD	ALT4
PMIC_STBY_REQ	CCM_PMIC_STBY_REQ	No Muxing (ALT0)	
REF_EN_B	GPIO1_IO06	ALT7	
CSI	DATA0	LCD_DATA17	ALT3
		UART3_RX_DATA	ALT3
	DATA1	LCD_DATA16	ALT3
		UART3_TX_DATA	ALT3
	DATA2	CSI_DATA00	ALT0
		UART1_TX_DATA	ALT3
	DATA3	CSI_DATA01	ALT0
		UART1_RX_DATA	ALT3
	DATA4	CSI_DATA02	ALT0
		UART1_CTS_B	ALT3
	DATA5	CSI_DATA03	ALT0
		UART1_RTS_B	ALT3
	DATA6	CSI_DATA04	ALT0
		UART2_TX_DATA	ALT3
	DATA7	CSI_DATA05	ALT0
		UART2_RX_DATA	ALT3
	DATA8	CSI_DATA06	ALT0
		UART2_CTS_B	ALT3
	DATA9	CSI_DATA07	ALT0
		UART2_RTS_B	ALT3
	DATA10	LCD_DATA18	ALT3
		UART3_CTS_B	ALT3
	DATA11	LCD_DATA19	ALT3
		UART3_RTS_B	ALT3
	DATA12	LCD_DATA20	ALT3
		UART4_TX_DATA	ALT3
DATA13	LCD_DATA21	ALT3	
	UART4_RX_DATA	ALT3	

Table continues on the next page...

Instance	Port	Pad	Mode
	DATA14	LCD_DATA22	ALT3
		UART5_TX_DATA	ALT3
	DATA15	LCD_DATA23	ALT3
		UART5_RX_DATA	ALT3
	DATA16	ENET1_RX_DATA0	ALT3
		LCD_DATA08	ALT3
	DATA17	ENET1_RX_DATA1	ALT3
		LCD_DATA09	ALT3
	DATA18	ENET1_RX_EN	ALT3
		LCD_DATA10	ALT3
	DATA19	ENET1_TX_DATA0	ALT3
		LCD_DATA11	ALT3
	DATA20	ENET1_TX_DATA1	ALT3
		LCD_DATA12	ALT3
	DATA21	ENET1_TX_EN	ALT3
		LCD_DATA13	ALT3
	DATA22	ENET1_TX_CLK	ALT3
		LCD_DATA14	ALT3
	DATA23	ENET1_RX_ER	ALT3
		LCD_DATA15	ALT3
	FIELD	GPIO1_IO05	ALT3
		NAND_DQS	ALT1
	HSYNC	CSI_HSYNC	ALT0
GPIO1_IO09		ALT3	
MCLK	CSI_MCLK	ALT0	
	GPIO1_IO06	ALT3	
PIXCLK	CSI_PIXCLK	ALT0	
	GPIO1_IO07	ALT3	
VSYNC	CSI_VSYNC	ALT0	
	GPIO1_IO08	ALT3	
ECSPI1	MISO	CSI_DATA07	ALT3
		LCD_DATA23	ALT2
	MOSI	CSI_DATA06	ALT3
		LCD_DATA22	ALT2
	RDY	LCD_DATA12	ALT8
	SCLK	CSI_DATA04	ALT3
		LCD_DATA20	ALT2
	SS0	CSI_DATA05	ALT3
LCD_DATA21		ALT2	
SS1	LCD_DATA05	ALT8	
SS2	LCD_DATA06	ALT8	

Table continues on the next page...

Overview

Instance	Port	Pad	Mode
	SS3	LCD_DATA07	ALT8
ECSPI2	MISO	CSI_DATA03	ALT3
		UART5_RX_DATA	ALT8
	MOSI	CSI_DATA02	ALT3
		UART5_TX_DATA	ALT8
	RDY	LCD_ENABLE	ALT8
	SCLK	CSI_DATA00	ALT3
		UART4_TX_DATA	ALT8
	SS0	CSI_DATA01	ALT3
		UART4_RX_DATA	ALT8
	SS1	LCD_HSYNC	ALT8
SS2	LCD_VSYNC	ALT8	
SS3	LCD_RESET	ALT8	
ECSPI3	MISO	NAND_CLE	ALT3
		UART2_RTS_B	ALT8
	MOSI	NAND_CE1_B	ALT3
		UART2_CTS_B	ALT8
	RDY	NAND_WP_B	ALT8
	SCLK	NAND_CE0_B	ALT3
		UART2_RX_DATA	ALT8
	SS0	NAND_READY_B	ALT3
		UART2_TX_DATA	ALT8
	SS1	NAND_ALE	ALT8
SS2	NAND_RE_B	ALT8	
SS3	NAND_WE_B	ALT8	
ECSPI4	MISO	ENET2_TX_CLK	ALT3
		NAND_DATA06	ALT3
	MOSI	ENET2_TX_EN	ALT3
		NAND_DATA05	ALT3
	RDY	NAND_DATA00	ALT8
	SCLK	ENET2_TX_DATA1	ALT3
		NAND_DATA04	ALT3
	SS0	ENET2_RX_ER	ALT3
		NAND_DATA07	ALT3
	SS1	NAND_DATA01	ALT8
SS2	NAND_DATA02	ALT8	
SS3	NAND_DATA03	ALT8	
EIM	ACLK_FREERUN	ENET2_TX_EN	ALT4
	AD0	CSI_DATA00	ALT4
	AD1	CSI_DATA01	ALT4
	AD2	CSI_DATA02	ALT4

Table continues on the next page...

Instance	Port	Pad	Mode
	AD3	CSI_DATA03	ALT4
	AD4	CSI_DATA04	ALT4
	AD5	CSI_DATA05	ALT4
	AD6	CSI_DATA06	ALT4
	AD7	CSI_DATA07	ALT4
	AD8	NAND_DATA00	ALT4
	AD9	NAND_DATA01	ALT4
	AD10	NAND_DATA02	ALT4
	AD11	NAND_DATA03	ALT4
	AD12	NAND_DATA04	ALT4
	AD13	NAND_DATA05	ALT4
	AD14	NAND_DATA06	ALT4
	AD15	NAND_DATA07	ALT4
	ADDR16	NAND_CLE	ALT4
	ADDR17	NAND_ALE	ALT4
	ADDR18	NAND_CE1_B	ALT4
	ADDR19	SD1_CMD	ALT4
	ADDR20	SD1_CLK	ALT4
	ADDR21	SD1_DATA0	ALT4
	ADDR22	SD1_DATA1	ALT4
	ADDR23	SD1_DATA2	ALT4
	ADDR24	SD1_DATA3	ALT4
	ADDR25	ENET2_RX_ER	ALT4
	ADDR26	ENET2_RX_EN	ALT4
	BCLK	NAND_WP_B	ALT4
	CRE	ENET1_RX_ER	ALT4
	CS0_B	CSI_MCLK	ALT4
	CS1_B	NAND_READY_B	ALT4
	CS2_B	LCD_CLK	ALT4
	CS3_B	LCD_ENABLE	ALT4
	DATA0	LCD_DATA08	ALT4
	DATA1	LCD_DATA09	ALT4
	DATA2	LCD_DATA10	ALT4
	DATA3	LCD_DATA11	ALT4
	DATA4	LCD_DATA12	ALT4
	DATA5	LCD_DATA13	ALT4
	DATA6	LCD_DATA14	ALT4
	DATA7	LCD_DATA15	ALT4
	DATA8	LCD_DATA16	ALT4
	DATA9	LCD_DATA17	ALT4
	DATA10	LCD_DATA18	ALT4

Table continues on the next page...

Overview

Instance	Port	Pad	Mode
	DATA11	LCD_DATA19	ALT4
	DATA12	LCD_DATA20	ALT4
	DATA13	LCD_DATA21	ALT4
	DATA14	LCD_DATA22	ALT4
	DATA15	LCD_DATA23	ALT4
	DTACK_B	NAND_CE0_B	ALT4
	EB0_B	NAND_RE_B	ALT4
	EB1_B	NAND_WE_B	ALT4
	EB2_B	ENET2_TX_DATA0	ALT4
	EB3_B	ENET2_TX_DATA1	ALT4
	LBA_B	CSI_HSYNC	ALT4
	OE	CSI_PIXCLK	ALT4
	RW	CSI_VSYNC	ALT4
	WAIT	NAND_DQS	ALT4
ENET1	1588_EVENT0_IN	GPIO1_IO00	ALT6
	1588_EVENT0_OUT	GPIO1_IO01	ALT6
	1588_EVENT1_IN	UART3_CTS_B	ALT4
	1588_EVENT1_OUT	UART3_RTS_B	ALT4
	1588_EVENT2_IN	LCD_DATA00	ALT3
	1588_EVENT2_OUT	LCD_DATA01	ALT3
	1588_EVENT3_IN	LCD_DATA02	ALT3
	1588_EVENT3_OUT	LCD_DATA03	ALT3
	COL	UART2_RTS_B	ALT1
	CRS	UART2_CTS_B	ALT1
	MDC	ENET2_RX_DATA1	ALT4
		GPIO1_IO07	ALT0
	MDIO	ENET2_RX_DATA0	ALT4
		GPIO1_IO06	ALT0
	RDATA0	ENET1_RX_DATA0	ALT0
	RDATA1	ENET1_RX_DATA1	ALT0
	RDATA2	UART1_TX_DATA	ALT1
	RDATA3	UART1_RX_DATA	ALT1
	RX_CLK	UART1_CTS_B	ALT1
	RX_EN	ENET1_RX_EN	ALT0
	RX_ER	ENET1_RX_ER	ALT0
	TDATA0	ENET1_TX_DATA0	ALT0
	TDATA1	ENET1_TX_DATA1	ALT0
	TDATA2	UART2_TX_DATA	ALT1
	TDATA3	UART2_RX_DATA	ALT1
	TX_CLK	ENET1_TX_CLK	ALT0
	TX_EN	ENET1_TX_EN	ALT0

Table continues on the next page...

Instance	Port	Pad	Mode
	TX_ER	UART1_RTS_B	ALT1
ENET2	1588_EVENT0_IN	GPIO1_IO04	ALT6
	1588_EVENT0_OUT	GPIO1_IO05	ALT6
	1588_EVENT1_IN	UART1_CTS_B	ALT4
	1588_EVENT1_OUT	UART1_RTS_B	ALT4
	1588_EVENT2_IN	LCD_DATA04	ALT3
	1588_EVENT2_OUT	LCD_DATA05	ALT3
	1588_EVENT3_IN	LCD_DATA06	ALT3
	1588_EVENT3_OUT	LCD_DATA07	ALT3
	COL	UART5_RX_DATA	ALT1
	CRS	UART5_TX_DATA	ALT1
	MDC	ENET1_TX_EN	ALT4
		GPIO1_IO07	ALT1
	MDIO	ENET1_TX_DATA1	ALT4
		GPIO1_IO06	ALT1
	RDATA0	ENET2_RX_DATA0	ALT0
	RDATA1	ENET2_RX_DATA1	ALT0
	RDATA2	UART3_TX_DATA	ALT1
	RDATA3	UART3_RX_DATA	ALT1
	RX_CLK	UART3_CTS_B	ALT1
	RX_EN	ENET2_RX_EN	ALT0
	RX_ER	ENET2_RX_ER	ALT0
	TDATA0	ENET2_TX_DATA0	ALT0
	TDATA1	ENET2_TX_DATA1	ALT0
	TDATA2	UART4_TX_DATA	ALT1
	TDATA3	UART4_RX_DATA	ALT1
	TX_CLK	ENET2_TX_CLK	ALT0
	TX_EN	ENET2_TX_EN	ALT0
TX_ER	UART3_RTS_B	ALT1	
EPIT1	OUT	JTAG_TMS	ALT8
		UART3_RX_DATA	ALT8
EPIT2	OUT	JTAG_TDO	ALT8
		UART3_CTS_B	ALT8
EPDC	BDR[0]	TEST_MODE	ALT9
	BDR[1]	POR_B	ALT9
	GDCLK	ONOFF	ALT9
	GDOE	SNVS_PMIC_ON_REQ	ALT9
	GDRL	CCM_PMIC_STBY_REQ	ALT9
	GDSP	BOOT_MODE0	ALT9
	PWRCOM	BOOT_MODE1	ALT9
	PWRCTRL[0]	SNVS_TAMPER0	ALT9

Table continues on the next page...

Overview

Instance	Port	Pad	Mode
	PWRCTRL[1]	SNVS_TAMPER1	ALT9
	PWRCTRL[2]	SNVS_TAMPER2	ALT9
	PWRCTRL[3]	SNVS_TAMPER3	ALT9
	PWRIRQ	SNVS_TAMPER4	ALT9
	PWRSTAT	SNVS_TAMPER5	ALT9
	PWRWAKE	SNVS_TAMPER6	ALT9
	SDCE[0]	SNVS_TAMPER7	ALT9
	SDCE[1]	SNVS_TAMPER8	ALT9
	SDCE[2]	SNVS_TAMPER9	ALT9
	SDCE[3]	JTAG_MOD	ALT9
	SDCE[4]	JTAG_TMS	ALT9
	SDCE[5]	JTAG_TDO	ALT9
	SDCE[6]	JTAG_TDI	ALT9
	SDCE[7]	JTAG_TCK	ALT9
	SDCE[8]	JTAG_TRST_B	ALT9
	SDCE[9]	GPIO1_IO00	ALT9
	SDCLK	GPIO1_IO01	ALT9
	SDDO[0]	GPIO1_IO02	ALT9
	SDDO[1]	GPIO1_IO03	ALT9
	SDDO[2]	UART1_TXD	ALT9
	SDDO[3]	UART1_RXD	ALT9
	SDDO[4]	UART1_CTS	ALT9
	SDDO[5]	UART1_RTS	ALT9
	SDDO[6]	UART2_TXD	ALT9
	SDDO[7]	UART2_RXD	ALT9
	SDDO[8]	UART2_CTS	ALT9
	SDDO[9]	UART2_RTS	ALT9
	SDDO[10]	GPIO1_IO04	ALT9
	SDDO[11]	GPIO1_IO05	ALT9
	SDDO[12]	GPIO1_IO06	ALT9
	SDDO[13]	GPIO1_IO07	ALT9
	SDDO[14]	GPIO1_IO08	ALT9
	SDDO[15]	GPIO1_IO09	ALT9
	SDLE	UART3_TXD	ALT9
	SDOE	UART3_RXD	ALT9
	SDOED	UART3_CTS	ALT9
	SDOEZ	UART3_RTS	ALT9
	SDSHR	UART4_TXD	ALT9
	VCOM[0]	UART4_RXD	ALT9
	VCOM[1]	UART5_TXD	ALT9
FLEXCAN1	RX	ENET1_RX_DATA1	ALT4

Table continues on the next page...

Instance	Port	Pad	Mode
	TX	LCD_DATA09	ALT8
		SD1_DATA1	ALT3
		UART3_RTS_B	ALT2
		ENET1_RX_DATA0	ALT4
		LCD_DATA08	ALT8
		SD1_DATA0	ALT3
		UART3_CTS_B	ALT2
FLEXCAN2	RX	ENET1_TX_DATA0	ALT4
		LCD_DATA11	ALT8
		SD1_DATA3	ALT3
		UART2_RTS_B	ALT2
	TX	ENET1_RX_EN	ALT4
		LCD_DATA10	ALT8
		SD1_DATA2	ALT3
		UART2_CTS_B	ALT2
GPIO1	IO0	GPIO1_IO00	ALT5
	IO1	GPIO1_IO01	ALT5
	IO2	GPIO1_IO02	ALT5
	IO3	GPIO1_IO03	ALT5
	IO4	GPIO1_IO04	ALT5
	IO5	GPIO1_IO05	ALT5
	IO6	GPIO1_IO06	ALT5
	IO7	GPIO1_IO07	ALT5
	IO8	GPIO1_IO08	ALT5
	IO9	GPIO1_IO09	ALT5
	IO10	JTAG_MOD	ALT5
	IO11	JTAG_TMS	ALT5
	IO12	JTAG_TDO	ALT5
	IO13	JTAG_TDI	ALT5
	IO14	JTAG_TCK	ALT5
	IO15	JTAG_TRST_B	ALT5
	IO16	UART1_TX_DATA	ALT5
	IO17	UART1_RX_DATA	ALT5
	IO18	UART1_CTS_B	ALT5
	IO19	UART1_RTS_B	ALT5
	IO20	UART2_TX_DATA	ALT5
	IO21	UART2_RX_DATA	ALT5
	IO22	UART2_CTS_B	ALT5
	IO23	UART2_RTS_B	ALT5
	IO24	UART3_TX_DATA	ALT5
	IO25	UART3_RX_DATA	ALT5

Table continues on the next page...

Overview

Instance	Port	Pad	Mode
	IO26	UART3_CTS_B	ALT5
	IO27	UART3_RTS_B	ALT5
	IO28	UART4_TX_DATA	ALT5
	IO29	UART4_RX_DATA	ALT5
	IO30	UART5_TX_DATA	ALT5
	IO31	UART5_RX_DATA	ALT5
GPIO2	IO0	ENET1_RX_DATA0	ALT5
	IO1	ENET1_RX_DATA1	ALT5
	IO2	ENET1_RX_EN	ALT5
	IO3	ENET1_TX_DATA0	ALT5
	IO4	ENET1_TX_DATA1	ALT5
	IO5	ENET1_TX_EN	ALT5
	IO6	ENET1_TX_CLK	ALT5
	IO7	ENET1_RX_ER	ALT5
	IO8	ENET2_RX_DATA0	ALT5
	IO9	ENET2_RX_DATA1	ALT5
	IO10	ENET2_RX_EN	ALT5
	IO11	ENET2_TX_DATA0	ALT5
	IO12	ENET2_TX_DATA1	ALT5
	IO13	ENET2_TX_EN	ALT5
	IO14	ENET2_TX_CLK	ALT5
	IO15	ENET2_RX_ER	ALT5
	IO16	SD1_CMD	ALT5
	IO17	SD1_CLK	ALT5
	IO18	SD1_DATA0	ALT5
	IO19	SD1_DATA1	ALT5
	IO20	SD1_DATA2	ALT5
IO21	SD1_DATA3	ALT5	
GPIO3	IO0	LCD_CLK	ALT5
	IO1	LCD_ENABLE	ALT5
	IO2	LCD_HSYNC	ALT5
	IO3	LCD_VSYNC	ALT5
	IO4	LCD_RESET	ALT5
	IO5	LCD_DATA00	ALT5
	IO6	LCD_DATA01	ALT5
	IO7	LCD_DATA02	ALT5
	IO8	LCD_DATA03	ALT5
	IO9	LCD_DATA04	ALT5
	IO10	LCD_DATA05	ALT5
	IO11	LCD_DATA06	ALT5
IO12	LCD_DATA07	ALT5	

Table continues on the next page...

Instance	Port	Pad	Mode
	IO13	LCD_DATA08	ALT5
	IO14	LCD_DATA09	ALT5
	IO15	LCD_DATA10	ALT5
	IO16	LCD_DATA11	ALT5
	IO17	LCD_DATA12	ALT5
	IO18	LCD_DATA13	ALT5
	IO19	LCD_DATA14	ALT5
	IO20	LCD_DATA15	ALT5
	IO21	LCD_DATA16	ALT5
	IO22	LCD_DATA17	ALT5
	IO23	LCD_DATA18	ALT5
	IO24	LCD_DATA19	ALT5
	IO25	LCD_DATA20	ALT5
	IO26	LCD_DATA21	ALT5
	IO27	LCD_DATA22	ALT5
	IO28	LCD_DATA23	ALT5
GPIO4	IO0	NAND_RE_B	ALT5
	IO1	NAND_WE_B	ALT5
	IO2	NAND_DATA00	ALT5
	IO3	NAND_DATA01	ALT5
	IO4	NAND_DATA02	ALT5
	IO5	NAND_DATA03	ALT5
	IO6	NAND_DATA04	ALT5
	IO7	NAND_DATA05	ALT5
	IO8	NAND_DATA06	ALT5
	IO9	NAND_DATA07	ALT5
	IO10	NAND_ALE	ALT5
	IO11	NAND_WP_B	ALT5
	IO12	NAND_READY_B	ALT5
	IO13	NAND_CE0_B	ALT5
	IO14	NAND_CE1_B	ALT5
	IO15	NAND_CLE	ALT5
	IO16	NAND_DQS	ALT5
	IO17	CSI_MCLK	ALT5
	IO18	CSI_PIXCLK	ALT5
	IO19	CSI_VSYNC	ALT5
	IO20	CSI_HSYNC	ALT5
	IO21	CSI_DATA00	ALT5
	IO22	CSI_DATA01	ALT5
	IO23	CSI_DATA02	ALT5
IO24	CSI_DATA03	ALT5	

Table continues on the next page...

Overview

Instance	Port	Pad	Mode
	IO25	CSI_DATA04	ALT5
	IO26	CSI_DATA05	ALT5
	IO27	CSI_DATA06	ALT5
	IO28	CSI_DATA07	ALT5
GPIO5	IO0	SNVS_TAMPER0	No Muxing (ALT5)
	IO1	SNVS_TAMPER1	No Muxing (ALT5)
	IO2	SNVS_TAMPER2	No Muxing (ALT5)
	IO3	SNVS_TAMPER3	No Muxing (ALT5)
	IO4	SNVS_TAMPER4	No Muxing (ALT5)
	IO5	SNVS_TAMPER5	No Muxing (ALT5)
	IO6	SNVS_TAMPER6	No Muxing (ALT5)
	IO7	SNVS_TAMPER7	No Muxing (ALT5)
	IO8	SNVS_TAMPER8	No Muxing (ALT5)
	IO9	SNVS_TAMPER9	No Muxing (ALT5)
	IO10	BOOT_MODE0	No Muxing (ALT5)
	IO11	BOOT_MODE1	No Muxing (ALT5)
GPT1	CAPTURE1	GPIO1_IO00	ALT1
		UART2_TX_DATA	ALT4
	CAPTURE2	ENET1_RX_ER	ALT8
		UART2_RX_DATA	ALT4
	CLK	ENET1_TX_CLK	ALT8
		UART1_RX_DATA	ALT4
	COMPARE1	GPIO1_IO01	ALT1
		UART1_TX_DATA	ALT4
	COMPARE2	GPIO1_IO02	ALT1
		UART2_CTS_B	ALT4
	COMPARE3	GPIO1_IO03	ALT1
		UART2_RTS_B	ALT4
GPT2	CAPTURE1	JTAG_TMS	ALT1
		SD1_DATA2	ALT1
	CAPTURE2	JTAG_TDO	ALT1
		SD1_DATA3	ALT1
	CLK	JTAG_MOD	ALT1
		SD1_DATA1	ALT1
	COMPARE1	JTAG_TDI	ALT1
		SD1_CMD	ALT1
	COMPARE2	JTAG_TCK	ALT1
		SD1_CLK	ALT1
	COMPARE3	JTAG_TRST_B	ALT1
		SD1_DATA0	ALT1
I2C1	SCL	CSI_PIXCLK	ALT3

Table continues on the next page...

Instance	Port	Pad	Mode
		GPIO1_IO02	ALT0
		UART4_TX_DATA	ALT2
	SDA	CSI_MCLK	ALT3
		GPIO1_IO03	ALT0
		UART4_RX_DATA	ALT2
I2C2	SCL	CSI_HSYNC	ALT3
		GPIO1_IO00	ALT0
		UART5_TX_DATA	ALT2
	SDA	CSI_VSYNC	ALT3
		GPIO1_IO01	ALT0
		UART5_RX_DATA	ALT2
I2C3	SCL	ENET2_RX_DATA0	ALT3
		LCD_DATA01	ALT4
		UART1_TX_DATA	ALT2
	SDA	ENET2_RX_DATA1	ALT3
		LCD_DATA00	ALT4
		UART1_RX_DATA	ALT2
I2C4	SCL	ENET2_RX_EN	ALT3
		LCD_DATA03	ALT4
		UART2_TX_DATA	ALT2
	SDA	ENET2_TX_DATA0	ALT3
		LCD_DATA02	ALT4
		UART2_RX_DATA	ALT2
KPP	COL0	ENET1_RX_DATA1	ALT6
		NAND_WE_B	ALT3
	COL1	ENET1_TX_DATA0	ALT6
		NAND_DATA01	ALT3
	COL2	ENET1_TX_EN	ALT6
		NAND_DATA03	ALT3
	COL3	ENET1_RX_ER	ALT6
	COL4	ENET2_RX_DATA1	ALT6
	COL5	ENET2_TX_DATA0	ALT6
	COL6	ENET2_TX_EN	ALT6
	COL7	ENET2_RX_ER	ALT6
	ROW0	ENET1_RX_DATA0	ALT6
		NAND_RE_B	ALT3
	ROW1	ENET1_RX_EN	ALT6
		NAND_DATA00	ALT3
ROW2	ENET1_TX_DATA1	ALT6	
	NAND_DATA02	ALT3	
ROW3	ENET1_TX_CLK	ALT6	

Table continues on the next page...

Overview

Instance	Port	Pad	Mode
	ROW4	ENET2_RX_DATA0	ALT6
	ROW5	ENET2_RX_EN	ALT6
	ROW6	ENET2_TX_DATA1	ALT6
	ROW7	ENET2_TX_CLK	ALT6
LCDIF	BUSY	LCD_VSYNC	ALT1
	CLK	LCD_CLK	ALT0
	CS	LCD_RESET	ALT1
	DATA0	LCD_DATA00	ALT0
	DATA1	LCD_DATA01	ALT0
	DATA2	LCD_DATA02	ALT0
	DATA3	LCD_DATA03	ALT0
	DATA4	LCD_DATA04	ALT0
	DATA5	LCD_DATA05	ALT0
	DATA6	LCD_DATA06	ALT0
	DATA7	LCD_DATA07	ALT0
	DATA8	LCD_DATA08	ALT0
	DATA9	LCD_DATA09	ALT0
	DATA10	LCD_DATA10	ALT0
	DATA11	LCD_DATA11	ALT0
	DATA12	LCD_DATA12	ALT0
	DATA13	LCD_DATA13	ALT0
	DATA14	LCD_DATA14	ALT0
	DATA15	LCD_DATA15	ALT0
	DATA16	LCD_DATA16	ALT0
	DATA17	LCD_DATA17	ALT0
	DATA18	LCD_DATA18	ALT0
	DATA19	LCD_DATA19	ALT0
	DATA20	LCD_DATA20	ALT0
	DATA21	LCD_DATA21	ALT0
	DATA22	LCD_DATA22	ALT0
	DATA23	LCD_DATA23	ALT0
	ENABLE	LCD_ENABLE	ALT0
	HSYNC	LCD_HSYNC	ALT0
	RD_E	LCD_ENABLE	ALT1
RESET	LCD_RESET	ALT0	
RS	LCD_HSYNC	ALT1	
VSYNC	LCD_VSYNC	ALT0	
WR_RWN	LCD_CLK	ALT1	
MMDC	ADDR0	DRAM_ADDR00	No Muxing (ALT0)
	ADDR1	DRAM_ADDR01	No Muxing (ALT0)
	ADDR2	DRAM_ADDR02	No Muxing (ALT0)

Table continues on the next page...

Instance	Port	Pad	Mode
	ADDR3	DRAM_ADDR03	No Muxing (ALT0)
	ADDR4	DRAM_ADDR04	No Muxing (ALT0)
	ADDR5	DRAM_ADDR05	No Muxing (ALT0)
	ADDR6	DRAM_ADDR06	No Muxing (ALT0)
	ADDR7	DRAM_ADDR07	No Muxing (ALT0)
	ADDR8	DRAM_ADDR08	No Muxing (ALT0)
	ADDR9	DRAM_ADDR09	No Muxing (ALT0)
	ADDR10	DRAM_ADDR10	No Muxing (ALT0)
	ADDR11	DRAM_ADDR11	No Muxing (ALT0)
	ADDR12	DRAM_ADDR12	No Muxing (ALT0)
	ADDR13	DRAM_ADDR13	No Muxing (ALT0)
	ADDR14	DRAM_ADDR14	No Muxing (ALT0)
	ADDR15	DRAM_ADDR15	No Muxing (ALT0)
	CAS_B	DRAM_CAS_B	No Muxing (ALT0)
	CS0_B	DRAM_CS0_B	No Muxing (ALT0)
	CS1_B	DRAM_CS1_B	No Muxing (ALT0)
	DATA0	DRAM_DATA00	No Muxing (ALT0)
	DATA1	DRAM_DATA01	No Muxing (ALT0)
	DATA2	DRAM_DATA02	No Muxing (ALT0)
	DATA3	DRAM_DATA03	No Muxing (ALT0)
	DATA4	DRAM_DATA04	No Muxing (ALT0)
	DATA5	DRAM_DATA05	No Muxing (ALT0)
	DATA6	DRAM_DATA06	No Muxing (ALT0)
	DATA7	DRAM_DATA07	No Muxing (ALT0)
	DATA8	DRAM_DATA08	No Muxing (ALT0)
	DATA9	DRAM_DATA09	No Muxing (ALT0)
	DATA10	DRAM_DATA10	No Muxing (ALT0)
	DATA11	DRAM_DATA11	No Muxing (ALT0)
	DATA12	DRAM_DATA12	No Muxing (ALT0)
	DATA13	DRAM_DATA13	No Muxing (ALT0)
	DATA14	DRAM_DATA14	No Muxing (ALT0)
	DATA15	DRAM_DATA15	No Muxing (ALT0)
	DQM0	DRAM_DQM0	No Muxing (ALT0)
	DQM1	DRAM_DQM1	No Muxing (ALT0)
	ODT0	DRAM_ODT0	No Muxing (ALT0)
	ODT1	DRAM_ODT1	No Muxing (ALT0)
	RAS_B	DRAM_RAS_B	No Muxing (ALT0)
	RESET	DRAM_RESET	No Muxing (ALT0)
	SDBA0	DRAM_SDBA0	No Muxing (ALT0)
	SDBA1	DRAM_SDBA1	No Muxing (ALT0)
	SDBA2	DRAM_SDBA2	No Muxing (ALT0)

Table continues on the next page...

Overview

Instance	Port	Pad	Mode
	SDCKE0	DRAM_SDCKE0	No Muxing (ALT0)
	SDCKE1	DRAM_SDCKE1	No Muxing (ALT0)
	SDCLK0_P	DRAM_SDCLK0_P	No Muxing (ALT0)
	SDCLK0_N	DRAM_SDCLK0_N	No Muxing (ALT0)
	SDQS0_P	DRAM_SDQS0_P	No Muxing (ALT0)
	SDQS0_N	DRAM_SDQS0_N	No Muxing (ALT0)
	SDQS1_P	DRAM_SDQS1_P	No Muxing (ALT0)
	SDQS1_N	DRAM_SDQS1_N	No Muxing (ALT0)
	SDWE_B	DRAM_SDWE_B	No Muxing (ALT0)
MQS	LEFT	GPIO1_IO01	ALT4
		JTAG_TDI	ALT6
		LCD_DATA23	ALT1
	RIGHT	GPIO1_IO00	ALT4
		JTAG_TDO	ALT6
		LCD_DATA22	ALT1
NAND	ALE	NAND_ALE	ALT0
	CE0_B	NAND_CE0_B	ALT0
	CE1_B	NAND_CE1_B	ALT0
	CE2_B	CSI_MCLK	ALT2
	CE3_B	CSI_PIXCLK	ALT2
	CLE	NAND_CLE	ALT0
	DATA00	NAND_DATA00	ALT0
	DATA01	NAND_DATA01	ALT0
	DATA02	NAND_DATA02	ALT0
	DATA03	NAND_DATA03	ALT0
	DATA04	NAND_DATA04	ALT0
	DATA05	NAND_DATA05	ALT0
	DATA06	NAND_DATA06	ALT0
	DATA07	NAND_DATA07	ALT0
	DQS	NAND_DQS	ALT0
	READY_B	NAND_READY_B	ALT0
	RE_B	NAND_RE_B	ALT0
	WE_B	NAND_WE_B	ALT0
	WP_B	NAND_WP_B	ALT0
PWM1	OUT	ENET1_RX_DATA0	ALT2
		GPIO1_IO08	ALT0
		LCD_DATA00	ALT1
PWM2	OUT	ENET1_RX_DATA1	ALT2
		GPIO1_IO09	ALT0
		LCD_DATA01	ALT1
PWM3	OUT	GPIO1_IO04	ALT1

Table continues on the next page...

Instance	Port	Pad	Mode
		LCD_DATA02	ALT1
		NAND_ALE	ALT3
PWM4	OUT	GPIO1_IO05	ALT1
		LCD_DATA03	ALT1
		NAND_WP_B	ALT3
PWM5	OUT	ENET1_TX_DATA1	ALT2
		LCD_DATA18	ALT1
		NAND_DQS	ALT3
PWM6	OUT	ENET1_TX_EN	ALT2
		JTAG_TDI	ALT4
		LCD_DATA19	ALT1
PWM7	OUT	CSI_VSYNC	ALT6
		ENET1_TX_CLK	ALT2
		JTAG_TCK	ALT4
PWM8	OUT	CSI_HSYNC	ALT6
		ENET1_RX_ER	ALT2
		JTAG_TRST_B	ALT4
QSPI	A_DATA0	NAND_READY_B	ALT2
	A_DATA1	NAND_CE0_B	ALT2
	A_DATA2	NAND_CE1_B	ALT2
	A_DATA3	NAND_CLE	ALT2
	A_DQS	NAND_ALE	ALT2
	A_SCLK	NAND_WP_B	ALT2
	A_SS0_B	NAND_DQS	ALT2
	A_SS1_B	NAND_DATA07	ALT2
	B_DATA0	NAND_DATA02	ALT2
	B_DATA1	NAND_DATA03	ALT2
	B_DATA2	NAND_DATA04	ALT2
	B_DATA3	NAND_DATA05	ALT2
	B_DQS	NAND_DATA01	ALT2
	B_SCLK	NAND_RE_B	ALT2
	B_SS0_B	NAND_WE_B	ALT2
	B_SS1_B	NAND_DATA00	ALT2
SAI1	MCLK	CSI_DATA01	ALT6
		LCD_DATA00	ALT8
	RX_BCLK	CSI_DATA03	ALT6
	RX_DATA	CSI_DATA06	ALT6
		LCD_DATA03	ALT8
	RX_SYNC	CSI_DATA02	ALT6
	TX_BCLK	CSI_DATA05	ALT6
LCD_DATA02		ALT8	

Table continues on the next page...

Overview

Instance	Port	Pad	Mode
	TX_DATA	CSI_DATA07	ALT6
		LCD_DATA04	ALT8
	TX_SYNC	CSI_DATA04	ALT6
		LCD_DATA01	ALT8
SAI2	MCLK	JTAG_TMS	ALT2
		SD1_CLK	ALT2
	RX_BCLK	NAND_DATA06	ALT2
	RX_DATA	JTAG_TCK	ALT2
		SD1_DATA2	ALT2
	RX_SYNC	SD1_CMD	ALT2
	TX_BCLK	JTAG_TDI	ALT2
		SD1_DATA1	ALT2
	TX_DATA	JTAG_TRST_B	ALT2
		SD1_DATA3	ALT2
TX_SYNC	JTAG_TDO	ALT2	
	SD1_DATA0	ALT2	
SAI3	MCLK	LCD_CLK	ALT3
		LCD_DATA09	ALT1
	RX_BCLK	LCD_DATA11	ALT1
	RX_DATA	LCD_DATA14	ALT1
	RX_SYNC	LCD_VSYNC	ALT3
		LCD_DATA10	ALT1
	TX_BCLK	LCD_DATA13	ALT1
		LCD_HSYNC	ALT3
	TX_DATA	LCD_DATA15	ALT1
		LCD_RESET	ALT3
TX_SYNC	LCD_DATA12	ALT1	
	LCD_ENABLE	ALT3	
SDMA	EXT_EVENT0	GPIO1_IO02	ALT6
		JTAG_MOD	ALT6
		SD1_CMD	ALT6
	EXT_EVENT1	JTAG_TMS	ALT6
		NAND_DQS	ALT6
SJC	DE_B	UART2_CTS_B	ALT7
	MOD	JTAG_MOD	ALT0
	TCK	JTAG_TCK	ALT0
	TDI	JTAG_TDI	ALT0
	TDO	JTAG_TDO	ALT0
	TMS	JTAG_TMS	ALT0
	TRSTB	JTAG_TRST_B	ALT0
SNVS	VIO_5	CSI_PIXCLK	ALT6

Table continues on the next page...

Instance	Port	Pad	Mode	
	VIO_5_CTL	CSI_MCLK	ALT6	
	PMIC_ON_REQ	SNVS_PMIC_ON_REQ	No Muxing (ALT0)	
SRC	BT_CFG0	LCD_DATA00	ALT6	
	BT_CFG1	LCD_DATA01	ALT6	
	BT_CFG2	LCD_DATA02	ALT6	
	BT_CFG3	LCD_DATA03	ALT6	
	BT_CFG4	LCD_DATA04	ALT6	
	BT_CFG5	LCD_DATA05	ALT6	
	BT_CFG6	LCD_DATA06	ALT6	
	BT_CFG7	LCD_DATA07	ALT6	
	BT_CFG8	LCD_DATA08	ALT6	
	BT_CFG9	LCD_DATA09	ALT6	
	BT_CFG10	LCD_DATA10	ALT6	
	BT_CFG11	LCD_DATA11	ALT6	
	BT_CFG12	LCD_DATA12	ALT6	
	BT_CFG13	LCD_DATA13	ALT6	
	BT_CFG14	LCD_DATA14	ALT6	
	BT_CFG15	LCD_DATA15	ALT6	
	BT_CFG24	LCD_DATA16	ALT6	
	BT_CFG25	LCD_DATA17	ALT6	
	BT_CFG26	LCD_DATA18	ALT6	
	BT_CFG27	LCD_DATA19	ALT6	
	BT_CFG28	LCD_DATA20	ALT6	
	BT_CFG29	LCD_DATA21	ALT6	
	BT_CFG30	LCD_DATA22	ALT6	
	BT_CFG31	LCD_DATA23	ALT6	
		POR_B	POR_B	No Muxing (ALT0)
		ONOFF	ONOFF	No Muxing (ALT0)
	BOOT_MODE0	BOOT_MODE0	No Muxing	
	BOOT_MODE1	BOOT_MODE1	No Muxing	
SPDIF	EXT_CLK	LCD_DATA07	ALT4	
		NAND_DQS	ALT8	
	IN	GPIO1_IO09	ALT2	
		LCD_DATA08	ALT1	
		SD1_CLK	ALT3	
		UART1_RX_DATA	ALT8	
	LOCK	LCD_DATA06	ALT4	
	OUT	GPIO1_IO08	ALT2	
		JTAG_MOD	ALT2	
		LCD_DATA05	ALT4	
SD1_CMD		ALT3		

Table continues on the next page...

Overview

Instance	Port	Pad	Mode
UART1		UART1_TX_DATA	ALT8
	SR_CLK	LCD_DATA04	ALT4
	CTS_B	GPIO1_IO06	ALT8
		UART1_CTS_B	ALT0
	RTS_B	GPIO1_IO07	ALT8
		UART1_RTS_B	ALT0
	RX_DATA	GPIO1_IO03	ALT8
UART1_RX_DATA		ALT0	
TX_DATA	GPIO1_IO02	ALT8	
	UART1_TX_DATA	ALT0	
UART2	CTS_B	NAND_DATA06	ALT8
		UART2_CTS_B	ALT0
		UART3_TX_DATA	ALT4
	RTS_B	NAND_DATA07	ALT8
		UART2_RTS_B	ALT0
		UART3_RX_DATA	ALT4
	RX_DATA	NAND_DATA05	ALT8
		UART2_RX_DATA	ALT0
	TX_DATA	NAND_DATA04	ALT8
		UART2_TX_DATA	ALT0
UART3	CTS_B	NAND_CE1_B	ALT8
		UART3_CTS_B	ALT0
	RTS_B	NAND_CLE	ALT8
		UART3_RTS_B	ALT0
	RX_DATA	NAND_CE0_B	ALT8
		UART3_RX_DATA	ALT0
TX_DATA	NAND_READY_B	ALT8	
	UART3_TX_DATA	ALT0	
UART4	CTS_B	ENET1_RX_DATA1	ALT1
		LCD_HSYNC	ALT2
	RTS_B	ENET1_RX_DATA0	ALT1
		LCD_VSYNC	ALT2
	RX_DATA	LCD_ENABLE	ALT2
		UART4_RX_DATA	ALT0
TX_DATA	LCD_CLK	ALT2	
	UART4_TX_DATA	ALT0	
UART5	CTS_B	CSI_DATA03	ALT8
		ENET1_TX_DATA0	ALT1
		GPIO1_IO09	ALT8
	RTS_B	CSI_DATA02	ALT8
		ENET1_RX_EN	ALT1

Table continues on the next page...

Instance	Port	Pad	Mode	
	RX_DATA	GPIO1_IO08	ALT8	
		CSI_DATA01	ALT8	
		GPIO1_IO05	ALT8	
	TX_DATA	UART5_RX_DATA	ALT0	
		CSI_DATA00	ALT8	
		GPIO1_IO04	ALT8	
UART6	CTS_B	UART5_TX_DATA	ALT0	
		CSI_HSYNC	ALT8	
	RTS_B	ENET1_TX_DATA1	ALT1	
		CSI_VSYNC	ALT8	
	RX_DATA	ENET1_TX_EN	ALT1	
		CSI_PIXCLK	ALT8	
	TX_DATA	ENET2_RX_DATA1	ALT1	
		CSI_MCLK	ALT8	
	UART7	CTS_B	ENET2_RX_DATA0	ALT1
			ENET1_TX_CLK	ALT1
		RTS_B	LCD_DATA06	ALT1
			ENET1_RX_ER	ALT1
RX_DATA		LCD_DATA07	ALT1	
		ENET2_TX_DATA0	ALT1	
TX_DATA		LCD_DATA17	ALT1	
		ENET2_RX_EN	ALT1	
UART8		CTS_B	LCD_DATA16	ALT1
			ENET2_TX_CLK	ALT1
		RTS_B	LCD_DATA04	ALT1
			ENET2_RX_ER	ALT1
	RX_DATA	LCD_DATA05	ALT1	
		ENET2_TX_EN	ALT1	
	TX_DATA	LCD_DATA21	ALT1	
		ENET2_TX_DATA1	ALT1	
	USB	OTG1_ID	LCD_DATA20	ALT1
			GPIO1_IO00	ALT2
			SD1_DATA0	ALT8
		OTG2_ID	UART3_TX_DATA	ALT8
ENET2_TX_CLK			ALT8	
GPIO1_IO05			ALT2	
OTG1_OC		SD1_DATA3	ALT8	
		ENET2_RX_DATA1	ALT8	
		GPIO1_IO01	ALT2	
OTG1_PWR		SD1_CLK	ALT8	
		ENET2_RX_DATA0	ALT8	

Table continues on the next page...

Overview

Instance	Port	Pad	Mode	
		GPIO1_IO04	ALT2	
		SD1_CMD	ALT8	
		ENET2_TX_EN	ALT8	
	OTG2_OC	GPIO1_IO03	ALT2	
		SD1_DATA2	ALT8	
		ENET2_TX_DATA1	ALT8	
	OTG2_PWR	GPIO1_IO02	ALT2	
		SD1_DATA1	ALT8	
USDHC1	CD_B	CSI_DATA05	ALT8	
		GPIO1_IO03	ALT4	
		UART1_RTS_B	ALT2	
	CLK	SD1_CLK	ALT0	
	CMD	SD1_CMD	ALT0	
	DATA0	SD1_DATA0	ALT0	
	DATA1	SD1_DATA1	ALT0	
	DATA2	SD1_DATA2	ALT0	
	DATA3	SD1_DATA3	ALT0	
	DATA4	NAND_READY_B	ALT1	
	DATA5	NAND_CE0_B	ALT1	
	DATA6	NAND_CE1_B	ALT1	
	DATA7	NAND_CLE	ALT1	
	LCTL	ENET1_RX_DATA0	ALT8	
	RESET_B	CSI_DATA06	ALT8	
		GPIO1_IO04	ALT4	
		GPIO1_IO09	ALT6	
		NAND_WP_B	ALT1	
	VSELECT	CSI_DATA07	ALT8	
		ENET1_RX_EN	ALT8	
		GPIO1_IO05	ALT4	
	WP	CSI_DATA04	ALT8	
		GPIO1_IO02	ALT4	
		UART1_CTS_B	ALT2	
	USDHC2	CD_B	CSI_MCLK	ALT1
			GPIO1_IO07	ALT4
			UART1_RTS_B	ALT8
CLK		CSI_VSYNC	ALT1	
		LCD_DATA19	ALT8	
		NAND_RE_B	ALT1	
CMD		CSI_HSYNC	ALT1	
		LCD_DATA18	ALT8	
		NAND_WE_B	ALT1	

Table continues on the next page...

Instance	Port	Pad	Mode	
	DATA0	CSI_DATA00	ALT1	
		LCD_DATA20	ALT8	
		NAND_DATA00	ALT1	
	DATA1	CSI_DATA01	ALT1	
		LCD_DATA21	ALT8	
		NAND_DATA01	ALT1	
	DATA2	CSI_DATA02	ALT1	
		LCD_DATA22	ALT8	
		NAND_DATA02	ALT1	
	DATA3	CSI_DATA03	ALT1	
		LCD_DATA23	ALT8	
		NAND_DATA03	ALT1	
	DATA4	CSI_DATA04	ALT1	
		LCD_DATA14	ALT8	
		NAND_DATA04	ALT1	
	DATA5	CSI_DATA05	ALT1	
		LCD_DATA15	ALT8	
		NAND_DATA05	ALT1	
	DATA6	CSI_DATA06	ALT1	
		LCD_DATA16	ALT8	
		NAND_DATA06	ALT1	
	DATA7	CSI_DATA07	ALT1	
		LCD_DATA17	ALT8	
		NAND_DATA07	ALT1	
	LCTL		ENET1_RX_DATA1	ALT8
	RESET_B		GPIO1_IO09	ALT4
			LCD_DATA13	ALT8
		NAND_ALE	ALT1	
VSELECT		ENET1_TX_DATA0	ALT8	
		GPIO1_IO08	ALT4	
WP		CSI_PIXCLK	ALT1	
		GPIO1_IO06	ALT4	
		UART1_CTS_B	ALT8	
WDOG1	WDOG_ANY	ENET2_RX_ER	ALT8	
		GPIO1_IO09	ALT1	
		LCD_DATA19	ALT2	
		LCD_RESET	ALT4	
	WDOG_B	GPIO1_IO01	ALT8	
		GPIO1_IO08	ALT1	
		UART3_RTS_B	ALT8	
	WDOG_RST_B_DEB		ENET1_TX_DATA1	ALT8

Table continues on the next page...

Overview

Instance	Port	Pad	Mode
		LCD_CLK	ALT8
WDOG2	WDOG_B	LCD_VSYNC	ALT4
	WDOG_RST_B_DEB	ENET1_TX_EN	ALT8
WDOG3	WDOG_B	GPIO1_IO00	ALT8
	WDOG_RST_B_DEB	LCD_HSYNC	ALT4
XTALOSC	REF_CLK_32K	ENET1_RX_EN	ALT2
		GPIO1_IO03	ALT3
		JTAG_TCK	ALT6
	REF_CLK_24M	ENET1_TX_DATA0	ALT2
		ENET2_TX_DATA0	ALT8
		GPIO1_IO04	ALT3
		JTAG_TRST_B	ALT6
	REF_CLK1	ENET1_TX_CLK	ALT4
		GPIO1_IO00	ALT3
		GPIO1_IO04	ALT0
	REF_CLK_25M	ENET2_RX_EN	ALT8
		GPIO1_IO02	ALT3
		JTAG_MOD	ALT3
	REF_CLK2	ENET2_TX_CLK	ALT4
		GPIO1_IO01	ALT3
		GPIO1_IO05	ALT0
	XTALI	XTALI	no muxing
XTALO	XTALO	no muxing	

Chapter 5

Fusemap

5.1 Boot Fusemap

The following section details the various modes and selection of the required boot devices.

A separate map is given for each and every boot device. The device select is specified by BOOT_CFG1[6:4] fuses listed in [Table 5-1](#).

Table 5-1. Boot Device Select

Boot Device	BOOT_CFG1[7]	BOOT_CFG1[6]	BOOT_CFG1[5]	BOOT_CFG1[4]	BOOT_CFG1[3]	BOOT_CFG1[2]	BOOT_CFG1[1]	BOOT_CFG1[0]
QSPI	0	0	0	1	0 - QSPI0	DDRSMP: 000 - Default 001 - 111	DDRSMP: 000 - Default 001 - 111	DDRSMP: 000 - Default 001 - 111
WEIM	0	0	0	0	Memory Type: 0 - NOR Flash 1 - OneNAND	Reserved	Reserved	Reserved
Serial-ROM	0	0	1	1	Reserved	Reserved	Reserved	Reserved
SD/eSD	0	1	0	Fast boot: 0 - Regular 1 - Fast boot	SD/SDXC speed: 00 - Normal/SDR12 01 - High/SDR25 10 - SDR50 11 - SDR104	SD/SDXC speed: 00 - Normal/SDR12 01 - High/SDR25 10 - SDR50 11 - SDR104	SD power cycle enable: 0 - No power cycle 1 - Enabled via USDHC_RS T pad (uSDHC3 and 4 only)	SD loopback clock source sel (for SDR50 and SDR104 only): 0 - Through SD pad 1 - Direct

Table continues on the next page...

Table 5-1. Boot Device Select (continued)

Boot Device	BOOT_CF G1[7]	BOOT_CF G1[6]	BOOT_CF G1[5]	BOOT_CF G1[4]	BOOT_CF G1[3]	BOOT_CF G1[2]	BOOT_CF G1[1]	BOOT_CF G1[0]
MMC/eMMC	0	1	1	Fast boot: 0 - Regular 1 - Fast boot	SD/MMC speed: 0 - Normal 1 - High	Fast boot acknowledge disable: 0 - Boot ack enabled 1 - Boot ack disabled	SD power cycle enable: 0 - No power cycle 1 - Enabled via USDHC_RST pad (uSDHC3 and 4 only)	SD loopback clock source sel (for SDR50 and SDR104 only): 0 - Through SD pad 1 - Direct
NAND	1	BT_TOGGL EMODE	Pages in block: 00 - 128 01 - 64 10 - 32 11 - 256	Pages in block: 00 - 128 01 - 64 10 - 32 11 - 256	Nand number of devices: 00 - 1 01 - 2 10 - 4 11 - Reserved	Nand number of devices: 00 - 1 01 - 2 10 - 4 11 - Reserved	Nand_Row_address_bytes: 00 - 3 01 - 2 10 - 4 11 - 5	Nand_Row_address_bytes: 00 - 3 01 - 2 10 - 4 11 - 5

NOTE

Fuses marked as “Reserved” are reserved for NXP internal (and future) use only. Customers should not attempt to burn these, as the IC behavior may be unpredictable. The reserved fuses can be read as either '0' or '1'.

Table 5-2. QSPI Boot Fusemap

Addr	7	6	5	4	3	2	1	0
0x450[7:0] (BOOT_CFG1)	0	0	0	1	x	DDRSMP: 000 - Default		
0x450[15:8] (BOOT_CFG2)	Reserved	HSPHS: Half Speed Phase Selection 0 - select sampling at non-inverted clock 1 - select sampling at inverted clock	HSDLY: Half Speed Delay selection 0 - one clock delay 1 - two clock delay	FSPHS: Full Speed Phase Selection 0 - select sampling at non-inverted clock 1 - select sampling at inverted clock	FSDLY: Full Speed Delay selection 0 - one clock delay 1 - two clock delay	Boot Frequencies (ARM/DDR) 0 - 500 / 400 MHz 1 - 250 / 200 MHz	Reserved	Reserved

Table continues on the next page...

Table 5-2. QSPI Boot Fusemap (continued)

Addr	7	6	5	4	3	2	1	0
0x450[23:16] (BOOT_CFG3)	Reserved							
0x460[7:0]	Reserved		FORCE_C OLD_BOOT	BT_FUSE_ SEL	DIR_BT_DI S	Reserved	SEC_CONF IG[1]	Reserved
0x460[15:8]	Reserved							
0x460[23:16]	JTAG_SMODE[1:0]		WDOG_EN ABLE 0 - Disabled 1 - Enabled	SJC_DISAB LE	Reserved			
0x460[31:24]	Reserved			TZASC_EN ABLE	JTAG_HEO	KTE	Reserved	DLL_ENAB LE 0 - Disable DLL for SD/ eMMC 1 - Enable DLL for SD/ eMMC
0x470[7:0]	Not used				Reserved	L1 I-Cache DISABLE	BT_MMU_D ISABLE	Reserved
0x470[15:8]	Reserved	Not used	Reserved	ADD_DS_ SET_GPR1 _16 0 - Set 1 - Don't set	Reserved			
0x470[23:16]	Reserved	LPB_BOOT (Core / DDR- Bus) 00 - LPB Disable 01 - 1 GPIO (def freq) 10 - Div by2 11 - Div by 4	BT_LPB_P OLARITY (GPIO polarity) 0 - Active High 1 -Active Low	Reserved				

Table 5-3. EIM Boot Fusemap

Addr	7	6	5	4	3	2	1	0
0x450[7:0] (BOOT_CFG1)	0	0	0	0	Memory Type: 0 - NOR Flash 1 - OneNAND	Reserved	Reserved	Reserved

Table continues on the next page...

Table 5-3. EIM Boot Fusemap (continued)

Addr	7	6	5	4	3	2	1	0
0x450[15:8] (BOOT_CFG2)	Muxing Scheme: 00 - A/D16 (HW Default in external boot) 01 - A+DH 10 - A+DL 11 - Reserved		OneNand Page Size: 00 - 1KB 01 - 2KB 10 - 4KB 11 - Reserved		Reserved	Boot Frequencies (ARM/DDR) 0 - 500 / 400 MHz 1 - 250 / 200 MHz	Reserved	Reserved
0x450[23:16] (BOOT_CFG3)	Reserved							
0x450[31:24] (BOOT_CFG4)	Reserved	EEPROM Recovery Enable 0 - Disabled 1 - Enabled Fuse is Reserved for 'Serial-ROM' Boot mode	eCSPI chip select: 00 - ECSPiX_SS0 (default) 01 - ECSPiX_SS1 10 - ECSPiX_SS2 11 - ECSPiX_SS3		eCSPI Addressing: 0 - 2-bytes (16-bit) 1 - 3-bytes (24-bit)	Port Select: 000 - eCSPI1 001 - eCSPI2 010 - eCSPI3 011 - eCSPI4 100 - Reserved 101 - Reserved 110 - Reserved 111 - Reserved		
0x460[7:0]	Reserved		FORCE_C OLD_BOOT	BT_FUSE_ SEL	DIR_BT_DI S	Reserved	SEC_CONF IG[1]	Reserved
0x460[15:8]	Reserved							
0x460[23:16]	JTAG_SMODE[1:0]		WDOG_EN ABLE 0 - Disabled 1 - Enabled	SJC_DISAB LE	Reserved			
0x460[31:24]	Reserved			TZASC_EN ABLE	JTAG_HEO	KTE	Reserved	DLL_ENAB LE 0 - Disable DLL for SD/ eMMC 1 - Enable DLL for SD/ eMMC
0x470[7:0]	DLL Override: 0 - DLL Slave Mode for SD/ eMMC 1 - DLL Override Mode for SD/eMMC	SD1_RST_ POLARITY_ SELECT 0 - Reset active low 1 - Reset active high	SD2 VOLTAGE SELECTIO N 0 - 3.3V 1 - 1.8V	Reserved	Disable SDMMC Manufactur e mode 0 - Enable 1 - Disable	L1 I-Cache DISABLE	BT_MMU_D ISABLE	Override SD Pad Settings (using PAD_SETTI NGS value)

Table continues on the next page...

Table 5-3. EIM Boot Fusemap (continued)

Addr	7	6	5	4	3	2	1	0
0x470[15:8]	SD2_RST_POLARITY_SELECT 0 - Reset active low 1 - Reset active high	eMMC 4.4 - RESET TO PRE-IDLE STATE	Override HYS bit for SD/MMC pads	USDHC_PAD_PULL_DOWN 0 - no action 1 - pull down	ENABLE_EMMC_22K_PULLUP 0 - 47K pullup 1 - 22K pullup	ADD_DS_SET_GPR1_16 0 - Set 1 - Do not set	USDHC_IOMUXION_BIT_ENABLE 0 - Disable 1 - Enable	USDHC_IOMUX_SRE Enable 0 - Disable 1 - Enable
0x470[23:16]	Reserved	LPB_BOOT (Core / DDR-Bus) 00 - LPB Disable 01 - 1 GPIO (def freq) 10 - Div by 2 11 - Div by 4	BT_LPB_POLARITY (GPIO polarity) 0 - Active High 1 -Active Low	Reserved				
0x470[31:24]	Override NAND Pad Settings (Use PAD_SETTINGS value)	MMC_DLL_DLY[6:0]						
0x6D0[7:0]	RANDOMIZER_ENABLE	Reserved	PAD_SETTINGS[5:0]					

Table 5-4. Serial-ROM Boot Fusemap

Addr	7	6	5	4	3	2	1	0
0x450[7:0] (BOOT_CFG1)	0	0	1	1	Reserved	Reserved	Reserved	Reserved
0x450[15:8] (BOOT_CFG2)	Reserved	Reserved	Reserved	Reserved	Reserved	Boot Frequencies (ARM/DDR) 0 - 500 / 400 MHz 1 - 250 / 200 MHz	Reserved	Reserved
0x450[23:16] (BOOT_CFG3)	Reserved							
0x450[31:24] (BOOT_CFG4)	Reserved	EEPROM Recovery Enable 0 - Disabled	eCSPI chip select: 00 - ECSPiX_SS0 (default) 01 - ECSPiX_SS1 10 - ECSPiX_SS2	eCSPI Addressing: 0 - 2-bytes (16-bit) 1 - 3-bytes (24-bit)	Port Select: 000 - eCSPI1 001 - eCSPI2 010 - eCSPI3 011 - eCSPI4			

Table continues on the next page...

Table 5-4. Serial-ROM Boot Fusemap (continued)

Addr	7	6	5	4	3	2	1	0
		1 - Enabled Fuse is Reserved for 'Serial- ROM' Boot mode	11 - ECSPiX_SS3			100 - Reserved 101 - Reserved 110 - Reserved 111 - Reserved		
0x460[7:0]	Reserved		FORCE_C OLD_BOOT	BT_FUSE_ SEL	DIR_BT_DI S	Reserved	SEC_CONF IG[1]	Reserved
0x460[15:8]	Reserved							
0x460[23:16]	JTAG_SMODE[1:0]		WDOG_EN ABLE 0 - Disabled 1 - Enabled	SJC_DISAB LE	Reserved			
0x460[31:24]	Reserved			TZASC_EN ABLE	JTAG_HEO	KTE	Reserved	DLL_ENAB LE 0 - Disable DLL for SD/ eMMC 1 - Enable DLL for SD/ eMMC
0x470[7:0]	DLL Override: 0 - DLL Slave Mode for SD/ eMMC 1 - DLL Override Mode for SD/eMMC	SD1_RST_ POLARITY_ SELECT 0 - Reset active low 1 - Reset active high	SD2 VOLTAGE SELECTIO N 0 - 3.3V 1 - 1.8V	Reserved	Disable SDMMC Manufactur e mode 0 - Enable 1 - Disable	L1 I-Cache DISABLE	BT_MMU_D ISABLE	Override SD Pad Settings (using PAD_SETTI NGS value)
0x470[15:8]	SD2_RST_ POLARITY_ SELECT 0 - Reset active low 1 - Reset active high	eMMC 4.4 - RESET TO PRE-IDLE STATE	Override HYS bit for SD/MMC pads	USDHC_PA D_PULL_D OWN 0 - no action 1 - pull down	ENABLE_E MMC_22K_ PULLUP 0 - 47K pullup 1 - 22K pullup	ADD_DS_ SET_GPR1 _16 0 - Set 1 - Do not set	USDHC_IO MUX_SION _BIT_ENAB LE 0 - Disable 1 - Enable	USDHC IOMUX SRE Enable 0 - Disable 1 - Enable
0x470[23:16]	Reserved	LPB_BOOT (Core / DDR- Bus) 00 - LPB Disable 01 - 1 GPIO (def freq) 10 - Div by2 11 - Div by 4	BT_LPB_P OLARITY (GPIO polarity) 0 - Active High 1 -Active Low	Reserved				

Table continues on the next page...

Table 5-4. Serial-ROM Boot Fusemap (continued)

Addr	7	6	5	4	3	2	1	0
0x470[31:24]	Override NAND Pad Settings (Use PAD_SETTINGS value)	MMC_DLL_DLY[6:0]						
0x6D0[7:0]	RANDOMIZER_ENABLE	Reserved	PAD_SETTINGS[5:0]					

Table 5-5. SD/eSD Boot Fusemap

Addr	7	6	5	4	3	2	1	0
0x450[7:0] (BOOT_CFG1)	0	1	0	Fast Boot: 0 - Regular 1 - Fast Boot	SD/SDXC Speed 00 - Normal/SDR12 01 - High/SDR25 10 - SDR50 11 - SDR104	SD Power Cycle Enable 0 - No power cycle 1 - Enabled via USDHC_RST pad	SD Loopback Clock Source Sel (for SDR50 and SDR104 only) 0 - through SD pad 1 - direct	
0x450[15:8] (BOOT_CFG2)	SD Calibration Step 00 - 1 delay cell		Bus Width: 0 - 1-bit 1 - 4-bit	Port Select: 00 - eSDHC1 01 - eSDHC2 10 - Reserved 11 - Reserved	Boot Frequencies (ARM/DDR) 0 - 500 / 400 MHz 1 - 250 / 200 MHz	SD VOLTAGE SELECTION 0 - 3.3V 1 - 1.8V	Reserved	
0x450[23:16] (BOOT_CFG3)	Reserved							
0x450[31:24] (BOOT_CFG4)	Reserved	EEPROM Recovery Enable 0 - Disabled 1 - Enabled Fuse is Reserved for 'Serial-ROM' Boot mode	eCSPI chip select: 00 - ECSPiX_SS0 (default) 01 - ECSPiX_SS1 10 - ECSPiX_SS2 11 - ECSPiX_SS3	eCSPI Addressing: 0 - 2-bytes (16-bit) 1 - 3-bytes (24-bit)	Port Select: 000 - eCSPI1 001 - eCSPI2 010 - eCSPI3 011 - eCSPI4 100 - Reserved 101 - Reserved 110 - Reserved 111 - Reserved			
0x460[7:0]	Reserved		FORCE_COLD_BOOT	BT_FUSE_SEL	DIR_BT_DISS	Reserved	SEC_CONFIG[1]	Reserved

Table continues on the next page...

Table 5-5. SD/eSD Boot Fusemap (continued)

Addr	7	6	5	4	3	2	1	0
0x460[15:8]	Reserved							
0x460[23:16]	JTAG_SMODE[1:0]	WDOG_EN ABLE 0 - Disabled 1 - Enabled		SJC_DISAB LE	Reserved			
0x460[31:24]	Reserved			TZASC_EN ABLE	JTAG_HEO	KTE	Reserved	DLL Enable: 0 - Disable DLL for SD/ eMMC 1 - Enable DLL for SD/ eMMC
0x470[7:0]	DLL Override: 0 - DLL Slave Mode for SD/ eMMC 1 - DLL Override Mode for SD/eMMC	SD1 RST_POLA RITY_SELE CT 0 - Reset active-low 1 - Reset active-high	SD2 VOLTAGE SELECTIO N 0 - 3.3V 1 - 1.8V	Reserved	Disable SDMMC Manufactur e mode 0 - Enable 1 - Disable	L1 I-Cache DISABLE	BT_MMU_D ISABLE	Override SD Pad Settings (using PAD_SETTI NGS value)
0x470[15:8]	SD2 Reset Signal Polarity: 0 - Reset active-low 1 - Reset active-high	eMMC 4.4 - RESET TO PRE-IDLE STATE	Override HYS bit for SD/MMC pads	USDHC_PA D_PULL_D OWN 0 - no action 1 - pull down	ENABLE_E MMC_22K_ PULLUP 0 - 47K pullup 1 - 22K pullup	ADD_DS_ SET_GPR1 _16 0 - Set 1 - Don't set	USDHC_IO MUX_SION _BIT_ENAB LE 0 - Disable 1 - Enable	USDHC IOMUX SRE Enable 0 - Disable 1 - Enable
0x470[23:16]	Reserved	LPB_BOOT (Core / DDR- Bus) 00 - LPB Disable 01 - 1 GPIO (def freq) 10 - Div by2 11 - Div by 4	BT_LPB_P OLARITY (GPIO polarity) 0 - Active High 1 -Active Low	Reserved				
0x470[31:24]	Override NAND Pad Settings (Use PAD_SETTI NGS value)	MMC_DLL_DLY[6:0]						

Table continues on the next page...

Table 5-5. SD/eSD Boot Fusemap (continued)

Addr	7	6	5	4	3	2	1	0
0x6D0[7:0]	RANDOMIZER_ENABLE	Reserved	PAD_SETTINGS[5:0]					

Table 5-6. MMC/eMMC Boot Fusemap

Addr	7	6	5	4	3	2	1	0
0x450[7:0] (BOOT_CFG1)	0	1	1	Fast Boot: 0 - Regular 1 - Fast Boot	SD/MMC Speed 0 - High 1 - Normal	Fast Boot Acknowledge Disable: 0 - Boot Ack Enabled 1 - Boot Ack Disabled	SD Power Cycle Enable 0 - No power cycle 1 - Enabled via USDHC_RST pad	SD Loopback Clock Source Sel (for SDR50 and SDR104 only) 0 - through SD pad 1 - direct
0x450[15:8] (BOOT_CFG2)	Bus Width: 000 - 1-bit 001 - 4-bit 010 - 8-bit 101 - 4-bit DDR (MMC 4.4) 110 - 8-bit DDR (MMC 4.4) Else - Reserved			Port Select: 00 - eSDHC1 01 - eSDHC2 10 - Reserved 11 - Reserved		Boot Frequencies (ARM/DDR) 0 - 500 / 400 MHz 1 - 250 / 200 MHz	SD VOLTAGE SELECTION 0 - 3.3V 1 - 1.8V	Reserved
0x450[23:16] (BOOT_CFG3)	Reserved							
0x450[31:24] (BOOT_CFG4)	Reserved	EEPROM Recovery Enable 0 - Disabled 1 - Enabled Fuse is Reserved for 'Serial-ROM' Boot mode	eCSPI chip select: 00 - ECSPiX_SS0 (default) 01 - ECSPiX_SS1 10 - ECSPiX_SS2 11 - ECSPiX_SS3	eCSPI Addressing: 0 - 2-bytes (16-bit) 1 - 3-bytes (24-bit)	Port Select: 000 - eCSPI1 001 - eCSPI2 010 - eCSPI3 011 - eCSPI4 100 - Reserved 101 - Reserved 110 - Reserved 111 - Reserved			
0x460[7:0]	Reserved		FORCE_C OLD_BOOT	BT_FUSE_ SEL	DIR_BT_DI S	Reserved	SEC_CONF IG[1]	Reserved
0x460[15:8]	Reserved							

Table continues on the next page...

Table 5-6. MMC/eMMC Boot Fusemap (continued)

Addr	7	6	5	4	3	2	1	0
0x460[23:16]	JTAG_SMODE[1:0]		WDOG_EN ABLE 0 - Disabled 1 - Enabled	SJC_DISAB LE	Reserved			
0x460[31:24]	Reserved			TZASC_EN ABLE	JTAG_HEO	KTE	Reserved	DLL_ENAB LE 0 - Disable DLL for SD/ eMMC 1 - Enable DLL for SD/ eMMC
0x470[7:0]	DLL Override: 0 - DLL Slave Mode for SD/ eMMC 1 - DLL Override Mode for SD/eMMC	SD1_RST_ POLARITY_ SELECT 0 - Reset active low 1 - Reset active high	SD2 VOLTAGE SELECTIO N 0 - 3.3V 1 - 1.8V	Reserved	Disable SDMMC Manufactur e mode 0 - Enable 1 - Disable	L1 I-Cache DISABLE	BT_MMU_D ISABLE	Override SD Pad Settings (using PAD_SETTI NGS value)
0x470[15:8]	SD2 Reset Signal Polarity: 0 - Reset active-low 1 - Reset active-high	eMMC 4.4 - RESET TO PRE-IDLE STATE	Override HYS bit for SD/MMC pads	USDHC_PA D_PULL_D OWN 0 - no action 1 - pull down	ENABLE_E MMC_22K_ PULLUP 0 - 47K pullup 1 - 22K pullup	ADD_DS_ SET_GPR1 _16 0 - Set 1 - Don't set	USDHC_IO MUX_SION _BIT_ENAB LE 0 - Disable 1 - Enable	USDHC IOMUX SRE Enable 0 - Disable 1 - Enable
0x470[23:16]	USDHC_C MD_OE_PR E_EN (SD/ eMMC Debug) 0 - COM OE Disabled 1 - COM OE Enabled	LPB_BOOT (Core / DDR- Bus) 00 - LPB Disable 01 - 1 GPIO (def freq) 10 - Div by2 11 - Div by 4	BT_LPB_P OLARITY (GPIO polarity) 0 - Active High 1 - Active Low	Reserved				
0x470[31:24]	Override NAND Pad Settings (Use PAD_SETTI NGS value)	MMC_DLL_DLY[6:0]						
0x6D0[7:0]	RANDOMIZ ER_ENABL E	Reserved	PAD_SETTINGS[5:0]					

Table 5-7. NAND Boot Fusemap

Addr	7	6	5	4	3	2	1	0
0x450[7:0] (BOOT_CFG1)	1	BT_TOGGL EMODE	Pages in Block: 00 - 128 01 - 64 10 - 32 11 - 256		Nand Number Of Devices: 00 - 1 01 - 2 10 - 4 11 - Reserved		Nand_Row_address_byte s: 00 - 3 01 - 2 10 - 4 11 - 5	
0x450[15:8] (BOOT_CFG2)	Toggle Mode 33 MHz Preamble Delay, Read Latency: 000 - 16 GPMICKL cycles. 001 - 1 GPMICKL cycles. 010 - 2 GPMICKL cycles. 011 - 3 GPMICKL cycles. 100 - 4 GPMICKL cycles. 101 - 5 GPMICKL cycles. 110 - 6 GPMICKL cycles. 111 - 7 GPMICKL cycles.		Boot Search Count: 00 - 2 01 - 2 10 - 4 11 - 8		Boot Frequencies (ARM/DDR) 0 - 500 / 400 MHz 1 - 250 / 200 MHz		Reset Time 0 - 12 ms 1 - 22 ms (LBA NAND)	Reserved
0x450[23:16] (BOOT_CFG3)	Reserved							
0x450[31:24] (BOOT_CFG4)	Reserved	EEPROM Recovery Enable 0 - Disabled 1 - Enabled Fuse is Reserved for 'Serial- ROM' Boot mode	eCSPI chip select: 00 - ECSPiX_SS0 (default) 01 - ECSPiX_SS1 10 - ECSPiX_SS2 11 - ECSPiX_SS3	eCSPI Addressing: 0 - 2-bytes (16-bit) 1 - 3-bytes (24-bit)	Port Select: 000 - eCSPI1 001 - eCSPI2 010 - eCSPI3 011 - eCSPI4 100 - Reserved 101 - Reserved 110 - Reserved 111 - Reserved			
0x460[7:0]	Reserved		FORCE_C OLD_BOOT	BT_FUSE_ SEL	DIR_BT_DI S	Reserved	SEC_CONF IG[1]	Reserved
0x460[15:8]	Reserved							
0x460[23:16]	JTAG_SMODE[1:0]		WDOG_EN ABLE 0 - Disabled 1 - Enabled	SJC_DISAB LE	Reserved			
0x460[31:24]	Reserved			TZASC_EN ABLE	JTAG_HEO	KTE	Reserved	DLL_ENAB LE 0 - Disable DLL for SD/ eMMC

Table continues on the next page...

Table 5-7. NAND Boot Fusemap (continued)

Addr	7	6	5	4	3	2	1	0
								1 - Enable DLL for SD/ eMMC
0x470[7:0]	DLL Override: 0 - DLL Slave Mode for SD/ eMMC 1 - DLL Override Mode for SD/eMMC	SD1_RST_ POLARITY_ SELECT 0 - Reset active low 1 - Reset active high	SD2 VOLTAGE SELECTIO N 0 - 3.3V 1 - 1.8V	Reserved	Disable SDMMC Manufactur e mode 0 - Enable 1 - Disable	L1 I-Cache DISABLE	BT_MMU_D ISABLE	Override SD Pad Settings (using PAD_SETTI NGS value)
0x470[15:8]	SD2_RST_ POLARITY_ SELECT 0 - Reset acitve low 1 - Reset active high	eMMC 4.4 - RESET TO PRE-IDLE STATE	Override HYS bit for SD/MMC pads	USDHC_PA D_PULL_D OWN 0 - no action 1 - pull down	ENABLE_E MMC_22K_ PULLUP 0 - 47K pullup 1 - 22K pullup	ADD_DS_ SET_GPR1 _16 0 - Set 1 - Do not set	USDHC_IO MUX_SION _BIT_ENAB LE 0 - Disable 1 - Enable	USDHC IOMUX SRE Enable 0 - Disable 1 - Enable
0x470[23:16]	Reserved	LPB_BOOT (Core / DDR- Bus) 00 - LPB Disable 01 - 1 GPIO (def freq) 10 - Div by2 11 - Div by 4	BT_LPB_P OLARITY (GPIO polarity) 0 - Active High 1 -Active Low	Reserved				
0x470[31:24]	Override NAND Pad Settings (Use PAD_SETTI NGS value)	MMC_DLL_DLY[6:0]						
0x6D0[7:0]	RANDOMIZ ER_ENABL E	Reserved	PAD_SETTINGS[5:0]					
0x6D0[23:16]	NAND_READ_CMD_CODE1[7:0]							
0x6D0[31:24]	NAND_READ_CMD_CODE2[7:0]							

5.2 Lock Fusemap

Table 5-8 describes the functions of a set of lock fuses.

Table 5-8. Lock Fuses

Addr	7	6	5	4	3	2	1	0
0x400[7:0]	Reserved	SJC_RESP_LOCK WRP,OP,RP	MEM_TRIM_LOCK 1x - OP x1 - WP		BOOT_CFG_LOCK 1x - OP x1 - WP		TESTER_LOCK 1x - OP x1 - WP	
00x400[15:8]	GP3_LOCK 1 - WP + OP	SRK_LOCK	GP2_LOCK 1x - OP x1 - WP		GP1_LOCK 1x - OP x1 - WP		MAC_ADDR_LOCK 1x - OP x1 - WP	
0x400[23:16]	GP4_LOCK 1 - WP + OP	MISC_CONF_LOCK 1 - WP + OP	ROM_PATCH_LOCK 1 - WP + OP	OTPMK_CRC_LOCK 1 - WP + RP	ANALOG_LOCK 1x - OP x1 - WP	OTPMK_LOCK 1 - RP, WP, OP	SW_GP_LOCK 1 - WP + OP of SW_GP fuses	
0x400[31:24]	GP3_RLOCK 1 - RP	GP4_RLOCK 1 - RP	Reserved		Reserved	Reserved	Reserved (LOCK_PIN)	Reserved

5.3 Fusemap Descriptions Table

Table 5-9. Fusemap Descriptions

Fuse Address	Fuses Name	Number of Fuses	Fuses Function	Setting	Used by
0x400[1:0]	TESTER_LOCK	2			OCOTP
0x400[3:2]	BOOT_CFG_LOCK	2	Perform lock on BOOT related fuses.	0 - Unlock (The controlled field can be read, sensed, burned or overridden in the corresponded IIM register) 1 - Lock (The controlled field can be read or sensed only)	OCOTP
0x400[5:4]	MEM_TRIM_LOCK	2	Trimming fuses. Burnt on the tester or by customer before the final product shipment.	0 - Unlock (The controlled field can be read, burned or overridden in the corresponded IIM register) 1 - Lock (The controlled field can be read only)	OCOTP
0x400[6]	SJC_RESP_LOCK	1			OCOTP
0x400[9:8]	MAC_ADDR_LOCK	2	Lock MAC_ADDR fuses.		OCOTP

Table continues on the next page...

Table 5-9. Fusemap Descriptions (continued)

Fuse Address	Fuses Name	Number of Fuses	Fuses Function	Setting	Used by
0x400[11:10]	GP1_LOCK	2	Lock for General Purpose fuse register #1 (GP1)		OCOTP
0x400[13:12]	GP2_LOCK	2	Lock for General Purpose fuse register #2 (GP2)		OCOTP
0x400[14]	SRK_LOCK	1	Locking SRK_HASH[255:0]		OCOTP
0x400[15]	GP3_LOCK	1	Lock for General Purpose fuse register #3 (GP3)		OCOTP
0x400[19:18]	ANALOG_LOCK	2			OCOTP
0x400[22]	MISC_CONF_LOCK	1			OCOTP
0x400[31]	GP4_RLOCK	1	Read protection for general purpose fuse		OCOTP
0x410[10:0]	LOT_NO_ENC[42:0] (SJC_CHALL/UNIQUE_ID[42:0])	43	FSL-wide unique, encoded LOT ID STD II/SJC CHALLENGE/ Unique ID		SJC, SW
0x420[15:11]	WAFER_NO[4:0] (SJC_CHALL[47:43] / UNIQUE_ID[47:43])	5	The wafer number of the wafer on which the device was fabricated/SJC CHALLENGE/ Unique ID		SJC, SW
0x420[23:16]	DIE-Y-COORDINATE[7:0] (SJC_CHALL[55:48] / UNIQUE_ID[55:48])	8	The Y-coordinate of the die location on the wafer/SJC CHALLENGE/ Unique ID		SJC, SW
0x420[31:24]	DIE-X-COORDINATE[7:0] (SJC_CHALL[63:56] / UNIQUE_ID[63:56])	8	The X-coordinate of the die location on the wafer/SJC CHALLENGE/ Unique ID		SJC, SW
0x430[19:16]	SI_REV[3:0]	4	Silicon Revision number		SW
0x430[21:20]	TAMPER_PIN_DISABLE[1:0]	2	Disable ten tamper pins	00 - enabled, TAMPER0-9 used as TAMPER detection pins. 01 - disabled, TAMPER2-4 and TAMPER7-9 used as GPIO. 10 - disabled, TAMPER0-1 and TAMPER5-6 used as GPIO. 11 - disabled, TAMPER0-9 used as GPIO.	SNVS

Table continues on the next page...

Table 5-9. Fusemap Descriptions (continued)

Fuse Address	Fuses Name	Number of Fuses	Fuses Function	Setting					Used by
				FH A[3:2]	FC A[5:4]	FR AL[0:1]	MH z	P/N Code	
0x440[17:16]	SPEED_GRADING[1:0]	2	Burned by tester program, for indicating IC core speed (Hot burn may not be used).	xx	xx	00	Reserved	Reserved	PROD / SW
				xx	xx	01	528	05	
				xx	xx	10	800	08	
				xx	xx	11	900	09	
0x450[7:0]	BOOT_CFG1	8	BOOT configuration register #1, Usage varies, depending on selected boot device.	0x0000XXXX - WEIM (NOR/OneNAND) boot 0x0011XXXX - Serial ROM (I2C/SPI) boot 0x1XXXXXXXX - NAND FLASH boot 0x010XXXXX - SD/eSD 0x011XXXXX - MMC/eMMC boot Others - Reserved Refer to Fuse Map for details.					SRC
0x450[15:8]	BOOT_CFG2	8	BOOT configuration register #2, Usage varies, depending on selected boot device.	See fuse-map tab for details.					SRC
0x450[23:16]	BOOT_CFG3	8	BOOT configuration register #3	See fuse-map tab for details.					SRC
0x450[31:24]	BOOT_CFG4	8	BOOT configuration register #3	See fuse-map tab for details.					SRC
0x460[1]	SEC_CONFIG[1]	1	Security Configuration (with SEC_CONFIG[0])	00 - FAB (Open) 01 - Open - allows any code to be flashed and executed, even if it has no valid signature. 1x - Closed (Security On)					SW (ROM), SRC, SNVS, TPSMP
0x460[3]	DIR_BT_DIS	1	Direct External Memory Boot Disable	0 - Direct boot from external memory is allowed 1 - Direct boot from external memory is not allowed					SW(ROM), SRC
0x460[4]	BT_FUSE_SEL	1	Determines, whether using fuses for boot configuration, or GPIO /Serial loader.	If boot_mode="00" (Development) 0=Boot mode configuration is taken from GPIOs. 1=Boot mode configuration is taken from fuses. If boot_mode="10" (Production) 0 - Boot using Serila Loader (USB) 1- Boot mode configuration is taken from fuses.					SRC SW(ROM)
0x460[5]	FORCE_COLD_BOOT(SBMR)	1	Force cold boot when A9 core come out of reset.	Fuse Function: 0 – Default behavior equivalent to the					SRC

Table continues on the next page...

Table 5-9. Fusemap Descriptions (continued)

Fuse Address	Fuses Name	Number of Fuses	Fuses Function	Setting	Used by
			Reflected in SBMR reg of SRC	rest of the i.MX6 family allowing a fast recovery from low power modes. That is, the ROM is allowed to jump to the address previously programmed in the SRC persistent register. 1 – Fast recovery path in the ROM is not allowed and a cold boot is always performed. Customers wanting a higher level of security should burn this fuse.	
0x460[15:8]	DDR3_CONFIG[7:0]	8	DDR3 config options		SW(ROM)
0x460[16]	FORCE_INTERNAL_BOOT	1	Once been blown, the external BT_MODE[1:0] pins will be ignored, BootROM takes Boot Mode as "Internal Boot"	0—Boot Mode from BT_MODE pins 1—BT_MODE pins be ignored, Boot Mode forced to "Internal Boot"	SW(ROM)
0x460[17]	SDP_DISABLE	1	Disable/Enable serial download support	0—Serial download supported 1—No serial download support	SW(ROM)
0x460[18]	SDP_READ_DISABLE	1	Disable/Enable serial download READ_REGISTER command	0—SDP READ_REGISTER command is enabled 1—SDP READ_REGISTER is disabled	SW(ROM)
0x460[20]	SJC_DISABLE	1	Disable/Enable the Secure JTAG Controller module. This fuse is used to create highest JTAG security level, where JTAG is totally blocked.	0 - Secure JTAG Controller is enabled 1 - Secure JTAG Controller is disabled	Security logic
0x460[21]	WDOG_ENABLE	1	Watchdog Enable	Used to specify whether to enable / not watchdog at boot. '0' - Watch-Dog is disabled. '1' - Watch-Dog is enabled.	SW(ROM)
0x460[23:22]	JTAG_SMODE[1:0]	2	JTAG Security Mode. Controls the security mode of the JTAG debug interface	00 - JTAG enable mode 01 - Secure JTAG mode 11 - No debug mode	Security logic
0x460[24]	DLL_ENABLE	1	Controls the enable/disable of the DLL for SD/eMMC boot.	0 - Disable DLL for SD/eMMC 1 - Enable DLL for SD/eMMC	SW (ROM)

Table continues on the next page...

Table 5-9. Fusemap Descriptions (continued)

Fuse Address	Fuses Name	Number of Fuses	Fuses Function	Setting	Used by
0x460[26]	KTE	1	Kill Trace Enable. Enables tracing capability on ETM, and other modules.	0 - Bus tracing is allowed 1 - Bus tracing is allowed in case security state as defined by Secure JTAG allows it (for example, JTAG_ENABLE or NO_DEBUG)	SJC
0x460[27]	JTAG_HEO	1	JTAG HAB Enable Override. Disallows HAB JTAG enabling. The HAB may normally enable JTAG debugging by means of the HAB_JDE-bit in the OCOTP SCS register. The JTAG_HEO-bit can override this behavior.	0 - HAB may enable JTAG debug access 1 - HAB JTAG enable is overridden (HAB may not enable JTAG debug access)	SJC
0x460[28]	TZASC_ENABLE	1	TZASC enable fuse.	0 - TZASC module left in disable and bypass state. 1 - TZASC modules and associated clocks and muxing are enabled by Boot ROM code.	SW (ROM)
0x460[29]	PWR_STABLE_CYCLE_SELECTION	1	Select power stable cycle	0 - 5 ms 1 - 2.5 ms	SW (ROM)
0x470[0]	Override SD Pad Settings	1	Overrides ROM default value for SD PAD control register. When set ROM will override SD pad control register with value programmed into PAD_SETTINGS fuse bits.		SW (ROM)
0x470[1]	BT_MMU_DISABLE	1	The fuse bit is used for ROM to not enable MMU		SW (ROM)
0x470[2]	L1 I-Cache DISABLE	1	The fuse bit is used for ROM to not enable L1 I-Cache		SW (ROM)
0x470[3]	Disable SDMMC Manufacture mode	1	The fuse bit is used to disable ROM feature "SD/MMC Manufacturing Mode".	0 - Enable 1 - Disable	SW (ROM)
0x470[4]	UART Serial Download Disable	1	Disable UART Serial Download	0 - Enable 1 - Disable	SW (ROM)
0x470[5]	SD2 VOLTAGE SELECTION	1	Fuse bit to change voltage selection for SD2 pads. When set ROM will select 1.8V for SD3 pads otherwise 3.3V	0 - 3.3V 1 - 1.8V	SW (ROM)
0x470[6]	SD1_RST_POLARITY_SELECT	1	Select reset polarity for SD1	0 - Reset active low 1 - Reset active high	SW (ROM)

Table continues on the next page...

Table 5-9. Fusemap Descriptions (continued)

Fuse Address	Fuses Name	Number of Fuses	Fuses Function	Setting	Used by
0x470[7]	DLL Override	1	Select the DLL mode for SD/eMMC.	0 - DLL Slave Mode for SD/eMMC 1 - DLL Override Mode for SD/eMMC	SW (ROM)
0x470[8]	USDHC IOMUX SRE Enable	1	The fuse bit is used for ROM to enable SRE bit for SD pads	0 - Disable 1 - Enable	SW (ROM)
0x470[9]	USDHC_IOMUX_SION_BIT_ENABLE	1	The fuse bit is used for ROM to enable SION bit for MUX control register.	0 - Disable 1 - Enable	SW (ROM)
0x470[10]	Boot Failure Indicator Pin Select[4]	1	Indicator boot failure	00000 - gpio1.IO00 00001 - gpio1.IO01 ... 11111 - gpio1.IO31	SW (ROM)
0x470[11]	ENABLE_EMMC_22K_PULLUP	1	The fuse bit is used for ROM to enable 22K pullup for SD pads.	0 - 47K pullup 1 - 22K pullup	SW (ROM)
0x470[12]	USDHC_PAD_PULLDOWN	1	The fuse bit is used for ROM to enable pull down bit for SD pads.	0 - no action 1 - pull down	SW (ROM)
0x470[13]	Override HYS bit for SD/MMC pads	1	Once this fuse be blown, the [HYS] bit of IOMUXC_SW_PAD_CTL_PAD_SDx_CLK(x is the SD port which the ROM boot from), IOMUXC_SW_PAD_CTL_PAD_SDx_CMD, IOMUXC_SW_PAD_CTL_PAD_SDx_DAT0-n(n will be 0, 3, or 7, depends on the bus width selected) will be set.		SW (ROM)
0x470[14]	eMMC 4.4 - RESET TO PRE-IDLE STATE	1	Once this fuse be blown, the CMD0 with argument 0xf0f0f0 will be sent to put the eMMC card into pre-IDLE state so that eMMC card's fast boot can work properly. This is useful for the warm boot, such as boot due to the WDOG reset.		SW (ROM)
0x470[15]	SD2_RST_POLARITY_SELECT	1	select the polarity of SD2	0 – Active Low ; 1 – Active high	SW (ROM)
0x470[19:16]	Boot Failure Indicator Pin Select[3:0]	4	Miscellaneous power management configuration bits.	00000 - gpio1.IO00 00001 - gpio1.IO01 ... 11111 - gpio1.IO31	SW (ROM)

Table continues on the next page...

Table 5-9. Fusemap Descriptions (continued)

Fuse Address	Fuses Name	Number of Fuses	Fuses Function	Setting	Used by
0x470[20]	BT_LPB_POLARITY	1	Define GPIO3 polarity, for determining LPB boot mode.	0' - Active High '1' -Active Low	SW (ROM)
0x470[22:21]	LPB_BOOT	2	Defined the LowPower Boot options	(Core / DDR- Bus) '00' - LPB Disable '01' - 1 GPIO (def freq) '10' - Div by2 '11' - Div by 4	SW (ROM)
0x470[30:24]	MMC_DLL_DLY[6:0]	7	eMMC 4.4 delay line default value (set by boot rom), used in conjunction with "DLL Override" = 1 (BOOT_CFG3[3])	Connected to LVDS module	SW (ROM)
0x470[31]	Override NAND Pad Settings	1	Override pad settings for NAND boot.		SW (ROM)
0x4F0[15:0]	USB_VID[31:0]	16	USB VID		SW
0x4F0[31:16]	USB_PID[31:0]	16	USB PID		SW
0x580[31:0]	SRK_HASH[255:0]	256	SRK key, no HW visible lines. NO HW Visible signals available		SW (HAB)
0x600[23:0]	SJC_RESP[55:0]	56	Response reference value for the secure JTAG controller		SJC
0x620[15:0]	MAC1_ADDR[47:0]	48	Ethernet1 MAC Address		SW
0x660[31:0]	GP1[31:0]	32	General Purpose fuse register #1		PROD / SW
0x670[31:0]	GP2[31:0]	32	General Purpose fuse register #2		PROD / SW
0x680[31:0]	SW_GP[159:0]	160	SW general purpose key		PROD / SW
0x6D0[5:0]	PAD_SETTINGS	6	Used with conjunction of MMC/SD/Nand "Override Pad Settings" fuse value, as follow: '0' - Use IO default settings for boot device IO pads. '1' - Use "Override" value, as set by this register.	IO pads settings of selected boot interface, are override with this fuses, as follow: [0] - Slew Rate [3:1] Drive Strength [5:4] - Speed Settings. Refer to IO PAD chapter for "Settings" fields value	SW (ROM)
0x6D0[6]	USB_VBUS_EVENT_HANDLER_EN	1	ROM handle USB VBUS attach or detach event	0 - ROM not handle USB VBUS attach or detach event 1 - ROM handle USB VBUS attach or detach event	SW (ROM)
0x6D0[7]	Enable boot failure indication pin	1	Enable boot failure indicator pin	0 - disable 1 - enable	SW (ROM)
0x6D0[11:8]	READ_RETRY_SEQ_ID[3:0]	4	Choose read retry sequence	0000 - don't use read retry(RR) sequence embedded in ROM	SW (ROM)

Table continues on the next page...

Table 5-9. Fusemap Descriptions (continued)

Fuse Address	Fuses Name	Number of Fuses	Fuses Function	Setting	Used by
				0001 - Micron 20 nm RR sequence 0010 - Toshiba A19 nm RR sequence 0011 - Toshiba 19 nm RR sequence 0100 - SanDisk 19 nm RR sequence 0101 - SanDisk 19nmRR sequence 0110 - use Hynix 20 nm A die read retry sequence 0111 - use Hynix 26 nm read retry sequence 1000 - use Hynix 20 nm B die read retry sequence 1001 - use Hynix 20 nm C die read retry sequence Others - Reserved	
0x6D0[15:13]	WDOG Timeout Select	3	Select WDOG timeout	000 - 64s 001 - 32s 010 - 16s 011 - 8s 100 - 4s Others - Reserved	SW (ROM)
0x6D0[23:16]	NAND_READ_CMD_CODE1[7:0]	8	NAND_READ_CMD_CODE1	First command word to be used for Nand read.	SW (ROM)
0x6D0[31:24]	NAND_READ_CMD_CODE2[7:0]	8	NAND_READ_CMD_CODE2	Second command word to be used for Nand read.	SW (ROM)
0x6E0[0]	FIELD_RETURN	1	Configure device for field return testing. Fuse burning is protected by CSF command, with proper parameter passed. Write/OP protected by FIELD_RETURN_LOCK bit in control register.	0 - Device is in functional / secure mode. 1 - Device is open for field-return testing.	SW (ROM), SNVS_HP, SRC, TPSMP, Security Logic
0x880-0x8B0	GP3[127:0]	128	General Purpose fuse Register #3		SW
0x8C0-0x8F0	GP4[127:0]	128	General Purpose fuse Register #4		SW

Chapter 6

External Memory Controllers

6.1 Overview

This chip has these external memory interfaces and controllers:

- Multi-Mode DDR Controller (MMDC)
- EIM-PSRAM/NOR flash controller

6.2 Multi-mode DDR controller (MMDC) overview and feature summary

The MMDC module is a DDR controller that supports several types of DDR memories.

Table 6-1. MMDC feature summary

Feature	Description
Supported standards	<ul style="list-style-type: none"> • LPDDR2 1ch x16, LV-DDR3, DDR3 x16
DDR interface	<ul style="list-style-type: none"> • Density of 256 MB-4 GB <ul style="list-style-type: none"> • Column size of 8-12 bits • Row size of 11-16 bits • Supports burst length of 8 (aligned) for DDR3 and burst lengths of 4 for LPDDR2
DDR performance	<ul style="list-style-type: none"> • Supports Real-Time priority by means of QoS the sideband priority signals from the chip to enable different priority levels in the re-ordering mechanism • Page hit/page miss optimizations • Consecutive read/write access optimizations • Supports deep read and write requests queues to enable bank prediction • Drives back the critical word in a read transaction as soon as it is received by the DDR device (doesn't wait until the whole data phase has been completed) • Can track open memory pages • Supports bank interleaving • Special optimization for non-aligned wrap accesses in burst length 8
AXI interface	<ul style="list-style-type: none"> • AXI bus compliant with glueless interface to PL301 AXI network interconnect

Table continues on the next page...

Table 6-1. MMDC feature summary (continued)

Feature	Description
DDR calibration and delay-lines	<ul style="list-style-type: none"> • All calibrations can be done automatically by hardware or manually by software. • ZQ calibration for an external DDR device (in DDR3 through the ZQ calibration command and in LPDDR2 through the MRW command). <ul style="list-style-type: none"> • Can be handled automatically for ZQ Short (periodically) and ZQ Long (at exit from self-refresh). • Can be handled manually at ZQ INIT.
DDR general	<ul style="list-style-type: none"> • Configurable timing parameters • Configurable refresh scheme • Supports dynamic voltage, frequency change, and low-power mode entry through hardware negotiation with the system (req/ack handshake) • Supports automatic self-refresh and power down entry and exit • Supports the fast and slow precharge power down in DDR3 • Supports various ODT control schemes. <ul style="list-style-type: none"> • Assertion/Deassertion of ODT control per read or write accesses and for active or passive CS • Supports MRW and MRR commands for LPDDR2 • Software control for moving to derated timing parameters and derated refresh rate according to the temperature variation. • Supports various debug and profiling modes

6.3 EIM-PSRAM/NOR flash controller overview

EIM is an external interface module that manages the interface to external chip devices, including the generation of chip selects, clocks, and control for external peripherals and memory.

It provides asynchronous and synchronous access to devices with an SRAM-like interface.

6.3.1 EIM features

- Up to four (software configurable) chip selects for external devices
 - Flexible address decoding; each chip-select memory space is determined separately according to the GPR bits in IOMUXC.
 - Maximum supported density is 128 MB by default (AUS bit is cleared). When the AUS bit is set, the maximum supported density is 32 MB.
- Selectable write protection for each chip select
- Programmable wait-state generator for each chip select, for write and read accesses separately
- Asynchronous accesses with programmable setup and hold times for control signals

- Independent synchronous memory burst write mode support for PSRAM and NOR-flash memories (CellularRAM™ from Micron, Infineon, and Cypress, OneNAND™ and utRAM™ from Samsung, and COSMORAM™ from Toshiba)
- Supports NAND-flash devices with a NOR-flash interfaces - OneNAND™ (Samsung)
- Independent programmable variable/fix latency support for read and write synchronous (burst) mode
- Support for little-endian operation
- ARM AXI slave interface accesses are only handled in parallel for single AXI ID transactions
- External interrupt support using the RDY_INT signal function as an external interrupt pin
- Boot from external device support according to boot signals, using the RDY_INT signal
 - RDY signal support assertion after reset
 - INT signal support assertion after reset for OneNAND™ (Samsung) device
 - Supports little-endian mode only

6.3.2 EIM boot scenarios

EIM allows booting from NOR-flash devices. To select the NOR flash as the boot source, use either the boot mode and configuration GPIO pins or the internal boot-related fuses.

See [Sytem Boot](#) for more information.

6.3.3 EIM boot configuration

This table shows the EIM boot configuration:

Table 6-2. EIM boot configuration

EIM_BOOT_CFG bus	EIM affected bits	EIM register
12	NUM16_BYP_GRANT	CS0GCR2
11	DSZ[2]	CS0GCR1
10	AUS	CS0GCR1
[9:8]	CSREC[2:1]	CS0GCR1
[7:5]	RWSC[4:2]	CS0GCR1
	WWSC[4:2]	CS0WCR
4	ERRST	WCR
3	RAL	CS0RCR1

Table continues on the next page...

Table 6-2. EIM boot configuration (continued)

EIM_BOOT_CFG bus	EIM affected bits	EIM register
	WAL	CS0WCR
2	MUM	CS0GCR1
	OEA[1]	CS0RCR1
[1:0]	DSZ[1:0]	CS0GCR1

6.3.4 OneNAND requirements

By default, the Ready/Busy pin is not in use, perform these steps to configure the OneNAND:

- Poll the device to see whether it is ready; software performs a read from the device.
- Connect the Ready/Busy signal of the OneNAND device to any GPIO pin and use it as an interrupt that indicates the OneNAND device ready state.

Chapter 7

System Debug

7.1 Overview

This section describes the hardware and software debug and application development features and resources of the chip. It describes the following:

- Core/platform-specific resources
- Resources associated with complex IP blocks
- Chip-wide resources
- Interface to the external debug and development tools

The debug and trace architecture is designed around the following:

- ARM CoreSight architecture, adapted to SoC (for core debug), including a cross-trigger subsystem for cross-domain triggering of debug resources
- JTAG port used to interact with core under the debug by means of SJC, the system JTAG controller port
- DAP, the debug access port that supports the interface to the ARM RealView Debugging tools and other third-party tools
- TPIU, a trace port interface unit that efficiently accesses the program trace information from the system
- Various chip-wide resources, such as debug features built into the IP blocks and critical signal visibility available through alternate pin functions or observability muxes

7.2 Chip and ARM Platform Debug Architecture

The ARM Debug architecture is based on the CoreSight architecture by ARM. The CoreSight architecture provides a system-wide solution to real-time debug and trace.

The CoreSight architecture is embodied in a set of CoreSight components and compliant processors that form the CoreSight systems. Its architecture maintains the traditional requirements of debug and trace:

- To access the debug functionality without software interaction
- To connect to a running system without performing a reset

Full access to the processor debug capability is available by the ARM debug register map through the Advanced Peripheral Bus (APB) slave port. The core includes a Processor Debug Unit which stops program execution, examines and alters the processor and coprocessor state, examines and alters the memory and input/output peripheral state, and restarts the processor core.

7.2.1 Debug Features

- CoreSight Embedded Trace Macrocell (ETM): trace generator for ARM processors
- Support for a TrustZone-related 3-level debug scheme:
 - Debug in Non-Secure privileged and user, and Secure user
 - Debug in Non-Secure only
- EmbeddedICE-RT logic
 - Support for both the monitor-mode and halt-mode debugging:
 - Core run/halt control, debug status/control
 - Breakpoint/watchpoint control
 - Core-mapped and memory-mapped resource examination/modification
- Data communication channel between the ARM core and the host debugger via JTAG and the Debug Access Port (DAP) module
- PMU (Performance Metrics Unit) used for system profiling and debug
- CP15 register for debugging the MMU, I and D L1 cache, and TLB

The chip includes ARM CoreSight components for multicore debug and trace solutions.

7.2.2 Debug system components

The CoreSight components include:

- Embedded Trace Buffer (ETB): RAM array to be used for on-chip capture of trace data output from the PTM
- ATB Replicator to connect the trace data to TPIU (Trace Port Interface) and ETB (Embedded Trace Buffer)
- Cross Triggering logic for event routing, including CTIs and CTMs

Other related IPs and functionality:

- ROMPATCH module to support modification of program/data information in the MCU ROM
- Debug Visibility which selects critical signals routed to the I/O pads as alternate outputs for external visibility

7.2.2.1 AMBA Trace Bus (ATB)

ATB transfers trace data through the chip CoreSight infrastructure. The trace sources are ATB masters and the sinks are ATB slaves. The ARM (via PTM) cores are the data generators. Link components such as the Trace Funnel and Replicator provide both the master and slave interfaces.

The ATB protocol supports:

- Stalling of trace sources to enable the CoreSight components to funnel and combine the sources into a single trace stream
- Association of the trace data with the generating source using trace source IDs. The CoreSight system can trace up to 111 different items at any time
- Capture and transfer of multiple byte bus widths, currently to 32 bits
- A flushing mechanism to force the historic trace to drain from any sources, links, or sinks up to the point that the request is initiated

7.2.2.2 ATB replicator

The ATB replicator enables two trace sinks to be wired together and to operate from the same incoming trace stream.

There are no programmable registers. This component is invisible to the user on a particular trace path, from source to sink.

- Incoming ATB Interface—the ATB replicator accepts the trace data from the trace source, either directly or through a trace funnel.
- Outgoing ATB Interfaces—the ATB replicator sends identical trace data on the outgoing master port interfaces.

7.2.2.3 Embedded Cross Triggering

The ECT is a modular component from ARM Limited that supports the interaction and synchronization of multiple triggering events within a chip. The main function of the ECT (CTI and CTM) is to pass debug events from one core to another. For example, the ECT can communicate the debug state information from one core to another, so that the program execution can be stopped on both processors at the same time (if required).

The ECT consists of these types of modules:

- Cross Trigger Interfaces (CTI)
- Cross Trigger Matrix (CTM)

The cross trigger interfaces provide the interface between the component or subsystem and the cross trigger matrix. The system requires a CTI for each subsystem that supports cross triggering. The CTI combines and maps the trigger requests, and broadcasts them to all other interfaces on the ECT as channel events. When the CTI receives a channel event, it maps it onto a trigger output. This enables the subsystems to cross trigger with each other. The reception and transmission of triggers is performed through the trigger interface.

The Cross Trigger Matrix (CTM) combines the trigger requests generated from the CTIs and broadcasts them to all CTIs as channel triggers. The CTM controls the distribution of channel events. It provides the Channel Interfaces (CIs) to connect to either the CTIs or CTMs. This enables multiple CTIs to be linked together. The ECT is composed of three/five CTIs (Cross Trigger Interface) and two CTMs (Cross Trigger Matrix). The ECT is key in the multi-core and multi-IP debug strategy. The outcome is a software-controlled debug signal matrix that receives signals from various sources (cores and peripherals) and propagates/ routes them to the different debug resources of the SoC. These debug resources include the time-stamping capability, profiling capabilities, real-time trace (trace enabled or disabled), triggers, SOC level multiplexing, and debug interrupts.

NOTE

Because the ECT should only be used during the debug sessions, it is disabled by default.

7.2.2.3.1 Cross-Trigger Matrix (CTM)

The CTM (Cross-Trigger Matrix) is provided by ARM. A brief description is provided below. See the ARM documentation for more details.

The CTM is a relatively simple block with no configuration options. There are two CTM instances in in the ARM platform.

One of them is used to route Core's CTI's, while the second one is used for the additional CoreSight CTIs. Each CTI has four channel lines, to which the CTI events are mapped. The exact mapping is configured in the CTI logic.

7.2.2.3.2 Cross-Trigger Interface (CTI)

The Cross-Trigger Interface (CTI) component is provided by ARM. A brief description of the CTI is provided below.

There are CTIs in the chip's ARM platform. of which, dedicated to , while the is used for various other signals routing.

Each of these CTIs has 8 trigger inputs and 8 trigger outputs that connect to logic in the domain to be debugged or profiled. Each CTI also includes a 4 channel interface to the CTM (4 inputs and 4 outputs).

For more information, see [ARM platform chapter](#).

7.2.2.4 Debug Access Port (DAP)

The DAP enables debug access to the chip modules through APB-AP (the APB access port) and APB-Mux (the APB multiplexer).

AHB-AP provides system access. Debug tools can use JTAG to connect to the chip.

DAP has the following features:

- AMBA 3 Peripheral Bus Multiplexor access though AMBA 3 APB Access Port, providing debug peripheral access through the APB interface.
- External JTAG access using the JTAG Debug Port (JTAG-DP).
- Internal chip module access using:
 - AHB Access Port (AHB-AP)
 - APB Access Port (APB-AP)
 - JTAG Access Port (JTAG-AP)

APB-Mux enables system access to CoreSight components connected to the Debug APB.

The ROM table provides a list of memory locations of CoreSight components connected to the Debug APB. This is visible from both tools and system access and one configures it during system implementation.

External read/write access to the internal interface is provided by JTAG-DP. JTAG-DP provides a standard interface for debug access to the chip through DAP. It interfaces to the DAP internal bus.

Internal access to on-chip buses and other interfaces are provided by the access ports (APs). The available APs are:

- AHB-AP which provides an AHB-Lite master for access to a system AHB bus.
- APB-AP which provides an AMBA 3 APB master for access to the Debug APB that configures all CoreSight components.
- JTAG-AP which provides JTAG access to on-chip components and operates as a JTAG master port to drive JTAG chains throughout the chip.

7.2.3 Chip-Specific SJC Features

7.2.3.1 JTAG Disable Mode

In addition to different JTAG security modes that are implemented internally in the System JTAG Controller (SJC), there is an option to disable the SJC functionality by e-fuse configuration.

This creates additional JTAG mode "JTAG Disabled" with highest level of JTAG protection. In this mode all JTAG features are disabled. Specifically, the following debug features are disabled in addition to the features that were already disabled in "No Debug" JTAG mode:

- Non-Secure JTAG control registers (PLL configuration, Deterministic Reset, PLL bypass)
- Non-Secure JTAG status registers (Core status)
- Chip Identification Code (IDCODE)

7.2.3.2 JTAG ID

Table 7-1. i.MX JTAG ID

Device	Silicon revision	JTAG ID
i.MX 6ULL	Rev 1.0	0891_E01Dh ¹

1. In follow-on silicon revisions, the ID value is subject to change by incrementing the first nibble as follows: 1891_E01Dh for Rev 1.1, 2891_E01Dh for Rev 1.2 , etc.

7.2.4 System JTAG Controller - SJC

The SJC module is the bridge between external development and test instrumentation and the internal JTAG-accessible debug and test resources.

It implements and manages the daisy-chained topology consisting of its own TAP and those of the SDMA, and the ARM Debug Access Port (DAP).

NOTE

Single Wire Debug (SWD) protocol is not supported.

7.2.5 System JTAG controller main features

- IEEE P1149.1, 1149.6 (standard JTAG) interface to off-chip test and development equipment
 - Includes an SJC-only mode for true IEEE P1149.1 compliance, used primarily for board-level implementation of boundary scan.
 - Supports IEEE P1149.6 extensions to the JTAG standard for AC testing of selected I/O signals.
- Debug-related control and status; putting selected cores into reset and/or debug mode and monitoring individual core status signals by means of JTAG
- System status, such as the state of the PLLs (locked or not locked)
- levels of security, ranging from no security to no JTAG accessibility to the chip

7.2.6 SJC TAP Port

The SJC supports the following standard JTAG pins:

- TRSTB
- TDI
- TDO
- TCK
- TMS

7.2.7 SJC main blocks

- Interface to the outside world via the standard JTAG pins
- Interface to the external Debug_Event pin
- A master TAP controller which implements the standard JTAG state machine
- Implementation of the mandatory and optional IEEE P1149.1 (JTAG) instructions
 - Mandatory: "EXTEST", "SAMPLE/PRELOAD", and "BYPASS"
 - Optional: "ID_CODE" (SOC JTAG ID register), "HIGHZ"
- Supports the SDMA's DR-path-only JTAG architecture by implementing the controller portion of its TAP (including "BYPASS" as the default state) within the SJC

- The ExtraDebug registers, which implement a variety of control and status features
 - Three 32-bit insecure general purpose status registers
 - Two 32-bit secure status registers - one predefined, one general purpose.
 - Control and status registers for debug, core, charge pump, and PLL.
- Four levels of fuse-defined security, ranging from no security to no access.

Both predefined and user-defined control and status functions are supported by the SJC.

7.3 Smart DMA (SDMA) core

SDMA is a dedicated, programmable DMA engine. It is an integration of a 32-bit RISC core and DMA-specific hardware. It includes ports for the AP domain and a peripheral domain, along with a burst-capable port for direct external memory access.

NOTE

The SDMA and its integration in the chip is unchanged from previous i.MX chips.

The main SDMA debug features are:

- OnCE - On Chip Emulator, provides the following capabilities:
 - SDMA core control - run/halt/single-step
 - SDMA core register/memory-map access
 - Event detection, watchpoints, and hardware breakpoints
 - Real time buffer and PC trace buffer capability
- Trace buffer
 - Contains information to identify the 32 last changes of flow detected during a program execution
- Context dump
 - Includes information about all the channel dump activity
 - Current contents of SDMA RAM
- ROMPATCH

7.3.1 SDMA On Chip Emulation Module (OnCE) Feature Summary

The SDMA debug features are primarily defined by the OnCE portion of its design.

They are summarized as follows:

- Memory And Register Access - dedicated logic enables user-access to SDMA memory and register locations. These accesses are supported only when the processor is in debug mode.
- Event Detection Unit - watches signals from the data memory bus (DMBus) which is used by the RISC core to access its RAM, ROM, and memory-mapped registers
- Watchpoints - one output signal is available to watch event matching conditions at the chip level. Match conditions are defined by programming memory-mapped registers.
- Hardware Breakpoint - a counter is decremented after an event detection. A debug request is sent to the SDMA core only when the counter reaches the value of zero. It is possible to program the initial value of the counter or to disable the use of the counter if a debug request must be generated after each event detection.
- Real Time Buffer - The Real Time Buffer Register (RTB) is a single 32-bit memory-mapped register which can be accessed as a regular memory location during program execution. It is used to store and retrieve run time information without putting the SDMA in debug mode. Each write to this register causes an event. This register is, in fact, located in the OnCE. Executing through JTAG, a buffer command exports the content of this register through the JTAG port.
- Core Control (Core Status / Single Stepping) - Commands are provided to monitor and control processor activity. The commands can halt the core, rerun the core from another address location, and get processor status.
- Trace Buffer - a 32x32 buffer which records the last 32 changes of flow during program execution. The buffer stores data in a modulo fashion (i.e. the 33rd instruction change replaces the 1st). Captured trace information is retrieved via reads to the Trace Buffer Register.

7.3.1.1 Other SDMA Debug Functionality

- Core Trace - basic core trace capability is available through debug visibility functionality only. PTM trace capability does not exist.
- ROM Patch - can be accomplished by manipulating the CHN0ADDR register through JTAG or via the MCU's ability to write to SDMA OnCE registers. This must be done right after reset and before the SDMA core is enabled to begin processing events.
- Additional debug control/status interaction with the SJC module
 - SJC-controlled Debug Request
 - SJC-readable Debug Acknowledge (in debug mode)
 - Debug clock control - allows SJC to force clocks on for debug purposes
 - Debug core state (SDMA RISC Core State) - 4 bits accessible from the SJC via JTAG

7.3.1.2 SDMA ROM Patching

After reset, the SDMA is in its IDLE_AFTER_RESET mode. A debug request also puts the SDMA in its DEBUG_IN_IDLE_AFTER_RESET mode. The new address boot must be stored in CHN0ADDR register (e.g., through the SDMA OnCE via debugger).

The user must then issue the exec_core <instruction> SDMA OnCE instruction to return to the IDLE_AFTER_RESET mode. The very first instructions of the boot code fetches the contents of this register (which is also mapped in the SDMA memory space) and jumps to the given address.

7.4 Miscellaneous

The Miscellaneous function described in this section provide useful general capabilities.

7.4.1 Clock/Reset/Power

CDBGPWRUPREQ and CDBGPWRUPACK are the handshake signals between the DAP and the clock control module to ensure debug power and clocks are turned on. If the debug components are always powered on, the handshake becomes a mechanism to turn debug clocks on. Similarly, there is a register bit in the CCM which allows internal software to turn debug clocks on as well because the CDBGPWRUPREQ is in the TCLK domain and is inaccessible to software.

The Cortex-A7 core can receive resets from the following sources:

- Debug Reset (CDBGGRSTREQ bit within the SWJ-DP CTRL/STAT register of the DAP) in the TCLK domain. This allows the debug tools to reset the debug logic.
- System POR reset

7.5 Supported tools

DS-5 ARM Debugger is supported.

The debugger is connected to the chip from the host by the DS-5 ICE protocol converter. Other third party tools can be used via the standard JTAG interface, but may need to be adapted for individual IC. It is important to check with tool vendors for specific tool requirements, especially for on-chip IC.

Chapter 8

System Boot

8.1 Overview

The boot process begins at the Power-On Reset (POR) where the hardware reset logic forces the Arm core to begin the execution starting from the on-chip boot ROM.

The boot ROM code uses the state of the internal register `BOOT_MODE[1:0]` as well as the state of various eFUSES and/or GPIO settings to determine the boot flow behavior of the device.

The main features of the ROM include:

- Support for booting from various boot devices
- Serial downloader support (USB OTG and UART)
- Device Configuration Data (DCD) and plugin
- Digital signature and encryption based High-Assurance Boot (HAB)
- Wake-up from the low-power modes

The boot ROM supports these boot devices:

- NOR flash
- NAND flash
- OneNAND flash
- SD/MMC
- Serial (SPI) NOR flash and EEPROM
- QuadSPI (QSPI) flash

The boot ROM uses the state of the `BOOT_MODE` and eFUSES to determine the boot device. For development purposes, the eFUSES used to determine the boot device may be overridden using the GPIO pin inputs.

The boot ROM code also allows to download the programs to be run on the device. The example is a provisioning program that can make further use of the serial connection to provide a boot device with a new image. Typically, the provisioning program is

downloaded to the internal RAM and allows to program the boot devices, such as the SD/MMC flash. The ROM serial downloader uses a high-speed USB in a non-stream mode connection and the UART in a stream mode connection.

The boot ROM allows waking up from the low-power modes. On reset, the ROM checks the power gating status register. When waking from the low-power mode, the core skips loading an image from the boot device and jumps to the address saved in `PERSISTENT_ENTRY0`.

The Device Configuration Data (DCD) feature allows the boot ROM code to obtain the SOC configuration data from an external program image residing on the boot device. As an example, the DCD can be used to program the DDR controller for optimal settings, improving the boot performance. The DCD is restricted to the memory areas and peripheral addresses that are considered essential for the boot purposes (see [Write data command](#)).

A key feature of the boot ROM is the ability to perform a secure boot, also known as a High-Assurance Boot (HAB). This is supported by the HAB security library which is a subcomponent of the ROM code. The HAB uses a combination of hardware and software together with the Public Key Infrastructure (PKI) protocol to protect the system from executing unauthorized programs. Before the HAB allows the user image to execute, the image must be signed. The signing process is done during the image build process by the private key holder and the signatures are then included as a part of the final program image. If configured to do so, the ROM verifies the signatures using the public keys included in the program image. In addition to supporting the digital signature verification to authenticate the program images, the encrypted boot is also supported. The encrypted boot can be used to prevent the cloning of the program image directly off the boot device. A secure boot with HAB can be performed on all boot devices supported on the chip in addition to the serial downloader. The HAB library in the boot ROM also provides the API functions, allowing the additional boot chain components (bootloaders) to extend the secure boot chain. The out-of-fab setting for the `SEC_CONFIG` is the open configuration, in which the ROM/HAB performs the image authentication, but all authentication errors are ignored and the image is still allowed to execute.

8.2 Boot modes

During reset, the chip checks the power gating controller status register.

During boot, the core's behavior is defined by the boot mode pin settings, as described in [Boot mode pin settings](#). When waking up from the low-power boot mode, the core skips the clock settings. The boot ROM checks that the `PERSISTENT_ENTRY0` (see

Persistent bits) is a pointer to a valid address space (OCRAM, DDR, QSPI, or EIM). If the PERSISTENT_ENTRY0 is a pointer to a valid range, it starts the execution using the entry point from the PERSISTENT_ENTRY0 register. If the PERSISTENT_ENTRY0 is a pointer to an invalid range, the core performs the system reset.

8.2.1 Boot mode pin settings

The device has four boot modes (one is reserved for NXP use). The boot mode is selected based on the binary value stored in the internal BOOT_MODE register.

The BOOT_MODE is initialized by sampling the BOOT_MODE0 and BOOT_MODE1 inputs on the rising edge of the POR_B. After these inputs are sampled, their subsequent state does not affect the contents of the BOOT_MODE internal register. The state of the internal BOOT_MODE register may be read from the BMOD[1:0] field of the SRC Boot Mode Register (SRC_SBMR2). The available boot modes are: Boot From Fuses, serial boot via USB, and Internal Boot. See this table for settings:

Table 8-1. Boot MODE pin settings

BOOT_MODE[1:0]	Boot Type
00	Boot From Fuses
01	Serial Downloader
10	Internal Boot
11	Reserved

8.2.2 High-level boot sequence

The figure found here show the high-level boot ROM code flow.

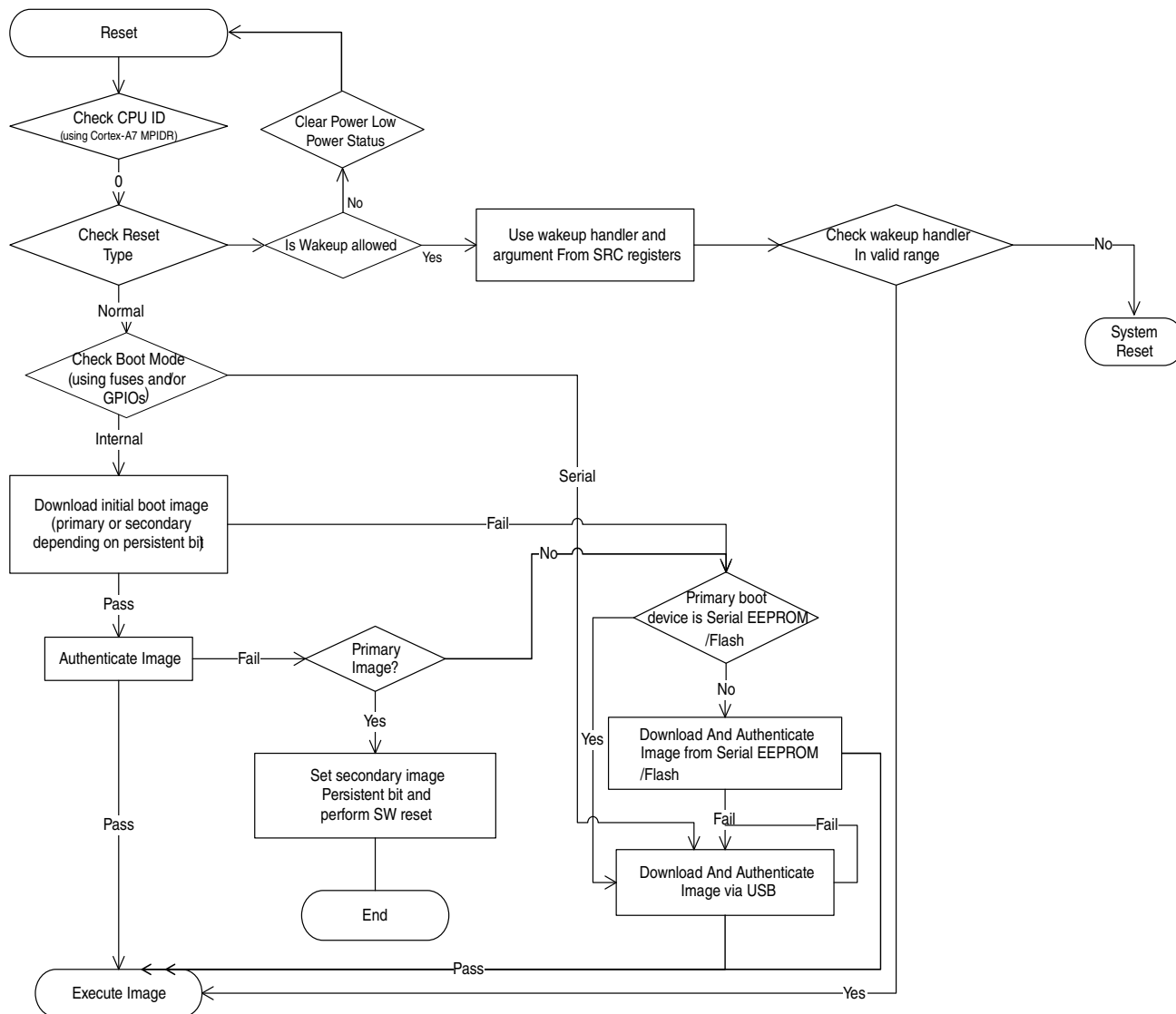

Figure 8-1. Boot flow

8.2.3 Boot From Fuses mode (BOOT_MODE[1:0] = 00b)

A value of 00b in the BOOT_MODE[1:0] register selects the Boot From Fuses mode.

This mode is similar to the Internal Boot mode described in [Internal Boot mode](#) (`BOOT_MODE[1:0] = 0b10`) with one difference. In this mode, the GPIO boot override pins are ignored. The boot ROM code uses the boot eFUSE settings only. This mode also supports a secure boot using HAB.

If set to Boot From Fuses, the boot flow is controlled by the `BT_FUSE_SEL` eFUSE value. If `BT_FUSE_SEL = 0`, indicating that the boot device (for example, flash, SD/MMC) was not programmed yet, the boot flow jumps directly to the Serial Downloader. If `BT_FUSE_SEL = 1`, the normal boot flow is followed, where the ROM attempts to boot from the selected boot device.

The first time a board is used, the default eFUSES may be configured incorrectly for the hardware on the platform. In such case, the Boot ROM code may try to boot from a device that does not exist. This may cause an electrical/logic violation on some pads. Using the Boot From Fuses mode addresses this problem.

Setting the `BT_FUSE_SEL=0` forces the ROM code to jump directly to the Serial Downloader. This allows a bootloader to be downloaded which can then provision the boot device with a program image and blow the `BT_FUSE_SEL` and the other boot configuration eFUSES. After the reset, the boot ROM code determines that the `BT_FUSE_SEL` is blown (`BT_FUSE_SEL = 1`) and the ROM code performs an internal boot according to the new eFUSE settings. This allows the user to set `BOOT_MODE[1:0]=00b` on a production device and burn the fuses on the same device (by forcing the entry to the Serial Downloader), without changing the value of the `BOOT_MODE[1:0]` or the pullups/pulldowns on the `BOOT_MODE` pins.

8.2.4 Serial Downloader

The Serial Downloader provides a means to download a program image to the chip over the USB and UART serial connection.

In this mode, the ROM programs the WDOG1 for a time-out specified by the fuse WDOG Time-out Select (See fusemap for details) if the `WDOG_ENABLE` eFuse is 1 and continuously polls for the USB and UART connection. If no activity is found on the USB OTG1 and UART 1/2 and the watchdog timer expires, the Arm core is reset.

NOTE

After the downloaded image is loaded, it is responsible for managing the watchdog resets properly.

This figure shows the USB and UART boot flow:

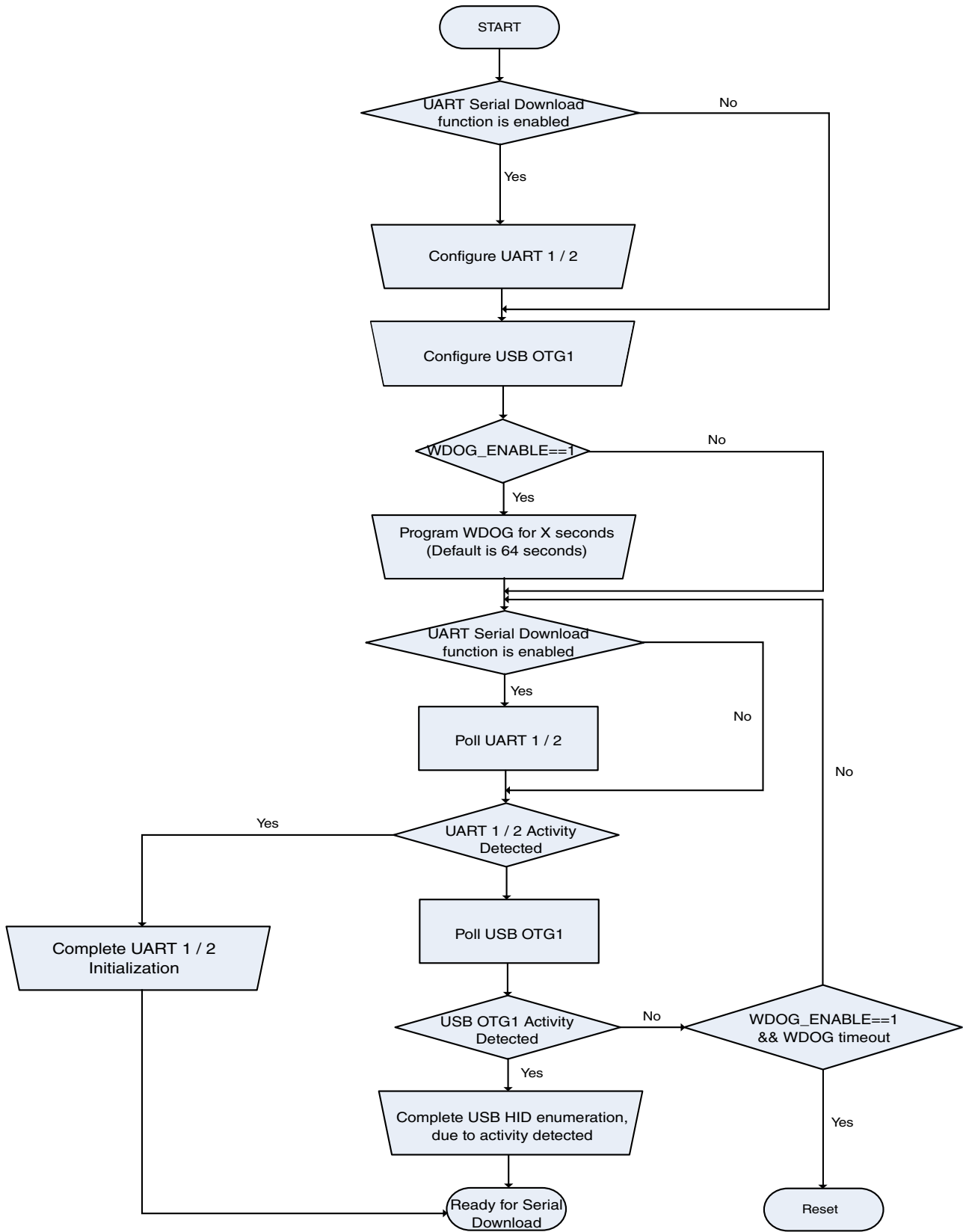

Figure 8-2. Serial Downloader boot flow

8.2.5 Internal Boot mode (BOOT_MODE[1:0] = 0b10)

A value of 0b10 in the BOOT_MODE[1:0] register selects the Internal Boot mode. In this mode, the processor continues to execute the boot code from the internal boot ROM.

The boot code performs the hardware initialization, loads the program image from the chosen boot device, performs the image validation using the HAB library (see [Boot security settings](#)), and then jumps to an address derived from the program image. If an error occurs during the internal boot, the boot code jumps to the Serial Downloader (see [Serial Downloader](#)). A secure boot using the HAB is possible in all the three boot modes.

When set to the Internal Boot, the boot flow may be controlled by a combination of eFUSE settings with an option of overriding the fuse settings using the General Purpose I/O (GPIO) pins. The GPIO Boot Select FUSE (BT_FUSE_SEL) determines whether the ROM uses the GPIO pins for a selected number of configuration parameters or eFUSES in this mode.

- If BT_FUSE_SEL = 1, all boot options are controlled by the eFUSES described in [Table 8-2](#).
- If BT_FUSE_SEL = 0, the specific boot configuration parameters may be set using the GPIO pins rather than eFUSES. The fuses that can be overridden when in this mode are indicated in the GPIO column of [Table 8-2](#). [Table 8-3](#) provides the details of the GPIO pins.

The use of the GPIO overrides is intended for development since these pads are used for other purposes in the deployed products. NXP recommends controlling the boot configuration by the eFUSES in the deployed products and reserving the use of the GPIO mode for the development and testing purposes only.

8.2.6 Boot security settings

The internal boot modes use one of three security configurations.

- Closed: This level is intended for use with shipping-secure products. All HAB functions are executed and the security hardware is initialized (the Security Controller or SNVS enters the Secure state), the DCD is processed if present, and the program image is authenticated by the HAB before its execution. All detected errors are logged, and the boot flow is aborted with the control being passed to the serial downloader. At this level, the execution does not leave the internal ROM unless the target executable image is authenticated.

- **Open:** This level is intended for use in non-secure products or during the development phases of a secure product. All HAB functions are executed as for a closed device. The security hardware is initialized (except for the SNVS which is left in the Non-Secure state), the DCD is processed if present, and the program image is authenticated by the HAB before its execution. All detected errors are logged, but have no influence on the boot flow which continues as if the errors did not occur. This configuration is useful for a secure product development because the program image runs even if the authentication data is missing or incorrect, and the error log can be examined to determine the cause of the authentication failure.
- **Field Return:** This level is intended for the parts returned from the shipped products.

8.3 Device configuration

This section describes the external inputs that control the behavior of the Boot ROM code.

This includes the boot device selection (SPI, EIM, NOR, SD, MMC, QSPI, and so on), boot device configuration (SD bus width, speed, and so on), and other. In general, the source for this configuration comes from the eFUSES embedded inside the chip. However, certain configuration parameters can be sourced from the GPIO pins, allowing further flexibility during the development process.

8.3.1 Boot eFUSE descriptions

This table is a comprehensive list of the configuration parameters that the ROM uses.

Table 8-2. Boot eFUSE descriptions

Fuse	Configuration	Definition	GPIO ¹	Shipped value	Settings ²
DIR_BT_DIS	OEM	Disables the NXP reserved modes.	NA	0	0—The reserved NXP modes are enabled. 1—The reserved NXP modes are disabled. This fuse must be blown to 1 for normal operation.
BT_FUSE_SEL	OEM	In the Internal Boot mode BOOT_MODE[1:0] = 10, the BT_FUSE_SEL fuse determines whether the boot settings indicated by a Yes in the GPIO column are controlled by the GPIO pins	NA	0	If BOOT_MODE[1:0] = 0b10: <ul style="list-style-type: none"> • 0—The bits of the SBMR are overridden by the GPIO pins. • 1—The specific bits of the SBMR are controlled by the eFUSE settings. If BOOT_MODE[1:0] = 0b00

Table continues on the next page...

**Table 8-2. Boot eFUSE descriptions
(continued)**

Fuse	Configuratio n	Definition	GPIO ¹	Shipped value	Settings ²
		<p>or the eFUSE settings in the On-Chip OTP Controller (OCOTP).</p> <p>In the Boot From Fuse mode BOOT_MODE[1:0] = 00, the BT_FUSE_SEL fuse indicates whether the bit configuration eFuses are programmed.</p>			<ul style="list-style-type: none"> • 0—The BOOT configuration eFuses are not programmed yet. The boot flow jumps to the serial downloader. • 1—The BOOT configuration eFuses are programmed. The regular boot flow is performed.
SEC_CONFIG[1:0]	SEC_C ONFIG[0] - NXP SEC_C ONFIG[1] - OEM	Security Configuration, as defined in Boot security settings	NA	01	<p>00—Reserved</p> <p>01—Open (allows any program image, even if the authentication fails)</p> <p>1x—Closed (The program image executes only if authenticated)</p>
FIELD_RETURN	OEM	Enables the NXP reserved modes.			<p>0—The NXP reserved modes are enabled/disabled based on the DIR_BT_DIS value.</p> <p>1—The NXP reserved modes are enabled.</p>
SRK_HASH[255:0]	OEM	256-bit hash value of the super root key (SRK_HASH)	NA	0	Settings vary—used by HAB
UNIQUE_ID[63:0]	NXP	Device Unique ID, 64-bit UID	NA	Unique ID	Settings vary—used by HAB
BT_MMU_DISABLE	OEM	The MMU/L1 D Cache/PL310 disable bit used by the boot ROM for fast HAB processing.	No	0	<p>0—MMU/L1 D Cache/PL310 is enabled by the ROM during the boot.</p> <p>1—MMU/L1 D Cache/PL310 is disabled by the ROM during the boot.</p>
L1 I-Cache DISABLE	OEM	L1 I Cache disable bit used by the boot during the entire execution.	No	0	<p>0—L1 I Cache is enabled by the ROM during the boot.</p> <p>1—L1 I Cache is disabled by the ROM during the boot.</p>
BT_FREQ	OEM	Boot frequency selection	Yes	0	<p>0—Arm—396 MHz, DDR—396 MHz, AXI—198 MHz</p> <p>1—Arm—198 MHz, DDR—307 MHz, AXI—153 MHz</p>
BOOT_CFG1[7:0]	OEM	Boot configuration 1	Yes	0	Specific to the selected boot mode
BOOT_CFG2[7:0]	OEM	Boot configuration 2	Yes	0	Specific to the selected boot mode
BOOT_CFG4[6:0]	OEM	Boot configuration 4		0	Specific to the selected boot mode
BOOT_CFG4[7]	OEM	Infinite Loop Enable at the start of the boot ROM. Used for debugging purposes. Ignored if the DIR_BT_DIS	Yes	0	<p>0—Disabled</p> <p>1—Enabled</p>

Table continues on the next page...

**Table 8-2. Boot eFUSE descriptions
(continued)**

Fuse	Configuratio n	Definition	GPIO ¹	Shipped value	Settings ²
		is 1 and FIELD_RETURN is 0.			
LPB_BOOT	OEM	USB Low-Power Boot	No	0	00—396 MHz 01—396 MHz 10—198 MHz 11—99 MHz
BT_LPB_POLARITY	OEM	USB Low-Power Boot GPIO polarity	No	0	0—Low on the GPIO pad indicates the low-power condition. 1—High on the GPIO pad indicates the low-power condition.
WDOG_ENABLE	OEM	Watchdog reset counter enable	No	0	0—The watchdog reset counter is disabled during the serial downloader. 1—The watchdog reset counter is enabled during the serial downloader.
SRK_REVOKE[2:0]	OEM	SRK revocation mask	No	0	SRK revocation mask
DISABLE_SDMMC_MFG	OEM	Disable the SDMMC manufacture mode	Yes	0	0—enable the SD/MMC MFG mode 1—disable the SD/MMC MFG mode
PAD_SETTINGS	OEM	Override values for the SD/MMC and NAND boot modes	No	0	Override these IO PAD settings: <ul style="list-style-type: none"> • PAD_SETTINGS[0]—Slew Rate • PAD_SETTINGS[3:1]—Drive Strength • PAD_SETTINGS[5:4]—Speed Settings

1. This setting can be overridden by the GPIO settings when the BT_FUSE_SEL fuse is intact. See [GPIO Boot Overrides](#) for the corresponding GPIO pin.
2. 0 = intact fuse and 1= blown fuse

8.3.2 GPIO boot overrides

This table provides a list of the GPIO boot overrides:

Table 8-3. GPIO override contact assignments

Package pin	Direction on reset	eFuse
BOOT_MODE1	Input	Boot mode selection
BOOT_MODE0	Input	

Table continues on the next page...

Table 8-3. GPIO override contact assignments (continued)

Package pin	Direction on reset	eFuse
LCD1_DATA00	Input	BOOT_CFG1[0]
LCD1_DATA01	Input	BOOT_CFG1[1]
LCD1_DATA02	Input	BOOT_CFG1[2]
LCD1_DATA03	Input	BOOT_CFG1[3]
LCD1_DATA04	Input	BOOT_CFG1[4]
LCD1_DATA05	Input	BOOT_CFG1[5]
LCD1_DATA06	Input	BOOT_CFG1[6]
LCD1_DATA07	Input	BOOT_CFG1[7]
LCD1_DATA08	Input	BOOT_CFG2[0]
LCD1_DATA09	Input	BOOT_CFG2[1]
LCD1_DATA10	Input	BOOT_CFG2[2]
LCD1_DATA11	Input	BOOT_CFG2[3]
LCD1_DATA12	Input	BOOT_CFG2[4]
LCD1_DATA13	Input	BOOT_CFG2[5]
LCD1_DATA14	Input	BOOT_CFG2[6]
LCD1_DATA15	Input	BOOT_CFG2[7]
LCD1_DATA16	Input	BOOT_CFG4[0]
LCD1_DATA17	Input	BOOT_CFG4[1]
LCD1_DATA18	Input	BOOT_CFG4[2]
LCD1_DATA19	Input	BOOT_CFG4[3]
LCD1_DATA20	Input	BOOT_CFG4[4]
LCD1_DATA21	Input	BOOT_CFG4[5]
LCD1_DATA22	Input	BOOT_CFG4[6]
LCD1_DATA23	Input	BOOT_CFG4[7]

The input pins provided are sampled at boot, and can be used to override the corresponding eFUSE values, depending on the setting of the BT_FUSE_SEL fuse.

8.3.3 Device Configuration Data (DCD)

The DCD is the configuration information contained in the program image (external to the ROM) that the ROM interprets to configure various on-chip peripherals. See [Device Configuration Data \(DCD\)](#) for more details on DCD.

8.4 Device initialization

This section describes the details of the ROM and provides the initialization details.

This includes details on:

- The ROM memory map
- The RAM memory map
- On-chip blocks that the ROM must use or change the POR register default values
- Clock initialization
- Enabling the MMU/L2 cache
- Exception handling and interrupt handling

8.4.1 Internal ROM/RAM memory map

These figures show the iROM memory map:

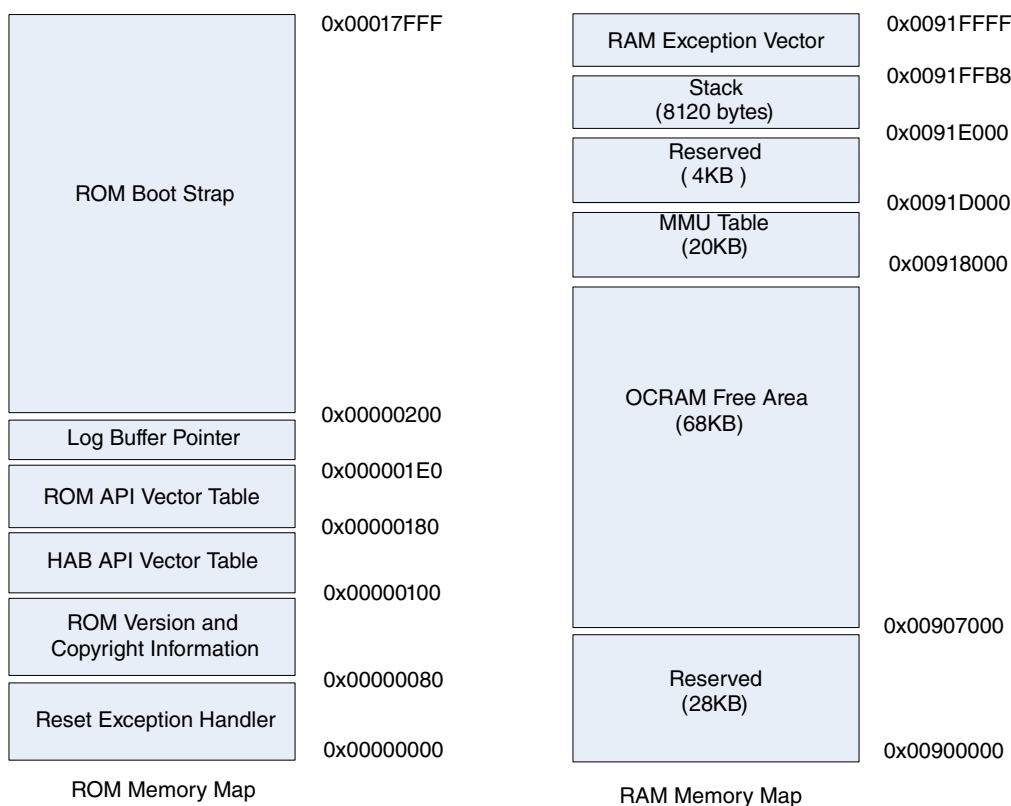

Figure 8-3. Internal ROM and RAM memory map

NOTE

The entire OCRAM region can be used freely after the boot.

8.4.2 Boot block activation

The boot ROM affects a number of different hardware blocks which are activated and play a vital role in the boot flow.

The ROM configures and uses the following blocks (listed in an alphabetical order) during the boot process. Note that the blocks actually used depend on the boot mode and the boot device selection:

- APBH—the DMA engine to drive the GPMI module
- BCH—40-bit error correction hardware engine with the AXI bus master and a private connection to the GPMI
- CCM—Clock Control Module
- ECSPI—Enhanced Configurable Serial Peripheral Interface
- EIM—External Interface Module used for the NOR and OneNAND devices
- GPMI—NAND controller pin interface
- OCOTP_CTRL—On-Chip OTP Controller; the OCOTP contains the eFUSES
- IOMUXC—I/O Multiplexer Control which allows the GPIO use to override the eFUSE boot settings;
- IOMUXC GPR—I/O Multiplexer Control General-Purpose Registers
- DCP—Data Co-Processor
- QSPI—QuadSPI flash
- SNVS—Secure Non-Volatile Storage
- SRC—System Reset Controller
- UART—Universal Asynchronous Receiver/Transmitter controller
- USB—used for the serial download of a boot device provisioning program
- USDHC—Ultra-Secure Digital Host Controller
- WDOG-1—Watchdog timer

8.4.3 Clocks at boot time

The table below show the various clocks and their sources used by the ROM.

Table 8-4. Normal frequency clocks configuration

Clock	CCM signal	Source	Frequency (MHz)	Frequency (MHz)
			BT_FREQ=0	BT_FREQ=1
ARM PLL	pll1_sw_clk		396	396
System PLL	pll2_sw_clk		528	528
USB PLL	pll3_sw_clk		480	480
AHB	ahb_clk_root	528 MHz PLL/PFD352	132	88
IPG	ipg_clk_root	528 MHz PLL/PFD352	66	44

Device initialization

After the reset, each Arm core has access to all peripherals. The ROM code disables the clocks listed in the following table, except for the boot devices listed in the second column.

Table 8-5. List of disabled clocks

Clock name	Enabled for boot device
CCGR0_APBHDMA_CLK_SEL	NAND
CCGR0_ASRC_CLK_SEL	
CCGR0_CAN1_CLK_SEL	
CCGR0_CAN1_SERIAL_CLK_SEL	
CCGR0_CAN2_CLK_SEL	
CCGR0_CAN2_SERIAL_CLK_SEL	
CCGR0_UART2_CLK_SEL	UART2
CCGR1_ECSP11_CLK_SEL	ECSP11
CCGR1_ECSP12_CLK_SEL	ECSP12
CCGR1_ECSP13_CLK_SEL	ECSP13
CCGR1_ECSP14_CLK_SEL	ECSP14
CCGR1_EPIT1_CLK_SEL	
CCGR1_EPIT2_CLK_SEL	
CCGR1_ADC1_CLK_SEL	
CCGR1_ADC2_CLK_SEL	
CCGR1_UART3_CLK_SEL	
CCGR1_UART4_CLK_SEL	
CCGR2_CSI_CLK_SEL	
CCGR3_CSI_CORE_CLK_SEL	
CCGR2_I2C1_CLK_SEL	
CCGR2_I2C2_CLK_SEL	
CCGR2_I2C3_CLK_SEL	
CCGR2_LCD_CLK_SEL	
CCGR2_PXP_CLK_SEL	
CCGR3_ENET_CLK_SEL	
CCGR3_LCDIF_PIX_CLK_SEL	
CCGR3_QSPI1_CLK_SEL	QSPI1
CCGR3_UART5_CLK_SEL	
CCGR3_UART6_CLK_SEL	
CCGR4_PWM1_CLK_SEL	
CCGR4_PWM2_CLK_SEL	
CCGR4_PWM3_CLK_SEL	
CCGR4_PWM4_CLK_SEL	
CCGR4_RAWNAND_U_BCH_INPUT_A_CLK_SEL	NAND
CCGR4_RAWNAND_U_GPMI_BCH_INPUT_BCG_CLK_SEL	NAND
CCGR4_RAWNAND_U_GPMI_BCH_INPUT_GPMI_CLK_SEL	NAND

Table continues on the next page...

Table 8-5. List of disabled clocks (continued)

Clock name	Enabled for boot device
CCGR4_RAWNAND_U_GPMI_INPUT_APB_CLK_SEL	NAND
CCGR4_TSC_CLK_SEL	
CCGR5_SDMA_CLK_SEL	
CCGR5_SPDIF_CLK_SEL	
CCGR5_SPBA_CLK_SEL	
CCGR5_UART1_CLK_SEL	
CCGR5_UART7_CLK_SEL	
CCGR5_KPP_CLK_SEL	
CCGR5_SAI1_CLK_SEL	
CCGR5_SAI2_CLK_SEL	
CCGR5_SAI3_CLK_SEL	
CCGR6_USBOH3_CLK_SEL	USB
CCGR6_USDHC1_CLK_SEL	USDHC1
CCGR6_USDHC2_CLK_SEL	USDHC2
CCGR6_EMI_SLOW_CLK_SEL	NOR, OneNAND
CCGR6_PWM8_CLK_SEL	
CCGR6_SIM1_CLK_SEL	
CCGR6_SIM2_CLK_SEL	
CCGR6_I2C4_SERIAL_CLK_SEL	
CCGR6_PWM5_CLK_SEL	
CCGR6_PWM6_CLK_SEL	
CCGR6_PWM7_CLK_SEL	
CCGR6_UART8_CLK_SEL	

8.4.4 Enabling MMU and caches

The boot ROM includes a feature that enables the Memory Management Unit (MMU) and the caches to improve the boot speed.

The L1 instruction cache is enabled at the start of the image download. The L1 data cache, L2 cache, and MMU are enabled during the image authentication. When the HAB authentication completes, the ROM disables the L1 data cache, L2 cache, and MMU.

The L1 Instruction cache, L1 data cache, L2 cache, and MMU is controlled by eFuse. By default, these features are enabled.

Enabling the MMU when booting non-securely with SEC_CONFIG=Open and setting the CSF pointer in the Image Vector Table to NULL has no impact on the boot performance. With this configuration, it is recommended to blow the BT_MMU_DISABLE fuse.

8.4.5 Exception handling

The exception vectors located at the start of the ROM are used to map all the Arm exceptions (except the reset exception) to a duplicate exception vector table in the internal RAM.

During the boot phase of CPU0, the RAM vectors point to the serial downloader in the ROM.

After the boot, the program image can overwrite the vectors as required. The code shown below is used to map the ROM exception vector table to the duplicate exception vector table in the RAM.

Mapping ROM Exception Vector Table

```
;; Define linker area for ROM exception vector table
AREA IROM_VECTORS, CODE, READONLY
LDR    PC, Reset_Addr
LDR    PC, Undefined_Addr
LDR    PC, SWI_Addr
LDR    PC, Prefetch_Addr
LDR    PC, Abort_Addr
NOP                                ; Reserved vector
LDR    PC, IRQ_Addr
LDR    PC, FIQ_Addr

;; Define exception vector table
Reset_Addr    DCD    start_address
Undefined_Addr DCD    iRAM_Undefined_Handler
SWI_Addr      DCD    iRAM_SWI_Handler
Prefetch_Addr DCD    iRAM_Prefetch_Handler
Abort_Addr    DCD    iRAM_Abort_Handler
              DCD    0 ; Reserved vector
IRQ_Addr      DCD    iRAM_IRQ_Handler
FIQ_Addr      DCD    iRAM_FIQ_Handler

start_address DCD start ;reset handler vector
```

8.4.6 Interrupt handling during boot

No special interrupt-handling routines are required during the boot process. The interrupts are disabled during the boot ROM execution and may be enabled in a later boot stage.

8.4.7 Persistent bits

Some modes of the boot ROM require the registers that keep their values after a warm reset. The SRC General-Purpose registers are used for this purpose.

See this table for persistent bits list and description:

Table 8-6. Persistent bits

Bit name	Bit location	Description
PERSIST_SECONDARY_BOOT	SRC_GPR10[30]	This bit identifies which image must be used—primary and secondary. Used only for the boot modes that support redundant boot.
PERSIST_BLOCK_REWRITE	SRC_GPR10[29]	This bit is used as a warning. It identifies that there are errors in the NAND blocks that hold the application image. See NAND flash for more details.
PERSISTENT_ENTRY0[31:0]	SRC_GPR1[31:0]	Holds the entry function for the CPU0 to wake up from the low-power mode.
PERSISTENT_ARG0[31:0]	SRC_GPR2[31:0]	Holds the argument of entry function for the CPU0 to wake up from the low-power mode.
PERSIST_OVERRIDE_SBMR1	SRC_GPR10[28]	This bit instructs the ROM code to use the SRC_GPR9 register as if it is the SBMR1. This allows the software to override the fuse bits and boot from an alternative boot source. This feature is valid for a WDOG time-out reset only, and can be disabled if the DIR_BT_DIS fuse is blown.
PERSIST_SBMR1_VALUE	SRC_GPR9	The value to override the SBMR1.

8.5 Boot devices (internal boot)

The chip supports these boot flash devices:

- NOR flash with the External Interface Module (EIM), located on CS0, 16-bit bus width.
- OneNAND flash with the EIM interface, located on CS0, 16-bits bus width.
- Raw NAND (MLC and SLC), and Toggle-mode NAND flash through GPMI-2 interface. Page sizes of 2 KB, 4 KB, and 8 KB. The bus widths of 8-bit with 2 through 40-bit BCH hardware ECC (Error Correction) are supported.
- Quad SPI flash.
- SD/MMC/eSD/SDXC/eMMC4.4 via USDHC interface, supporting high capacity cards.
- EEPROM boot via SPI (serial flash).

Boot devices (internal boot)

The selection of the external boot device type is controlled by the BOOT_CFG1[7:4] eFUSES. See this table for more details:

Table 8-7. Boot device selection

BOOT_CFG1[7:4]	Boot device
0000	NOR/OneNAND (EIM)
0001	QSPI
0011	Serial ROM (SPI)
010x	SD/eSD/SDXC
011x	MMC/eMMC
1xxx	Raw NAND

8.5.1 NOR flash/OneNAND using EIM interface

The External Interface Module (EIM) works in the asynchronous mode, and supports either muxed, Address/Data, or non-muxed schemes, based on the fuse settings.

Table 8-8. EIM boot eFUSE descriptions

Fuse	Config	Definition	GPIO ¹	Shipped value	Settings
BOOT_CFG1[7:4]	OEM	Boot device selection	Yes	0000	0000—boot from the EIM interface
BOOT_CFG1[3]	OEM	NOR/OneNAND selection	Yes	0	0—NOR 1—OneNAND
BOOT_CFG2[7:6]	OEM	Muxing scheme	Yes	00	00—muxed, 16-bit data (low half) interface 01—reserved 10—not muxed, 16-bit data (low half) interface 11—reserved
BOOT_CFG2[5:4]	OEM	OneNAND page size	Yes	00	00—1 KB 01—2 KB 10—4 KB 11—reserved

1. This setting can be overridden by the GPIO settings when the BT_FUSE_SEL fuse is intact. See [GPIO Boot Overrides](#) for the corresponding GPIO pin.

8.5.1.1 NOR flash boot operation

Booting from the NOR flash is supported via the EIM interface. The ROM reads the Image Vector Table and Boot Data structures to determine if the image can be executed directly from the EIM address space or copied to another memory.

The start field of the Boot Data Structure specifies the final location of the image (see [Image Vector Table and Boot Data](#)).

8.5.1.2 OneNAND flash boot operation

At system power-up, the OneNAND device automatically copies the Initial Load Region of 1 KB from the start of the flash array (sector 0 and sector 1, page 0, block 0) to its Boot RAM (OneNAND's internal RAM).

NOTE

The OneNAND boot RAM memory containing the Initial 1-KB Load Region must contain the IVT, DCD, and the Boot Data structures.

Next, the ROM processes the DCD and then proceeds to copy the program image contents to the application destination pointer (located in the start entry of the Boot Data (see [Image Vector Table and Boot Data](#)). The ROM determines the size of the program image by the length specified by the size entry in the Boot Data structure (see [Image Vector Table and Boot Data](#)). A failure in loading data from the OneNAND device for any reason forces the chip to enter the Serial Downloader. Otherwise, the booting from the OneNAND device continues.

This figure illustrates the layout of the program image on the OneNAND boot device:

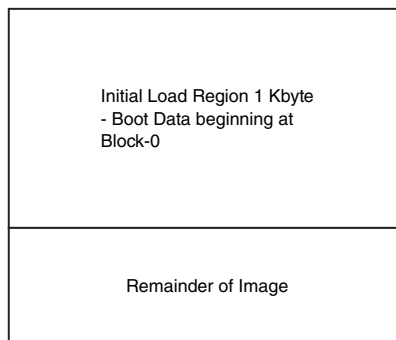

Figure 8-4. Program image layout on the OneNAND flash device

Before accessing the OneNAND device, the chip waits approximately 500 μ s after the Power-On Reset. This delay is required for the OneNAND device to become ready. After this initial 500 μ s delay, it can take additional 70 μ s for the OneNAND device to load the

Initial Load Region of 1 KB into its boot RAM. The chip polls the OneNAND device Interrupt Status Register to confirm that the first 1 KB was loaded to the OneNAND boot RAM before continuing with the boot flow.

8.5.1.3 IOMUX configuration for EIM devices

The EIM interface uses the dedicated contacts on the IC.

The contacts assigned to the data signals used by the EIM are shown in this table:

Table 8-9. EIM IOMUX pin configuration

Signal	A/D16 (Muxed, 16-bit data interface)	A+D (Not muxed, 16-bit data interface)
DATA0	CSI_DATA00.alt4	LCD_DATA08.alt4
DATA1	CSI_DATA01.alt4	LCD_DATA09.alt4
DATA2	CSI_DATA02.alt4	LCD_DATA10.alt4
DATA3	CSI_DATA03.alt4	LCD_DATA11.alt4
DATA4	CSI_DATA04.alt4	LCD_DATA12.alt4
DATA5	CSI_DATA05.alt4	LCD_DATA13.alt4
DATA6	CSI_DATA06.alt4	LCD_DATA14.alt4
DATA7	CSI_DATA07.alt4	LCD_DATA15.alt4
DATA8	NAND_DATA00.alt4	LCD_DATA16.alt4
DATA9	NAND_DATA01.alt4	LCD_DATA17.alt4
DATA10	NAND_DATA02.alt4	LCD_DATA18.alt4
DATA11	NAND_DATA03.alt4	LCD_DATA19.alt4
DATA12	NAND_DATA04.alt4	LCD_DATA20.alt4
DATA13	NAND_DATA05.alt4	LCD_DATA21.alt4
DATA14	NAND_DATA06.alt4	LCD_DATA22.alt4
DATA15	NAND_DATA07.alt4	LCD_DATA23.alt4
ADDR0	CSI_DATA00.alt4	
ADDR1	CSI_DATA01.alt4	
ADDR2	CSI_DATA02.alt4	
ADDR3	CSI_DATA03.alt4	
ADDR4	CSI_DATA04.alt4	
ADDR5	CSI_DATA05.alt4	
ADDR6	CSI_DATA06.alt4	
ADDR7	CSI_DATA07.alt4	
ADDR8	NAND_DATA00.alt4	
ADDR9	NAND_DATA01.alt4	
ADDR10	NAND_DATA02.alt4	
ADDR11	NAND_DATA03.alt4	
ADDR12	NAND_DATA04.alt4	

Table continues on the next page...

Table 8-9. EIM IOMUX pin configuration (continued)

Signal	A/D16 (Muxed, 16-bit data interface)	A+D (Not muxed, 16-bit data interface)
ADDR13		NAND_DATA05.alt4
ADDR14		NAND_DATA06.alt4
ADDR15		NAND_DATA07.alt4
ADDR16		NAND_CLE.alt4
ADDR17		NAND_ALE.alt4
ADDR18		NAND_CE1_B.alt4
ADDR19		SD1_CMD.alt4
ADDR20		SD1_CLK.alt4
ADDR21		SD1_DATA0.alt4
ADDR22		SD1_DATA1.alt4
ADDR23		SD1_DATA2.alt4
ADDR24		SD1_DATA3.alt4
ADDR25		ENET2_RXER.alt4
ADDR26		ENET2_CRS_DV.alt4

8.5.2 NAND flash

The boot ROM supports a number of MLC/SLC NAND flash devices from different vendors and LBA NAND flash devices. The Error Correction and Control (ECC) subblock (BCH) is used to detect the errors.

8.5.2.1 NAND eFUSE configuration

The boot ROM determines the configuration of the external NAND flash by parameters, either provided by the eFUSE, or sampled on the GPIO pins during boot. See [Table 8-10](#) for parameters details.

NOTE

BOOT_CFGx sampled on the GPIO pins depends on the BT_FUSE_SEL setting. See [Boot Fusemap](#) for details.

NOTE

For BOOT_CFG[3:2], although ROM always boots from CS0_B, for multiple chip selects, such as some NAND chips which consist of multi CS. This fuse must be burned correctly. The number of devices means the number of chip selects.

Table 8-10. NAND boot eFUSE descriptions

Fuse	Config	Definition	GPIO ¹	Shipped value	Settings
BOOT_CFG1[7]	OEM	Boot device selection	Yes	0	1—boot from the NAND Interface
BOOT_CFG1[6]	OEM	BT_TOGGLEMODE	Yes	0	0—raw NAND 1—toggle mode NAND
BOOT_CFG1[5:4]	OEM	Pages in block	Yes	0	00—128 01—64 10—32 11—256
BOOT_CFG1[3:2]	OEM	Number of devices	Yes	00	00—1 device 01—2 device 10—4 device 11—Reserved
BOOT_CFG1[1:0]	OEM	Row address cycles	Yes	00	00—3 01—2 10—4 11—5
BOOT_CFG2[7:5]	OEM	Toggle mode 33 MHz preamble delay, read latency	Yes	000	000—16 GPMICK cycles 001—1 GPMICK cycles 010—2 GPMICK cycles 011—3 GPMICK cycles 100—4 GPMICK cycles 101—5 GPMICK cycles 110—6 GPMICK cycles 111—7 GPMICK cycles
BOOT_CFG2[4:3]	OEM	Boot search count	Yes	00	00—2 01—2 10—4 11—8
BOOT_CFG2[2]	OEM	Boot frequencies (ARM/DDR)	Yes	0	0—500/400 MHz 1—250/200 MHz
BOOT_CFG2[1]	OEM	Reset time	Yes	0	0—12 ms 1—22 ms (LBA NAND)
0x470[0]	OEM	Override pad settings	Yes	0	Override NAND pad settings 0—use the default values 1—use the PAD_SETTINGS value
0x6D0[5:0]	OEM	PAD_SETTINGS[5:0]	Yes	0	NAND pad settings value

Table continues on the next page...

Table 8-10. NAND boot eFUSE descriptions (continued)

Fuse	Config	Definition	GPIO ¹	Shipped value	Settings
0x6D0[11:8]	OEM	READ_RETRY_SEQ_ID[3:0]	Yes	0000	0000—don't use the ROM embedded read-retry sequence 0001—use Micron 20 nm read-retry sequence 0010—use Toshiba A19 nm read-retry sequence 0011—use Toshiba 19 nm read-retry sequence 0100—use SanDisk 19 nm read-retry sequence 0101—use SanDisk 1nm read-retry sequence 0110—use Hynix 20 nm A die read-retry sequence 0111—use Hynix 26 nm read-retry sequence 1000—use Hynix 20 nm B die read-retry sequence 1001—use Hynix 20 nm C die read-retry sequence 1010 to 1111—reserved

1. The setting can be overridden by the GPIO settings when the BT_FUSE_SEL fuse is intact. See [Table 3](#) for the corresponding GPIO pin.

8.5.2.2 NAND flash boot flow and Boot Control Blocks (BCB)

There are two BCB data structures:

- FCB
- DBBT

As a part of the NAND media initialization, the ROM driver uses safe NAND timings to search for the Firmware Configuration Block (FCB) that contains the optimum NAND timings, the page address of the Discovered Bad Block Table (DBBT) Search Area, and the start page address of the primary and secondary firmware.

The hardware ECC level to use is embedded inside the FCB block. The FCB data structure is also protected using the ECC. The driver reads raw 2112 bytes of the first sector and runs through the software ECC engine that determines whether the FCB data is valid or not.

If the FCB is found, the optimum NAND timings are loaded for further reads. If the ECC fails, or the fingerprints do not match, the Block Search state machine increments the page number to the Search Stride number of pages to read for the next BCB until the SearchCount pages have been read.

If the search fails to find a valid FCB, the NAND driver responds with an error and the boot ROM enters the serial download mode.

The FCB contains the page address of the DBBT Search Area, and the page address for primary and secondary boot images. The DBBT is searched in the DBBT Search Area, just like the FCB is searched. After the FCB is read, the DBBT is loaded, and the primary or secondary boot image is loaded using the starting page address from the FCB.

This figure shows the state diagram of the FCB search:

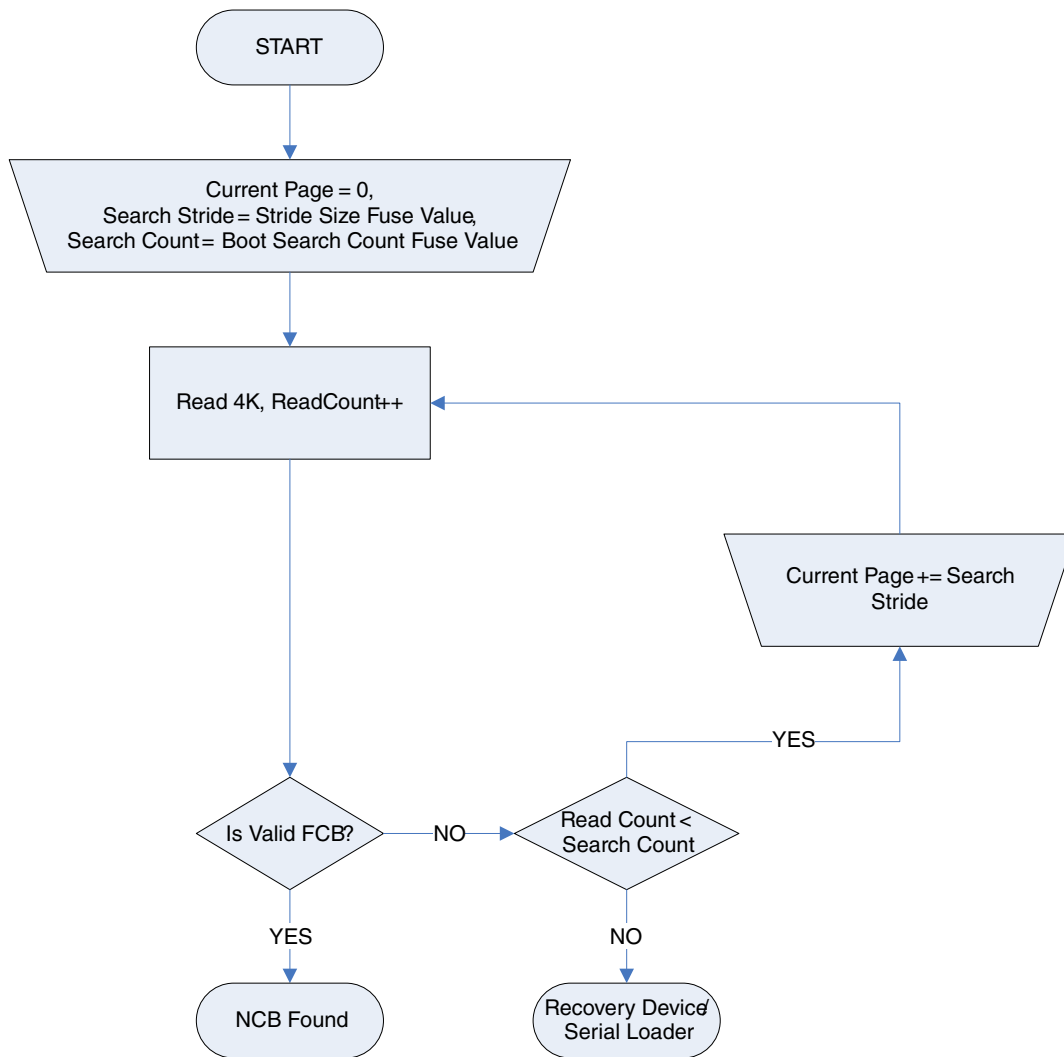

Figure 8-5. FCB search flow

When the FCB is found, the boot ROM searches for the Discovered Bad Blocks Table (DBBT). If the DBBT Search Area is 0 in the FCB, the ROM assumes that there are no bad blocks on the NAND device boot area. See this figure for the DBBT search flow:

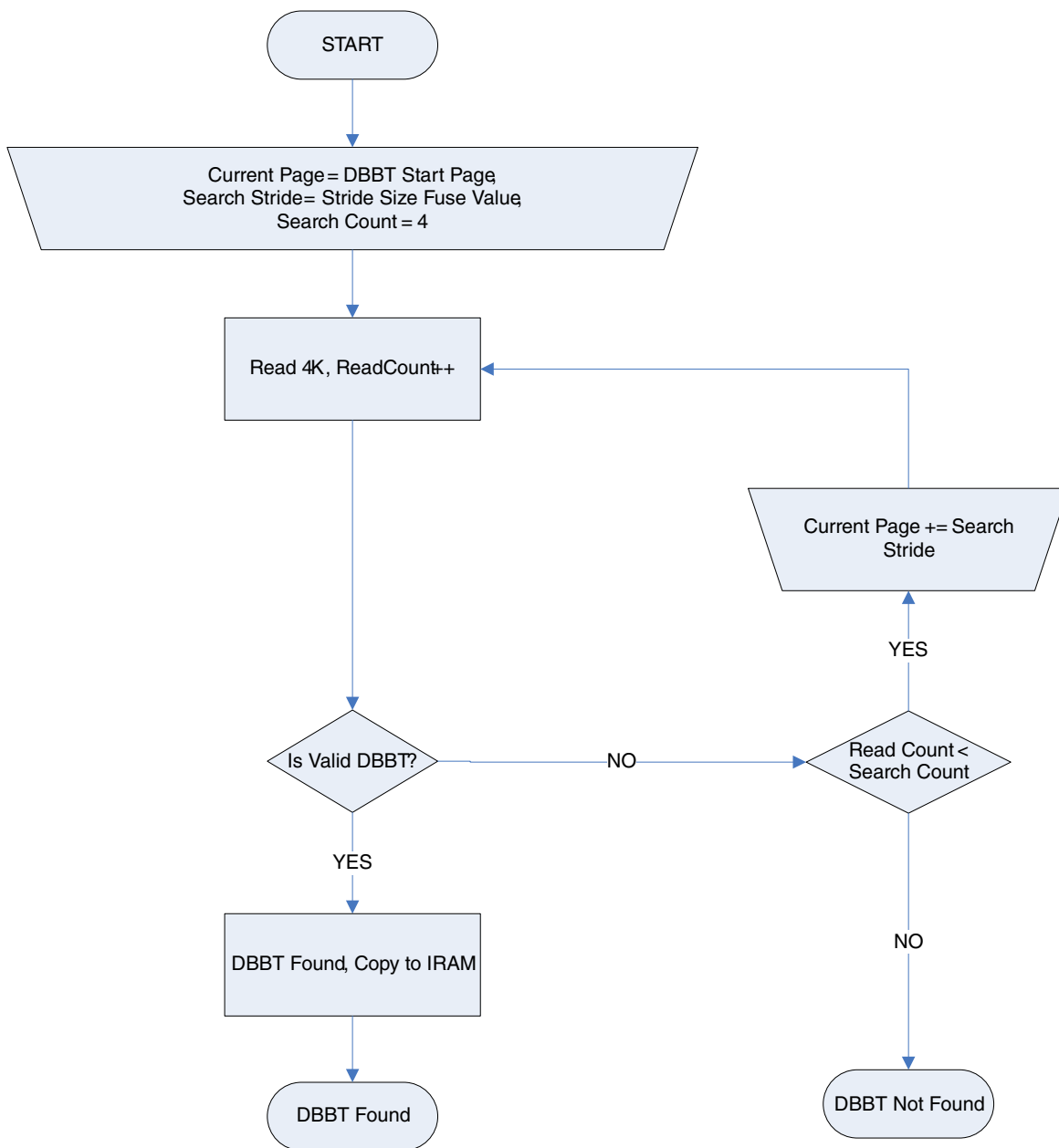

Figure 8-6. DBBT search flow

The BCB search and load function also monitors the ECC correction threshold and sets the `PERSIST_BLOCK_REWRITE` persistent bit if the threshold exceeds the maximum ECC correction ability.

If there is a page with a number of errors higher than ECC can correct during the primary image read, the boot ROM turns on the `PERSIST_SECONDARY_BOOT` bit and performs the software reset (After the software reset, the secondary image is used).

If there is a page with number of errors higher than ECC can correct during secondary image read, the boot ROM goes to the serial loader.

8.5.2.3 Firmware configuration block

The FCB is the first sector in the first good block. The FCB must be present at each search stride of the search area.

The search area contains copies of the FCB at each stride distance, so, in case the first NAND block becomes corrupted, the ROM finds its copy in the next NAND block. The search area must span over at least two NAND blocks. The location information for the DBBT search area, FW1, and FW2 are all specified in the FCB. This table shows the flash control block structure:

Table 8-11. Flash control block structure

Name	Start byte	Size in bytes	Description
Reserved	0	4	Reserved for Fingerprint #1(Checksum)
FingerPrint	4	4	32-bit word with a value of 0x20424346, in ascii "FCB"
Version	8	4	32-bit version number; this version of FCB is 0x00000001
m_NANDTiming	12	8	8 B of data for eight NAND timing parameters from the NAND datasheet. The eight parameters are: m_NandTiming[0]=data_setup, m_NandTiming[1]=data_hold, m_NandTiming[2]=address_setup, m_NandTiming[3]=dsample_time, m_NandTiming[4]=nand_timing_state, m_NandTiming[5]=REA, m_NandTiming[6]=RLOH, m_NandTiming[7]=RHOH. The ROM only uses the first four parameters, but the FCB provides space for other four parameters to be used by the bootloader or other applications.
PageDataSize	20	4	The number of bytes of data in a page. Typically, this is 2048 bytes for 2112 bytes page size or 4096 bytes for 4314/4224 bytes page size or 8192 for 8568 bytes page size.
TotalPageSize	24	4	The total number of bytes in a page. Typically, 2112 for 2-KB page or 4224 or 4314 for 4-KB page or 8568 for 8-KB page.

Table continues on the next page...

Table 8-11. Flash control block structure (continued)

Name	Start byte	Size in bytes	Description
SectorsPerBlock	28	4	The number of pages per block. Typically 64 or 128 or depending on the NAND device type.
NumberOfNANDs	32	4	Not used by ROM
TotalInternalDie	36	4	Not used by ROM
CellType	40	4	Not used by ROM
EccBlockNEccType	44	4	Value from 0 to 20 is used to set the BCH Error Correction level 0, 2, 4, .. or 40 for Block BN of ECC page, used in configuring the BCH40 page layout registers.
EccBlock0Size	48	4	Size of block B0 used in configuring the BCH40 page-layout registers.
EccBlockNSize	52	4	Size of block BN used in configuring the BCH40 page-layout registers.
EccBlock0EccType	56	4	Value from 0 to 20 used to set the BCH Error Correction level 0, 2, 4, .. or 40 for Block BN of ECC page, used in configuring the BCH40 page layout registers.
MetadataBytes	60	4	Size of metadata bytes used in configuring the BCH40 page-layout registers.
NumEccBlocksPerPage	64	4	Number of the ECC blocks BN not including B0. This value is used in configuring the BCH40 page-layout registers.
EccBlockNEccLevelSDK	68	4	Not used by ROM
EccBlock0SizeSDK	72	4	Not used by ROM
EccBlockNSizeSDK	76	4	Not used by ROM
EccBlock0EccLevelSDK	80	4	Not used by ROM
NumEccBlocksPerPageSDK	84	4	Not used by ROM
MetadataBytesSDK	88	4	Not used by ROM
EraseThreshold	92	4	Not used by ROM
Firmware1_startingPage	104	4	Page number address where the first copy of bootable firmware is located.
Firmware2_startingPage	108	4	Page number address where the second copy of bootable firmware is located.
PagesInFirmware1	112	4	Size of the first copy of firmware in pages.
PagesInFirmware2	116	4	Size of the second copy of firmware in pages.
DBBTSearchAreaStartAddress	120	4	Page address for the bad block table search area.
BadBlockMarkerByte	124	4	This is an input offset in the BCH page for the ROM to swap with the first byte of metadata after reading a page using the BCH40. The ROM supports the restoration of manufacturer-marked bad block markers in the page and this offset is the bad block marker offset location.

Table continues on the next page...

Table 8-11. Flash control block structure (continued)

Name	Start byte	Size in bytes	Description
BadBlockMarkerStartBit	128	4	This is an input bit offset in the BadBlockMarkerByte for the ROM to use when swapping eight bits with the first byte of metadata.
BBMarkerPhysicalOffset	132	4	This is the offset where the manufacturer leaves the bad block marker on a page.
BCHType	136	4	0 for BCH20 and 1 for BCH40. The chip is backwards compatible to BCH20 and this field tells the ROM to use the BCH20 or BCH40 block.
TMTiming2_ReadLatency	140	4	Toggle mode NAND timing parameter read latency, the ROM uses this value to configure the timing2 register of the GPMI.
TMTiming2_PreambleDelay	144	4	Toggle mode NAND timing parameter Preamble Delay. The ROM uses this value to configure the timing2 register of the GPMI.
TMTiming2_CEDelay	148	4	Toggle mode NAND timing parameter CE Delay. The ROM uses this value to configure the timing2 register of the GPMI.
TMTiming2_PostambleDelay	152	4	Toggle mode NAND timing parameter Postamble Delay. The ROM uses this value to configure the timing2 register of the GPMI.
TMTiming2_CmdAddPause	156	4	Toggle mode NAND timing parameter Cmd Add Pause. The ROM uses this value to configure the timing2 register of the GPMI.
TMTiming2_DataPause	160	4	Toggle mode NAND timing parameter Data Pause. The ROM uses this value to configure the timing2 register of the GPMI.
TMSpeed	164	4	This is the toggle mode speed for the ROM to configure the gpmi clock. 0 for 33 MHz, 1 for 40 MHz, and 2 for 66 MHz.
TMTiming1_BusyTimeout	168	4	Toggle mode NAND timing parameter Busy Timeout. The ROM uses this value to configure the timing1 register of the GPMI.
DISBBM	172	4	If 0, the ROM swaps the BadBlockMarkerByte with metadata[0] after reading a page using the BCH40. If the value is 1, the ROM does not swap.
BBMark_spare_offset	176	4	The offset in the metadata place which stores the data in the bad block marker place.
Onfi_sync_enable	180	4	Enable the Onfi nand sync mode support.
Onfi_sync_speed	184	4	Speed for the Onfi nand sync mode: 0 - 24 MHz, 1 - 33 MHz, 2 - 40 MHz, 3 - 50 MHz, 4 - 66 MHz, 5 - 80 MHz, 6 - 100 MHz, 7 - 133 MHz, 8 - 160 MHz, 9 - 200 MHz

Table continues on the next page...

Table 8-11. Flash control block structure (continued)

Name	Start byte	Size in bytes	Description
Onfi_syncNANDData	188	28	The parameters for the Onfi nand sync mode timing. They are read latency, ce_delay, preamble_delay, postamble_delay, cmdadd_pause, data_pause, and busy_timeout.
DISBB_Search	216	4	Disable the bad block search function when reading the firmware, only using DBBT.
Reserved	220	64	Reserved for future use.

8.5.2.4 Discovered Bad Block Table (DBBT)

See this table for the DBBT format:

Table 8-12. DBBT structure

Name	Start byte	Size in bytes	Description
reserved	0	4	-
FingerPrint	4	4	32-bit word with a value of 0x444424254, in ascii "DBBT"
Version	8	4	32-bit version number; this version of DBBT is 0x00000001
reserved	12	4	-
DBBT_NUM_OF_PAGES	16	4	Size of the DBBT in pages
reserved	20	4*PageSize-20	-
reserved	4*PageSize	4	-
Number of Entries	4*PageSize + 4	4	Number of bad blocks
Bad Block Number	4*PageSize + 8	4	First bad block number
Bad Block Number	4*PageSize + 12	4	Second bad block number
-	-	-	Next bad block number
-	-	-	-
Last bad block number	-	-	Last bad block number

8.5.2.5 Bad block handling in ROM

During the firmware boot, at the block boundary, the Bad Block table is searched for a match to the next block.

If no match is found, the next block can be loaded. If a match is found, the block must be skipped and the next block checked.

If the Bad Block table start page is null, check the manufactory made Bad Block marker. The location of the Bad Block maker is at the first three or last three pages in every block of the NAND flash. The NAND manufacturers normally use one byte in the spare area of certain pages within a block to mark that a block is bad or not. A value of 0xFF means good block, non-FF means bad block.

To preserve the BI (bad block information), the flash updater or gang programmer applications must swap the Bad Block Information (BI) data to byte 0 of the metadata area for every page before programming the NAND flash. When the ROM loads the firmware, it copies back the value at metadata[0] to the BI offset in the page data. This figure shows how the factory bad block marker is preserved:

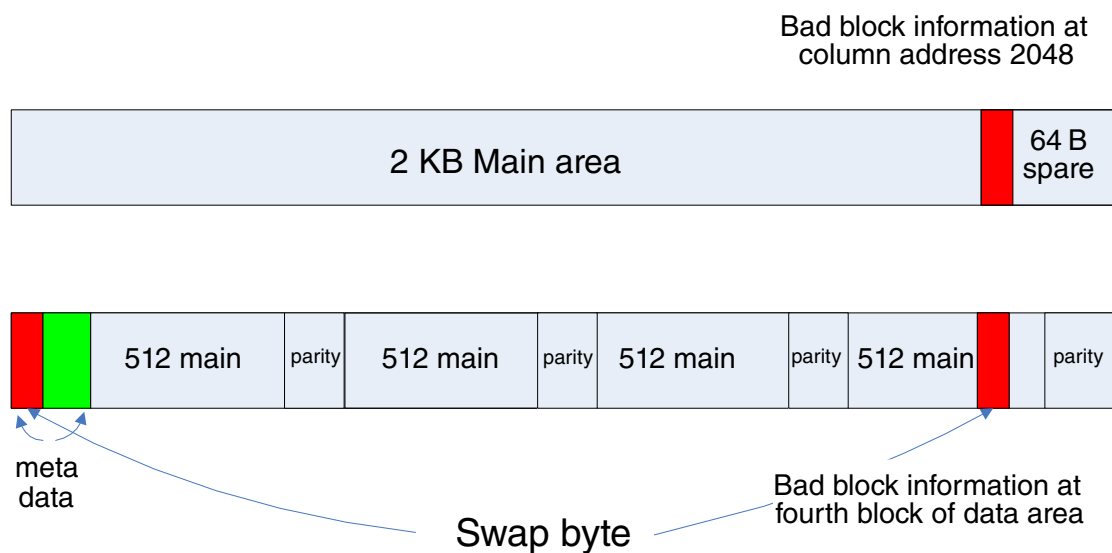

Figure 8-7. Factory bad block marker preservation

In the FCB structure, there are two elements (`m_u32BadBlockMarkerByte` and `m_u32BadBlockMarkerStartBit`) to indicate the byte and bit place in the page data that the manufacturer marked the bad block marker.

8.5.2.6 Read-retry handling in the ROM

The read-retry is used to recover the bit errors beyond the ECC correction threshold from NAND. If reading of a page failed and the `read_retry_enable` field in FCB is set to 1, the ROM issues a read-retry command sequence to shift the read level before reading the page again. If the previous reading failed, the ROM continues to shift the read level until the reading succeeds or all levels were tried. The state diagram of the read-retry is shown in this figure:

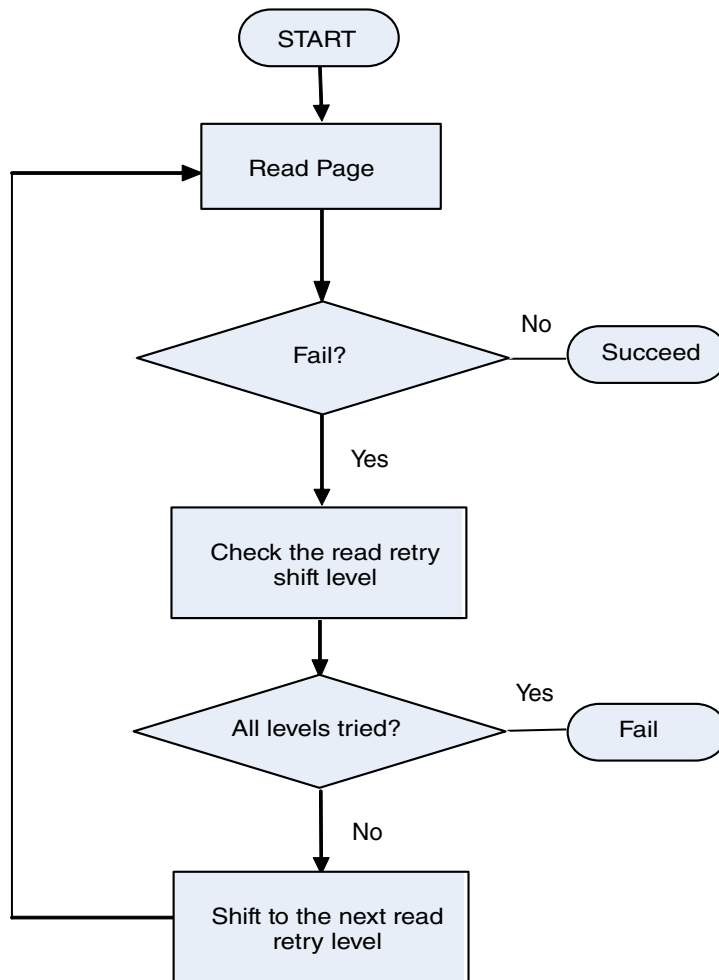

Figure 8-8. Read-retry flow

Different vendors and different processes may have different read-retry sequences. At this time, the ROM supports five read-retry sequences. Blowing the READ_RETRY_SEQ_ID[3:0] fuse can help to determine which sequence to use.

The read-retry sequences are listed in this table:

Table 8-13. Read-retry sequences

Vendor	Process	READ_RETRY_SEQ_ID[3:0]	Comment
Micron	20nm	2'b0001	The detail of this RR sequence is documented in "64 Gb, 128 Gb, 256 Gb, 512 Gb Asynchronous/Synchronous NAND Features(Release: 4/20/12)", contact Micron for that document.

Table continues on the next page...

Table 8-13. Read-retry sequences (continued)

Vendor	Process	READ_RETRY_SEQ_ID[3:0]	Comment
Toshiba	A19nm	2'b0010	The detail of this RR sequence is documented in "TOSHIBA Technical Information A19nm MLC NAND Retry Read Sequence", contact Toshiba for that document.
	19nm	2'b0011	The detail of this RR sequence is documented in "TOSHIBA Technical Information 19nm MLC NAND Read Retry Sequence Rev1.6", contact Toshiba for that document.
SanDisk	19nm	2'b0100	The detail of this RR sequence is documented in "App Note 023 (v1.0) 19nm eX2 ABL Dynamic Read Sequence & Parameter Table", contact SanDisk for that document.
	19nm	2'b0101	The detail of this RR sequence is documented in "Application Note 1y_023 19nm eX2 ABL Dynamic Read Sequence & Parameter Table", contact SanDisk for that document.
Hynix	26nm	2'b0111	The detail of this RR sequence is documented in "26nm 32Gb MLC RAWNAND", contact Hynix for that document.
	20nm A Die	2'b0110	The detail of this RR sequence is documented in "20nm 32Gb MLC C-die Application Note", contact Hynix for that document.
	20nm B Die	2'b1000	The detail of this RR sequence is documented in "20nm 32Gb MLC C-die Application Note", contact Hynix for that document.
	20nm C Die	2'b1001	The detail of this RR sequence is documented in "20nm 32Gb MLC C-die Application Note", contact Hynix for that document.

8.5.2.7 Toggle mode DDR NAND boot

If the BT_TOGGLEMODE efuse is blown, the ROM does the following to boot from the Samsung's toggle mode DDR NAND.

8.5.2.7.1 GPMI and BCH clocks configuration

The ROM sets the clock source and the dividers in the CCM registers.

If the BOOT_CFG1[6] is set (toggle mode), the GPMI/BCH CLK source is PLL2PFD4, and running at 66 MHz, otherwise the GPMI/ BCH CLK source is PLL3, running at 24 MHz. The ROM sets the default values to timing0, timing1, and timing2 gpmi registers for 24 MHz clock speed. It uses the BOOT_CFG fuse to configure the GPMI timing2 register parameters preamble delay and read latency. The default value for these parameters is 2 when the fuses are not blown.

The default timing parameter values used by the ROM for the toggle-mode device are:

- Timing0.ADDRESS_SETUP = 5
- Timing0.DATA_SETUP = 10
- Timing0.DATA_HOLD = 10
- Timing1.DEVICE_BUSY_TIMEOUT = 0 x 500
- Timing2.READ_LATENCY = BOOT_CFG2[7:5] if blown, otherwise 2
- Timing2.CE_DELAY = 2
- Timing2.PREAMBLE_DELAY = BOOT_CFG2[7:5] if blown, otherwise 2
- Timing2.POSTAMBLE_DELAY = 3
- Timing2.CMDADD_PAUSE = 4
- Timing2.DATA_PAUSE = 6

The default timing parameters can be overridden by the TMTiming2_ReadLatency, TMTiming2_PreambleDelay, TMTiming2_CEDelay, TMTiming2_PostambleDelay, TMTiming2_CmdAddPause, and TMTiming2_DataPause parameters of the FCB.

8.5.2.7.2 Setup DMA for DDR transfers

In the DMA descriptors, the GPMI is configured to read the page data at a double data rate, the word length is set to 16, and the transfer count to a half of the page size.

8.5.2.7.3 Reconfigure timing and speed using values in FCB

After reading the FCB page with the GPMI set to default timings and a speed of 33 MHz, the ROM reconfigures the CCM dividers to run the gpmi/bch clks to a desired speed specified in the FCB for the rest of the boot process. The GPMI timing registers are also reconfigured to the values specified in the FCB.

The GPMI speed can be configured using the FCB parameter TMSpeed:

- 0—24 MHz
- 1—33 MHz
- 2—40 MHz
- 3—50 MHz
- 4—66 MHz
- 5—80 MHz
- 6—100 MHz
- 7—133 MHz
- 8—160 MHz
- 9—200 MHz

The GPMI timing0 register fields `data_setup`, `data_hold`, and `address_setup` are set to the values specified for the `data_setup` and `data_hold` and `address_setup` in the FCB member `m_NANDTiming`.

The GPMI timing1.`DEVICE_BUSY_TIMEOUT` is set to the value specified in the FCB member `TMTiming1_BusyTimeout`.

The GPMI timing2 register values are set using the FCB members `TMTiming2.READ_LATENCY`, `CE_DELAY`, `PREAMBLE_DELAY`, `POSTAMBLE_DELAY`, `CMDADD_PAUSE`, and `DATA_PAUSE`.

8.5.2.8 Typical NAND page organization

8.5.2.8.1 BCH ECC page organization

The first data block is called block 0 and the rest of the blocks are called block N. A separate ECC level scan is used for block 0 and block N.

The metadata bytes must be located at the beginning of a page, starting at byte 0, followed by the data block 0, the ECC bytes for data block 0, the block 1 and its ECC bytes, and so on, up until the N data blocks. The ECC level for the block 0 can be different from the ECC level for the rest of the blocks.

For the NAND boot with page-size restrictions and the data block size restricted to 512 B, only few combinations of the ECC for block 0 and block N are possible.

This figure shows the valid layout for 2112-byte sized page.

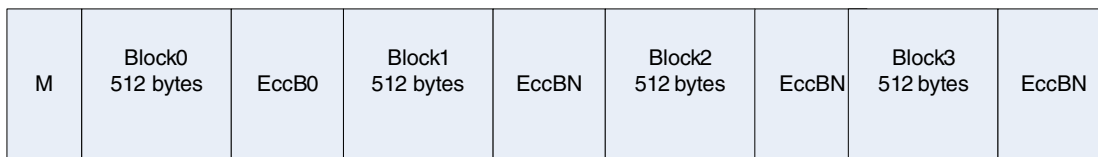

Figure 8-9. Valid layout for 2112-byte sized page

The example below is for 13 bits of parity (GF13). The number of ECC bits required for a data block is calculated using the $(\text{ECC_Correction_Level} * 13)$ bits.

In the above layout, the ECC size for `EccB0` and `EccBN` must be selected to not exceed a total page size of 2112 bytes. The `EccB0` and `EccBN` can be one of the 2, 4, 6, 8, 10, 12, 14, 16, 18, and 20 bits on the ECC correction level. The total bytes are:

$$[M + (\text{data_block_size} * 4) + ((\text{EccB0} + (\text{EccBN} * 3)) * 13) / 8] \leq 2112;$$

M = metadata bytes and `data_block_size` is 512.

There are four data blocks of 512 bytes each in a page of 2-KB page sized NAND. The values of EccB0 and EccBN must be such that the above calculation does not result in a value greater than 2112 bytes.

M	Block0 512 bytes	EccB0	Block1 512 bytes	EccBN	Block2 512 bytes	EccBN	Block3 512 bytes	EccBN
	Block4 512 bytes	EccBN	Block5 512 bytes	EccBN	Block6 512 bytes	EccBN	Block7 512 bytes	EccBN

Figure 8-10. Valid layout for 4-KB sized page

Different NAND manufacturers have different sizes for a 4-KB page; 4314 bytes is typical.

$$[M + (\text{data_block_size} \times 8) + ([\text{EccB0} + (\text{EccBN} \times 7)] \times 13) / 8] \leq 4314;$$

M= metadata bytes and data_block_size is 512.

There are eight data blocks of 512 bytes each in a page of a 4-KB page sized NAND. The values of the EccB0 and EccBN must be such that the above calculation does not result in a value greater than the size of a page in a 4-KB page NAND.

8.5.2.8.2 Metadata

The number of bytes used for the metadata is specified in the FCB. The metadata for the BCH encoded pages is placed at the beginning of a page. The ROM only cares about the first byte of metadata to swap it with a bad block marker byte in the page data after each page read; it is important to have at least one byte for the metadata bytes field in the FCB data structure.

8.5.2.9 IOMUX configuration for NAND

The following table shows the RawNAND IOMUX pin configuration.

Table 8-14. NAND IOMUX pin configuration

Signal	Pad name
NAND.CLE	NAND_CLE.alt0
NAND.ALE	NAND_ALE.alt0
NAND.DATA00	NAND_DATA00.alt0

Table continues on the next page...

Table 8-14. NAND IOMUX pin configuration (continued)

Signal	Pad name
NAND.DATA01	NAND_DATA01.alt0
NAND.DATA02	NAND_DATA02.alt0
NAND.DATA03	NAND_DATA03.alt0
NAND.DATA04	NAND_DATA04.alt0
NAND.DATA05	NAND_DATA05.alt0
NAND.DATA06	NAND_DATA06.alt0
NAND.DATA07	NAND_DATA07.alt0
NAND.RE_B	NAND_RE_B.alt0
NAND.WE_B	NAND_WE_B.alt0
NAND.CE1_B	NAND_CE1_B.alt0
NAND.CE0_B	NAND_CE0_B.alt0
NAND.DQS	NAND_DQS.alt0
NAND.READY_B	NAND_READY_B.alt0
NAND.CE2_B	CSI_MCLK.alt2
NAND.CE3_B	CSI_PIXCLK.alt2
NAND.WP_B	NAND_WP_B.alt0

8.5.3 Expansion device

The ROM supports booting from the MMC/eMMC and SD/eSD compliant devices.

8.5.3.1 Expansion device eFUSE configuration

The SD/MMC/eSD/eMMC/SDXC boot can be performed using either the USDHC ports, based on the setting of the BOOT_CFG2[4:3] (Port Select) fuse or it is associated to the GPIO input value at the boot.

All USDHC ports support the eMMC4.4 and eMMC4.5 fast boot. See this table for details:

Table 8-15. USDHC boot eFUSE descriptions

Fuse	Config	Definition	GPIO	Shipped value	Settings
0x450[7:6]	OEM	Boot device selection	Yes	00	01 - Boot from the USDHC interface
0x450[5]	OEM	SD/MMC selection	Yes	0	0 - SD/eSD/SDXC 1 - MMC/eMMC
0x450[4]	OEM	Fast boot support	Yes	0	0 - Normal boot

Table continues on the next page...

**Table 8-15. USDHC boot eFUSE descriptions
(continued)**

Fuse	Config	Definition	GPIO	Shipped value	Settings
					1 - Fast boot
0x450[3:2]	OEM	SD/MMC speed mode, and eMMC acknowledge enabled selection	Yes	00	MMC 0x - Normal speed mode 1x - High-speed mode x0 - eMMC fast boot acknowledge enable x1 - eMMC fast boot acknowledge disable SD 00 - Normal/SDR12 01 - High/SDR25 10 - SDR50 11 - SDR104
0x450[1]	OEM	SD power cycle enable/eMMC reset enable	Yes	0	MMC 0 - No action 1 - eMMC reset enabled via the SD_RST pad SD 0 - No power cycle 1 - Power cycle enabled via the SD_RST pad
0x450[0]	OEM	SD loopback clock source sel (for SDR50 and SDR104 only)	Yes	0	0 - through the SD pad 1 - direct
0x450[15:13]	OEM	SD MMC bus width selection/SD calibration step	Yes	00	SD/eSD/SDXC (BOOT_CFG1[5]=0) Bus width xx0 - 1-bit xx1 - 4-bit SD calibration step 00x - 1 delay cell 01x - 1 delay cell 10x - 2 delay cells 11x - 3 delay cells MMC/eMMC (BOOT_CFG1[5]=1) 000 - 1-bit 001 - 4-bit 010 - 8-bit

Table continues on the next page...

**Table 8-15. USDHC boot eFUSE descriptions
(continued)**

Fuse	Config	Definition	GPIO	Shipped value	Settings
					101 - 4-bit DDR (MMC 4.4) 110 - 8-bit DDR (MMC 4.4) Else - Reserved
0x450[12:11]	OEM	USDHC port selection	Yes	00	00 - USDHC-1 01 - USDHC-2 1x - Reserved
0x450[9]	OEM	USDHC1 voltage selection	Yes	0	0 - 3.3 V 1 - 1.8 V
0x460[31:30]	OEM	Power cycle selection	Yes	00	00 - 20 ms 01 - 10 ms 10 - 5 ms 11 - 2.5 ms
0X460[29]	OEM	Power stable cycle selection	Yes	0	0 - 5 ms 1 - 2.5 ms
0X460[24]	OEM	SD/MMC DLL enable selection	Yes	0	0 - Disable DLL for SD/eMMC 1 - Enable DLL for SD/Emmc
0X470[7]	OEM	DLL override selection	Yes	0	0 - No override 1 - DLL override mode for SD/eMMC (Override by MMC_DLL_DLY, 0x470[19:16])
0X470[6]	OEM	USDHC1 reset polarity selection	Yes	0	0 - Reset active low 1 - Reset active high
0X470[5]	OEM	USDHC2 voltage selection	Yes	0	0 - 3.3 V 1 - 1.8 V
0X470[0]	OEM	SD/MMC pad settings override selection	Yes	0	0 - No override 1 - Override (override by PAD_SETTINGS, 0x6d0[5:0])
0X470[15]	OEM	USDHC2 reset polarity selection	Yes	0	0 - Reset active-low 1 - Reset active-high
0X470[14]	OEM	eMMC4.4 pre-idle enabled selection	Yes	0	0 - Issue pre-idle command 1 - Do not issue
0x470[13]	OEM	Override HYS bit for SD/MMC pads	Yes	0	0 - No override 1 - Override HYS bit with 1
0X470[30:24]	OEM	MMC_DLL_DLY	Yes	0000000	Override number
0X6D0[5:0]	OEM	PAD_SETTINGS	Yes	000000	Override number

The boot code supports these standards:

Boot devices (internal boot)

- MMCv4.4 or less
- eMMCv4.4 or less
- SDv2.0 or less
- eSDv2.10 rev-0.9, with or without FAST_BOOT
- SDXCv3.0

The MMC/SD/eSD/SDXC/eMMC can be connected to any of the USDHC blocks and can be booted by copying 4 KB of data from the MMC/SD/eSD/eMMC device to the internal RAM. After checking the Image Vector Table header value (0xD1) from program image, the ROM code performs a DCD check. After a successful DCD extraction, the ROM code extracts from the Boot Data Structure the destination pointer and length of image to be copied to the RAM device from where the code execution occurs.

The maximum image size to load into the SD/MMC boot is 32 MB. This is due to a limited number of uSDHC ADMA Buffer Descriptors allocated by the ROM.

NOTE

The initial 4 KB of the program image must contain the IVT, DCD, and the Boot Data structures.

Table 8-16. SD/MMC frequencies

	SD	MMC	MMC (DDR mode)
Identification (KHz)	347.22		
Normal-speed mode (MHz)	25	20	25
High-speed mode (MHz)	50	40	50
UHSI SDR50 (MHz)	100		
UHSI SDR104 (MHz)	200		

NOTE

The boot ROM code reads the application image length and the application destination pointer from the image.

8.5.3.2 MMC and eMMC boot

This table provides the MMC and eMMC boot details.

Table 8-17. MMC and eMMC boot details

Normal boot mode	During the initialization (normal boot mode), the MMC frequency is set to 347.22 KHz. When the MMC card enters the identification portion of the initialization, the voltage validation is performed, and the ROM boot code checks the high-voltage settings and the card capacity. The ROM boot
------------------	--

Table continues on the next page...

Table 8-17. MMC and eMMC boot details (continued)

	<p>code supports both the high-capacity and low-capacity MMC/eMMC cards. After the initialization phase is complete, the ROM boot code switches to a higher frequency (20 MHz in the normal boot mode or 40 MHz in the high-speed mode). The eMMC is also interfaced via the USDHC and follows the same flow as the MMC.</p> <p>The boot partition can be selected for an MMC4.x card after the card initialization is complete. The ROM code reads the <code>BOOT_PARTITION_ENABLE</code> field in the <code>Ext_CSD[179]</code> to get the boot partition to be set. If there is no boot partition mentioned in the <code>BOOT_PARTITION_ENABLE</code> field or the user partition was mentioned, the ROM boots from the user partition.</p>
eMMC4.3 or eMMC4.4 device supporting special boot mode	<p>If using an eMMC4.3 or eMMC4.4 device that supports the special boot mode, it can be initiated by pulling the CMD line low. If the BOOT ACK is enabled, the eMMC4.3/eMMC4.4 device sends the BOOT ACK via the DATA lines and the ROM can read the BOOT ACK [S010E] to identify the eMMC4.3/eMMC4.4 device. If the BOOT ACK is enabled, the ROM waits 50 ms to get the BOOT ACK and if the BOOT ACK is received by the ROM. If BOOT ACK is disabled ROM waits 1 second for data. If the BOOT ACK or data was received, the eMMC4.3/eMMC4.4 is booted in the "boot mode", otherwise the eMMC4.3/eMMC4.4 boots as a normal MMC card from the selected boot partition. This boot mode can be selected by the <code>BOOT_CFG1[4]</code> (fast boot) fuse. The BOOT ACK is selected by the <code>BOOT_CFG2[1]</code>.</p>
eMMC4.4 device	<p>If using the eMMC4.4 device, the Double Data Rate (DDR) mode can be used. This mode can be selected by the <code>BOOT_CFG2[7:5]</code> (bus width) fuse.</p>

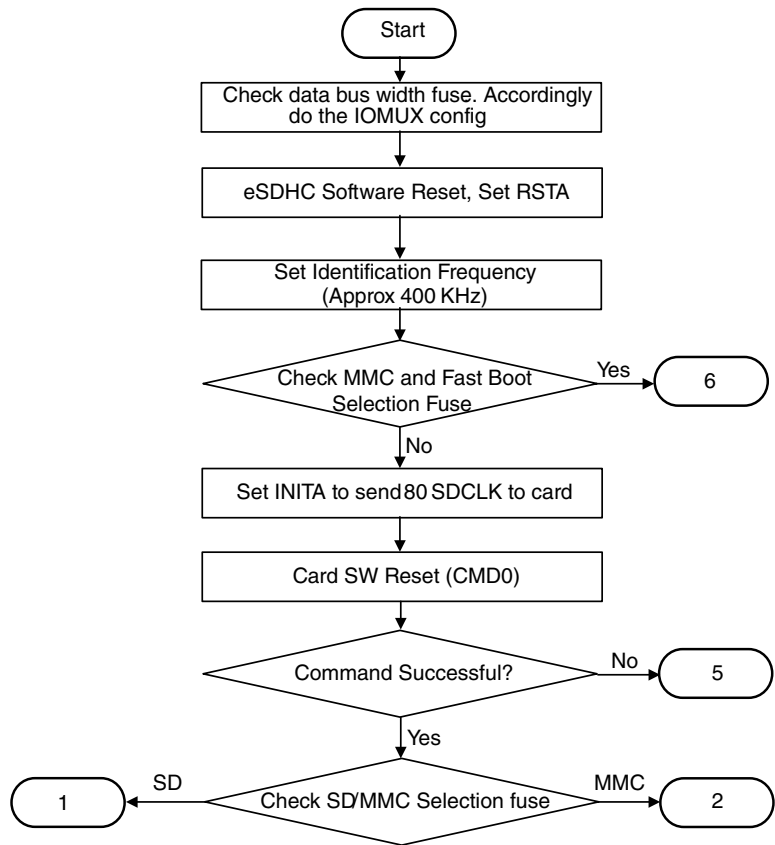

Figure 8-11. Expansion device boot flow (1 of 6)

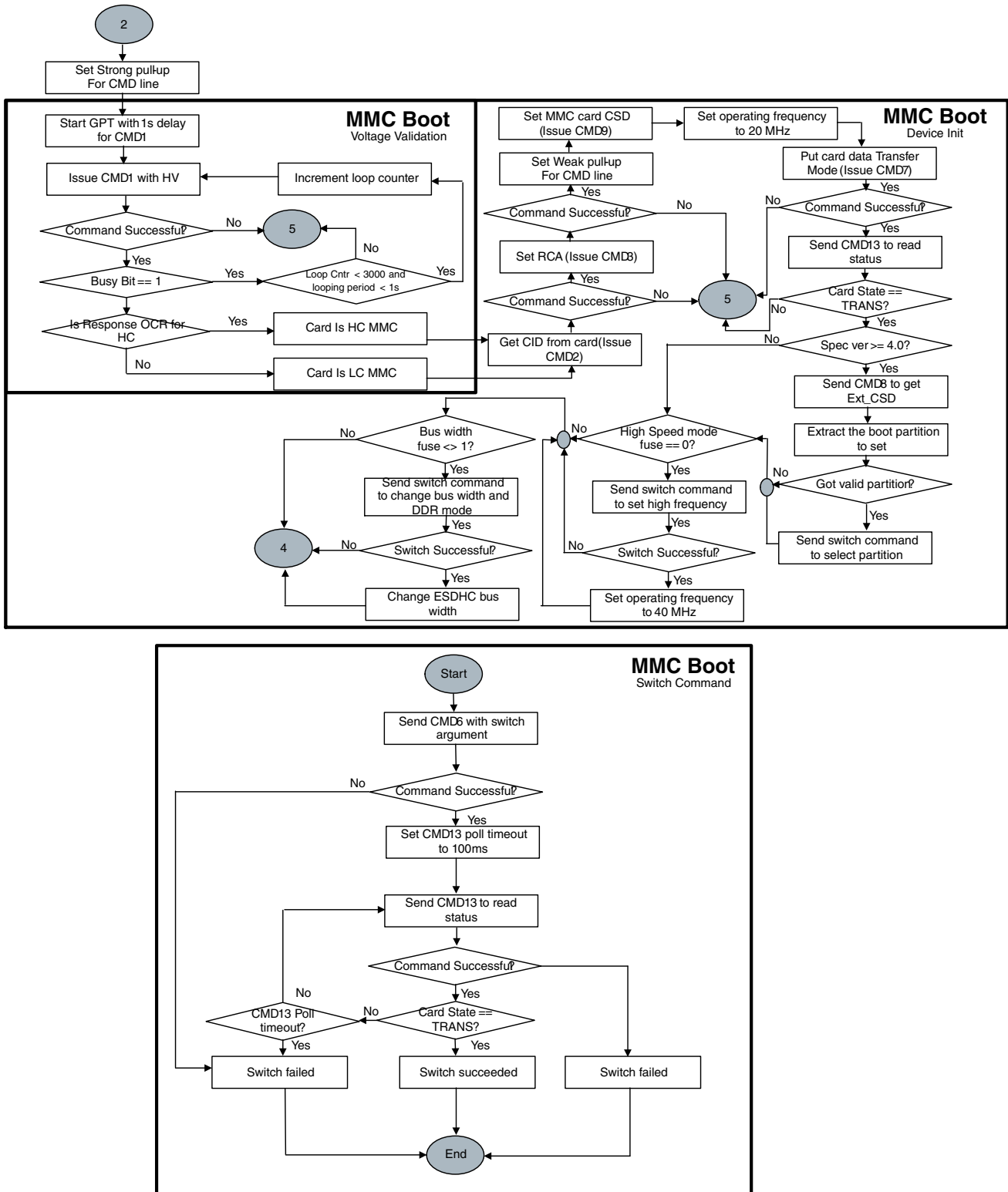

Figure 8-12. Expansion device (MMC) boot flow (2 of 6)

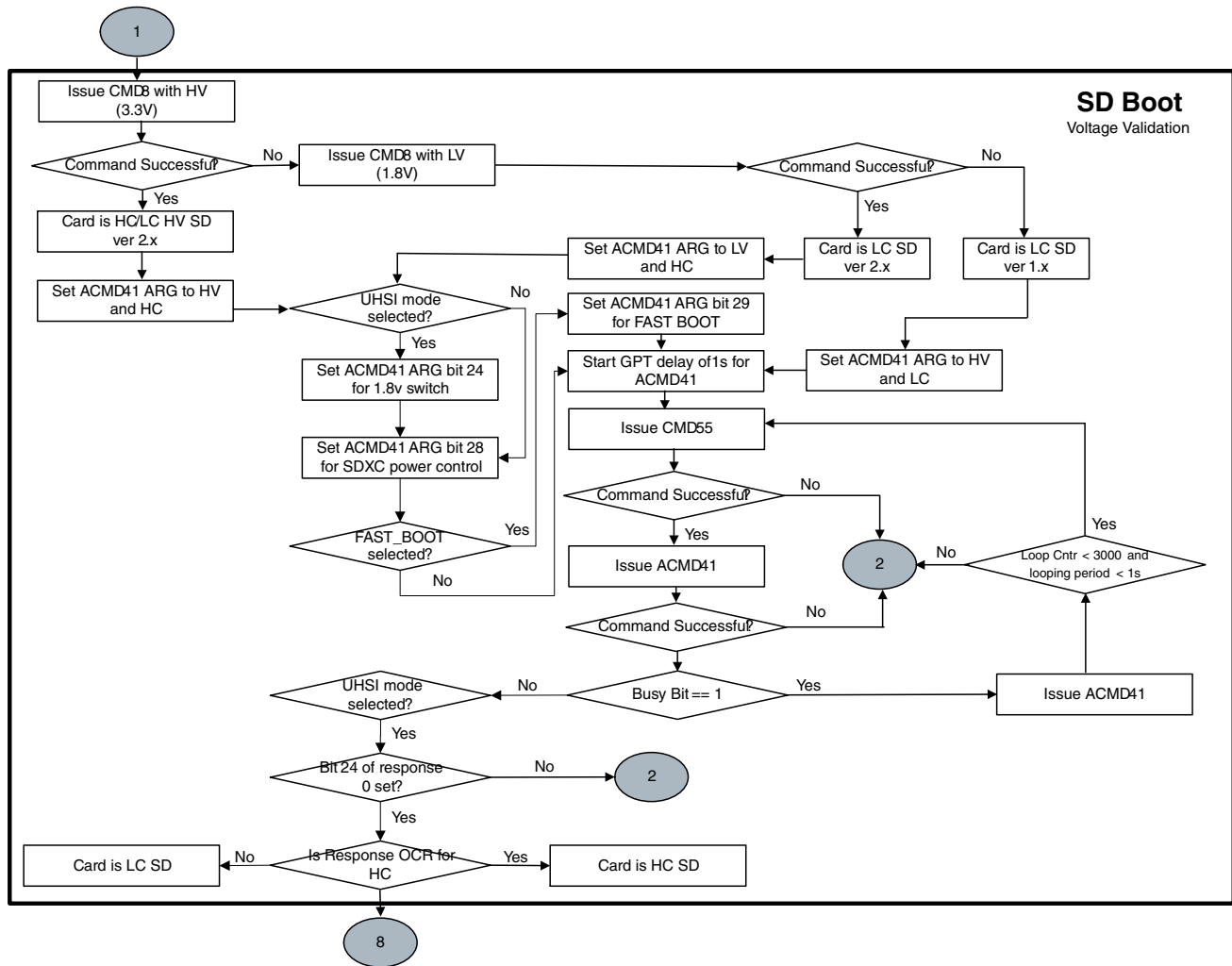

Figure 8-13. Expansion device (SD/eSD/SDXC) boot flow (3 of 6) part 1

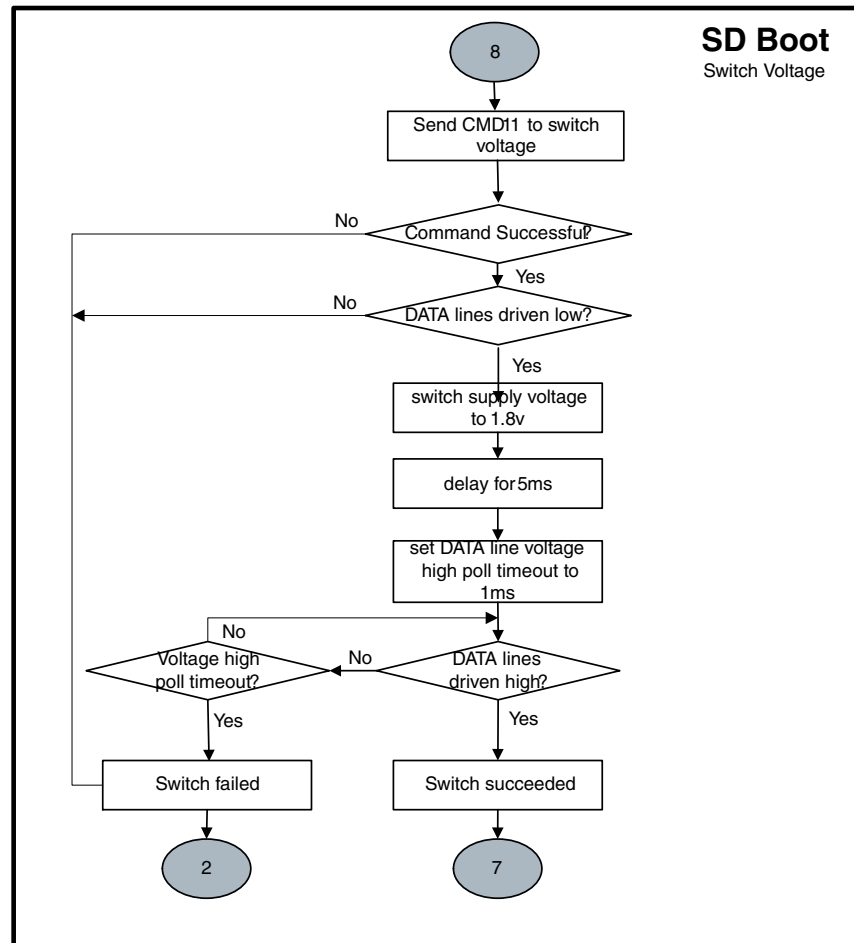

Figure 8-14. Expansion device (SD/eSD/SDXC) boot flow (3 of 6) part 2

Boot devices (internal boot)

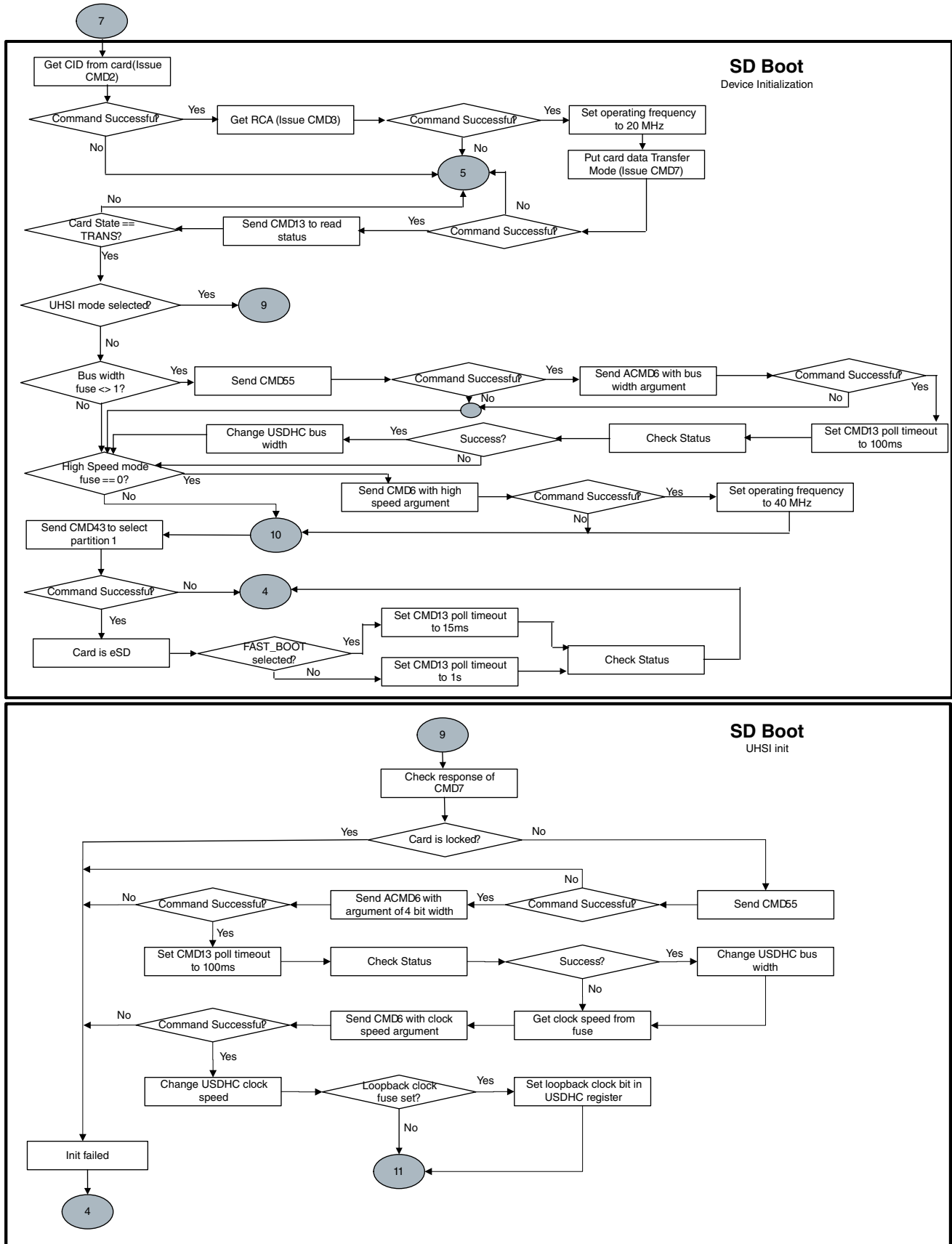

Figure 8-15. Expansion device (MMCSD/eSD/SDXC) boot flow (4 of 6)
i.MX 6ULL Applications Processor Reference Manual, Rev. 1, 11/2017

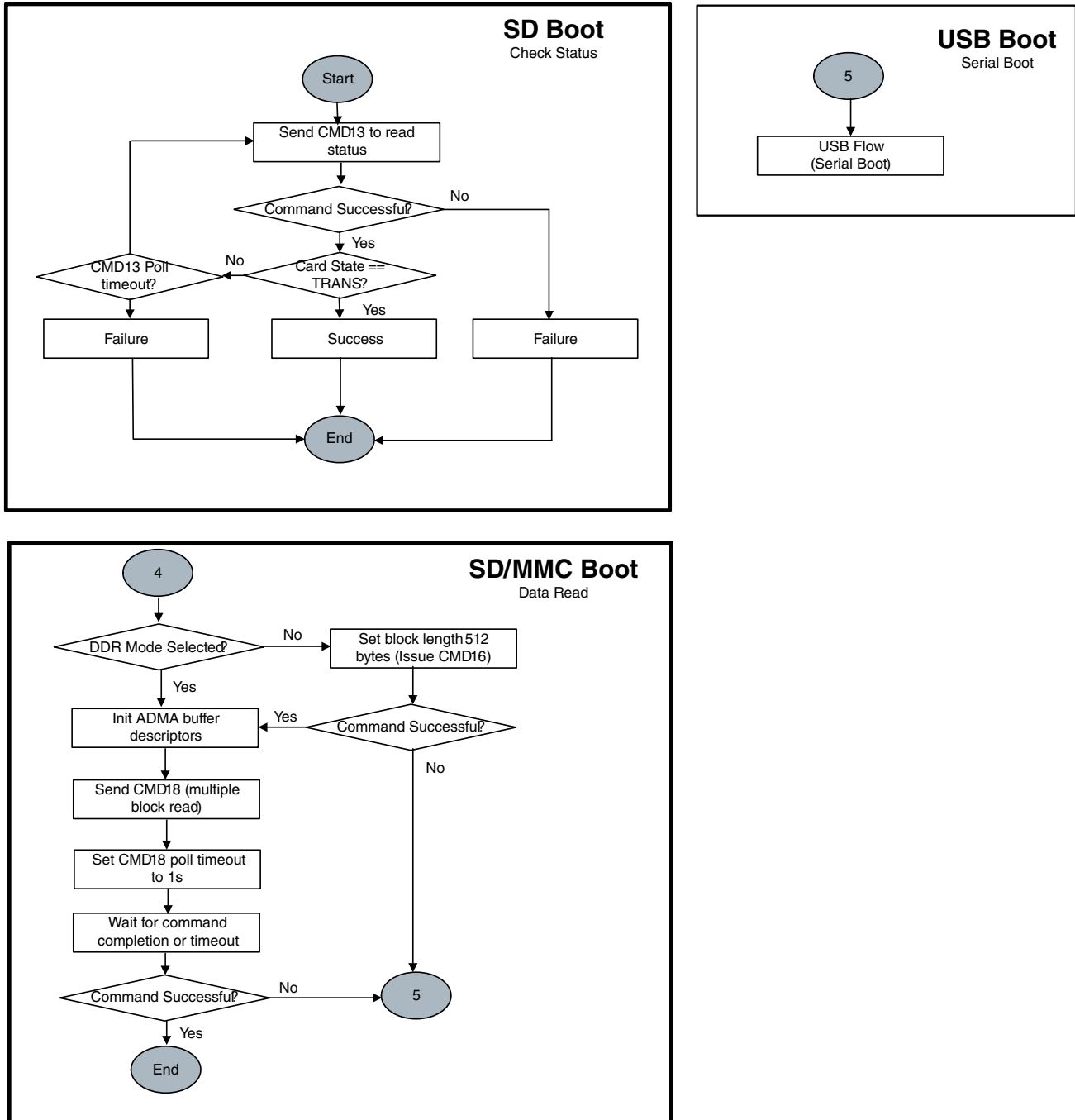

Figure 8-16. Expansion device (SD/eSD) boot flow (5 of 6)

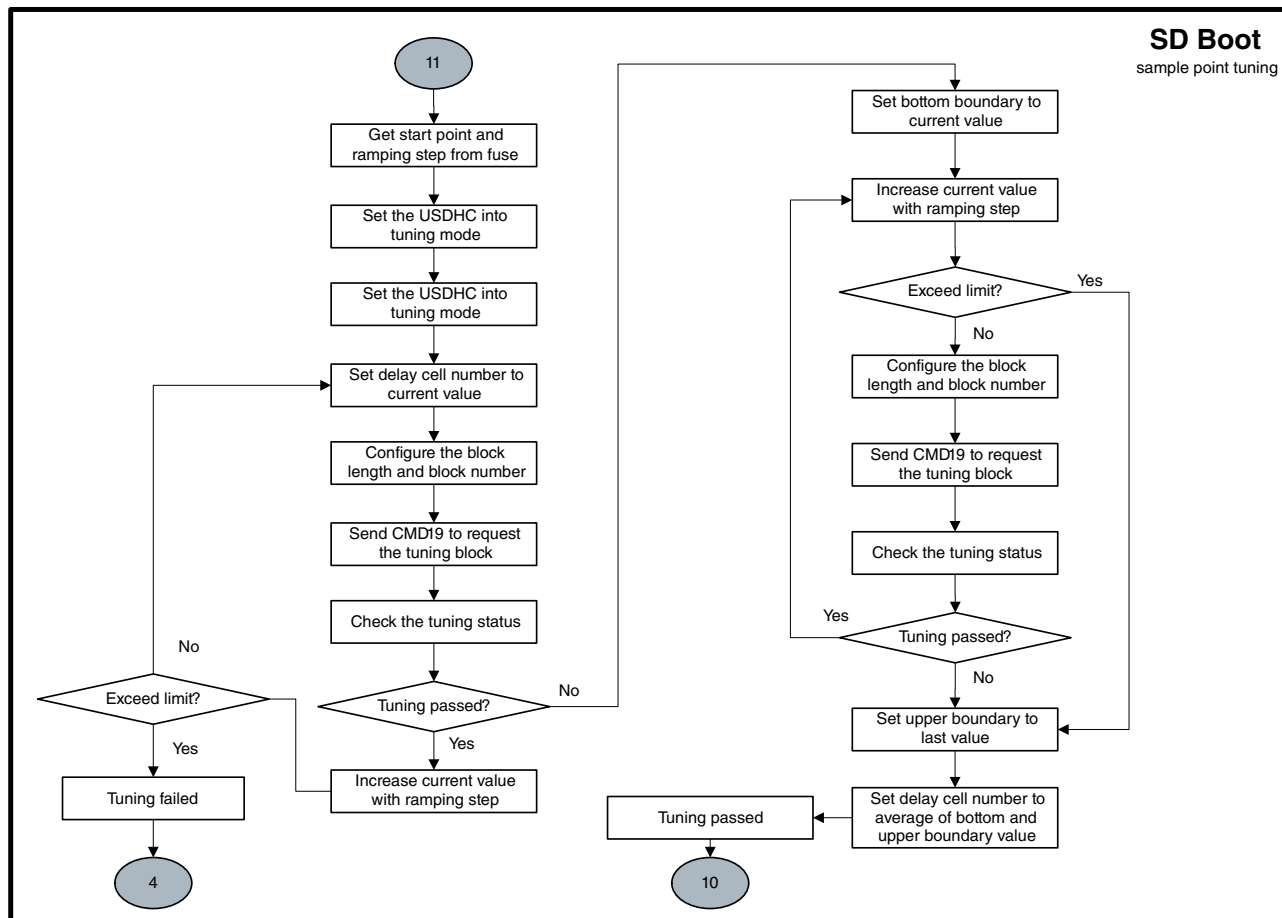
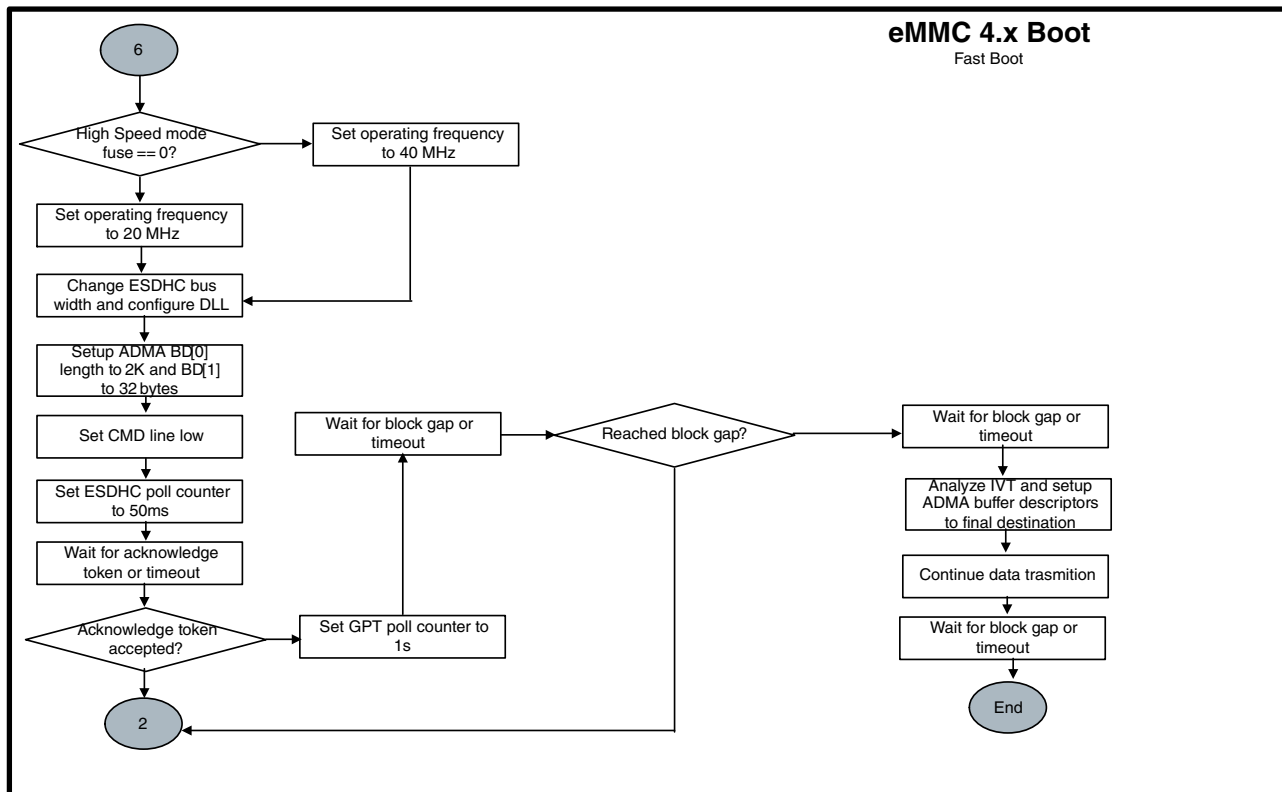

Figure 8-17. Expansion device boot flow (6 of 6)
i.MX 6ULL Applications Processor Reference Manual, Rev. 1, 11/2017

8.5.3.3 SD, eSD, and SDXC

After the normal boot mode initialization begins, the SD/eSD/SDXC frequency is set to 347.22 kHz. During the identification phase, the SD/eSD/SDXC card voltage validation is performed. During the voltage validation, the boot code first checks with the high-voltage settings; if that fails, it checks with the low-voltage settings.

The capacity of the card is also checked. The boot code supports the high-capacity and low-capacity SD/eSD/SDXC cards after the voltage validation card initialization is done.

During the card initialization, the ROM boot code attempts to set the boot partition for all SD, eSD, and SDXC devices. If this fails, the boot code assumes that the card is a normal SD or SDXC card. If it does not fail, the boot code assumes it is an eSD card. After the initialization phase is over, the boot code switches to a higher frequency (25 MHz in the normal-speed mode or 50 MHz in the high-speed mode). The ROM also supports the FAST_BOOT mode booting from the eSD card. This mode can be selected by the BOOT_CFG1[4] (Fast Boot) fuse described in [Table 8-15](#).

For the UHSI cards, the clock speed fuses can be set to SDR50 or SDR104 on USDHC1, USDHC2, ports. This enables the voltage switch process to set the signaling voltage to 1.8 V during the voltage validation. The bus width is fixed at a 4-bit width and a sampling point tuning process is needed to calibrate the number of the delay cells. If the SD Loopback Clock eFuse is set, the feedback clock comes directly from the loopback SD clock, instead of the card clock (by default). The SD clock speed can be selected by the BOOT_CFG1[3:2], and the SD Loopback Clock is selected by the BOOT_CFG1[0].

The UHSI calibration start value (MMC_DLL_DLY[6:0]) and the step value (BOOT_CFG2[7:5]) can be set to optimize the sample point tuning process.

If the SD Power Cycle Enable eFuse is 1, the ROM sets the SD_RST pad low, waits for 5 ms, and then sets the SD_RST pad high. If the SD_RST pad is connected to the SD power supply enable logic on board, it enables the power cycle of the SD card. This may be crucial in case the SD logic is in the 1.8 V states and must be reset to the 3.3 V states.

The SDR50 and SDR104 boots are not supported on the USDHC1 and USDHC2 ports because there are no reset signals for those ports when connected in the IOMUX.

8.5.3.4 IOMUX configuration for SD/MMC

Table 8-18. SD/MMC IOMUX pin configuration

Signal	USDHC1	USDHC2
CLK	SD1_CLK.alt0	NAND_RE_B.alt1
CMD	SD1_CMD.alt0	NAND_WE_B.alt1
DATA0	SD1_DATA0.alt0	NAND_DATA00.alt1
DATA1	SD1_DATA1.alt0	NAND_DATA01.alt1
DATA2	SD1_DATA2.alt0	NAND_DATA02.alt1
DATA3	SD1_DATA3.alt0	NAND_DATA03.alt1
DATA4	NAND_READY_B.alt1	NAND_DATA04.alt1
DATA5	NAND_CE0_B.alt1	NAND_DATA05.alt1
DATA6	NAND_CE1_B.alt1	NAND_DATA06.alt1
DATA7	NAND_CLE.alt1	NAND_DATA07.alt1
VSELECT	GPIO1_IO05.alt4	GPIO1_IO08.alt4
RESET_B	GPIO1_IO09.alt5	NAND_ALE.alt5
CD_B	UART1_RTS_B.alt2	—

8.5.3.5 Redundant boot support for expansion device

The ROM supports the redundant boot for an expansion device. The primary or secondary image is selected, depending on the PERSIST_SECONDARY_BOOT setting. (see [Table 8-6](#)).

If the PERSIST_SECONDARY_BOOT is 0, the boot ROM uses address 0x0 for the primary image.

If the PERSIST_SECONDARY_BOOT is 1, the boot ROM reads the secondary image table from address 0x200 on the boot media and uses the address specified in the table.

Table 8-19. Secondary image table format

Reserved (chipNum)
Reserved (driveType)
tag
firstSectorNumber
Reserved (sectorCount)

Where:

- The tag is used as an indication of the valid secondary image table. It must be 0x00112233.
- The firstSectorNumber is the first 512-byte sector number of the secondary image.

For the secondary image support, the primary image must reserve the space for the secondary image table. See this figure for the typical structures layout on an expansion device.

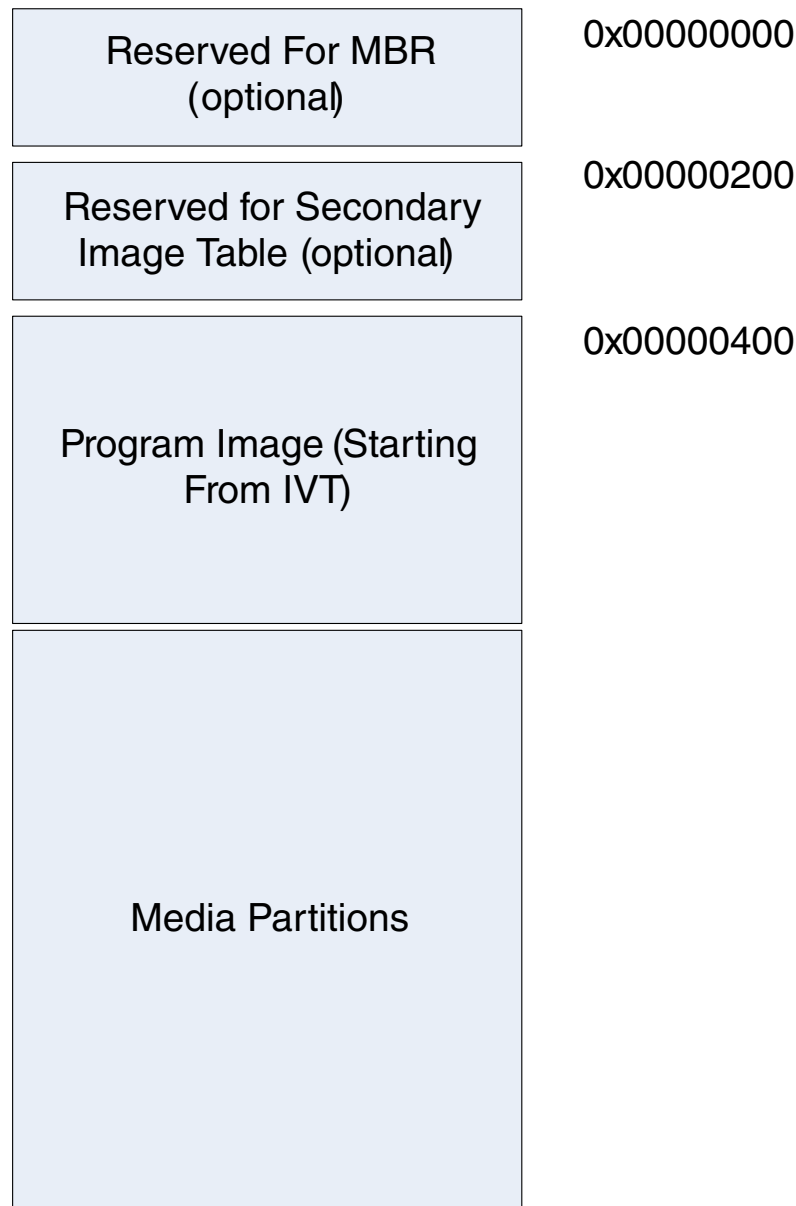

Figure 8-18. Expansion device structures layout

For the Closed mode, if there are failures during primary image authentication, the boot ROM turns on the PERSIST_SECONDARY_BOOT bit (see [Table 8-6](#)) and performs the software reset. (After the software reset, the secondary image is used.)

8.5.4 Serial ROM through SPI

The chip supports booting from serial memory devices, such as EEPROM and serial flash, using the SPI.

These ports are available for serial boot: eCSPI (eCSPI1, eCSPI2, eCSPI3, eCSPI4) interfaces.

8.5.4.1 Serial ROM eFUSE configuration

The boot ROM code determines the type of device using the following parameters, either provided by the eFUSE settings or sampled on the I/O pins, during boot.

See this table for details:

Table 8-20. Serial ROM boot eFUSE descriptions

Fuse	Config	Definition	GPIO ¹	Shipped value	Settings
BOOT_CFG1[7:4]	OEM	Boot device selection	Yes	0000	0011 - Boot from the serial ROM
BOOT_CFG4[6]	OEM	EEPROM recovery enable	Yes	0	0 - Disabled EEPROM recovery 1 - Enabled EEPROM recovery
BOOT_CFG4[5:4]	OEM	CS select (SPI only)	Yes	00	00 - ECSPi _x _SS0 01 - ECSPi _x _SS1 10 - ECSPi _x _SS2 11 - ECSPi _x _SS3
BOOT_CFG4[3]	OEM	SPI addressing (SPI only)	Yes	0	0 - 2 B (16-bit) 1 - 3 B (24-bit)
BOOT_CFG4[2:0]	OEM	Port select	Yes	00	000 - ECSPi-1 001 - ECSPi-2 010 - ECSPi-3 011 - ECSPi-4 1xx - Reserved

1. The setting can be overridden by the GPIO settings when the BT_FUSE_SEL fuse is intact. See [GPIO Boot Overrides](#) for the corresponding GPIO pin.

The ECPSI-1/ECPSI-2/ECPSI-3/ECPSI-4 block can be used as a boot device using the ECSPi interface for the serial ROM boot. The SPI interface is configured to operate at 15 MHz for 3-byte addressing devices and at 3.75 MHz for 2-byte addressing devices.

The boot ROM copies 4 KB of data from the serial ROM device to the internal RAM. After checking the Image Vector Table header value (0xD1) from the program image, the ROM code performs a DCD check. After a successful DCD extraction, the ROM code extracts the destination pointer and length of image from the Boot Data Structure to be copied to the RAM device from where the code execution occurs.

NOTE

The Initial 4 KB of program image must contain the IVT, DCD, and the Boot Data Structures.

8.5.4.2 ECSPi boot

The Enhanced Configurable SPI (ECSPi) interface is configured in the master mode and the EEPROM device is connected to the ECSPi interface as a slave.

The boot ROM code copies 4 KB of data from the EEPROM device to the internal RAM. If the DCD verification is successful, the ROM code copies the initial 4 KB of data, as well as the rest of the image extracted from the application image, directly to the application destination. The ECSPi can read data from the EEPROM using 2- or 3-byte addressing. Its burst length is 32 B.

NOTE

The Serial ROM Chip Select Number is determined by the BOOT_CFG4[5:4] (Chip Select) fuse.

When using the SPI as a boot device, the chip supports booting from both the serial EEPROM and serial flash devices. The boot code determines which device is being used by reading the appropriate eFUSE/I/O values at the boot (see [Table 8-20](#) for details).

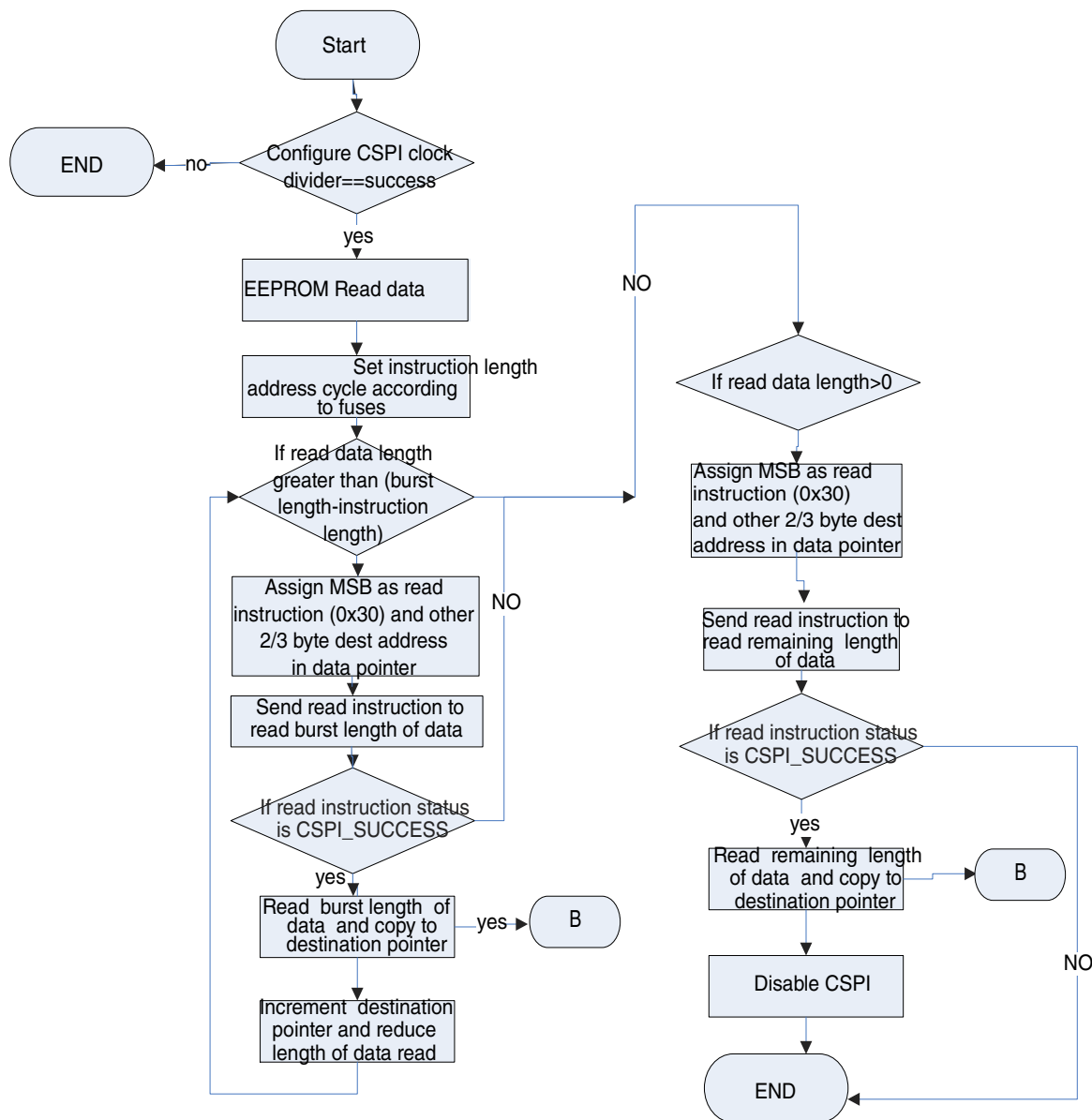

Figure 8-19. CSPI flow chart

8.5.4.2.1 ECSPI IOMUX pin configuration

The contacts assigned to the signals used by the CSPI blocks are shown in this table:

Table 8-21. ECSPI IOMUX pin configuration

Signal	eCSPI1	eCSPI2	eCSPI3	eCSPI4
MISO	CSI_DATA07.alt3	CSI_DATA03.alt3	UART2_RTS_B.alt8	ENET2_TX_CLK.alt3
MOSI	CSI_DATA06.alt3	CSI_DATA02.alt3	UART2_CTS_B.alt8	ENET2_TX_EN.alt3

Table continues on the next page...

**Table 8-21. ECSPi IOMUX pin configuration
(continued)**

Signal	eCSPI1	eCSPI2	eCSPI3	eCSPI4
SCLK	CSI_DATA04.alt3	CSI_DATA00.alt3	UART2_RX_DATA.alt8	ENET2_TX_DATA1.alt3
SS0	CSI_DATA05.alt3	CSI_DATA01.alt3	UART2_TX_DATA.alt8	ENET2_RX_ER.alt3
SS1	LCD_DATA05.alt8	LCD_HSYNC.alt8	NAND_ALE.alt8	NAND_DATA01.alt8
SS2	LCD_DATA06.alt8	LCD_VSYNC.alt8	NAND_RE_B.alt8	NAND_DATA02.alt8
SS3	LCD_DATA07.alt8	LCD_RESET.alt8	NAND_WE_B.alt8	NAND_DATA03.alt8

8.6 QuadSPI serial flash memory boot

8.6.1 QuadSPI eFUSE configuration

Table 8-22. QSPI Boot eFUSE descriptions

Fuse	Config	Definition	GPIO	Shipped value	Settings
BOOT_CFG1[7:4]	OEM	Boot device selection	Yes	0001	0001 - Boot from QuadSPI
BOOT_CFG1[3]	OEM	QuadSPI interface selection	Yes	0	0 - QSPI1 1 - Reserved

8.6.2 QuadSPI serial flash BOOT operation

The Boot ROM attempts to boot from the QuadSPI flash if the BOOT_CFG1[7:4] fuses are programmed to 0001, as shown in the QuadSPI eFUSE configuration table. The ROM initializes the requested QuadSPI Interface as selected in the Fuse bit BOOT_CFG1[3] in the QuadSPI eFUSE configuration. The QuadSPI interface initialization is a two-step process.

The ROM expects the QuadSPI configuration parameters (as explained in the QuadSPI Configuration Parameters) to be present in the serial flash memory from the offset 0x400 of serial flash of length 512 bytes. The ROM reads these configuration parameters using the default read command configured in the LUT of the QuadSPI interface with the SCLOCK operating at 18 MHz.

In the second step, the ROM configures the selected QuadSPI interface with the configuration parameters read from the serial flash and starts the boot procedure. Refer to Table 19-12 for details on the QuadSPI configuration parameters and to the QuadSPI boot flow chart for a detailed boot flow chart of the QuadSPI.

Both booting the XIP and non-XIP image is supported from the serial flash. For the XIP boot, the image must be built for the QuadSPI address space, and for the non-XIP, the image can be built to execute from the DDR or OCRM.

For the QUAD mode boot, the Boot ROM expects the Quad Enable bit inside the QSPI flash to be already set before the booting starts. Therefore, the QUAD enable bit must be set in the non-volatile register of the flash at the time of programming.

NOTE

If the SPI flash device requires the quad enable command, it can be sent via these configuration structure fields:
 device_quad_mode_en, device_cmd, write_cmd_ipcr,
 write_enable_ipcr, busy_bit_offset, and read_status_ipcr.

8.6.3 QuadSPI configuration parameters

The QuadSPI Configuration Parameters Table is built in the boot image at a fixed offset of 0x400 from the QSPI NOR A1 base address (368 B). This table lists the various QuadSPI configuration parameters:

Table 8-23. QuadSPI configuration parameters

Name	Offset	Size in bytes	Description															
DQS Loopback	0	4	DQS LoopBack Mode to enable the Dummy Pad, 0 - Disable, 1 - Enable															
Hold Delay	4	4	Hold Delay for QSPI[0,1] A/B															
			<table border="1"> <thead> <tr> <th>Value</th> <th>QSPI1 B</th> <th>QSPI1 A</th> </tr> </thead> <tbody> <tr> <td>00</td> <td>Disable</td> <td>Disable</td> </tr> <tr> <td>01</td> <td>Disable</td> <td>Enable</td> </tr> <tr> <td>10</td> <td>Enable</td> <td>Disable</td> </tr> <tr> <td>11</td> <td>Enable</td> <td>Enable</td> </tr> </tbody> </table>	Value	QSPI1 B	QSPI1 A	00	Disable	Disable	01	Disable	Enable	10	Enable	Disable	11	Enable	Enable
			Value	QSPI1 B	QSPI1 A													
			00	Disable	Disable													
			01	Disable	Enable													
10	Enable	Disable																
11	Enable	Enable																
Reserved	8	4	Reserved to 0															
Reserved	12	4	Reserved to 0															
device_quad_mode_en	16	4	Send the Quad enable command to the SPI device.															
device_cmd	20	4	Command to send to the SPI device.															

Table continues on the next page...

Table 8-23. QuadSPI configuration parameters (continued)

Name	Offset	Size in bytes	Description																
write_cmd_ipcr	24	4	IPCR register value for a write command																
write_enable_ipcr	28	4	IPCR register value for Enable																
Chip Select hold time	32	4	This is a chip-select hold time in terms of Serial clock (For Example 1 serial clock cycle 0-15).																
Chip Select setup time	36	4	Chip select setup time in terms of Serial clock (For example 1 serial clock).																
Serial Flash A1 size	40	4	Serial flash A1 size in units of bytes																
Serial Flash A2 size	44	4	Serial flash A2 size in units of bytes																
Serial Flash B1 size	48	4	Serial flash B1 size in units of bytes																
Serial Flash B2	52	4	Serial flash B2 size in units of bytes																
Serial Clock Frequency	56	4	This is a serial clock frequency select parameter. <table border="1" data-bbox="613 810 1474 1141"> <thead> <tr> <th>Value</th> <th>Clock</th> </tr> </thead> <tbody> <tr> <td>00</td> <td>18 MHz</td> </tr> <tr> <td>01</td> <td>49 MHz</td> </tr> <tr> <td>02</td> <td>55 MHz</td> </tr> <tr> <td>03</td> <td>60 MHz</td> </tr> <tr> <td>04</td> <td>66 MHz</td> </tr> <tr> <td>05</td> <td>76 MHz</td> </tr> <tr> <td>06</td> <td>99 MHz (only SDR mode)</td> </tr> </tbody> </table>	Value	Clock	00	18 MHz	01	49 MHz	02	55 MHz	03	60 MHz	04	66 MHz	05	76 MHz	06	99 MHz (only SDR mode)
Value	Clock																		
00	18 MHz																		
01	49 MHz																		
02	55 MHz																		
03	60 MHz																		
04	66 MHz																		
05	76 MHz																		
06	99 MHz (only SDR mode)																		
busy_bit_offset	60	4	SPI flash device busy bit offset in its status register, used for enabling the Quad mode of the SPI device																
Mode of operation of serial Flash	64	4	This field describes the mode of operation of Serial flash <table border="1" data-bbox="613 1332 1474 1500"> <thead> <tr> <th>Value</th> <th>Mode</th> </tr> </thead> <tbody> <tr> <td>01</td> <td>Single</td> </tr> <tr> <td>02</td> <td>Dual</td> </tr> <tr> <td>04</td> <td>Quad</td> </tr> </tbody> </table>	Value	Mode	01	Single	02	Dual	04	Quad								
Value	Mode																		
01	Single																		
02	Dual																		
04	Quad																		
Serial Flash Port B Selection	68	4	Port A is always available. This field informs the device ROM about the availability of Port B. 0 – Port B is not used. 1 – Port B is used.																
Dual Data Rate mode enable	72	4	This field enables the device ROM to enable the DDR mode. 0 – DDR mode is disabled. 1 – DDR mode is enabled.																

Table continues on the next page...

Table 8-23. QuadSPI configuration parameters (continued)

Name	Offset	Size in bytes	Description
Data Strobe Signal enable in Serial Flash	76	4	This field enables the Data Strobe signal in the Serial flash which supports it. 0 – Disable DQS 1 – Enable DQS
Parallel Mode enable	80	4	This field enables the parallel mode. The data are read from the Serial flash in the parallel mode. Refer to the QSP chapter for details. 0 – Disable Parallel mode in QSPI 1 – Enable Parallel Mode in QSPI
CS1 on Port A	84	4	This field enables CS1 on port A 0 – Disable CS1 on Port A 1 – Enable CS1 on Port A
CS1 on Port B	88	4	This field enables CS1 on port B 0 – Disable CS1 on Port B 1 – Enable CS1 on Port B
Full Speed Phase Selection	92	4	Select the edge of the sampling clock valid for the full-speed commands: 0 - Select the sampling at the non-inverted clock 1 - Select the sampling at the inverted clock This bit is also used to shift the dqs_enable when the DQS mode is selected.
Full Speed Delay Selection	96	4	Select the delay w.r.t. the reference edge for the sample point valid for full-speed commands: 0 - One clock cycle delay 1 - Two clock cycles delay This bit is also used to shift the dqs_enable when the DQS mode is selected.
DDR Sampling Point	100	4	Select the sampling point for the incoming data when the serial flash is in the DDR mode. NOTE: The valid values are (b000-b111)
LUT program sequence	104	256	256 bytes of the Look-Up Table program sequence. The ROM programs the LUT of QuadSPI with this parameter supplied. It assumes that the optimize read command sequence which is used to read the data from the Serial flash and fill the AHB buffer is programmed at index 0.
read_status_ipcr	360	4	IPCR value of Read Status Reg
enable_dqs_phase	364	4	Enable DQS Phase
Reserved	368	36	Not used
dqs_pad_setting_override	404	4	DQS pin pad setting override
sclk_pad_setting_override	408	4	SCLK pin pad setting override
data_pad_setting_override	412	4	DATA pins pad setting override

Table continues on the next page...

Table 8-23. QuadSPI configuration parameters (continued)

Name	Offset	Size in bytes	Description
cs_pad_setting_override	416	4	CS pins pad setting override
dqs_loopback_internal	420	4	0 - dqs loopback from pad 1 - dqs loopback internally
dqs_phase_sel	424	4	dqs phase selection
dqs_fa_delay_chain_sel	428	4	dqs fa delay chain selection
dqs_fb_delay_chain_sel	432	4	dqs fb delay chain selection
sclk_fa_delay_chain_sel	436	4	sclk fa delay chain selection
sclk_fb_delay_chain_sel	440	4	sclk fb delay chain selection
Reserved	444	64	Reserved
tag	508	4	End flag of the QSPI parameters area

8.6.4 IOMUX configuration for QSPI devices

The QSPI interface uses the dedicated contacts on the IC. The contacts assigned to the data signals used by the QSPI are shown in these tables:

Table 8-24. QuadSPI IOMUX pin configuration

Signal	QSPI1
A_SCLK	NAND_WP_b.alt2
A_SS0_B	NAND_DQS.alt2
A_SS1_B	NAND_DATA07.alt2
A_DATA0	NAND_READY_B.alt2
A_DATA1	NAND_CE0_B.alt2
A_DATA2	NAND_CE1.B.alt2
A_DATA3	NAND_CLE.alt2
A_DQS	NAND_ALE.alt2
B_SCLK	NAND_RE_B.alt2
B_SS0_B	NAND_WE_B.alt2
B_SS1_B	NAND_DATA00.alt2
B_DATA0	NAND_DATA02.alt2
B_DATA1	NAND_DATA03.alt2
B_DATA2	NAND_DATA04.alt2
B_DATA3	NAND_DATA05.alt2
B_DQS	NAND_DATA01.alt2

8.6.5 QuadSPI boot flow chart

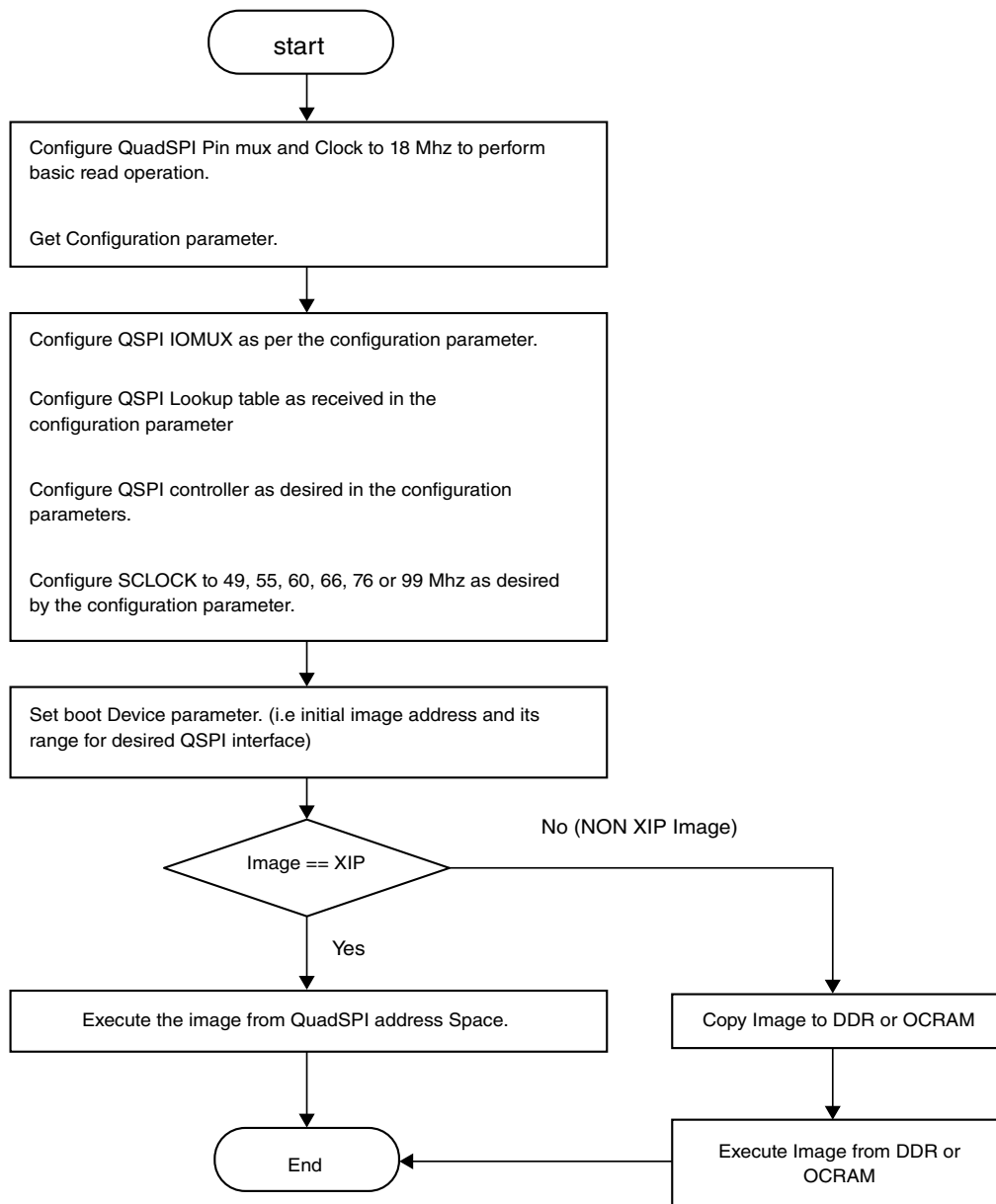

Figure 8-20. QuadSPI boot flow chart

NOTE

If the flash is configured for the "high-performance mode" (where the command is generated only once) in the LUT program sequence, then the external reset must be routed to the flash reset to allow rebooting in case of a device reset different from the Power-On Reset. This high-performance mode must

be exited by the application before any low-power mode entry, where the device is supposed to reboot from QSPI flash on the low-power mode exit. In general, any preserved configuration in the external flash is not understood by the device after the reset.

8.7 Program image

This section describes the data structures that are required to be included in the user's program image. The program image consists of:

- Image vector table—a list of pointers located at a fixed address that the ROM examines to determine where the other components of the program image are located.
- Boot data—a table that indicates the program image location, program image size in bytes, and the plugin flag.
- Device configuration data—IC configuration data.
- User code and data.

8.7.1 Image Vector Table and Boot Data

The Image Vector Table (IVT) is the data structure that the ROM reads from the boot device supplying the program image containing the required data components to perform a successful boot.

The IVT includes the program image entry point, a pointer to Device Configuration Data (DCD) and other pointers used by the ROM during the boot process. The ROM locates the IVT at a fixed address that is determined by the boot device connected to the Chip. The IVT offset from the base address and initial load region size for each boot device type is defined in the table below. The location of the IVT is the only fixed requirement by the ROM. The remainder of the image memory map is flexible and is determined by the contents of the IVT.

Table 8-25. Image Vector Table Offset and Initial Load Region Size

Boot Device Type	Image Vector Table Offset	Initial Load Region Size
NOR	4 Kbyte = 0x1000 bytes	Entire Image Size
OneNAND	256 bytes = 0x100 bytes	1 Kbyte
SD/MMC/eSD/eMMC/SDXC	1 Kbyte = 0x400 bytes	4 Kbyte
SPI EEPROM	1 Kbyte = 0x400 bytes	4 Kbyte

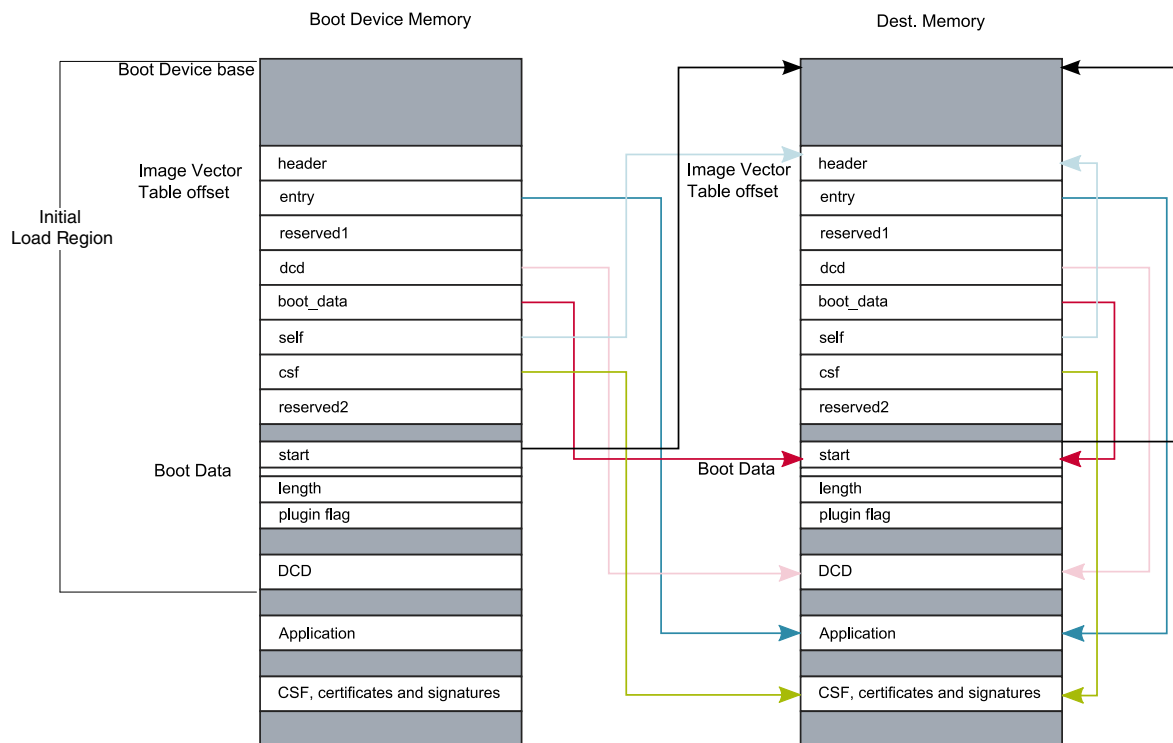

Figure 8-21. Image Vector Table

8.7.1.1 Image vector table structure

The IVT has the following format where each entry is a 32-bit word:

Table 8-26. IVT format

header
entry: Absolute address of the first instruction to execute from the image
reserved1: Reserved and should be zero
dcd: Absolute address of the image DCD. The DCD is optional so this field may be set to NULL if no DCD is required. See Device Configuration Data (DCD) for further details on the DCD.
boot data: Absolute address of the boot data
self: Absolute address of the IVT. Used internally by the ROM.
csf: Absolute address of the Command Sequence File (CSF) used by the HAB library. See High-Assurance Boot (HAB) for details on the secure boot using HAB. This field must be set to NULL when not performing a secure boot
reserved2: Reserved and should be zero

Figure 8-22 shows the IVT header format:

Tag	Length	Version
-----	--------	---------

Figure 8-22. IVT header format

where:

Tag: A single byte field set to 0xD1

Length: a two byte field in big endian format containing the overall length of the IVT, in bytes, including the header. (the length is fixed and must have a value of 32 bytes)

Version: A single byte field set to 0x40 or 0x41

8.7.1.2 Boot data structure

The boot data must follow the format defined in the table found here, each entry is a 32-bit word.

Table 8-27. Boot data format

start	Absolute address of the image
length	Size of the program image
plugin	Plugin flag (see Plugin image)

8.7.2 Device Configuration Data (DCD)

Upon reset, the chip uses the default register values for all peripherals in the system. However, these settings typically are not ideal for achieving the optimal system performance and there are even some peripherals that must be configured before they can be used.

The DCD is a configuration information contained in the program image (external to the ROM) that the ROM interprets to configure various peripherals on the chip.

For example, the EIM default settings allow the core to interface to a NOR flash device immediately after the reset. This allows the chip to interface with any NOR flash device, but has the disadvantage of slow performance. Additionally, some components (such as DDR) require some sequence of register programming as a part of the configuration before it is ready to be used. The DCD feature can be used to program the EIM registers and the MMDC registers to the optimal settings.

Program image

The ROM determines the location of the DCD table based on the information located in the Image Vector Table (IVT). See [Image Vector Table and Boot Data](#) for more details. The DCD table shown below is a big-endian byte array of the allowable DCD commands. The maximum size of the DCD is limited to 1768 B.

Header
[CMD]
[CMD]
...

Figure 8-23. DCD data format

The DCD header is 4 B with the following format:

Tag	Length	Version
-----	--------	---------

Figure 8-24. DCD header format

where:

Tag: A single-byte field set to 0xD2

Length: a two-byte field in the big-endian format containing the overall length of the DCD (in bytes) including the header

Version: A single-byte field set to 0x41

8.7.2.1 Write data command

The write data command is used to write a list of given 1-, 2- or 4-byte values (or bitmasks) to a corresponding list of target addresses.

The format of the write data command (in a big-endian byte array) is shown in this table:

Table 8-28. Write data command format

Tag	Length	Parameter
	Address	
	Value/Mask	

Table continues on the next page...

Table 8-28. Write data command format (continued)

[Address]
[Value/Mask]
...
[Address]
[Value/Mask]

where:

Tag: a single-byte field set to 0xCC

Length: a two-byte field in a big-endian format, containing the length of the Write Data Command (in bytes) including the header

Address: the target address to which the data must be written

Value/Mask: the data value (or bitmask) to be written to the preceding address

The parameter field is a single byte divided into the bitfields, as follows:

Table 8-29. Write data command parameter field

7	6	5	4	3	2	1	0
flags					bytes		

where

bytes: the width of the target locations in bytes (either 1, 2, or 4)

flags: control flags for the command behavior

Data Mask = bit 3: if set, only specific bits may be overwritten at the target address (otherwise all bits may be overwritten)

Data Set = bit 4: if set, the bits at the target address are overwritten with this flag (otherwise it is ignored)

One or more target address and value/bitmask pairs can be specified. The same bytes' and flags' parameters apply to all locations in the command.

When successful, this command writes to each target address in accordance with the flags as follows:

Table 8-30. Interpretation of write data command flags

"Mask"	"Set"	Action	Interpretation
0	0	*address = val_msk	Write value
0	1	*address = val_msk	Write value
1	0	*address &= ~val_msk	Clear bitmask
1	1	*address = val_msk	Set bitmask

NOTE

If any of the target addresses does not have the same alignment as the data width indicated in the parameter field, none of the values are written.

If any of the values are larger or any of the bitmasks are wider than permitted by the data width indicated in the parameter field, none of the values are written.

If any of the target addresses do not lie within the allowed region, none of the values are written. The list of allowable blocks and target addresses for the chip are provided below.

Table 8-31. Valid DCD address ranges

Address range	Start address	Last address
IOMUX Control (IOMUXC) registers	0x020E0000	0x020E3FFF
IOMUXC GPR	0x020E4000	0x020E7FFF
CCM register set	0x020C4000	0x020C7FFF
ANADIG registers	0x020C8000	0x020C8FFF
MMDC register set	0x021B0000	0x021B3FFF
OCRAM free space	0x00907000	0x00917FF0
EIM registers	0x021B8000	0x021BBFFF
DDR	0x10000000	0xFFFF7FFF
EPIT	EPIT1: 0x020D0000	EPIT1: 0x020D3FFF

8.7.2.2 Check data command

The check data command is used to test for a given 1-, 2-, or 4-byte bitmasks from a source address.

The check data command is a big-endian byte array with the format shown in this table:

Table 8-32. Check data command format

Tag	Length	Parameter
	Address	
	Mask	
	[Count]	

where:

Tag: a single-byte field set to 0xCF

Length: a two-byte field in the big-endian format containing the length of the check data command (in bytes) including the header

Address: the source address to test
 Mask: the bit mask to test
 Count: an optional poll count; If the count is not specified, this command polls indefinitely until the exit condition is met. If count = 0, this command behaves as for the NOP.

The parameter field is a single byte divided into bitfields, as follows:

Table 8-33. Check data command parameter field

7	6	5	4	3	2	1	0
flags					bytes		

where

bytes: the width of target locations in bytes (either 1, 2, or 4)
 flags: control flags for the command behavior
 Data Mask = bit 3: if set, only the specific bits may be overwritten at a target address (otherwise all bits may be overwritten)
 Data Set = bit 4: if set, the bits at the target address are overwritten with this flag (otherwise it is ignored)

This command polls the source address until either the exit condition is satisfied, or the poll count is reached. The exit condition is determined by the flags as follows:

Table 8-34. Interpretation of check data command flags

"Mask"	"Set"	Action	Interpretation
0	0	(*address & mask) == 0	All bits clear
0	1	(*address & mask) == mask	All bits set
1	0	(*address & mask) != mask	Any bit clear
1	1	(*address & mask) != 0	Any bit set

NOTE

If the source address does not have the same alignment as the data width indicated in the parameter field, the value is not read.

If the bitmask is wider than permitted by the data width indicated in the parameter field, the value is not read.

8.7.2.3 NOP command

This command has no effect.

The format of the NOP command is a big-endian four-byte array, as shown in this table:

Table 8-35. NOP command format

Tag	Length	Undefined
-----	--------	-----------

where:

Tag: a single-byte field set to 0xC0

Length: a two-byte field in big endian containing the length of the NOP command in bytes (fixed to a value of 4)

Undefined: this byte is ignored and can be set to any value.

8.7.2.4 Unlock command

The unlock command is used to prevent specific engine features from being locked when exiting the ROM.

The format of the unlock command (in a big-endian byte array) is shown in this table:

Table 8-36. Unlock command format

Tag	Length	Eng
	Value	
	Value	
	...	
	Value	

where:

Tag: a single-byte field set to 0xB2

Eng: the engine to be left unlocked

Values: [optional] the unlock values required by the engine

NOTE

This command may not be used in the DCD structure if the SEC_CONFIG is configured as closed.

8.8 Plugin image

The ROM supports a limited number of boot devices. When using other devices as a boot source (for example, Ethernet, CDROM, or USB), the supported boot device must be used (typically serial ROM) as a firmware to provide the missing boot drivers.

Additionally, the plugin can be customized to support boot drivers, which is more flexible when performing the device initialization, such as condition judging, delay assertion, or to apply custom settings to the boot device and memory system.

In addition to the standard images, the chip also supports plugin images. The plugin images return the execution to the ROM whereas the standard image does not.

The boot ROM detects the image type using the plugin flag of the boot data structure (see [Boot data structure](#)). If the plugin flag is 1, then the ROM uses the image as a plugin function. The function must initialize the boot device and copy the program image to the final location. At the end, the plugin function must return with the program image parameters. (See [High-level boot sequence](#) for details about the boot flow).

The boot ROM authenticates the plugin image before running the plugin function and then authenticates the program image.

The plugin function must follow the API described below:

```
typedef BOOLEAN (*plugin_download_f)(void **start, size_t *bytes, UINT32
*ivt_offset);
```

ARGUMENTS PASSED:

- start - the image load address on exit.
- bytes - the image size on exit.
- ivt_offset - the offset (in bytes) of the IVT from the image start address on exit.

RETURN VALUE:

- 1 - success
- 0 - failure

8.9 Serial Downloader

The Serial Downloader provides a means to download a program image to the chip over the USB and UART serial connection.

In this mode, the ROM programs the WDOG1 for a time-out specified by the fuse WDOG Time-out Select (See fusemap for details) if the WDOG_ENABLE eFuse is 1 and continuously polls for the USB and UART connection. If no activity is found on the USB OTG1 and UART 1/2 and the watchdog timer expires, the Arm core is reset.

NOTE

After the downloaded image is loaded, it is responsible for managing the watchdog resets properly.

This figure shows the USB and UART boot flow:

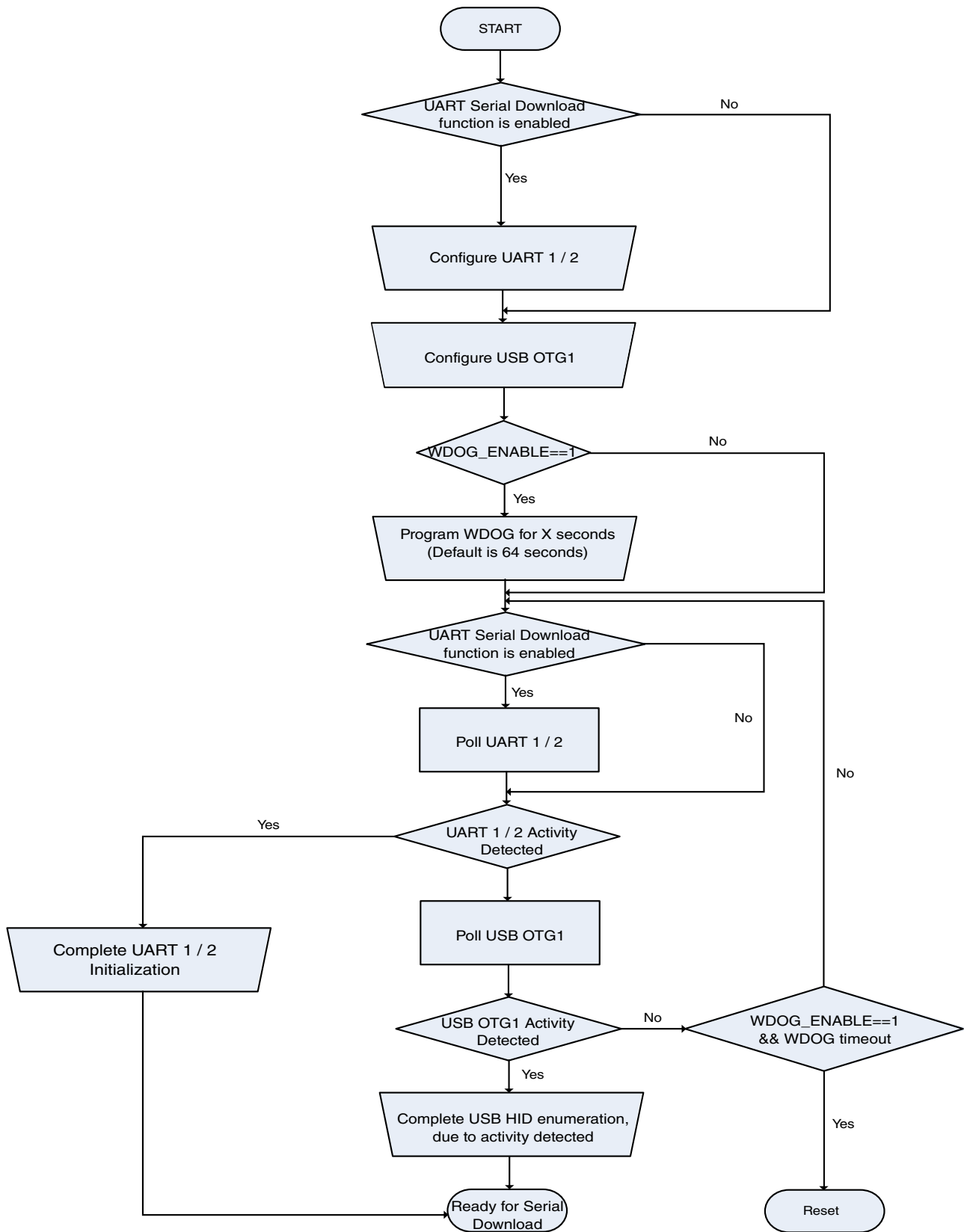

Figure 8-25. Serial Downloader boot flow

8.9.1 USB

The USB support is composed of the USBOH3USBO2 (USB OTG1USB OTG core controller, compliant with the USB 2.0 specification) and the USBPHY (HS USB transceiver).

The ROM supports the USB OTG port for boot purposes. The other USB ports on the chip are not supported for boot purposes.

The USB Driver is implemented as a USB HID class. A collection of four HID reports are used to implement the SDP protocol for data transfers, as described in [Table 8-37](#).

Table 8-37. USB HID reports

Report ID (first byte)	Transfer endpoint	Direction	Length	Description
1	control OUT	Host to device	17 B	SDP command from the host to the device.
2	control OUT	Host to device	Up to 1025 B	Data associated with the report 1 SDP command.
3	interrupt	Device to host	5 B	HAB security configuration. The device sends 0x12343412 in the closed mode and 0x56787856 in the open mode.
4	interrupt	Device to host	Up to 65 B	Data in response to the SDP command in report 1.

8.9.1.1 USB configuration details

The USB OTG function device driver supports a high speed (HS for UTMI) non-stream mode with a maximal packet size of 512 B and a low-level USB OTG function.

The VID/PID and strings for the USB device driver are listed in the following table.

Table 8-38. VID/PID and strings for USB device driver

Descriptor	Value
VID	0x15A2 (NXP vendor ID)
PID ¹	0x007D

Table continues on the next page...

Table 8-38. VID/PID and strings for USB device driver (continued)

Descriptor	Value
String Descriptor1 (manufacturer)	NXP Semiconductors
String Descriptor2 (product)	S Blank SE Blank NS Blank
String Descriptor4	NXP Flash
String Descriptor5	NXP Flash

1. Allocation based on the BPN (Before Part Number)

8.9.1.2 IOMUX configuration for USB

The interface signals of the UTMI PHY are not configured in the IOMUX. The UTMI PHY interface uses the dedicated contacts on the IC. See the chip data sheet for details.

8.9.2 UART

The ROM supports the UART1 and UART2 ports for boot purposes. The other UART ports on the chip are not supported for boot purposes.

If an event of data ready in the UART FIFO is detected, the ROM enters the UART serial download boot mode, and starts to read the data from the UART port which reports the data ready event. The noise on the UART RX data pad may cause a “data ready” event reported by the UART controller, and further cause the ROM to enter the UART serial download mode. Hardware designers must take care to avoid such exception.

8.9.2.1 UART configuration details

Table 8-39. UART configuration details

Transmission protocol	RS232
Start bit	1 bit
Stop bit	1 bit
Parity bit	No needed
Flow control	No needed
Baud rate	115200 bps

8.9.2.2 UART eFUSE configuration

Table 8-40. UART eFUSE configuration

Fuse	Config	Definition	GPIO	Shipped value	Settings
0x470[4]	OEM	UART Serial Download Disabled Selection	Yes	0	0 - UART serial download enabled 1 - disabled

8.9.2.3 IOMUX configuration for UART

Table 8-41. IOMUX configuration for UART

Signal	UART1	UART2
TXD	UART1_TX_DATA.alt0	UART2_TX_DATA.alt0
RXD	UART1_RX_DATA.alt0	UART2_RX_DATA.alt0

8.9.3 Serial Download Protocol (SDP)

The 16-byte SDP command from the host to device is sent using the HID report 1.

This table describes the 16-byte SDP command data structure:

Table 8-42. 16-byte SDP command data structure

BYTE offset	Size	Name	Description
0	2	COMMAND TYPE	These commands are supported for the ROM: <ul style="list-style-type: none"> • 0x0101 READ_REGISTER • 0x0202 WRITE_REGISTER • 0x0404 WRITE_FILE • 0x0505 ERROR_STATUS • 0x0A0A DCD_WRITE • 0x0B0B JUMP_ADDRESS • 0x0C0C SKIP_DCD_HEADER
2	4	ADDRESS	Only relevant for these commands: READ_REGISTER, WRITE_REGISTER, WRITE_FILE, DCD_WRITE, and JUMP_ADDRESS.

Table continues on the next page...

Table 8-42. 16-byte SDP command data structure (continued)

BYTE offset	Size	Name	Description
			For the READ_REGISTER and WRITE_REGISTER commands, this field is the address to a register. For the WRITE_FILE and JUMP_ADDRESS commands, this field is an address to the internal or external memory address.
6	1	FORMAT	Format of access, 0x8 for an 8-bit access, 0x10 for a 16-bit access, and 0x20 for a 32-bit access. Only relevant for the READ_REGISTER and WRITE_REGISTER commands.
7	4	DATA COUNT	Size of the data to read or write. Only relevant for the WRITE_FILE, READ_REGISTER, WRITE_REGISTER, and DCD_WRITE commands. For the WRITE_FILE and DCD_WRITE commands, the DATA COUNT is in the byte units.
11	4	DATA	The value to write. Only relevant for the WRITE_REGISTER command.
15	1	RESERVED	Reserved

8.9.3.1 SDP commands

The SDP commands are described in the following sections.

8.9.3.1.1 READ_REGISTER

The transaction for the READ_REGISTER command consists of these reports: Report1 for the command, Report3 for the security configuration, and Report4 for the response or the register value.

The register to read is specified in the ADDRESS field of the SDP command. The first device sends Report3 with the security configuration followed by the Report4 with the bytes read at a given address. If the count is greater than 64, multiple reports with the report id 4 are sent until the entire data requested by the host is sent. The STATUS is either 0x12343412 for the closed parts and 0x56787856 for the open or field return parts.

Report1, Command, Host to Device:

1	Valid values for the READ_REGISTER COMMAND, ADDRESS, FORMAT, DATA_COUNT
---	---

ID 16-byte SDP command

Report3, Response, Device to Host:

3	Four bytes indicating the security configuration
---	--

ID 4 bytes status

Report4, Response, Device to Host: first response report

4	Register value
---	----------------

ID 4 bytes of data containing the register value. If the number of bytes requested is less than 4, the remaining bytes must be ignored by the host.

Multiple reports of the report id 4 are sent until the entire requested data is sent.

Report4, Response, Device to Host: last response report

4	Register value
---	----------------

ID 64 bytes of data containing the register value. If the number of bytes requested is less than 64, the remaining bytes must be ignored by the host.

8.9.3.1.2 WRITE_REGISTER

The transaction for the WRITE_REGISTER command consists of these reports: Report1 for the command, Report3 for the security configuration and Report4 for the write status.

The host sends Report1 with the WRITE_REGISTER command. The register to write is specified in the ADDRESS field of the SDP command of Report1, with the FORMAT field set to the data type (number of bits to write, either 8, 16, or 32) and the value to write in the DATA field of the SDP command. The device writes the DATA to the register address and returns the WRITE_COMPLETE code using Report4 and the security configuration using Report3 to complete the transaction.

Report1, Command, Host to Device:

1	Valid values for WRITE_REGISTER COMMAND, ADDRESS, FORMAT, DATA_COUNT and DATA
---	---

ID 16-byte SDP command

Report3, Response, Device to Host:

3	4 bytes indicating the security configuration
---	---

ID 4 bytes status

Report4, Response, Device to Host:

4	WRITE_COMPLETE (0x128A8A12) status
---	------------------------------------

ID 64 bytes data with the first 4 bytes to indicate that the write is completed with code 0x128A8A12. On failure, the device reports the HAB error status.

8.9.3.1.3 WRITE_FILE

The transaction for the WRITE_FILE command consists of these reports: Report1 for the command phase, Report2 for the data phase, Report3 for the HAB mode, and Report4 to indicate that the data are received in full.

The size of each Report2 is limited to 1024 bytes (limitation of the USB HID protocol). Hence, multiple Report2 packets are sent by the host in the data phase until the entire data is transferred to the device. When the entire data (DATA_COUNT bytes) is received, the device sends Report3 with the HAB mode and Report4 with 0x88888888, indicating that the file download completed.

Report1, Host to Device:

1	Valid values for WRITE_FILE COMMAND, ADDRESS, DATA_COUNT
---	--

ID 16-byte SDP command

=====Optional Begin=====

Host sends the ERROR_STATUS command to query if the HAB rejected the address

===== Optional End=====

Report2, Host to Device:

2	File data
---	-----------

ID Max 1024 bytes data per report

Report2, Host to Device:

2	File data
---	-----------

ID Max 1024 bytes data per report

Report3, Device to Host:

Serial Downloader

3	4 bytes indicating security configuration
---	---

ID 4 bytes status

Report4, Response, Device to Host:

4	COMPLETE (0x88888888) status
---	------------------------------

ID 64 bytes data with the first four bytes to indicate that the file download completed with code 0x88888888. On failure, the device reports the HAB error status.

8.9.3.1.4 ERROR_STATUS

The transaction for the SDP command ERROR_STATUS consists of three reports.

Report1 is used by the host to send the command; the device sends global error status in four bytes of Report4 after returning the security configuration in Report3. When the device receives the ERROR_STATUS command, it returns the global error status that is updated for each command. This command is useful to find out whether the last command resulted in a device error or succeeded.

Report1, Command, Host to Device:

1	ERROR_STATUS COMMAND
---	----------------------

ID 16-byte SDP Command

Report3, Response, Device to Host:

3	Four bytes indicating the security configuration
---	--

ID 4 bytes status

Report4, Response, Device to Host:

4	Four bytes Error status
---	-------------------------

ID first 4 bytes status in 64 bytes Report4

8.9.3.1.5 DCD_WRITE

The SDP command DCD_WRITE is used by the host to send multiple register writes in one shot. This command is provided to speed up the process of programming the register writes (such as to configure an external RAM device).

The command goes with Report1 from the host with COMMAND TYPE set to DCD_WRITE, ADDRESS which is used as a temporary location of the DCD data, and DATA_COUNT to the number of bytes sent in the data out phase. In the data phase, the host sends the data for a number of registers using Report2. The device completes the transaction with Report3 indicating the security configuration and Report4 with the WRITE_COMPLETE code 0x12828212.

Report1, Command, Host to Device:

1	DCD_WRITE COMMAND, ADDRESS, DATA_COUNT
---	--

ID 16-byte SDP Command

Report2, Data, Host to Device:

2	DCD binary data
---	-----------------

ID Max 1024 bytes per report

Report3, Response, Device to Host:

3	Four bytes indicating the security configuration
---	--

ID 4 bytes status

Report4, Response, Device to Host:

4	WRITE_COMPLETE (0x128A8A12) status
---	------------------------------------

ID 64 bytes report with the first four bytes to indicate that the write completed with the code 0x128A8A12. On failure, the device reports the HAB error status.

See [Device Configuration Data \(DCD\)](#) for the DCD format description.

8.9.3.1.6 SKIP_DCD_HEADER

The SDP command SKIP_DCD_HEADER is used by the host to inform the device to skip the DCD configuration within the download image.

If the download image must be run on the DDR, the DCD configuration data must be built into the image. In case the host issued DCD_WRITE to push the DCD configuration data to the device for the DDR initialization, the image with the DCD information causes the ROM to initialize the DDR twice, and may cause the initialization processing to hang.

The SKIP_DCD_HEADER command informs the device to skip the DCD configuration within the download image and avoid this issue.

This command is typically sent after JUMP_ADDRESS. This command is sent by the host in the command-phase of the transaction using Report1, there is no data phase for this command. The device completes the transaction with Report3 indicating the security configuration and Report4 with the OK_ACK code 0x900DD009.

Report1, Command, Host to Device:

1	SKIP_DCD_HEADER
---	-----------------

ID 16-byte SDP Command

Report3, Response, Device to Host:

3	Four bytes indicating the security configuration
---	--

ID 4 bytes status

Report4, Response, Device to Host:

4	OK_ACK (0x900DD009)
---	---------------------

8.9.3.1.7 JUMP_ADDRESS

The SDP command JUMP_ADDRESS is the last command that the host can send to the device. After this command, the device jumps to the address specified in the ADDRESS field of the SDP command and starts to execute.

This command usually follows after the WRITE_FILE command. The command is sent by the host in the command-phase of the transaction using Report1. There is no data phase for this command, but the device sends the status Report3 to complete the transaction. If the authentication fails, it also sends Report4 with the HAB error status.

Report1, Command, Host to Device:

1	JUMP_ADDRESS COMMAND, ADDRESS
---	-------------------------------

ID 16-byte SDP Command

Report3, Response, Device to Host:

3	Four bytes indicating the security configuration
---	--

ID 4 bytes status

This report is sent by the device only in case of an error jumping to the given address, or if the device reports error in Report4, Response, Device to Host:

4	Four bytes HAB error status
---	-----------------------------

ID 4 bytes status, 64 bytes report length

8.10 Recovery devices

The chip supports recovery devices. If the primary boot device fails, the boot ROM tries to boot from the recovery device using one of the ECSPI ports.

To enable the recovery device, the BOOT_CFG4[6] fuse must be set. Additionally, the serial EEPROM fuses must be set as described in [Serial ROM through SPI](#).

8.11 USB low-power boot

The ROM supports the USB low-power boot. This feature enables a device with a dead or weak battery to power up and boot if the device is connected to a USB upstream port, no matter if the upstream port is a USB charger or a USB host/hub.

If a USB dedicated charger or a host/hub charger are connected, as soon as the device is connected to the upstream port, a stable current (max.1.5 A) can be supplied by the charger. If a USB host/hub is connected, a maximal current of 100 mA is supplied to the device and the device is able to power up to boot the image with less than 100 mA.

If the LPB_BOOT fuses are blown, the chip checks if there is a low-power condition via the UART3_CTS (as GPIO1_26) pad. If there is a low-power boot condition, the USB charger detection is activated. If there is no USB charger, the ROM initializes the USB as a device and applies division factors on the Arm, DDR, AXI, and AHB root clocks based on the LPB_BOOT fuses value (see the table below). The polarity of the low-power boot condition on the UART3_CTS (as GPIO1_26) pad is set by the BT_LPBPOLARITY fuse (see the following figure).

Table 8-43. USB low-power bus boot frequencies

LPB_BOOT	Boot Frequencies=0	Boot Frequencies=1
0	MMDC_CLK_ROOT = 396 MHz FABRIC_CLK_ROOT = 198 MHz AHB_CLK_ROOT = 132 MHz	MMDC_CLK_ROOT = 307 MHz FABRIC_CLK_ROOT = 153 MHz AHB_CLK_ROOT = 102 MHz
1	MMDC_CLK_ROOT = 396 MHz FABRIC_CLK_ROOT = 198 MHz AHB_CLK_ROOT = 132 MHz	MMDC_CLK_ROOT = 307 MHz FABRIC_CLK_ROOT = 153 MHz AHB_CLK_ROOT = 102 MHz
10	MMDC_CLK_ROOT = 198 MHz FABRIC_CLK_ROOT = 99 MHz AHB_CLK_ROOT = 66 MHz	MMDC_CLK_ROOT = 153 MHz FABRIC_CLK_ROOT = 76 MHz AHB_CLK_ROOT = 51 MHz
11	Reserved	Reserved

Table 8-44. USB low-power CPU boot frequencies

LPB_BOOT	Boot Frequencies=0	Boot Frequencies=1
0	ARM_CLK_ROOT = 396 MHz	ARM_CLK_ROOT = 198 MHz
1	ARM_CLK_ROOT = 396 MHz	ARM_CLK_ROOT = 198 MHz
10	ARM_CLK_ROOT = 198 MHz	ARM_CLK_ROOT = 99 MHz
11	Reserved	Reserved

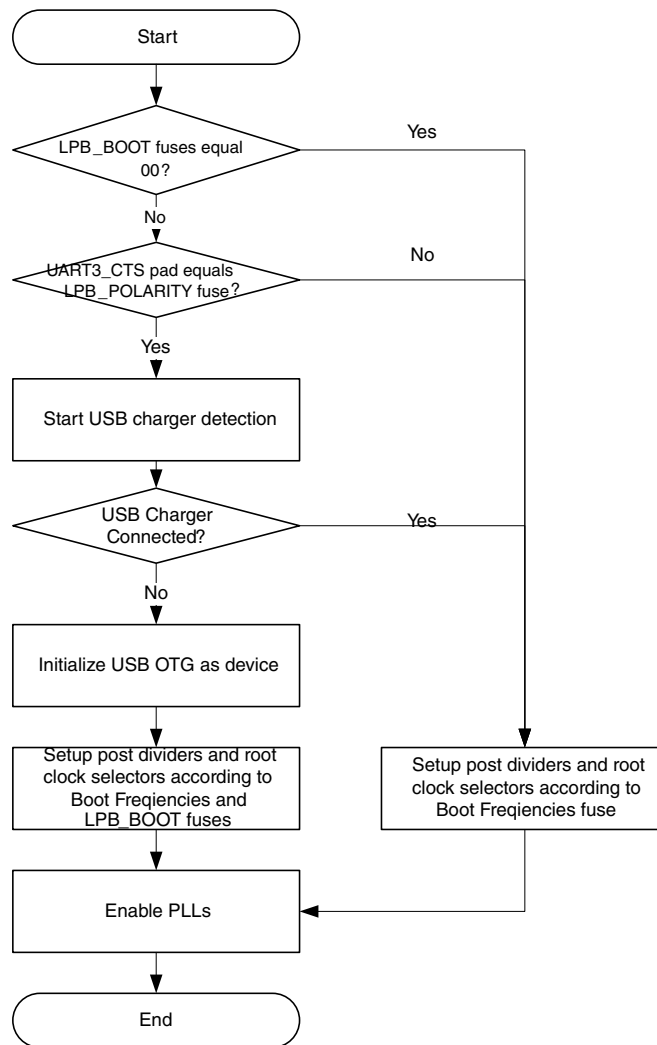

Figure 8-26. USB low-power boot flow

8.12 SD/MMC manufacture mode

When the internal boot and recover boot (if enabled) failed, the SDMMC_MFG_DISABLE fuse bit isn't set and the EEPROM recovery fuse bit is set, the boot goes to the SD/MMC manufacture mode before the serial download mode. In the manufacture mode, one bit bus width is used despite of the fuse setting.

In the manufacture mode, the SD or MMC card will be scanned on the uSDHC1. If a card is detected and a valid boot image is found in the card, the boot image is loaded and executed. Pad of SD1_CD is used to detect whether a card is inserted or not.

By default, the SD/MMC manufacture mode is enabled. Blow the fuse of the DISABLE_SDMMC_MFG to disable it.

NOTE

A secondary boot is not supported in the SD/MMC manufacture mode.

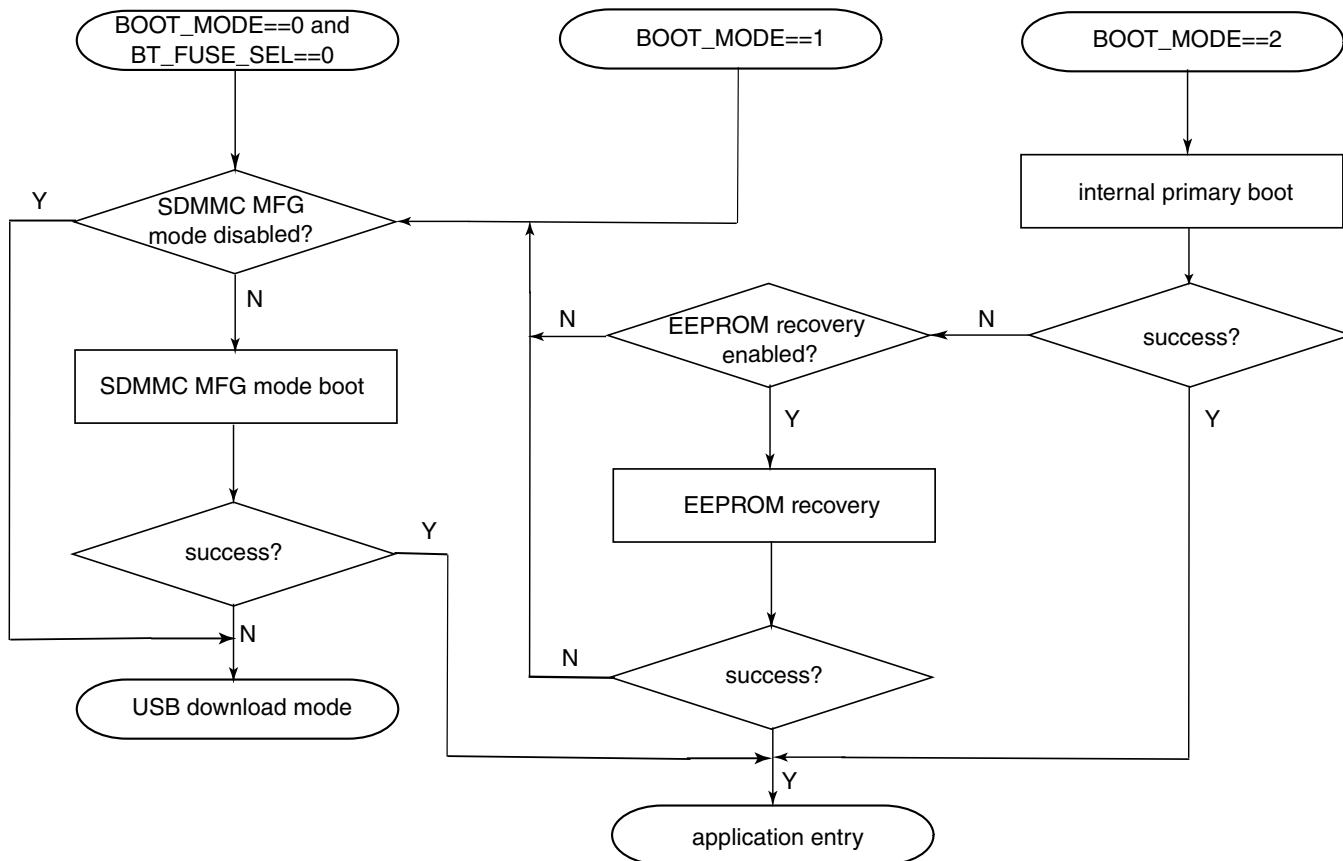

Figure 8-27. SD/MMC manufacture boot flow

8.13 High-Assurance Boot (HAB)

The High Assurance Boot (HAB) component of the ROM protects against the potential threat of attackers modifying the areas of code or data in the programmable memory to make it behave in an incorrect manner. The HAB also prevents the attempts to gain access to features which must not be available.

The integration of the HAB feature with the ROM code ensures that the chip does not enter an operational state if the existing hardware security blocks detected a condition that may be a security threat or if the areas of memory deemed to be important were modified. The HAB uses the RSA digital signatures to enforce these policies.

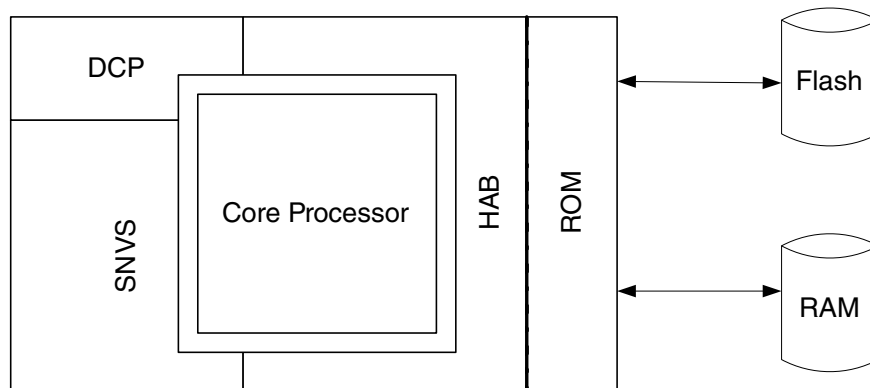

Figure 8-28. Secure boot components

The figure above illustrates the components used during a secure boot using HAB. The HAB interfaces with the SNVS to make sure that the system security state is as expected. The HAB includes a software implementation of SHA-256 for cases where a hardware accelerator can't be used. The RSA key sizes supported are 1024, 2048, and 3072 bits. The RSA signature verification operations are performed by a software implementation contained in the HAB library. The main features supported by the HAB are:

- X.509 public key certificate support
- CMS signature format support

NOTE

NXP provides the reference Code Signing Tool (CST) for key generation, certificate generation, and code signing for use with the HAB library. The CST can be found by searching for "IMX_CST_TOOL" at <http://www.nxp.com>.

NOTE

For further details on using the secure boot feature using HAB, contact your local NXP representative.

8.13.1 HAB API vector table addresses

For devices that perform a secure boot, the HAB library may be called by the boot stages that execute after the ROM code.

The RVT table contains the pointers to the HAB API functions and is located at 0x00000100.

NOTE

For additional information on the secure boot including the HAB API, contact your local NXP representative.

Chapter 9 Multimedia

9.1 Display and graphics subsystem

The chip display and graphics subsystem consists of the dedicated modules found here.

- EPDC (electrophoretic display controller): display controller for E-INK EPD panel
- LCD Interface (LCDIF): 24-bit parallel RGB LCD interface
- PXP pixel pipeline: pixel/image processing engine for LCD display
- Camera Sensor Interface (CSI): up to 24-bit parallel interface for image sensor

The following figure shows the high-level integration scheme of the chip display and graphics system.

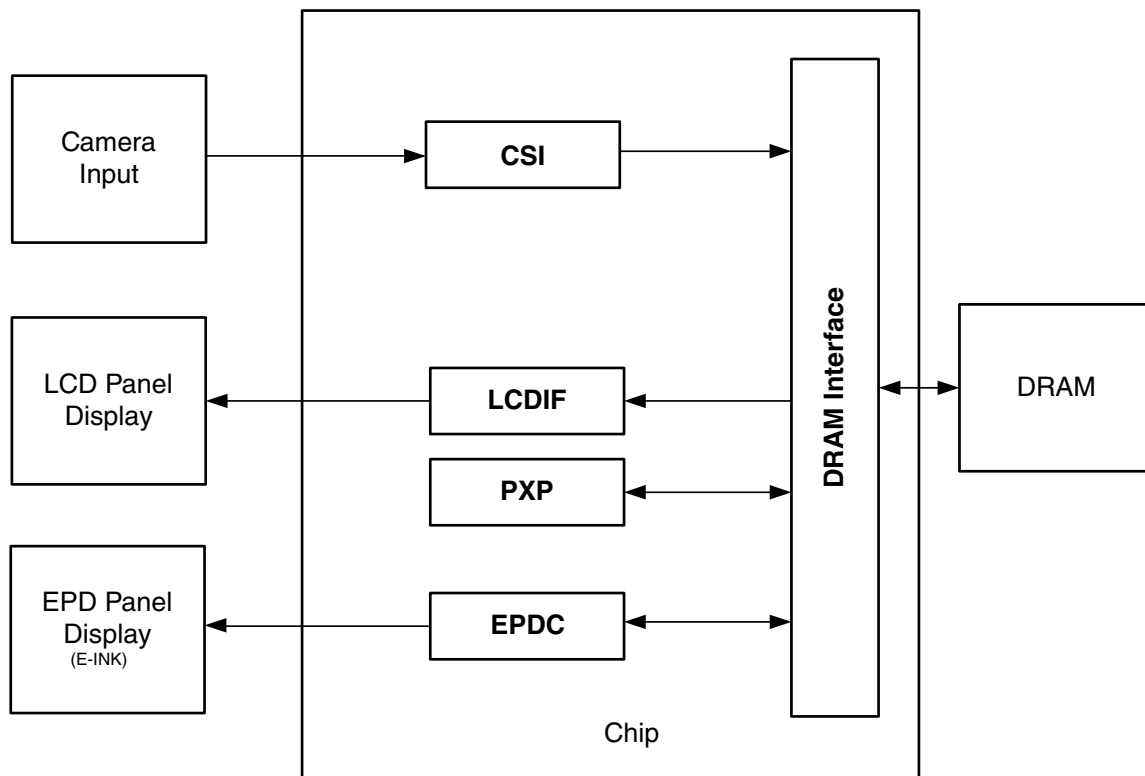

Figure 9-1. Chip display and graphics subsystem

9.1.1 Electrophoretic Display Controller

The EPDC is a feature-rich, low power, and high-performance direct-drive active matrix EPD controller. It is specifically designed to drive E•INK™ EPD panels supporting a wide variety of TFT backplanes. The goal of the EPDC is to provide an efficient SoC integration of this functionality for e-paper applications, allowing a significant BOM cost saving over an external solution whilst reaching much higher levels of performance and lower power. The EPDC module is defined in the context of an optimized HW/SW partitioning and works in conjunction with the ePXP IP module to form a complete display processing solution.

The key features of the EPDC are as follows:

- Supports direct-driver for E-Ink EPD panels, with up to 2048x1536 resolution at 106 Hz refresh rate (or 4096x4096 resolution at 20 Hz refresh rate)
- Supports up to 64 LUT for concurrent update
- Supports automatic waveform selection based on both input image and current panel content
- Supports collision detection
- Supports both PVI panels and LGD GIP panels.

9.1.2 PiXel Processing Pipeline (PXP)

The pixel processing pipeline is used to perform image processing on image/video buffers before sending to an LCD display.

The main features of PXP include:

- Multiple input/output format support, including YUV/RGB/Grayscale
- Supports both RGB/YUV scaling
- Supports overlay with Alpha blending

9.1.3 LCD Interface (LCDIF)

The LCDIF is a general purpose display controller that is used to drive a wide range of display devices. These displays can vary in size and capability. Many of these displays have had an asynchronous parallel MPU interface for command and data transfer to an integrated frame buffer. There are other popular displays that support moving pictures and require the RGB interface mode (called DOTCLK interface in this document) or the VSYNC mode for high-speed data transfers. In addition to these displays, it is also common to provide support for digital video encoders that accept ITU-R BT.656 format 4:2:2 YCbCr digital component video and convert it to analog TV signals. The LCDIF block supports these different interfaces by providing fully programmable functionality.

The block has several major features:

- Bus master interface to source frame buffer data for display refresh and a DMA interface to manage input data transfers from the LCD requiring minimal CPU overhead.
- 8/16/18/24 bit LCD data bus support available depending on I/O mux options.
- Programmable timing and parameters for MPU, VSYNC and DOTCLK LCD interfaces to support a wide variety of displays.
- ITU-R BT.656 mode (called Digital Video Interface or DVI mode here) including progressive-to-interlace feature and RGB to YCbCr 4:2:2 color space conversion to support 525/60 and 625/50 operation.

9.1.4 CMOS Sensor Interface (CSI)

The CSI enables the chip to connect directly to external CMOS image sensors. CMOS image sensors are separated into two classes, dumb and smart. Dumb sensors are those that support only traditional sensor timing (Vertical SYNC and Horizontal SYNC) and output only Bayer and statistics data, while smart sensors support CCIR656 video decoder formats and perform additional processing of the image (for example, image compression, image pre-filtering, and various data output formats).

The capabilities of the CSI include:

- Configurable interface logic to support most commonly available CMOS sensors.
- Support for CCIR656 video interface as well as traditional sensor interface.
- 8-bit data port for YCC, YUV, or RGB data input.
- 8-bit/10-bit/16-bit data port for Bayer data input.
- Embedded DMA controllers to transfer data from receive FIFO or statistic FIFO through AHB bus.
- Support for 2D DMA transfer from the receive FIFO to the frame buffers in the external memory.
- Support for double buffering two frames in the external memory.
- Single interrupt source to interrupt controller from maskable interrupt sources:
 - Start of Frame
 - End of Frame
 - Change of Field
 - FIFO full
 - FIFO overrun
 - DMA transfer done
 - CCIR error
 - AHB bus response error
- Configurable master clock frequency output to sensor.
- Statistic data generation for Auto Exposure (AE) and Auto White Balance (AWB) control of the camera (only for Bayer data and 8-bit/pixel format).

9.2 Audio subsystem

[Audio Subsystem Module Overview](#) provides an overview of each of the audio subsystem component modules, followed by a module-specific section.

9.2.1 Audio Subsystem Module Overview

The following figure shows a high level block diagram of the audio subsystem.

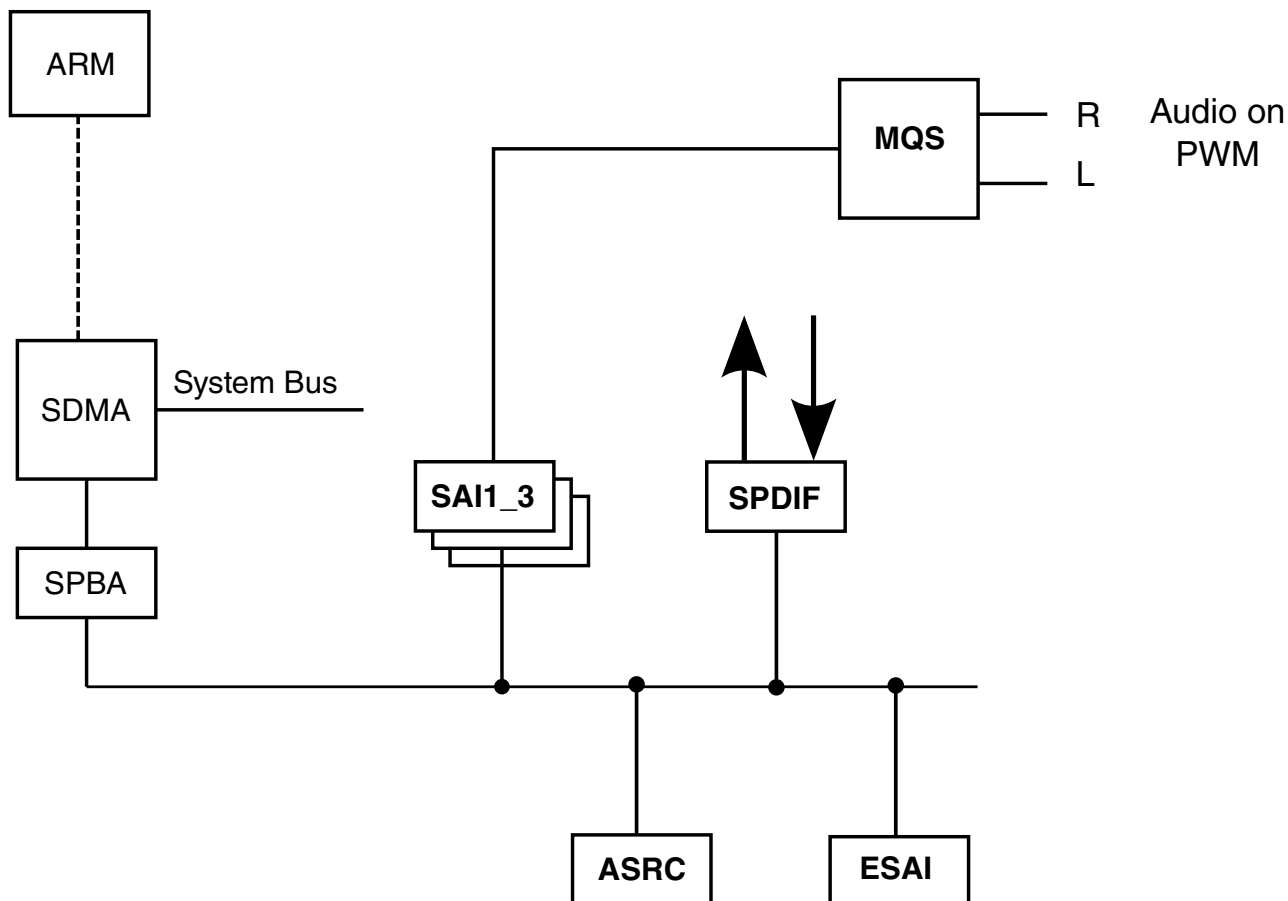

Figure 9-2. Audio subsystem block diagram

AUDMUX routes audio data (and even splices together multiple time-multiplexed audio streams) but does not decode or process audio data itself. The ARM controls AUDMUX, but AUDMUX can route data even when the ARM is in a low-power mode.

The SPDIF (Sony/Philips digital interface) audio module is a stereo transceiver that allows the processor to receive and transmit digital audio over it. The SPDIF receiver section includes a frequency measurement block that allows the precise measurement of an incoming sampling frequency. A recovered clock is provided by the SPDIF receiver section and may be used to drive both internal and external components in the system. SPDIF is connected to the shared peripheral bus.

ASRC (asynchronous sample rate converter) converts the sampling rate of a signal associated to an input clock into a signal associated to a different output clock. ASRC supports concurrent sample rate conversion of up to 10 channels of over 120dB THD+N.

The sample rate conversion of each channel is associated to a pair of incoming and outgoing sampling rates. ASRC supports up to 3 sampling rate pairs. ASRC is connected to the shared peripheral bus.

9.2.2 Medium Quality Sound (MQS)

MQS is used to generate medium quality audio via a standard GPIO in the pinmux. The user can connect stereo speakers or headphones to a power amplifier without an additional DAC chip.

- 2-channel, MSB-valid 16 bit, MSB first
- Frame sync aligned with the left channel data
- 44.1 kHz or 48 kHz I2S signals from SAI1
- SNR target as no more than 20 dB for the signals below 10 kHz
- Signals Over 10 kHz have worse THD + N values

9.2.3 Synchronous Audio Interface (SAI)

- Transmitter with independent Bit Clock and Frame Sync supporting 1 data line
- Receiver with independent Bit Clock and Frame Sync supporting 1 data line
- Maximum Frame Size of 32 Words
- Word size programmable from 8-bits to 32-bits
- Word size configured separately for first word and remaining words in frame
- Asynchronous FIFO for each Transmit and Receive data line
- Graceful restart after FIFO Error

9.2.4 Enhanced Serial Audio Interface (ESAI)

The Enhanced Serial Audio Interface (ESAI) provides a full-duplex serial port for serial communication with a variety of serial devices, including industry-standard codecs, SPDIF transceivers, and other processors.

The ESAI consists of independent transmitter and receiver sections, each section with its own clock generator. All serial transfers are synchronized to a clock. Additional synchronization signals are used to delineate the word frames. The normal mode of operation is used to transfer data at a periodic rate, one word per period. The network mode is also intended for periodic transfers; however, it supports up to 32 words (time slots) per period. This mode can be used to build time division multiplexed (TDM) networks. In contrast, the on-demand mode is intended for non-periodic transfers of data and to transfer data serially at high speed when the data becomes available.

The ESAI has 12 pins for data and clocking connection to external devices. The ESAI is internally connected to the ESAI_BIFIFO, and does not connect directly to the shared peripheral bus. The ESAI interface is designed for a 24-bit data bus, while the shared peripheral data bus is 32-bit wide. Also, the ESAI data paths are only double buffered, not allowing efficient DMA service in the applications processor environment. The ESAI_BIFIFO allows increasing the data buffering and data width matching to the shared peripheral bus.

9.2.5 Sony/Philips Digital Interface (SPDIF)

The SPDIF module is a stereo that allows the processor transmit digital audio over it using the IEC60958 standard, consumer format. The chip provides one SPDIF transmitter with one output and one SPDIF receiver with four inputs.

The SPDIF allows the handling of both SPDIF channel status (CS) and User (U) data.

For the SPDIF transmitter, the audio data is provided by the processor via the SPDIFTxLeft and SPDIFTxRight registers, and the data is stored in two 16-word-deep FIFOs, one for the right channel, the other for the left channel. The FIFOs support programmable watermark levels so that FIFO Empty service request can be triggered when the combined number of empty data words locations in both FIFOs is 8, 16, 24 or 32 words. It is recommended to program the watermark level to trigger a FIFO Empty service request when 16 word locations are empty. For optimal performance when servicing the FIFO Empty service request, the FIFOs should be written alternately, starting with the left channel FIFO. The Channel Status bits are also provided via the corresponding registers. The SPDIF transmitter generates an SPDIF output bitstream in the biphasic mark format (IEC 60958), which consists of audio data, channel status and user bits.

The data handled by the SPDIF module is 24-bit wide. The 24-bit SPDIF data is aligned in the 24 least significant bits of the 32-bit shared peripheral bus data word. The 8 most significant bits of the 32-bit word are ignored by the SPDIF Transmitter when data is being stored in the Transmit FIFOs from the peripheral bus. The 8 most significant bits of the 32-bit word are zeroed by the SPDIF Receiver module when the data is being read from the Receiver FIFOs to the peripheral bus.

Note that 16-bit data is left-aligned in the 24-bit word format of the SPDIF. When 16-bit data is to be transmitted, the 32-bit word to be written to the SPDIF Transmit FIFOs should be created as follows: the 16-bit data should be located in the middle two bytes of the 32-bit data word and the 8 bits of the LSB must be set to zero, while the 8 bits of the MSB will be ignored.

The SPDIF Transmit clock is generated by the SPDIF internal clock generator module and the clock sources are from outside of the SPDIF block. The clock sources should provide a clock that is at least $64 \times F_s$, where F_s is the sampling frequency. The external clock source should provide at least $128 \times F_s$. Clocks of higher frequency may be provided as long as the multiplication factor is a power of 2 (for example, $128x$, $256x$ or $512x$). Also, clock frequency precision of 100ppm or better should be provided.

9.2.6 Asynchronous Sample Rate Converter (ASRC)

The incoming audio data may be received from various sources at different sampling rates. The outgoing audio data may have different sampling rates, and it can also be associated to output clocks that are asynchronous to the input clocks.

ASRC converts the sampling rate of a signal associated to an input clock into a signal associated to a different output clock. ASRC supports concurrent sample rate conversion of up to 10 channels of about -120dB THD+N . The sampling rate conversion of each channel is associated to a pair of incoming and outgoing sampling rates. ASRC supports up to 3 sampling rate pairs.

In the real-time audio use case, both input/output sampling rate clocks are activated. Both sampling rate clocks are directly connected to ASRC, and the ratio estimation of the input clocks to output clocks is used to perform the sample rate conversion in ASRC hardware.

The SAI1, SAI2, SAI3, and SPDIF audio modules can act as either a clock master or a clock slave. Multiplexors are provided on a chip level to select which of the module's clock signal, input or output, will be connected to ASRC input in dependence of the module's operational mode as it is shown in [Figure 9-3](#) and [Table 9-1](#). [Figure 9-3](#) presents the multiplexor cell used for all ASRC input clocks. [Table 9-1](#) shows the detailed clocks, multiplexor control and data bits for each ASRC input clock. For the audio blocks clocks that are directly connected to ASRC (without the multiplexor scheme) see [Table 9-2](#).

In the non-real time streaming audio use case, the input sampling rate clock does not need to be provided. Instead the ideal-ratio value conversion is set in the ASRC interface registers. In this case only the output sampling rate clock must be provided, and the fixed ratio of the input to the output in the register is used to perform the sample rate conversion.

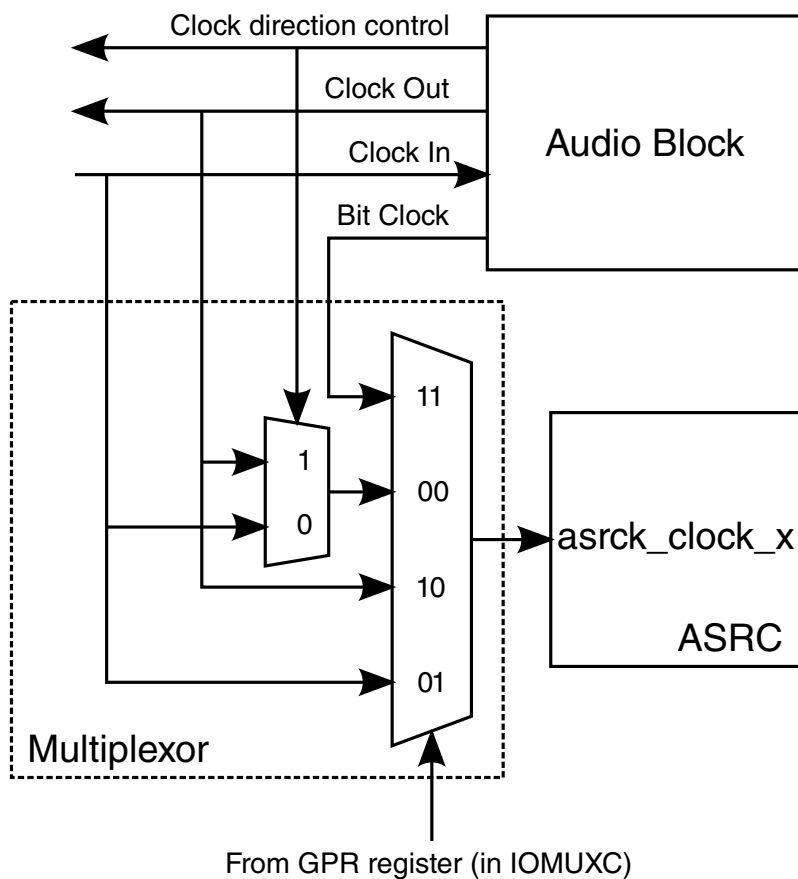

Figure 9-3. Muxing scheme template for ASRC input clocks

Table 9-1. ASRC Muxed Input Clocks

ASRC Clock Input	Audio block source	MUX2:1 Control	MUX2:1 Input 0	MUX2:1 Input 1	MUX4:1 Control	MUX4:1 Input 00	MUX4:1 Input 01	MUX4:1 Input 10	MUX4:1 Input 11
asrck_cloc k_1	SAI1-Rx	SRCR[RX DIR] ¹	External SRCK	InternalSR CK	GPR0[17:1 6] ²	MUX2:1 output	External SRCK	InternalSR CK	RX bit clock
asrck_cloc k_4	SAI1-Rx	SRCR[RX DIR]	External SRCK	InternalSR CK	GPR0[17:1 6]	MUX2:1 output	InternalSR CK	InternalSR CK	RX bit clock
asrck_cloc k_7	SAI2-Rx	SRCR[RX DIR]	External SRCK	InternalSR CK	GPR0[19:1 8]	MUX2:1 output	External SRCK	InternalSR CK	RX bit clock
asrck_cloc k_9	SAI1-Tx	STCR[TXD IR]	External STCK	InternalST CK	GPR0[19:1 8]	MUX2:1 output	External STCK	InternalST CK	TX bit clock
asrck_cloc k_c	SAI1-Tx	STCR[TXD IR]	External STCK	InternalST CK	GPR0[21:2 0]	MUX2:1 output	External STCK	InternalST CK	TX bit clock
asrck_cloc k_d	spdif_clk_r oot	STCR[TXD IR]	External STCK	InternalST CK	GPR0[21:2 0]	MUX2:1 output	External STCK	InternalST CK	SPDIF bit clock
asrck_cloc k_e	SAI2-Tx	STCR[TXD IR]	External STCK	InternalST CK	GPR0[23:2 2]	MUX2:1 output	External STCK	InternalST CK	TX bit clock

1. Register[bit] format, SRCR is the register name in the block specified in the "Audio block source" column, while RXDIR is name field/bit in the register.

Audio subsystem

2. GPR0 is the General Register 0 in the IOMUX controller. See IOMUXC chapter for more details.

Table 9-2. ASRC Direct Clocks

ASRC Clock Input	Block driving clock source	Block output clock
asrck_clock_4	SPDIF (Rx)	SPDIF Rx Clock
asrck_clock_c	SPDIF (Tx)	SPDIF Tx Clock
asrck_clock_6	External (from PAD)	Via IOMUX (from PAD) KEY_ROW3 (ALT1) [default] GPIO_0 (ALT3) GPIO_18 (ALT4)
asrck_clock_7	Reserved	Reserved ¹
asrck_clock_d	CCM	SPDIF1 clock root

1. Not in used, the clock value is "0".

Chapter 10

Clock and Power Management

10.1 Introduction

This chapter describes the Clock and Power Management architecture of the SoC.

The chip targets applications where low power consumption, long battery life, always-on and instant-on capabilities are paramount, and where there is no need for active cooling. To achieve these capabilities, the primary focus of the chip's design is reducing current consumption as much as possible, while simultaneously enabling the maximum level of peak performance and a balanced level of sustained performance for target applications. To achieve this, the chip architecture uses a wide range of power-management techniques and their combinations for maximum system design flexibility.

This chapter contains information about:

- Structural components of the power and clock management systems of the chip
- Power, clock and thermal management techniques supported by the chip

All given numerical values are typical or examples. For accurate values one should refer to the datasheet.

10.2 Device Power Management Architecture Components

To provide a clean and versatile architecture supporting a wide range of power-management techniques, clocks, and power rails are managed resources.

For each rail, two levels of management are defined: the first level is centralized or SoC-level resource management, and the second is a local or "module level" resource management.

The high level architectural view of the clock, power and thermal management system of the chip is presented in the figure below.

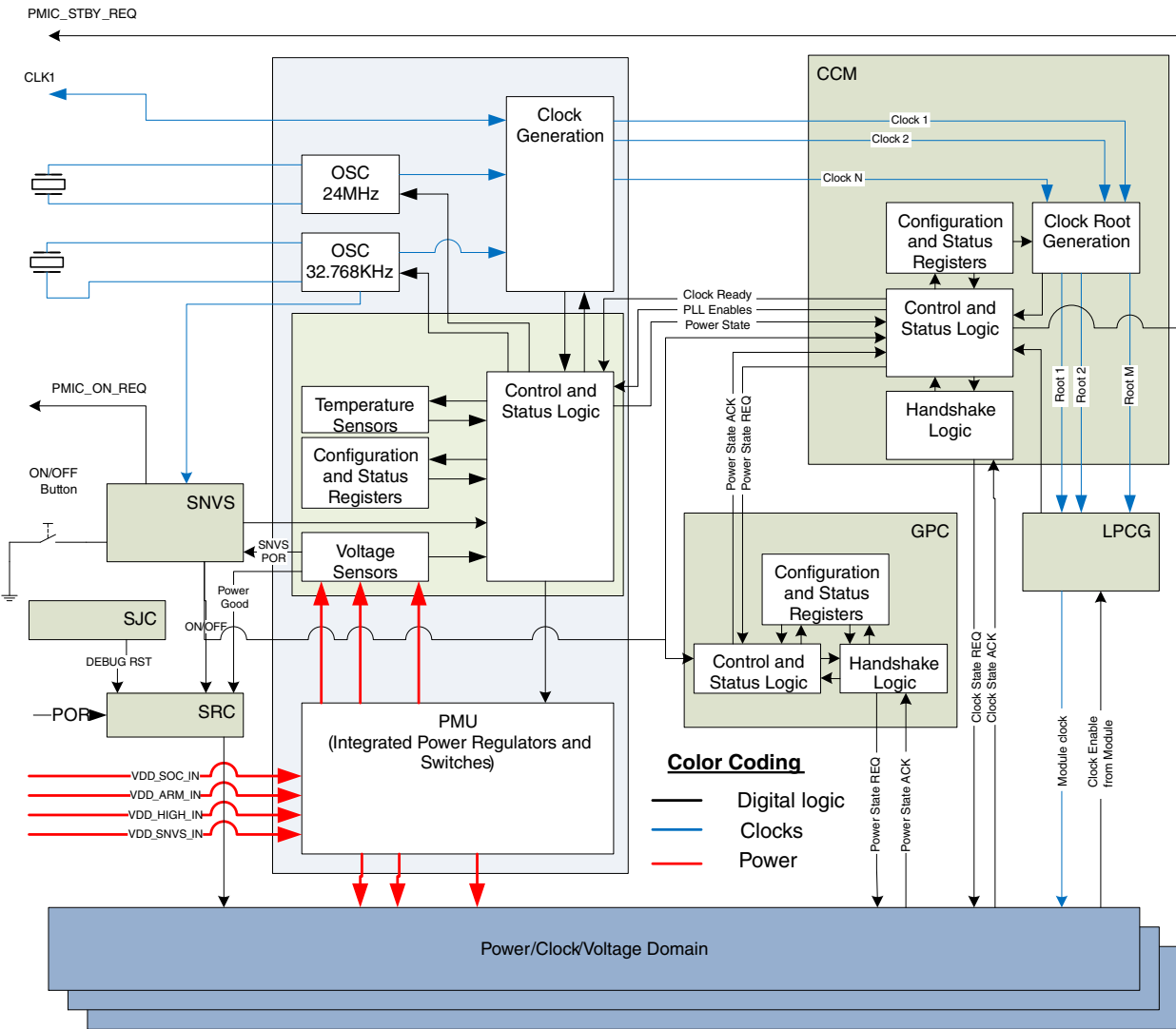

Figure 10-1. Power and clock management framework

10.2.1 Centralized components of clock generation and management

Centralized components of the clock generation and management sub-system are implemented in the following blocks:

- **CCM (Clock Control Module):** The CCM module provides control for primary (source level) and secondary (root level) clock generation, division, distribution, synchronization, and coarse-level gating. See [Clock Controller Module \(CCM\)](#) for

information on the CCM architecture, functional description and programming model.

- **LPCG (Low Power Clock Gating):** This module distributes the clocks to all blocks in the SoC and handles block level software-controllable and automated clock gating. See [Clock Controller Module \(CCM\)](#) for information on the LPCG architecture and functional description.

10.2.2 Centralized components of power generation, distribution and management

Centralized components of the power generation, distribution and management subsystem are implemented in the following blocks:

- **Power Management Unit (PMU).** See [Power Management Unit \(PMU\)](#) for information on the PMU architecture, functional description and programming model.
- **General Power Controller (GPC).** See [General Power Controller \(GPC\)](#) for information on the GPC architecture, functional description and programming model.

10.2.3 Reset generation and distribution system

Power and clock management are accompanied with an appropriate reset generation and distribution system, centralized functions of which are implemented by the [System Reset Controller \(SRC\)](#). See [General Power Controller \(GPC\)](#) for information on the GPC architecture, functional description and programming model.

10.2.4 Power and clock management framework

Together, the modules listed above provide enhanced power-management features with centralized control for the clock, reset, and power-management signals on the SoC.

The centralized management framework defines the managed components of the power-management architecture. These components are called the clock, power, and voltage domains.

NOTE

A domain is a group of modules or functional blocks that share a common resource entity (for example, common clock root, common power source, or a common power switch). The software component managing shared resources should take

into account the joint constraints of all the modules belonging to that resource domain.

10.3 Clock Management

10.3.1 Centralized components of clock management system

The clock generation and management system is built around the CCM and LPCG blocks.

A high level block diagram of the clock management system in the SoC environment is shown in the following figure.

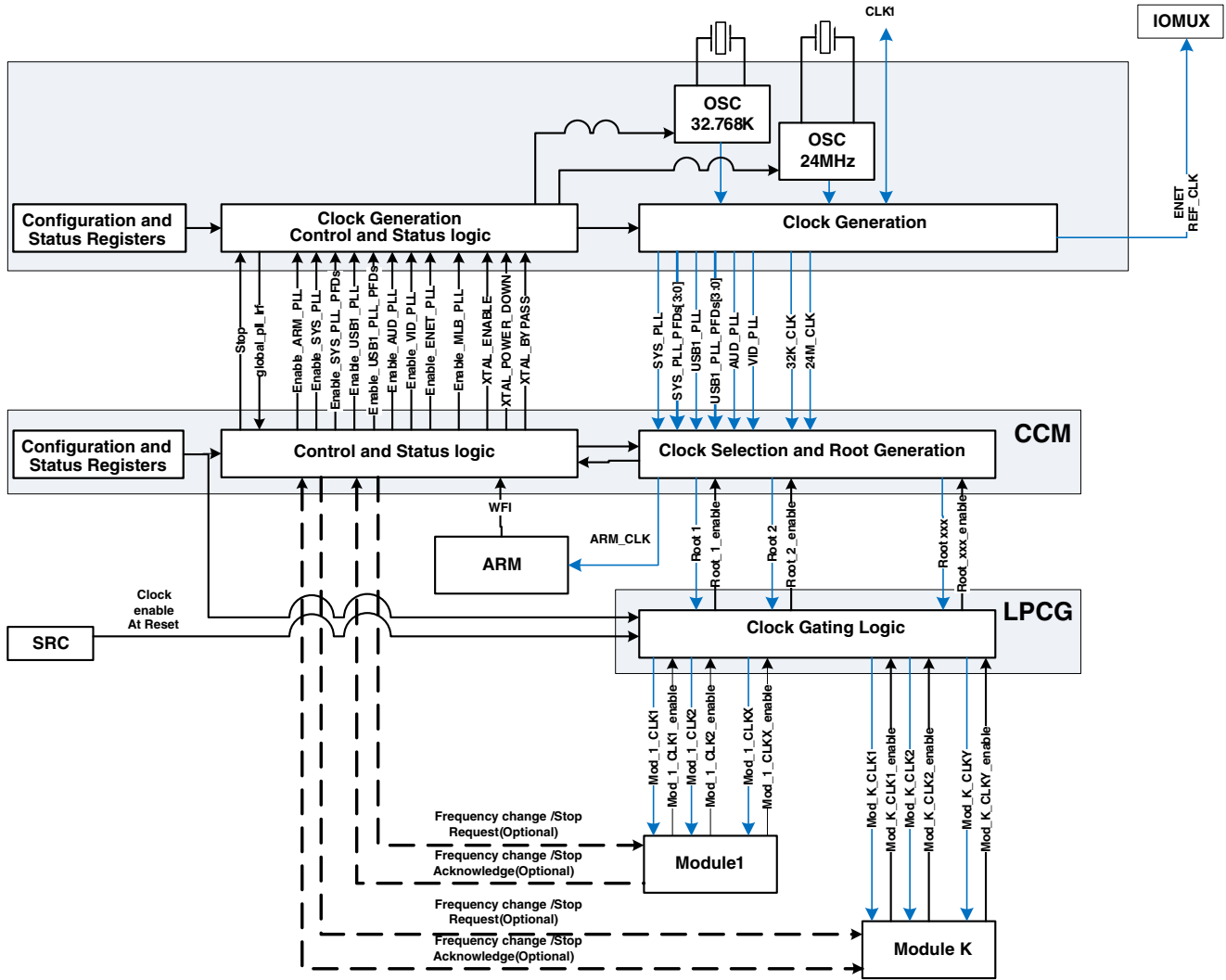

Figure 10-2. Clock Management System

A high level block diagram of the clock generation is shown in the figure below.

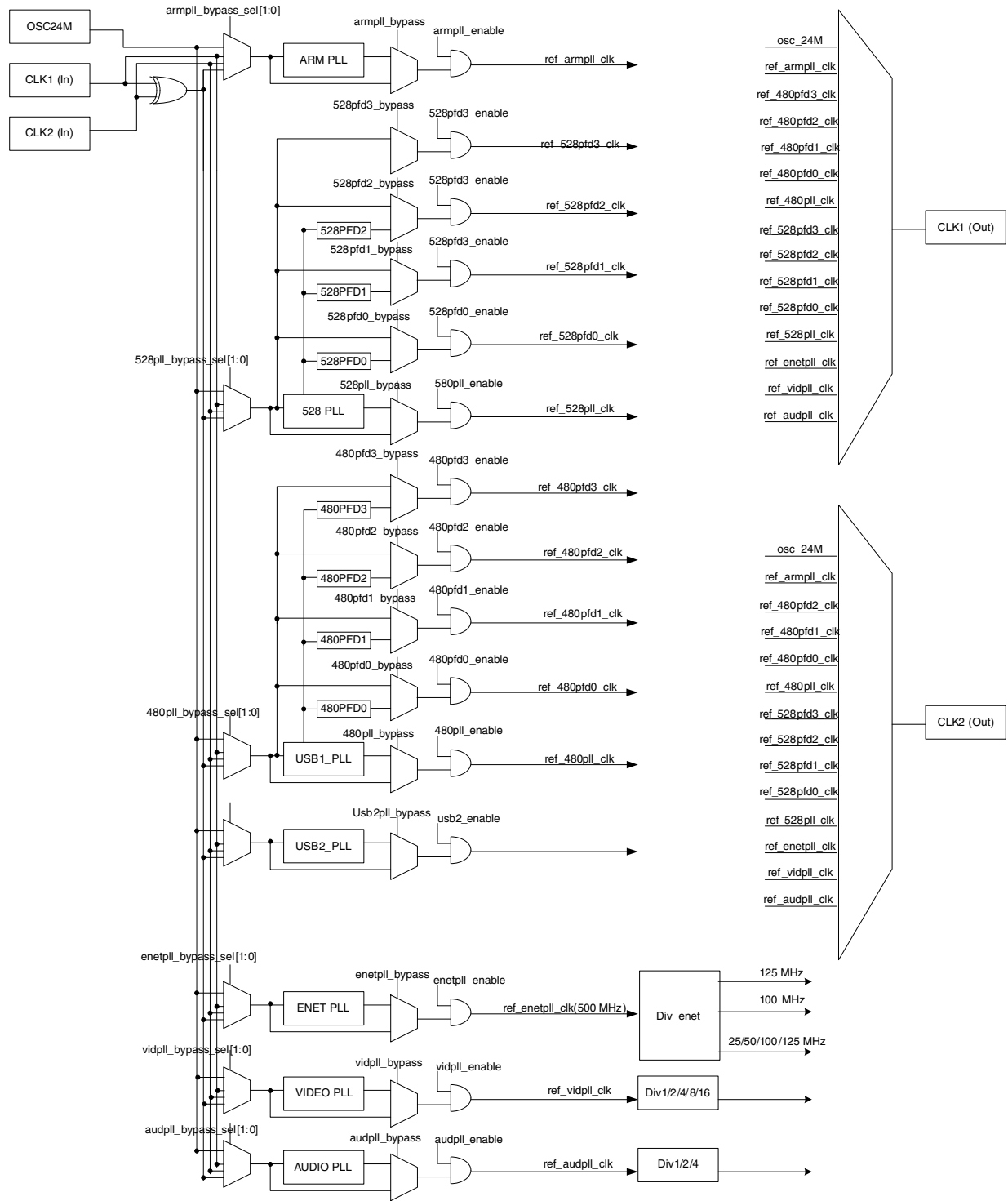

Figure 10-3. Primary Clock Generation

10.3.2 Clock generation

The clock generation section includes the components detailed in the following sections.

10.3.2.1 Crystal Oscillator (XTALOSC)

The Crystal Oscillator block is comprised of both the high frequency oscillator (typical frequency is 24 MHz) and the low frequency real time clock oscillator (typical frequency of 32.768 KHz). Each of these oscillators is implemented as a biased amplifier that, when combined with a suitable external quartz crystal and external load capacitors, implements an oscillator. See [Crystal Oscillator \(XTALOSC\)](#) for details of the XTALOSC block.

10.3.2.2 Low Voltage Differential Signaling (LVDS) I/O ports

There is one LVDS I/O port used for clock generation. The low jitter differential I/O port is provided to input and output clocks. It can take input clocks from outside of the SoC and provide them to the PLLs or to the other modules, or it can take the outputs of the PLLs and provide them outside of the SoC as a functional or reference clock.

10.3.2.3 PLLs

Seven PLLs are included in the clock generation section. Two of these PLLs are each equipped with four Phase Fractional Dividers (PFDs) in order to generate additional frequencies.

NOTE

Each PFD works independently by interpolating the VCO of the PLL to which it is connected. It effectively takes the PLL VCO frequency and produces $18/N \times F_{vco}$ at its output where N ranges from 12 to 35. PFD is a completely digital design with no analog components or feedback loops. The frequency switch time is much faster than a PLL because keeping the base PLL locked and changing the integer N only changes the logical combination of the interpolated outputs of the VCO. Note that the PFD not only enables faster frequency changes than a PLL, but also allows the configuration to be safely changed "on-the-fly" without going through the output clock disabling/enabling process.

The seven PLLs are listed below:

- PLL1 (also referred to as ARM_PLL) - This is the PLL clocking the ARM core complex. It is a programmable integer frequency multiplier capable of output

frequency of up to 1.3 GHz. Note that this frequency is higher than the maximum chip supported frequency 1.0 GHz.

- PLL2 (also referred to as System_PLL or 528_PLL) - PLL2 runs at a fixed multiplier of 22, producing 528 MHz output frequency with 24 MHz reference from XTALOSC. Besides the main output, this PLL drives four PFDs (PLL2_PFD0...PLL2_PFD3). The main PLL output and its PFD outputs are used as inputs for many clock roots. These do not require exact/constant frequency and can be changed as a part of dynamic frequency scaling procedure. Typically, this PLL or its PFDs are a clock source for internal system buses, internal processing logic, DDR interface, NAND/NOR interface modules, etc.
- PLL3 (also referred to as USB1_PLL) - PLL3 is used in conjunction with the first instance of USB PHY (USBPHY1, also known as OTG PHY). This PLL drives four PFDs (PLL3_PFD0...PLL3_PFD3) and runs at a fixed multiplier of 20. This results in a VCO frequency of 480 MHz with a 24 MHz oscillator. The main PLL output and its PFD outputs are used as inputs for many clock roots that require constant frequency, such as UART and other serial interfaces, audio interfaces, etc.
- PLL4 (also referred to as an Audio PLL) - This is a fractional multiplier PLL used for generating a low jitter and high precision audio clock with standardized audio frequencies. The PLLs oscillator frequency range is from 650 MHz to 1300 MHz, and the frequency resolution is better than 1 Hz. This clock is mainly used as a clock for serial audio interfaces and as a reference clock for external audio codecs. It is equipped with a divider on its output and can generate divided by 1, 2 or 4 from the PLL VCO frequency.
- PLL5 (also referred to as a Video PLL) - This is a fractional multiplier PLL used for generating a low jitter and high precision video clock with standardized video frequencies. The PLLs oscillator frequency range is from 650 MHz to 1300 MHz, and the frequency resolution is better than 1 Hz. This clock is mainly used as a clock for display and video interfaces. It is equipped with dividers on its output and can generate clock divided by 1, 2, 4, 8 or 16 from the PLL VCO frequency
- PLL6 (also referred to as ENET_PLL) - This PLL implements a fixed $20 + (5/6)$ multiplier. With a 24 MHz input, it has a VCO frequency of 500 MHz. This PLL is used to generate:
 - 50 or 25 MHz for the external ethernet interface.
 - 125 MHz for reduced gigabit ethernet interface.
 - 100 MHz for general purposes.
- PLL7 (also referred to as USB2_PLL) - This PLL provides clock exclusively to USB2 PHY (USBPHY2, also known as OTG PHY). It runs at a fixed multiplier of 20, resulting in a VCO frequency of 480 MHz with a 24 MHz oscillator.

10.3.2.3.1 General PLL Control and Status Functions

Each PLLs configuration and control functions are accessible individually through its PFDs and global configuration and status registers.

Reference input clock for any of the PLLs could be selected individually by the `BYPASS_CLK_SRC` field of the PLL control register. See [CCM Analog Memory Map/ Register Definition](#) for more information.

Each of the PLLs could be individually configured to "Bypass", "Output disabled" and "Power Down" modes.

When configured in "Bypass" PLL pass directly its input reference clocks to the PLL output. Bypassing the PLL is done by setting the `BYPASS` bit in the control register. For the PLL equipped with PFDs the input reference clock is also bypassed to all PFDs outputs.

When configured in output disabled mode (`ENABLE=0`), the PLL's output is completely gated and there is neither a bypass clock nor PLL generated clock that propagates to PLL output. Each PLL output has an individual "Output Enable" control bit. The PFDs are gated by the `ENABLE` bit of their associated PLL. Each PFD does have an associated clock gate bit that can be used to turn it off individually.

When configured in "Power Down mode" most of the PLL circuitry is switched off. Neither main PLL output nor PFD outputs are available in this mode.

When the related PLL is powered up from the power down state or made to go through a relock cycle due to PLL reprogramming, it is required that the related `PFDx_CLKGATE` bit in `CCM_ANALOG_PFD_480n` or `CCM_ANALOG_PFD_528n`, be cycled on and off (1 to 0) after PLL lock. The PFDs can be in the clock gated state during PLL relock but must be un-clock gated only after lock is achieved. See the engineering bulletin, Configuration of Phase Fractional Dividers (EB790) at www.nxp.com for procedure details.

Individual PLL status is reflected in "PLL Lock" bits of the PLL control registers. PLL enable logic which monitors the register value change is implemented to gate off the PLL outputs during the "lock in" period.

Outputs are generated to be sent out by monitoring the individual PLL lock flags and filtering out any random initial edges.

Individual PLL Lock ready flags are first "ORED" with "enables" and then "ANDED" together to generate the global PLL lock ready flag that reflects status of all PLLs enabled in certain moment.

[CCM Memory Map/Register Definition](#) and [CCM Analog Memory Map/Register Definition](#) contains detailed descriptions of the memory mapped registers and control functions of the clock generation sub-module.

10.3.2.4 CCM

CCM includes:

- Clock root generation logic - This sub-block provides the registers that control most of the secondary clock source programming, including both the primary clock source selection and the clock dividers. The clock roots are each individual clocks to the core, system buses (AXI, AHB, IPG) and all other SoC peripherals, among those are serial clocks, baud clocks, and special functional clocks. Most of clock roots are specific per module.
- CCM, in coordination with GPC, PMU and SRC, manages the [Power modes](#), namely RUN, WAIT and STOP modes. The gating of the peripheral clocks is programmable in RUN and WAIT modes.

CCM manages the frequency scaling procedure for:

- ARM core clock - "on the fly" without clock interruption, by either shifting between PLL sources [PLL clock change](#) or by changing the divider ratio.
- changing of the DDR memory controller clock. See [MMDC handshake](#) and [Self refresh and Frequency change entry/exit](#) for more details.
- Peripheral root clock - by using programmable divider. The division factor can change on the fly without loss of clocks.

NOTE

On-the-fly frequency changing for synchronous interfaces like serial audio interfaces, video and display interfaces, or general purpose serial interfaces (e.g. UART, CAN) may cause synchronization loss and should not be done.

10.3.2.5 Low Power Clock Gating unit (LPCG)

The LPCG block receives the root clocks from CCM and splits them to clock branches for each block. The clock branches are individually gated clocks.

The enables for those gates can come from three sources:

- Clock enable signal from CCM - This signal is generated depending on the power mode the system is in. For each power mode, it is defined in the software using the configuration of the CGR bits in CCM.
- Clock enable signal from the block - This signal is generated by the block based on its internal logic. Not every enable signal from the block is used. Each clock enable signal from the block can be overridden based on the programmable bit in CCM.
- Clock enable signal from the reset controller (SRC) - This signal will enable the clock during the reset procedure.

10.3.3 Peripheral components of clock management system

10.3.3.1 Interface and functional clock

Each block within the SoC has specific clock input characteristic requirements. Based on the characteristics of the clocks delivered to modules, the clocks are divided into two categories: bus interface clocks and functional clocks.

The bus interface clocks have the following characteristics:

- They ensure proper communication between any block/subsystem and the system buses.
- In most cases, they supply the system interface and configuration registers of the block.
- A typical block has one system bus clock, but blocks with multiple interface clocks may also exist (that is, when a block is connected to multiple buses).
- The bus interface clocks are always fed by the outputs of the CCM/LPCG.
- Clock management for this type of clock is always implemented at the system level because it requires coordinated clock management between the block and system buses.

Functional clocks have the following characteristics:

- They supply the functional part of a block or a subsystem.
- Typically, these clocks are completely asynchronous and independent from the bus interface clock of the same block.
- A block can have one or more functional clocks. Some functional clocks are mandatory, while others are optional for its functioning. A block needs its mandatory

clock(s) to be operational. The optional clocks are used for specific features and can be shut down without stopping the block activity.

- The functional clocks are fed either by a CCM/LPCG block functional clock output, or by some other clock source, such as a clock output of another block or an external signal coming from IOMUX.

10.3.3.2 Block level clock management

Each block in the system may also have specific clock requirements. Certain module clocks must be active when operating in some specific modes, or may be gated in some others. Generally, the activation and gating of the module clocks are managed by LPCG. Hence, the LPCG block must be programmed properly and, in case of hardware controllable clock gating, peripheral module should provide signals indicating when to activate and when to gate the module clocks.

The LPCG block differentiates the clock-management behavior for device modules based on whether the block can initiate transactions on the device interconnect (called master module), or if it cannot initiate transactions and only responds to the transactions initiated by the master (called slave module). Thus, two hardware-based clock-management protocols are used:

- Master protocol - Clock-management protocol between the CCM/LPCG and blocks that can be bus master
- Slave protocol - Clock-management protocol between the CCM/LPCG and slave modules

10.3.3.2.1 Master clock protocol

This protocol is used to indicate that a master module is ready to initiate a transaction on the device interconnect and requests specific (both functional and interface) clocks. The CCM/LPCG block ensures that the required clocks are active when the master module requests that the CCM/LPCG enable them. The module is said to be functional after the required clocks are activated.

Similarly, when the master module no longer requires the clocks, it informs the LPCG/CCM block and the LPCG/CCM can then gate the clocks to the module and all the clock precedents that are not used by other blocks. The master module is then said to be in clock-gated or partially clock gated mode.

Examples of module supporting master clock protocol USDHC. Please see details in chapters describing these modules and in the CCM enable override register (CCM_CMEOR).

10.3.3.2 Slave clock protocol

This hardware protocol allows CCM to control the state of a slave module. CCM informs the slave module, through assertion of a stop/change request, when its clocks (both interface and functional) can be changed or gated. The slave acknowledges the request and CCM is then allowed to gate or change the clocks to the block.

Similarly, a clock-gated slave module may need to be woken up because of some event or a service request from a master module. In this situation, CCM enables the clocks to the module and then de-asserts the stop request to signal the module to wake up.

Examples of modules supporting slave clock protocol are CAN, EPIT and GPT. Please see details in chapters describing these modules and in the CCM Module Enable Override Register (CCM_CMEOR). See [CCM Memory Map/Register Definition](#) for more details.

The protocol in both "master" and "slave" cases is completely hardware-controlled, but software should configure the clock management behavior for the module in two places: in the CCM registers associated with the block and in the block configuration registers.

10.3.3.3 Clock Domain(s)

A clock domain is a group of blocks fed by clock signals controlled by the same clock controls in CCM. By gating the clocks in a clock domain, the clocks to all the blocks belonging to that clock domain can be gated/activated, either by software control or by hardware control associated with block activity. Thus, a clock domain allows efficient control of the dynamic power consumption of the domain.

The device is partitioned into multiple clock domains and each clock domain is controlled by an associated group of clock gating cells within the LPCG block. This allows the CCM/LPCG to individually activate and gate each clock domain of the system.

10.3.3.4 Domain level clock management

The domain clock manager can automatically (based on hardware conditions) and manage the bus interface clocks within the clock domain. The functional clocks within the clock domain are managed through software settings.

10.3.3.5 Domain dependencies

A domain dependency is a hierarchical relationship between two clock domains. Clock domain "X" is said to depend on a clock domain "Y" when a block in clock domain "Y" provides services (or even just a clock) to a block in clock domain "X". As a result, clock domain "Y" must be active whenever clock domain "X" is active.

The dependency between two clock domains may also exist if one clock domain serves to ensure communication between two blocks (for example, the clock domain of the device interconnect).

10.4 Power management

10.4.1 Centralized Components of Power Management System

The power generation and management system is built around the PMU and GPC blocks. A high level block diagram of the power management system in the SoC environment is shown in the figure below.

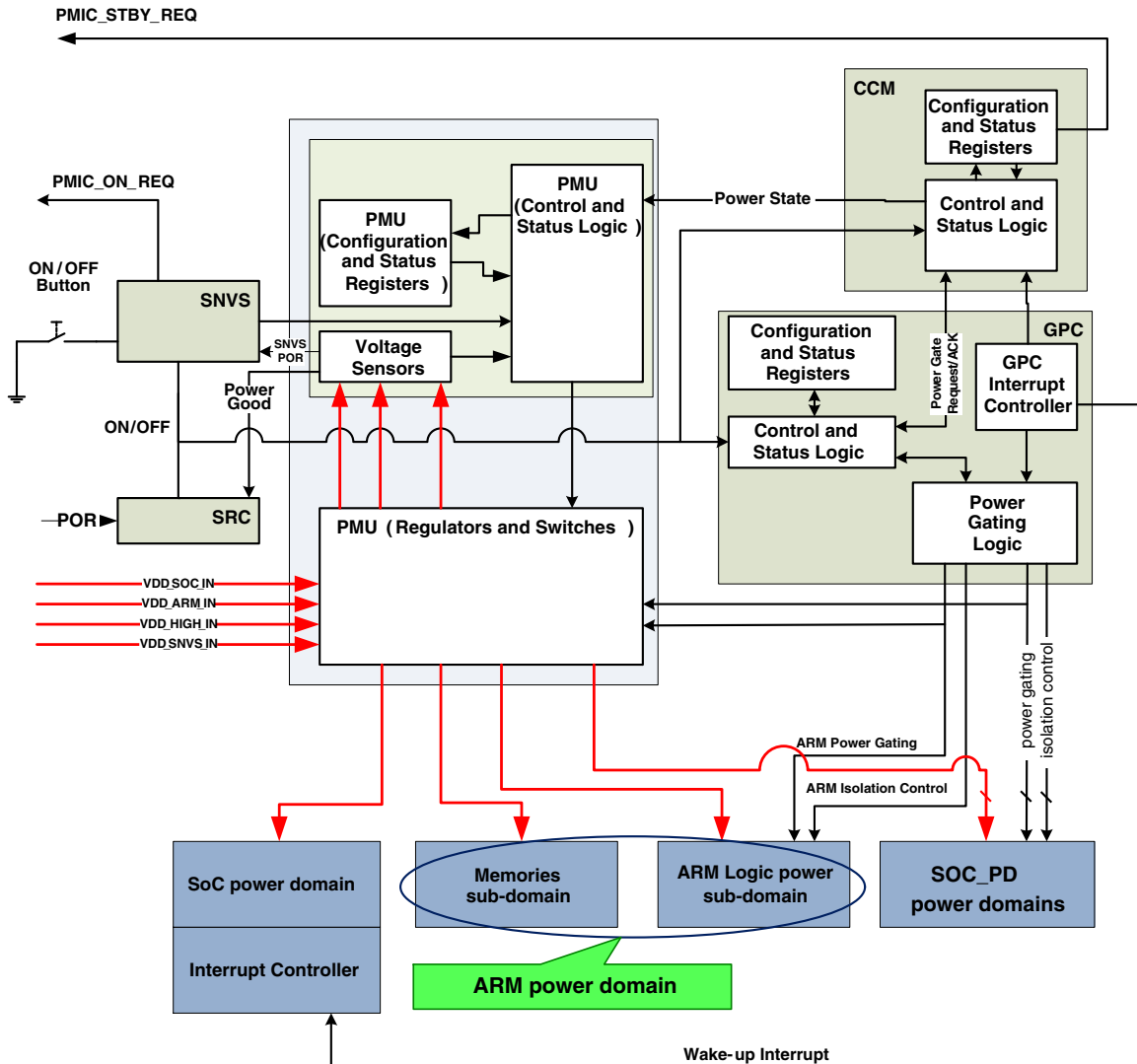

Figure 10-4. Power Management System

10.4.1.1 Integrated PMU

The first component of the power management system, referred to as the integrated PMU, is designed to simplify the external power interface.

Power management

It consists of a set of secondary power supplies that enable SoC operations from just two or three primary supplies. The high level block diagram of the power tree, utilizing the integrated PMU, is shown below.

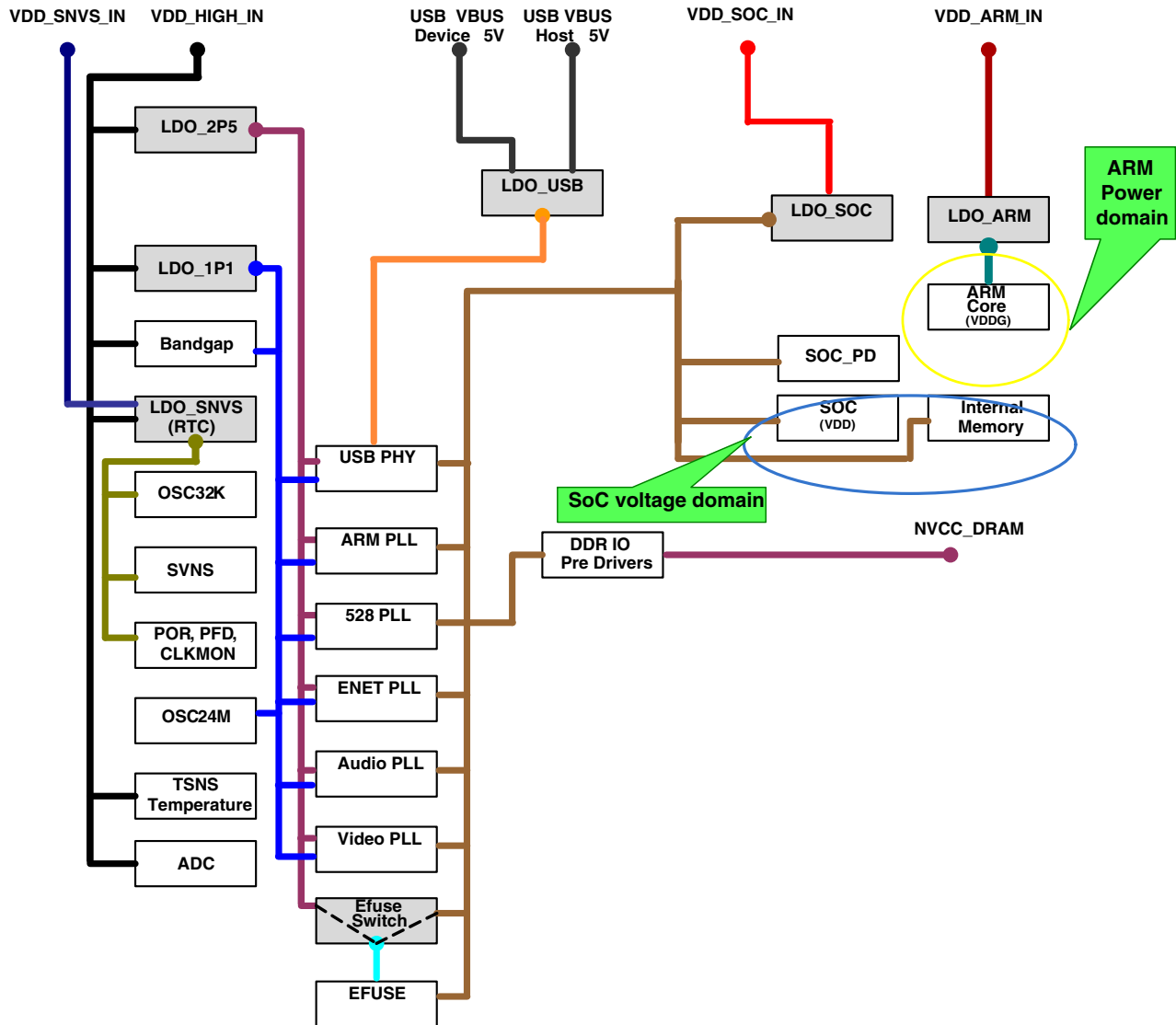

Figure 10-5. i.MX 6ULL Power Tree

The integrated PMU includes the following components:

- Two Digital LDO regulators
- Two Analog LDO regulators
- USB LDO
- SNVS regulator

See [Power Management Unit \(PMU\)](#) for further details on integrated PMU functional description and programmability.

10.4.1.1.1 Digital LDO Regulators

The integrated PMU includes three digital LDO regulators: LDO_ARM(VDD_ARM_IN, VDD_ARM_CAP), and LDO_SOC(VDD_SOC_IN, VDD_SOC_CAP). LDO_ARM and LDO_SOC regulators provide power to the ARM core power domain. LDO_SOC provides power to the SOC_PD and SOC power domains(except always-ON SNVS domain).

NOTE

The name "digital" only refers to the type of load. It is not related to the LDO design or feature set.

The digital LDO regulators can operate in the following modes:

- **Internal Bypass** - The regulation pass device (FET) is switched fully on, passing the external input voltage to the load unaltered. The analog part of the regulator is powered down in this state, removing any loss other than the IR drop through the power grid and the FET. Be aware that a period of time (see datasheet) is required to switch from the internal digital bypass mode to the analog regulation mode. Typically it takes less than 100us. Please refer to [PMU](#) for further details on bypass and power gate configuration.
- **Power Gate** - The regulation FET is switched fully off, limiting the current draw from the supply. The analog part of the regulator is powered down, limiting the power consumption. The output voltage will fall to a level where the residual leakage of the power FET balances with the leakage of the load.
- **Analog regulation mode** - The regulation FET is controlled such that the output voltage of the regulator equals the programmed target voltage. The target voltage is fully programmable in 25mV steps.

These modes allow the regulators to implement voltage scaling and power gating, and allow bypass when an external high power efficient regulator is used as a direct source for some of the SoC loads.

These digital regulators also feature brownout detection, which is helpful to sense when supplies are starting to collapse. Note that the core will be interrupted on a brownout. Please see details in [Miscellaneous Control Register \(PMU_MISC2n\)](#).

For further details of LDO programming and configuration please refer to [Digital Regulator Core Register \(PMU_REG_COREn\)](#).

The power management system is built under assumption that in typical applications the single (and simple) shared power supply will be used for ARM core domain and SoC domain. The combined load gains some efficiency, especially in low power modes and saves BoM significantly.

The DVFS in a typical cost/complexity optimized application is considered by mean of internal LDO. In "full speed" modes LDO bypass is considered in both domains. The dynamic voltage scaling to low load workpoints for ARM domain is implemented by programming associated LDO.

10.4.1.1.2 Analog LDO regulators

There are two analog LDO regulators used for general system purposes:

- LDO_1P1 - The LDO_1P1 (VDD_HIGH_IN, NVCC_PLL) linearly regulates down a higher supply voltage (2.8V-3.3V) to produce a nominal 1.1V output voltage. This regulator supplies digital portions of USB PHYs, PLLs, and the internal 24 MHz oscillator.
- LDO_2P5 - The LDO_2P5 (VDD_HIGH_IN, VDD_HIGH_CAP) linearly regulates down a higher supply voltage (2.8V-3.3V) to produce a nominal 2.5V output voltage. The regular 2.5V LDO is combined with an alternate self-biased low-precision weak regulator which can be enabled for applications that need to keep the 2.5V output voltage alive during low power modes, where the main regulator and its associated global bandgap reference module are disabled to save power. The output of this weak-regulator is not programmable and is a function of its input power supply as well as its load current. Typically with a 3V input power supply, the weak-regulator output is 2.525V and its output impedance is approximately 40Ohm. Special procedure is recommended to move load back and forth between the main and low power regulators. This regulator supplies most of the analog circuitry of the integrated PHYs, special I/Os (DDR I/O), and other analog and mix signal components integrated into the SoC.

10.4.1.1.3 USB LDO

The USB_LDO linearly regulates down the USB VBUS input voltages (typically 5V) to produce a nominal 3.0V output voltage. This regulator has a built in power-mux that allows the user to run the regulator from either one of the VBUS supplies when both are present. If only one of the VBUS voltages is present, the regulator automatically selects that supply. Current limit is also included to help the system keep the in-rush current within limits as required in USB 2.0 specification. This regulator supplies only low speed and full speed transceivers of USB PHYs.

10.4.1.1.4 SNVS regulator

The SNVS regulator takes the SNVS_IN supply and generates the SNVS_CAP supply, which in turn powers the real time clock and low power section of the SNVS blocks. If VDDHIGH_IN is present, then the SNVS_IN supply is internally shorted to the VDDHIGH_IN supply to allow coin cell recharging if necessary.

10.4.1.2 GPC - General Power Controller

The GPC block includes the sub-blocks listed here.

- Power Gating Controller (PGC) - This sub-block of GPC has the following functions:
 - Provides the user with the ability to switch off power to a target subsystem.
 - Generates power-up and power-down control sequences. This includes interaction with CCM/LPCG and SRC, and control for clock and reset generation for power domains affected by power gating.
 - Provides programmable registers that adjust the timing of the power control signals.
 - Controls the CPU power domain and SOC_PD power domain.
- Wake-up interrupt controller - This controller initiates the system wake-up from low power modes when only low frequency real time clock remains active, and thus the Generic Interrupt Controller (GIC) can not handle synchronous interrupt signals. Additional features are as follows:
 - Supports up to 128 interrupts
 - Provides an option to mask/unmask each interrupt
 - Detects interrupts and generates the wake up signal

See [General Power Controller \(GPC\)](#) for further details on GPC, its sub-blocks, and information on its functional description and programmability.

10.4.1.3 SRC - System reset Controller

The reset controller is responsible for the generation of all reset signals and boot configuration decoding.

It determines the source and the type of reset, such as POR, WARM, and COLD, and performs the necessary reset signal qualifications. SRC is capable of generating reset sequences in the following conditions:

- in interaction with external PMIC, based on external POR_B signal and "power ready" signals generated by the integrated PMU
- or in interaction with the integrated PMU only, based on its "power ready" signal.

Based on the type of reset, the reset logic generates the reset sequence for either the entire SoC or for the blocks that are power-gated.

See [System Reset Controller \(SRC\)](#) for further details on SRC functional description and programmability.

10.4.1.4 Power domain(s)

A power domain is a group of blocks or sub-blocks fed by power sources controlled by the same power controls in GPC.

Some power domains can be split into a logic sub-domain and a memory sub-domain. The memory sub-domain in such case may contain two entities:

- Memory array(s) - Powered by a dedicated voltage rail enabling memory retention while core is OFF.
- Memory interface logic - Powered by the same voltage source as the logic sub-domain of the power domain.

Signals crossing power domain boundaries or sub-domain boundaries are passed through proper isolation and/or level-shifting cells to ensure robust operations of the SoC when some of domains are power gated or working at a reduced voltage.

The following figure shows the power domain interface within the system.

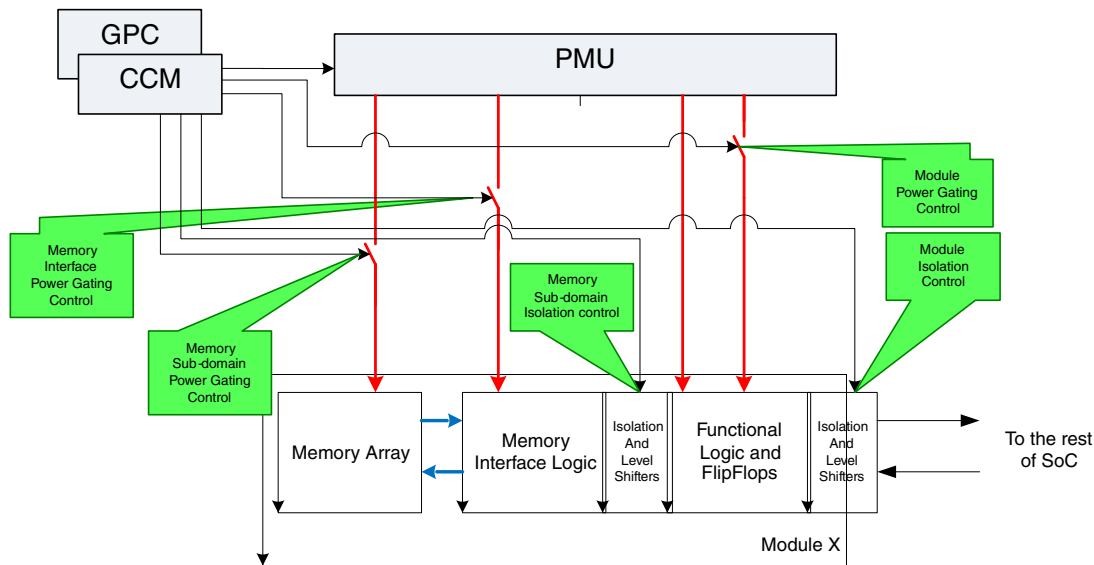

Figure 10-6. Power domain interface

10.4.1.4.1 Power distribution

The power distribution tree is comprised of multiple power domains. The main power domains are:

- ARM - The ARM domain contains the ARM Core platform (except for memory arrays and interface logic). This domain can be supplied either from an integrated power supply or from an external controllable regulator, preferably high efficiency DCDC converter.
- ARM Memory array - Memory arrays are connected to a separate and dedicated power domain (separated from the Main logic and ARM domain). In normal operation mode (functional mode), the memory arrays domain voltage level should be kept equal to (same as) the rest of the core logic domains (Main, ARM). Please refer to the Datasheet for further information about voltage level difference between domains allowed in different power modes.
- SOC_PD domain -- The SOC_PD domain contains MMDC, APBHDMA, CSI, ENET, LCDIF, PXP, RawNAND, SDMA, uSDHC and USB. It is supplied by external regulator.
- SNVS/RTC low power domain - The SRTC domain contains only counter, comparator and compared data of the on-chip RTC. This domain should be supplied from an external single cell LiION battery and/or an external pre-regulated power supply. SNVS also contains Low Power State Retention (LPSR) GPIO, IOMUX, and LPSR general purpose register.
- Analog domain - The analog domain contains the PLLs, LDOs and USB PHY. The domain supplies should be constant to allow continuous clock during any dynamic voltage scaling techniques. The digital supply should be provided from an internal regulator, and can be combined with the memory array supply. The analog supply should be provided from internal low noise regulator.
- Main SoC logic - The main SoC logic domain contains the rest of the logic of the SoC. It is supplied by an internal regulator.

From a DVFS and Power Gating standpoint, the following digital logic domains are affected:

- Cortex-A7 Core Platform - DVFS and power gating.
- ARM Cortex-A7 memories - Power gating only.
- SOC_PD - Power gating only.

See table below for details of the system power domains layout and dependencies.

10.4.1.4.2 Domain Memory and domain logic state retention in case of Power Gating

The following is the list of relevant memories and logic domains with the description of their state-retention support:

- Cortex-A7 Core Platform is sub-divided into three sub-domains listed below:
- Cortex-A7 Core Platform logic: The software state retention for all logic is implemented in this domain. That means that the content of relevant registers should be stored in some memory retaining its state (L2 cache for example) while the logic domain is power-gated. Details on how to implement the software retention can be found in the Cortex-A7 Core Platform TRM.
- Cortex-A7 Core L1 memories - No retention. The L1 memories have a dedicated supply on the package (VDD_CACHE_CAP) which should be connected to the Cortex-A7 Core Platform supply. The L1 cache should be flushed prior to power gating in order to allow powering up of the CPU at the same state as before power gating.
- Cortex-A7 Core L2 memories - hardware state-retention since its supplies are driven by the SoC supplies. When Cortex-A7 core is power gated, L2 Cache can be either leaved on with its content retained or power gated together with the core.
- SOC_PD: This module can be powered gated (together) independently of Cortex-A7 power gating. SOC_PD is not allowed power down when Cortex-A7 is on. SOC_PD will be powered on automatically together with Cortex-A7.
- SoC - hardware state-retention in Standby mode.
- SNVS_LP - hardware state-retention even when SoC supplies are removed.

10.4.1.4.3 Power Gating Domain Management

The following bullets provide the sequence required for power-gating the relevant power-domains:

10.4.1.4.3.1 ARM Core Platform

1. Copy through software all the Core configuration registers to a powered-on memory
2. Configure the GPC/PGC CPU registers in [PGC Memory Map/Register Definition](#) as follows to power-down the core on the next "WFI" instruction:
 - Configure the GPC/PGC PGC_CPU_PDNPCR Register ISO and ISO2SW bits. These bits determine the delay between the power-down request to enabling the platform isolation and the platform isolation to the actual power-off switch to the supplies accordingly.
 - Configure the GPC/PGC PGC_CPU_PUPPCR Register SW and SW2ISO bits. These bits determine the delay between the power-up request to the actual power-up of the supplies and the last to the platform isolation disabling.

- Configure the GPC PGC PGC_CPU_CTRL PCR bit to allow the power down of the platform
- ARM Core Platform should execute a "WFI" instruction.

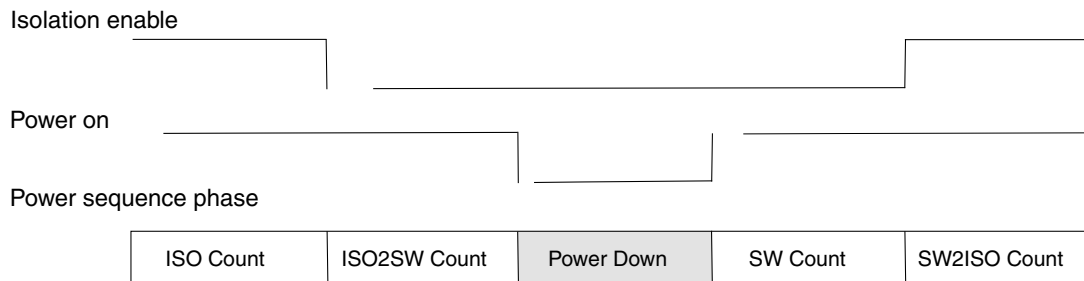

Figure 10-7. ARM Core Platform isolation and power on switch flow

10.4.1.4.3.2 SOC_PD

1. Configure the CCM CGR bits ([CCM Memory Map/Register Definition](#)) to disable the SOC_PD clocks .
2. Configure the GPC/PGC Registers ([GPC Memory Map/Register Definition](#)) as follows to power-down isolate the SOC_PD logic from the rest of the SoC logic:

Configure the GPC/PGC PDNSCR Register ISO bits. These bits determine the delay between the power-down request to enabling the LDO domain isolation.

Configure the GPC/PGC PUPSCR Register SW2ISO bits. These bits determine the power-up request to the LDO domain isolation disabling.

Configure the GPC/PGC CTRL[PCR] bit to allow the power down of the block.

Configure the GPC/PGC GPC_CNTR to power down SOC_PD

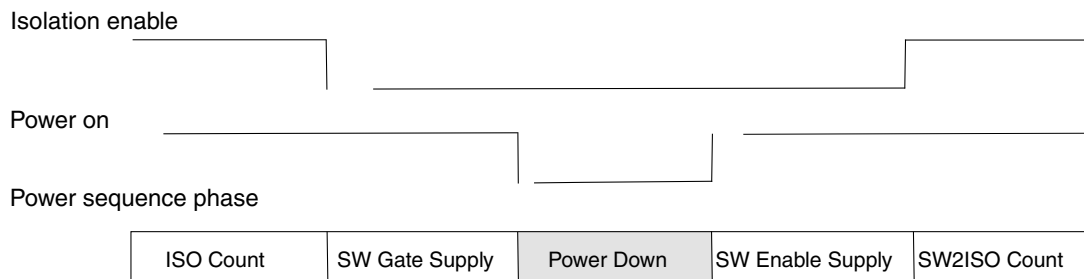

Figure 10-8. SOC_PD isolation and power on switch flow

10.4.1.4.3.3 SoC

For additional power reduction it is possible to do the following:

- Power-down the internal oscillator by configuring the following bits CCM_CCR[COSEC_EN] ([CCM Memory Map/Register Definition](#)). This can be done only in case there is no dependency on 24 MHz XTAL for wake-up.
- It is possible to turn off and turn on the PMIC supplies to the SoC even when the SoC supplies are off. Since SNVS_LP is powered through an "always on" supply, configuring the SNVS_LP DP_EN to "1" allows changing the PMIC_ON_REQ pad (SoC on/off supply indication to the PMIC) through the ONOFF pad.

10.4.1.4.4 Power Gating domain dependencies

There are 3 power domains that need to be isolated in different power-down cases:

- Cortex-A7 Core Platform and SOC_PD - Isolation needs to be enabled before power-down. This is taken care of automatically once CCM and PGC are configured and the Cortex-A7 Core Platform executes the "WFI" instruction.
- SNVS_LP - Different from the 2 cases above, the SNVS_LP isolation isolates the signals coming from the SoC to the SNVS_LP. This is required for saving the contents of the SNVS_LP (such as the real-time clock). The isolation is activated in 2 ways:
 - Automatically through the power-fail detector in the PMU
 - Through software configuration

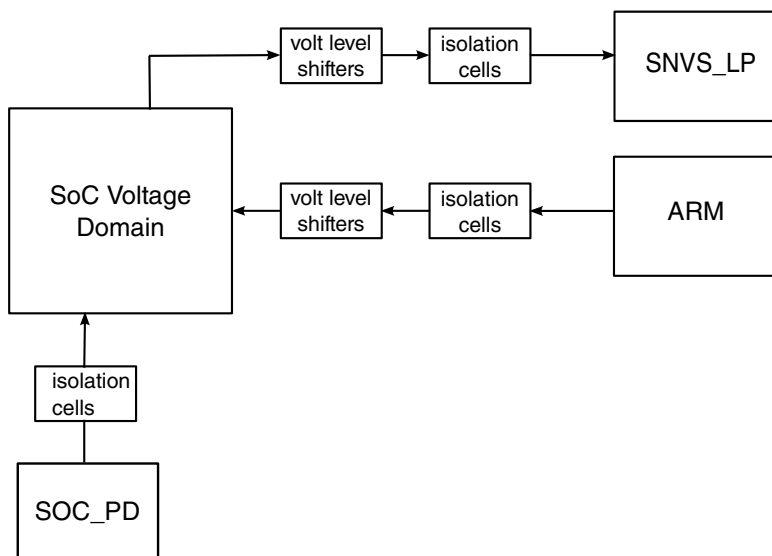

Note: The arrows refer to the signal directions for the voltage level shifters and isolation cells

Figure 10-9. Isolation cells and Voltage level shifters placing

10.4.1.5 Voltage domains

The list found here states the different voltage domains and their scalability in regarding to power-saving in dynamic and static scenarios.

- ARM - Cortex-A7 Core Platform including L1 and L2 cache - Scalable voltage in both dynamic and static scenarios
- SoC Domains - Scalable voltage only in static scenarios
- ANALOG components including PLLs - Fixed voltage
- I/O - Fixed voltage
- SNVS_LP - Fixed voltage

10.4.1.6 Voltage domain management

10.4.1.6.1 Dynamic

10.4.1.6.1.1 Voltage Scaling

A simplistic way to reduce power consumption in dynamic scenarios is to scale down the ARM, SoC and LDOs voltage according to the allowed voltage points and corresponding frequencies specified in datasheet.

10.4.1.6.2 Static

10.4.1.6.2.1 Standby Leakage reduction (SLR)

Standby leakage reduction is a power-management technique utilizing:

- Reduced supply voltage for relevant domains

With SLR, the device switches into low-power active system modes automatically or in response to user requests during system Stop, Wait, or DSM modes (that is, in situations when no application is started and no system activity is presented).

When applying SLR, the system remains in the lowest static power mode while retaining logic and memory states. This technique trades static power consumption for wake-up latency while maintaining fast system response time suitable for most applications.

See CCM Control Register (CCM_CCR), CCM Low Power Control Register (CCM_CLPCR) and PMU Miscellaneous Register 0 (PMU_MISC0) for further details on SLR programmability options.

The following describes the flow for applying standby voltage:

Power management

- Configure the external PMIC standby voltage, refer to chip datasheet.
- Configure CCM_CCR[RBC_EN] bits to bypass and disable PMU regulators in the next ARM "WFI" execution.
- Configure CCM_CCR[REG_BYP_COUNT] bits to allow proper voltage restoration by the external PMIC when exiting standby.
- ARM Core Platform executes the "WFI" instruction that completes the software sequence putting the SoC into low power mode

10.4.1.6.2 ANALOG PHYs IPs

Details on how to put the IPs in low power mode can be found in each of the IP documentation. Further reduction can be achieved by settings the ENABLE_WEAK_LINREG in the PMU PMU_REG_2P5 register.

10.4.1.7 System domains layout

The following table describes the different power modes.

Table 10-1. Low Power Mode Definition (LDO Enabled Mode)

	System IDLE	Low Power IDLE	SUSPEND
CCM LPM Mode	WAIT	WAIT	STOP
ARM Core	Low Voltage	Power Down	Power Down
L1 Cache	ON	Power Down	Power Down
L2 Cache	ON	ON	Power Down
SOC	Nominal Voltage	Nominal Voltage	Standby Voltage
SOC_PD	ON	ON	ON/Power Down
PLL	ON/Power Down	Power Down	Power Down
XTAL	ON	OFF	OFF
RC OSC	OFF	ON	OFF
DRAM	Self_Refresh ¹	Self-Refresh ²	Self-Refresh ²
DRAM IO Low Power	No	Yes	Yes
LDO ARM	ON	Power Gate	Power Gate
LDO SOC	ON	ON	Digital Bypass
LDO2P5	ON	OFF	OFF
LDO1P1	ON	OFF	OFF
WEAK2P5	OFF	ON	OFF
WEAK1P1	OFF	ON	OFF
Bandgap	ON	ON	OFF
Low Power Bandgap	OFF	OFF	OFF
MMDC Clock	24 MHz	OFF	OFF

Table continues on the next page...

Table 10-1. Low Power Mode Definition (LDO Enabled Mode) (continued)

	System IDLE	Low Power IDLE	SUSPEND
AHB clock	24 MHz	3 MHz	OFF
IPG clock	12 MHz	1.5 MHz	OFF
PER clock	24 MHz	1 MHz	OFF
Module clocks	ON as needed	ON as needed	OFF
GPIO wakeup	yes	Yes	Yes
RTC wakeup	Yes	Yes	Yes
USB remote wakeup	Yes	Yes ³	Yes ³
Other wakeup source	Yes	Yes ⁴	No

1. Automatic enter self-refresh when there is no DRAM access;
2. Put into self-refresh mode by SW before entering low power mode;
3. Need SOC_PD power on to support USB remote wakeup;
4. When a module is inside SOC_PD domain, need SOC_PD power on to support wakeup from it.

Table 10-2. Low Power Mode Definition (LDO Bypass Mode)

	System IDLE	Low Power IDLE	SUSPEND
CCM LPM Mode	WAIT	WAIT	STOP
ARM Core	Low Voltage	Power Down	Power Down
L1 Cache	Low Voltage	Power Down	Power Down
L2 Cache	ON	ON	Power Down
SOC	Nominal Voltage	Nominal Voltage	Standby Voltage
SOC_PD	ON	ON	ON/Power Down
PLL	ON/Power Down	Power Down	Power Down
XTAL	ON	OFF	OFF
RC OSC	OFF	ON	OFF
DRAM	Self_Refresh ¹	Self-Refresh ²	Self-Refresh ²
DRAM IO Low Power	No	Yes	Yes
LDO ARM	Digital Bypass	Power Gate	Power Gate
LDO SOC	Digital Bypass	Digital Bypass	Digital Bypass
LDO2P5	ON	OFF	OFF
LDO1P1	ON	OFF	OFF
WEAK2P5	OFF	ON	OFF
WEAK1P1	OFF	ON	OFF
Bandgap	ON	OFF	OFF
Low Power Bandgap	OFF	ON	OFF
MMDC Clock	24 MHz	OFF	OFF
AHB clock	24 MHz	3 MHz	OFF
IPG clock	12 MHz	1.5 MHz	OFF
PER clock	24 MHz	1 MHz	OFF
Module clocks	ON as needed	ON as needed	OFF
GPIO wakeup	Yes	Yes	Yes

Table continues on the next page...

Table 10-2. Low Power Mode Definition (LDO Bypass Mode) (continued)

	System IDLE	Low Power IDLE	SUSPEND
RTC wakeup	Yes	Yes	Yes
USB remote wakeup	Yes	Yes ³	Yes ³
Other wakeup source	Yes	Yes ⁴	No

1. Automatic enter self-refresh when there is no DRAM access;
2. Put into self-refresh mode by SW before entering low power mode;
3. Need SOC_PD power on to support USB remote wakeup;
4. When a module is inside SOC_PD domain, need SOC_PD power on to support wakeup from it.

There is a single hardware signal coming into PMU which sets the PMU in either of two "STOP" states. The STOP state is implemented is controlled by the PMU_MISC0[STOP_MODE_CONFIG] bit (See [PMU Memory Map/Register Definition](#)). It is recommended that the blocks be configured for safe powerdown/up through the registers before asserting the stop_mode signal. Blocks not described in the section below are unaffected by stop_mode.

If the stop_mode_config is set to zero, thus in the STOP mode all blocks powered down in minimum power configuration.

If the stop_mode_config is set to one, thus in the STOP mode some of the blocks remain powered and in different states as defined in the table below.

Table 10-3. STOP mode configuration

Block	STOP_MODE_CONFIG=0	STOP_MODE_CONFIG=1
reg1p1	off	on
reg2p5	off	on
reg3p0	off/on depending on vbus. Uses crude local reference if vbus is present	off/on depending on vbus . Uses analog central bandgap if VBUS is present.
reg_core	bypassed if not power gated.	bypassed if not power gated
reg_soc	bypassed	bypassed
bandgap	off	functional
temp_sensor	off	off
well_bias	hardware controlled	hardware controlled
All PLLs	off	off
OSC24M	off	Controlled by CCM configuration

10.4.2 Power management techniques

The device supports the power-management techniques with the features found here.

- Partitioning of the device into voltage, power, clock, and reset domains

- Domain isolation that allows flexible configurations of domains on/off states to form use cases targeting various applications
- Clock tree with selective clock-gating conditions and almost independent clock roots
- Power, reset, and clock control hardware mechanism to manage sleep and wake-up dependencies of power domains
- Software-controllable and hardware-controllable clock gating for functional modules and buses
- Memory retention and state retention capability (Software State Retention for ARM core) for preserving memory contents and device state in low-power modes
- Support for low-power device modes input/output (I/O) pad configuration for minimum power
- Variety of operating modes to optimize device performance and wake-up times
- Thermal monitoring and thermal aware performance management

Many of the low power features are fully or partially software controllable and can be configured for the specific requirements of a target system.

Combining these techniques, the system designer may meet tight requirements of low-power standby and operational modes while maintaining high performance for time-critical tasks.

10.4.2.1 Power saving techniques

The table below lists power saving techniques supported by the SoC in their connection to different components of power consumption.

Table 10-4. Power saving design/architecture and power saving techniques

Techniques	Active SoC Power	Standby SoC Power	System Power
Temperature Monitoring, and active frequency throttling	√		
ARM Core Platform SRPG (Software)		√	
ARM Core Platform Power Gating		√	
Clock gating (automatic dynamic and forced)	√		
Integrated PMU (IR drop, efficiency, accuracy)	√		√
C4 package (IR drop, thermal)	√		
Display Backlight optimization (SW)			√
Architecture: L2 cache	√		
Architecture: USB integration			√
Low Power DDR: LPDDR2, LV-DDR3			√

10.4.2.2 Thermal-aware power management

The temperature sensor block (TEMPMON) implements a temperature sensor/conversion function. The block features an alarm function that can raise an interrupt signal if the temperature is above a specified threshold.

Software may implement temperature aware DVFS for the ARM domain as well as temperature aware frequency scaling for other system components to ensure that both the frequency and voltage is lowered when the die temperature is above the specified limit.

Software may also implement temperature aware task scheduling to ensure that non-critical tasks are suspended when the die temperature is above the specified limit.

See [Temperature Monitor \(TEMPMON\)](#) for further details on temperature monitor functions and programmability options.

10.4.2.3 Peripheral Power management

10.4.2.3.1 Main memory power management

Main system memory, DDR3, and LPDDR2 are some of the most power-hungry system components, but the SoC provides several options to manage DDR power.

Automated power saving modes are supported by the MMDC hardware. This feature allows the DDR memory to automatically enter self-refresh mode when there are no DDR accesses for a configurable time. The default setting is 1024 clock cycles which can be optimized based on the customer use case and application.

See [Power Saving and Clock Frequency Change modes](#) for further details on MMDC power saving features and programmability options.

Software may support DDR frequency scaling. Automated frequency changing procedure is supported by MMDC and CCM modules.

NOTE

DDR frequency changes cost extra time and power. Slowing requestors while keeping DDR at full speed may increase total system power. Software may also implement Cooperative Dynamic Frequency Scaling in order to keep the system balanced, (that is, keep the system in balance when DDR throughput is equal or slightly higher than total amount of requests generated by all requestors).

Reducing the DDR frequency while in DLL-ON mode may be not efficient because:

- Reduction in DDR frequency will cause bus duty cycle to increase and thus reduces chance of automatic MMDC power saving (place memory into SR).
- Total amount of read/write operation does not change (power is per-operation).
- The termination is active longer, though, lowering frequency below 396 MHz may enable lowering drive strengths and termination.

When possible at lower performance use cases, software may switch DDR3 to DLL-off mode. This allows it to greatly reduce DDR3 frequency and thus disable or reduce termination and drive strength, which significantly reduces the power consumption of the DDR3 interface.

A good strategy for many types of workloads is to combine most activity in bursts (natively possible, for example, for typical multimedia applications, communication, etc.) and run this segment at maximal speed, then switch to DLL-OFF mode to support background activity (communication, display refresh, housekeeping).

The DRAM Interface power dissipation depends on many variables, however, proper termination and drive strength is key for power and thermal performance. Memory and controllers provide a host of programmable options for the drive strength of the output buffers and for the on-die termination impedance.

The ideal settings for drive strength and ODT also depend on the clock frequency to ensure that inter-symbol interference (ISI) effects are not introduced.

DDR PHY power is proportional to the amount and type of bus activity.

In cases where the DDR is placed into self-refresh, software can configure DDR I/O to be floated or lowered to the minimum drive allowed by JEDEC.

Modifying the DDR drive strength must be done by code that is executing from a memory region other than DDR (for example, IRAM). No access to DDR (including page table walks, cache misses, alternate bus master accesses, etc.) is allowed while the DDR I/O pads are being re-configured.

10.4.2.3.2 Video-Graphics system power management

10.4.2.3.3 IO power reduction

Software configures IO to low power modes:

- PHYs - make sure that all unused PHYs are placed to lowest power state. Please refer relevant chapter for further information about different PHYs

- Digital IOs - Make sure all unnecessary PU/PD are disabled and IO are switched to either minimal drive strength or to input mode (when applicable)
- Set DDR type IO to CMOS mode if possible

10.4.3 Examples of External Power Supply Interface

This section presents the example of external power supply interfacing to the chip.

The scenario based on integrated PMU system is presented in the following figure. This scenario minimizes BoM and board design complexity.

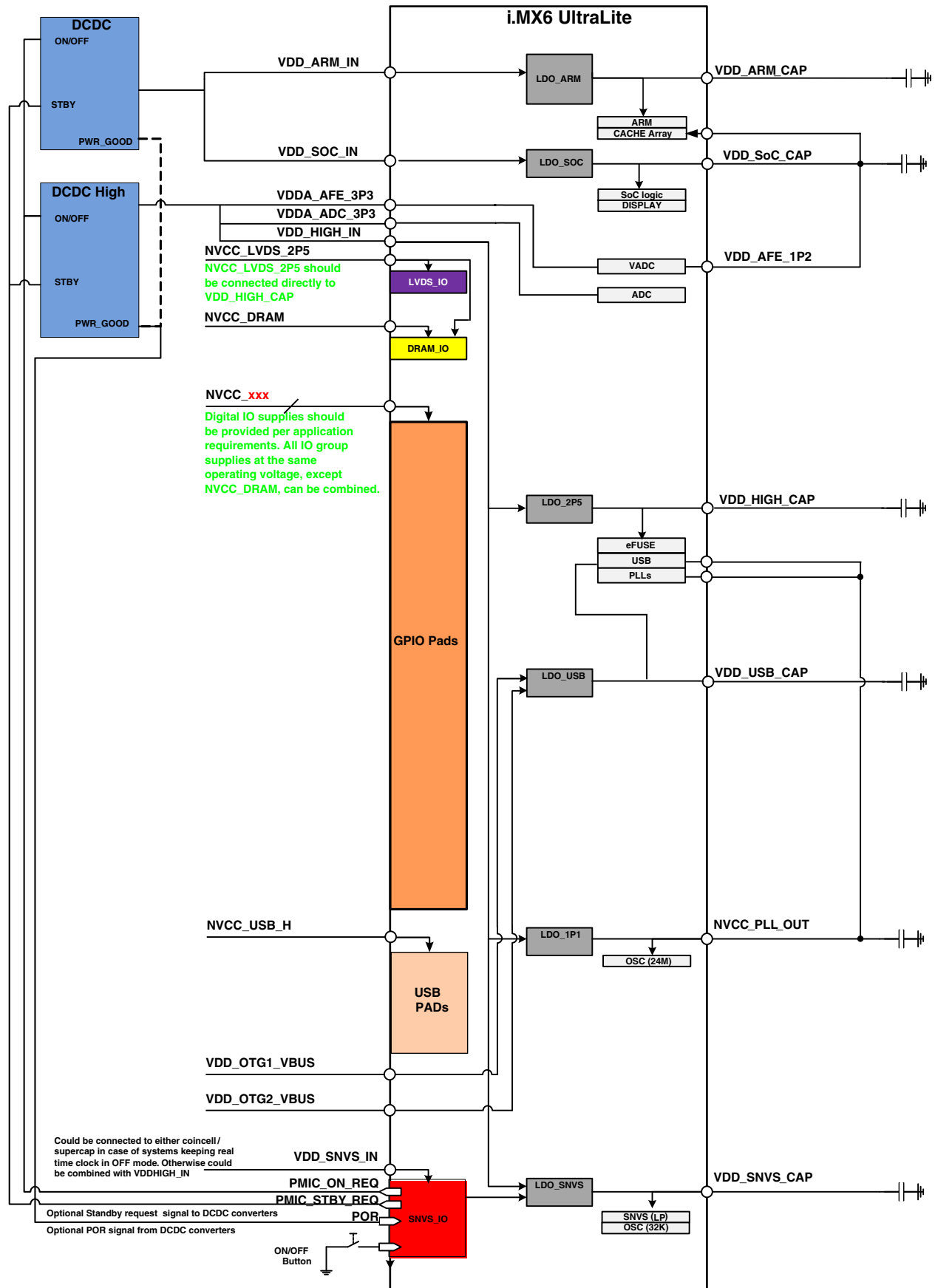

Figure 10-10. Supplying i.MX6ULL power using integrated PMU
 i.MX6ULL Applications Processor Reference Manual, Rev. 1, 11/2017

10.5 ONOFF (Button)

The chip supports the use of a button input signal to request main SoC power state changes (i.e. On or Off) from the PMU.

The ONOFF logic inside of SNVS_LP allows for connecting directly to a PMIC or other voltage regulator device. The logic takes a button input signal and then outputs a `pmic_en_b` and `set_pwr_off_irq` signal. PMIC logic also supports the SNVS_LP tamper logic which will allow waking the system up when a tamper event has happened while in the OFF state. The logic has two different modes of operation (Dumb and Smart mode).

The Dumb PMIC Mode uses `pmic_en_b` to issue a level signal for on and off. Dumb pmic mode has many different configuration options which include (debounce, off to on time, and max time out).

- **Debounce:** The debounce configuration supports 0 msec, 50 msec, 100 msec and 500 msec. The debounce is used to generate the `set_pwr_off_irq` interrupt. While in the ON state and the button is pressed longer than the debounce time the `set_pwr_off_irq` is generated.
- **Off to On Time:** The Off to On configuration supports 0 msec, 50 msec, 100 msec, and 500 msec. This configuration supports the time it takes to request power on after the configured button press time has been reached. Once the button is pressed longer than the configuration time, the state machine will transition from the OFF to the ON state.
- **Max Timeout:** The max timeout configuration supports 5 secs, 10 secs, 15 secs and disable. This configuration supports the time it takes to request power down after the button has been pressed for the defined time.

The Dumb PMIC mode uses a 2 state state machine, as shown below. The output of the `pmic_en_b` is generated by the state of the state machine.

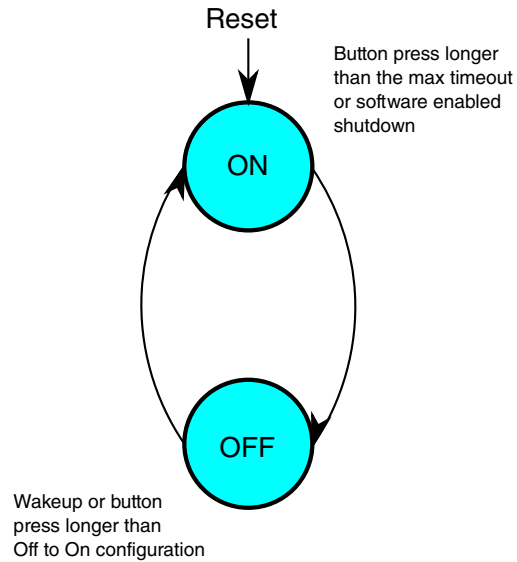

Figure 10-11. Dumb PMIC Mode State Machine

The Smart PMIC mode is meant to connect to another PMIC. The `pmic_en_b` signal issues a pulse instead of a level signal. The only configuration option available for this mode is the Debounce configuration that is used for the `set_pwr_off_irq`.

ONOFF (Button)

Chapter 11

System Security

11.1 Overview

Security is a common requirement for platforms built using the chip, although the specific needs vary greatly depending on the platform and market. The type and cost of assets to be protected on a portable consumer device are very different from those to be protected on automotive or industrial platforms, and the same applies to the kind of attacks and level of resources threatening those assets. The platform designer must select an appropriate set of counter measures to meet the relevant platform security needs.

For the platform designer to meet the requirements for each market, the chip incorporates a range of security features which can be used individually or in concert to underpin the platform security architecture. Most of the chip security features provide protection against particular kinds of attack and can be configured at various levels according to the required degree of protection. These features are designed to work together and can be integrated with appropriate software to create defensive layers. In addition to protection features, the chip includes a general purpose accelerator to enhance the performance of selected industry standard cryptographic algorithms.

The following is an introduction to the chip security components.

- High Assurance Boot (HAB) feature in the System Boot up to RSA-4096 signature verification
- Secure Non Volatile Storage (SNVS)
- TrustZone (TZ) Architecture in the ARM Cortex A7 Platform, TrustZone aware Interrupt Controller (GIC) and TrustZone Watchdog Timer (WDOG-2)
- TrustZone Address Space Controller (TZC-380) - providing security address region control functions on DDR memory space.
- On-chip RAM (OCRAM) with TrustZone protection using OCRAM controller.
- On chip OTP (OCOTP) with on-chip electrical fuses
- Central Security Unit (CSU)
- Secure JTAG Controller (SJC)

- Locked mode in the Smart Direct Memory Access (SDMA) controller
- 2 tamper pins supported
- Hardware Cryptographic Accelerators
 - Symmetric: AES-128
 - Hash Message Digest: SHA-1 and SHA-256
- True and Pseudo Random Number Generator

11.2 Central Security Unit (CSU)

11.2.1 CSU Overview

The CSU manages the system security policy for peripheral access on the SoC. The CSU allows trusted code to set individual security access privileges on each of the peripherals, using one of eight security access privilege levels. Also, according to programmed policy, the CSU may assign bus master security privileges during bus transactions.

11.2.2 CSU Features

The Central Security Unit (CSU) sets access control policies between bus masters and bus slaves, allowing peripherals to be separated into distinct security domains. This protects against unauthorized access to data e.g. when software programs a DMA bus master to access addresses that the software itself is prohibited from accessing directly. Configuring DMA bus master privileges in the CSU consistent with software privileges defends against such attempted accesses.

CSU has the following security related features:

- Peripheral access policy - Appropriate bus master privileges and identity are required to access each peripheral.
- Masters privilege policy - CSU overrides bus master privilege signals, i.e. user/supervisor secure/non-secure, according to access control policy.

11.2.3 CSU Functional Description

The CSU enables secure software to set bus privilege security policy within the platform.

Security policies may be set, and optionally locked in the CSU registers. These privilege values may originate in the command sequence file (CSF) which is processed by the High Assurance Boot (HAB) itself or by an HAB authenticated image which executes after the initial boot ROM phase.

11.2.3.1 CSU Peripheral Access Policy

According to its programmed policy, the CSU determines the bus master privileges and the masters that are allowed to access each of the slave peripherals.

There are four security modes of operation (i.e. bus privileges) in the system distinguished by security (TrustZone/non-TrustZone) and privilege (Supervisor/User) setting of the module. Below is the list of these security modes from the highest security level to the lowest:

- TrustZone (Secure) Privilege (Supervisor) Mode - Highest Security Level
- TrustZone (Secure) non-Privilege (User) Mode - Medium Security Level
- non-TrustZone (Regular) Privilege (Supervisor) Mode - Medium Security Level
- non-TrustZone (Regular) non-Privilege (User) Mode - Lowest Security Level

This functionality is implemented as follows:

The Configure Slave Level (CSL) Register value for a specified peripheral resource defines the output signal -- `csu_sec_level` for that peripheral. The value of this signal determines by what master privileges a peripheral is accessible. The relationship between the value of the `csu_sec_level` signal and security operation mode is shown in the table below. The CSL registers reside in the CSU module. Details, describing CSL register fields and how they are programmed to control access privileges for specific peripherals, can be found in the Security Reference Manual.

Table 11-1. Permission Access Table

CSU_SEC_LEVEL[2:0]	Non-Secure User Mode	Non-Secure Spvr Mode	Secure (TZ) User Mode	Secure (TZ) Spvr Mode	CSL register value
(0) 000	RD+WR	RD+WR	RD+WR	RD+WR	8'b1111_1111
(1) 001	None	RD+WR	RD+WR	RD+WR	8'b1011_1011
(2) 010	RD	RD	RD+WR	RD+WR	8'b0011_1111
(3) 011	None	RD	RD+WR	RD+WR	8'b0011_1011
(4) 100	None	None	RD+WR	RD+WR	8'b0011_0011
(5) 101	None	None	None	RD+WR	8'b0010_0010
(6) 110	None	None	RD	RD	8'b0000_0011
(7) 111	None	None	None	None	Any other value

11.3 Secure Non-Volatile Storage (SNVS)

11.3.1 SNVS Overview

SNVS is a hardware device that includes a security state machine and security violation detection circuits that, together with High Assurance Boot software, determine whether the chip is currently in a secure state.

When the security state machine indicates a secure state, the SNVS allows use of special cryptographic keys to decrypt long-term secrets such as public/private keypairs, Digital Rights Management keys and proprietary software. When the SNVS detects a potential security violation, such as a tamper alert, the SNVS sends an interrupt to alert the Operating System of the event. The SNVS also includes a general purpose real-time counter.

The SNVS includes the following features:

- Security State Machine driven by High Assurance Boot software and tamper detection circuits
- Master Key Control that protects the integrity and secrecy of the Master Key (OTPMK) stored in fuses
- Tamper detection circuits that detect JTAG events, power glitches, Master Key ECC check failure, and software-reported and hardware-reported security violations
- 256-bit Zeroizable Master Key that can be automatically erased in the event of a security breach
- Tamper-protected Secure Realtime Counter that continues running when the chip is powered off
- Non-volatile Monotonic Counter used to protect against “roll-back” attacks
- Non-volatile General Purpose Register can be used to store a 32-bit value across power cycles
- Non-Secure Real Time Counter with programmable alarm and periodic interrupt
- Controls the access to the OTP master secret key used by DCP to protect confidential data in off-chip storage
- Smart button input in the SNVS_LP logic of the SoC.
- Pulse mode output signal to request power state changes to a ‘Smart’ external PMIC.

11.3.2 Tamper Detection

External Tamper Detection is a special mechanism provided through a chip pin to signal when the device encounters unauthorized opening or tampering. Inside the chip, the received signal is compared with the desired signal level, once unequal, tamper event is found. When the desired signal is fixed, it is a passive tamper; when the desired signal level is also toggling with time, it is an active tamper. The chip supports at most 10 passive tamper detection pins, or 5 active tamper pairs alternatively. The use of each active tamper pair will reduce the available number of passive tamper pins at most by 2.

An always-ON power supply (coin-cell battery) should be present in the system. If the tamper detection feature is enabled by software then opening of the tamper contact:

- Switches system power ON with a Tamper Detection alarm interrupt asserted (for software reaction)
- Activate security related hardware (e.g. automatic and immediate erasure of the Zeroizable Master Key and deny access and erase secure memory contents)

11.4 Data Co-Processor (DCP)

For security purposes, the Data Co-Processor (DCP) provides hardware acceleration for the cryptographic algorithms. The features of DCP are:

- Encryption Algorithms: AES-128 (ECB and CBC modes)
- Hashing Algorithms: SHA-1 and SHA-256
- Key selection from the SNVS, DCP internal key storage, or general memory
- Internal Memory for storing up to four AES-128 keys—when a key is written to a key slot it can be read only by the DCP AES-128 engine
- IP slave interface
- DMA

11.5 High-Assurance Boot (HAB)

The HAB, which is the high-assurance boot feature in the system boot ROM, detects and prevents the execution of unauthorized software (malware) during the boot sequence.

When the unauthorized software is permitted to gain control of the boot sequence, it can be used for a variety of goals, such as exposing stored secrets; circumventing access controls to sensitive data, services, or networks, or for repurposing the platform. The unauthorized software can enter the platform during upgrades or reprovisioning, or when booting from the USB connections or removable devices.

The HAB protects against unauthorized software by:

- Using digital signatures to recognize the authentic software. This enables you to boot the device to a known initial state and run the software signed by the device manufacturer.

11.6 System JTAG Controller (SJC)

The JTAG port provides debug access to hardware blocks, including the Arm processor and the system bus. This enables program control and manipulation as well as visibility to the chip peripherals and memory.

The JTAG port must be accessible during initial platform development, manufacturing tests, and general troubleshooting. Given its capabilities, JTAG manipulation is a known attack vector for accessing sensitive data and gaining control over software execution. The System JTAG Controller (SJC) protects against the whole range of attacks based on unauthorized JTAG manipulation. It also provides a JTAG port that conforms to the IEEE 1149.1 and IEEE 1149.6 (AC) standards for BSR (boundary-scan) testing.

The SJC provides these security levels:

- The JTAG Disabled-JTAG use is permanently blocked.
- The No-Debug-All security sensitive JTAG features are permanently blocked.
- The Secure JTAG-JTAG use is restricted (as in the No-Debug level) unless a secret-key challenge/response protocol is successfully executed.
- The JTAG Enabled-JTAG use is unrestricted.

The security levels are selected via the e-fuse configuration.

Chapter 12

ARM Cortex A7 Platform (CA7)

12.1 Overview

The Cortex-A7 MPCore platform is a high-performance, low-power processor compliant with the ARMv7-A architecture. The Cortex-A7 MPCore platform has a single Arm®Cortex®-A7 core with a L1 cache subsystem and integrated Generic Interrupt Controller (GIC).

Each Cortex-A7 MPCore includes the following:

- 32 KB L1 Instruction Cache
- 32 KB L1 Data Cache
- Media Processing Engine (MPE) with NEON technology supporting the Advanced Single Instruction Multiple Data version 2 (SIMDv2) architecture
- Floating Point Unit (FPU) with support of the VFPv4-D32 architecture

NOTE

This is a superset of VFPv4-D16

- Support of ARMv7A architecture including:
 - Security extensions for enhanced security
 - Virtualization extensions
 - Large Physical Address (LPA) extension (LPA only supported within Cortex-A7 MPCore platform)

The Cortex-A7 MPCore platform includes the following:

- Integrated Global Interrupt Controller (GIC) configured to support 128 shared peripheral interrupts
- Generic timer
- Snoop control unit (SCU)
- 128 KB unified L2 cache
- Interconnect using a single 128-bit wide bus AMBA AXI bus
- ARMv7.1 Arm debug architecture that complies with the Coresight debug/trace architecture

12.2 External Signals

The following table describes the external signals of Arm:

12.3 Clocks

This section will discuss the Cortex-A7 clocks. For the specification of the maximum Cortex-A7 core frequency, please see the product datasheet. The following table describes the clock sources for Arm. Please see [Clock Controller Module \(CCM\)](#) for clock setting, configuration and gating information.

Table 12-1. Arm Clocks

Clock name	Clock Root	Description
clk_ahb	ahb_clk_root	AHB Clock
clk_apb_dbg	ahb_clk_root	APB Debug Clock
clk_atb	ahb_clk_root	ATB Clock
ipg_clk	ipg_clk_root	Peripheral Clock
trace_clk_in	ahb_clk_root	Trace Clock

Bus Clocks: The AXI master port of the Cortex-A7 MPCore platform is designed to run at half the speed (1:2 ratio) of the Cortex-A7 core.

Debug Clocks: The APB debug interface is designed to run at half the speed (1:2 ratio) of the Cortex-A7 core.

12.4 Platform Configuration

The revision and configuration of components the Cortex-A7 MPCore platform are detailed below.

Table 12-2. Component Revision

Component	Revision
Cortex-A7 MPCore	MP020-BU-50000-r0p5-00rel0
	MP020-BU-50000-r0p5-50rel0
ETM-A7	TM956-BU-50000-r0p0-00rel0

Table 12-3. Cortex-A7 MPCore Global Configuration

Option	Selected Value	Comments
Instruction cache size	32 KB	L1 instruction cache size per core
Data cache size	32 KB	L1 data cache size per core
L2 cache controller	Present	Integrated L2 cache controller
L2 data RAM cycle latency	2 cycles	
Shared Peripheral Interrupts	128	128 shared peripheral interrupts
Number of processors	1	Single Cortex-A7 MPCore
Integrated GIC	True	GIC included

Table 12-4. Cortex-A7 Core-Level Configuration

Option	Selected Value	Comments
NEON and/or FPU	FPU and NEON	FPU and NEON are both included in each processor

12.5 Low-Power and Performance

This section will discuss the low-power and performance features of the Cortex-A7 Core Platform.

The Cortex-A7 MPCore includes the following low-power features:

- Power-efficient processing provided by Cortex-A7 CPU
- 40nm LL process technology
- Flexible power domain partitioning with separate domains for the following blocks:
 - CPU and respective L1 caches
 - SCU and L2 cache controller
 - L2 cache memory
 - Debug including ETM
- Power-efficient timer events using combination of local generic timers and the global system counter
- DVFS to support overdrive and non-overdrive modes of operation

Chapter 13

Analog-to-Digital Converter (ADC)

13.1 Overview

The analog-to-digital converter (ADC) is a successive approximation ADC designed for operation within an integrated microcontroller system-on-chip.

13.1.1 Features

The features of the ADC are as follows:

- Configuration registers
 - 32-bit, word aligned, byte enabled registers. (byte and halfword access is not supported)
- Linear successive approximation algorithm with up to 12-bit resolution with 10/11 bit accuracy.
- Up to 10 ENOB (dedicated single ended channels)
- Up to 1MS/s sampling rate
- Up to 8 single-ended external analog inputs
- Single or continuous conversion (automatic return to idle after single conversion)
- Output Modes: (in right-justified unsigned format)
 - 12-bit
 - 10-bit
 - 8-bit
- Configurable sample time and conversion speed/power
- Conversion complete and hardware average complete flag and interrupt
- Input clock selectable from up to three sources
- Asynchronous clock source for lower noise operation with option to output the clock
- Automatic compare with interrupt for less-than, greater-than or equal-to, within range, or out-of-range, programmable value
- Operation in low power modes for lower noise operation

Overview

- Hardware average function
- Self-calibration mode

13.1.2 ADC I/F block diagram

The following diagram represents the ADC I/F block.

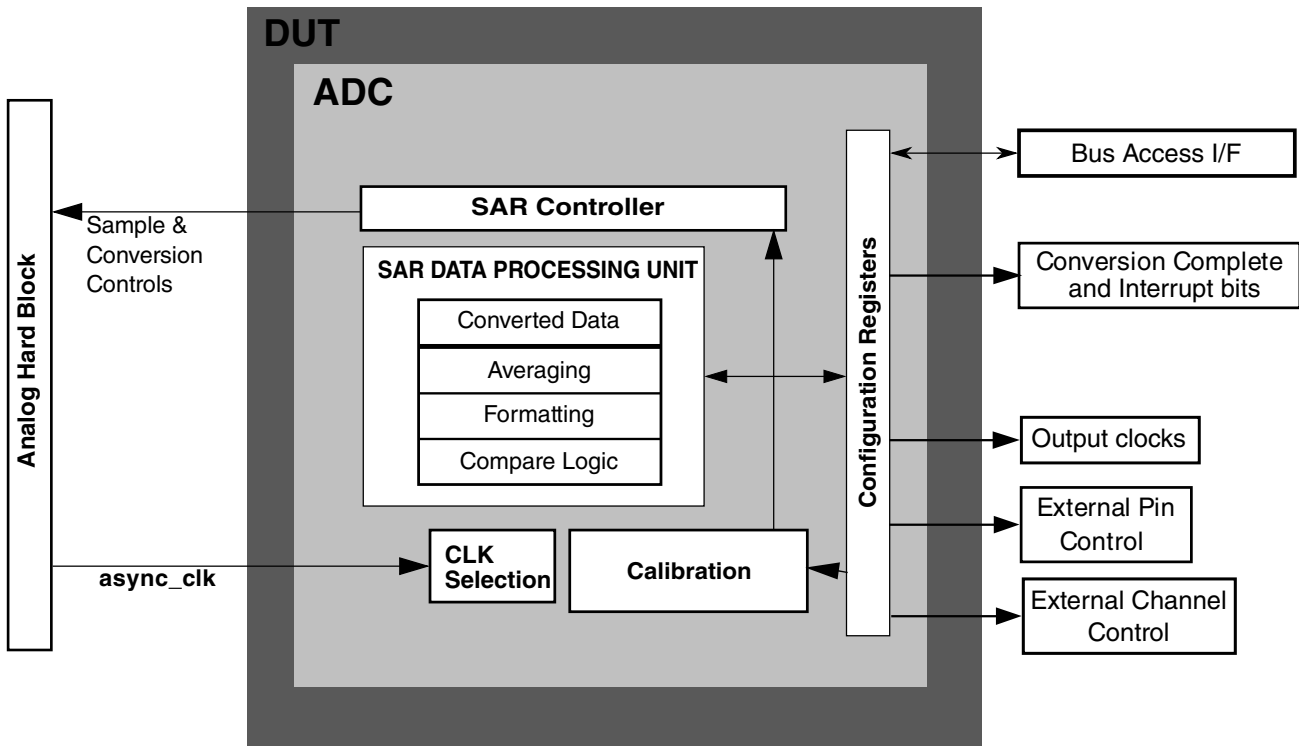

Figure 13-1. ADC I/F block diagram

13.1.3 ADC block diagram

The following figure shows a top-level block diagram of the ADC module.

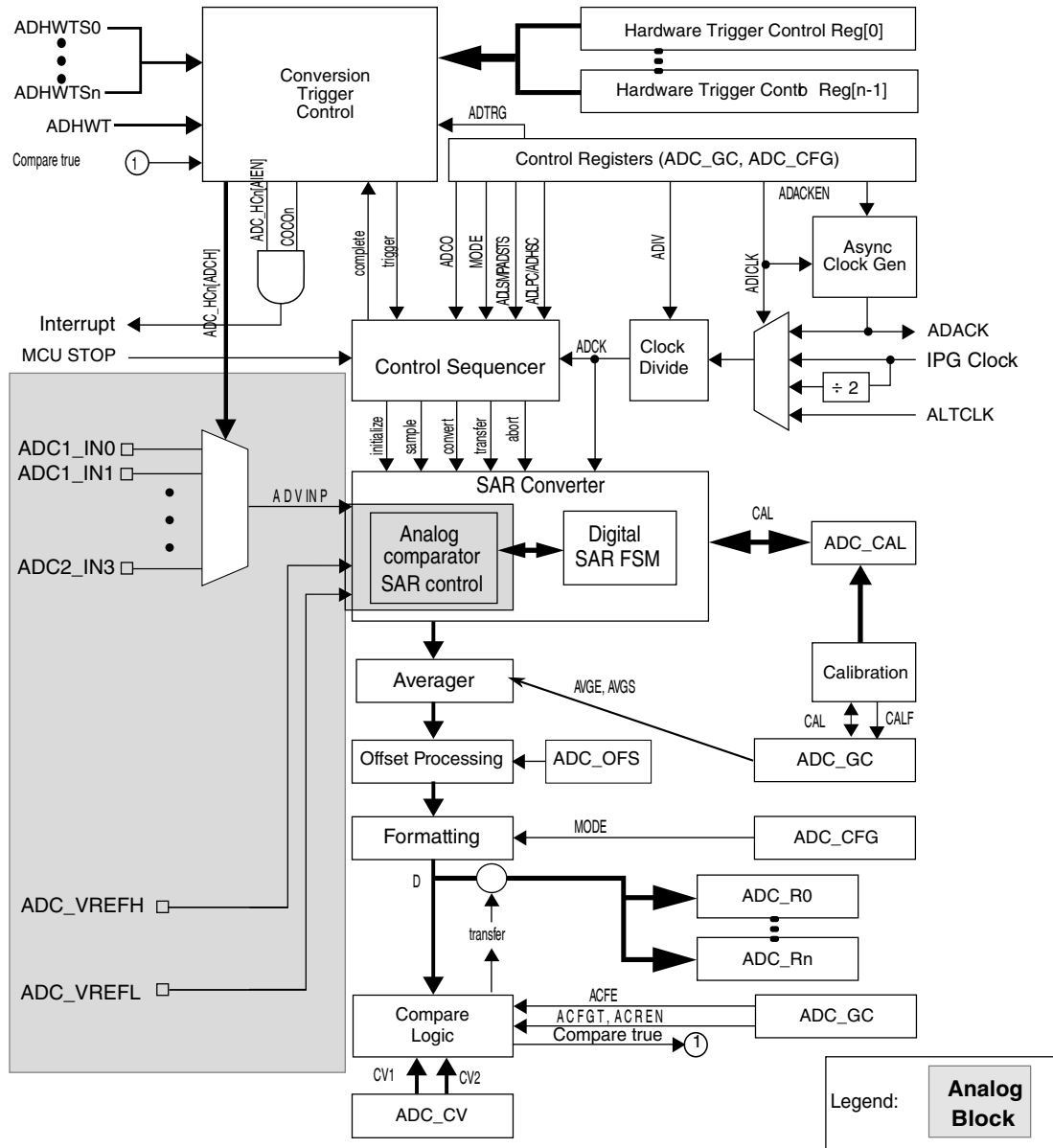

Figure 13-2. ADC block diagram

NOTE

ADC_VREFL is shorted to ground internally, no dedicate ball for this signal.

13.1.4 ADC module interface

The ADC is connected to many interfaces such as the clocks and reset, access bus, voltage references, interrupt controller, ADC pin control, and analog I/F as shown in the following figure.

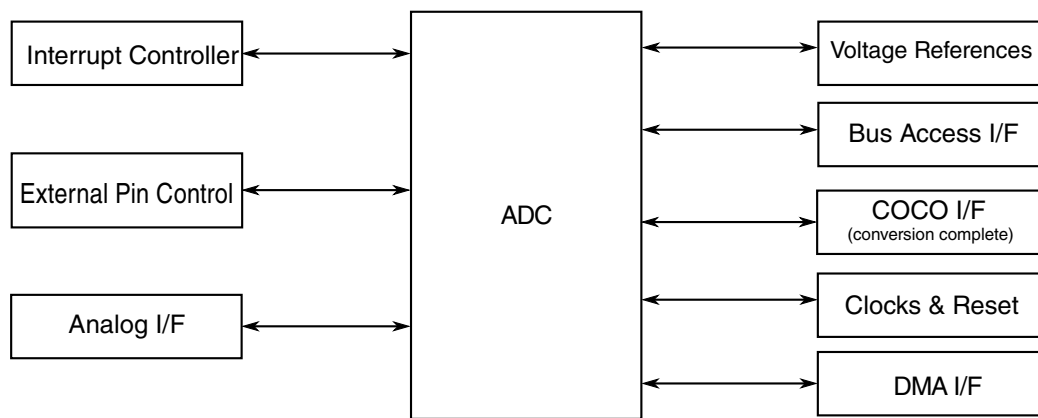

Figure 13-3. ADC module interface

13.1.5 Modes of Operation

By default, the ADC is in disabled mode. In this state, no conversion or other actions occur. All of the ADC control registers are accessible in this state through an access bus interface. To enable the ADC, required configurations should be done by programming the ADC configuration registers.

13.2 External Signals

The following table describes the external signals of ADC:

Table 13-1. ADC External Signals

Signal	Description	Pad	Mode	Direction
ADC_VREFH	Voltage reference high	ADC_VREFH	-	I
ADC1_IN0	Analog channel 1 input 0	GPIO1_IO00	-	I
ADC1_IN1	Analog channel 1 input 1	GPIO1_IO01	-	I
ADC1_IN2	Analog channel 1 input 2	GPIO1_IO02	-	I
ADC1_IN3	Analog channel 1 input 3	GPIO1_IO03	-	I
ADC1_IN4	Analog channel 1 input 4	GPIO1_IO04	-	I
ADC1_IN5	Analog channel 1 input 5	GPIO1_IO05	-	I
ADC1_IN6	Analog channel 1 input 6	GPIO1_IO06	-	I
ADC1_IN7	Analog channel 1 input 7	GPIO1_IO07	-	I
ADC1_IN8	Analog channel 1 input 8	GPIO1_IO08	-	I
ADC1_IN9	Analog channel 1 input 9	GPIO1_IO09	-	I
ADC2_IN0	Analog channel 2 input 0	GPIO1_IO00	-	I
ADC2_IN1	Analog channel 2 input 1	GPIO1_IO01	-	I
ADC2_IN2	Analog channel 2 input 2	GPIO1_IO02	-	I

Table continues on the next page...

Table 13-1. ADC External Signals (continued)

Signal	Description	Pad	Mode	Direction
ADC2_IN3	Analog channel 2 input 3	GPIO1_IO03	-	I
ADC2_IN4	Analog channel 2 input 4	GPIO1_IO04	-	I
ADC2_IN5	Analog channel 2 input 5	GPIO1_IO05	-	I
ADC2_IN6	Analog channel 2 input 6	GPIO1_IO06	-	I
ADC2_IN7	Analog channel 2 input 7	GPIO1_IO07	-	I
ADC2_IN8	Analog channel 2 input 8	GPIO1_IO08	-	I
ADC2_IN9	Analog channel 2 input 9	GPIO1_IO09	-	I

Signal	Description	Pad	Mode	Direction
ADC 1_IN0	Analog channel 1 input 0	GPIO_AD_B1_11	-	I
ADC1_IN1	Analog channel 1 input 1	GPIO_AD_B0_12	-	I
ADC1_IN2	Analog channel 1 input 2	GPIO_AD_B0_13	-	I
ADC1_IN3	Analog channel 1 input 3	GPIO_AD_B0_14	-	I
ADC1_IN4	Analog channel 1 input 4	GPIO_AD_B0_15	-	I
ADC1_IN5	Analog channel 1 input 5	GPIO_AD_B1_00	-	I
ADC1_IN6	Analog channel 1 input 6	GPIO_AD_B1_01	-	I
ADC1_IN7	Analog channel 1 input 7	GPIO_AD_B1_02	-	I
ADC1_IN8	Analog channel 1 input 8	GPIO_AD_B1_03	-	I
ADC1_IN9	Analog channel 1 input 9	GPIO_AD_B1_04	-	I
ADC1_IN10	Analog channel 1 input 10	GPIO_AD_B1_05	-	I
ADC1_IN11	Analog channel 1 input 11	GPIO_AD_B1_06	-	I
ADC1_IN12	Analog channel 1 input 12	GPIO_AD_B1_07	-	I
ADC1_IN13	Analog channel 1 input 13	GPIO_AD_B1_08	-	I
ADC1_IN14	Analog channel 1 input 14	GPIO_AD_B1_09	-	I
ADC1_IN15	Analog channel 1 input 15	GPIO_AD_B1_10	-	I
ADC 2_IN0	Analog channel 2 input 0	GPIO_AD_B1_11	-	I

Table continues on the next page...

Functional Description

ADC2_IN1	Analog channel 2 input 1	GPIO_AD_B1_12	-	
ADC2_IN2	Analog channel 2 input 2	GPIO_AD_B1_13	-	
ADC2_IN3	Analog channel 2 input 3	GPIO_AD_B1_14	-	
ADC2_IN4	Analog channel 2 input 4	GPIO_AD_B1_15	-	
ADC2_IN5	Analog channel 2 input 5	GPIO_AD_B1_00	-	
ADC2_IN6	Analog channel 2 input 6	GPIO_AD_B1_01	-	
ADC2_IN7	Analog channel 2 input 7	GPIO_AD_B1_02	-	
ADC2_IN8	Analog channel 2 input 8	GPIO_AD_B1_03	-	
ADC2_IN9	Analog channel 2 input 9	GPIO_AD_B1_04	-	
ADC2_IN10	Analog channel 2 input 10	GPIO_AD_B1_05	-	
ADC2_IN11	Analog channel 2 input 11	GPIO_AD_B1_06	-	
ADC2_IN12	Analog channel 2 input 12	GPIO_AD_B1_07	-	
ADC2_IN13	Analog channel 2 input 13	GPIO_AD_B1_08	-	
ADC2_IN14	Analog channel 2 input 14	GPIO_AD_B1_09	-	
ADC2_IN15	Analog channel 2 input 15	GPIO_AD_B1_10	-	

NOTE

The ADC input signals connect to GPIO[0:9]. The GPIO default configuration is enabled for keeper. The keeper causes an undesired jump behavior in ADC. To avoid the problem, disable keeper before starting ADC. For detailed information about keeper, refer to the GPIO block.

13.3 Functional Description

There are three possible states which ADC module can be in:

1. Disabled State
2. Idle state

3. Performing conversions

Disabled State:

The ADC module is disabled during reset or stop mode (if internal clock is not selected as source of clock).

Idle State:

The module is idle when a conversion has completed and another conversion has not been initiated. When idle and the asynchronous clock output enable is disabled ($ADACKEN = 0$), the module is in its lowest power state.

Conversion State:

The ADC can perform an analog-to-digital conversion on any of the software selectable channels. All modes perform conversion by a successive approximation algorithm.

To meet accuracy specifications the ADC module must be calibrated using the on chip calibration function. Calibration is recommended to be done after any reset.

When the conversion is completed, the result is placed in the data result registers (ADC_Rn). The conversion complete flag ($COCON$) field in the Hardware Status register is/are then set and an interrupt is generated, if the respective conversion complete interrupt has been enabled ($ADC_HCn[AIEN]=1$).

The ADC module has the capability of automatically comparing the result of a conversion with the contents of the compare value registers. The compare function is enabled by setting $ACFE$ (ADC Compare Function Enable) in the ADC general control register.

The ADC module has the capability of automatically averaging the result of multiple conversions. The hardware average function is enabled by setting $AVGE$ in the ADC general control register.

13.3.1 Clock Select and Divide Control

The ADC digital module has two clock sources:

- IPG clock
- Internal clock ($ADACK$) is a dedicated clock used only by the ADC.

ADC digital block generates $IPG\ clock/2$ by internally dividing the IPG clock. The final clock is chosen from the following clocks.

Functional Description

- IPG clock
- IPG clock divided by 2
- ADACK

From the three clocks listed above, one is chosen depending on the configuration of ADICLK[1:0] bits of ADC_CFG. This chosen clock is divided depending on the configuration of ADIV[1:0] bits of ADC_CFG. The final generated clock is used as conversion clock for ADC.

ADICLK	Selected Clock Source
00	IPG clock
01	IPG clock divided by 2
10	Reserved
11	Asynchronous clock (ADACK)

- The IPG clock. This is the default selection following reset.
- The IPG clock divided by two. For higher IPG clock rates, this allows a maximum divide by 16 of the IPG clock using the ADIV bits.
- The asynchronous clock (ADACK). This clock is generated from a clock source within the ADC module. Conversions are possible using ADACK as the input clock source while the MCU is in stop mode.

Whichever clock is selected, its frequency must fall within the specified frequency range for ADCK. If the available clocks are too slow, the ADC may not perform according to specifications. If the available clocks are too fast, the clock must be divided to the appropriate frequency. This divider is specified by the ADIV bits and can be divide-by 1, 2, 4, or 8.

13.3.2 Voltage Reference Selection

The ADC can be configured to use reference pairs as the reference voltages used for conversions (V_{REFSH} and V_{REFSL}). Each pair contains a positive reference which must be between the minimum Ref Voltage High and V_{DDAD} , and a ground reference which must be at the same potential as V_{SSAD} . The pairs can be as follows:

- External (V_{REFH} and V_{REFL})

These voltage references are selected by configuring ADC_CFG[REFSEL].

13.3.3 Conversion Control

Conversions are performed as determined by ADC_CFG[MODE] field.

Conversions are initiated by a software trigger. In addition, the ADC can be configured for low power operation, long sample time, continuous conversion, hardware average, and automatic comparison of conversion results with predetermined values.

13.3.3.1 Initiating Conversions

A conversion is initiated:

- Following a write to ADC_HC0 when a software triggered operation is selected (ADTRG=0).
- Following the transfer of the result to the data registers when continuous conversion is enabled (ADCO=1 in ADC_GC register).

If continuous conversion is enabled, a new conversion is automatically initiated after the completion of the current conversion. In software triggered operation (ADTRG=0), continuous conversions begin after ADC_HC0 is written and continue until aborted.

If hardware averaging is enabled, a new conversion is automatically initiated after the completion of the current conversion until the correct number of conversions is completed. In software triggered operation, conversions begin after ADC_HC0 is written. If continuous conversions is also enabled, a new set of conversions to be averaged are initiated following the last of the selected number of conversions.

13.3.3.2 Completing Conversions

A conversion is completed when the result of the conversion is transferred into the data result registers. (provided the compare function & hardware averaging is disabled), this is indicated by the setting of COCON. If hardware averaging is enabled, COCON sets only, if the last of the selected number of conversions is complete. If the compare function is enabled, COCON sets and conversion result data is transferred only if the compare condition is true. If both hardware averaging and compare functions are enabled, then COCON sets only if the last of the selected number of conversions is complete and the compare condition is true. An interrupt is generated, if ADC_HCn[AIEN] is high at the time that COCON is set and if DMAEN is set, DMA request is asserted, if COCON is set. Both the requests get deasserted when COCON is low, cleared, which happens when data is read.

In all modes a blocking mechanism prevents a new result from overwriting previous data in ADC_Rn, if the previous data is in the process of being read. When blocking is active (OVWREN=0 in ADC_CFG), the conversion result data transfer is blocked, COCO_n is not set, and the new result is lost. In all other cases of operation, when a conversion result data transfer is blocked, another conversion is initiated regardless of the state of ADCO (single or continuous conversions enabled).

Note

If continuous conversions are enabled, the blocking mechanism could result in the loss of data occurring at specific timepoints. To avoid this issue, the data must be read in fewer cycles than an ADC conversion time, accounting for interrupt or software polling loop latency.

If single conversions are enabled, the blocking mechanism could result in several discarded conversions and excess power consumption. To avoid this issue, the data registers must not be read after initiating a single conversion until the conversion completes.

13.3.3.3 Aborting Conversions

Any conversion in progress is aborted when:

- The MCU enters stop mode with ADACK not enabled.
- In software trigger mode, write to ADC_HC0 register, while ADC_HC0 is actively (already) controlling a conversion, aborts the current conversion.
- A write to any ADC register other than the ADC_HC0 register occurs. This indicates a mode of operation change has occurred and the current conversion is therefore invalid.

Note

When a conversion is aborted, the contents of the data result registers, ADCR_n are not altered. The data result registers continue to hold the values, transferred after the completion of the last successful conversion. If the conversion is aborted by a reset or stop (not operated with internal ADACK), ADCR_n (data result register) return to their reset states.

13.3.3.4 Power Control

The ADC module remains in its idle state until a conversion is initiated. If ADACK is selected as the conversion clock source but the asynchronous clock output is disabled (ADACKEN=0), the ADACK clock generator will also remain in its idle state (disabled) until a conversion is initiated. If the asynchronous clock output is enabled (ADACKEN=1), it will remain active regardless of the state of the ADC or the MCU power mode.

Power consumption when the ADC is active can be reduced by setting ADLPC.

13.3.3.5 Sample Time and Total Conversion Time

The total conversion time depends upon the following:

- the sample phase time (as determined by ADLSMP and ADSTS bits in ADC_CFG register),
- the compare phase time (determined by MODE bits)
- the frequency of the conversion clock (f_{ADCK}).
- the MCU bus frequency (for Handshaking and selection of clock)

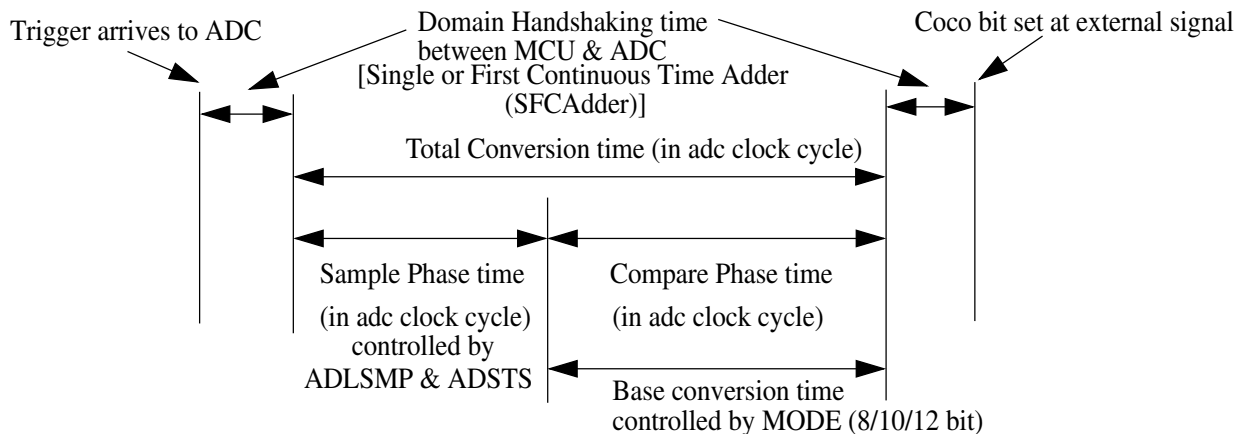

Figure 13-4. ADC conversion time details

After the module becomes active, sampling of the input begins. ADLSMP and ADSTS decide the sample time duration. When sampling is complete, the converter is isolated from the input channel and a successive approximation algorithm is performed to determine the digital value of the analog signal. The result of the conversion is transferred to ADC_Rn upon completion of the conversion algorithm.

Functional Description

If the bus frequency is less than the f_{ADCK} frequency, precise sample time for continuous conversions cannot be guaranteed.

The maximum total conversion time is determined by the clock source chosen and the divide ratio selected. The clock source is selectable by the ADICLK bits in ADC_CFG register, and the divide ratio is specified by the ADIV bits.

The maximum total conversion time for all configurations is summarized in [Equation 1 on page 402](#). Refer to [Table 13-2](#) through [Table 13-5](#) for the variables referenced in the equation.

$$\text{ConversionTime} = \text{SFCAdder} + \text{AverageNum} \times (\text{BCT} + \text{LSTAdder})$$

Equation 1. Equation of Conversion Time

Table 13-2. Single or First Continuous Time Adder (SFCAdder)

ADACKEN	ADICLK	Single or First Continuous Time Adder (SFCAdder)
x	0x, 10	3 ADCK cycles (before starting of conversion) + 1 ADCK (after end of conversion) + 2 bus clock cycles
1	11	3 ADCK cycles (before starting of conversion) + 1 ADCK (after end of conversion) + 2 bus clock cycles
0	11	1.5 μ s + 3 ADCK cycles (before starting of conversion) + 1 ADCK (after end of conversion) + 2 bus clock cycles

Table 13-3. Average Number Factor (AverageNum)

AVGE	AVGS[1:0]	Average Number Factor (AverageNum)
0	xx	1
1	00	4
1	01	8
1	10	16
1	11	32

Table 13-4. Base Conversion Time (BCT) (compare phase duration)

Mode	Base Conversion Time (BCT) (compare phase duration)
8 bit	17 ADCK cycles

Table continues on the next page...

Table 13-4. Base Conversion Time (BCT) (compare phase duration) (continued)

Mode	Base Conversion Time (BCT) (compare phase duration)
10 bit	21 ADCK cycles
12 bit	25 ADCK cycles

Table 13-5. Long Sample Time

ADLSMP	ADSTS	Long Sample Time Adder (LSTAdder)
0	00	3 ADCK cycles
0	01	5 ADCK cycles
0	10	7 ADCK cycles (default)
0	11	9 ADCK cycles
1	00	13 ADCK cycles
1	01	17 ADCK cycles
1	10	21 ADCK cycles
1	11	25 ADCK cycles

Note

The ADCK frequency must be between f_{ADCK} minimum and f_{ADCK} maximum to meet ADC specifications.

13.3.3.6 Conversion Time Examples

The following examples uses [Equation 1 on page 402](#) and the information provided in tables [Table 13-2](#) through [Table 13-5](#).

13.3.3.6.1 Typical conversion time configuration

A typical configuration for ADC conversion is: 10-bit mode, with the bus clock selected as the input clock source, the input clock divide-by-1 ratio selected, and a bus frequency of 40 MHz, ADLSMP=0,ADLSTS=10 and high speed conversion disabled. The conversion time for a single conversion is calculated by using [Equation 1 on page 402](#) and the information provided in [Table 13-6](#) through [Table 13-8](#). The table below list the variables of [Equation 1 on page 402](#).

Table 13-6. Typical Conversion Time

Variable	Time
SFCAdder	5 ADCK cycles + 5 bus clock cycles
AverageNum	1

Table continues on the next page...

Table 13-6. Typical Conversion Time (continued)

Variable	Time
BCT	21 ADCK cycles
LSTAdder	7

The resulting conversion time is generated using the parameters listed in [Table 13-6](#). So for Bus clock equal to 40 Mhz and ADCK equal to 40 Mhz the resulting conversion time is 0.95 us.

13.3.3.6.2 Long conversion time configuration

A configuration for long ADC conversion is: 12-bit mode, with the bus clock selected as the input clock source, the input clock divide-by-8 ratio selected, and a bus frequency of 40 MHz, long sample time enabled (ADLSMP=1, ADSTS=11) and configured for longest adder and high speed conversion disabled. Average enabled for 32 conversions (AVGE=1, AVGS=11). The conversion time for this conversion is calculated by using equation on [Sample Time and Total Conversion Time](#) and the information provided in [Table 13-2](#) through [Table 13-5](#). The table below lists the variables of equation.

Table 13-7. Typical Conversion Time

Variable	Time
SFCAdder	3 ADCK cycles + 5 bus clock cycles
AverageNum	32
BCT	25 ADCK cycles
LSTAdder	25 ADCK cycles

The resulting conversion time is generated using the parameters listed in [Table 13-7](#). So for Bus clock equal to 40 Mhz and ADCK equal to 5 Mhz the resulting conversion time is 10.0226 us (AverageNum). This results in a total conversion time of 320.725 us.

13.3.3.6.3 Short conversion time configuration

A configuration for short ADC conversion is: 8-bit mode, with the bus clock selected as the input clock source, the input clock divide-by-1 ratio selected, and a bus frequency of 40 MHz, long sample time disabled (ADLSMP=0, ADSTS=00) and high speed conversion enabled. The conversion time for this conversion is calculated by using the equation and the information provided in [Table 13-2](#) to [Table 13-5](#). The table below list the variables of equation.

Table 13-8. Typical Conversion Time

Variable	Time
SFCAdder	3 ADCK cycles + 5 bus clock cycles
AverageNum	1
BCT	17 ADCK cycles
LSTAdder	3 ADCK cycles

The resulting conversion time is generated using the parameters listed in [Table 13-8](#). So for Bus clock equal to 40Mhz and ADCK equal to 40Mhz the resulting conversion time is 700 ns.

13.3.3.7 Hardware Average Function

The hardware average function can be enabled (AVGE=1) to perform a hardware average of multiple conversions. The number of conversions is determined by the AVGS[1:0] bits, which select 4, 8, 16 or 32 conversions to be averaged. While the hardware average function is in progress the ADACT bit will be set.

After the selected input is sampled and converted, the result is placed in an accumulator from which an average is calculated once the selected number of conversions has been completed. When hardware averaging is selected the completion of a single conversion will not set the COCON bit.

If the compare function is either disabled or evaluates true, after the selected number of conversions are completed, the average conversion result is transferred into the data result registers, ADC_Rn , and the COCON bit is set. An ADC interrupt is generated upon the setting of COCON if the respective ADC interrupt is enabled (AIENn=1).

13.3.4 Automatic Compare Function

The compare function can be configured to check if the result is less than or greater-than-or-equal-to a single compare value, or if the result falls within or outside a range determined by two compare values. The compare mode is determined by ACFGT, ACREN and the values in the compare value register (ADC_CV). After the input is sampled and converted, the compare values (CV1 and CV2) are used as described in the table below. There are six compare modes as shown in the table below.

Table 13-9. Compare Modes

ACFGT	ACREN	CV1 relative to CV2	Function	Compare Mode Description
0	0	-	Less than threshold	Compare true if the result is less than the CV1 registers.
1	0	-	Greater than or equal to threshold	Compare true if the result is greater than or equal to CV1 registers.
0	1	Less than or equal	Outside range, not inclusive	Compare true if the result is less than CV1 Or the result is Greater than CV2
0	1	Greater than	Inside range, not inclusive	Compare true if the result is less than CV1 And the result is greater than CV2
1	1	Less Than or equal	Inside range, inclusive	Compare true if the result is greater than or equal to CV1 And the result is less than or equal to CV2
1	1	Greater than	Outside range, inclusive	Compare true if the result is greater than or equal to CV1 Or the result is less than or equal to CV2

With the ADC range enable bit set, ADCREN =1, if compare value 1(CV1 value) is less than or equal to the compare value 2 (CV2 value), setting ACFGT will select a trigger-if-inside-compare-range, inclusive-of-endpoints function. Clearing ACFGT will select a trigger-if-outside-compare-range, not-inclusive-of-endpoints function.

If CV1 is greater than the CV2, setting ACFGT will select a trigger-if-outside-compare-range, inclusive-of-endpoints function. Clearing ACFGT will select a trigger-if-inside-compare-range, not-inclusive-of-endpoints function.

If the condition selected evaluates true, COCON is set.

Upon completion of a conversion while the compare function is enabled, if the compare condition is not true, COCON is not set and the conversion result data will not be transferred to the result register. If the hardware averaging function is enabled, the compare function compares the averaged result to the compare values. The same compare function definitions apply. An ADC interrupt is generated upon the setting of COCON if the respective ADC interrupt is enabled (ADC_HCN[AIEN]=1).

Note

The compare function can monitor the voltage on a channel while the MCU is in wait or stop3 mode. The ADC interrupt wakes the MCU when the compare condition is met.

13.3.5 Calibration Function

The ADC contains a self-calibration function that is required to achieve the specified accuracy. Calibration should be run or valid calibration values should be written after power up and system reset (as the calibration register will be reset on reset assertion) with specified settings before any conversion is initiated. The calibration function sets the calibration value at the end of running the full calibration sequence in ADC_CAL register. The user must configure the ADC correctly prior to starting the calibration process, and must allow the process to run the full calibration sequence by checking the status of ADC_GC[*CAL*] and ADC_GS[*CALF*] so that the generated calibration value can be loaded.

Prior to calibration, the user must configure the ADC's clock source and frequency, low power configuration, voltage reference selection, sample time, averaging, and the high speed configuration according to the application's clock source availability and needs. If the application uses the ADC in a wide variety of configurations, the configuration for which the highest accuracy is required should be selected, or multiple calibrations can be done for the different configurations. The input channel, conversion mode, continuous function and compare function are all ignored during the calibration process.

To initiate calibration, the user sets the CAL bit and the calibration will automatically begin if the ADTRG bit = 0. If ADTRG = 1, the CAL bit will not get set and the calibration fail flag (CALF) will be set. While calibration is active, no ADC register can be written and no stop mode may be entered or the calibration routine will be aborted causing the CAL bit to clear and the CALF bit to set.

At the end of a calibration sequence the COCO[0] bit of the ADC_HS register will be set. The ADC_HCn[AIEN] bit can be used to allow an interrupt to occur at the end of a calibration sequence. If, at the end of calibration routine, the CALF bit is not set, the automatic calibration routine completed successfully.

To complete calibration, the user must follow the below procedure :

- Configure ADC_CFG with actual operating values for maximum accuracy.
- Configure the ADC_GC values along with CAL bit
- Check the status of CALF bit in ADC_GS and the CAL bit in ADC_GC
- When CAL bit becomes '0' then check the CALF status and COCO[0] bit status

When complete the user may reconfigure and use the ADC as desired.

A second calibration may also be performed if desired by clearing and again setting the CAL bit

Overall the calibration routine may take as many as 14000 ADCK cycles and 100 bus cycles, depending on the results and the clock source chosen.

13.3.6 User Defined Offset Function

The ADC Offset Correction Register (ADC_OFS) contains the user configured offset value. This register is 13 bit wide. The value in MSB (13th bit) is the operation bit, if this bit is '0' then the value in rest 12 bit is added with the converted result value to generate final result to be loaded into ADC_Rn and if this bit is '1' then this field is subtracted from converted value to generate final Result (ADC_Rn). If the Final result is above the maximum or below the minimum result value, it is forced to the appropriate limit for the current mode of operation. Forced to 0x0FFF if over and 0x0000 if lower for 12 bit mode.

The offset value has no effect during calibration on the final result.

The formatting of the ADC Offset Register is different from the Data Result Registers (ADC_Rn) to preserve the resolution of the value regardless of the conversion mode selected. Lower order bits are ignored in lower resolution modes. For example, in 8b single-ended mode, the bits OFS[11:4] are subtracted from D[7:0] when bit OFS[12] (sign bit) is '1' ; indicates subtraction and bits OFS[4:0] are ignored. For 12b single-ended mode, bits OFS[11:0] are directly subtracted from the conversion result data CDATA[11:0] when OFS[12] (sign bit) is '1'. The similar is the addition operation when OFS[12](sign bit) is 0.

ADC_OFS is manually set according to user requirements once the self calibration sequence is done (CAL is cleared). The user have to write ADC_OFS with desired value.

NOTE

There is an effective limit to the values of Offset that can be set by the user. If the magnitude of the offset is too great the results of the conversions will cap off at the limits.

The offset function may be employed by the user to remove application offsets or DC bias values. An offset correction that results in an out-of-range value will be forced to the minimum or maximum value.

For applications which may change the offset repeatedly during operation, it is recommended to store the initial offset value in flash so that it can be recovered and added to any user offset adjustment value and the sum stored in the ADC_OFS registers.

13.3.7 MCU Wait Mode Operation

Wait mode is a **lower power-consumption standby mode** from which **recovery is fast** because **the clock sources remain active**. If a conversion is in progress when the MCU enters wait mode, it continues until completion. Conversions can be initiated while the MCU is in wait mode if continuous conversions are enabled.

The bus clock, bus clock divided by two, and ADACK are available as conversion clock sources while in wait mode.

A conversion complete event sets the COCON and generates an ADC interrupt to wake the MCU from wait mode.

If the compare and hardware averaging functions are disabled, a conversion complete event sets the COCON and generates an ADC interrupt to wake the MCU from wait mode if the respective ADC interrupt is enabled ($ADC_HCn[AIEN]=1$).

If the hardware averaging function is enabled the COCON will set (and generate an interrupt if enabled) when the selected number of conversions are complete.

If the compare function is enabled the COCON will set (and generate an interrupt if enabled) only if the compare conditions are met.

If a single conversion is selected and the compare trigger is not met, the ADC will return to its idle state and cannot wake the MCU from wait mode.

13.3.8 MCU Stop Mode Operation

Stop mode is a low power-consumption standby mode during which most or all clock sources on the MCU are disabled. Stop mode is entered when stop indication comes from the MCU.

13.3.8.1 Stop Mode With ADACK Disabled

If the asynchronous clock, ADACK, is not selected as the conversion clock, executing a stop instruction aborts the current conversion and places the ADC in its idle state. The contents of the ADC registers, including ADC_Rn are unaffected by stop mode. After exiting from stop mode, a software trigger is required to resume conversions.

13.3.8.2 Stop Mode With ADACK Enabled

If ADACK is selected as the conversion clock, the ADC continues operation during stop mode. For guaranteed ADC operation, the MCU's voltage regulator must remain active during stop mode.

If a conversion is in progress when the MCU enters stop mode, it continues until completion. Conversions can be initiated while the MCU is in stop mode if continuous conversions are enabled.

A conversion complete event sets the COCON and generates an ADC interrupt to wake the MCU from stop mode :

Note

The ADC module can wake the system from low-power stop and cause the MCU to begin consuming run-level currents without generating a system level interrupt. To prevent this scenario, software should ensure the conversion result data transfer blocking mechanism (discussed in [Completing Conversions](#)) is cleared when entering stop and continuing ADC conversions.

13.4 Initialization Information

This section gives an example that provides some basic direction on how to initialize and configure the ADC module. User can configure the module for 8, 10, 12 bit resolution, single or continuous conversion, and a polled or interrupt approach, among many other options.

13.4.1 ADC Module Initialization Example

This section describes the initialization sequence along with pseudo-code.

13.4.1.1 Initialization Sequence

Before the ADC module can be used to complete conversions, an initialization procedure must be performed. A typical sequence is as follows:

- Calibrate the ADC by following the calibration instructions in [Calibration Function](#)

- Update the configuration register (ADC_CFG) to select the input clock source and the divide ratio used to generate the internal clock, ADCK. This register is also used for selecting sample time and low-power configuration.
- Update General control register (ADC_GC) to select whether conversions will be continuous or completed only once (ADCO) and to select whether to perform hardware averaging, etc.
- Update Trigger control register (ADC_HCn) to select the conversion trigger and compare function options, if enabled.

13.4.1.2 Pseudo-Code Example

In this example, the ADC module is set up with interrupts enabled to perform a single 10-bit conversion at low power with a long sample time on input channel 1, where the internal ADCK clock is derived from the bus clock divided by 1.

ADC_CFG

Bit 7	ADLPC	1	Configures for low power (lowers maximum clock speed).
Bit 6:5	ADIV	00	Sets the ADCK to the input clock \div 1.
Bit 4	ADLSMP	1	Configures for long sample time.
Bit 3:2	MODE	10	Sets mode at 10-bit conversions.
Bit 1:0	ADICLK	00	Selects bus clock as input clock source.

ADC_GC

Bit 7	CAL	0	Flag indicates if a conversion is in progress.
Bit 6	ADCO	0	Software trigger selected.
Bit 5	AVGE	0	Compare function disabled.
Bit 4	ACFE	0	Compare function disabled.
Bit 3	ACFGT	0	Not used in this example.
Bit 2	ACREN	0	Not used in this example.
Bit 1	DMAEN	0	Not used in this example.
Bit 0	ADACKEN	0	Not used in this example.

ADC_HC0

Bit 7	AIEN	1	Conversion complete interrupt enabled.
Bit 4:0	ADCH	00001	Input channel 1 selected as ADC input channel.

ADC_R0

Holds results of conversion. Read high byte (ADCRHA) before low byte (ADCRLA) so that conversion data cannot be overwritten with data from the next conversion.

ADC_CV

Holds compare values when compare function enabled.

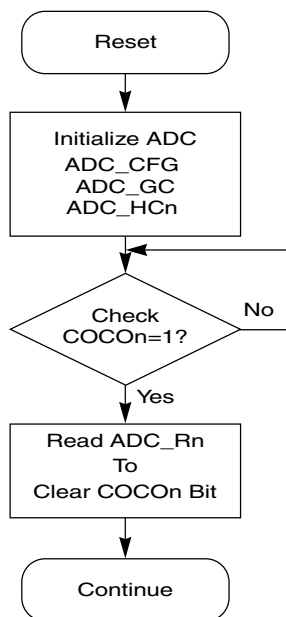

Figure 13-5. Initialization Flowchart for Example

13.5 Application Information

This section contains information for using the ADC module in applications. The ADC has been designed to be integrated into a microcontroller for use in embedded control applications requiring an A/D converter.

13.5.1 Sources of Error

Several sources of error exist for A/D conversions. These are discussed in the following sections.

13.5.1.1 Sampling Error

For proper conversions, the input must be sampled long enough to achieve the proper accuracy. Given the maximum input resistance of approximately 7k Ω and input capacitance of approximately 1.3 pF, sampling to within 1/4LSB (at 12-bit resolution) can be achieved within the nominal sample window (6 cycles @ 40 MHz maximum ADCK frequency) provided the resistance of the external analog source (R_{AS}) is kept below 4 k Ω .

Higher source resistances or higher-accuracy sampling is possible by setting ADLSMP and changing the ADSTS bits (to increase the sample window) or decreasing ADCK frequency to increase sample time.

13.5.1.2 Pin Leakage Error

Leakage on the I/O pins can cause conversion error if the external analog source resistance (R_{AS}) is high. If this error cannot be tolerated by the application, keep R_{AS} lower than $V_{DDAD}/(2^N \cdot I_{LEAK})$ for less than 1/4LSB leakage error ($N = 8$ in 8-bit, 10 in 10-bit or 12 in 12-bit mode).

13.5.1.3 Noise-Induced Errors

System noise that occurs during the sample or conversion process can affect the accuracy of the conversion. The ADC accuracy numbers are guaranteed as specified only if the following conditions are met:

- There is a 0.1 μ F low-ESR capacitor from V_{REFH} to V_{REFL} .
- There is a 0.1 μ F low-ESR capacitor from V_{DDAD} to V_{SSAD} .
- If inductive isolation is used from the primary supply, an additional 1 μ F capacitor is placed from V_{DDAD} to V_{SSAD} .
- V_{SSAD} (and V_{REFL} , if connected) is connected to V_{SS} at a quiet point in the ground plane.
- Operate the MCU in wait or stop mode immediately after initiating (software triggered conversions) the ADC conversion.
 - For software triggered conversions, immediately follow the write to ADCSC1 with a wait instruction or stop instruction.
 - For stop mode operation, select ADACK as the clock source. Operation in stop reduces V_{DD} noise but increases effective conversion time due to stop recovery.
- There is no I/O switching, input or output, on the MCU during the conversion.

There are some situations where external system activity causes radiated or conducted noise emissions or excessive V_{DD} noise is coupled into the ADC. In these situations, or when the MCU cannot be placed in wait or stop or I/O activity cannot be halted, these recommended actions may reduce the effect of noise on the accuracy:

- Place a 0.01 μF capacitor (CAS) on the selected input channel to V_{REFL} or V_{SS} (this improves noise issues, but affects the sample rate based on the external analog source resistance).
- Average the result by converting the analog input many times in succession and dividing the sum of the results. Four samples are required to eliminate the effect of a 1LSB, one-time error.
- Reduce the effect of synchronous noise by operating off the asynchronous clock (ADACK) and averaging. Noise that is synchronous to ADCK cannot be averaged out.

13.5.1.4 Code Width and Quantization Error

Note

This will remain the same as long as the result is rounded for 8 and 10-bit modes. If the result is truncated in 8/10b modes then they will match 12b mode where the quantization error is -1 to 0.

The ADC quantizes the ideal straight-line transfer function into 4096 steps (in 12-bit mode). Each step ideally has the same height (1 code) and width. The width is defined as the delta between the transition points to one code and the next. The ideal code width for an N bit converter (in this case N can be 8, 10 or 12), defined as 1LSB, is:

$$1\text{lsb} = (V_{\text{REFH}} - V_{\text{REFL}}) / 2^N$$

There is an inherent quantization error due to the digitization of the result. For 8-bit or 10-bit conversions the code transitions when the voltage is at the midpoint between the points where the straight line transfer function is exactly represented by the actual transfer function. Therefore, the quantization error will be $\pm 1/2$ lsb in 8- or 10-bit mode. As a consequence, however, the code width of the first (0x000) conversion is only 1/2 lsb and the code width of the last (0xFF or 0x3FF) is 1.5 lsb.

For 12-bit conversions the code transitions only after the full code width is present, so the quantization error is -1 lsb to 0 lsb and the code width of each step is 1 lsb.

13.5.1.5 Linearity Errors

The ADC may also exhibit non-linearity of several forms. Every effort has been made to reduce these errors but the system should be aware of them because they affect overall accuracy. These errors are:

- Zero-scale error (E_{ZS}) (sometimes called offset) — This error is defined as the difference between the actual code width of the first conversion and the ideal code width (1/2 lsb in 8-bit or 10-bit modes and 1 lsb in 12-bit mode). If the first conversion is 0x001, the difference between the actual 0x001 code width and its ideal (1 lsb) is used.
- Full-scale error (E_{FS}) — This error is defined as the difference between the actual code width of the last conversion and the ideal code width (1.5 lsb in 8-bit or 10-bit modes and 1LSB in 12-bit mode). If the last conversion is 0x3FE, the difference between the actual 0x3FE code width and its ideal (1LSB) is used.
- Differential non-linearity (DNL) — This error is defined as the worst-case difference between the actual code width and the ideal code width for all conversions.
- Integral non-linearity (INL) — This error is defined as the highest-value the (absolute value of the) running sum of DNL achieves. More simply, this is the worst-case difference of the actual transition voltage to a given code and its corresponding ideal transition voltage, for all codes.
- Total unadjusted error (TUE) — This error is defined as the difference between the actual transfer function and the ideal straight-line transfer function and includes all forms of error.

13.5.1.6 Code Jitter, Non-Monotonicity, and Missing Codes

Analog-to-digital converters are susceptible to three special forms of error. These are code jitter, non-monotonicity, and missing codes.

Code jitter is when, at certain points, a given input voltage converts to one of two values when sampled repeatedly. Ideally, when the input voltage is infinitesimally smaller than the transition voltage, the converter yields the lower code (and vice-versa). However, even small amounts of system noise can cause the converter to be indeterminate (between two codes) for a range of input voltages around the transition voltage. This range is normally around $\pm 1/2$ lsb in 8-bit or 10-bit mode, or around 2 lsb in 12-bit mode, and increases with noise.

This error may be reduced by repeatedly sampling the input and averaging the result. Additionally the techniques discussed in [Noise-Induced Errors](#) reduces this error.

Non-monotonicity is defined as when, except for code jitter, the converter converts to a lower code for a higher input voltage. Missing codes are those values never converted for any input value.

In 8-bit or 10-bit mode, the ADC is guaranteed to be monotonic and have no missing codes.

13.6 Memory map and register definition

The ADC-Digital contains 32-bit, word aligned, byte enables registers; byte or half word access are not supported. All configuration registers are accessible via 32-bit access bus Interface. Write access to reserved locations have no impact while read access to reserved locations always return 0.

NOTE

No protection or indication mechanism is available (for example, 32-bit access starting with address offset value 0x01 or 0x02 or 0x03). The ADC does not check for correctness of the programmed values in the registers and the programmer must ensure that correct values are being written.

ADC memory map

Absolute address (hex)	Register name	Width (in bits)	Access	Reset value	Section/ page
219_8000	Control register (ADC1_HC0)	32	R/W	0000_001Fh	13.6.1/417
219_8008	Status register (ADC1_HS)	32	R (reads 0)	0000_0000h	13.6.2/418
219_800C	Data result register (ADC1_R0)	32	R	0000_0000h	13.6.3/419
219_8014	Configuration register (ADC1_CFG)	32	R/W	0000_0200h	13.6.4/420
219_8018	General control register (ADC1_GC)	32	R/W	0000_0000h	13.6.5/422
219_801C	General status register (ADC1_GS)	32	R/W	0000_0000h	13.6.6/424
219_8020	Compare value register (ADC1_CV)	32	R/W	0000_0000h	13.6.7/425
219_8024	Offset correction value register (ADC1_OFS)	32	R/W	0000_0000h	13.6.8/426
219_8028	Calibration value register (ADC1_CAL)	32	R/W	0000_0000h	13.6.9/427

13.6.1 Control register (ADCx_HC0)

ADC_HC0 is used to control software triggers. Writing ADC_HC0 while ADC_HC0 is actively controlling a conversion aborts the current conversion. In software trigger mode (ADTRG=0), writes to ADC_HC0 subsequently initiate a new conversion (if the ADCH bits are equal to a value other than all 1s).

Address: Base address + 0h offset

Bit	31	30	29	28	27	26	25	24		23	22	21	20	19	18	17	16
R	0																
W																	
Reset	0	0	0	0	0	0	0	0		0	0	0	0	0	0	0	0
Bit	15	14	13	12	11	10	9	8		7	6	5	4	3	2	1	0
R	0								AIEN	0		ADCH					
W																	
Reset	0	0	0	0	0	0	0	0		0	0	0	1	1	1	1	1

ADCx_HC0 field descriptions

Field	Description
31–8 Reserved	This read-only field is reserved and always has the value 0.
7 AIEN	Conversion Complete Interrupt Enable/Disable Control An interrupt is generated whenever ADC_HS[COCO0]=1 (conversion ADC_HC0 completed), provided the corresponding interrupt is enabled. 1 Conversion complete interrupt enabled 0 Conversion complete interrupt disabled
6–5 Reserved	This read-only field is reserved and always has the value 0.
ADCH	Input Channel Select This 5-bit field selects one of the input channels. The successive approximation converter subsystem is turned off when the channel select bits are all set (ADCH = 11111b). This feature allows for explicit disabling of the ADC and isolation of the input channel from all sources. Terminating continuous conversions this way prevents an additional single conversion from being performed. 00000-01111 External channels 0 to 15. 10000-10111 Reserved 11000 Reserved. 11001 VREFSH = internal channel, for ADC self-test, hard connected to VRH internally 11010 Reserved. 11011 Reserved. 11100-11110 Reserved. 11111 Conversion Disabled.

13.6.2 Status register (ADCx_HS)

Bit 0 is used for software trigger modes of operation.

Address: Base address + 8h offset

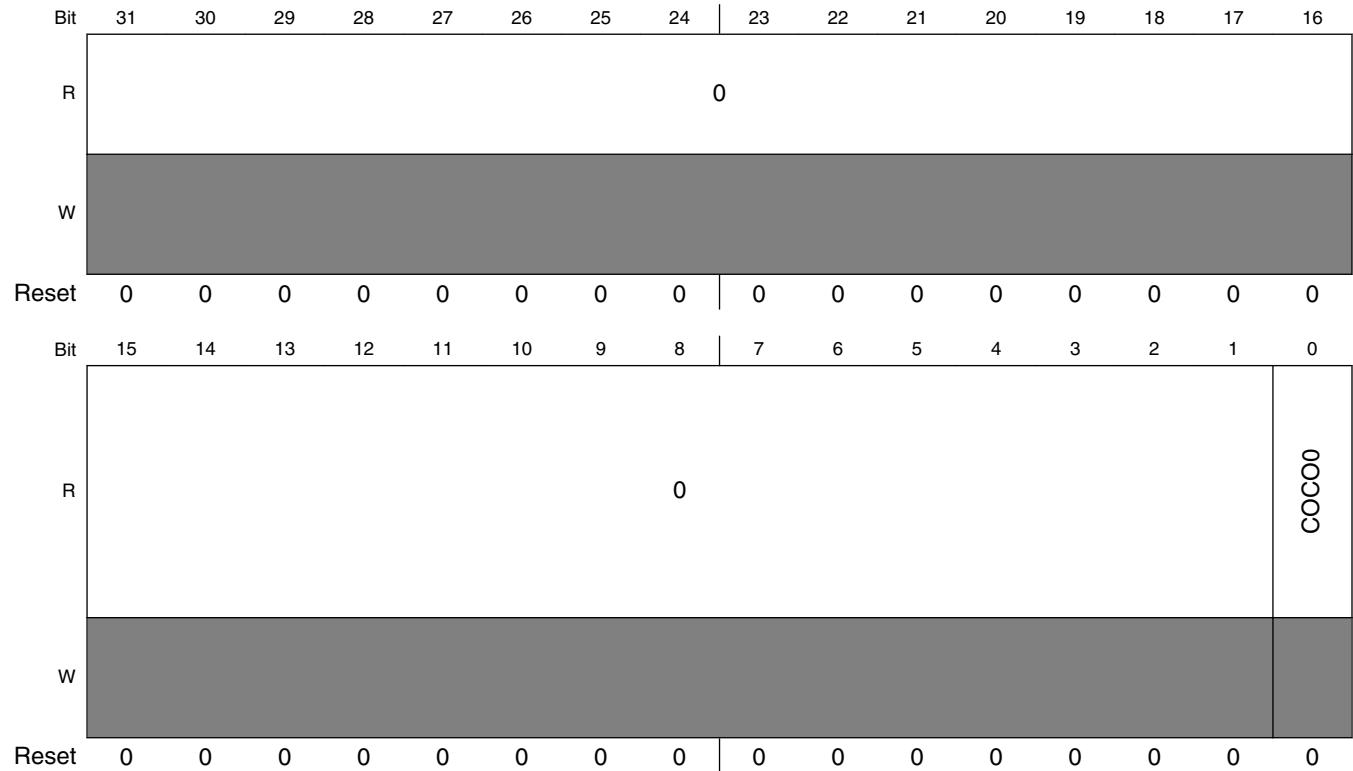

ADCx_HS field descriptions

Field	Description
31–1 Reserved	This read-only field is reserved and always has the value 0.
0 COCO0	<p>Conversion Complete Flag</p> <p>The COCO_n flag is a read-only bit that is set each time a conversion is completed when the compare function is disabled (ADC_GC[ACFE]=0) and the hardware average function is disabled (ADC_GC[AVGE]=0). When the compare function is enabled (ADC_GC[ACFE]=1), the COCO_n flag is set upon completion of a conversion only if the compare result is true. When the hardware average function is enabled (ADC_GC[AVGE]=1), the COCO_n flag is set upon completion of the selected number of conversions (determined by the ADC_CFG[AVGS] field). The COCO₀ flag will also set at the completion of a Calibration and Test sequence. A COCO_n bit is cleared when the respective ADC_HC_n is written or when the respective ADC_R_n is read.</p>

13.6.3 Data result register (ADCx_R0)

Contains the result of an ADC conversion of the channel selected by the respective channel control register (ADC_HC0). Unused bits in the ADC_Rn register are cleared in unsigned right justified modes. For example when configured for 10-bit single-ended mode, D[31:10] are cleared. The table below describes the behavior of the data result registers in the different modes of operation.

Table 13-10. Data Result Register Description

Conversion Mode	Data Result Register bits																Format
	D31	D30	...	D12	D11	D10	D9	D8	D7	D6	D5	D4	D3	D2	D1	D0	
12b single-ended	0	0	0	0	D	D	D	D	D	D	D	D	D	D	D	D	unsigned right justified
10b single-ended	0	0	0	0	0	0	D	D	D	D	D	D	D	D	D	D	unsigned right justified
8b single-ended	0	0	0	0	0	0	0	0	D	D	D	D	D	D	D	D	unsigned right justified

Address: Base address + Ch offset

Bit	31	30	29	28	27	26	25	24	23	22	21	20	19	18	17	16	15	14	13	12	11	10	9	8	7	6	5	4	3	2	1	0
R	0																CDATA															
W	0																0															
Reset	0	0	0	0	0	0	0	0	0	0	0	0	0	0	0	0	0	0	0	0	0	0	0	0	0	0	0	0	0	0	0	0

ADCx_R0 field descriptions

Field	Description
31–12 Reserved	This read-only field is reserved and always has the value 0.
CDATA	Data (result of an ADC conversion)

13.6.4 Configuration register (ADCx_CFG)

Selects the mode of operation, clock source, clock divide, configure for low power, long sample time, high speed configuration and selects the sample time duration.

Address: Base address + 14h offset

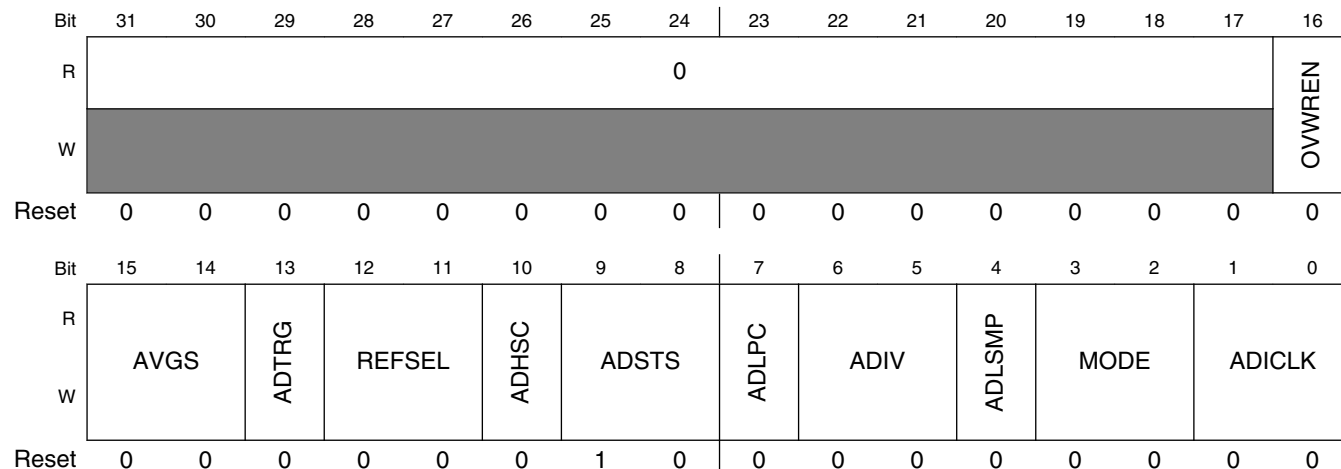

ADCx_CFG field descriptions

Field	Description
31–17 Reserved	This read-only field is reserved and always has the value 0.
16 OVWREN	Data Overwrite Enable Controls the overwriting of the next converted Data onto the existing (previous) unread data into the Data result register. 1 Enable the overwriting. 0 Disable the overwriting. Existing Data in Data result register will not be overwritten by subsequent converted data.
15–14 AVGS	Hardware Average select Determines how many ADC conversions will be averaged to create the ADC average result. This functionality is activated when ADC_GC[AVGE] = 1. 00 4 samples averaged 01 8 samples averaged 10 16 samples averaged 11 32 samples averaged
13 ADTRG	Conversion Trigger Select Only software trigger is supported. When software trigger is selected, a conversion is initiated following a write to ADC_HC0. 0 Software trigger selected 1 Reserved

Table continues on the next page...

ADCx_CFG field descriptions (continued)

Field	Description
12–11 REFSEL	<p>Voltage Reference Selection</p> <p>Selects the voltage reference source used for conversions.</p> <p>00 Selects VREFH/VREFL as reference voltage. 01 Reserved 10 Reserved 11 Reserved</p>
10 ADHSC	<p>High Speed Configuration</p> <p>This bit configures the ADC for high speed operation. The internal ADC clock is higher than normal.</p> <p>0 Normal conversion selected. 1 High speed conversion selected.</p>
9–8 ADSTS	<p>Defines the sample time duration. This has two modes, short and long. When long sample time is selected (ADLSMP=1) this works for long sample time otherwise this works for short sample. This allows higher impedance inputs to be accurately sampled or to maximize conversion speed for lower impedance inputs. Longer sample times can also be used to lower overall power consumption when continuous conversions are enabled if high conversion rates are not required.</p> <p>00 Sample period (ADC clocks) = 2 if ADLSMP=0b Sample period (ADC clocks) = 12 if ADLSMP=1b 01 Sample period (ADC clocks) = 4 if ADLSMP=0b Sample period (ADC clocks) = 16 if ADLSMP=1b 10 Sample period (ADC clocks) = 6 if ADLSMP=0b Sample period (ADC clocks) = 20 if ADLSMP=1b 11 Sample period (ADC clocks) = 8 if ADLSMP=0b Sample period (ADC clocks) = 24 if ADLSMP=1b</p>
7 ADLPC	<p>Low-Power Configuration</p> <p>Puts the ADC hard block into low power mode and reduces the comparator enable period by controlling its timing in the SAR controller block towards the analog hard block.</p> <p>The signal indicating low power mode to the Analog block is asserted when this bit is set.</p> <p>0 ADC hard block not in low power mode. 1 ADC hard block in low power mode.</p>
6–5 ADIV	<p>Clock Divide Select</p> <p>Selects the divide ratio used by the ADC to generate the internal clock ADCK.</p> <p>00 Input clock 01 Input clock / 2 10 Input clock / 4 11 Input clock / 8</p>
4 ADLSMP	<p>Long Sample Time Configuration</p> <p>Selects between different sample times based on the ADC_CFG[ADSTS] field. This bit adjusts the sample period to allow higher impedance inputs to be accurately sampled or to maximize conversion speed for lower impedance inputs. If high conversion rates are not required, longer sample times can also be used</p>

Table continues on the next page...

ADCx_CFG field descriptions (continued)

Field	Description
	to lower overall power consumption when continuous conversions are enabled. When ADLSMP=1, the Long Sample Time mode is selected and the time is defined by ADSTS[1:0] of the ADC_CFG register. 0 Short sample mode. 1 Long sample mode.
3-2 MODE	Conversion Mode Selection Used to set the ADC resolution mode. 00 8-bit conversion 01 10-bit conversion 10 12-bit conversion 11 Reserved
ADICLK	Input Clock Select Selects the input clock source to generate the internal clock ADCK. 00 IPG clock 01 IPG clock divided by 2 10 Reserved 11 Asynchronous clock (ADACK)

13.6.5 General control register (ADCx_GC)

Controls the calibration, continuous convert, hardware averaging functions, conversion active, compare function and voltage reference select of the ADC module.

Address: Base address + 18h offset

Bit	31	30	29	28	27	26	25	24	23	22	21	20	19	18	17	16
R	0															
W	[Shaded]															
Reset	0	0	0	0	0	0	0	0	0	0	0	0	0	0	0	0
Bit	15	14	13	12	11	10	9	8	7	6	5	4	3	2	1	0
R	0								CAL	ADCO	AVGE	ACFE	ACFGT	ACREN	DMAEN	ADACKEN
W	[Shaded]															
Reset	0	0	0	0	0	0	0	0	0	0	0	0	0	0	0	0

ADCx_GC field descriptions

Field	Description
31–8 Reserved	This read-only field is reserved and always has the value 0.
7 CAL	<p>Calibration</p> <p>CAL begins the calibration sequence when set. This bit stays set while the calibration is in progress and is cleared when the calibration sequence is complete. The ADC_GS[CALF] bit must be checked to determine the result of the calibration sequence. Once started, the calibration routine cannot be interrupted by writes to the ADC registers or the results will be invalid and the ADC_GS[CALF] bit will set. Setting the CAL bit will abort any current conversion.</p>
6 ADCO	<p>Continuous Conversion Enable</p> <p>Enables continuous conversions.</p> <p>0 One conversion or one set of conversions if the hardware average function is enabled (AVGE=1) after initiating a conversion.</p> <p>1 Continuous conversions or sets of conversions if the hardware average function is enabled (AVGE=1) after initiating a conversion.</p>
5 AVGE	<p>Hardware average enable</p> <p>Enables the hardware average function of the ADC.</p> <p>0 Hardware average function disabled</p> <p>1 Hardware average function enabled</p>
4 ACFE	<p>Compare Function Enable</p> <p>Enables the compare function.</p> <p>0 Compare function disabled</p> <p>1 Compare function enabled</p>
3 ACFGT	<p>Compare Function Greater Than Enable</p> <p>Configures the compare function to check the conversion result relative to the compare value register (ADC_CV) based upon the value of ACREN (bit 2 in ADC_GC register). The ACFE bit must be set for ACFGT to have any effect.</p> <p>0 Configures "Less Than Threshold, Outside Range Not Inclusive and Inside Range Not Inclusive" functionality based on the values placed in the ADC_CV register.</p> <p>1 Configures "Greater Than Or Equal To Threshold, Outside Range Inclusive and Inside Range Inclusive" functionality based on the values placed in the ADC_CV registers.</p>
2 ACREN	<p>Compare Function Range Enable</p> <p>Configures the compare function to check the conversion result of the input being monitored is either between or outside the range formed by the compare values in register (ADC_CV) determined by the value of ACFGT. The ACFE bit must be set for ACFGT to have any effect.</p> <p>0 Range function disabled. Only the compare value 1 of ADC_CV register (CV1) is compared.</p> <p>1 Range function enabled. Both compare values of ADC_CV registers (CV1 and CV2) are compared.</p>
1 DMAEN	<p>DMA Enable</p> <p>Enables the DMA logic.</p>

Table continues on the next page...

ADCx_GC field descriptions (continued)

Field	Description
	0 DMA disabled (default) 1 DMA enabled
0 ADACKEN	Asynchronous clock output enable Enables the ADC's asynchronous clock source and the clock source output regardless of the conversion and input clock select (ADC_CFG[ADICLK]) settings of the ADC. Based on MCU configuration, the asynchronous clock may be used by other modules (see module introduction section). Setting this bit allows the clock to be used even while the ADC is idle or operating from a different clock source. Also, latency of initiating a single or first-continuous conversion with the asynchronous clock selected is reduced since the ADACK clock is already operational. 0 Asynchronous clock output disabled; Asynchronous clock only enabled if selected by ADICLK and a conversion is active. 1 Asynchronous clock and clock output enabled regardless of the state of the ADC

13.6.6 General status register (ADCx_GS)

Indicates the status of the asynchronous wakeup interrupt, calibration failure and conversion active functions.

Address: Base address + 1Ch offset

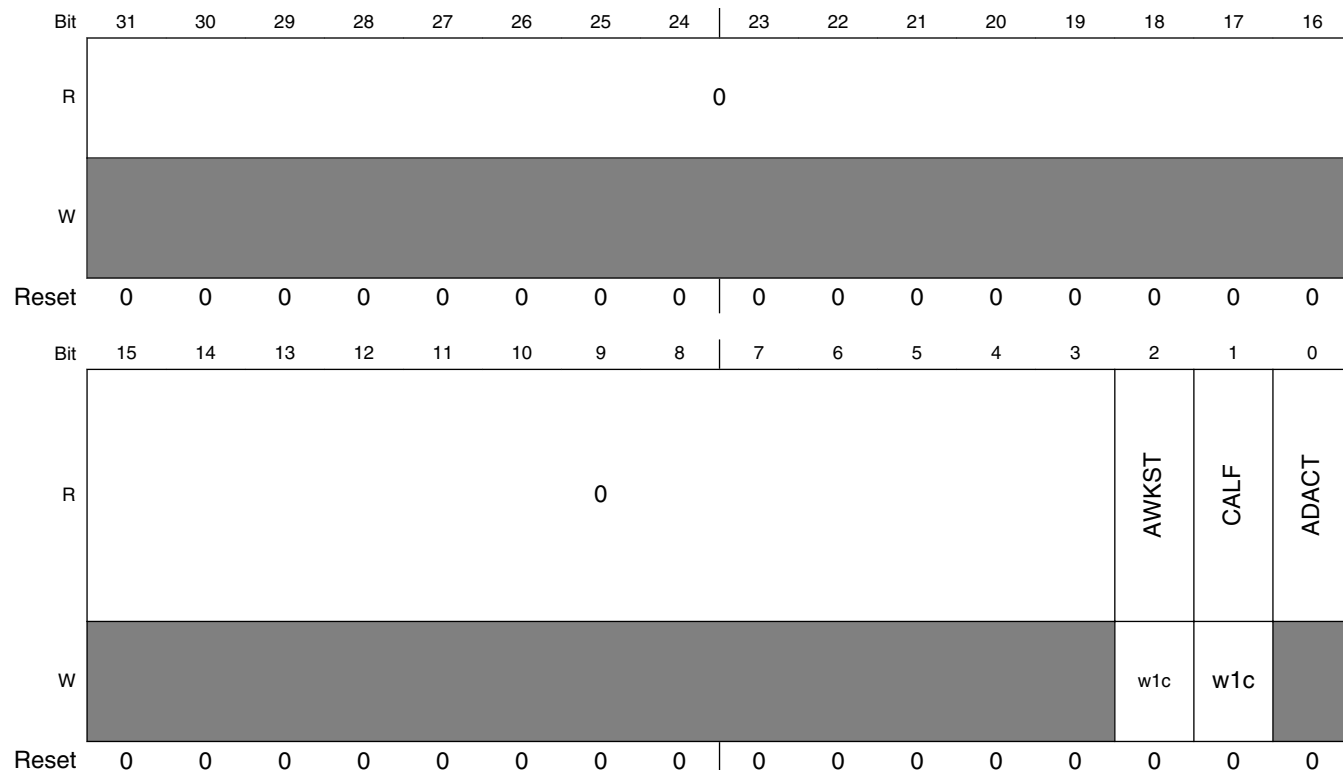

ADCx_GS field descriptions

Field	Description
31–3 Reserved	This read-only field is reserved and always has the value 0.
2 AWKST	Asynchronous wakeup interrupt status Holds the status of asynchronous interrupt status that occurred during stop mode. This bit is set when ipg_stop is deasserted and ipg_clk has started. It is cleared by writing '1' to it. Clearing this bit also deasserts the Asynchronous interrupt to CPU. 1 Asynchronous wake up interrupt occurred in stop mode. 0 No asynchronous interrupt.
1 CALF	Calibration Failed Flag Displays the result of the calibration sequence. The calibration sequence will fail if any ADC register is written, or any stop mode is entered before the calibration sequence completes. The CALF bit is cleared by writing a 1 to it. 0 Calibration completed normally. 1 Calibration failed. ADC accuracy specifications are not guaranteed.
0 ADACT	Conversion Active Indicates that a conversion or hardware averaging is in progress. ADACT is set when a conversion is initiated and cleared when a conversion is completed or aborted. 0 Conversion not in progress. 1 Conversion in progress.

13.6.7 Compare value register (ADCx_CV)

Contains compare values used to compare with the conversion result when the compare function is enabled ($ADC_GC[ACFE]=1$). The compare values are right justified. Therefore, the compare function only uses the compare value register bits that are related to the ADC mode of operation. (e.g. in 8 bit mode, $CV1 = ADC_CV[7:0]$ and $CV2 = ADC_CV[23:16]$, similarly in 10 bit mode, $CV1 = ADC_CV[9:0]$ and $CV2 = ADC_CV[25:16]$ etc.) The compare value 2 in this register is utilized only when the compare range function is enabled ($ADC_GC[ACREN]=1$).

Address: Base address + 20h offset

Bit	31	30	29	28	27	26	25	24	23	22	21	20	19	18	17	16	15	14	13	12	11	10	9	8	7	6	5	4	3	2	1	0
R	0				CV2												0				CV1											
W	0				0												0				0											
Reset	0	0	0	0	0	0	0	0	0	0	0	0	0	0	0	0	0	0	0	0	0	0	0	0	0	0	0	0	0	0	0	

ADCx_CV field descriptions

Field	Description
31–28 Reserved	This read-only field is reserved and always has the value 0.
27–16 CV2	Compare Value 2 Contains a compare value used to compare with the conversion result when the compare function and compare range function are enabled (ADC_GC[ACFE]=1, ADC_GC[ACREN]=1).
15–12 Reserved	This read-only field is reserved and always has the value 0.
CV1	Compare Value 1 Contains a compare value used to compare with the conversion result when the compare function is enabled (ADC_GC[ACFE]=1).

13.6.8 Offset correction value register (ADCx_OFS)

Contains the user-defined offset error correction value. This register is 13 bits wide. The value in the most significant bit (13th bit) is the operation bit. If this bit is ‘0’ then the value in the other 12 bits is added with the converted result value to generate final result to be loaded into ADC_Rn; if this bit is ‘1’ then this field is subtracted from converted value to generate final result (ADC_Rn).

Address: Base address + 24h offset

Bit	31	30	29	28	27	26	25	24		23	22	21	20	19	18	17	16
R	0																
W	[Shaded]																
Reset	0	0	0	0	0	0	0	0		0	0	0	0	0	0	0	0
Bit	15	14	13	12	11	10	9	8		7	6	5	4	3	2	1	0
R	0		SIGN	OFS													
W	[Shaded]		[Shaded]	[Shaded]													
Reset	0	0	0	0	0	0	0	0		0	0	0	0	0	0	0	0

ADCx_OFS field descriptions

Field	Description
31–13 Reserved	This read-only field is reserved and always has the value 0.
12 SIGN	Sign bit 0 The offset value is added with the raw result 1 The offset value is subtracted from the raw converted value
OFS	Offset value User configurable offset value.

13.6.9 Calibration value register (ADCx_CAL)

Contains calibration information that is generated by the calibration function. This register contains a calibration value of four bits(CAL[3:0]); this is automatically set once the self calibration sequence is done (ADC_SC[*CAL*] bit is cleared). If this register is written to by the user after calibration, the linearity error specifications may not be met.

Address: Base address + 28h offset

Bit	31	30	29	28	27	26	25	24	23	22	21	20	19	18	17	16	15	14	13	12	11	10	9	8	7	6	5	4	3	2	1	0
R	0																CAL_CODE															
W																																
Reset	0	0	0	0	0	0	0	0	0	0	0	0	0	0	0	0	0	0	0	0	0	0	0	0	0	0	0	0	0	0	0	0

ADCx_CAL field descriptions

Field	Description
31–4 Reserved	This read-only field is reserved and always has the value 0.
CAL_CODE	Calibration Result Value This value is automatically loaded and updated at the end of calibration.

13.7 Memory map and register definition

The ADC-Digital contains 32-bit, word aligned, byte enables registers; byte or half word access are not supported. All configuration registers are accessible via 32-bit access bus Interface. Write access to reserved locations have no impact while read access to reserved locations always return 0.

NOTE

No protection or indication mechanism is available (for example, 32-bit access starting with address offset value 0x01 or 0x02 or 0x03). The ADC does not check for correctness of the programmed values in the registers and the programmer must ensure that correct values are being written.

ADC memory map

Absolute address (hex)	Register name	Width (in bits)	Access	Reset value	Section/page
219_C000	Control register for hardware triggers (ADC2_HC0)	32	R/W	0000_001Fh	13.7.1/429

Table continues on the next page...

ADC memory map (continued)

Absolute address (hex)	Register name	Width (in bits)	Access	Reset value	Section/page
219_C004	Control register for hardware triggers (ADC2_HC1)	32	R/W	0000_001Fh	13.7.2/430
219_C008	Control register for hardware triggers (ADC2_HC2)	32	R/W	0000_001Fh	13.7.2/430
219_C00C	Control register for hardware triggers (ADC2_HC3)	32	R/W	0000_001Fh	13.7.2/430
219_C010	Control register for hardware triggers (ADC2_HC4)	32	R/W	0000_001Fh	13.7.2/430
219_C014	Status register for HW triggers (ADC2_HS)	32	R (reads 0)	0000_0000h	13.7.3/432
219_C018	Data result register for HW triggers (ADC2_R0)	32	R/W	0000_0000h	13.7.4/433
219_C01C	Data result register for HW triggers (ADC2_R1)	32	R/W	0000_0000h	13.7.5/434
219_C020	Data result register for HW triggers (ADC2_R2)	32	R/W	0000_0000h	13.7.5/434
219_C024	Data result register for HW triggers (ADC2_R3)	32	R/W	0000_0000h	13.7.5/434
219_C028	Data result register for HW triggers (ADC2_R4)	32	R/W	0000_0000h	13.7.5/434
219_C02C	Configuration register (ADC2_CFG)	32	R/W	0000_0200h	13.7.6/435
219_C030	General control register (ADC2_GC)	32	R/W	0000_0000h	13.7.7/437
219_C034	General status register (ADC2_GS)	32	R/W	0000_0000h	13.7.8/439
219_C038	Compare value register (ADC2_CV)	32	R/W	0000_0000h	13.7.9/440
219_C03C	Offset correction value register (ADC2_OFS)	32	R/W	0000_0000h	13.7.10/441
219_C040	Calibration value register (ADC2_CAL)	32	R/W	0000_0000h	13.7.11/442

13.7.1 Control register for hardware triggers (ADCx_HC0)

ADC_HC0 can be used for both software and hardware trigger mode. Other ADC_HC n ($n = 1\dots$) are for use only in hardware trigger mode. The ADC_HC0 to ADC_HC n ($n = 0,1$) registers have identical fields, and are used to control ADC operation. At any one point in time, only one of the ADC_HC0 to ADC_HC n ($n = 0,1$) registers is actively controlling ADC conversions. Updating ADC_HC0 while ADC_HC n ($n = 0,1$) is actively controlling a conversion is allowed (and vice-versa for any of the ADC_HC n ($n = 0,1$) registers). Writing ADC_HC0 while ADC_HC0 is actively controlling a conversion aborts the current conversion. In software trigger mode (ADTRG=0), writes to ADC_HC0 subsequently initiates a new conversion (if the ADCH bits are equal to a value other than all 1s). Similarly, writing any of the ADC_HC n ($n = 0,1$) registers while that specific ADC_HC register is actively controlling a conversion aborts the current conversion. ADC_HC1 register is not used for software trigger operation and therefore writes to any of them do not initiate a new conversion.

Address: Base address + 0h offset

Bit	31	30	29	28	27	26	25	24		23	22	21	20	19	18	17	16
R	0																
W																	
Reset	0	0	0	0	0	0	0	0		0	0	0	0	0	0	0	0
Bit	15	14	13	12	11	10	9	8		7	6	5	4	3	2	1	0
R	0								AIEN	0		ADCH					
W																	
Reset	0	0	0	0	0	0	0	0		0	0	0	1	1	1	1	1

ADCx_HC0 field descriptions

Field	Description
31–8 Reserved	This read-only field is reserved and always has the value 0.
7 AIEN	Conversion Complete Interrupt Enable/Disable Control An interrupt is generated whenever ADC_HS[COCO0]=1 (conversion ADC_HC0 completed), provided the corresponding interrupt is enabled. 1 Conversion complete interrupt enabled 0 Conversion complete interrupt disabled
6–5 Reserved	This read-only field is reserved and always has the value 0.
ADCH	Input Channel Select This 5-bit field selects one of the input channels. The successive approximation converter subsystem is turned off when the channel select bits are all set (ADCH = 11111b). This feature allows for explicit

Table continues on the next page...

ADCx_HC0 field descriptions (continued)

Field	Description
	disabling of the ADC and isolation of the input channel from all sources. Terminating continuous conversions this way prevents an additional single conversion from being performed.
00000-01111	External channels 0 to 15.
10000-10111	Reserved
11000	Reserved.
11001	VREFSH = internal channel, for ADC self-test, hard connected to VRH internally
11010	Reserved.
11011	Reserved.
11100-11110	Reserved.
11111	Conversion Disabled. Hardware Triggers will not initiate any conversion.

13.7.2 Control register for hardware triggers (ADCx_HCn)

ADC_HCn are for use only in hardware trigger mode. The ADC_HC0 to ADC_HCn registers have identical fields, and are used to control ADC operation. At any one point in time, only one of the ADC_HC0 to ADC_HCn registers is actively controlling ADC conversions. Updating ADC_HC0 while ADC_HCn is actively controlling a conversion is allowed (and vice-versa for any of the ADC_HCn registers). Writing any of the ADC_HCn registers while that specific ADC_HCn register is actively controlling a conversion aborts the current conversion. Any of the ADC_HC1 - ADC_HCn registers are not used for software trigger operation and therefore writes to any of them do not initiate a new conversion.

Address: Base address + 4h offset + (4d × i), where i=0d to 3d

Bit	31	30	29	28	27	26	25	24	23	22	21	20	19	18	17	16	
R	0																
W																	
Reset	0	0	0	0	0	0	0	0	0	0	0	0	0	0	0	0	
Bit	15	14	13	12	11	10	9	8	7	6	5	4	3	2	1	0	
R	0								AIEN	0		ADCH					
W																	
Reset	0	0	0	0	0	0	0	0	0	0	0	1	1	1	1	1	

ADCx_HCn field descriptions

Field	Description
31–8 Reserved	This read-only field is reserved and always has the value 0.

Table continues on the next page...

ADCx_HCn field descriptions (continued)

Field	Description
7 AIEN	<p>Conversion Complete Interrupt Enable/Disable Control</p> <p>An interrupt is generated whenever ADC_HS[COCO0]=1 (conversion ADC_HC0 completed), provided the corresponding interrupt is enabled.</p> <p>1 Conversion complete interrupt enabled 0 Conversion complete interrupt disabled</p>
6–5 Reserved	This read-only field is reserved and always has the value 0.
ADCH	<p>Input Channel Select</p> <p>This 5-bit field selects one of the input channels. The successive approximation converter subsystem is turned off when the channel select bits are all set (ADCH = 11111b). This feature allows for explicit disabling of the ADC and isolation of the input channel from all sources. Terminating continuous conversions this way prevents an additional single conversion from being performed.</p> <p>00000-01111 External channels 0 to 15. 10000-10111 Reserved 11000 Reserved 11001 VREFSH = internal channel, for ADC self-test, hard connected to VRH internally 11010 Reserved 11011 Reserved 11100-11110 Reserved 11111 Conversion Disabled. Hardware Triggers will not initiate any conversion.</p>

13.7.3 Status register for HW triggers (ADCx_HS)

Bit 0 is used for both software and hardware trigger modes of operation. Bit 1 to bit (n-1) indicate the rest of the HW triggers' statuses similar to bit 0, potentially corresponding to multiple ADC_HC registers (for use only in hardware trigger mode).

Address: Base address + 14h offset

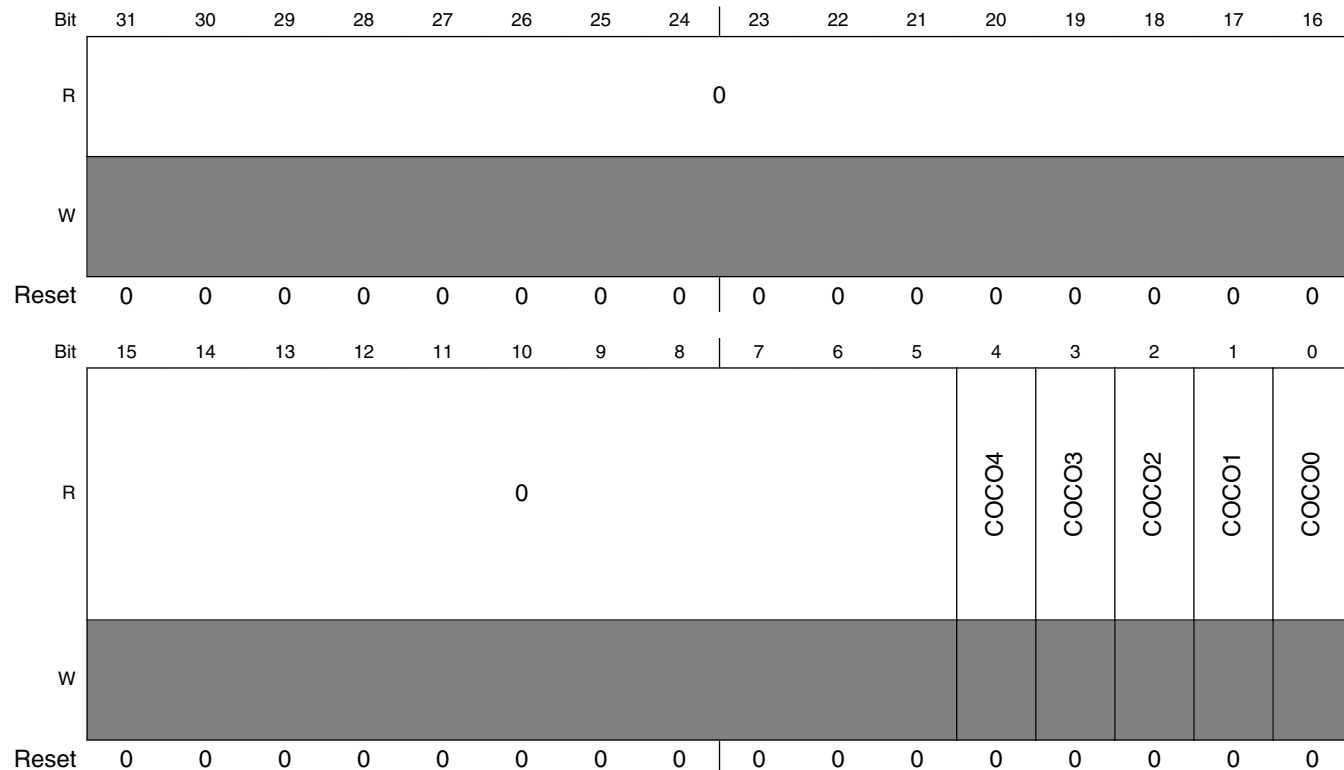

ADCx_HS field descriptions

Field	Description
31–5 Reserved	This read-only field is reserved and always has the value 0.
4 COCO4	See description for COCO0.
3 COCO3	See description for COCO0.
2 COCO2	See description for COCO0.
1 COCO1	See description for COCO0.
0 COCO0	Conversion Complete Flag

Table continues on the next page...

ADCx_HS field descriptions (continued)

Field	Description
	The COCON flag is a read-only bit that is set each time a conversion is completed when the compare function is disabled (ADC_GC[ACFE]=0) and the hardware average function is disabled (ADC_GC[AVGE]=0). When the compare function is enabled (ADC_GC[ACFE]=1), the COCON flag is set upon completion of a conversion only if the compare result is true. When the hardware average function is enabled (ADC_GC[AVGE]=1), the COCON flag is set upon completion of the selected number of conversions (determined by the ADC_CFG[AVGS] field). The COCO0 flag will also set at the completion of a Calibration and Test sequence. A COCON bit is cleared when the respective ADC_HCn is written or when the respective ADC_Rn is read.

13.7.4 Data result register for HW triggers (ADCx_R0)

Contains the result of an ADC conversion of the channel selected by the respective hardware trigger and channel control register (ADC_HC0:ADC_HCn). For every ADC_HC0:ADC_HCn status and channel control register, there is a respective ADC_R0:ADC_Rn data result register. Unused bits in the ADC_Rn register are cleared in unsigned right justified modes. For example when configured for 10-bit single-ended mode, D[31:10] are cleared. The table below describes the behavior of the data result registers in the different modes of operation.

Table 13-11. Data Result Register Description

Conversion Mode	Data Result Register bits															Format	
	D31	D30	...	D12	D11	D10	D9	D8	D7	D6	D5	D4	D3	D2	D1		D0
12b single-ended	0	0	0	0	D	D	D	D	D	D	D	D	D	D	D	D	unsigned right justified
10b single-ended	0	0	0	0	0	0	D	D	D	D	D	D	D	D	D	D	unsigned right justified
8b single-ended	0	0	0	0	0	0	0	0	D	D	D	D	D	D	D	D	unsigned right justified

Address: Base address + 18h offset

Bit	31	30	29	28	27	26	25	24	23	22	21	20	19	18	17	16	15	14	13	12	11	10	9	8	7	6	5	4	3	2	1	0
R	0															CDATA																
W																																
Reset	0	0	0	0	0	0	0	0	0	0	0	0	0	0	0	0	0	0	0	0	0	0	0	0	0	0	0	0	0	0	0	0

ADCx_R0 field descriptions

Field	Description
31–12 Reserved	This read-only field is reserved and always has the value 0.
CDATA	Data (result of an ADC conversion)

13.7.5 Data result register for HW triggers (ADCx_Rn)

Contains the result of an ADC conversion of the channel selected by the respective Hardware Trigger and channel control register (ADC_HC0:ADC_HCn). For every ADC_HC0:ADC_HCn status and channel control register, there is a respective ADC_R0 to ADC_Rn data result register. Unused bits in the ADC_Rn register are cleared in unsigned right justified modes. For example when configured for 10-bit single-ended mode, D[31:10] are cleared. The table below describes the behavior of the data result registers in the different modes of operation.

Table 13-12. Data Result Register Description

Conversion Mode	Data Result Register bits															Format	
	D31	D30	...	D12	D11	D10	D9	D8	D7	D6	D5	D4	D3	D2	D1		D0
12b single-ended	0	0	0	0	D	D	D	D	D	D	D	D	D	D	D	D	unsigned right justified
10b single-ended	0	0	0	0	0	0	D	D	D	D	D	D	D	D	D	D	unsigned right justified
8b single-ended	0	0	0	0	0	0	0	0	D	D	D	D	D	D	D	D	unsigned right justified

Address: Base address + 1Ch offset + (4d × i), where i=0d to 3d

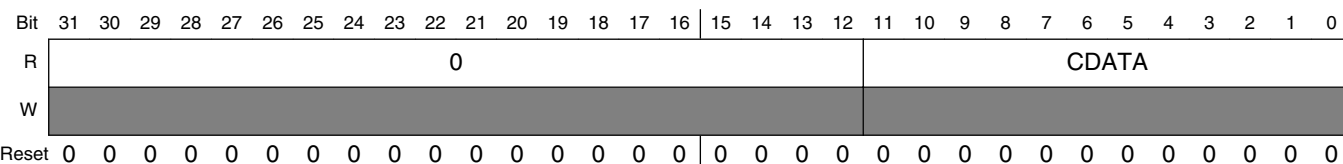

ADCx_Rn field descriptions

Field	Description
31–12 Reserved	This read-only field is reserved and always has the value 0.
CDATA	Data (result of an ADC conversion)

13.7.6 Configuration register (ADCx_CFG)

Selects the mode of operation, clock source, clock divide, configure for low power, long sample time, high speed configuration and selects the sample time duration.

Address: Base address + 2Ch offset

Bit	31	30	29	28	27	26	25	24	23	22	21	20	19	18	17	16
R	0															OVWREN
W																
Reset	0	0	0	0	0	0	0	0	0	0	0	0	0	0	0	0
Bit	15	14	13	12	11	10	9	8	7	6	5	4	3	2	1	0
R	AVGS	ADTRG	REFSEL	ADHSC	ADSTS	ADLPC	ADIV	ADLSMP	MODE	ADICLK						
W																
Reset	0	0	0	0	0	0	1	0	0	0	0	0	0	0	0	0

ADCx_CFG field descriptions

Field	Description
31–17 Reserved	This read-only field is reserved and always has the value 0.
16 OVWREN	Data Overwrite Enable Controls the overwriting of the next converted Data onto the existing (previous) unread data into the Data result register. 1 Enable the overwriting. 0 Disable the overwriting. Existing Data in Data result register will not be overwritten by subsequent converted data.
15–14 AVGS	Hardware Average select Determines how many ADC conversions will be averaged to create the ADC average result. This functionality is activated when ADC_GC[AVGE] = 1. 00 4 samples averaged 01 8 samples averaged 10 16 samples averaged 11 32 samples averaged
13 ADTRG	Conversion Trigger Select Selects the type of trigger used for initiating a conversion. Two types of trigger are selectable: software trigger and hardware trigger. When software trigger is selected, a conversion is initiated following a write to ADC_HC0. When hardware trigger is selected, a conversion is initiated following the assertion of a pulse on Alternate Hardware trigger input along with the assertion of the enable of respective the hardware Triggers input.

Table continues on the next page...

ADCx_CFG field descriptions (continued)

Field	Description
	0 Software trigger selected 1 Hardware trigger selected
12–11 REFSEL	Voltage Reference Selection Selects the voltage reference source used for conversions. 00 Selects VREFH/VREFL as reference voltage. 01 Reserved 10 Reserved 11 Reserved
10 ADHSC	High Speed Configuration This bit configures the ADC for high speed operation. The internal ADC clock is higher than normal. 0 Normal conversion selected. 1 High speed conversion selected.
9–8 ADSTS	Defines the sample time duration. This has two modes, short and long. When long sample time is selected (ADLSMP=1) this works for long sample time otherwise this works for short sample. This allows higher impedance inputs to be accurately sampled or to maximize conversion speed for lower impedance inputs. Longer sample times can also be used to lower overall power consumption when continuous conversions are enabled if high conversion rates are not required. 00 Sample period (ADC clocks) = 2 if ADLSMP=0b Sample period (ADC clocks) = 12 if ADLSMP=1b 01 Sample period (ADC clocks) = 4 if ADLSMP=0b Sample period (ADC clocks) = 16 if ADLSMP=1b 10 Sample period (ADC clocks) = 6 if ADLSMP=0b Sample period (ADC clocks) = 20 if ADLSMP=1b 11 Sample period (ADC clocks) = 8 if ADLSMP=0b Sample period (ADC clocks) = 24 if ADLSMP=1b
7 ADLPC	Low-Power Configuration Puts the ADC hard block into low power mode and reduces the comparator enable period by controlling its timing in the SAR controller block towards the analog hard block. The signal indicating low power mode to the Analog block is asserted when this bit is set. 0 ADC hard block not in low power mode. 1 ADC hard block in low power mode.
6–5 ADIV	Clock Divide Select Selects the divide ratio used by the ADC to generate the internal clock ADCK. 00 Input clock 01 Input clock / 2 10 Input clock / 4 11 Input clock / 8
4 ADLSMP	Long Sample Time Configuration

Table continues on the next page...

ADCx_CFG field descriptions (continued)

Field	Description
	<p>Selects between different sample times based on the ADC_CFG[ADSTS] field. This bit adjusts the sample period to allow higher impedance inputs to be accurately sampled or to maximize conversion speed for lower impedance inputs. If high conversion rates are not required, longer sample times can also be used to lower overall power consumption when continuous conversions are enabled. When ADLSMP=1, the Long Sample Time mode is selected and the time is defined by ADSTS[1:0] of the ADC_CFG register.</p> <p>0 Short sample mode. 1 Long sample mode.</p>
3–2 MODE	<p>Conversion Mode Selection</p> <p>Used to set the ADC resolution mode.</p> <p>00 8-bit conversion 01 10-bit conversion 10 12-bit conversion 11 Reserved</p>
ADICLK	<p>Input Clock Select</p> <p>Selects the input clock source to generate the internal clock ADCK.</p> <p>00 IPG clock 01 IPG clock divided by 2 10 Reserved 11 Asynchronous clock (ADACK)</p>

13.7.7 General control register (ADCx_GC)

Controls the calibration, continuous convert, hardware averaging functions, conversion active, hardware/software trigger select, compare function and voltage reference select of the ADC module.

Address: Base address + 30h offset

Bit	31	30	29	28	27	26	25	24	23	22	21	20	19	18	17	16
R	0															
W																
Reset	0	0	0	0	0	0	0	0	0	0	0	0	0	0	0	0
Bit	15	14	13	12	11	10	9	8	7	6	5	4	3	2	1	0
R	0								CAL	ADCO	AVGE	ACFE	ACFGT	ACREN	DMAEN	ADACKEN
W																
Reset	0	0	0	0	0	0	0	0	0	0	0	0	0	0	0	0

ADCx_GC field descriptions

Field	Description
31–8 Reserved	This read-only field is reserved and always has the value 0.
7 CAL	<p>Calibration</p> <p>CAL begins the calibration sequence when set. This bit stays set while the calibration is in progress and is cleared when the calibration sequence is complete. The ADC_GS[CALF] bit must be checked to determine the result of the calibration sequence. Once started, the calibration routine cannot be interrupted by writes to the ADC registers or the results will be invalid and the ADC_GS[CALF] bit will set. Setting the CAL bit will abort any current conversion.</p>
6 ADCO	<p>Continuous Conversion Enable</p> <p>Enables continuous conversions.</p> <p>0 One conversion or one set of conversions if the hardware average function is enabled (AVGE=1) after initiating a conversion. 1 Continuous conversions or sets of conversions if the hardware average function is enabled (AVGE=1) after initiating a conversion.</p>
5 AVGE	<p>Hardware average enable</p> <p>Enables the hardware average function of the ADC.</p> <p>0 Hardware average function disabled 1 Hardware average function enabled</p>
4 ACFE	<p>Compare Function Enable</p> <p>Enables the compare function.</p> <p>0 Compare function disabled 1 Compare function enabled</p>
3 ACFGT	<p>Compare Function Greater Than Enable</p> <p>Configures the compare function to check the conversion result relative to the compare value register (ADC_CV) based upon the value of ACREN (bit 2 in ADC_GC register). The ACFE bit must be set for ACFGT to have any effect.</p> <p>0 Configures "Less Than Threshold, Outside Range Not Inclusive and Inside Range Not Inclusive" functionality based on the values placed in the ADC_CV register. 1 Configures "Greater Than Or Equal To Threshold, Outside Range Inclusive and Inside Range Inclusive" functionality based on the values placed in the ADC_CV registers.</p>
2 ACREN	<p>Compare Function Range Enable</p> <p>Configures the compare function to check the conversion result of the input being monitored is either between or outside the range formed by the compare values in register (ADC_CV) determined by the value of ACFGT. The ACFE bit must be set for ACFGT to have any effect.</p> <p>0 Range function disabled. Only the compare value 1 of ADC_CV register (CV1) is compared. 1 Range function enabled. Both compare values of ADC_CV registers (CV1 and CV2) are compared.</p>
1 DMAEN	<p>DMA Enable</p> <p>Enables the DMA logic.</p>

Table continues on the next page...

ADCx_GC field descriptions (continued)

Field	Description
	0 DMA disabled (default) 1 DMA enabled
0 ADACKEN	Asynchronous clock output enable Enables the ADC's asynchronous clock source and the clock source output regardless of the conversion and input clock select (ADC_CFG[ADICLK]) settings of the ADC. Based on MCU configuration, the asynchronous clock may be used by other modules (see module introduction section). Setting this bit allows the clock to be used even while the ADC is idle or operating from a different clock source. Also, latency of initiating a single or first-continuous conversion with the asynchronous clock selected is reduced since the ADACK clock is already operational. 0 Asynchronous clock output disabled; Asynchronous clock only enabled if selected by ADICLK and a conversion is active. 1 Asynchronous clock and clock output enabled regardless of the state of the ADC

13.7.8 General status register (ADCx_GS)

Controls the calibration, continuous convert, hardware averaging functions, conversion active, hardware/software trigger select, compare function and voltage reference select of the ADC module.

Address: Base address + 34h offset

Bit	31	30	29	28	27	26	25	24	23	22	21	20	19	18	17	16
R	0															
W																
Reset	0	0	0	0	0	0	0	0	0	0	0	0	0	0	0	0
Bit	15	14	13	12	11	10	9	8	7	6	5	4	3	2	1	0
R	0													AWKST	CALF	ADACT
W														w1c	w1c	
Reset	0	0	0	0	0	0	0	0	0	0	0	0	0	0	0	0

ADCx_GS field descriptions

Field	Description
31–3 Reserved	This read-only field is reserved and always has the value 0.
2 AWKST	Asynchronous wakeup interrupt status Holds the status of asynchronous interrupt status that occurred during stop mode. This bit is set when ipg_stop is deasserted and ipg_clk has started. It is cleared by writing '1' to it. Clearing this bit also deasserts the Asynchronous interrupt to CPU. 1 Asynchronous wake up interrupt occurred in stop mode. 0 No asynchronous interrupt.
1 CALF	Calibration Failed Flag Displays the result of the calibration sequence. The calibration sequence will fail if Hardware Trigger is selected (i.e. ADC_CFG[ADTRG] = 1), or any ADC register is written, or any stop mode is entered before the calibration sequence completes. The CALF bit is cleared by writing a 1 to it. 0 Calibration completed normally. 1 Calibration failed. ADC accuracy specifications are not guaranteed.
0 ADACT	Conversion Active Indicates that a conversion or hardware averaging is in progress. ADACT is set when a conversion is initiated and cleared when a conversion is completed or aborted. 0 Conversion not in progress. 1 Conversion in progress.

13.7.9 Compare value register (ADCx_CV)

Contains compare values used to compare with the conversion result when the compare function is enabled (ADC_GC[ACFE]=1). The compare values are right justified. Therefore, the compare function only uses the compare value register bits that are related to the ADC mode of operation. (e.g. in 8 bit mode, CV1 = ADC_CV[7:0] and CV2 = ADC_CV[23:16], similarly in 10 bit mode, CV1 = ADC_CV[9:0] and CV2 = ADC_CV[25:16] etc.) The compare value 2 in this register is utilized only when the compare range function is enabled (ADC_GC[ACREN]=1).

Address: Base address + 38h offset

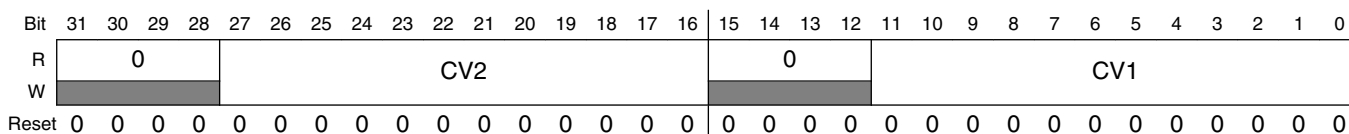

ADCx_CV field descriptions

Field	Description
31–28 Reserved	This read-only field is reserved and always has the value 0.
27–16 CV2	Compare Value 2 Contains a compare value used to compare with the conversion result when the compare function and compare range function are enabled (ADC_GC[ACFE]=1, ADC_GC[ACREN]=1).
15–12 Reserved	This read-only field is reserved and always has the value 0.
CV1	Compare Value 1 Contains a compare value used to compare with the conversion result when the compare function is enabled (ADC_GC[ACFE]=1).

13.7.10 Offset correction value register (ADCx_OFS)

Contains the user-defined offset error correction value. This register is 13 bits wide. The value in the most significant bit (13th bit) is the operation bit. If this bit is ‘0’ then the value in the other 12 bits is added with the converted result value to generate final result to be loaded into ADC_Rn; if this bit is ‘1’ then this field is subtracted from converted value to generate final result (ADC_Rn).

Address: Base address + 3Ch offset

Bit	31	30	29	28	27	26	25	24		23	22	21	20	19	18	17	16
R	0																
W																	
Reset	0	0	0	0	0	0	0	0		0	0	0	0	0	0	0	0
Bit	15	14	13	12	11	10	9	8		7	6	5	4	3	2	1	0
R	0			SIGN	OFS												
W																	
Reset	0	0	0	0	0	0	0	0		0	0	0	0	0	0	0	0

ADCx_OFS field descriptions

Field	Description
31–13 Reserved	This read-only field is reserved and always has the value 0.
12 SIGN	Sign bit 0 The offset value is added with the raw result 1 The offset value is subtracted from the raw converted value
OFS	Offset value User configurable offset value.

13.7.11 Calibration value register (ADCx_CAL)

Contains calibration information that is generated by the calibration function. This register contains a calibration value of four bits(CAL[3:0]); this is automatically set once the self calibration sequence is done (ADC_SC[CAL] bit is cleared). If this register is written to by the user after calibration, the linearity error specifications may not be met.

Address: Base address + 40h offset

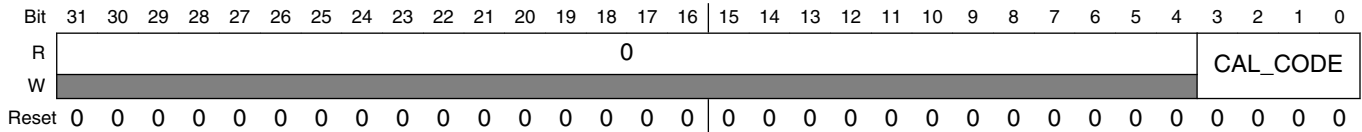

ADCx_CAL field descriptions

Field	Description
31–4 Reserved	This read-only field is reserved and always has the value 0.
CAL_CODE	Calibration Result Value This value is automatically loaded and updated at the end of calibration.

Chapter 14

AHB to IP Bridge (AIPSTZ)

14.1 Overview

This section provides an overview of the AHB to IP Bridge (AIPSTZ). This particular peripheral is designed as the bridge between AHB bus and peripherals with the lower bandwidth IP Slave (IPS) buses.

14.1.1 Features

The following list summarizes the key features of the bridge:

- The bridge supports the IPS slave bus signals. This interface is only meant for slave peripherals.
- The bridge supports 8-, 16-, and 32-bit IPS peripherals. (Accesses larger than the size of a peripheral are not supported, except to 32-bit memory.)
- The bridge supports a pair of IPS accesses for 64-bit and certain misaligned AHB transfers to 32-bit memory in 64-bit platforms.
- The bridge directly supports up to 32 16-Kbyte external IPS peripherals, and 2 global external IPS peripheral spaces. The bridge occupies 1 MBytes of total address space.
- The bridge provides configurable per-block and per-master access protections. Access permissions are based on bus master (e.g. DMA or core) privilege levels and resource domain. More details on the protection features and configuration can be found in the Security Reference Manual
- Peripheral read transactions require a minimum of 2 hclk clocks, and unbuffered write transactions require a minimum of 3 hclk clocks.
- The bridge uses one single asynchronous reset and one global clock.

14.2 Clocks

The following table describes the clock sources for AIPSTZ. Please see [Clock Controller Module \(CCM\)](#) for clock setting, configuration and gating information.

Table 14-1. AIPSTZ Clocks

Clock name	Clock Root	Description
hclk	ahb_clk_root	Module clock

14.3 Functional Description

The AIPS bridge serves as a protocol translator between the AHB system bus and the IP bus.

Support is provided for generating a pair of 32-bit IP bus accesses when targeted by a 64-bit system bus access, or a misaligned access which crosses a 32-bit boundary. No other bus-sizing access support is provided.

The AHB to IP bridge is the interface between the AHB and on-chip IPS peripherals, which are sub-blocks containing readable/writable control and status registers.

The AHB master reads and writes these registers through the AIPSTZ. The bridge generates block enables, the block address, transfer attributes, byte enables and write data as inputs to the IPS peripherals. The bridge captures read data from the IPS interface and drives it on the AHB.

Each bridge that connects to the IPS (or peripherals) are referred as AIPS. The chip has three separate AIPS modules, and peripherals are grouped and assigned under each AIPS block. The list of peripherals are indicated as n-1, n-2, and n-3 for AIPS-1, AIPS-2, and AIPS-3 respectively.

AIPS occupies a 1-Mbyte portion of the address space. The register maps of the IPS peripherals are located on 16-Kbyte boundaries. Each IPS peripheral is allocated one 16-Kbyte block of the memory map, and is activated by one of the block enables from the bridge. Up to thirty-two 16-Kbyte external IPS peripherals may be implemented, occupying contiguous blocks of 16-Kbytes. Two global external IPS block enables are available for the remaining address space to allow for customization and expansion of addressed peripheral devices. In addition, a single "non-global" block enable is also asserted whenever any of the thirty-two non-global block enables is asserted.

The bridge is responsible for indicating to IPS peripherals if an access is in supervisor or user mode. It may block user mode accesses to certain IPS peripherals or it may allow the individual IPS peripherals to determine if user mode accesses are allowed. In addition, peripherals may be designated as write-protected.

The bridge supports the notion of "trusted" masters for security purposes. Masters may be individually designated as trusted for reads, trusted for writes, or trusted for both reads and writes, as well as being forced to look as though all accesses from a master are in user-mode privilege level. Refer to [AIPSTZ Memory Map/Register Definition](#) for more information.

The AIPSTZ prevents access to a peripheral if the transaction originated from a source from a resource domain that has been explicitly omitted. Resource domains are assigned in the RDC submodule. Please refer to the RDC chapter for programming details.

All peripheral devices are expected to only require aligned accesses equal to or smaller in size than the peripheral size. An exception to this rule is supported for 32-bit peripherals to allow memory to be placed on the IPS.

14.4 Access Protections

The AIPSTZ bridge provides programmable access protections for both masters and peripherals. It allows the privilege level of a master to be overridden, forcing it to user-mode privilege, and allows masters to be designated as trusted or untrusted.

Peripherals may require supervisor privilege level for access, may restrict access to a trusted master only, and may be write-protected. IP bus peripherals are subject to access control policies set in both CSU registers and AIPSTZ registers. An access is blocked if it is denied by either policy.

Masters and peripherals are assigned to one or more resource domains in the RDC submodule (see the RDC chapter for details). Depending on RDC programming, masters transactions through the AIPSTZ may or may not be allowed access to peripherals in different resource domains.

14.5 Access Support

Aligned 64-bit accesses, aligned and misaligned word and half word accesses, as well as byte accesses are supported for 32-bit peripherals. Misaligned accesses are supported to allow memory to be placed on the IPS.

Peripheral registers must not be misaligned, although no explicit checking is performed by the AIPS bridge. The bridge will perform two IPS transfers for 64-bit accesses, word accesses with byte offsets of 1, 2, or 3, and for half word accesses with a byte offset of 3. All other accesses will be performed with a single IPS transfer.

Only aligned half word and byte accesses are supported for 16-bit peripherals. All other accesses types are unsupported, and results of such accesses are undefined. They are not terminated with an error response.

Only byte accesses are supported for 8-bit peripherals. All other accesses types are unsupported, and results of such accesses are undefined. They are not terminated with an error response.

14.6 Initialization Information

The AIPS bridge should be programmed before use.

The following registers should be initialized: The Master Privilege Registers (AIPSTZ_MPRs), the Peripheral Access Control registers (AIPSTZ_PACRs), and the Off-platform Peripheral Access Control registers (AIPSTZ_OPACRs) described in [AIPSTZ Memory Map/Register Definition](#).

14.6.1 Security Block

The AIPSTZ contains a security block that is connected to each off-platform peripheral. This block filters accesses based on write/read, non-secure, and supervisor signals.

Each peripheral can be individually configured to allow or deny each of the following transactions as described in the table below:

Table 14-2. Peripheral Access Configuration options

Config Bit	Write	Non-Secure	Supervisor	Meaning
0	0	0	0	Secure User Read
1	0	0	1	Secure Supervisor Read
2	0	1	0	Non-Secure User Read
3	0	1	1	Non-Secure Supervisor Read
4	1	0	0	Secure User Write
5	1	0	1	Secure Supervisor Write
6	1	1	0	Non-Secure User Write
7	1	1	1	Non-Secure Supervisor Write

Each peripheral has a security configuration (`sec_config_X`) input for determining whether to allow or deny a given access type. These are 8-bit vectors, with each bit corresponding to one of the transactions above as listed in the Config Bit column of [Table 14-2](#). If the bit is asserted (1'b1), the transaction is allowed. If the bit is negated (1'b0), the transaction is not allowed.

For example, if peripheral 0 is configured as follows:

```
sec_config_0 [7:0] = 8'b0011_0011
```

This peripheral can only be accessed by secure transactions. Bits 0, 1, 4, and 5 are asserted and these bits refer to the four types of secure transactions. If an insecure transaction is attempted to this peripheral, it will result in an error.

Eight bits per peripheral across an entire system can result in a large number of configuration bits that must be assigned and controlled, most likely in a series of registers in another block. To reduce the number of register bits required predefined sets of security profiles can be defined and encapsulated in an external security translation block. The table below describes one set of security profiles that has been proposed for use with the AIPSTZ.

Table 14-3. Security Levels

CSU_SEC_LEVEL	Non-Secure User	Non-Secure Supervisor	Secure User	Secure Supervisor
0	RD+WR	RD+WR	RD+WR	RD+WR
1	NOT ALLOWED	RD+WR	RD+WR	RD+WR
2	Read Only	Read Only	RD+WR	RD+WR
3	NOT ALLOWED	Read Only	RD+WR	RD+WR
4	NOT ALLOWED	NOT ALLOWED	RD+WR	RD+WR
5	NOT ALLOWED	NOT ALLOWED	NOT ALLOWED	RD+WR
6	NOT ALLOWED	NOT ALLOWED	Read Only	Read Only
7	NOT ALLOWED	NOT ALLOWED	NOT ALLOWED	NOT ALLOWED

Information regarding CSU is provided in the Security Reference Manual. Contact your NXP representative for information about obtaining this document.

A 3-bit input, 8-bit output translation block can be used such that only three register bits are required to set the security profile and the translation block will drive the correct 8-bit configuration vector. Each peripheral connected to the AIPSTZ would require this translation block. The top level AIPSTZ has this three bit input line ``csu_sec_level[2:0]'` corresponding to each peripheral X.

14.7 AIPSTZ Memory Map/Register Definition

The memory map for the AIPS SW-visible registers is shown in the table below.

The MPROT and OPACR fields are 4 bits in width. Some bits may be reserved depending on device.

AIPSTZ memory map

Absolute address (hex)	Register name	Width (in bits)	Access	Reset value	Section/page
207_C000	Master Priviledge Registers (AIPSTZ1_MPR)	32	R/W	7700_0000h	14.7.1/449
207_C040	Off-Platform Peripheral Access Control Registers (AIPSTZ1_OPACR)	32	R/W	4444_4444h	14.7.2/451
207_C044	Off-Platform Peripheral Access Control Registers (AIPSTZ1_OPACR1)	32	R/W	4444_4444h	14.7.3/454
207_C048	Off-Platform Peripheral Access Control Registers (AIPSTZ1_OPACR2)	32	R/W	4444_4444h	14.7.4/457
207_C04C	Off-Platform Peripheral Access Control Registers (AIPSTZ1_OPACR3)	32	R/W	4444_4444h	14.7.5/460
207_C050	Off-Platform Peripheral Access Control Registers (AIPSTZ1_OPACR4)	32	R/W	4444_4444h	14.7.6/463
217_C000	Master Priviledge Registers (AIPSTZ2_MPR)	32	R/W	7700_0000h	14.7.1/449
217_C040	Off-Platform Peripheral Access Control Registers (AIPSTZ2_OPACR)	32	R/W	4444_4444h	14.7.2/451
217_C044	Off-Platform Peripheral Access Control Registers (AIPSTZ2_OPACR1)	32	R/W	4444_4444h	14.7.3/454
217_C048	Off-Platform Peripheral Access Control Registers (AIPSTZ2_OPACR2)	32	R/W	4444_4444h	14.7.4/457
217_C04C	Off-Platform Peripheral Access Control Registers (AIPSTZ2_OPACR3)	32	R/W	4444_4444h	14.7.5/460
217_C050	Off-Platform Peripheral Access Control Registers (AIPSTZ2_OPACR4)	32	R/W	4444_4444h	14.7.6/463
227_C000	Master Priviledge Registers (AIPSTZ3_MPR)	32	R/W	7700_0000h	14.7.1/449
227_C040	Off-Platform Peripheral Access Control Registers (AIPSTZ3_OPACR)	32	R/W	4444_4444h	14.7.2/451
227_C044	Off-Platform Peripheral Access Control Registers (AIPSTZ3_OPACR1)	32	R/W	4444_4444h	14.7.3/454
227_C048	Off-Platform Peripheral Access Control Registers (AIPSTZ3_OPACR2)	32	R/W	4444_4444h	14.7.4/457
227_C04C	Off-Platform Peripheral Access Control Registers (AIPSTZ3_OPACR3)	32	R/W	4444_4444h	14.7.5/460
227_C050	Off-Platform Peripheral Access Control Registers (AIPSTZ3_OPACR4)	32	R/W	4444_4444h	14.7.6/463

14.7.1 Master Priviledge Registers (AIPSTZx_MPR)

Each AIPSTZ_MPR specifies 16 4-bit fields defining the access privilege level associated with a bus master in the platform, as well as specifying whether write accesses from this master are bufferable shown in [Table 14-4](#)

The registers provide one field per bus master, where field 15 corresponds to master 15, field 14 to master 14,... field 0 to master 0 (typically the processor core). The master index allocation is shown in [Table 14-5](#).

Table 14-4. MPROT Field

Bit	Field	Description
3	MBW	Master Buffer Writes - This bit determines whether the AIPSTZ is enabled to buffer writes from this master.
2	MTR	Master Trusted for Reads - This bit determines whether the master is trusted for read accesses.
1	MTW	Master Trusted for Writes - This bit determines whether the master is trusted for write accesses.
0	MPL	Master Privilege Level - This bit determines how the privilege level of the master is determined.

NOTE

The reset value is set to 0000_0000_7700_0000, which makes master 0 and master 1 (Arm CORE) the trusted masters. Trusted software can change the settings after reset.

Table 14-5. Master Index Allocation

Master Index	Master Name	Comments
Master 0	All masters excluding Arm core, SDMA and CAAM	Share the same number allocation.
Master 1	Arm A7 CORE	
Master 2	CAAM	
Master 3	SDMA	
Master 4	Reserved	
Master 5	Arm M4 Core	
Master 6-15	Reserved	

Address: Base address + 0h offset

Bit	31	30	29	28	27	26	25	24	23	22	21	20	19	18	17	16	15	14	13	12	11	10	9	8	7	6	5	4	3	2	1	0
R																																
W																																
Reset	0	1	1	1	0	1	1	1	0	0	0	0	0	0	0	0	0	0	0	0	0	0	0	0	0	0	0	0	0	0	0	

AIPSTZx_MPR field descriptions

Field	Description
31–28 MPROT0	<p>Master 0 Privilege, Buffer, Read, Write Control</p> <p>xxx0 MPL — Accesses from this master are forced to user-mode (ips_supervisor_access is forced to zero) regardless of the hprot[1] access attribute.</p> <p>xxx1 MPL — Accesses from this master are not forced to user-mode. The hprot[1] access attribute is used directly to determine ips_supervisor_access.</p> <p>xx0x MTW — This master is not trusted for write accesses.</p> <p>xx1x MTW — This master is trusted for write accesses.</p> <p>x0xx MTR — This master is not trusted for read accesses.</p> <p>x1xx MTR — This master is trusted for read accesses.</p> <p>0xxx MBW — Write accesses from this master are not bufferable</p> <p>1xxx MBW — Write accesses from this master are allowed to be buffered</p>
27–24 MPROT1	<p>Master 1 Privilege, Buffer, Read, Write Control</p> <p>xxx0 MPL — Accesses from this master are forced to user-mode (ips_supervisor_access is forced to zero) regardless of the hprot[1] access attribute.</p> <p>xxx1 MPL — Accesses from this master are not forced to user-mode. The hprot[1] access attribute is used directly to determine ips_supervisor_access.</p> <p>xx0x MTW — This master is not trusted for write accesses.</p> <p>xx1x MTW — This master is trusted for write accesses.</p> <p>x0xx MTR — This master is not trusted for read accesses.</p> <p>x1xx MTR — This master is trusted for read accesses.</p> <p>0xxx MBW — Write accesses from this master are not bufferable</p> <p>1xxx MBW — Write accesses from this master are allowed to be buffered</p>
23–20 MPROT2	<p>Master 2 Privilege, Buffer, Read, Write Control</p> <p>xxx0 MPL — Accesses from this master are forced to user-mode (ips_supervisor_access is forced to zero) regardless of the hprot[1] access attribute.</p> <p>xxx1 MPL — Accesses from this master are not forced to user-mode. The hprot[1] access attribute is used directly to determine ips_supervisor_access.</p> <p>xx0x MTW — This master is not trusted for write accesses.</p> <p>xx1x MTW — This master is trusted for write accesses.</p> <p>x0xx MTR — This master is not trusted for read accesses.</p> <p>x1xx MTR — This master is trusted for read accesses.</p> <p>0xxx MBW — Write accesses from this master are not bufferable</p> <p>1xxx MBW — Write accesses from this master are allowed to be buffered</p>
19–16 MPROT3	<p>Master 3 Privilege, Buffer, Read, Write Control.</p> <p>xxx0 MPL — Accesses from this master are forced to user-mode (ips_supervisor_access is forced to zero) regardless of the hprot[1] access attribute.</p> <p>xxx1 MPL — Accesses from this master are not forced to user-mode. The hprot[1] access attribute is used directly to determine ips_supervisor_access.</p> <p>xx0x MTW — This master is not trusted for write accesses.</p> <p>xx1x MTW — This master is trusted for write accesses.</p> <p>x0xx MTR — This master is not trusted for read accesses.</p> <p>x1xx MTR — This master is trusted for read accesses.</p> <p>0xxx MBW — Write accesses from this master are not bufferable</p> <p>1xxx MBW — Write accesses from this master are allowed to be buffered</p>

Table continues on the next page...

AIPSTZx_MPR field descriptions (continued)

Field	Description
15–12 -	This field is reserved. Reserved
11–8 MPROT5	Master 5 Privilege, Buffer, Read, Write Control. xxx0 MPL — Accesses from this master are forced to user-mode (ips_supervisor_access is forced to zero) regardless of the hprot[1] access attribute. xxx1 MPL — Accesses from this master are not forced to user-mode. The hprot[1] access attribute is used directly to determine ips_supervisor_access. xx0x MTW — This master is not trusted for write accesses. xx1x MTW — This master is trusted for write accesses. x0xx MTR — This master is not trusted for read accesses. x1xx MTR — This master is trusted for read accesses. 0xxx MBW — Write accesses from this master are not bufferable 1xxx MBW — Write accesses from this master are allowed to be buffered
-	This field is reserved. Reserved

14.7.2 Off-Platform Peripheral Access Control Registers (AIPSTZx_OPACR)

Each of the off-platform peripherals have an Off-platform Peripheral Access Control Register (AIPSTZ_OPACR) which defines the access levels supported by the given block.

Each AIPSTZ_OPACR has the following format shown in [Table 14-6](#)

Table 14-6. OPAC Field

Bit	Field	Description
3	BW	Buffer Writes - This bit determines whether write accesses to this peripheral are allowed to be buffered. ¹
2	SP	Supervisor Protect - This bit determines whether the peripheral requires supervisor privilege level for access.
1	WP	Write Protect - This bit determines whether the peripheral allows write accesses.
0	TP	Trusted Protect - This bit determines whether the peripheral allows accesses from an untrusted master.

1. Buffered writes are not available for AIPSTZ. This bit should be set to '0'.

Address: Base address + 40h offset

Bit	31	30	29	28	27	26	25	24	23	22	21	20	19	18	17	16	15	14	13	12	11	10	9	8	7	6	5	4	3	2	1	0
R																																
W																																
Reset	0	1	0	0	0	1	0	0	0	1	0	0	0	1	0	0	0	1	0	0	0	1	0	0	0	1	0	0	0	1	0	0

AIPSTZx_OPACR field descriptions

Field	Description
31–28 OPAC0	<p>Off-platform Peripheral Access Control 0</p> <p>xxx0 TP — Accesses from an untrusted master are allowed.</p> <p>xxx1 TP — Accesses from an untrusted master are not allowed. If an access is attempted by an untrusted master, the access is terminated with an error response and no peripheral access is initiated on the IPS bus.</p> <p>xx0x WP — This peripheral allows write accesses.</p> <p>xx1x WP — This peripheral is write protected. If a write access is attempted, the access is terminated with an error response and no peripheral access is initiated on the IPS bus.</p> <p>x0xx SP — This peripheral does not require supervisor privilege level for accesses.</p> <p>x1xx SP — This peripheral requires supervisor privilege level for accesses. The master privilege level must indicate supervisor via the hprot[1] access attribute, and the MPROTx[MPL] control bit for the master must be set. If not, the access is terminated with an error response and no peripheral access is initiated on the IPS bus.</p> <p>0xxx BW — Write accesses to this peripheral are not bufferable by the AIPSTZ.</p> <p>1xxx BW — Write accesses to this peripheral are allowed to be buffered by the AIPSTZ.</p>
27–24 OPAC1	<p>Off-platform Peripheral Access Control 1</p> <p>xxx0 TP — Accesses from an untrusted master are allowed.</p> <p>xxx1 TP — Accesses from an untrusted master are not allowed. If an access is attempted by an untrusted master, the access is terminated with an error response and no peripheral access is initiated on the IPS bus.</p> <p>xx0x WP — This peripheral allows write accesses.</p> <p>xx1x WP — This peripheral is write protected. If a write access is attempted, the access is terminated with an error response and no peripheral access is initiated on the IPS bus.</p> <p>x0xx SP — This peripheral does not require supervisor privilege level for accesses.</p> <p>x1xx SP — This peripheral requires supervisor privilege level for accesses. The master privilege level must indicate supervisor via the hprot[1] access attribute, and the MPROTx[MPL] control bit for the master must be set. If not, the access is terminated with an error response and no peripheral access is initiated on the IPS bus.</p> <p>0xxx BW — Write accesses to this peripheral are not bufferable by the AIPSTZ.</p> <p>1xxx BW — Write accesses to this peripheral are allowed to be buffered by the AIPSTZ.</p>
23–20 OPAC2	<p>Off-platform Peripheral Access Control 2</p> <p>xxx0 TP — Accesses from an untrusted master are allowed.</p> <p>xxx1 TP — Accesses from an untrusted master are not allowed. If an access is attempted by an untrusted master, the access is terminated with an error response and no peripheral access is initiated on the IPS bus.</p> <p>xx0x WP — This peripheral allows write accesses.</p> <p>xx1x WP — This peripheral is write protected. If a write access is attempted, the access is terminated with an error response and no peripheral access is initiated on the IPS bus.</p> <p>x0xx SP — This peripheral does not require supervisor privilege level for accesses.</p> <p>x1xx SP — This peripheral requires supervisor privilege level for accesses. The master privilege level must indicate supervisor via the hprot[1] access attribute, and the MPROTx[MPL] control bit for the master must be set. If not, the access is terminated with an error response and no peripheral access is initiated on the IPS bus.</p> <p>0xxx BW — Write accesses to this peripheral are not bufferable by the AIPSTZ.</p> <p>1xxx BW — Write accesses to this peripheral are allowed to be buffered by the AIPSTZ.</p>
19–16 OPAC3	<p>Off-platform Peripheral Access Control 3</p>

Table continues on the next page...

AIPSTZx_OPACR field descriptions (continued)

Field	Description
	<p>xxx0 TP — Accesses from an untrusted master are allowed.</p> <p>xxx1 TP — Accesses from an untrusted master are not allowed. If an access is attempted by an untrusted master, the access is terminated with an error response and no peripheral access is initiated on the IPS bus.</p> <p>xx0x WP — This peripheral allows write accesses.</p> <p>xx1x WP — This peripheral is write protected. If a write access is attempted, the access is terminated with an error response and no peripheral access is initiated on the IPS bus.</p> <p>x0xx SP — This peripheral does not require supervisor privilege level for accesses.</p> <p>x1xx SP — This peripheral requires supervisor privilege level for accesses. The master privilege level must indicate supervisor via the hprot[1] access attribute, and the MPROTx[MPL] control bit for the master must be set. If not, the access is terminated with an error response and no peripheral access is initiated on the IPS bus.</p> <p>0xxx BW — Write accesses to this peripheral are not bufferable by the AIPSTZ.</p> <p>1xxx BW — Write accesses to this peripheral are allowed to be buffered by the AIPSTZ.</p>
15–12 OPAC4	<p>Off-platform Peripheral Access Control 4</p> <p>xxx0 TP — Accesses from an untrusted master are allowed.</p> <p>xxx1 TP — Accesses from an untrusted master are not allowed. If an access is attempted by an untrusted master, the access is terminated with an error response and no peripheral access is initiated on the IPS bus.</p> <p>xx0x WP — This peripheral allows write accesses.</p> <p>xx1x WP — This peripheral is write protected. If a write access is attempted, the access is terminated with an error response and no peripheral access is initiated on the IPS bus.</p> <p>x0xx SP — This peripheral does not require supervisor privilege level for accesses.</p> <p>x1xx SP — This peripheral requires supervisor privilege level for accesses. The master privilege level must indicate supervisor via the hprot[1] access attribute, and the MPROTx[MPL] control bit for the master must be set. If not, the access is terminated with an error response and no peripheral access is initiated on the IPS bus.</p> <p>0xxx BW — Write accesses to this peripheral are not bufferable by the AIPSTZ.</p> <p>1xxx BW — Write accesses to this peripheral are allowed to be buffered by the AIPSTZ.</p>
11–8 OPAC5	<p>Off-platform Peripheral Access Control 5</p> <p>xxx0 TP — Accesses from an untrusted master are allowed.</p> <p>xxx1 TP — Accesses from an untrusted master are not allowed. If an access is attempted by an untrusted master, the access is terminated with an error response and no peripheral access is initiated on the IPS bus.</p> <p>xx0x WP — This peripheral allows write accesses.</p> <p>xx1x WP — This peripheral is write protected. If a write access is attempted, the access is terminated with an error response and no peripheral access is initiated on the IPS bus.</p> <p>x0xx SP — This peripheral does not require supervisor privilege level for accesses.</p> <p>x1xx SP — This peripheral requires supervisor privilege level for accesses. The master privilege level must indicate supervisor via the hprot[1] access attribute, and the MPROTx[MPL] control bit for the master must be set. If not, the access is terminated with an error response and no peripheral access is initiated on the IPS bus.</p> <p>0xxx BW — Write accesses to this peripheral are not bufferable by the AIPSTZ.</p> <p>1xxx BW — Write accesses to this peripheral are allowed to be buffered by the AIPSTZ.</p>
7–4 OPAC6	<p>Off-platform Peripheral Access Control 6</p> <p>xxx0 TP — Accesses from an untrusted master are allowed.</p>

Table continues on the next page...

AIPSTZx_OPACR field descriptions (continued)

Field	Description
xxx1	TP — Accesses from an untrusted master are not allowed. If an access is attempted by an untrusted master, the access is terminated with an error response and no peripheral access is initiated on the IPS bus.
xx0x	WP — This peripheral allows write accesses.
xx1x	WP — This peripheral is write protected. If a write access is attempted, the access is terminated with an error response and no peripheral access is initiated on the IPS bus.
x0xx	SP — This peripheral does not require supervisor privilege level for accesses.
x1xx	SP — This peripheral requires supervisor privilege level for accesses. The master privilege level must indicate supervisor via the hprot[1] access attribute, and the MPROTx[MPL] control bit for the master must be set. If not, the access is terminated with an error response and no peripheral access is initiated on the IPS bus.
0xxx	BW — Write accesses to this peripheral are not bufferable by the AIPSTZ.
1xxx	BW — Write accesses to this peripheral are allowed to be buffered by the AIPSTZ.
OPAC7	Off-platform Peripheral Access Control 7
xxx0	TP — Accesses from an untrusted master are allowed.
xxx1	TP — Accesses from an untrusted master are not allowed. If an access is attempted by an untrusted master, the access is terminated with an error response and no peripheral access is initiated on the IPS bus.
xx0x	WP — This peripheral allows write accesses.
xx1x	WP — This peripheral is write protected. If a write access is attempted, the access is terminated with an error response and no peripheral access is initiated on the IPS bus.
x0xx	SP — This peripheral does not require supervisor privilege level for accesses.
x1xx	SP — This peripheral requires supervisor privilege level for accesses. The master privilege level must indicate supervisor via the hprot[1] access attribute, and the MPROTx[MPL] control bit for the master must be set. If not, the access is terminated with an error response and no peripheral access is initiated on the IPS bus.
0xxx	BW — Write accesses to this peripheral are not bufferable by the AIPSTZ.
1xxx	BW — Write accesses to this peripheral are allowed to be buffered by the AIPSTZ.

14.7.3 Off-Platform Peripheral Access Control Registers (AIPSTZx_OPACR1)

Each of the off-platform peripherals have an Off-platform Peripheral Access Control Register (AIPSTZ_OPACR) which defines the access levels supported by the given block.

Each AIPSTZ_OPACR has the following format shown in [Table 14-6](#)

Address: Base address + 44h offset

Bit	31	30	29	28	27	26	25	24	23	22	21	20	19	18	17	16	15	14	13	12	11	10	9	8	7	6	5	4	3	2	1	0
R																																
W																																
Reset	0	1	0	0	0	1	0	0	0	1	0	0	0	1	0	0	0	1	0	0	0	1	0	0	0	1	0	0	0	1	0	0

AIPSTZx_OPACR1 field descriptions

Field	Description
31–28 OPAC8	<p>Off-platform Peripheral Access Control 8</p> <p>xxx0 TP — Accesses from an untrusted master are allowed.</p> <p>xxx1 TP — Accesses from an untrusted master are not allowed. If an access is attempted by an untrusted master, the access is terminated with an error response and no peripheral access is initiated on the IPS bus.</p> <p>xx0x WP — This peripheral allows write accesses.</p> <p>xx1x WP — This peripheral is write protected. If a write access is attempted, the access is terminated with an error response and no peripheral access is initiated on the IPS bus.</p> <p>x0xx SP — This peripheral does not require supervisor privilege level for accesses.</p> <p>x1xx SP — This peripheral requires supervisor privilege level for accesses. The master privilege level must indicate supervisor via the hprot[1] access attribute, and the MPROTx[MPL] control bit for the master must be set. If not, the access is terminated with an error response and no peripheral access is initiated on the IPS bus.</p> <p>0xxx BW — Write accesses to this peripheral are not bufferable by the AIPSTZ.</p> <p>1xxx BW — Write accesses to this peripheral are allowed to be buffered by the AIPSTZ.</p>
27–24 OPAC9	<p>Off-platform Peripheral Access Control 9</p> <p>xxx0 TP — Accesses from an untrusted master are allowed.</p> <p>xxx1 TP — Accesses from an untrusted master are not allowed. If an access is attempted by an untrusted master, the access is terminated with an error response and no peripheral access is initiated on the IPS bus.</p> <p>xx0x WP — This peripheral allows write accesses.</p> <p>xx1x WP — This peripheral is write protected. If a write access is attempted, the access is terminated with an error response and no peripheral access is initiated on the IPS bus.</p> <p>x0xx SP — This peripheral does not require supervisor privilege level for accesses.</p> <p>x1xx SP — This peripheral requires supervisor privilege level for accesses. The master privilege level must indicate supervisor via the hprot[1] access attribute, and the MPROTx[MPL] control bit for the master must be set. If not, the access is terminated with an error response and no peripheral access is initiated on the IPS bus.</p> <p>0xxx BW — Write accesses to this peripheral are not bufferable by the AIPSTZ.</p> <p>1xxx BW — Write accesses to this peripheral are allowed to be buffered by the AIPSTZ.</p>
23–20 OPAC10	<p>Off-platform Peripheral Access Control 10</p> <p>xxx0 TP — Accesses from an untrusted master are allowed.</p> <p>xxx1 TP — Accesses from an untrusted master are not allowed. If an access is attempted by an untrusted master, the access is terminated with an error response and no peripheral access is initiated on the IPS bus.</p> <p>xx0x WP — This peripheral allows write accesses.</p> <p>xx1x WP — This peripheral is write protected. If a write access is attempted, the access is terminated with an error response and no peripheral access is initiated on the IPS bus.</p> <p>x0xx SP — This peripheral does not require supervisor privilege level for accesses.</p> <p>x1xx SP — This peripheral requires supervisor privilege level for accesses. The master privilege level must indicate supervisor via the hprot[1] access attribute, and the MPROTx[MPL] control bit for the master must be set. If not, the access is terminated with an error response and no peripheral access is initiated on the IPS bus.</p> <p>0xxx BW — Write accesses to this peripheral are not bufferable by the AIPSTZ.</p> <p>1xxx BW — Write accesses to this peripheral are allowed to be buffered by the AIPSTZ.</p>
19–16 OPAC11	<p>Off-platform Peripheral Access Control 11</p>

Table continues on the next page...

AIPSTZx_OPACR1 field descriptions (continued)

Field	Description
	xxx0 TP — Accesses from an untrusted master are allowed. xxx1 TP — Accesses from an untrusted master are not allowed. If an access is attempted by an untrusted master, the access is terminated with an error response and no peripheral access is initiated on the IPS bus. xx0x WP — This peripheral allows write accesses. xx1x WP — This peripheral is write protected. If a write access is attempted, the access is terminated with an error response and no peripheral access is initiated on the IPS bus. x0xx SP — This peripheral does not require supervisor privilege level for accesses. x1xx SP — This peripheral requires supervisor privilege level for accesses. The master privilege level must indicate supervisor via the hprot[1] access attribute, and the MPROTx[MPL] control bit for the master must be set. If not, the access is terminated with an error response and no peripheral access is initiated on the IPS bus. 0xxx BW — Write accesses to this peripheral are not bufferable by the AIPSTZ. 1xxx BW — Write accesses to this peripheral are allowed to be buffered by the AIPSTZ.
15–12 OPAC12	Off-platform Peripheral Access Control 12 xxx0 TP — Accesses from an untrusted master are allowed. xxx1 TP — Accesses from an untrusted master are not allowed. If an access is attempted by an untrusted master, the access is terminated with an error response and no peripheral access is initiated on the IPS bus. xx0x WP — This peripheral allows write accesses. xx1x WP — This peripheral is write protected. If a write access is attempted, the access is terminated with an error response and no peripheral access is initiated on the IPS bus. x0xx SP — This peripheral does not require supervisor privilege level for accesses. x1xx SP — This peripheral requires supervisor privilege level for accesses. The master privilege level must indicate supervisor via the hprot[1] access attribute, and the MPROTx[MPL] control bit for the master must be set. If not, the access is terminated with an error response and no peripheral access is initiated on the IPS bus. 0xxx BW — Write accesses to this peripheral are not bufferable by the AIPSTZ. 1xxx BW — Write accesses to this peripheral are allowed to be buffered by the AIPSTZ.
11–8 OPAC13	Off-platform Peripheral Access Control 13 xxx0 TP — Accesses from an untrusted master are allowed. xxx1 TP — Accesses from an untrusted master are not allowed. If an access is attempted by an untrusted master, the access is terminated with an error response and no peripheral access is initiated on the IPS bus. xx0x WP — This peripheral allows write accesses. xx1x WP — This peripheral is write protected. If a write access is attempted, the access is terminated with an error response and no peripheral access is initiated on the IPS bus. x0xx SP — This peripheral does not require supervisor privilege level for accesses. x1xx SP — This peripheral requires supervisor privilege level for accesses. The master privilege level must indicate supervisor via the hprot[1] access attribute, and the MPROTx[MPL] control bit for the master must be set. If not, the access is terminated with an error response and no peripheral access is initiated on the IPS bus. 0xxx BW — Write accesses to this peripheral are not bufferable by the AIPSTZ. 1xxx BW — Write accesses to this peripheral are allowed to be buffered by the AIPSTZ.
7–4 OPAC14	Off-platform Peripheral Access Control 14 xxx0 TP — Accesses from an untrusted master are allowed.

Table continues on the next page...

AIPSTZx_OPACR1 field descriptions (continued)

Field	Description
xxx1	TP — Accesses from an untrusted master are not allowed. If an access is attempted by an untrusted master, the access is terminated with an error response and no peripheral access is initiated on the IPS bus.
xx0x	WP — This peripheral allows write accesses.
xx1x	WP — This peripheral is write protected. If a write access is attempted, the access is terminated with an error response and no peripheral access is initiated on the IPS bus.
x0xx	SP — This peripheral does not require supervisor privilege level for accesses.
x1xx	SP — This peripheral requires supervisor privilege level for accesses. The master privilege level must indicate supervisor via the hprot[1] access attribute, and the MPROTx[MPL] control bit for the master must be set. If not, the access is terminated with an error response and no peripheral access is initiated on the IPS bus.
0xxx	BW — Write accesses to this peripheral are not bufferable by the AIPSTZ.
1xxx	BW — Write accesses to this peripheral are allowed to be buffered by the AIPSTZ.
OPAC15	Off-platform Peripheral Access Control 15
xxx0	TP — Accesses from an untrusted master are allowed.
xxx1	TP — Accesses from an untrusted master are not allowed. If an access is attempted by an untrusted master, the access is terminated with an error response and no peripheral access is initiated on the IPS bus.
xx0x	WP — This peripheral allows write accesses.
xx1x	WP — This peripheral is write protected. If a write access is attempted, the access is terminated with an error response and no peripheral access is initiated on the IPS bus.
x0xx	SP — This peripheral does not require supervisor privilege level for accesses.
x1xx	SP — This peripheral requires supervisor privilege level for accesses. The master privilege level must indicate supervisor via the hprot[1] access attribute, and the MPROTx[MPL] control bit for the master must be set. If not, the access is terminated with an error response and no peripheral access is initiated on the IPS bus.
0xxx	BW — Write accesses to this peripheral are not bufferable by the AIPSTZ.
1xxx	BW — Write accesses to this peripheral are allowed to be buffered by the AIPSTZ.

14.7.4 Off-Platform Peripheral Access Control Registers (AIPSTZx_OPACR2)

Each of the off-platform peripherals have an Off-platform Peripheral Access Control Register (AIPSTZ_OPACR) which defines the access levels supported by the given block.

Each AIPSTZ_OPACR has the following format shown in [Table 14-6](#)

Address: Base address + 48h offset

Bit	31	30	29	28	27	26	25	24	23	22	21	20	19	18	17	16	15	14	13	12	11	10	9	8	7	6	5	4	3	2	1	0
R																																
W																																
Reset	0	1	0	0	0	1	0	0	0	1	0	0	0	1	0	0	0	1	0	0	0	1	0	0	0	1	0	0	0	1	0	0

AIPSTZx_OPACR2 field descriptions

Field	Description
31–28 OPAC16	<p>Off-platform Peripheral Access Control 16</p> <p>xxx0 TP — Accesses from an untrusted master are allowed.</p> <p>xxx1 TP — Accesses from an untrusted master are not allowed. If an access is attempted by an untrusted master, the access is terminated with an error response and no peripheral access is initiated on the IPS bus.</p> <p>xx0x WP — This peripheral allows write accesses.</p> <p>xx1x WP — This peripheral is write protected. If a write access is attempted, the access is terminated with an error response and no peripheral access is initiated on the IPS bus.</p> <p>x0xx SP — This peripheral does not require supervisor privilege level for accesses.</p> <p>x1xx SP — This peripheral requires supervisor privilege level for accesses. The master privilege level must indicate supervisor via the hprot[1] access attribute, and the MPROTx[MPL] control bit for the master must be set. If not, the access is terminated with an error response and no peripheral access is initiated on the IPS bus.</p> <p>0xxx BW — Write accesses to this peripheral are not bufferable by the AIPSTZ.</p> <p>1xxx BW — Write accesses to this peripheral are allowed to be buffered by the AIPSTZ.</p>
27–24 OPAC17	<p>Off-platform Peripheral Access Control 17</p> <p>xxx0 TP — Accesses from an untrusted master are allowed.</p> <p>xxx1 TP — Accesses from an untrusted master are not allowed. If an access is attempted by an untrusted master, the access is terminated with an error response and no peripheral access is initiated on the IPS bus.</p> <p>xx0x WP — This peripheral allows write accesses.</p> <p>xx1x WP — This peripheral is write protected. If a write access is attempted, the access is terminated with an error response and no peripheral access is initiated on the IPS bus.</p> <p>x0xx SP — This peripheral does not require supervisor privilege level for accesses.</p> <p>x1xx SP — This peripheral requires supervisor privilege level for accesses. The master privilege level must indicate supervisor via the hprot[1] access attribute, and the MPROTx[MPL] control bit for the master must be set. If not, the access is terminated with an error response and no peripheral access is initiated on the IPS bus.</p> <p>0xxx BW — Write accesses to this peripheral are not bufferable by the AIPSTZ.</p> <p>1xxx BW — Write accesses to this peripheral are allowed to be buffered by the AIPSTZ.</p>
23–20 OPAC18	<p>Off-platform Peripheral Access Control 18</p> <p>xxx0 TP — Accesses from an untrusted master are allowed.</p> <p>xxx1 TP — Accesses from an untrusted master are not allowed. If an access is attempted by an untrusted master, the access is terminated with an error response and no peripheral access is initiated on the IPS bus.</p> <p>xx0x WP — This peripheral allows write accesses.</p> <p>xx1x WP — This peripheral is write protected. If a write access is attempted, the access is terminated with an error response and no peripheral access is initiated on the IPS bus.</p> <p>x0xx SP — This peripheral does not require supervisor privilege level for accesses.</p> <p>x1xx SP — This peripheral requires supervisor privilege level for accesses. The master privilege level must indicate supervisor via the hprot[1] access attribute, and the MPROTx[MPL] control bit for the master must be set. If not, the access is terminated with an error response and no peripheral access is initiated on the IPS bus.</p> <p>0xxx BW — Write accesses to this peripheral are not bufferable by the AIPSTZ.</p> <p>1xxx BW — Write accesses to this peripheral are allowed to be buffered by the AIPSTZ.</p>
19–16 OPAC19	<p>Off-platform Peripheral Access Control 19</p>

Table continues on the next page...

AIPSTZx_OPACR2 field descriptions (continued)

Field	Description
	<p>xxx0 TP — Accesses from an untrusted master are allowed.</p> <p>xxx1 TP — Accesses from an untrusted master are not allowed. If an access is attempted by an untrusted master, the access is terminated with an error response and no peripheral access is initiated on the IPS bus.</p> <p>xx0x WP — This peripheral allows write accesses.</p> <p>xx1x WP — This peripheral is write protected. If a write access is attempted, the access is terminated with an error response and no peripheral access is initiated on the IPS bus.</p> <p>x0xx SP — This peripheral does not require supervisor privilege level for accesses.</p> <p>x1xx SP — This peripheral requires supervisor privilege level for accesses. The master privilege level must indicate supervisor via the hprot[1] access attribute, and the MPROTx[MPL] control bit for the master must be set. If not, the access is terminated with an error response and no peripheral access is initiated on the IPS bus.</p> <p>0xxx BW — Write accesses to this peripheral are not bufferable by the AIPSTZ.</p> <p>1xxx BW — Write accesses to this peripheral are allowed to be buffered by the AIPSTZ.</p>
15–12 OPAC20	<p>Off-platform Peripheral Access Control 20</p> <p>xxx0 TP — Accesses from an untrusted master are allowed.</p> <p>xxx1 TP — Accesses from an untrusted master are not allowed. If an access is attempted by an untrusted master, the access is terminated with an error response and no peripheral access is initiated on the IPS bus.</p> <p>xx0x WP — This peripheral allows write accesses.</p> <p>xx1x WP — This peripheral is write protected. If a write access is attempted, the access is terminated with an error response and no peripheral access is initiated on the IPS bus.</p> <p>x0xx SP — This peripheral does not require supervisor privilege level for accesses.</p> <p>x1xx SP — This peripheral requires supervisor privilege level for accesses. The master privilege level must indicate supervisor via the hprot[1] access attribute, and the MPROTx[MPL] control bit for the master must be set. If not, the access is terminated with an error response and no peripheral access is initiated on the IPS bus.</p> <p>0xxx BW — Write accesses to this peripheral are not bufferable by the AIPSTZ.</p> <p>1xxx BW — Write accesses to this peripheral are allowed to be buffered by the AIPSTZ.</p>
11–8 OPAC21	<p>Off-platform Peripheral Access Control 21</p> <p>xxx0 TP — Accesses from an untrusted master are allowed.</p> <p>xxx1 TP — Accesses from an untrusted master are not allowed. If an access is attempted by an untrusted master, the access is terminated with an error response and no peripheral access is initiated on the IPS bus.</p> <p>xx0x WP — This peripheral allows write accesses.</p> <p>xx1x WP — This peripheral is write protected. If a write access is attempted, the access is terminated with an error response and no peripheral access is initiated on the IPS bus.</p> <p>x0xx SP — This peripheral does not require supervisor privilege level for accesses.</p> <p>x1xx SP — This peripheral requires supervisor privilege level for accesses. The master privilege level must indicate supervisor via the hprot[1] access attribute, and the MPROTx[MPL] control bit for the master must be set. If not, the access is terminated with an error response and no peripheral access is initiated on the IPS bus.</p> <p>0xxx BW — Write accesses to this peripheral are not bufferable by the AIPSTZ.</p> <p>1xxx BW — Write accesses to this peripheral are allowed to be buffered by the AIPSTZ.</p>
7–4 OPAC22	<p>Off-platform Peripheral Access Control 22</p> <p>xxx0 TP — Accesses from an untrusted master are allowed.</p>

Table continues on the next page...

AIPSTZx_OPACR2 field descriptions (continued)

Field	Description
xxx1	TP — Accesses from an untrusted master are not allowed. If an access is attempted by an untrusted master, the access is terminated with an error response and no peripheral access is initiated on the IPS bus.
xx0x	WP — This peripheral allows write accesses.
xx1x	WP — This peripheral is write protected. If a write access is attempted, the access is terminated with an error response and no peripheral access is initiated on the IPS bus.
x0xx	SP — This peripheral does not require supervisor privilege level for accesses.
x1xx	SP — This peripheral requires supervisor privilege level for accesses. The master privilege level must indicate supervisor via the hprot[1] access attribute, and the MPROTx[MPL] control bit for the master must be set. If not, the access is terminated with an error response and no peripheral access is initiated on the IPS bus.
0xxx	BW — Write accesses to this peripheral are not bufferable by the AIPSTZ.
1xxx	BW — Write accesses to this peripheral are allowed to be buffered by the AIPSTZ.
OPAC23	Off-platform Peripheral Access Control 23
xxx0	TP — Accesses from an untrusted master are allowed.
xxx1	TP — Accesses from an untrusted master are not allowed. If an access is attempted by an untrusted master, the access is terminated with an error response and no peripheral access is initiated on the IPS bus.
xx0x	WP — This peripheral allows write accesses.
xx1x	WP — This peripheral is write protected. If a write access is attempted, the access is terminated with an error response and no peripheral access is initiated on the IPS bus.
x0xx	SP — This peripheral does not require supervisor privilege level for accesses.
x1xx	SP — This peripheral requires supervisor privilege level for accesses. The master privilege level must indicate supervisor via the hprot[1] access attribute, and the MPROTx[MPL] control bit for the master must be set. If not, the access is terminated with an error response and no peripheral access is initiated on the IPS bus.
0xxx	BW — Write accesses to this peripheral are not bufferable by the AIPSTZ.
1xxx	BW — Write accesses to this peripheral are allowed to be buffered by the AIPSTZ.

14.7.5 Off-Platform Peripheral Access Control Registers (AIPSTZx_OPACR3)

Each of the off-platform peripherals have an Off-platform Peripheral Access Control Register (AIPSTZ_OPACR) which defines the access levels supported by the given block.

Each AIPSTZ_OPACR has the following format shown in [Table 14-6](#)

Address: Base address + 4Ch offset

Bit	31	30	29	28	27	26	25	24	23	22	21	20	19	18	17	16	15	14	13	12	11	10	9	8	7	6	5	4	3	2	1	0	
^R	OPAC24		OPAC25		OPAC26		OPAC27		OPAC28		OPAC29		OPAC30		OPAC31																		
^W	OPAC24		OPAC25		OPAC26		OPAC27		OPAC28		OPAC29		OPAC30		OPAC31																		
Reset	0	1	0	0	0	1	0	0	0	1	0	0	0	1	0	0	0	1	0	0	0	1	0	0	0	1	0	0	0	1	0	0	

AIPSTZx_OPACR3 field descriptions

Field	Description
31–28 OPAC24	<p>Off-platform Peripheral Access Control 24</p> <p>xxx0 TP — Accesses from an untrusted master are allowed.</p> <p>xxx1 TP — Accesses from an untrusted master are not allowed. If an access is attempted by an untrusted master, the access is terminated with an error response and no peripheral access is initiated on the IPS bus.</p> <p>xx0x WP — This peripheral allows write accesses.</p> <p>xx1x WP — This peripheral is write protected. If a write access is attempted, the access is terminated with an error response and no peripheral access is initiated on the IPS bus.</p> <p>x0xx SP — This peripheral does not require supervisor privilege level for accesses.</p> <p>x1xx SP — This peripheral requires supervisor privilege level for accesses. The master privilege level must indicate supervisor via the hprot[1] access attribute, and the MPROTx[MPL] control bit for the master must be set. If not, the access is terminated with an error response and no peripheral access is initiated on the IPS bus.</p> <p>0xxx BW — Write accesses to this peripheral are not bufferable by the AIPSTZ.</p> <p>1xxx BW — Write accesses to this peripheral are allowed to be buffered by the AIPSTZ.</p>
27–24 OPAC25	<p>Off-platform Peripheral Access Control 25</p> <p>xxx0 TP — Accesses from an untrusted master are allowed.</p> <p>xxx1 TP — Accesses from an untrusted master are not allowed. If an access is attempted by an untrusted master, the access is terminated with an error response and no peripheral access is initiated on the IPS bus.</p> <p>xx0x WP — This peripheral allows write accesses.</p> <p>xx1x WP — This peripheral is write protected. If a write access is attempted, the access is terminated with an error response and no peripheral access is initiated on the IPS bus.</p> <p>x0xx SP — This peripheral does not require supervisor privilege level for accesses.</p> <p>x1xx SP — This peripheral requires supervisor privilege level for accesses. The master privilege level must indicate supervisor via the hprot[1] access attribute, and the MPROTx[MPL] control bit for the master must be set. If not, the access is terminated with an error response and no peripheral access is initiated on the IPS bus.</p> <p>0xxx BW — Write accesses to this peripheral are not bufferable by the AIPSTZ.</p> <p>1xxx BW — Write accesses to this peripheral are allowed to be buffered by the AIPSTZ.</p>
23–20 OPAC26	<p>Off-platform Peripheral Access Control 26</p> <p>xxx0 TP — Accesses from an untrusted master are allowed.</p> <p>xxx1 TP — Accesses from an untrusted master are not allowed. If an access is attempted by an untrusted master, the access is terminated with an error response and no peripheral access is initiated on the IPS bus.</p> <p>xx0x WP — This peripheral allows write accesses.</p> <p>xx1x WP — This peripheral is write protected. If a write access is attempted, the access is terminated with an error response and no peripheral access is initiated on the IPS bus.</p> <p>x0xx SP — This peripheral does not require supervisor privilege level for accesses.</p> <p>x1xx SP — This peripheral requires supervisor privilege level for accesses. The master privilege level must indicate supervisor via the hprot[1] access attribute, and the MPROTx[MPL] control bit for the master must be set. If not, the access is terminated with an error response and no peripheral access is initiated on the IPS bus.</p> <p>0xxx BW — Write accesses to this peripheral are not bufferable by the AIPSTZ.</p> <p>1xxx BW — Write accesses to this peripheral are allowed to be buffered by the AIPSTZ.</p>
19–16 OPAC27	<p>Off-platform Peripheral Access Control 27</p>

Table continues on the next page...

AIPSTZx_OPACR3 field descriptions (continued)

Field	Description
	xxx0 TP — Accesses from an untrusted master are allowed. xxx1 TP — Accesses from an untrusted master are not allowed. If an access is attempted by an untrusted master, the access is terminated with an error response and no peripheral access is initiated on the IPS bus. xx0x WP — This peripheral allows write accesses. xx1x WP — This peripheral is write protected. If a write access is attempted, the access is terminated with an error response and no peripheral access is initiated on the IPS bus. x0xx SP — This peripheral does not require supervisor privilege level for accesses. x1xx SP — This peripheral requires supervisor privilege level for accesses. The master privilege level must indicate supervisor via the hprot[1] access attribute, and the MPROTx[MPL] control bit for the master must be set. If not, the access is terminated with an error response and no peripheral access is initiated on the IPS bus. 0xxx BW — Write accesses to this peripheral are not bufferable by the AIPSTZ. 1xxx BW — Write accesses to this peripheral are allowed to be buffered by the AIPSTZ.
15–12 OPAC28	Off-platform Peripheral Access Control 28 xxx0 TP — Accesses from an untrusted master are allowed. xxx1 TP — Accesses from an untrusted master are not allowed. If an access is attempted by an untrusted master, the access is terminated with an error response and no peripheral access is initiated on the IPS bus. xx0x WP — This peripheral allows write accesses. xx1x WP — This peripheral is write protected. If a write access is attempted, the access is terminated with an error response and no peripheral access is initiated on the IPS bus. x0xx SP — This peripheral does not require supervisor privilege level for accesses. x1xx SP — This peripheral requires supervisor privilege level for accesses. The master privilege level must indicate supervisor via the hprot[1] access attribute, and the MPROTx[MPL] control bit for the master must be set. If not, the access is terminated with an error response and no peripheral access is initiated on the IPS bus. 0xxx BW — Write accesses to this peripheral are not bufferable by the AIPSTZ. 1xxx BW — Write accesses to this peripheral are allowed to be buffered by the AIPSTZ.
11–8 OPAC29	Off-platform Peripheral Access Control 29 xxx0 TP — Accesses from an untrusted master are allowed. xxx1 TP — Accesses from an untrusted master are not allowed. If an access is attempted by an untrusted master, the access is terminated with an error response and no peripheral access is initiated on the IPS bus. xx0x WP — This peripheral allows write accesses. xx1x WP — This peripheral is write protected. If a write access is attempted, the access is terminated with an error response and no peripheral access is initiated on the IPS bus. x0xx SP — This peripheral does not require supervisor privilege level for accesses. x1xx SP — This peripheral requires supervisor privilege level for accesses. The master privilege level must indicate supervisor via the hprot[1] access attribute, and the MPROTx[MPL] control bit for the master must be set. If not, the access is terminated with an error response and no peripheral access is initiated on the IPS bus. 0xxx BW — Write accesses to this peripheral are not bufferable by the AIPSTZ. 1xxx BW — Write accesses to this peripheral are allowed to be buffered by the AIPSTZ.
7–4 OPAC30	Off-platform Peripheral Access Control 30 xxx0 TP — Accesses from an untrusted master are allowed.

Table continues on the next page...

AIPSTZx_OPACR3 field descriptions (continued)

Field	Description
xxx1	TP — Accesses from an untrusted master are not allowed. If an access is attempted by an untrusted master, the access is terminated with an error response and no peripheral access is initiated on the IPS bus.
xx0x	WP — This peripheral allows write accesses.
xx1x	WP — This peripheral is write protected. If a write access is attempted, the access is terminated with an error response and no peripheral access is initiated on the IPS bus.
x0xx	SP — This peripheral does not require supervisor privilege level for accesses.
x1xx	SP — This peripheral requires supervisor privilege level for accesses. The master privilege level must indicate supervisor via the hprot[1] access attribute, and the MPROTx[MPL] control bit for the master must be set. If not, the access is terminated with an error response and no peripheral access is initiated on the IPS bus.
0xxx	BW — Write accesses to this peripheral are not bufferable by the AIPSTZ.
1xxx	BW — Write accesses to this peripheral are allowed to be buffered by the AIPSTZ.
OPAC31	Off-platform Peripheral Access Control 31
xxx0	TP — Accesses from an untrusted master are allowed.
xxx1	TP — Accesses from an untrusted master are not allowed. If an access is attempted by an untrusted master, the access is terminated with an error response and no peripheral access is initiated on the IPS bus.
xx0x	WP — This peripheral allows write accesses.
xx1x	WP — This peripheral is write protected. If a write access is attempted, the access is terminated with an error response and no peripheral access is initiated on the IPS bus.
x0xx	SP — This peripheral does not require supervisor privilege level for accesses.
x1xx	SP — This peripheral requires supervisor privilege level for accesses. The master privilege level must indicate supervisor via the hprot[1] access attribute, and the MPROTx[MPL] control bit for the master must be set. If not, the access is terminated with an error response and no peripheral access is initiated on the IPS bus.
0xxx	BW — Write accesses to this peripheral are not bufferable by the AIPSTZ.
1xxx	BW — Write accesses to this peripheral are allowed to be buffered by the AIPSTZ.

14.7.6 Off-Platform Peripheral Access Control Registers (AIPSTZx_OPACR4)

Each of the off-platform peripherals have an Off-platform Peripheral Access Control Register (AIPSTZ_OPACR) which defines the access levels supported by the given block.

Each AIPSTZ_OPACR has the following format shown in [Table 14-6](#)

Address: Base address + 50h offset

Bit	31	30	29	28	27	26	25	24	23	22	21	20	19	18	17	16	15	14	13	12	11	10	9	8	7	6	5	4	3	2	1	0
R																																
W																																
Reset	0	1	0	0	0	1	0	0	0	1	0	0	0	1	0	0	0	1	0	0	0	1	0	0	0	1	0	0	0	1	0	0

AIPSTZx_OPACR4 field descriptions

Field	Description
31–28 OPAC32	<p>Off-platform Peripheral Access Control 32</p> <p>xxx0 TP — Accesses from an untrusted master are allowed.</p> <p>xxx1 TP — Accesses from an untrusted master are not allowed. If an access is attempted by an untrusted master, the access is terminated with an error response and no peripheral access is initiated on the IPS bus.</p> <p>xx0x WP — This peripheral allows write accesses.</p> <p>xx1x WP — This peripheral is write protected. If a write access is attempted, the access is terminated with an error response and no peripheral access is initiated on the IPS bus.</p> <p>x0xx SP — This peripheral does not require supervisor privilege level for accesses.</p> <p>x1xx SP — This peripheral requires supervisor privilege level for accesses. The master privilege level must indicate supervisor via the hprot[1] access attribute, and the MPROTx[MPL] control bit for the master must be set. If not, the access is terminated with an error response and no peripheral access is initiated on the IPS bus.</p> <p>0xxx BW — Write accesses to this peripheral are not bufferable by the AIPSTZ.</p> <p>1xxx BW — Write accesses to this peripheral are allowed to be buffered by the AIPSTZ.</p>
27–24 OPAC33	<p>Off-platform Peripheral Access Control 33</p> <p>xxx0 TP — Accesses from an untrusted master are allowed.</p> <p>xxx1 TP — Accesses from an untrusted master are not allowed. If an access is attempted by an untrusted master, the access is terminated with an error response and no peripheral access is initiated on the IPS bus.</p> <p>xx0x WP — This peripheral allows write accesses.</p> <p>xx1x WP — This peripheral is write protected. If a write access is attempted, the access is terminated with an error response and no peripheral access is initiated on the IPS bus.</p> <p>x0xx SP — This peripheral does not require supervisor privilege level for accesses.</p> <p>x1xx SP — This peripheral requires supervisor privilege level for accesses. The master privilege level must indicate supervisor via the hprot[1] access attribute, and the MPROTx[MPL] control bit for the master must be set. If not, the access is terminated with an error response and no peripheral access is initiated on the IPS bus.</p> <p>0xxx BW — Write accesses to this peripheral are not bufferable by the AIPSTZ.</p> <p>1xxx BW — Write accesses to this peripheral are allowed to be buffered by the AIPSTZ.</p>
-	<p>This field is reserved. Reserved</p>

Chapter 15

AHB-to-APBH Bridge with DMA (APBH-Bridge-DMA)

15.1 Overview

The AHB-to-APBH bridge provides the chip with an inexpensive peripheral attachment bus running on the AHB's HCLK. (The H in APBH denotes that the APBH is synchronous to HCLK.)

As shown in the figure below, the AHB-to-APBH bridge includes the AHB-to-APB PIO bridge for a memory-mapped I/O to the APB devices, as well as a central DMA facility for devices on this bus and a vectored interrupt controller for the Arm core. Each one of the APB peripherals, including the vectored interrupt controller, is documented in their respective chapters.

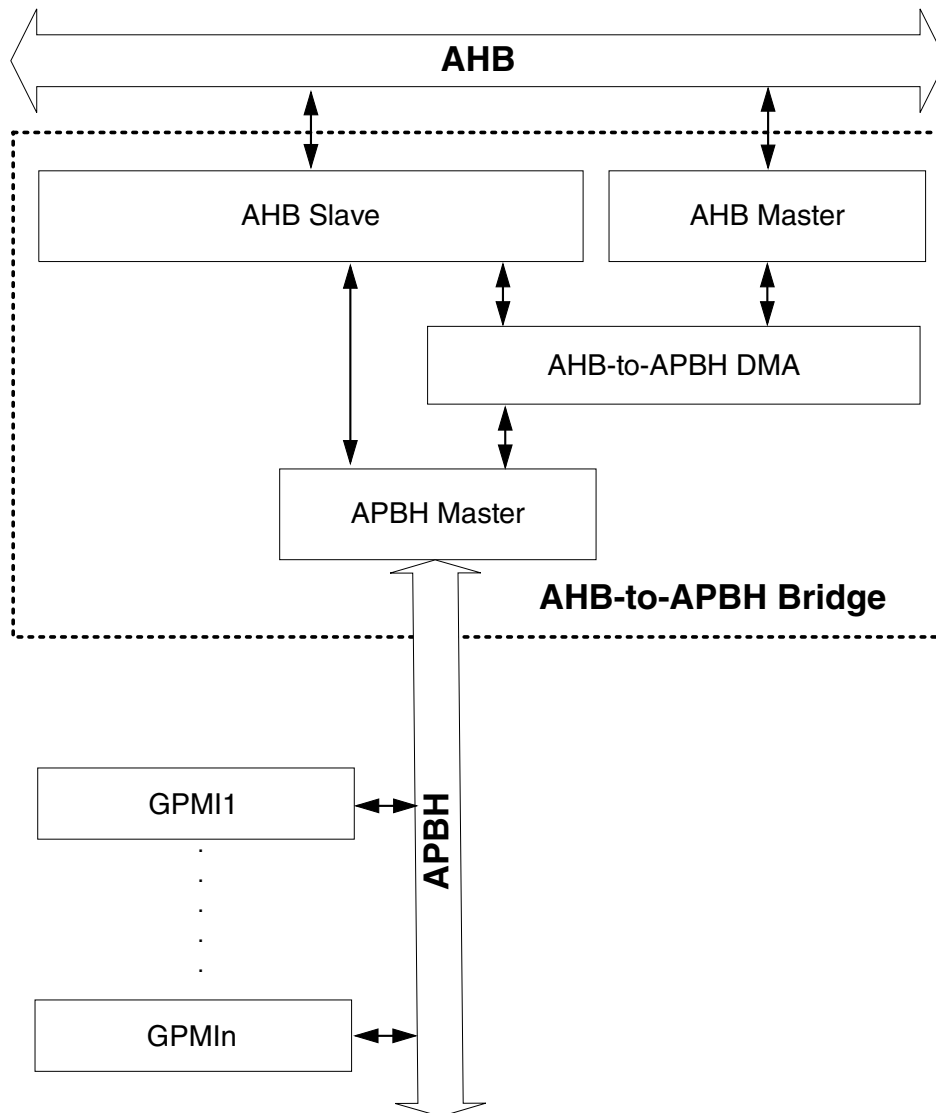

Figure 15-1. AHB-to-APBH Bridge DMA Block Diagram

The DMA controller uses the APBH bus to transfer read and write data to and from each peripheral. There is no separate DMA bus for these devices. Contention between the DMA's use of the APBH bus and the AHB-to-APB bridge functions' use of the APBH is mediated by an internal arbitration logic. For contention between these two units, the DMA is favored and the AHB slave will report "not ready" through its HREADY output until the bridge transfer can complete. The arbiter tracks repeated lockouts and inverts the priority, guaranteeing the Arm platform every fourth transfer on the APB.

15.2 Clocks

The table found here describes the clock sources for APBH. Please see [Clock Controller Module \(CCM\)](#) for clock setting, configuration and gating information.

Table 15-1. APBH Clocks

Clock name	Clock Root	Description
hclk	bch_clk_root	Module clock

15.3 APBH DMA

The DMA supports four channels of DMA services, as shown in the following table. The shared DMA resource allows each independent channel to follow a simple chained command list. Command chains are built up using the general structure, as shown in [Figure 15-2](#).

Table 15-2. APBH DMA channel assignments

APBH DMA Channel #	Usage
0	GPMI0
1	GPMI1
2	GPMI2
3	GPMI3

A single command structure or channel command word specifies a number of operations to be performed by the DMA in support of a given device. Thus, the Arm platform can set up large units of work, chaining together many DMA channel command words, pass them off to the DMA, and have no further concern for the device until the DMA completion interrupt occurs. The goal is to have enough intelligence in the DMA and the devices to keep the interrupt frequency from any device below 1 KHz (arrival intervals longer than 1 ms).

A single command structure can issue 32-bit PIO write operations to key registers in the associated device using the same APB bus and controls that it uses to write DMA data bytes to the device. For example, this allows a chain of operations to be issued to the GPMI controller to send NAND command bytes, address bytes, and data transfers where the command and the address structure is completely under software control, but the administration of that transfer is handled autonomously by the DMA. Each DMA structure can have 0–15 PIO words appended to it. The CMDPIOWORDS field, if non-zero, instructs the DMA engine to copy these words to the APB, beginning at the first register address offset for the peripheral and incrementing the register offset each cycle.

The DMA master generates only normal read/write transfers to the APBH. It does *not* generate set, clear, or toggle (SCT) transfers.

After any requested PIO words have been transferred to the peripheral, the DMA examines the two-bit command field in the channel command structure. [Table 15-3](#) shows the four commands implemented by the DMA.

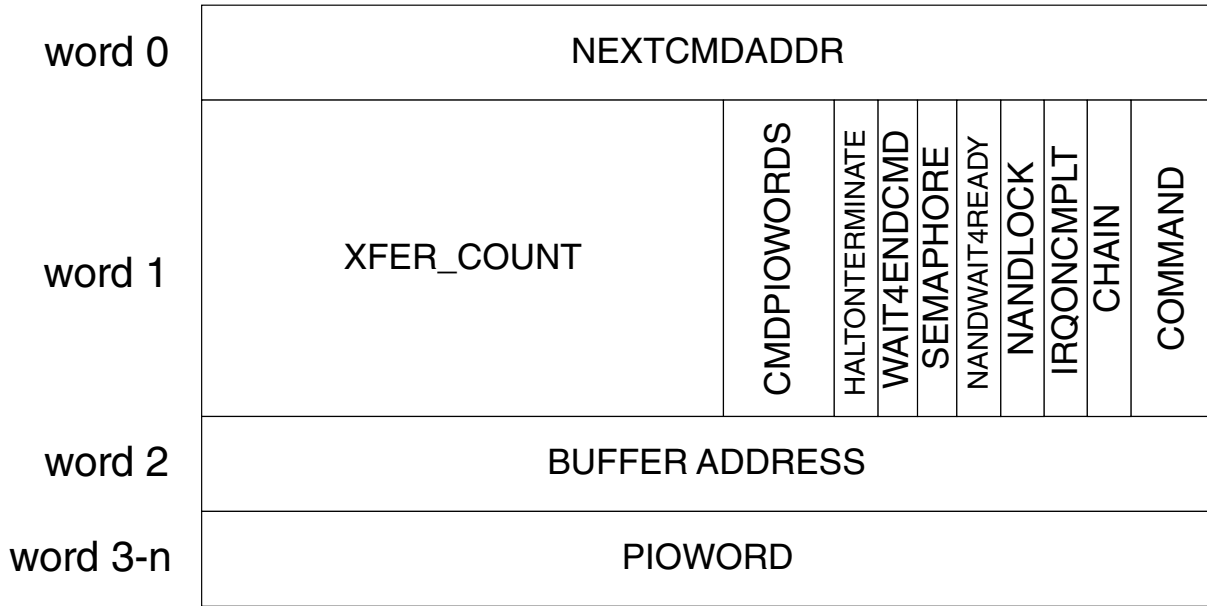

Figure 15-2. AHB-to-APBH Bridge DMA channel command structure

Table 15-3. APBH DMA commands

DMA Command	Usage
00	NO_DMA_XFER. Perform any requested PIO word transfers, but terminate the command before any DMA transfer.
01	DMA_WRITE. Perform any requested PIO word transfers, then perform a DMA transfer from the peripheral for the specified number of bytes.
10	DMA_READ. Perform any requested PIO word transfers and then perform a DMA transfer to the peripheral for the specified number of bytes.
11	DMA_SENSE. Perform any requested PIO word transfers, then perform a conditional branch to the next chained device. Follow the NEXTCMD_ADDR pointer if the peripheral sense is false. Follow the BUFFER_ADDRESS as a chain pointer if the peripheral sense line is true. This command becomes a no-operation for any channel other than a GPMI channel.

DMA_WRITE operations copy data bytes to the system memory (on-chip RAM or SDRAM) from the associated peripheral.

DMA_READ operations copy data bytes to the APB peripheral from the system memory. The DMA engine contains a shared byte aligner that aligns bytes from system memory to or from the peripherals. Peripherals always assume little-endian-aligned data arrives or departs on their 32-bit APB. The DMA_READ transfer uses the BUFFER_ADDRESS word in the command structure to point to the DMA data buffer to be read by the DMA_READ command.

The NO_DMA_XFER command is used to write PIO words to a device without performing any DMA data byte transfers. This command is useful in such applications as activating the NAND devices CHECKSTATUS operation. The check status command reads a status byte from the NAND device, performs an XOR and MASK against an expected value supplied as part of the PIO transfer. Once the read check completes (see [NAND Read Status Polling Example](#)), the NO_DMA_XFER command completes. The result in the peripheral is that its sense line is driven by the results of the comparison. The sense flip-flop is only updated by CHECKSTATUS for the device that is executed. At some future point, the chain contains a DMA command structure with the fourth and final command value, that is, the DMA_SENSE command.

As each DMA command completes, it triggers the DMA to load the next DMA command structure in the chain. The normal flow list of DMA commands is found by following the NEXTCMD_ADDR pointer in the DMA command structure. The DMA_SENSE command uses the DMA buffer pointer word of the command structure to point to an alternate DMA command structure chain or list. The DMA_SENSE command examines the sense line of the associated peripheral. If the sense line is false, then the DMA follows the standard list found whose next command is found from the pointer in the NEXTCMD_ADDR word of the command structure. If the sense line is true, then the DMA follows the alternate list whose next command is found from the pointer in the DMA Buffer Pointer word of the DMA_SENSE command structure (see [Figure 15-2](#)). The sense command ignores the CHAIN bit, so that both pointers must be valid when the DMA comes to a sense command.

If the wait-for-end-command bit (WAIT4ENDCMD) is set in a command structure, the DMA channel waits for the device to signal completion of a command by toggling the endcmd signal before proceeding to load and execute the next command structure. Then, if DECREMENT_SEMAPHORE is set, the semaphore is decremented after the end command is seen.

A detailed bit-field view of the DMA command structure is shown in the following table, which shows a field that specifies the number of bytes to be transferred by this DMA command. The transfer-count mechanism is duplicated in the associated peripheral, either as an implied or as a specified count in the peripheral.

Table 15-4. DMA channel command word in system memory

31	30	29	28	27	26	25	24	23	22	21	20	19	18	17	16	15	14	13	12	11	10	09	08	07	06	05	04	03	02	01	00
NEXT_COMMAND_ADDRESS																															

Table continues on the next page...

Table 15-4. DMA channel command word in system memory (continued)

Number DMA Bytes to Transfer	Number PIO Words to Write					HALTONTERMINATE	WAIT4ENDCMD	DECREMENT SEMAPHORE	NANDWAIT4READY	NANDLOCK	IRQ_COMPLETE	CHAIN	COMMAND
DMA Buffer or Alternate CCW													
Zero or More PIO Words to Write to the Associated Peripheral Starting at its Base Address on the APBH Bus													

Figure 15-2 also shows the CHAIN bit in bit 2 of the second word of the command structure. This bit is set to 1, if the NEXT_COMMAND_ADDRESS contains a pointer to another DMA command structure. If a null pointer (0) is loaded into the NEXT_COMMAND_ADDRESS, it is not detected by the DMA hardware. Only the CHAIN bit indicates whether a valid list exists beyond the current structure.

If the IRQ_COMPLETE bit is set in the command structure, then the last act of the DMA before loading the next command is to set the interrupt-status bit corresponding to the current channel. The sticky interrupt request bit in the DMA CSR remains set until cleared by the software. It can be used to interrupt the Arm platform.

The NAND_LOCK bit is monitored by the DMA channel arbiter. Once a NAND channel (from channel 0 to channel 3) succeeds in the arbiter with its NAND_LOCK bit set, then the arbiter ignores the other NAND channels until a command is completed in which the NAND_LOCK is not set. Notice that the semantic here is that the NAND_LOCK state is to limit scheduling of a non-locked DMA. A DMA channel can go from unlocked to locked in the arbiter at the beginning of a command when the NAND_LOCK bit is set. When the last DMA command of an atomic sequence is completed, the lock should be removed. To accomplish this, the last command does not have the NAND_LOCK bit. It is still locked in the atomic state within the arbiter when the command starts, so that it is the only NAND command that can be executed. At the end, it drops from the atomic state within the arbiter.

The NAND_WAIT4READY bit also has a special use for GPMI channels (from channel 0 to channel 3), i.e., the NAND device channels. The GPMI peripheral supplies a sample of the ready line from the NAND device. This ready value is used to hold off of a command with this bit set until the ready line is asserted to 1. Once the arbiter sees a command with a wait-for-ready set, it holds off that channel until ready is asserted.

Receiving an IRQ for HALTONTERMINATE (HOT) is a feature in the APBH DMA descriptor that allows GPMI to signal to the DMA engine that an error has occurred. If a command is stalled due to an error, a HOT signal is sent from the peripheral to the DMA engine and causes an IRQ after terminating the DMA descriptor being executed.

Therefore, it is recommended that software use this signal as follows:

- Always set HALTONTERMINATE to 1 in a DMA descriptor. That way, if a peripheral signals HOT, the transfer will end, leaving the peripheral block and the DMA engine synchronized (but at the end of a command).
- When an IRQ from an APBH channel is received, and the IRQ is determined to be due to an error (as opposed to an IRQONCOMPLETE interrupt) the software should:
 - Reset the channel.
 - Determine the error from error reporting in the peripheral block, then manage the error in the peripheral that is attached to that channel in whatever appropriate way exists for that device (software recovery, device reset, block reset, etc).

Each channel has an eight-bit counting semaphore that controls whether it is in the idle state. When the semaphore is non-zero, the channel is ready to run, process commands and perform DMA transfers. Whenever a command finishes its DMA transfer, it checks the DECREMENT_SEMAPHORE bit. If set, it decrements the counting semaphore. If the semaphore goes to 0 as a result, then the channel enters the idle state and remains there until the semaphore is incremented by the software. When the semaphore goes to non-zero and the channel is in its idle state, then it uses the value in the APBH_CHn_NXTCMDAR register (next command address register) to fetch a pointer to the next command to process.

NOTE

This is a double indirect case. This method allows the software to append to a running command list under the protection of the counting semaphore.

To start processing the first time, software creates the command list to be processed. It writes the address of the first command into the APBH_CHn_NXTCMDAR register, and then writes 1 to the counting semaphore in APBH_CHn_SEMA. The DMA channel loads APBH_CHn_CURCMDAR register and then enters the normal state machine processing for the next command. When the software writes a value to the counting semaphore, it is added to the semaphore count by hardware, protecting the case where both hardware and software are trying to change the semaphore on the same clock edge.

Software can examine the value of APBH_CHn_CURCMDAR at any time to determine the location of the command structure currently being processed.

15.4 NAND Read Status Polling Example

The following figure shows a more complicated scenario.

This subset of a NAND device workload shows that the first two command structures are used during the data-write phase of an NAND device write operation (CLE and ALE transfers omitted for clarity).

- After writing the data, one must wait until the NAND device status register indicates that the write charge has been transferred. This is built into the workload using a check status command in the NAND in a loop created from the next two DMA command structures.
- The NO_DMA_TRANSFER command is shown here performing the read check, followed by a DMA_SENSE command to branch the DMA command structure list, based on the status of a bit in the external NAND device.

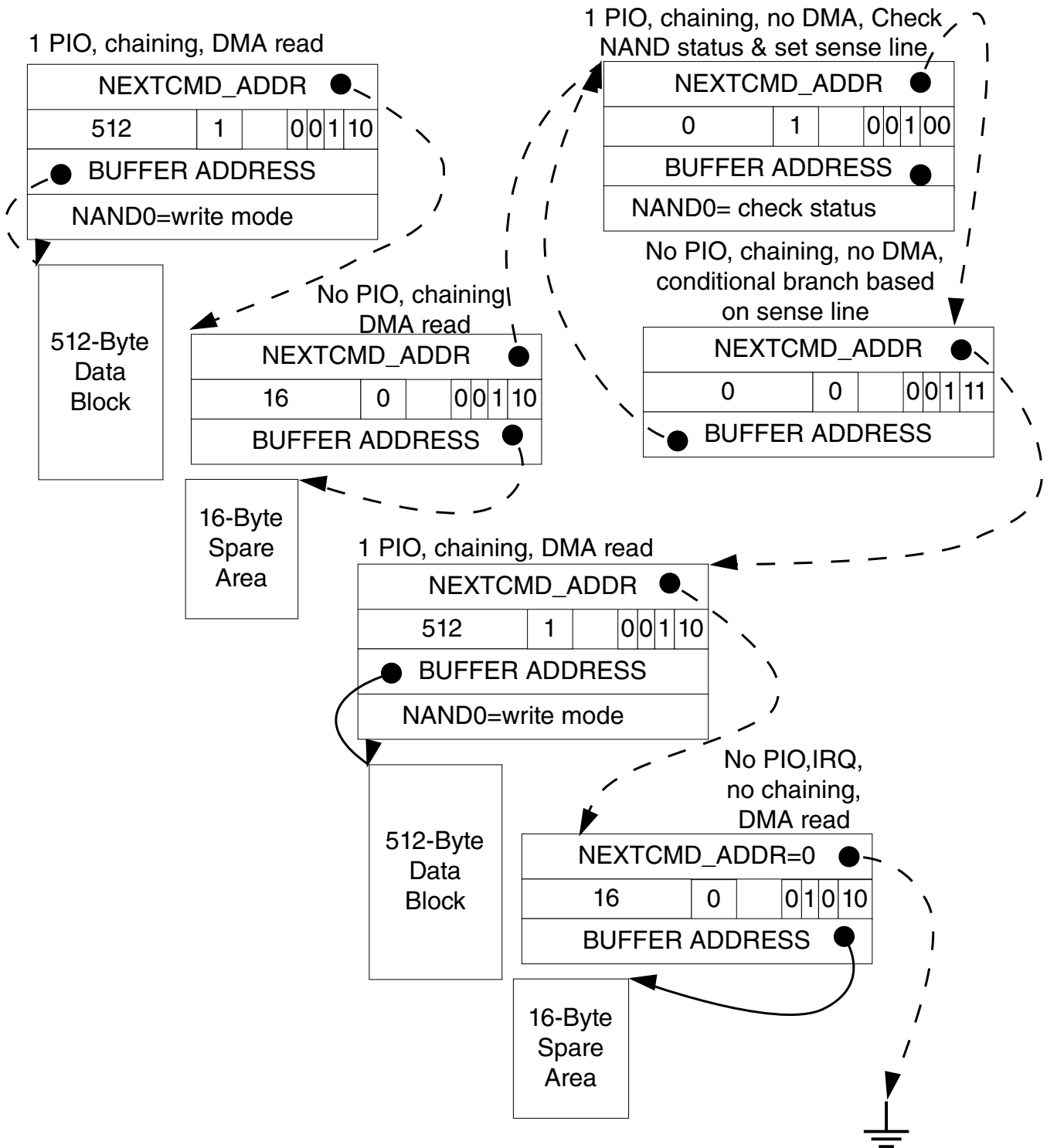

Figure 15-3. AHB-to-APBH Bridge DMA NAND Read Status Polling with DMA Sense Command

The example in the above figure shows the workload continuing immediately to the next NAND page transfer. However, one could perform a second sense operation to see if an error has occurred after the write. One could then point the sense command alternate branch at a NO_DMA_XFER command with the interrupt bit set. If the CHAIN bit is not

set on this failure branch, then the Arm platform is interrupted immediately, and the channel process is also immediately terminated in the presence of a workload-detected NAND error bit.

Note that each word of the three-word DMA command structure corresponds to a PIO register of the DMA that is accessible on the APBH bus. Normally, the DMA copies the next command structure onto these registers for processing at the start of each command by following the value of the pointer previously loaded into the NEXTCMD_ADDR register.

To start DMA processing for the first command, initialize the PIO registers of the desired channel, as follows:

- First, load the next command address register with a pointer to the first command to be loaded.
- Then, write 1 to the counting semaphore register. This causes the DMA to schedule the targeted channel for the DMA command structure load, just as if it had finished its previous command.

15.5 APBH Memory Map/Register Definition

APBH Hardware Register Format Summary

APBH memory map

Absolute address (hex)	Register name	Width (in bits)	Access	Reset value	Section/page
180_4000	AHB to APBH Bridge Control and Status Register 0 (APBH_CTRL0)	32	R/W	E000_0000h	15.5.1/480
180_4004	AHB to APBH Bridge Control and Status Register 0 (APBH_CTRL0_SET)	32	R/W	E000_0000h	15.5.1/480
180_4008	AHB to APBH Bridge Control and Status Register 0 (APBH_CTRL0_CLR)	32	R/W	E000_0000h	15.5.1/480
180_400C	AHB to APBH Bridge Control and Status Register 0 (APBH_CTRL0_TOG)	32	R/W	E000_0000h	15.5.1/480
180_4010	AHB to APBH Bridge Control and Status Register 1 (APBH_CTRL1)	32	R/W	0000_0000h	15.5.2/481
180_4014	AHB to APBH Bridge Control and Status Register 1 (APBH_CTRL1_SET)	32	R/W	0000_0000h	15.5.2/481
180_4018	AHB to APBH Bridge Control and Status Register 1 (APBH_CTRL1_CLR)	32	R/W	0000_0000h	15.5.2/481

Table continues on the next page...

APBH memory map (continued)

Absolute address (hex)	Register name	Width (in bits)	Access	Reset value	Section/page
180_401C	AHB to APBH Bridge Control and Status Register 1 (APBH_CTRL1_TOG)	32	R/W	0000_0000h	15.5.2/481
180_4020	AHB to APBH Bridge Control and Status Register 2 (APBH_CTRL2)	32	R/W	0000_0000h	15.5.3/485
180_4024	AHB to APBH Bridge Control and Status Register 2 (APBH_CTRL2_SET)	32	R/W	0000_0000h	15.5.3/485
180_4028	AHB to APBH Bridge Control and Status Register 2 (APBH_CTRL2_CLR)	32	R/W	0000_0000h	15.5.3/485
180_402C	AHB to APBH Bridge Control and Status Register 2 (APBH_CTRL2_TOG)	32	R/W	0000_0000h	15.5.3/485
180_4030	AHB to APBH Bridge Channel Register (APBH_CHANNEL_CTRL)	32	R/W	0000_0000h	15.5.4/490
180_4034	AHB to APBH Bridge Channel Register (APBH_CHANNEL_CTRL_SET)	32	R/W	0000_0000h	15.5.4/490
180_4038	AHB to APBH Bridge Channel Register (APBH_CHANNEL_CTRL_CLR)	32	R/W	0000_0000h	15.5.4/490
180_403C	AHB to APBH Bridge Channel Register (APBH_CHANNEL_CTRL_TOG)	32	R/W	0000_0000h	15.5.4/490
180_4040	AHB to APBH DMA Device Assignment Register (APBH_DEVSEL)	32	R/W	0000_0000h	15.5.5/491
180_4050	AHB to APBH DMA burst size (APBH_DMA_BURST_SIZE)	32	R/W	0055_5555h	15.5.6/492
180_4060	AHB to APBH DMA Debug Register (APBH_DEBUG)	32	R/W	0000_0000h	15.5.7/493
180_4100	APBH DMA Channel n Current Command Address Register (APBH_CH0_CURCMDAR)	32	R/W	0000_0000h	15.5.8/494
180_4110	APBH DMA Channel n Next Command Address Register (APBH_CH0_NXTCMDAR)	32	R/W	0000_0000h	15.5.9/495
180_4120	APBH DMA Channel n Command Register (APBH_CH0_CMD)	32	R/W	0000_0000h	15.5.10/495
180_4130	APBH DMA Channel n Buffer Address Register (APBH_CH0_BAR)	32	R/W	0000_0000h	15.5.11/497
180_4140	APBH DMA Channel n Semaphore Register (APBH_CH0_SEMA)	32	R/W	0000_0000h	15.5.12/498
180_4150	AHB to APBH DMA Channel n Debug Information (APBH_CH0_DEBUG1)	32	R/W	00A0_0000h	15.5.13/499
180_4160	AHB to APBH DMA Channel n Debug Information (APBH_CH0_DEBUG2)	32	R/W	0000_0000h	15.5.14/502
180_4170	APBH DMA Channel n Current Command Address Register (APBH_CH1_CURCMDAR)	32	R/W	0000_0000h	15.5.8/494
180_4180	APBH DMA Channel n Next Command Address Register (APBH_CH1_NXTCMDAR)	32	R/W	0000_0000h	15.5.9/495
180_4190	APBH DMA Channel n Command Register (APBH_CH1_CMD)	32	R/W	0000_0000h	15.5.10/495
180_41A0	APBH DMA Channel n Buffer Address Register (APBH_CH1_BAR)	32	R/W	0000_0000h	15.5.11/497

Table continues on the next page...

APBH memory map (continued)

Absolute address (hex)	Register name	Width (in bits)	Access	Reset value	Section/page
180_41B0	APBH DMA Channel n Semaphore Register (APBH_CH1_SEMA)	32	R/W	0000_0000h	15.5.12/498
180_41C0	AHB to APBH DMA Channel n Debug Information (APBH_CH1_DEBUG1)	32	R/W	00A0_0000h	15.5.13/499
180_41D0	AHB to APBH DMA Channel n Debug Information (APBH_CH1_DEBUG2)	32	R/W	0000_0000h	15.5.14/502
180_41E0	APBH DMA Channel n Current Command Address Register (APBH_CH2_CURCMDAR)	32	R/W	0000_0000h	15.5.8/494
180_41F0	APBH DMA Channel n Next Command Address Register (APBH_CH2_NXTCMDAR)	32	R/W	0000_0000h	15.5.9/495
180_4200	APBH DMA Channel n Command Register (APBH_CH2_CMD)	32	R/W	0000_0000h	15.5.10/495
180_4210	APBH DMA Channel n Buffer Address Register (APBH_CH2_BAR)	32	R/W	0000_0000h	15.5.11/497
180_4220	APBH DMA Channel n Semaphore Register (APBH_CH2_SEMA)	32	R/W	0000_0000h	15.5.12/498
180_4230	AHB to APBH DMA Channel n Debug Information (APBH_CH2_DEBUG1)	32	R/W	00A0_0000h	15.5.13/499
180_4240	AHB to APBH DMA Channel n Debug Information (APBH_CH2_DEBUG2)	32	R/W	0000_0000h	15.5.14/502
180_4250	APBH DMA Channel n Current Command Address Register (APBH_CH3_CURCMDAR)	32	R/W	0000_0000h	15.5.8/494
180_4260	APBH DMA Channel n Next Command Address Register (APBH_CH3_NXTCMDAR)	32	R/W	0000_0000h	15.5.9/495
180_4270	APBH DMA Channel n Command Register (APBH_CH3_CMD)	32	R/W	0000_0000h	15.5.10/495
180_4280	APBH DMA Channel n Buffer Address Register (APBH_CH3_BAR)	32	R/W	0000_0000h	15.5.11/497
180_4290	APBH DMA Channel n Semaphore Register (APBH_CH3_SEMA)	32	R/W	0000_0000h	15.5.12/498
180_42A0	AHB to APBH DMA Channel n Debug Information (APBH_CH3_DEBUG1)	32	R/W	00A0_0000h	15.5.13/499
180_42B0	AHB to APBH DMA Channel n Debug Information (APBH_CH3_DEBUG2)	32	R/W	0000_0000h	15.5.14/502
180_42C0	APBH DMA Channel n Current Command Address Register (APBH_CH4_CURCMDAR)	32	R/W	0000_0000h	15.5.8/494
180_42D0	APBH DMA Channel n Next Command Address Register (APBH_CH4_NXTCMDAR)	32	R/W	0000_0000h	15.5.9/495
180_42E0	APBH DMA Channel n Command Register (APBH_CH4_CMD)	32	R/W	0000_0000h	15.5.10/495
180_42F0	APBH DMA Channel n Buffer Address Register (APBH_CH4_BAR)	32	R/W	0000_0000h	15.5.11/497
180_4300	APBH DMA Channel n Semaphore Register (APBH_CH4_SEMA)	32	R/W	0000_0000h	15.5.12/498

Table continues on the next page...

APBH memory map (continued)

Absolute address (hex)	Register name	Width (in bits)	Access	Reset value	Section/page
180_4310	AHB to APBH DMA Channel n Debug Information (APBH_CH4_DEBUG1)	32	R/W	00A0_0000h	15.5.13/499
180_4320	AHB to APBH DMA Channel n Debug Information (APBH_CH4_DEBUG2)	32	R/W	0000_0000h	15.5.14/502
180_4330	APBH DMA Channel n Current Command Address Register (APBH_CH5_CURCMDAR)	32	R/W	0000_0000h	15.5.8/494
180_4340	APBH DMA Channel n Next Command Address Register (APBH_CH5_NXTCMDAR)	32	R/W	0000_0000h	15.5.9/495
180_4350	APBH DMA Channel n Command Register (APBH_CH5_CMD)	32	R/W	0000_0000h	15.5.10/495
180_4360	APBH DMA Channel n Buffer Address Register (APBH_CH5_BAR)	32	R/W	0000_0000h	15.5.11/497
180_4370	APBH DMA Channel n Semaphore Register (APBH_CH5_SEMA)	32	R/W	0000_0000h	15.5.12/498
180_4380	AHB to APBH DMA Channel n Debug Information (APBH_CH5_DEBUG1)	32	R/W	00A0_0000h	15.5.13/499
180_4390	AHB to APBH DMA Channel n Debug Information (APBH_CH5_DEBUG2)	32	R/W	0000_0000h	15.5.14/502
180_43A0	APBH DMA Channel n Current Command Address Register (APBH_CH6_CURCMDAR)	32	R/W	0000_0000h	15.5.8/494
180_43B0	APBH DMA Channel n Next Command Address Register (APBH_CH6_NXTCMDAR)	32	R/W	0000_0000h	15.5.9/495
180_43C0	APBH DMA Channel n Command Register (APBH_CH6_CMD)	32	R/W	0000_0000h	15.5.10/495
180_43D0	APBH DMA Channel n Buffer Address Register (APBH_CH6_BAR)	32	R/W	0000_0000h	15.5.11/497
180_43E0	APBH DMA Channel n Semaphore Register (APBH_CH6_SEMA)	32	R/W	0000_0000h	15.5.12/498
180_43F0	AHB to APBH DMA Channel n Debug Information (APBH_CH6_DEBUG1)	32	R/W	00A0_0000h	15.5.13/499
180_4400	AHB to APBH DMA Channel n Debug Information (APBH_CH6_DEBUG2)	32	R/W	0000_0000h	15.5.14/502
180_4410	APBH DMA Channel n Current Command Address Register (APBH_CH7_CURCMDAR)	32	R/W	0000_0000h	15.5.8/494
180_4420	APBH DMA Channel n Next Command Address Register (APBH_CH7_NXTCMDAR)	32	R/W	0000_0000h	15.5.9/495
180_4430	APBH DMA Channel n Command Register (APBH_CH7_CMD)	32	R/W	0000_0000h	15.5.10/495
180_4440	APBH DMA Channel n Buffer Address Register (APBH_CH7_BAR)	32	R/W	0000_0000h	15.5.11/497
180_4450	APBH DMA Channel n Semaphore Register (APBH_CH7_SEMA)	32	R/W	0000_0000h	15.5.12/498
180_4460	AHB to APBH DMA Channel n Debug Information (APBH_CH7_DEBUG1)	32	R/W	00A0_0000h	15.5.13/499

Table continues on the next page...

APBH memory map (continued)

Absolute address (hex)	Register name	Width (in bits)	Access	Reset value	Section/page
180_4470	AHB to APBH DMA Channel n Debug Information (APBH_CH7_DEBUG2)	32	R/W	0000_0000h	15.5.14/502
180_4480	APBH DMA Channel n Current Command Address Register (APBH_CH8_CURCMDAR)	32	R/W	0000_0000h	15.5.8/494
180_4490	APBH DMA Channel n Next Command Address Register (APBH_CH8_NXTCMDAR)	32	R/W	0000_0000h	15.5.9/495
180_44A0	APBH DMA Channel n Command Register (APBH_CH8_CMD)	32	R/W	0000_0000h	15.5.10/495
180_44B0	APBH DMA Channel n Buffer Address Register (APBH_CH8_BAR)	32	R/W	0000_0000h	15.5.11/497
180_44C0	APBH DMA Channel n Semaphore Register (APBH_CH8_SEMA)	32	R/W	0000_0000h	15.5.12/498
180_44D0	AHB to APBH DMA Channel n Debug Information (APBH_CH8_DEBUG1)	32	R/W	00A0_0000h	15.5.13/499
180_44E0	AHB to APBH DMA Channel n Debug Information (APBH_CH8_DEBUG2)	32	R/W	0000_0000h	15.5.14/502
180_44F0	APBH DMA Channel n Current Command Address Register (APBH_CH9_CURCMDAR)	32	R/W	0000_0000h	15.5.8/494
180_4500	APBH DMA Channel n Next Command Address Register (APBH_CH9_NXTCMDAR)	32	R/W	0000_0000h	15.5.9/495
180_4510	APBH DMA Channel n Command Register (APBH_CH9_CMD)	32	R/W	0000_0000h	15.5.10/495
180_4520	APBH DMA Channel n Buffer Address Register (APBH_CH9_BAR)	32	R/W	0000_0000h	15.5.11/497
180_4530	APBH DMA Channel n Semaphore Register (APBH_CH9_SEMA)	32	R/W	0000_0000h	15.5.12/498
180_4540	AHB to APBH DMA Channel n Debug Information (APBH_CH9_DEBUG1)	32	R/W	00A0_0000h	15.5.13/499
180_4550	AHB to APBH DMA Channel n Debug Information (APBH_CH9_DEBUG2)	32	R/W	0000_0000h	15.5.14/502
180_4560	APBH DMA Channel n Current Command Address Register (APBH_CH10_CURCMDAR)	32	R/W	0000_0000h	15.5.8/494
180_4570	APBH DMA Channel n Next Command Address Register (APBH_CH10_NXTCMDAR)	32	R/W	0000_0000h	15.5.9/495
180_4580	APBH DMA Channel n Command Register (APBH_CH10_CMD)	32	R/W	0000_0000h	15.5.10/495
180_4590	APBH DMA Channel n Buffer Address Register (APBH_CH10_BAR)	32	R/W	0000_0000h	15.5.11/497
180_45A0	APBH DMA Channel n Semaphore Register (APBH_CH10_SEMA)	32	R/W	0000_0000h	15.5.12/498
180_45B0	AHB to APBH DMA Channel n Debug Information (APBH_CH10_DEBUG1)	32	R/W	00A0_0000h	15.5.13/499
180_45C0	AHB to APBH DMA Channel n Debug Information (APBH_CH10_DEBUG2)	32	R/W	0000_0000h	15.5.14/502

Table continues on the next page...

APBH memory map (continued)

Absolute address (hex)	Register name	Width (in bits)	Access	Reset value	Section/page
180_45D0	APBH DMA Channel n Current Command Address Register (APBH_CH11_CURCMDAR)	32	R/W	0000_0000h	15.5.8/494
180_45E0	APBH DMA Channel n Next Command Address Register (APBH_CH11_NXTCMDAR)	32	R/W	0000_0000h	15.5.9/495
180_45F0	APBH DMA Channel n Command Register (APBH_CH11_CMD)	32	R/W	0000_0000h	15.5.10/495
180_4600	APBH DMA Channel n Buffer Address Register (APBH_CH11_BAR)	32	R/W	0000_0000h	15.5.11/497
180_4610	APBH DMA Channel n Semaphore Register (APBH_CH11_SEMA)	32	R/W	0000_0000h	15.5.12/498
180_4620	AHB to APBH DMA Channel n Debug Information (APBH_CH11_DEBUG1)	32	R/W	00A0_0000h	15.5.13/499
180_4630	AHB to APBH DMA Channel n Debug Information (APBH_CH11_DEBUG2)	32	R/W	0000_0000h	15.5.14/502
180_4640	APBH DMA Channel n Current Command Address Register (APBH_CH12_CURCMDAR)	32	R/W	0000_0000h	15.5.8/494
180_4650	APBH DMA Channel n Next Command Address Register (APBH_CH12_NXTCMDAR)	32	R/W	0000_0000h	15.5.9/495
180_4660	APBH DMA Channel n Command Register (APBH_CH12_CMD)	32	R/W	0000_0000h	15.5.10/495
180_4670	APBH DMA Channel n Buffer Address Register (APBH_CH12_BAR)	32	R/W	0000_0000h	15.5.11/497
180_4680	APBH DMA Channel n Semaphore Register (APBH_CH12_SEMA)	32	R/W	0000_0000h	15.5.12/498
180_4690	AHB to APBH DMA Channel n Debug Information (APBH_CH12_DEBUG1)	32	R/W	00A0_0000h	15.5.13/499
180_46A0	AHB to APBH DMA Channel n Debug Information (APBH_CH12_DEBUG2)	32	R/W	0000_0000h	15.5.14/502
180_46B0	APBH DMA Channel n Current Command Address Register (APBH_CH13_CURCMDAR)	32	R/W	0000_0000h	15.5.8/494
180_46C0	APBH DMA Channel n Next Command Address Register (APBH_CH13_NXTCMDAR)	32	R/W	0000_0000h	15.5.9/495
180_46D0	APBH DMA Channel n Command Register (APBH_CH13_CMD)	32	R/W	0000_0000h	15.5.10/495
180_46E0	APBH DMA Channel n Buffer Address Register (APBH_CH13_BAR)	32	R/W	0000_0000h	15.5.11/497
180_46F0	APBH DMA Channel n Semaphore Register (APBH_CH13_SEMA)	32	R/W	0000_0000h	15.5.12/498
180_4700	AHB to APBH DMA Channel n Debug Information (APBH_CH13_DEBUG1)	32	R/W	00A0_0000h	15.5.13/499
180_4710	AHB to APBH DMA Channel n Debug Information (APBH_CH13_DEBUG2)	32	R/W	0000_0000h	15.5.14/502
180_4720	APBH DMA Channel n Current Command Address Register (APBH_CH14_CURCMDAR)	32	R/W	0000_0000h	15.5.8/494

Table continues on the next page...

APBH memory map (continued)

Absolute address (hex)	Register name	Width (in bits)	Access	Reset value	Section/page
180_4730	APBH DMA Channel n Next Command Address Register (APBH_CH14_NXTCMDAR)	32	R/W	0000_0000h	15.5.9/495
180_4740	APBH DMA Channel n Command Register (APBH_CH14_CMD)	32	R/W	0000_0000h	15.5.10/495
180_4750	APBH DMA Channel n Buffer Address Register (APBH_CH14_BAR)	32	R/W	0000_0000h	15.5.11/497
180_4760	APBH DMA Channel n Semaphore Register (APBH_CH14_SEMA)	32	R/W	0000_0000h	15.5.12/498
180_4770	AHB to APBH DMA Channel n Debug Information (APBH_CH14_DEBUG1)	32	R/W	00A0_0000h	15.5.13/499
180_4780	AHB to APBH DMA Channel n Debug Information (APBH_CH14_DEBUG2)	32	R/W	0000_0000h	15.5.14/502
180_4790	APBH DMA Channel n Current Command Address Register (APBH_CH15_CURCMDAR)	32	R/W	0000_0000h	15.5.8/494
180_47A0	APBH DMA Channel n Next Command Address Register (APBH_CH15_NXTCMDAR)	32	R/W	0000_0000h	15.5.9/495
180_47B0	APBH DMA Channel n Command Register (APBH_CH15_CMD)	32	R/W	0000_0000h	15.5.10/495
180_47C0	APBH DMA Channel n Buffer Address Register (APBH_CH15_BAR)	32	R/W	0000_0000h	15.5.11/497
180_47D0	APBH DMA Channel n Semaphore Register (APBH_CH15_SEMA)	32	R/W	0000_0000h	15.5.12/498
180_47E0	AHB to APBH DMA Channel n Debug Information (APBH_CH15_DEBUG1)	32	R/W	00A0_0000h	15.5.13/499
180_47F0	AHB to APBH DMA Channel n Debug Information (APBH_CH15_DEBUG2)	32	R/W	0000_0000h	15.5.14/502
180_4800	APBH Bridge Version Register (APBH_VERSION)	32	R/W	0301_0000h	15.5.15/503

15.5.1 AHB to APBH Bridge Control and Status Register 0 (APBH_CTRL0n)

The APBH CTRL 0 provides overall control of the AHB to APBH bridge and DMA. This register contains module softreset, clock gating, channel clock gating/freeze bits.

Address: 180_4000h base + 0h offset + (4d × i), where i=0d to 3d

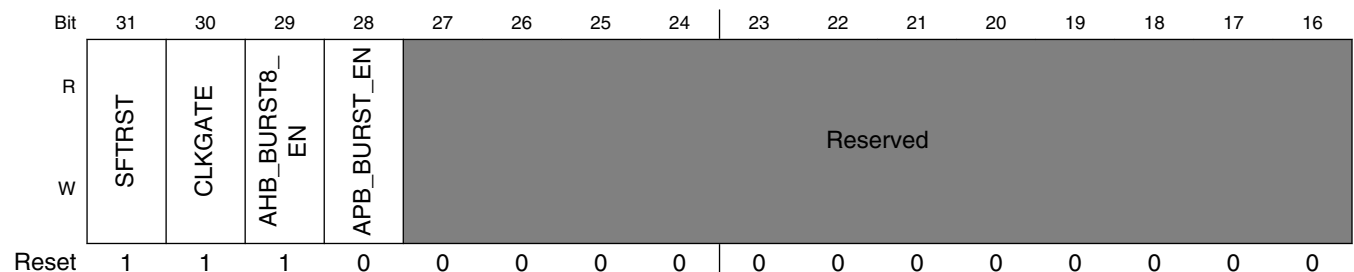

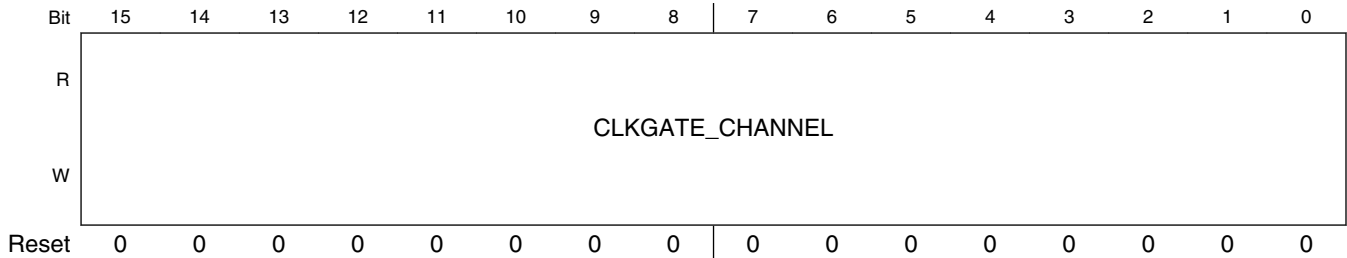

APBH_CTRL0n field descriptions

Field	Description
31 SFTRST	Set this bit to zero to enable normal APBH DMA operation. Set this bit to one (default) to disable clocking with the APBH DMA and hold it in its reset (lowest power) state. This bit can be turned on and then off to reset the APBH DMA block to its default state.
30 CLKGATE	This bit must be set to zero for normal operation. When set to one it gates off the clocks to the block.
29 AHB_BURST8_EN	Set this bit to one (default) to enable AHB 8-beat burst. Set to zero to disable 8-beat burst on AHB interface.
28 APB_BURST_EN	Set this bit to one to enable apb master do a continous transfers when a device request a burst dma. Set to zero will treat a burst dma request as 4/8 individual requests.
27–16 RSVD0	This field is reserved. Reserved, always set to zero.
CLKGATE_CHANNEL	These bits must be set to zero for normal operation of each channel. When set to one they gate off the individual clocks to the channels. 0x0001 NAND0 — 0x0002 NAND1 — 0x0004 NAND2 — 0x0008 NAND3 — 0x0010 NAND4 — 0x0020 NAND5 — 0x0040 NAND6 — 0x0080 NAND7 — 0x0100 SSP —

15.5.2 AHB to APBH Bridge Control and Status Register 1 (APBH_CTRL1n)

The APBH CTRL one provides overall control of the interrupts generated by the AHB to APBH DMA. This register contains the per channel interrupt status bits and the per channel interrupt enable bits. Each channel has a dedicated interrupt vector in the vectored interrupt controller.

EXAMPLE

```
BF_WR (APBH_CTRL1, CH5_CMDCMPLT_IRQ, 0); // use bitfield write macro
```

APBH Memory Map/Register Definition

```
BF_APBH_CTRL1.CH5_CMDCMPLT_IRQ = 0; // or, assign to register
struct's bitfield
```

Address: 180_4000h base + 10h offset + (4d × i), where i=0d to 3d

Bit	31	30	29	28	27	26	25	24	23	22	21	20	19	18	17	16
R																
W	CH15_CMDCMPLT_IRQ_EN	CH14_CMDCMPLT_IRQ_EN	CH13_CMDCMPLT_IRQ_EN	CH12_CMDCMPLT_IRQ_EN	CH11_CMDCMPLT_IRQ_EN	CH10_CMDCMPLT_IRQ_EN	CH9_CMDCMPLT_IRQ_EN	CH8_CMDCMPLT_IRQ_EN	CH7_CMDCMPLT_IRQ_EN	CH6_CMDCMPLT_IRQ_EN	CH5_CMDCMPLT_IRQ_EN	CH4_CMDCMPLT_IRQ_EN	CH3_CMDCMPLT_IRQ_EN	CH2_CMDCMPLT_IRQ_EN	CH1_CMDCMPLT_IRQ_EN	CH0_CMDCMPLT_IRQ_EN
Reset	0	0	0	0	0	0	0	0	0	0	0	0	0	0	0	0
Bit	15	14	13	12	11	10	9	8	7	6	5	4	3	2	1	0
R																
W	CH15_CMDCMPLT_IRQ	CH14_CMDCMPLT_IRQ	CH13_CMDCMPLT_IRQ	CH12_CMDCMPLT_IRQ	CH11_CMDCMPLT_IRQ	CH10_CMDCMPLT_IRQ	CH9_CMDCMPLT_IRQ	CH8_CMDCMPLT_IRQ	CH7_CMDCMPLT_IRQ	CH6_CMDCMPLT_IRQ	CH5_CMDCMPLT_IRQ	CH4_CMDCMPLT_IRQ	CH3_CMDCMPLT_IRQ	CH2_CMDCMPLT_IRQ	CH1_CMDCMPLT_IRQ	CH0_CMDCMPLT_IRQ
Reset	0	0	0	0	0	0	0	0	0	0	0	0	0	0	0	0

APBH_CTRL1n field descriptions

Field	Description
31 CH15_CMDCMPLT_IRQ_EN	Setting this bit enables the generation of an interrupt request for APBH DMA channel 15.
30 CH14_CMDCMPLT_IRQ_EN	Setting this bit enables the generation of an interrupt request for APBH DMA channel 14.
29 CH13_CMDCMPLT_IRQ_EN	Setting this bit enables the generation of an interrupt request for APBH DMA channel 13.
28 CH12_CMDCMPLT_IRQ_EN	Setting this bit enables the generation of an interrupt request for APBH DMA channel 12.
27 CH11_CMDCMPLT_IRQ_EN	Setting this bit enables the generation of an interrupt request for APBH DMA channel 11.
26 CH10_CMDCMPLT_IRQ_EN	Setting this bit enables the generation of an interrupt request for APBH DMA channel 10.

Table continues on the next page...

APBH_CTRL1n field descriptions (continued)

Field	Description
25 CH9_ CMDAMPLT_ IRQ_EN	Setting this bit enables the generation of an interrupt request for APBH DMA channel 9.
24 CH8_ CMDAMPLT_ IRQ_EN	Setting this bit enables the generation of an interrupt request for APBH DMA channel 8.
23 CH7_ CMDAMPLT_ IRQ_EN	Setting this bit enables the generation of an interrupt request for APBH DMA channel 7.
22 CH6_ CMDAMPLT_ IRQ_EN	Setting this bit enables the generation of an interrupt request for APBH DMA channel 6.
21 CH5_ CMDAMPLT_ IRQ_EN	Setting this bit enables the generation of an interrupt request for APBH DMA channel 5.
20 CH4_ CMDAMPLT_ IRQ_EN	Setting this bit enables the generation of an interrupt request for APBH DMA channel 4.
19 CH3_ CMDAMPLT_ IRQ_EN	Setting this bit enables the generation of an interrupt request for APBH DMA channel 3.
18 CH2_ CMDAMPLT_ IRQ_EN	Setting this bit enables the generation of an interrupt request for APBH DMA channel 2.
17 CH1_ CMDAMPLT_ IRQ_EN	Setting this bit enables the generation of an interrupt request for APBH DMA channel 1.
16 CH0_ CMDAMPLT_ IRQ_EN	Setting this bit enables the generation of an interrupt request for APBH DMA channel 0.
15 CH15_ CMDAMPLT_ IRQ	Interrupt request status bit for APBH DMA Channel 15. This sticky bit is set by DMA hardware and reset by software. It is ANDed with its corresponding enable bit to generate an interrupt.
14 CH14_ CMDAMPLT_ IRQ	Interrupt request status bit for APBH DMA Channel 14. This sticky bit is set by DMA hardware and reset by software. It is ANDed with its corresponding enable bit to generate an interrupt.

Table continues on the next page...

APBH_CTRL1n field descriptions (continued)

Field	Description
13 CH13_ CMDCMPLT_ IRQ	Interrupt request status bit for APBH DMA Channel 13. This sticky bit is set by DMA hardware and reset by software. It is ANDed with its corresponding enable bit to generate an interrupt.
12 CH12_ CMDCMPLT_ IRQ	Interrupt request status bit for APBH DMA Channel 12. This sticky bit is set by DMA hardware and reset by software. It is ANDed with its corresponding enable bit to generate an interrupt.
11 CH11_ CMDCMPLT_ IRQ	Interrupt request status bit for APBH DMA Channel 11. This sticky bit is set by DMA hardware and reset by software. It is ANDed with its corresponding enable bit to generate an interrupt.
10 CH10_ CMDCMPLT_ IRQ	Interrupt request status bit for APBH DMA Channel 10. This sticky bit is set by DMA hardware and reset by software. It is ANDed with its corresponding enable bit to generate an interrupt.
9 CH9_ CMDCMPLT_ IRQ	Interrupt request status bit for APBH DMA Channel 9. This sticky bit is set by DMA hardware and reset by software. It is ANDed with its corresponding enable bit to generate an interrupt.
8 CH8_ CMDCMPLT_ IRQ	Interrupt request status bit for APBH DMA Channel 8. This sticky bit is set by DMA hardware and reset by software. It is ANDed with its corresponding enable bit to generate an interrupt.
7 CH7_ CMDCMPLT_ IRQ	Interrupt request status bit for APBH DMA channel 7. This sticky bit is set by DMA hardware and reset by software. It is ANDed with its corresponding enable bit to generate an interrupt.
6 CH6_ CMDCMPLT_ IRQ	Interrupt request status bit for APBH DMA channel 6. This sticky bit is set by DMA hardware and reset by software. It is ANDed with its corresponding enable bit to generate an interrupt.
5 CH5_ CMDCMPLT_ IRQ	Interrupt request status bit for APBH DMA channel 5. This sticky bit is set by DMA hardware and reset by software. It is ANDed with its corresponding enable bit to generate an interrupt.
4 CH4_ CMDCMPLT_ IRQ	Interrupt request status bit for APBH DMA channel 4. This sticky bit is set by DMA hardware and reset by software. It is ANDed with its corresponding enable bit to generate an interrupt.
3 CH3_ CMDCMPLT_ IRQ	Interrupt request status bit for APBH DMA channel 3. This sticky bit is set by DMA hardware and reset by software. It is ANDed with its corresponding enable bit to generate an interrupt.
2 CH2_ CMDCMPLT_ IRQ	Interrupt request status bit for APBH DMA channel 2. This sticky bit is set by DMA hardware and reset by software. It is ANDed with its corresponding enable bit to generate an interrupt.

Table continues on the next page...

APBH_CTRL1n field descriptions (continued)

Field	Description
1 CH1_ CMDCMPLT_ IRQ	Interrupt request status bit for APBH DMA channel 1. This sticky bit is set by DMA hardware and reset by software. It is ANDed with its corresponding enable bit to generate an interrupt.
0 CH0_ CMDCMPLT_ IRQ	Interrupt request status bit for APBH DMA channel 0. This sticky bit is set by DMA hardware and reset by software. It is ANDed with its corresponding enable bit to generate an interrupt.

15.5.3 AHB to APBH Bridge Control and Status Register 2 (APBH_CTRL2n)

The APBH CTRL 2 provides channel error interrupts generated by the AHB to APBH DMA. This register contains the per channel interrupt status bits and the per channel interrupt enable bits. Each channel has a dedicated interrupt vector in the vectored interrupt controller.

EXAMPLE

```

struct's bitfield
BF_WR(APBH_CTRL1, CH5_CMDCMPLT_IRQ, 0); // use bitfield write macro
BF_APBH_CTRL1.CH5_CMDCMPLT_IRQ = 0;    // or, assign to register

```

APBH Memory Map/Register Definition

Address: 180_4000h base + 20h offset + (4d × i), where i=0d to 3d

Bit	31	30	29	28	27	26	25	24	23	22	21	20	19	18	17	16
R	CH15_ERROR_STATUS	CH14_ERROR_STATUS	CH13_ERROR_STATUS	CH12_ERROR_STATUS	CH11_ERROR_STATUS	CH10_ERROR_STATUS	CH9_ERROR_STATUS	CH8_ERROR_STATUS	CH7_ERROR_STATUS	CH6_ERROR_STATUS	CH5_ERROR_STATUS	CH4_ERROR_STATUS	CH3_ERROR_STATUS	CH2_ERROR_STATUS	CH1_ERROR_STATUS	CH0_ERROR_STATUS
W																
Reset	0	0	0	0	0	0	0	0	0	0	0	0	0	0	0	0
Bit	15	14	13	12	11	10	9	8	7	6	5	4	3	2	1	0
R	CH15_ERROR_IRQ	CH14_ERROR_IRQ	CH13_ERROR_IRQ	CH12_ERROR_IRQ	CH11_ERROR_IRQ	CH10_ERROR_IRQ	CH9_ERROR_IRQ	CH8_ERROR_IRQ	CH7_ERROR_IRQ	CH6_ERROR_IRQ	CH5_ERROR_IRQ	CH4_ERROR_IRQ	CH3_ERROR_IRQ	CH2_ERROR_IRQ	CH1_ERROR_IRQ	CH0_ERROR_IRQ
W																
Reset	0	0	0	0	0	0	0	0	0	0	0	0	0	0	0	0

APBH_CTRL2n field descriptions

Field	Description
31 CH15_ERROR_STATUS	Error status bit for APBH DMA Channel 15. Valid when corresponding Error IRQ is set. 1 - AHB bus error

Table continues on the next page...

APBH_CTRL2n field descriptions (continued)

Field	Description
	0 - channel early termination. 0x0 TERMINATION — An early termination from the device causes error IRQ. 0x1 BUS_ERROR — An AHB bus error causes error IRQ.
30 CH14_ERROR_STATUS	Error status bit for APBH DMA Channel 14. Valid when corresponding Error IRQ is set. 1 - AHB bus error 0 - channel early termination. 0x0 TERMINATION — An early termination from the device causes error IRQ. 0x1 BUS_ERROR — An AHB bus error causes error IRQ.
29 CH13_ERROR_STATUS	Error status bit for APBH DMA Channel 13. Valid when corresponding Error IRQ is set. 1 - AHB bus error 0 - channel early termination. 0x0 TERMINATION — An early termination from the device causes error IRQ. 0x1 BUS_ERROR — An AHB bus error causes error IRQ.
28 CH12_ERROR_STATUS	Error status bit for APBH DMA Channel 12. Valid when corresponding Error IRQ is set. 1 - AHB bus error 0 - channel early termination. 0x0 TERMINATION — An early termination from the device causes error IRQ. 0x1 BUS_ERROR — An AHB bus error causes error IRQ.
27 CH11_ERROR_STATUS	Error status bit for APBH DMA Channel 11. Valid when corresponding Error IRQ is set. 1 - AHB bus error 0 - channel early termination. 0x0 TERMINATION — An early termination from the device causes error IRQ. 0x1 BUS_ERROR — An AHB bus error causes error IRQ.
26 CH10_ERROR_STATUS	Error status bit for APBH DMA Channel 10. Valid when corresponding Error IRQ is set. 1 - AHB bus error 0 - channel early termination. 0x0 TERMINATION — An early termination from the device causes error IRQ. 0x1 BUS_ERROR — An AHB bus error causes error IRQ.
25 CH9_ERROR_STATUS	Error status bit for APBH DMA Channel 9. Valid when corresponding Error IRQ is set. 1 - AHB bus error 0 - channel early termination. 0x0 TERMINATION — An early termination from the device causes error IRQ. 0x1 BUS_ERROR — An AHB bus error causes error IRQ.
24 CH8_ERROR_STATUS	Error status bit for APBH DMA Channel 8. Valid when corresponding Error IRQ is set. 1 - AHB bus error 0 - channel early termination.

Table continues on the next page...

APBH_CTRL2n field descriptions (continued)

Field	Description
	0x0 TERMINATION — An early termination from the device causes error IRQ. 0x1 BUS_ERROR — An AHB bus error causes error IRQ.
23 CH7_ERROR_STATUS	Error status bit for APBX DMA Channel 7. Valid when corresponding Error IRQ is set. 1 - AHB bus error 0 - channel early termination. 0x0 TERMINATION — An early termination from the device causes error IRQ. 0x1 BUS_ERROR — An AHB bus error causes error IRQ.
22 CH6_ERROR_STATUS	Error status bit for APBX DMA Channel 6. Valid when corresponding Error IRQ is set. 1 - AHB bus error 0 - channel early termination. 0x0 TERMINATION — An early termination from the device causes error IRQ. 0x1 BUS_ERROR — An AHB bus error causes error IRQ.
21 CH5_ERROR_STATUS	Error status bit for APBX DMA Channel 5. Valid when corresponding Error IRQ is set. 1 - AHB bus error 0 - channel early termination. 0x0 TERMINATION — An early termination from the device causes error IRQ. 0x1 BUS_ERROR — An AHB bus error causes error IRQ.
20 CH4_ERROR_STATUS	Error status bit for APBX DMA Channel 4. Valid when corresponding Error IRQ is set. 1 - AHB bus error 0 - channel early termination. 0x0 TERMINATION — An early termination from the device causes error IRQ. 0x1 BUS_ERROR — An AHB bus error causes error IRQ.
19 CH3_ERROR_STATUS	Error status bit for APBX DMA Channel 3. Valid when corresponding Error IRQ is set. 1 - AHB bus error 0 - channel early termination. 0x0 TERMINATION — An early termination from the device causes error IRQ. 0x1 BUS_ERROR — An AHB bus error causes error IRQ.
18 CH2_ERROR_STATUS	Error status bit for APBX DMA Channel 2. Valid when corresponding Error IRQ is set. 1 - AHB bus error 0 - channel early termination. 0x0 TERMINATION — An early termination from the device causes error IRQ. 0x1 BUS_ERROR — An AHB bus error causes error IRQ.
17 CH1_ERROR_STATUS	Error status bit for APBX DMA Channel 1. Valid when corresponding Error IRQ is set. 1 - AHB bus error 0 - channel early termination. 0x0 TERMINATION — An early termination from the device causes error IRQ. 0x1 BUS_ERROR — An AHB bus error causes error IRQ.

Table continues on the next page...

APBH_CTRL2n field descriptions (continued)

Field	Description
16 CH0_ERROR_STATUS	Error status bit for APBX DMA Channel 0. Valid when corresponding Error IRQ is set. 1 - AHB bus error 0 - channel early termination. 0x0 TERMINATION — An early termination from the device causes error IRQ. 0x1 BUS_ERROR — An AHB bus error causes error IRQ.
15 CH15_ERROR_IRQ	Error interrupt status bit for APBH DMA Channel 15. This sticky bit is set by DMA hardware and reset by software. It is ORed with the corresponding cmdcmplt irq to generate an irq to Arm.
14 CH14_ERROR_IRQ	Error interrupt status bit for APBH DMA Channel 14. This sticky bit is set by DMA hardware and reset by software. It is ORed with the corresponding cmdcmplt irq to generate an irq to Arm.
13 CH13_ERROR_IRQ	Error interrupt status bit for APBH DMA Channel 13. This sticky bit is set by DMA hardware and reset by software. It is ORed with the corresponding cmdcmplt irq to generate an irq to Arm.
12 CH12_ERROR_IRQ	Error interrupt status bit for APBH DMA Channel 12. This sticky bit is set by DMA hardware and reset by software. It is ORed with the corresponding cmdcmplt irq to generate an irq to Arm.
11 CH11_ERROR_IRQ	Error interrupt status bit for APBH DMA Channel 11. This sticky bit is set by DMA hardware and reset by software. It is ORed with the corresponding cmdcmplt irq to generate an irq to Arm.
10 CH10_ERROR_IRQ	Error interrupt status bit for APBH DMA Channel 10. This sticky bit is set by DMA hardware and reset by software. It is ORed with the corresponding cmdcmplt irq to generate an irq to Arm.
9 CH9_ERROR_IRQ	Error interrupt status bit for APBH DMA Channel 9. This sticky bit is set by DMA hardware and reset by software. It is ORed with the corresponding cmdcmplt irq to generate an irq to Arm.
8 CH8_ERROR_IRQ	Error interrupt status bit for APBH DMA Channel 8. This sticky bit is set by DMA hardware and reset by software. It is ORed with the corresponding cmdcmplt irq to generate an irq to Arm.
7 CH7_ERROR_IRQ	Error interrupt status bit for APBX DMA Channel 7. This sticky bit is set by DMA hardware and reset by software. It is ORed with the corresponding cmdcmplt irq to generate an irq to Arm.
6 CH6_ERROR_IRQ	Error interrupt status bit for APBX DMA Channel 6. This sticky bit is set by DMA hardware and reset by software. It is ORed with the corresponding cmdcmplt irq to generate an irq to Arm.
5 CH5_ERROR_IRQ	Error interrupt status bit for APBX DMA Channel 5. This sticky bit is set by DMA hardware and reset by software. It is ORed with the corresponding cmdcmplt irq to generate an irq to Arm.
4 CH4_ERROR_IRQ	Error interrupt status bit for APBX DMA Channel 4. This sticky bit is set by DMA hardware and reset by software. It is ORed with the corresponding cmdcmplt irq to generate an irq to Arm.
3 CH3_ERROR_IRQ	Error interrupt status bit for APBX DMA Channel 3. This sticky bit is set by DMA hardware and reset by software. It is ORed with the corresponding cmdcmplt irq to generate an irq to Arm.
2 CH2_ERROR_IRQ	Error interrupt status bit for APBX DMA Channel 2. This sticky bit is set by DMA hardware and reset by software. It is ORed with the corresponding cmdcmplt irq to generate an irq to Arm.

Table continues on the next page...

APBH_CTRL2n field descriptions (continued)

Field	Description
1 CH1_ERROR_IRQ	Error interrupt status bit for APBX DMA Channel 1. This sticky bit is set by DMA hardware and reset by software. It is ORed with the corresponding cmdcmplt irq to generate an irq to Arm.
0 CH0_ERROR_IRQ	Error interrupt status bit for APBX DMA Channel 0. This sticky bit is set by DMA hardware and reset by software. It is ORed with the corresponding cmdcmplt irq to generate an irq to Arm.

15.5.4 AHB to APBH Bridge Channel Register (APBH_CHANNEL_CTRLn)

The APBH CHANNEL CTRL provides reset/freeze control of each DMA channel. This register contains individual channel reset/freeze bits.

Address: 180_4000h base + 30h offset + (4d × i), where i=0d to 3d

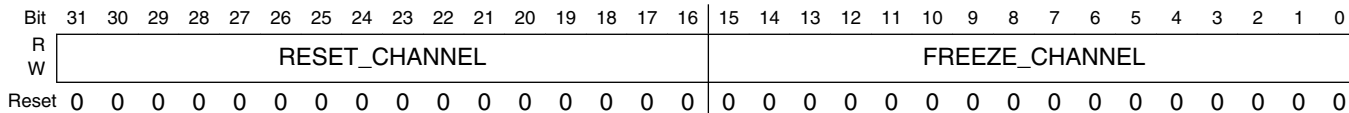

APBH_CHANNEL_CTRLn field descriptions

Field	Description
31-16 RESET_CHANNEL	Setting a bit in this field causes the DMA controller to take the corresponding channel through its reset state. The bit is reset after the channel resources are cleared. 0x0001 NAND0 — 0x0002 NAND1 — 0x0004 NAND2 — 0x0008 NAND3 — 0x0010 NAND4 — 0x0020 NAND5 — 0x0040 NAND6 — 0x0080 NAND7 — 0x0100 SSP —
FREEZE_CHANNEL	Setting a bit in this field will freeze the DMA channel associated with it. This field is a direct input to the DMA channel arbiter. When frozen, the channel is denied access to the central DMA resources. 0x0001 NAND0 — 0x0002 NAND1 — 0x0004 NAND2 — 0x0008 NAND3 — 0x0010 NAND4 — 0x0020 NAND5 — 0x0040 NAND6 —

Table continues on the next page...

APBH_CHANNEL_CTRLn field descriptions (continued)

Field	Description
0x0080	NAND7 —
0x0100	SSP —

15.5.5 AHB to APBH DMA Device Assignment Register (APBH_DEVSEL)

This register allows reassignment of the APBH device connected to the DMA Channels.

In this chip, APBH DMA channel resource is enough for high speed peripherals, so this register is of no use and reserved.

Address: 180_4000h base + 40h offset = 180_4040h

Bit	31	30	29	28	27	26	25	24	23	22	21	20	19	18	17	16
R																
W																
Reset	0	0	0	0	0	0	0	0	0	0	0	0	0	0	0	0
Bit	15	14	13	12	11	10	9	8	7	6	5	4	3	2	1	0
R																
W																
Reset	0	0	0	0	0	0	0	0	0	0	0	0	0	0	0	0

APBH_DEVSEL field descriptions

Field	Description
31–30 CH15	This field is reserved. Reserved.
29–28 CH14	This field is reserved. Reserved.
27–26 CH13	This field is reserved. Reserved.
25–24 CH12	This field is reserved. Reserved.
23–22 CH11	This field is reserved. Reserved.
21–20 CH10	This field is reserved. Reserved.
19–18 CH9	This field is reserved. Reserved.
17–16 CH8	This field is reserved. Reserved.
15–14 CH7	This field is reserved. Reserved.
13–12 CH6	This field is reserved. Reserved.

Table continues on the next page...

APBH_DEVSEL field descriptions (continued)

Field	Description
11–10 CH5	This field is reserved. Reserved.
9–8 CH4	This field is reserved. Reserved.
7–6 CH3	This field is reserved. Reserved.
5–4 CH2	This field is reserved. Reserved.
3–2 CH1	This field is reserved. Reserved.
CH0	This field is reserved. Reserved.

15.5.6 AHB to APBH DMA burst size (APBH_DMA_BURST_SIZE)

This register programs the apbh burst size of the APBH DMA devices when a DMA burst request is issued.

This register provides a mechanism for assigning the device.

Address: 180_4000h base + 50h offset = 180_4050h

Bit	31	30	29	28	27	26	25	24	23	22	21	20	19	18	17	16
R																
W																
Reset	0	0	0	0	0	0	0	0	0	1	0	1	0	1	0	1
Bit	15	14	13	12	11	10	9	8	7	6	5	4	3	2	1	0
R																
W																
Reset	0	1	0	1	0	1	0	1	0	1	0	1	0	1	0	1

APBH_DMA_BURST_SIZE field descriptions

Field	Description
31–30 CH15	This field is reserved. Reserved.
29–28 CH14	This field is reserved. Reserved.
27–26 CH13	This field is reserved. Reserved.
25–24 CH12	This field is reserved. Reserved.
23–22 CH11	This field is reserved. Reserved.

Table continues on the next page...

APBH_DMA_BURST_SIZE field descriptions (continued)

Field	Description
21–20 CH10	This field is reserved. Reserved.
19–18 CH9	This field is reserved. Reserved.
17–16 CH8	DMA burst size for SSP. 0x0 BURST0 — 0x1 BURST4 — 0x2 BURST8 —
15–14 CH7	DMA burst size for GPPI channel 7. Do not change. GPPI only support burst size 4.
13–12 CH6	DMA burst size for GPPI channel 6. Do not change. GPPI only support burst size 4.
11–10 CH5	DMA burst size for GPPI channel 5. Do not change. GPPI only support burst size 4.
9–8 CH4	DMA burst size for GPPI channel 4. Do not change. GPPI only support burst size 4.
7–6 CH3	DMA burst size for GPPI channel 3. Do not change. GPPI only support burst size 4.
5–4 CH2	DMA burst size for GPPI channel 2. Do not change. GPPI only support burst size 4.
3–2 CH1	DMA burst size for GPPI channel 1. Do not change. GPPI only support burst size 4.
CH0	DMA burst size for GPPI channel 0. Do not change. GPPI only support burst size 4.

15.5.7 AHB to APBH DMA Debug Register (APBH_DEBUG)

This register is for debug purpose.

The debug register is for internal use only. Not recommend for customer useage.

Address: 180_4000h base + 60h offset = 180_4060h

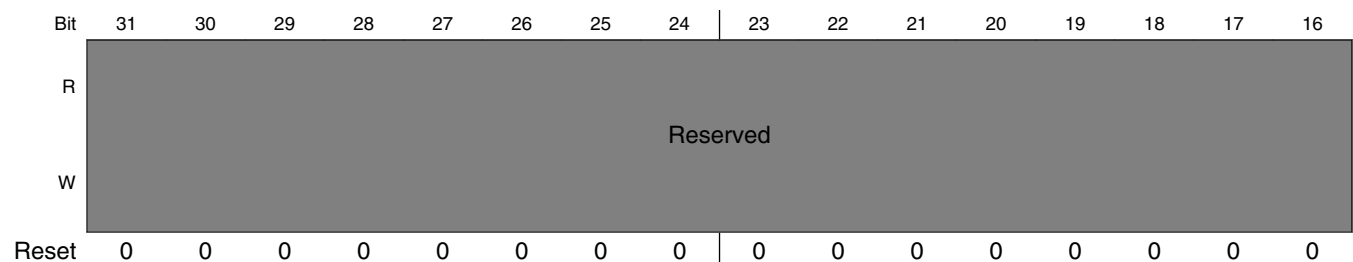

APBH Memory Map/Register Definition

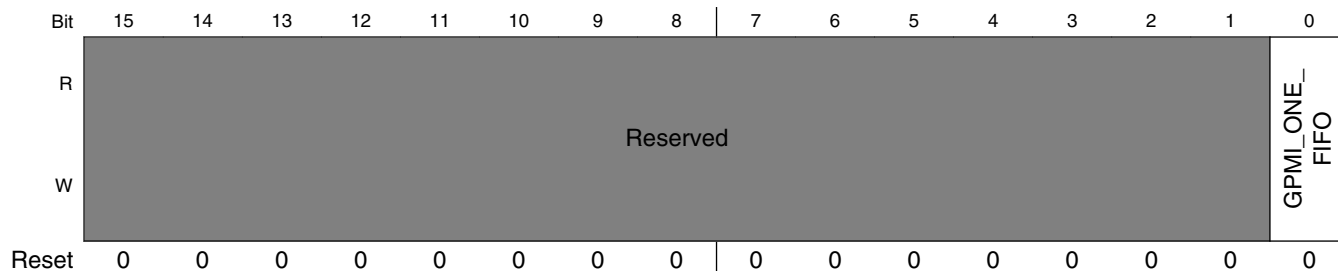

APBH_DEBUG field descriptions

Field	Description
31-1 -	This field is reserved. Reserved, always set to zero.
0 GPMI_ONE_FIFO	Set to One and the 8 GPMI channels will share the DMA FIFO, and when set to zero, the 8 GPMI channels will use its own DMA FIFO.

15.5.8 APBH DMA Channel n Current Command Address Register (APBH_CHn_CURCMDAR)

The APBH DMA channel n current command address register points to the multiword command that is currently being executed. Commands are threaded on the command address.

APBH DMA Channel n is controlled by a variable sized command structure. This register points to the command structure currently being executed.

EXAMPLE

```
pCurCmd = (apbh_chn_cmd_t *) APBH_CHn_CURCMDAR_RD(0);           // read the whole
register, since there is only one field
pCurCmd = (apbh_chn_cmd_t *) BF_RDn(APBH_CHn_CURCMDAR, 0, CMD_ADDR); // or, use multi-
register bitfield read macro
pCurCmd = (apbh_chn_cmd_t *) APBH_CHn_CURCMDAR(0).CMD_ADDR;   // or, assign from
bitfield of indexed register's struct
```

Address: 180_4000h base + 100h offset + (112d × i), where i=0d to 15d

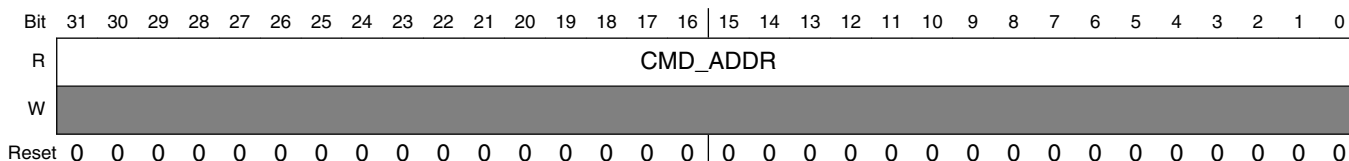

APBH_CHn_CURCMDAR field descriptions

Field	Description
CMD_ADDR	Pointer to command structure currently being processed for channel n.

15.5.9 APBH DMA Channel n Next Command Address Register (APBH_CHn_NXTCMDAR)

The APBH DMA Channel n Next Command Address register contains the address of the next multiword command to be executed. Commands are threaded on the command address. Set CHAIN to 1 in the DMA command word to process command lists.

APBH DMA Channel n is controlled by a variable sized command structure. Software loads this register with the address of the first command structure to process and increments the Channel n semaphore to start processing. This register points to the next command structure to be executed when the current command is completed.

EXAMPLE

```
APBH_CHn_NXTCMDAR_WR(0, (reg32_t) pCommandTwoStructure);           // write the entire
register, since there is only one field
BF_WRn(APBH_CHn_NXTCMDAR, 0, (reg32_t) pCommandTwoStructure);     // or, use multi-
register bitfield write macro
APBH_CHn_NXTCMDAR(0).CMD_ADDR = (reg32_t) pCommandTwoStructure;  // or, assign to bitfield
of indexed register's struct
```

Address: 180_4000h base + 110h offset + (112d × i), where i=0d to 15d

Bit	31	30	29	28	27	26	25	24	23	22	21	20	19	18	17	16	15	14	13	12	11	10	9	8	7	6	5	4	3	2	1	0																
R																																																
W																																																
Reset	0	0	0	0	0	0	0	0	0	0	0	0	0	0	0	0	0	0	0	0	0	0	0	0	0	0	0	0	0	0	0	0	0	0	0	0	0	0	0	0	0	0	0	0	0	0	0	0

APBH_CHn_NXTCMDAR field descriptions

Field	Description
CMD_ADDR	Pointer to next command structure for channel n.

15.5.10 APBH DMA Channel n Command Register (APBH_CHn_CMD)

The APBH DMA Channel n command register specifies the DMA transaction to perform for the current command chain item.

The command register controls the overall operation of each DMA command for this channel. It includes the number of bytes to transfer to or from the device, the number of APB PIO command words included with this command structure, whether to interrupt at command completion, whether to chain an additional command to the end of this one and whether this transfer is a read or write DMA transfer.

APBH Memory Map/Register Definition

EXAMPLE

```

apbh_chn_cmd_t dma_cmd;
dma_cmd.XFER_COUNT = 512; // transfer 512 bytes
dma_cmd.COMMAND = BV_APBH_CHn_CMD_COMMAND_DMA_WRITE; // transfer to system memory from
peripheral device
dma_cmd.CHAIN = 1; // chain an additional command
structure on to the list
dma_cmd.IRQONCMPLT = 1; // generate an interrupt on
completion of this command structure
    
```

Address: 180_4000h base + 120h offset + (112d × i), where i=0d to 15d

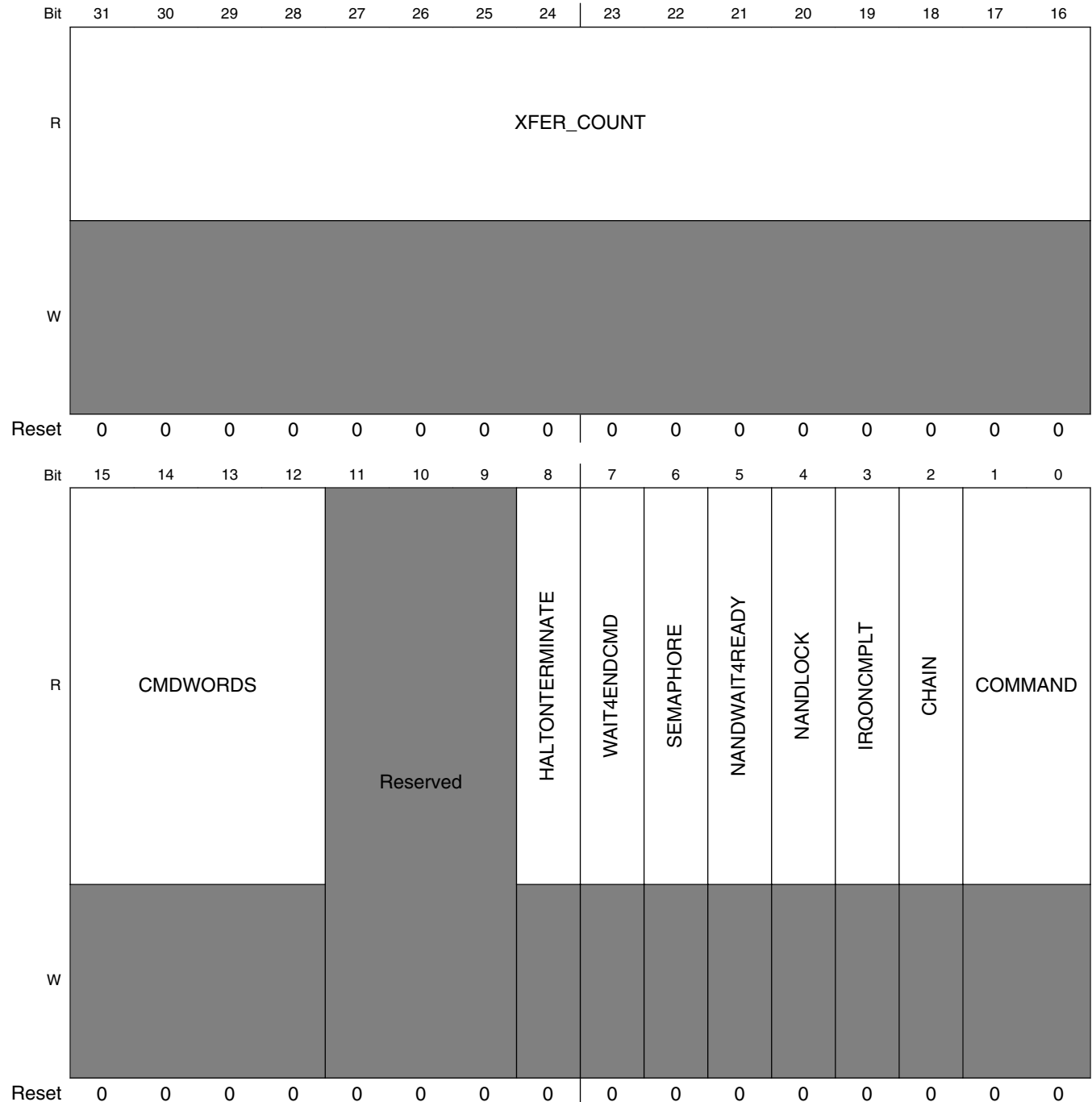

APBH_CHn_CMD field descriptions

Field	Description
31–16 XFER_COUNT	This field indicates the number of bytes to transfer to or from the appropriate PIO register in the GPMIO device. A value of 0 indicates a 64 KBytes transfer.
15–12 CMDWORDS	This field indicates the number of command words to send to the GPMIO, starting with the base PIO address of the GPMIO control register and incrementing from there. Zero means transfer NO command words
11–9 -	This field is reserved. Reserved, always set to zero.
8 HALTONTERMINATE	A value of one indicates that the channel will immediately terminate the current descriptor and halt the DMA channel if a terminate signal is set. A value of 0 will still cause an immediate terminate of the channel if the terminate signal is set, but the channel will continue as if the count had been exhausted, meaning it will honor IRQONCMPLT, CHAIN, SEMAPHORE, and WAIT4ENDCMD.
7 WAIT4ENDCMD	A value of one indicates that the channel will wait for the end of command signal to be sent from the APBH device to the DMA before starting the next DMA command.
6 SEMAPHORE	A value of one indicates that the channel will decrement its semaphore at the completion of the current command structure. If the semaphore decrements to zero, then this channel stalls until software increments it again.
5 NANDWAIT4READY	A value of one indicates that the NAND DMA channel will wait until the NAND device reports "ready" before executing the command. It is ignored for non-NAND DMA channels.
4 NANDLOCK	A value of one indicates that the NAND DMA channel will remain "locked" in the arbiter at the expense of other NAND DMA channels. It is ignored for non-NAND DMA channels.
3 IRQONCMPLT	A value of one indicates that the channel will cause the interrupt status bit to be set upon completion of the current command, i.e. after the DMA transfer is complete.
2 CHAIN	A value of one indicates that another command is chained onto the end of the current command structure. At the completion of the current command, this channel will follow the pointer in APBH_CHn_CMDAR to find the next command.
COMMAND	This bitfield indicates the type of current command: 0x0 NO_DMA_XFER — Perform any requested PIO word transfers but terminate command before any DMA transfer. 0x1 DMA_WRITE — Perform any requested PIO word transfers and then perform a DMA transfer from the peripheral for the specified number of bytes. 0x2 DMA_READ — Perform any requested PIO word transfers and then perform a DMA transfer to the peripheral for the specified number of bytes. 0x3 DMA_SENSE — Perform any requested PIO word transfers and then perform a conditional branch to the next chained device. Follow the NEXCMD_ADDR pointer if the peripheral sense is true. Follow the BUFFER_ADDRESS as a chain pointer if the peripheral sense line is false.

15.5.11 APBH DMA Channel n Buffer Address Register (APBH_CHn_BAR)

The APBH DMA Channel n buffer address register contains a pointer to the data buffer for the transfer. For immediate forms, the data is taken from this register. This is a byte address which means transfers can start on any byte boundary.

This register holds a pointer to the data buffer in system memory. After the command values have been read into the DMA controller and the device controlled by this channel, then the DMA transfer will begin, to or from the buffer pointed to by this register.

EXAMPLE

```
apbh_chn_bar_t dma_data;
dma_data.ADDRESS = (reg32_t) pDataBuffer;
```

Address: 180_4000h base + 130h offset + (112d × i), where i=0d to 15d

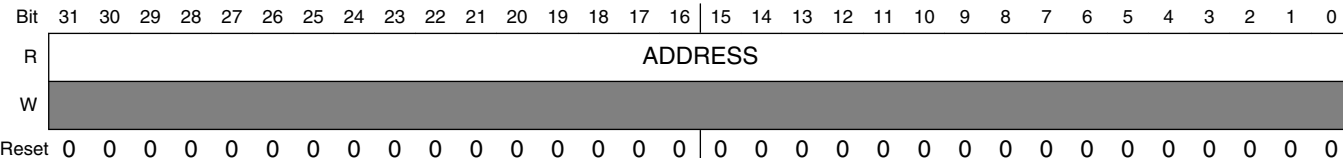

APBH_CHn_BAR field descriptions

Field	Description
ADDRESS	Address of system memory buffer to be read or written over the AHB bus.

15.5.12 APBH DMA Channel n Semaphore Register (APBH_CHn_SEMA)

The APBH DMA Channel n semaphore register is used to synchronize the Arm platform instruction stream and the DMA chain processing state.

Each DMA channel has an 8 bit counting semaphore that is used to synchronize between the program stream and and the DMA chain processing. DMA processing continues until the DMA attempts to decrement a semaphore that has already reached a value of zero. When the attempt is made, the DMA channel is stalled until software increments the semaphore count.

EXAMPLE

```
BF_WR(APBH_CHn_SEMA, 0, INCREMENT_SEMA, 2); // increment semaphore by two
current_sema = BF_RD(APBH_CHn_SEMA, 0, PHORE); // get instantaneous value
```

Address: 180_4000h base + 140h offset + (112d × i), where i=0d to 15d

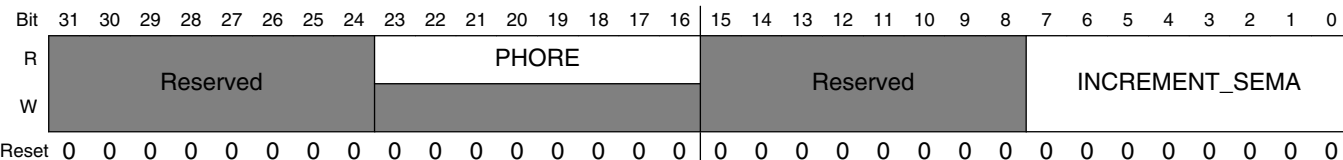

APBH_CHn_SEMA field descriptions

Field	Description
31–24 -	This field is reserved. Reserved, always set to zero.
23–16 PHORE	This read-only field shows the current (instantaneous) value of the semaphore counter.
15–8 -	This field is reserved. Reserved, always set to zero.
INCREMENT_ SEMA	The value written to this field is added to the semaphore count in an atomic way such that simultaneous software adds and DMA hardware subtracts happening on the same clock are protected. This bit field reads back a value of 0x00. Writing a value of 0x02 increments the semaphore count by two, unless the DMA channel decrements the count on the same clock, then the count is incremented by a net one.

15.5.13 AHB to APBH DMA Channel n Debug Information (APBH_CHn_DEBUG1)

This register gives debug visibility into the APBH DMA Channel n state machine and controls.

This register allows debug visibility of the APBH DMA Channel n.

APBH Memory Map/Register Definition

Address: 180_4000h base + 150h offset + (112d × i), where i=0d to 15d

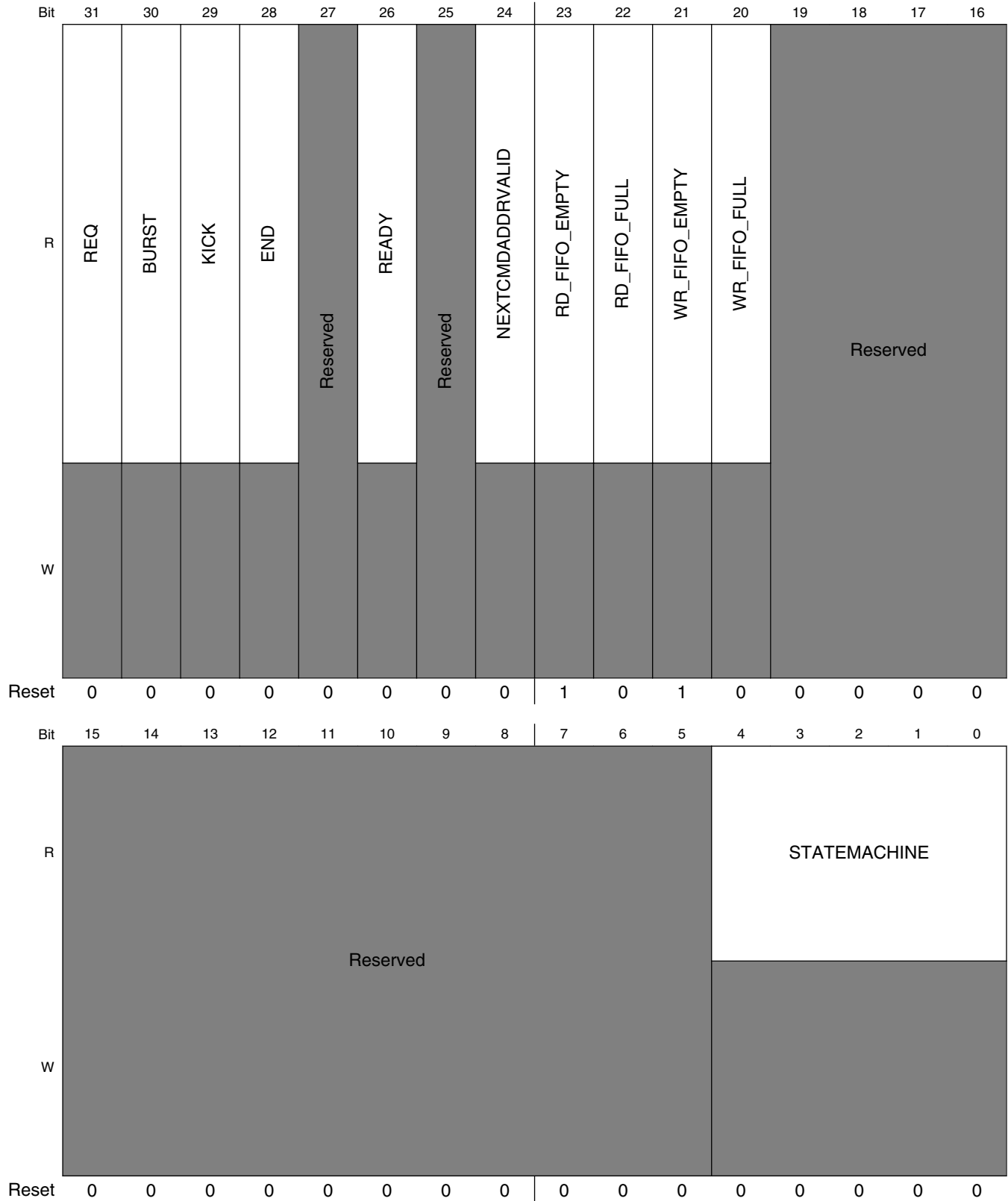

APBH_CHn_DEBUG1 field descriptions

Field	Description
31 REQ	This bit reflects the current state of the DMA Request Signal from the APB device
30 BURST	This bit reflects the current state of the DMA Burst Signal from the APB device
29 KICK	This bit reflects the current state of the DMA Kick Signal sent to the APB Device
28 END	This bit reflects the current state of the DMA End Command Signal sent from the APB Device
27 SENSE	This field is reserved. This bit is reserved for this DMA Channel and always reads 0.
26 READY	This bit is reserved for this DMA Channel and always reads 0.
25 LOCK	This field is reserved. This bit is reserved for this Channel and always reads 0.
24 NEXTCMDADDRVALID	This bit reflects the internal bit which indicates whether the channel's next command address is valid.
23 RD_FIFO_EMPTY	This bit reflects the current state of the DMA Channel's Read FIFO Empty signal.
22 RD_FIFO_FULL	This bit reflects the current state of the DMA Channel's Read FIFO Full signal.
21 WR_FIFO_EMPTY	This bit reflects the current state of the DMA Channel's Write FIFO Empty signal.
20 WR_FIFO_FULL	This bit reflects the current state of the DMA Channel's Write FIFO Full signal.
19–5 RSVD1	This field is reserved. Reserved
STATEMACHINE	PIO Display of the DMA Channel n state machine state. 0x00 IDLE — This is the idle state of the DMA state machine. 0x01 REQ_CMD1 — State in which the DMA is waiting to receive the first word of a command. 0x02 REQ_CMD3 — State in which the DMA is waiting to receive the third word of a command. 0x03 REQ_CMD2 — State in which the DMA is waiting to receive the second word of a command. 0x04 XFER_DECODE — The state machine processes the descriptor command field in this state and branches accordingly. 0x05 REQ_WAIT — The state machine waits in this state for the PIO APB cycles to complete. 0x06 REQ_CMD4 — State in which the DMA is waiting to receive the fourth word of a command, or waiting to receive the PIO words when PIO count is greater than 1. 0x07 PIO_REQ — This state determines whether another PIO cycle needs to occur before starting DMA transfers. 0x08 READ_FLUSH — During a read transfers, the state machine enters this state waiting for the last bytes to be pushed out on the APB. 0x09 READ_WAIT — When an AHB read request occurs, the state machine waits in this state for the AHB transfer to complete. 0x0C WRITE — During DMA Write transfers, the state machine waits in this state until the AHB master arbiter accepts the request from this channel. 0x0D READ_REQ — During DMA Read transfers, the state machine waits in this state until the AHB master arbiter accepts the request from this channel.

Table continues on the next page...

APBH_CHn_DEBUG1 field descriptions (continued)

Field	Description
0x0E	CHECK_CHAIN — Upon completion of the DMA transfers, this state checks the value of the Chain bit and branches accordingly.
0x0F	XFER_COMPLETE — The state machine goes to this state after the DMA transfers are complete, and determines what step to take next.
0x14	TERMINATE — When a terminate signal is set, the state machine enters this state until the current AHB transfer is completed.
0x15	WAIT_END — When the Wait for Command End bit is set, the state machine enters this state until the DMA device indicates that the command is complete.
0x1C	WRITE_WAIT — During DMA Write transfers, the state machine waits in this state until the AHB master completes the write to the AHB memory space.
0x1D	HALT_AFTER_TERM — If HALTONTERMINATE is set and a terminate signal is set, the state machine enters this state and effectively halts. A channel reset is required to exit this state
0x1E	CHECK_WAIT — If the Chain bit is a 0, the state machine enters this state and effectively halts.
0x1F	WAIT_READY — When the NAND Wait for Ready bit is set, the state machine enters this state until the GPMI device indicates that the external device is ready.

15.5.14 AHB to APBH DMA Channel n Debug Information (APBH_CHn_DEBUG2)

This register gives debug visibility for the APB and AHB byte counts for DMA Channel n.

This register allows debug visibility of the APBH DMA Channel n.

Address: 180_4000h base + 160h offset + (112d x i), where i=0d to 15d

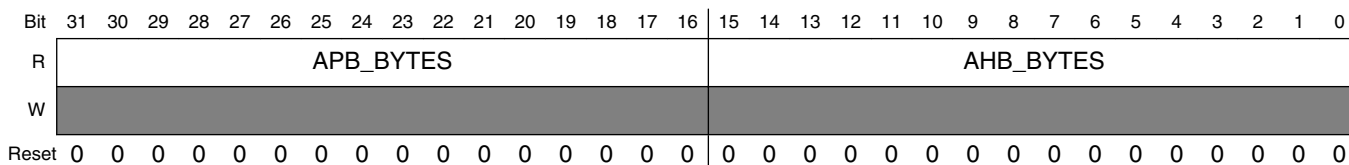

APBH_CHn_DEBUG2 field descriptions

Field	Description
31–16 APB_BYTES	This value reflects the current number of APB bytes remaining to be transferred in the current transfer.
AHB_BYTES	This value reflects the current number of AHB bytes remaining to be transferred in the current transfer.

15.5.15 APBH Bridge Version Register (APBH_VERSION)

This register always returns a known read value for debug purposes it indicates the version of the block.

This register indicates the RTL version in use.

EXAMPLE

```
if (APBH_VERSION.B.MAJOR != 3)
    Error();
```

Address: 180_4000h base + 800h offset = 180_4800h

Bit	31	30	29	28	27	26	25	24	23	22	21	20	19	18	17	16	15	14	13	12	11	10	9	8	7	6	5	4	3	2	1	0	
R	MAJOR								MINOR								STEP																
W	[Shaded]																																
Reset	0	0	0	0	0	0	0	1	1	0	0	0	0	0	0	0	1	0	0	0	0	0	0	0	0	0	0	0	0	0	0	0	0

APBH_VERSION field descriptions

Field	Description
31–24 MAJOR	Fixed read-only value reflecting the MAJOR field of the RTL version.
23–16 MINOR	Fixed read-only value reflecting the MINOR field of the RTL version.
STEP	Fixed read-only value reflecting the stepping of the RTL version.

Chapter 16

Asynchronous Sample Rate Converter (ASRC)

16.1 Overview

The Asynchronous Sample Rate Converter (ASRC) converts the sampling rate of a signal associated with an input clock into a signal associated with a different output clock.

The ASRC supports concurrent sample rate conversion of up to 10 channels of about -120dB THD+N. The ASRC supports up to three sampling rate pairs.

The incoming audio data to this chip may be received from various sources at different sampling rates. The outgoing audio data of this chip may have different sampling rates and it can also be associated with output clocks that are asynchronous to the input clocks.

The ASRC is implemented as a co-processor in hardware, with minimal ARM Platform intervention required.

The following figure is a system view of the connection between the ASRC block and other blocks.

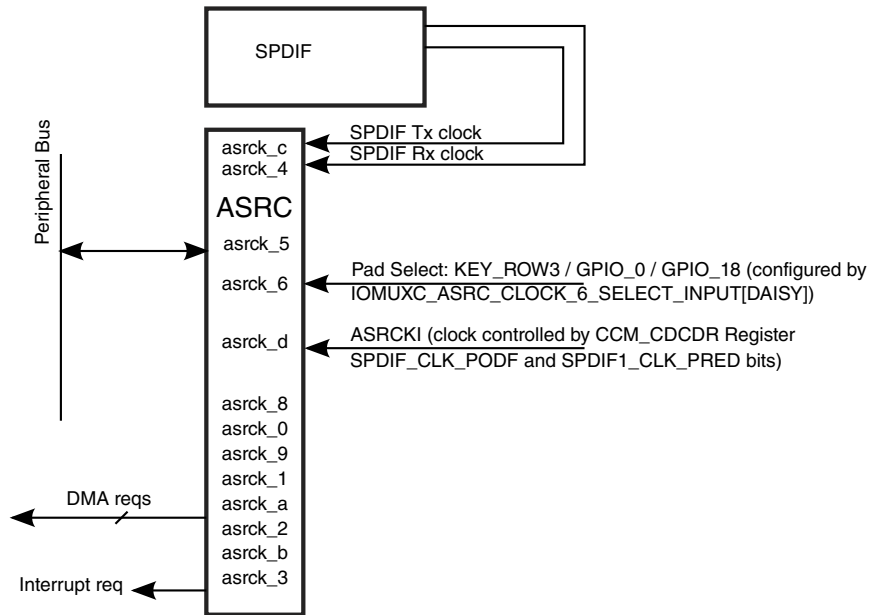

Figure 16-1. General System Overview

The following figure is the ASRC block diagram.

The red dotted line designates the ASRC block. Objects outside the dotted line represent SoC-level resources.

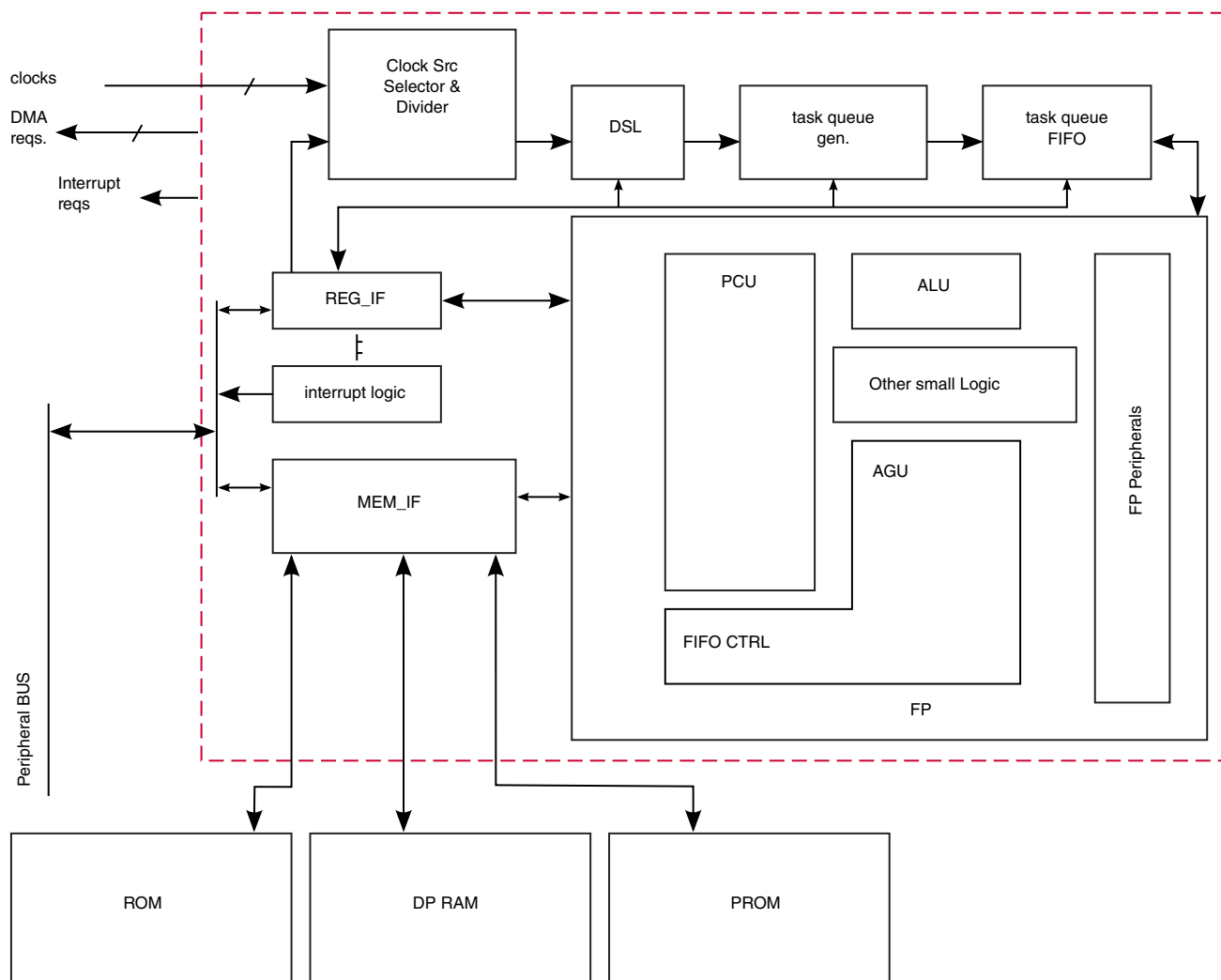

Figure 16-2. ASRC block diagram

16.1.1 Features

Table 16-1. ASRC Specifications

Parameters	Test Conditions	Minimum	Typical	Maximum	Unit
Channels Supported		0 ¹	n (0-10)	10	
Pairs of Rate Conversion		1	-	3	
THD+N	120 MHz < F _{SASRC} ² <160 MHz		-120		dB
Dynamic Range				144	dB
Settling Time			40		ms
Comment:					

1. When a pair has zero channels, the pair will be disabled, although the pair enable bit may be set in ASRCTR register.
 2. F_{SASRC} is the processing clock of ASRC block.

Other Features:

- Any number (0-10) of contiguous channels can be associated to one of the sampling rate pairs.
- Support user-programmable threshold for the input/output FIFOs.
- Support flexible 8/16/24-bit width of input data, and 16/24-bit width of output data.
- Designed for rate conversion between 44.1 kHz, 32 kHz, 48 kHz, 96 kHz, and 192 kHz. The useful signal bandwidth is below 24 kHz.
- Other input sampling rates in the range of 8 kHz to 200 kHz is also supported, but possibly with less desirable bandwidth.
- Other output sampling rates in the range of 30 kHz to 200 kHz is also supported, but possibly with less desirable bandwidth.
- Automatic accommodation to slow variations in the incoming and outgoing sampling rates.
- Linear phase
- Tolerant to sample clock jitter

Clock/Data Connections

- The sampling rate clocks are directly connected to the ASRC block, the ratio estimation of the input clocks with output clocks are done in ASRC hardware when both input/output sampling clocks are physically available.
- When both the input sampling clock and the output sampling clock are physically available, the rate conversion can work by configuring the physical clocks.
- When the input sampling clock is not physically available, the rate conversion can still work by setting ideal-ratio values into ASRC interface registers.
- The clock signals come from the following blocks:
 - Receiving bit clock and transmitting bit clock
 - SPDIF, receiving bit clock and transmitting bit clock
 - other audio peripherals etc.
- The exchange of audio data is done by the processor accessing ASRC block through registers defined on shared peripheral bus.

16.1.2 Modes of Operation

See [ASRC Memory Map/Register Definition](#) for a definition of the registers and parameters used in ASRC.

16.1.2.1 Data Transfer Schemes

16.1.2.1.1 Data Input Modes

The input mode for each of the three channel sets may be set independently. Three modes of supplying data to the ASRC input FIFOs are available:

- Polling
- Interrupt
- DMA

In all input-data transfer schemes, the ASRC fetches data from each enabled FIFO and processes the data sample-by-sample after each rising edge of the associated input sampling clock until the FIFO level reaches a threshold.

After the threshold is reached, the ASRC requests data. The FIFO size for each channel set is 64 samples and the threshold is set at 32 samples. The threshold can be defined by interface registers ASRMCRx, x=A, B or C.

If the ASRC attempts to fetch data from an empty FIFO, an error is generated and the ASRSTR_AOLE bit is set. If the ASRC overload interrupt is enabled (ASRIER_AOLIE bit is set), an interrupt is generated.

When writing data to an input FIFO, you must ensure that it is in a predefined sequence. For example, when writing to an input FIFO, the sequence should be: channel_0, channel_1, channel_2, ..., channel_n, channel_0, channel_1, channel_2, etc. Here channel_n stands for the data intended for the n-th channel. The hardware will re-allocate each data to its corresponding channel FIFO. The channel being re-allocated is shown by ASRCCR_ACIX, x=A,B or C.

Mode 1 (Polling Mode)

Polling mode is the default mode following power-on or individual reset, and is selected by clearing the associated channel set A, B, or C data-input interrupt enable bit (ASRIER_ADIE_x, where x=A, B or C). In this mode, data-input interrupts are disabled. When the FIFO level is below the threshold, the associated status bit (ASRSTR_AIDIE_x, where x=A, B, or C) is set. To clear the status bit, the FIFO must be written with enough data to raise the level above the threshold.

Mode 2 (Interrupt Mode)

The ASRC input FIFOs can also be serviced by interrupts. To enable interrupts, the corresponding data-input interrupt enable bits (ASRIER_ADIE_x, where x=A, B, or C) should be set. An interrupt is automatically generated any time the input FIFO level is below the threshold. The interrupt is cleared when enough data is written to the FIFO to raise the level above the threshold.

Mode 3 (DMA Mode)

The ASRC input FIFOs can also be filled using DMA. In this mode, the data-input interrupt-enable bits (ASRIER_ADIE_x, where x=A, B, or C) should be cleared and the DMA controller should be configured to use the ASRC as a request source.

16.1.2.1.2 Data Output Modes

The output mode for each of the 3 channel sets (A, B, and C) may be set independently.

Three modes of retrieving data from the ASRC output FIFOs are available:

- Polling
- Interrupt
- DMA

In all output-data transfer schemes, the ASRC places a processed sample into the associated output FIFO. After a threshold is reached, the ASRC requests that data be transferred out of the FIFO.

The FIFO size for each channel set is 64 samples and the threshold is set at 32 samples. The threshold can be defined by interface registers ASRMCR_x, x=A, B or C.

If the ASRC attempts to place data into a FIFO that is already full, an error is generated and the ASRSTR_AOLE bit is set. If the ASRC overload interrupt is enabled (ASRIER_AOLIE bit is set), an interrupt is generated.

Each output FIFO is organized in the same channel order in which the associated input FIFO was written.

Three transfer modes are supported by Interface Block.

Mode 1 (Polling Mode)

The ASRC output FIFOs can be serviced by polling. In this mode, ensure the associated output-data interrupt enable bit (ASRIER_ADOE_x, where x=A, B, or C) is cleared. In this mode, all output-data interrupts are disabled. Any time the output FIFO exceeds the threshold the associated status bit (ASRSTR_AODF_x, where x=A, B, or C) is set. To clear the status bit, enough data must be read from the associated output FIFO to lower the level below the threshold.

Mode 2 (Interrupt Mode)

The ASRC output FIFOs may also be serviced using interrupts. To enable this mode, the corresponding output-data interrupt-enable bits (ASRIER_ADOE_x, where x=A, B, or C) should be set. Any time the output FIFO level exceeds the threshold, an interrupt is automatically generated. The interrupt is cleared when enough data is read from the FIFO to lower the level below the threshold.

Mode 3 (DMA Mode)

Table 16-3. Output Data Alignment (continued)

Format	Bit Number																																
	31	30	29	28	27	26	25	24	23	22	21	20	19	18	17	16	15	14	13	12	11	10	9	8	7	6	5	4	3	2	1	0	
16-bit LSB Aligned with Sign Extension	1	1	1	1	1	1	1	1	1	1	1	1	1	1	1	1	1	1	1	1	1	1	1	9	8	7	6	5	4	3	2	1	0
16-bit MSB Aligned	1	1	1	1	1	1	9	8	7	6	5	4	3	2	1	0																	
24-bit LSB Aligned										2	2	2	2	1	1	1	1	1	1	1	1	1	1	9	8	7	6	5	4	3	2	1	0
24-bit LSB Aligned with Sign Extension	2	2	2	2	2	2	2	2	2	2	2	2	2	1	1	1	1	1	1	1	1	1	1	9	8	7	6	5	4	3	2	1	0
24-bit MSB Aligned	2	2	2	2	1	1	1	1	1	1	1	1	1	1	1	9	8	7	6	5	4	3	2	1	0								

16.2 Clocks

The table found here describes the clock sources for ASRC.

Please see clock control block for clock setting, configuration and gating information.

Table 16-4. ASRC Clocks

Clock name	Clock Root	Description
asrck_clock_d	spdif1_clk_root	ASRC module clock (SPDIF clock)
ipg_clk	ahb_clk_root	Peripheral clock
mem_clk	ahb_clk_root	Peripheral access clock

16.3 Interrupts

ASRC has several interrupts events.

The priorities are shown in the following table.

Table 16-5. Interrupt Priorities/Vector

Priority	Offset	Description
lowest	0x0	ASRC Pair A input data needed
	0x2	ASRC Pair B input data needed

Table continues on the next page...

Table 16-5. Interrupt Priorities/Vector (continued)

Priority	Offset	Description
	0x4	ASRC Pair C input data needed
	0x6	ASRC Pair A output data ready
	0x8	ASRC Pair B output data ready
	0xA	ASRC Pair C output data ready
highest	0xC	ASRC Overload

16.4 DMA requests

ASRC has six DMA requests. They are directly connected to the lowest six status bits in the ASRSTR register. For some ARM platforms, the six status bits are directly connected to SDMA or HDMA as DMA event signals.

Table 16-6. DMA requests

Type	Description
0	ASRC Pair A input data needed
1	ASRC Pair B input data needed
2	ASRC Pair C input data needed
3	ASRC Pair A output data ready
4	ASRC Pair B output data ready
5	ASRC Pair C output data ready

16.5 Functional Description

This section provides a complete functional description of the block.

16.5.1 Algorithm Description

16.5.1.1 Signal processing flow

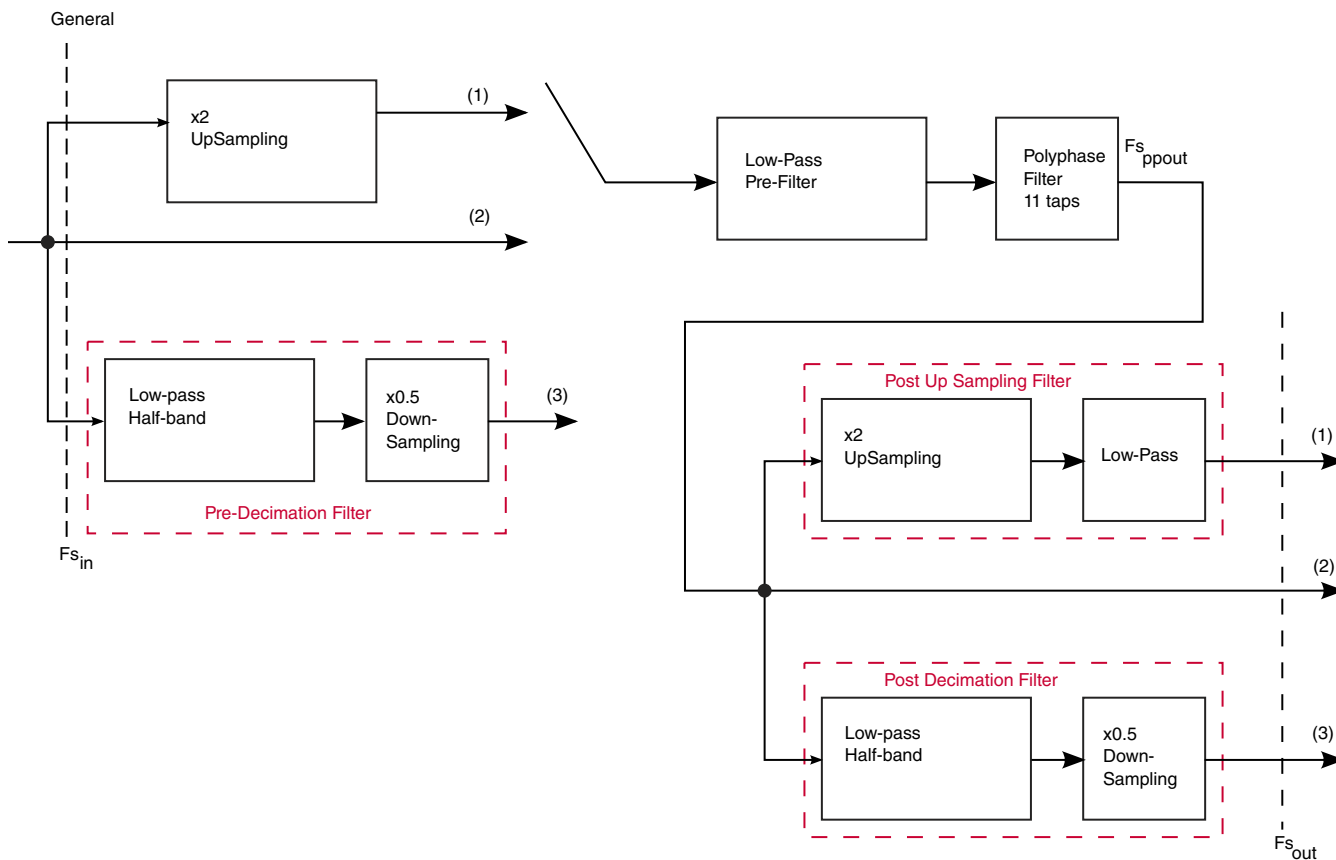

Figure 16-3. Signal processing configurations

The figure above shows the possible configurations of the ASRC. Each configuration consists of 2 to 4 stages.

- x2 up-sampling rate expander (zero insertion only) (input branch 1), direct connection (input branch 2), or low-pass pre decimation filter (consisting of a low-pass half-band FIR filter with x0.5 downsampling rate decimator) (input branch 3),
- low-pass pre-filter, the low-pass bandwidth is at most $0.25 \times F_s$, where F_s is the sampling rate of the input signal to this low-pass pre-filter,
- polyphase filter,
- x2 post upsampling filter (consisting of a x2 up-sampling rate expander (zero insertion only) with low-pass half-band FIR filter) (output branch 1), direct connection (output branch 2), or low-pass post decimation filter (consisting of a low-pass half-band FIR filter with x0.5 downsampling rate decimator) (output branch 3).

By flowing through different processing branches and different setups of the pre-filter, this ASRC scheme can be used to handle different rate conversion requirements.

- Configuration (a): Input Branch 1+Output Branch 1:

The signal bandwidth observed before the polyphase filter is at most $BW_{in} = F_{s_{in}}/2$.
The signal sampling rate of the polyphase filter output is $F_{s_{ppout}} = F_{s_{out}}/2$.

- Configuration (b): Input Branch 1+Output Branch 2:

The signal bandwidth observed before the polyphase filter is at most $BW_{in} = F_{s_{in}}/2$.
The signal sampling rate of the polyphase filter output is $F_{s_{ppout}} = F_{s_{out}}$.

- Configuration (c): Input Branch 1+Output Branch 3:

The signal bandwidth observed before the polyphase filter is at most $BW_{in} = F_{s_{in}}/2$.
The signal sampling rate of the polyphase filter output is $F_{s_{ppout}} = 2F_{s_{out}}$.

- Configuration (d): Input Branch 2+Output Branch 1:

The signal bandwidth observed before the polyphase filter is at most $BW_{in} = F_{s_{in}}/4$.
The signal sampling rate of the polyphase filter output is $F_{s_{ppout}} = F_{s_{out}}/2$.

- Configuration (e): Input Branch 2+Output Branch 2:

The signal bandwidth observed before the polyphase filter is at most $BW_{in} = F_{s_{in}}/4$.
The signal sampling rate of the polyphase filter output is $F_{s_{ppout}} = F_{s_{out}}$.

- Configuration (f): Input Branch 2+Output Branch 3:

The signal bandwidth observed before the polyphase filter is at most $BW_{in} = F_{s_{in}}/4$.
The signal sampling rate of the polyphase filter output is $F_{s_{ppout}} = 2F_{s_{out}}$.

- Configuration (g): Input Branch 3+Output Branch 1:

The signal bandwidth observed before the polyphase filter is at most $BW_{in} = F_{s_{in}}/8$.
The signal sampling rate of the polyphase filter output is $F_{s_{ppout}} = F_{s_{out}}/2$.

- Configuration (h): Input Branch 3+Output Branch 2:

The signal bandwidth observed before the polyphase filter is at most $BW_{in} = F_{s_{in}}/8$.
The signal sampling rate of the polyphase filter output is $F_{s_{ppout}} = F_{s_{out}}$.

- Configuration (i): Input Branch 3+Output Branch 3:

The signal bandwidth observed before the polyphase filter is at most $BW_{in} = F_{s_{in}}/8$.
The signal sampling rate of the polyphase filter output is $F_{s_{ppout}} = 2F_{s_{out}}$.

Table 16-7. Pre-processing, post-processing options

{Pre_Proc, Post_Proc}		Fsout (KHz)											
		8	12	16	24	32	44.1	48	64	88.2	96	128	192
Fsin (KHz)	8	{0,1}	{0,1}	{0,1}	{0,0}	{0,0}	{0,0}	{0,0}	{0,0}	{0,0}	{0,0}	{0,0}	{0,0}
	12	{0,2}	{0,1}	{0,1}	{0,1}	{0,1}	{0,0}	{0,0}	{0,0}	{0,0}	{0,0}	{0,0}	{0,0}
	16	{1,2}	{0,2}	{0,1}	{0,1}	{0,1}	{0,1}	{0,1}	{0,0}	{0,0}	{0,0}	{0,0}	{0,0}
	24	{1,2}	{1,2}	{0,2}	{0,1}	{0,1}	{0,1}	{0,1}	{0,1}	{0,0}	{0,0}	{0,0}	{0,0}
	32	{1,2}	{1,2}	{1,2}	{0,2}	{0,1}	{0,1}	{0,1}	{0,1}	{0,1}	{0,0}	{0,0}	{0,0}
	44.1	{2,2}	{1,2}	{1,2}	{0,2}	{0,2}	{0,1}	{0,1}	{0,1}	{0,1}	{0,1}	{0,0}	{0,0}
	48	{2,2}	{1,2}	{1,2}	{1,2}	{0,2}	{0,2}	{0,1}	{0,1}	{0,1}	{0,1}	{0,1}	{0,0}
	64	{2,2}	{2,2}	{1,2}	{1,2}	{0,2}	{0,2}	{0,2}	{0,1}	{0,1}	{0,1}	{0,1}	{0,0}
	88.2	NA	{2,2}	{2,2}	{1,2}	{1,2}	{1,2}	{1,2}	{1,1}	{1,1}	{1,1}	{1,1}	{1,1}
	96	NA	{2,2}	{2,2}	{1,2}	{1,2}	{1,2}	{1,2}	{1,1}	{1,1}	{1,1}	{1,1}	{1,1}
	128	NA	NA	{2,2}	{2,2}	{1,2}	{1,2}	{1,2}	{1,1}	{1,1}	{1,1}	{1,1}	{1,1}
192	NA	NA	NA	{2,2}	{2,2}	{2,2}	{2,2}	{2,1}	{2,1}	{2,1}	{2,1}	{2,1}	

NOTE: In the {Pre_Proc, Post_Proc} pair, the meaning of the values are:

Pre_Proc:

- 0 --- Pre-processing Branch 1 as shown in [Figure 16-3](#)
- 1 --- Pre-processing Branch 2 as shown in [Figure 16-3](#)
- 2 --- Pre-processing Branch 3 as shown in [Figure 16-3](#), decimation-by-2

Post_Proc:

- 0 --- Post-processing Branch 1 as shown in [Figure 16-3](#)
- 1 --- Post-processing Branch 2 as shown in [Figure 16-3](#)
- 2 --- Post-processing Branch 3 as shown in [Figure 16-3](#)

The latencies of the different option can be roughly calculated as follows:

- For PreProc = 0, PostProc = 1 : min latency = constant_A / input-sample-rate + constant_B / output-sample-rate
- For PreProc = 0, PostProc = 0 : min latency = constant_A / input-sample-rate + constant_C / output-sample-rate
- For PreProc = 1, PostProc = 1 : min latency = constant_D / input-sample-rate + constant_B / output-sample-rate

The constants above (e.g., constant_A means the Constant for Preproc = 0, constant_B means the Constant for Postproc = 1, ...) are only influenced by the PreProc/PostProc and (input/output) sampling rate to which they are connected. Input latencies have no relationship with the output latencies, but both elements add together to form the total latencies.

For a rough estimation, the constants can be set as:

- Constant for Preproc = 0: 39

- Constant for Preproc = 1: 78.5
- Constant for Preproc = 2: 235
- Constant for Postproc = 0: 42.5
- Constant for Postproc = 1: 8.5
- Constant for Postproc = 2: 172

The max latency can be derived from this value by using the following formula (where 32 means the input/output FIFO depth that will arouse data transfer):

- $\text{max latency} = \text{min latency} + 32 / \text{input-sample-rate} + 32 / \text{output-sample-rate}$

16.5.1.2 Operation of the Filter

16.5.1.2.1 Support of Physical Clocks

This design supports physical sampling clocks. The clocks can be provided by:

- Sony/Phillips digital interface (SPDIF)
- Serial Audio Interface (SAI)
- Core master clock derivative as ASRCK1

Functional Description

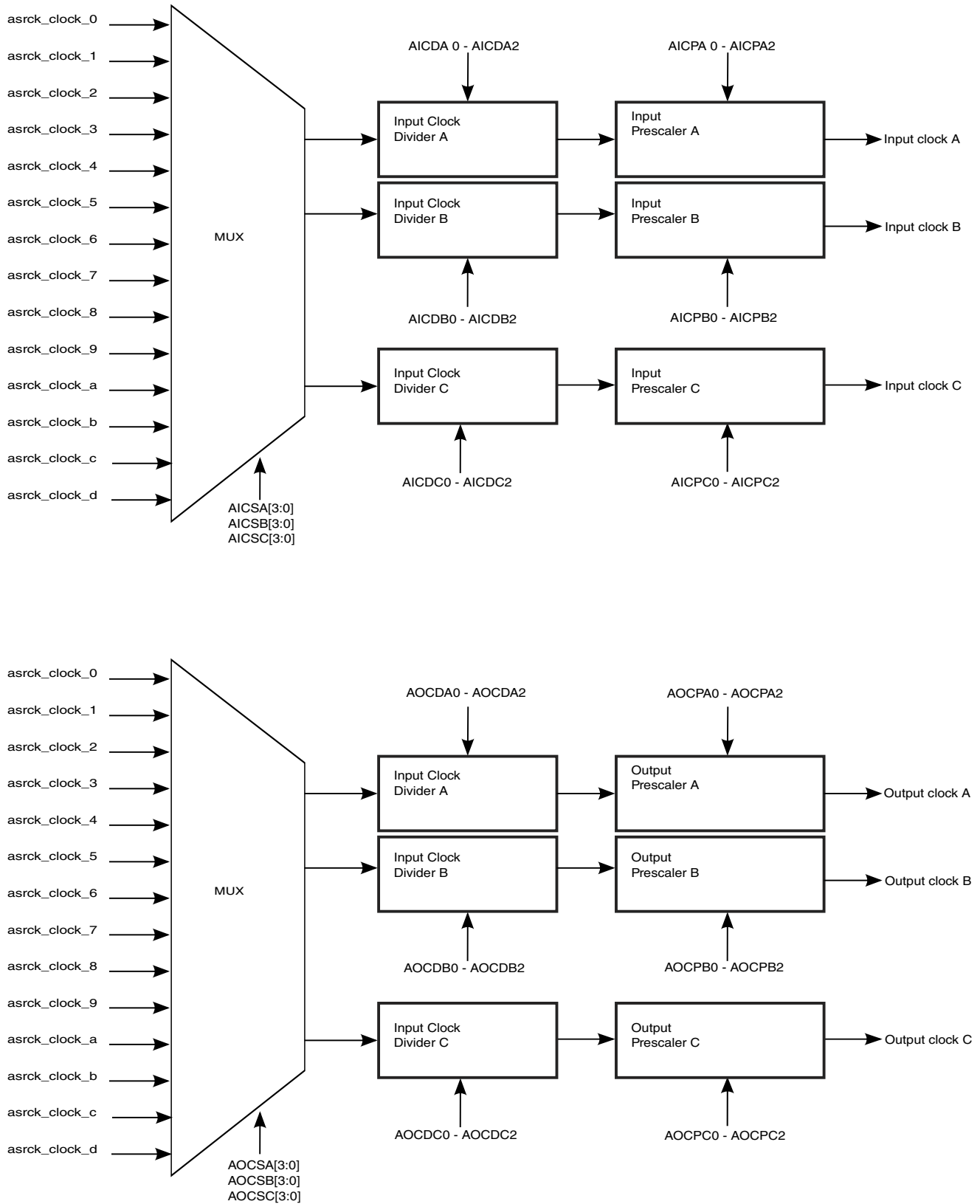

Figure 16-4. Clock Source Selector and Divider

Software can set the ASRC Clock Source Register (ASRC_SR) and the Clock Divider Register to select the desired clock source and divide it to the needed sample rate clock for use by the ASRC. The clocks have the following restriction. If the prescaler is set to 1, the clock divider can only be set to 1 and the clock source must have a 50% duty cycle.

16.6 Startup Procedure

The following example shows the normal setup procedure for the ASRC block.

```
#include "asrc_common.h"
#include "stdio.h"
#include "soc_api.h"

int incnt=0;
int outcnt=0;

#include "wy_ideal_ratio_dataini_part.h"

WORD IdealRatio_High=0x04; //
WORD IdealRatio_Low=0x0; //

void asrc_config_alloc(WORD ASRC_SR_VAL, WORD ASRC_SR_DIV_VAL, WORD ASRC_SR_DIV2_VAL,
                      WORD ASRC_SR_DIV3_VAL, WORD ASRC_SR_DIV4_VAL, WORD ASRC_SR_DIV5_VAL,
                      WORD ASRC_SR_DIV6_VAL)

{ // Disable ASRC

    reg32_write(ASRC_SR, 0x0);

    reg32_write(ASRC_SR, ASRC_SR_VAL);

    reg32_write(ASRC_SR_DIV, ASRC_SR_DIV_VAL);

    reg32_write(ASRC_SR_DIV2, 0x0);

    reg32_write(ASRC_SR_DIV3, ASRC_SR_DIV3_VAL);

    reg32_write(ASRC_SR_DIV4, ASRC_SR_DIV4_VAL);

    reg32_write(ASRC_SR_DIV5, ASRC_SR_DIV5_VAL);

    reg32_write(ASRC_SR_DIV6, ASRC_SR_DIV6_VAL);

    reg32_write(ASRC_SR_DIV7, 0x7fffffff);

    reg32_write(ASRC_SR_DIV8, 0x255555);

    reg32_write(ASRC_SR_DIV9, 0xff7280);

    reg32_write(ASRC_SR_DIV10, 0xff7280);

    reg32_write(ASRC_SR_DIV11, 0xff7280);
```

Startup Procedure

```
    reg32_write(ASRC_ASRQFIFO1, 0x001f00);

    reg32_write(ASRC_ASRMCRA, 0x001f00);

    reg32_write(ASRC_ASRMCRB, 0x001f00);

    reg32_write(ASRC_ASRMCRC, 0x001f00);

}

void sim_ideal_ratio()
{
    WORD tmp32bit;

#define ASRSTR_AIDEA_MASK    0x1

#define ASRSTR_AODFA_MASK    0x1 <<3

#define ASRSTR_AOLE_MASK    0x1<<6

#define ASRCTR_DBG_EN        1<<23

#define ASRCTR_IDRA          1<<13

#define ASRCTR_USRA          1<<14

#define ASRC_CLK_PRED_RSTRICTED 0<<28

#define ASRC_CLK_PRED_DFLT    1<<28 // default: 596MHz div by 2

#define ASRC_CLK_PRED_DIV3    2<<28 // 596MHz div by 3

#define ASRC_CLK_PRED_DIV4    3<<28 // 596MHz div by 4

#define ASRC_CLK_PRED_DIV5    4<<28 // 596MHz div by 5

#define ASRC_CLK_PRED_DIV6    5<<28 // 596MHz div by 6

#define ASRC_CLK_PRED_DIV7    6<<28 // 596MHz div by 7

#define ASRC_CLK_PRED_DIV8    7<<28 // 596MHz div by 8

#define ECSPI_CLK_PRED_DFLT    1<<25

#define ECSPI_CLK_PODF_DFLT    1<<19

#define ASRC_CLK_PODF_DIV1     0<<9 // pred output divide by 1 again

#define ASRC_CLK_PODF_DIV2     1<<9 // pred output divide by 2 again

#define ASRC_CLK_PODF_DIV3     2<<9 // pred output divide by 3 again

#define ASRC_CLK_PODF_DIV4     3<<9 // pred output divide by 4 again

#define ASRC_CLK_PODF_DFLT     4<<9 // default: pred output divide by 5 again

#define ASRC_CLK_PODF_DIV6     5<<9 // pred output divide by 6 again

#define ASRC_CLK_PODF_DIV7     6<<9 // pred output divide by 7 again

#define ASRC_CLK_PODF_DIV25    24<<9 // pred output divide by 7 again

#define IEEE_CLK_PRED_DFLT     1<<6 //
```

```

#define IEEE_CLK_PODF_DFLT      4      //
#define ASR_HFA_HFB            0
#define ASR_PREMODA_UP2        0<<6
#define ASR_PREMODA_DIR        1<<6
#define ASR_PREMODA_DN2        2<<6
#define ASR_PREMODA_PAS        3<<6
#define ASR_POSTMODA_UP2       0<<8
#define ASR_POSTMODA_DIR       1<<8
#define ASR_POSTMODA_DN2       2<<8

    reg32_write(CCM_CSCDR2, ASRC_CLK_PRED_DIV8|ECSPI_CLK_PRED_DFLT|ECSPI_CLK_PODF_DFLT|
ASRC_CLK_PODF_DIV25|IEEE_CLK_PRED_DFLT|IEEE_CLK_PODF_DFLT);

    // Disable the ASRC
    reg32_write(ASRC_ASRCTR, 0x0);

    // program AHB clocks
    tmp32bit = reg32_read(CCM_CBCDR);
    tmp32bit = tmp32bit & (~0x00001C00);

    //tmp32bit = tmp32bit | (0x00000C00); // AHB 100MHz // divided-by-4
    //tmp32bit = tmp32bit | (0x00001000); // AHB 80MHz // divided-by-5
    //tmp32bit = tmp32bit | (0x00001400); // AHB 66MHz // divided-by-6
    //tmp32bit = tmp32bit | (0x00001800); // AHB 57MHz // divided-by-7
    tmp32bit = tmp32bit | (0x00001C00); // AHB 50MHz // divided-by-8

    reg32_write(CCM_CBCDR, tmp32bit); // enable all perihperal clocks during all modes,
except stop mode

    while ( (reg32_read(CCM_CDHIPR) & 0x000008) != 0);

        asrc_config_alloc ( 0x002 | ASRCTR_IDRA | ASRCTR_USRA,      // ASRCTR_VAL, Use
Ratio input, use ideal ratio, Enable Pair A,

        0x0, //0x09,          // ASRIER_VAL, Open
PairA input and output interrupt

        0x002,      // ASRCNCR_VAL, assign 2 channels to Pair A

        ASR_PREMODA_DIR | ASR_POSTMODA_DIR | ASR_HFA_HFB,          // ASRCFG_VAL,
POSTMODA=downsampling by 2 ; PREMODA=downsampling by 2

        0x03b03b , // ASRCDR1_VAL, AOCPA=3(FoutA/(2^3)); AICPA=3(FinA/(2^3));
AOCDA=7(div 8); AICDA=7(div 8);

        0x0 ,      // ASRCDR2_VAL,

        0x00d00d // ASRCSR_VAL, AOCSA=d: bit clock d: ASRCK1 clk from CCM; AICSA=d:
bit clock d: ASRCK1 clock from CCM;

    );

```

Startup Procedure

```
reg32_write(ASRC_ASRIDRHA, 0x04); //
reg32_write(ASRC_ASRIDRLA, 0x0); // Ideal Ratio is set to be 1.
#define OUTFIFO_THRESH_0 8<<12
#define INFIFO_THRESH_1 32
reg32_write(ASRC_ASRMCRA, OUTFIFO_THRESH_0 | INFIFO_THRESH_1);
reg32_clrbit(ASRC_ASRMCRA, 23); // zeroize Pair A buffers
reg32_setbit(ASRC_ASRMCRA, 21); // stall conversion in case of near full/near empty
condition
reg32_clrbit(ASRC_ASRMCRA, 20); // Do not bypass polyA filter
// Set ASRC Interrupt
//CAPTURE_INTERRUPT(ASRC_INT_ROUTINE, asrc_handler);
//enable_hdlr(ASRC_INT_NUM);
disable_hdlr(ASRC_INT_NUM);
incnt=0;
outcnt=0;
reg32_setbit(ASRC_ASRCTR,0); // enable ASRC
#define ASRCFG_INIA_FINISH 0x1<<21
while ( (reg32_read(ASRC_ASRCFG) & ASRCFG_INIA_FINISH) == 0); // wait for ini finished.
// Polling
while (outcnt < 100) <
{
    int ii;
    if ( (reg32_read(ASRC_ASRSTR) & ASRSTR_AIDEA_MASK) != 0 )
    {
        for (ii=0;ii<2;ii++)</codeblock
        {
            data reg32_write(ASRC_ASRDIA,asrc_input_array[incnt]); // feed in input
            data reg32_write(ASRC_ASRDIA,asrc_input_array[incnt]); // feed in input
            incnt=(incnt+1)%128;
        }
    }
    if ( (reg32_read(ASRC_ASRSTR) & ASRSTR_AODFA_MASK) != 0 )
    {
```

```

for (ii=0;ii<2;ii++)<
{
WORD TempRdOut;

TempRdOut=reg32_read(ASRC_ASRDOA); // get output data
TempRdOut=reg32_read(ASRC_ASRDOA); // get output data
outcnt=outcnt+1;
}
}

if ( (reg32_read(ASRC_ASRSTR) & ASRSTR_AOLE_MASK) != 0 )
{
errors
reg32_write(ASRC_ASRSTR,ASRSTR_AOLE_MASK); // clear overloading
}
}

reg32clrbit(ASRC_ASRCTR,0); // disable ASRC
}

```

16.7 ASRC Memory Map/Register Definition

All useful registers are listed in the memory map below. The access of undefined registers will behave as normal registers.

All the interface registers are LSB aligned except the input FIFOs and the output FIFOs, and each register has only 24 effective bits.

The input FIFO and output FIFO word alignment can be defined using ASRMCR1{A,B,C} registers in 32-bit interface system.

ASRC memory map

Absolute address (hex)	Register name	Width (in bits)	Access	Reset value	Section/page
203_4000	ASRC Control Register (ASRC_ASRCTR)	32	R/W	0000_0000h	16.7.1/526
203_4004	ASRC Interrupt Enable Register (ASRC_ASRIER)	32	R/W	0000_0000h	16.7.2/529
203_400C	ASRC Channel Number Configuration Register (ASRC_ASRCNCR)	32	R/W	0000_0000h	16.7.3/530

Table continues on the next page...

ASRC memory map (continued)

Absolute address (hex)	Register name	Width (in bits)	Access	Reset value	Section/page
203_4010	ASRC Filter Configuration Status Register (ASRC_ASRCFG)	32	R/W	0000_0000h	16.7.4/532
203_4014	ASRC Clock Source Register (ASRC_ASRCSTR)	32	R/W	0000_0000h	16.7.5/534
203_4018	ASRC Clock Divider Register 1 (ASRC_ASRCDR1)	32	R/W	0000_0000h	16.7.6/537
203_401C	ASRC Clock Divider Register 2 (ASRC_ASRCDR2)	32	R/W	0000_0000h	16.7.7/538
203_4020	ASRC Status Register (ASRC_ASRSTR)	32	R	0000_0000h	16.7.8/539
203_4040	ASRC Parameter Register n (ASRC_ASRPMn1)	32	R/W	0000_0000h	16.7.9/542
203_4044	ASRC Parameter Register n (ASRC_ASRPMn2)	32	R/W	0000_0000h	16.7.9/542
203_4048	ASRC Parameter Register n (ASRC_ASRPMn3)	32	R/W	0000_0000h	16.7.9/542
203_404C	ASRC Parameter Register n (ASRC_ASRPMn4)	32	R/W	0000_0000h	16.7.9/542
203_4050	ASRC Parameter Register n (ASRC_ASRPMn5)	32	R/W	0000_0000h	16.7.9/542
203_4054	ASRC ASRC Task Queue FIFO Register 1 (ASRC_ASRTFR1)	32	R/W	0000_0000h	16.7.10/ 543
203_405C	ASRC Channel Counter Register (ASRC_ASRCR)	32	R/W	0000_0000h	16.7.11/ 544
203_4060	ASRC Data Input Register for Pair x (ASRC_ASRDIA)	32	W	0000_0000h	16.7.12/ 545
203_4064	ASRC Data Output Register for Pair x (ASRC_ASRDOA)	32	R	0000_0000h	16.7.13/ 545
203_4068	ASRC Data Input Register for Pair x (ASRC_ASRDIB)	32	W	0000_0000h	16.7.12/ 545
203_406C	ASRC Data Output Register for Pair x (ASRC_ASRDOB)	32	R	0000_0000h	16.7.13/ 545
203_4070	ASRC Data Input Register for Pair x (ASRC_ASRDIC)	32	W	0000_0000h	16.7.12/ 545
203_4074	ASRC Data Output Register for Pair x (ASRC_ASRDOC)	32	R	0000_0000h	16.7.13/ 545
203_4080	ASRC Ideal Ratio for Pair A-High Part (ASRC_ASRIDRHA)	32	R/W	0000_0000h	16.7.14/ 546
203_4084	ASRC Ideal Ratio for Pair A -Low Part (ASRC_ASRIDRLA)	32	R/W	0000_0000h	16.7.15/ 546
203_4088	ASRC Ideal Ratio for Pair B-High Part (ASRC_ASRIDRHB)	32	R/W	0000_0000h	16.7.16/ 547
203_408C	ASRC Ideal Ratio for Pair B-Low Part (ASRC_ASRIDRLB)	32	R/W	0000_0000h	16.7.17/ 547
203_4090	ASRC Ideal Ratio for Pair C-High Part (ASRC_ASRIDRHC)	32	R/W	0000_0000h	16.7.18/ 548
203_4094	ASRC Ideal Ratio for Pair C-Low Part (ASRC_ASRIDRLC)	32	R/W	0000_0000h	16.7.19/ 548
203_4098	ASRC 76 kHz Period in terms of ASRC processing clock (ASRC_ASR76K)	32	R/W	0000_0A47h	16.7.20/ 549
203_409C	ASRC 56 kHz Period in terms of ASRC processing clock (ASRC_ASR56K)	32	R/W	0000_0DF3h	16.7.21/ 550

Table continues on the next page...

ASRC memory map (continued)

Absolute address (hex)	Register name	Width (in bits)	Access	Reset value	Section/page
203_40A0	ASRC Misc Control Register for Pair A (ASRC_ASRMCRA)	32	R/W	0000_0000h	16.7.22/551
203_40A4	ASRC FIFO Status Register for Pair A (ASRC_ASRFSTA)	32	R	0000_0000h	16.7.23/553
203_40A8	ASRC Misc Control Register for Pair B (ASRC_ASRMCRB)	32	R/W	0000_0000h	16.7.24/554
203_40AC	ASRC FIFO Status Register for Pair B (ASRC_ASRFSTB)	32	R	0000_0000h	16.7.25/556
203_40B0	ASRC Misc Control Register for Pair C (ASRC_ASRMCRC)	32	R/W	0000_0000h	16.7.26/557
203_40B4	ASRC FIFO Status Register for Pair C (ASRC_ASRFSTC)	32	R	0000_0000h	16.7.27/559
203_40C0	ASRC Misc Control Register 1 for Pair X (ASRC_ASRMCR1A)	32	R/W	0000_0000h	16.7.28/560
203_40C4	ASRC Misc Control Register 1 for Pair X (ASRC_ASRMCR1B)	32	R/W	0000_0000h	16.7.28/560
203_40C8	ASRC Misc Control Register 1 for Pair X (ASRC_ASRMCR1C)	32	R/W	0000_0000h	16.7.28/560

16.7.1 ASRC Control Register (ASRC_ASRCTR)

The ASRC control register (ASRCTR) is a read/write register that controls the ASRC operations.

Address: 203_4000h base + 0h offset = 203_4000h

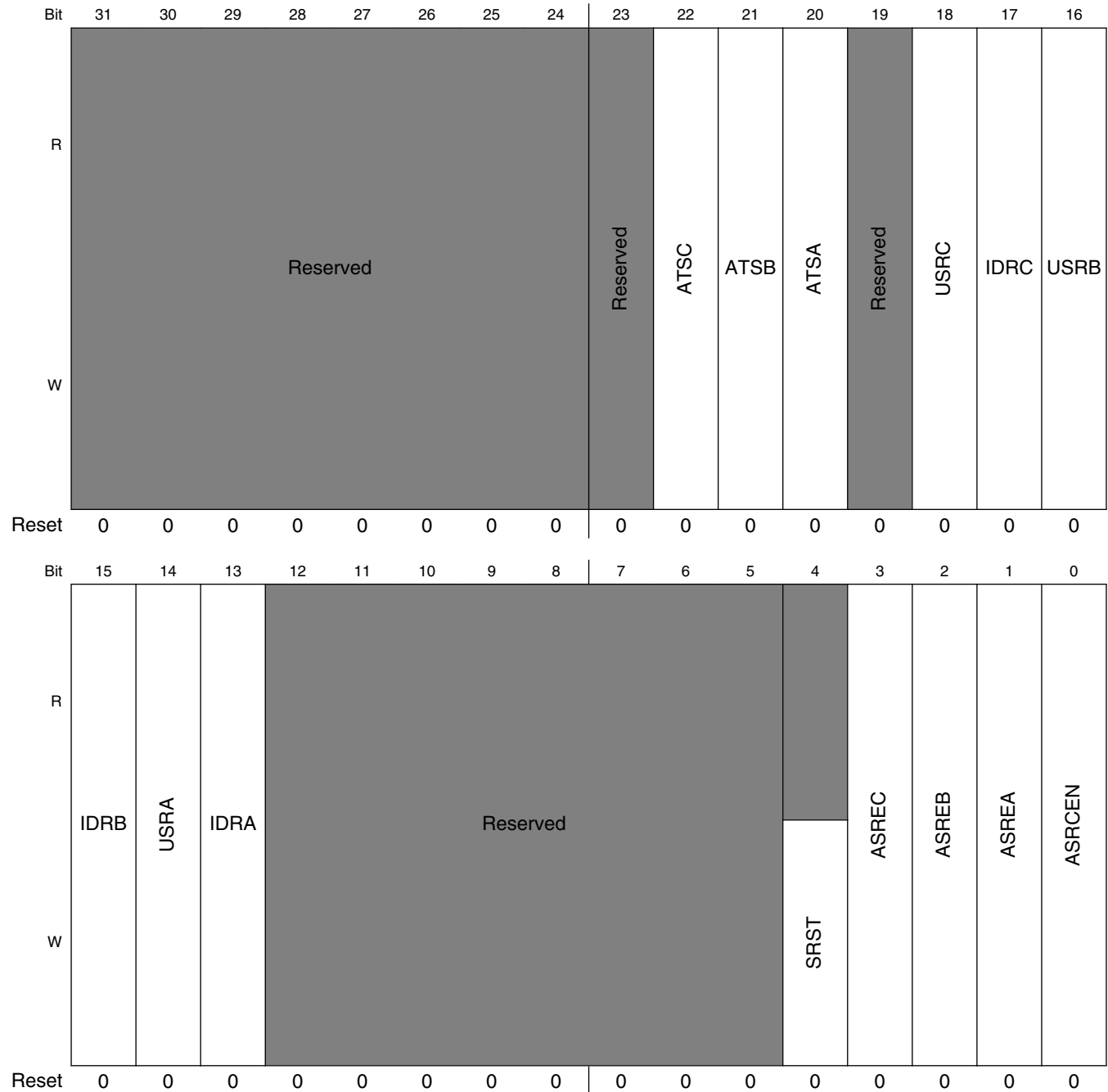

ASRC_ASRCCTR field descriptions

Field	Description
31–24 -	This field is reserved. Reserved
23 -	This field is reserved. Reserved. Should be written as zero for compatibility.
22 ATSC	ASRC Pair C Automatic Selection For Processing Options When this bit is 1, pair C will automatic update its pre-processing and post-processing options (ASRCFG:PREMODC, ASRCFG:POSTMODC see ASRC Misc Control Register 1 for Pair C) based on the frequencies it detected. To use this option, the two parameter registers(ASR76K and ASR56K) should be set correctly (see ASRC Misc Control Register 1 for Pair C and ASRC Misc Control Register 1 for Pair C). When this bit is 0, the user is responsible for choosing the proper processing options for pair C. This bit should be disabled when {USRC, IDRC}={1,1}.
21 ATSB	ASRC Pair B Automatic Selection For Processing Options When this bit is 1, pair B will automatic update its pre-processing and post-processing options (ASRCFG:PREMODB, ASRCFG:POSTMODB see ASRC Misc Control Register 1 for Pair C) based on the frequencies it detected. To use this option, the two parameter registers(ASR76K and ASR56K) should be set correctly (see ASRC Misc Control Register 1 for Pair C and ASRC Misc Control Register 1 for Pair C). When this bit is 0, the user is responsible for choosing the proper processing options for pair B. This bit should be disabled when {USRB, IDRB}={1,1}.
20 ATSA	ASRC Pair A Automatic Selection For Processing Options When this bit is 1, pair A will automatic update its pre-processing and post-processing options (ASRCFG:PREMODA, ASRCFG:POSTMODA see ASRC Misc Control Register 1 for Pair C) based on the frequencies it detected. To use this option, the two parameter registers(ASR76K and ASR56K) should be set correctly (see ASRC Misc Control Register 1 for Pair C and ASRC Misc Control Register 1 for Pair C). When this bit is 0, the user is responsible for choosing the proper processing options for pair A. This bit should be disabled when {USRA, IDRA}={1,1}.
19 -	This field is reserved. Reserved. Should be written as zero for compatibility.
18 USRC	Use Ratio for Pair C Use ratio as the input to ASRC. This bit is used in conjunction with IDRC control bit.
17 IDRC	Use Ideal Ratio for Pair C When USRC=0, this bit has no usage. When USRC=1 and IDRC=0, ASRC internal measured ratio will be used. When USRC=1 and IDRC=1, the idea ratio from the interface register ASRIDRHC, ASRIDRLC will be used. It is suggested to manually set ASRCFG:POSTMODC, ASRCFG:PREMODC according to Table 16-7 in this case.
16 USRB	Use Ratio for Pair B Use ratio as the input to ASRC. This bit is used in conjunction with IDRB control bit.
15 IDRB	Use Ideal Ratio for Pair B When USRB=0, this bit has no usage. When USRB=1 and IDRB=0, ASRC internal measured ratio will be used. When USRB=1 and IDRB=1, the idea ratio from the interface register ASRIDRHB, ASRIDRLB will be used. It is suggested to manually set ASRCFG:POSTMODB, ASRCFG:PREMODB according to Table 16-7 in this case.

Table continues on the next page...

ASRC_ASRCR field descriptions (continued)

Field	Description
14 USRA	Use Ratio for Pair A Use ratio as the input to ASRC. This bit is used in conjunction with IDRA control bit.
13 IDRA	Use Ideal Ratio for Pair A When USRA=0, this bit has no usage. When USRA=1 and IDRA=0, ASRC internal measured ratio will be used. When USRA=1 and IDRA=1, the idea ratio from the interface register ASRIDRHA, ASRIDRLA will be used. It is suggested to manually set ASRCFG:POSTMODA, ASRCFG:PREMODA according to Table 16-7 in this case.
12–5 -	This field is reserved. Reserved. Should be written as zero for compatibility.
4 SRST	Software Reset This bit is self-clear bit. Once it is been written as 1, it will generate a software reset signal inside ASRC. After 9 cycles of the ASRC processing clock, this reset process will stop, and this bit will be cleared automatically.
3 ASREC	ASRC Enable C Enable the operation of the conversion C of ASRC. When ASREC is cleared, operation of conversion C is disabled.
2 ASREB	ASRC Enable B Enable the operation of the conversion B of ASRC. When ASREB is cleared, operation of conversion B is disabled.
1 ASREA	ASRC Enable A Enable the operation of the conversion A of ASRC. When ASREA is cleared, operation of conversion A is disabled.
0 ASRCEN	ASRC Enable Enable the operation of ASRC.

16.7.2 ASRC Interrupt Enable Register (ASRC_ASRIER)

Address: 203_4000h base + 4h offset = 203_4004h

Bit	31	30	29	28	27	26	25	24	23	22	21	20	19	18	17	16
R	Reserved								Reserved							
W	Reserved								Reserved							
Reset	0	0	0	0	0	0	0	0	0	0	0	0	0	0	0	0
Bit	15	14	13	12	11	10	9	8	7	6	5	4	3	2	1	0
R	Reserved								AFPWE	AOLIE	ADOEC	ADOEB	ADIEA	ADIEB	ADIEC	
W	Reserved								AFPWE	AOLIE	ADOEC	ADOEB	ADIEA	ADIEB	ADIEC	
Reset	0	0	0	0	0	0	0	0	0	0	0	0	0	0	0	0

ASRC_ASRIER field descriptions

Field	Description
31–24 -	This field is reserved. Reserved
23–8 -	This field is reserved. Reserved. Should be written as zero for compatibility.
7 AFPWE	FP in Wait State Interrupt Enable Enables the FP in wait state interrupt. 1 interrupt enabled 0 interrupt disabled
6 AOLIE	Overload Interrupt Enable Enables the overload interrupt. 1 interrupt enabled 0 interrupt disabled
5 ADOEC	Data Output C Interrupt Enable Enables the data output C interrupt. 1 interrupt enabled 0 interrupt disabled
4 ADOEB	Data Output B Interrupt Enable Enables the data output B interrupt. 1 interrupt enabled 0 interrupt disabled

Table continues on the next page...

ASRC_ASRIER field descriptions (continued)

Field	Description
3 ADOEA	Data Output A Interrupt Enable Enables the data output A interrupt. 1 interrupt enabled 0 interrupt disabled
2 ADIEC	Data Input C Interrupt Enable Enables the data input C interrupt. 1 interrupt enabled 0 interrupt disabled
1 ADIEB	Data Input B Interrupt Enable Enables the data input B interrupt. 1 interrupt enabled 0 interrupt disabled
0 ADIEA	Data Input A Interrupt Enable Enables the data input A Interrupt. 1 interrupt enabled 0 interrupt disabled

16.7.3 ASRC Channel Number Configuration Register (ASRC_ASRCNCR)

The ASRC channel number configuration register (ASRCNCR) is a read/write register that sets the number of channels used by each ASRC conversion pair.

There are 10 channels available for distribution among 3 conversion pairs, they are ordered as 0,1,...,9. The bottom [0, ANCA-1] channels are used for pair A, the top [10-ANCC, 9] channels are used for pair C, and the [ANCA, ANCA+ANCB-1] channels are allocated for pair B. In case that ANCA=0, then the [0, ANCB-1] channels are assigned for pair B.

Address: 203_4000h base + Ch offset = 203_400Ch

Bit	31	30	29	28	27	26	25	24	23	22	21	20	19	18	17	16	15	14	13	12	11	10	9	8	7	6	5	4	3	2	1	0
R	Reserved																ANCC				ANCB			ANCA								
W	Reserved																ANCC				ANCB			ANCA								
Reset	0	0	0	0	0	0	0	0	0	0	0	0	0	0	0	0	0	0	0	0	0	0	0	0	0	0	0	0	0	0	0	0

ASRC_ASRCNCR field descriptions

Field	Description
31–24 -	This field is reserved. Reserved
23–12 -	This field is reserved. Reserved. Should be written as zero for compatibility.
11–8 ANCC	Number of C Channels ¹ 0000 0 channels in C (Pair C is disabled) 0001 1 channel in C 0010 2 channels in C 0011 3 channels in C 0100 4 channels in C 0101 5 channels in C 0110 6 channels in C 0111 7 channels in C 1000 8 channels in C 1001 9 channels in C 1010 10 channels in C 1011-1111 Should not be used.
7–4 ANCB	Number of B Channels 0000 0 channels in B (Pair B is disabled) 0001 1 channel in B 0010 2 channels in B 0011 3 channels in B 0100 4 channels in B 0101 5 channels in B 0110 6 channels in B 0111 7 channels in B 1000 8 channels in B 1001 9 channels in B 1010 10 channels in B 1011-1111 Should not be used.
ANCA	Number of A Channels 0000 0 channels in A (Pair A is disabled) 0001 1 channel in A 0010 2 channels in A 0011 3 channels in A 0100 4 channels in A 0101 5 channels in A 0110 6 channels in A 0111 7 channels in A 1000 8 channels in A 1001 9 channels in A 1010 10 channels in A 1011-1111 Should not be used.

1. ANCC+ANCB+ANCA<=10. Hardware is not checking the constraint. Programmer should take the responsibility to ensure the constraint is satisfied.

16.7.4 ASRC Filter Configuration Status Register (ASRC_ASRCFG)

The ASRC configuration status register (ASRCFG) is a read/write register that sets and/or automatically senses the ASRC operations.

Address: 203_4000h base + 10h offset = 203_4010h

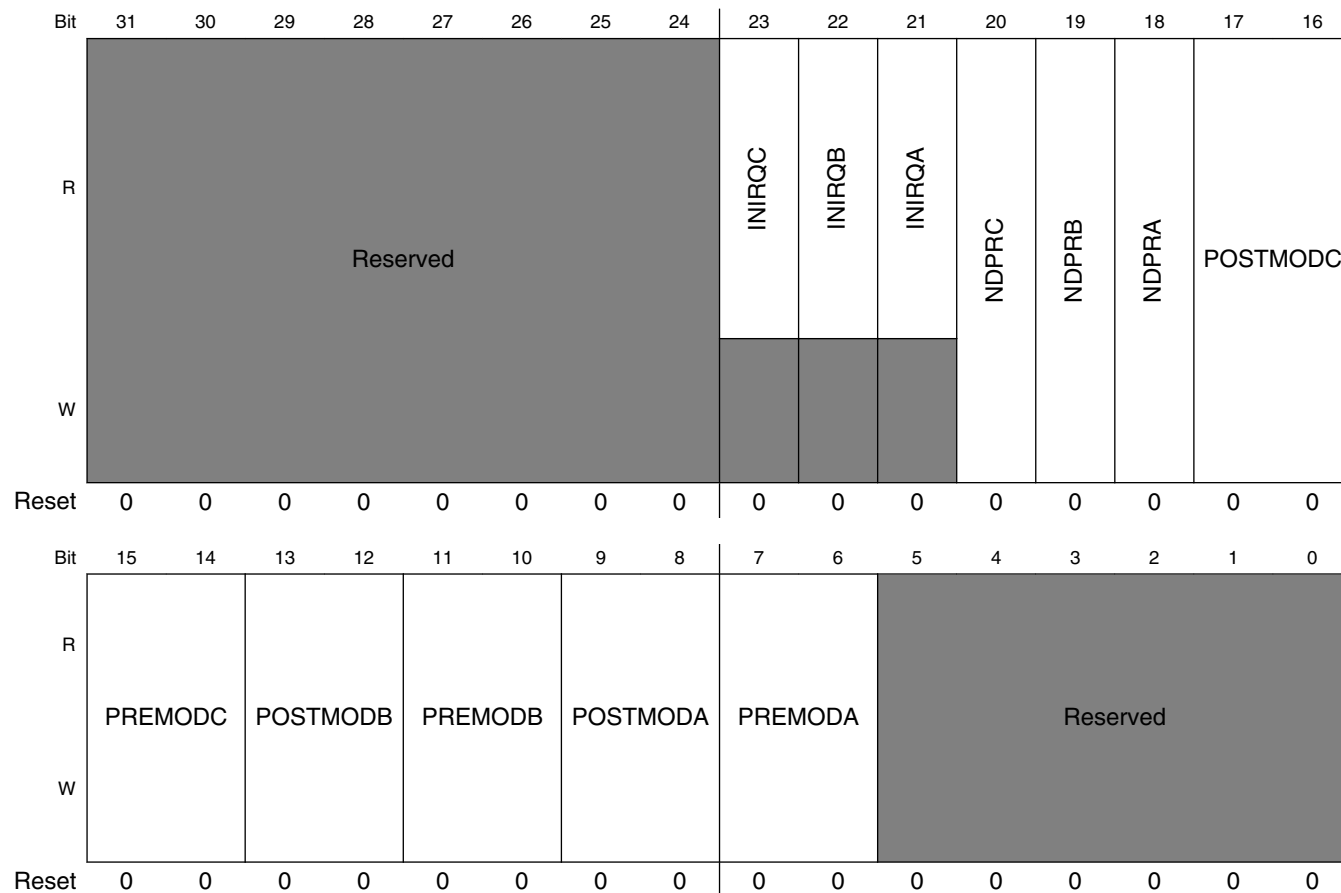

ASRC_ASRCFG field descriptions

Field	Description
31–24 -	This field is reserved. Reserved
23 INIRQC	Initialization for Conversion Pair C is served When this bit is 1, it means the initialization for conversion pair C is served. This bit is cleared by disabling the ASRC conversion pair (ASRCTR:ASREC=0 or ASRCTR:ASRCEN=0).
22 INIRQB	Initialization for Conversion Pair B is served When this bit is 1, it means the initialization for conversion pair B is served. This bit is cleared by disabling the ASRC conversion pair (ASRCTR:ASREB=0 or ASRCTR:ASRCEN=0).

Table continues on the next page...

ASRC_ASRCFG field descriptions (continued)

Field	Description
21 INIRQA	Initialization for Conversion Pair A is served When this bit is 1, it means the initialization for conversion pair A is served. This bit is cleared by disabling the ASRC conversion pair (ASRCTR:ASREA=0 or ASRCTR:ASRCEN=0).
20 NDPRC	Not Use Default Parameters for RAM-stored Parameters For Conversion Pair C 0 Use default parameters for RAM-stored parameters. Override any parameters already in RAM. 1 Don't use default parameters for RAM-stored parameters. Use the parameters already stored in RAM.
19 NDPRB	Not Use Default Parameters for RAM-stored Parameters For Conversion Pair B 0 Use default parameters for RAM-stored parameters. Override any parameters already in RAM. 1 Don't use default parameters for RAM-stored parameter. Use the parameters already stored in RAM.
18 NDPRA	Not Use Default Parameters for RAM-stored Parameters For Conversion Pair A 0 Use default parameters for RAM-stored parameters. Override any parameters already in RAM. 1 Don't use default parameters for RAM-stored parameters. Use the parameters already stored in RAM.
17–16 POSTMODC	Post-Processing Configuration for Conversion Pair C These bits will be read/write by user if ASRCTR:ATSC=0, and can also be automatically updated by the ASRC internal logic if ASRCTR:ATSC=1 (see ASRC Misc Control Register 1 for Pair C). These bits set the selection of the post-processing configuration. 00 Select Upsampling-by-2 as defined in Signal Processing Flow. 01 Select Direct-Connection as defined in Signal Processing Flow. 10 Select Downsampling-by-2 as defined in Signal Processing Flow.
15–14 PREMODC	Pre-Processing Configuration for Conversion Pair C These bits will be read/write by user if ASRCTR:ATSC=0, and can also be automatically updated by the ASRC internal logic if ASRCTR:ATSC=1 (see ASRC Misc Control Register 1 for Pair C). These bits set the selection of the pre-processing configuration. 00 Select Upsampling-by-2 as defined in Signal processing flow 01 Select Direct-Connection as defined in Signal processing flow 10 Select Downsampling-by-2 as defined in Signal processing flow 11 Select passthrough mode. In this case, POSTMODC[1-0] have no use.
13–12 POSTMODB	Post-Processing Configuration for Conversion Pair B These bits will be read/write by user if ASRCTR:ATSB=0, and can also be automatically updated by the ASRC internal logic if ASRCTR:ATSB=1 (see ASRC Misc Control Register 1 for Pair C). These bits set the selection of the post-processing configuration. 00 Select Upsampling-by-2 as defined in Signal processing flow 01 Select Direct-Connection as defined in Signal processing flow 10 Select Downsampling-by-2 as defined in Signal processing flow
11–10 PREMODB	Pre-Processing Configuration for Conversion Pair B These bits will be read/write by user if ASRCTR:ATSB=0, and can also be automatically updated by the ASRC internal logic if ASRCTR:ATSB=1 (see ASRC Misc Control Register 1 for Pair C). These bits set the selection of the pre-processing configuration. 00 Select Upsampling-by-2 as defined in Signal processing flow 01 Select Direct-Connection as defined in Signal processing flow

Table continues on the next page...

ASRC_ASRCFG field descriptions (continued)

Field	Description
	10 Select Downsampling-by-2 as defined in Signal processing flow 11 Select passthrough mode. In this case, POSTMODB[1-0] have no use.
9–8 POSTMODA	Post-Processing Configuration for Conversion Pair A These bits will be read/write by user if ASRCTR:ATSA=0, and can also be automatically updated by the ASRC internal logic if ASRCTR:ATSA=1 (see ASRC Misc Control Register 1 for Pair C). These bits set the selection of the post-processing configuration. 00 Select Upsampling-by-2 as defined in Signal processing flow 01 Select Direct-Connection as defined in Signal processing flow 10 Select Downsampling-by-2 as defined in Signal processing flow
7–6 PREMODA	Pre-Processing Configuration for Conversion Pair A These bits will be read/write by user if ASRCTR:ATSA=0, and can also be automatically updated by the ASRC internal logic if ASRCTR:ATSA=1 (see ASRC Misc Control Register 1 for Pair C). These bits set the selection of the pre-processing configuration. 00 Select Upsampling-by-2 as defined in Signal processing flow 01 Select Direct-Connection as defined in Signal processing flow 10 Select Downsampling-by-2 as defined in Signal processing flow 11 Select passthrough mode. In this case, POSTMODA[1-0] have no use.
-	This field is reserved. Reserved. Should be written as zero for compatibility.

16.7.5 ASRC Clock Source Register (ASRC_ASRCR)

The ASRC clock source register (ASRCR) is a read/write register that controls the sources of the input and output clocks of the ASRC.

Address: 203_4000h base + 14h offset = 203_4014h

Bit	31	30	29	28	27	26	25	24	23	22	21	20	19	18	17	16	15	14	13	12	11	10	9	8	7	6	5	4	3	2	1	0
R																																
W																																
Reset	0	0	0	0	0	0	0	0	0	0	0	0	0	0	0	0	0	0	0	0	0	0	0	0	0	0	0	0	0	0	0	

ASRC_ASRCR field descriptions

Field	Description
31–24 -	This field is reserved. Reserved
23–20 AOCSC	Output Clock Source C 0000 bit clock 0 0001 bit clock 1 0010 bit clock 2

Table continues on the next page...

ASRC_ASRCR field descriptions (continued)

Field	Description
	0011 bit clock 3 0100 bit clock 4 0101 bit clock 5 0110 bit clock 6 0111 bit clock 7 1000 bit clock 8 1001 bit clock 9 1010 bit clock A 1011 bit clock B 1100 bit clock C 1101 bit clock D 1110 bit clock E 1111 clock disabled, connected to zero
19–16 AOCSE	Output Clock Source B 0000 bit clock 0 0001 bit clock 1 0010 bit clock 2 0011 bit clock 3 0100 bit clock 4 0101 bit clock 5 0110 bit clock 6 0111 bit clock 7 1000 bit clock 8 1001 bit clock 9 1010 bit clock A 1011 bit clock B 1100 bit clock C 1101 bit clock D 1110 bit clock E 1111 clock disabled, connected to zero
15–12 AOCSA	Output Clock Source A 0000 bit clock 0 0001 bit clock 1 0010 bit clock 2 0011 bit clock 3 0100 bit clock 4 0101 bit clock 5 0110 bit clock 6 0111 bit clock 7 1000 bit clock 8 1001 bit clock 9 1010 bit clock A 1011 bit clock B 1100 bit clock C 1101 bit clock D

Table continues on the next page...

ASRC_ASRCR field descriptions (continued)

Field	Description
	1110 bit clock E 1111 clock disabled, connected to zero
11–8 AICSC	Input Clock Source C 0000 bit clock 0 0001 bit clock 1 0010 bit clock 2 0011 bit clock 3 0100 bit clock 4 0101 bit clock 5 0110 bit clock 6 0111 bit clock 7 1000 bit clock 8 1001 bit clock 9 1010 bit clock A 1011 bit clock B 1100 bit clock C 1101 bit clock D 1110 bit clock E 1111 clock disabled, connected to zero
7–4 AICSB	Input Clock Source B 0000 bit clock 0 0001 bit clock 1 0010 bit clock 2 0011 bit clock 3 0100 bit clock 4 0101 bit clock 5 0110 bit clock 6 0111 bit clock 7 1000 bit clock 8 1001 bit clock 9 1010 bit clock A 1011 bit clock B 1100 bit clock C 1101 bit clock D 1110 bit clock E 1111 clock disabled, connected to zero
AICSA	Input Clock Source A 0000 bit clock 0 0001 bit clock 1 0010 bit clock 2 0011 bit clock 3 0100 bit clock 4 0101 bit clock 5 0110 bit clock 6

Table continues on the next page...

ASRC_ASRCR field descriptions (continued)

Field	Description
0111	bit clock 7
1000	bit clock 8
1001	bit clock 9
1010	bit clock A
1011	bit clock B
1100	bit clock C
1101	bit clock D
1110	bit clock E
1111	clock disabled, connected to zero

16.7.6 ASRC Clock Divider Register 1 (ASRC_ASRCR1)

The ASRC clock divider register (ASRCR1) is a read/write register that controls the division factors of the ASRC input and output clock sources.

Address: 203_4000h base + 18h offset = 203_4018h

Bit	31	30	29	28	27	26	25	24	23	22	21	20	19	18	17	16	15	14	13	12	11	10	9	8	7	6	5	4	3	2	1	0
R	Reserved								AOCDB	AOCPB	AOCDA	AOCPA	AICDB	AICPB	AICDA	AICPA																
W	Reserved																															
Reset	0	0	0	0	0	0	0	0	0	0	0	0	0	0	0	0	0	0	0	0	0	0	0	0	0	0	0	0	0	0	0	0

ASRC_ASRCR1 field descriptions

Field	Description
31–24 -	This field is reserved. Reserved
23–21 AOCDB	Output Clock Divider B Specify the divide ratio of the output clock divider B. The divide ratio may range from 1 to 8 (AOCDB[2:0] = 000 to 111).
20–18 AOCPB	Output Clock Prescaler B Specify the prescaling factor of the output prescaler B. The prescaling ratio may be any power of 2 from 1 to 128.
17–15 AOCDA	Output Clock Divider A Specify the divide ratio of the output clock divider A. The divide ratio may range from 1 to 8 (AOCDA[2:0] = 000 to 111).
14–12 AOCPA	Output Clock Prescaler A Specify the prescaling factor of the output prescaler A. The prescaling ratio may be any power of 2 from 1 to 128.
11–9 AICDB	Input Clock Divider B Specify the divide ratio of the input clock divider B. The divide ratio may range from 1 to 8 (AICDB[2:0] = 000 to 111).

Table continues on the next page...

ASRC_ASRCDR1 field descriptions (continued)

Field	Description
8–6 AICPB	Input Clock Prescaler B Specify the prescaling factor of the input prescaler B. The prescaling ratio may be any power of 2 from 1 to 128.
5–3 AICDA	Input Clock Divider A Specify the divide ratio of the input clock divider A. The divide ratio may range from 1 to 8 (AICDA[2:0] = 000 to 111).
AICPA	Input Clock Prescaler A Specify the prescaling factor of the input prescaler A. The prescaling ratio may be any power of 2 from 1 to 128.

16.7.7 ASRC Clock Divider Register 2 (ASRC_ASRCDR2)

The ASRC clock divider register (ASRCDR2) is a read/write register that controls the division factors of the ASRC input and output clock sources.

Address: 203_4000h base + 1Ch offset = 203_401Ch

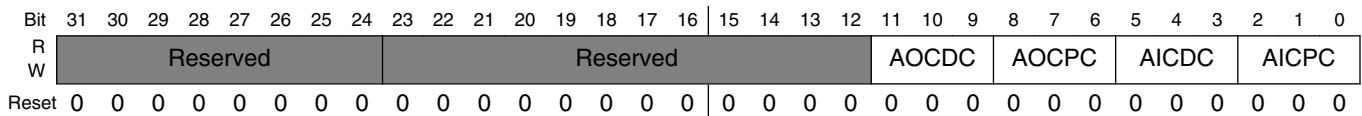

ASRC_ASRCDR2 field descriptions

Field	Description
31–24 -	This field is reserved. Reserved
23–12 -	This field is reserved. Reserved. Should be written as zero for compatibility.
11–9 AODC	Output Clock Divider C Specify the divide ratio of the output clock divider C. The divide ratio may range from 1 to 8 (AODC[2:0] = 000 to 111).
8–6 AOCPC	Output Clock Prescaler C Specify the prescaling factor of the output prescaler C. The prescaling ratio may be any power of 2 from 1 to 128.
5–3 AICDC	Input Clock Divider C Specify the divide ratio of the input clock divider C. The divide ratio may range from 1 to 8 (AICDC[2:0] = 000 to 111).
AICPC	Input Clock Prescaler C Specify the prescaling factor of the input prescaler C. The prescaling ratio may be any power of 2 from 1 to 128.

16.7.8 ASRC Status Register (ASRC_ASRSTR)

The ASRC status register (ASRSTR) is a read/write register used by the processor core to examine the status of the ASRC block and clear the overload interrupt request and AOLE flag bit. Read the status register will return the current state of ASRC.

Address: 203_4000h base + 20h offset = 203_4020h

Bit	31	30	29	28	27	26	25	24	23	22	21	20	19	18	17	16
R	Reserved								Reserved		DSLNT	ATQOL	AOLC	AOLB	AOLA	AOLC
W																
Reset	0	0	0	0	0	0	0	0	0	0	0	0	0	0	0	0
Bit	15	14	13	12	11	10	9	8	7	6	5	4	3	2	1	0
R	AOLB	AOLA	AODOC	AODOB	AODOA	AIDUC	AIDUB	AIDUA	FPWT	AOLE	AODFC	AODFB	AODFA	AIDEC	AIDEB	AIDEA
W																
Reset	0	0	0	0	0	0	0	0	0	0	0	0	0	0	0	0

ASRC_ASRSTR field descriptions

Field	Description
31–24 -	This field is reserved. Reserved
23–22 -	This field is reserved. Reserved. Should be written as zero for compatibility.

Table continues on the next page...

ASRC_ARSTR field descriptions (continued)

Field	Description
21 DSL CNT	<p>DSL Counter Input to FIFO ready</p> <p>When set, this bit indicates that new DSL counter information is stored in the internal ASRC FIFO. When clear, this bit indicates that new DSL counter information is in the process of storage into the internal ASRC FIFO.</p> <p>When ASRIER:AFPWE=1, the rising edge of this signal will propose an interrupt request.</p> <p>Writing any value with this bit set will clear the interrupt request proposed by the rising edge of this bit.</p>
20 ATQOL	<p>Task Queue FIFO overload</p> <p>When set, this bit indicates that task queue FIFO logic is overloaded. This may help to check the reason why overload interrupt happens.</p> <p>The bit is cleared when writing ASRSTR:AOLE as 1.</p>
19 AOOLC	<p>Pair C Output Task Overload</p> <p>When set, this bit indicates that pair C output task is overloaded. This may help to check the reason why overload interrupt happens.</p> <p>The bit is cleared when writing ASRSTR:AOLE as 1.</p>
18 AOOLB	<p>Pair B Output Task Overload</p> <p>When set, this bit indicates that pair B output task is overloaded. This may help to check the reason why overload interrupt happens.</p> <p>The bit is cleared when writing ASRSTR:AOLE as 1.</p>
17 AOOLA	<p>Pair A Output Task Overload</p> <p>When set, this bit indicates that pair A output task is overloaded. This may help to check the reason why overload interrupt happens.</p> <p>The bit is cleared when writing ASRSTR:AOLE as 1.</p>
16 AIOLC	<p>Pair C Input Task Overload</p> <p>When set, this bit indicates that pair C input task is overloaded. This may help to check the reason why overload interrupt happens.</p> <p>The bit is cleared when writing ASRSTR:AOLE as 1.</p>
15 AIOLB	<p>Pair B Input Task Overload</p> <p>When set, this bit indicates that pair B input task is overloaded. This may help to check the reason why overload interrupt happens.</p> <p>The bit is cleared when writing ASRSTR:AOLE as 1.</p>
14 AIOLA	<p>Pair A Input Task Overload</p> <p>When set, this bit indicates that pair A input task is overloaded. This may help to check the reason why overload interrupt happens.</p> <p>The bit is cleared when writing ASRSTR:AOLE as 1.</p>
13 AODOC	<p>Output Data Buffer C has overflowed</p> <p>When set, this bit indicates that output data buffer C has overflowed. When clear, this bit indicates that output data buffer C has not overflowed</p> <p>The bit is cleared when writing ASRSTR:AOLE as 1.</p>
12 AODOB	<p>Output Data Buffer B has overflowed</p> <p>When set, this bit indicates that output data buffer B has overflowed. When clear, this bit indicates that output data buffer B has not overflowed</p>

Table continues on the next page...

ASRC_ASRSTR field descriptions (continued)

Field	Description
	The bit is cleared when writing ASRSTR:AOLE as 1.
11 AODOA	Output Data Buffer A has overflowed When set, this bit indicates that output data buffer A has overflowed. When clear, this bit indicates that output data buffer A has not overflowed The bit is cleared when writing ASRSTR:AOLE as 1.
10 AIDUC	Input Data Buffer C has underflowed When set, this bit indicates that input data buffer C has underflowed. When clear, this bit indicates that input data buffer C has not underflowed. The bit is cleared when writing ASRSTR:AOLE as 1.
9 AIDUB	Input Data Buffer B has underflowed When set, this bit indicates that input data buffer B has underflowed. When clear, this bit indicates that input data buffer B has not underflowed. The bit is cleared when writing ASRSTR:AOLE as 1.
8 AIDUA	Input Data Buffer A has underflowed When set, this bit indicates that input data buffer A has underflowed. When clear, this bit indicates that input data buffer A has not underflowed. The bit is cleared when writing ASRSTR:AOLE as 1.
7 FPWT	FP is in wait states This bit is for debug only. When set, this bit indicates that ASRC is in wait states. When clear, this bit indicates that ASRC is not in wait states.
6 AOLE	Overload Error Flag When set, this bit indicates that the task rate is too high for the ASRC to handle. The reasons for overload may be: - too high input clock frequency, - too high output clock frequency, - incorrect selection of the pre-filter, - low ASRC processing clock, - too many channels, - underrun, - or any combination of the reasons above. Since the ASRC uses the same hardware resources to perform various tasks, the real reason for the overload is not straight forward, and it should be carefully analyzed by the programmer. If ASRIER:AOLIE=1, an interrupt will be proposed when this bit is set. Write any value with this bit set as one into the status register will clear this bit and the interrupt request proposed by this bit.
5 AODFC	Number of data in Output Data Buffer C is greater than threshold

Table continues on the next page...

ASRC_ASRSTR field descriptions (continued)

Field	Description
	When set, this bit indicates that number of data already existing in ASRDORC is greater than threshold and the processor can read data from ASRDORC. When AODFC is set, the ASRC generates data output C interrupt request to the processor, if enabled (that is, ASRIER:ADOEC = 1). A DMA request is always generated when the AODFC bit is set, but a DMA transfer takes place only if a DMA channel is active and triggered by this event.
4 AODFB	Number of data in Output Data Buffer B is greater than threshold When set, this bit indicates that number of data already existing in ASRDORB is greater than threshold and the processor can read data from ASRDORB. When AODFB is set, the ASRC generates data output B interrupt request to the processor, if enabled (that is, ASRIER:ADOEB = 1). A DMA request is always generated when the AODFB bit is set, but a DMA transfer takes place only if a DMA channel is active and triggered by this event.
3 AODFA	Number of data in Output Data Buffer A is greater than threshold When set, this bit indicates that number of data already existing in ASRDORA is greater than threshold and the processor can read data from ASRDORA. When AODFA is set, the ASRC generates data output A interrupt request to the processor, if enabled (that is, ASRIER:ADOEA = 1). A DMA request is always generated when the AODFA bit is set, but a DMA transfer takes place only if a DMA channel is active and triggered by this event.
2 AIDEC	Number of data in Input Data Buffer C is less than threshold When set, this bit indicates that number of data still available in ASRDIRC is less than threshold and the processor can write data to ASRDIRC. When AIDEC is set, the ASRC generates data input C interrupt request to the processor, if enabled (that is, ASRIER:ADIEC = 1). A DMA request is always generated when the AIDEC bit is set, but a DMA transfer takes place only if a DMA channel is active and triggered by this event.
1 AIDEB	Number of data in Input Data Buffer B is less than threshold When set, this bit indicates that number of data still available in ASRDIRB is less than threshold and the processor can write data to ASRDIRB. When AIDEB is set, the ASRC generates data input B interrupt request to the processor, if enabled (that is, ASRIER:ADIEB = 1). A DMA request is always generated when the AIDEB bit is set, but a DMA transfer takes place only if a DMA channel is active and triggered by this event.
0 AIDEA	Number of data in Input Data Buffer A is less than threshold When set, this bit indicates that number of data still available in ASRDIRA is less than threshold and the processor can write data to ASRDIRA. When AIDEA is set, the ASRC generates data input A interrupt request to the processor, if enabled (that is, ASRIER:ADIEA = 1). A DMA request is always generated when the AIDEA bit is set, but a DMA transfer takes place only if a DMA channel is active and triggered by this event.

16.7.9 ASRC Parameter Register n (ASRC_ASRPMnn)

Parameter registers determine the performance of ASRC.

The parameter registers must be initialized by software before ASRC is enabled. Recommended values are given in [ASRC Misc Control Register 1 for Pair C](#) below,

Table 16-8. ASRC Parameter Registers (ASRPM1~ASRPM5)

Register	Offset	Access	Reset Value	Recommend Value
asrcpm1	0x40	R/W	0x00_0000	0x7fffff
asrcpm2	0x44	R/W	0x00_0000	0x255555
asrcpm3	0x48	R/W	0x00_0000	0xff7280
asrcpm4	0x4C	R/W	0x00_0000	0xff7280
asrcpm5	0x50	R/W	0x00_0000	0xff7280

Address: 203_4000h base + 40h offset + (4d × i), where i=0d to 4d

Bit	31	30	29	28	27	26	25	24	23	22	21	20	19	18	17	16	15	14	13	12	11	10	9	8	7	6	5	4	3	2	1	0
R	Reserved								PARAMETER_VALUE																							
W	Reserved								PARAMETER_VALUE																							
Reset	0	0	0	0	0	0	0	0	0	0	0	0	0	0	0	0	0	0	0	0	0	0	0	0	0	0	0	0	0	0	0	

ASRC_ASRPMnn field descriptions

Field	Description
31–24 -	This field is reserved. Reserved
PARAMETER_ VALUE	See recommended values table.

16.7.10 ASRC ASRC Task Queue FIFO Register 1 (ASRC_ASRTFR1)

The register defines and shows the parameters for ASRC inner task queue FIFOs.

Address: 203_4000h base + 54h offset = 203_4054h

Bit	31	30	29	28	27	26	25	24	23	22	21	20	19	18	17	16	15	14	13	12	11	10	9	8	7	6	5	4	3	2	1	0
R	Reserved								Reserved				TF_FILL				TF_BASE				Reserved											
W	Reserved								Reserved				TF_FILL				TF_BASE				Reserved											
Reset	0	0	0	0	0	0	0	0	0	0	0	0	0	0	0	0	0	0	0	0	0	0	0	0	0	0	0	0	0	0	0	

ASRC_ASRTFR1 field descriptions

Field	Description
31–24 -	This field is reserved. Reserved
23–20 -	This field is reserved. Reserved. Should be written as zero for compatibility.
19–13 TF_FILL	Current number of entries in task queue FIFO.

Table continues on the next page...

ASRC_ASRTFR1 field descriptions (continued)

Field	Description
12–6 TF_BASE	Base address for task queue FIFO. Set to 0x7C.
-	This field is reserved. Reserved. Should be written as zero for compatibility.

16.7.11 ASRC Channel Counter Register (ASRC_ASRCCR)

The ASRC channel counter register (ASRCCR) is a read/write register that sets and reflects the current specific input/output FIFO being accessed through shared peripheral bus for each ASRC conversion pair.

Address: 203_4000h base + 5Ch offset = 203_405Ch

Bit	31	30	29	28	27	26	25	24	23	22	21	20	19	18	17	16	15	14	13	12	11	10	9	8	7	6	5	4	3	2	1	0
R																																
W																																
Reset	0	0	0	0	0	0	0	0	0	0	0	0	0	0	0	0	0	0	0	0	0	0	0	0	0	0	0	0	0	0	0	

ASRC_ASRCCR field descriptions

Field	Description
31–24 -	This field is reserved. Reserved
23–20 ACOC	The channel counter for Pair C's output FIFO These bits stand for the current channel being accessed through shared peripheral bus for Pair C's output FIFO's usage. The value can be any value between [0, ANCC-1]
19–16 ACOB	The channel counter for Pair B's output FIFO These bits stand for the current channel being accessed through shared peripheral bus for Pair B's output FIFO's usage. The value can be any value between [0, ANCB-1]
15–12 ACOA	The channel counter for Pair A's output FIFO These bits stand for the current channel being accessed through shared peripheral bus for Pair A's output FIFO's usage. The value can be any value between [0, ANCA-1]
11–8 ACIC	The channel counter for Pair C's input FIFO These bits stand for the current channel being accessed through shared peripheral bus for Pair C's input FIFO's usage. The value can be any value between [0, ANCC-1]
7–4 ACIB	The channel counter for Pair B's input FIFO These bits stand for the current channel being accessed through shared peripheral bus for Pair B's input FIFO's usage. The value can be any value between [0, ANCB-1]
ACIA	The channel counter for Pair A's input FIFO These bits stand for the current channel being accessed through shared peripheral bus for Pair A's input FIFO's usage. The value can be any value between [0, ANCA-1]

16.7.12 ASRC Data Input Register for Pair x (ASRC_ASRDIn)

These registers are the interface registers for the audio data input of pair A,B,C respectively. They are backed by FIFOs.

Address: 203_4000h base + 60h offset + (8d × i), where i=0d to 2d

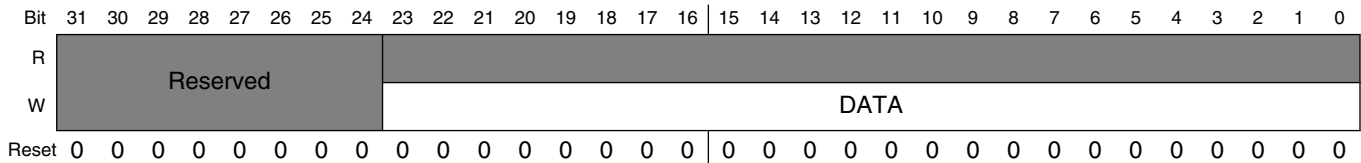

ASRC_ASRDIn field descriptions

Field	Description
31–24 -	This field is reserved. Reserved
DATA	Audio data input

16.7.13 ASRC Data Output Register for Pair x (ASRC_ASRDO_n)

These registers are the interface registers for the audio data output of pair A,B,C respectively. They are backed by FIFOs.

Address: 203_4000h base + 64h offset + (8d × i), where i=0d to 2d

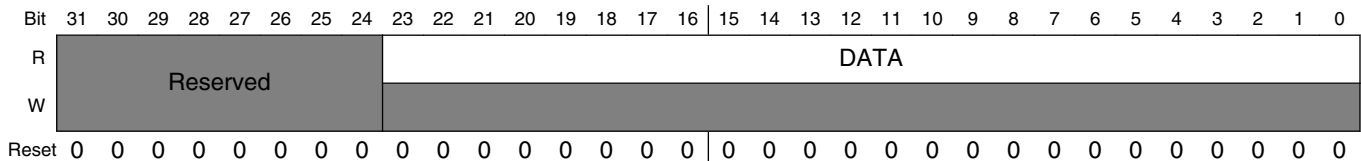

ASRC_ASRDO_n field descriptions

Field	Description
31–24 -	This field is reserved. Reserved
DATA	Audio data output

16.7.14 ASRC Ideal Ratio for Pair A-High Part (ASRC_ASRIDRHA)

The ideal ratio registers (ASRIDRHA, ASRIDRLA) hold the ratio value IDRATIOA. $IDRATIOA = F_{s_{inA}}/F_{s_{outA}} = T_{s_{outA}}/T_{s_{inA}}$ is a 32-bit fixed point value with 26 fractional bits. This value is only useful when ASRCCTR:{USRA, IDRA}=2'b11.

Address: 203_4000h base + 80h offset = 203_4080h

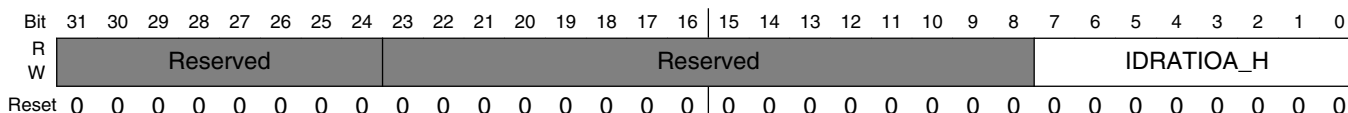

ASRC_ASRIDRHA field descriptions

Field	Description
31–24 -	This field is reserved. Reserved
23–8 -	This field is reserved. Reserved
IDRATIOA_H	IDRATIOA[31:24]. High part of ideal ratio value for pair A

16.7.15 ASRC Ideal Ratio for Pair A -Low Part (ASRC_ASRIDRLA)

The ideal ratio registers (ASRIDRHA, ASRIDRLA) hold the ratio value IDRATIOA. $IDRATIOA = F_{s_{inA}}/F_{s_{outA}} = T_{s_{outA}}/T_{s_{inA}}$ is a 32-bit fixed point value with 26 fractional bits. This value is only useful when ASRCCTR:{USRA, IDRA}=2'b11.

Address: 203_4000h base + 84h offset = 203_4084h

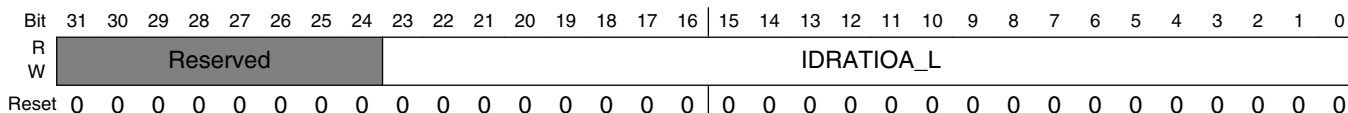

ASRC_ASRIDRLA field descriptions

Field	Description
31–24 -	This field is reserved. Reserved
IDRATIOA_L	IDRATIOA[23:0]. Low part of ideal ratio value for pair A

16.7.16 ASRC Ideal Ratio for Pair B-High Part (ASRC_ASRIDRHB)

The ideal ratio registers (ASRIDRHB, ASRIDRLB) hold the ratio value IDRATIOB. $IDRATIOB = F_{S_{inB}}/F_{S_{outB}} = T_{S_{outB}}/T_{S_{inB}}$ is a 32-bit fixed point value with 26 fractional bits. This value is only useful when $ASRC_{CTR}:\{USRB, IDRB\}=2'b11$.

Address: 203_4000h base + 88h offset = 203_4088h

Bit	31	30	29	28	27	26	25	24	23	22	21	20	19	18	17	16	15	14	13	12	11	10	9	8	7	6	5	4	3	2	1	0																
R	Reserved																Reserved																IDRATIOB_H															
W	Reserved																Reserved																IDRATIOB_H															
Reset	0	0	0	0	0	0	0	0	0	0	0	0	0	0	0	0	0	0	0	0	0	0	0	0	0	0	0	0	0	0	0	0	0	0	0	0	0	0	0	0	0	0	0	0	0	0	0	0

ASRC_ASRIDRHB field descriptions

Field	Description
31–24 -	This field is reserved. Reserved
23–8 -	This field is reserved. Reserved
IDRATIOB_H	IDRATIOB[31:24]. High part of ideal ratio value for pair B.

16.7.17 ASRC Ideal Ratio for Pair B-Low Part (ASRC_ASRIDRLB)

The ideal ratio registers (ASRIDRHB, ASRIDRLB) hold the ratio value IDRATIOB. $IDRATIOB = F_{S_{inB}}/F_{S_{outB}} = T_{S_{outB}}/T_{S_{inB}}$ is a 32-bit fixed point value with 26 fractional bits. This value is only useful when $ASRC_{CTR}:\{USRB, IDRB\}=2'b11$.

Address: 203_4000h base + 8Ch offset = 203_408Ch

Bit	31	30	29	28	27	26	25	24	23	22	21	20	19	18	17	16	15	14	13	12	11	10	9	8	7	6	5	4	3	2	1	0																
R	Reserved																IDRATIOB_L																															
W	Reserved																IDRATIOB_L																															
Reset	0	0	0	0	0	0	0	0	0	0	0	0	0	0	0	0	0	0	0	0	0	0	0	0	0	0	0	0	0	0	0	0	0	0	0	0	0	0	0	0	0	0	0	0	0	0	0	0

ASRC_ASRIDRLB field descriptions

Field	Description
31–24 -	This field is reserved. Reserved
IDRATIOB_L	IDRATIOB[23:0]. Low part of ideal ratio value for pair B.

16.7.18 ASRC Ideal Ratio for Pair C-High Part (ASRC_ASRIDRHC)

The ideal ratio registers (ASRIDRHC, ASRIDRLC) hold the ratio value IDRATIOC. $IDRATIOC = F_{s_{inC}}/F_{s_{outC}} = T_{s_{outC}}/T_{s_{inC}}$ is a 32-bit fixed point value with 26 fractional bits. This value is only useful when ASRCRTR:{USRC, IDRC}=2'b11.

Address: 203_4000h base + 90h offset = 203_4090h

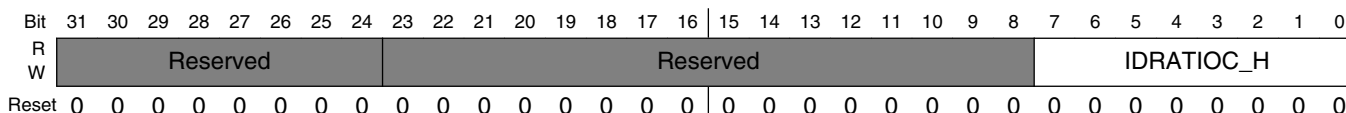

ASRC_ASRIDRHC field descriptions

Field	Description
31–24 -	This field is reserved. Reserved
23–8 -	This field is reserved. Reserved
IDRATIOC_H	IDRATIOC[31:24]. High part of ideal ratio value for pair C.

16.7.19 ASRC Ideal Ratio for Pair C-Low Part (ASRC_ASRIDRLC)

The ideal ratio registers (ASRIDRHC, ASRIDRLC) hold the ratio value IDRATIOC. $IDRATIOC = F_{s_{inC}}/F_{s_{outC}} = T_{s_{outC}}/T_{s_{inC}}$ is a 32-bit fixed point value with 26 fractional bits. This value is only useful when ASRCRTR:{USRC, IDRC}=2'b11.

Address: 203_4000h base + 94h offset = 203_4094h

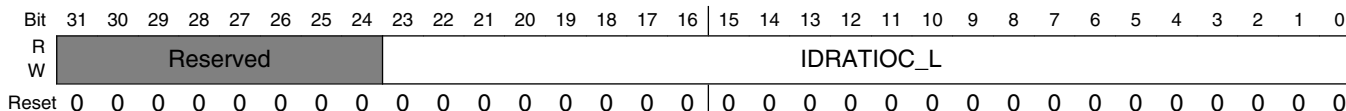

ASRC_ASRIDRLC field descriptions

Field	Description
31–24 -	This field is reserved. Reserved
IDRATIOC_L	IDRATIOC[23:0]. Low part of ideal ratio value for pair C.

16.7.20 ASRC 76 kHz Period in terms of ASRC processing clock (ASRC_ASR76K)

The register (ASR76K) holds the period of the 76 kHz sampling clock in terms of the ASRC processing clock with frequency $F_{S_{ASRC}}$. $ASR76K = F_{S_{ASRC}}/F_{S_{76k}}$. Reset value is 0x0A47 which assumes that $F_{S_{ASRC}}=200$ MHz. This register is used to help the ASRC internal logic to decide the pre-processing and the post-processing options automatically (see [ASRC Misc Control Register 1 for Pair C](#) and [ASRC Misc Control Register 1 for Pair C](#)). In a system when $F_{S_{ASRC}} = 133$ MHz, the value should be assigned explicitly as 0x06D6 in user application code.

Address: 203_4000h base + 98h offset = 203_4098h

Bit	31	30	29	28	27	26	25	24	23	22	21	20	19	18	17	16	15	14	13	12	11	10	9	8	7	6	5	4	3	2	1	0
R	Reserved																ASR76K															
W	Reserved																ASR76K															
Reset	0	0	0	0	0	0	0	0	0	0	0	0	0	0	0	0	0	0	0	0	1	0	1	0	0	1	0	0	0	1	1	1

ASRC_ASR76K field descriptions

Field	Description
31–24 -	This field is reserved. Reserved
23–17 -	This field is reserved. Reserved
ASR76K	Value for the period of the 76 kHz sampling clock.

16.7.21 ASRC 56 kHz Period in terms of ASRC processing clock (ASRC_ASR56K)

The register (ASR56K) holds the period of the 56 kHz sampling clock in terms of the ASRC processing clock with frequency $F_{s_{ASRC}}$. $ASR56K = F_{s_{ASRC}}/F_{s_{56k}}$. Reset value is 0x0DF3 which assumes that $F_{s_{ASRC}} = 200$ MHz. This register is used to help the ASRC internal logic to decide the pre-processing and the post-processing options automatically (see [ASRC Misc Control Register 1 for Pair C](#) and [ASRC Misc Control Register 1 for Pair C](#)). In a system when $F_{s_{ASRC}} = 133$ MHz, the value should be assigned explicitly as 0x0947 in user application code.

Address: 203_4000h base + 9Ch offset = 203_409Ch

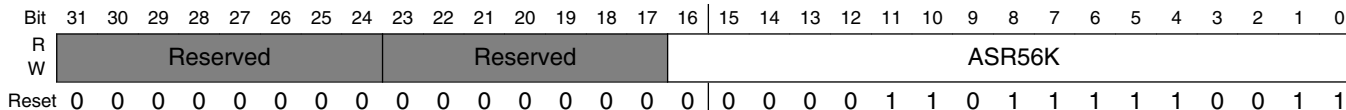

ASRC_ASR56K field descriptions

Field	Description
31–24 -	This field is reserved. Reserved
23–17 -	This field is reserved. Reserved
ASR56K	Value for the period of the 56 kHz sampling clock

16.7.22 ASRC Misc Control Register for Pair A (ASRC_ASRMCRA)

The register (ASRMCRA) is used to control Pair A internal logic.

Address: 203_4000h base + A0h offset = 203_40A0h

Bit	31	30	29	28	27	26	25	24	23	22	21	20	19	18	17	16
R	Reserved								ZEROBUFA	EXTTHRSA	BUFSTALLA	BYPASSPOLY A	Reserved		OUTFIFO_ THRESHOL DA	
W																
Reset	0	0	0	0	0	0	0	0	0	0	0	0	0	0	0	0
Bit	15	14	13	12	11	10	9	8	7	6	5	4	3	2	1	0
R	OUTFIFO_THRESHOLDA				RSYNIFA	RSYNOFA	Reserved				INFIFO_THRESHOLDA					
W																
Reset	0	0	0	0	0	0	0	0	0	0	0	0	0	0	0	0

ASRC_ASRMCRA field descriptions

Field	Description
31–24 -	This field is reserved. Reserved
23 ZEROBUFA	Initialize buf of Pair A when pair A is enabled. Always clear option. This bit is used to control whether the buffer is to be zeroized when pair A is enabled. 1 Don't zeroize the buffer 0 Zeroize the buffer
22 EXTTHRSA	Use external thresholds for FIFO control of Pair A This bit will determine whether the FIFO thresholds externally defined in this register is used to control ASRC internal FIFO logic for pair A. 1 Use external defined thresholds. 0 Use default thresholds.
21 BUFSTALLA	Stall Pair A conversion in case of Buffer Near Empty/Full Condition This bit will determine whether the near empty/full FIFO condition will stall the rate conversion for pair A. This option can only work when external ratio is used. Near empty condition is the condition when input FIFO has less than 4 useful samples per channel. Near full condition is the condition when the output FIFO has less than 4 vacant sample words to fill per channel.

Table continues on the next page...

ASRC_ASRMCRA field descriptions (continued)

Field	Description
	<p>1 Stall Pair A conversion in case of near empty/full FIFO conditions.</p> <p>0 Don't stall Pair A conversion even in case of near empty/full FIFO conditions.</p>
20 BYPASSPOLYA	<p>Bypass Polyphase Filtering for Pair A</p> <p>This bit will determine whether the polyphase filtering part of Pair A conversion will be bypassed.</p> <p>1 Bypass polyphase filtering.</p> <p>0 Don't bypass polyphase filtering.</p>
19–18 -	<p>This field is reserved.</p> <p>Reserved. Should be written as zero for future compatibility.</p>
17–12 OUTFIFO_ THRESHOLDA	<p>The threshold for Pair A's output FIFO per channel</p> <p>These bits stand for the threshold for Pair A's output FIFO per channel. Possible range is [0,63].</p> <p>When the value is n, it means that:</p> <p>when the number of output FIFO fillings of the pair is greater than n samples per channel, the output data ready flag is set;</p> <p>when the number of output FIFO fillings of the pair is less than or equal to n samples per channel, the output data ready flag is automatically cleared.</p>
11 RSYNIFA	<p>Re-sync Input FIFO Channel Counter</p> <p>If bit set, force ASRCCR:ACIA=0. If bit clear, untouch ASRCCR:ACIA.</p>
10 RSYNOFA	<p>Re-sync Output FIFO Channel Counter</p> <p>If bit set, force ASRCCR:ACOA=0. If bit clear, untouch ASRCCR:ACOA.</p>
9–6 -	<p>This field is reserved.</p> <p>Reserved. Should be written as zero for future compatibility.</p>
INFIFO_ THRESHOLDA	<p>The threshold for Pair A's input FIFO per channel</p> <p>These bits stand for the threshold for Pair A's input FIFO per channel. Possible range is [0,63].</p> <p>When the value is n, it means that:</p> <p>when the number of input FIFO fillings of the pair is less than n samples per channel, the input data needed flag is set;</p> <p>when the number of input FIFO fillings of the pair is greater than or equal to n samples per channel, the input data needed flag is automatically cleared.</p>

16.7.23 ASRC FIFO Status Register for Pair A (ASRC_ASRFSTA)

The register (ASRFSTA) is used to show Pair A internal FIFO conditions.

Address: 203_4000h base + A4h offset = 203_40A4h

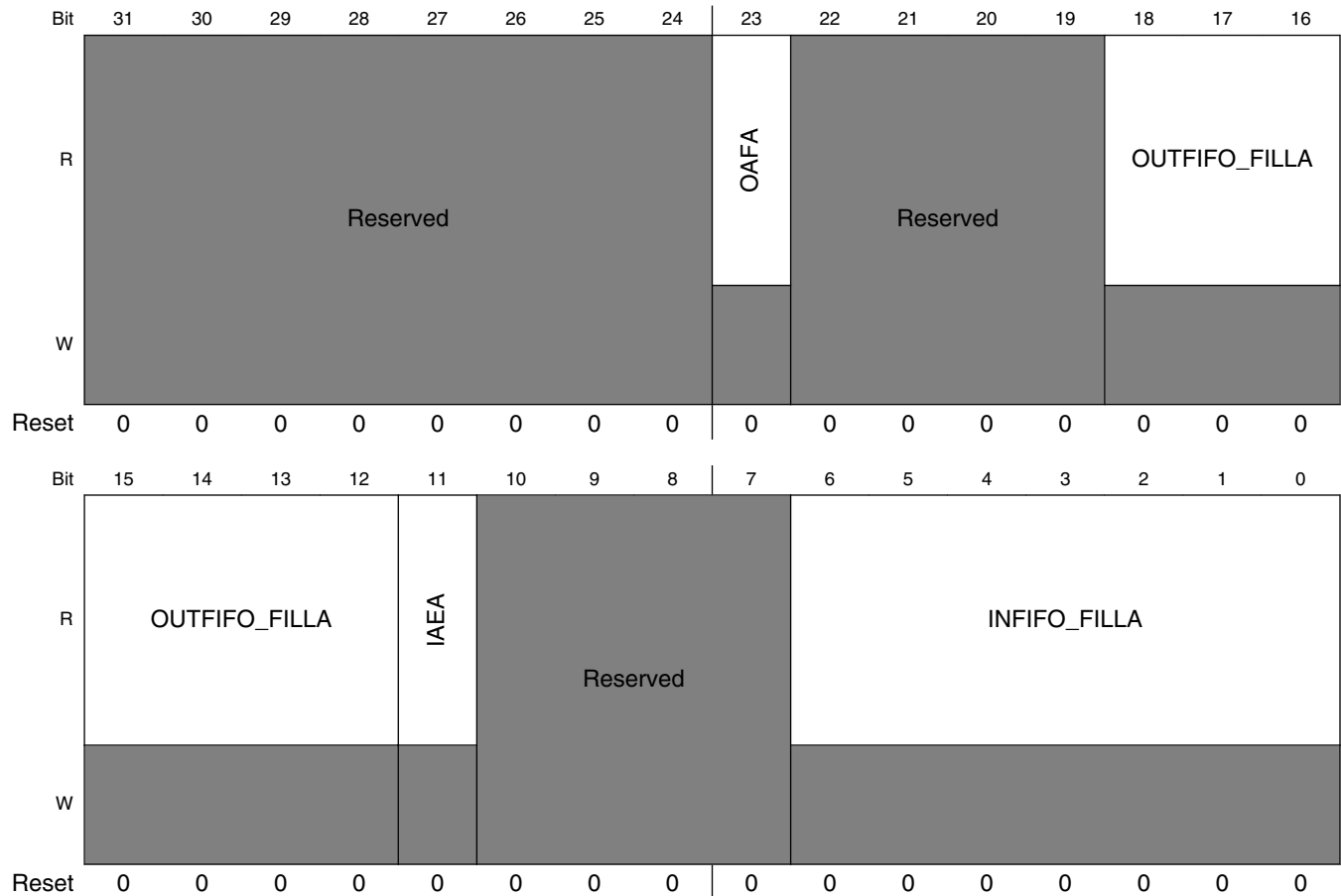

ASRC_ASRFSTA field descriptions

Field	Description
31–24 -	This field is reserved. Reserved
23 OAFA	Output FIFO is near Full for Pair A This bit is to indicate whether the output FIFO of Pair A is near full.
22–19 -	This field is reserved. Reserved. Should be written as zero for future compatibility.
18–12 OUTFIFO_FILLA	The fillings for Pair A's output FIFO per channel These bits stand for the fillings for Pair A's output FIFO per channel. Possible range is [0,64].

Table continues on the next page...

ASRC_ASRFSTA field descriptions (continued)

Field	Description
11 IAEA	Input FIFO is near Empty for Pair A This bit is to indicate whether the input FIFO of Pair A is near empty.
10–7 -	This field is reserved. Reserved. Should be written as zero for future compatibility.
INFIFO_FILLA	The fillings for Pair A's input FIFO per channel These bits stand for the fillings for Pair A's input FIFO per channel. Possible range is [0,64].

16.7.24 ASRC Misc Control Register for Pair B (ASRC_ASRMCRB)

The register (ASRMCRB) is used to control Pair B internal logic.

Address: 203_4000h base + A8h offset = 203_40A8h

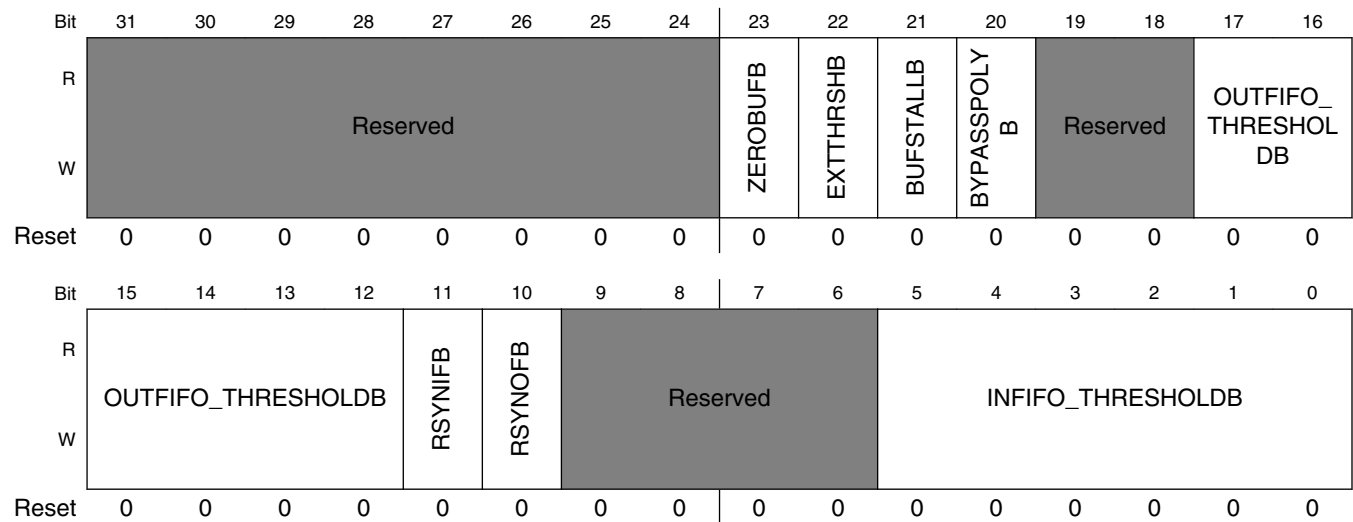

ASRC_ASRMCRB field descriptions

Field	Description
31–24 -	This field is reserved. Reserved
23 ZEROBUFB	Initialize buf of Pair B when pair B is enabled This bit is used to control whether the buffer is to be zeroized when pair B is enabled. 1 Don't zeroize the buffer 0 Zeroize the buffer
22 EXTTHRSB	Use external thresholds for FIFO control of Pair B

Table continues on the next page...

ASRC_ASRMCRB field descriptions (continued)

Field	Description
	<p>This bit will determine whether the FIFO thresholds externally defined in this register is used to control ASRC internal FIFO logic for pair B.</p> <p>1 Use external defined thresholds. 0 Use default thresholds.</p>
21 BUFSTALLB	<p>Stall Pair B conversion in case of Buffer Near Empty/Full Condition</p> <p>This bit will determine whether the near empty/full FIFO condition will stall the rate conversion for pair B. This option can only work when external ratio is used.</p> <p>Near empty condition is the condition when input FIFO has less than 4 useful samples per channel.</p> <p>Near full condition is the condition when the output FIFO has less than 4 vacant sample words to fill per channel.</p> <p>1 Stall Pair B conversion in case of near empty/full FIFO conditions. 0 Don't stall Pair B conversion even in case of near empty/full FIFO conditions.</p>
20 BYPASSPOLYB	<p>Bypass Polyphase Filtering for Pair B</p> <p>This bit will determine whether the polyphase filtering part of Pair B conversion will be bypassed.</p> <p>1 Bypass polyphase filtering. 0 Don't bypass polyphase filtering.</p>
19–18 -	<p>This field is reserved. Reserved. Should be written as zero for future compatibility.</p>
17–12 OUTFIFO_ THRESHOLDB	<p>The threshold for Pair B's output FIFO per channel</p> <p>These bits stand for the threshold for Pair B's output FIFO per channel. Possible range is [0,63].</p> <p>When the value is n, it means that:</p> <p>when the number of output FIFO fillings of the pair is greater than n samples per channel, the output data ready flag is set;</p> <p>when the number of output FIFO fillings of the pair is less than or equal to n samples per channel, the output data ready flag is automatically cleared.</p>
11 RSYNIFB	<p>Re-sync Input FIFO Channel Counter</p> <p>If bit set, force ASRCCR:ACIB=0. If bit clear, untouched ASRCCR:ACIB.</p>
10 RSYNOFB	<p>Re-sync Output FIFO Channel Counter</p> <p>If bit set, force ASRCCR:ACOB=0. If bit clear, untouched ASRCCR:ACOB.</p>
9–6 -	<p>This field is reserved. Reserved. Should be written as zero for future compatibility.</p>
INFIFO_ THRESHOLDB	<p>The threshold for Pair B's input FIFO per channel</p> <p>These bits stand for the threshold for Pair B's input FIFO per channel. Possible range is [0,63].</p> <p>When the value is n, it means that:</p> <p>when the number of input FIFO fillings of the pair is less than n samples per channel, the input data needed flag is set;</p> <p>when the number of input FIFO fillings of the pair is greater than or equal to n samples per channel, the input data needed flag is automatically cleared.</p>

16.7.25 ASRC FIFO Status Register for Pair B (ASRC_ASRFSTB)

The register (ASRFSTB) is used to show Pair B internal FIFO conditions.

Address: 203_4000h base + ACh offset = 203_40ACh

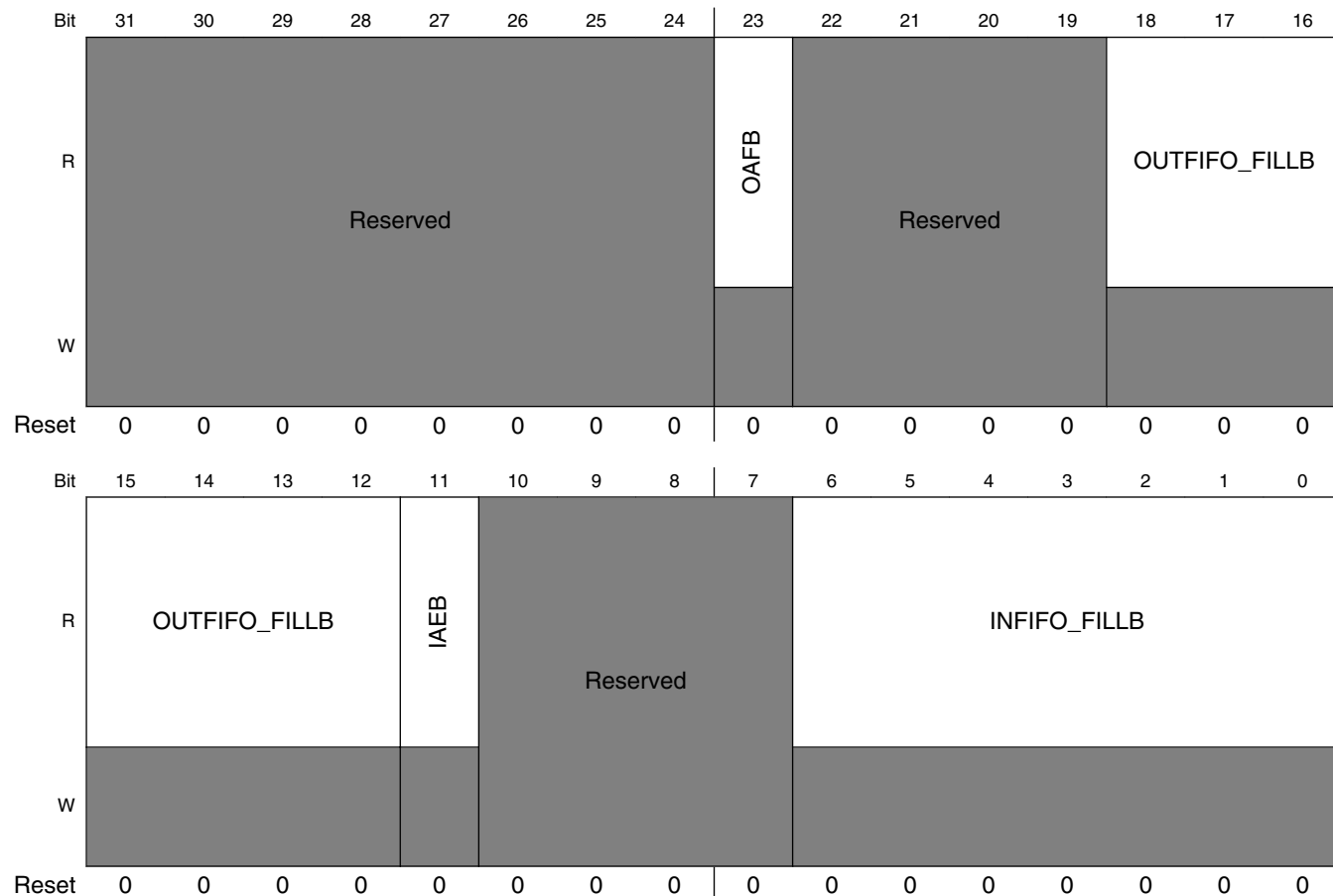

ASRC_ASRFSTB field descriptions

Field	Description
31–24 -	This field is reserved. Reserved
23 OAFB	Output FIFO is near Full for Pair B This bit is to indicate whether the output FIFO of Pair B is near full.
22–19 -	This field is reserved. Reserved. Should be written as zero for future compatibility.
18–12 OUTFIFO_FILLB	The fillings for Pair B's output FIFO per channel These bits stand for the fillings for Pair B's output FIFO per channel. Possible range is [0,64].

Table continues on the next page...

ASRC_ASRFSTB field descriptions (continued)

Field	Description
11 IAEB	Input FIFO is near Empty for Pair B This bit is to indicate whether the input FIFO of Pair B is near empty.
10–7 -	This field is reserved. Reserved. Should be written as zero for future compatibility.
INFIFO_FILLB	The fillings for Pair B's input FIFO per channel These bits stand for the fillings for Pair B's input FIFO per channel. Possible range is [0,64].

16.7.26 ASRC Misc Control Register for Pair C (ASRC_ASRMCR)

The register (ASRMCR) is used to control Pair C internal logic.

Address: 203_4000h base + B0h offset = 203_40B0h

Bit	31	30	29	28	27	26	25	24	23	22	21	20	19	18	17	16
R	Reserved								ZEROBUFC	EXTTHRS HC	BUFSTALLC	BYPASSPOLY C	Reserved		OUTFIFO_THRESHOLDC	
W	Reserved								ZEROBUFC	EXTTHRS HC	BUFSTALLC	BYPASSPOLY C	Reserved		OUTFIFO_THRESHOLDC	
Reset	0	0	0	0	0	0	0	0	0	0	0	0	0	0	0	0
Bit	15	14	13	12	11	10	9	8	7	6	5	4	3	2	1	0
R	OUTFIFO_THRESHOLDC				RSYNIFC	RSYNOFC	Reserved				INFIFO_THRESHOLDC					
W	OUTFIFO_THRESHOLDC				RSYNIFC	RSYNOFC	Reserved				INFIFO_THRESHOLDC					
Reset	0	0	0	0	0	0	0	0	0	0	0	0	0	0	0	0

ASRC_ASRMCR field descriptions

Field	Description
31–24 -	This field is reserved. Reserved
23 ZEROBUFC	Initialize buf of Pair C when pair C is enabled This bit is used to control whether the buffer is to be zeroized when pair C is enabled. 1 Don't zeroize the buffer 0 Zeroize the buffer
22 EXTTHRS HC	Use external thresholds for FIFO control of Pair C

Table continues on the next page...

ASRC_ASRMCRC field descriptions (continued)

Field	Description
	<p>This bit will determine whether the FIFO thresholds externally defined in this register is used to control ASRC internal FIFO logic for pair C.</p> <p>1 Use external defined thresholds. 0 Use default thresholds.</p>
21 BUFSTALLC	<p>Stall Pair C conversion in case of Buffer Near Empty/Full Condition</p> <p>This bit will determine whether the near empty/full FIFO condition will stall the rate conversion for pair C. This option can only work when external ratio is used.</p> <p>Near empty condition is the condition when input FIFO has less than 4 useful samples per channel.</p> <p>Near full condition is the condition when the output FIFO has less than 4 vacant sample words to fill per channel.</p> <p>1 Stall Pair C conversion in case of near empty/full FIFO conditions. 0 Don't stall Pair C conversion even in case of near empty/full FIFO conditions.</p>
20 BYPASSPOLYC	<p>Bypass Polyphase Filtering for Pair C</p> <p>This bit will determine whether the polyphase filtering part of Pair C conversion will be bypassed.</p> <p>1 Bypass polyphase filtering. 0 Don't bypass polyphase filtering.</p>
19–18 -	<p>This field is reserved. Reserved. Should be written as zero for future compatibility.</p>
17–12 OUTFIFO_ THRESHOLDC	<p>The threshold for Pair C's output FIFO per channel</p> <p>These bits stand for the threshold for Pair C's output FIFO per channel. Possible range is [0,63].</p> <p>When the value is n, it means that:</p> <p>when the number of output FIFO fillings of the pair is greater than n samples per channel, the output data ready flag is set;</p> <p>when the number of output FIFO fillings of the pair is less than or equal to n samples per channel, the output data ready flag is automatically cleared.</p>
11 RSYNIFC	<p>Re-sync Input FIFO Channel Counter</p> <p>If bit set, force ASRCCR:ACIC=0. If bit clear, untouched ASRCCR:ACIC.</p>
10 RSYNOFC	<p>Re-sync Output FIFO Channel Counter</p> <p>If bit set, force ASRCCR:ACOC=0. If bit clear, untouched ASRCCR:ACOC.</p>
9–6 -	<p>This field is reserved. Reserved. Should be written as zero for future compatibility.</p>
INFIFO_ THRESHOLDC	<p>The threshold for Pair C's input FIFO per channel</p> <p>These bits stand for the threshold for Pair C's input FIFO per channel. Possible range is [0,63].</p> <p>When the value is n, it means that:</p> <p>when the number of input FIFO fillings of the pair is less than n samples per channel, the input data needed flag is set;</p> <p>when the number of input FIFO fillings of the pair is greater than or equal to n samples per channel, the input data needed flag is automatically cleared.</p>

16.7.27 ASRC FIFO Status Register for Pair C (ASRC_ASRFSTC)

The register (ASRFSTC) is used to show Pair C internal FIFO conditions.

Address: 203_4000h base + B4h offset = 203_40B4h

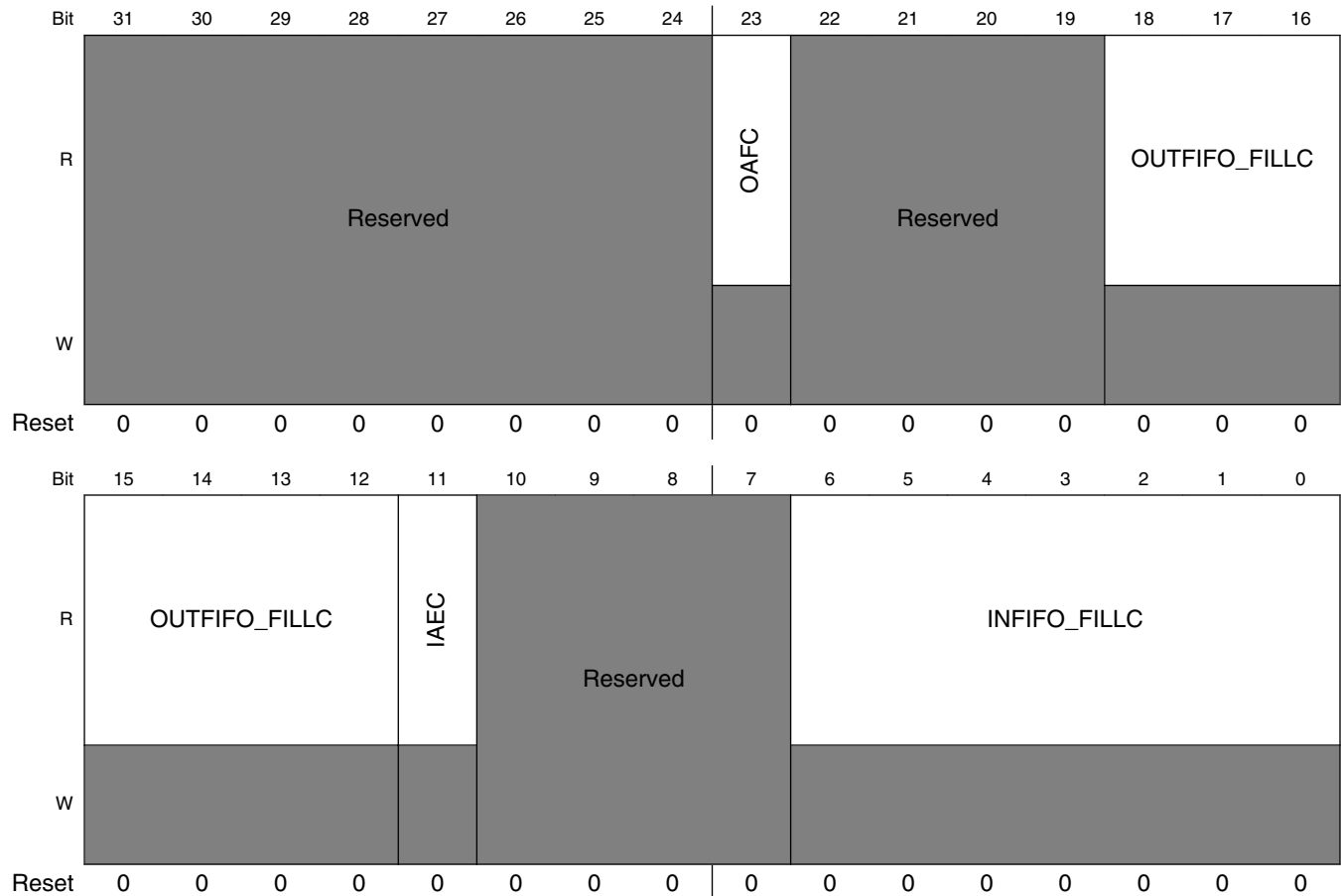

ASRC_ASRFSTC field descriptions

Field	Description
31–24 -	This field is reserved. Reserved
23 O AFC	Output FIFO is near Full for Pair C This bit is to indicate whether the output FIFO of Pair C is near full.
22–19 -	This field is reserved. Reserved. Should be written as zero for future compatibility.
18–12 OUTFIFO_FILLC	The fillings for Pair C's output FIFO per channel These bits stand for the fillings for Pair C's output FIFO per channel. Possible range is [0,64].

Table continues on the next page...

ASRC_ASRFSTC field descriptions (continued)

Field	Description
11 IAEC	Input FIFO is near Empty for Pair C This bit is to indicate whether the input FIFO of Pair C is near empty.
10–7 -	This field is reserved. Reserved. Should be written as zero for future compatibility.
INFIFO_FILLC	The fillings for Pair C's input FIFO per channel These bits stand for the fillings for Pair C's input FIFO per channel. Possible range is [0,64].

16.7.28 ASRC Misc Control Register 1 for Pair X (ASRC_ASRMCR1n)

The register (ASRMCR1x) is used to control Pair x internal logic (for data alignment etc.).

The bit assignment for all the input data formats is the same as that supported by the SAI.

Address: 203_4000h base + C0h offset + (4d × i), where i=0d to 2d

Bit	31	30	29	28	27	26	25	24	23	22	21	20	19	18	17	16
R	Reserved								Reserved							
W	Reserved								Reserved							
Reset	0	0	0	0	0	0	0	0	0	0	0	0	0	0	0	0
Bit	15	14	13	12	11	10	9	8	7	6	5	4	3	2	1	0
R	Reserved				IWD			IWSB	Reserved				OW16	OSGN	OW16	
W	Reserved				IWD			IWSB	Reserved				OW16	OSGN	OW16	
Reset	0	0	0	0	0	0	0	0	0	0	0	0	0	0	0	0

ASRC_ASRMCR1n field descriptions

Field	Description
31–24 -	This field is reserved. Reserved
23–12 -	This field is reserved. Reserved. Should be written as zero for future compatibility.
11–9 IWD	Data Width of the input FIFO These three bits will determine the bitwidth for the audio data into ASRC All other settings not shown are reserved. 3'b000 24-bit audio data. 3'b001 16-bit audio data.

Table continues on the next page...

ASRC_ASRMCR1n field descriptions (continued)

Field	Description
	3'b010 8-bit audio data.
8 IMSB	Data Alignment of the input FIFO This bit will determine the data alignment of the input FIFO. 1 MSB aligned. 0 LSB aligned.
7-3 -	This field is reserved. Reserved. Should be written as zero for future compatibility.
2 OMSB	Data Alignment of the output FIFO This bit will determine the data alignment of the output FIFO. 1 MSB aligned. 0 LSB aligned.
1 OSGN	Sign Extension Option of the output FIFO This bit will determine the sign extension option of the output FIFO. 1 Sign extension. 0 No sign extension.
0 OW16	Bit Width Option of the output FIFO This bit will determine the bit width option of the output FIFO. 1 16-bit output data 0 24-bit output data.

Chapter 17

40-BIT Correcting ECC Accelerator (BCH)

17.1 Overview

The hardware ECC accelerator provides a forward error-correction function for improving the reliability of various storage media that may be attached to the device.

For example, NAND flash devices use a spare area to store ecc codes to correct some hard bit errors in data stored within the device, allowing higher device yields and, therefore, lower NAND device costs.

The Bose, Ray-Chaudhuri, Hocquenghem (BCH) Encoder and Decoder module is capable of correcting from 2 to 40 single bit errors within a block of data no larger than about 1900 bytes (512 bytes or 1024 bytes are typical) in applications such as protecting data and resources stored on modern NAND flash devices. The correction level in the BCH block is programmable to provide flexibility for varying applications and configurations of flash page size. The design can be programmed to encode protection of 2 to 40 bit errors when writing flash and to correct the corresponding number of errors on decode. The correction level when decoding **MUST** be programmed to the same correction level as was used during the encode phase.

BCH-codes are a type of block-code, which implies that all error-correction is performed over a block of N-symbols. The BCH operation will be performed over $GF(2^{13} = 8192)$ or $GF(2^{14} = 16384)$, which is the Galois Field consisting of 8191 or 16383 one-bit symbols. BCH-encoding (or encode for any block-code) can be performed by two algorithms: systematic encoding or multiplicative encoding. Systematic encoding is the process of reading all the symbols which constitute a block, dividing continuously these symbols by the generator polynomial for the $GF(8192)$ or $GF(16384)$ and appending the resulting t parity symbols to the block to create a BCH codeword (where t is the number of correctable bits).

The BCH encode process creates $t \times 13$ (or $t \times 14$)-bit parity symbols for each data block when the data is written to the flash device. The parity symbols are written to the flash device after the corresponding data block, and together these are collectively called the codeword. The codeword can be used during the decode process to correct errors that occur in either the data or parity blocks.

The BCH decoder processes code words in a 4-step fashion:

1. Syndrome Calculation (SC): This is the process of reading in all of the symbols of the codeword and continuously dividing by the generator polynomial for the field. $2 \times t$ syndromes must be calculated for each codeword and inspection of the syndromes determines if there are errors: a non-zero set of syndromes indicates one or more errors. This process is implemented parallel hardware to minimize processing time since it must be done every time the decode is performed.
2. Key Equation Solver (KES): The syndromes represent $2t$ -linear equations with $2t$ -unknown variables. The process of solving these equations and selecting from the numerous solutions constitutes the KES module. When the KES block completes its operations, it generates an error locator polynomial (σ) that is used in the proceeding block to determine the locations and values of the errors.
3. Chien Search (CS): This block takes input from the KES block and uses the Chien Algorithm for finding the locations of the errors based on the error locator polynomial. The method basically involves substituting all 8191 symbols from the GF(8192) or 16383 symbols from the GF(16383) into the locator polynomial. All evaluations that produce a zero solution indicate locations of the various errors. Since each located error corresponds to a single bit, the bit in the original data may be corrected by simply flipping the polarity of the incorrect location.
4. Correction: this block has to convert the symbol index and mask information to memory byte indexes and masks.

The BCH block, shown in the figure, was designed to operate in a pipelined fashion to maximize throughput. Aside from the initial latency to fill the pipeline stages, the BCH throughput is about 7/4 cycles/byte. Thus, the bottleneck in performing NAND reads and error corrections is the BCH rate. Current GPMI read rates are approximately 1/2 cycles/byte maximally for the current generation of NAND flash. Fortunately, BCH has a different master clock from GPMI, this gives some flexibility to match the throughput rate. The CPU is not directly involved in generating parity symbols, checking for errors, or correcting them.

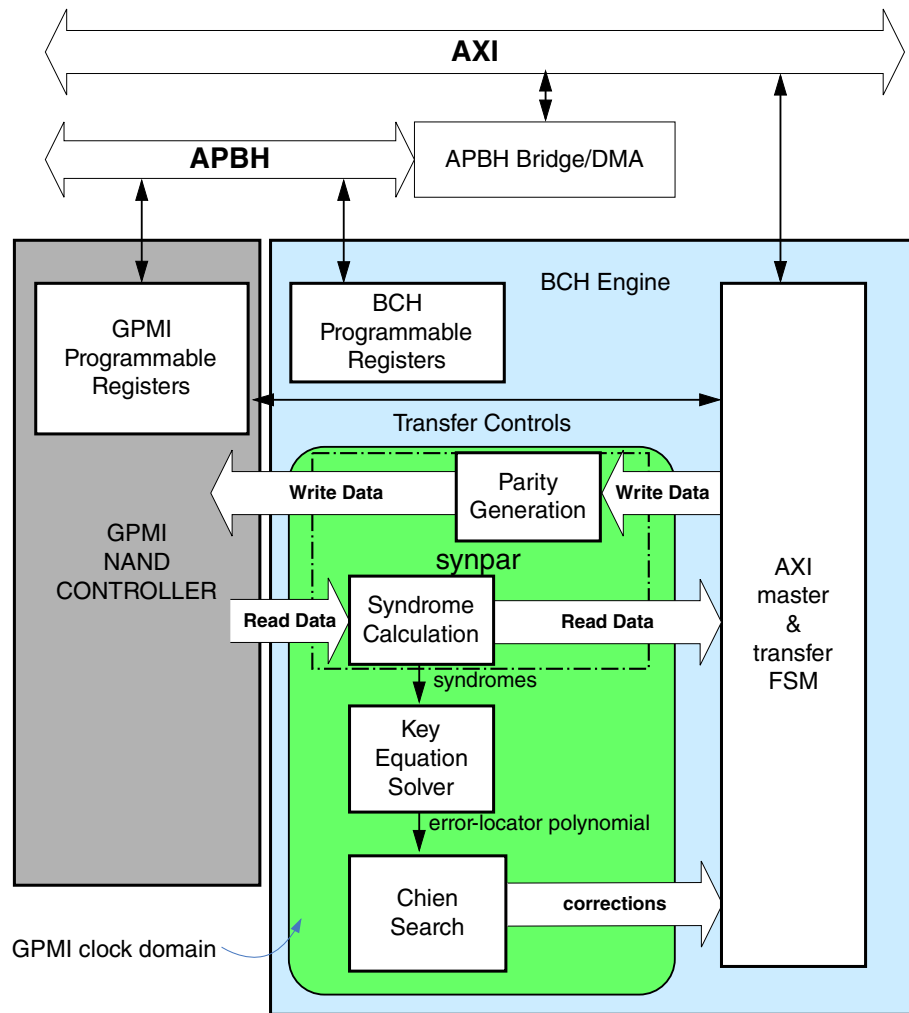

Figure 17-1. Hardware BCH Accelerator

17.2 Operation

Before performing any NAND flash read or write operations, software should first program the BCH's flash layout registers (see [Flash Page Layout](#)) to specify how data is to be formatted on the flash device. The BCH hardware allows full programmability over the flash page layout to enable users flexibility in balancing ECC correction levels and ever-changing flash page sizes.

To initiate a NAND Flash write, software will program a GPMI DMA operation. The DMA need only program the GPMI control registers (and handle the requisite flash addressing handshakes) since the BCH will handle all data operations using its AXI bus interface. The BCH will then send the data to the GPMI controller to be written to flash

as it computes the parity symbols. At the end of each data block the BCH will insert the parity symbols into the data stream so that the GPMI sees only a continuous stream of data to be written.

NAND Flash read operations operate in a similar manner. As the GPMI controller reads the device, all data is sent to the BCH hardware for error detection/correction. The BCH controller writes all incoming read data to system memory and in parallel computes the syndromes used to detect bit errors. If errors are detected within a block, the BCH hardware activates the error correction logic to determine where bit errors have occurred and ultimately correct them in the data buffer in system memory. After an entire flash page has been read and corrected, the BCH will signal an interrupt to the CPU.

The figure below indicates how data read from the GPMI is operated on within the BCH hardware. As the BCH receives data from the GPMI (top row), it is written to memory by the BCH's Bus Interface Unit (BIU) (second row). For blocks requiring correction, the KES logic will be activated after the entire block has been received. Once the error locator polynomial has been computed, the corrections are determined by the Chien Search and fed back to the BIU, which performs a read, modify, write operation on the buffer in memory to correct the data.

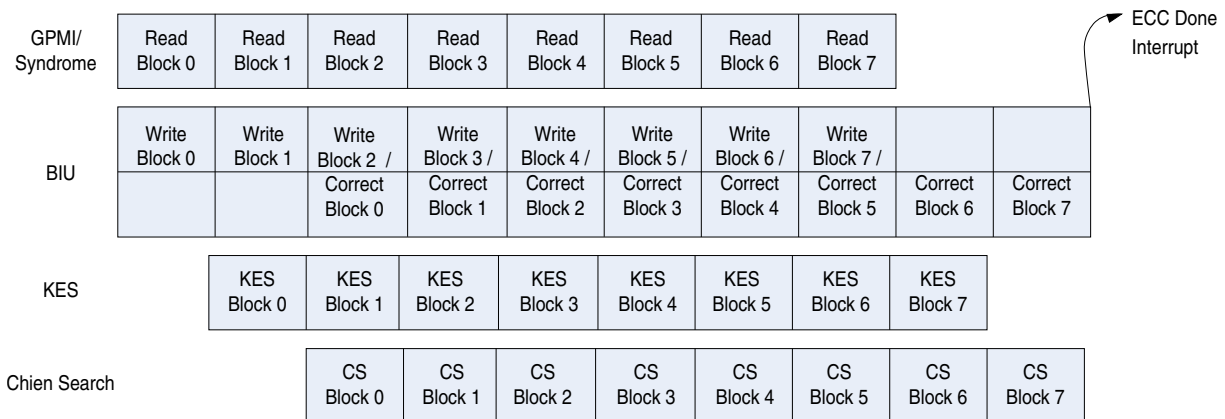

Figure 17-2. Block Pipeline while Reading Flash

17.2.1 BCH Limitations and Assumptions

- The BCH is programmable to support 2 to 40 bit error correction. ECC0 is supported as a pass-through, non-correcting mode.
- Data block sizes must be a multiple of 4 bytes and be aligned in system memory.
- The BCH supports a programmable number of metadata/auxiliary data bytes, from 0 to 255.

- Metadata will be written at the beginning of the flash page to facilitate fast access for filesystem operations.
- Metadata may be treated as an independent block for ECC purposes or combined with the first data block to conserve bits in the flash.
- The BCH does not support a partial page write (this can be accomplished by programming the BCH layout registers such that the BCH only sees a portion of the page).
- Flash read operations can read the entire page or the first block on the page.
- The BCH also supports a memory-to-memory mode of operation that does not require the use of DMA or the GPMI.

17.2.2 Flash Page Layout

The BCH supports a fully programmable flash page layout. The BCH maintains four independent layout registers that can describe four completely different NAND devices or layouts.

When the BCH initiates an operation, it selects one of the layouts by using the chip select as an index into the BCH_LAYOUTSELECT register that determines which layout should be used for the operation.

Three possible (generic) flash layout schemes are supported, as indicated in the figure below. (In each case, the metadata size may also be programmed to 0 bytes). Metadata may either be combined with the first block of data or the size of the first data block can be programmed to 0 to allow the metadata to be protected by its own ECC parity bits.

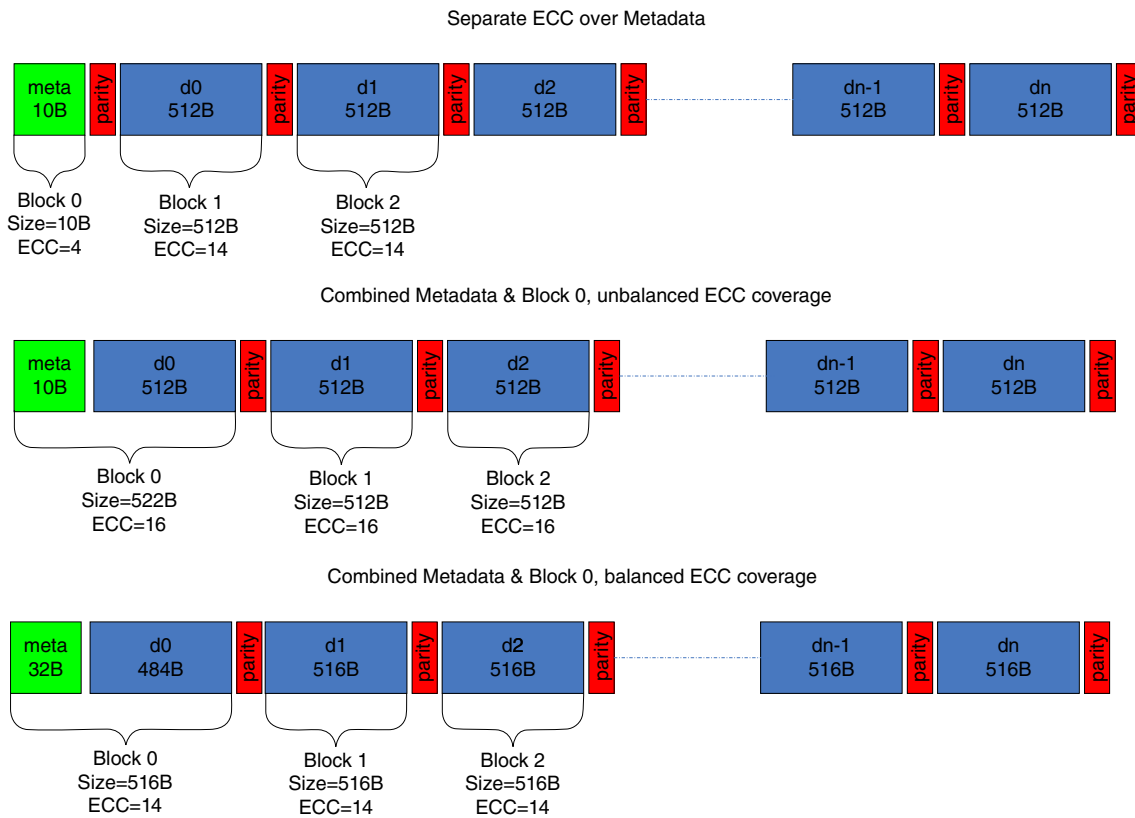

Figure 17-3. FLASH Page Layout Options

Each layout is determined by a pair of registers that define the following parameters:

- **DATA0_SIZE:** Indicates the number of data bytes in the first block on the page (this should not include parity or metadata bytes). This should be set to 0 when the metadata is to be covered separately with its own ECC. This must be a multiple of 4 bytes.
- **ECC0:** Indicates the ECC level to be used for the first block on the flash (data0+metadata).
- **META_SIZE:** Indicates the number of bytes (from 0-255) that are stored as metadata.
- **NBLOCKS:** Indicates the number of subsequent DATAN blocks on the flash, or the number of blocks following the DATA0 block.
- **DATAN_SIZE:** Indicates the number of data bytes in all subsequent data blocks. This **MUST** be a multiple of 4 bytes.
- **ECCN:** Indicates the ECC level to be used for the subsequent data blocks.

- GF0 or GFN: Indicates the Galois field the meta / data blocks are using
- PAGE_SIZE: Indicates the total number of bytes available per page on the physical flash device. This includes the spare area and is typically 4096+128, 4096+218, or 2048+64 bytes.

17.2.3 Determining the ECC layout for a device

Since the BCH is programmable, a system can trade off ECC levels for flash size and layout configurations.

The following examples indicate how to determine a valid layout based on the required storage space and flash size. For all cases, the size of the parity will be 13 (or 14 for GF(2¹⁴))*ECC level *bits*-- so for ECC8, 13 (or 14) bytes are required (per block).

17.2.3.1 4K+218 flash, 10 bytes metadata, 512 byte data blocks, separate metadata, Assuming GF(2¹³)

In this case, we have 8 data blocks each consisting of 512 bytes. Since the flash has 218 spare bytes (1744 bits), first estimate an ECC level for the data blocks by first subtracting the number of metadata bytes from the spare bytes (218 – 10 = 208 bytes = 1664 bits) then dividing the number of bits by 8 (number of blocks) and then by 13 (bits per ECC level).

$$(218 - 10) \times 8 = 1664/13(8) = 16$$

Therefore all the data blocks could be covered by ECC16 if the metadata had no parity. This isn't acceptable, so assume ECC14 for all the data blocks. Now calculate the number of free bits for the metadata parity as

$$1664 - (14) \times 13 \times 8 = 208$$

Therefore, 208 bits remain for metadata parity. Dividing by 13 (bits/ECC) gives 16, so the metadata can be covered with ECC16. The settings for this device would then be

Table 17-1. Settings for 4K+218 FLASH

Setting	Value
PAGE_SIZE	4096+218=4314=0x10DA
META_SIZE	10=0x0A
DATA0_SIZE	0
ECC0	16=0x10

Table continues on the next page...

Table 17-1. Settings for 4K+218 FLASH (continued)

Setting	Value
GF0	GF(2 ¹³)
DATAN_SIZE	512=0x200 (in register interface, assigned as 0x80)
ECCN	14=0x0E
GFN	GF(2 ¹³)
NBLOCKS	8

17.2.3.2 4K+128 flash, 10 bytes metadata, 1024 byte data blocks, separate metadata, assuming GF(2¹³) for data and GF(2¹⁴) for metadata

This flash will have 118 bytes available for ECC (after subtracting the metadata size), therefore, 994 bits.

Dividing by 4*14 (number of blocks * ECC level) we get 17.75, therefore we can support ECC16 on the data blocks. The number of free spare bits becomes 944 - 16 * 4 * 14 = 944 - 896 = 48, divided by 13 = 3.69, therefore the metadata can be also covered by ECC2.

Table 17-2. Settings for 4K+128 FLASH

Setting	Value
PAGE_SIZE	4096+128=4224=0x1080
META_SIZE	10=0x0A
DATA0_SIZE	0
ECC0	2
GF0	GF(2 ¹³)
DATAN_SIZE	1024=0x400 (in register interface, assigned as 0x100)
ECCN	16
GFN	GF(2 ¹⁴)
NBLOCKS	4

In this case, there will be additional unused spare bits, with the BCH will pad out with zeros.

17.2.4 Data Buffers in System Memory

While the data on the flash is interleaved with parity symbols, the BCH assumes that the data buffers in memory are contiguous.

Metadata read from the flash will be stored to the location pointed to by the GPMI_AUXILIARY register and data will be written to the address specified in the GPMI_PAYLOAD register as is shown in the following figure where the block length is 512 bytes for example. Since the number of blocks on a flash page is programmable, the BCH also writes individual block correction status to the auxiliary pointer at the word-aligned address following the end of the metadata. Optionally, the computed syndromes may also be written to the auxiliary area if the DEBUGSYNDROME bit is set in the control register.

As blocks complete processing, the bus master will accumulate the status for each block and write it to the auxiliary data buffer following the metadata. The metadata area will be padded with 0's until the next word boundary and the status for blocks 0-3 will be written to the next word. The status for subsequent blocks will then be written to the buffer. The status for the first block (metadata block) is also stored in the STATUS_BLK0 register in the BCH_STATUS register. The completion codes for the blocks are indicated in the [Table 17-3](#). Note that the definition of the bytes and their ordering in the auxiliary and payload storage areas are user defined. When this data is read back from the flash and put into memory, it will resemble the original buffer that was written out to the flash.

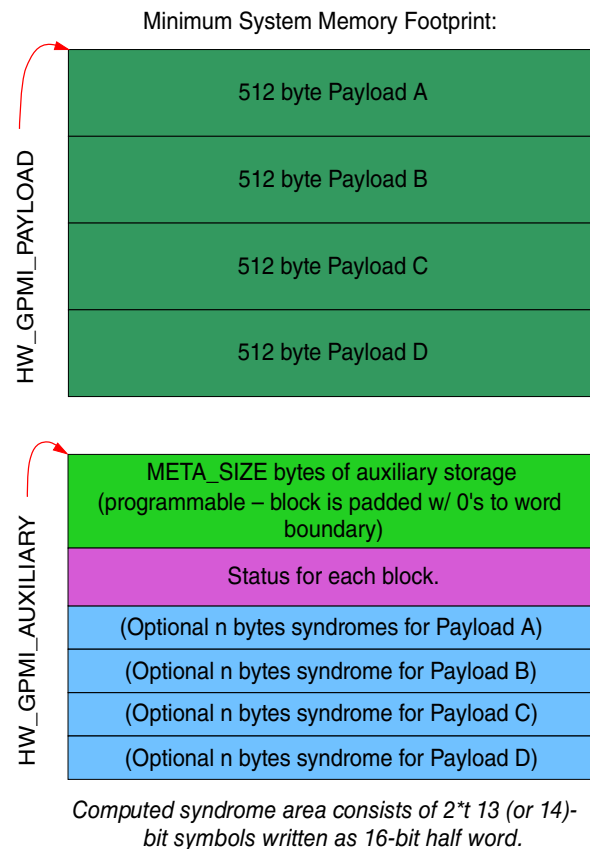
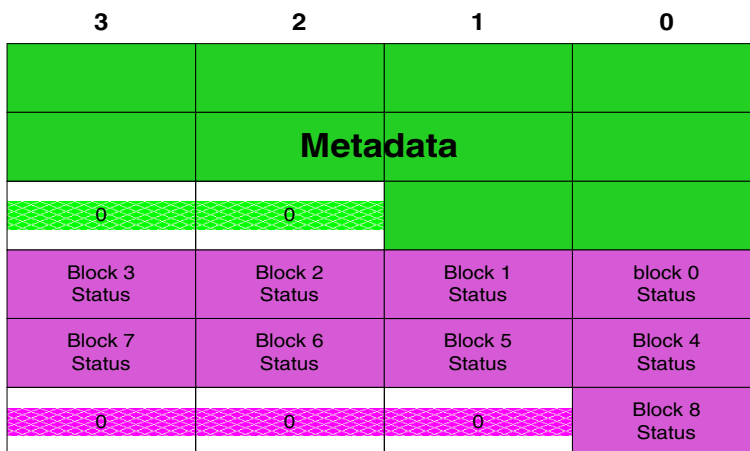

Figure 17-4. BCH Data Buffers in Memory

Table 17-3. Status Block Completion Codes

Code	Description
0xFF	Block is erased
0xFE	Block is uncorrectable
0x00	No errors found
0x01-0x28	Number of errors corrected

The following figure shows the layout of the bytes within the status field.



Status bytes are allocated based on the NBLOCKS programmed into the flash format register. The number of status bytes are computed by NBLOCK+1. The status area will be padded with zeros to the next word boundary.

Syndrome data written for debug purposes follows the end of the status block.

Figure 17-5. Memory-to-Memory Operations

17.3 Memory to Memory (Loopback) Operation

The BCH supports a memory-to-memory mode of operation where both the encoded and decoded buffers reside in system memory.

This can be useful for applications where data must be protected by ECC, but the storage device does not reside on the GPMI bus.

The BCH operation in memory to memory mode is much simpler than in GPMI mode since DMAs are not required to manage the operation. Instead, software simply writes the BCH_DATAPTR and BCH_METAPTR with the addresses of the data and metadata (auxiliary) buffers and the BCH_ENCODEPTR with the address of the buffer for encoded data. To initiate the operation, software simply sets the M2M_ENCODE and

M2M_ENABLE bits in the control register. The BCH can be programmed to either issue an interrupt at the end of the operation or software may poll the status bits for completion.

Memory to memory decode operations work in a similar manner. The encoded data address is written to the BCH_ENCODEPTR and the data and meta pointers are written to buffers that correspond to the desired decoded data addresses. To initiate a decode, software must set the M2M_ENCODE bit to 0 while writing the M2M_ENABLE bit. Note that the addresses written to the BCH_DATAPTR, BCH_METAPTR and BCH_ENCODEPTR registers should always be aligned on a 4 byte boundary. In other words, the 2 lower bits of the address should always be written with zeros.

17.4 Programming the BCH/GPMI Interfaces

Programming the BCH for NAND operations consists largely of disabling the soft reset and clock bits (SFTRST and CLKGATE) from the BCH_CTRL register and then programming the flash layout registers to correspond to the format of the attached NAND device(s).

The BCH_LAYOUTSELECT register should also be programmed to map the chip select of each attached device into one of the four layout registers.

The bulk of the programming is actually applied to the GPMI through PIO operations embedded in DMA command structures. The DMA will perform all the requisite handshaking with the GPMI interface to negotiate the address portion of the transfer, then the BCH will handle all the movement of data from memory to the GPMI (writes) or the GPMI to memory (reads). The BCH will direct all data blocks to the buffer pointed to by the PAYLOAD_BUFFER and the metadata will be written to the AUXILIARY_BUFFER. Both of these registers are located in the GPMI PIO data space and are communicated to the BCH hardware at the beginning of the transfer. Thus, the normal multi-NAND DMA based device interleaving is preserved, that is, four NANDs on four separate chip selects can be scheduled for read or write operations using the BCH. Whichever channel finishes its ready wait first and enters the DMA arbiter with its lock bit set owns the GPMI command interface and through it owns the BCH resources for the duration of its processing.

17.4.1 BCH Encoding for NAND Writes

The BCH encoder flowchart in [Figure 17-6](#) shows the detailed steps involved in programming and using the BCH encoder. This flowchart shows how to use the BCH block with the GPMI.

To use the BCH encoder with the GPMI's DMA, create a DMA command chain containing ten descriptor structures, as shown in [Figure 17-8](#) and detailed in the DMA structure code example that follows it in [DMA Structure Code Example](#). The ten descriptors perform the following tasks:

1. Disable the BCH block (in case it was enabled) and issue NAND write setup command byte (under CLE) and address bytes (under ALE).
2. Configure and enable the BCH and GPMI blocks to perform the NAND write.
3. Disable the BCH block and issue NAND write execute command byte (under CLE).
4. Wait for the NAND device to finish writing the data by watching the ready signal.
5. Check for NAND timeout through PSENSE.
6. Issue NAND status command byte (under CLE).
7. Read the status and compare against expected.
8. If status is incorrect or incomplete, branch to error handling descriptor chain.
9. Otherwise, write is complete and emit GPMI interrupt.

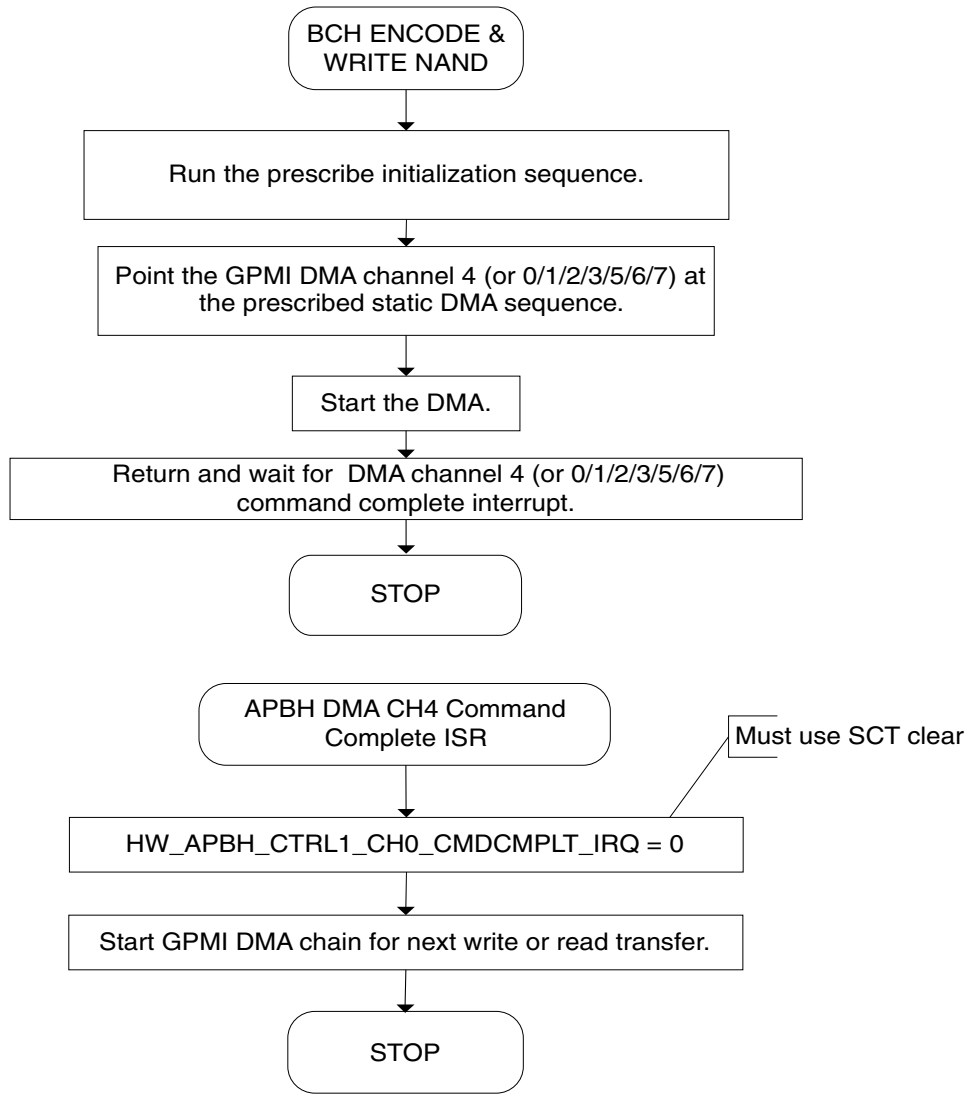

Figure 17-6. BCH Encode Flowchart

Descriptor Legend

NEXT CMD ADDR										
CMD	<=	xfer_count	cmdwords	wait4endcmd	semaphore	nandwait4ready	nandlock	irqoncmplt	chain	command
BUFFER ADDR										
HW_GPMI_CTRL0	<=	command_mode	word_length	lock_cs	CS	address	address_increment	xfer_count		
HW_GPMI_COMPARE	<=	mask				reference				
HW_GPMI_ECCCTRL	<=	ecc_cmd			enable_ecc				buffer_mask	
HW_GPMI_ECCCOUNT										
HW_GPMI_PAYLOAD										
HW_GPMI_AUXILIARY										

Figure 17-7. BCH DMA Descriptor Legend

Programming the BCH/GPMI Interfaces

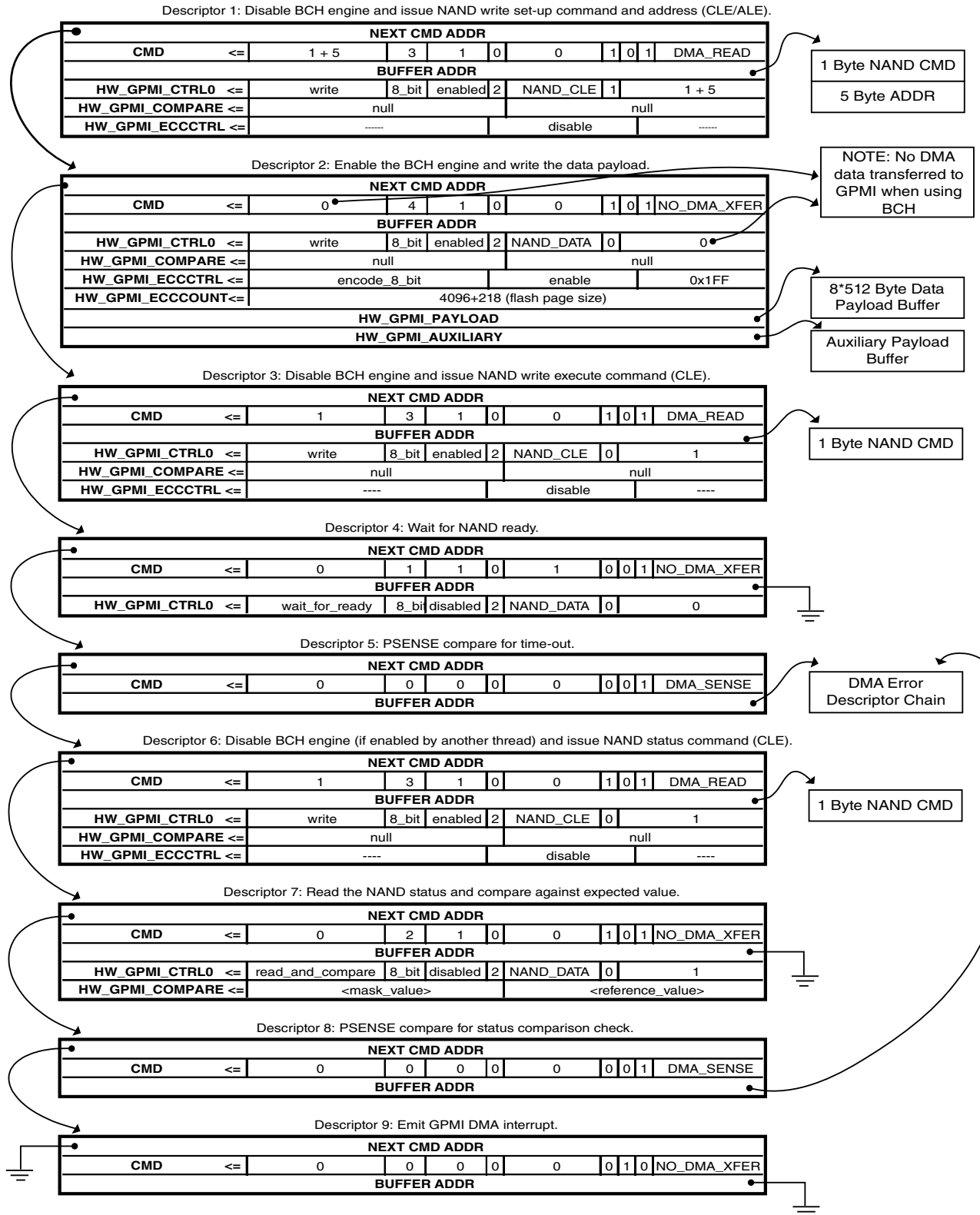

Figure 17-8. BCH Encode DMA Descriptor Chain

17.4.1.1 DMA Structure Code Example

The following code sample illustrates the coding for one write transaction involving 4096 bytes of data payload (eight 512-byte blocks) and 10 bytes of auxiliary payload (also referred to as metadata) to a 4K NAND page sitting on GPMI CS2.

```
//-----
// generic DMA/GPMI/ECC descriptor struct, order sensitive!
//-----
typedef struct {
    // DMA related fields
    unsigned int dma_nxtcmdar;
    unsigned int dma_cmd;
    unsigned int dma_bar;
    // GPMI related fields
    unsigned int gpmi_ctrl0;
    unsigned int gpmi_compare;
    unsigned int gpmi_eccctrl;
    unsigned int gpmi_ecccount;
    unsigned int gpmi_data_ptr;
    unsigned int gpmi_aux_ptr;
} GENERIC_DESCRIPTOR;
//-----
// allocate 10 descriptors for doing a NAND ECC Write
//-----
GENERIC_DESCRIPTOR write[10];
//-----
// DMA descriptor pointer to handle error conditions from psense checks
//-----
unsigned int * dma_error_handler;
//-----
// 8 byte NAND command and address buffer
// any alignment is ok, it is read by the GPMI DMA
// byte 0 is write setup command
// bytes 1-5 is the NAND address
// byte 6 is write execute command
// byte 7 is status command
//-----
unsigned char nand_cmd_addr_buffer[8];
//-----
// 4096 byte payload buffer used for reads or writes
// needs to be word aligned
//-----
unsigned int write_payload_buffer[(4096/4)];
//-----
// 65 byte meta-data to be written to NAND
// needs to be word aligned
//-----
unsigned int write_aux_buffer[65];
//-----
// Descriptor 1: issue NAND write setup command (CLE/ALE)
//-----
write[0].dma_nxtcmdar = &write[1]; // point to the next descriptor
write[0].dma_cmd = BF_APBH_CHn_CMD_XFER_COUNT (1 + 5) | // 1 byte command, 5 byte address
                  BF_APBH_CHn_CMD_CMDWORDS (3) | // send 3 words to the GPMI
                  BF_APBH_CHn_CMD_WAIT4ENDCMD (1) | // wait for command to finish
before
                  BF_APBH_CHn_CMD_SEMAPHORE (0) | // continuing
                  BF_APBH_CHn_CMD_NANDWAIT4READY (0) |
                  BF_APBH_CHn_CMD_NANDLOCK (1) | // prevent other DMA channels
from
                  BF_APBH_CHn_CMD_IRQONCMPLT (0) | // taking over
                  BF_APBH_CHn_CMD_CHAIN (1) | // follow chain to next command
```

Programming the BCH/GPMI Interfaces

```

        BV_FLD(APBH_CHn_CMD, COMMAND, DMA_READ); // read data from DMA, write to
NAND
write[0].dma_bar = &nand_cmd_addr_buffer;          // byte 0 write setup, bytes 1 - 5 NAND
address
// 3 words sent to the GPMI
write[0].gpmi_ctrl0 = BV_FLD(GPMI_CTRL0, COMMAND_MODE, WRITE) | // write to the NAND
                    BV_FLD(GPMI_CTRL0, WORD_LENGTH, 8_BIT) |
                    BV_FLD(GPMI_CTRL0, LOCK_CS, ENABLED) |
BF_GPMI_CTRL0_CS          (2) | // must correspond to NAND CS
used
                    BV_FLD(GPMI_CTRL0, ADDRESS, NAND_CLE) |
                    BF_GPMI_CTRL0_ADDRESS_INCREMENT (1) | // send command and
address
                    BF_GPMI_CTRL0_XFER_COUNT (1 + 5); // 1 byte command, 5 byte
address
write[0].gpmi_compare = NULL; // field not used but necessary to
set eccctrl
write[0].gpmi_eccctrl = BV_FLD(GPMI_ECCCTRL, ENABLE_ECC, DISABLE); // disable the ECC block
//-----
// Descriptor 2: write the data payload (DATA)
//-----
write[1].dma_nxtcmdar = &write[2]; // point to the next descriptor
write[1].dma_cmd = BF_APBH_CHn_CMD_XFER_COUNT (0) | // NOTE: No DMA data transfer
                 BF_APBH_CHn_CMD_CMDWORDS (4) | // send 4 words to the GPMI
                 BF_APBH_CHn_CMD_WAIT4ENDCMD (1) | // Wait to end
                 BF_APBH_CHn_CMD_SEMAPHORE (0) |
                 BF_APBH_CHn_CMD_NANDWAIT4READY (0) |
                 BF_APBH_CHn_CMD_NANDLOCK (1) | // maintain resource lock
                 BF_APBH_CHn_CMD_IRQONCMPLT (0) |
                 BF_APBH_CHn_CMD_CHAIN (1) | // follow chain to next command
                 BV_FLD(APBH_CHn_CMD, COMMAND, DMA_NO_XFER); // No data transferred
write[1].dma_bar = &write_payload_buffer; // pointer for the 4K byte
data area
// 4 words sent to the GPMI
write[1].gpmi_ctrl0 = BV_FLD(GPMI_CTRL0, COMMAND_MODE, WRITE) | // write to the NAND
                    BV_FLD(GPMI_CTRL0, WORD_LENGTH, 8_BIT) |
                    BV_FLD(GPMI_CTRL0, LOCK_CS, ENABLED) |
CS used
                    BF_GPMI_CTRL0_CS (2) | // must correspond to NAND
                    BV_FLD(GPMI_CTRL0, ADDRESS, NAND_DATA) |
                    BF_GPMI_CTRL0_ADDRESS_INCREMENT (0) |
                    BF_GPMI_CTRL0_XFER_COUNT (0); // NOTE: this field
contains
// the total amount
// DMA transferred to GPMI via DMA (0)!
write[1].gpmi_compare = NULL; // field not used but necessary
to
set eccctrl
write[1].gpmi_eccctrl = BV_FLD(GPMI_ECCCTRL, ECC_CMD, ENCODE_8_BIT) | // specify t = 8
mode
                    BV_FLD(GPMI_ECCCTRL, ENABLE_ECC, ENABLE) | // enable ECC module
                    BF_GPMI_ECCCTRL_BUFFER_MASK (0x1FF); // write all 8 data
blocks
// and 1 aux block
write[1].gpmi_ecccount = BF_GPMI_ECCCOUNT_COUNT(4096+218); // specify number of bytes
// written to NAND
write[1].gpmi_data_pointer = &write_payload_pointer; // data buffer address
write[1].gpmi_aux_pointer = &write_aux_pointer; // metadata pointer
//-----
// Descriptor 3: issue NAND write execute command (CLE)
//-----
write[2].dma_nxtcmdar = &write[3]; // point to the next descriptor
write[2].dma_cmd = BF_APBH_CHn_CMD_XFER_COUNT (1) | // 1 byte command
                 BF_APBH_CHn_CMD_CMDWORDS (3) | // send 3 words to the GPMI
                 BF_APBH_CHn_CMD_WAIT4ENDCMD (1) | // wait for command to finish
before
// continuing
                 BF_APBH_CHn_CMD_SEMAPHORE (0) |
                 BF_APBH_CHn_CMD_NANDWAIT4READY(0) |
                 BF_APBH_CHn_CMD_NANDLOCK (1) | // maintain resource lock

```

```

        BF_APBH_CHn_CMD_IRQONCPLT    (0) |
        BF_APBH_CHn_CMD_CHAIN        (1) | // follow chain to next command
        BV_FLD(APBH_CHn_CMD, COMMAND, DMA_READ); // read data from DMA, write to
NAND
write[2].dma_bar = &nand_cmd_addr_buffer[6]; // point to byte 6, write execute
command
// 3 words sent to the GPMI
write[2].gpmi_ctrl0 = BV_FLD(GPMI_CTRL0, COMMAND_MODE, WRITE) | // write to the NAND
                    BV_FLD(GPMI_CTRL0, WORD_LENGTH, 8_BIT) |
                    BV_FLD(GPMI_CTRL0, LOCK_CS, ENABLED) |
                    BF_GPMI_CTRL0_CS (2) | // must correspond to NAND CS
used
                    BV_FLD(GPMI_CTRL0, ADDRESS, NAND_CLE) |
                    BF_GPMI_CTRL0_ADDRESS_INCREMENT (0) |
                    BF_GPMI_CTRL0_XFER_COUNT (1); // 1 byte command
write[2].gpmi_compare = NULL; // field not used but necessary to set
eccctrl
write[2].gpmi_eccctrl = BV_FLD(GPMI_ECCCTRL, ENABLE_ECC, DISABLE); // disable the ECC block
//-----
// Descriptor 4: wait for ready (CLE)
//-----
write[3].dma_nxtcmdar = &write[4]; // point to the next descriptor

write[3].dma_cmd = BF_APBH_CHn_CMD_XFER_COUNT (0) | // no dma transfer
                  BF_APBH_CHn_CMD_CMDWORDS (1) | // send 1 word to the GPMI
                  BF_APBH_CHn_CMD_WAIT4ENDCMD (1) | // wait for command to finish before
                  // continuing
                  BF_APBH_CHn_CMD_SEMAPHORE (0) |
                  BF_APBH_CHn_CMD_NANDWAIT4READY(1) | // wait for nand to be ready
                  BF_APBH_CHn_CMD_NANDLOCK (0) | // relinquish nand lock
                  BF_APBH_CHn_CMD_IRQONCPLT (0) |
                  BF_APBH_CHn_CMD_CHAIN (1) | // follow chain to next command
                  BV_FLD(APBH_CHn_CMD, COMMAND, NO_DMA_XFER); // no dma transfer
write[3].dma_bar = NULL; // field not used
// 1 word sent to the GPMI
write[3].gpmi_ctrl0 = BV_FLD(GPMI_CTRL0, COMMAND_MODE, WAIT_FOR_READY) | // wait for NAND
ready
                    BV_FLD(GPMI_CTRL0, WORD_LENGTH, 8_BIT) |
                    BV_FLD(GPMI_CTRL0, LOCK_CS, DISABLED) |
                    BF_GPMI_CTRL0_CS (2) | // must correspond to NAND CS
used
                    BV_FLD(GPMI_CTRL0, ADDRESS, NAND_DATA) |
                    BF_GPMI_CTRL0_ADDRESS_INCREMENT (0) |
                    BF_GPMI_CTRL0_XFER_COUNT (0);
//-----
// Descriptor 5: psense compare (time out check)
//-----
write[4].dma_nxtcmdar = &write[5]; // point to the next descriptor
write[4].dma_cmd = BF_APBH_CHn_CMD_XFER_COUNT (0) | // no dma transfer
                  BF_APBH_CHn_CMD_CMDWORDS (0) | // no words sent to GPMI
                  BF_APBH_CHn_CMD_WAIT4ENDCMD (0) | // do not wait to continue
                  BF_APBH_CHn_CMD_SEMAPHORE (0) |
                  BF_APBH_CHn_CMD_NANDWAIT4READY(0) |
                  BF_APBH_CHn_CMD_NANDLOCK (0) |
                  BF_APBH_CHn_CMD_IRQONCPLT (0) |
                  BF_APBH_CHn_CMD_CHAIN (1) | // follow chain to next command
                  BV_FLD(APBH_CHn_CMD, COMMAND, DMA_SENSE); // perform a sense check
write[4].dma_bar = dma_error_handler; // if sense check fails, branch to error
handler
//-----
// Descriptor 6: issue NAND status command (CLE)
//-----
write[5].dma_nxtcmdar = &write[6]; // point to the next descriptor
write[5].dma_cmd = BF_APBH_CHn_CMD_XFER_COUNT (1) | // 1 byte command
                  BF_APBH_CHn_CMD_CMDWORDS (3) | // send 3 words to the GPMI
                  BF_APBH_CHn_CMD_WAIT4ENDCMD (1) | // wait for command to finish
before
continuing
                    BF_APBH_CHn_CMD_SEMAPHORE (0) |
                    BF_APBH_CHn_CMD_NANDWAIT4READY(0) |

```

Programming the BCH/GPMI Interfaces

```

        BF_APBH_CHn_CMD_NANDLOCK      (1) | // prevent other DMA channels from
taking over
        BF_APBH_CHn_CMD_IRQONCMPLT   (0) |
        BF_APBH_CHn_CMD_CHAIN         (1) | // follow chain to next command
        BV_FLD(APBH_CHn_CMD, COMMAND, DMA_READ); // read data from DMA, write to
NAND
write[5].dma_bar = &nand_cmd_addr_buffer[7]; // point to byte 7, status
command
write[5].gpmi_compare = NULL; // field not used but necessary to set
eccctrl
write[5].gpmi_eccctrl = BV_FLD(GPMI_ECCCTRL, ENABLE_ECC, DISABLE); // disable the ECC block
// 3 words sent to the GPMI
write[5].gpmi_ctrl0 = BV_FLD(GPMI_CTRL0, COMMAND_MODE, WRITE) | // write to the NAND
        BV_FLD(GPMI_CTRL0, WORD_LENGTH, 8_BIT) |
        BV_FLD(GPMI_CTRL0, LOCK_CS, ENABLED) |
        BF_GPMI_CTRL0_CS (2) | // must correspond to NAND CS
used
        BV_FLD(GPMI_CTRL0, ADDRESS, NAND_CLE) |
        BF_GPMI_CTRL0_ADDRESS_INCREMENT (0) |
        BF_GPMI_CTRL0_XFER_COUNT (1); // 1 byte command
//-----
// Descriptor 7: read status and compare (DATA)
//-----
write[6].dma_nxtcmdar = &write[7]; // point to the next descriptor
write[6].dma_cmd = BF_APBH_CHn_CMD_XFER_COUNT (0) | // no dma transfer
        BF_APBH_CHn_CMD_CMDWORDS (2) | // send 2 words to the GPMI
        BF_APBH_CHn_CMD_WAIT4ENDCMD (1) | // wait for command to finish
before
        // continuing
        BF_APBH_CHn_CMD_SEMAPHORE (0) |
        BF_APBH_CHn_CMD_NANDWAIT4READY(0) |
        BF_APBH_CHn_CMD_NANDLOCK (1) | // maintain resource lock
        BF_APBH_CHn_CMD_IRQONCMPLT (0) |
        BF_APBH_CHn_CMD_CHAIN (1) | // follow chain to next command
        BV_FLD(APBH_CHn_CMD, COMMAND, NO_DMA_XFER); // no dma transfer
write[6].dma_bar = NULL; // field not used
// 2 word sent to the GPMI
write[6].gpmi_ctrl0 = BV_FLD(GPMI_CTRL0, COMMAND_MODE, READ_AND_COMPARE) | // read from the
// NAND and
// compare to expect
//
        BV_FLD(GPMI_CTRL0, WORD_LENGTH, 8_BIT) |
        BV_FLD(GPMI_CTRL0, LOCK_CS, DISABLED) |
        BF_GPMI_CTRL0_CS (2) | // must correspond to NAND CS
used
        BV_FLD(GPMI_CTRL0, ADDRESS, NAND_DATA) |
        BF_GPMI_CTRL0_ADDRESS_INCREMENT (0) |
        BF_GPMI_CTRL0_XFER_COUNT (1);
write[6].gpmi_compare = <MASK_AND_REFERENCE_VALUE>; // NOTE: mask and reference values are
NAND
// SPECIFIC to evaluate the NAND
status
//-----
// Descriptor 8: psense compare (time out check)
//-----
write[7].dma_nxtcmdar = &write[8]; // point to the next descriptor
write[7].dma_cmd = BF_APBH_CHn_CMD_XFER_COUNT (0) | // no dma transfer
        BF_APBH_CHn_CMD_CMDWORDS (0) | // no words sent to GPMI
        BF_APBH_CHn_CMD_WAIT4ENDCMD (0) | // do not wait to continue
        BF_APBH_CHn_CMD_SEMAPHORE (0) |
        BF_APBH_CHn_CMD_NANDWAIT4READY(0) |
        BF_APBH_CHn_CMD_NANDLOCK (0) | // relinquish nand lock
        BF_APBH_CHn_CMD_IRQONCMPLT (0) |
        BF_APBH_CHn_CMD_CHAIN (1) | // follow chain to next command
        BV_FLD(APBH_CHn_CMD, COMMAND, DMA_SENSE); // perform a sense check
write[7].dma_bar = dma_error_handler; // if sense check fails, branch to error
handler
//-----
// Descriptor 9: emit GPMI interrupt
//-----
write[8].dma_nxtcmdar = NULL; // not used since this is

```



```

last
descriptor
write[8].dma_cmd = BF_APBH_CHn_CMD_XFER_COUNT      (0)      | // no dma transfer
                  BF_APBH_CHn_CMD_CMDWORDS      (0)      | // no words sent to GPMI
                  BF_APBH_CHn_CMD_WAIT4ENDCMD    (0)      | // do not wait to continue
                  BF_APBH_CHn_CMD_SEMAPHORE     (0)
                  BF_APBH_CHn_CMD_NANDWAIT4READY(0)
                  BF_APBH_CHn_CMD_NANDLOCK      (0)
                  BF_APBH_CHn_CMD_IRQONCMPLT    (1)      | // emit GPMI interrupt
                  BF_APBH_CHn_CMD_CHAIN         (0)      | // terminate DMA chain
processing
                  BV_FLD(APBH_CHn_CMD, COMMAND, NO_DMA_XFER); // no dma transfer

```

17.4.1.2 Using the BCH Encoder

To use the BCH encoder, first turn off the module-wide soft reset bit in both the GPMI and BCH blocks before starting any DMA activity.

Turning off the soft reset must take place by itself, prior to programming the rest of the control registers. Turn off the BCH bus master soft reset bit. Turn off the clock gate bits.

Program the remainder of the GPMI, BCH and APBH DMA as follows:

```

// bring APBH out of reset
APBH_CTRL0_CLR(BM_APBH_CTRL0_SFRST);
APBH_CTRL0_CLR(BM_APBH_CTRL0_CLKGATE);

// bring BCH out of reset
BCH_CTRL_CLR(BM_BCH_CTRL_SFTRST);
BCH_CTRL_CLR(BM_BCH_CTRL_CLKGATE);

// bring gpmi out of reset
GPMI_CTRL0_CLR(BM_GPMI_CTRL0_SFTRST);
GPMI_CTRL0_CLR(BM_GPMI_CTRL0_CLKGATE);
GPMI_CTRL1_SET(BM_GPMI_CTRL1_DEV_RESET | // deassert reset
               BM_GPMI_CTRL1_BCH_MODE ); // enable BCH mode

// enable pinctrl
PINCTRL_CTRL_WR(0x00000000);

// enable gpmi pins
PINCTRL_MUXSEL0_CLR(0x0000ffff); // data bits
PINCTRL_MUXSEL1_CLR(0x03ffffff); // control bits
PINCTRL_MUXSEL8_CLR(0x0003f3ff); // control bits
PINCTRL_MUXSEL8_SET(0x00015155); // control bits

```

Note that for writing NANDs (ECC encoding), only GPMI DMA command complete interrupts are used. The BCH engine is used for writing to the NAND but may optionally produce an interrupt. From the sample code in [DMA Structure Code Example](#) :

- DMA descriptor 1 prepares the NAND for data write by using the GPMI to issue a write setup command byte under CLE, then sends a 5-byte address under ALE. The BCH engine is disabled and not used for these commands.

- DMA descriptor 2 enables the BCH engine for encoding to begin the initial writing of the NAND data by specifying where the data and auxiliary payload are coming from in system memory.
- DMA descriptor 3 issues the write commit command byte under CLE to the NAND.
- DMA descriptor 4 waits for the NAND to complete the write commit/transfer by watching the NAND's ready line status. This descriptor relinquishes the NANDLOCK on the GPMI to enable the other DMA channels to initiate NAND transactions on different NAND CS lines.
- DMA descriptor 6 issues a NAND status command byte under "CLE" to check the status of the NAND device following the page write.
- DMA descriptor 7 reads back the NAND status and compares the status with an expected value. If there are differences, then the DMA processing engine follows an error-handling DMA descriptor path.
- DMA descriptor 8 disables the BCH engine and emits a GPMI interrupt to indicate that the NAND write has been completed.

17.4.2 BCH Decoding for NAND Reads

When a page is read from NAND flash, BCH syndromes will be computed and, if correctable errors are found, they will be corrected on a per block basis within the NAND page. This decoding process is fully overlapped with other NAND data reads and with CPU execution. The BCH decoder flowchart in the figure below shows the steps involved in programming the decoder. The hardware flow of reading and decoding a 4096-byte page is shown in [Figure 17-10](#).

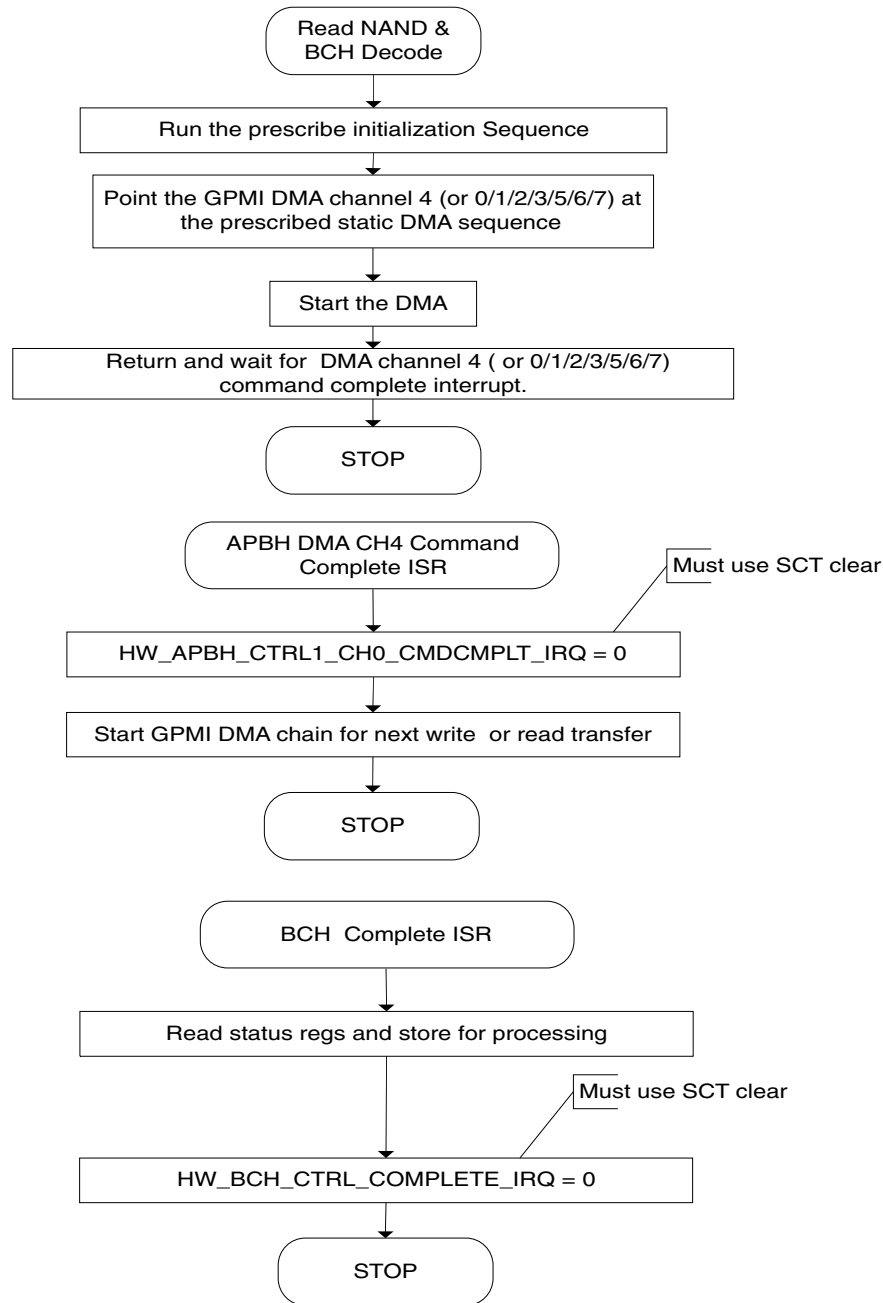

Figure 17-9. BCH Decode Flowchart

Conceptually, an APBH DMA Channel (0,1,2 or 3) command chain with seven command structures linked together is used to perform the BCH decode operation (as shown in [Figure 17-10](#)).

Note

The GPMI's DMA command structures controls the BCH decode operation.

To use the BCH decoder with the GPMI's DMA, create a DMA command chain containing seven descriptor structures, as shown in the figure below and detailed in the DMA structure code example that follows it in [DMA Structure Code Example](#). The seven DMA descriptors perform the following tasks:

1. Issue NAND read setup command byte (under "CLE") and address bytes (under "ALE").
2. Issue NAND read execute command byte (under "CLE").
3. Wait for the NAND device to complete accessing the block data by watching the ready signal.
4. Check for NAND timeout through "PSENSE".
5. Configure and enable the BCH block and read the NAND block data.
6. Disable the BCH block.
7. Descriptor NOP to allow NANDLOCK in the previous descriptor to the thread-safe.

Descriptor 1: Disable BCH engine and issue NAND read set-up command and address (CLE/ALE).

NEXT CMD ADDR										
CMD	<=	1 + 5	3	1	0	0	1	0	1	DMA_READ
BUFFER ADDR										
HW_GPMI_CTRL0	<=	write	8_bit	enabled	2	NAND_CLE	1	1 + 5		
HW_GPMI_COMPARE	<=	null				null				
HW_GPMI_ECCCTRL	<=	----				disable		----		

1 Byte NAND CMD
5 Byte ADDR

Descriptor 2: NAND read execute command (CLE).

NEXT CMD ADDR										
CMD	<=	1	1	1	0	0	1	0	1	DMA_READ
BUFFER ADDR										
HW_GPMI_CTRL0	<=	write	8_bit	disabled	2	NAND_CLE	0	1		

1 Byte NAND CMD

Descriptor 3: Wait for NAND ready.

NEXT CMD ADDR										
CMD	<=	0	1	1	0	1	0	0	1	NO_DMA_XFER
BUFFER ADDR										
HW_GPMI_CTRL0	<=	wait_for_ready	8_bit	disabled	2	NAND_DATA	0	0		



Descriptor 4: PSENSE compare for time-out.

NEXT CMD ADDR										
CMD	<=	0	0	0	0	0	0	0	1	DMA_SENSE
BUFFER ADDR										

DMA Error
Descriptor Chain

Descriptor 5: Enable BCH engine and read NAND data.

NEXT CMD ADDR										
CMD	<=	0	6	1	0	0	1	0	1	NO_DMA_XFER
BUFFER ADDR										
HW_GPMI_CTRL0	<=	read	8_bit	disabled	2	NAND_DATA	0	4096+218		
HW_GPMI_COMPARE	<=	null				null				
HW_GPMI_ECCCTRL	<=	decode_8_bit			enable		0x1FF			
HW_GPMI_ECCCOUNT	<=	4096+218 (flash page size)								
HW_GPMI_PAYLOAD										
HW_GPMI_AUXILIARY										

8*512 Byte Data
Payload Buffer
412 Byte Auxiliary
Payload Buffer

Descriptor 6: Disable BCH engine (wait for ready is a NOP here).

NEXT CMD ADDR										
CMD	<=	0	3	1	0	1	1	0	1	NO_DMA_XFER
BUFFER ADDR										
HW_GPMI_CTRL0	<=	wait_for_ready	8_bit	disabled	0	NAND_DATA	0	0		
HW_GPMI_COMPARE	<=	null				null				
HW_GPMI_ECCCTRL	<=	----				disable		----		



Descriptor 7: NOP to ensure NANDLOCK in previous descriptor .

NEXT CMD ADDR										
CMD	<=	0	0	0	0	0	0	0	0	NO_DMA_XFER
BUFFER ADDR										



Figure 17-10. BCH Decode DMA Descriptor Chain

17.4.2.1 DMA Structure Code Example

The following sample code illustrates the coding for one read transaction, consisting of a seven DMA command structure chain for reading all 4096 bytes of payload data (eight 512-byte blocks) and 65 bytes of metadata with the associative parity bytes ($8 * (18) + 9$) from a 4K NAND page sitting on GPMI CS2.

```
//-----
// generic DMA/GPMI/ECC descriptor struct, order sensitive!
//-----
typedef struct {
    // DMA related fields
    unsigned int dma_nxtcmdar;
    unsigned int dma_cmd;
    unsigned int dma_bar;
    // GPMI related fields
    unsigned int gpmi_ctrl0;
    unsigned int gpmi_compare;
    unsigned int gpmi_eccctrl;
    unsigned int gpmi_ecccount;
    unsigned int gpmi_data_ptr;
    unsigned int gpmi_aux_ptr;
} GENERIC_DESCRIPTOR;
//-----
// allocate 7 descriptors for doing a NAND ECC Read
//-----
GENERIC_DESCRIPTOR read[7];
//-----
// DMA descriptor pointer to handle error conditions from psense checks
//-----
unsigned int * dma_error_handler;
//-----
// 7 byte NAND command and address buffer
// any alignment is ok, it is read by the GPMI DMA
// byte 0 is read setup command
// bytes 1-5 is the NAND address
// byte 6 is read execute command
//-----
unsigned char nand_cmd_addr_buffer[7];
//-----
// 4096 byte payload buffer used for reads or writes
// needs to be word aligned
//-----
unsigned int read_payload_buffer[(4096/4)];
//-----
// 412 byte auxiliary buffer used for reads
// needs to be word aligned
//-----
unsigned int read_aux_buffer[(412/4)];
//-----
// Descriptor 1: issue NAND read setup command (CLE/ALE)
//-----
read[0].dma_nxtcmdar = &read[1]; // point to the next descriptor
read[0].dma_cmd = BF_APBH_CHn_CMD_XFER_COUNT (1 + 5) | // 1 byte command, 5 byte address
                 BF_APBH_CHn_CMD_CMDWORDS (3) | // send 3 words to the GPMI
                 BF_APBH_CHn_CMD_WAIT4ENDCMD (1) | // wait for command to finish
                 // before continuing
                 BF_APBH_CHn_CMD_SEMAPHORE (0) |
                 BF_APBH_CHn_CMD_NANDWAIT4READY (0) |
                 BF_APBH_CHn_CMD_NANDLOCK (1) | // prevent other DMA channels from
                 // taking over
                 BF_APBH_CHn_CMD_IRQONCMPLT (0) |
```

```

BF_APBH_CHn_CMD_CHAIN          (1)          | // follow chain to next command
BV_FLD(APBH_CHn_CMD, COMMAND, DMA_READ); // read data from DMA, write to
NAND
read[0].dma_bar = &nand_cmd_addr_buffer;          // byte 0 read setup, bytes 1 - 5 NAND
address
// 3 words sent to the GPMI
read[0].gpmi_ctrl0 = BV_FLD(GPMI_CTRL0, COMMAND_MODE, WRITE) | // write to the NAND
                   BV_FLD(GPMI_CTRL0, WORD_LENGTH, 8_BIT)   |
                   BV_FLD(GPMI_CTRL0, LOCK_CS, ENABLED)     |
                   BF_GPMI_CTRL0_CS                          (2)          | // must correspond to NAND
CS used
                   BV_FLD(GPMI_CTRL0, ADDRESS, NAND_CLE)    |
                   BF_GPMI_CTRL0_ADDRESS_INCREMENT          (1)          | // send command and address
                   BF_GPMI_CTRL0_XFER_COUNT                  (1 + 5);     | // 1 byte command, 5 byte
address
read[0].gpmi_compare = NULL;                      // field not used but necessary to set
eccctrl
read[0].gpmi_eccctrl = BV_FLD(GPMI_ECCCTRL, ENABLE_ECC, DISABLE); // disable the ECC block
//-----
// Descriptor 2: issue NAND read execute command (CLE)
//-----
read[1].dma_nxtcmdar = &read[2];                  // point to the next descriptor
read[1].dma_cmd = BF_APBH_CHn_CMD_XFER_COUNT      (1)          | // 1 byte read command
                 BF_APBH_CHn_CMD_CMDWORDS        (1)          | // send 1 word to GPMI
                 BF_APBH_CHn_CMD_WAIT4ENDCMD     (1)          | // wait for command to finish
before
// continuing
                 BF_APBH_CHn_CMD_SEMAPHORE       (0)          |
                 BF_APBH_CHn_CMD_NANDWAIT4READY (0)          |
                 BF_APBH_CHn_CMD_NANDLOCK        (1)          | // prevent other DMA channels from
// taking over
                 BF_APBH_CHn_CMD_IRQONCMPLT     (0)          |
                 BF_APBH_CHn_CMD_CHAIN          (1)          | // follow chain to next command
                 BV_FLD(APBH_CHn_CMD, COMMAND, DMA_READ); // read data from DMA, write
to NAND
read[1].dma_bar = &nand_cmd_addr_buffer[6];      // point to byte 6, read execute
command
// 1 word sent to the GPMI
read[1].gpmi_ctrl0 = BV_FLD(GPMI_CTRL0, COMMAND_MODE, WRITE) | // write to the NAND
                   BV_FLD(GPMI_CTRL0, WORD_LENGTH, 8_BIT)   |
                   BV_FLD(GPMI_CTRL0, LOCK_CS, DISABLED)     |
                   BF_GPMI_CTRL0_CS                          (2)          | // must correspond to NAND
CS used
                   BV_FLD(GPMI_CTRL0, ADDRESS, NAND_CLE)    |
                   BF_GPMI_CTRL0_ADDRESS_INCREMENT          (0)          |
                   BF_GPMI_CTRL0_XFER_COUNT                  (1);         | // 1 byte command
//-----
// Descriptor 3: wait for ready (DATA)
//-----
read[2].dma_nxtcmdar = &read[3];                  // point to the next descriptor
read[2].dma_cmd = BF_APBH_CHn_CMD_XFER_COUNT      (0)          | // no dma transfer
                 BF_APBH_CHn_CMD_CMDWORDS        (1)          | // send 1 word to GPMI
                 BF_APBH_CHn_CMD_WAIT4ENDCMD     (1)          | // wait for command to finish
before
// continuing
                 BF_APBH_CHn_CMD_SEMAPHORE       (0)          |
                 BF_APBH_CHn_CMD_NANDWAIT4READY (1)          | // wait for nand to be ready
                 BF_APBH_CHn_CMD_NANDLOCK        (0)          | // relinquish nand lock
                 BF_APBH_CHn_CMD_IRQONCMPLT     (0)          |
                 BF_APBH_CHn_CMD_CHAIN          (1)          | // follow chain to next command
                 BV_FLD(APBH_CHn_CMD, COMMAND, NO_DMA_XFER); // no dma transfer
read[2].dma_bar = NULL;                          // field not used
// 1 word sent to the GPMI
read[2].gpmi_ctrl0 = BV_FLD(GPMI_CTRL0, COMMAND_MODE, WAIT_FOR_READY) | // wait for NAND
ready
                   BV_FLD(GPMI_CTRL0, WORD_LENGTH, 8_BIT)   |
                   BV_FLD(GPMI_CTRL0, LOCK_CS, DISABLED)     |
                   BF_GPMI_CTRL0_CS                          (2)          | // must correspond
to NAND CS used
                   BV_FLD(GPMI_CTRL0, ADDRESS, NAND_DATA)    |

```

Programming the BCH/GPMI Interfaces

```

                BF_GPMI_CTRL0_ADDRESS_INCREMENT (0) |
                BF_GPMI_CTRL0_XFER_COUNT      (0);
//-----
// Descriptor 4: psense compare (time out check)
//-----
read[3].dma_nxtcmdar = &read[4]; // point to the next
descriptor
read[3].dma_cmd = BF_APBH_CHn_CMD_XFER_COUNT (0) | // no dma transfer
                 BF_APBH_CHn_CMD_CMDWORDS  (0) | // no words sent to GPMI
                 BF_APBH_CHn_CMD_WAIT4ENDCMD (0) | // do not wait to continue
                 BF_APBH_CHn_CMD_SEMAPHORE  (0) |
                 BF_APBH_CHn_CMD_NANDWAIT4READY (0)
                 BF_APBH_CHn_CMD_NANDLOCK    (0) |
                 BF_APBH_CHn_CMD_IRQONCMPLT (0) |
                 BF_APBH_CHn_CMD_CHAIN      (1) | // follow chain to next
command
                BV_FLD(APBH_CHn_CMD, COMMAND, DMA_SENSE); // perform a sense check
read[3].dma_bar = dma_error_handler; // if sense check fails, branch to
error handler
//-----
// Descriptor 5: read 4K page plus 65 byte meta-data Nand data
// and send it to ECC block (DATA)
//-----
read[4].dma_nxtcmdar = &read[5]; // point to the next descriptor
read[4].dma_cmd = BF_APBH_CHn_CMD_XFER_COUNT (0) | // no dma transfer
                 BF_APBH_CHn_CMD_CMDWORDS  (6) | // send 6 words to GPMI
                 BF_APBH_CHn_CMD_WAIT4ENDCMD (1) | // wait for command to finish before
// continuing
                 BF_APBH_CHn_CMD_SEMAPHORE  (0) |
                 BF_APBH_CHn_CMD_NANDWAIT4READY (0)
                 BF_APBH_CHn_CMD_NANDLOCK    (1) | // prevent other DMA channels from
taking over
                 BF_APBH_CHn_CMD_IRQONCMPLT (0) | // ECC block generates BCH interrupt
// on completion
                 BF_APBH_CHn_CMD_CHAIN      (1) | // follow chain to next command
                 BV_FLD(APBH_CHn_CMD, COMMAND, NO_DMA_XFER); // no DMA transfer,
// ECC block handles
transfer
read[4].dma_bar = NULL; // field not used
// 6 words sent to the GPMI
read[4].gpml0 = BV_FLD(GPMI_CTRL0, COMMAND_MODE, READ) | // read from the NAND
               BV_FLD(GPMI_CTRL0, WORD_LENGTH, 8_BIT) |
               BV_FLD(GPMI_CTRL0, LOCK_CS, DISABLED) |
               BF_GPMI_CTRL0_CS (2) | // must correspond to
NAND CS used
               BV_FLD(GPMI_CTRL0, ADDRESS, NAND_DATA) |
               BF_GPMI_CTRL0_ADDRESS_INCREMENT (0) |
               BF_GPMI_CTRL0_XFER_COUNT (4096+218); // eight 512 byte data
blocks
// metadata, and parity

read[4].gpml0_compare = NULL; // field not used but necessary to set
eccctrl
// GPMI ECCCTRL PIO This launches the 4K byte transfer through BCH's
// bus master. Setting the ECC_ENABLE bit redirects the data flow
// within the GPMI so that read data flows to the BCH engine instead
// of flowing to the GPMI's DMA channel.
read[4].gpml0_eccctrl = BV_FLD(GPMI_ECCCTRL, ECC_CMD, DECODE_8_BIT) | // specify t = 8
mode
                 BV_FLD(GPMI_ECCCTRL, ENABLE_ECC, ENABLE) | // enable ECC
module
                 BF_GPMI_ECCCTRL_BUFFER_MASK (0X1FF); // read all 8 data blocks
and 1 aux block
read[4].gpml0_ecccount = BF_GPMI_ECCCOUNT_COUNT(4096+218); // specify number of bytes
// read from NAND
read[4].gpml0_data_ptr = &read_payload_buffer; // pointer for the 4K byte
// data area
read[4].gpml0_aux_ptr = &read_aux_buffer; // pointer for the 65 byte
aux area +
// parity and syndrome

```



```

bytes for both
//-----
// Descriptor 6: disable ECC block
//-----
read[5].dma_nextcmdar = &read[6]; // point to the next descriptor
read[5].dma_cmd = BF_APBH_CHn_CMD_XFER_COUNT (0) | // no dma transfer
                 BF_APBH_CHn_CMD_CMDWORDS (3) | // send 3 words to GPMI
                 BF_APBH_CHn_CMD_WAIT4ENDCMD (1) | // wait for command to finish
before
// continuing
                 BF_APBH_CHn_CMD_SEMAPHORE (0) |
                 BF_APBH_CHn_CMD_NANDWAIT4READY (1) | // wait for nand to be ready
                 BF_APBH_CHn_CMD_NANDLOCK (1) | // need nand lock to be
// thread safe while turn-off BCH
                 BF_APBH_CHn_CMD_IRQONCMPLT (0) |
                 BF_APBH_CHn_CMD_CHAIN (1) | // follow chain to next command
                 BV_FLD(APBH_CHn_CMD, COMMAND, NO_DMA_XFER); // no dma transfer
read[5].dma_bar = NULL; // field not used
// 3 words sent to the GPMI
read[5].gpml_ctrl0 = BV_FLD(GPMI_CTRL0, COMMAND_MODE, READ) |
                   BV_FLD(GPMI_CTRL0, WORD_LENGTH, 8_BIT) |
                   BV_FLD(GPMI_CTRL0, LOCK_CS, DISABLED) |
                   BF_GPMI_CTRL0_CS (2) | // must correspond to
NAND CS used
                   BV_FLD(GPMI_CTRL0, ADDRESS, NAND_DATA) |
                   BF_GPMI_CTRL0_ADDRESS_INCREMENT (0) |
                   BF_GPMI_CTRL0_XFER_COUNT (0);
read[5].gpml_compare = NULL; // field not used but necessary to set
eccctrl
read[5].gpml_eccctrl = BV_FLD(GPMI_ECCCTRL, ENABLE_ECC, DISABLE); // disable the ECC block
//-----
// Descriptor 7: deassert nand lock
//-----
read[6].dma_nextcmdar = NULL; // not used since this is last
descriptor
read[6].dma_cmd = BF_APBH_CHn_CMD_XFER_COUNT (0) | // no dma transfer
                 BF_APBH_CHn_CMD_CMDWORDS (0) | // no words sent to GPMI
                 BF_APBH_CHn_CMD_WAIT4ENDCMD (0) | // wait for command to finish
before
// continuing
                 BF_APBH_CHn_CMD_SEMAPHORE (0) |
                 BF_APBH_CHn_CMD_NANDWAIT4READY (0) |
                 BF_APBH_CHn_CMD_NANDLOCK (0) | // relinquish nand lock
                 BF_APBH_CHn_CMD_IRQONCMPLT (0) | // BCH engine generates interrupt
                 BF_APBH_CHn_CMD_CHAIN (0) | // terminate DMA chain processing
                 BV_FLD(APBH_CHn_CMD, COMMAND, NO_DMA_XFER); // no dma transfer
read[6].dma_bar = NULL; // field not used

```

17.4.2.2 Using the Decoder

As illustrated in [Figure 17-10](#) and the sample code in [DMA Structure Code Example](#) :

- DMA descriptor 1 prepares the NAND for data read by using the GPMI to issue a NAND read setup command byte under CLE, then sends a 5-byte address under ALE. The BCH engine is not used for these commands.
- DMA descriptor 2 issues a one-byte read execute command to the NAND device that triggers its read access. The NAND then goes not ready.

- DMA descriptor 3 performs a wait for ready operation allowing the DMA chain to remain dormant until the NAND device completes its read access time.
- DMA descriptor 5 handles the reading and error correction of the NAND data. This command's PIOs activate the BCH engine to write the read NAND data to system memory and to process it for any errors that need to be corrected. This DMA descriptor contains two PIO values that are system memory addresses pointing to the PAYLOAD data area and to the AUXILIARY data area. These addresses are used by the BCH engine's AHB master to move data into system memory and to correct it. While this example is reading an entire 4K page—payload plus metadata—it is equally possible to read just one 512-byte payload block or just the uniquely protected metadata block in a single 7 DMA structure transfer.
- DMA descriptor 6 disables the BCH engine with the NANDLOCK asserted. This is necessary to ensure that the GPMI resource is not arbitrated to another DMA channel when multiple DMA channels are active concurrently.
- DMA descriptor 7 de-asserts the NANDLOCK to free up the GPMI resource to another channel.

As the BCH block receives data from the GPMI:

- The decoder transforms the read NAND data block into a BCH code word and computes the codeword syndrome.
- If no errors are present, then the BCH block can immediately report back to firmware. This report is passed as the BCH_CTRL_COMPLETE_IRQ interrupt status bit and the associated status registers in BCH_STATUS0/1 registers.
- If an error is present, then the BCH block corrects the necessary data block or parity block bytes, if possible (not all errors are correctable).

As the BCH decoder reads the data and parity blocks, it records a special condition, i.e., that all of the bits of a payload data block or metadata block are one, including any associated parity bytes. The all-ones case for both parity and data indicates an erased block in the NAND device.

The BCH_STATUS0 register contains a 4-bit field that indicates the final status of the auxiliary block. A value of 0x0 indicates no errors found for a block.

- A value of 1 to 20 inclusive indicates that many correctable errors were found and fixed.
- A value of 0xFE indicates uncorrectable errors detected on the block.

- A value of 0xFF indicates that the block was in the special ALL ONES state and is therefore considered to be an ERASED block.
- All other values are disallowed by the hardware design.

Recall that up to eight NAND devices can have DMA chains in-flight at once, i.e. they can all be contending for access to the GPMI data bus. It is impossible to predict which NAND device will enter the BCH engine with a transfer first, because each chain includes a wait4ready command structure. As a result, firmware should look at the BCH_STATUS0_COMPLETED_CE bit field to determine which block is being reported in the status register. There is also a 16-bit HANDLE field in the GPMI_ECCCTRL register that is passed down the pipeline with each transaction. This handle field can be used to speed firmware's detection of which transaction is being reported.

These examples of reading and writing have focused on full page transfers of 4K page NAND devices. Other device configurations can be specified by changing the ECCOUNT field in the GPMI registers and reprogramming the BCH's FLASHnLAYOUTm registers.

The BCH and GPMI blocks are designed to be very efficient at reading single 512 (or 1024)-byte pages in one transaction. With no errors, the transaction takes less than 20 HCLKs longer than the time to read the raw data from the NAND.

To summarize, the APBH DMA command chain for a BCH decode operation is shown in [Figure 17-10](#). Seven DMA command structures must be present for each NAND read transaction decoded by the BCH. The seven DMA command structures for multiple NAND read transaction blocks can be chained together to make larger units of work for the BCH, and each will produce an appropriate error report in the BCH PIO space. Multiple NAND devices can have such multiple chains scheduled. The results can come back out of order with respect to the multiple chains.

17.4.3 Interrupts

There are two interrupt sources used in processing BCH protected NAND read and write transfers.

Since all BCH operations are initiated by GPMI DMA command structures, the DMA completion interrupt for the GPMI is an important ISR. Both of the flow charts of [Figure 17-6](#) and [Figure 17-9](#) show the GPMI DMA complete ISR skeleton. In both reads and writes, the GPMI DMA completion interrupt is used to schedule work *INTO* the error correction pipeline. As the front end processing completes, the DMA interrupt is

generated and additional work, such as DMA chains, are passed to the GPMI DMA to keep it *fed*. For write operations, this is the only interrupt that is generated for processing the NAND write transfer.

For reads, however, two interrupts are needed. Every read is started by a GPMI DMA command chain and the front end queue is fed as described above. The back end of the read pipeline is drained by monitoring the BCH completion interrupt found in `HW_BCH_CTRL_COMPLETE_IRQ`.

An BCH transaction consists of reading or writing all of the blocks requested in the `HW_GPMI_ECCCTRL_BUFFER_MASK` bit field. As every read transaction completes, it posts the status of all of the blocks to the `HW_BCH_STATUS0` and `HW_BCH_STATUS1` registers and sets the completion interrupt. The five stages of the BCH read pipeline completes, one in the GPMI and four in the BCH, are independently stalled as they complete and try to deliver to the next stage in the data flow. Several of these stages can be skipped if no-errors are found or once an uncorrectable error is found in a block.

In any case, the final stage will stall if the status register is busy waiting for the CPU to take status register results. The hardware monitors the state of the `HW_BCH_CTRL_COMPLETE_IRQ` bit. If it is still set when the last pipeline stage is ready to post data, then the stage will stall. It follows that the next previous stage will stall when it is ready to hand off work to the final stage, and so on up the pipeline.

CAUTION

It is important that firmware read the STATUS0/1 results and save them before clearing the interrupt request bit. Otherwise, a transaction and its results could be completely lost.

17.5 Behavior During Reset

A soft reset (SFTRST) can take multiple clock periods to complete, so do NOT set `CLKGATE` when setting SFTRST.

The reset process gates the clocks automatically. The example code is shown below.

```
// A soft reset can take multiple clocks to complete, so do NOT gate the
// clock when setting soft reset. The reset process will gate the clock
// automatically. Poll until this has happened before subsequently
// preparing soft-reset and clock gate
BCH_CTRL_CLR(BM_BCH_CTRL_SFTRST);
BCH_CTRL_CLR(BM_BCH_CTRL_CLKGATE);
// asserting soft-reset
BCH_CTRL_SET(BM_BCH_CTRL_SFTRST);
// waiting for confirmation of soft-reset
while (!BCH_CTRL.B.CLKGATE)
```

```

{
// busy wait
}
// Done.
BCH_CTRL_CLR(BM_BCH_CTRL_SFTRST);
BCH_CTRL_CLR(BM_BCH_CTRL_CLKGATE);

```

17.6 BCH Memory Map/Register Definition

BCH Hardware Register Format Summary

BCH memory map

Absolute address (hex)	Register name	Width (in bits)	Access	Reset value	Section/page
180_8000	Hardware BCH ECC Accelerator Control Register (BCH_CTRL)	32	R/W	C000_0000h	17.6.1/597
180_8004	Hardware BCH ECC Accelerator Control Register (BCH_CTRL_SET)	32	R/W	C000_0000h	17.6.1/597
180_8008	Hardware BCH ECC Accelerator Control Register (BCH_CTRL_CLR)	32	R/W	C000_0000h	17.6.1/597
180_800C	Hardware BCH ECC Accelerator Control Register (BCH_CTRL_TOG)	32	R/W	C000_0000h	17.6.1/597
180_8010	Hardware ECC Accelerator Status Register 0 (BCH_STATUS0)	32	R	0000_0010h	17.6.2/599
180_8014	Hardware ECC Accelerator Status Register 0 (BCH_STATUS0_SET)	32	R	0000_0010h	17.6.2/599
180_8018	Hardware ECC Accelerator Status Register 0 (BCH_STATUS0_CLR)	32	R	0000_0010h	17.6.2/599
180_801C	Hardware ECC Accelerator Status Register 0 (BCH_STATUS0_TOG)	32	R	0000_0010h	17.6.2/599
180_8020	Hardware ECC Accelerator Mode Register (BCH_MODE)	32	R/W	0000_0000h	17.6.3/601
180_8024	Hardware ECC Accelerator Mode Register (BCH_MODE_SET)	32	R/W	0000_0000h	17.6.3/601
180_8028	Hardware ECC Accelerator Mode Register (BCH_MODE_CLR)	32	R/W	0000_0000h	17.6.3/601
180_802C	Hardware ECC Accelerator Mode Register (BCH_MODE_TOG)	32	R/W	0000_0000h	17.6.3/601
180_8030	Hardware BCH ECC Loopback Encode Buffer Register (BCH_ENCODEPTR)	32	R/W	0000_0000h	17.6.4/602
180_8034	Hardware BCH ECC Loopback Encode Buffer Register (BCH_ENCODEPTR_SET)	32	R/W	0000_0000h	17.6.4/602
180_8038	Hardware BCH ECC Loopback Encode Buffer Register (BCH_ENCODEPTR_CLR)	32	R/W	0000_0000h	17.6.4/602
180_803C	Hardware BCH ECC Loopback Encode Buffer Register (BCH_ENCODEPTR_TOG)	32	R/W	0000_0000h	17.6.4/602

Table continues on the next page...

BCH memory map (continued)

Absolute address (hex)	Register name	Width (in bits)	Access	Reset value	Section/page
180_8040	Hardware BCH ECC Loopback Data Buffer Register (BCH_DATAPTR)	32	R/W	0000_0000h	17.6.5/602
180_8044	Hardware BCH ECC Loopback Data Buffer Register (BCH_DATAPTR_SET)	32	R/W	0000_0000h	17.6.5/602
180_8048	Hardware BCH ECC Loopback Data Buffer Register (BCH_DATAPTR_CLR)	32	R/W	0000_0000h	17.6.5/602
180_804C	Hardware BCH ECC Loopback Data Buffer Register (BCH_DATAPTR_TOG)	32	R/W	0000_0000h	17.6.5/602
180_8050	Hardware BCH ECC Loopback Metadata Buffer Register (BCH_METAPTR)	32	R/W	0000_0000h	17.6.6/603
180_8054	Hardware BCH ECC Loopback Metadata Buffer Register (BCH_METAPTR_SET)	32	R/W	0000_0000h	17.6.6/603
180_8058	Hardware BCH ECC Loopback Metadata Buffer Register (BCH_METAPTR_CLR)	32	R/W	0000_0000h	17.6.6/603
180_805C	Hardware BCH ECC Loopback Metadata Buffer Register (BCH_METAPTR_TOG)	32	R/W	0000_0000h	17.6.6/603
180_8070	Hardware ECC Accelerator Layout Select Register (BCH_LAYOUTSELECT)	32	R/W	E4E4_E4E4h	17.6.7/603
180_8074	Hardware ECC Accelerator Layout Select Register (BCH_LAYOUTSELECT_SET)	32	R/W	E4E4_E4E4h	17.6.7/603
180_8078	Hardware ECC Accelerator Layout Select Register (BCH_LAYOUTSELECT_CLR)	32	R/W	E4E4_E4E4h	17.6.7/603
180_807C	Hardware ECC Accelerator Layout Select Register (BCH_LAYOUTSELECT_TOG)	32	R/W	E4E4_E4E4h	17.6.7/603
180_8080	Hardware BCH ECC Flash 0 Layout 0 Register (BCH_FLASH0LAYOUT0)	32	R/W	070A_4080h	17.6.8/604
180_8084	Hardware BCH ECC Flash 0 Layout 0 Register (BCH_FLASH0LAYOUT0_SET)	32	R/W	070A_4080h	17.6.8/604
180_8088	Hardware BCH ECC Flash 0 Layout 0 Register (BCH_FLASH0LAYOUT0_CLR)	32	R/W	070A_4080h	17.6.8/604
180_808C	Hardware BCH ECC Flash 0 Layout 0 Register (BCH_FLASH0LAYOUT0_TOG)	32	R/W	070A_4080h	17.6.8/604
180_8090	Hardware BCH ECC Flash 0 Layout 1 Register (BCH_FLASH0LAYOUT1)	32	R/W	10DA_4080h	17.6.9/606
180_8094	Hardware BCH ECC Flash 0 Layout 1 Register (BCH_FLASH0LAYOUT1_SET)	32	R/W	10DA_4080h	17.6.9/606
180_8098	Hardware BCH ECC Flash 0 Layout 1 Register (BCH_FLASH0LAYOUT1_CLR)	32	R/W	10DA_4080h	17.6.9/606
180_809C	Hardware BCH ECC Flash 0 Layout 1 Register (BCH_FLASH0LAYOUT1_TOG)	32	R/W	10DA_4080h	17.6.9/606
180_80A0	Hardware BCH ECC Flash 1 Layout 0 Register (BCH_FLASH1LAYOUT0)	32	R/W	070A_4080h	17.6.10/607
180_80A4	Hardware BCH ECC Flash 1 Layout 0 Register (BCH_FLASH1LAYOUT0_SET)	32	R/W	070A_4080h	17.6.10/607

Table continues on the next page...

BCH memory map (continued)

Absolute address (hex)	Register name	Width (in bits)	Access	Reset value	Section/page
180_80A8	Hardware BCH ECC Flash 1 Layout 0 Register (BCH_FLASH1LAYOUT0_CLR)	32	R/W	070A_4080h	17.6.10/ 607
180_80AC	Hardware BCH ECC Flash 1 Layout 0 Register (BCH_FLASH1LAYOUT0_TOG)	32	R/W	070A_4080h	17.6.10/ 607
180_80B0	Hardware BCH ECC Flash 1 Layout 1 Register (BCH_FLASH1LAYOUT1)	32	R/W	10DA_4080h	17.6.11/ 609
180_80B4	Hardware BCH ECC Flash 1 Layout 1 Register (BCH_FLASH1LAYOUT1_SET)	32	R/W	10DA_4080h	17.6.11/ 609
180_80B8	Hardware BCH ECC Flash 1 Layout 1 Register (BCH_FLASH1LAYOUT1_CLR)	32	R/W	10DA_4080h	17.6.11/ 609
180_80BC	Hardware BCH ECC Flash 1 Layout 1 Register (BCH_FLASH1LAYOUT1_TOG)	32	R/W	10DA_4080h	17.6.11/ 609
180_80C0	Hardware BCH ECC Flash 2 Layout 0 Register (BCH_FLASH2LAYOUT0)	32	R/W	070A_4080h	17.6.12/ 610
180_80C4	Hardware BCH ECC Flash 2 Layout 0 Register (BCH_FLASH2LAYOUT0_SET)	32	R/W	070A_4080h	17.6.12/ 610
180_80C8	Hardware BCH ECC Flash 2 Layout 0 Register (BCH_FLASH2LAYOUT0_CLR)	32	R/W	070A_4080h	17.6.12/ 610
180_80CC	Hardware BCH ECC Flash 2 Layout 0 Register (BCH_FLASH2LAYOUT0_TOG)	32	R/W	070A_4080h	17.6.12/ 610
180_80D0	Hardware BCH ECC Flash 2 Layout 1 Register (BCH_FLASH2LAYOUT1)	32	R/W	10DA_4080h	17.6.13/ 612
180_80D4	Hardware BCH ECC Flash 2 Layout 1 Register (BCH_FLASH2LAYOUT1_SET)	32	R/W	10DA_4080h	17.6.13/ 612
180_80D8	Hardware BCH ECC Flash 2 Layout 1 Register (BCH_FLASH2LAYOUT1_CLR)	32	R/W	10DA_4080h	17.6.13/ 612
180_80DC	Hardware BCH ECC Flash 2 Layout 1 Register (BCH_FLASH2LAYOUT1_TOG)	32	R/W	10DA_4080h	17.6.13/ 612
180_80E0	Hardware BCH ECC Flash 3 Layout 0 Register (BCH_FLASH3LAYOUT0)	32	R/W	070A_4080h	17.6.14/ 613
180_80E4	Hardware BCH ECC Flash 3 Layout 0 Register (BCH_FLASH3LAYOUT0_SET)	32	R/W	070A_4080h	17.6.14/ 613
180_80E8	Hardware BCH ECC Flash 3 Layout 0 Register (BCH_FLASH3LAYOUT0_CLR)	32	R/W	070A_4080h	17.6.14/ 613
180_80EC	Hardware BCH ECC Flash 3 Layout 0 Register (BCH_FLASH3LAYOUT0_TOG)	32	R/W	070A_4080h	17.6.14/ 613
180_80F0	Hardware BCH ECC Flash 3 Layout 1 Register (BCH_FLASH3LAYOUT1)	32	R/W	10DA_4080h	17.6.15/ 615
180_80F4	Hardware BCH ECC Flash 3 Layout 1 Register (BCH_FLASH3LAYOUT1_SET)	32	R/W	10DA_4080h	17.6.15/ 615
180_80F8	Hardware BCH ECC Flash 3 Layout 1 Register (BCH_FLASH3LAYOUT1_CLR)	32	R/W	10DA_4080h	17.6.15/ 615
180_80FC	Hardware BCH ECC Flash 3 Layout 1 Register (BCH_FLASH3LAYOUT1_TOG)	32	R/W	10DA_4080h	17.6.15/ 615

Table continues on the next page...

BCH memory map (continued)

Absolute address (hex)	Register name	Width (in bits)	Access	Reset value	Section/page
180_8100	Hardware BCH ECC Debug Register0 (BCH_DEBUG0)	32	R/W	0000_0000h	17.6.16/ 616
180_8104	Hardware BCH ECC Debug Register0 (BCH_DEBUG0_SET)	32	R/W	0000_0000h	17.6.16/ 616
180_8108	Hardware BCH ECC Debug Register0 (BCH_DEBUG0_CLR)	32	R/W	0000_0000h	17.6.16/ 616
180_810C	Hardware BCH ECC Debug Register0 (BCH_DEBUG0_TOG)	32	R/W	0000_0000h	17.6.16/ 616
180_8110	KES Debug Read Register (BCH_DBGKESREAD)	32	R	0000_0000h	17.6.17/ 618
180_8114	KES Debug Read Register (BCH_DBGKESREAD_SET)	32	R	0000_0000h	17.6.17/ 618
180_8118	KES Debug Read Register (BCH_DBGKESREAD_CLR)	32	R	0000_0000h	17.6.17/ 618
180_811C	KES Debug Read Register (BCH_DBGKESREAD_TOG)	32	R	0000_0000h	17.6.17/ 618
180_8120	Chien Search Debug Read Register (BCH_DBGCSFEREAD)	32	R	0000_0000h	17.6.18/ 619
180_8124	Chien Search Debug Read Register (BCH_DBGCSFEREAD_SET)	32	R	0000_0000h	17.6.18/ 619
180_8128	Chien Search Debug Read Register (BCH_DBGCSFEREAD_CLR)	32	R	0000_0000h	17.6.18/ 619
180_812C	Chien Search Debug Read Register (BCH_DBGCSFEREAD_TOG)	32	R	0000_0000h	17.6.18/ 619
180_8130	Syndrome Generator Debug Read Register (BCH_DBGSYNDGENREAD)	32	R	0000_0000h	17.6.19/ 619
180_8134	Syndrome Generator Debug Read Register (BCH_DBGSYNDGENREAD_SET)	32	R	0000_0000h	17.6.19/ 619
180_8138	Syndrome Generator Debug Read Register (BCH_DBGSYNDGENREAD_CLR)	32	R	0000_0000h	17.6.19/ 619
180_813C	Syndrome Generator Debug Read Register (BCH_DBGSYNDGENREAD_TOG)	32	R	0000_0000h	17.6.19/ 619
180_8140	Bus Master and ECC Controller Debug Read Register (BCH_DBGAHBMREAD)	32	R	0000_0000h	17.6.20/ 620
180_8144	Bus Master and ECC Controller Debug Read Register (BCH_DBGAHBMREAD_SET)	32	R	0000_0000h	17.6.20/ 620
180_8148	Bus Master and ECC Controller Debug Read Register (BCH_DBGAHBMREAD_CLR)	32	R	0000_0000h	17.6.20/ 620
180_814C	Bus Master and ECC Controller Debug Read Register (BCH_DBGAHBMREAD_TOG)	32	R	0000_0000h	17.6.20/ 620
180_8150	Block Name Register (BCH_BLOCKNAME)	32	R	2048_4342h	17.6.21/ 620
180_8154	Block Name Register (BCH_BLOCKNAME_SET)	32	R	2048_4342h	17.6.21/ 620

Table continues on the next page...

BCH memory map (continued)

Absolute address (hex)	Register name	Width (in bits)	Access	Reset value	Section/page
180_8158	Block Name Register (BCH_BLOCKNAME_CLR)	32	R	2048_4342h	17.6.21/ 620
180_815C	Block Name Register (BCH_BLOCKNAME_TOG)	32	R	2048_4342h	17.6.21/ 620
180_8160	BCH Version Register (BCH_VERSION)	32	R	0100_0000h	17.6.22/ 621
180_8164	BCH Version Register (BCH_VERSION_SET)	32	R	0100_0000h	17.6.22/ 621
180_8168	BCH Version Register (BCH_VERSION_CLR)	32	R	0100_0000h	17.6.22/ 621
180_816C	BCH Version Register (BCH_VERSION_TOG)	32	R	0100_0000h	17.6.22/ 621
180_8170	Hardware BCH ECC Debug Register 1 (BCH_DEBUG1)	32	R/W	0000_0000h	17.6.23/ 622
180_8174	Hardware BCH ECC Debug Register 1 (BCH_DEBUG1_SET)	32	R/W	0000_0000h	17.6.23/ 622
180_8178	Hardware BCH ECC Debug Register 1 (BCH_DEBUG1_CLR)	32	R/W	0000_0000h	17.6.23/ 622
180_817C	Hardware BCH ECC Debug Register 1 (BCH_DEBUG1_TOG)	32	R/W	0000_0000h	17.6.23/ 622

17.6.1 Hardware BCH ECC Accelerator Control Register (BCH_CTRL_n)

The BCH CTRL provides overall control of the hardware ECC accelerator

Address: 180_8000h base + 0h offset + (4d × i), where i=0d to 3d

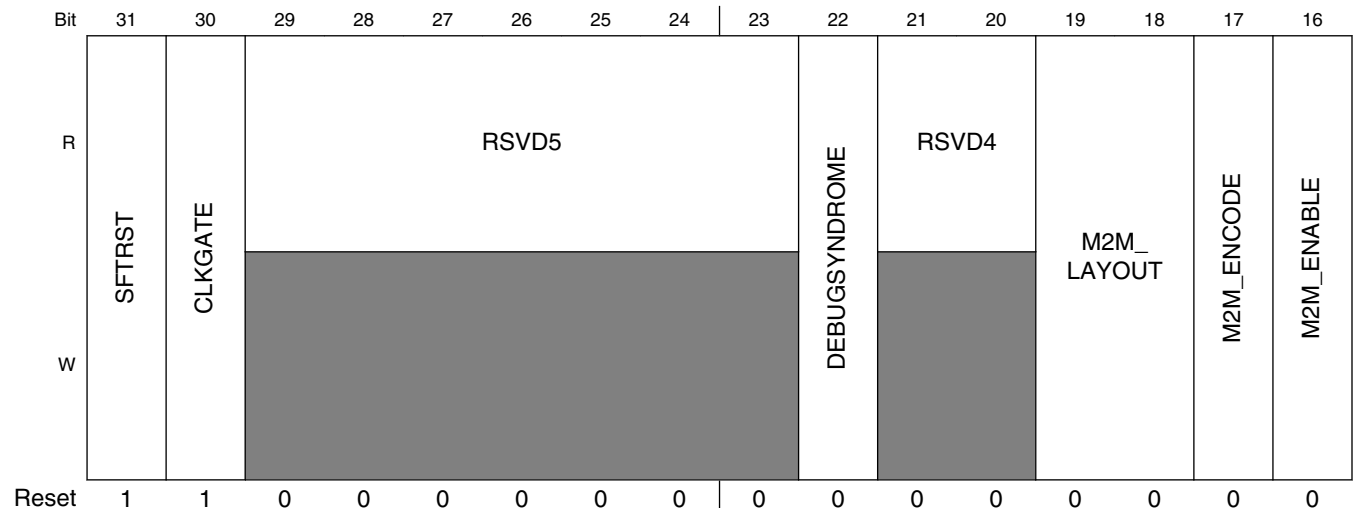

BCH Memory Map/Register Definition

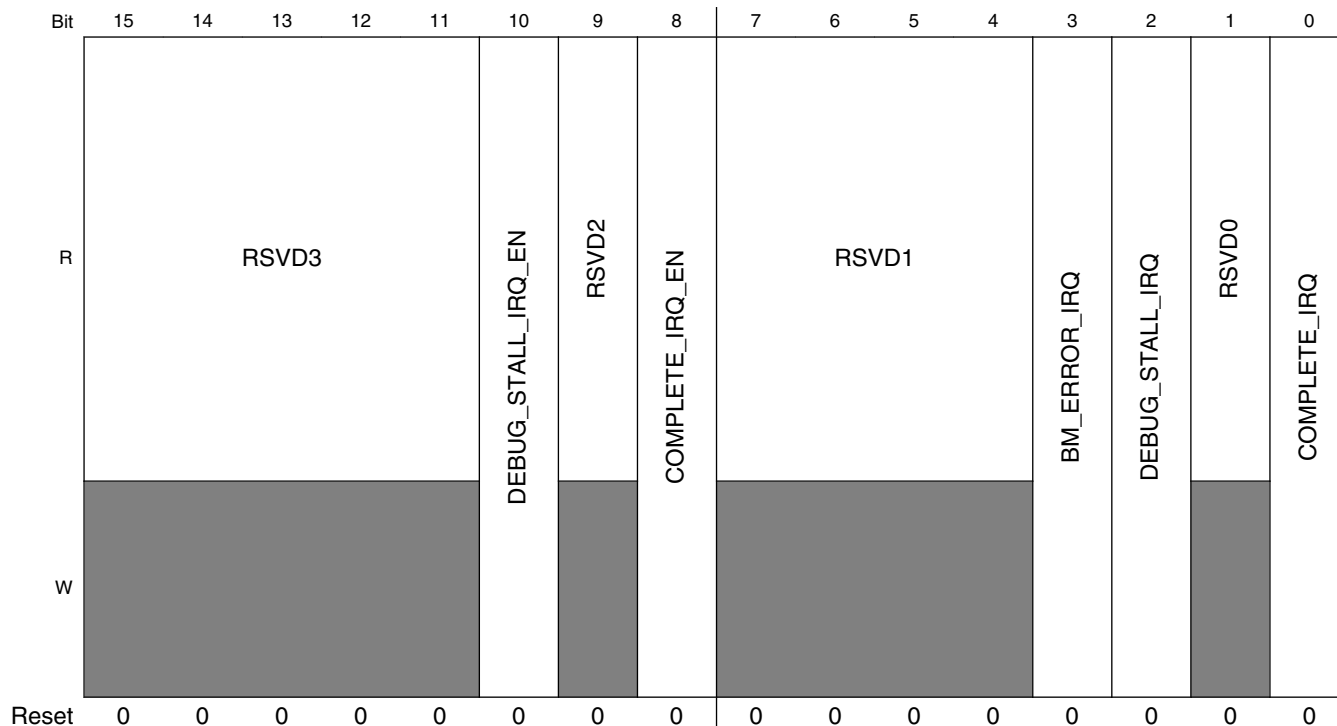

BCH_CTRLn field descriptions

Field	Description
31 SFTRST	Set this bit to 0 to enable normal BCH operation. Set this bit to 1 (default) to disable clocking with the BCH and hold it in its reset (lowest power) state. This bit can be turned on and then off to reset the BCH block to its default state. This bit resets all state machines except for the AHB master state machine 0x0 RUN — Allow BCH to operate normally. 0x1 RESET — Hold BCH in reset.
30 CLKGATE	This bit must be set to 0 for normal operation. When set to 1 it gates off the clocks to the block. 0x0 RUN — Allow BCH to operate normally. 0x1 NO_CLKS — Do not clock BCH gates in order to minimize power consumption.
29–23 RSVD5	This field is reserved. This read-only field is reserved and always has the value 0.
22 DEBUGSYNDROME	(For debug purposes only). Enable write of computed syndromes to memory on BCH decode operations. Computed syndromes will be written to the auxiliary buffer after the status block. Syndromes will be written as padded 16-bit values.
21–20 RSVD4	This field is reserved. This read-only field is reserved and always has the value 0
19–18 M2M_LAYOUT	Selects the flash page format for memory-to-memory operations.
17 M2M_ENCODE	Selects encode (parity generation) or decode (correction) mode for memory-to-memory operations.
16 M2M_ENABLE	NOTE! WRITING THIS BIT INITIATES A MEMORY-TO-MEMORY OPERATION. The BCH module must be inactive (not processing data from the GPML) when this bit is set. The M2M_ENCODE and

Table continues on the next page...

BCH_CTRL n field descriptions (continued)

Field	Description
	M2M_LAYOUT bits as well as the ENCODEPTR, DATAPTR, and METAPTR registers are used for memory-to-memory operations and must be correctly programmed before writing this bit.
15–11 RSVD3	This field is reserved. This read-only field is reserved and always has the value 0
10 DEBUG_STALL_ IRQ_EN	1 = interrupt on debug stall mode is enabled. The IRQ is raised on every block
9 RSVD2	This field is reserved. This read-only field is reserved and always has the value 0.
8 COMPLETE_IRQ_ EN	1 = interrupt on completion of correction is enabled.
7–4 RSVD1	This field is reserved. This read-only field is reserved and always has the value 0.
3 BM_ERROR_IRQ	AHB Bus interface Error Interrupt Status. Write a 1 to the SCT clear address to clear the interrupt status bit.
2 DEBUG_STALL_IRQ	DEBUG STALL Interrupt Status. Write a 1 to the SCT clear address to clear the interrupt status bit.
1 RSVD0	This field is reserved. This read-only field is reserved and always has the value 0.
0 COMPLETE_IRQ	This bit indicates the state of the external interrupt line. Write a 1 to the SCT clear address to clear the interrupt status bit. NOTE: subsequent ECC completions will be held off as long as this bit is set. Be sure to read the data from BCH_STATUS0, 1 before clearing this interrupt bit.

17.6.2 Hardware ECC Accelerator Status Register 0 (BCH_STATUS0 n)

The BCH STAT register provides visibility into the run-time status of the BCH and status information when processing is complete. It provides overall status of the hardware ECC accelerator.

BCH Memory Map/Register Definition

Address: 180_8000h base + 10h offset + (4d × i), where i=0d to 3d

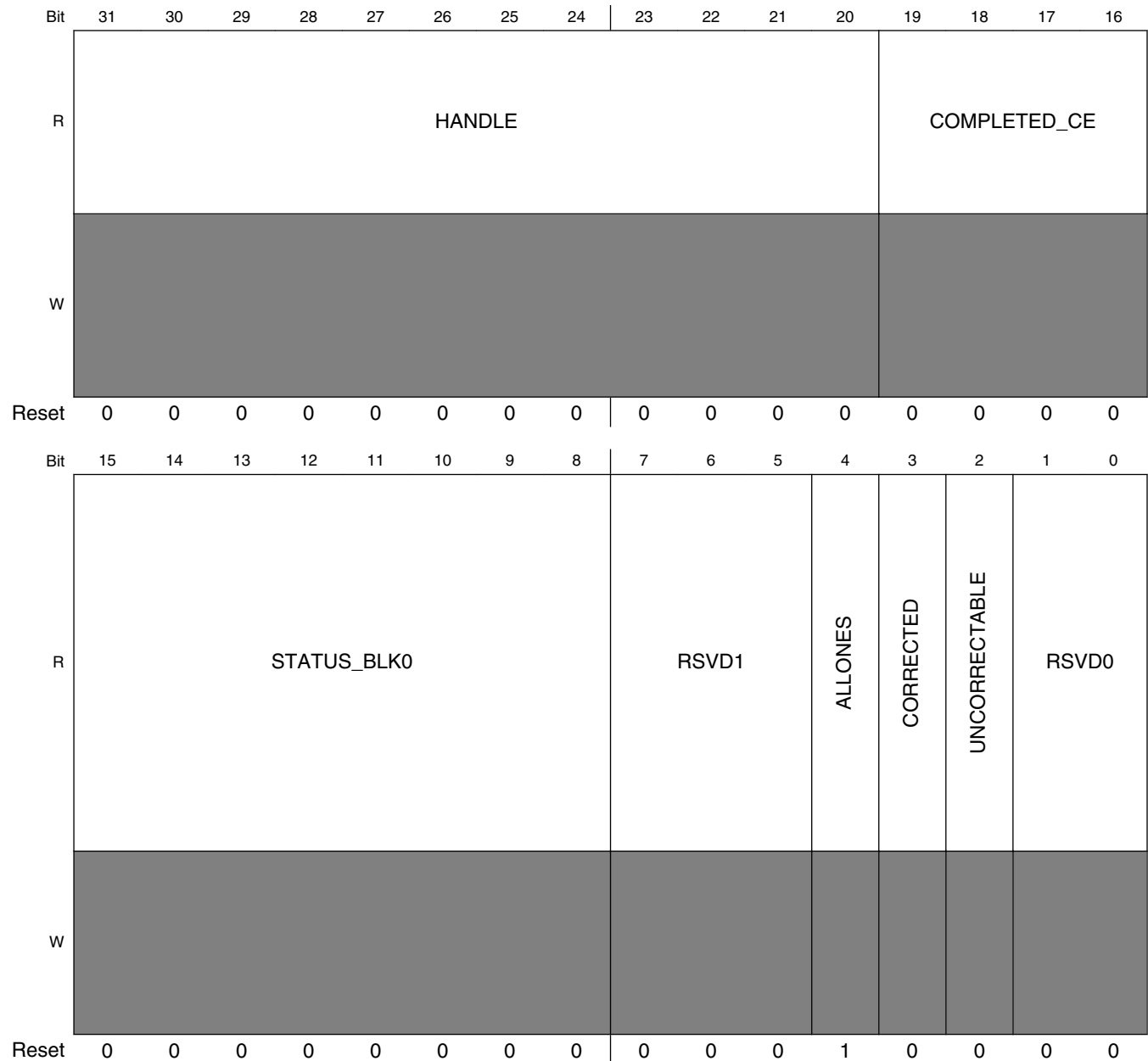

BCH_STATUS0n field descriptions

Field	Description
31–20 HANDLE	Software supplies a 12 bit handle for this transfer as part of the GPMI DMA PIO operation that started the transaction. That handle passes down the pipeline and ends up here at the time the BCH interrupt is signaled.
19–16 COMPLETED_CE	This is the chip enable number corresponding to the NAND device from which this data came.
15–8 STATUS_BLK0	Count of symbols in error during processing of first block of flash (metadata block). The number of errors reported will be in the range of 0 to the ECC correction level for block 0. 0x00 ZERO — No errors found on block.

Table continues on the next page...

BCH_STATUS0n field descriptions (continued)

Field	Description
	0x01 ERROR1 — One error found on block. 0x02 ERROR2 — One errors found on block. 0x03 ERROR3 — One errors found on block. 0x04 ERROR4 — One errors found on block. 0xFE UNCORRECTABLE — Block exhibited uncorrectable errors. 0xFF ERASED — Page is erased.
7–5 RSVD1	This field is reserved. This read-only field is reserved and always has the value 0.
4 ALLONES	1 = All data bits of this transaction are ONE.
3 CORRECTED	1 = At least one correctable error encountered during last processing cycle.
2 UNCORRECTABLE	1 = Uncorrectable error encountered during last processing cycle.
RSVD0	This field is reserved. This read-only field is reserved and always has the value 0.

17.6.3 Hardware ECC Accelerator Mode Register (BCH_MODEn)

The BCH MODE register provides additional mode controls.

Contains additional global mode controls for the BCH engine.

Address: 180_8000h base + 20h offset + (4d × i), where i=0d to 3d

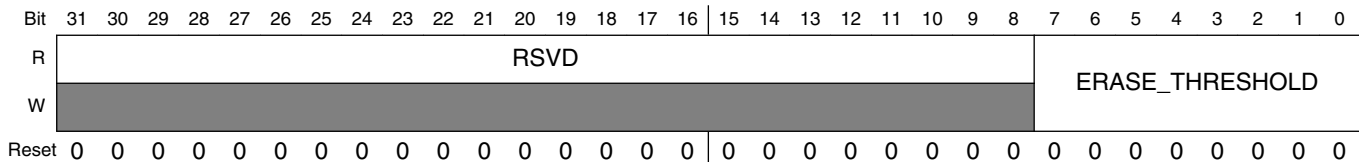
**BCH_MODEn field descriptions**

Field	Description
31–8 RSVD	This field is reserved. This read-only field is reserved and always has the value 0.
ERASE_ THRESHOLD	This value indicates the maximum number of zero bits on a flash subpage for it to be considered erased. For SLC NAND devices, this value should be programmed to 0 (meaning that the entire page should consist of bytes of 0xFF. For MLC NAND devices, bit errors may occur on reads (even on blank pages), so this threshold can be used to tune the erased page checking algorithm.

17.6.4 Hardware BCH ECC Loopback Encode Buffer Register (BCH_ENCODEPTRn)

When performing memory to memory operations, indicates the address of the encode buffer. This register should be programmed before writing a 1 to the M2M_ENABLE bit in the CTRL register.

For memory to memory operations, this register is used as the pointer to the encoded data, which is an output when encoding and an input while decoding.

Address: 180_8000h base + 30h offset + (4d × i), where i=0d to 3d

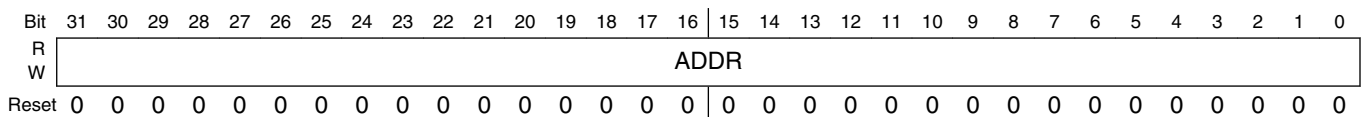

BCH_ENCODEPTRn field descriptions

Field	Description
ADDR	Address pointer to encode buffer. This is the source for decode operations and the destination for encode operations. This value must be aligned on a 4 bytes boundary.

17.6.5 Hardware BCH ECC Loopback Data Buffer Register (BCH_DATAPTRn)

When performing memory to memory operations, indicates the address of the data buffer.

For memory to memory operations, this register is used as the pointer to the data to encode or the destination buffer for decode operations.

Address: 180_8000h base + 40h offset + (4d × i), where i=0d to 3d

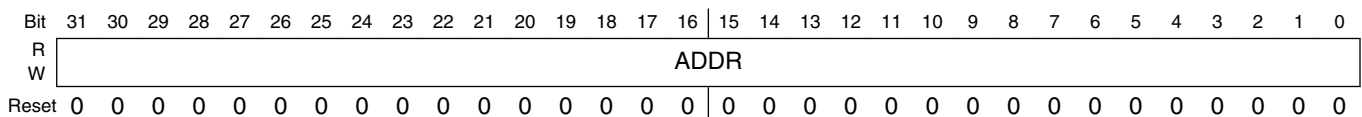

BCH_DATAPTRn field descriptions

Field	Description
ADDR	Address pointer to data buffer. This is the source for encode operations and the destination for decode operations. This register should be programmed before writing a 1 to the M2M_ENABLE bit in the CTRL register. This value must be aligned on a 4 byte boundary.

17.6.6 Hardware BCH ECC Loopback Metadata Buffer Register (BCH_METAPTR_n)

When performing memory to memory operations, indicates the address of the metadata buffer.

For memory to memory operations, this register is used as the pointer to the metadata to encode or the extracted metadata for decode operations.

Address: 180_8000h base + 50h offset + (4d × i), where i=0d to 3d

Bit	31	30	29	28	27	26	25	24	23	22	21	20	19	18	17	16	15	14	13	12	11	10	9	8	7	6	5	4	3	2	1	0
R																																
W	ADDR																															
Reset	0	0	0	0	0	0	0	0	0	0	0	0	0	0	0	0	0	0	0	0	0	0	0	0	0	0	0	0	0	0	0	0

BCH_METAPTR_n field descriptions

Field	Description
ADDR	Address pointer to metadata buffer. This is the source for encode metadata read operations and the destination for metadata decode operations. This register should be programmed before writing a 1 to the M2M_ENABLE bit in the CTRL register. This value must be aligned on a 4 bytes boundary.

17.6.7 Hardware ECC Accelerator Layout Select Register (BCH_LAYOUTSELECT_n)

The BCH LAYOUTSELECT register provides a mapping of chip selects to layout registers.

When the BCH engine receives a request to process a data block from the GPMI interface, it will use this register to map the incoming chip select to one of the four possible flash layout registers

Address: 180_8000h base + 70h offset + (4d × i), where i=0d to 3d

Bit	31	30	29	28	27	26	25	24	23	22	21	20	19	18	17	16
R																
W	CS15_SELECT		CS14_SELECT		CS13_SELECT		CS12_SELECT		CS11_SELECT		CS10_SELECT		CS9_SELECT		CS8_SELECT	
Reset	1	1	1	0	0	1	0	0	1	1	1	0	0	1	0	0
Bit	15	14	13	12	11	10	9	8	7	6	5	4	3	2	1	0
R																
W	CS7_SELECT		CS6_SELECT		CS5_SELECT		CS4_SELECT		CS3_SELECT		CS2_SELECT		CS1_SELECT		CS0_SELECT	
Reset	1	1	1	0	0	1	0	0	1	1	1	0	0	1	0	0

BCH_LAYOUTSELECT n field descriptions

Field	Description
31–30 CS15_SELECT	Selects which layout is used for chip select 15.
29–28 CS14_SELECT	Selects which layout is used for chip select 14.
27–26 CS13_SELECT	Selects which layout is used for chip select 13.
25–24 CS12_SELECT	Selects which layout is used for chip select 12.
23–22 CS11_SELECT	Selects which layout is used for chip select 11.
21–20 CS10_SELECT	Selects which layout is used for chip select 10.
19–18 CS9_SELECT	Selects which layout is used for chip select 9.
17–16 CS8_SELECT	Selects which layout is used for chip select 8.
15–14 CS7_SELECT	Selects which layout is used for chip select 7.
13–12 CS6_SELECT	Selects which layout is used for chip select 6.
11–10 CS5_SELECT	Selects which layout is used for chip select 5.
9–8 CS4_SELECT	Selects which layout is used for chip select 4.
7–6 CS3_SELECT	Selects which layout is used for chip select 3.
5–4 CS2_SELECT	Selects which layout is used for chip select 2.
3–2 CS1_SELECT	Selects which layout is used for chip select 1.
CS0_SELECT	Selects which layout is used for chip select 0.

17.6.8 Hardware BCH ECC Flash 0 Layout 0 Register (BCH_FLASH0LAYOUT0 n)

The flash format register contains a description of the logical layout of data on the flash device. This register is used in conjunction with the FLASH0LAYOUT1 register to control the format for the devices selecting layout 0 in the LAYOUTSELECT register.

Each pair of layout registers describes one of four supported flash configurations. Software should program the LAYOUTSELECT register for each supported GPMI chip select to select from one of the four layout values. Each pair of registers contains settings that are used by the BCH block while reading / writing the flash page to control data,

metadata, and flash page sizes as well as the ECC correction level. The first block written to flash can be programmed to have different ECC, metadata, and data sizes from subsequent data blocks on the device. In addition, the number of blocks stored on a page of flash is not fixed, but instead is determined by the number of bytes consumed by the initial (block 0) and subsequent data blocks.

See sections [Flash Page Layout](#) and [Determining the ECC layout for a device](#) for more detail information on setting up the flash layout registers.

Address: 180_8000h base + 80h offset + (4d × i), where i=0d to 3d

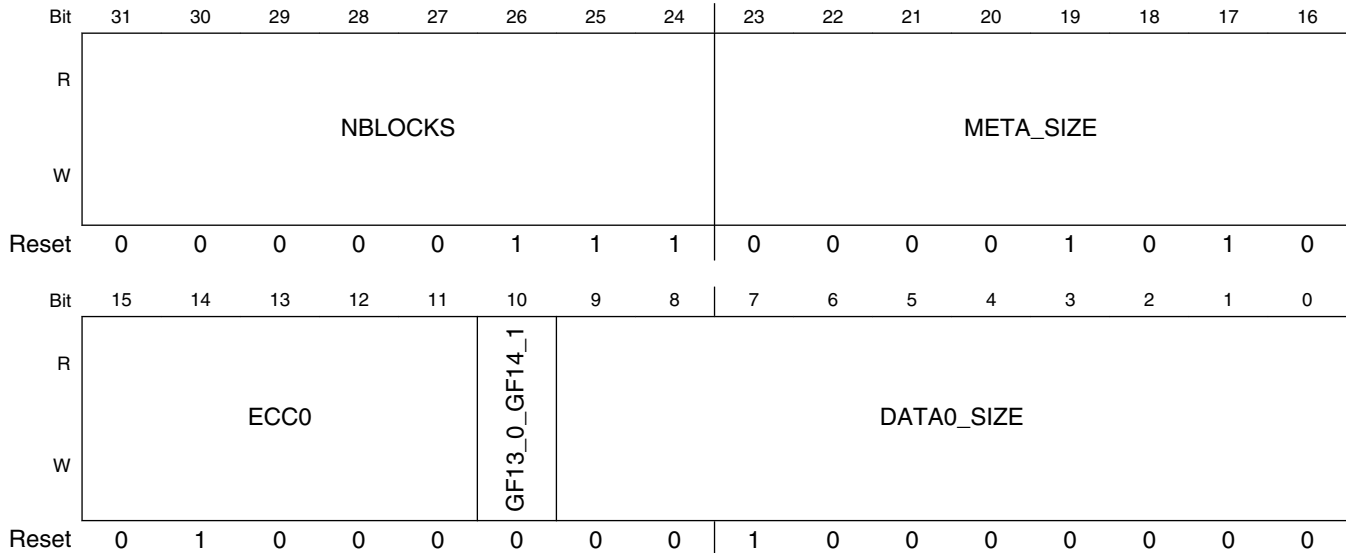

BCH_FLASH0LAYOUT0n field descriptions

Field	Description
31–24 NBLOCKS	Number of subsequent blocks on the flash page (excluding the data0 block). A value of 0 indicates that only the DATA0 block is present and a value of 8 indicates that 8 subsequent blocks are present for a total of 9 blocks on the flash (including the DATA0 block). Any values from 0 to 255 are supported by the hardware.
23–16 META_SIZE	Indicates the size of the metadata (in bytes) to be stored on a flash page. The BCH design support from 0 to 255 bytes for metadata—if set to 0, no metadata will be stored. Metadata is stored before the associated data in block 0. If the DATA0_SIZE field is programmed to a 0, then metadata effectively be stored with its own parity. When both the metadata and data0 fields are programmed with non-zero values, the first block will contain both portions of data and covered by a single parity block.
15–11 ECC0	Indicates the ECC level for the first block on the flash page. The first block covers metadata plus the associated data from the DATA0_SIZE field. 0x0 NONE — No ECC to be performed 0x1 ECC2 — ECC 2 to be performed 0x2 ECC4 — ECC 4 to be performed 0x3 ECC6 — ECC 6 to be performed 0x4 ECC8 — ECC 8 to be performed 0x5 ECC10 — ECC 10 to be performed 0x6 ECC12 — ECC 12 to be performed 0x7 ECC14 — ECC 14 to be performed

Table continues on the next page...

BCH_FLASH0LAYOUT0n field descriptions (continued)

Field	Description
0x8	ECC16 — ECC 16 to be performed
0x9	ECC18 — ECC 18 to be performed
0xA	ECC20 — ECC 20 to be performed
0xB	ECC22 — ECC 22 to be performed
0xC	ECC24 — ECC 24 to be performed
0xD	ECC26 — ECC 26 to be performed
0xE	ECC28 — ECC 28 to be performed
0xF	ECC30 — ECC 30 to be performed
0x10	ECC32 — ECC 32 to be performed
0x11	ECC34 — ECC 34 to be performed
0x12	ECC36 — ECC 36 to be performed
0x13	ECC38 — ECC 38 to be performed
0x14	ECC40 — ECC 40 to be performed
10 GF13_0_GF14_1	Select GF13 or GF14: 0-GF13; 1-GF14
DATA0_SIZE	Indicates the size of the data 0 block (in DWORDS / four bytes) to be stored on the flash page. If set to 0, the first block only contains metadata.

17.6.9 Hardware BCH ECC Flash 0 Layout 1 Register (BCH_FLASH0LAYOUT1n)

The flash format register contains a description of the logical layout of data on the flash device. This register is used in conjunction with the FLASH0LAYOUT0 register to control the format for the device selecting layout 0 in the LAYOUTSELECT register.

Address: 180_8000h base + 90h offset + (4d × i), where i=0d to 3d

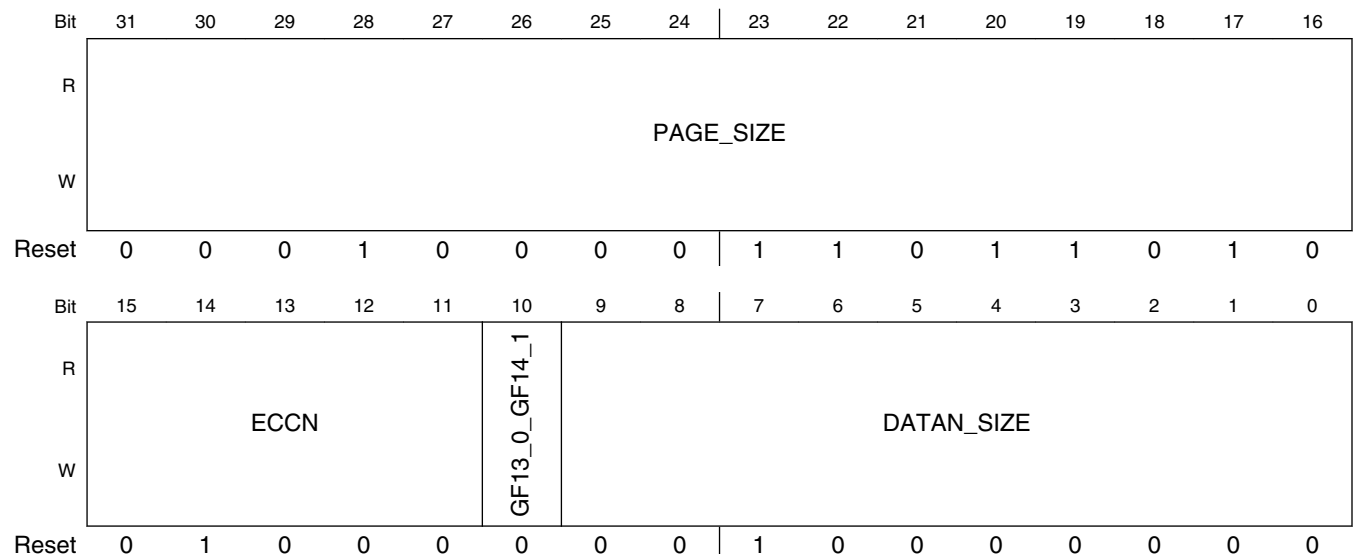

BCH_FLASH0LAYOUT1n field descriptions

Field	Description
31–16 PAGE_SIZE	Indicates the total size of the flash page (in bytes). This should be set to the page size including spare area. The page size is programmable to accommodate different flash configurations that may be available in the future.
15–11 ECCN	Indicates the ECC level for the subsequent blocks on the flash page (blocks 1-n). Subsequent blocks only contain data (no metadata). 0x0 NONE — No ECC to be performed 0x1 ECC2 — ECC 2 to be performed 0x2 ECC4 — ECC 4 to be performed 0x3 ECC6 — ECC 6 to be performed 0x4 ECC8 — ECC 8 to be performed 0x5 ECC10 — ECC 10 to be performed 0x6 ECC12 — ECC 12 to be performed 0x7 ECC14 — ECC 14 to be performed 0x8 ECC16 — ECC 16 to be performed 0x9 ECC18 — ECC 18 to be performed 0xA ECC20 — ECC 20 to be performed 0xB ECC22 — ECC 22 to be performed 0xC ECC24 — ECC 24 to be performed 0xD ECC26 — ECC 26 to be performed 0xE ECC28 — ECC 28 to be performed 0xF ECC30 — ECC 30 to be performed 0x10 ECC32 — ECC 32 to be performed 0x11 ECC34 — ECC 34 to be performed 0x12 ECC36 — ECC 36 to be performed 0x13 ECC38 — ECC 38 to be performed 0x14 ECC40 — ECC 40 to be performed
10 GF13_0_GF14_1	Select GF13 or GF14: 0-GF13; 1-GF14
DATAN_SIZE	Indicates the size of the subsequent data blocks (in DWORDS / four bytes) to be stored on the flash page. The size of subsequent data blocks does not have to match the data size for block 0, which is important when metadata is stored separately or for balancing the amount of data stored in each block.

17.6.10 Hardware BCH ECC Flash 1 Layout 0 Register (BCH_FLASH1LAYOUT0n)

The flash format register contains a description of the logical layout of data on the flash device. This register is used in conjunction with the FLASH1LAYOUT1 register to control the format for the devices selecting layout 1 in the LAYOUTSELECT register.

Each pair of layout registers describes one of four supported flash configurations. Software should program the LAYOUTSELECT register for each supported GPMI chip select to select from one of the four layout values. Each pair of registers contains settings that are used by the BCH block while reading / writing the flash page to control data,

BCH Memory Map/Register Definition

metadata, and flash page sizes as well as the ECC correction level. The first block written to flash can be programmed to have different ECC, metadata, and data sizes from subsequent data blocks on the device. In addition, the number of blocks stored on a page of flash is not fixed, but instead is determined by the number of bytes consumed by the initial (block 0) and subsequent data blocks.

See sections [Flash Page Layout](#) and [Determining the ECC layout for a device](#) for more detail information on setting up the flash layout registers.

Address: 180_8000h base + A0h offset + (4d × i), where i=0d to 3d

Bit	31	30	29	28	27	26	25	24	23	22	21	20	19	18	17	16
R	NBLOCKS								META_SIZE							
W																
Reset	0	0	0	0	0	1	1	1	0	0	0	0	1	0	1	0
Bit	15	14	13	12	11	10	9	8	7	6	5	4	3	2	1	0
R	ECC0					GF13_0_GF14_1	DATA0_SIZE									
W																
Reset	0	1	0	0	0	0	0	0	1	0	0	0	0	0	0	0

BCH_FLASH1LAYOUT0n field descriptions

Field	Description
31–24 NBLOCKS	Number of subsequent blocks on the flash page (excluding the data0 block). A value of 0 indicates that only the DATA0 block is present and a value of 8 indicates that 8 subsequent blocks are present for a total of 9 blocks on the flash (including the DATA0 block). Any values from 0 to 255 are supported by the hardware.
23–16 META_SIZE	Indicates the size of the metadata (in bytes) to be stored on a flash page. The BCH design supports from 0 to 255 bytes for metadata—if set to 0, no metadata will be stored. Metadata is stored before the associated data is in block 0. If the DATA0_SIZE field is programmed to a 0, then metadata effectively be stored with its own parity. When both the metadata and data0 fields are programmed with non-zero values, the first block will contain both portions of data and covered by a single parity block.
15–11 ECC0	Indicates the ECC level for the first block on the flash page. The first block covers metadata plus the associated data from the DATA0_SIZE field. 0x0 NONE — No ECC to be performed 0x1 ECC2 — ECC 2 to be performed 0x2 ECC4 — ECC 4 to be performed 0x3 ECC6 — ECC 6 to be performed 0x4 ECC8 — ECC 8 to be performed 0x5 ECC10 — ECC 10 to be performed 0x6 ECC12 — ECC 12 to be performed 0x7 ECC14 — ECC 14 to be performed

Table continues on the next page...

BCH_FLASH1LAYOUT0n field descriptions (continued)

Field	Description
0x8	ECC16 — ECC 16 to be performed
0x9	ECC18 — ECC 18 to be performed
0xA	ECC20 — ECC 20 to be performed
0xB	ECC22 — ECC 22 to be performed
0xC	ECC24 — ECC 24 to be performed
0xD	ECC26 — ECC 26 to be performed
0xE	ECC28 — ECC 28 to be performed
0xF	ECC30 — ECC 30 to be performed
0x10	ECC32 — ECC 32 to be performed
0x11	ECC34 — ECC 34 to be performed
0x12	ECC36 — ECC 36 to be performed
0x13	ECC38 — ECC 38 to be performed
0x14	ECC40 — ECC 40 to be performed
10 GF13_0_GF14_1	Select GF13 or GF14: 0-GF13; 1-GF14
DATA0_SIZE	Indicates the size of the data 0 block (in DWORDS / four bytes) to be stored on the flash page. If set to 0, the first block will contains metadata.

17.6.11 Hardware BCH ECC Flash 1 Layout 1 Register (BCH_FLASH1LAYOUT1n)

The flash format register contains a description of the logical layout of data on the flash device. This register is used in conjunction with the FLASH1LAYOUT0 register to control the format for the device selecting layout 1 in the LAYOUTSELECT register.

Address: 180_8000h base + B0h offset + (4d × i), where i=0d to 3d

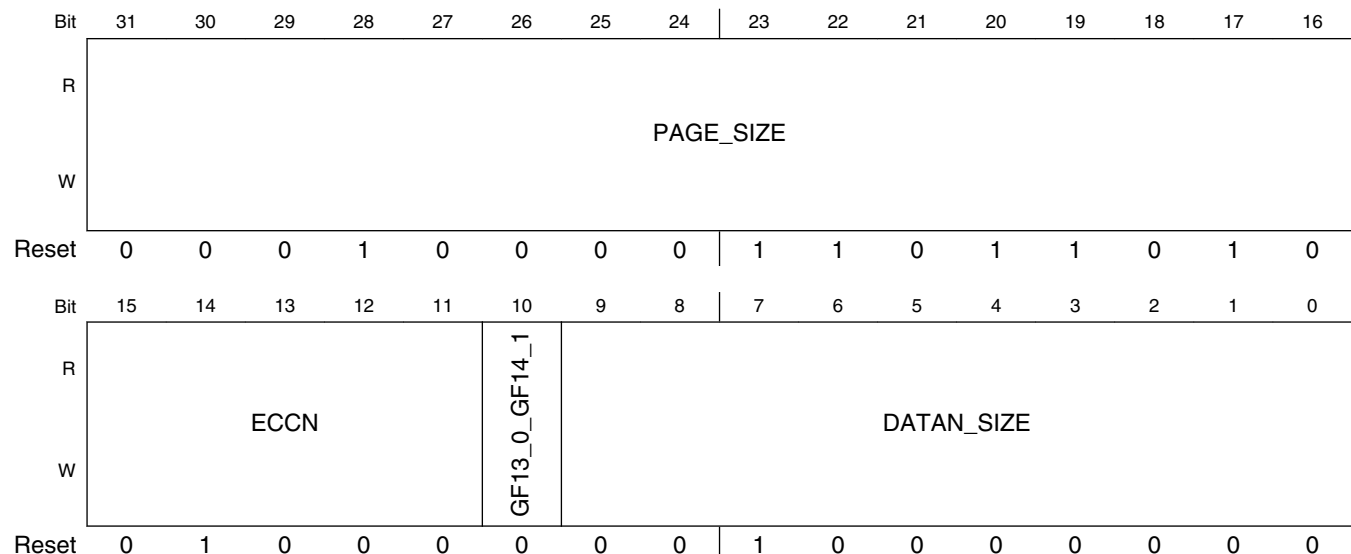

BCH_FLASH1LAYOUT1n field descriptions

Field	Description
31–16 PAGE_SIZE	Indicates the total size of the flash page (in bytes). This should be set to the page size including spare area. The page size is programmable to accommodate different flash configurations that may be available in the future.
15–11 ECCN	Indicates the ECC level for the subsequent blocks on the flash page (blocks 1-n). Subsequent blocks only contain data (no metadata). 0x0 NONE — No ECC to be performed 0x1 ECC2 — ECC 2 to be performed 0x2 ECC4 — ECC 4 to be performed 0x3 ECC6 — ECC 6 to be performed 0x4 ECC8 — ECC 8 to be performed 0x5 ECC10 — ECC 10 to be performed 0x6 ECC12 — ECC 12 to be performed 0x7 ECC14 — ECC 14 to be performed 0x8 ECC16 — ECC 16 to be performed 0x9 ECC18 — ECC 18 to be performed 0xA ECC20 — ECC 20 to be performed 0xB ECC22 — ECC 22 to be performed 0xC ECC24 — ECC 24 to be performed 0xD ECC26 — ECC 26 to be performed 0xE ECC28 — ECC 28 to be performed 0xF ECC30 — ECC 30 to be performed 0x10 ECC32 — ECC 32 to be performed 0x11 ECC34 — ECC 34 to be performed 0x12 ECC36 — ECC 36 to be performed 0x13 ECC38 — ECC 38 to be performed 0x14 ECC40 — ECC 40 to be performed
10 GF13_0_GF14_1	Select GF13 or GF14: 0-GF13; 1-GF14
DATAN_SIZE	Indicates the size of the subsequent data blocks (in DWORDS / four bytes) to be stored on the flash page. The size of subsequent data blocks does not have to match the data size for block 0, which is important when metadata is stored separately or for balancing the amount of data stored in each block.

17.6.12 Hardware BCH ECC Flash 2 Layout 0 Register (BCH_FLASH2LAYOUT0n)

The flash format register contains a description of the logical layout of data on the flash device. This register is used in conjunction with the FLASH2LAYOUT1 register to control the format for the devices selecting layout 2 in the LAYOUTSELECT register.

Each pair of layout registers describes one of four supported flash configurations. Software should program the LAYOUTSELECT register for each supported GPMI chip select to select from one of the four layout values. Each pair of registers contains settings that are used by the BCH block while reading / writing the flash page to control data,

metadata, and flash page sizes as well as the ECC correction level. The first block written to flash can be programmed to have different ECC, metadata, and data sizes from subsequent data blocks on the device. In addition, the number of blocks stored on a page of flash is not fixed, but instead is determined by the number of bytes consumed by the initial (block 0) and subsequent data blocks.

See sections [Flash Page Layout](#) and [Determining the ECC layout for a device](#) for more detail information on setting up the flash layout registers.

Address: 180_8000h base + C0h offset + (4d × i), where i=0d to 3d

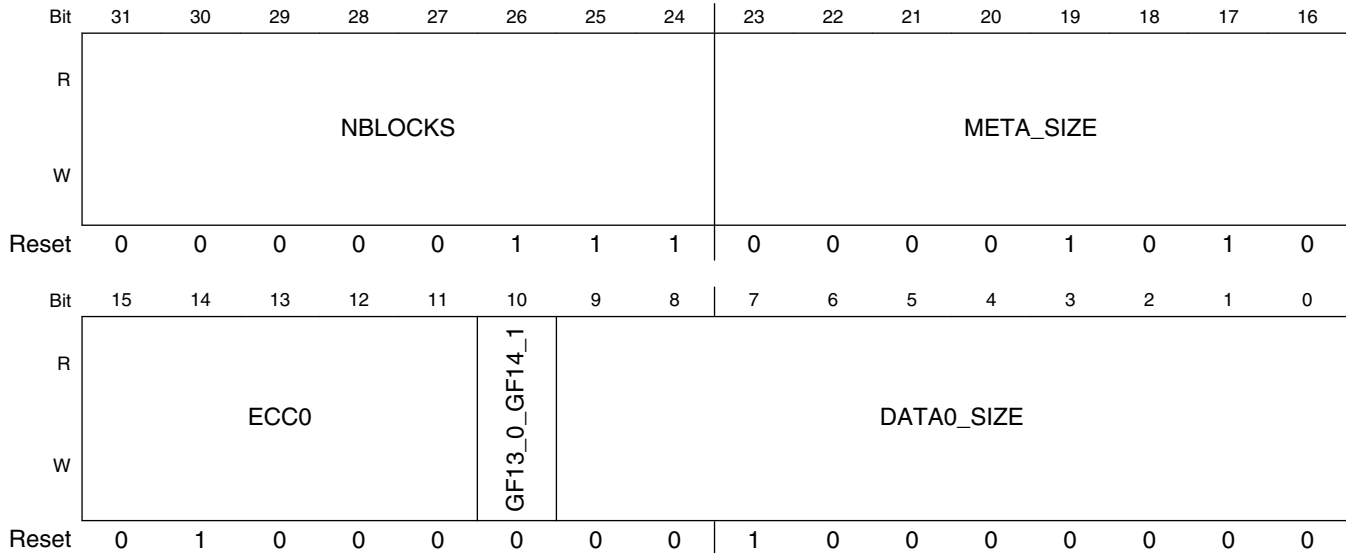

BCH_FLASH2LAYOUT0n field descriptions

Field	Description
31–24 NBLOCKS	Number of subsequent blocks on the flash page (excluding the data0 block). A value of 0 indicates that only the DATA0 block is present and a value of 8 indicates that eight subsequent blocks are present for a total of nine blocks on the flash (including the DATA0 block). Any values from 0 to 255 are supported by the hardware.
23–16 META_SIZE	Indicates the size of the metadata (in bytes) to be stored on a flash page. The BCH design support from 0 to 255 bytes for metadata—if set to 0, no metadata will be stored. Metadata is stored before the associated data in block 0. If the DATA0_SIZE field is programmed to a 0, then metadata effectively be stored with its own parity. When both the metadata and data0 fields are programmed with non-zero values, the first block will contain both portions of data and will be covered by a single parity block.
15–11 ECC0	Indicates the ECC level for the first block on the flash page. The first block covers metadata plus the associated data from the DATA0_SIZE field. 0x0 NONE — No ECC to be performed 0x1 ECC2 — ECC 2 to be performed 0x2 ECC4 — ECC 4 to be performed 0x3 ECC6 — ECC 6 to be performed 0x4 ECC8 — ECC 8 to be performed 0x5 ECC10 — ECC 10 to be performed 0x6 ECC12 — ECC 12 to be performed 0x7 ECC14 — ECC 14 to be performed

Table continues on the next page...

BCH_FLASH2LAYOUT0n field descriptions (continued)

Field	Description
0x8	ECC16 — ECC 16 to be performed
0x9	ECC18 — ECC 18 to be performed
0xA	ECC20 — ECC 20 to be performed
0xB	ECC22 — ECC 22 to be performed
0xC	ECC24 — ECC 24 to be performed
0xD	ECC26 — ECC 26 to be performed
0xE	ECC28 — ECC 28 to be performed
0xF	ECC30 — ECC 30 to be performed
0x10	ECC32 — ECC 32 to be performed
0x11	ECC34 — ECC 34 to be performed
0x12	ECC36 — ECC 36 to be performed
0x13	ECC38 — ECC 38 to be performed
0x14	ECC40 — ECC 40 to be performed
10 GF13_0_GF14_1	Select GF13 or GF14: 0-GF13; 1-GF14
DATA0_SIZE	Indicates the size of the data 0 block (in DWORDS / four bytes) to be stored on the flash page. If set to 0, the first block will only contain metadata.

17.6.13 Hardware BCH ECC Flash 2 Layout 1 Register (BCH_FLASH2LAYOUT1n)

The flash format register contains a description of the logical layout of data on the flash device. This register is used in conjunction with the FLASH2LAYOUT0 register to control the format for the device selecting layout 2 in the LAYOUTSELECT register.

Address: 180_8000h base + D0h offset + (4d × i), where i=0d to 3d

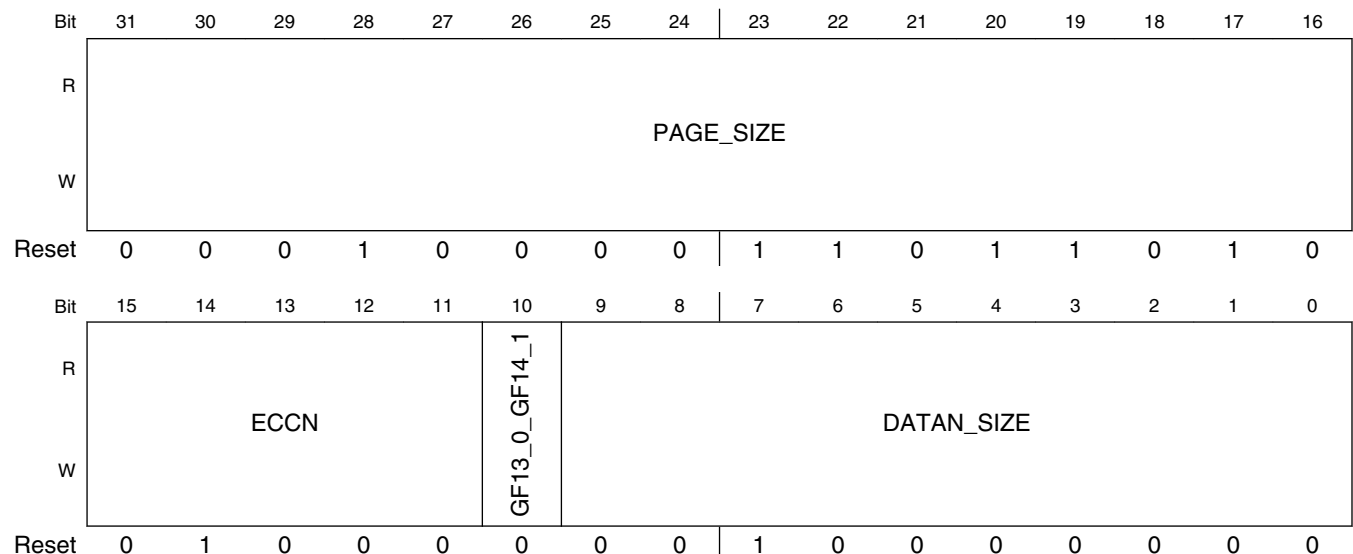

BCH_FLASH2LAYOUT1n field descriptions

Field	Description
31–16 PAGE_SIZE	Indicates the total size of the flash page (in bytes). This should be set to the page size including spare area. The page size is programmable to accommodate different flash configurations that may be available in the future.
15–11 ECCN	Indicates the ECC level for the subsequent blocks on the flash page (blocks 1-n). Subsequent blocks only contain data (no metadata). 0x0 NONE — No ECC to be performed 0x1 ECC2 — ECC 2 to be performed 0x2 ECC4 — ECC 4 to be performed 0x3 ECC6 — ECC 6 to be performed 0x4 ECC8 — ECC 8 to be performed 0x5 ECC10 — ECC 10 to be performed 0x6 ECC12 — ECC 12 to be performed 0x7 ECC14 — ECC 14 to be performed 0x8 ECC16 — ECC 16 to be performed 0x9 ECC18 — ECC 18 to be performed 0xA ECC20 — ECC 20 to be performed 0xB ECC22 — ECC 22 to be performed 0xC ECC24 — ECC 24 to be performed 0xD ECC26 — ECC 26 to be performed 0xE ECC28 — ECC 28 to be performed 0xF ECC30 — ECC 30 to be performed 0x10 ECC32 — ECC 32 to be performed 0x11 ECC34 — ECC 34 to be performed 0x12 ECC36 — ECC 36 to be performed 0x13 ECC38 — ECC 38 to be performed 0x14 ECC40 — ECC 40 to be performed
10 GF13_0_GF14_1	Select GF13 or GF14: 0-GF13; 1-GF14
DATAN_SIZE	Indicates the size of the subsequent data blocks (in DWORDS / four bytes) to be stored on the flash page. The size of subsequent data blocks does not have to match the data size for block 0, which is important when metadata is stored separately or for balancing the amount of data stored in each block.

17.6.14 Hardware BCH ECC Flash 3 Layout 0 Register (BCH_FLASH3LAYOUT0n)

The flash format register contains a description of the logical layout of data on the flash device. This register is used in conjunction with the FLASH3LAYOUT1 register to control the format for the devices selecting layout 3 in the LAYOUTSELECT register.

Each pair of layout registers describes one of four supported flash configurations. Software should program the LAYOUTSELECT register for each supported GPMI chip select to select from one of the four layout values. Each pair of registers contains settings that are used by the BCH block while reading / writing the flash page to control data,

BCH Memory Map/Register Definition

metadata, and flash page sizes as well as the ECC correction level. The first block written to flash can be programmed to have different ECC, metadata, and data sizes from subsequent data blocks on the device. In addition, the number of blocks stored on a page of flash is not fixed, but instead is determined by the number of bytes consumed by the initial (block 0) and subsequent data blocks.

See sections [Flash Page Layout](#) and [Determining the ECC layout for a device](#) for more detail information on setting up the flash layout registers.

Address: 180_8000h base + E0h offset + (4d × i), where i=0d to 3d

Bit	31	30	29	28	27	26	25	24	23	22	21	20	19	18	17	16
R	NBLOCKS								META_SIZE							
W																
Reset	0	0	0	0	0	1	1	1	0	0	0	0	1	0	1	0
Bit	15	14	13	12	11	10	9	8	7	6	5	4	3	2	1	0
R	ECC0					GF13_0_GF14_1	DATA0_SIZE									
W																
Reset	0	1	0	0	0	0	0	0	1	0	0	0	0	0	0	0

BCH_FLASH3LAYOUT0n field descriptions

Field	Description
31–24 NBLOCKS	Number of subsequent blocks on the flash page (excluding the data0 block). A value of 0 indicates that only the DATA0 block is present and a value of 8 indicates that 8 subsequent blocks are present for a total of 9 blocks on the flash (including the DATA0 block). Any values from 0 to 255 are supported by the hardware.
23–16 META_SIZE	Indicates the size of the metadata (in bytes) to be stored on a flash page. The BCH design support from 0 to 255 bytes for metadata—if set to 0, no metadata will be stored. Metadata is stored before the associated data in block 0. If the DATA0_SIZE field is programmed to a 0, then metadata effectively be stored with its own parity. When both the metadata and data0 fields are programmed with non-zero values, the first block will contain both portions of data and will be covered by a single parity block.
15–11 ECC0	Indicates the ECC level for the first block on the flash page. The first block covers metadata plus the associated data from the DATA0_SIZE field. 0x0 NONE — No ECC to be performed 0x1 ECC2 — ECC 2 to be performed 0x2 ECC4 — ECC 4 to be performed 0x3 ECC6 — ECC 6 to be performed 0x4 ECC8 — ECC 8 to be performed 0x5 ECC10 — ECC 10 to be performed 0x6 ECC12 — ECC 12 to be performed 0x7 ECC14 — ECC 14 to be performed

Table continues on the next page...

BCH_FLASH3LAYOUT0n field descriptions (continued)

Field	Description
0x8	ECC16 — ECC 16 to be performed
0x9	ECC18 — ECC 18 to be performed
0xA	ECC20 — ECC 20 to be performed
0xB	ECC22 — ECC 22 to be performed
0xC	ECC24 — ECC 24 to be performed
0xD	ECC26 — ECC 26 to be performed
0xE	ECC28 — ECC 28 to be performed
0xF	ECC30 — ECC 30 to be performed
0x10	ECC32 — ECC 32 to be performed
0x11	ECC34 — ECC 34 to be performed
0x12	ECC36 — ECC 36 to be performed
0x13	ECC38 — ECC 38 to be performed
0x14	ECC40 — ECC 40 to be performed
10 GF13_0_GF14_1	Select GF13 or GF14: 0-GF13; 1-GF14
DATA0_SIZE	Indicates the size of the data 0 block (in DWORDS / four bytes) to be stored on the flash page. If set to 0, the first block will only contain metadata.

17.6.15 Hardware BCH ECC Flash 3 Layout 1 Register (BCH_FLASH3LAYOUT1n)

The flash format register contains a description of the logical layout of data on the flash device. This register is used in conjunction with the FLASH3LAYOUT0 register to control the format for the device selecting layout 3 in the LAYOUTSELECT register.

Address: 180_8000h base + F0h offset + (4d × i), where i=0d to 3d

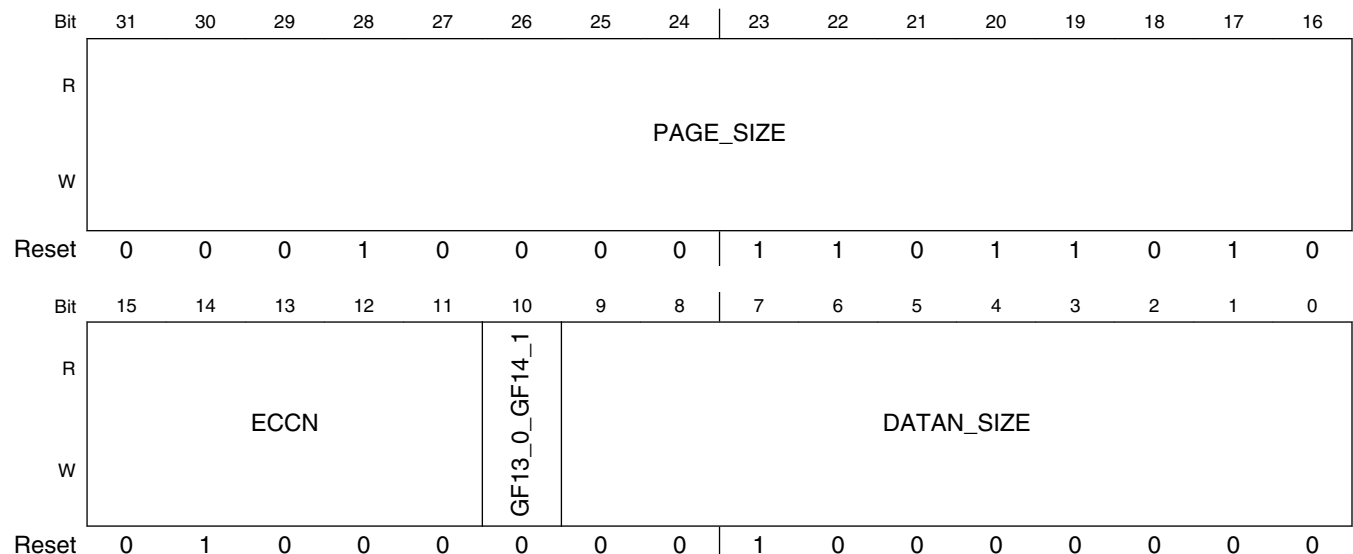

BCH_FLASH3LAYOUT1n field descriptions

Field	Description
31–16 PAGE_SIZE	Indicates the total size of the flash page (in bytes). This should be set to the page size including spare area. The page size is programmable to accommodate different flash configurations that may be available in the future.
15–11 ECCN	Indicates the ECC level for the subsequent blocks on the flash page (blocks 1-n). Subsequent blocks only contain data (no metadata). 0x0 NONE — No ECC to be performed 0x1 ECC2 — ECC 2 to be performed 0x2 ECC4 — ECC 4 to be performed 0x3 ECC6 — ECC 6 to be performed 0x4 ECC8 — ECC 8 to be performed 0x5 ECC10 — ECC 10 to be performed 0x6 ECC12 — ECC 12 to be performed 0x7 ECC14 — ECC 14 to be performed 0x8 ECC16 — ECC 16 to be performed 0x9 ECC18 — ECC 18 to be performed 0xA ECC20 — ECC 20 to be performed 0xB ECC22 — ECC 22 to be performed 0xC ECC24 — ECC 24 to be performed 0xD ECC26 — ECC 26 to be performed 0xE ECC28 — ECC 28 to be performed 0xF ECC30 — ECC 30 to be performed 0x10 ECC32 — ECC 32 to be performed 0x11 ECC34 — ECC 34 to be performed 0x12 ECC36 — ECC 36 to be performed 0x13 ECC38 — ECC 38 to be performed 0x14 ECC40 — ECC 40 to be performed
10 GF13_0_GF14_1	Select GF13 or GF14: 0-GF13; 1-GF14
DATAN_SIZE	Indicates the size of the subsequent data blocks (in DWORDS / four bytes) to be stored on the flash page. The size of subsequent data blocks does not have to match the data size for block 0, which is important when metadata is stored separately or for balancing the amount of data stored in each block.

17.6.16 Hardware BCH ECC Debug Register0 (BCH_DEBUG0n)

The hardware BCH accelerator internal state machines and signals can be seen in the ECC debug register.

The BCH_DEBUG0 register provides access to various internal state information which might prove useful during hardware debug and validation.

Address: 180_8000h base + 100h offset + (4d × i), where i=0d to 3d

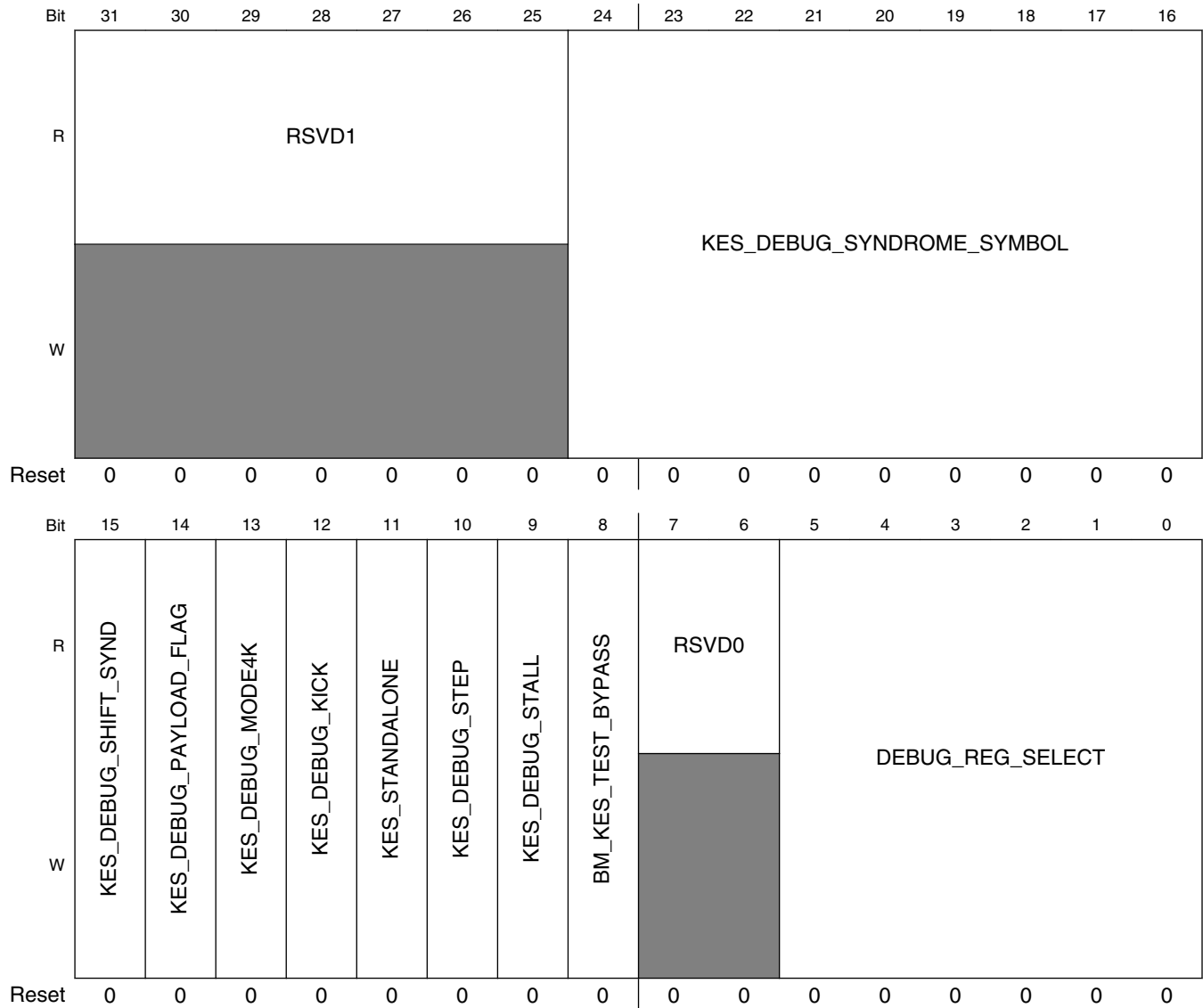

BCH_DEBUG0n field descriptions

Field	Description
31–25 RSVD1	This field is reserved. This read-only field is reserved and always has the value 0.
24–16 KES_DEBUG_SYNDROME_SYMBOL	The 9 bit value in this bit field shifts into the syndrome register array at the input of the KES engine whenever BCH_DEBUG0_KES_DEBUG_SHIFT_SYND is toggled. 0x0 NORMAL — Bus master address generator for SYND_GEN writes operates normally. 0x1 TEST_MODE — Bus master address generator always addresses last four bytes in Auxiliary block.
15 KES_DEBUG_SHIFT_SYND	Toggling this bit causes the value in BCH_DEBUG0_KES_SYNDROME_SYMBOL to be shift into the syndrome register array at the input to the KES engine. After shifting in 16 symbols, one can kick off both KES and CF cycles by toggling BCH_DEBUG0_KES_DEBUG_KICK. Make sure that set KES_BCH_DEBUG0_KES_STANDALONE mode to 1 before kicking.

Table continues on the next page...

BCH_DEBUG0n field descriptions (continued)

Field	Description
14 KES_DEBUG_ PAYLOAD_FLAG	When running the stand alone debug mode on the error calculator, the state of this bit is presented to the KES engine as the input payload flag. 0x1 DATA — Payload is set for 512 bytes data block. 0x1 AUX — Payload is set for 65 or 19 bytes auxiliary block.
13 KES_DEBUG_ MODE4K	When running the stand alone debug mode on the error calculator, the state of this bit is presented to the KES engine as the input mode (4K or 2K pages). 0x1 4k — Mode is set for 4K NAND pages. 0x1 2k — Mode is set for 2K NAND pages.
12 KES_DEBUG_ KICK	Toggling causes KES engine FSM to start as if kick by the Bus Master. This allows stand alone testing of the KES and Chien Search engines. Be sure to set KES_BCH_DEBUG0_KES_STANDALONE mode to 1 before kicking.
11 KES_ STANDALONE	Set to one, cause the KES engine to suppress toggling the KES_BM_DONE signal to the bus master and suppress toggling the CF_BM_DONE signal by the CF engine. 0x0 NORMAL — Bus master address generator for SYND_GEN writes operates normally. 0x1 TEST_MODE — Bus master address generator always addresses last four bytes in Auxiliary block.
10 KES_DEBUG_ STEP	Toggling this bit causes the KES FSM to skip passed the stall state if it is in DEBUG_STALL mode and completed processing a block.
9 KES_DEBUG_ STALL	Set to one to cause KES FSM to stall after notifying Chien search engine to start processing its block but before notifying the bus master that the KES computation is complete. This allows a diagnostic to stall the FSM after each blocks key equations are solved. This also has the effect of stalling the CSFE search engine so it's state can be examined after it finishes processing the KES stalled block. 0x0 NORMAL — KES FSM proceeds to next block supplied by bus master. 0x1 WAIT — KES FSM waits after current equations are solved and the search engine is started.
8 BM_KES_TEST_ BYPASS	1 = Point all SYND_GEN writes to dummy area at the end of the AUXILLIARY block so that diagnostics can preload all payload, parity bytes and computed syndrome bytes for test the KES engine. 0x0 NORMAL — Bus master address generator for SYND_GEN writes operates normally. 0x1 TEST_MODE — Bus master address generator always addresses last four bytes in Auxiliary block.
7–6 RSVD0	This field is reserved. This read-only field is reserved and always has the value 0.
DEBUG_REG_ SELECT	The value loaded in this bit field is used to select the internal register state view of KES engine or the Chien search engine.

17.6.17 KES Debug Read Register (BCH_DBGKESREADn)

The hardware BCH ECC accelerator key equation solver internal state machines and signals can be seen in the ECC debug registers.

Address: 180_8000h base + 110h offset + (4d × i), where i=0d to 3d

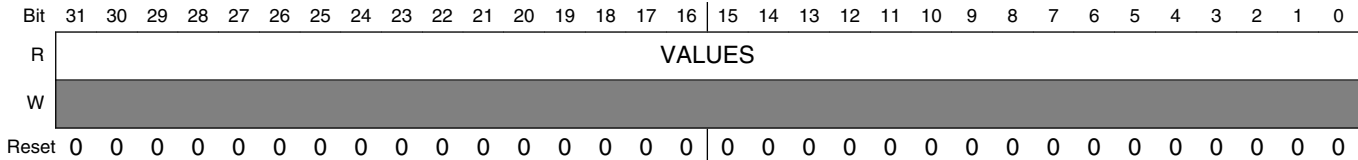

BCH_DBGKESREAD_n field descriptions

Field	Description
VALUES	This register returns the ROM BIST CRC value after a BIST test.

17.6.18 Chien Search Debug Read Register (BCH_DBGCSFEREAD_n)

The hardware BCH ECC accelerator Chien Search internal state machines and signals can be seen in the ECC debug registers.

Address: 180_8000h base + 120h offset + (4d × i), where i=0d to 3d

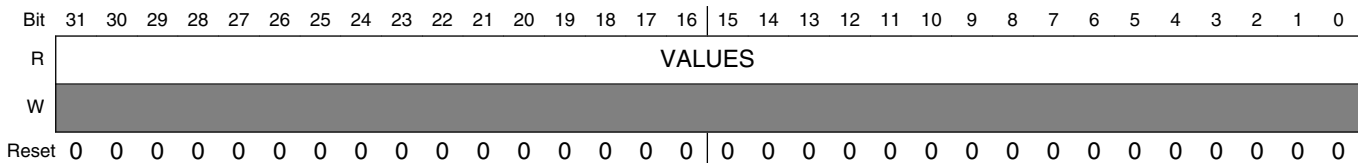

BCH_DBGCSFEREAD_n field descriptions

Field	Description
VALUES	Reserved

17.6.19 Syndrome Generator Debug Read Register (BCH_DBGSYNDGENREAD_n)

The hardware BCH ECC accelerator syndrome generator internal state machines and signals can be seen in the ECC debug registers.

Address: 180_8000h base + 130h offset + (4d × i), where i=0d to 3d

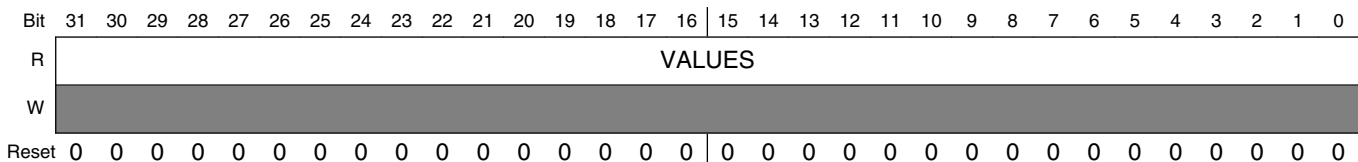

BCH_DBGSYNDGENREAD_n field descriptions

Field	Description
VALUES	Reserved

17.6.20 Bus Master and ECC Controller Debug Read Register (BCH_DBGAHBMREAD_n)

The hardware BCH ECC accelerator bus master, ECC controller internal state machines, and signals can be seen in the ECC debug registers.

Address: 180_8000h base + 140h offset + (4d × i), where i=0d to 3d

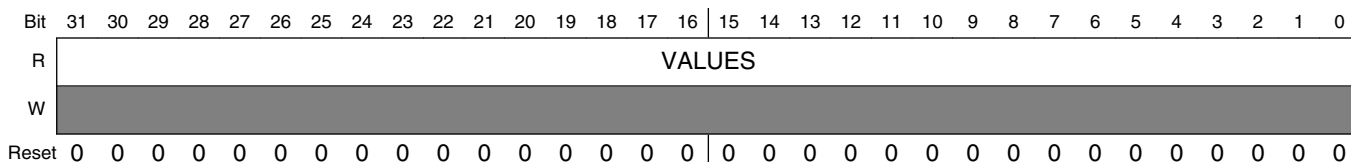

BCH_DBGAHBMREAD_n field descriptions

Field	Description
VALUES	Reserved

17.6.21 Block Name Register (BCH_BLOCKNAME_n)

Read only view of the block name string BCH.

Fixed pattern read only value is for test purposes. It can be read as an ASCII string with the zero termination coming from the first byte of the BLOCKVERSION register.

Address: 180_8000h base + 150h offset + (4d × i), where i=0d to 3d

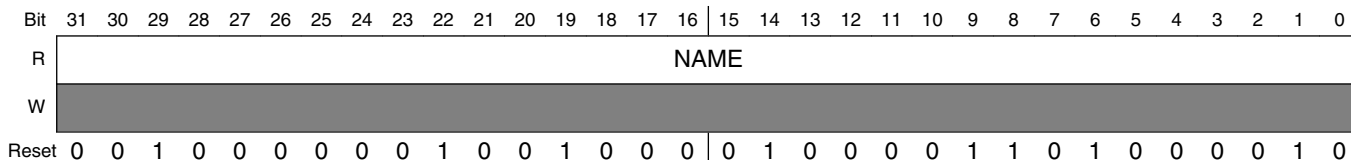

BCH_BLOCKNAME_n field descriptions

Field	Description
NAME	The name is in the ASCII characters BCH (0x20, H, C, B).

17.6.22 BCH Version Register (BCH_VERSIONn)

This register always returns a known read value for debug purposes and indicates the version of the block and RTL version in use.

Address: 180_8000h base + 160h offset + (4d × i), where i=0d to 3d

Bit	31	30	29	28	27	26	25	24	23	22	21	20	19	18	17	16	15	14	13	12	11	10	9	8	7	6	5	4	3	2	1	0
R	MAJOR								MINOR								STEP															
W	0																															
Reset	0	0	0	0	0	0	0	1	0	0	0	0	0	0	0	0	0	0	0	0	0	0	0	0	0	0	0	0	0	0	0	0

BCH_VERSIONn field descriptions

Field	Description
31–24 MAJOR	Fixed read-only value indicates the MAJOR field of the RTL version.
23–16 MINOR	Fixed read-only value indicates the MINOR field of the RTL version.
STEP	Fixed read-only value reflecting the stepping of the RTL version.

17.6.23 Hardware BCH ECC Debug Register 1 (BCH_DEBUG1n)

The BCH_DEBUG1 register provides erased zero count information and pre-erase check.

Address: 180_8000h base + 170h offset + (4d × i), where i=0d to 3d

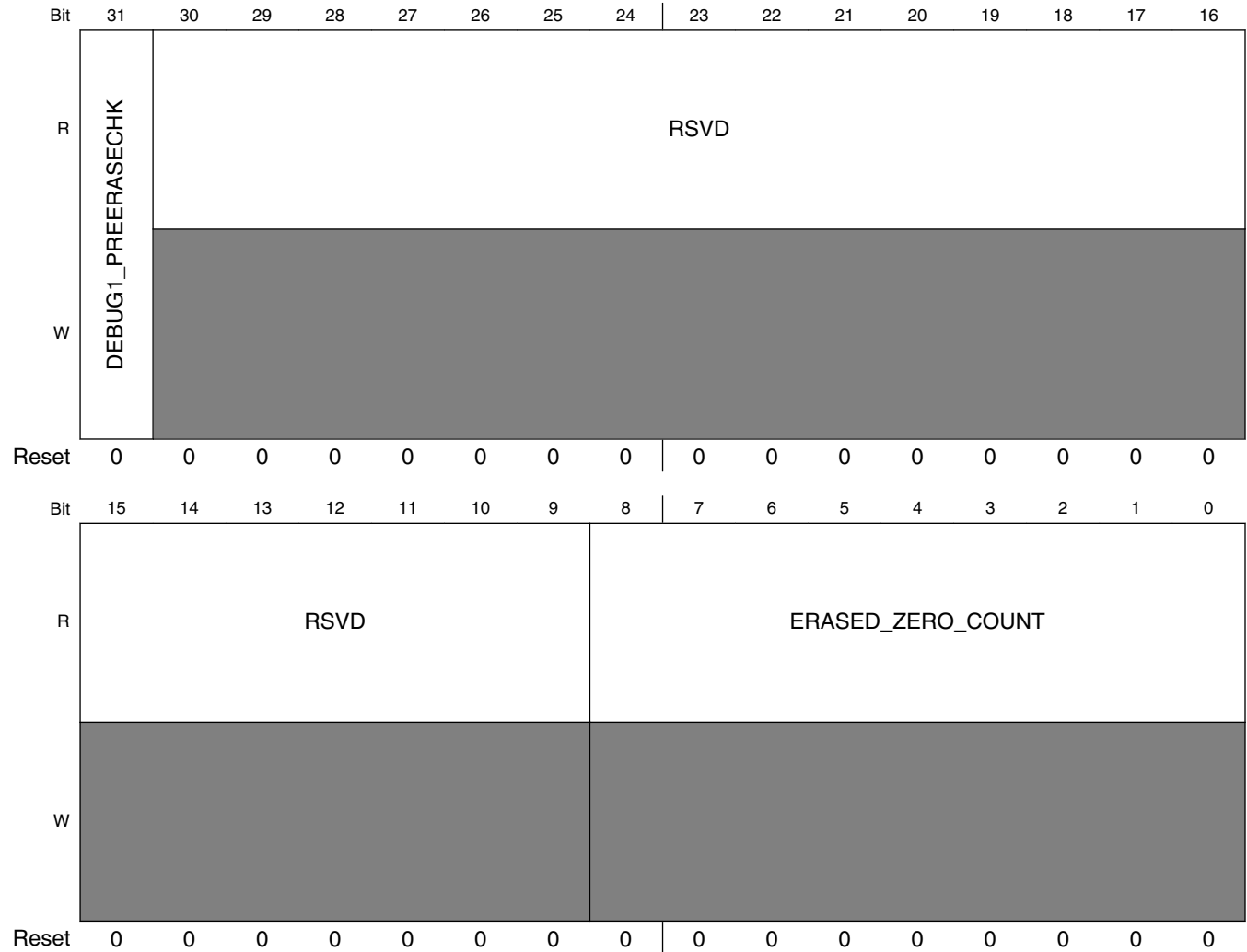

BCH_DEBUG1n field descriptions

Field	Description
31 DEBUG1_ PREERASECHK	Blank page enables pre-erase check. 0x0 Turn off pre-erase check 0x1 Turn on pre-erase check
30–9 RSVD	This field is reserved. This read-only field is reserved and always has the value 0.

Table continues on the next page...

BCH_DEBUG1n field descriptions (continued)

Field	Description
ERASED_ ZERO_COUNT	The zero counts on one page.

Chapter 18

Clock Controller Module (CCM)

18.1 Overview

The Clock Control Module (CCM) generates and controls clocks to the various modules in the design and manages low power modes. This module uses the available clock sources to generate the clock roots.

The Clock Controller Module controls the following functions:

- Uses the available clock sources to generate clock roots to various parts of the chip:
 - PLL1 also referenced as ARM PLL
 - PLL2 also referenced as System PLL
 - PLL3 also referenced as USB1 PLL
 - PLL4 also referenced as Audio PLL
 - PLL5 also referenced as Video PLL
 - PLL6 also referenced as ENET PLL
 - PLL7 also referenced as USB2 PLL (This PLL is only used by the USB UTM interface through a direct connection.)
- Uses programmable bits to control frequencies of the clock roots.
- Controls the low power mechanism.
- Provides control signals to LPCG for gating clocks.
- Provides handshake with SRC for reset performance.
- Provides handshake with GPC for support of power gating operations.

18.1.1 Features

The CCM includes these distinctive features:

- Provides root clock to SoC modules based on several source clocks.
- ARM core root clock is generated from a dedicated source clock.

- Includes separate dividers to control generation of core and bus root clocks (AXI, AHB, IPG).
- Includes separate dividers and clock source selectors for each serial root clock.
- Optional external clocks to bypass PLL clocks.
- Selects clock signals to output on CCM_CLKO onto the pads for observability.
- Controllable registers are accessible via IP bus.
- Manages the Low Power Modes, namely RUN, WAIT and STOP. The gating of the peripheral clocks is programmable in RUN and WAIT modes.
- Manages frequency scaling procedure for ARM core clock by shifting between PLL sources, without loss of clocks.
- Manages frequency scaling procedure for peripheral root clock by programmable divider. The division is done on the fly without loss of clocks.
- Interface for the following IPs:
 - PLL - Interfaces for each PLL
 - LPCG - Low Power Clock Gating unit
 - SRC - System Reset Controller
 - GPC - General Power Controller

18.1.2 CCM Block Diagram

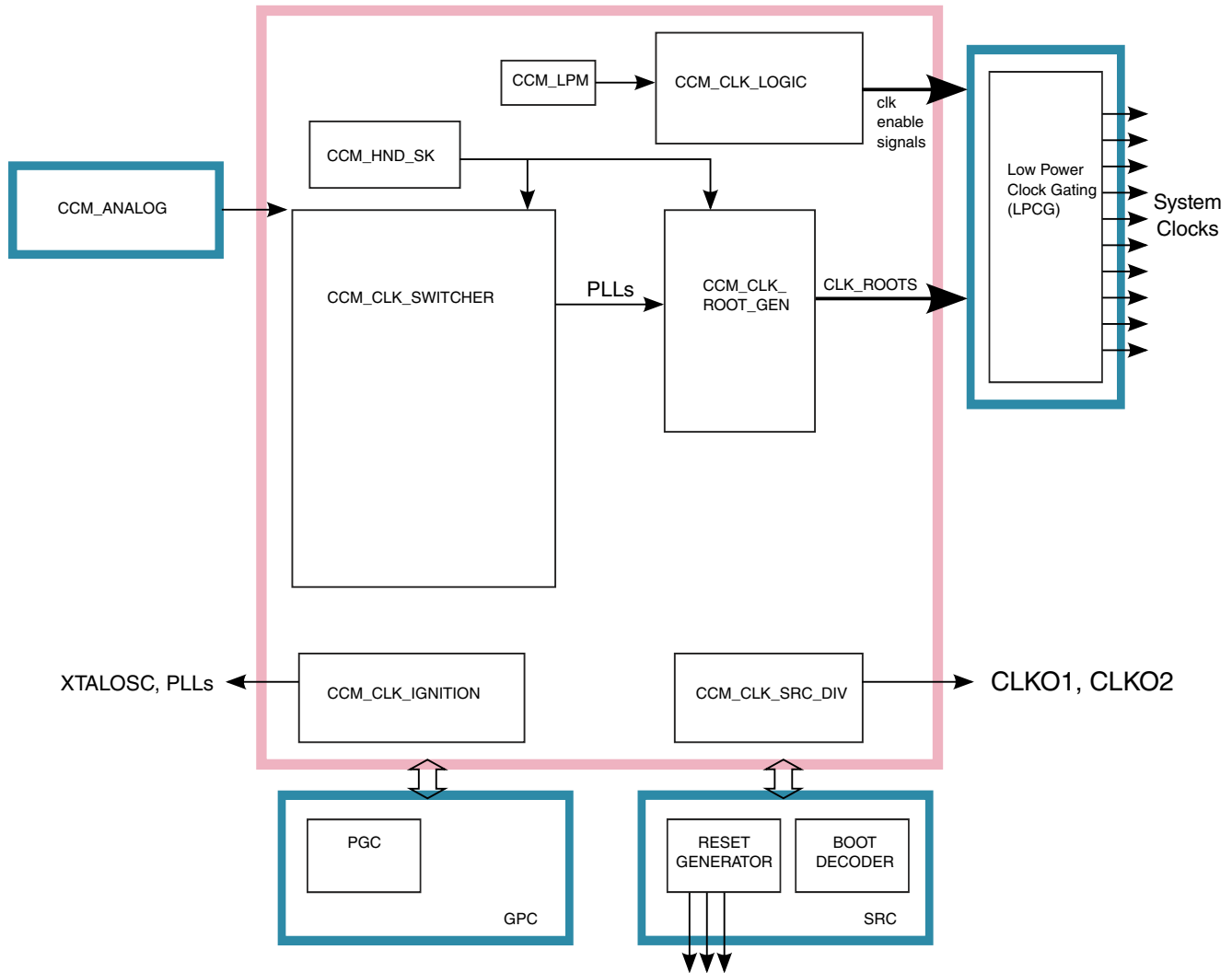

Figure 18-1. Block Diagram

CCM contains the following sub-blocks:

Table 18-1. CCM Sub-blocks

CCM_CLK_SRC_DIV Sub-block	Description
CCM_CLK_IGNITION	Manages the ignition process. This module starts its functionality once CCM comes out of reset. It manages the process that begins with starting the OSC, PLLs and finishes with creation of stable output root clocks after reset.
CCM_CLK_SWITCHER	Receives the clock outputs of the PLLs, together with the bypass clocks for the PLLs, and generates switcher clock outputs (pll1_sw_clk, pll3_sw_clk) for the CCM_CLK_ROOT_GEN sub-module.
CCM_CLK_ROOT_GEN	Receives the main clocks (PLLs / PFDs) and generates the output root clocks.
CCM_CLK_LOGIC	Generates the clock enables. It generates the clock enable signals based on info from CCM_LPM and CCM_IP. The clock enables are used in LPCG to turn off and on the split clocks.

Table continues on the next page...

Table 18-1. CCM Sub-blocks (continued)

CCM_CLK_SRC_DIV Sub-block	Description
CCM_LPM	Manages the low power modes of the IC.
CCM_HND_SK	Manages the handshake when changing certain root clock dividers that require handshake.

18.2 External Signals

The following table describes the external signals of CCM:

Table 18-2. CCM External Signals

Signal	Description	Pad	Mode	Direction
CCM_CLKO1	Observability clock 1 output	JTAG_TMS	ALT3	O
		SD1_DATA2	ALT6	
CCM_CLKO2	Observability clock 2 output	JTAG_TDO	ALT3	O
		SD1_DATA3	ALT6	
CCM_REF_EN_B	Enable external reference clock (CKIH)	GPIO1_IO06	ALT7	O

18.3 CCM Clock Tree

The following figures (Part 1 and Part 2) show the clock tree configuration and clock roots for CCM.

For detailed sub-block information, see:

- [Clock Switcher](#)
- [Clock Root Generator](#)
- [Low Power Clock Gating module \(LPCG\)](#)
- [System Clocks](#)

NOTE

The default frequency values (in MHz) for the PLLs and PFDs are shown in the Clock Tree diagram that follows. The PLLs and PFDs control registers may be reprogrammed according to the speed grade of the SoC being used, but should not exceed that maximum setting for that speed grade.

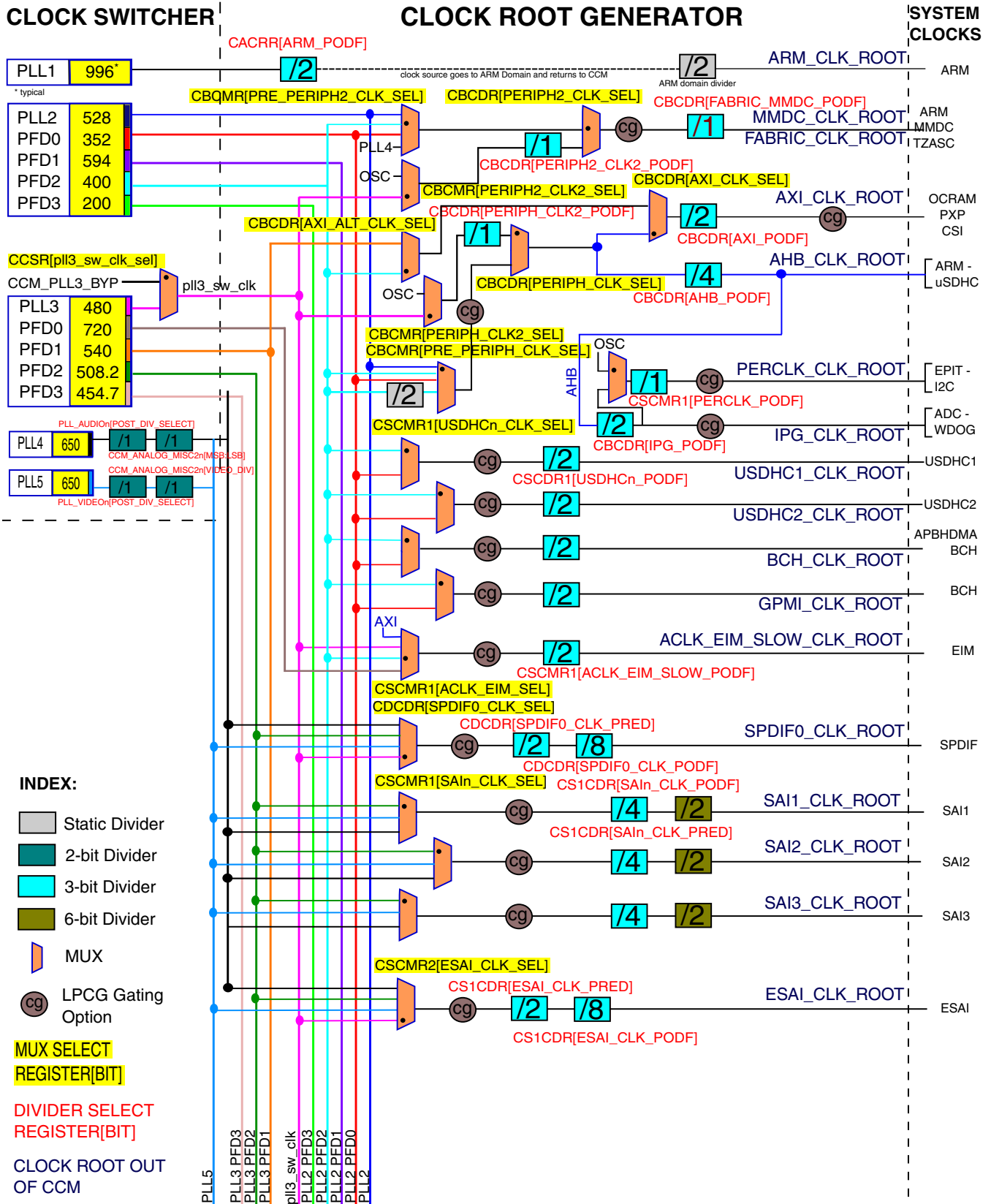

Figure 18-2. Clock Tree - Part 1

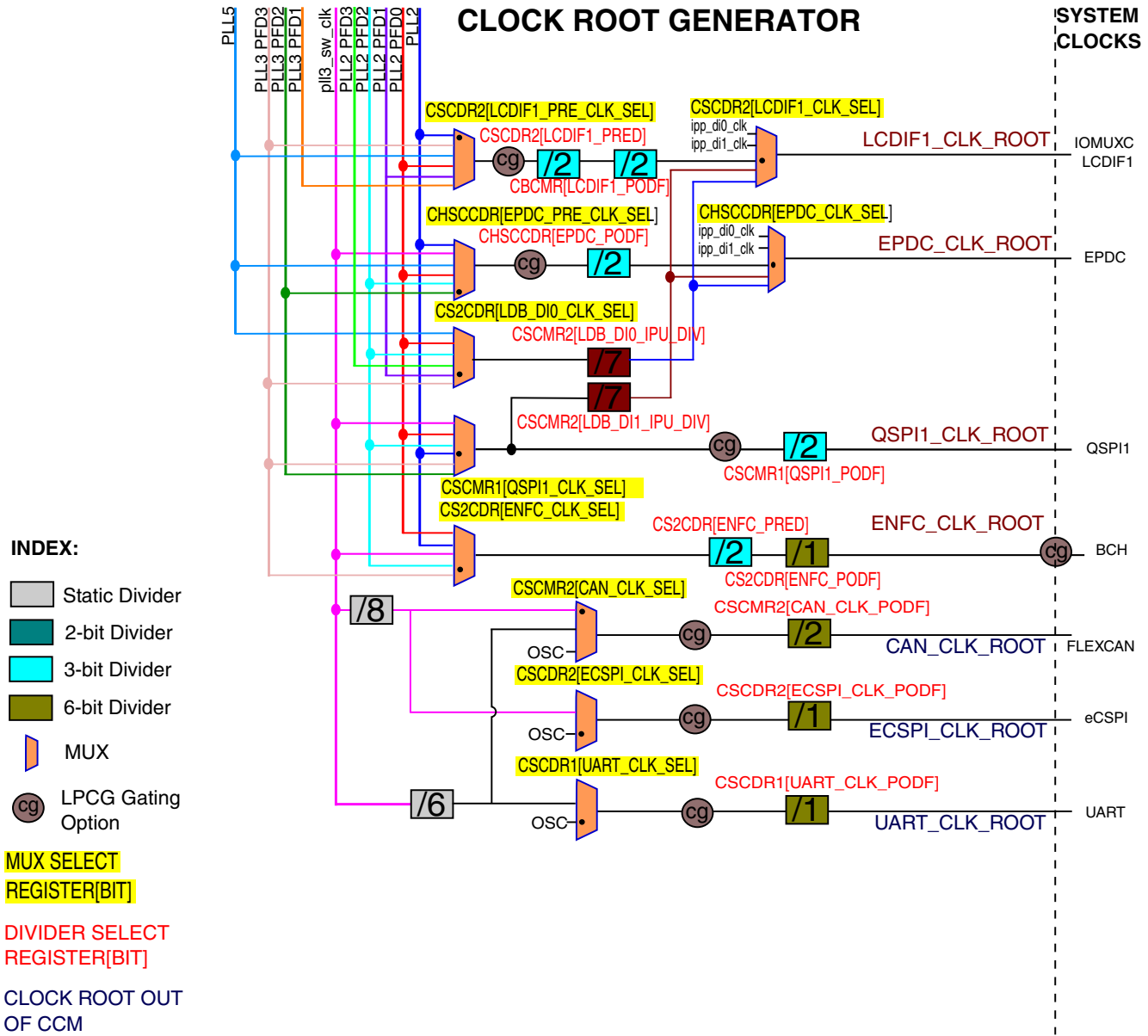

Figure 18-3. Clock Tree - Part 2

18.4 System Clocks

The table found here shows the CCM output clocks' system-level connectivity.

The gating option in the table can either be CGR bit or clock enable from the block itself. Applicable override bits are also shown.

Table 18-3. System Clocks, Gating, and Override

Module	Module Clock	Clock Root	Module Clock Gating Enable	Module Override Enable
ADC _n	IPG_CLK	IPG_CLK_ROOT	CCGR1[CG8] (ADC1_CLK_ENABLE) CCGR1[CG4] (ADC2_CLK_ENABLE)	
AIPSTZ _n	HCLK	AHB_CLK_ROOT	CCGR0[CG0] (AIPS_TZ1_CLK_ENABLE) CCGR0[CG1] (AIPS_TZ2_CLK_ENABLE) CCGR2[CG8] (IPMUX1_CLK_ENABLE) CCGR2[CG9] (IPMUX2_CLK_ENABLE) CCGR2[CG10] (IPMUX3_CLK_ENABLE) CCGR4[CG4] (CXAPBSYNCRIDGE_SLAVE_CLK_ENABLE) CCGR6[CG4] (IPMUX4_CLK_ENABLE) CCGR6[CG9] (AIPS_TZ3_CLK_ENABLE)	
APBHDMA	HCLK	BCH_CLK_ROOT	CCGR0[CG2] (APBHDMA_HCLK_ENABLE)	
	SEC_MST_HCLK	BCH_CLK_ROOT	CCGR0[CG2] (APBHDMA_HCLK_ENABLE)	
ARM	TRACE_CLK_IN	AHB_CLK_ROOT	CCGR0[CG11] (ARM_DBG_CLK_ENABLE)	
	CLKDIV_PATCH_IPG_CLK	AHB_CLK_ROOT	CCGR3[CG9] (A7CLKDIV_PATCH_CLK_ENABLE)	
ASRC	ASRCK_CLOCK_D	SPDIF0_CLK_ROOT	CCGR0[CG3] (ASRC_CLK_ENABLE)	
	IPG_CLK	AHB_CLK_ROOT	CCGR0[CG3] (ASRC_CLK_ENABLE)	
	MEM_CLK	AHB_CLK_ROOT	CCGR0[CG3] (ASRC_CLK_ENABLE)	

Table continues on the next page...

Table 18-3. System Clocks, Gating, and Override (continued)

Module	Module Clock	Clock Root	Module Clock Gating Enable	Module Override Enable
BCH	U_BCH_INPUT_APB_CLK	BCH_CLK_ROOT	CCGR4[CG12] (RAWNAND_U_BCH_INPUT_APB_CLK_ENABLE)	
	U_GPMI_BCH_INPUT_BCH_CLK	GPMI_CLK_ROOT	CCGR4[CG13] (RAWNAND_U_GPMI_BCH_INPUT_BCH_CLK_ENABLE)	
	U_GPMI_BCH_INPUT_GPMI_IO_CLK	ENFC_CLK_ROOT	CCGR4[CG14] (RAWNAND_U_GPMI_BCH_INPUT_GPMI_IO_CLK_ENABLE)	
	U_GPMI_INPUT_APB_CLK	BCH_CLK_ROOT	CCGR4[CG15] (RAWNAND_U_GPMI_INPUT_APB_CLK_ENABLE)	
CCM	CCM_IPG_CLK_S	IPG_CLK_ROOT		
	IPG_CLK	IPG_CLK_ROOT		
	ANALOG_APB_CLK	IPG_CLK_ROOT	CCGR6[CG11] (ANADIG_CLK_ENABLE)	
	CLK_APB_DBG	IPG_CLK_ROOT	CCGR3[CG4] (CCM_DAP_CLK_ENABLE)	
CSI	CSI_HCLK	AXI_CLK_ROOT	CCGR2[CG1] (CSI_CLK_ENABLE)	
	IPG_CLK	AXI_CLK_ROOT	CCGR2[CG1] (CSI_CLK_ENABLE)	
	IPG_CLK_S	AXI_CLK_ROOT	CCGR2[CG1] (CSI_CLK_ENABLE)	
	IPG_CLK_S_RAW	AXI_CLK_ROOT	CCGR2[CG1] (CSI_CLK_ENABLE)	
	MEM_RXFIFO_CLK	AXI_CLK_ROOT	CCGR2[CG1] (CSI_CLK_ENABLE)	
CSU	AP_CKIL_CLK	CKIL_SYNC_CLK_ROOT	CCGR1[CG14] (CSU_CLK_ENABLE)	
	IPG_CLK_S	IPG_CLK_ROOT	CCGR1[CG14] (CSU_CLK_ENABLE)	
DCP	CLK	AHB_CLK_ROOT	CCGR0[CG5] (DCP_CLK_ENABLE)	
EPDC	ACLK	AXI_CLK_ROOT	CCGR3[CG2] (EPDC_CLK_ENABLE)	
	PIXCLK	EPDC_CLK_ROOT	CCGR3[CG2] (EPDC_CLK_ENABLE)	
ESAI	IPG_CLK_ESAI	AHB_CLK_ROOT	CCGR2[CG0] (ESAI_CLK_ENABLE)	
	EXTAL_CLK	ESAI_CLK_ROOT	CCGR2[CG0] (ESAI_CLK_ENABLE)	

Table continues on the next page...

Table 18-3. System Clocks, Gating, and Override (continued)

Module	Module Clock	Clock Root	Module Clock Gating Enable	Module Override Enable
	IPG_CLK_S	IPG_CLK_ROOT		
ECSPIn	IPG_CLK	IPG_CLK_ROOT	CCGR1[CG0] (ECSPI1_CLK_ENABLE) CCGR1[CG1] (ECSPI2_CLK_ENABLE) CCGR1[CG2] (ECSPI3_CLK_ENABLE) CCGR1[CG3] (ECSPI4_CLK_ENABLE)	
	IPG_CLK_32K	CKIL_SYNC_CLK_ROOT		
	IPG_CLK_PER	ECSPI_CLK_ROOT	CCGR1[CG0] (ECSPI1_CLK_ENABLE) CCGR1[CG1] (ECSPI2_CLK_ENABLE) CCGR1[CG2] (ECSPI3_CLK_ENABLE) CCGR1[CG3] (ECSPI4_CLK_ENABLE)	
	IPG_CLK_S	IPG_CLK_ROOT	CCGR1[CG0] (ECSPI1_CLK_ENABLE) CCGR1[CG1] (ECSPI2_CLK_ENABLE) CCGR1[CG2] (ECSPI3_CLK_ENABLE) CCGR1[CG3] (ECSPI4_CLK_ENABLE)	
EIM	ACLK	ACLK_EIM_SLOW_CLK_ROOT	CCGR6[CG5] (EIM_SLOW_CLK_ENABLE)	
	ACLK_SLOW	ACLK_EIM_SLOW_CLK_ROOT	CCGR6[CG5] (EIM_SLOW_CLK_ENABLE)	
	IPG_CLK_S	IPG_CLK_ROOT		
	ACLK_EXSC	ACLK_EIM_SLOW_CLK_ROOT	CCGR6[CG5] (EIM_SLOW_CLK_ENABLE)	
	IPG_CLK	IPG_CLK_ROOT		
ENETn	IPG_CLK	AHB_CLK_ROOT	CCGR0[CG6] (ENET_CLK_ENABLE)	
	IPG_CLK_MAC0	AHB_CLK_ROOT	CCGR0[CG6] (ENET_CLK_ENABLE)	
	IPG_CLK_MAC0_S	IPG_CLK_ROOT	CCGR0[CG6] (ENET_CLK_ENABLE)	
	IPG_CLK_S	IPG_CLK_ROOT	CCGR0[CG6] (ENET_CLK_ENABLE)	

Table continues on the next page...

Table 18-3. System Clocks, Gating, and Override (continued)

Module	Module Clock	Clock Root	Module Clock Gating Enable	Module Override Enable
	IPG_CLK_TIME	REF_ENETPLL2_CLK	CCGR0[CG6] (ENET_CLK_ENABLE)	
	MAC0_RXMEM_CLK	AHB_CLK_ROOT	CCGR0[CG6] (ENET_CLK_ENABLE)	
	MAC0_TXMEM_CLK	AHB_CLK_ROOT	CCGR0[CG6] (ENET_CLK_ENABLE)	
EPIT _n	IPG_CLK	PERCLK_CLK_ROOT	CCGR1[CG6] (EPIT1_CLK_ENABLE) CCGR1[CG7] (EPIT2_CLK_ENABLE)	CMEOR[MOD_EN_OV_EPIT]
	IPG_CLK_32K	CKIL_SYNC_CLK_ROOT		
	IPG_CLK_HIGHFREQ	PERCLK_CLK_ROOT	CCGR1[CG6] (EPIT1_CLK_ENABLE) CCGR1[CG7] (EPIT2_CLK_ENABLE)	
	IPG_CLK_S	PERCLK_CLK_ROOT	CCGR1[CG6] (EPIT1_CLK_ENABLE) CCGR1[CG7] (EPIT2_CLK_ENABLE)	
FLEXCAN _n	IPG_CLK	IPG_CLK_ROOT	CCGR0[CG7] (CAN1_CLK_ENABLE) CCGR0[CG9] (CAN2_CLK_ENABLE)	
	IPG_CLK_CHI	IPG_CLK_ROOT	CCGR0[CG7] (CAN1_CLK_ENABLE) CCGR0[CG9] (CAN2_CLK_ENABLE)	
	IPG_CLK_PE	CAN_CLK_ROOT	CCGR0[CG8] (CAN1_SERIAL_CLK_ENABLE) CCGR0[CG10] (CAN2_SERIAL_CLK_ENABLE)	CMEOR[MOD_EN_OV_CAN _n _CPI]
	IPG_CLK_PE_NOGATE	CAN_CLK_ROOT	CCGR0[CG8] (CAN1_SERIAL_CLK_ENABLE) CCGR0[CG10] (CAN2_SERIAL_CLK_ENABLE)	
	IPG_CLK_S	IPG_CLK_ROOT	CCGR0[CG7] (CAN1_CLK_ENABLE) CCGR0[CG9] (CAN2_CLK_ENABLE)	
	RAM_CLK	IPG_CLK_ROOT	CCGR0[CG7] (CAN1_CLK_ENABLE)	

Table continues on the next page...

Table 18-3. System Clocks, Gating, and Override (continued)

Module	Module Clock	Clock Root	Module Clock Gating Enable	Module Override Enable
			CCGR0[CG9] (CAN2_CLK_ENABLE)	
GPC	IPG_CLK	IPG_CLK_ROOT		
	IPG_CLK_S	IPG_CLK_ROOT		
	PGC_CLK	IPG_CLK_ROOT		
	SPARE_IN[0]	CKIL_SYNC_CLK_ROOT		
	SYS_CLK	IPG_CLK_ROOT		
GPIO _n	IPG_CLK_S	IPG_CLK_ROOT 0	CCGR1[CG13] (GPIO1_CLK_ENABLE) CCGR0[CG15] (GPIO2_CLK_ENABLE) CCGR2[CG13] (GPIO3_CLK_ENABLE) CCGR3[CG6] (GPIO4_CLK_ENABLE) CCGR1[CG15] (GPIO5_CLK_ENABLE)	
GPT _n	IPG_CLK	PERCLK_CLK_ROOT	CCGR1[CG10] (GPT1_CLK_ENABLE) CCGR0[CG12] (GPT2_CLK_ENABLE)	CMEOR[MOD_EN_OV_GPT]
	IPG_CLK_24M	CKIH_SYNC_CLK_ROOT		CMEOR[MOD_EN_OV_GPT]
	IPG_CLK_32K	CKIL_SYNC_CLK_ROOT		
	IPG_CLK_HIGHFREQ	PERCLK_CLK_ROOT	CCGR1[CG11] (GPT1_SERIAL_CLK_ENABLE) CCGR0[CG13] (GPT2_SERIAL_CLK_ENABLE)	
	IPG_CLK_S	PERCLK_CLK_ROOT	CCGR1[CG10] (GPT1_CLK_ENABLE) CCGR0[CG12] (GPT2_CLK_ENABLE)	
HS	CLK	IPG_CLK_ROOT		
I2C _n	IPG_CLK_PATREF	PERCLK_CLK_ROOT	CCGR2[CG3] (I2C1_SERIAL_CLK_ENABLE) CCGR2[CG4] (I2C2_SERIAL_CLK_ENABLE) CCGR2[CG5] (I2C3_SERIAL_CLK_ENABLE)	

Table continues on the next page...

Table 18-3. System Clocks, Gating, and Override (continued)

Module	Module Clock	Clock Root	Module Clock Gating Enable	Module Override Enable
			CCGR6[CG12] (I2C4_SERIAL_CLK_ENABLE)	
	IPG_CLK_S	PERCLK_CLK_ROOT	CCGR2[CG3] (I2C1_SERIAL_CLK_ENABLE) CCGR2[CG4] (I2C2_SERIAL_CLK_ENABLE) CCGR2[CG5] (I2C3_SERIAL_CLK_ENABLE) CCGR6[CG12] (I2C4_SERIAL_CLK_ENABLE)	
IOMUXC	IPG_CLK_S	IPG_CLK_ROOT	CCGR2[CG2] (IOMUXC_SNVS_CLK_ENABLE)	
	IPT_CLK_IO	LCDIF_PIX_CLK_ROOT	CCGR2[CG7] (IOMUX_IPT_CLK_IO_ENABLE)	
	IPG_CLK_S	IPG_CLK_ROOT	CCGR3[CG15] (IOMUXC_SNVS_GPR_CLK_ENABLE)	
	IPG_CLK_S	IPG_CLK_ROOT	CCGR4[CG1] (IOMUXC_CLK_ENABLE)	
	IPG_CLK_S	IPG_CLK_ROOT	CCGR4[CG2] (IOMUXC_GPR_CLK_ENABLE)	
KPP _n	IPG_CLK_32K	CKIL_SYNC_CLK_ROOT		
	IPG_CLK_S	IPG_CLK_ROOT	CCGR5[CG4] (KPP_CLK_ENABLE)	
LCDIF	APB_CLK	AXI_CLK_ROOT	CCGR2[CG14] (LCD_CLK_ENABLE)	
	PIX_CLK	LCDIF_CLK_ROOT	CCGR3[CG5] (LCDIF_PIX_CLK_ENABLE)	
MMDC	ACLK_FAST_CORE_P0	MMDC_CLK_ROOT	CCGR3[CG10] (MMDC_CORE_ACLK_FAST_CORE_P0_ENABLE)	
	ACLK_FAST_PHY_P0	MMDC_CLK_ROOT	CCGR3[CG10] (MMDC_CORE_ACLK_FAST_CORE_P0_ENABLE)	
	CLK32	CKIL_SYNC_CLK_ROOT	CCGR3[CG13] (MMDC_CORE_IPG_CLK_P1_ENABLE)	

Table continues on the next page...

Table 18-3. System Clocks, Gating, and Override (continued)

Module	Module Clock	Clock Root	Module Clock Gating Enable	Module Override Enable
	IPG_CLK_P0	IPG_CLK_ROOT	CCGR3[CG12] (MMDC_CORE_IPG_CLK_P0_ENABLE)	
	ACLK_EXSC	MMDC_CLK_ROOT	CCGR3[CG10] (MMDC_CORE_ACLK_FAST_CORE_P0_ENABLE)	
NIC-301	AXI_A_SIM_S	FABRIC_CLK_ROOT	CCGR1[CG9] (SIM_S_CLK_ENABLE)	
	AXI_A_SIM_CPU	FABRIC_CLK_ROOT	CCGR4[CG3] (SIM_CPU_CLK_ENABLE)	
	AXI_B_BCH	BCH_CLK_ROOT	CCGR4[CG6] (PL301_MX6QPER1_BCHCLK_ENABLE)	
	AXI_A_MAIN	FABRIC_CLK_ROOT	CCGR4[CG7] (PL301_MX6QPER2_MAINCLK_ENABLE)	
	AXI_A_SIM_MAIN	FABRIC_CLK_ROOT	CCGR5[CG8] (SIM_MAIN_CLK_ENABLE)	
OCOTP	IPG_CLK	IPG_CLK_ROOT	CCGR2[CG6] (IIM_CLK_ENABLE)	
	IPG_CLK_S	IPG_CLK_ROOT	CCGR2[CG6] (IIM_CLK_ENABLE)	
OCRAM	CTRL_CLK	AXI_CLK_ROOT	CCGR3[CG14] (OCRAM_CLK_ENABLE)	
	ACLK_EXSC	AXI_CLK_ROOT	CCGR3[CG14] (OCRAM_CLK_ENABLE)	
	MEM_CLK	AXI_CLK_ROOT	CCGR3[CG14] (OCRAM_CLK_ENABLE)	
PWM _n	IPG_CLK	PERCLK_CLK_ROOT	CCGR4[CG11:CG8] (PWM[4:1]_CLK_ENABLE) CCGR6[CG15:CG13] (PWM[7:5]_CLK_ENABLE) CCGR6[CG8] (PWM8_CLK_ENABLE)	
	IPG_CLK_32K	CKIL_SYNC_CLK_ROOT		
	IPG_CLK_HIGHFREQ	PERCLK_CLK_ROOT	CCGR4[CG11:CG8] (PWM[4:1]_CLK_ENABLE) CCGR6[CG15:CG13] (PWM[7:5]_CLK_ENABLE)	

Table continues on the next page...

Table 18-3. System Clocks, Gating, and Override (continued)

Module	Module Clock	Clock Root	Module Clock Gating Enable	Module Override Enable
			CCGR6[CG8] (PWM8_CLK_ENABLE)	
	IPG_CLK_S	PERCLK_CLK_ROOT	CCGR4[CG11:CG8] (PWM[4:1]_CLK_ENABLE)) CCGR6[CG15:CG13] (PWM[7:5]_CLK_ENABLE)) CCGR6[CG8] (PWM8_CLK_ENABLE)	
PXP	CLK	AXI_CLK_ROOT	CCGR2[CG15] (PXP_CLK_ENABLE)	
QSPI	AHB_CLK	AHB_CLK_ROOT	CCGR3[CG7] (QSPI_CLK_ENABLE)	
	IPG_CLK	IPG_CLK_ROOT	CCGR3[CG7] (QSPI_CLK_ENABLE)	
	IPG_CLK_4XSIFIF	QSPIn_CLK_ROOT	CCGR3[CG7] (QSPI_CLK_ENABLE)	
	IPG_CLK_S	IPG_CLK_ROOT	CCGR3[CG7] (QSPI_CLK_ENABLE)	
	SEC_IPG_CLK	IPG_CLK_ROOT	CCGR3[CG7] (QSPI_CLK_ENABLE)	
	SEC_IPG_CLK_S	IPG_CLK_ROOT	CCGR3[CG7] (QSPI_CLK_ENABLE)	
	MST_HCLK	AHB_CLK_ROOT	CCGR3[CG7] (QSPI_CLK_ENABLE)	
ROMCP	ROM_CLK	AHB_CLK_ROOT	CCGR5[CG0] (ROM_CLK_ENABLE)	
	HCLK	AHB_CLK_ROOT	CCGR5[CG0] (ROM_CLK_ENABLE)	
	HCLK_REG	IPG_CLK_ROOT	CCGR5[CG0] (ROM_CLK_ENABLE)	
	MST_HCLK	AHB_CLK_ROOT	CCGR5[CG0] (ROM_CLK_ENABLE)	
SAIn	IPG_CLK	IPG_CLK_ROOT	CCGR5[CG14] (SAI1_CLK_ENABLE) CCGR5[CG15] (SAI2_CLK_ENABLE) CCGR5[CG11] (SAI3_CLK_ENABLE)	
	IPG_CLK_S	IPG_CLK_ROOT	CCGR5[CG14] (SAI1_CLK_ENABLE) CCGR5[CG15] (SAI2_CLK_ENABLE)	

Table continues on the next page...

Table 18-3. System Clocks, Gating, and Override (continued)

Module	Module Clock	Clock Root	Module Clock Gating Enable	Module Override Enable
			CCGR5[CG11] (SAI3_CLK_ENABLE)	
	IPG_CLK_SAI_MCLK1	SAIN_CLK_ROOT	CCGR5[CG14] (SAI1_CLK_ENABLE) CCGR5[CG15] (SAI2_CLK_ENABLE) CCGR5[CG11] (SAI3_CLK_ENABLE)	
	IPT_CLK_SAI_BCLK	SAIN_CLK_ROOT	CCGR5[CG14] (SAI1_CLK_ENABLE) CCGR5[CG15] (SAI2_CLK_ENABLE) CCGR5[CG11] (SAI3_CLK_ENABLE)	
	IPT_CLK_SAI_BCLK_B	SAIN_CLK_ROOT	CCGR5[CG14] (SAI1_CLK_ENABLE) CCGR5[CG15] (SAI2_CLK_ENABLE) CCGR5[CG11] (SAI3_CLK_ENABLE)	
	IPT_CLK_SAI_MCLK	SAIN_CLK_ROOT	CCGR5[CG14] (SAI1_CLK_ENABLE) CCGR5[CG15] (SAI2_CLK_ENABLE) CCGR5[CG11] (SAI3_CLK_ENABLE)	
SDMA	IPS_HOSTCTRL_CLK	IPG_CLK_ROOT	CCGR5[CG3] (SDMA_CLK_ENABLE)	
	SDMA_AP_AHB_CLK	AHB_CLK_ROOT	CCGR5[CG3] (SDMA_CLK_ENABLE)	
	SDMA_CORE_CLK	IPG_CLK_ROOT	CCGR5[CG3] (SDMA_CLK_ENABLE)	
	EVENTS_SYNC_CLK	AHB_CLK_ROOT	CCGR5[CG3] (SDMA_CLK_ENABLE)	
SNVS	HP_IPG_CLK	IPG_CLK_ROOT	CCGR5[CG9] (SNVS_HP_CLK_ENABLE)	
	HP_IPG_CLK_S	IPG_CLK_ROOT	CCGR5[CG9] (SNVS_HP_CLK_ENABLE)	
	HP_IPG_HP_RTC_CLK	CKIL_SYNC_CLK_ROOT		
	LP_IPG_CLK	IPG_CLK_ROOT	CCGR5[CG10] (SNVS_LP_CLK_ENABLE)	

Table continues on the next page...

Table 18-3. System Clocks, Gating, and Override (continued)

Module	Module Clock	Clock Root	Module Clock Gating Enable	Module Override Enable
	IPG_DRYICE_CLK_S	IPG_CLK_ROOT	CCGR5[CG2] (SNVS_DRYICE_CLK_ENABLE)	
	LP_IPG_CLK_S	IPG_CLK_ROOT	CCGR5[CG10] (SNVS_LP_CLK_ENABLE)	
SPBA	IPG_CLK	IPG_CLK_ROOT	CCGR5[CG6] (SPBA_CLK_ENABLE)	
	IPG_CLK_S	IPG_CLK_ROOT	CCGR5[CG6] (SPBA_CLK_ENABLE)	
	DISP_IPG_CLK	IPG_CLK_ROOT	CCGR5[CG6] (SPBA_CLK_ENABLE)	
	DISP_IPG_CLK_S	IPG_CLK_ROOT	CCGR5[CG6] (SPBA_CLK_ENABLE)	
SPDIF	GCLKW_T0	IPG_CLK_ROOT	CCGR5[CG7] (SPDIF_CLK_ENABLE)	
	IPG_CLK_S	IPG_CLK_ROOT		
	TX_CLK	SPDIF0_CLK_ROOT	CCGR5[CG7] (SPDIF_CLK_ENABLE)	
SRC	IPG_CLK	IPG_CLK_ROOT		
	SRC_IPG_CLK_S	IPG_CLK_ROOT		
SYS_CTR	SYS_CTR_BASE_CLK	24M OSC	CCGR5[CG1] (SCTR_CLK_ENABLE)	
	SYS_CTR_SLOW_CLK	32K OSC		
	IPG_CLK	IPG_CLK_ROOT	CCGR5[CG1] (SCTR_CLK_ENABLE)	
	IPG_CLK_S	IPG_CLK_ROOT	CCGR5[CG1] (SCTR_CLK_ENABLE)	
TZASC _n	ACLK	MMDC_CLK_ROOT	CCGR2[CG11] (IPSYNC_IP2APB_TZASC1_IPG_MASTER_CLK_ENABLE)	
TSC_DIG	IPG_CLK_S	IPG_CLK_ROOT	CCGR4[CG5] (TSC_CLK_ENABLE)	
	IPG_CLK	IPG_CLK_ROOT	CCGR4[CG5] (TSC_CLK_ENABLE)	
	LP_CLK	CKIL_SYNC_CLK_ROOT		
UART _n	IPG_CLK	IPG_CLK_ROOT	CCGR5[CG12] (UART1_CLK_ENABLE) CCGR0[CG14] (UART2_CLK_ENABLE) CCGR1[CG5] (UART3_CLK_ENABLE) CCGR1[CG12] (UART4_CLK_ENABLE)	

Table continues on the next page...

Table 18-3. System Clocks, Gating, and Override (continued)

Module	Module Clock	Clock Root	Module Clock Gating Enable	Module Override Enable
			CCGR3[CG1] (UART5_CLK_ENABLE) CCGR3[CG3] (UART6_CLK_ENABLE) CCGR5[CG13] (UART7_CLK_ENABLE) CCGR6[CG7] (UART8_CLK_ENABLE)	
	IPG_CLK_S	IPG_CLK_ROOT	CCGR5[CG12] (UART1_CLK_ENABLE) CCGR0[CG14] (UART2_CLK_ENABLE) CCGR1[CG5] (UART3_CLK_ENABLE) CCGR1[CG12] (UART4_CLK_ENABLE) CCGR3[CG1] (UART5_CLK_ENABLE) CCGR3[CG3] (UART6_CLK_ENABLE) CCGR5[CG13] (UART7_CLK_ENABLE) CCGR6[CG7] (UART8_CLK_ENABLE)	
	IPG_PERCLK	UART_CLK_ROOT	CCGR5[CG12] (UART1_CLK_ENABLE) CCGR0[CG14] (UART2_CLK_ENABLE) CCGR1[CG5] (UART3_CLK_ENABLE) CCGR1[CG12] (UART4_CLK_ENABLE) CCGR3[CG1] (UART5_CLK_ENABLE) CCGR3[CG3] (UART6_CLK_ENABLE) CCGR5[CG13] (UART7_CLK_ENABLE) CCGR6[CG7] (UART8_CLK_ENABLE)	
USB	IPG_AHB_CLK	AHB_CLK_ROOT	CCGR6[CG0] (USBOH3_CLK_ENABLE)	
	IPG_CLK_32KHZ	CKIL_SYNC_CLK_ROOT		

Table continues on the next page...

Table 18-3. System Clocks, Gating, and Override (continued)

Module	Module Clock	Clock Root	Module Clock Gating Enable	Module Override Enable
	IPG_CLK_S	IPG_CLK_ROOT	CCGR6[CG0] (USBOH3_CLK_ENABLE)	
	IPG_CLK_S_PL301	IPG_CLK_ROOT	CCGR6[CG0] (USBOH3_CLK_ENABLE)	
	TEST_CLK_240M	IPG_CLK_ROOT	CCGR6[CG0] (USBOH3_CLK_ENABLE)	
	TEST_CLK_480M	IPG_CLK_ROOT	CCGR6[CG0] (USBOH3_CLK_ENABLE)	
	TEST_CLK_60M	IPG_CLK_ROOT	CCGR6[CG0] (USBOH3_CLK_ENABLE)	
USDHC _n	HCLK	AHB_CLK_ROOT	CCGR6[CG1] (USDHC1_CLK_ENABLE) CCGR6[CG2] (USDHC2_CLK_ENABLE)	CMEOR[MOD_EN_OV_U SDHC]
	IPG_CLK	IPG_CLK_ROOT	CCGR6[CG1] (USDHC1_CLK_ENABLE) CCGR6[CG2] (USDHC2_CLK_ENABLE)	CMEOR[MOD_EN_OV_U SDHC]
	IPG_CLK_PERCLK	USDHC _n _CLK_ROOT	CCGR6[CG1] (USDHC1_CLK_ENABLE) CCGR6[CG2] (USDHC2_CLK_ENABLE)	CMEOR[MOD_EN_OV_U SDHC]
	IPG_CLK_S	IPG_CLK_ROOT	CCGR6[CG1] (USDHC1_CLK_ENABLE) CCGR6[CG2] (USDHC2_CLK_ENABLE)	
WDOG _n	IPG_CLK	IPG_CLK_ROOT	CCGR3[CG8] WDOG1_CLK_ENABLE CCGR5[CG5] WDOG2_CLK_ENABLE CCGR6[CG10] WDOG3_CLK_ENABLE	
	IPG_CLK_32K	CKIL_SYNC_CLK_ROOT		
	IPG_CLK_S	IPG_CLK_ROOT	CCGR3[CG8] WDOG1_CLK_ENABLE CCGR5[CG5] WDOG2_CLK_ENABLE CCGR6[CG10] WDOG3_CLK_ENABLE	

Table 18-4. System Clock Frequency Values

Clock Root	Default Frequency (MHz)	Maximum Frequency (MHz)
ARM_CLK_ROOT	12	528

Table continues on the next page...

Table 18-4. System Clock Frequency Values (continued)

Clock Root	Default Frequency (MHz)	Maximum Frequency (MHz)
MMDC_CLK_ROOT	24	396
FABRIC_CLK_ROOT		
AXI_CLK_ROOT	12	264
AHB_CLK_ROOT	6	132
PERCLK_CLK_ROOT	3	66
IPG_CLK_ROOT	3	66
USDHCn_CLK_ROOT	12	198
ACLK_EIM_SLOW_CLK_ROOT	6	132
SPDIF0_CLK_ROOT	1.5	66.6
SAIn_CLK_ROOT	3	66.6
LCDIF_CLK_ROOT	6	150
EPDC_CLK_ROOT	12	264
QSPI_CLK_ROOT	12	396
ENFC_CLK_ROOT	12	198
CAN_CLK_ROOT	1.5	80
ECSPI_CLK_ROOT	3	60
UART_CLK_ROOT	4	80

NOTE

The default frequency is reset value after system power on reset. It is different with the value initialized by ROM code, which depends on boot CFG pins/fuse setting.

18.5 Functional Description

This section provides a complete functional description of the block.

18.5.1 Clock Generation

18.5.1.1 External Low Frequency Clock - CKIL

The chip can use a 32 kHz or 32.768 kHz crystal as the external low-frequency source (XTALOSC). Throughout this chapter, the low-frequency crystal is referred to as the 32 kHz crystal.

This clock source should always be active when the chip is powered on. The 32 kHz entering the CCM are referred to as CKIL. CKIL is synchronized to IPG_CLK and supplied to modules that need it.

18.5.1.1.1 CKIL synchronizing to IPG_CLK

CKIL is synchronized to ipg_clk when the system is in functional mode. When the system is in STOP mode (when there is no IPG_CLK) the CKIL synchronizer is bypassed, and raw CKIL is supplied to the system.

18.5.1.2 External High Frequency Clock - CKIH and internal oscillator

The chip uses an internal oscillator to generate the reference clock (OSC). The internal oscillator is connected to the external crystal (XTALOSC) which generates the 24 MHz reference clock.

18.5.1.3 PLL reference clock

There are several PLLs in this chip.

PLL1 - ARM PLL (typical functional frequency)

PLL2 - System PLL (functional frequency 528 MHz)

PLL3 - USB1 PLL (functional frequency 480 MHz)

PLL4 - Audio PLL

PLL5 - Video PLL

PLL6 - ENET PLL

PLL7 - USB2 PLL (functional frequency 480 MHz)

Some of the PLLs are described in the sections below. See [CCM Analog Memory Map/ Register Definition](#) for register information.

18.5.1.3.1 ARM PLL

This PLL synthesizes a low jitter clock from a 24 MHz reference clock. The clock output frequency for this PLL ranges from 650 MHz to 1.3 GHz. The output frequency is selected by a 7-bit register field CCM_ANALOG_PLL_ARM[DIV_SELECT].

PLL output frequency = Fref * DIV_SEL/2

NOTE

The upper frequency range may exceed the maximum frequency supported. Please see the datasheet for more information.

18.5.1.3.2 USB PLLs

These PLLs synthesize a low jitter clock from the 24 MHz reference clock. USB1 PLL has 4 frequency-programmable PFD (phase fractional divider) outputs.

The output frequency of USB1 PLL is 480 MHz. Even though USB1 PLL has a DIV_SELECT register field, this PLL should always be set to 480 MHz in normal operation. USB2 PLL is only used by the USB UTM interface through a direct connection.

18.5.1.3.3 System PLL

This PLL synthesizes a low jitter clock from the 24 MHz reference clock. The PLL has one output clock, plus 4 PFD outputs. The System PLL supports spread spectrum modulation for use in applications to minimize radiated emissions. The spread spectrum PLL output clock is frequency modulated so that the energy is spread over a wider bandwidth, thereby reducing peak radiated emissions. Due to this feature support, the associated lock time of this PLL is longer than other PLLs in the SoC that do not support spread spectrum modulation.

Spread spectrum operation is controlled by configuring the CCM_ANALOG_PLL_SYS_SS register. When enabled, the PLL output frequency will decrease by the amount defined in the STEP field, until it reaches the limiting frequency in the STOP field. The frequency will then similarly return to the original nominal frequency. The following equations control the spread-spectrum operation:

$$\text{Spread spectrum range} = \text{Fref} \times \frac{\text{CCM_ANALOG_PLL_SYS_SS[STOP]}}{\text{CCM_ANALOG_PLL_SYS_DENOM[B]}}$$

$$\text{Modulation frequency} = \text{Fref} \times \frac{\text{CCM_ANALOG_PLL_SYS_SS[STEP]}}{2 \times \text{CCM_ANALOG_PLL_SYS_SS[STOP]}}$$

Although this PLL does have a DIV_SELECT register field, it is intended that this PLL will only be run at the default frequency of 528 MHz.

18.5.1.3.4 Audio / Video PLL

The audio PLL and video PLL each synthesize a low jitter clock from a 24 MHz reference clock. The clock output frequency range for this PLL is from 650 MHz to 1.3 GHz. It has a Fractional-N synthesizer.

There are /1, /2, /4, /8, /16 post dividers for the Video PLL and /1, /2, /4, /8, /16 post dividers for the Audio PLL. The output frequency can be set by programming the fields in the CCM_ANALOG_PLL_AUDIO, CCM_ANALOG_PLL_VIDEO, and CCM_ANALOG_MISC2 register sets according to the following equation.

PLL output frequency = Fref * (DIV_SELECT + NUM/DENOM)

18.5.1.3.5 Ethernet PLL

This PLL synthesizes a low jitter clock from the 24 MHz reference clock.

The reference clocks generated by this PLL are:

- ref_enetpll0 programmable to 25, 50, 100 and 125 MHz by setting CCM_ANALOG_PLL_ENET[DIV_SELECT] bitfield
- ref_enetpll1 programmable to 25, 50, 100 and 125 MHz by setting CCM_ANALOG_PLL_ENET[DIV_SELECT] bitfield
- ref_enetpll2 fixed at 25 MHz

18.5.1.4 Phase Fractional Dividers (PFD)

There are several PFD outputs from the System PLL and USB1 PLL.

Each PFD output generates a fractional multiplication of the associated PLL's VCO frequency. Where the output frequency is equal to $F_{vco} * 18/N$, N can range from 12-35. The PFDs allow for clock frequency changes without forcing the relock of the root PLL. This feature is useful in support of dynamic voltage and frequency scaling (DVFS). See [CCM Analog Memory Map/Register Definition](#).

When the related PLL is powered up from the power down state or made to go through a relock cycle due to PLL reprogramming, it is required that the related PFDx_CLKGATE bit in CCM_ANALOG_PFD_480n or CCM_ANALOG_PFD_528n, be cycled on and off (1 to 0) after PLL lock. The PFDs can be in the clock gated state during PLL relock but must be un-clock gated only after lock is achieved. See the engineering bulletin, *Configuration of Phase Fractional Dividers (EB790)* at www.nxp.com for procedure details.

18.5.1.5 CCM internal clock generation

The clock generation is comprised of two sub-modules:

CCM_CLK_SWITCHER

CCM_CLK_ROOT_GEN

18.5.1.5.1 Clock Switcher

The Clock Switcher (CCM_CLK_SWITCHER) sub-module receives the PLL output clocks and the PLL bypass clocks.

[Figure 18-4](#) describes the generation of the three switcher clocks.

The figure also includes the Frequency Switch Control sub-module responsible for frequency change.

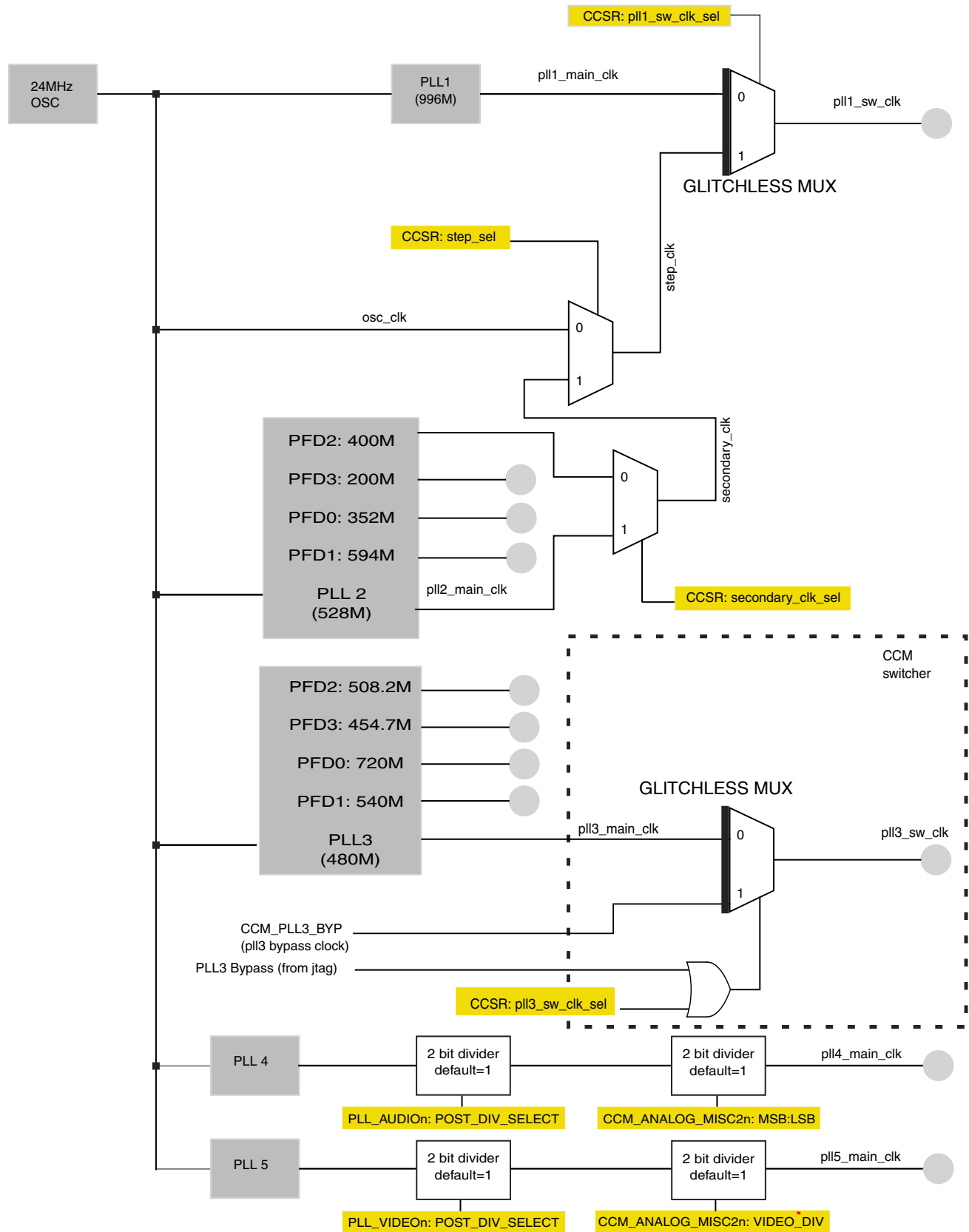

Figure 18-4. Switcher clock generation

18.5.1.5.2 PLL bypass procedure

In addition to PLL bypass options in CCM_ANALOG module, switcher and clk_root_gen sub-modules includes capability for each of the PLL clocks to be bypassed with an external bypass clock.

18.5.1.5.3 PLL clock change

In order to modify or stop the clock output of a specific PLL, all the clocks generated from the current PLL must be transitioned to the new PLL whose frequency is not being modified.

For clocks which can't be stopped (core and bus clocks), this should be done via the glitchless mux. Before changing the PLL setting, power it down. Power up the PLL after the change. See [Disabling / Enabling PLLs](#) for more information.

18.5.1.5.4 Clock Root Generator

The Clock Root Generator (CCM_CLK_ROOT_GEN) sub-module generates the root clocks to be delivered to LPCG.

The following figures describe clock generation. The frequencies in parantheses are the default typical frequencies.

Functional Description

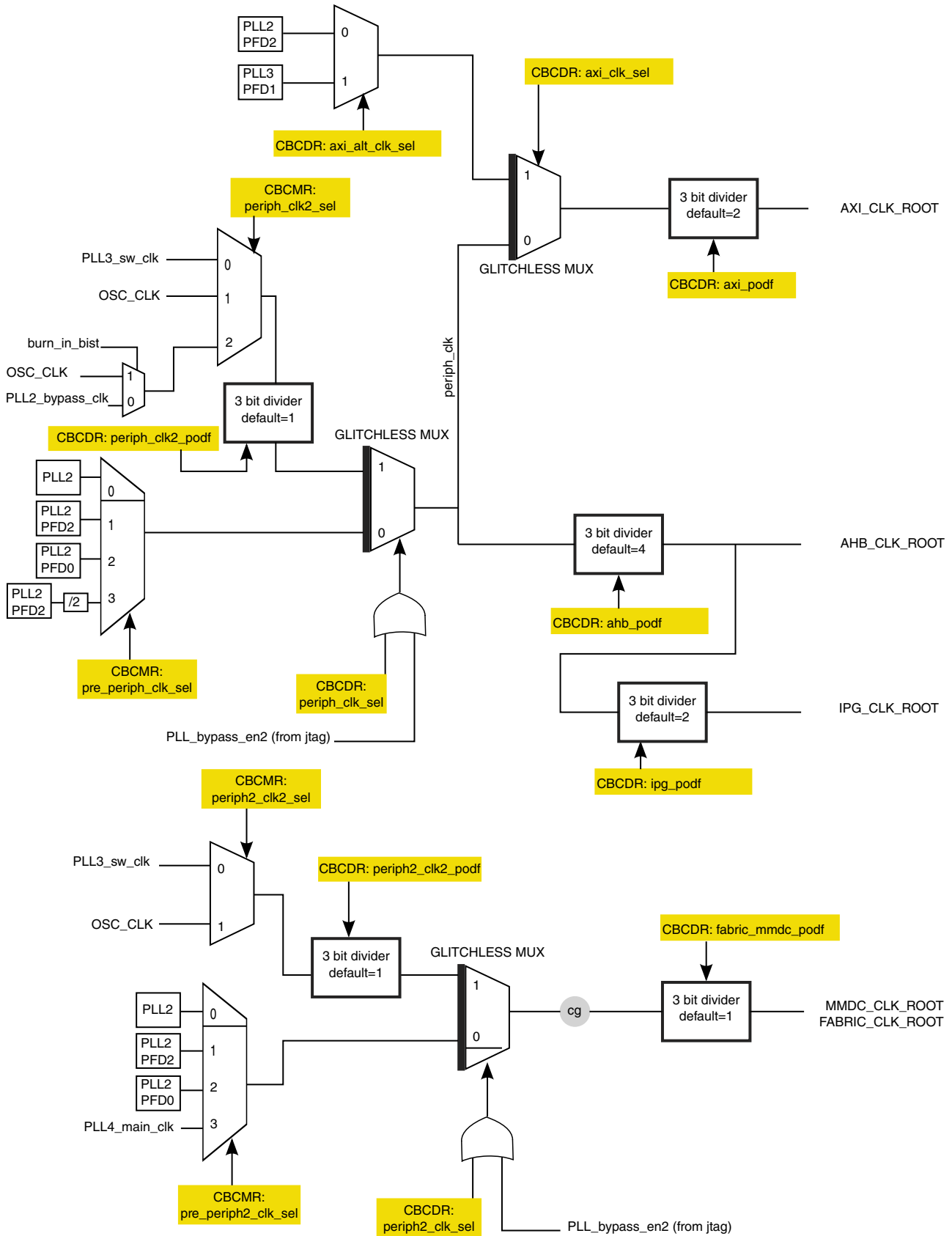

Figure 18-5. BUS clock generation

NOTE

All 6-bit PODF dividers found in the diagrams above can operate on low frequency.

18.5.1.5.5 Initial values controlled by the System JTAG Controller (SJC).

The initial values of the following dividers and muxes can be controlled by SJC.

In regular functional mode, the SJC will drive the reset values stated in the CCM register memory map. If SJC is programmed to change those values, then the reset value for those dividers/muxes will be taken from the SJC programability.

Software can update the changed reset value after reset sequence. The control signals and the dividers/muxes are listed below:

- [2:0] init_periph2_clk2_podf
- [1:0] init_ipg_podf
- [2:0] init_ahb_podf
- [2:0] init_axi_podf
- [2:0] init_periph_clk2_podf
- init_periph_clk_sel
- init_periph2_clk_sel

18.5.1.5.6 Divider change handshake

Modifying the following dividers will start the handshake with MMDC.

- mmdc_podf
- periph_clk_sel
- periph2_clk_sel
- arm_podf
- ahb_podf

The dividers listed above are designed with a handshake. For dividers without a handshake design, the following sequence must be performed when updating PODF value:

1. Gate the output clock off before updating PODF value.
2. Gate the output clock on after the PODF value is updated and stable.

To update the PODF value without gating the output clock off will cause unpredictable results such as no clock output.

18.5.1.6 Disabling / Enabling PLLs

PLL disabling and enabling is done via analog module.

Before disabling a PLL using the analog registers, software should first move all the clocks generated from that specific PLL to another source. This alternate source could be another PLL, or a PFD driven by another PLL. Alternatively, software can bypass the PLL and use the PLL reference clock (usually 24 MHz) as the output clock. Bypassing the PLL is done by setting the analog BYPASS bit in the control register for that PLL.

18.5.1.7 Clock Switching Multiplexers

There are a multitude of multiplexers available throughout the clock generation logic that provide alternate clock sources for the system clocks controlled by the CCM. The CCM uses several synchronous glitchless clock multiplexers as well as asynchronous glitchy clock multiplexers.

Synchronous muxes ensure there are no glitches between the transition of two asynchronous clocks and that there will be no pulses that are of a frequency higher than either input clock. For the synchronous multiplexer to work properly, both the current clock and the clock to be selected must remain active during the entire selection process.

There are five glitchless (synchronous) muxes used in the CCM. The table below lists the muxes and the respective control bits.

Table 18-5. Glitchless Multiplexers

Glitchless Mux	Mux Select Bit	Handshake Bit
periph_clk_mux	CBCDR[periph_clk_sel]	CDHIPR[periph_clk_sel_busy]
periph2_clk_mux	CBCDR[periph2_clk_sel]	CDHIPR[periph2_clk_sel_busy]
axi_alt_clk_mux	CBCDR[axi_sel]	
pll3_sw_clk_mux	CCSR[pll3_sw_clk_sel]	
pll1_sw_clk_mux	CCSR[pll1_sw_clk_sel]	

NOTE

Any change of the `periph_clk_sel` and `periph2_clk_sel` sync mux select will involve handshake with the MMDC. Refer to the CCDCR and CDHIPR registers for the handshake bypass and busy bits.

For critical system bus clocks, changing the clock source can be done in the CCM using the glitchless clock muxes in [Figure 18-5](#). In the figure, the thick bar on the input side indicates the glitchless muxes. Those without the thick bar are regular muxes (not glitchless).

For example, before disabling PLL2, software can switch the FABRIC_CLK_ROOT away from the PLL2 or one of its PFDs by programming CBCMR[PERIPH2_CLK2_SEL] and CBCDR[PERIPH2_CLK2_PODF] to provide an appropriate frequency clock, then glitchlessly switch to it by programming CBCDR[PERIPH2_CLK_SEL].

Asynchronous multiplexers or glitchy multiplexers, allow the clock to switch immediately after the multiplexer select changed. This immediate switch of two asynchronous clock domains can cause the output clock to glitch. Since both clock sources to the mux are asynchronous, switching the clocks from one source to the other can cause a glitch to be generated, regardless of the input clock source.

The output clocks to the mux are required to be gated before switching the source clock in the CCM clock mux. If the output clocks are not gated, clock glitches can propagate to the logic that follows the clock mux, causing the logic to behave unpredictably.

For serial clocks, software should first disable the module, then gate its clock in the LPCG. Then it should move the mux controlling the source of the clocks to another PLL, and reset the module and its clocks. Only then is it safe to disable the PLL. The mux for the serial clocks is not glitchless.

18.5.1.8 Low Power Clock Gating module (LPCG)

The LPCG module receives the root clocks and splits them to clock branches for each module. The clock branches are gated clocks.

The enables for those gates can come from four sources:

1. Clock enable signal from CCM - this signal is generated by configuring of the CGR bits in the CCM. It is based on the low power mode.
2. Clock enable signal from the module - this signal is generated by the module based on internal logic of the module. Not every enable signal from the module is used. For used clock enable signals from the module, CCM will generate an override signal based on a programmable bit in CCM (CMEOR).
3. Clock enable signal from Reset controller (SRC) - this signal will enable the clock during the reset procedure. Please see the SRC chapter for details on the clock enable signal during reset procedure.
4. Hard-coded enable from fuse box.

Functional Description

These enable signals are ANDed to generate the enable signal for the gating cell.

The enable signal for the gating cell is synchronized with the clock it needs to gate in order to prevent glitches on the gated clock.

Notifications are generated for CCM to indicate when clock roots should be opened and closed. All notifications that correspond to the same clock root will be ORed to generate one notification signal to CCM for clock root gating.

The following figure describes the clock split inside the LPCG module. It describes the case of two modules; one module is without an enable signal and one is shown with an enable signal. SRC enable signals and sync flip flops are omitted from this figure.

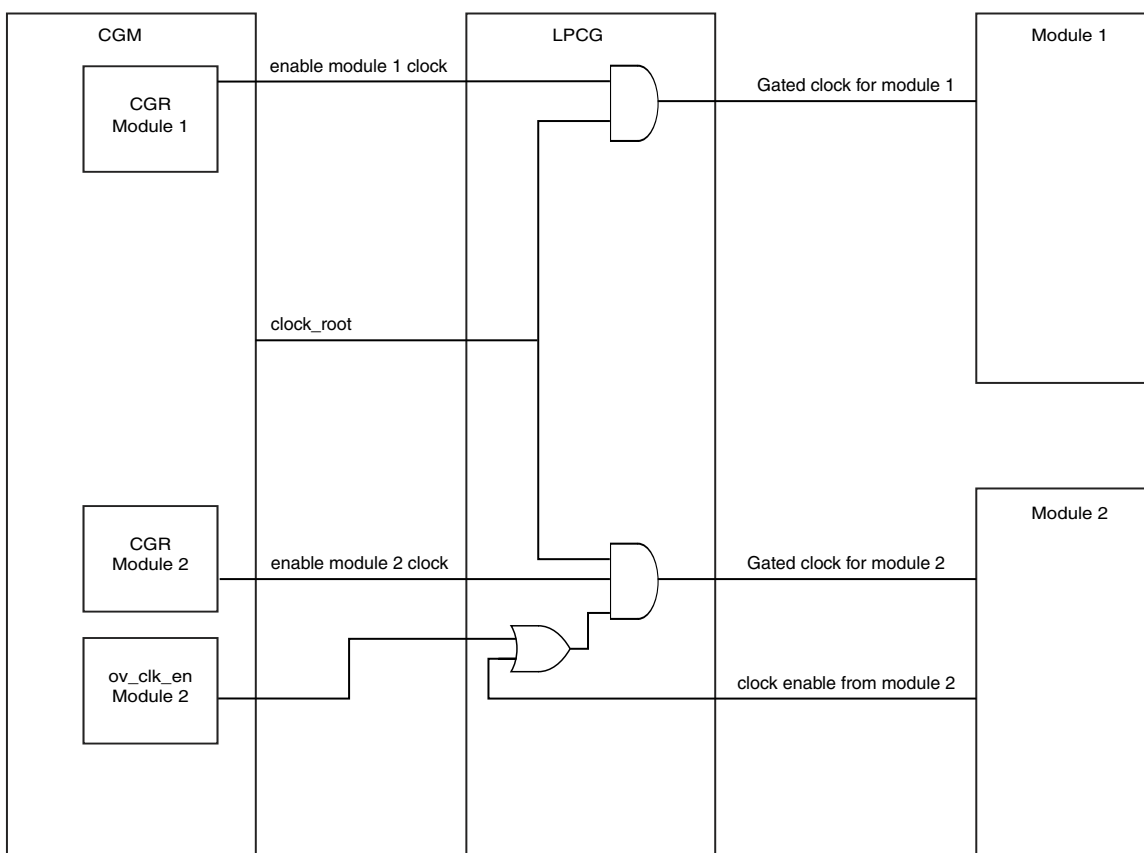

Figure 18-6. Clock split in LPCG

18.5.1.9 MMDC handshake

CCM will assert the `mmdc_freq_change_req` signal.

MMDC will assert the `mmdc_freq_change_ack` signals to acknowledge that the frequency change request has been received and that the frequency can now be changed safely.

CCM will commence the actual change of division ratio of mmdc dividers or apply mux change on root clocks once both of the non-masked acknowledgements are asserted.

NOTE

MMDC handshakes can be masked.

NOTE

Set register `CCDR[17]` to 1 before beginning any operation that initiates a handshake. It is acceptable to program and leave this override bit asserted.

18.5.2 DVFS support

When performing DVFS, the frequency shift procedure for the ARM core clock domain can be performed by software.

CPU PLL frequency and CCM ARM clock divider is controlled by CCM and CPU power domain supply voltage value is controlled by `CCM_ANALOG` module.

NOTE

The frequency should be shifted down first and then voltage value reduced, and vice-versa, when shifting the frequency up.

NOTE

`CCM_ANALOG` will not control the voltage value in Bypass mode

18.5.3 Power modes

The chip supports 3 low power modes: RUN mode, WAIT mode, STOP mode.

18.5.3.1 RUN mode

This is the normal/functional operating mode. In this mode, the CPU runs in its normal operational mode. Clocks to the modules can be gated by configuring the corresponding `CCGRx` bits.

18.5.3.2 WAIT mode

In this mode the CPU clock is gated. All other clocks are functional and can be gated by programming their CGR bits when all ARM cores are in WFI, and L2 cache and SCU are idle.

18.5.3.2.1 Entering WAIT mode

If the CLPCR[LPM] bit is set by software to WAIT mode, when CPU executes the next wait for interrupt (WFI) instruction, WAIT mode sequence will start.

As part of the WFI routine, alternative interrupt controller in GPC should be updated; the CPU platform interrupt controller will be disabled first by software and will be not functional, due to clock gating. Interrupts during WAIT mode are monitored by alternative interrupt controller.

After execution of the WFI routine, the CPU platform will assert idle signals for each component of the platform and CCM will gate clock to the platform.

The next actions can be programmed during WAIT mode:

1. CCM requests an acknowledge to close clocks to MMDC if its CGR bits indicate to close its clocks on WAIT mode, and if those clocks are not already closed in run mode. The request will be issued if the handshake is not bypassed by programming the CLPCR register. If the corresponding bits are set, the request signal will not be issued to the corresponding module and CCM will not wait for its acknowledge in the process of entering low power mode. Once CCM receives all the acknowledge signals needed, then it will enter WAIT mode.
2. Close the clocks to the modules which were defined to be shut at WAIT mode in the CCGR bits.
3. Observability to indicate WAIT mode.

NOTE

Setting MMDC CGR bits to 01 can hang the entire system since the MMDC clock and fabric clock share the same clock root.

Any enabled interrupt assertion will start the exit from WAIT mode.

18.5.3.2.2 Exiting WAIT mode

As soon as enabled interrupt is asserted, CPU supply will be restored if CPU SRPG was applied and clocks are enabled to CPU and other modules.

18.5.3.3 STOP mode

In this mode all system clocks are stopped, along with the CPU, system buses and all PLLs. Power gating can be applied for ARM platform. External supply voltage can be reduced to decrease leakage.

18.5.3.3.1 Entering STOP mode

Procedure entering STOP mode is the same, as entering WAIT mode until the moment of disabling clocks to modules. (LPM bit should be configured to STOP mode.)

After clocks to modules are gated, the following actions will be taken:

- PLLs are disabled
- CCM_PMIC_STBY_REQ asserted, if vstby bit is set
- osc_en signal is negated
- osc_pwrdsn is asserted, if sbyos bit is set

Counter will be triggered after CCM_PMIC_STBY_REQ assertion to allow to external regulator or PMIC to decrease voltage until valid voltage range. On counter completion, stop_mode signal will be asserted, that will trigger disabling analog elements in anatop.

CCM's low power state machine will remain in state STOP_GPC until STOP mode is exited.

18.5.3.3.2 Exiting STOP mode

As soon as an enabled interrupt is asserted, the CCM will begin the process of exiting STOP mode.

The following will take place:

1. If vstby bit was set, deassert PMIC_STBY_REQ to notify power management IC to change voltage from standby voltage to functional voltage.
2. If sbyos was set, and CCM closed either external oscillator or on board oscillator, then CCM will start oscillator by asserting ref_en_b signal and deasserting cosc_pwrdown signal respectively.
3. After the number of cycles of CKILs defined in stby_count bits, wait until PMIC functional voltage is ready. This is the notification from power management IC that the voltage is ready at its functional value. Only then will CCM continue the steps.
4. Start osc. If oscillator was started, wait until oscnt has finished its counting to make sure that oscillator is ready.

5. Start PLLs. Only the PLLs that were configured to be on prior to the entrance to STOP mode will be started.
6. CCM will request GPC to restore ARM power by GPC_PUP_REQ. If power was removed from the ARM platform, GPC will notify CCM by asserting signal GPC_PUP_ACK that power to ARM is back on, and its safe to exit from STOP mode. Only then will the CCM progress to the next step.
7. Once assertion of notification from src that the resets for the power gated modules has been finished, (src_power_gating_reset_done is set) negate the low power request signals to all modules and enable all module clocks including ARM clocks and CKIL sync, and return to run mode. (Clocks whose CCGR bits are not to be opened in RUN mode will not be opened; they will continued to be gated.)

Once the system is in run mode, negate signals ccm_ipg_stop and system_in_stop_mode.

18.6 CCM Memory Map/Register Definition

NOTE

The register reset values for CCM change depending on the boot configuration. See [Clocks at boot time](#) for more information.

CCM memory map

Absolute address (hex)	Register name	Width (in bits)	Access	Reset value	Section/page
20C_4000	CCM Control Register (CCM_CCR)	32	R/W	0401_167Fh	18.6.1/660
20C_4004	CCM Control Divider Register (CCM_CCDR)	32	R/W		18.6.2/661
20C_4008	CCM Status Register (CCM_CSR)	32	R	0000_0010h	18.6.3/663
20C_400C	CCM Clock Switcher Register (CCM_CCSR)	32	R/W	0000_0100h	18.6.4/664
20C_4010	CCM Arm Clock Root Register (CCM_CACRR)	32	R/W	0000_0000h	18.6.5/665
20C_4014	CCM Bus Clock Divider Register (CCM_CBCDR)	32	R/W	0001_8D00h	18.6.6/666
20C_4018	CCM Bus Clock Multiplexer Register (CCM_CBCMR)	32	R/W	2486_0324h	18.6.7/669
20C_401C	CCM Serial Clock Multiplexer Register 1 (CCM_CSCMR1)	32	R/W	0490_0080h	18.6.8/670
20C_4020	CCM Serial Clock Multiplexer Register 2 (CCM_CSCMR2)	32	R/W	0319_2C06h	18.6.9/673
20C_4024	CCM Serial Clock Divider Register 1 (CCM_CSCDR1)	32	R/W	0049_0B00h	18.6.10/674
20C_4028	CCM SAI1 Clock Divider Register (CCM_CS1CDR)	32	R/W	0EC1_02C1h	18.6.11/676
20C_402C	CCM SAI2 Clock Divider Register (CCM_CS2CDR)	32	R/W	0003_36C1h	18.6.12/678

Table continues on the next page...

CCM memory map (continued)

Absolute address (hex)	Register name	Width (in bits)	Access	Reset value	Section/page
20C_4030	CCM D1 Clock Divider Register (CCM_CDCDR)	32	R/W	33F7_1F92h	18.6.13/680
20C_4034	CCM HSC Clock Divider Register (CCM_CHSCCDR)	32	R/W	0002_9148h	18.6.14/681
20C_4038	CCM Serial Clock Divider Register 2 (CCM_CSCDR2)	32	R/W	0002_9B48h	18.6.15/682
20C_403C	CCM Serial Clock Divider Register 3 (CCM_CSCDR3)	32	R/W	0001_4841h	18.6.16/684
20C_4048	CCM Divider Handshake In-Process Register (CCM_CDHIPR)	32	R	0000_0000h	18.6.17/685
20C_4054	CCM Low Power Control Register (CCM_CLPCR)	32	R/W	0000_0079h	18.6.18/688
20C_4058	CCM Interrupt Status Register (CCM_CISR)	32	w1c	0000_0000h	18.6.19/690
20C_405C	CCM Interrupt Mask Register (CCM_CIMR)	32	R/W	FFFF_FFFFh	18.6.20/693
20C_4060	CCM Clock Output Source Register (CCM_CCOSR)	32	R/W	000A_0001h	18.6.21/695
20C_4064	CCM General Purpose Register (CCM_CGPR)	32	R/W	0000_FE62h	18.6.22/697
20C_4068	CCM Clock Gating Register 0 (CCM_CCGR0)	32	R/W	FFFF_FFFFh	18.6.23/698
20C_406C	CCM Clock Gating Register 1 (CCM_CCGR1)	32	R/W	FFFF_FFFFh	18.6.24/700
20C_4070	CCM Clock Gating Register 2 (CCM_CCGR2)	32	R/W	FC3F_FFFFh	18.6.25/702
20C_4074	CCM Clock Gating Register 3 (CCM_CCGR3)	32	R/W	FFFF_FFFFh	18.6.26/703
20C_4078	CCM Clock Gating Register 4 (CCM_CCGR4)	32	R/W	FFFF_FFFFh	18.6.27/704
20C_407C	CCM Clock Gating Register 5 (CCM_CCGR5)	32	R/W	FFFF_FFFFh	18.6.28/706
20C_4080	CCM Clock Gating Register 6 (CCM_CCGR6)	32	R/W	FFFF_FFFFh	18.6.29/707
20C_4088	CCM Module Enable Override Register (CCM_CMEOR)	32	R/W	FFFF_FFFFh	18.6.30/709

18.6.1 CCM Control Register (CCM_CCR)

The figure below represents the CCM Control Register (CCR), which contains bits to control general operation of CCM. The table below provides its field descriptions.

Address: 20C_4000h base + 0h offset = 20C_4000h

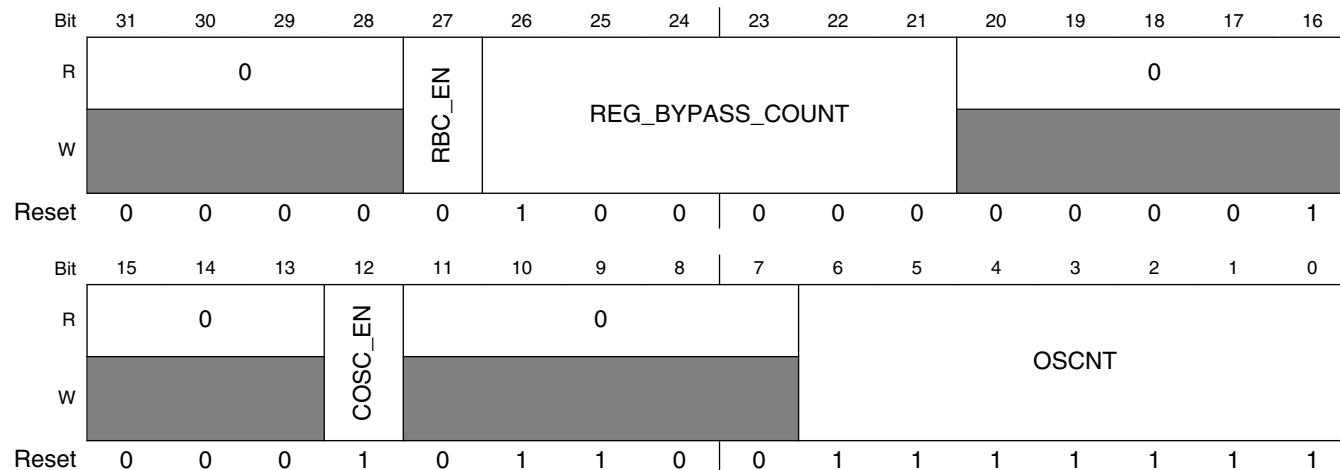

CCM_CCR field descriptions

Field	Description
31–28 Reserved	This read-only field is reserved and always has the value 0.
27 RBC_EN	Enable for REG_BYPASS_COUNTER. If enabled, analog_reg_bypass signal will be asserted after REG_BYPASS_COUNT clocks of CKIL, after standby voltage is requested. If standby voltage is not requested analog_reg_bypass won't be asserted, event if counter is enabled. 1 REG_BYPASS_COUNTER enabled. 0 REG_BYPASS_COUNTER disabled
26–21 REG_BYPASS_COUNT	Counter for analog_reg_bypass signal assertion after standby voltage request by PMIC_STBY_REQ. Should be zeroed and reconfigured after exit from low power mode. REG_BYPASS_COUNT can also be used for holding off interrupts when the PGC unit is sending signals to power gate the core. 000000 no delay 000001 1 CKIL clock period delay 111111 63 CKIL clock periods delay
20–13 Reserved	This read-only field is reserved and always has the value 0.
12 COSC_EN	On chip oscillator enable bit - this bit value is reflected on the output cosc_en. The system will start with on chip oscillator enabled to supply source for the PLLs. Software can change this bit if a transition to the bypass PLL clocks was performed for all the PLLs. In cases that this bit is changed from '0' to '1' then CCM will enable the on chip oscillator and after counting oscnt ckil clock cycles it will notify that on chip

Table continues on the next page...

CCM_CCR field descriptions (continued)

Field	Description
	oscillator is ready by a interrupt <code>cosc_ready</code> and by status bit <code>cosc_ready</code> . The <code>cosc_en</code> bit should be changed only when on chip oscillator is not chosen as the clock source. 0 disable on chip oscillator 1 enable on chip oscillator
11–7 Reserved	This field is reserved. This read-only field is reserved and always has the value 0.
OSCNT	Oscillator ready counter value. These bits define value of 32KHz counter, that serve as counter for oscillator lock time. This is used for oscillator lock time. Current estimation is ~5ms. This counter will be used in ignition sequence and in wake from stop sequence if <code>sbyos</code> bit was defined, to notify that on chip oscillator output is ready for the <code>dpll_ip</code> to use and only then the gate in <code>dpll_ip</code> can be opened. 0000000 count 1 ckil 1111111 count 128 ckil's

18.6.2 CCM Control Divider Register (CCDR)

The figure below represents the CCM Control Divider Register (CCDR), which contains bits that control the loading of the dividers that need handshake with the modules they affect. The table below provides its field descriptions.

Address: 20C_4000h base + 4h offset = 20C_4004h

Bit	31	30	29	28	27	26	25	24	23	22	21	20	19	18	17	16
R	0														MMDC_CH0_ MASK	MMDC_CH1_ MASK
W																
Reset	0	0	0	0	0	0	0	0	0	0	0	0	0	0	0	0
Bit	15	14	13	12	11	10	9	8	7	6	5	4	3	2	1	0
R	0															
W																
Reset	0	0	0	0	0	0	0	0	0	0	0	0	0	0	0	0

CCM_CCDR field descriptions

Field	Description
31–18 Reserved	This read-only field is reserved and always has the value 0.
17 MMDC_CH0_ MASK	<p>During divider ratio mmdc_ch0_axi_podf change or sync mux periph_clk_sel change (but not jtag) or SRC request during warm reset, mask handshake with mmdc_ch0 module.</p> <p>0 allow handshake with mmdc_ch0 module 1 mask handshake with mmdc_ch0. Request signal will not be generated.</p>
16 MMDC_CH1_ MASK	<p>During divider ratio mmdc_ch1_axi_podf change or sync mux periph2_clk_sel change (but not jtag) or SRC request during warm reset, mask handshake with mmdc_ch1 module.</p> <p>0 Allow handshake with mmdc_ch1 module. 1 Mask handshake with mmdc_ch1. Request signal will not be generated.</p>
Reserved	This read-only field is reserved and always has the value 0.

18.6.3 CCM Status Register (CCM_CSR)

The figure below represents the CCM status Register (CSR). The status bits are read-only bits. The table below provides its field descriptions.

Address: 20C_4000h base + 8h offset = 20C_4008h

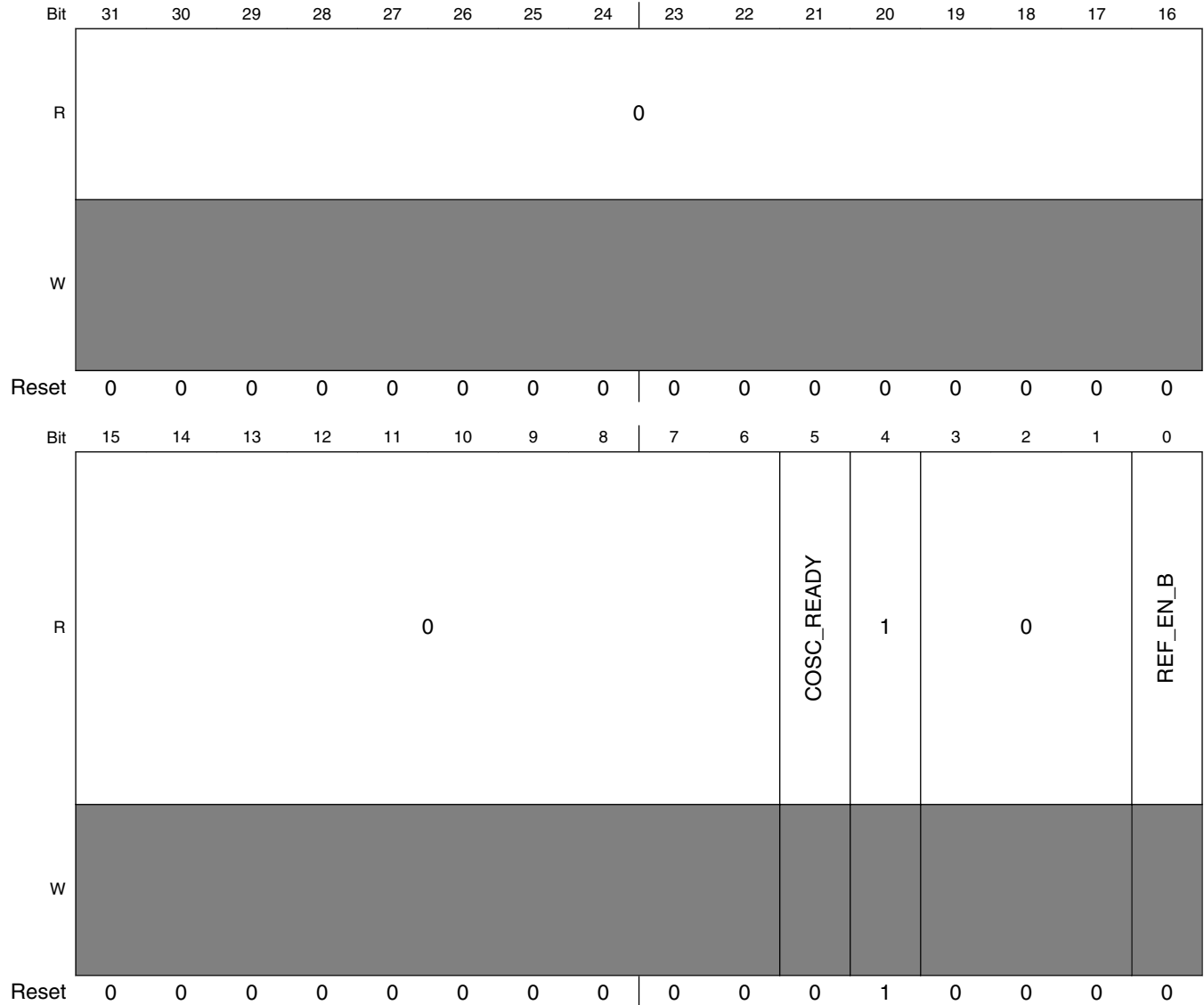

CCM_CSR field descriptions

Field	Description
31–6 Reserved	This read-only field is reserved and always has the value 0.

Table continues on the next page...

CCM_CSR field descriptions (continued)

Field	Description
5 COSCO_READY	Status indication of on board oscillator. This bit will be asserted if on chip oscillator is enabled and on chip oscillator is not powered down, and if oscnt counter has finished counting. 0 on board oscillator is not ready. 1 on board oscillator is ready.
4 Reserved	This read-only field is reserved and always has the value 1.
3-1 Reserved	This read-only field is reserved and always has the value 0.
0 REF_EN_B	Status of the value of CCM_REF_EN_B output of ccm 0 value of CCM_REF_EN_B is '0' 1 value of CCM_REF_EN_B is '1'

18.6.4 CCM Clock Switcher Register (CCM_CCSR)

The figure below represents the CCM Clock Switcher register (CCSR). The CCSR register contains bits to control the switcher sub-module dividers and multiplexers. The table below provides its field descriptions.

Address: 20C_4000h base + Ch offset = 20C_400Ch

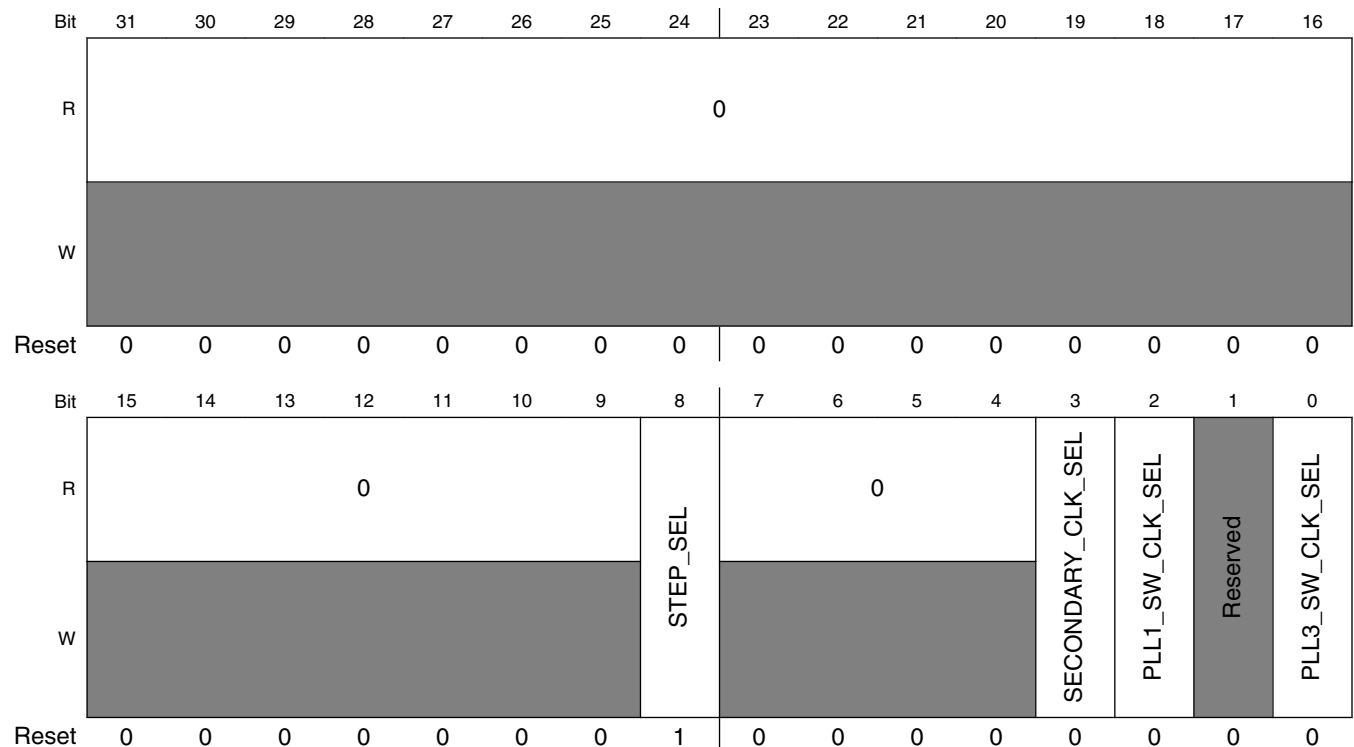

CCM_CCSR field descriptions

Field	Description
31–9 Reserved	This read-only field is reserved and always has the value 0.
8 STEP_SEL	Selects the option to be chosen for the step frequency when shifting ARM frequency. This will control the step_clk. NOTE: This mux is allowed to be changed only if its output is not used, i.e. ARM uses the output of pll1, and step_clk is not used. 0 derive clock from osc_clk (24M) - source for lp_apm. 1 derive clock from secondary_clk
7–4 Reserved	This read-only field is reserved and always has the value 0.
3 SECONDARY_CLK_SEL	Select source to generate secondary_clk 0 PLL2 PFD2 (400 M) 1 PLL2 (528 M)
2 PLL1_SW_CLK_SEL	Selects source to generate pll1_sw_clk. 0 pll1_main_clk 1 step_clk
1 -	This field is reserved. Reserved
0 PLL3_SW_CLK_SEL	Selects source to generate pll3_sw_clk. This bit should only be used for testing purposes. 0 pll3_main_clk 1 pll3 bypass clock

18.6.5 CCM Arm Clock Root Register (CCM_CACRR)

The figure below represents the CCM Arm Clock Root register (CACRR). The CACRR register contains bits to control the ARM clock root generation. The table below provides its field descriptions.

Address: 20C_4000h base + 10h offset = 20C_4010h

Bit	31	30	29	28	27	26	25	24	23	22	21	20	19	18	17	16	15	14	13	12	11	10	9	8	7	6	5	4	3	2	1	0
R	0																ARM_		PODF													
W																																
Reset	0	0	0	0	0	0	0	0	0	0	0	0	0	0	0	0	0	0	0	0	0	0	0	0	0	0	0	0	0	0	0	0

CCM_CACRR field descriptions

Field	Description
31–3 Reserved	This read-only field is reserved and always has the value 0.
ARM_PODF	<p>Divider for ARM clock root.</p> <p>NOTE: If arm_freq_shift_divider is set to '1' then any new write to arm_podf will be held until arm_clk_switch_req signal is asserted.</p> <p>NOTE: arm_podf should be >= 3 if fuse bit CPU_SPEED_LIMIT is set.</p> <p>000 divide by 1 001 divide by 2 010 divide by 3 011 divide by 4 100 divide by 5 101 divide by 6 110 divide by 7 111 divide by 8</p>

18.6.6 CCM Bus Clock Divider Register (CCM_CBCDR)

The figure below represents the CCM Bus Clock Divider Register (CBCDR). The CBCDR register contains bits to control the clock generation sub module dividers. The table below provides its field descriptions.

Address: 20C_4000h base + 14h offset = 20C_4014h

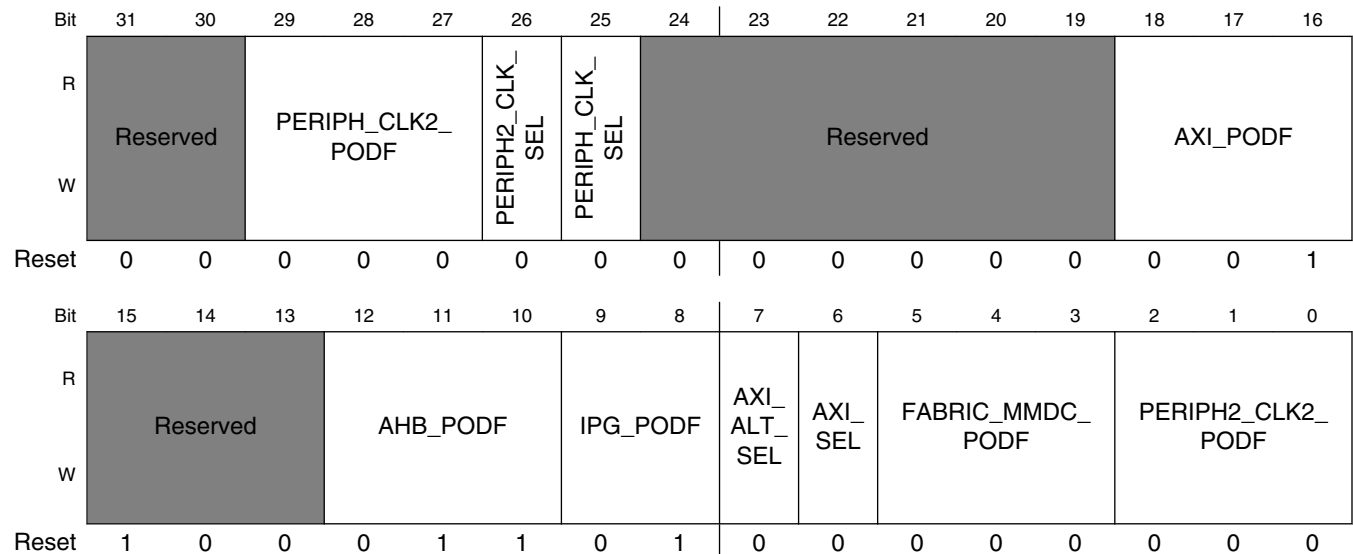

CCM_CBCDR field descriptions

Field	Description
31–30 -	This field is reserved. Reserved
29–27 PERIPH_CLK2_ PODF	Divider for periph_clk2_podf. 000 divide by 1 001 divide by 2 010 divide by 3 011 divide by 4 100 divide by 5 101 divide by 6 110 divide by 7 111 divide by 8
26 PERIPH2_CLK_ SEL	Selector for peripheral2 main clock (source of mmdc_clk_root). NOTE: Any change of this mux select will involve handshake with the MMDC. Refer to the CCCR and CDHIPR registers for the handshake bypass and busy bits. 0 PLL2 (pll2_main_clk) 1 derive clock from periph2_clk2_clk clock source.
25 PERIPH_CLK_ SEL	Selector for peripheral main clock. NOTE: Alternative clock source should be used when PLL is relocked. For PLL relock procedure pls refer to the PLL chapter. NOTE: Any change of this sync mux select will involve handshake with the MMDC. Refer to the CCCR and CDHIPR registers for the handshake bypass and busy bits. 0 PLL2 (pll2_main_clk) 1 derive clock from periph_clk2_clk clock source.
24–19 -	This field is reserved. Reserved
18–16 AXI_PODF	Divider for axi podf. NOTE: Any change of this divider might involve handshake with EMI. See CDHIPR register for the handshake busy bits. 000 divide by 1 001 divide by 2 010 divide by 3 011 divide by 4 100 divide by 5 101 divide by 6 110 divide by 7 111 divide by 8
15–13 -	This field is reserved. Reserved
12–10 AHB_PODF	Divider for AHB PODF. NOTE: Any change of this divider might involve handshake with EMI. See CDHIPR register for the handshake busy bits.

Table continues on the next page...

CCM_CBCDR field descriptions (continued)

Field	Description
	000 divide by 1 001 divide by 2 010 divide by 3 011 divide by 4 100 divide by 5 101 divide by 6 110 divide by 7 111 divide by 8
9–8 IPG_PODF	Divider for ipg podf. NOTE: SDMA module will not support ratio of 1:3 and 1:4 for ahb_clk:ipg_clk. In case SDMA is used, then those ratios should not be used. 00 divide by 1 01 divide by 2 10 divide by 3 11 divide by 4
7 AXI_ALT_SEL	AXI alternative clock select 0 PLL2 PFD2 will be selected as alternative clock for AXI root clock 1 PLL3 PFD1 will be selected as alternative clock for AXI root clock
6 AXI_SEL	AXI clock source select 0 Periph_clk output will be used as AXI clock root 1 AXI alternative clock will be used as AXI clock root
5–3 FABRIC_MMDC_PODF	Post divider for fabric / mmdc clock. 000 divide by 1 001 divide by 2 010 divide by 3 011 divide by 4 100 divide by 5 101 divide by 6 110 divide by 7 111 divide by 8
PERIPH2_CLK2_PODF	Divider for periph2_clk2 podf. NOTE: Divider should be updated when output clock is gated. 000 divide by 1 001 divide by 2 010 divide by 3 011 divide by 4 100 divide by 5 101 divide by 6 110 divide by 7 111 divide by 8

18.6.7 CCM Bus Clock Multiplexer Register (CCM_CBCMR)

The figure below represents the CCM Bus Clock Multiplexer Register (CBCMR). The CBCMR register contains bits to control the multiplexers that generate the bus clocks. The table below provides its field descriptions.

NOTE

Any change on the above multiplexer will have to be done while the module that its clock is affected is not functional and the respective clock is gated in LPCG. If the change will be done during operation of the module, then it is not guaranteed that the modules operation will not be harmed.

The change for arm_clk_sel should be done through sdma so that ARM will not use this clock during the change and the clock will be gated in LPCG.

Address: 20C_4000h base + 18h offset = 20C_4018h

Bit	31	30	29	28	27	26	25	24	23	22	21	20	19	18	17	16
R	Reserved						LCDIF1_PODF		PRE_PERIPH2_CLK_SEL		PERIPH2_CLK2_SEL	PRE_PERIPH_CLK_SEL		Reserved		
W	Reserved						LCDIF1_PODF		PRE_PERIPH2_CLK_SEL		PERIPH2_CLK2_SEL	PRE_PERIPH_CLK_SEL		Reserved		
Reset	0	0	1	0	0	1	0	0	1	0	0	0	0	1	1	0
Bit	15	14	13	12	11	10	9	8	7	6	5	4	3	2	1	0
R	Reserved		PERIPH_CLK2_SEL		Reserved											
W	Reserved		PERIPH_CLK2_SEL		Reserved											
Reset	0	0	0	0	0	0	1	1	0	0	1	0	0	1	0	0

CCM_CBCMR field descriptions

Field	Description
31–26 -	This field is reserved. Reserved
25–23 LCDIF1_PODF	Post-divider for LCDIF1 clock. 000 divide by 1 001 divide by 2 010 divide by 3 011 divide by 4 100 divide by 5

Table continues on the next page...

CCM_CBCMR field descriptions (continued)

Field	Description
	101 divide by 6 110 divide by 7 111 divide by 8
22–21 PRE_PERIPH2_ CLK_SEL	Selector for pre_periph2 clock multiplexer 00 derive clock from PLL2 01 derive clock from PLL2 PFD2 10 derive clock from PLL2 PFD0 11 derive clock from PLL4
20 PERIPH2_CLK2_ SEL	Selector for periph2_clk2 clock multiplexer 0 derive clock from pll3_sw_clk 1 derive clock from OSC
19–18 PRE_PERIPH_ CLK_SEL	Selector for pre_periph clock multiplexer 00 derive clock from PLL2 01 derive clock from PLL2 PFD2 10 derive clock from PLL2 PFD0 11 derive clock from divided (/2) PLL2 PFD2
17–14 -	This field is reserved. Reserved
13–12 PERIPH_CLK2_ SEL	Selector for peripheral clk2 clock multiplexer 00 derive clock from pll3_sw_clk 01 derive clock from osc_clk (pll1_ref_clk) 10 derive clock from pll2_bypass_clk 11 reserved
-	This field is reserved. Reserved

18.6.8 CCM Serial Clock Multiplexer Register 1 (CCM_CSCMR1)

The figure below represents the CCM Serial Clock Multiplexer Register 1 (CSCMR1). The CSCMR1 register contains bits to control the multiplexers that generate the serial clocks. The table below provides its field descriptions.

NOTE

Any change on the above multiplexer will have to be done while the module that its clock is affected is not functional and the clock is gated. If the change will be done during operation of the module, then it is not guaranteed that the modules operation will not be harmed.

Address: 20C_4000h base + 1Ch offset = 20C_401Ch

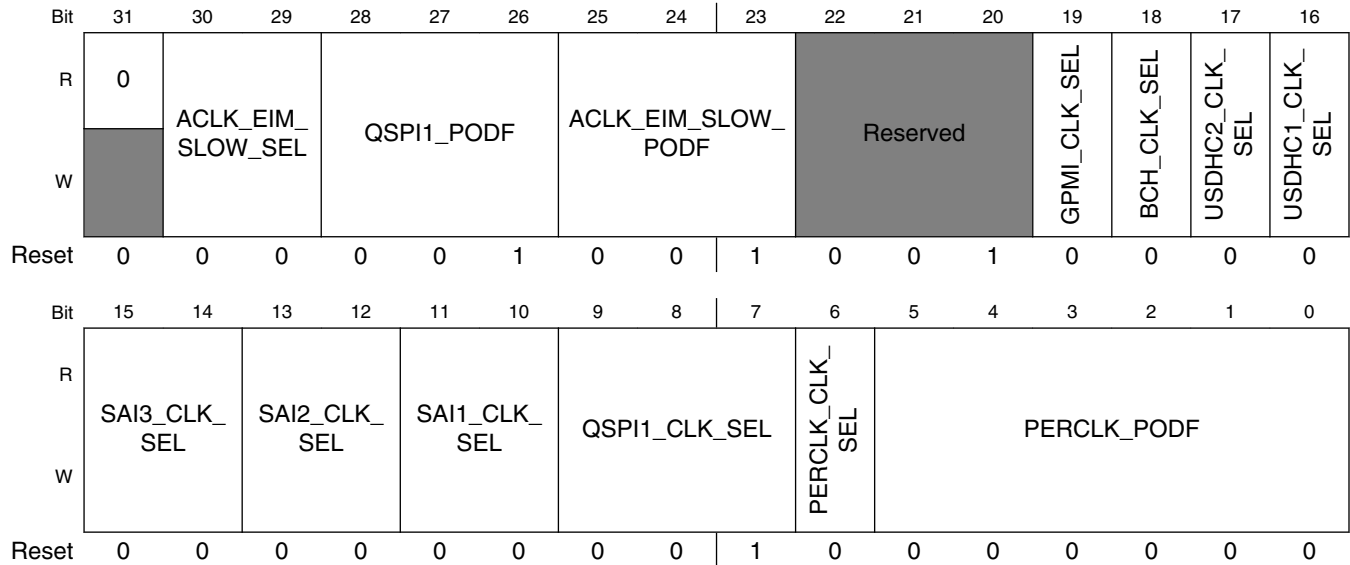

CCM_CSCMR1 field descriptions

Field	Description
31 Reserved	This read-only field is reserved and always has the value 0.
30–29 ACLK_EIM_SLOW_SEL	Selector for aclk_eim_slow root clock multiplexer 00 derive clock from AXI 01 derive clock from pll3_sw_clk 10 derive clock from PLL2 PFD2 11 derive clock from PLL3 PFD0
28–26 QSPI1_PODF	Divider for QSPI1 clock root 000 divide by 1 001 divide by 2 111 divide by 8
25–23 ACLK_EIM_SLOW_PODF	Divider for aclk_eim_slow clock root. 000 divide by 1 001 divide by 2 010 divide by 3 011 divide by 4 100 divide by 5 101 divide by 6 110 divide by 7 111 divide by 8
22–20 -	This field is reserved. Reserved
19 GPMI_CLK_SEL	Selector for gpmi clock multiplexer 0 derive clock from PLL2 PFD2 1 derive clock from PLL2 PFD0

Table continues on the next page...

CCM_CSCMR1 field descriptions (continued)

Field	Description
18 BCH_CLK_SEL	Selector for bch clock multiplexer 0 derive clock from PLL2 PFD2 1 derive clock from PLL2 PFD0
17 USDHC2_CLK_SEL	Selector for usdhc2 clock multiplexer 0 derive clock from PLL2 PFD2 1 derive clock from PLL2 PFD0
16 USDHC1_CLK_SEL	Selector for usdhc1 clock multiplexer 0 derive clock from PLL2 PFD2 1 derive clock from PLL2 PFD0
15–14 SAI3_CLK_SEL	Selector for sai3 clock multiplexer 00 derive clock from PLL3 PFD2 01 derive clock from PLL5 10 derive clock from PLL4 11 Reserved
13–12 SAI2_CLK_SEL	Selector for sai2 clock multiplexer 00 derive clock from PLL3 PFD2 01 derive clock from PLL5 10 derive clock from PLL4 11 Reserved
11–10 SAI1_CLK_SEL	Selector for sai1 clock multiplexer 00 derive clock from PLL3 PFD2 01 derive clock from PLL5 10 derive clock from PLL4 11 Reserved
9–7 QSPI1_CLK_SEL	QSPI1 clock select 000 Derive clock from PLL3 001 Derive clock from PLL2 PFD0 010 Derive clock from PLL2 PFD2 011 Derive clock from PLL2 100 Derive clock from PLL3 PFD3 101 Derive clock from PLL3 PFD2
6 PERCLK_CLK_SEL	Selector for the perclk clock multiplexor 0 derive clock from ipg clk root 1 derive clock from osc_clk
PERCLK_PODF	Divider for perclk podf. 000000 divide by 1 000001 divide by 2 000010 divide by 3 000011 divide by 4 000100 divide by 5

Table continues on the next page...

CCM_CSCMR1 field descriptions (continued)

Field	Description
000101	divide by 6
000110	divide by 7
111111	divide by 64

18.6.9 CCM Serial Clock Multiplexer Register 2 (CCM_CSCMR2)

The figure below represents the CCM Serial Clock Multiplexer Register 2 (CSCMR2). The CSCMR2 register contains bits to control the multiplexers that generate the serial clocks. The table below provides its field descriptions.

NOTE

Any change on the above multiplexer will have to be done while the module that its clock is affected is not functional and the clock is gated. If the change will be done during operation of the module, then it is not guaranteed that the modules operation will not be harmed.

Address: 20C_4000h base + 20h offset = 20C_4020h

Bit	31	30	29	28	27	26	25	24	23	22	21	20	19	18	17	16
R	Reserved											ESAI_CLK_SEL		Reserved		
W	Reserved											ESAI_CLK_SEL		Reserved		
Reset	0	0	0	0	0	0	1	1	0	0	0	1	1	0	0	1
Bit	15	14	13	12	11	10	9	8	7	6	5	4	3	2	1	0
R	Reserved				LDB_DI1_DIV	LDB_DI0_DIV	CAN_CLK_SEL		CAN_CLK_PODF					Reserved		
W	Reserved				LDB_DI1_DIV	LDB_DI0_DIV	CAN_CLK_SEL		CAN_CLK_PODF					Reserved		
Reset	0	0	1	0	1	1	0	0	0	0	0	0	0	1	1	0

CCM_CSCMR2 field descriptions

Field	Description
31–21 -	This field is reserved. Reserved
20–19 ESAI_CLK_SEL	Selector for the ESAI clock 00 derive clock from PLL4 divided clock 01 derive clock from PLL3 PFD2 clock 10 derive clock from PLL5 clock 11 derive clock from pll3_sw_clk
18–12 -	This field is reserved. Reserved

Table continues on the next page...

CCM_CSCMR2 field descriptions (continued)

Field	Description
11 LDB_DI1_DIV	Control for divider of ldb clock for di1 0 divide by 3.5 1 divide by 7
10 LDB_DI0_DIV	Control for divider of ldb clock for di0 0 divide by 3.5 1 divide by 7
9-8 CAN_CLK_SEL	Selector for FlexCAN clock multiplexer 00 derive clock from pll3_sw_clk divided clock (60M) 01 derive clock from osc_clk (24M) 10 derive clock from pll3_sw_clk divided clock (80M) 11 Disable FlexCAN clock
7-2 CAN_CLK_PODF	Divider for can clock podf. 000000 divide by 1 ... 000111 divide by 8 ... 111111 divide by 2^6
-	This field is reserved. Reserved

18.6.10 CCM Serial Clock Divider Register 1 (CCM_CSCDR1)

The figure below represents the CCM Serial Clock Divider Register 1 (CSCDR1). The CSCDR1 register contains bits to control the clock generation sub-module dividers. The table below provides its field descriptions.

NOTE

Any change on the above dividers will have to be done while the module that its clock is affected is not functional and the affected clock is gated. If the change will be done during operation of the module, then it is not guaranteed that the modules operation will not be harmed.

Address: 20C_4000h base + 24h offset = 20C_4024h

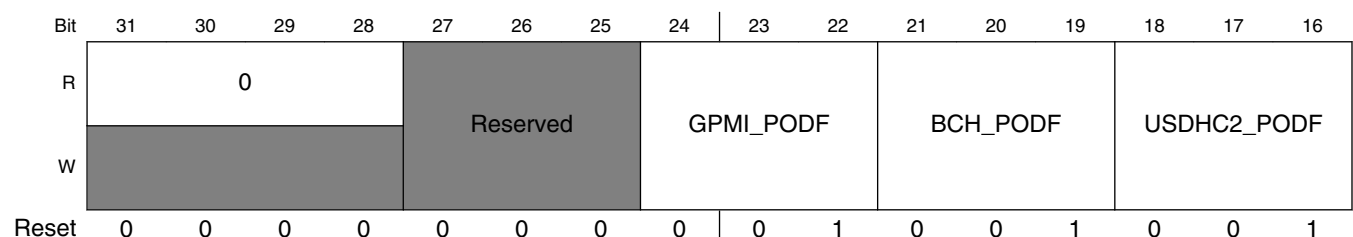

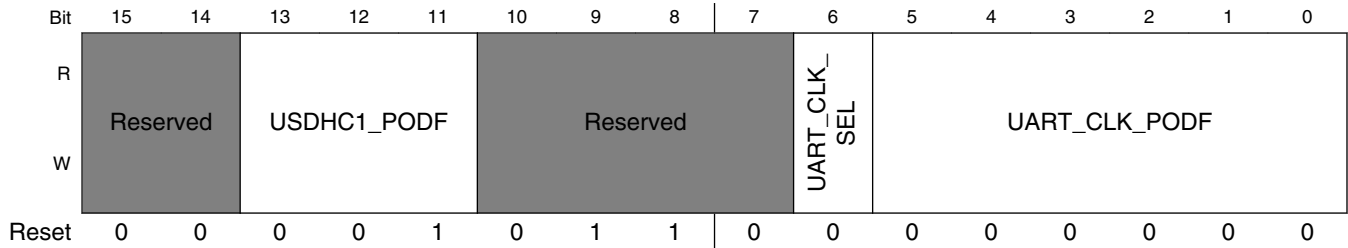

CCM_CSCDR1 field descriptions

Field	Description
31–28 Reserved	This read-only field is reserved and always has the value 0.
27–25 -	This field is reserved. Reserved
24–22 GPMI_PODF	Divider for gpmi clock pred. NOTE: Divider should be updated when output clock is gated. 000 divide by 1 001 divide by 2 010 divide by 3 011 divide by 4 100 divide by 5 101 divide by 6 110 divide by 7 111 divide by 8
21–19 BCH_PODF	Divider for bch clock podf. NOTE: Divider should be updated when output clock is gated. 000 divide by 1 001 divide by 2 010 divide by 3 011 divide by 4 100 divide by 5 101 divide by 6 110 divide by 7 111 divide by 8
18–16 USDHC2_PODF	Divider for usdhc2 clock. NOTE: Divider should be updated when output clock is gated. 000 divide by 1 001 divide by 2 010 divide by 3 011 divide by 4 100 divide by 5 101 divide by 6 110 divide by 7 111 divide by 8

Table continues on the next page...

CCM_CSCDR1 field descriptions (continued)

Field	Description
15–14 -	This field is reserved. Reserved
13–11 USDHC1_PODF	Divider for usdhc1 clock podf. NOTE: Divider should be updated when output clock is gated. 000 divide by 1 001 divide by 2 010 divide by 3 011 divide by 4 100 divide by 5 101 divide by 6 110 divide by 7 111 divide by 8
10–7 -	This field is reserved. Reserved.
6 UART_CLK_SEL	Selector for the UART clock multiplexor 0 derive clock from pll3_80m 1 derive clock from osc_clk
UART_CLK_PODF	Divider for uart clock podf. 000000 divide by 1 111111 divide by 2 ⁶

18.6.11 CCM SAI1 Clock Divider Register (CCM_CS1CDR)

The figure below represents the CCM SAI1, and SAI3 Clock Divider Register (CS1CDR). The CS1CDR register contains bits to control the SAI1 and SAI3 clock generation dividers. The table below provides its field descriptions.

Address: 20C_4000h base + 28h offset = 20C_4028h

Bit	31	30	29	28	27	26	25	24	23	22	21	20	19	18	17	16	15	14	13	12	11	10	9	8	7	6	5	4	3	2	1	0	
R	0				ESAI_CLK_PODF	SAI3_CLK_PRED	SAI3_CLK_PODF				0				ESAI_CLK_PRED	SAI1_CLK_PRED	SAI1_CLK_PODF																
W	1				1	1	1	0	1	1	0	0	0	0	0	0	1	0	0	0	0	0	0	1	0	1	1	0	0	0	0	0	1
Reset	0	0	0	0	1	1	1	0	1	1	0	0	0	0	0	1	0	0	0	0	0	0	1	0	1	1	0	0	0	0	0	1	

CCM_CS1CDR field descriptions

Field	Description
31–28 Reserved	This read-only field is reserved and always has the value 0.

Table continues on the next page...

CCM_CS1CDR field descriptions (continued)

Field	Description
27–25 ESAI_CLK_ PODF	Divider for ESAI clock 000 Divide by 1 001 Divide by 2 010 Divide by 3 011 Divide by 4 100 Divide by 5 101 Divide by 6 110 Divide by 7 111 Divide by 8
24–22 SAI3_CLK_ PRED	Divider for sai3 clock pred. 000 divide by 1 001 divide by 2 010 divide by 3 011 divide by 4 100 divide by 5 101 divide by 6 110 divide by 7 111 divide by 8
21–16 SAI3_CLK_ PODF	Divider for sai3 clock pdf. The input clock to this divider should be lower than 300Mhz, the predivider can be used to achieve this. 000000 divide by 1 111111 divide by 2 ⁶
15–12 Reserved	This read-only field is reserved and always has the value 0.
11–9 ESAI_CLK_ PRED	Divider for ESAI clock pred 000 Divide by 1 001 Divide by 2 010 Divide by 3 011 Divide by 4 100 Divide by 5 101 Divide by 6 110 Divide by 7 111 Divide by 8
8–6 SAI1_CLK_ PRED	Divider for sai1 clock pred. 000 divide by 1 001 divide by 2 010 divide by 3 011 divide by 4 100 divide by 5 101 divide by 6 110 divide by 7 111 divide by 8

Table continues on the next page...

CCM_CS1CDR field descriptions (continued)

Field	Description
SAI1_CLK_PODF	Divider for sai1 clock podf. The input clock to this divider should be lower than 300Mhz, the predivider can be used to achieve this. 000000 divide by 1 111111 divide by 2^6

18.6.12 CCM SAI2 Clock Divider Register (CCM_CS2CDR)

The figure below represents the CCM SAI2, LDB Clock Divider Register (CS2CDR). The CS2CDR register contains bits to control the SAI2 clock generation dividers, and ldb serial clocks select. The table below provides its field descriptions.

Address: 20C_4000h base + 2Ch offset = 20C_402Ch

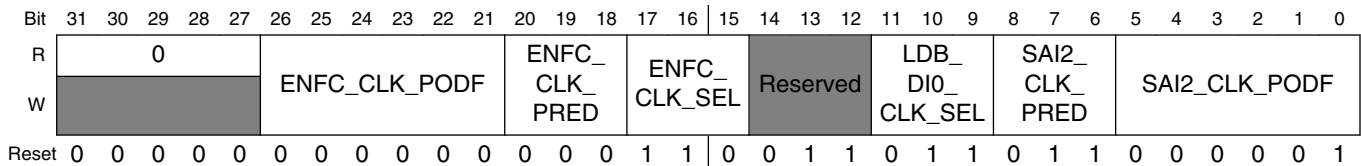

CCM_CS2CDR field descriptions

Field	Description
31–27 Reserved	This read-only field is reserved and always has the value 0.
26–21 ENFC_CLK_PODF	Divider for enfc clock divider. 000000 divide by 1 000001 divide by 2 111111 divide by 2^6
20–18 ENFC_CLK_PRED	Divider for enfc clock pred divider. NOTE: Divider should be updated when output clock is gated. 000 divide by 1 001 divide by 2 010 divide by 3 011 divide by 4 100 divide by 5 101 divide by 6 110 divide by 7 111 divide by 8

Table continues on the next page...

CCM_CS2CDR field descriptions (continued)

Field	Description
17–15 ENFC_CLK_SEL	<p>Selector for enfc clock multiplexer</p> <p>NOTE: Multiplexor should be updated when output clock is gated.</p> <p>000 derive clock from PLL2 PFD0 001 derive clock from PLL2 010 derive clock from pll3_sw_clk 011 derive clock from PLL2 PFD2 100 derive clock from PLL3 PFD3 101 Reserved 110 derive clock from PLL3 PFD3 111 Reserved</p>
14–12 -	<p>This field is reserved. Reserved</p>
11–9 LDB_DI0_CLK_SEL	<p>Selector for ldb_di0 clock multiplexer</p> <p>NOTE: Multiplexor should be updated when both input and output clocks are gated.</p> <p>000 PLL5 clock 001 PLL2 PFD0 010 PLL2 PFD2 011 PLL2 PFD3 100 PLL2 PFD1 101 PLL3 PFD3 110 Reserved 111 Reserved</p>
8–6 SAI2_CLK_PRED	<p>Divider for sai2 clock pred.</p> <p>NOTE: Divider should be updated when output clock is gated.</p> <p>000 divide by 1 001 divide by 2 010 divide by 3 011 divide by 4 100 divide by 5 101 divide by 6 110 divide by 7 111 divide by 8</p>
SAI2_CLK_PODF	<p>Divider for sai2 clock podf. The input clock to this divider should be lower than 300Mhz, the predivider can be used to achieve this.</p> <p>NOTE: Divider should be updated when output clock is gated.</p> <p>000000 divide by 1 111111 divide by 2⁶</p>

18.6.13 CCM D1 Clock Divider Register (CCM_CDCDR)

The figure below represents the CCM DI Clock Divider Register (CDCDR). The table below provides its field descriptions.

Address: 20C_4000h base + 30h offset = 20C_4030h

Bit	31	30	29	28	27	26	25	24	23	22	21	20	19	18	17	16
R																
W																
Reset	0	0	1	1	0	0	1	1	1	1	1	1	0	1	1	1
Bit	15	14	13	12	11	10	9	8	7	6	5	4	3	2	1	0
R	Reserved															
W	Reserved															
Reset	0	0	0	1	1	1	1	1	1	0	0	1	0	0	1	0

CCM_CDCDR field descriptions

Field	Description
31–28 -	This field is reserved. Reserved 0 derive from pll3_120M clock 1 derive clock from PLL2 PFD2
27–25 SPDIF0_CLK_PRED	Divider for spdif0 clock pred. NOTE: Divider should be updated when output clock is gated. 000 divide by 1 (do not use with high input frequencies) 001 divide by 2 010 divide by 3 111 divide by 8
24–22 SPDIF0_CLK_PODF	Divider for spdif0 clock podf. NOTE: Divider should be updated when output clock is gated. 000 divide by 1 111 divide by 8
21–20 SPDIF0_CLK_SEL	Selector for spdif0 clock multiplexer 00 derive clock from PLL4 01 derive clock from PLL3 PFD2 10 derive clock from PLL5 11 derive clock from pll3_sw_clk
-	This field is reserved. Reserved

18.6.14 CCM HSC Clock Divider Register (CCM_CHSCCCR)

The figure below represents the CCM HSC Clock Divider Register (CHSCCCR). The CHSCCCR register contains bits to control the clock generation dividers. The table below provides its field descriptions.

Address: 20C_4000h base + 34h offset = 20C_4034h

Bit	31	30	29	28	27	26	25	24	23	22	21	20	19	18	17	16	15	14	13	12	11	10	9	8	7	6	5	4	3	2	1	0
R	0														EPDC_ PRE_ CLK_SEL			EPDC_ PODF		EPDC_ CLK_SEL			Reserved									
W																																
Reset	0	0	0	0	0	0	0	0	0	0	0	0	0	0	1	0	1	0	0	1	0	0	0	1	0	1	0	0	1	0	0	0

CCM_CHSCCCR field descriptions

Field	Description
31–18 Reserved	This read-only field is reserved and always has the value 0.
17–15 EPDC_PRE_ CLK_SEL	Selector for EPDC root clock pre-multiplexer 000 Derive clock from PLL2 001 Derive clock from PLL3_SW_CLK 010 Derive clock from PLL5 011 Derive clock from PLL2 PFD0 100 Derive clock from PLL2 PFD2 101 Derive clock from PLL3 PFD2 110 - 111 Reserved
14–12 EPDC_PODF	Divider for EPDC clock divider. NOTE: Divider should be updated when output clock is gated. 000 Divide by 1 001 Divide by 2 010 Divide by 3 011 Divide by 4 100 Divide by 5 101 Divide by 6 110 Divide by 7 111 Divide by 8
11–9 EPDC_CLK_SEL	Selector for EPDC root clock multiplexer 000 Derive clock from divided pre-muxed EPDC clock 001 Derive clock from ipp_di0_clk 010 Derive clock from ipp_di1_clk 011 Derive clock from ldb_di0_clk

Table continues on the next page...

CCM_CHSCDR field descriptions (continued)

Field	Description
100	Derive clock from ldb_di1_clk
101 - 111	Reserved
-	This field is reserved. Reserved. Always set to 0.

18.6.15 CCM Serial Clock Divider Register 2 (CCM_CSCDR2)

The figure below represents the CCM Serial Clock Divider Register 2(CSCDR2). The CSCDR2 register contains bits to control the clock generation sub-module dividers. The table below provides its field descriptions.

Address: 20C_4000h base + 38h offset = 20C_4038h

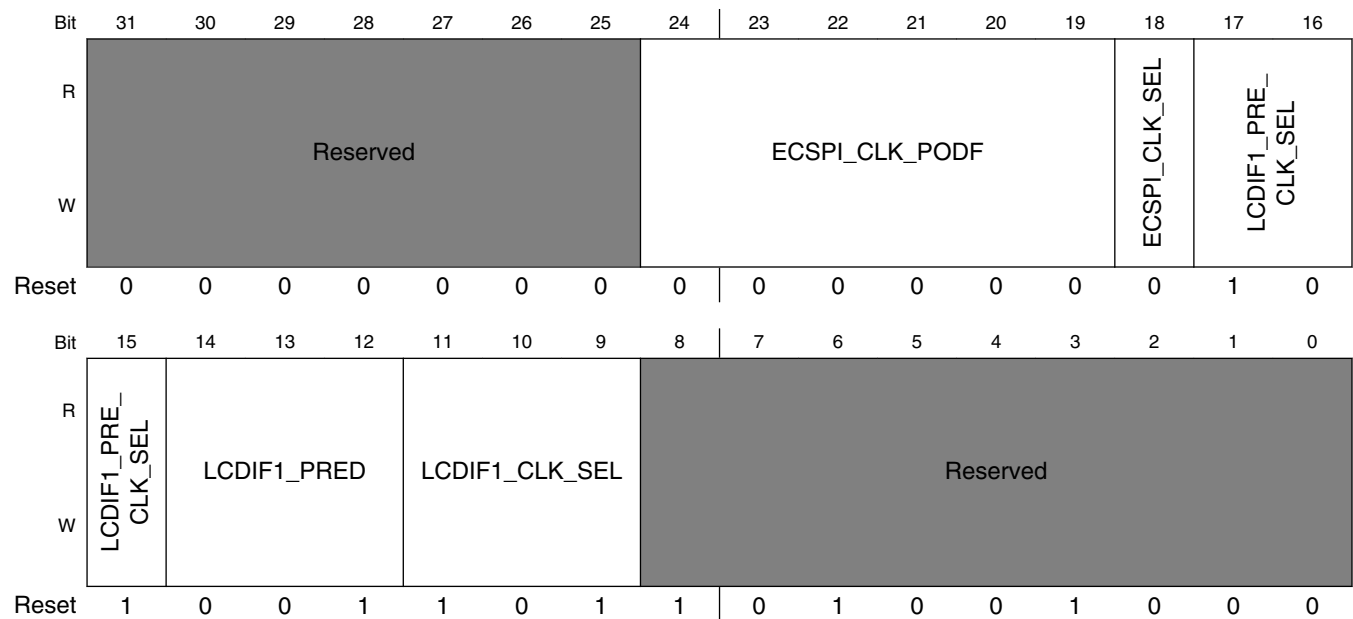

CCM_CSCDR2 field descriptions

Field	Description
31-25 -	This field is reserved. Reserved
24-19 ECSPI_CLK_PODF	Divider for ecspi clock podf. NOTE: Divider should be updated when output clock is gated. NOTE: The input clock to this divider should be lower than 300Mhz, the predivider can be used to achieve this.

Table continues on the next page...

CCM_CSCDR2 field descriptions (continued)

Field	Description
	000000 divide by 1 111111 divide by 2 ⁶
18 ECSPI_CLK_SEL	Selector for the ECSPI clock multiplexor 0 derive clock from pll3_60m 1 derive clock from osc_clk
17–15 LCDIF1_PRE_CLK_SEL	Selector for lcdif1 root clock pre-multiplexer 000 derive clock from PLL2 001 derive clock from PLL3 PFD3 010 derive clock from PLL5 011 derive clock from PLL2 PFD0 100 derive clock from PLL2 PFD1 101 derive clock from PLL3 PFD1 110-111 Reserved
14–12 LCDIF1_PRED	Pre-divider for lcdif1 clock. NOTE: Divider should be updated when output clock is gated. 000 divide by 1 001 divide by 2 010 divide by 3 011 divide by 4 100 divide by 5 101 divide by 6 110 divide by 7 111 divide by 8
11–9 LCDIF1_CLK_SEL	Selector for LCDIF1 root clock multiplexer 000 derive clock from divided pre-muxed LCDIF1 clock 001 derive clock from ipp_di0_clk 010 derive clock from ipp_di1_clk 011 derive clock from ldb_di0_clk 100 derive clock from ldb_di1_clk 101-111 Reserved
-	This field is reserved. Reserved

18.6.16 CCM Serial Clock Divider Register 3 (CCM_CSCDR3)

The figure below represents the CCM Serial Clock Divider Register 3(CSCDR3). The CSCDR3 register contains bits to control the clock generation sub-module dividers. The table below provides its field descriptions.

Address: 20C_4000h base + 3Ch offset = 20C_403Ch

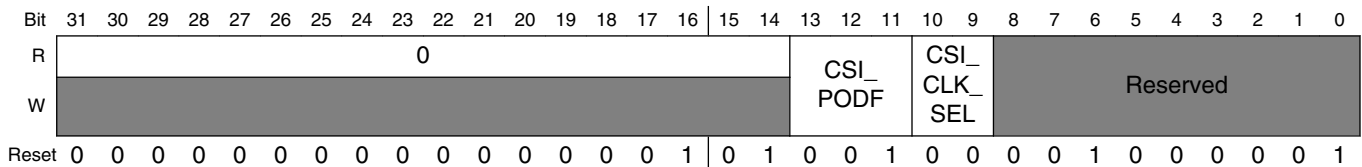

CCM_CSCDR3 field descriptions

Field	Description
31–14 Reserved	This read-only field is reserved and always has the value 0.
13–11 CSI_PODF	Post divider for csi_mclk. NOTE: Divider should be updated when output clock is gated. 000 divide by 1 001 divide by 2 010 divide by 3 011 divide by 4 100 divide by 5 101 divide by 6 110 divide by 7 111 divide by 8
10–9 CSI_CLK_SEL	Selector for csi_mclk multiplexer 00 derive clock from osc_clk (24M) 01 derive clock from PLL2 PFD2 10 derive clock from pll3_120M 11 derive clock from PLL3 PFD1
-	This field is reserved. Reserved

18.6.17 CCM Divider Handshake In-Process Register (CCM_CDHIPR)

The figure below represents the CCM Divider Handshake In-Process Register (CDHIPR). The CDHIPR register contains read-only bits that indicate that CCM is in the process of updating dividers or muxes that might need handshake with modules.

Address: 20C_4000h base + 48h offset = 20C_4048h

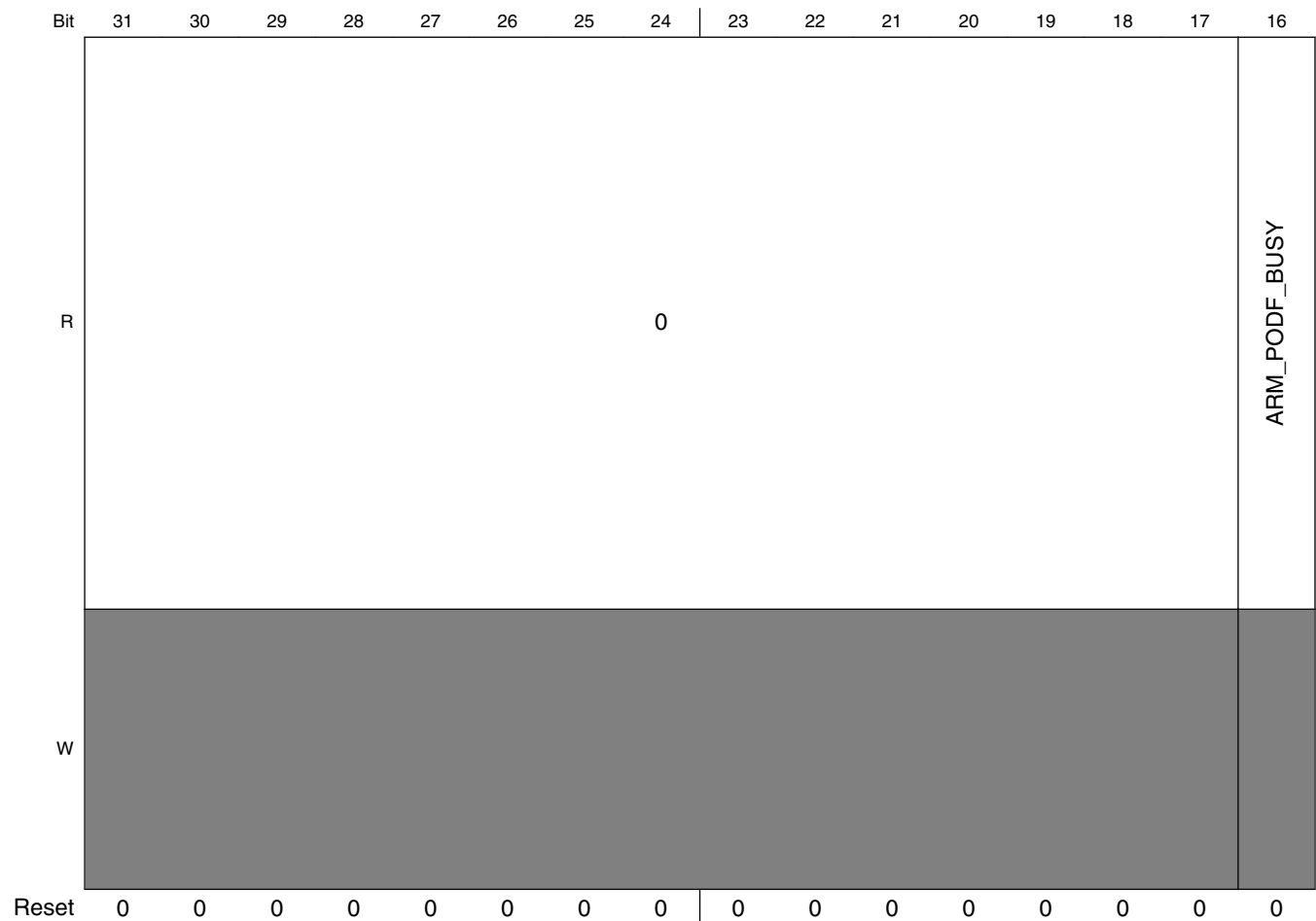

CCM Memory Map/Register Definition

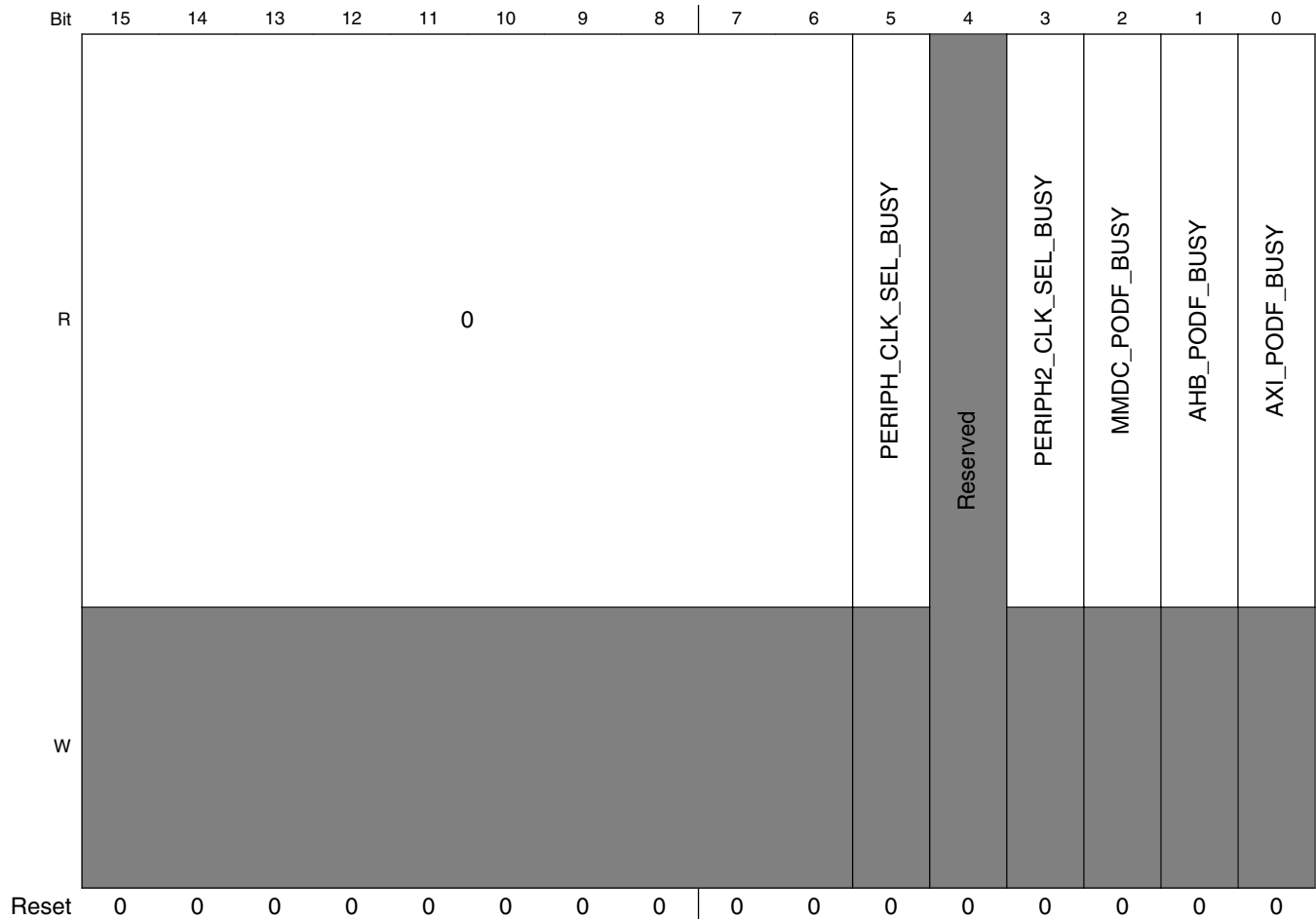

CCM_CDHIPR field descriptions

Field	Description
31–17 Reserved	This read-only field is reserved and always has the value 0.
16 ARM_PODF_ BUSY	Busy indicator for arm_podf. 0 divider is not busy and its value represents the actual division. 1 divider is busy with handshake process with module. The value read in the divider represents the previous value of the division factor, and after the handshake the written value of the arm_podf will be applied.
15–6 Reserved	This read-only field is reserved and always has the value 0.
5 PERIPH_CLK_ SEL_BUSY	Busy indicator for periph_clk_sel mux control. 0 mux is not busy and its value represents the actual division. 1 mux is busy with handshake process with module. The value read in the periph_clk_sel represents the previous value of select, and after the handshake periph_clk_sel value will be applied.
4 -	This field is reserved. Reserved

Table continues on the next page...

CCM_CDHIPR field descriptions (continued)

Field	Description
3 PERIPH2_CLK_ SEL_BUSY	<p>Busy indicator for periph2_clk_sel mux control.</p> <p>0 mux is not busy and its value represents the actual division.</p> <p>1 mux is busy with handshake process with module. The value read in the periph2_clk_sel represents the previous value of select, and after the handshake periph2_clk_sel value will be applied.</p>
2 MMDC_PODF_ BUSY	<p>Busy indicator for mmdc_axi_podf.</p> <p>0 divider is not busy and its value represents the actual division.</p> <p>1 divider is busy with handshake process with module. The value read in the divider represents the previous value of the division factor, and after the handshake the written value of the mmdc_axi_podf will be applied.</p>
1 AHB_PODF_ BUSY	<p>Busy indicator for ahb_podf.</p> <p>0 divider is not busy and its value represents the actual division.</p> <p>1 divider is busy with handshake process with module. The value read in the divider represents the previous value of the division factor, and after the handshake the written value of the ahb_podf will be applied.</p>
0 AXI_PODF_ BUSY	<p>Busy indicator for axi_podf.</p> <p>0 divider is not busy and its value represents the actual division.</p> <p>1 divider is busy with handshake process with module. The value read in the divider represents the previous value of the division factor, and after the handshake the written value of the axi_podf will be applied.</p>

18.6.18 CCM Low Power Control Register (CCM_CLPCR)

The figure below represents the CCM Low Power Control Register (CLPCR). The CLPCR register contains bits to control the low power modes operation. The table below provides its field descriptions.

Address: 20C_4000h base + 54h offset = 20C_4054h

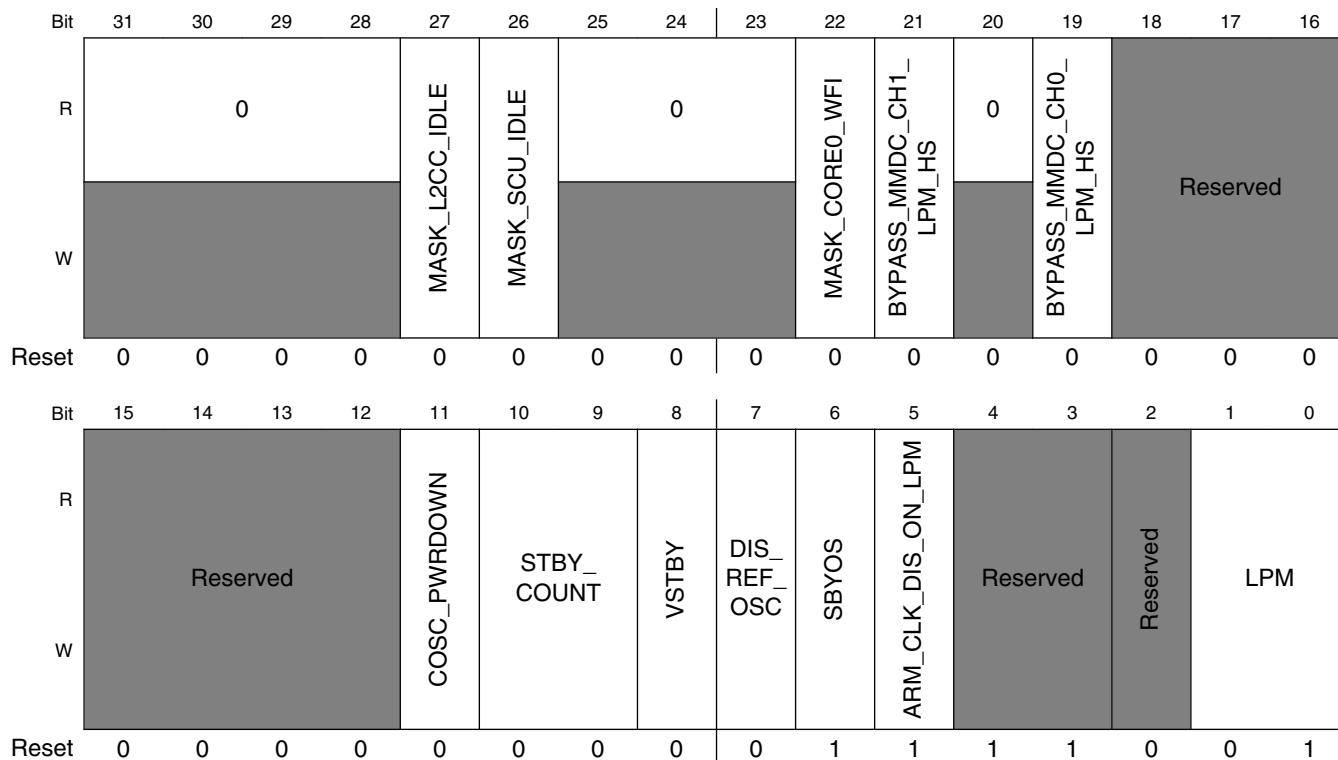

CCM_CLPCR field descriptions

Field	Description
31–28 Reserved	This read-only field is reserved and always has the value 0.
27 MASK_L2CC_IDLE	Mask L2CC IDLE for entering low power mode. NOTE: Assertion of all bits[27:22] will generate low power mode request 1 L2CC IDLE is masked 0 L2CC IDLE is not masked
26 MASK_SCU_IDLE	Mask SCU IDLE for entering low power mode NOTE: Assertion of all bits[27:22] will generate low power mode request 1 SCU IDLE is masked 0 SCU IDLE is not masked

Table continues on the next page...

CCM_CLPCR field descriptions (continued)

Field	Description
25–23 Reserved	This read-only field is reserved and always has the value 0.
22 MASK_CORE0_ WFI	Mask WFI of core0 for entering low power mode NOTE: Assertion of all bits[27:22] will generate low power mode request 0 WFI of core0 is not masked 1 WFI of core0 is masked
21 BYPASS_ MMDCH1_ LPM_HS	Bypass handshake with mmdc_ch1 on next entrance to low power mode (STOP or WAIT). CCM doesn't wait for the module's acknowledge. 0 Handshake with mmdc_ch1 on next entrance to low power mode will be performed. 1 Handshake with mmdc_ch1 on next entrance to low power mode will be bypassed.
20 Reserved	This read-only field is reserved and always has the value 0.
19 BYPASS_ MMDCH0_ LPM_HS	Bypass handshake with mmdc_ch0 on next entrance to low power mode (STOP or WAIT). CCM doesn't wait for the module's acknowledge. Handshake will also be bypassed, if CGR3 CG10 is set to gate fast mmdc_ch0 clock. NOTE: MMDCH0 clock is not used. This bit should always be programmed HIGH to let CCM know not to wait for the acknowledge from MMDCH0, due to no connection. 0 Handshake with mmdc_ch0 on next entrance to low power mode will be performed. 1 Handshake with mmdc_ch0 on next entrance to low power mode will be bypassed.
18–12 -	This field is reserved. Reserved
11 COSCPWRDOWN	In run mode, software can manually control powering down of on chip oscillator, i.e. generating '1' on cosc_pwrdown signal. If software manually powered down the on chip oscillator, then sbyos functionality for on chip oscillator will be bypassed. The manual closing of onchip oscillator should be performed only in case the reference oscillator is not the source of all the clocks generation. 0 On chip oscillator will not be powered down, i.e. cosc_pwrdown = '0'. 1 On chip oscillator will be powered down, i.e. cosc_pwrdown = '1'.
10–9 STBY_COUNT	Standby counter definition. These two bits define, in the case of stop exit (if VSTBY bit was set). NOTE: Clock cycles ratio depends on pmic_delay_scaler, defined by CGPR[0] bit. 00 CCM will wait (1*pmic_delay_scaler)+1 ckil clock cycles 01 CCM will wait (3*pmic_delay_scaler)+1 ckil clock cycles 10 CCM will wait (7*pmic_delay_scaler)+1 ckil clock cycles 11 CCM will wait (15*pmic_delay_scaler)+1 ckil clock cycles
8 VSTBY	Voltage standby request bit. This bit defines if PMIC_STBY_REQ pin, which notifies external power management IC to move from functional voltage to standby voltage, will be asserted in STOP mode. 0 Voltage will not be changed to standby voltage after next entrance to STOP mode. (PMIC_STBY_REQ will remain negated - '0') 1 Voltage will be requested to change to standby voltage after next entrance to stop mode. (PMIC_STBY_REQ will be asserted - '1').

Table continues on the next page...

CCM_CLPCR field descriptions (continued)

Field	Description
7 DIS_REF_OSC	<p>dis_ref_osc - in run mode, software can manually control closing of external reference oscillator clock, i.e. generating '1' on CCM_REF_EN_B signal. If software closed manually the external reference clock, then sbyos functionality will be bypassed.</p> <p>The manual closing of external reference oscillator should be performed only in case the reference oscillator is not the source of any clock generation.</p> <p>NOTE: When returning from stop mode, the PMIC_STBY_REQ will be deasserted (if it was asserted when entering stop mode). See stby_count bits.</p> <p>0 external high frequency oscillator will be enabled, i.e. CCM_REF_EN_B = '0'. 1 external high frequency oscillator will be disabled, i.e. CCM_REF_EN_B = '1'</p>
6 SBYOS	<p>Standby clock oscillator bit. This bit defines if cosc_pwrdown, which power down the on chip oscillator, will be asserted in STOP mode. This bit is discarded if cosc_pwrdown='1' for the on chip oscillator.</p> <p>0 On-chip oscillator will not be powered down, after next entrance to STOP mode. (CCM_REF_EN_B will remain asserted - '0' and cosc_pwrdown will remain de asserted - '0')</p> <p>1 On-chip oscillator will be powered down, after next entrance to STOP mode. (CCM_REF_EN_B will be deasserted - '1' and cosc_pwrdown will be asserted - '1'). When returning from STOP mode, external oscillator will be enabled again, on-chip oscillator will return to oscillator mode, and after oscnt count, CCM will continue with the exit from the STOP mode process.</p>
5 ARM_CLK_DIS_ON_LPM	<p>Define if ARM clocks (arm_clk, soc_mxclk, soc_pclk, soc_dbg_pclk, vl_wrck) will be disabled on wait mode. This is useful for debug mode, when the user still wants to simulate entering wait mode and still keep ARM clock functioning.</p> <p>NOTE: Software should not enable ARM power gating in wait mode if this bit is cleared.</p> <p>0 ARM clock enabled on wait mode. 1 ARM clock disabled on wait mode. .</p>
4-3 -	This field is reserved. Reserved
2 -	This field is reserved. Reserved
LPM	<p>Setting the low power mode that system will enter on next assertion of dsm_request signal.</p> <p>00 Remain in run mode 01 Transfer to wait mode 10 Transfer to stop mode 11 Reserved</p>

18.6.19 CCM Interrupt Status Register (CCM_CISR)

The figure below represents the CCM Interrupt Status Register (CISR). This is a write one to clear register. Once a interrupt is generated, software should write one to clear it. The table below provides its field descriptions.

NOTE

CCM interrupt request 1 can be masked by CCM interrupt request 1 mask bit. CCM interrupt request 2 can be masked by CCM interrupt request 2 mask bit.

Address: 20C_4000h base + 58h offset = 20C_4058h

Bit	31	30	29	28	27	26	25	24	23	22	21	20	19	18	17	16	
R					0		ARM_PODF_LOADED	0		Reserved	PERIPH_CLK_SEL_LOADED	MMDc_PODF_LOADED	AHB_PODF_LOADED	PERIPH2_CLK_SEL_LOADED	Reserved	AXI_PODF_LOADED	0
W							w1c			Reserved	w1c	w1c	w1c	w1c	Reserved	w1c	
Reset	0	0	0	0	0	0	0	0	0	0	0	0	0	0	0	0	0
Bit	15	14	13	12	11	10	9	8	7	6	5	4	3	2	1	0	
R					0						COSC_READY					0	LRF_PLL
W											w1c						w1c
Reset	0	0	0	0	0	0	0	0	0	0	0	0	0	0	0	0	

CCM_CISR field descriptions

Field	Description
31–27 Reserved	This read-only field is reserved and always has the value 0.
26 ARM_PODF_ LOADED	CCM interrupt request 1 generated due to frequency change of arm_podf. The interrupt will commence only if arm_podf is loaded during a DVFS operation. 0 interrupt is not generated due to frequency change of arm_podf 1 interrupt generated due to frequency change of arm_podf
25–24 Reserved	This read-only field is reserved and always has the value 0.
23 -	This field is reserved. Reserved
22 PERIPH_CLK_ SEL_LOADED	CCM interrupt request 1 generated due to update of periph_clk_sel. 0 interrupt is not generated due to update of periph_clk_sel. 1 interrupt generated due to update of periph_clk_sel.
21 MMDC_PODF_ LOADED	CCM interrupt request 1 generated due to frequency change of mmdc_podf_ loaded 0 interrupt is not generated due to frequency change of mmdc_podf_ loaded 1 interrupt generated due to frequency change of mmdc_podf_ loaded
20 AHB_PODF_ LOADED	CCM interrupt request 1 generated due to frequency change of ahb_podf 0 interrupt is not generated due to frequency change of ahb_podf 1 interrupt generated due to frequency change of ahb_podf
19 PERIPH2_CLK_ SEL_LOADED	CCM interrupt request 1 generated due to frequency change of periph2_clk_sel 0 interrupt is not generated due to frequency change of periph2_clk_sel 1 interrupt generated due to frequency change of periph2_clk_sel
18 -	This field is reserved. Reserved
17 AXI_PODF_ LOADED	CCM interrupt request 1 generated due to frequency change of axi_podf 0 interrupt is not generated due to frequency change of axi_podf 1 interrupt generated due to frequency change of axi_podf
16–7 Reserved	This read-only field is reserved and always has the value 0.
6 COSC_READY	CCM interrupt request 2 generated due to on board oscillator ready, i.e. oscnt has finished counting. 0 interrupt is not generated due to on board oscillator ready 1 interrupt generated due to on board oscillator ready
5–1 Reserved	This read-only field is reserved and always has the value 0.
0 LRF_PLL	CCM interrupt request 2 generated due to lock of all enabled and not bypassed PLLs 0 interrupt is not generated due to lock ready of all enabled and not bypassed PLLs 1 interrupt generated due to lock ready of all enabled and not bypassed PLLs

18.6.20 CCM Interrupt Mask Register (CCM_CIMR)

The figure below represents the CCM Interrupt Mask Register (CIMR). The table below provides its field descriptions.

Address: 20C_4000h base + 5Ch offset = 20C_405Ch

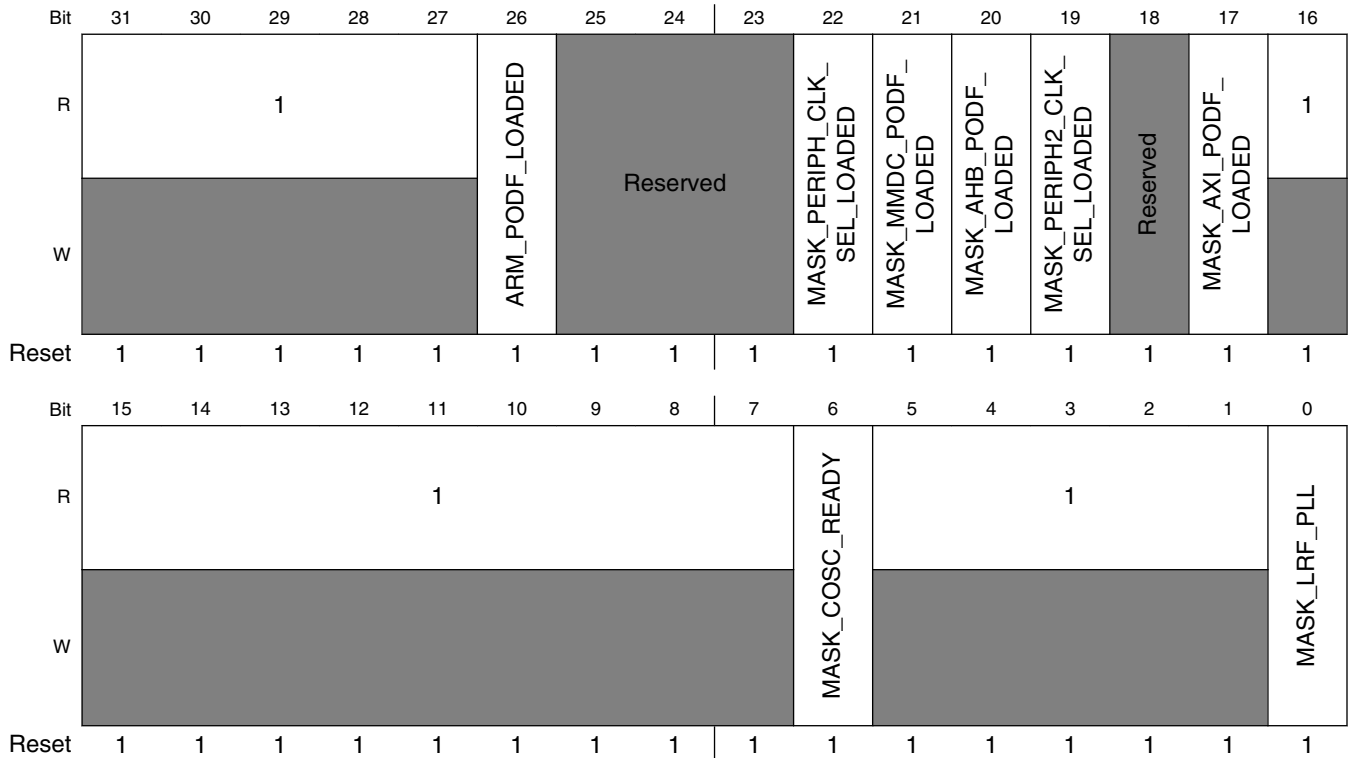

CCM_CIMR field descriptions

Field	Description
31–27 Reserved	This read-only field is reserved and always has the value 1.
26 ARM_PODF_LOADED	mask interrupt generation due to frequency change of arm_podf 0 don't mask interrupt due to frequency change of arm_podf - interrupt will be created 1 mask interrupt due to frequency change of arm_podf
25–23 -	This field is reserved. Reserved
22 MASK_PERIPH_CLK_SEL_LOADED	mask interrupt generation due to update of periph_clk_sel. 0 don't mask interrupt due to update of periph_clk_sel - interrupt will be created 1 mask interrupt due to update of periph_clk_sel

Table continues on the next page...

CCM_CIMR field descriptions (continued)

Field	Description
21 MASK_MMDC_ PODF_LOADED	mask interrupt generation due to update of mask_mmdc_podf 0 don't mask interrupt due to update of mask_mmdc_podf - interrupt will be created 1 mask interrupt due to update of mask_mmdc_podf
20 MASK_AHB_ PODF_LOADED	mask interrupt generation due to frequency change of ahb_podf 0 don't mask interrupt due to frequency change of ahb_podf - interrupt will be created 1 mask interrupt due to frequency change of ahb_podf
19 MASK_ PERIPH2_CLK_ SEL_LOADED	mask interrupt generation due to update of periph2_clk_sel. 0 don't mask interrupt due to update of periph2_clk_sel - interrupt will be created 1 mask interrupt due to update of periph2_clk_sel
18 -	This field is reserved. Reserved
17 MASK_AXI_ PODF_LOADED	mask interrupt generation due to frequency change of axi_podf 0 don't mask interrupt due to frequency change of axi_podf - interrupt will be created 1 mask interrupt due to frequency change of axi_podf
16–7 Reserved	This read-only field is reserved and always has the value 1.
6 MASK_COSC_ READY	mask interrupt generation due to on board oscillator ready 0 don't mask interrupt due to on board oscillator ready - interrupt will be created 1 mask interrupt due to on board oscillator ready
5–1 Reserved	This read-only field is reserved and always has the value 1.
0 MASK_LRF_PLL	mask interrupt generation due to lrf of PLLs 0 don't mask interrupt due to lrf of PLLs - interrupt will be created 1 mask interrupt due to lrf of PLLs

18.6.21 CCM Clock Output Source Register (CCM_CCOSR)

The figure below represents the CCM Clock Output Source Register (CCOSR). The CCOSR register contains bits to control the clock that will be generated on the output `ipp_do_clk01` (CCM_CLKO). The table below provides its field descriptions.

Address: 20C_4000h base + 60h offset = 20C_4060h

Bit	31	30	29	28	27	26	25	24	23	22	21	20	19	18	17	16
R	0							CLKO2_EN	CLKO2_DIV			CLKO2_SEL				
W	[Shaded]															
Reset	0	0	0	0	0	0	0	0	0	0	0	0	1	0	1	0
Bit	15	14	13	12	11	10	9	8	7	6	5	4	3	2	1	0
R	0							CLK_OUT_SEL	CLKO1_EN	CLKO1_DIV			CLKO_SEL			
W	[Shaded]															
Reset	0	0	0	0	0	0	0	0	0	0	0	0	0	0	0	1

CCM_CCOSR field descriptions

Field	Description
31–25 Reserved	This read-only field is reserved and always has the value 0.
24 CLKO2_EN	Enable of CCM_CLKO2 clock 0 CCM_CLKO2 disabled. 1 CCM_CLKO2 enabled.
23–21 CLKO2_DIV	Setting the divider of CCM_CLKO2 000 divide by 1 001 divide by 2 010 divide by 3 011 divide by 4 100 divide by 5 101 divide by 6 110 divide by 7 111 divide by 8
20–16 CLKO2_SEL	Selection of the clock to be generated on CCM_CLKO2 00001 mmdc_clk_root 00010 gpml_clk_root

Table continues on the next page...

CCM_CCOSR field descriptions (continued)

Field	Description
	00011 usdhc1_clk_root 00101 wrck_clk_root 00110 ecspi_clk_root 01000 bch_clk_root 01010 arm_clk_root 01011 csi_core 01110 osc_clk 10001 usdhc2_clk_root 10010 sai1_clk_root 10011 sai2_clk_root 10100 sai3_clk_root 10111 can_clk_root 11001 qspi1_clk_root 11011 aclk_eim_slow_clk_root 11100 uart_clk_root 11101 spdif0_clk_root 11111 Reserved
15–9 Reserved	This read-only field is reserved and always has the value 0.
8 CLK_OUT_SEL	CCM_CLKO1 output to reflect CCM_CLKO1 or CCM_CLKO2 clocks 0 CCM_CLKO1 output drives CCM_CLKO1 clock 1 CCM_CLKO1 output drives CCM_CLKO2 clock
7 CLKO1_EN	Enable of CCM_CLKO1 clock 0 CCM_CLKO1 disabled. 1 CCM_CLKO1 enabled.
6–4 CLKO1_DIV	Setting the divider of CCM_CLKO1 000 divide by 1 001 divide by 2 010 divide by 3 011 divide by 4 100 divide by 5 101 divide by 6 110 divide by 7 111 divide by 8
CLKO_SEL	Selection of the clock to be generated on CCM_CLKO1 0101 axi_clk_root 0110 enfc_clk_root 1000 epdc_clk_root 1001 1010 lcdif_pix_clk_root 1011 ahb_clk_root 1100 ipg_clk_root 1101 perclk_root

Table continues on the next page...

CCM_CCOSR field descriptions (continued)

Field	Description
1110	ckil_sync_clk_root
1111	pll4_main_clk

18.6.22 CCM General Purpose Register (CCM.CGPR)

Fast PLL enable. Can be used to engage PLL faster after STOP mode, if 24MHz OSC was active

Address: 20C_4000h base + 64h offset = 20C_4064h

Bit	31	30	29	28	27	26	25	24	23	22	21	20	19	18	17	16
R	0														INT_MEM_CLK_LPM	FPL
W	Reserved														INT_MEM_CLK_LPM	FPL
Reset	0	0	0	0	0	0	0	0	0	0	0	0	0	0	0	0
Bit	15	14	13	12	11	10	9	8	7	6	5	4	3	2	1	0
R	SYS_MEM_DS_CTRL		1					0	1		EFUSE_PROG_SUPPLY_GATE	Reserved	MMDC_EXT_CLK_DIS	1		PMIC_DELAY_SCALER
W	SYS_MEM_DS_CTRL		Reserved					EFUSE_PROG_SUPPLY_GATE	Reserved	MMDC_EXT_CLK_DIS	1		PMIC_DELAY_SCALER			
Reset	1	1	1	1	1	1	1	0	0	1	1	0	0	0	1	0

CCM.CGPR field descriptions

Field	Description
31–18 Reserved	This read-only field is reserved and always has the value 0.
17 INT_MEM_CLK_LPM	Control for the Deep Sleep signal to the ARM Platform memories with additional control logic based on the ARM WFI signal. Used to keep the ARM Platform memory clocks enabled if an interrupt is pending when entering low power mode.

Table continues on the next page...

CCM_CGPR field descriptions (continued)

Field	Description
	<p>NOTE: This bit should always be set when the CCM_CLPCR_LPM bits are set to 01(WAIT Mode) or 10 (STOP mode) without power gating. This bit does not have to be set for STOP mode entry.</p> <p>0 Disable the clock to the ARM platform memories when entering Low Power Mode 1 Keep the clocks to the ARM platform memories enabled only if an interrupt is pending when entering Low Power Modes (WAIT and STOP without power gating)</p>
16 FPL	<p>Fast PLL enable.</p> <p>0 Engage PLL enable default way. 1 Engage PLL enable 3 CKIL clocks earlier at exiting low power mode (STOP). Should be used only if 24MHz OSC was active in low power mode.</p>
15–14 SYS_MEM_DS_CTRL	<p>System memory DS control</p> <p>00 Disable memory DS mode always 01 Enable memory (outside ARM platform) DS mode when system STOP and PLL are disabled 1x enable memory (outside ARM platform) DS mode when system is in STOP mode</p>
13–9 Reserved	This read-only field is reserved and always has the value 1.
8–7 Reserved	This read-only field is reserved and always has the value 0.
6–5 Reserved	This read-only field is reserved and always has the value 1.
4 EFUSE_PROG_SUPPLY_GATE	<p>Defines the value of the output signal cgpr_dout[4]. Gate of program supply for efuse programming</p> <p>0 fuse programming supply voltage is gated off to the efuse module 1 allow fuse programming.</p>
3 -	This field is reserved. Reserved
2 MMDC_EXT_CLK_DIS	<p>Disable external clock driver of MMDC during STOP mode</p> <p>1 disable during stop mode 0 don't disable during stop mode.</p>
1 -	Reserved. Keep default value set to '1' for proper operation.
0 PMIC_DELAY_SCALER	<p>Defines clock division of clock for stby_count (pmic delay counter)</p> <p>0 clock is not divided 1 clock is divided /8</p>

18.6.23 CCM Clock Gating Register 0 (CCM_CCGR0)

CG(i) bits CCGR 0-6

These bits are used to turn on/off the clock to each module independently. The following table details the possible clock activity conditions for each module.

CGR value	Clock Activity Description
00	Clock is off during all modes. Stop enter hardware handshake is disabled.
01	Clock is on in run mode, but off in WAIT and STOP modes
10	Not applicable (Reserved).
11	Clock is on during all modes, except STOP mode.

Module should be stopped, before set its bits to "0"; clocks to the module will be stopped immediately.

The tables above show the register mappings for the different CGRs. The clock connectivity table should be used to match the "CCM output affected" to the actual clocks going into the modules.

The figure below represents the CCM Clock Gating Register 0 (CCM_CCGR0). The clock gating Registers define the clock gating for power reduction of each clock (CG(i) bits). There are 7 CGR registers. The number of registers required is according to the number of peripherals in the system.

Address: 20C_4000h base + 68h offset = 20C_4068h

Bit	31	30	29	28	27	26	25	24	23	22	21	20	19	18	17	16
R																
W																
	CG15		CG14		CG13		CG12		CG11		CG10		CG9		CG8	
Reset	1	1	1	1	1	1	1	1	1	1	1	1	1	1	1	1
Bit	15	14	13	12	11	10	9	8	7	6	5	4	3	2	1	0
R																
W																
	CG7		CG6		CG5		CG4		CG3		CG2		CG1		CG0	
Reset	1	1	1	1	1	1	1	1	1	1	1	1	1	1	1	1

CCM_CCGR0 field descriptions

Field	Description
31–30 CG15	gpio2_clocks (gpio2_clk_enable)
29–28 CG14	uart2 clock (uart2_clk_enable)
27–26 CG13	gpt2 serial clocks (gpt2_serial_clk_enable)
25–24 CG12	gpt2 bus clocks (gpt2_bus_clk_enable)
23–22 CG11	CPU debug clocks (arm_dbg_clk_enable)
21–20 CG10	can2_serial clock (can2_serial_clk_enable)
19–18 CG9	can2 clock (can2_clk_enable)

Table continues on the next page...

CCM_CCGR0 field descriptions (continued)

Field	Description
17–16 CG8	can1_serial clock (can1_serial_clk_enable)
15–14 CG7	can1 clock (can1_clk_enable)
13–12 CG6	enet clock (enet_clk_enable)
11–10 CG5	dcp clock (dcp_clk_enable)
9–8 CG4	Reserved
7–6 CG3	asrc clock (asrc_clk_enable)
5–4 CG2	apbhdma hclk clock (apbhdma_hclk_enable)
3–2 CG1	aips_tz2 clocks (aips_tz2_clk_enable)
CG0	aips_tz1 clocks (aips_tz1_clk_enable)

18.6.24 CCM Clock Gating Register 1 (CCM_CCGR1)

The figure below represents the CCM Clock Gating Register 1(CCM_CCGR1). The clock gating registers define the clock gating for power reduction of each clock (CG(i) bits). There are 8 CGR registers. The number of registers required is determined by the number of peripherals in the system.

Address: 20C_4000h base + 6Ch offset = 20C_406Ch

Bit	31	30	29	28	27	26	25	24	23	22	21	20	19	18	17	16
R																
W																
Reset	1	1	1	1	1	1	1	1	1	1	1	1	1	1	1	1
Bit	15	14	13	12	11	10	9	8	7	6	5	4	3	2	1	0
R																
W																
Reset	1	1	1	1	1	1	1	1	1	1	1	1	1	1	1	1

CCM_CCGR1 field descriptions

Field	Description
31–30 CG15	Reserved
29–28 CG14	csu clock (csu_clk_enable)

Table continues on the next page...

CCM_CCGR1 field descriptions (continued)

Field	Description
27–26 CG13	gpio1 clock (gpio1_clk_enable)
25–24 CG12	uart4 clock (uart4_clk_enable)
23–22 CG11	gpt serial clock (gpt_serial_clk_enable)
21–20 CG10	gpt bus clock (gpt_clk_enable)
19–18 CG9	sim_s clock (sim_s_clk_enable)
17–16 CG8	adc1 clock (adc1_clk_enable)
15–14 CG7	epit2 clocks (epit2_clk_enable)
13–12 CG6	epit1 clocks (epit1_clk_enable)
11–10 CG5	uart3 clock (uart3_clk_enable)
9–8 CG4	adc2 clock (adc2_clk_enable)
7–6 CG3	ecspi4 clocks (ecspi4_clk_enable)
5–4 CG2	ecspi3 clocks (ecspi3_clk_enable)
3–2 CG1	ecspi2 clocks (ecspi2_clk_enable)
CG0	ecspi1 clocks (ecspi1_clk_enable)

18.6.25 CCM Clock Gating Register 2 (CCM_CCGR2)

The figure below represents the CCM Clock Gating Register 2 (CCM_CCGR2). The clock gating registers define the clock gating for power reduction of each clock (CG(i) bits). There are 8 CGR registers. The number of registers required is determined by the number of peripherals in the system.

Address: 20C_4000h base + 70h offset = 20C_4070h

Bit	31	30	29	28	27	26	25	24	23	22	21	20	19	18	17	16
R																
W																
	CG15		CG14		CG13		CG12		CG11		CG10		CG9		CG8	
Reset	1	1	1	1	1	1	0	0	0	0	1	1	1	1	1	1
Bit	15	14	13	12	11	10	9	8	7	6	5	4	3	2	1	0
R																
W																
	CG7		CG6		CG5		CG4		CG3		CG2		CG1		CG0	
Reset	1	1	1	1	1	1	1	1	1	1	1	1	1	1	1	1

CCM_CCGR2 field descriptions

Field	Description
31–30 CG15	pxp clocks (pxp_clk_enable)
29–28 CG14	lcd clocks (lcd_clk_enable)
27–26 CG13	gpio3 clock (gpio3_clk_enable)
25–24 CG12	Reserved
23–22 CG11	ipsync_ip2apb_tzasc1_ipg clocks (ipsync_ip2apb_tzasc1_ipg_master_clk_enable)
21–20 CG10	ipmux3 clock (ipmux3_clk_enable)
19–18 CG9	ipmux2 clock (ipmux2_clk_enable)
17–16 CG8	ipmux1 clock (ipmux1_clk_enable)
15–14 CG7	iomux_ipt_clk_io clock (iomux_ipt_clk_io_enable)
13–12 CG6	OCOTP_CTRL clock (iim_clk_enable)
11–10 CG5	i2c3_serial clock (i2c3_serial_clk_enable)
9–8 CG4	i2c2_serial clock (i2c2_serial_clk_enable)

Table continues on the next page...

CCM_CCGR2 field descriptions (continued)

Field	Description
7–6 CG3	i2c1_serial clock (i2c1_serial_clk_enable)
5–4 CG2	iomuxc_snvs clock (iomuxc_snvs_clk_enable)
3–2 CG1	csi clock (csi_clk_enable)
CG0	esai clock (esai_clk_enable)

18.6.26 CCM Clock Gating Register 3 (CCM_CCGR3)

The figure below represents the CCM Clock Gating Register 3 (CCM_CCGR3). The clock gating Registers define the clock gating for power reduction of each clock (CG(i) bits). There are 8 CGR registers. The number of registers required is determined by the number of peripherals in the system.

Address: 20C_4000h base + 74h offset = 20C_4074h

Bit	31	30	29	28	27	26	25	24	23	22	21	20	19	18	17	16
R																
W																
Reset	1	1	1	1	1	1	1	1	1	1	1	1	1	1	1	1
Bit	15	14	13	12	11	10	9	8	7	6	5	4	3	2	1	0
R																
W																
Reset	1	1	1	1	1	1	1	1	1	1	1	1	1	1	1	1

CCM_CCGR3 field descriptions

Field	Description
31–30 CG15	iomuxc_snvs_gpr clock (iomuxc_snvs_gpr_clk_enable)
29–28 CG14	ocram clock (ocram_clk_enable)
27–26 CG13	mmdc_core_ipg_clk_p1 clock (mmdc_core_ipg_clk_p1_enable)
25–24 CG12	mmdc_core_ipg_clk_p0 clock (mmdc_core_ipg_clk_p0_enable)
23–22 CG11	Reserved
21–20 CG10	mmdc_core_aclk_fast_core_p0 clock (mmdc_core_aclk_fast_core_p0_enable)
19–18 CG9	a7 clkdiv patch clock (a7_clkdiv_patch_clk_enable)

Table continues on the next page...

CCM_CCGR3 field descriptions (continued)

Field	Description
17–16 CG8	wdog1 clock (wdog1_clk_enable)
15–14 CG7	qspi clock (qspi_clk_enable)
13–12 CG6	gpio4 clock (gpio4_clk_enable)
11–10 CG5	lcdif1 pix clock (lcdif1_pix_clk_enable)
9–8 CG4	CA7 CCM DAP clock (ccm_dap_clk_enable)
7–6 CG3	uart6 clock (uart6_clk_enable)
5–4 CG2	epdc clock (epdc_clk_enable)
3–2 CG1	uart5 clock (uart5_clk_enable)
CG0	Reserved

18.6.27 CCM Clock Gating Register 4 (CCM_CCGR4)

The figure below represents the CCM Clock Gating Register 4 (CCM_CCGR4). The clock gating Registers define the clock gating for power reduction of each clock (CG(i) bits). There are 8 CGR registers. The number of registers required is determined by the number of peripherals in the system.

Address: 20C_4000h base + 78h offset = 20C_4078h

Bit	31	30	29	28	27	26	25	24	23	22	21	20	19	18	17	16
R																
W																
Reset	1	1	1	1	1	1	1	1	1	1	1	1	1	1	1	1
Bit	15	14	13	12	11	10	9	8	7	6	5	4	3	2	1	0
R																
W																
Reset	1	1	1	1	1	1	1	1	1	1	1	1	1	1	1	1

CCM_CCGR4 field descriptions

Field	Description
31–30 CG15	rawnand_u_gpmi_input_apb clock (rawnand_u_gpmi_input_apb_clk_enable)
29–28 CG14	rawnand_u_gpmi_bch_input_gpmi_io clock (rawnand_u_gpmi_bch_input_gpmi_io_clk_enable)

Table continues on the next page...

CCM_CCGR4 field descriptions (continued)

Field	Description
27–26 CG13	rawnand_u_gpmi_bch_input_bch clock (rawnand_u_gpmi_bch_input_bch_clk_enable)
25–24 CG12	rawnand_u_bch_input_apb clock (rawnand_u_bch_input_apb_clk_enable)
23–22 CG11	pwm4 clocks (pwm4_clk_enable)
21–20 CG10	pwm3 clocks (pwm3_clk_enable)
19–18 CG9	pwm2 clocks (pwm2_clk_enable)
17–16 CG8	pwm1 clocks (pwm1_clk_enable)
15–14 CG7	pl301_mx6qper2_mainclk_enable (pl301_mx6qper2_mainclk_enable)
13–12 CG6	pl301_mx6qper1_bch clocks (pl301_mx6qper1_bchclk_enable) NOTE: This gates bch_clk_root to sim_m fabric.
11–10 CG5	tsc_dig clock (tsc_clk_enable)
9–8 CG4	cxapbsyncbridge slave clock (cxapbsyncbridge_slave_clk_enable)
7–6 CG3	sim_cpu clock(sim_cpu_clk_enable)
5–4 CG2	iomuxc gpr clock (iomuxc_gpr_clk_enable)
3–2 CG1	iomuxc clock (iomuxc_clk_enable)
CG0	Reserved

18.6.28 CCM Clock Gating Register 5 (CCM_CCGR5)

The figure below represents the CCM Clock Gating Register 5 (CCM_CCGR5). The clock gating Registers define the clock gating for power reduction of each clock (CG(i) bits). There are 8 CGR registers. The number of registers required is determined by the number of peripherals in the system.

Address: 20C_4000h base + 7Ch offset = 20C_407Ch

Bit	31	30	29	28	27	26	25	24	23	22	21	20	19	18	17	16
R																
W																
	CG15		CG14		CG13		CG12		CG11		CG10		CG9		CG8	
Reset	1	1	1	1	1	1	1	1	1	1	1	1	1	1	1	1
Bit	15	14	13	12	11	10	9	8	7	6	5	4	3	2	1	0
R																
W																
	CG7		CG6		CG5		CG4		CG3		CG2		CG1		CG0	
Reset	1	1	1	1	1	1	1	1	1	1	1	1	1	1	1	1

CCM_CCGR5 field descriptions

Field	Description
31–30 CG15	sai2 clock (sai2_clk_enable)
29–28 CG14	sai1 clock (sai1_clk_enable)
27–26 CG13	uart7 clock (uart7_clk_enable)
25–24 CG12	uart1 clock (uart1_clk_enable)
23–22 CG11	sai3 clock (sai3_clk_enable)
21–20 CG10	snvs_lp clock (snvs_lp_clk_enable)
19–18 CG9	snvs_hp clock (snvs_hp_clk_enable)
17–16 CG8	sim_main clock (sim_main_clk_enable)
15–14 CG7	spdif / audio clock (spdif_clk_enable, audio_clk_root)
13–12 CG6	spba clock (spba_clk_enable)
11–10 CG5	wdog2 clock (wdog2_clk_enable)
9–8 CG4	kpp clock (kpp_clk_enable)

Table continues on the next page...

CCM_CCGR5 field descriptions (continued)

Field	Description
7–6 CG3	sdma clock (sdma_clk_enable)
5–4 CG2	snvs dryice clock (snvs_dryice_clk_enable)
3–2 CG1	sctr clock (sctr_clk_enable)
CG0	rom clock (rom_clk_enable)

18.6.29 CCM Clock Gating Register 6 (CCM_CCGR6)

The figure below represents the CCM Clock Gating Register 6 (CCM_CCGR6). The clock gating Registers define the clock gating for power reduction of each clock (CG(i) bits). There are 8 CGR registers. The number of registers required is determined by the number of peripherals in the system.

Address: 20C_4000h base + 80h offset = 20C_4080h

Bit	31	30	29	28	27	26	25	24	23	22	21	20	19	18	17	16
R																
W																
Reset	1	1	1	1	1	1	1	1	1	1	1	1	1	1	1	1
Bit	15	14	13	12	11	10	9	8	7	6	5	4	3	2	1	0
R																
W																
Reset	1	1	1	1	1	1	1	1	1	1	1	1	1	1	1	1

CCM_CCGR6 field descriptions

Field	Description
31–30 CG15	pwm7 clocks (pwm7_clk_enable)
29–28 CG14	pwm6 clocks (pwm6_clk_enable)
27–26 CG13	pwm5 clocks (pwm5_clk_enable)
25–24 CG12	i2c4 serial clock (i2c4_serial_clk_enable)
23–22 CG11	anadig clocks (anadig_clk_enable)
21–20 CG10	wdog3 clock (wdog3_clk_enable)
19–18 CG9	aips_tz3 clock (aips_tz3_clk_enable)

Table continues on the next page...

CCM_CCGR6 field descriptions (continued)

Field	Description
17–16 CG8	pwm8 clocks (pwm8_clk_enable)
15–14 CG7	uart8 clocks (uart8_clk_enable)
13–12 CG6	uart debug req gate NOTE: This is not a clock, but a gate for the debug request signal to reach the UART module.
11–10 CG5	eim_slow clocks (eim_slow_clk_enable)
9–8 CG4	ipmux4 clock (ipmux4_clk_enable)
7–6 CG3	Reserved
5–4 CG2	usdhc2 clocks (usdhc2_clk_enable)
3–2 CG1	usdhc1 clocks (usdhc1_clk_enable)
CG0	usboh3 clock (usboh3_clk_enable)

18.6.30 CCM Module Enable Override Register (CCM_CMEOR)

The follow figure represents the CCM Module Enable Override Register (CMEOR). The CMEOR register contains bits to override the clock enable signal from the module. This bit will be applicable only for modules whose clock enable signals are used. The following table provides its field descriptions.

Address: 20C_4000h base + 88h offset = 20C_4088h

Bit	31	30	29	28	27	26	25	24	23	22	21	20	19	18	17	16
R	1		1		1											
W		MOD_EN_OV_ CAN1_CPI		MOD_EN_OV_ CAN2_CPI												
Reset	1	1	1	1	1	1	1	1	1	1	1	1	1	1	1	1
Bit	15	14	13	12	11	10	9	8	7	6	5	4	3	2	1	0
R									1				1			
W										MOD_EN_USDHC	MOD_EN_OV_ EPIT	MOD_EN_OV_GPT				
Reset	1	1	1	1	1	1	1	1	1	1	1	1	1	1	1	1

CCM_CMEOR field descriptions

Field	Description
31 Reserved	This read-only field is reserved and always has the value 1.
30 MOD_EN_OV_ CAN1_CPI	Override clock enable signal from CAN1 - clock will not be gated based on CAN's signal 'enable_clk_cpi'. 0 don't override module enable signal 1 override module enable signal
29 Reserved	This read-only field is reserved and always has the value 1.
28 MOD_EN_OV_ CAN2_CPI	Override clock enable signal from CAN2 - clock will not be gated based on CAN's signal 'enable_clk_cpi'. 0 don't override module enable signal 1 override module enable signal
27-8 Reserved	This read-only field is reserved and always has the value 1.

Table continues on the next page...

CCM_CMEOR field descriptions (continued)

Field	Description
7 MOD_EN_ USDHC	override clock enable signal from USDHC. 0 don't override module enable signal 1 override module enable signal
6 MOD_EN_OV_ EPIT	Override clock enable signal from EPIT - clock will not be gated based on EPIT's signal 'ipg_enable_clk' . 0 don't override module enable signal 1 override module enable signal
5 MOD_EN_OV_ GPT	Override clock enable signal from GPT - clock will not be gated based on GPT's signal 'ipg_enable_clk' . 0 don't override module enable signal 1 override module enable signal
Reserved	This read-only field is reserved and always has the value 1.

18.7 CCM Analog Memory Map/Register Definition

This section describes the registers for the analog PLLs. The registers which have the same description are grouped within {}. The register offsets for the various PLLs are:

- ARM PLL: {0h000, 0h004, 0h008, 0h00C}.
- USB1 PLL: {0h010, 0h014, 0h018, 0h01C}, {0h0F0, 0h0F4, 0h0F8, 0h0FC}.
- System PLL: {0h030, 0h034, 0h038, 0h03C}, 0h040, 0h050, 0h060, {0h100, 0h104, 0h108, 0h10C}.
- Audio / Video PLL: {0h070, 0h074, 0h078, 0h07C}, 0h080, 0h090, {0h0A0, 0h0A4, 0h0A8, 0h0AC}, 0h0B0, 0h0C0

CCM_ANALOG memory map

Absolute address (hex)	Register name	Width (in bits)	Access	Reset value	Section/ page
20C_8000	Analog ARM PLL control Register (CCM_ANALOG_PLL_ARM)	32	R/W	0001_3063h	18.7.1/714
20C_8004	Analog ARM PLL control Register (CCM_ANALOG_PLL_ARM_SET)	32	R/W	0001_3063h	18.7.1/714
20C_8008	Analog ARM PLL control Register (CCM_ANALOG_PLL_ARM_CLR)	32	R/W	0001_3063h	18.7.1/714
20C_800C	Analog ARM PLL control Register (CCM_ANALOG_PLL_ARM_TOG)	32	R/W	0001_3063h	18.7.1/714
20C_8010	Analog USB1 480MHz PLL Control Register (CCM_ANALOG_PLL_USB1)	32	R/W	0001_2000h	18.7.2/716

Table continues on the next page...

CCM_ANALOG memory map (continued)

Absolute address (hex)	Register name	Width (in bits)	Access	Reset value	Section/page
20C_8014	Analog USB1 480MHz PLL Control Register (CCM_ANALOG_PLL_USB1_SET)	32	R/W	0001_2000h	18.7.2/716
20C_8018	Analog USB1 480MHz PLL Control Register (CCM_ANALOG_PLL_USB1_CLR)	32	R/W	0001_2000h	18.7.2/716
20C_801C	Analog USB1 480MHz PLL Control Register (CCM_ANALOG_PLL_USB1_TOG)	32	R/W	0001_2000h	18.7.2/716
20C_8020	Analog USB2 480MHz PLL Control Register (CCM_ANALOG_PLL_USB2)	32	R/W	0001_2000h	18.7.3/718
20C_8024	Analog USB2 480MHz PLL Control Register (CCM_ANALOG_PLL_USB2_SET)	32	R/W	0001_2000h	18.7.3/718
20C_8028	Analog USB2 480MHz PLL Control Register (CCM_ANALOG_PLL_USB2_CLR)	32	R/W	0001_2000h	18.7.3/718
20C_802C	Analog USB2 480MHz PLL Control Register (CCM_ANALOG_PLL_USB2_TOG)	32	R/W	0001_2000h	18.7.3/718
20C_8030	Analog System PLL Control Register (CCM_ANALOG_PLL_SYS)	32	R/W	0001_3001h	18.7.4/720
20C_8034	Analog System PLL Control Register (CCM_ANALOG_PLL_SYS_SET)	32	R/W	0001_3001h	18.7.4/720
20C_8038	Analog System PLL Control Register (CCM_ANALOG_PLL_SYS_CLR)	32	R/W	0001_3001h	18.7.4/720
20C_803C	Analog System PLL Control Register (CCM_ANALOG_PLL_SYS_TOG)	32	R/W	0001_3001h	18.7.4/720
20C_8040	528MHz System PLL Spread Spectrum Register (CCM_ANALOG_PLL_SYS_SS)	32	R/W	0000_0000h	18.7.5/722
20C_8050	Numerator of 528MHz System PLL Fractional Loop Divider Register (CCM_ANALOG_PLL_SYS_NUM)	32	R/W	0000_0000h	18.7.6/722
20C_8060	Denominator of 528MHz System PLL Fractional Loop Divider Register (CCM_ANALOG_PLL_SYS_DENOM)	32	R/W	0000_0012h	18.7.7/723
20C_8070	Analog Audio PLL control Register (CCM_ANALOG_PLL_AUDIO)	32	R/W	0001_1006h	18.7.8/724
20C_8074	Analog Audio PLL control Register (CCM_ANALOG_PLL_AUDIO_SET)	32	R/W	0001_1006h	18.7.8/724
20C_8078	Analog Audio PLL control Register (CCM_ANALOG_PLL_AUDIO_CLR)	32	R/W	0001_1006h	18.7.8/724
20C_807C	Analog Audio PLL control Register (CCM_ANALOG_PLL_AUDIO_TOG)	32	R/W	0001_1006h	18.7.8/724
20C_8080	Numerator of Audio PLL Fractional Loop Divider Register (CCM_ANALOG_PLL_AUDIO_NUM)	32	R/W	05F5_E100h	18.7.9/726
20C_8090	Denominator of Audio PLL Fractional Loop Divider Register (CCM_ANALOG_PLL_AUDIO_DENOM)	32	R/W	2964_619Ch	18.7.10/ 727
20C_80A0	Analog Video PLL control Register (CCM_ANALOG_PLL_VIDEO)	32	R/W	0001_100Ch	18.7.11/ 728
20C_80A4	Analog Video PLL control Register (CCM_ANALOG_PLL_VIDEO_SET)	32	R/W	0001_100Ch	18.7.11/ 728

Table continues on the next page...

CCM_ANALOG memory map (continued)

Absolute address (hex)	Register name	Width (in bits)	Access	Reset value	Section/page
20C_80A8	Analog Video PLL control Register (CCM_ANALOG_PLL_VIDEO_CLR)	32	R/W	0001_100Ch	18.7.11/ 728
20C_80AC	Analog Video PLL control Register (CCM_ANALOG_PLL_VIDEO_TOG)	32	R/W	0001_100Ch	18.7.11/ 728
20C_80B0	Numerator of Video PLL Fractional Loop Divider Register (CCM_ANALOG_PLL_VIDEO_NUM)	32	R/W	05F5_E100h	18.7.12/ 730
20C_80C0	Denominator of Video PLL Fractional Loop Divider Register (CCM_ANALOG_PLL_VIDEO_DENOM)	32	R/W	10A2_4447h	18.7.13/ 731
20C_80E0	Analog ENET PLL Control Register (CCM_ANALOG_PLL_ENET)	32	R/W	0001_1001h	18.7.14/ 732
20C_80E4	Analog ENET PLL Control Register (CCM_ANALOG_PLL_ENET_SET)	32	R/W	0001_1001h	18.7.14/ 732
20C_80E8	Analog ENET PLL Control Register (CCM_ANALOG_PLL_ENET_CLR)	32	R/W	0001_1001h	18.7.14/ 732
20C_80EC	Analog ENET PLL Control Register (CCM_ANALOG_PLL_ENET_TOG)	32	R/W	0001_1001h	18.7.14/ 732
20C_80F0	480MHz Clock (PLL3) Phase Fractional Divider Control Register (CCM_ANALOG_PFD_480)	32	R/W	1311_100Ch	18.7.15/ 734
20C_80F4	480MHz Clock (PLL3) Phase Fractional Divider Control Register (CCM_ANALOG_PFD_480_SET)	32	R/W	1311_100Ch	18.7.15/ 734
20C_80F8	480MHz Clock (PLL3) Phase Fractional Divider Control Register (CCM_ANALOG_PFD_480_CLR)	32	R/W	1311_100Ch	18.7.15/ 734
20C_80FC	480MHz Clock (PLL3) Phase Fractional Divider Control Register (CCM_ANALOG_PFD_480_TOG)	32	R/W	1311_100Ch	18.7.15/ 734
20C_8100	528MHz Clock (PLL2) Phase Fractional Divider Control Register (CCM_ANALOG_PFD_528)	32	R/W	1018_101Bh	18.7.16/ 736
20C_8104	528MHz Clock (PLL2) Phase Fractional Divider Control Register (CCM_ANALOG_PFD_528_SET)	32	R/W	1018_101Bh	18.7.16/ 736
20C_8108	528MHz Clock (PLL2) Phase Fractional Divider Control Register (CCM_ANALOG_PFD_528_CLR)	32	R/W	1018_101Bh	18.7.16/ 736
20C_810C	528MHz Clock (PLL2) Phase Fractional Divider Control Register (CCM_ANALOG_PFD_528_TOG)	32	R/W	1018_101Bh	18.7.16/ 736
20C_8150	Miscellaneous Register 0 (CCM_ANALOG_MISC0)	32	R/W	0400_0000h	18.7.17/ 739
20C_8154	Miscellaneous Register 0 (CCM_ANALOG_MISC0_SET)	32	R/W	0400_0000h	18.7.17/ 739
20C_8158	Miscellaneous Register 0 (CCM_ANALOG_MISC0_CLR)	32	R/W	0400_0000h	18.7.17/ 739
20C_815C	Miscellaneous Register 0 (CCM_ANALOG_MISC0_TOG)	32	R/W	0400_0000h	18.7.17/ 739
20C_8160	Miscellaneous Register 1 (CCM_ANALOG_MISC1)	32	R/W	0000_0000h	18.7.18/ 743
20C_8164	Miscellaneous Register 1 (CCM_ANALOG_MISC1_SET)	32	R/W	0000_0000h	18.7.18/ 743

Table continues on the next page...

CCM_ANALOG memory map (continued)

Absolute address (hex)	Register name	Width (in bits)	Access	Reset value	Section/page
20C_8168	Miscellaneous Register 1 (CCM_ANALOG_MISC1_CLR)	32	R/W	0000_0000h	18.7.18/743
20C_816C	Miscellaneous Register 1 (CCM_ANALOG_MISC1_TOG)	32	R/W	0000_0000h	18.7.18/743
20C_8170	Miscellaneous Register 2 (CCM_ANALOG_MISC2)	32	R/W	0027_2727h	18.7.19/746
20C_8174	Miscellaneous Register 2 (CCM_ANALOG_MISC2_SET)	32	R/W	0027_2727h	18.7.19/746
20C_8178	Miscellaneous Register 2 (CCM_ANALOG_MISC2_CLR)	32	R/W	0027_2727h	18.7.19/746
20C_817C	Miscellaneous Register 2 (CCM_ANALOG_MISC2_TOG)	32	R/W	0027_2727h	18.7.19/746

18.7.1 Analog ARM PLL control Register (CCM_ANALOG_PLL_ARMn)

The control register provides control for the system PLL.

Address: 20C_8000h base + 0h offset + (4d × i), where i=0d to 3d

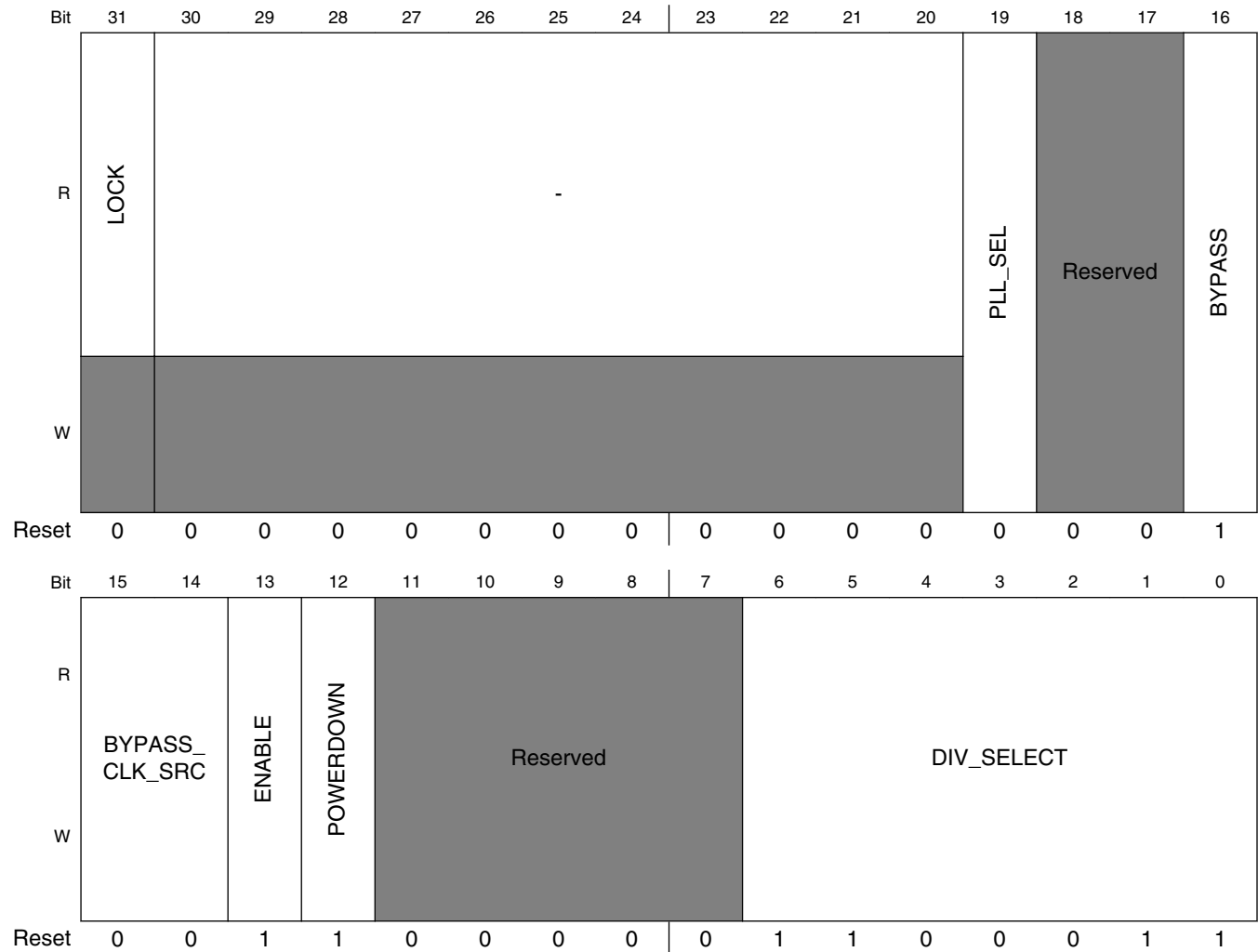

CCM_ANALOG_PLL_ARMn field descriptions

Field	Description
31 LOCK	1 - PLL is currently locked. 0 - PLL is not currently locked.
30-20 -	Always set to zero (0).
19 PLL_SEL	Reserved

Table continues on the next page...

CCM_ANALOG_PLL_ARM n field descriptions (continued)

Field	Description
18–17 -	This field is reserved. Reserved
16 BYPASS	Bypass the PLL.
15–14 BYPASS_CLK_SRC	Determines the bypass source. NOTE: Changing the Bypass clock source also changes the PLL reference clock source. 0x0 REF_CLK_24M — Select the 24MHz oscillator as source. 0x1 CLK1 — Select the CLK1_N / CLK1_P as source. 0x2 Reserved — 0x3 Reserved —
13 ENABLE	Enable the clock output.
12 POWERDOWN	Powers down the PLL.
11–7 -	This field is reserved. Reserved.
DIV_SELECT	This field controls the PLL loop divider. Valid range for divider value: 54-108. $F_{out} = F_{in} * div_select / 2.0$.

18.7.2 Analog USB1 480MHz PLL Control Register (CCM_ANALOG_PLL_USB1n)

The control register provides control for USBPHY0 480MHz PLL.

Address: 20C_8000h base + 10h offset + (4d × i), where i=0d to 3d

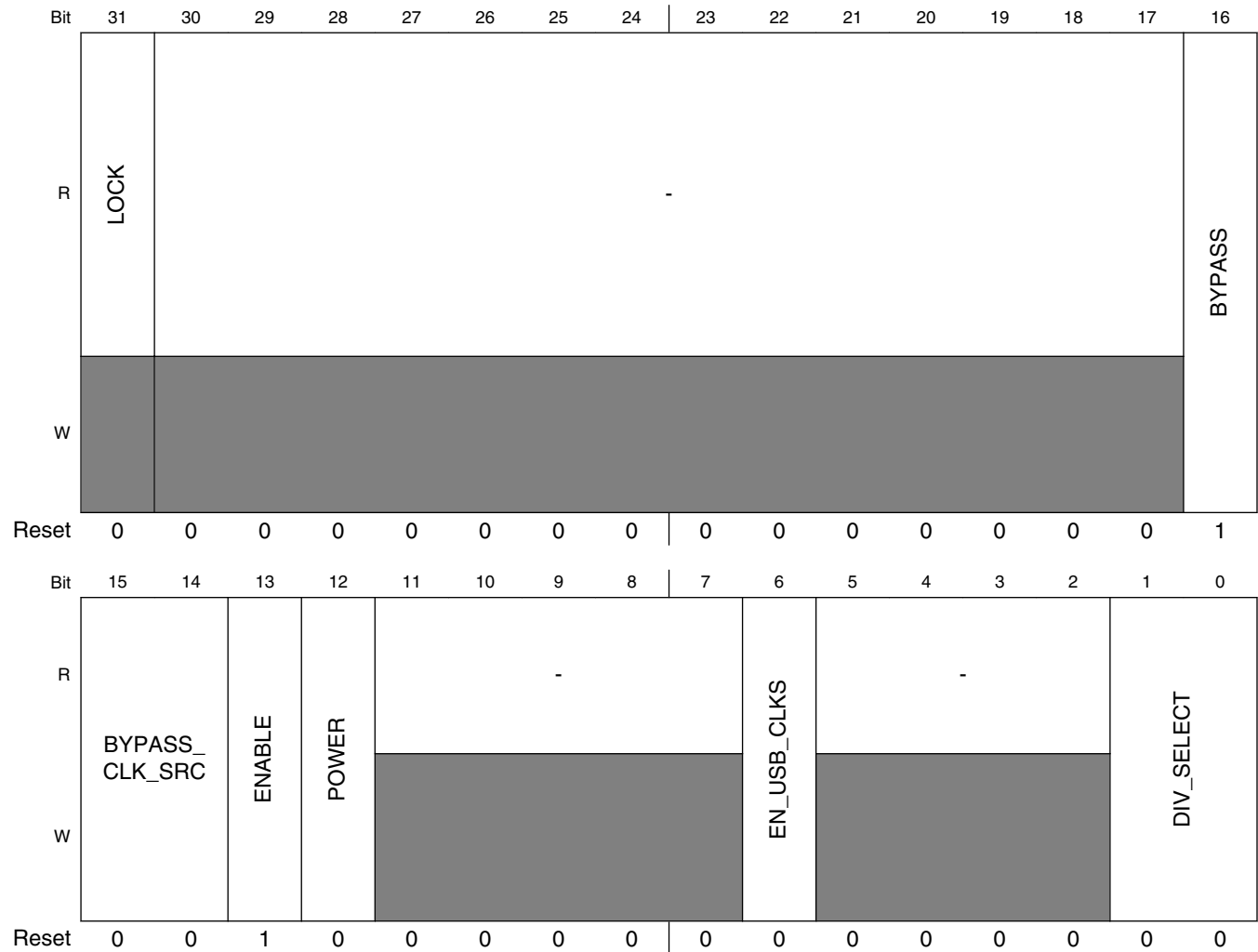

CCM_ANALOG_PLL_USB1n field descriptions

Field	Description
31 LOCK	1 - PLL is currently locked. 0 - PLL is not currently locked.
30-17 -	Always set to zero (0).
16 BYPASS	Bypass the PLL.

Table continues on the next page...

CCM_ANALOG_PLL_USB1n field descriptions (continued)

Field	Description
15–14 BYPASS_CLK_SRC	Determines the bypass source. 0x0 REF_CLK_24M — Select the 24MHz oscillator as source. 0x1 CLK1 — Select the CLK1_N / CLK1_P as source. 0x2 GPANAIO — 0x3 CHRG_DET_B —
13 ENABLE	Enable the PLL clock output.
12 POWER	Powers up the PLL. This bit will be set automatically when USBPHY0 remote wakeup event happens.
11–7 -	Always set to zero (0).
6 EN_USB_CLKS	Powers the 9-phase PLL outputs for USBPHYn. Additionally, the UTMI clock gate must be deasserted in the USBPHYn to enable USBn operation (clear CLKGATE bit in USBPHYn_CTRL). This bit will be set automatically when USBPHYn remote wakeup event occurs. 0 PLL outputs for USBPHYn off. 1 PLL outputs for USBPHYn on.
5–2 -	Always set to zero (0).
DIV_SELECT	This field controls the PLL loop divider. 0 - $F_{out}=F_{ref}*20$; 1 - $F_{out}=F_{ref}*22$.

18.7.3 Analog USB2 480MHz PLL Control Register (CCM_ANALOG_PLL_USB2n)

The control register provides control for USBPHY1 480MHz PLL.

Address: 20C_8000h base + 20h offset + (4d × i), where i=0d to 3d

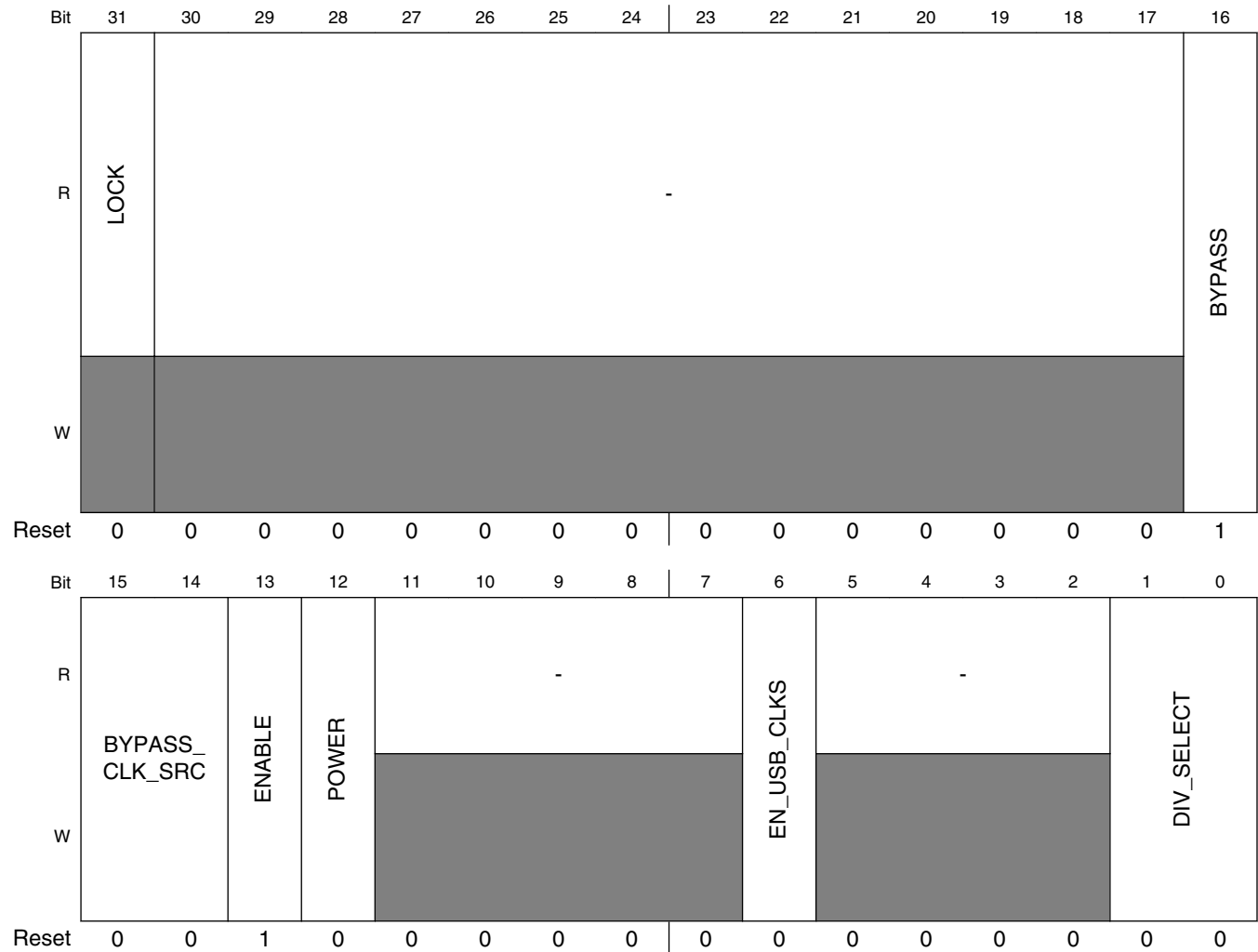

CCM_ANALOG_PLL_USB2n field descriptions

Field	Description
31 LOCK	1 - PLL is currently locked. 0 - PLL is not currently locked.
30-17 -	Always set to zero (0).
16 BYPASS	Bypass the PLL.

Table continues on the next page...

CCM_ANALOG_PLL_USB2n field descriptions (continued)

Field	Description
15–14 BYPASS_CLK_SRC	Determines the bypass source. 0x0 REF_CLK_24M — Select the 24MHz oscillator as source. 0x1 CLK1 — Select the CLK1_N / CLK1_P as source. 0x2 Reserved — 0x3 Reserved —
13 ENABLE	Enable the PLL clock output.
12 POWER	Powers up the PLL. This bit will be set automatically when USBPHY1 remote wakeup event happens.
11–7 -	Always set to zero (0).
6 EN_USB_CLKS	0: 8-phase PLL outputs for USBPHY1 are powered down. If set to 1, 8-phase PLL outputs for USBPHY1 are powered up. Additionally, the utmi clock gate must be deasserted in the USBPHY1 to enable USB0 operation (clear CLKGATE bit in USBPHY1_CTRL). This bit will be set automatically when USBPHY1 remote wakeup event happens.
5–2 -	Always set to zero (0).
DIV_SELECT	This field controls the PLL loop divider. 0 - $F_{out}=F_{ref}*20$; 1 - $F_{out}=F_{ref}*22$.

18.7.4 Analog System PLL Control Register (CCM_ANALOG_PLL_SYSn)

The control register provides control for the 528MHz PLL.

Address: 20C_8000h base + 30h offset + (4d × i), where i=0d to 3d

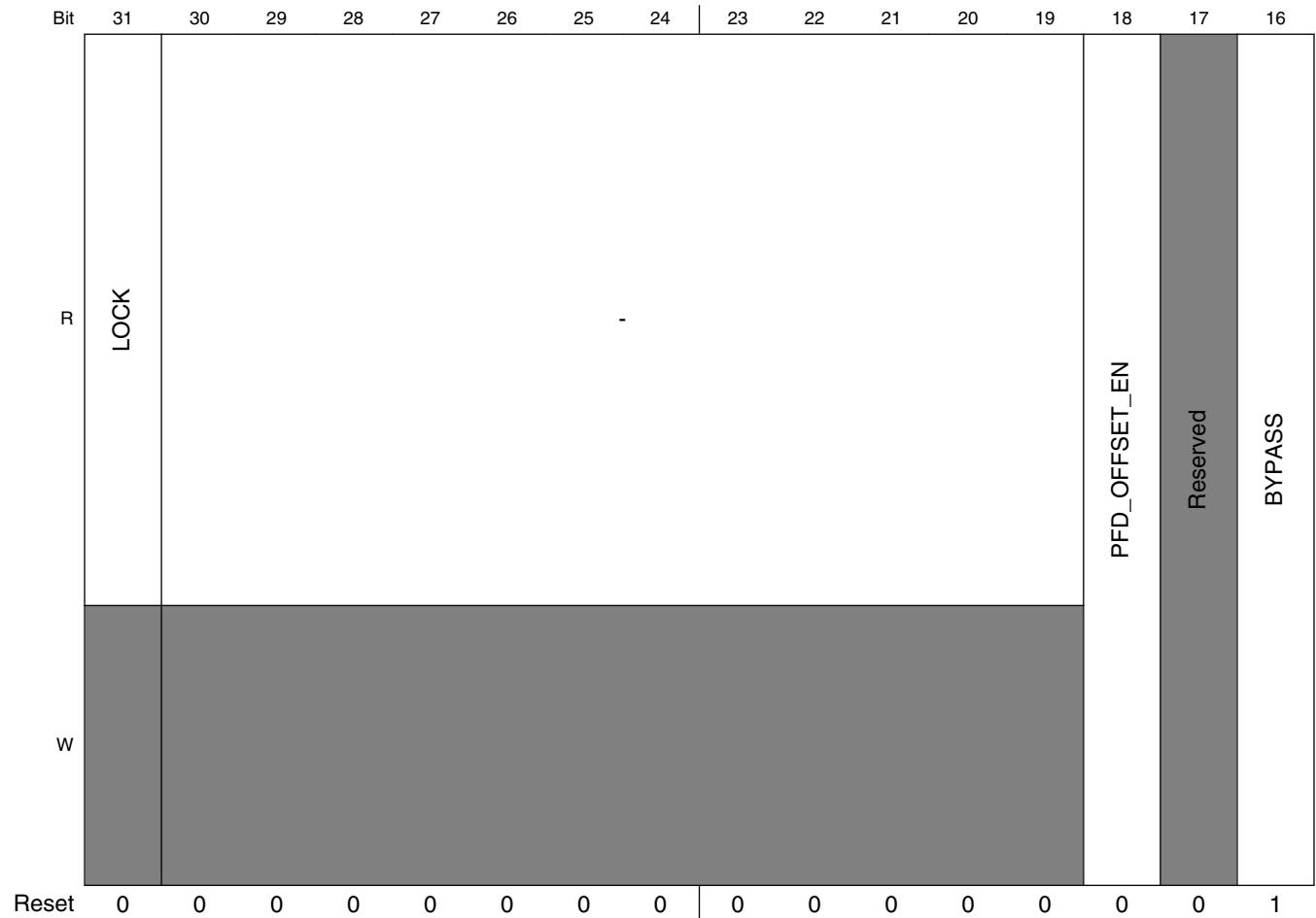

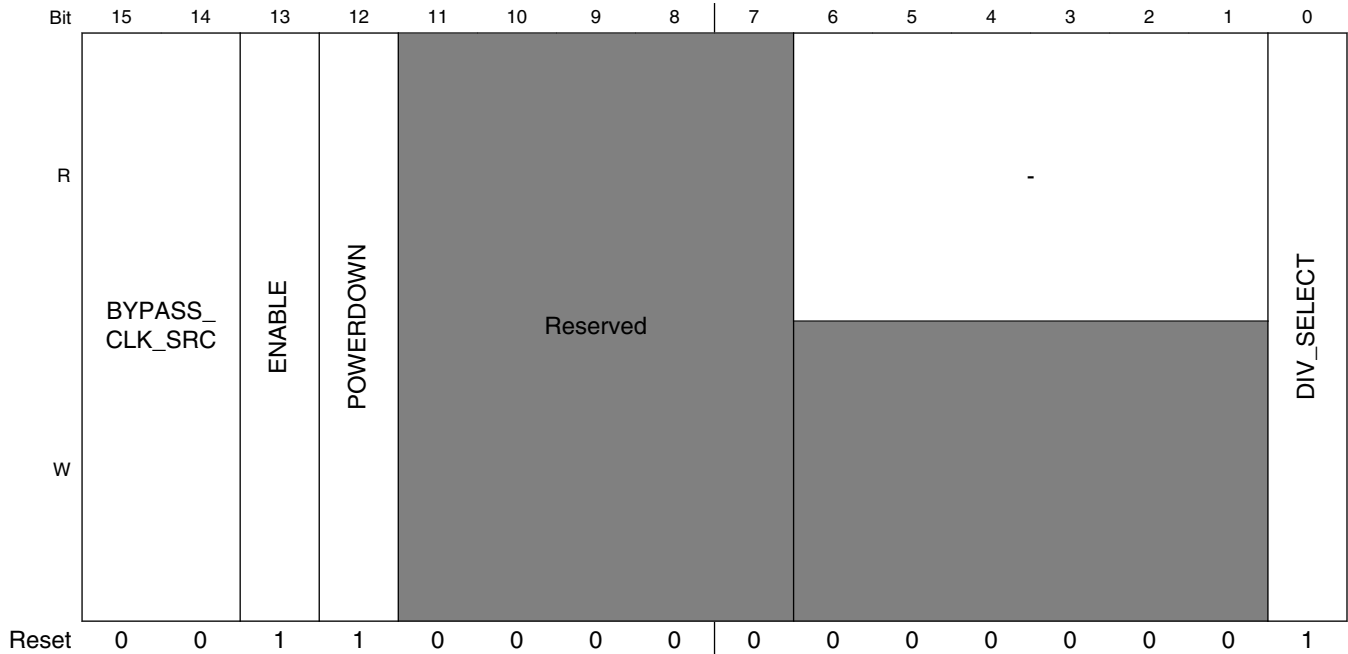

CCM_ANALOG_PLL_SYSn field descriptions

Field	Description
31 LOCK	1 - PLL is currently locked; 0 - PLL is not currently locked.
30–19 -	Always set to zero (0).
18 PFD_OFFSET_EN	Enables an offset in the phase frequency detector.
17 -	This field is reserved. Reserved
16 BYPASS	Bypass the PLL.
15–14 BYPASS_CLK_SRC	Determines the bypass source. 0x0 REF_CLK_24M — Select the 24MHz oscillator as source. 0x1 CLK1 — Select the CLK1_N / CLK1_P as source. 0x2 GPANAIO — 0x3 CHRG_DET_B —
13 ENABLE	Enable PLL output
12 POWERDOWN	Powers down the PLL.
11–7 -	This field is reserved. Reserved.
6–1 -	Always set to zero (0).
0 DIV_SELECT	This field controls the PLL loop divider. 0 - Fout=Fref*20; 1 - Fout=Fref*22.

18.7.5 528MHz System PLL Spread Spectrum Register (CCM_ANALOG_PLL_SYS_SS)

This register contains the 528 PLL spread spectrum controls.

Address: 20C_8000h base + 40h offset = 20C_8040h

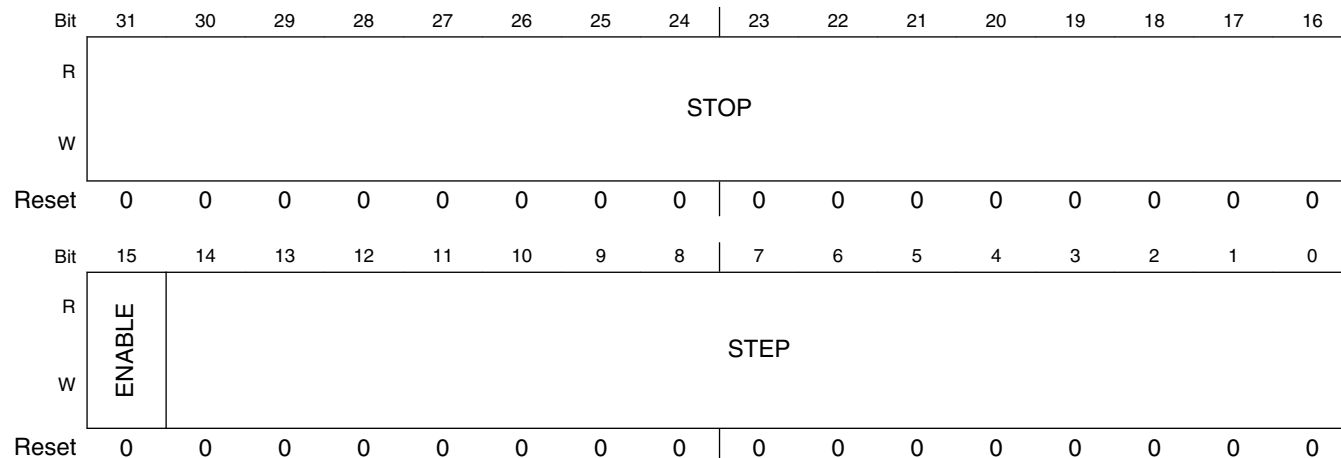

CCM_ANALOG_PLL_SYS_SS field descriptions

Field	Description
31-16 STOP	Frequency change = stop/CCM_ANALOG_PLL_SYS_DENOM[B]*24MHz.
15 ENABLE	Enable bit 0 — Spread spectrum modulation disabled 1 — Soread spectrum modulation enabled
STEP	Frequency change step = step/CCM_ANALOG_PLL_SYS_DENOM[B]*24MHz.

18.7.6 Numerator of 528MHz System PLL Fractional Loop Divider Register (CCM_ANALOG_PLL_SYS_NUM)

This register contains the numerator of 528MHz PLL fractional loop divider (signed number).

Absoulte value should be less than denominator

Address: 20C_8000h base + 50h offset = 20C_8050h

Bit	31	30	29	28	27	26	25	24	23	22	21	20	19	18	17	16	15	14	13	12	11	10	9	8	7	6	5	4	3	2	1	0	
R	-																																
W			A																														
Reset	0	0	0	0	0	0	0	0	0	0	0	0	0	0	0	0	0	0	0	0	0	0	0	0	0	0	0	0	0	0	0	0	0

CCM_ANALOG_PLL_SYS_NUM field descriptions

Field	Description
31–30 -	Always set to zero (0).
A	30 bit numerator (A) of fractional loop divider (signed integer).

18.7.7 Denominator of 528MHz System PLL Fractional Loop Divider Register (CCM_ANALOG_PLL_SYS_DENOM)

This register contains the Denominator of 528MHz PLL fractional loop divider.

Address: 20C_8000h base + 60h offset = 20C_8060h

Bit	31	30	29	28	27	26	25	24	23	22	21	20	19	18	17	16	15	14	13	12	11	10	9	8	7	6	5	4	3	2	1	0	
R	-																																
W			B																														
Reset	0	0	0	0	0	0	0	0	0	0	0	0	0	0	0	0	0	0	0	0	0	0	0	0	0	0	0	0	1	0	0	1	0

CCM_ANALOG_PLL_SYS_DENOM field descriptions

Field	Description
31–30 -	Always set to zero (0).
B	30 bit Denominator (B) of fractional loop divider (unsigned integer).

18.7.8 Analog Audio PLL control Register (CCM_ANALOG_PLL_AUDION)

The control register provides control for the audio PLL.

Address: 20C_8000h base + 70h offset + (4d × i), where i=0d to 3d

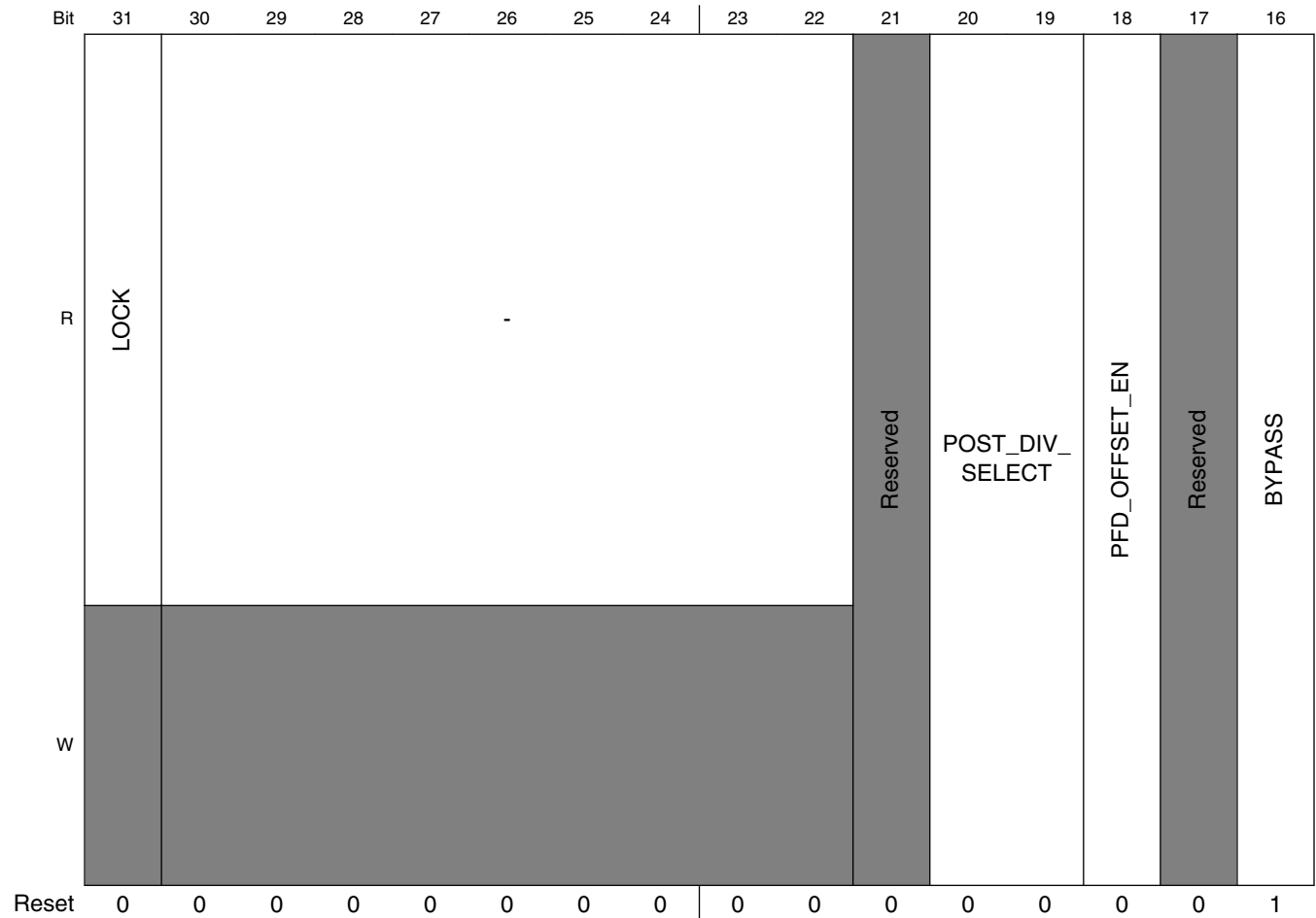

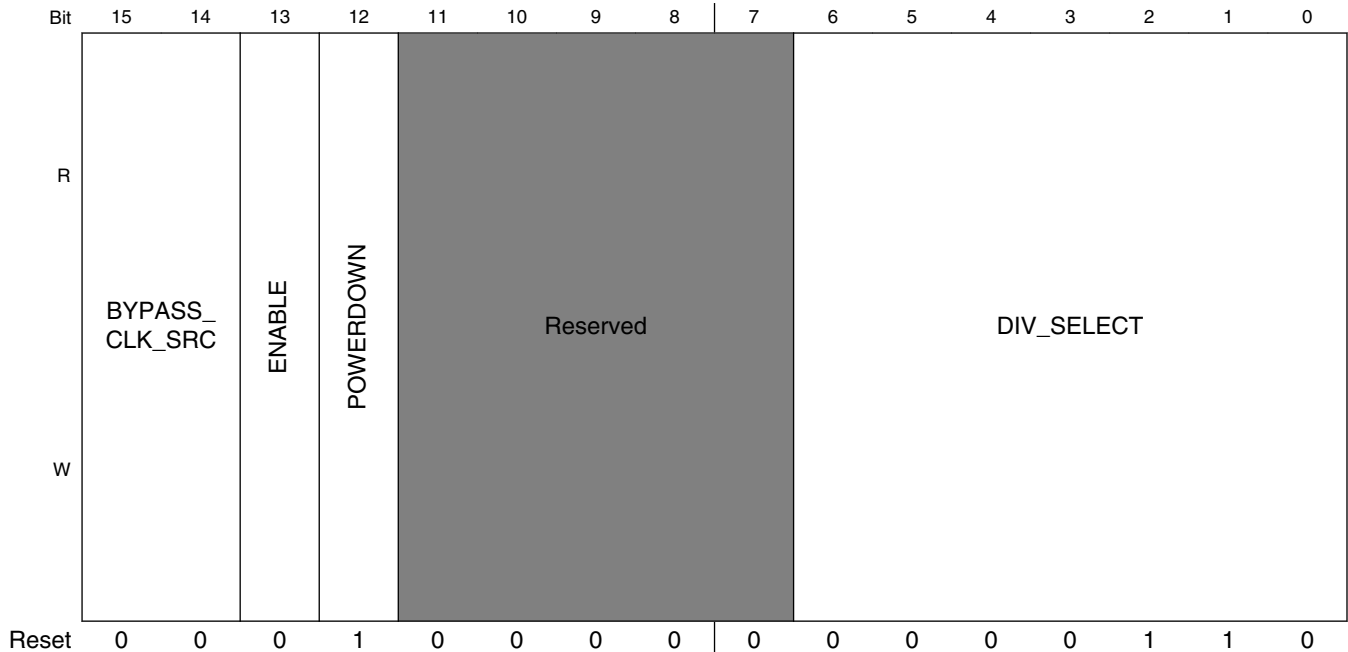

CCM_ANALOG_PLL_AUDIO_n field descriptions

Field	Description
31 LOCK	1 - PLL is currently locked. 0 - PLL is not currently locked.
30–22 -	Always set to zero (0).
21 -	This field is reserved. Reserved
20–19 POST_DIV_SELECT	These bits implement a divider after the PLL, but before the enable and bypass mux. 00 — Divide by 4. 01 — Divide by 2. 10 — Divide by 1. 11 — Reserved
18 PFD_OFFSET_EN	Enables an offset in the phase frequency detector.
17 -	This field is reserved. Reserved
16 BYPASS	Bypass the PLL.
15–14 BYPASS_CLK_SRC	Determines the bypass source. 0x0 REF_CLK_24M — Select the 24MHz oscillator as source. 0x1 CLK1 — Select the CLK1_N / CLK1_P as source. 0x2 Reserved — 0x3 Reserved —

Table continues on the next page...

CCM_ANALOG_PLL_AUDIO n field descriptions (continued)

Field	Description
13 ENABLE	Enable PLL output
12 POWERDOWN	Powers down the PLL.
11–7 -	This field is reserved. Reserved.
DIV_SELECT	This field controls the PLL loop divider. Valid range for DIV_SELECT divider value: 27~54.

18.7.9 Numerator of Audio PLL Fractional Loop Divider Register (CCM_ANALOG_PLL_AUDIO_NUM)

This register contains the numerator (A) of Audio PLL fractional loop divider.(Signed number), absolute value should be less than denominator

Absolute value should be less than denominator

Address: 20C_8000h base + 80h offset = 20C_8080h

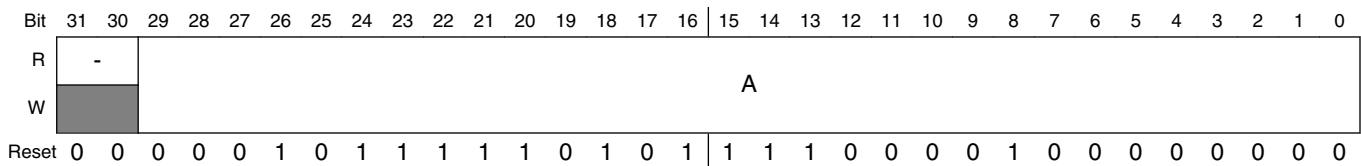

CCM_ANALOG_PLL_AUDIO_NUM field descriptions

Field	Description
31–30 -	Always set to zero (0).
A	30 bit numerator of fractional loop divider.

18.7.10 Denominator of Audio PLL Fractional Loop Divider Register (CCM_ANALOG_PLL_AUDIO_DENOM)

This register contains the Denominator (B) of Audio PLL fractional loop divider. (unsigned number)

Address: 20C_8000h base + 90h offset = 20C_8090h

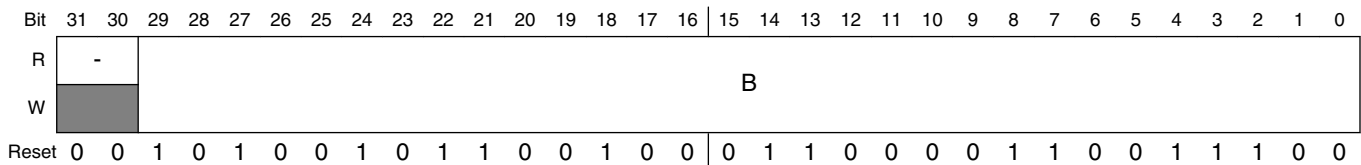

CCM_ANALOG_PLL_AUDIO_DENOM field descriptions

Field	Description
31–30 -	Always set to zero (0).
B	30 bit Denominator of fractional loop divider.

18.7.11 Analog Video PLL control Register (CCM_ANALOG_PLL_VIDEOn)

The control register provides control for the Video PLL.

Address: 20C_8000h base + A0h offset + (4d × i), where i=0d to 3d

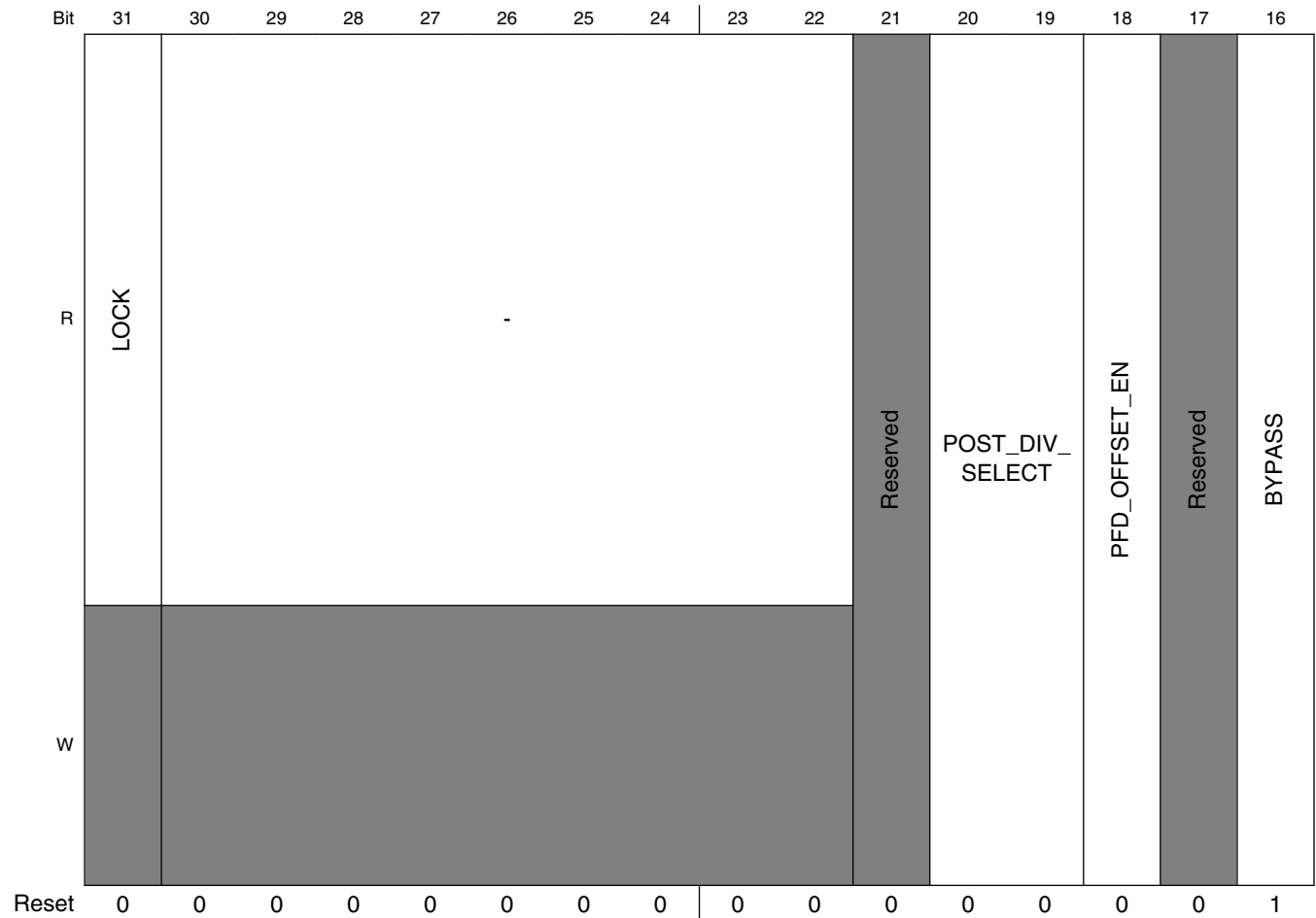

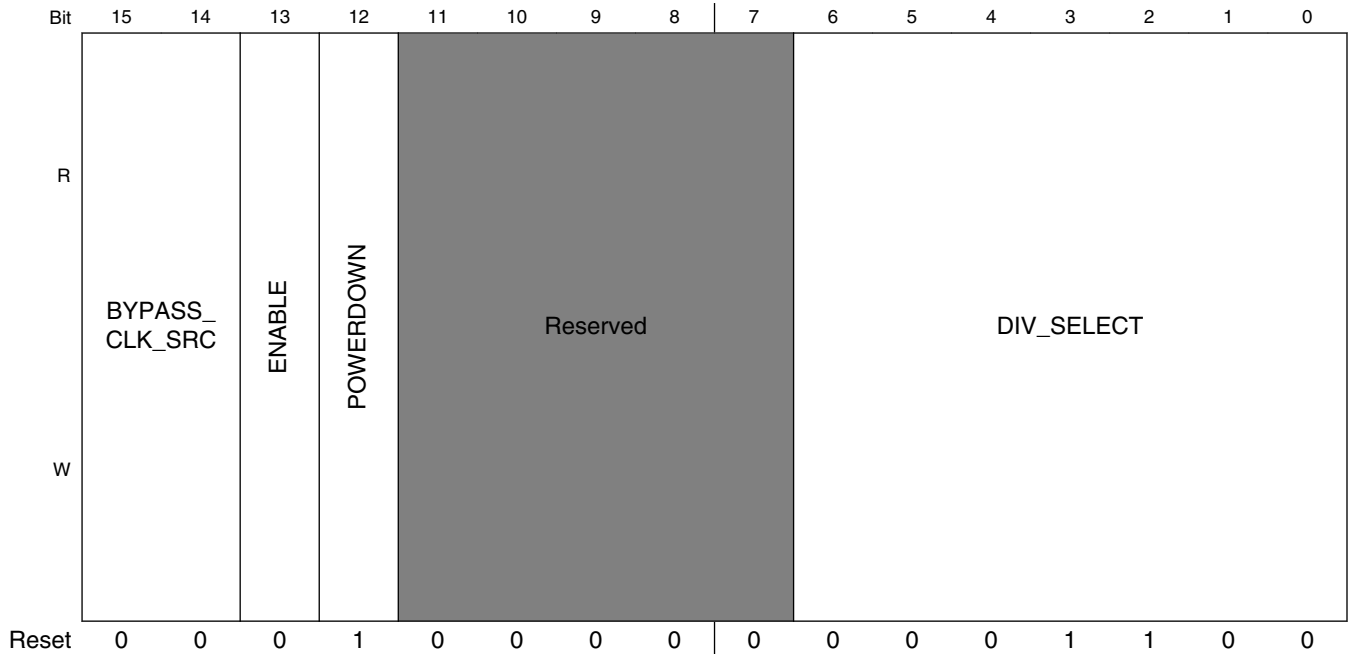

CCM_ANALOG_PLL_VIDEO_n field descriptions

Field	Description
31 LOCK	1 - PLL is currently locked; 0 - PLL is not currently locked.
30–22 -	Always set to zero (0).
21 -	This field is reserved. Reserved
20–19 POST_DIV_SELECT	These bits implement a divider after the PLL, but before the enable and bypass mux. 00 — Divide by 4. 01 — Divide by 2. 10 — Divide by 1. 11 — Reserved
18 PFD_OFFSET_EN	Enables an offset in the phase frequency detector.
17 -	This field is reserved. Reserved
16 BYPASS	Bypass the PLL.
15–14 BYPASS_CLK_SRC	Determines the bypass source. 0x0 REF_CLK_24M — Select the 24MHz oscillator as source. 0x1 CLK1 — Select the CLK1_N / CLK1_P as source. 0x2 Reserved — 0x3 Reserved —

Table continues on the next page...

CCM_ANALOG_PLL_VIDEO_n field descriptions (continued)

Field	Description
13 ENABLE	Enable PLL output
12 POWERDOWN	Powers down the PLL.
11–7 -	This field is reserved. Reserved.
DIV_SELECT	This field controls the PLL loop divider. Valid range for DIV_SELECT divider value: 27~54.

18.7.12 Numerator of Video PLL Fractional Loop Divider Register (CCM_ANALOG_PLL_VIDEO_NUM)

This register contains the numerator (A) of Video PLL fractional loop divider.(Signed number)

Absolute value should be less than denominator

Address: 20C_8000h base + B0h offset = 20C_80B0h

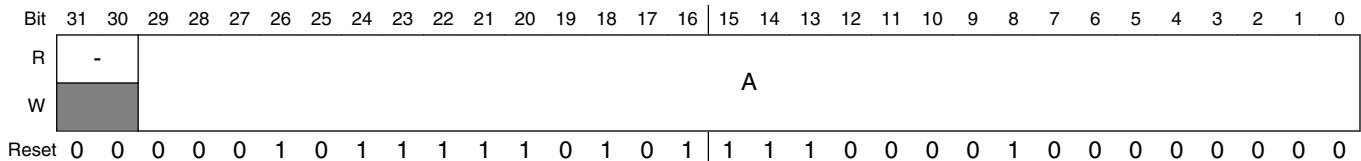

CCM_ANALOG_PLL_VIDEO_NUM field descriptions

Field	Description
31–30 -	Always set to zero (0).
A	30 bit numerator of fractional loop divider(Signed number), absolute value should be less than denominator

18.7.13 Denominator of Video PLL Fractional Loop Divider Register (CCM_ANALOG_PLL_VIDEO_DENOM)

This register contains the Denominator (B) of Video PLL fractional loop divider.
(Unsigned number)

Address: 20C_8000h base + C0h offset = 20C_80C0h

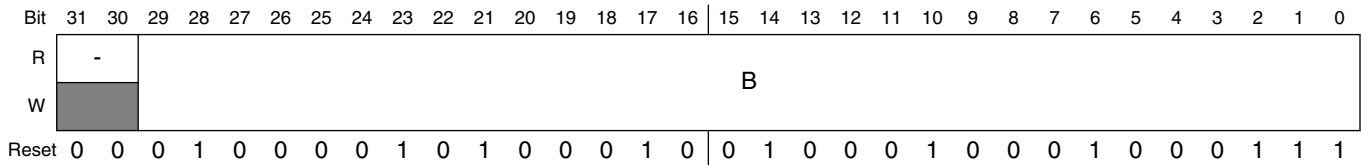

CCM_ANALOG_PLL_VIDEO_DENOM field descriptions

Field	Description
31–30 -	Always set to zero (0).
B	30 bit Denominator of fractional loop divider.

18.7.14 Analog ENET PLL Control Register (CCM_ANALOG_PLL_ENETn)

The control register provides control for the ENET PLL.

Address: 20C_8000h base + E0h offset + (4d × i), where i=0d to 3d

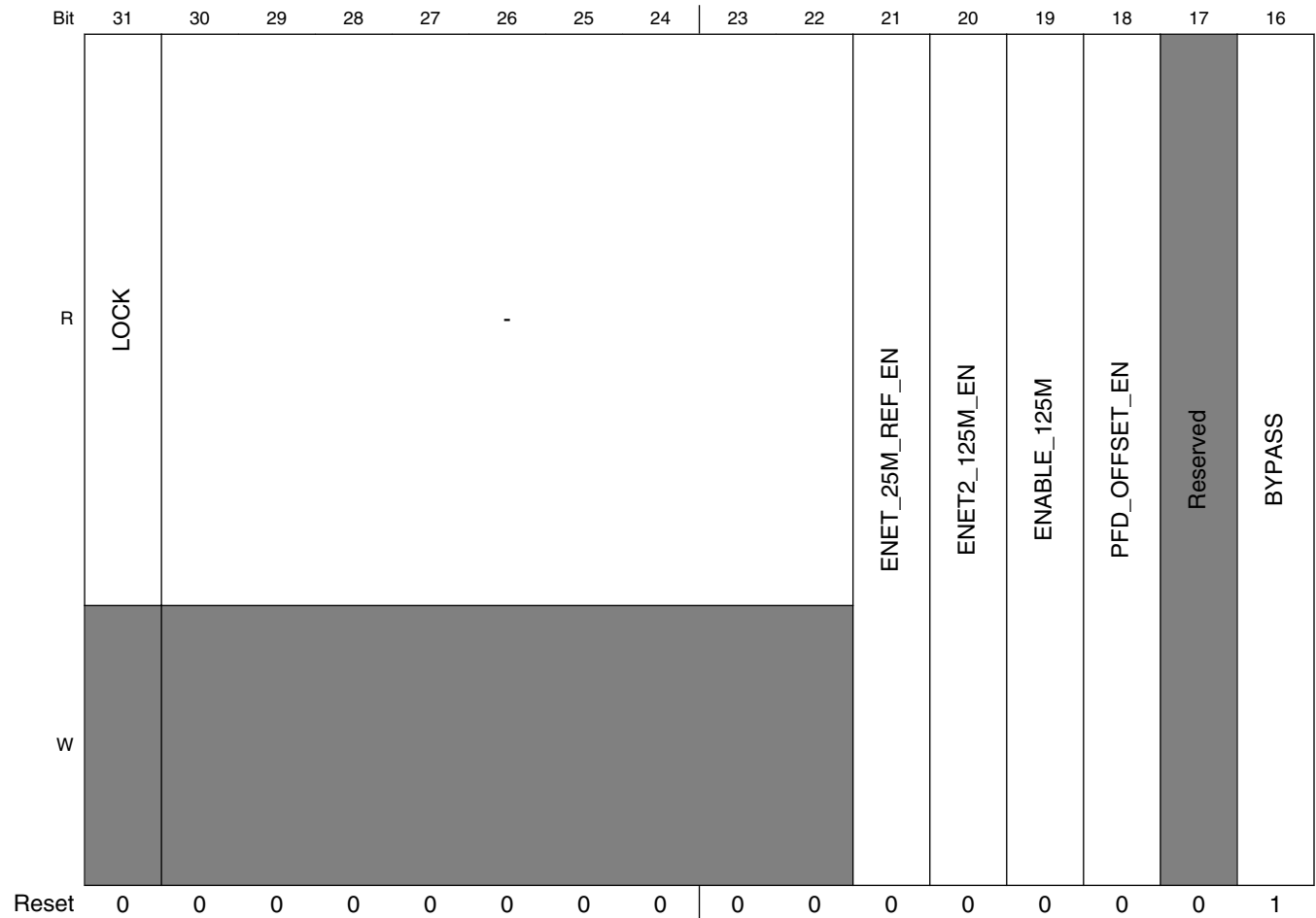

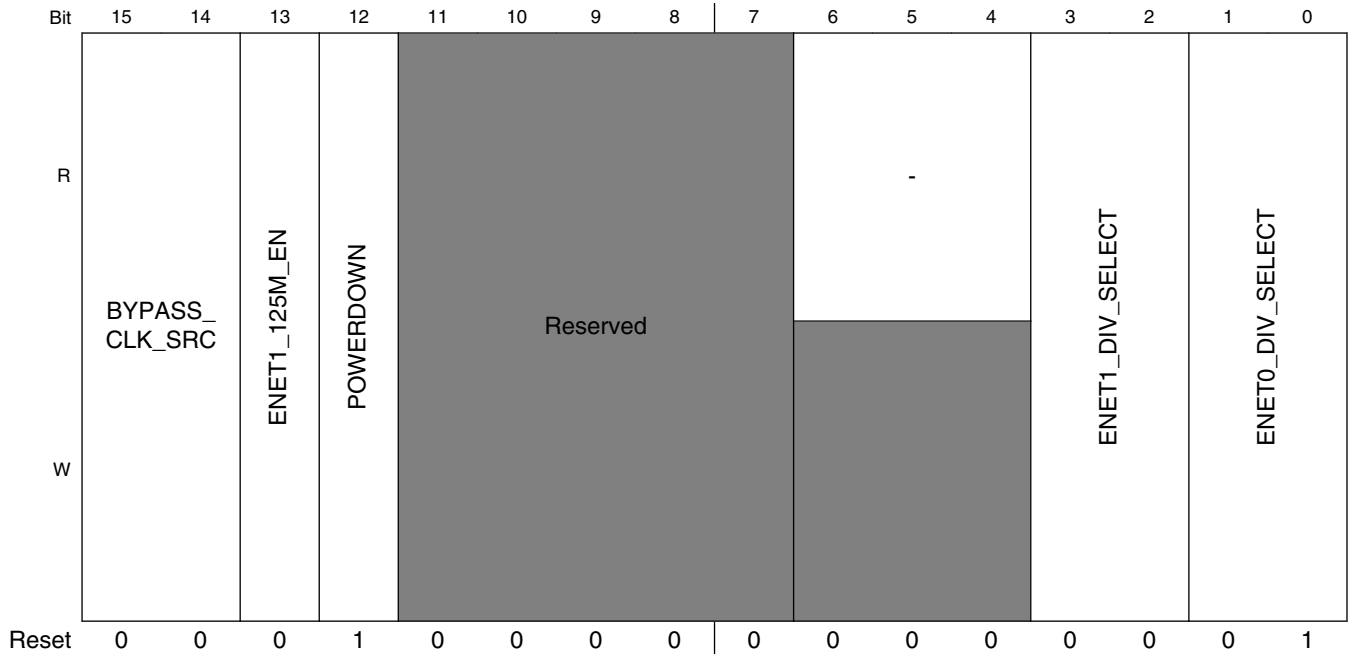

CCM_ANALOG_PLL_ENETn field descriptions

Field	Description
31 LOCK	1 - PLL is currently locked; 0 - PLL is not currently locked.
30–22 -	Always set to zero (0).
21 ENET_25M_ REF_EN	Enable the PLL providing ENET 25 MHz reference clock
20 ENET2_125M_ EN	Enable the PLL providing the ENET2 125 MHz reference clock
19 ENABLE_125M	Enables an offset in the phase frequency detector.
18 PFD_OFFSET_ EN	Enables an offset in the phase frequency detector.
17 -	This field is reserved. Reserved
16 BYPASS	Bypass the PLL.
15–14 BYPASS_CLK_ SRC	Determines the bypass source. 0x0 REF_CLK_24M — Select the 24MHz oscillator as source. 0x1 CLK1 — Select the CLK1_N / CLK1_P as source. 0x2 Reserved — 0x3 Reserved —

Table continues on the next page...

CCM_ANALOG_PLL_ENET n field descriptions (continued)

Field	Description
13 ENET1_125M_ EN	Enable the PLL providing the ENET1 125 MHz reference clock.
12 POWERDOWN	Powers down the PLL.
11–7 -	This field is reserved. Reserved.
6–4 -	Always set to zero (0).
3–2 ENET1_DIV_ SELECT	Controls the frequency of the ethernet1 reference clock. 00 25MHz 01 50MHz 10 100MHz (not 50% duty cycle) 11 125MHz
ENET0_DIV_ SELECT	Controls the frequency of the ethernet0 reference clock. 00 25MHz 01 50MHz 10 100MHz (not 50% duty cycle) 11 125MHz

18.7.15 480MHz Clock (PLL3) Phase Fractional Divider Control Register (CCM_ANALOG_PFD_480 n)

The PFD_480 control register provides control for PFD clock generation.

This register controls the 4-phase fractional clock dividers. The fractional clock frequencies are a product of the values in these registers.

Address: 20C_8000h base + F0h offset + (4d × i), where i=0d to 3d

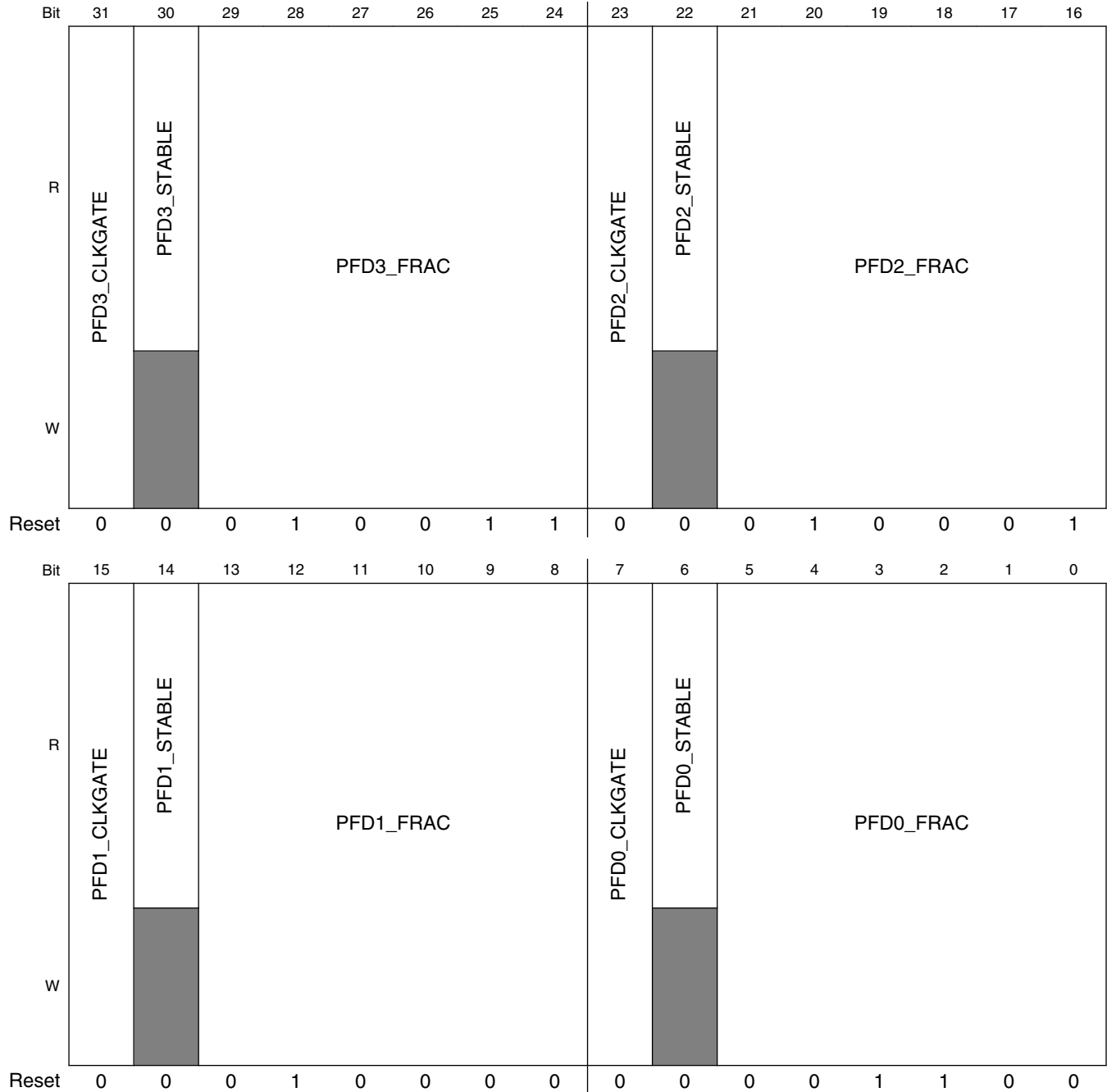

CCM_ANALOG_PFD_480n field descriptions

Field	Description
31 PFD3_CLKGATE	IO Clock Gate. If set to 1, the 3rd fractional divider clock (reference ref_pfd3) is off (power savings). 0: ref_pfd3 fractional divider clock is enabled. Need to assert this bit before PLL is powered down
30 PFD3_STABLE	This read-only bitfield is for DIAGNOSTIC PURPOSES ONLY since the fractional divider should become stable quickly enough that this field will never need to be used by either device driver or application code. The value inverts when the new programmed fractional divide value has taken effect. Read this bit,

Table continues on the next page...

CCM_ANALOG_PFD_480n field descriptions (continued)

Field	Description
	program the new value, and when this bit inverts, the phase divider clock output is stable. Note that the value will not invert when the fractional divider is taken out of or placed into clock-gated state.
29–24 PFD3_FRAC	This field controls the fractional divide value. The resulting frequency shall be $480 \cdot 18 / \text{PFD3_FRAC}$ where PFD3_FRAC is in the range 12-35.
23 PFD2_CLKGATE	IO Clock Gate. If set to 1, the IO fractional divider clock (reference ref_pfd2) is off (power savings). 0: ref_pfd2 fractional divider clock is enabled. Need to assert this bit before PLL is powered down
22 PFD2_STABLE	This read-only bitfield is for DIAGNOSTIC PURPOSES ONLY since the fractional divider should become stable quickly enough that this field will never need to be used by either device driver or application code. The value inverts when the new programmed fractional divide value has taken effect. Read this bit, program the new value, and when this bit inverts, the phase divider clock output is stable. Note that the value will not invert when the fractional divider is taken out of or placed into clock-gated state.
21–16 PFD2_FRAC	This field controls the fractional divide value. The resulting frequency shall be $480 \cdot 18 / \text{PFD2_FRAC}$ where PFD2_FRAC is in the range 12-35.
15 PFD1_CLKGATE	IO Clock Gate. If set to 1, the IO fractional divider clock (reference ref_pfd1) is off (power savings). 0: ref_pfd1 fractional divider clock is enabled. Need to assert this bit before PLL is powered down
14 PFD1_STABLE	This read-only bitfield is for DIAGNOSTIC PURPOSES ONLY since the fractional divider should become stable quickly enough that this field will never need to be used by either device driver or application code. The value inverts when the new programmed fractional divide value has taken effect. Read this bit, program the new value, and when this bit inverts, the phase divider clock output is stable. Note that the value will not invert when the fractional divider is taken out of or placed into clock-gated state.
13–8 PFD1_FRAC	This field controls the fractional divide value. The resulting frequency shall be $480 \cdot 18 / \text{PFD1_FRAC}$ where PFD1_FRAC is in the range 12-35.
7 PFD0_CLKGATE	If set to 1, the IO fractional divider clock (reference ref_pfd0) is off (power savings). 0: ref_pfd0 fractional divider clock is enabled. Need to assert this bit before PLL is powered down
6 PFD0_STABLE	This read-only bitfield is for DIAGNOSTIC PURPOSES ONLY since the fractional divider should become stable quickly enough that this field will never need to be used by either device driver or application code. The value inverts when the new programmed fractional divide value has taken effect. Read this bit, program the new value, and when this bit inverts, the phase divider clock output is stable. Note that the value will not invert when the fractional divider is taken out of or placed into clock-gated state.
PFD0_FRAC	This field controls the fractional divide value. The resulting frequency shall be $480 \cdot 18 / \text{PFD0_FRAC}$ where PFD0_FRAC is in the range 12-35.

18.7.16 528MHz Clock (PLL2) Phase Fractional Divider Control Register (CCM_ANALOG_PFD_528n)

The PFD_528 control register provides control for PFD clock generation.

This register controls the 3-phase fractional clock dividers. The fractional clock frequencies are a product of the values in these registers.

Address: 20C_8000h base + 100h offset + (4d × i), where i=0d to 3d

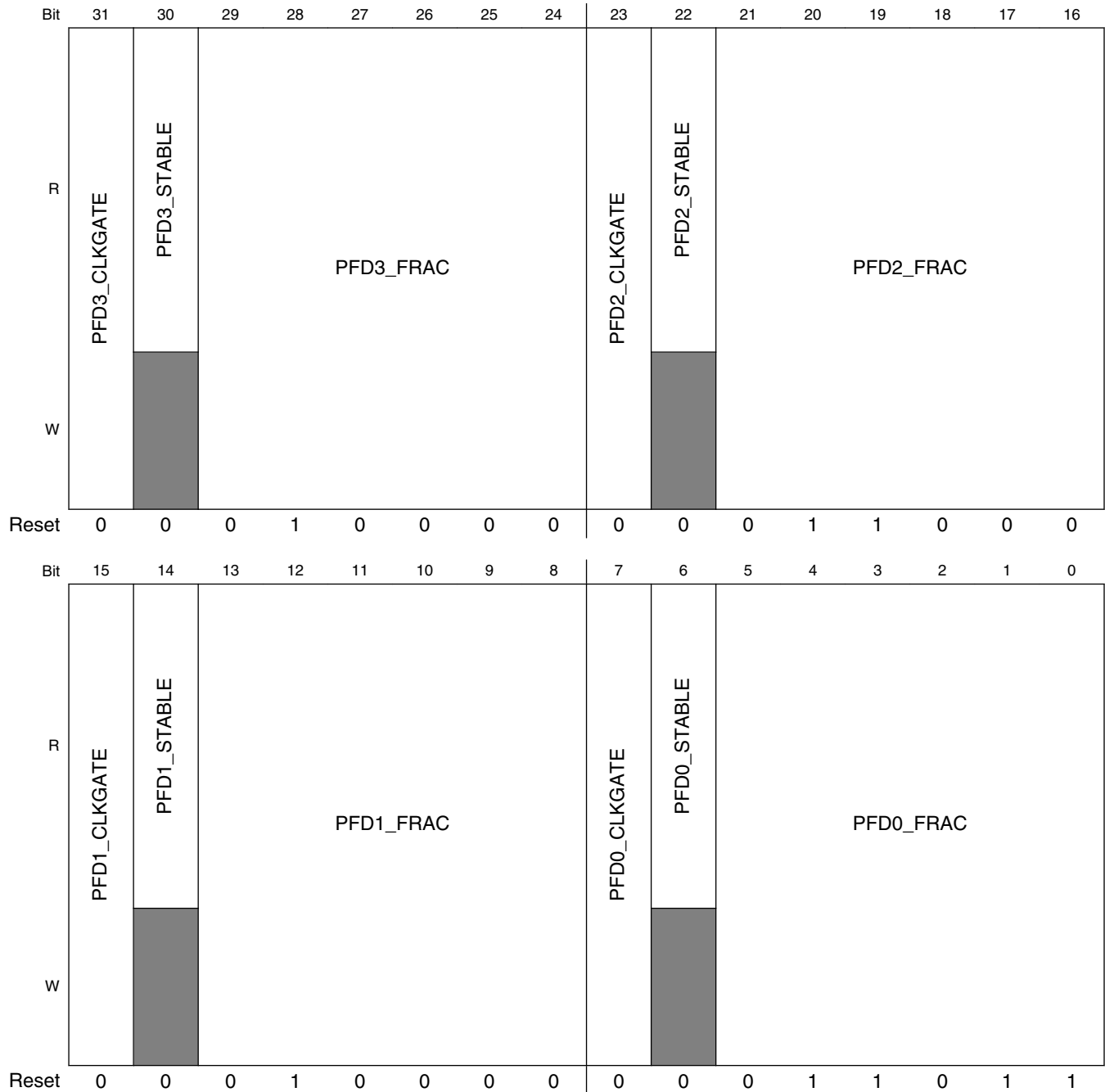

CCM_ANALOG_PFD_528n field descriptions

Field	Description
31 PFD3_CLKGATE	IO Clock Gate. If set to 1, the 3rd fractional divider clock (reference ref_pfd3) is off (power savings). 0: ref_pfd3 fractional divider clock is enabled. Need to assert this bit before PLL powered down
30 PFD3_STABLE	This read-only bitfield is for DIAGNOSTIC PURPOSES ONLY since the fractional divider should become stable quickly enough that this field will never need to be used by either device driver or application code. The value inverts when the new programmed fractional divide value has taken effect. Read this bit,

Table continues on the next page...

CCM_ANALOG_PFD_528n field descriptions (continued)

Field	Description
	program the new value, and when this bit inverts, the phase divider clock output is stable. Note that the value will not invert when the fractional divider is taken out of or placed into clock-gated state.
29–24 PFD3_FRAC	This field controls the fractional divide value. The resulting frequency shall be $528 \times 18 / \text{PFD3_FRAC}$ where PFD3_FRAC is in the range 12-35.
23 PFD2_CLKGATE	IO Clock Gate. If set to 1, the IO fractional divider clock (reference ref_pfd2) is off (power savings). 0: ref_pfd2 fractional divider clock is enabled. Need to assert this bit before PLL powered down
22 PFD2_STABLE	This read-only bitfield is for DIAGNOSTIC PURPOSES ONLY since the fractional divider should become stable quickly enough that this field will never need to be used by either device driver or application code. The value inverts when the new programmed fractional divide value has taken effect. Read this bit, program the new value, and when this bit inverts, the phase divider clock output is stable. Note that the value will not invert when the fractional divider is taken out of or placed into clock-gated state.
21–16 PFD2_FRAC	This field controls the fractional divide value. The resulting frequency shall be $528 \times 18 / \text{PFD2_FRAC}$ where PFD2_FRAC is in the range 12-35. NOTE: The maximum allowed frequency of PFD2 is 400MHz
15 PFD1_CLKGATE	IO Clock Gate. If set to 1, the IO fractional divider clock (reference ref_pfd1) is off (power savings). 0: ref_pfd1 fractional divider clock is enabled. Need to assert this bit before PLL powered down
14 PFD1_STABLE	This read-only bitfield is for DIAGNOSTIC PURPOSES ONLY since the fractional divider should become stable quickly enough that this field will never need to be used by either device driver or application code. The value inverts when the new programmed fractional divide value has taken effect. Read this bit, program the new value, and when this bit inverts, the phase divider clock output is stable. Note that the value will not invert when the fractional divider is taken out of or placed into clock-gated state.
13–8 PFD1_FRAC	This field controls the fractional divide value. The resulting frequency shall be $528 \times 18 / \text{PFD1_FRAC}$ where PFD1_FRAC is in the range 12-35.
7 PFD0_CLKGATE	If set to 1, the IO fractional divider clock (reference ref_pfd0) is off (power savings). 0: ref_pfd0 fractional divider clock is enabled. Need to assert this bit before PLL powered down
6 PFD0_STABLE	This read-only bitfield is for DIAGNOSTIC PURPOSES ONLY since the fractional divider should become stable quickly enough that this field will never need to be used by either device driver or application code. The value inverts when the new programmed fractional divide value has taken effect. Read this bit, program the new value, and when this bit inverts, the phase divider clock output is stable. Note that the value will not invert when the fractional divider is taken out of or placed into clock-gated state.
PFD0_FRAC	This field controls the fractional divide value. The resulting frequency shall be $528 \times 18 / \text{PFD0_FRAC}$ where PFD0_FRAC is in the range 12-35. NOTE: For QSPI boot at 76 MHz, this PFD is relocked to 307MHz, so the default value for this field (modified by ROM) would be 0x1f. Also for Low Freq Boot, ROM will relock this PFD to 307MHz, hence default would be 0x1f.

18.7.17 Miscellaneous Register 0 (CCM_ANALOG_MISC0n)

This register defines the control and status bits for miscellaneous analog blocks.

Address: 20C_8000h base + 150h offset + (4d × i), where i=0d to 3d

Bit	31	30	29	28	27	26	25	24	23	22	21	20	19	18	17	16
R									Reserved							
W									Reserved							
Reset	0	0	0	0	0	1	0	0	0	0	0	0	0	0	0	0
Bit	15	14	13	12	11	10	9	8	7	6	5	4	3	2	1	0
R																
W																
Reset	0	0	0	0	0	0	0	0	0	0	0	0	0	0	0	0

CCM_ANALOG_MISC0n field descriptions

Field	Description
31 VID_PLL_ PREDIV	Predivider for the source clock of the PLL's. 0 Divide by 1 1 Divide by 2
30 XTAL_24M_PWD	This field powers down the 24M crystal oscillator if set true. NOTE: Not related to CCM. See Crystal Oscillator (XTALOSC)
29 RTC_XTAL_ SOURCE	This field indicates which chip source is being used for the rtc clock. NOTE: Not related to CCM. See Crystal Oscillator (XTALOSC) 0 Internal ring oscillator 1 RTC_XTAL
28–26 CLKGATE_ DELAY	This field specifies the delay between powering up the XTAL 24MHz clock and releasing the clock to the digital logic inside the analog block. NOTE: Do not change the field during a low power event. This is not a field that the user would normally need to modify. NOTE: Not related to CCM. See Crystal Oscillator (XTALOSC) 000 0.5ms 001 1.0ms 010 2.0ms 011 3.0ms 100 4.0ms 101 5.0ms 110 6.0ms 111 7.0ms
25 CLKGATE_CTRL	This bit allows disabling the clock gate (always ungated) for the xtal 24MHz clock that clocks the digital logic in the analog block. NOTE: Do not change the field during a low power event. This is not a field that the user would normally need to modify. NOTE: Not related to CCM. See Crystal Oscillator (XTALOSC) 0 ALLOW_AUTO_GATE — Allow the logic to automatically gate the clock when the XTAL is powered down. 1 NO_AUTO_GATE — Prevent the logic from ever gating off the clock.
24–17 -	This field is reserved. Always set to zero.
16 OSC_XTALOK_ EN	This bit enables the detector that signals when the 24MHz crystal oscillator is stable. NOTE: Not related to CCM. See Crystal Oscillator (XTALOSC)
15 OSC_XTALOK	Status bit that signals that the output of the 24-MHz crystal oscillator is stable. Generated from a timer and active detection of the actual frequency. NOTE: Not related to CCM. See Crystal Oscillator (XTALOSC)

Table continues on the next page...

CCM_ANALOG_MISC0n field descriptions (continued)

Field	Description
14–13 OSC_I	<p>This field determines the bias current in the 24MHz oscillator. The aim is to start up with the highest bias current, which can be decreased after startup if it is determined to be acceptable.</p> <p>NOTE: Not related to CCM. See Crystal Oscillator (XTALOSC)</p> <p>00 NOMINAL — Nominal 01 MINUS_12_5_PERCENT — Decrease current by 12.5% 10 MINUS_25_PERCENT — Decrease current by 25.0% 11 MINUS_37_5_PERCENT — Decrease current by 37.5%</p>
12 DISCON_HIGH_SNVS	<p>This bit controls a switch from VDD_HIGH_IN to VDD_SNVS_IN.</p> <p>0 Turn on the switch 1 Turn off the switch</p>
11–10 STOP_MODE_CONFIG	<p>Configure the analog behavior in stop mode.</p> <p>00 All analog except rtc powered down on stop mode assertion. XtalOsc=on, RCOsc=off; 01 Certain analog functions such as certain regulators left up. XtalOsc=on, RCOsc=off; 10 XtalOsc=off, RCOsc=on, Old BG=on, New BG=off. 11 XtalOsc=off, RCOsc=on, Old BG=off, New BG=on.</p>
9–8 -	<p>This field is reserved. Reserved</p>
7 REFTOP_VBGUP	<p>Status bit that signals the analog bandgap voltage is up and stable. 1 - Stable.</p> <p>NOTE: Not related to CCM. See Power Management Unit (PMU)</p>
6–4 REFTOP_VBGADJ	<p>NOTE: Not related to CCM. See Power Management Unit (PMU)</p> <p>000 Nominal VBG 001 VBG+0.78% 010 VBG+1.56% 011 VBG+2.34% 100 VBG-0.78% 101 VBG-1.56% 110 VBG-2.34% 111 VBG-3.12%</p>
3 REFTOP_SELFBIASOFF	<p>Control bit to disable the self-bias circuit in the analog bandgap. The self-bias circuit is used by the bandgap during startup. This bit should be set after the bandgap has stabilized and is necessary for best noise performance of analog blocks using the outputs of the bandgap.</p> <p>NOTE: Value should be returned to zero before removing vddhigh_in or asserting bit 0 of this register (REFTOP_PWD) to assure proper restart of the circuit.</p> <p>NOTE: Not related to CCM. See Power Management Unit (PMU)</p> <p>0 Uses coarse bias currents for startup 1 Uses bandgap-based bias currents for best performance.</p>
2–1 -	<p>This field is reserved.</p>

Table continues on the next page...

CCM_ANALOG_MISC0n field descriptions (continued)

Field	Description
0 REFTOP_PWD	<p>Control bit to power-down the analog bandgap reference circuitry.</p> <p>NOTE: A note of caution, the bandgap is necessary for correct operation of most of the LDO, PLL, and other analog functions on the die.</p> <p>NOTE: Not related to CCM. See Power Management Unit (PMU)</p>

18.7.18 Miscellaneous Register 1 (CCM_ANALOG_MISC1n)

This register defines the control and status bits for miscellaneous analog blocks.

Address: 20C_8000h base + 160h offset + (4d × i), where i=0d to 3d

Bit	31	30	29	28	27	26	25	24	23	22	21	20	19	18	17	16	
R	IRQ_DIG_BO	IRQ_ANA_BO	IRQ_TEMPHIGH	IRQ_TEMFLOW	IRQ_TEMPANIC	Reserved										PFD_528_AUTOGATE_EN	PFD_480_AUTOGATE_EN
W	w1c	w1c	w1c	w1c	w1c												
Reset	0	0	0	0	0	0	0	0	0	0	0	0	0	0	0	0	
Bit	15	14	13	12	11	10	9	8	7	6	5	4	3	2	1	0	
R	Reserved		Reserved	LVDSCLK1_IBEN	Reserved	LVDSCLK1_OBEN	Reserved					LVDS1_CLK_SEL					
W																	
Reset	0	0	0	0	0	0	0	0	0	0	0	0	0	0	0	0	

CCM_ANALOG_MISC1n field descriptions

Field	Description
31 IRQ_DIG_BO	This status bit is set to one when when any of the digital regulator brownout interrupts assert. Check the regulator status bits to discover which regulator interrupt asserted. NOTE: Not related to CCM. See Power Management Unit (PMU)
30 IRQ_ANA_BO	This status bit is set to one when when any of the analog regulator brownout interrupts assert. Check the regulator status bits to discover which regulator interrupt asserted. NOTE: Not related to CCM. See Power Management Unit (PMU)
29 IRQ_TEMPHIGH	This status bit is set to one when the temperature sensor high interrupt asserts for high temperature. NOTE: Not related to CCM. See Temperature Monitor (TEMPMON)
28 IRQ_TEMPLOW	This status bit is set to one when the temperature sensor low interrupt asserts for low temperature. NOTE: Not related to CCM. See Temperature Monitor (TEMPMON)
27 IRQ_TEMP PANIC	This status bit is set to one when the temperature sensor panic interrupt asserts for a panic high temperature. NOTE: Not related to CCM. See Temperature Monitor (TEMPMON)
26–18 -	This field is reserved. Reserved
17 PFD_528_ AUTOGATE_EN	This enables a feature that will clkgate (reset) all PFD_528 clocks anytime the PLL_528 is unlocked or powered off.
16 PFD_480_ AUTOGATE_EN	This enables a feature that will clkgate (reset) all PFD_480 clocks anytime the USB1_PLL_480 is unlocked or powered off.
15–14 -	This field is reserved. Reserved
13 -	This field is reserved. Reserved
12 LVDSCLK1_ IBEN	This enables the LVDS input buffer for anack1/1b. Do not enable input and output buffers simultaneously.
11 -	This field is reserved. Reserved
10 LVDSCLK1_ OBEN	This enables the LVDS output buffer for anack1/1b. Do not enable input and output buffers simultaneously.
9–5 -	This field is reserved. Reserved
LVDS1_CLK_ SEL	This field selects the clk to be routed to anack1/1b. 00000 ARM_PLL — Arm PLL 00001 SYS_PLL — System PLL 00010 PFD4 — ref_pfd4_clk == pll2_pfd0_clk

Table continues on the next page...

CCM_ANALOG_MISC1n field descriptions (continued)

Field	Description
00011	PFD5 — ref_pfd5_clk == pll2_pfd1_clk
00100	PFD6 — ref_pfd6_clk == pll2_pfd2_clk
00101	PFD7 — ref_pfd7_clk == pll2_pfd3_clk
00110	AUDIO_PLL — Audio PLL
00111	VIDEO_PLL — Video PLL
01001	ETHERNET_REF — ethernet ref clock (ENET_PLL)
01100	USB1_PLL — USB1 PLL clock
01101	USB2_PLL — USB2 PLL clock
01110	PFD0 — ref_pfd0_clk == pll3_pfd0_clk
01111	PFD1 — ref_pfd1_clk == pll3_pfd1_clk
10000	PFD2 — ref_pfd2_clk == pll3_pfd2_clk
10001	PFD3 — ref_pfd3_clk == pll3_pfd3_clk
10010	XTAL — xtal (24M)
10101 to 11111	ref_pfd7_clk == pll2_pfd3_clk

18.7.19 Miscellaneous Register 2 (CCM_ANALOG_MISC2n)

This register defines the control for miscellaneous analog blocks.

NOTE

This register is shared with PMU.

Address: 20C_8000h base + 170h offset + (4d × i), where i=0d to 3d

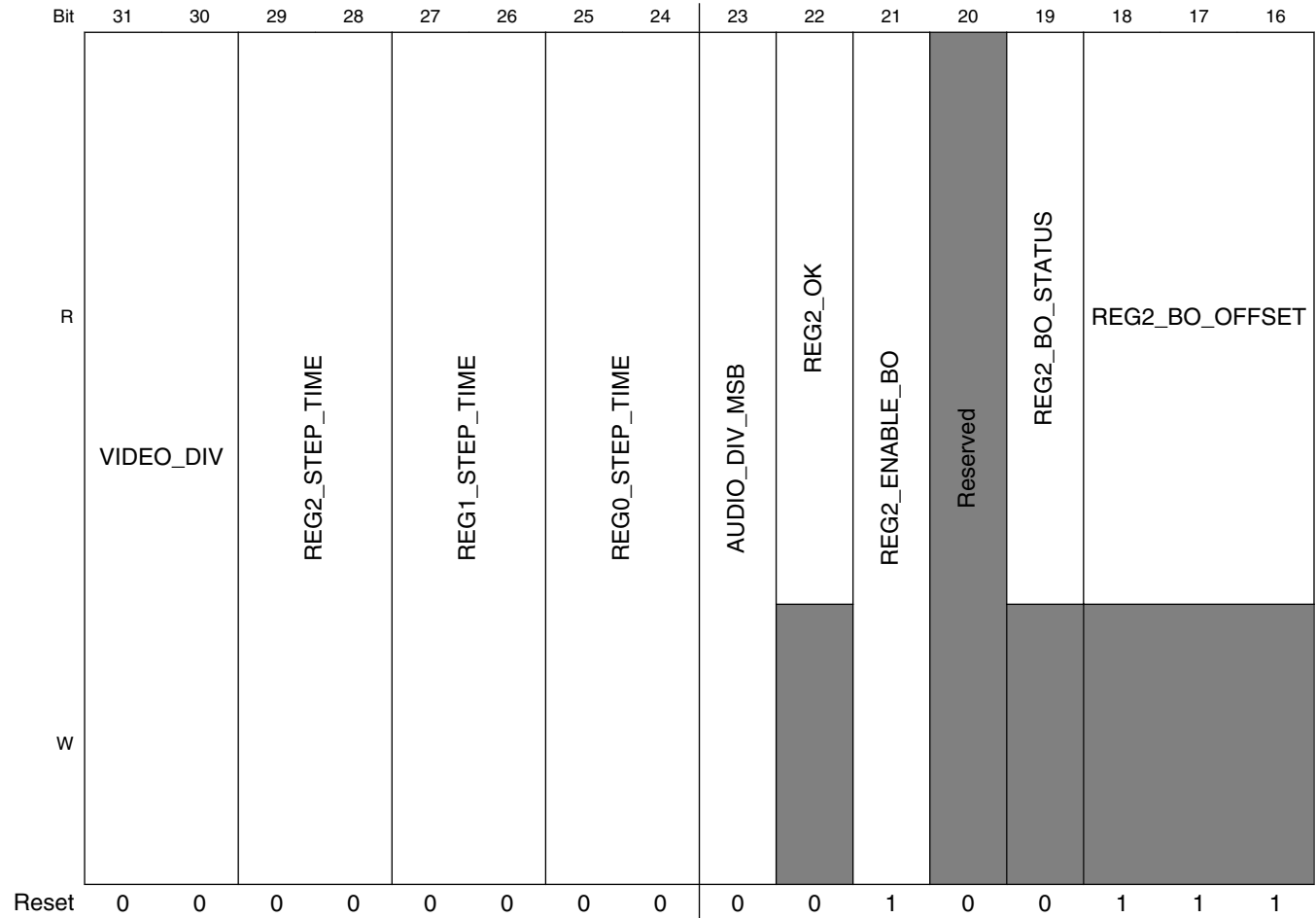

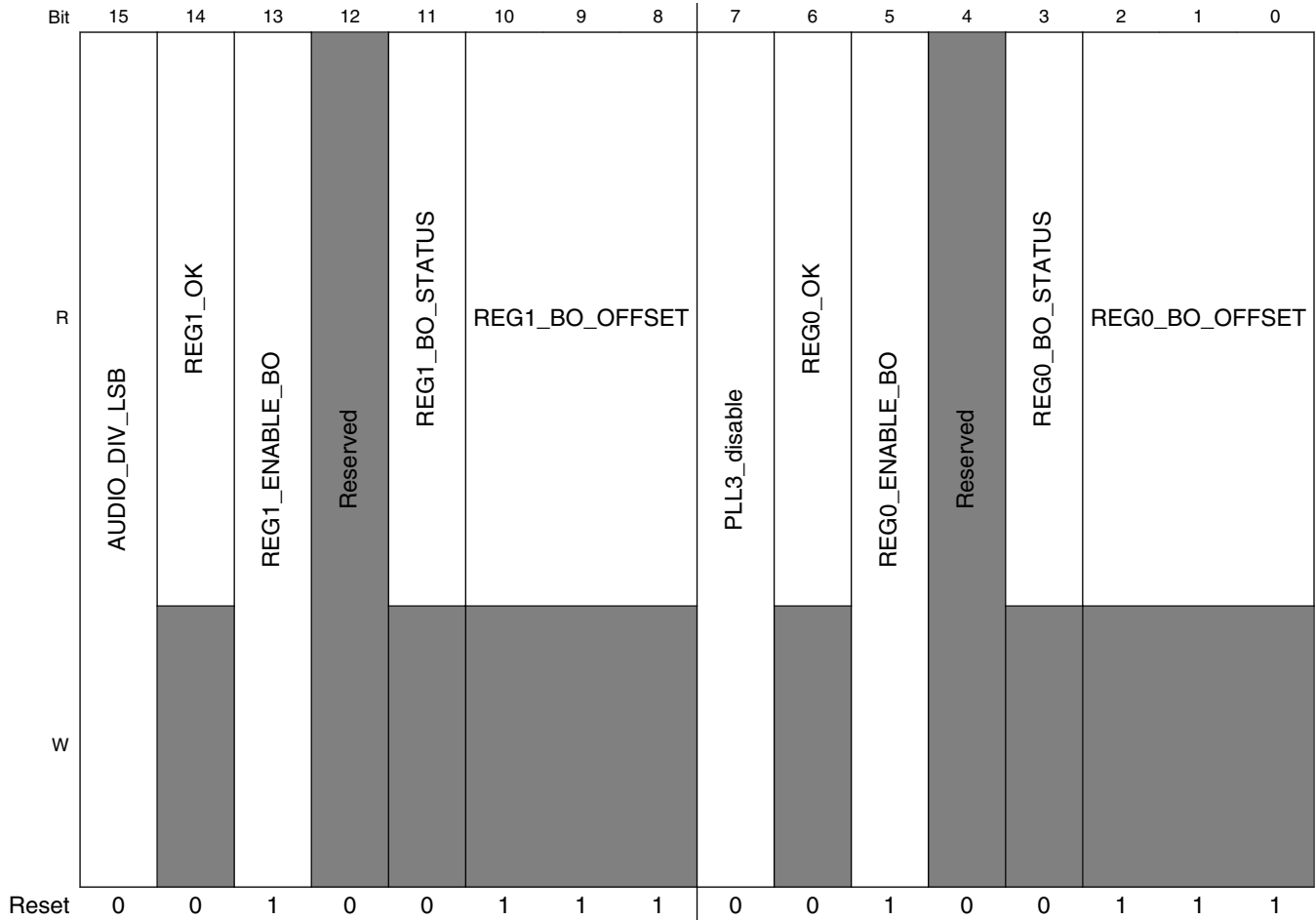

CCM_ANALOG_MISC2n field descriptions

Field	Description
31–30 VIDEO_DIV	<p>Post-divider for video. The output clock of the video PLL should be gated prior to changing this divider to prevent glitches. This divider is feed by PLL_VIDEOn[POST_DIV_SELECT] to achieve division ratios of /1, /2, /4, /8, and /16.</p> <p>00 divide by 1 (Default) 01 divide by 2 10 divide by 4 11 divide by 8</p>
29–28 REG2_STEP_TIME	<p>Number of clock periods (24MHz clock).</p> <p>NOTE: Not related to CCM. See Power Management Unit (PMU)</p> <p>00 64_CLOCKS — 64 01 128_CLOCKS — 128 10 256_CLOCKS — 256 11 512_CLOCKS — 512</p>
27–26 REG1_STEP_TIME	<p>Number of clock periods (24MHz clock).</p>

Table continues on the next page...

CCM_ANALOG_MISC2n field descriptions (continued)

Field	Description
	<p>NOTE: Not related to CCM. See Power Management Unit (PMU)</p> <p>00 64_CLOCKS — 64 01 128_CLOCKS — 128 10 256_CLOCKS — 256 11 512_CLOCKS — 512</p>
25-24 REG0_STEP_ TIME	<p>Number of clock periods (24MHz clock).</p> <p>NOTE: Not related to CCM. See Power Management Unit (PMU)</p> <p>00 64_CLOCKS — 64 01 128_CLOCKS — 128 10 256_CLOCKS — 256 11 512_CLOCKS — 512</p>
23 AUDIO_DIV_ MSB	<p>MSB of Post-divider for Audio PLL. The output clock of the video PLL should be gated prior to changing this divider to prevent glitches. This divider is feed by PLL_AUDIOOn[POST_DIV_SELECT] to achieve division ratios of /1, /2, /4, /8, and /16.</p> <p>NOTE: MSB bit value pertains to the first bit, please program the LSB bit (bit 15) as well to change divider value for more information.</p> <p>00 divide by 1 (Default) 01 divide by 2 10 divide by 1 11 divide by 4</p>
22 REG2_OK	<p>Signals that the voltage is above the brownout level for the SOC supply. 1 = regulator output > brownout_target</p> <p>NOTE: Not related to CCM. See Power Management Unit (PMU)</p>
21 REG2_ENABLE_ BO	<p>Enables the brownout detection.</p> <p>NOTE: Not related to CCM. See Power Management Unit (PMU)</p>
20 -	This field is reserved.
19 REG2_BO_ STATUS	<p>Reg2 brownout status bit.</p> <p>NOTE: Not related to CCM. See Power Management Unit (PMU)</p>
18-16 REG2_BO_ OFFSET	<p>This field defines the brown out voltage offset for the xPU power domain. IRQ_DIG_BO is also asserted. Single-bit increments reflect 25mV brownout voltage steps. The reset brown-offset is 175mV below the programmed target code. Brownout target = OUTPUT_TRG - BO_OFFSET. Some steps may be irrelevant because of input supply limitations or load operation.</p> <p>NOTE: Not related to CCM. See Power Management Unit (PMU)</p> <p>100 Brownout offset = 0.100V 111 Brownout offset = 0.175V</p>

Table continues on the next page...

CCM_ANALOG_MISC2n field descriptions (continued)

Field	Description
15 AUDIO_DIV_LSB	<p>LSB of Post-divider for Audio PLL. The output clock of the video PLL should be gated prior to changing this divider to prevent glitches. This divider is feed by PLL_AUDIO[POST_DIV_SELECT] to achieve division ratios of /1, /2, /4, /8, and /16.</p> <p>NOTE: LSB bit value pertains to the last bit, please program the MSB bit (bit 23) as well, to change divider value for more information.</p> <p>00 divide by 1 (Default) 01 divide by 2 10 divide by 1 11 divide by 4</p>
14 REG1_OK	<p>GPU/VPU supply</p> <p>NOTE: Not related to CCM. See Power Management Unit (PMU)</p>
13 REG1_ENABLE_BO	<p>Enables the brownout detection.</p> <p>NOTE: Not related to CCM. See Power Management Unit (PMU)</p>
12 -	This field is reserved.
11 REG1_BO_STATUS	<p>Reg1 brownout status bit.</p> <p>NOTE: Not related to CCM. See Power Management Unit (PMU)</p> <p>1 Brownout, supply is below target minus brownout offset.</p>
10-8 REG1_BO_OFFSET	<p>This field defines the brown out voltage offset for the xPU power domain. IRQ_DIG_BO is also asserted. Single-bit increments reflect 25mV brownout voltage steps. The reset brown-offset is 175mV below the programmed target code. Brownout target = OUTPUT_TRG - BO_OFFSET. Some steps may be irrelevant because of input supply limitations or load operation.</p> <p>NOTE: Not related to CCM. See Power Management Unit (PMU)</p> <p>100 Brownout offset = 0.100V 111 Brownout offset = 0.175V</p>
7 PLL3_disable	<p>When USB is in low power suspend mode this Control bit is used to indicate if other system peripherals require the USB PLL3 clock when the SoC is not in low power mode. A user needs to set this bit if they want to optionally disable PLL3 while the SoC is not in any low power mode to save power. When the system does go into low power mode this bit setting would not have any affect.</p> <p>NOTE: When USB is in low power suspend mode users would need to ensure PLL3 is not being used before setting this bit in RUN mode. Please refer to the correct PLL disabling procedure in Disabling / Enabling PLLs</p> <p>0 PLL3 is being used by peripherals and is enabled when SoC is not in any low power mode 1 PLL3 can be disabled when the SoC is not in any low power mode</p>
6 REG0_OK	<p>ARM supply</p> <p>NOTE: Not related to CCM. See Power Management Unit (PMU)</p>

Table continues on the next page...

CCM_ANALOG_MISC2n field descriptions (continued)

Field	Description
5 REG0_ENABLE_ BO	Enables the brownout detection. NOTE: Not related to CCM. See Power Management Unit (PMU)
4 -	This field is reserved.
3 REG0_BO_ STATUS	Reg0 brownout status bit. NOTE: Not related to CCM. See Power Management Unit (PMU) 1 Brownout, supply is below target minus brownout offset.
REG0_BO_ OFFSET	This field defines the brown out voltage offset for the CORE power domain. IRQ_DIG_BO is also asserted. Single-bit increments reflect 25mV brownout voltage steps. Some steps may be irrelevant because of input supply limitations or load operation. NOTE: Not related to CCM. See Power Management Unit (PMU) 100 Brownout offset = 0.100V 111 Brownout offset = 0.175V

Chapter 19

CMOS Sensor Interface (CSI)

19.1 Overview

This chapter presents the CMOS Sensor Interface (CSI) architecture, operation principles, and programming model.

The CSI enables the chip to connect directly to external CMOS image sensors. CMOS image sensors are separated into two classes, dumb and smart. Dumb sensors are those that support only traditional sensor timing (Vertical SYNC and Horizontal SYNC) and output only Bayer and statistics data, while smart sensors support CCIR656 video decoder formats and perform additional processing of the image (for example, image compression, image pre-filtering, and various data output formats).

The capabilities of the CSI include:

- Configurable interface logic to support most commonly available CMOS sensors.
- Support for CCIR656 video interface as well as traditional sensor interface.
- 8-bit / 16-bit / 24-bit data port for YCbCr, YUV, or RGB data input.
- 8-bit / 10-bit / 16-bit data port for Bayer data input.
- Full control of 8-bit/pixel, 10-bit/pixel or 16-bit / pixel data format to receive FIFO packing.
- 256 x 64 FIFO to store received image pixel data.
- Receive FIFO overrun protection mechanism.
- Embedded DMA controllers to transfer data from receive FIFO or statistic FIFO through AHB bus.
- Support 2D DMA transfer from the receive FIFO to the frame buffers in the external memory.
- Support double buffering two frames in the external memory.
- Single interrupt source to interrupt controller from maskable interrupt sources: Start of Frame, End of Frame, Change of Field, FIFO full, FIFO overrun, DMA transfer done, CCIR error and AHB bus response error.
- Configurable master clock frequency output to sensor.

- Statistic data generation for Auto Exposure (AE) and Auto White Balance (AWB) control of the camera (only for Bayer data and 8-bit/pixel format).
- Supports simple deinterlacing of interlaced input.

19.2 External Signals

The table below describes the external signals for the CSI. The external signals are tied between the CSI module and an external CMOS sensor.

Table 19-1. CSI External Signals

Signal	Description	Pad	Mode	Direction
DATA0	Data Sensor Signal 0, part of 24-bit Sensor Data Bus (Bayer, YUV, YCrCb, RGB)	LCD_DATA17	ALT3	I
		UART3_RX_DATA	ALT3	I
DATA1	Data Sensor Signal 1, part of 24-bit Sensor Data Bus (Bayer, YUV, YCrCb, RGB)	LCD_DATA16	ALT3	I
		UART3_TX_DATA	ALT3	I
DATA2	Data Sensor Signal 2, part of 24-bit Sensor Data Bus (Bayer, YUV, YCrCb, RGB)	CSI_DATA00	ALT0	I
		UART1_TX_DATA	ALT3	I
DATA3	Data Sensor Signal 3 part of 24-bit Sensor Data Bus (Bayer, YUV, YCrCb, RGB)	CSI_DATA01	ALT0	I
		UART1_RX_DATA	ALT3	I
DATA4	Data Sensor Signal 4, part of 24-bit Sensor Data Bus (Bayer, YUV, YCrCb, RGB)	CSI_DATA02	ALT0	I
		UART1_CTS_B	ALT3	I
DATA5	Data Sensor Signal 5, part of 24-bit Sensor Data Bus (Bayer, YUV, YCrCb, RGB)	CSI_DATA03	ALT0	I
		UART1_RTS_B	ALT3	I
DATA6	Data Sensor Signal 6, part of 24-bit Sensor Data Bus (Bayer, YUV, YCrCb, RGB)	CSI_DATA04	ALT0	I
		UART2_TX_DATA	ALT3	I
DATA7	Data Sensor Signal 7 part of 24-bit Sensor Data Bus (Bayer, YUV, YCrCb, RGB)	CSI_DATA05	ALT0	I
		UART2_RX_DATA	ALT3	I
DATA8	Data Sensor Signal 8, part of 24-bit Sensor Data Bus (Bayer, YUV, YCrCb, RGB)	CSI_DATA06	ALT0	I
		UART2_CTS_B	ALT3	I
DATA9	Data Sensor Signal 9 part of 24-bit Sensor Data Bus (Bayer, YUV, YCrCb, RGB)	CSI_DATA07	ALT0	I
		UART2_RTS_B	ALT3	I
DATA10	Data Sensor Signal 10, part of 24-bit Sensor Data Bus (Bayer, YUV, YCrCb, RGB)	LCD_DATA18	ALT3	I
		UART3_CTS_B	ALT3	I
DATA11	Data Sensor Signal 11, part of 24-bit Sensor Data Bus (Bayer, YUV, YCrCb, RGB)	LCD_DATA19	ALT3	I
		UART3_RTS_B	ALT3	I

Table continues on the next page...

Table 19-1. CSI External Signals (continued)

Signal	Description	Pad	Mode	Direction
DATA12	Data Sensor Signal 12, part of 24-bit Sensor Data Bus (Bayer, YUV, YCrCb, RGB)	LCD_DATA20	ALT3	I
		UART4_TX_DATA	ALT3	I
DATA13	Data Sensor Signal 13, part of 24-bit Sensor Data Bus (Bayer, YUV, YCrCb, RGB)	LCD_DATA21	ALT3	I
		UART4_RX_DATA	ALT3	I
DATA14	Data Sensor Signal 14, part of 24-bit Sensor Data Bus (Bayer, YUV, YCrCb, RGB)	LCD_DATA22	ALT3	I
		UART5_TX_DATA	ALT3	I
DATA15	Data Sensor Signal 15, part of 24-bit Sensor Data Bus (Bayer, YUV, YCrCb, RGB)	LCD_DATA23	ALT3	I
		UART5_RX_DATA	ALT3	I
DATA16	Data Sensor Signal 16, part of 24-bit Sensor Data Bus (Bayer, YUV, YCrCb, RGB)	ENET1_RX_DATA0	ALT3	I
		LCD_DATA08	ALT3	I
DATA17	Data Sensor Signal 17 part of 24-bit Sensor Data Bus (Bayer, YUV, YCrCb, RGB)	ENET1_RX_DATA1	ALT3	I
		LCD_DATA09	ALT3	I
DATA18	Data Sensor Signal 18, part of 24-bit Sensor Data Bus (Bayer, YUV, YCrCb, RGB)	ENET1_RX_EN	ALT3	I
		LCD_DATA10	ALT3	I
DATA19	Data Sensor Signal 19 part of 24-bit Sensor Data Bus (Bayer, YUV, YCrCb, RGB)	ENET1_TX_DATA0	ALT3	I
		LCD_DATA11	ALT3	I
DATA20	Data Sensor Signal 20, part of 24-bit Sensor Data Bus (Bayer, YUV, YCrCb, RGB)	ENET1_TX_DATA1	ALT3	I
		LCD_DATA12	ALT3	I
DATA21	Data Sensor Signal 21, part of 24-bit Sensor Data Bus (Bayer, YUV, YCrCb, RGB)	ENET1_TX_EN	ALT3	I
		LCD_DATA13	ALT3	I
DATA22	Data Sensor Signal 22, part of 24-bit Sensor Data Bus (Bayer, YUV, YCrCb, RGB)	ENET1_TX_CLK	ALT3	I
		LCD_DATA14	ALT3	I
DATA23	Data Sensor Signal 23, part of 24-bit Sensor Data Bus (Bayer, YUV, YCrCb, RGB)	ENET1_RX_ER	ALT3	I
		LCD_DATA15	ALT3	I
FIELD	CSI Field Signal	GPIO1_IO05	ALT3	I
		NAND_DQS	ALT1	I
HSYNC	Horizontal Sync (Blank Signal)	CSI_HSYNC	ALT0	I
		GPIO1_IO09	ALT3	I
MCLK	"CMOS Sensor Master Clock *Note: MCLK is provided by the CCM module directly, not from the CSI module itself"	CSI_MCLK	ALT0	O
		GPIO1_IO06	ALT3	O
PIXCLK	Pixel Clock	CSI_PIXCLK	ALT0	I
		GPIO1_IO07	ALT3	I
VSYNC	Vertical Sync (Start Of Frame)	CSI_VSYNC	ALT0	I

Table continues on the next page...

Table 19-1. CSI External Signals (continued)

Signal	Description	Pad	Mode	Direction
		GPIO1_IO08	ALT3	I

19.3 Clocks

The following table describes the clock sources for CSI. Please see [Clock Controller Module \(CCM\)](#) for clock setting, configuration and gating information.

Table 19-2. CSI Clocks

Clock name	Clock Root	Description
csi_hclk	ahb_clk_root	Module clock
ipg_clk	ipg_clk_root	Peripheral clock
ipg_clk_s	ipg_clk_root	Peripheral access clock
ipg_clk_s_raw	ipg_clk_root	Peripheral raw data clock

19.4 Principles of Operation

The information found here describes the modes of operation of the sensor interface.

The CSI is designed to support generic sensor interface timing as well as CCIR656 video interface timing. Traditional CMOS sensors typically use VSYNC (SOF), HSYNC (BLANK), and PIXCLK signals to output Bayer or YUV data. Smart CMOS sensors, that come with on-chip imaging processing, usually support video mode transfer. They use an embedded timing codec to replace the VSYNC and HSYNC signal. The timing codec is defined by the CCIR656 standard.

The CSI can support connection with the sensor as follows.

- To connect with one 8-bit sensor, the sensor data interface should connect to CSI_DATA[9:2].
- To connect with one 10-bit sensor, the sensor data interface should connect to CSI_DATA[9:0].
- To connect with one 16-bit sensor, the sensor data interface should connect to CSI_DATA[15:0].

- To connect with one 24-bit sensor, connect either the video pass-through, TV Decoder input, or the sensor data interface to CSI_DATA[23:0].
- To connect with two 8-bit sensors, the sensor data interfaces should connect to CSI_DATA[7:0] and CSI_DATA[15:8].

Table 19-3. CSI input data format

Signal Name	TVdecoder YCbCr 1 Cycle	RGB888 1 Cycle	RGB888/ YUV4444 3 Cycle	RGB666 1 Cycle	RGB565 1 Cycle	YCbCr422 1 Cycle	YCbCr422 2 Cycle	Generic 10 bit	CCIR656
ipp_csi_d[23]	Y[7]	R[7]		R[5]					
ipp_csi_d[22]	Y[6]	R[6]		R[4]					
ipp_csi_d[21]	Y[5]	R[5]		R[3]					
ipp_csi_d[20]	Y[4]	R[4]		R[2]					
ipp_csi_d[19]	Y[3]	R[3]		R[1]					
ipp_csi_d[18]	Y[2]	R[2]		R[0]					
ipp_csi_d[17]	Y[1]	R[1]		Y[5]					
ipp_csi_d[16]	Y[0]	R[0]		R[4]					
ipp_csi_d[15]	Cb[7]	G[7]		G[5]	R[4]	Y[7]			
ipp_csi_d[14]	Cb[6]	G[6]		G[4]	R[3]	Y[6]			
ipp_csi_d[13]	Cb[5]	G[5]		G[3]	R[2]	Y[5]			
ipp_csi_d[12]	Cb[4]	G[4]		G[2]	R[1]	Y[4]			
ipp_csi_d[11]	Cb[3]	G[3]		G[1]	R[0]	Y[3]			
ipp_csi_d[10]	Cb[2]	G[2]		G[0]	G[5]	Y[2]			
ipp_csi_d[9]	Cb[1]	G[1]	R/G/B[7]	G[5]	G[4]	Y[1]	Y/C[7]	Ge[9]	C/Y[7]
ipp_csi_d[8]	Cb[0]	G[0]	R/G/B[6]	G[4]	G[3]	Y[0]	Y/C[6]	Ge[8]	C/Y[6]
ipp_csi_d[7]	Cr[7]	B[7]	R/G/B[5]	B[5]	G[2]	C[7]	Y/C[5]	Ge[7]	C/Y[5]
ipp_csi_d[6]	Cr[6]	B[6]	R/G/B[4]	B[4]	G[1]	C[6]	Y/C[4]	Ge[6]	C/Y[4]
ipp_csi_d[5]	Cr[5]	B[5]	R/G/B[3]	B[3]	G[0]	C[5]	Y/C[3]	Ge[5]	C/Y[3]

Table continues on the next page...

Table 19-3. CSI input data format (continued)

Signal Name	TVdecoder YCbCr 1 Cycle	RGB888 1 Cycle	RGB888/ YUV4444 3 Cycle	RGB666 1 Cycle	RGB565 1 Cycle	YCbCr422 1 Cycle	YCbCr422 2 Cycle	Generic 10 bit	CCIR656
ipp_csi_d[4]	Cr[4]	B[4]	R/G/B[2]	B[2]	B[4]	C[4]	Y/C[2]	Ge[4]	C/Y[2]
ipp_csi_d[3]	Cr[3]	B[3]	R/G/B[1]	B[1]	B[3]	C[3]	Y/C[1]	Ge[3]	C/Y[1]
ipp_csi_d[2]	Cr[2]	B[2]	R/G/B[0]	B[0]	B[2]	C[2]	Y/C[0]	Ge[2]	C/Y[0]
ipp_csi_d[1]	Cr[1]	B[1]		B[5]	B[1]	C[1]		Ge[1]	
ipp_csi_d[0]	Cr[0]	B[0]		B[4]	B[0]	C[0]		Ge[0]	

19.4.1 Data Transfer with the Embedded DMA Controllers

The CSI has two embedded DMA controllers, one for the receive FIFO and the other for the statistic FIFO. It supports 2D DMA transfer from the receive FIFO to the frame buffers in the external memory and linear DMA transfer from the statistic FIFO.

To transfer data from the RxFIFO to the external memory, the user should set the start address in the frame buffer where the transferred data is stored, the parameters of the frame buffers, and the parameters of the image coming from the sensor. The user can have two frame buffers in the external memory. Each one will store a frame of image coming from the sensor. The embedded DMA controller will first write the frame buffer1 and then frame buffer2. These two frame buffers will be written by turns. The start address should be aligned in and set in the CSIDMASA-FB1 and CSIDMASA-FB2 registers. In the CSIFBUF_PARA register, the user should set the stride of the frame buffer to show how many to skip before starting to write the next row of the image. In the CSIIMAG_PARA register, the user should set the width and height of the image coming from the sensor. The RxFF_LEVEL and DMA_REQ_EN_RFF bits in CSICR3 registers also need to be set before the data transfer starts. When the number of the data in the RxFIFO reaches the trigger level, a DMA request will be sent to the embedded DMA controller and the data will be read out from the RxFIFO and written through AHB bus into the external frame buffers. The burst type of transfer can be INCR4, INCR8 and INCR16 by setting DMA_BURST_TYPE_RFF bits in CSICR2 register. After all data in an image frame are transferred, the DMA_TSF_DONE_FB1 or DMA_TSF_DONE_FB2 bit will be set in CSISR register and the interrupt can be triggered if the corresponding enable bit is set in CSICR1 register. The DMA_REFLASH_RFF bit in CSICR3 can be used to activate or restart the embedded DMA controller.

The RxFIFO has the overrun protection mechanism in case the RxFIFO is overrun during data transfer. If the RxFIFO is full and more data needs to be received during the data transfer, the RxFIFO will be overwritten continuously and all 128 words of data in the RxFIFO before overrun occurred will be discarded; the corresponding 128 words memory space in the frame buffer will keep the previous values.

To transfer data from the statistic FIFO to the external memory, the user should set the start address of the external memory where the transferred data is stored and the total transfer sizes. The start address and the transfer sizes are all aligned in and should be set in the CSIDMASA-STATFIFO and CSIDMATS-STATFIFO registers. The STATFF_LEVEL and DMA_REQ_EN_SFF bits in CSICR3 registers should also be set before the data transfer starts. When the number of the data in the STATFIFO reaches the trigger level, a dma request will be sent to the embedded DMA controller and the data will be read out from the STATFIFO and written through AHB bus into the external memory. The burst type of transfer can be INCR4, INCR8 and INCR16 by setting DMA_BURST_TYPE_SFF bits in CSICR2 register. After all expected data (defined by the total transfer sizes) are transferred, the DMA_TSF_DONE_SFF bit will be set in CSISR register and an interrupt can be triggered if the SFF_DMA_DONE_INTEN is enabled in CSICR1 register. The DMA_REFLASH_SFF bit in CSICR3 can be used to activate or re-start the embedded DMA controller.

19.4.2 Gated Clock Mode

VSYNC, HSYNC, and PIXCLK signals are used in gated clock mode.

A frame starts with an active edge on VSYNC, then HSYNC asserts and holds for the entire line. The Pixel clock is valid as long as HSYNC is asserted. Data is latched at the active edge of the valid pixel clocks. HSYNC deasserts at the end of line. Pixel clocks then become invalid and CSI stops receiving data from the stream. For the next line the HSYNC timing repeats. For the next frame the VSYNC timing repeats.

19.4.3 Non-Gated Clock Mode

In non-gated clock mode, only the VSYNC and PIXCLK signals are used; the HSYNC signal is ignored.

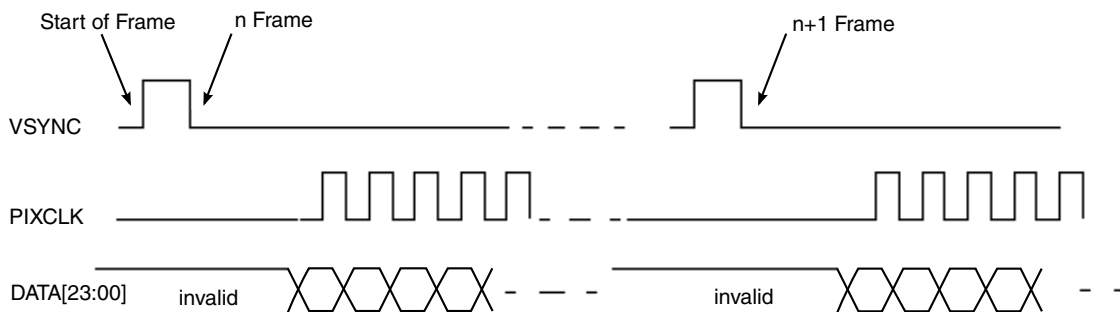

Figure 19-1. Non-Gated Clock Mode Timing Diagram

The overall timing of non-gated mode is the same as the gated-clock mode, except for the HSYNC signal. HSYNC signal is ignored by the CSI. All incoming pixel clocks are valid and cause data to be latched into RxFIFO. The PIXCLK signal is inactive (states low) until valid data is ready to be transmitted over the bus.

Figure 19-1 shows the timing of a typical sensor. Other sensors may have the slightly different timing from that shown. The CSI can be programmed to support rising/falling-edge triggered VSYNC, active-high/low HSYNC, and rising/falling-edge triggered PIXCLK.

19.4.4 CCIR656 Interlace Mode

In CCIR656 interlace mode, only the PIXCLK and CSI_DATA[9:2] signals are used. The start of frame and blank signals are replaced by a timing codec which is embedded in the data stream. Each active line starts with an Start of Active Video (SAV) code and ends with an End of Active Video (EAV) code. In some cases, digital blanking is inserted in between EAV and SAV code. The CSI decodes and filters out the timing-coding from the data stream, recovering VSYNC and HSYNC signals for internal use, such as statistical block control. Data is forwarded to the data receive and packing block in a sequential manner without reordering—that is, field 1 followed by field 2. The fields must be reordered in software to get back the original image.

Change of Field (COF) interrupt is triggered upon every field change. The interrupt service routine reads the status register to check for the current field.

According to the CCIR656 specification, the image must be in 625/50 PAL or 525/60 NTSC format. In addition, the image is interlaced into odd and even fields with vertical and horizontal blank data being filled into certain lines. Data must be in YCbCr422 format, each pixel contains 2 bytes, either Y + Cr or Y + Cb. These requirements are set for TV systems. The CSI module supports PAL and NTSC format only.

The following figure describes the frame structure in PAL system, showing vertical and horizontal blanking.

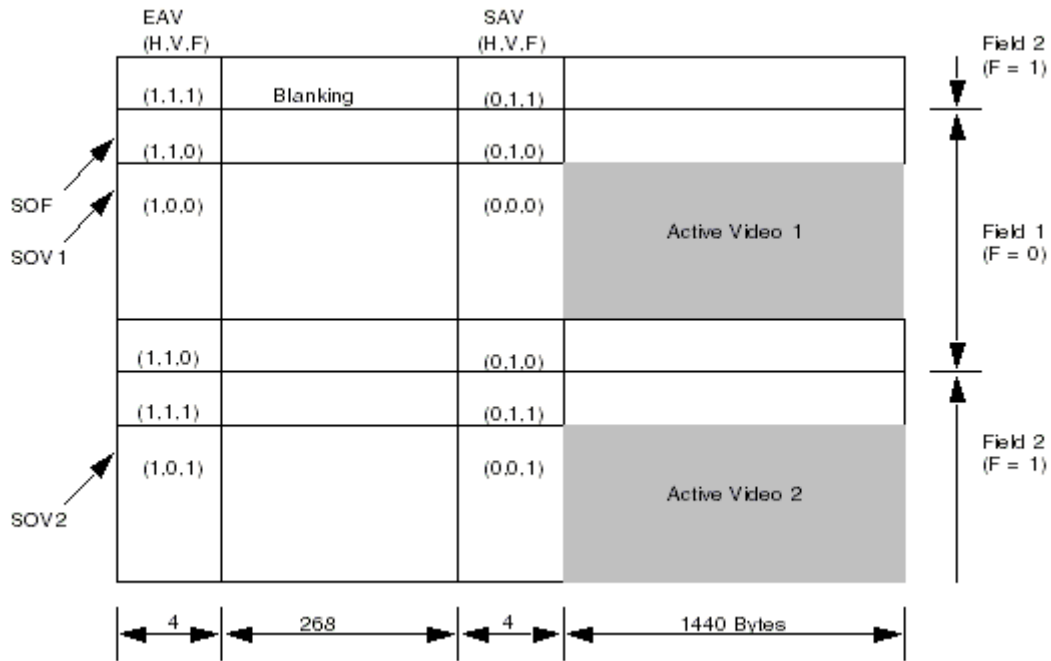

Figure 19-2. CCIR656 Interlace Mode (PAL)

The following figure describes the general timing for a single line, showing SAV and EAV.

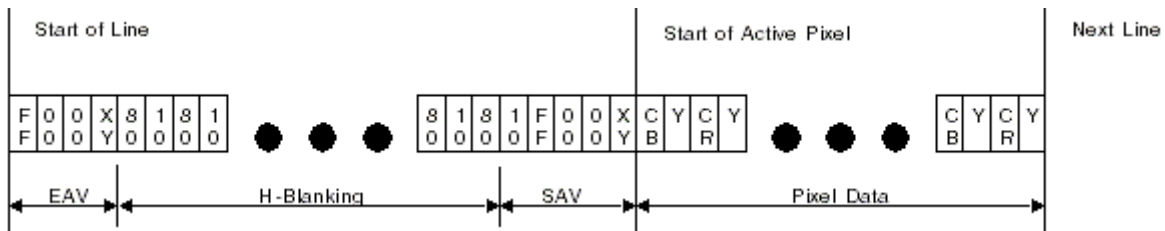

Figure 19-3. CCIR656 General Line Timing

The coding tables recommended by the CCIR656 specification are shown below. It is used in the CCIR656 mode to decode the video stream. An interrupt is generated for SOF, which is decoded from the embedded timing codec.

Table 19-4. Coding for SAV and EAV

Data Bit Number	1st Byte 0xFF	2nd Byte 0x00	3rd Byte 0x00	4th Byte 0xXY
7 (MSB)	1	0	0	1
6	1	0	0	F
5	1	0	0	V
4	1	0	0	H
3	1	0	0	P3
2	1	0	0	P2
1	1	0	0	P1
0	1	0	0	P0

Table 19-5. Codes with Protection bits for Error Detection/Correction

F	V	H	P3	P2	P1	P0
0	0	0	0	0	0	0
0	0	1	1	1	0	1
0	1	0	1	0	1	1
0	1	1	0	1	1	0
1	0	0	0	1	1	1
1	0	1	1	0	1	0
1	1	0	1	1	0	0
1	1	1	0	0	0	1

Table 19-6. Representations by F-Bit

F-Bit	Representations
0	ODD FIELD (FIELD 1)
1	EVEN FIELD (FIELD 2)

19.4.5 CCIR656 Progressive Mode

For a CMOS camera system of VGA or CIF resolution, strict adherence to the interlace requirements stated in the CIR standard is not required.

The image is considered to have only 1 active field which is scanned in a progressive manner. This active field is regarded as field 1 and the F-bit in the timing codec is ignored by the decoder. Most sensors support CCIR timing in this mode (progressive) by default.

The following figure shows the typical flow of progressive mode.

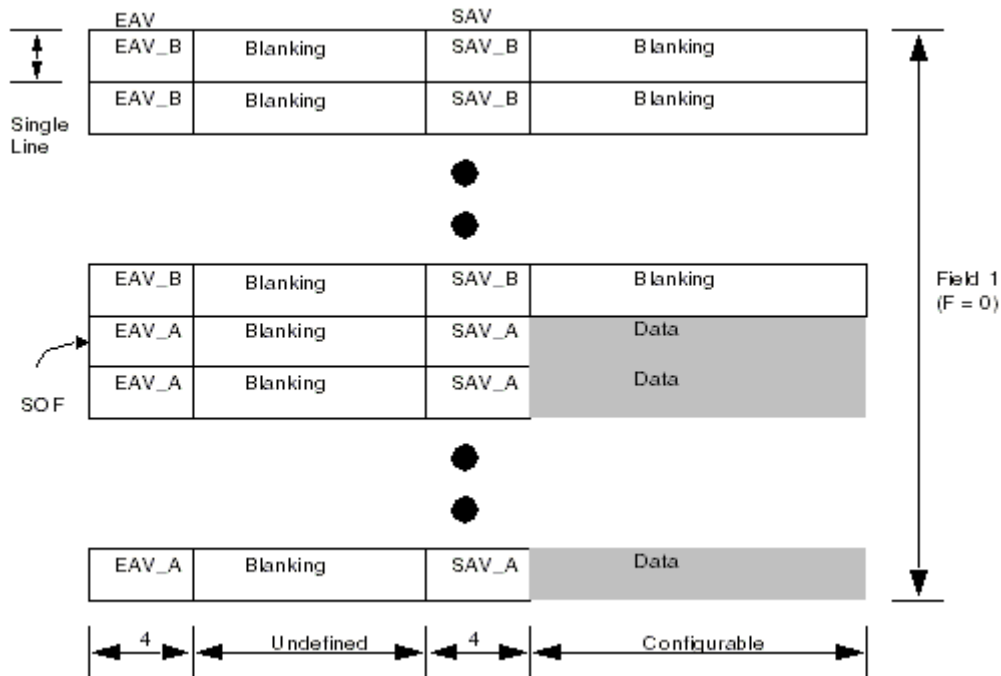

Figure 19-4. CCIR656 Progressive Mode (General Case)

An interrupt is generated for SOF but not for COF. In the general case, when SOF information is retrieved from the embedded coding, it is known as internal VSYNC mode. In other cases, when the VSYNC signal is provided by the sensor, it is known as external VSYNC mode. The CSI can be operated in internal or external VSYNC mode.

19.4.6 Error Correction for CCIR656 Coding

According to the algorithm for CCIR coding, protection bits in the SAV and EAV are encoded in the way that allows a 1-bit error to be corrected, or a 2-bit error to be detected by the decoder. This feature is supported by the interlace mode CCIR decoder in CSI.

For the 1-bit error case, users can select the error to be corrected automatically, or simply shown as a status flag instead. For the 2-bit error case, because the decoder is unable to make a correction, the error would be shown as a status flag only.

An interrupt can be generated upon the detection of an error. This signal can be enabled or disabled without affecting the operation of the status bit.

19.4.7 Deinterlacer

Deinterlacing is the process of converting interlaced video, such as CCIR656 input, into a non-interlaced form.

The CSI uses the weaving method to do deinterlacing. Weaving is done by adding consecutive fields together. CSI uses top-field detection function. No matter input is NTSC or PAL mode, the combined frame will always put the top-field first and then bottom-field.

19.5 Interrupt Generation

The information found here describes CSI events that generate interrupts.

19.5.1 Start Of Frame Interrupt (SOF_INT)

The source of an SOF interrupt is dependent on the mode of operation.

In traditional mode, VSYNC signal is taken from sensor and SOF_INT is generated at the rising or falling edge (programmable) of VSYNC.

In CCIR interlace mode, the SOF interrupt information is retrieved from the embedded coding and SOF_INT is generated.

In CCIR progressive mode, there are two sources of an SOF interrupt:

- In *internal* VSYNC mode, SOF is retrieved from the embedded coding.
- In *external* VSYNC mode, VSYNC is taken from the sensor and SOF is generated at the rising edge of VSYNC.

19.5.2 End Of Frame Interrupt (EOF_INT)

An EOF interrupt is generated when the frame ends and the complete frame data in RXFIFO is read.

The EOF event triggering works with the RX count register (CSIRXCNT). Software sets the RX count register to the frame size (in words). The CSI RX logic then counts the number of pixel data being received and compares it with the RX count. If the preset value is reached, an EOF interrupt is generated and the data in the RXFIFO are read. If a SOF event is detected before this happens, the EOF interrupt is not generated.

19.5.3 Change Of Field Interrupt (COF_INT)

The Change of Field interrupt is only valid in CCIR Interlace mode. The COF interrupt is generated when the field toggles, either from field 1 to field 2, or field 2 to field 1.

Software should first check COF_INT bit in the CSI Status Register (CSISTAT) before checking that F1_INT or F2_INT is turned on.

In PAL systems, the field changes at the beginning of the frame and coincides with SOF. For the first field, a COF interrupt is not generated, only an SOF. The COF interrupt is generated for the second field.

19.5.4 CCIR Error Interrupt (ECC_INT)

The CCIR Error Interrupt is only valid for CCIR Interlace mode. An ECC interrupt is generated when an error is found on the SAV or EAV codes in the incoming stream. When this happens, the ECC_INT status bit is set.

19.5.5 RxFIFO Full Interrupt (RxFF_INT)

A RxFIFO full interrupt is generated when the number of data in RxFIFO reaches the water mark defined by RxFF_LEVEL in CSICR3.

19.5.6 Statistic FIFO Full Interrupt (STATFF_INT)

A StatFIFO full interrupt is generated when the number of data in STATFIFO reaches the water mark defined by STATFF_LEVEL in CSICR3.

19.5.7 RxFIFO Overrun Interrupt (RFF_OR_INT)

A RxFIFO Overrun interrupt is generated when the RxFIFO has 128 words data and more data is being written in.

19.5.8 Statistic FIFO Overrun Interrupt (SFF_OR_INT)

A StatFIFO Overrun interrupt is generated when the STATFIFO has 64 words data and more data is being written in.

19.5.9 Frame Buffer1 DMA Transfer Done Interrupt (DMA_TSF_DONE_FB1)

A DMA transfer done interrupt of frame buffer1 is generated when one frame of data are transferred from RxFIFO to the frame buffer1 in the external memory.

19.5.10 Frame Buffer2 DMA Transfer Done Interrupt (DMA_TSF_DONE_FB2)

A DMA transfer done interrupt of frame buffer2 is generated when one frame of data are transferred from RxFIFO to the frame buffer2 in the external memory.

19.5.11 Statistic FIFO DMA Transfer Done Interrupt (DMA_TSF_DONE_SFF)

A StatFIFO DMA transfer done interrupt is generated when all the data are transferred from StatFIFO to the external memory. The transfer size is defined in the STATFIFO DMA Transfer Size Register.

19.5.12 AHB Bus Response Error Interrupt (HRESP_ERR_INT)

An AHB Bus response error interrupt is generated when a bus error is detected.

19.5.13 DMA Field 0 Transfer Done Interrupt (DMA_FIELD0_DONE)

A DMA transfer done interrupt of field 0 is generated when one field of data are transferred from RxFIFO to the frame buffer in external memory. This signal should work on interlaced mode.

19.5.14 DMA Field 1 Transfer Done Interrupt (DMA_FIELD1_DONE)

A DMA transfer done interrupt of field 1 is generated when one field of data are transferred from RxFIFO to the frame buffer in external memory. This signal should work on interlaced mode.

19.5.15 Base Address Change Error Interrupt (BASEADDR_CHANGE_ERROR)

A Base Address change error is generated when the base address changed while the last frame data transfer are not finished.

19.6 Data Packing Style

Careful attention to endianness is needed given the different port sizes at different stages of the image capture path.

To enable flexible packing of image data before storage in the FIFOs, the CSI module can swap data fields by use of the PACK_DIR and the SWAP16_EN bit in CSI Control Register 1 (CSICR1).

The CSI module accepts 8-bit, 10-bit or 16-bit data from the sensor by configuring PIXEL_BIT bit in CSI Control Register 1 (CSICR1) and TWO_8BIT_SENSOR bit in CSI Control Register3 (CSICR3). The input data is packed according to the setting of PACK_DIR bit. The packed data is stored in the RX FIFO according to the setting of the SWAP16_EN bit.

For 10-bit per pixel data format, each pixel is expanded to 16 bits by appending 6 zeros bits to the most significant bit. For 16-bit data format, the data path can be a combination by two 8-bit sensors. One sensor is connected to the CSI_DATA[7:0]. The other sensor is connected to CSI_DATA[15:8].

19.6.1 RX FIFO Path

19.6.1.1 Bayer Data

Bayer data is a type of raw data from the image sensor. This byte-wide data must be converted to the RGB space or YUV space by software. The data path for Bayer data is from the CSI to memory. If the system is in little endian, then the `PACK_DIR` bit should be set to 0. 8-bit data format from a sensor is packed to bits as `P0P1P2P3`, where P0 is the pixel coming in time slot 0 (first data) and P3 is the pixel coming in time slot 3 (the last data in the word). When the data is addressed as bytes by software, P0 is transferred first, P1 is transferred next, and so on. 10-bit data format is packed to bits as `P0P1P2P3P4P5P6P7P8P9`, where P0 is the 10-bit data coming in time slot 0 (first pixel) and P9 is the 10-bit data coming in time slot 9 (last pixel). 16-bit data, from two sensors, is packed to bits as `P0P1P2P3P4P5P6P7P8P9P10P11P12P13P14P15`, where P0 and P1 are the two 8-bit data coming in time slot 0 (P0 is the first pixel of the sensor connected with `CSI_DATA[7:0]` and P1 is the first pixel of the sensor connected with `CSI_DATA[15:8]`). P2 and P3 are the two 8-bit data coming in time slot 1 (second pixels of the two sensors).

19.6.1.2 RGB565 Data

RGB565 data is processed data from the image sensor, which can be put directly into the display buffer. The data is 16 bits wide. The data path is from CSI to memory to the display controller. On the sensor side, data must be transmitted as P0 first, followed by P1, and so on. For each pixel, whether the MSB or LSB is sent first depends on the endianness of the sensor. Data is 16 bits wide with the MSB labeled RG, and the LSB labeled GB. P0 is represented as RG0 and GB0.

CSI receives data in one of the following sequence:

- RG0, GB0, RG1, GB1, while RG0 comes out at time slot 0 (first data), and GB1 comes out at time slot 3 (last data)
- GB0, RG0, GB1, RG1

Using the first sequence as an example, and assuming the system is running in little endian, the data is presented as:

- 8-bit data from sensor: RG0, GB0, RG1, GB1, ...
- data before storage in the CSI RX FIFO (`PACK_DIR` bit = 1):
- data in CSI RX FIFO (`SWAP16_EN` bit enabled):
- transfer to system memory:
- 16-bit read by display controller: RG0GB0, RG1GB1

19.6.1.3 RGB888 Data

This is another kind of processed data from image sensor, which can be used for further image processing directly. Each of the data consist of 8-bit Red, 8-bit Green, and 8-bit Blue data. An example of timing scheme is shown in the following figure.

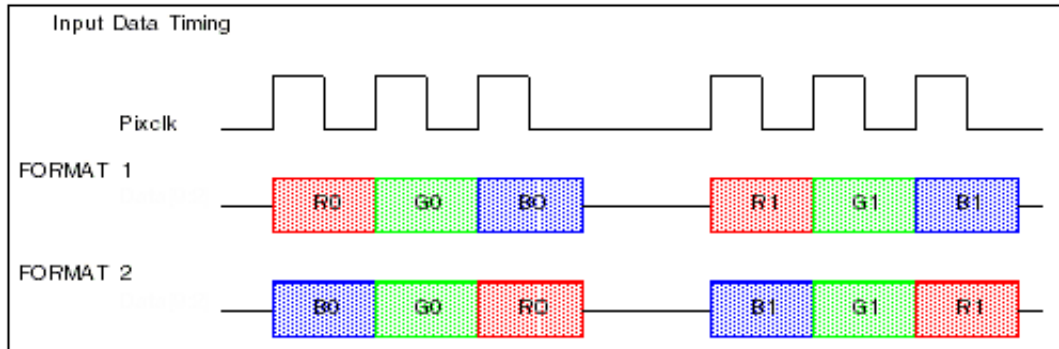

Figure 19-5. Sample Timing Diagram for RGB888 8 bits/cycle Data

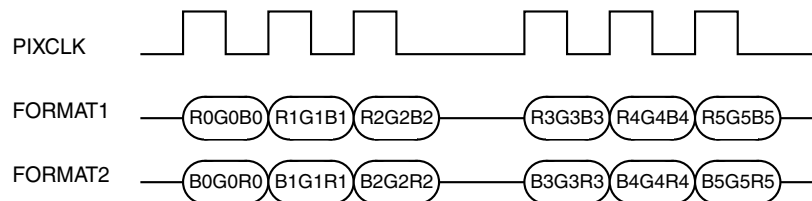
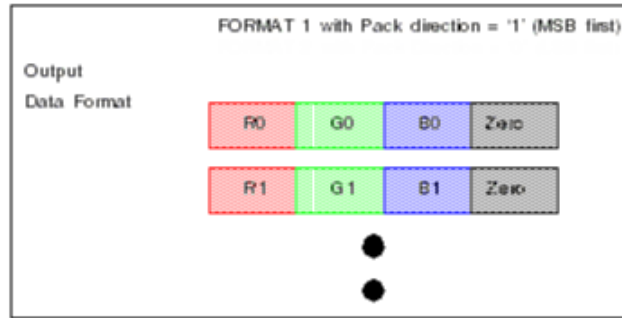

Figure 19-6. Sample Timing Diagram for RGB888 24 bits/cycle Data

An optional scheme to pack a dummy byte is provided. For every group of 3 bytes data, a dummy zero is packed to form a 32-bit word as shown in the following figure. The dummy zero can be packed at the LSB position or MSB position. Using RGB888A_FORMAT_SEL in CSI_CSICR18[18] to determine to put the dummy bytes packed at LSB or MSB position.



19.6.2 STAT FIFO Path

Statistics only works for Bayer data in 8-bit per pixel format. It generates 16-bit statistical output from the 8-bit Bayer input (CSI_DATA[13:6]). The outputs are Sum of Green (G), Sum of Red (R), Sum of Blue (B), and Auto Focus (F). Each output is 16-bits wide.

The settings of PACK_DIR and SWAP16_EN bits in the CSICR1 register have no effect on the input path. The PACK_DIR only controls how the 16-bit stat output is packed into the 32-bit STAT FIFO.

When the PACK_DIR bit = 1, the stat data is packed as:

First 32-bit: RG

Second 32-bit: BF

...

When the PACK_DIR bit = 0, the stat data is packed as:

First 32-bit GR

Second 32-bit: FB

...

19.7 CSI Memory Map/Register Definition

All the 32-bit registers of the CSI module are summarized in the Memory Map below:

CSI memory map

Absolute address (hex)	Register name	Width (in bits)	Access	Reset value	Section/page
21C_4000	CSI Control Register 1 (CSI_CSICR1)	32	R/W	4000_0800h	19.7.1/771
21C_4004	CSI Control Register 2 (CSI_CSICR2)	32	R/W	0000_0000h	19.7.2/775
21C_4008	CSI Control Register 3 (CSI_CSICR3)	32	R/W	0000_0000h	19.7.3/777
21C_400C	CSI Statistic FIFO Register (CSI_CSISTATFIFO)	32	R	0000_0000h	19.7.4/779
21C_4010	CSI RX FIFO Register (CSI_CSIRFIFO)	32	R	0000_0000h	19.7.5/780
21C_4014	CSI RX Count Register (CSI_CSIRXCNT)	32	R/W	0000_9600h	19.7.6/780
21C_4018	CSI Status Register (CSI_CSISR)	32	R/W	0000_4000h	19.7.7/781

Table continues on the next page...

CSI memory map (continued)

Absolute address (hex)	Register name	Width (in bits)	Access	Reset value	Section/page
21C_4020	CSI DMA Start Address Register - for STATFIFO (CSI_CSIDMASA_STATFIFO)	32	R/W	0000_0000h	19.7.8/784
21C_4024	CSI DMA Transfer Size Register - for STATFIFO (CSI_CSIDMATS_STATFIFO)	32	R/W	0000_0000h	19.7.9/784
21C_4028	CSI DMA Start Address Register - for Frame Buffer1 (CSI_CSIDMASA_FB1)	32	R/W	0000_0000h	19.7.10/785
21C_402C	CSI DMA Transfer Size Register - for Frame Buffer2 (CSI_CSIDMASA_FB2)	32	R/W	0000_0000h	19.7.11/786
21C_4030	CSI Frame Buffer Parameter Register (CSI_CSIFBUF_PARA)	32	R/W	0000_0000h	19.7.12/786
21C_4034	CSI Image Parameter Register (CSI_CSIIIMAG_PARA)	32	R/W	0000_0000h	19.7.13/787
21C_4048	CSI Control Register 18 (CSI_CSICR18)	32	R/W	0002_D000h	19.7.14/788
21C_404C	CSI Control Register 19 (CSI_CSICR19)	32	R/W	0000_0000h	19.7.15/790

19.7.1 CSI Control Register 1 (CSI_CSICR1)

This register controls the sensor interface timing and interrupt generation. The interrupt enable bits in this register control the interrupt signals and the status bits. That means status bits will only function when the corresponding interrupt bits are enabled.

Address: 21C_4000h base + 0h offset = 21C_4000h

Bit	31	30	29	28	27	26	25	24	23	22	21	20	19	18	17	16
R									Reserved							
W	SWAP16_EN	EXT_VSYNC	EOF_INT_EN	PiP_IF_EN	VIDEO_MODE	COF_INT_EN	SF_OR_INTEN	RF_OR_INTEN		SFF_DMA_DONE_INTEN	STATFF_INTEN	FB2_DMA_DONE_INTEN	FB1_DMA_DONE_INTEN	RXFF_INTEN	SOF_POL	SOF_INTEN
Reset	0	1	0	0	0	0	0	0	0	0	0	0	0	0	0	0
Bit	15	14	13	12	11	10	9	8	7	6	5	4	3	2	1	0
R	Reserved				HSYNC_POL	CCIR_EN	Reserved	FCC	PACK_DIR	CLR_STATFIFO	CLR_RXFIFO	GCLK_MODE	INV_DATA	INV_PCLK	REDGE	PIXEL_BIT
W	Reserved				HSYNC_POL	CCIR_EN	Reserved	FCC	PACK_DIR	CLR_STATFIFO	CLR_RXFIFO	GCLK_MODE	INV_DATA	INV_PCLK	REDGE	PIXEL_BIT
Reset	0	0	0	0	1	0	0	0	0	0	0	0	0	0	0	0

CSI_CSICR1 field descriptions

Field	Description
31 SWAP16_EN	<p>SWAP 16-Bit Enable. This bit enables the swapping of 16-bit data. Data is packed from 8-bit or 10-bit to 32-bit first (according to the setting of PACK_DIR) and then swapped as 16-bit words before being put into the RX FIFO. The action of the bit only affects the RX FIFO and has no affect on the STAT FIFO.</p> <p>NOTE: Example of swapping enabled: Data input to FIFO = 0x11223344 Data in RX FIFO = 0x 33441122</p> <p>NOTE: Example of swapping disabled: Data input to FIFO = 0x11223344 Data in RX FIFO = 0x11223344</p>

Table continues on the next page...

CSI_CSICR1 field descriptions (continued)

Field	Description
	0 Disable swapping 1 Enable swapping
30 EXT_VSYNC	External VSYNC Enable. This bit controls the operational VSYNC mode. NOTE: This only works when the CSI is in CCIR progressive mode. 0 Internal VSYNC mode 1 External VSYNC mode
29 EOF_INT_EN	End-of-Frame Interrupt Enable. This bit enables and disables the EOF interrupt. 0 EOF interrupt is disabled. 1 EOF interrupt is generated when RX count value is reached.
28 PrP_IF_EN	CSI-PrP Interface Enable. This bit controls the CSI to PrP bus. When enabled the RxFIFO is detached from the AHB bus and connected to PrP. All CPU reads or DMA accesses to the RxFIFO register are ignored. All CSI interrupts are also masked. 0 CSI to PrP bus is disabled 1 CSI to PrP bus is enabled
27 VIDEO_MODE	Video mode select. This bit controls the video mode in CCIR mode. 0 Progressive mode is selected 1 Interlace mode is selected
26 COF_INT_EN	Change Of Image Field (COF) Interrupt Enable. This bit enables the COF interrupt. This bit works only in CCIR interlace mode which is when CCIR_EN = 1 and CCIR_MODE = 1. 0 COF interrupt is disabled 1 COF interrupt is enabled
25 SF_OR_INTEN	STAT FIFO Overrun Interrupt Enable. This bit enables the STATFIFO overrun interrupt. 0 STATFIFO overrun interrupt is disabled 1 STATFIFO overrun interrupt is enabled
24 RF_OR_INTEN	RxFIFO Overrun Interrupt Enable. This bit enables the RX FIFO overrun interrupt. 0 RxFIFO overrun interrupt is disabled 1 RxFIFO overrun interrupt is enabled
23 -	This field is reserved. Reserved. This bit is reserved and should read 0.
22 SFF_DMA_DONE_INTEN	STATFIFO DMA Transfer Done Interrupt Enable. This bit enables the interrupt of STATFIFO DMA transfer done. 0 STATFIFO DMA Transfer Done interrupt disable 1 STATFIFO DMA Transfer Done interrupt enable
21 STATFF_INTEN	STATFIFO Full Interrupt Enable. This bit enables the STAT FIFO interrupt. 0 STATFIFO full interrupt disable 1 STATFIFO full interrupt enable
20 FB2_DMA_DONE_INTEN	Frame Buffer2 DMA Transfer Done Interrupt Enable. This bit enables the interrupt of Frame Buffer2 DMA transfer done.

Table continues on the next page...

CSI_CSICR1 field descriptions (continued)

Field	Description
	0 Frame Buffer2 DMA Transfer Done interrupt disable 1 Frame Buffer2 DMA Transfer Done interrupt enable
19 FB1_DMA_ DONE_INTEN	Frame Buffer1 DMA Transfer Done Interrupt Enable. This bit enables the interrupt of Frame Buffer1 DMA transfer done. 0 Frame Buffer1 DMA Transfer Done interrupt disable 1 Frame Buffer1 DMA Transfer Done interrupt enable
18 RXFF_INTEN	RxFIFO Full Interrupt Enable. This bit enables the RxFIFO full interrupt. 0 RxFIFO full interrupt disable 1 RxFIFO full interrupt enable
17 SOF_POL	SOF Interrupt Polarity. This bit controls the condition that generates an SOF interrupt. 0 SOF interrupt is generated on SOF falling edge 1 SOF interrupt is generated on SOF rising edge
16 SOF_INTEN	Start Of Frame (SOF) Interrupt Enable. This bit enables the SOF interrupt. 0 SOF interrupt disable 1 SOF interrupt enable
15–12 Reserved	This field is reserved. Reserved. This field is reserved.
11 HSYNC_POL	HSYNC Polarity Select. This bit controls the polarity of HSYNC. This bit only works in gated-clock-that is, GCLK_MODE = 1 and CCIR_EN = 0. 0 HSYNC is active low 1 HSYNC is active high
10 CCIR_EN	CCIR656 Interface Enable. This bit selects the type of interface used. When the CCIR656 timing decoder is enabled, it replaces the function of timing interface logic. 0 Traditional interface is selected. Timing interface logic is used to latch data. 1 CCIR656 interface is selected.
9 Reserved	This field is reserved. This field is reserved.
8 FCC	FIFO Clear Control. This bit determines how the RXFIFO and STATFIFO are cleared. When Synchronous FIFO clear is selected the RXFIFO and STATFIFO are cleared, and STAT block is reset, on every SOF. FIFOs and STAT block restarts immediately after reset. For information on the operation when Asynchronous FIFO clear is selected, refer to the descriptions for the CLR_RXFIFO and CLR_STATFIFO bits. 0 Asynchronous FIFO clear is selected. 1 Synchronous FIFO clear is selected.
7 PACK_DIR	Data Packing Direction. This bit Controls how 8-bit/10-bit image data is packed into 32-bit RX FIFO, and how 16-bit statistical data is packed into 32-bit STAT FIFO. 0 Pack from LSB first. For image data, 0x11, 0x22, 0x33, 0x44, it will appear as 0x44332211 in RX FIFO. For stat data, 0xAAAA, 0xB BBBB, it will appear as 0xB BBBBAAAA in STAT FIFO. 1 Pack from MSB first. For image data, 0x11, 0x22, 0x33, 0x44, it will appear as 0x11223344 in RX FIFO. For stat data, 0xAAAA, 0xB BBBB, it will appear as 0xAAAABBBB in STAT FIFO.

Table continues on the next page...

CSI_CSICR1 field descriptions (continued)

Field	Description
6 CLR_STATFIFO	Asynchronous STATFIFO Clear. This bit clears the STATFIFO and Reset STAT block. This bit works only in async FIFO clear mode-that is, FCC = 0. Otherwise this bit is ignored. Writing 1 will clear STATFIFO and reset STAT block immediately, STATFIFO and STAT block then wait and restart after the arrival of next SOF. The bit is restored to 0 automatically after finish. Normally reads 0.
5 CLR_RXFIFO	Asynchronous RXFIFO Clear. This bit clears the RXFIFO. This bit works only in async FIFO clear mode-that is, FCC = 0. Otherwise this bit is ignored. Writing 1 clears the RXFIFO immediately, RXFIFO restarts immediately after that. The bit is restored to 0 automatically after finish. Normally reads 0.
4 GCLK_MODE	Gated Clock Mode Enable. Controls if CSI is working in gated or non-gated mode. This bit works only in traditional mode-that is, CCIR_EN = 0. Otherwise this bit is ignored. 0 Non-gated clock mode. All incoming pixel clocks are valid. HSYNC is ignored. 1 Gated clock mode. Pixel clock signal is valid only when HSYNC is active.
3 INV_DATA	Invert Data Input. This bit enables or disables internal inverters on the data lines. 0 CSI_D[7:0] data lines are directly applied to internal circuitry 1 CSI_D[7:0] data lines are inverted before applied to internal circuitry
2 INV_PCLK	Invert Pixel Clock Input. This bit determines if the Pixel Clock (CSI_PIXCLK) is inverted before it is applied to the CSI module. 0 CSI_PIXCLK is directly applied to internal circuitry 1 CSI_PIXCLK is inverted before applied to internal circuitry
1 REDGE	Valid Pixel Clock Edge Select. Selects which edge of the CSI_PIXCLK is used to latch the pixel data. 0 Pixel data is latched at the falling edge of CSI_PIXCLK 1 Pixel data is latched at the rising edge of CSI_PIXCLK
0 PIXEL_BIT	Pixel Bit. This bit indicates the bayer data width for each pixel. This bit should be configured before activating or re-starting the embedded DMA controller. 0 8-bit data for each pixel 1 10-bit data for each pixel

19.7.2 CSI Control Register 2 (CSI_CSICR2)

This register provides the statistic block with data about which live view resolution is being used, and the starting sensor pixel of the Bayer pattern. It also contains the horizontal and vertical count used to determine the number of pixels to skip between the 64 x 64 blocks of statistics when generating statistics on live view image that are greater than 512 x 384.

Address: 21C_4000h base + 4h offset = 21C_4004h

Bit	31	30	29	28	27	26	25	24	23	22	21	20	19	18	17	16
R	DMA_BURST_TYPE_RFF		DMA_BURST_TYPE_SFF		Reserved	DRM	AFS		SCE	Reserved		BTS		LVRM		
W																
Reset	0	0	0	0	0	0	0	0	0	0	0	0	0	0	0	0
Bit	15	14	13	12	11	10	9	8	7	6	5	4	3	2	1	0
R	VSC								HSC							
W																
Reset	0	0	0	0	0	0	0	0	0	0	0	0	0	0	0	0

CSI_CSICR2 field descriptions

Field	Description
31–30 DMA_BURST_TYPE_RFF	Burst Type of DMA Transfer from RxFIFO. Selects the burst type of DMA transfer from RxFIFO. X0 INCR8 01 INCR4 11 INCR16
29–28 DMA_BURST_TYPE_SFF	Burst Type of DMA Transfer from STATFIFO. Selects the burst type of DMA transfer from STATFIFO. X0 INCR8 01 INCR4 11 INCR16

Table continues on the next page...

CSI_CSICR2 field descriptions (continued)

Field	Description
27 -	This field is reserved. Reserved. These bit is reserved and should read 0.
26 DRM	Double Resolution Mode. Controls size of statistics grid. 0 Stats grid of 8 x 6 1 Stats grid of 8 x 12
25–24 AFS	Auto Focus Spread. Selects which green pixels are used for auto-focus. 00 Abs Diff on consecutive green pixels 01 Abs Diff on every third green pixels 1x Abs Diff on every four green pixels
23 SCE	Skip Count Enable. Enables or disables the skip count feature. 0 Skip count disable 1 Skip count enable
22–21 -	This field is reserved. Reserved. These bits are reserved and should read 0.
20–19 BTS	Bayer Tile Start. Controls the Bayer pattern starting point. 00 GR 01 RG 10 BG 11 GB
18–16 LVRM	Live View Resolution Mode. Selects the grid size used for live view resolution. 0 512 x 384 1 448 x 336 2 384 x 288 3 384 x 256 4 320 x 240 5 288 x 216 6 400 x 300
15–8 VSC	Vertical Skip Count. Contains the number of rows to skip. SCE must be 1, otherwise VSC is ignored. 0-255 Number of rows to skip minus 1
HSC	Horizontal Skip Count. Contains the number of pixels to skip. SCE must be 1, otherwise HSC is ignored. 0-255 Number of pixels to skip minus 1

19.7.3 CSI Control Register 3 (CSI_CSICR3)

This read/write register acts as an extension of the functionality of the CSI Control register 1, adding additional control and features.

Address: 21C_4000h base + 8h offset = 21C_4008h

Bit	31	30	29	28	27	26	25	24	23	22	21	20	19	18	17	16
R	FRMCNT															
W																
Reset	0	0	0	0	0	0	0	0	0	0	0	0	0	0	0	0
Bit	15	14	13	12	11	10	9	8	7	6	5	4	3	2	1	0
R	FRMCNT_RST	DMA_REFLASH_RFF	DMA_REFLASH_SFF	DMA_REQ_EN_RFF	DMA_REQ_EN_SFF	STATFF_LEVEL			HRESP_ERR_EN	RxFF_LEVEL			TWO_8BIT_SENSOR	ZERO_PACK_EN	ECC_INT_EN	ECC_AUTO_EN
W																
Reset	0	0	0	0	0	0	0	0	0	0	0	0	0	0	0	0

CSI_CSICR3 field descriptions

Field	Description
31–16 FRMCNT	Frame Counter. This is a 16-bit Frame Counter (Wraps around automatically after reaching the maximum)
15 FRMCNT_RST	Frame Count Reset. Resets the Frame Counter. (Cleared automatically after reset is done) 0 Do not reset 1 Reset frame counter immediately
14 DMA_REFLASH_RFF	Reflash DMA Controller for Rx FIFO. This bit reflash the embedded DMA controller for Rx FIFO. It should be reflash before the embedded DMA controller starts to work. (Cleared automatically after reflash is done) 0 No reflash 1 Reflash the embedded DMA controller
13 DMA_REFLASH_SFF	Reflash DMA Controller for STAT FIFO. This bit reflash the embedded DMA controller for STAT FIFO. It should be reflash before the embedded DMA controller starts to work. (Cleared automatically after reflash is done) 0 No reflash 1 Reflash the embedded DMA controller

Table continues on the next page...

CSI_CSICR3 field descriptions (continued)

Field	Description
12 DMA_REQ_EN_ RFF	DMA Request Enable for RxFIFO. This bit enables the dma request from RxFIFO to the embedded DMA controller. 0 Disable the dma request 1 Enable the dma request
11 DMA_REQ_EN_ SFF	DMA Request Enable for STATFIFO. This bit enables the dma request from STATFIFO to the embedded DMA controller. 0 Disable the dma request 1 Enable the dma request
10–8 STATFF_LEVEL	STATFIFO Full Level. When the number of data in STATFIFO reach this level, STATFIFO full interrupt is generated, or STATFIFO DMA request is sent. 000 4 001 8 010 12 011 16 100 24 101 32 110 48 111 64
7 HRESP_ERR_ EN	Hresponse Error Enable. This bit enables the hresponse error interrupt. 0 Disable hresponse error interrupt 1 Enable hresponse error interrupt
6–4 RxFF_LEVEL	RxFIFO Full Level. When the number of data in RxFIFO reaches this level, a RxFIFO full interrupt is generated, or an RXFIFO DMA request is sent. 000 4 001 8 010 16 011 24 100 32 101 48 110 64 111 96
3 TWO_8BIT_ SENSOR	Two 8-bit Sensor Mode. This bit indicates one 16-bit sensor or two 8-bit sensors are connected to the 16-bit data ports. This bit should be set if there is one 16-bit sensor or two 8-bit sensors are connected. This bit should be configured before activating or restarting the embedded DMA controller. 0 Only one sensor is connected. 1 Two 8-bit sensors are connected or one 16-bit sensor is connected.
2 ZERO_PACK_ EN	Dummy Zero Packing Enable. This bit causes a dummy zero to be packed with every 3 incoming bytes, forming a 32-bit word. The dummy zero is always packed to the LSB position. This packing function is only available in 8-bit/pixel mode. 0 Zero packing disabled 1 Zero packing enabled

Table continues on the next page...

CSI_CSICR3 field descriptions (continued)

Field	Description
1 ECC_INT_EN	<p>Error Detection Interrupt Enable. This bit enables and disables the error detection interrupt. This feature only works in CCIR interlace mode.</p> <p>0 No interrupt is generated when error is detected. Only the status bit ECC_INT is set. 1 Interrupt is generated when error is detected.</p>
0 ECC_AUTO_EN	<p>Automatic Error Correction Enable. This bit enables and disables the automatic error correction. If an error occurs and error correction is disabled only the ECC_INT status bit is set. This feature only works in CCIR interlace mode.</p> <p>0 Auto Error correction is disabled. 1 Auto Error correction is enabled.</p>

19.7.4 CSI Statistic FIFO Register (CSI_CSISTATFIFO)

The StatFIFO is a read-only register containing statistic data from the sensor. Writing to this register has no effect.

Address: 21C_4000h base + Ch offset = 21C_400Ch

Bit	31	30	29	28	27	26	25	24	23	22	21	20	19	18	17	16	15	14	13	12	11	10	9	8	7	6	5	4	3	2	1	0																	
R	STAT																																																
W	[Shaded]																																																
Reset	0	0	0	0	0	0	0	0	0	0	0	0	0	0	0	0	0	0	0	0	0	0	0	0	0	0	0	0	0	0	0	0	0	0	0	0	0	0	0	0	0	0	0	0	0	0	0	0	0

CSI_CSISTATFIFO field descriptions

Field	Description
STAT	Static data from sensor

19.7.5 CSI RX FIFO Register (CSI_CSIRFIFO)

This read-only register contains received image data. Writing to this register has no effect.

Address: 21C_4000h base + 10h offset = 21C_4010h

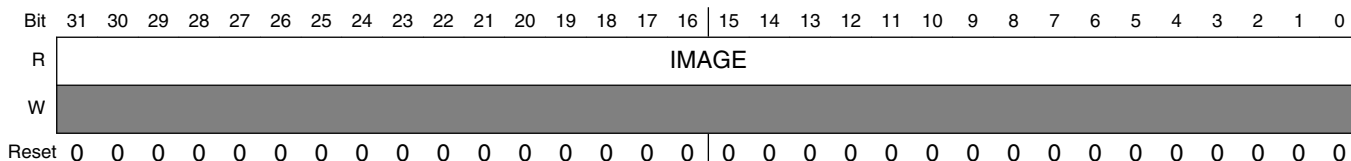

CSI_CSIRFIFO field descriptions

Field	Description
IMAGE	Received image data

19.7.6 CSI RX Count Register (CSI_CSIRXCNT)

This register works for EOF interrupt generation. It should be set to the number of words to receive that would generate an EOF interrupt.

There is an internal counter that counts the number of words read from the RX FIFO. Whenever the RX FIFO is being read, by either the CPU or the embedded DMA controller, the counter value is updated and compared with this register. If the values match, then an EOF interrupt is triggered.

Address: 21C_4000h base + 14h offset = 21C_4014h

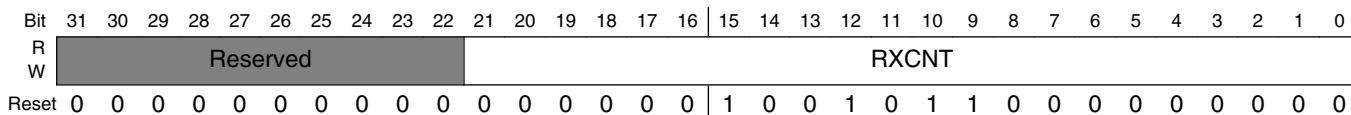

CSI_CSIRXCNT field descriptions

Field	Description
31-22 -	This field is reserved. Reserved. These bits are reserved and should read 0.
RXCNT	RxFIFO Count. This 22-bit counter for RxFIFO is updated each time the RxFIFO is read by CPU or DMA. This counter should be set to the expected number of words to receive that would generate an EOF interrupt.

19.7.7 CSI Status Register (CSI_CSISR)

This read/write register shows sensor interface status, and which kind of interrupt is being generated. The corresponding interrupt bits must be set for the status bit to function. Status bits should function normally even if the corresponding interrupt enable bits are not enabled.

Address: 21C_4000h base + 18h offset = 21C_4018h

Bit	31	30	29	28	27	26	25	24	23	22	21	20	19	18	17	16
R		-		BASEADDR_CHHANGE_ERROR	DMA_FIELD0_DONE	DMA_FIELD1_DONE	SF_OR_INT	RF_OR_INT	Reserved	DMA_TSF_DONE_SFF	STATFF_INT	DMA_TSF_DONE_FB2	DMA_TSF_DONE_FB1	RxFF_INT	EOF_INT	SOF_INT
W		-														
Reset	0	0	0	0	0	0	0	0	0	0	0	0	0	0	0	0
Bit	15	14	13	12	11	10	9	8	7	6	5	4	3	2	1	0
R	F2_INT	F1_INT	COF_INT	Reserved				HRESP_ERR_INT	Reserved				ECC_INT	DRDY		
W																
Reset	0	1	0	0	0	0	0	0	0	0	0	0	0	0	0	0

CSI_CSISR field descriptions

Field	Description
31–29 -	Reserved. These bits are reserved and should read 0.
28 BASEADDR_CHHANGE_ERROR	When using base address switching enable, this bit will be 1 when switching occur before DMA complete. This bit will be clear by writing 1. When this interrupt happens, follow the steps listed below. <ol style="list-style-type: none"> 1. Unassert the CSI enable, CSIx_CSICR18 bit31, 2. Reflash the DMA, assert the CSIX_CSICR3 bit 14, 3. Assert the CSI enable, CSIx_CSICR18 bit31.
27 DMA_FIELD0_DONE	When DMA field 0 is complete, this bit will be set to 1(clear by writing 1).

Table continues on the next page...

CSI_CSISR field descriptions (continued)

Field	Description
26 DMA_FIELD1_ DONE	When DMA field 0 is complete, this bit will be set to 1 (clear by writing 1).
25 SF_OR_INT	STATFIFO Overrun Interrupt Status. Indicates the overflow status of the STATFIFO register. (Cleared by writing 1) 0 STATFIFO has not overflowed. 1 STATFIFO has overflowed.
24 RF_OR_INT	RxFIFO Overrun Interrupt Status. Indicates the overflow status of the RxFIFO register. (Cleared by writing 1) 0 RxFIFO has not overflowed. 1 RxFIFO has overflowed.
23 -	This field is reserved. Reserved. This bit is reserved and should read 0.
22 DMA_TSF_ DONE_SFF	DMA Transfer Done from StatFIFO. Indicates that the dma transfer from StatFIFO is completed. It can trigger an interrupt if the corresponding enable bit is set in CSICR1. This bit can be cleared by writing 1 or reflashing the StatFIFO dma controller in CSICR3. (Cleared by writing 1) 0 DMA transfer is not completed. 1 DMA transfer is completed.
21 STATFF_INT	STATFIFO Full Interrupt Status. Indicates the number of data in the STATFIFO reaches the trigger level. (this bit is cleared automatically by reading the STATFIFO) 0 STATFIFO is not full. 1 STATFIFO is full.
20 DMA_TSF_ DONE_FB2	DMA Transfer Done in Frame Buffer2. Indicates that the DMA transfer from RxFIFO to Frame Buffer2 is completed. It can trigger an interrupt if the corresponding enable bit is set in CSICR1. This bit can be cleared by by writing 1 or reflashing the RxFIFO dma controller in CSICR3. (Cleared by writing 1) 0 DMA transfer is not completed. 1 DMA transfer is completed.
19 DMA_TSF_ DONE_FB1	DMA Transfer Done in Frame Buffer1. Indicates that the DMA transfer from RxFIFO to Frame Buffer1 is completed. It can trigger an interrupt if the corresponding enable bit is set in CSICR1. This bit can be cleared by by writing 1 or reflashing the RxFIFO dma controller in CSICR3. (Cleared by writing 1) 0 DMA transfer is not completed. 1 DMA transfer is completed.
18 RxFF_INT	RxFIFO Full Interrupt Status. Indicates the number of data in the RxFIFO reaches the trigger level. (this bit is cleared automatically by reading the RxFIFO) 0 RxFIFO is not full. 1 RxFIFO is full.
17 EOF_INT	End of Frame (EOF) Interrupt Status. Indicates when EOF is detected. (Cleared by writing 1) 0 EOF is not detected. 1 EOF is detected.
16 SOF_INT	Start of Frame Interrupt Status. Indicates when SOF is detected. (Cleared by writing 1)

Table continues on the next page...

CSI_CSISR field descriptions (continued)

Field	Description
	0 SOF is not detected. 1 SOF is detected.
15 F2_INT	CCIR Field 2 Interrupt Status. Indicates the presence of field 2 of video in CCIR mode. (Cleared automatically when current field does not match) NOTE: Only works in CCIR Interlace mode. 0 Field 2 of video is not detected 1 Field 2 of video is about to start
14 F1_INT	CCIR Field 1 Interrupt Status. Indicates the presence of field 1 of video in CCIR mode. (Cleared automatically when current field does not match) NOTE: Only works in CCIR Interlace mode. 0 Field 1 of video is not detected. 1 Field 1 of video is about to start.
13 COF_INT	Change Of Field Interrupt Status. Indicates that a change of the video field has been detected. Only works in CCIR Interlace mode. Software should read this bit first and then dispatch the new field from F1_INT and F2_INT. (Cleared by writing 1) 0 Video field has no change. 1 Change of video field is detected.
12–8 -	This field is reserved. Reserved. These bits are reserved and should read 0.
7 HRESP_ERR_INT	Hresponse Error Interrupt Status. Indicates that a hresponse error has been detected. (Cleared by writing 1) 0 No hresponse error. 1 Hresponse error is detected.
6–2 -	This field is reserved. Reserved. These bits are reserved and should read 0.
1 ECC_INT	CCIR Error Interrupt. This bit indicates an error has occurred. This only works in CCIR Interlace mode. (Cleared by writing 1) 0 No error detected 1 Error is detected in CCIR coding
0 DRDY	RXFIFO Data Ready. Indicates the presence of data that is ready for transfer in the RxFIFO. (Cleared automatically by reading FIFO) 0 No data (word) is ready 1 At least 1 datum (word) is ready in RXFIFO.

19.7.8 CSI DMA Start Address Register - for STATFIFO (CSI_CSIDMASA_STATFIFO)

This register provides the start address for the embedded DMA controller of STATFIFO. The embedded DMA controller will read data from STATFIFO and write it to the external memory from the start address. This register should be configured before activating or restarting the embedded DMA controller.

Address: 21C_4000h base + 20h offset = 21C_4020h

Bit	31	30	29	28	27	26	25	24		23	22	21	20	19	18	17	16
R	DMA_START_ADDR_SFF																
W	DMA_START_ADDR_SFF																
Reset	0	0	0	0	0	0	0	0		0	0	0	0	0	0	0	0
Bit	15	14	13	12	11	10	9	8		7	6	5	4	3	2	1	0
R	DMA_START_ADDR_SFF															Reserved	
W	DMA_START_ADDR_SFF															Reserved	
Reset	0	0	0	0	0	0	0	0		0	0	0	0	0	0	0	0

CSI_CSIDMASA_STATFIFO field descriptions

Field	Description
31–2 DMA_START_ADDR_SFF	DMA Start Address for STATFIFO. Indicates the start address to write data. The embedded DMA controller will read data from STATFIFO and write it from this address through AHB bus. The address should be aligned.
-	This field is reserved. Reserved. These bits are reserved and should read 0.

19.7.9 CSI DMA Transfer Size Register - for STATFIFO (CSI_CSIDMATS_STATFIFO)

This register provides the total transfer size for the embedded DMA controller of STATFIFO. This register should be configured before activating or restarting the embedded DMA controller.

Address: 21C_4000h base + 24h offset = 21C_4024h

Bit	31	30	29	28	27	26	25	24	23	22	21	20	19	18	17	16		15	14	13	12	11	10	9	8	7	6	5	4	3	2	1	0
R	DMA_TSF_SIZE_SFF																																
W	DMA_TSF_SIZE_SFF																																
Reset	0	0	0	0	0	0	0	0	0	0	0	0	0	0	0	0		0	0	0	0	0	0	0	0	0	0	0	0	0	0	0	0

CSI_CSIDMATS_STATFIFO field descriptions

Field	Description
DMA_TSF_SIZE_SFF	DMA Transfer Size for STATFIFO. Indicates how many words to be transferred by the embedded DMA controller. The size should be aligned.

19.7.10 CSI DMA Start Address Register - for Frame Buffer1 (CSI_CSIDMASA_FB1)

This register provides the start address in the frame buffer1 for the embedded DMA controller of RxFIFO. The embedded DMA controller will read data from RxFIFO and write it to the frame buffer1 from the start address. This register should be configured before activating or restarting the embedded DMA controller.

Address: 21C_4000h base + 28h offset = 21C_4028h

Bit	31	30	29	28	27	26	25	24	23	22	21	20	19	18	17	16
R																
W	DMA_START_ADDR_FB1															
Reset	0	0	0	0	0	0	0	0	0	0	0	0	0	0	0	0
Bit	15	14	13	12	11	10	9	8	7	6	5	4	3	2	1	0
R	DMA_START_ADDR_FB1															Reserved
W																
Reset	0	0	0	0	0	0	0	0	0	0	0	0	0	0	0	0

CSI_CSIDMASA_FB1 field descriptions

Field	Description
31–2 DMA_START_ADDR_FB1	DMA Start Address in Frame Buffer1. Indicates the start address to write data. The embedded DMA controller will read data from RxFIFO and write it from this address through AHB bus. The address should be aligned.
-	This field is reserved. Reserved. These bits are reserved and should read 0.

19.7.11 CSI DMA Transfer Size Register - for Frame Buffer2 (CSI_CSIDMASA_FB2)

This register provides the start address in the frame buffer2 for the embedded DMA controller of RxFIFO. The embedded DMA controller will read data from RxFIFO and write it to the frame buffer2 from the start address. This register should be configured before activating or restarting the embedded DMA controller.

Address: 21C_4000h base + 2Ch offset = 21C_402Ch

Bit	31	30	29	28	27	26	25	24	23	22	21	20	19	18	17	16
R	DMA_START_ADDR_FB2															
W	DMA_START_ADDR_FB2															
Reset	0	0	0	0	0	0	0	0	0	0	0	0	0	0	0	0
Bit	15	14	13	12	11	10	9	8	7	6	5	4	3	2	1	0
R	DMA_START_ADDR_FB2															Reserved
W	DMA_START_ADDR_FB2															Reserved
Reset	0	0	0	0	0	0	0	0	0	0	0	0	0	0	0	0

CSI_CSIDMASA_FB2 field descriptions

Field	Description
31–2 DMA_START_ADDR_FB2	DMA Start Address in Frame Buffer2. Indicates the start address to write data. The embedded DMA controller will read data from RxFIFO and write it from this address through AHB bus. The address should be aligned.
-	This field is reserved. Reserved. These bits are reserved and should read 0.

19.7.12 CSI Frame Buffer Parameter Register (CSI_CSIFBUF_PARA)

This register provides the stride of the frame buffer to show how many words to skip before starting to write the next row of the image. The width of the frame buffer minus the width of the image is the stride. This register should be configured before activating or restarting the embedded DMA controller.

Address: 21C_4000h base + 30h offset = 21C_4030h

Bit	31	30	29	28	27	26	25	24	23	22	21	20	19	18	17	16	15	14	13	12	11	10	9	8	7	6	5	4	3	2	1	0
R	DEINTERLACE_STRIDE																FBUF_STRIDE															
W	DEINTERLACE_STRIDE																FBUF_STRIDE															
Reset	0	0	0	0	0	0	0	0	0	0	0	0	0	0	0	0	0	0	0	0	0	0	0	0	0	0	0	0	0	0	0	0

CSI_CSIFBUF_PARA field descriptions

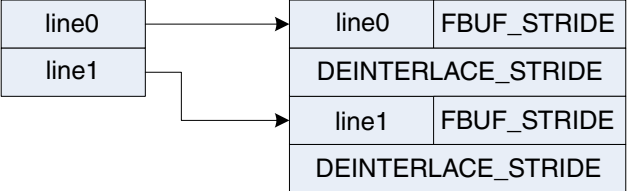
Field	Description
31–16 DEINTERLACE_STRIDE	<p>DEINTERLACE_STRIDE is only used in the deinterlace mode. If line stride feature is supported in deinterlace mode, FBUF_STRIDE and DEINTERLACE_STRIDE need to be configured at the same time. DEINTERLACE_STRIDE is configured the same as line width. In normal line stride feature, only FBUF_STRIDE needs to be configured.</p> 
FBUF_STRIDE	<p>Frame Buffer Parameter. Indicates the stride of the frame buffer. The width of the frame buffer(in) minus the width of the image(in) is the stride. The stride should be aligned. The embedded DMA controller will skip the stride before starting to write the next row of the image.</p>

19.7.13 CSI Image Parameter Register (CSI_CSIIIMAG_PARA)

This register provides the width and the height of the image from the sensor. The width and height should be aligned in pixel. The width of the image multiplied by the height is the total pixel size that will be transferred in a frame by the embedded DMA controller. This register should be configured before activating or restarting the embedded DMA controller.

Address: 21C_4000h base + 34h offset = 21C_4034h

Bit	31	30	29	28	27	26	25	24	23	22	21	20	19	18	17	16	15	14	13	12	11	10	9	8	7	6	5	4	3	2	1	0
R	IMAGE_WIDTH																IMAGE_HEIGHT															
W	0																0															
Reset	0	0	0	0	0	0	0	0	0	0	0	0	0	0	0	0	0	0	0	0	0	0	0	0	0	0	0	0	0	0	0	0

CSI_CSIIIMAG_PARA field descriptions

Field	Description
31–16 IMAGE_WIDTH	<p>Image Width. Indicates how many pixels in a line of the image from the sensor.</p> <p>If the input data from the sensor is 8-bit/pixel format, the IMAGE_WIDTH should be a multiple of pixels.</p> <p>If the input data from the sensor is 10-bit/pixel or 16-bit/pixel format, the IMAGE_WIDTH should be a multiple of pixels.</p>
IMAGE_HEIGHT	<p>Image Height. Indicates how many pixels in a column of the image from the sensor.</p>

19.7.14 CSI Control Register 18 (CSI_CSICR18)

This read/write register acts as an extension of the functionality of the CSI Control register 1

Address: 21C_4000h base + 48h offset = 21C_4048h

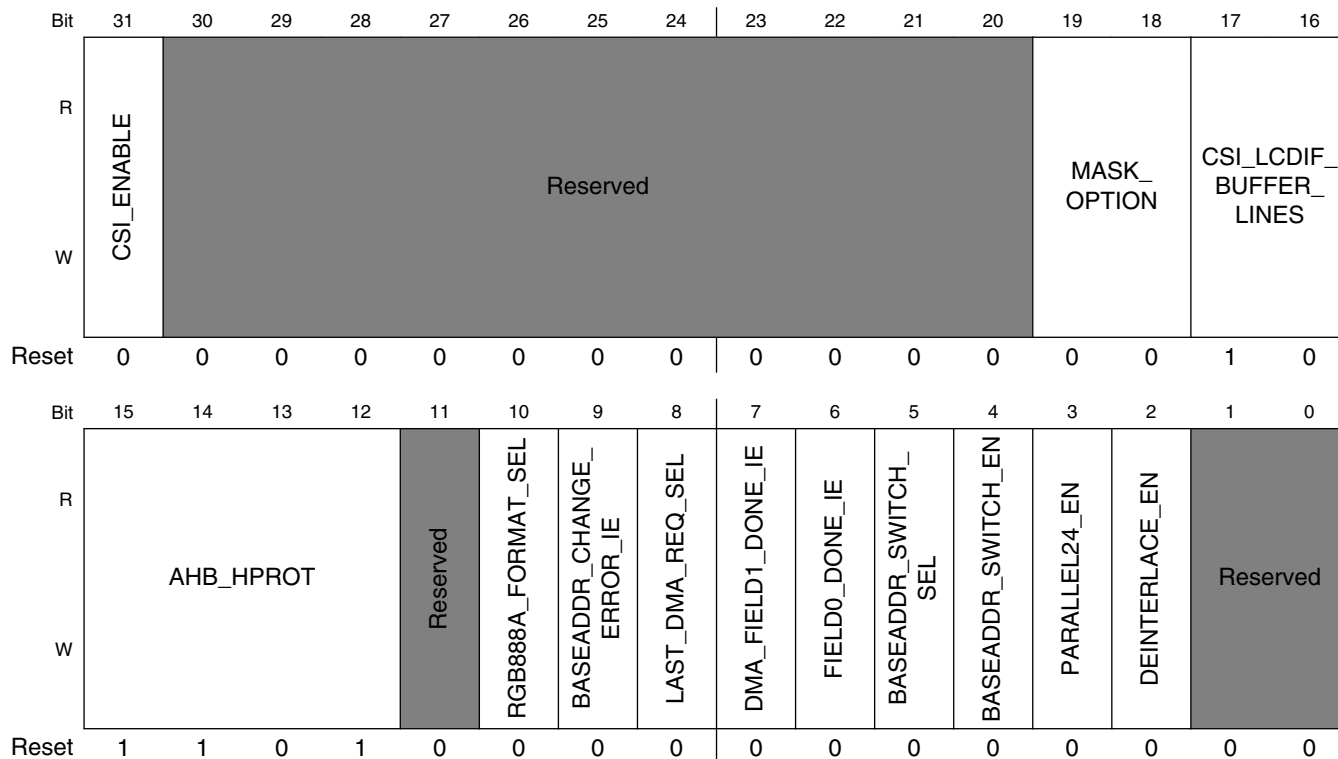

CSI_CSICR18 field descriptions

Field	Description
31 CSI_ENABLE	CSI global enable signal. Only when this bit is 1, CSI can start to receive the data and store to memory.
30-20 -	This field is reserved.
19-18 MASK_OPTION	These bits used to choose the method to mask the CSI input. 00 Writing to memory from first completely frame, when using this option, the CSI_ENABLE should be 1. 01 Writing to memory when CSI_ENABLE is 1. 02 Writing to memory from second completely frame, when using this option, the CSI_ENABLE should be 1. 03 Writing to memory when data comes in, not matter the CSI_ENABLE is 1 or 0.

Table continues on the next page...

CSI_CSICR18 field descriptions (continued)

Field	Description
17–16 CSI_LCDIF_ BUFFER_LINES	The number of lines are used in handshake mode with LCDIF. 00 4 lines 01 8 lines 02 16 lines 03 16 lines
15–12 AHB_HPROT	Hprot value in AHB bus protocol.
11 -	This field is reserved.
10 RGB888A_ FORMAT_SEL	Output is 32-bit format. 0 {8'h0, data[23:0]} 1 {data[23:0], 8'h0}
9 BASEADDR_ CHANGE_ ERROR_IE	Base address change error interrupt enable signal.
8 LAST_DMA_ REQ_SEL	Choosing the last DMA request condition. 0 fifo_full_level 1 hburst_length
7 DMA_FIELD1_ DONE_IE	When in interlace mode, field 1 done interrupt enable. 0 Interrupt disabled 1 Interrupt enabled
6 FIELD0_DONE_ IE	In interlace mode, field 0 means interrupt enabled. 0 Interrupt disabled 1 Interrupt enabled
5 BASEADDR_ SWITCH_SEL	CSI 2 base addresses switching method. When using this bit, BASEADDR_SWITCH_EN is 1. 0 Switching base address at the edge of the vsync 1 Switching base address at the edge of the first data of each frame
4 BASEADDR_ SWITCH_EN	When this bit is enabled, CSI DMA will switch the base address according to BASEADDR_SWITCH_SEL rather than atomically by DMA completed.
3 PARALLEL24_ EN	When input is parallel rgb888/yuv444 24bit, this bit can be enabled.
2 DEINTERLACE_ EN	This bit is used to select the output method When input is standard CCIR656 video. 0 Deinterlace disabled 1 Deinterlace enabled
-	This field is reserved. Reserved.

19.7.15 CSI Control Register 19 (CSI_CSICR19)

This read/write register acts as an extension of the functionality of the CSI Control register 1

Address: 21C_4000h base + 4Ch offset = 21C_404Ch

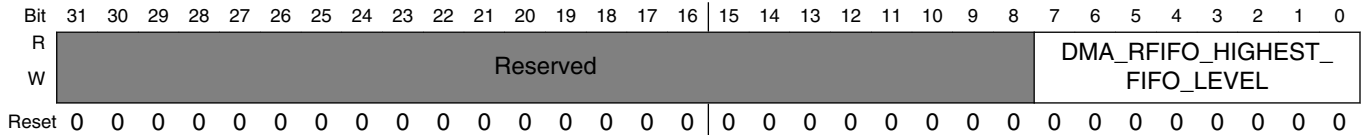

CSI_CSICR19 field descriptions

Field	Description
31–8 -	This field is reserved.
DMA_RFIFO_HIGHEST_FIFO_LEVEL	This byte stores the highest FIFO level achieved by CSI FIFO timely and will be clear by writing 8'ff to it.

Chapter 20

Enhanced Configurable SPI (ECSPI)

20.1 Overview

The Enhanced Configurable Serial Peripheral Interface (ECSPI) is a full-duplex, synchronous, four-wire serial communication block.

The ECSPI contains a 64 x 32 receive buffer (RXFIFO) and a 64 x 32 transmit buffer (TXFIFO). With data FIFOs, the ECSPI allows rapid data communication with fewer software interrupts. The figure below shows a block diagram of the ECSPI.

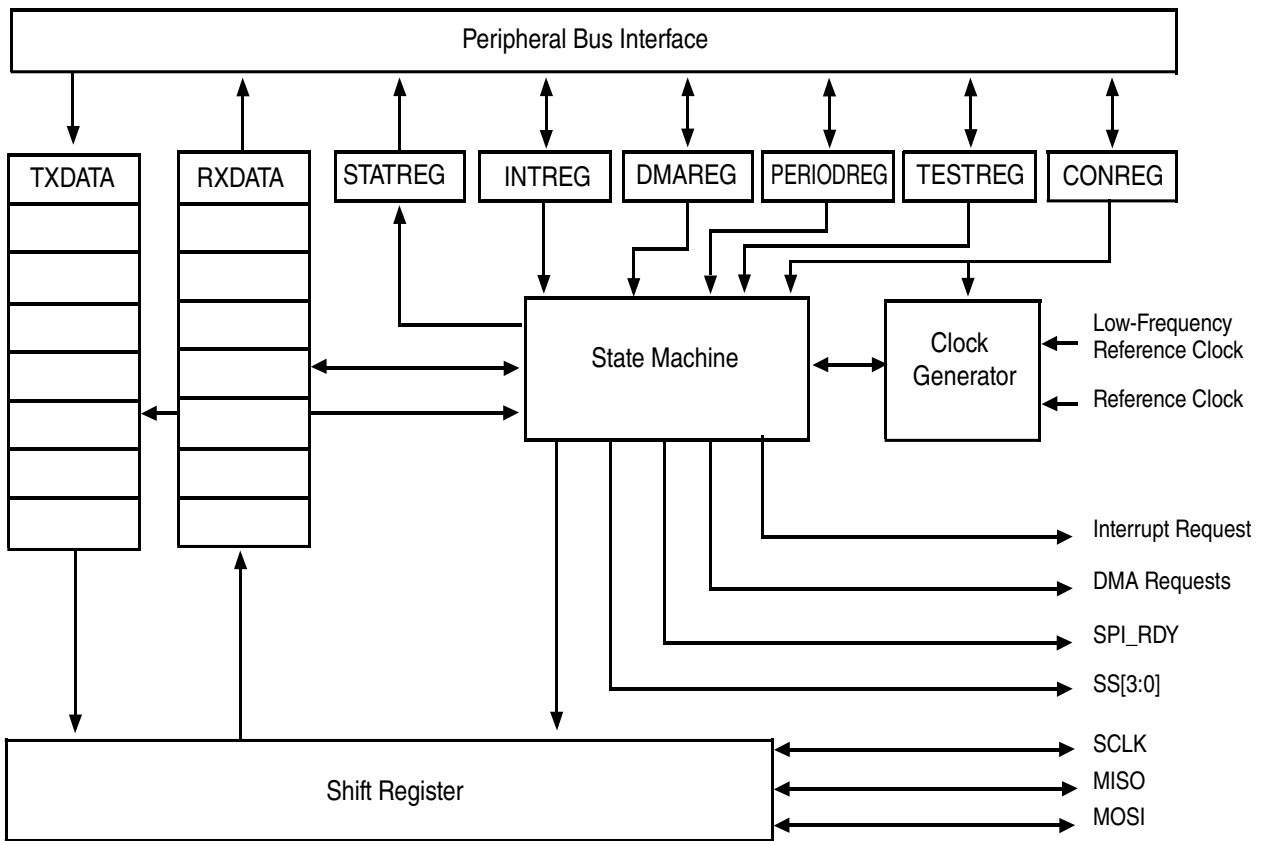

Figure 20-1. ECSPi Block Diagram

20.1.1 Features

Key features of the ECSPi include:

- Full-duplex synchronous serial interface
- Master/Slave configurable
- Four Chip Select (SS) signals to support multiple peripherals
- Transfer continuation function allows unlimited length data transfers
- 32-bit wide by 64-entry FIFO for both transmit and receive data
- Polarity and phase of the Chip Select (SS) and SPI Clock (SCLK) are configurable
- Direct Memory Access (DMA) support
- Max operation frequency up to the reference clock frequency.

20.1.2 Modes and Operations

The ECSPI supports the modes described in the indicated sections:

- [Master Mode](#)
- [Slave Mode](#)
- [Low Power Modes](#)

As described in [Operations](#), the ECSPI supports the operations described in the indicated sections:

- [Typical Master Mode](#)
 - [Master Mode with SPI_RDY](#)
 - [Master Mode with Wait States](#)
 - [Master Mode with SS_CTL\[3:0\] Control](#)
 - [Master Mode with Phase Control](#)
- [Typical Slave Mode](#)

20.2 External Signals

[Figure 20-2](#) shows the ECSPI in master mode connected to four external devices in a one-way communication link.

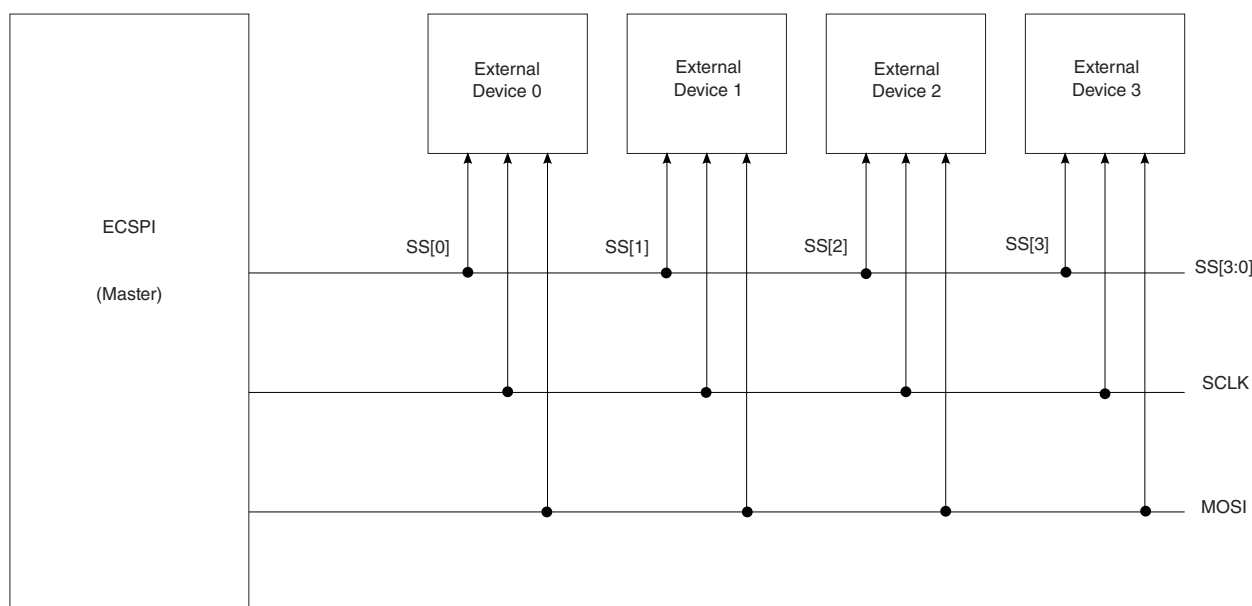

Figure 20-2. Example Connection Diagram

20.3 Clocks

The following table describes the clock sources for eCSPI. Please see [Clock Controller Module \(CCM\)](#) for clock setting, configuration and gating information.

Table 20-1. eCSPI Clocks

Clock name	Clock Root	Description
ipg_clk	ipg_clk_root	Peripheral clock
ipg_clk_32k	ckil_sync_clk_root	Low-frequency reference clock (32kHz)
ipg_clk_per	ecspi_clk_root	eCSPI module clock
ipg_clk_s	ipg_clk_root	Peripheral access clock

20.4 Functional Description

This section provides a complete functional description of the ECSPi. The figure found here shows the relationship of SCLK and data lines while ECSPi has been configured with different POL and PHA settings.

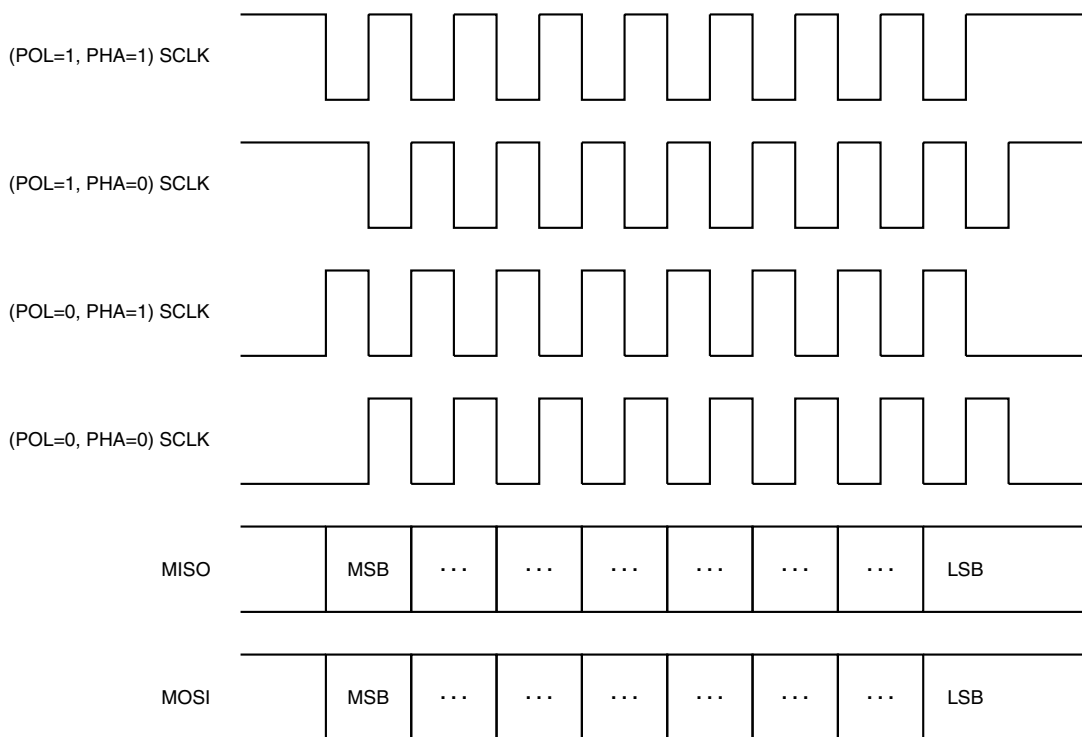

Figure 20-3. ECSPi SCLK, MISO, and MOSI Relationship

20.4.1 Master Mode

When the ECSPI is configured as a master, it uses a serial link to transfer data between the ECSPI and an external slave device.

One of the Chip Select (SS) signals and the clock signal (SCLK) are used to transfer data between two devices. If the external device is a transmit-only device, the ECSPI master's output port can be ignored and used for other purposes. In order to use the internal TXFIFO and RXFIFO, two auxiliary output signals, Chip Select (SS) and SPI_RDY, are used for data transfer rate control. Software can also configure the sample period control register to a fixed data transfer rate.

20.4.2 Slave Mode

When the ECSPI is configured as a slave, software can configure the ECSPI Control register to match the external SPI master's timing.

In this configuration, Chip Select (\overline{SS}) becomes an input signal, and is used to control data transfers through the Shift register, as well as to load/store the data FIFO.

Slave mode only supports the case when ECSPIx_CONFIGREG[SS_CTL] is cleared. The accurate burst length should always be specified using the BURST_LENGTH parameter. ECSPIx_CONFIGREG[SS_CTL] set to 1 is not supported in slave mode.

20.4.3 Low Power Modes

The ECSPI does not operate under low power mode.

It holds its operation when its clock is gated off in master mode. In slave mode, the ECSPI does not respond when its clock is gated off.

20.4.4 Operations

The information found here describes the ECSPI's operations.

20.4.4.1 Typical Master Mode

The ECSPI master uses the Chip Select (SS) signal to enable an external SPI device, and uses the SCLK signal to transfer data in and out of the Shift register.

The SPI_RDY enables fast data communication with fewer software interrupts. By programming the ECSPI_PERIODREG register accordingly, the ECSPI can be used for a fixed data transfer rate.

When the ECSPI is in Master mode the SS, SCLK, and MOSI are output signals, and the MISO signal is an input.

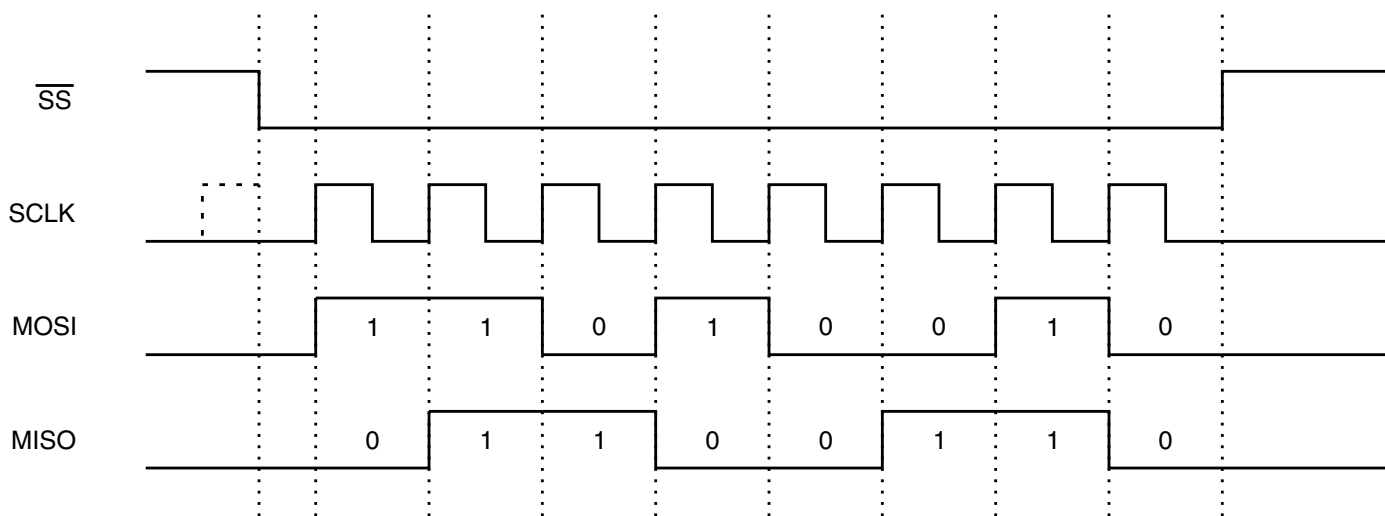

Figure 20-4. Typical SPI Burst (8-bit Transfer)

In the above figure, the Chip Select (SS) signal enables the selected external SPI device, and the SCLK synchronizes the data transfer. The MOSI and MISO signals change on rising edge of SCLK and the MISO signal is latched on the falling edge of the SCLK. The figure above shows a data of 0xD2 is shifted out, and a data of 0x66 is shifted in.

20.4.4.1.1 Master Mode with SPI_RDY

By default, the ECSPI does not use the SPI_RDY signal in master mode (MODE =1).

A SPI burst begins when the following events happen:

- The ECSPI is enabled, TXFIFO has data in it, and ECSPI_CONREG[XCH] bit or the ECSPI_CONREG[SMC] bit is set.
- When the SPI Data Ready Control (ECSPI_CONREG[DRCTL]) bits contains either 01 or 10, the SPI_RDY signal controls when a SPI burst starts.

A SPI burst is defined as a bus transaction that starts when the slave select is asserted and ends when the slave select is negated. The Chip Select (\overline{SS}) signal will remain asserted until all the bits in a SPI burst are shifted out.

If `ECSPI_CONREG[DRCTL]` is set to 01, the SPI burst can be triggered only if a falling edge of the `SPI_RDY` signal has been detected.

The following figure shows the relationship between a SPI burst and the falling edge of `SPI_RDY` signal.

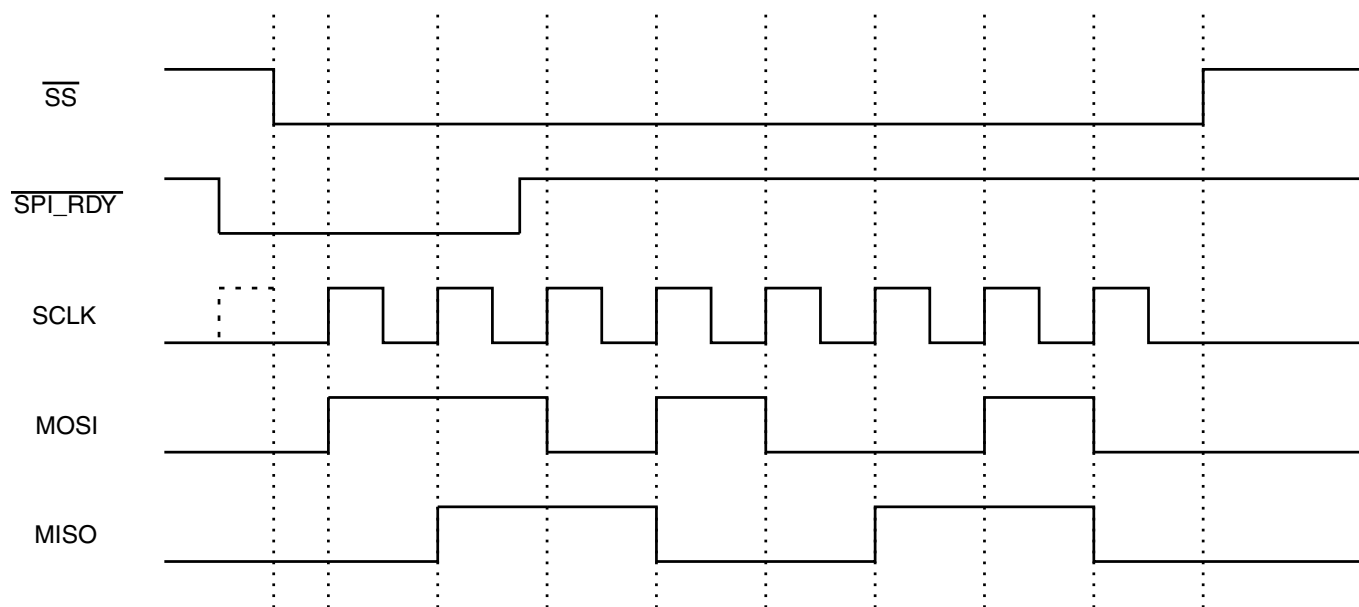

Figure 20-5. Relationship Between a SPI Burst and `SPI_RDY`: Falling-Edge Triggered

A SPI burst does not start until the falling edge of the `SPI_RDY` signal is detected. The next SPI burst starts when the next `SPI_RDY` falling edge is detected, after the last burst has finished.

If SPI Data Ready Control (`ECSPI_CONREG[DRCTL]`) is set to 10, the SPI burst can be triggered only if the `SPI_RDY` signal is low.

The following figure shows the relationship between a SPI burst and the `SPI_RDY` signal. The SPI burst does not begin until the `SPI_RDY` signal goes low. The ECSPI will keep transmitting SPI burst if the `SPI_RDY` signal remains low.

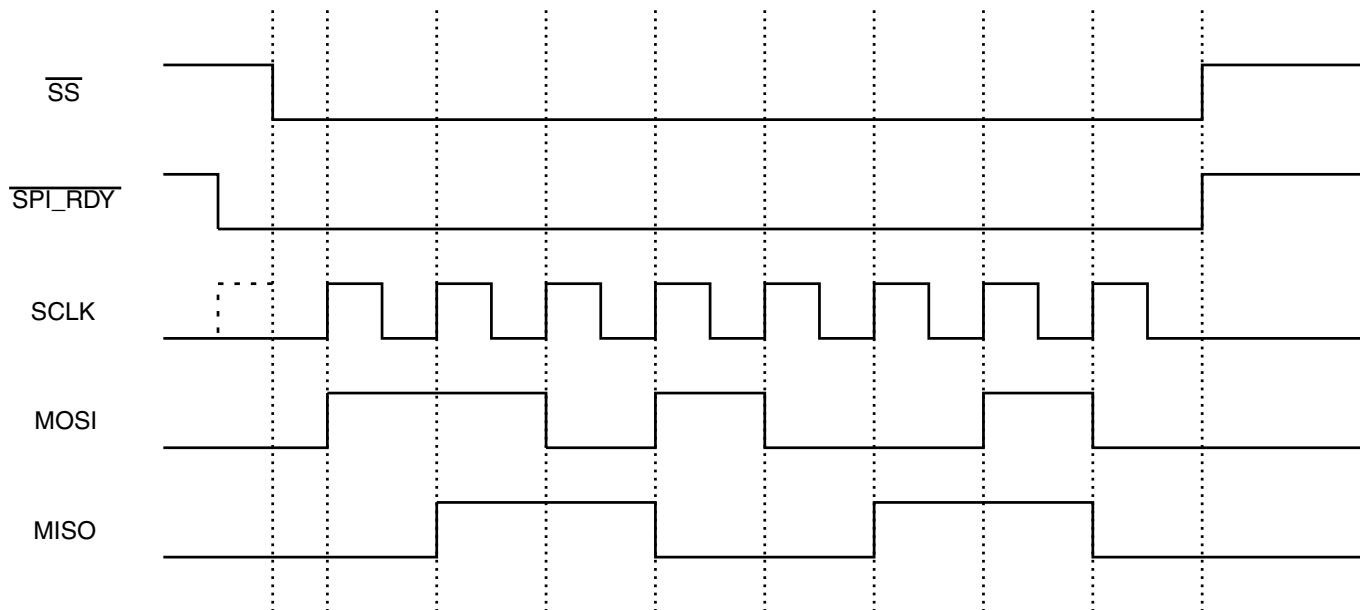

Figure 20-6. Relationship Between a SPI Burst and SPI_RDY: Low-Level Triggered

20.4.4.1.2 Master Mode with Wait States

Wait states can be inserted between SPI bursts. This provides a way for software to slow down the SPI burst to meet the timing requirements of a slower SPI device.

The following figure shows wait states inserted between SPI bursts.

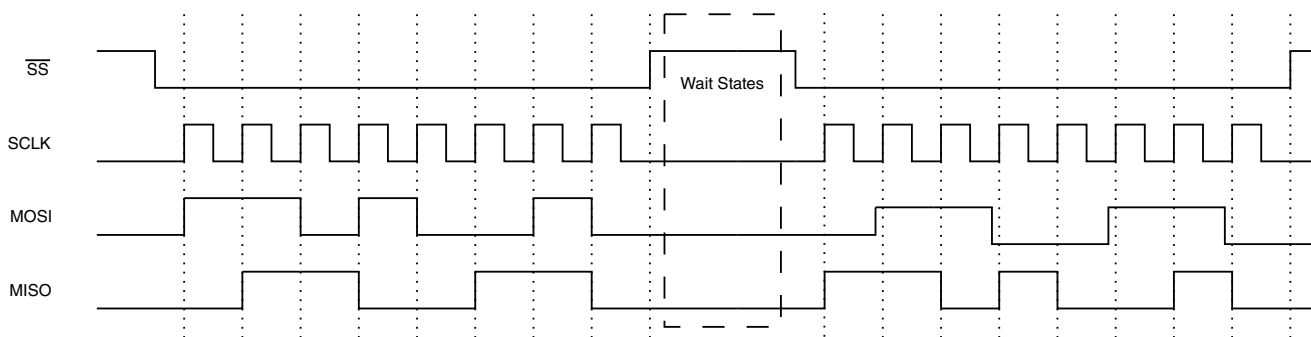

Figure 20-7. SPI Bursts with Wait States

In this case, the number of wait states is controlled by `ECSPI_PERIODREG[SAMPLE PERIOD]` and the wait states' clock source is selected by `ECSPI_PERIODREG[CSRC]`.

20.4.4.1.3 Master Mode with SS_CTL[3:0] Control

The SPI SS Control (`SS_CTL[3:0]`) controls whether the current operation is single burst or multiple bursts.

When the SPI SS Wave Form Select (`SS_CTL[3:0]`) is set, the current operation is multiple bursts transfer. When the SPI SS Wave Form Select (`SS_CTL[3:0]`) bit is cleared, the current operation is single burst transfer. A SPI burst can contains multiple words as defined in the BURST LENGTH field of the ECSPI_CONREG register.

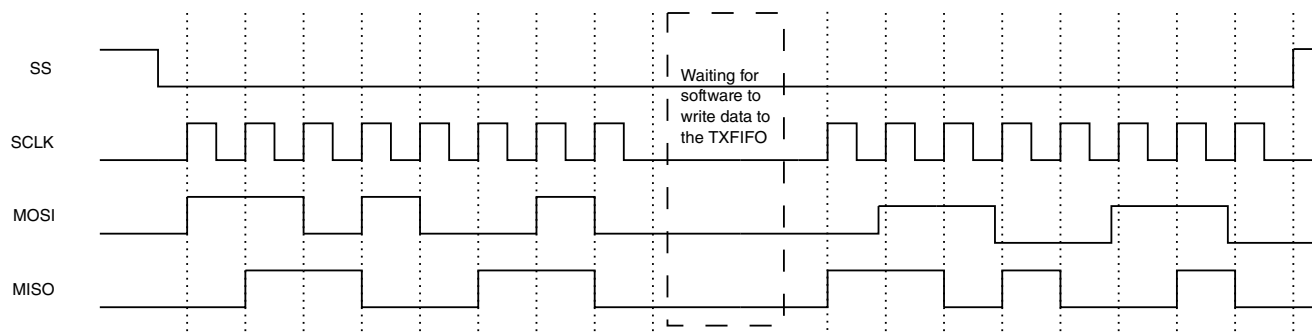

Figure 20-8. SPI Burst While `SS_CTL[3:0]` is Clear

In [Figure 20-8](#), two 8-bit bursts in the TXFIFO have been combined and transmitted in one SPI burst. The maximum length of a single SPI burst is defined by the BURST LENGTH and limited by the FIFO size. ([Figure 20-8](#) corresponds to a BURST LENGTH of 8.) This provides a way for transferring a longer SPI burst by writing data into TXFIFO while the ECSPI is transmitting.

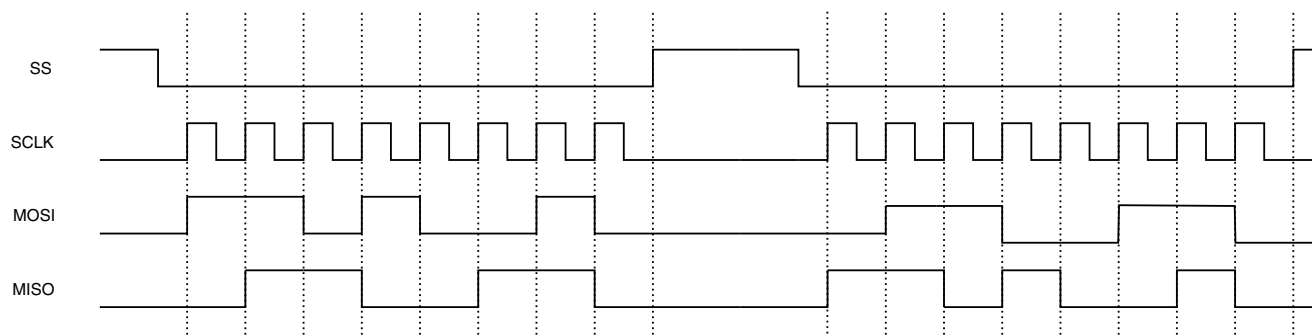

Figure 20-9. SPI Bursts While `SS_CTL[3:0]` is Set

In [Figure 20-9](#), two FIFO entries are transmitted, one entry with each SPI burst. The ECSPI will continue to transmit SPI bursts until the TXFIFO is empty. When wait states can be inserted between SPI bursts, the SS will negate between SPI bursts until the wait states finish.

20.4.4.1.4 Master Mode with Phase Control

The Phase Control (`ECSPI_CONREG[PHA]`) bit controls how the transmit data shifts out and the receive data shifts in.

Functional Description

When the Phase control (ECSPI_CONREG[PHA]) bit is set, the transmit data will shift out on the rising edge of SCLK, and the receive data is latched on the falling edge of SCLK. The most-significant bit is output on the first rising SCLK edge.

When ECSPI_CONREG[PHA] is cleared, the transmit data is shifted out on the falling edge of SCLK and the receive data is latched on the rising edge of SCLK. The MSB is output when the host processor loads the transmitted data.

Inverting the SCLK polarity does not impact the edge-triggered operations because they are internal to the serial peripheral interface master. [Figure 20-10](#) shows how SPI burst works with different POL and PHA configuration.

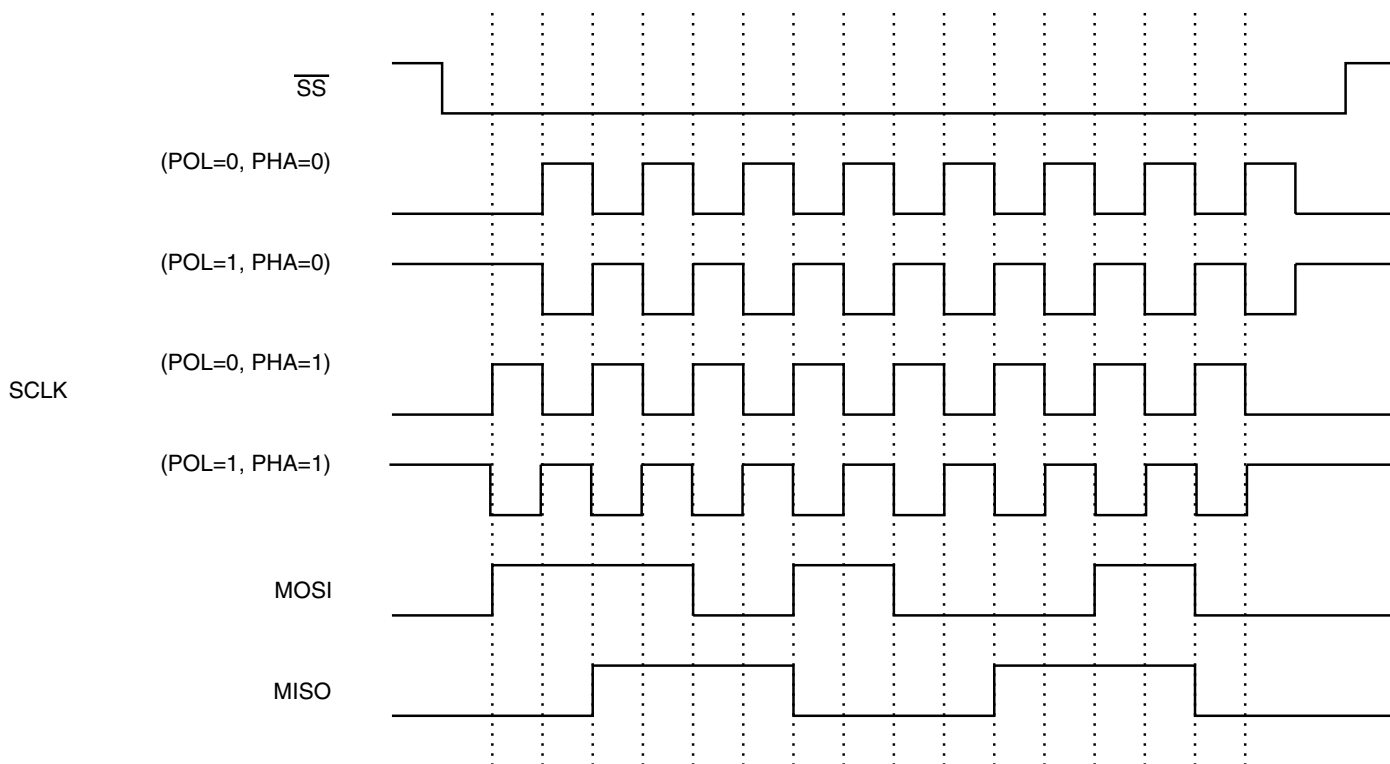

Figure 20-10. SPI Burst with Different POL and PHA Configurations

20.4.4.2 Typical Slave Mode

When the ECSPI is configured as a slave (Mode = 0), software can configure the ECSPI Control register to match the external SPI master's timing. In this configuration, \overline{SS} becomes an input signal, and is used to latch data in and out of the internal data Shift registers, as well as to advance the data FIFO.

The SS, SCLK, and MOSI are inputs and MISO is output. Most of the timing diagrams are similar to the diagrams shown previously for the SPI in Master mode (Mode = 1), because the inputs come from a SPI master device.

However, the timing is different when SS is used to advance the data FIFO. When the SS_POL=0 is set while the ECSPI is configured in Slave mode, the data FIFO will advance on the rising edge of the SS signal. When the polarity is reversed (SS_POL = 1), the data FIFO will advance on the falling edge of the SS signal.

The figure below shows a SPI burst in which the data FIFO is advanced by the rising edge of the SS signal.

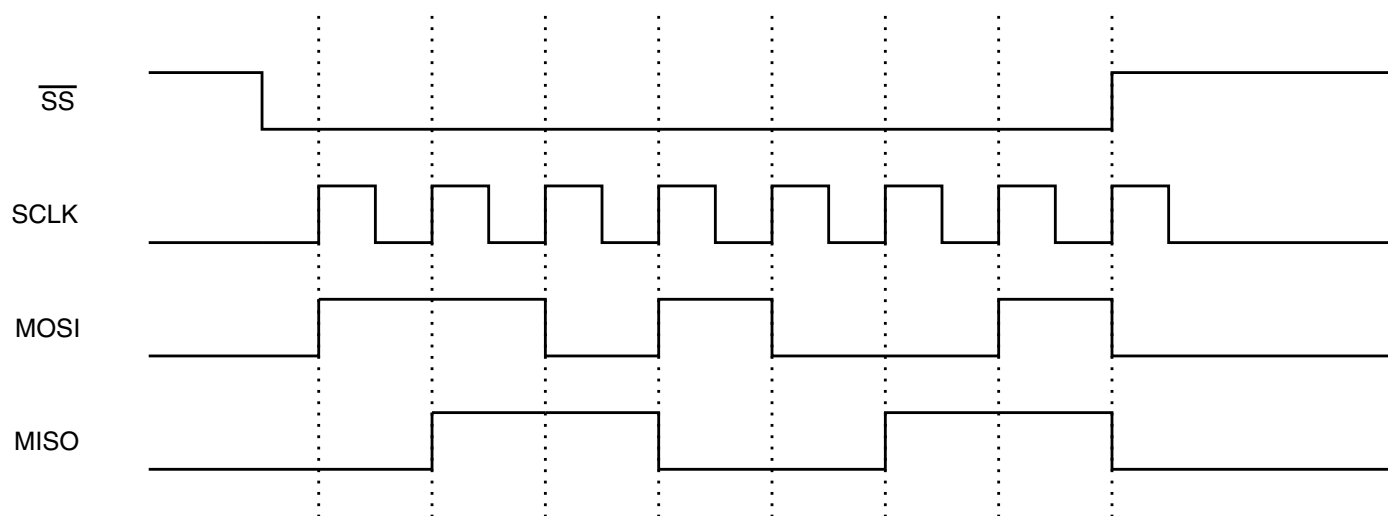

Figure 20-11. Advancing the Data FIFO on the Rising Edge of \overline{SS}

In the above case, only the most significant 7 bits are loaded to the RXFIFO.

20.4.5 Reset

Whenever a device reset occurs, a reset is performed on the ECSPI, resetting all registers to their default values.

Software can reset the block using the CONREG[EN] bit; see [ECSPI](#).

20.4.6 Interrupts

Interrupt control provides a way to manage the ECSPI FIFOs:

Functional Description

- For transmitting data, software can enable the TXFIFO empty, TXFIFO data request, and TXFIFO full interrupts to maintain the TXFIFO using an interrupt service routine.
- For receiving data, software can enable the RXFIFO ready, RXFIFO data request, and RXFIFO full interrupts to retrieve data from the RXFIFO using an interrupt service routine.

Other interrupt sources can be used to control or debug the SPI bursts:

- The transfer-completed interrupt means that there is no data left in the TXFIFO and that the data in the Shift register has been shifted out.
- The RXFIFO overflow interrupt means that the RXFIFO received more than 64 words and will not accept any other words.

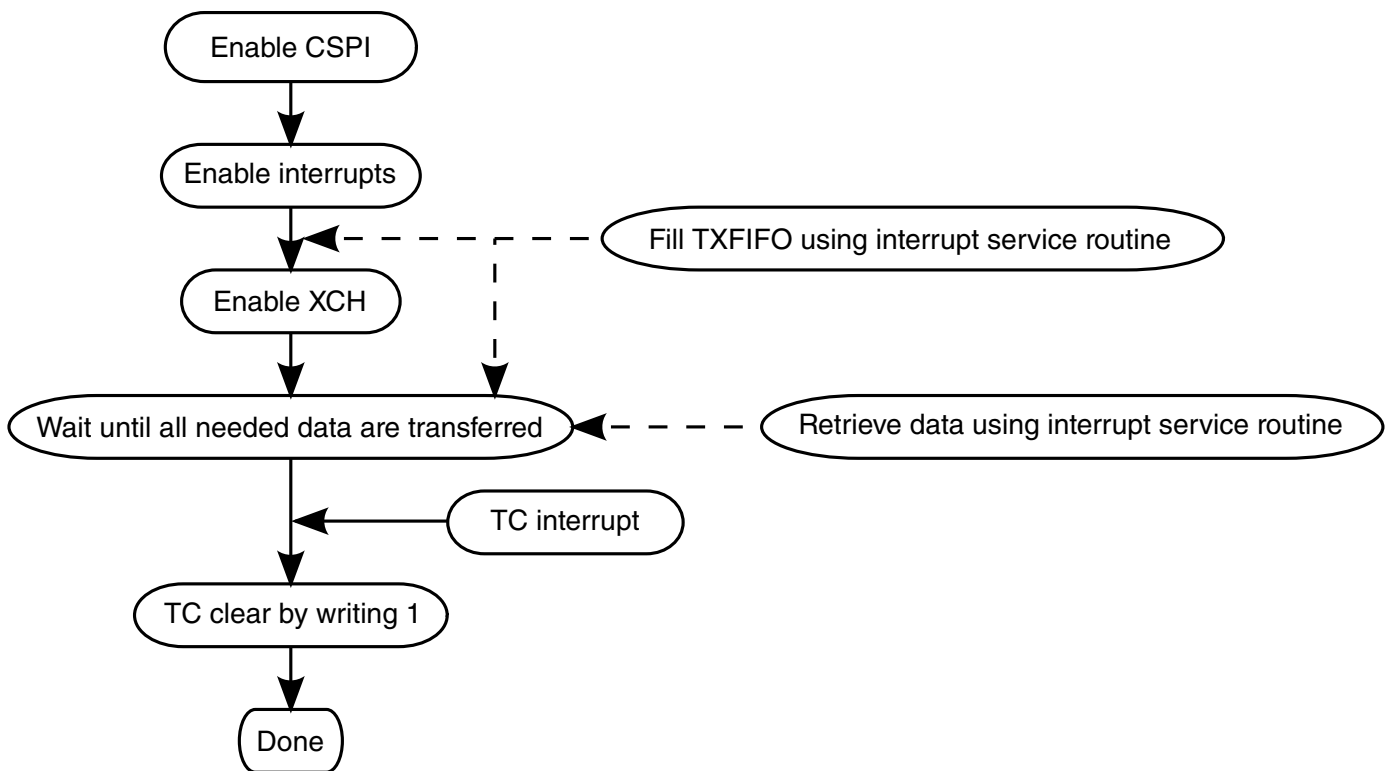

Figure 20-12. Program Sequence of SPI Burst Using Interrupt Control

20.4.7 DMA

DMA control provides another method to utilize the FIFOs in the ECSPI. By using DMA request and acknowledge signals, larger amounts of data can be transferred, and will reduce interrupts and host processor loading. When the appropriate conditions are matched, the block will send out a DMA request.

The DMA can deal with the following conditions:

- TXFIFO empty
- TXFIFO data request
- RXFIFO data request
- RXFIFO full

The figure below shows a program sequence of SPI bursts using DMA control.

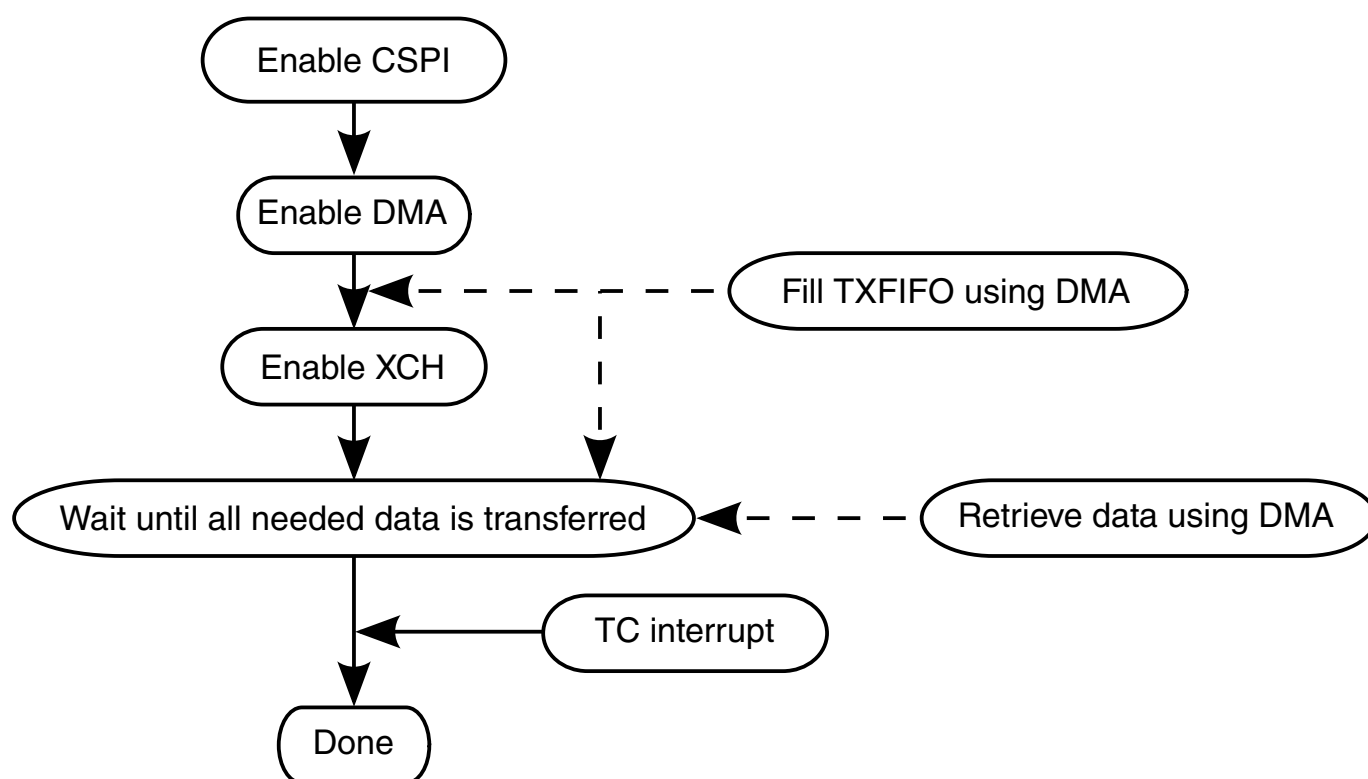

Figure 20-13. Program Sequence of SPI Burst Using DMA

20.4.8 Byte Order

The ECSPI does not support byte re-ordering in hardware.

20.5 Initialization

This section provides initialization information for ECSPI.

To initialize the block:

1. Clear the EN bit in ECSPI_CONREG to reset the block.
2. Enable the clocks for ECSPI within the CCM.
3. Configure the Control Register and then set the EN bit in the ECSPI_CONREG to put ECSPI out of reset.
4. Configure corresponding IOMUX for ECSPI external signals.
5. Configure registers of ECSPI properly according to the specifications of the external SPI device.

20.6 Applications

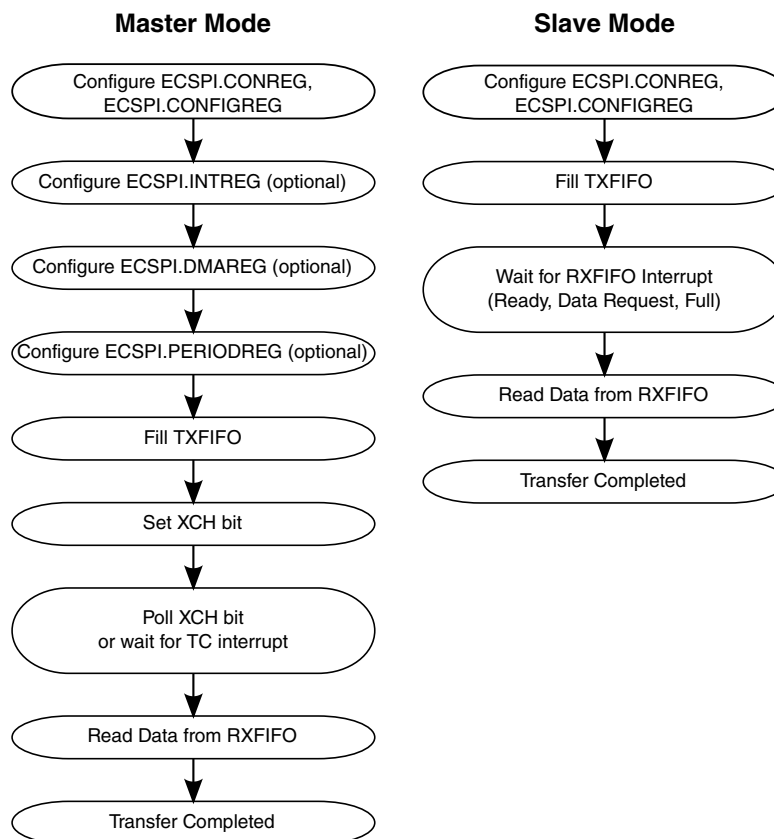

Figure 20-14. Flowchart of the ECSPI Operation

20.7 ECSPI Memory Map/Register Definition

This section includes the block memory map and detailed descriptions of all registers. For the base address of a particular block instantiation, see the system memory map.

ECSPI memory map

Absolute address (hex)	Register name	Width (in bits)	Access	Reset value	Section/page
200_8000	Receive Data Register (ECSPI1_RXDATA)	32	R	0000_0000h	20.7.1/806
200_8004	Transmit Data Register (ECSPI1_TXDATA)	32	W	0000_0000h	20.7.2/807
200_8008	Control Register (ECSPI1_CONREG)	32	R/W	0000_0000h	20.7.3/807
200_800C	Config Register (ECSPI1_CONFIGREG)	32	R/W	0000_0000h	20.7.4/810
200_8010	Interrupt Control Register (ECSPI1_INTREG)	32	R/W	0000_0000h	20.7.5/812
200_8014	DMA Control Register (ECSPI1_DMAREG)	32	R/W	0000_0000h	20.7.6/813
200_8018	Status Register (ECSPI1_STATREG)	32	R/W	0000_0003h	20.7.7/815
200_801C	Sample Period Control Register (ECSPI1_PERIODREG)	32	R/W	0000_0000h	20.7.8/816
200_8020	Test Control Register (ECSPI1_TESTREG)	32	R/W	0000_0000h	20.7.9/818
200_8040	Message Data Register (ECSPI1_MSGDATA)	32	W	0000_0000h	20.7.10/819
200_C000	Receive Data Register (ECSPI2_RXDATA)	32	R	0000_0000h	20.7.1/806
200_C004	Transmit Data Register (ECSPI2_TXDATA)	32	W	0000_0000h	20.7.2/807
200_C008	Control Register (ECSPI2_CONREG)	32	R/W	0000_0000h	20.7.3/807
200_C00C	Config Register (ECSPI2_CONFIGREG)	32	R/W	0000_0000h	20.7.4/810
200_C010	Interrupt Control Register (ECSPI2_INTREG)	32	R/W	0000_0000h	20.7.5/812
200_C014	DMA Control Register (ECSPI2_DMAREG)	32	R/W	0000_0000h	20.7.6/813
200_C018	Status Register (ECSPI2_STATREG)	32	R/W	0000_0003h	20.7.7/815
200_C01C	Sample Period Control Register (ECSPI2_PERIODREG)	32	R/W	0000_0000h	20.7.8/816
200_C020	Test Control Register (ECSPI2_TESTREG)	32	R/W	0000_0000h	20.7.9/818
200_C040	Message Data Register (ECSPI2_MSGDATA)	32	W	0000_0000h	20.7.10/819
201_0000	Receive Data Register (ECSPI3_RXDATA)	32	R	0000_0000h	20.7.1/806
201_0004	Transmit Data Register (ECSPI3_TXDATA)	32	W	0000_0000h	20.7.2/807
201_0008	Control Register (ECSPI3_CONREG)	32	R/W	0000_0000h	20.7.3/807
201_000C	Config Register (ECSPI3_CONFIGREG)	32	R/W	0000_0000h	20.7.4/810
201_0010	Interrupt Control Register (ECSPI3_INTREG)	32	R/W	0000_0000h	20.7.5/812
201_0014	DMA Control Register (ECSPI3_DMAREG)	32	R/W	0000_0000h	20.7.6/813
201_0018	Status Register (ECSPI3_STATREG)	32	R/W	0000_0003h	20.7.7/815
201_001C	Sample Period Control Register (ECSPI3_PERIODREG)	32	R/W	0000_0000h	20.7.8/816

Table continues on the next page...

ECSPI memory map (continued)

Absolute address (hex)	Register name	Width (in bits)	Access	Reset value	Section/page
201_0020	Test Control Register (ECSPI3_TESTREG)	32	R/W	0000_0000h	20.7.9/818
201_0040	Message Data Register (ECSPI3_MSGDATA)	32	W	0000_0000h	20.7.10/819
201_4000	Receive Data Register (ECSPI4_RXDATA)	32	R	0000_0000h	20.7.1/806
201_4004	Transmit Data Register (ECSPI4_TXDATA)	32	W	0000_0000h	20.7.2/807
201_4008	Control Register (ECSPI4_CONREG)	32	R/W	0000_0000h	20.7.3/807
201_400C	Config Register (ECSPI4_CONFIGREG)	32	R/W	0000_0000h	20.7.4/810
201_4010	Interrupt Control Register (ECSPI4_INTREG)	32	R/W	0000_0000h	20.7.5/812
201_4014	DMA Control Register (ECSPI4_DMAREG)	32	R/W	0000_0000h	20.7.6/813
201_4018	Status Register (ECSPI4_STATREG)	32	R/W	0000_0003h	20.7.7/815
201_401C	Sample Period Control Register (ECSPI4_PERIODREG)	32	R/W	0000_0000h	20.7.8/816
201_4020	Test Control Register (ECSPI4_TESTREG)	32	R/W	0000_0000h	20.7.9/818
201_4040	Message Data Register (ECSPI4_MSGDATA)	32	W	0000_0000h	20.7.10/819

20.7.1 Receive Data Register (ECSPiX_RXDATA)

The Receive Data register (ECSPI_RXDATA) is a read-only register that forms the top word of the 64 x 32 receive FIFO. This register holds the data received from an external SPI device during a data transaction. Only word-sized read operations are allowed.

Address: Base address + 0h offset

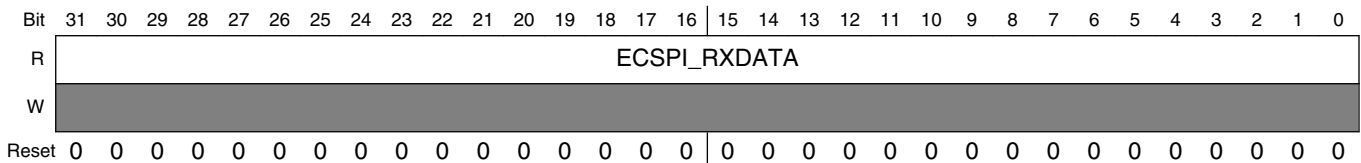

ECSPiX_RXDATA field descriptions

Field	Description
ECSPI_RXDATA	Receive Data. This register holds the top word of the receive data FIFO. The FIFO is advanced for each read of this register. The data read is undefined when the Receive Data Ready (RR) bit in the Interrupt Control/Status register is cleared. Zeros are read when ECSPI is disabled.

20.7.2 Transmit Data Register (ECSPIx_TXDATA)

The Transmit Data (ECSPI_TXDATA) register is a write-only data register that forms the bottom word of the 64 x 32 TXFIFO. The TXFIFO can be written to as long as it is not full, even when the SPI Exchange bit (XCH) in ECSPI_CONREG is set. This allows software to write to the TXFIFO during a SPI data exchange process. Writes to this register are ignored when the ECSPI is disabled (ECSPI_CONREG[EN] bit is cleared).

Address: Base address + 4h offset

Bit	31	30	29	28	27	26	25	24	23	22	21	20	19	18	17	16	15	14	13	12	11	10	9	8	7	6	5	4	3	2	1	0
R																																
W	ECSPI_TXDATA																															
Reset	0	0	0	0	0	0	0	0	0	0	0	0	0	0	0	0	0	0	0	0	0	0	0	0	0	0	0	0	0	0	0	0

ECSPIx_TXDATA field descriptions

Field	Description
ECSPI_TXDATA	Transmit Data. This register holds the top word of data loaded into the FIFO. Data written to this register must be a word operation. The number of bits actually transmitted is determined by the BURST_LENGTH field of the corresponding SPI Control register. If this field contains more bits than the number specified by BURST_LENGTH, the extra bits are ignored. For example, to transfer 10 bits of data, a 32-bit word must be written to this register. Bits 9-0 are shifted out and bits 31-10 are ignored. When the ECSPI is operating in Slave mode, zeros are shifted out when the FIFO is empty. Zeros are read when ECSPI is disabled.

20.7.3 Control Register (ECSPIx_CONREG)

The Control Register (ECSPI_CONREG) allows software to enable the ECSPI, configure its operating modes, specify the divider value, and SPI_RDY control signal, and define the transfer length.

Address: Base address + 8h offset

Bit	31	30	29	28	27	26	25	24	23	22	21	20	19	18	17	16
R																
W	BURST_LENGTH												CHANNEL_SELECT		DRCTL	
Reset	0	0	0	0	0	0	0	0	0	0	0	0	0	0	0	0
Bit	15	14	13	12	11	10	9	8	7	6	5	4	3	2	1	0
R																
W	PRE_DIVIDER				POST_DIVIDER				CHANNEL_MODE				SMC	XCH	HT	EN
Reset	0	0	0	0	0	0	0	0	0	0	0	0	0	0	0	0

ECSPiX_CONREG field descriptions

Field	Description
31–20 BURST_LENGTH	<p>Burst Length. This field defines the length of a SPI burst to be transferred. The Chip Select (SS) will remain asserted until all bits in a SPI burst are shifted out. A maximum of 2¹² bits can be transferred in a single SPI burst.</p> <p>In master mode, it controls the number of bits per SPI burst. Since the shift register always loads 32-bit data from transmit FIFO, only the n least-significant (n = BURST LENGTH + 1) will be shifted out. The remaining bits will be ignored.</p> <p>Number of Valid Bits in a SPI burst.</p> <p>0x000 A SPI burst contains the 1 LSB in a word. 0x001 A SPI burst contains the 2 LSB in a word. 0x002 A SPI burst contains the 3 LSB in a word. ... 0x01F A SPI burst contains all 32 bits in a word. 0x020 A SPI burst contains the 1 LSB in first word and all 32 bits in second word. 0x021 A SPI burst contains the 2 LSB in first word and all 32 bits in second word. ... 0xFFE A SPI burst contains the 31 LSB in first word and 2⁷ -1 words. 0xFFF A SPI burst contains 2⁷ words.</p>
19–18 CHANNEL_SELECT	<p>SPI CHANNEL SELECT bits. Select one of four external SPI Master/Slave Devices. In master mode, these two bits select the external slave devices by asserting the Chip Select (SSn) outputs. Only the selected Chip Select (SSn) signal can be active at a given time; the remaining three signals will be negated.</p> <p>00 Channel 0 is selected. Chip Select 0 (SS0) will be asserted. 01 Channel 1 is selected. Chip Select 1 (SS1) will be asserted. 10 Channel 2 is selected. Chip Select 2 (SS2) will be asserted. 11 Channel 3 is selected. Chip Select 3 (SS3) will be asserted.</p>
17–16 DRCTL	<p>SPI Data Ready Control. This field selects the utilization of the SPI_RDY signal in master mode. ECSPI checks this field before it starts an SPI burst.</p> <p>00 The $\overline{\text{SPI_RDY}}$ signal is a don't care. 01 Burst will be triggered by the falling edge of the SPI_RDY signal (edge-triggered). 10 Burst will be triggered by a low level of the SPI_RDY signal (level-triggered). 11 Reserved.</p>
15–12 PRE_DIVIDER	<p>SPI Pre Divider. ECSPI uses a two-stage divider to generate the SPI clock. This field defines the pre-divider of the reference clock.</p> <p>0000 Divide by 1. 0001 Divide by 2. 0010 Divide by 3. ... 1101 Divide by 14. 1110 Divide by 15. 1111 Divide by 16.</p>
11–8 POST_DIVIDER	<p>SPI Post Divider. ECSPI uses a two-stage divider to generate the SPI clock. This field defines the post-divider of the reference clock using the equation: 2ⁿ.</p> <p>0000 Divide by 1. 0001 Divide by 2.</p>

Table continues on the next page...

ECSPiX_CONREG field descriptions (continued)

Field	Description
	0010 Divide by 4. ... 1110 Divide by 2 ¹⁴ . 1111 Divide by 2 ¹⁵ .
7-4 CHANNEL_ MODE	SPI CHANNEL MODE selects the mode for each SPI channel. CHANNEL MODE[3] is for SPI channel 3. CHANNEL MODE[2] is for SPI channel 2. CHANNEL MODE[1] is for SPI channel 1. CHANNEL MODE[0] is for SPI channel 0. 0 Slave mode. 1 Master mode.
3 SMC	Start Mode Control. This bit applies only to channels configured in Master mode (CHANNEL MODE = 1). It controls how the ECSPI starts a SPI burst, either through the SPI exchange bit, or immediately when the TXFIFO is written to. 0 SPI Exchange Bit (XCH) controls when a SPI burst can start. Setting the XCH bit will start a SPI burst or multiple bursts. This is controlled by the SPI SS Wave Form Select (SS_CTL). Refer to XCH and SS_CTL descriptions. 1 Immediately starts a SPI burst when data is written in TXFIFO.
2 XCH	SPI Exchange Bit. This bit applies only to channels configured in Master mode (CHANNEL MODE = 1). If the Start Mode Control (SMC) bit is cleared, writing a 1 to this bit starts one SPI burst or multiple SPI bursts according to the SPI SS Wave Form Select (SS_CTL). The XCH bit remains set while either the data exchange is in progress, or when the ECSPI is waiting for an active input if SPIRDY is enabled through DRCTL. This bit is cleared automatically when all data in the TXFIFO and the shift register has been shifted out. 0 Idle. 1 Initiates exchange (write) or busy (read).
1 HT	Hardware Trigger Enable. This bit is used in master mode only. It enables hardware trigger (HT) mode. Note, HT mode is not supported by this product. 0 Disable HT mode. 1 Enable HT mode.
0 EN	SPI Block Enable Control. This bit enables the ECSPI. This bit must be set before writing to other registers or initiating an exchange. Writing zero to this bit disables the block and resets the internal logic with the exception of the ECSPiX_CONREG. The block's internal clocks are gated off whenever the block is disabled. 0 Disable the block. 1 Enable the block.

20.7.4 Config Register (ECSPiX_CONFIGREG)

The Config Register (ECSPI_CONFIGREG) allows software to configure each SPI channel, configure its operating modes, specify the phase and polarity of the clock, configure the Chip Select (SS), and define the HT transfer length. Note, HT mode is not supported by this product.

Address: Base address + Ch offset

Bit	31	30	29	28	27	26	25	24	23	22	21	20	19	18	17	16	15	14	13	12	11	10	9	8	7	6	5	4	3	2	1	0
R																																
W				Reserved					HT_LENGTH				SCLK_CTL				DATA_CTL				SS_POL			SS_CTL			SCLK_POL			SCLK_PHA		
Reset	0	0	0	0	0	0	0	0	0	0	0	0	0	0	0	0	0	0	0	0	0	0	0	0	0	0	0	0	0	0	0	0

ECSPiX_CONFIGREG field descriptions

Field	Description
31–29 -	This field is reserved. Reserved
28–24 HT_LENGTH	HT LENGTH. This field defines the message length in HT Mode. Note, HT mode is not supported by this product. The length in bits of one message is (HT LENGTH + 1).
23–20 SCLK_CTL	SCLK CTL. This field controls the inactive state of SCLK for each SPI channel. SCLK CTL[3] is for SPI channel 3. SCLK CTL[2] is for SPI channel 2. SCLK CTL[1] is for SPI channel 1. SCLK CTL[0] is for SPI channel 0. 0 Stay low. 1 Stay high.
19–16 DATA_CTL	DATA CTL. This field controls inactive state of the data line for each SPI channel. DATA CTL[3] is for SPI channel 3. DATA CTL[2] is for SPI channel 2. DATA CTL[1] is for SPI channel 1. DATA CTL[0] is for SPI channel 0. 0 Stay high. 1 Stay low.
15–12 SS_POL	SPI SS Polarity Select. In both Master and Slave modes, this field selects the polarity of the Chip Select (SS) signal. SS POL[3] is for SPI channel 3. SS POL[2] is for SPI channel 2. SS POL[1] is for SPI channel 1. SS POL[0] is for SPI channel 0.

Table continues on the next page...

ECSPiX_CONFIGREG field descriptions (continued)

Field	Description
	0 Active low. 1 Active high.
11–8 SS_CTL	<p>SPI SS Wave Form Select. In master mode, this field controls the output wave form of the Chip Select (SS) signal when the SMC (Start Mode Control) bit is cleared. The SS_CTL are ignored if the SMC bit is set.</p> <p>SS CTL[3] is for SPI channel 3. SS CTL[2] is for SPI channel 2. SS CTL[1] is for SPI channel 1. SS CTL[0] is for SPI channel 0.</p> <p>In slave mode, this bit controls when the SPI burst is completed.</p> <p>An SPI burst is completed by the Chip Select (SS) signal edges. (SSPOL = 0: rising edge; SSPOL = 1: falling edge) The RXFIFO is advanced whenever a Chip Select (SS) signal edge is detected or the shift register contains 32-bits of valid data.</p> <p>0 In master mode - only one SPI burst will be transmitted. 1 In master mode - Negate Chip Select (SS) signal between SPI bursts. Multiple SPI bursts will be transmitted. The SPI transfer will automatically stop when the TXFIFO is empty. 1 Reserved</p>
7–4 SCLK_POL	<p>SPI Clock Polarity Control. This field controls the polarity of the SCLK signal. See Figure 20-10 for more information.</p> <p>SCLK_POL[3] is for SPI channel 3. SCLK_POL[2] is for SPI channel 2. SCLK_POL[1] is for SPI channel 1. SCLK_POL[0] is for SPI channel 0.</p> <p>0 Active high polarity (0 = Idle). 1 Active low polarity (1 = Idle).</p>
SCLK_PHA	<p>SPI Clock/Data Phase Control. This field controls the clock/data phase relationship. See Figure 20-10 for more information.</p> <p>SCLK PHA[3] is for SPI channel 3. SCLK PHA[2] is for SPI channel 2. SCLK PHA[1] is for SPI channel 1. SCLK PHA[0] is for SPI channel 0.</p> <p>0 Phase 0 operation. 1 Phase 1 operation.</p>

20.7.5 Interrupt Control Register (ECSPIx_INTREG)

The Interrupt Control Register (ECSPI_INTREG) enables the generation of interrupts to the host processor. If the ECSPI is disabled, this register reads zero.

Address: Base address + 10h offset

Bit	31	30	29	28	27	26	25	24		23	22	21	20	19	18	17	16	
R	Reserved																	
W																		
Reset	0	0	0	0	0	0	0	0		0	0	0	0	0	0	0	0	0
Bit	15	14	13	12	11	10	9	8		7	6	5	4	3	2	1	0	
R	Reserved								TCEN	ROEN	RFEN	RDREN	RREN	TFEN	TDREN	TEEN		
W																		
Reset	0	0	0	0	0	0	0	0		0	0	0	0	0	0	0	0	

ECSPIx_INTREG field descriptions

Field	Description
31–8 -	This field is reserved. Reserved
7 TCEN	Transfer Completed Interrupt enable. This bit enables the Transfer Completed Interrupt. 0 Disable 1 Enable
6 ROEN	RXFIFO Overflow Interrupt enable. This bit enables the RXFIFO Overflow Interrupt. 0 Disable 1 Enable
5 RFEN	RXFIFO Full Interrupt enable. This bit enables the RXFIFO Full Interrupt. 0 Disable 1 Enable
4 RDREN	RXFIFO Data Request Interrupt enable. This bit enables the RXFIFO Data Request Interrupt when the number of data entries in the RXFIFO is greater than RX_THRESHOLD. 0 Disable 1 Enable
3 RREN	RXFIFO Ready Interrupt enable. This bit enables the RXFIFO Ready Interrupt. 0 Disable 1 Enable

Table continues on the next page...

ECSPIx_INTREG field descriptions (continued)

Field	Description
2 TFEN	TXFIFO Full Interrupt enable. This bit enables the TXFIFO Full Interrupt. 0 Disable 1 Enable
1 TDREN	TXFIFO Data Request Interrupt enable. This bit enables the TXFIFO Data Request Interrupt when the number of data entries in the TXFIFO is less than or equal to TX_THRESHOLD. 0 Disable 1 Enable
0 TEEN	TXFIFO Empty Interrupt enable. This bit enables the TXFIFO Empty Interrupt. 0 Disable 1 Enable

20.7.6 DMA Control Register (ECSPIx_DMAREG)

The Direct Memory Access Control Register (ECSPI_DMAREG) provides software a way to use an on-chip DMA controller for ECSPI data. Internal DMA request signals enable direct data transfers between the ECSPI FIFOs and system memory. The ECSPI sends out DMA requests when the appropriate FIFO conditions are matched.

If the ECSPI is disabled, this register is read as 0.

Address: Base address + 14h offset

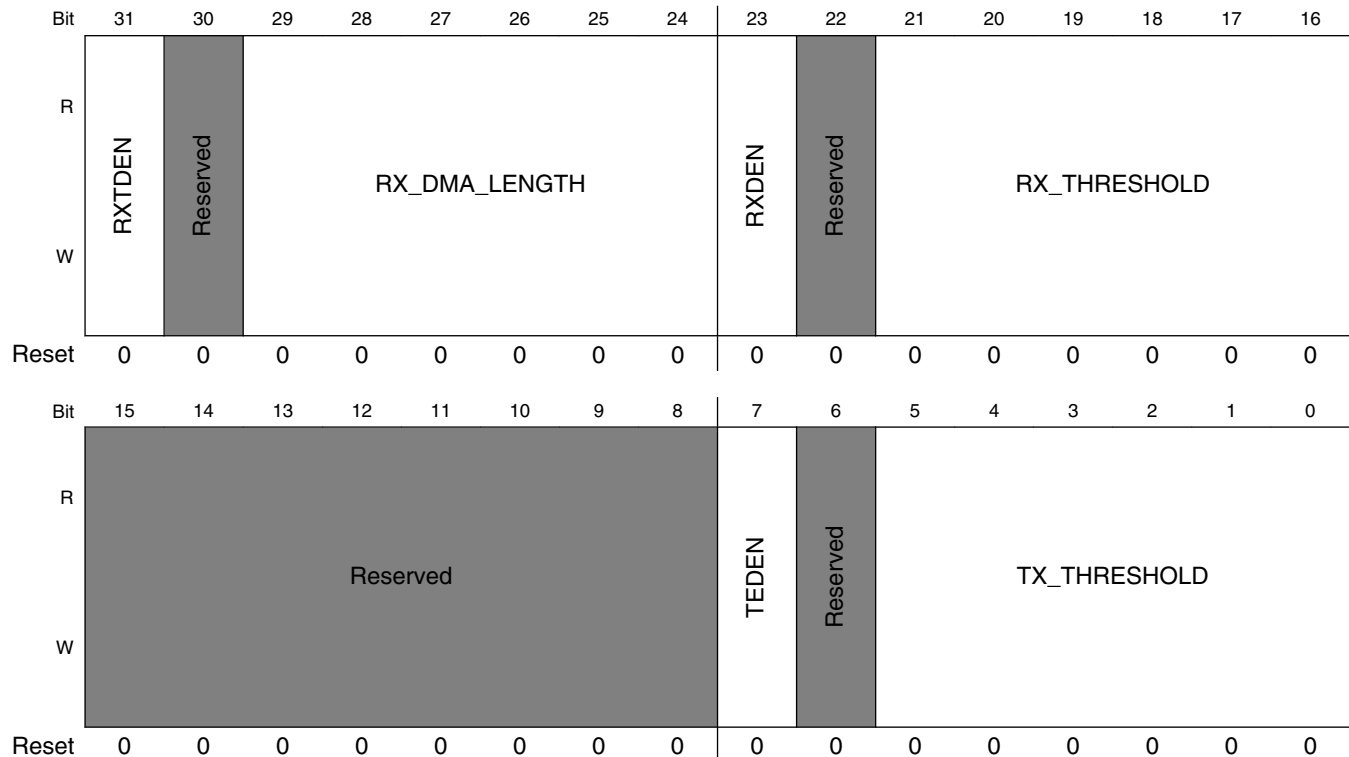

ECSPi_x_DMAREG field descriptions

Field	Description
31 RXTDEN	RXFIFO TAIL DMA Request/Interrupt Enable. This bit enables an internal counter that is increased at each read of the RXFIFO. This counter is cleared automatically when it reaches RX DMA LENGTH. If the number of words remaining in the RXFIFO is greater than or equal to RX DMA LENGTH, a DMA request/interrupt is generated even if it is less than or equal to RX_THRESHOLD. 0 Disable 1 Enable
30 -	This field is reserved. Reserved
29–24 RX_DMA_LENGTH	RX DMA LENGTH. This field defines the burst length of a DMA operation. Applies only when RXTDEN is set.
23 RXDEN	RXFIFO DMA Request Enable. This bit enables/disables the RXFIFO DMA Request. 0 Disable 1 Enable
22 -	This field is reserved. Reserved
21–16 RX_THRESHOLD	RX THRESHOLD. This field defines the FIFO threshold that triggers a RX DMA/INT request. A RX DMA/INT request is issued when the number of data entries in the RXFIFO is greater than RX_THRESHOLD.
15–8 -	This field is reserved. Reserved
7 TEDEN	TXFIFO Empty DMA Request Enable. This bit enables/disables the TXFIFO Empty DMA Request. 0 Disable 1 Enable
6 -	This field is reserved. Reserved
TX_THRESHOLD	TX THRESHOLD. This field defines the FIFO threshold that triggers a TX DMA/INT request. A TX DMA/INT request is issued when the number of data entries in the TXFIFO is not greater than TX_THRESHOLD.

20.7.7 Status Register (ECSPiX_STATREG)

The ECSPI Status Register (ECSPiX_STATREG) reflects the status of the ECSPI's operating condition. If the ECSPI is disabled, this register reads 0x0000_0003.

Address: Base address + 18h offset

Bit	31	30	29	28	27	26	25	24	23	22	21	20	19	18	17	16
R	Reserved															
W	Reserved															
Reset	0	0	0	0	0	0	0	0	0	0	0	0	0	0	0	0
Bit	15	14	13	12	11	10	9	8	7	6	5	4	3	2	1	0
R	Reserved								TC	RO	RF	RDR	RR	TF	TDR	TE
W	Reserved								w1c	w1c						
Reset	0	0	0	0	0	0	0	0	0	0	0	0	0	0	1	1

ECSPiX_STATREG field descriptions

Field	Description
31–8 -	This field is reserved. Reserved
7 TC	Transfer Completed Status bit. Writing 1 to this bit clears it. 0 Transfer in progress. 1 Transfer completed.
6 RO	RXFIFO Overflow. When set, this bit indicates that RXFIFO has overflowed. Writing 1 to this bit clears it. 0 RXFIFO has no overflow. 1 RXFIFO has overflowed.
5 RF	RXFIFO Full. This bit is set when the RXFIFO is full. 0 Not Full. 1 Full.
4 RDR	RXFIFO Data Request. 0 When RXTDE is set - Number of data entries in the RXFIFO is not greater than RX_THRESHOLD. 1 When RXTDE is set - Number of data entries in the RXFIFO is greater than RX_THRESHOLD or a DMA TAIL DMA condition exists. 0 When RXTDE is clear - Number of data entries in the RXFIFO is not greater than RX_THRESHOLD. 1 When RXTDE is clear - Number of data entries in the RXFIFO is greater than RX_THRESHOLD.
3 RR	RXFIFO Ready. This bit is set when one or more words are stored in the RXFIFO. 0 No valid data in RXFIFO. 1 More than 1 word in RXFIFO.
2 TF	TXFIFO Full. This bit is set when if the TXFIFO is full.

Table continues on the next page...

ECSPiX_STATREG field descriptions (continued)

Field	Description
	0 TXFIFO is not Full. 1 TXFIFO is Full.
1 TDR	TXFIFO Data Request. 0 Number of valid data slots in TXFIFO is greater than TX_THRESHOLD. 1 Number of valid data slots in TXFIFO is not greater than TX_THRESHOLD.
0 TE	TXFIFO Empty. This bit is set if the TXFIFO is empty. 0 TXFIFO contains one or more words. 1 TXFIFO is empty.

20.7.8 Sample Period Control Register (ECSPiX_PERIODREG)

The Sample Period Control Register (ECSPI_PERIODREG) provides software a way to insert delays (wait states) between consecutive SPI transfers. Control bits in this register select the clock source for the sample period counter and the delay count indicating the number of wait states to be inserted between data transfers.

The delay counts apply only when the current channel is operating in Master mode (ECSPI_CONREG[CHANNEL MODE] = 1). ECSPiX_PERIODREG also contains the CSD CTRL field used to insert a delay between the Chip Select's active edge and the first SPI Clock edge.

Address: Base address + 1Ch offset

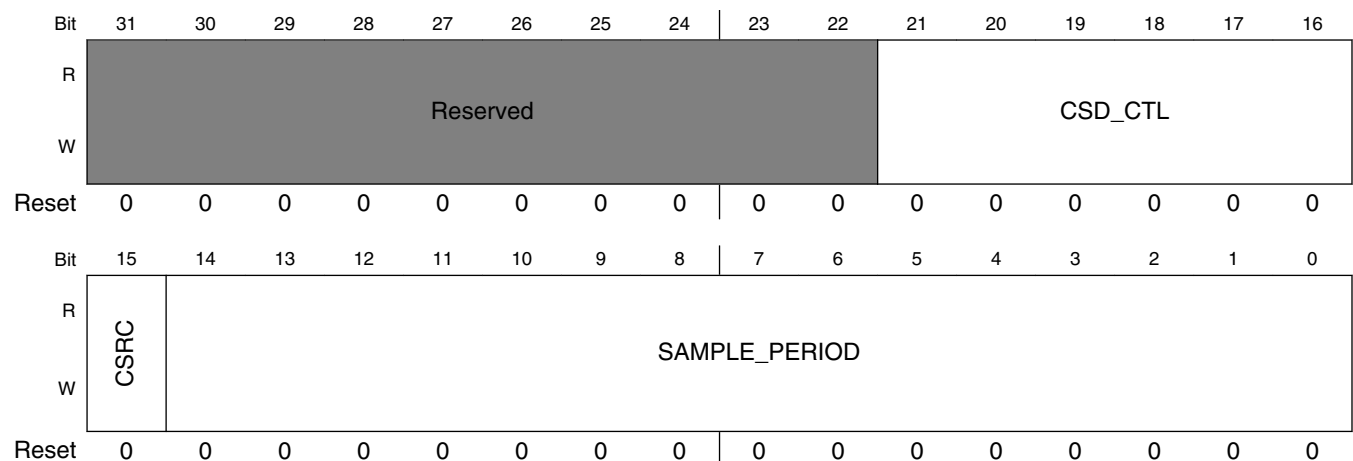

ECSPiX_PERIODREG field descriptions

Field	Description
31-22 -	This field is reserved. Reserved

Table continues on the next page...

ECSPi_x_PERIODREG field descriptions (continued)

Field	Description
21–16 CSD_CTL	Chip Select Delay Control bits. This field defines how many SPI clocks will be inserted between the chip select's active edge and the first SPI clock edge. The range is from 0 to 63.
15 CSRC	Clock Source Control. This bit selects the clock source for the sample period counter. 0 SPI Clock (SCLK) 1 Low-Frequency Reference Clock (32.768 KHz)
SAMPLE_ PERIOD	Sample Period Control. These bits control the number of wait states to be inserted in data transfers. During the idle clocks, the state of the SS output will operate according to the SS_CTL control field in the ECSPi _x _CONREG register. 0x0000 0 wait states inserted 0x0001 1 wait state inserted 0x7FFE 32766 wait states inserted 0x7FFF 32767 wait states inserted

20.7.9 Test Control Register (ECSPIx_TESTREG)

The Test Control Register (ECSPI_TESTREG) provides software a mechanism to internally connect the receive and transmit devices of the ECSPI, and monitor the contents of the receive and transmit FIFOs.

Address: Base address + 20h offset

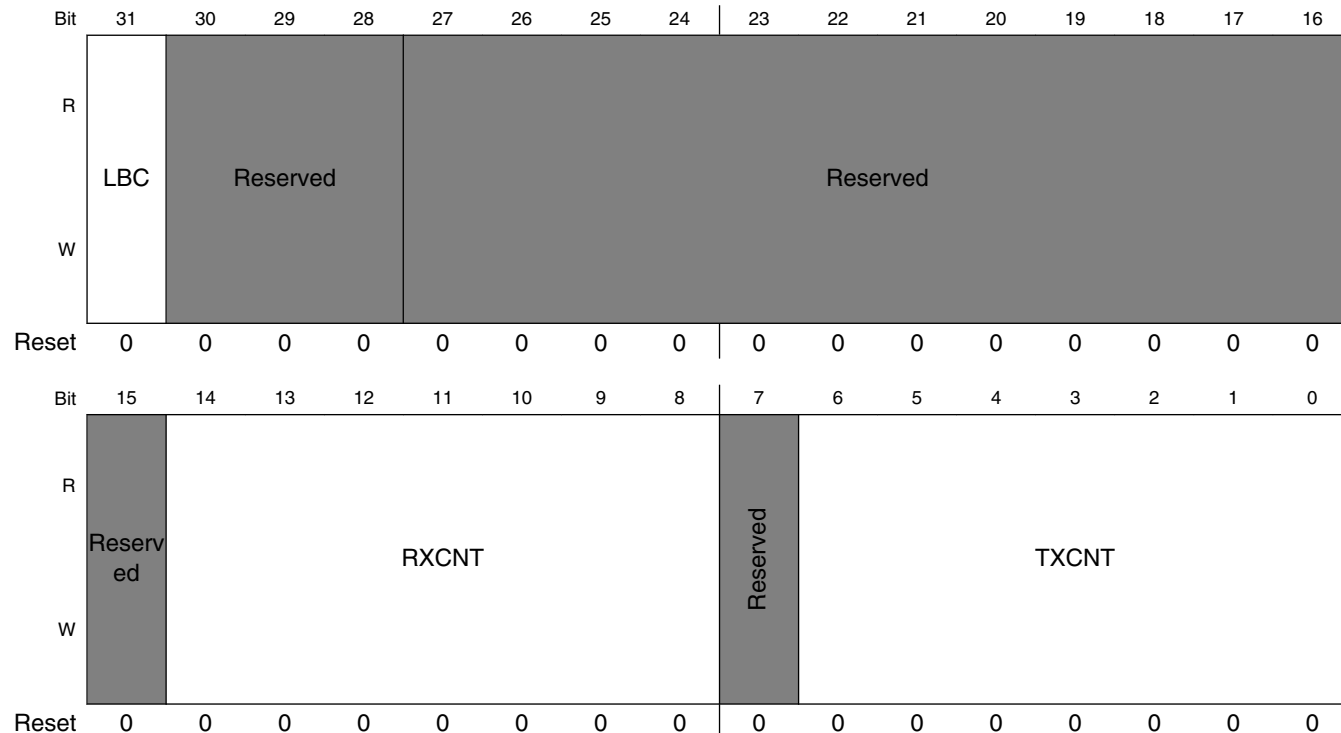

ECSPIx_TESTREG field descriptions

Field	Description
31 LBC	Loop Back Control. This bit is used in Master mode only. When this bit is set, the ECSPI connects the transmitter and receiver sections internally, and the data shifted out from the most-significant bit of the shift register is looped back into the least-significant bit of the Shift register. In this way, a self-test of the complete transmit/receive path can be made. The output pins are not affected, and the input pins are ignored. 0 Not connected. 1 Transmitter and receiver sections internally connected for Loopback.
30–28 -	This field is reserved. Reserved, all bits should be ignored.
27–15 -	This field is reserved. Reserved
14–8 RXCNT	RXFIFO Counter. This field indicates the number of words in the RXFIFO.

Table continues on the next page...

ECSPi_x_TESTREG field descriptions (continued)

Field	Description
7 -	This field is reserved. Reserved
TXCNT	TXFIFO Counter. This field indicates the number of words in the TXFIFO.

20.7.10 Message Data Register (ECSPi_x_MSGDATA)

The Message Data Register (ECSPi_x_MSGDATA) forms the top word of the 16 x 32 MSG Data FIFO. Only word-size accesses are allowed for this register. Reads to this register return zero, and writes to this register store data in the MSG Data FIFO.

Address: Base address + 40h offset

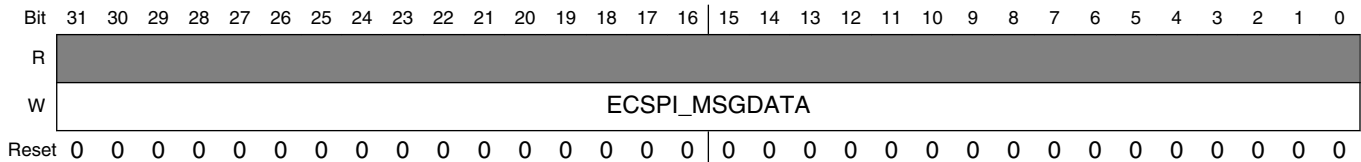
**ECSPi_x_MSGDATA field descriptions**

Field	Description
ECSPi _x _MSGDATA	ECSPi _x _MSGDATA holds the top word of MSG Data FIFO. The MSG Data FIFO is advanced for each write of this register. The data read is zero. The data written to this register is stored in the MSG Data FIFO.

Chapter 21

External Interface Module (EIM)

21.1 Overview

The EIM handles the interface to devices external to the chip, including generation of chip selects, clock and control for external peripherals and memory. It provides asynchronous access to devices with SRAM-like interface and synchronous access to devices with NOR-Flash-like or PSRAM-like interface.

Overview

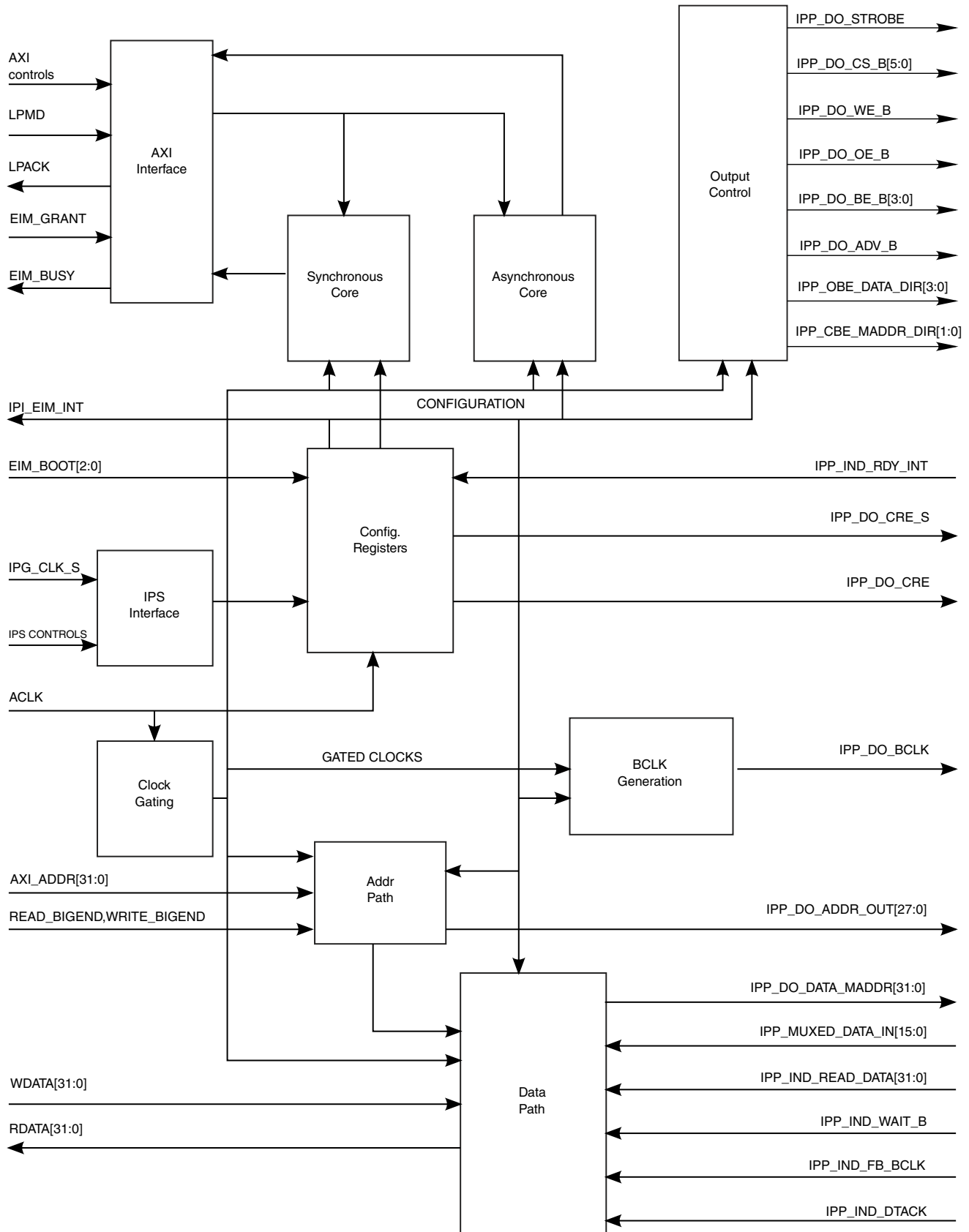

Figure 21-1. EIM Diagram

21.1.1 Features

- Six chip selects for external devices
 - Flexible address decoding. Each chip select memory space determined separately, according to VIA port configuration (see [Chip Select Memory Map](#)). Configurable Chip Select 0 base address (by VIA)
 - Individual select signal for each one of the memory space defined. Up to 6 memory spaces may be defined and programmed individually.
 - 128 MByte maximum supported density by default (AUS bit is cleared). When the AUS bit is set, maximum supported density is 32 MBytes.
- Selectable Write Protection for each Chip Select
- Support for multiplexed address / data bus operation x16 port size
- Programmable Data Port Size for each Chip Select (x8, x16)
- Programmable Wait-State generator for each Chip Select, for write and read accesses separately
- Asynchronous accesses with programmable setup and hold times for control signals
- Support for Asynchronous page mode accesses (x16 port size)
- Independent synchronous Memory Burst Read Mode support for NOR-Flash and PSRAM memories (x16 port size)
- Independent synchronous Memory Burst Write Mode support for PSRAM and NOR-Flash like memories (CellularRAM™ from Micron, Infineon, and Cypress, OneNAND™ and utRAM™ from Samsung, and COSMORAM™ from Toshiba)
- Support of NAND-Flash devices with NOR-Flash like interface - MDOC™ (M-Systems), OneNAND™ (Samsung)
- Independent programmable variable/fix Latency support for read and write synchronous (burst) mode
- Support for Big Endian and Little Endian operation modes per access
- Arm AXI slave interface. One ID at a time support.

21.1.2 Modes of Operation

The EIM has the following modes of operation:

- Asynchronous Mode
- Asynchronous Page Mode
- Multiplexed Address/Data mode
- Burst Clock Mode
- Low Power Modes
- Boot Mode

See details in the [EIM Operational Modes](#).

21.1.2.1 Asynchronous Mode

This is a non-burst mode that is used for SRAM access. In this mode, a single data is read/written with each access (asserted address).

All controls' timings are controlled by preset values in Chip Select Configuration Registers.

21.1.2.2 Asynchronous Page Read Mode

Setting the APR bit causes the EIM to perform memory burst accesses by emulating page mode operation.

The external address asserts for each piece of data. The initial access timing is according to RWSC field, and the next address assertions timing is according to PAT field. When APR bit is set, RCSN OEN, RADVN and RBEN fields are ignored for burst access to the external device.

The page size can be set via the BL field to 2, 4, 8, 16, or 32 words (the word size is determined by the DSZ field).

21.1.2.3 Multiplexed Address/Data Mode

In this mode, multiplexing addresses and data bits on the same pins is supported for synchronous/asynchronous accesses to x8/x16 data width memory devices.

For more information about the pins that drive data/address in 8/16 non-muxed mode and 16 muxed mode, see the following table.

Table 21-1. EIM Multiplexing

Setup	Non Multiplexed Address/Data Mode						Multiplexed Address/Data Mode
	8-Bit				16-Bit		16 Bit
	NUM = 0, DSZ = 100	NUM = 0, DSZ = 101	NUM = 0, DSZ = 110	NUM = 0, DSZ = 111	NUM = 0, DSZ = 001	NUM = 0, DSZ = 010	NUM = 1, DSZ = 001
EIM_ADDR[15:0]	EIM_AD[15:0]	EIM_AD[15:0]	EIM_AD[15:0]	EIM_AD [15:0]	EIM_AD[15:0]	EIM_AD[15:0]	EIM_AD[15:0]
EIM_ADDR[26:16]	EIM_ADDR[26:16]	EIM_ADDR[26:16]	EIM_ADDR[26:16]	EIM_ADDR[26:16]	EIM_ADDR[26:16]	EIM_ADDR[26:16]	EIM_ADDR[26:16]

Table continues on the next page...

Table 21-1. EIM Multiplexing (continued)

Setup	Non Multiplexed Address/Data Mode						Multiplexed Address/Data Mode
	8-Bit				16-Bit		16 Bit
	NUM = 0, DSZ = 100	NUM = 0, DSZ = 101	NUM = 0, DSZ = 110	NUM = 0, DSZ = 111	NUM = 0, DSZ = 001	NUM = 0, DSZ = 010	NUM = 1, DSZ = 001
EIM_DATA[07:00], EIM_EB0_B	EIM_DATA[07:00]	-	Reserved	Reserved	EIM_DATA[07:00]	Reserved	EIM_AD[07:00]
EIM_DATA[15:8], EIM_EB1_B	-	EIM_DATA[15:08]	Reserved	Reserved	EIM_DATA[15:08]	Reserved	EIM_A[15:08]

21.1.2.4 Burst Clock Mode

The controller has the ability to support burst synchronous operations in various frequencies, depending on the frequency of the input clock supplied by the system (EIM clock).

The EIM clock can be divided by one, two, three or four, and its frequency can be changed according to the requirements. Variable and fix latency are supported for this mode, according to the external device requirements.

- Synchronous read mode. This is a burst mode, which is used for reading from Flash/PSRAM memory devices. In this mode, after address assertion a burst of sequential data can be read. Data exchange is carried out according to BCLK being generated by EIM. An access is delayed according to external WAIT_B signal assertion (signal from the memory device).
- Synchronous write mode. A burst mode used for accessing external devices, which support synchronous write type of access (PSRAM protocol). In this mode, after address assertion a burst of sequential data can be written to the external device. Access may be delayed according to WAIT_B signal assertion (signal from the memory device) before first piece of data arrived to the external device.

NOTE

Maximum frequency of the EIM main clock is 133 MHz. It may be reduced by the system for special cases of external devices, which demand a different frequency then integer division of the 133 MHz clock.

21.1.2.5 Low Power Modes

The input clock is gated by ACT_CS bits. When all the ACT_CS are negated (all CS disable) the internal clock is turned off; awready/wready & arready signal are de-asserted and the master can't access the EIM.

21.1.2.6 Boot Mode

It is possible to perform a boot operation from external device located on CS0. The configuration of the relevant bits are done with boot mode signals according to the external device parameters (for example, port size and protocol assertion).

See for more details.

21.2 External Signals

The following table describes the external signals of EIM:

21.2.1 Other Important Block I/O Signals Internal to the SoC

The following table provides a description of other signals internal to the chip that are important in understanding the function of EIM.

Table 21-2. EIM Important Internal Signals

Name	I/O	Description
EIM_FB_BCLK	Input	Burst Clock Feedback. This block input is used to sample read data during high transfer speeds. The signal provides feedback from the I/O pad of the BCLK output pin and tends to align more closely with data from the external memory device.
EIM_BOOT	Input	EIM Boot Configuration. These block inputs determine the reset state of DSZ[1:0] and MUM.
ACLK	Input	AXI clock, maximum frequency 133 Mhz
IPG_CLK_S	Input	EIM module IPG clock
RST_B	Input	Active low HW reset
EIM_WARM_RESET	Input	Warm Reset. If this signal is asserted the rst_b will reset only the internal FF and state machine while S/W registers will keep their current state. This signal is active high signal.

21.3 Clocks

The following table describes the clock sources for EIM. Please see [Clock Controller Module \(CCM\)](#) for clock setting, configuration and gating information.

Table 21-3. EIM Clocks

Clock name	Clock Root	Description
aclk	aclk_eim_slow_clk_root	EIM clock (main)
aclk_slow	aclk_eim_slow_clk_root	EIM clock (slow)
ipg_clk_s	ipg_clk_root	Peripheral access clock
aclk_exsc	aclk_eim_slow_clk_root	EIM clock (external device)

- **ACLK:** EIM clock (main clock, AXI clock) with a Max frequency of 133 MHz. Can be gated externally when there is no active AXI access.
- **ACLK_SLOW:** EIM all time running ACLK. Used for flip-flops that must be active even when EIM is in low power down mode to provide clock for lpack/lpmd registers, IP registers and IP to AXI sync registers.
- **IPG_CLK_S:** IPG clock for IP accesses. IP registers are activated by ACLK_SLOW clock.
- **ACLK_EXSC:** Clock created from EIM clock for External device usage. Integer division by 1, 2, 3 and 4 of the clock can be use with BCD bit field configuration, according to external devices demands. EIM clock frequency may be reduced for lower frequency support which cannot be achieved via BCD bit field.

21.4 Chip Select Memory Map

The EIM memory space is mapped into 128 MB total memory space in the processor memory. For addresses, see the System memory map table and the CM4 memory map table. The total 128 MB of memory can be divided among the EIM four chip selects. The memory configuration across the chip selects is controlled by the IOMUXC_GPR1 register. The ADDRSn[10] fields control how much memory is allotted to each chip select.

The following four configurations are supported:

- CS0 (128 MB), CS1 (0 MB), CS2 (0 MB), CS3 (0 MB) [default configuration]
- CS0 (64 MB), CS1 (64 MB), CS2 (0 MB), CS3 (0 MB)
- CS0 (64 MB), CS1 (32 MB), CS2 (32 MB), CS3 (0 MB)
- CS0 (32 MB), CS1 (32 MB), CS2 (32 MB), CS3 (32 MB)

21.5 Functional Description

This section provides the functional description for the EIM.

21.5.1 Bus Sizing Configuration

The EIM supports byte, half word and word operands allowing access to x8, x16, x32 ports. It can be address/data multiplexed in x16, x32 ports. The port size is programmable via the DSZ bit field in the corresponding Chip Select Configuration Register. An 8-bit port can reside in each one of the bytes of the data bus. A 16-bit port can reside on the lower 16 bits of the data bus, DATA_IN/OUT[15:0] or on the higher 16 bits of the data bus, DATA_IN/OUT[31:16].

In the case of a multi-cycle transfer, the lower two address bits (ADDR[1:0]) are incremented appropriately. The EIM address bus is configured according to DSZ bit field and AUS bits. There is either one bit (for x16 port size) or two bits (for x32 port size) right shift of the address bits (only when AUS=0) and no bit shift when AUS = 1 or DSZ[2] = 1.

The EIM has a data multiplexer which takes the four bytes of the AXI data bus and routes them to their required positions to properly interface to memory.

NOTE

A word access to or from a x16 port requires two external bus cycles to complete the transfer.

A word access to or from a x8 port requires four external bus cycles to complete the transfer.

21.5.1.1 8 BIT PORT SUPPORT

EIM has limited support for mot68000 & intel 386 protocols.

21.5.1.1.1 MOTOROLA 68000

EIM has limited support for mot68000 protocol. Only basic read or write asynchronous operations are supported.

The following operations are not supported:

- Read modify write

- Sync access
- All special accesses (Arm platform space, bus arbitration, bus control, bus error & reset operations)
- FC outputs

21.5.1.1.2 INTEL 386

EIM has limited support for intel 386 protocol. Only basic read or write async non-pipelined operations are supported.

The following operations are not supported:

- Other bus cycles (interrupt, halt & refresh)
- Bus lock
- M/IO, DC, LBA, NA, REFRESH & BS8 signals

21.5.2 EIM Operational Modes

Listed here are the main operational modes for EIM selected by control bit fields settings.

For details, see the bit field descriptions of SWR / SRD / MUM. All modes are supported in with 8-, 16- or 32-bit port configuration, according to DSZ bit field.

Table 21-4. EIM Operation Modes Field Settings

Control bit fields			Brief mode description
MUM	SRD	SWR	
0	0	0	Asynchronous write / Asynchronous read for APR=0 / Asynchronous page read for APR=1, none multiplexed
		1	Synchronous write/ Asynchronous read or APR=0 / Asynchronous page read for APR=1,none multiplexed
	1	0	Asynchronous write/Synchronous read none multiplexed
		1	Synchronous write/read none multiplexed
1	0	0	Asynchronous write/read multiplexed
		1	Synchronous write/ Asynchronous read multiplexed
	1	0	Asynchronous write/Synchronous read multiplexed
		1	Synchronous write/read multiplexed

21.5.3 Burst Mode (Synchronous) Memory Operation

This mode is enabled for read or write access. Bit SWR sets the burst mode for write operations at the corresponding chip select and bit SRD sets it for read operation.

When this mode is set, the controller attempts to translate the Master burst accesses to memory burst accesses, being limited by the memory burst length, predefined by BL value, or memory and Master WRAP/INCR boundary crossing non-matching. Only the first address accessed is put by the controller on the external address bus in a memory burst sequence.

EIM may translate from some Master sequential accesses to one or several memory bursts, but not from two Master individual accesses to one memory burst.

For the first access in a memory burst sequence, the EIM asserts \overline{ADV} , causing the external burst device to latch the starting burst address; then toggle the burst clock (BCLK) for a predefined number of cycles in order to latch the first unit of data. Subsequent accessed data units can then be burst in fewer clock cycles, realizing an overall increase in bus bandwidth.

NOTE

The BCLK signal toggles only when burst access is executed toward the external device (BCM=1'b0 for normal mode use). It runs with a 50% duty cycle until the end of access is reached. When access is terminated, BCLK stops toggling.

Memory burst accesses are terminated by the EIM whenever it detects the following:

- The specific burst length has executed completely (end of access)
- Write access - missing data in write buffer (Master is delaying the data transfer toward the EIM)
- Next sequential access crosses boundary with unequal condition (wrap/increment, burst length) on the Master and memory
- Current memory burst length reached

21.5.4 Burst Clock Divisor (BCD)

In some cases, it may be necessary to slow the external bus in relation to the internal bus to allow accesses to burst devices that have a maximum operating frequency less than the operating frequency of the internal bus.

The internal bus frequency can be divided by one, two, three or four for presentation on the external bus in burst mode operation.

BCLK can only be set to integer divisions of the incoming clock frequency. To get a specific frequency on BCLK, configure the divider to change the incoming EIM clock accordingly.

By programming the BCD bit field to various values, two signals on the external bus are affected; \overline{ADV} and BCLK. The \overline{ADV} signal is asserted according to RADVA or WADVA bit fields programming, and is negated according to the formula mentioned in RADVN and WADVN bit fields description. The BCLK signal runs with a 50% duty cycle until the end of access is reached.

If BCM = 1, the BCLK runs at frequency according to GBCD bit field settings on every async memory access, regardless of the SWR and SRD bits configuration. Caution should be exercised when using BCM bit; GBCD bit field should be updated once and should not change when BCLK is toggling. The BCM bit is used mainly for system debug mode. It has no functional use of the EIM in normal mode.

21.5.5 Burst Clock Start (BCS)

In an effort to allow greater flexibility in achieving the minimum number of wait states on burst accesses, you can determine when you want the BCLK to start toggling after the start of access. This allows the BCLK to be skewed from point of data capture on the EIM clock by any number of EIM clock cycles.

Care must be exercised when setting BCS bit field in conjunction with the BCD and RWSC/WWSC bit fields. See the external timing diagrams in [Burst \(Synchronous Mode\) Read Memory Accesses Timing Diagram - BCD=1](#) and [Burst \(Synchronous Mode\) Read Memory Accesses Timing Diagram - BCD=0](#) for examples of how to use the BCS, BCD and RWSC/WWSC bit fields together.

21.5.6 Multiplexed Address/Data Mode Support

The control bit MUM allows support memory with multiplexed address/data bus both in asynchronous and in synchronous modes.

Caution should be exercised for using OEA/WEA & ADH bit fields. They should be configured according to the external device requirements, as it determines the time point of end of address phase and start of data phase.

21.5.7 Mixed Master/Memory Burst Modes Support

To provide mixed sequential/wrap accesses with different length, EIM interprets burst signal and generate additional \overline{ADV} signals whenever there appear unequal address or burst boundary crossing condition.

BL bit field is used to notify EIM about current memory burst and wrap condition for properly external address generation. In case of non-matching boundaries in both the memory and Master access, EIM starts a new memory burst access by updating address from Master on address bus and generating \overline{ADV} signal.

21.5.8 AXI (Master) Bus Cycles Support

The EIM uses an Arm AXI slave interface. It has a 32-bit bus and supports one access (one ID) at a time. No out of order or parallel accesses are supported.

The following AXI protocol signals are not supported:

- AWLOCK
- AWCACHE
- ARLOCK
- ARCACHE

ARID bus is sampled when:

- new read access is valid on the read address channel and is reflected on the RID bus output toward the master.

AWID bus is sampled when:

- new write access is valid on the write address channel and is reflected on the WID/BID bus output toward the master.

ARPROT and AWPROT signal are partially used. ARPROT[0] and AWPROT[0] bits are used for normal/privileged access detection. ARPROT[2:1] and AWPROT[2:1] are not used.

When sampling a valid access on both of the address channels, the read access will be performed first while write access is pending. After last data transfer completed, the pending write will be executed.

A new access may be executed one cycle after sampling a valid access on the read or write address channels, assuming there is no current access (back to back) which can cause a recovery or end of access penalty cycles, for write access, also assuming data is in write buffer for fast execution.

NOTE

- Only 32-bit word size accesses are supported for burst mode accesses.
- Only 8-bit (1 byte), 16-bit (2 byte) and 32-bit (4 byte) word size supported for single access.
- Maximum number of burst length is 16.
- According to AXI protocol, burst access should not cross 4 KB blocks. In case EIM gets an access that crosses the 4 KB, memory address calculation is invalid.

AXI transfers shown in the table below are also supported. These AXI cycles will be translated into the necessary cycles on the memory side. For example, for optimal operation in case Arm cache is configured to 8 beat burst with wrap, a synchronous flash and cellular RAM memory should be configured in 16 word wrap burst mode when using a 16-bit data port, and in 8 word wrap burst mode when using a 32-bit data port. EIM uses BL bit field to support different memory configurations. The controller splits the transaction when needed in some cases. See [Table 21-6](#).

Table 21-5. AXI Burst Cycles Supported

Burst Length - Number of data transfers	Burst size - Bytes in transfer	Burst type	Description
1	1	INCR	Single transfer
1	2	INCR	Single transfer
1	4	INCR	Single transfer
2	4	WRAP	2-beat wrapping burst
4	4	WRAP	4-beat wrapping burst
8	4	WRAP	8-beat wrapping burst
16	4	WRAP	16-beat wrapping burst
2	4	INCR	2-beat incrementing burst
3	4	INCR	3-beat incrementing burst
4	4	INCR	4-beat incrementing burst
5	4	INCR	5-beat incrementing burst
6	4	INCR	6-beat incrementing burst
7	4	INCR	7-beat incrementing burst
8	4	INCR	8-beat incrementing burst
9	4	INCR	9-beat incrementing burst
10	4	INCR	10-beat incrementing burst
11	4	INCR	11-beat incrementing burst
12	4	INCR	12-beat incrementing burst
13	4	INCR	13-beat incrementing burst
14	4	INCR	14-beat incrementing burst

Table continues on the next page...

Table 21-5. AXI Burst Cycles Supported (continued)

Burst Length - Number of data transfers	Burst size - Bytes in transfer	Burst type	Description
15	4	INCR	15-beat incrementing burst
16	4	INCR	16-beat incrementing burst

Table 21-6. AXI to Memory Burst Splits Number

AXI Burst Type	Memory Burst Type Config.	# of accesses to X8 Memory Port size	# of accesses to X16 Memory Port size	# of accesses to X32 Memory Port size
INC16 Aligned Addr.	WRAP4	16	8	4
	Cont.	1	1	1
INC16 Unaligned Addr.	WRAP4	17	9	5
	Cont.	1	1	1
WRAP16 Aligned Addr.	WRAP16	4	2	1
	Cont.	1	1	1
WRAP16 Unaligned Addr.	WRAP16	5	3	1
	Cont.	2	2	2
INC8 Aligned Addr.	WRAP8	4	2	1
	WRAP16	2	1	1
INC8 Unaligned Addr.	WRAP8	4 or 5	2 or 3	2
	WRAP16	2 or 3	2	1 or 2
WRAP8 Aligned Addr.	WRAP16	2	1	1
	Cont.	1	1	1
WRAP8 Unaligned Addr.	WRAP16	2 or 3	1	2
	Cont.	2	2	2

21.5.9 WAIT_B Signal, RWSC and WWSC bit fields Usage

Most of the external devices supporting burst mode for write or read accesses provide a signal which indicates data is valid on the memory bus (a.k.a. handshake mode). For this mode, RFL and WFL bits should be cleared and RWSC/ WWSC bit fields indicate when the controller should start sampling this signal from the external device or, in other words, how many BCLK cycles should be masked.

For devices which do not use this signal or have a fixed latency ability, the RFL and WFL bits may be set for internal calculation regarding BCLK cycles penalty until data is valid (memory initial access time). For this mode, RWSC/ WWSC indicates when the data is ready for sampling by the controller (read access) or the external device (write

access). There is separation between read and write accesses wait-state control. For read access, RWSC bit field is valid and WWSC bit field is ignored; for write access, WWSC is valid and RWSC is ignored.

21.5.10 IPS Register Interface

Access to the registers of the EIM, read or write, is made with IPS protocol signals. The system should avoid changing the registers while master/memory transaction is valid, as this can cause an unknown behavior of the controller.

Register access size is 32-bit as the register size definition, other size of access (byte or half word) is not supported.

21.5.11 MRS Set for PSRAM

Memory registers of PSRAM devices can be configured according to external signal, which indicates whether the access is to a memory array or memory register domain.

When the CRE bit is set, the following transactions to the external device will assert the CRE signal. The polarity of this signal is determined by the CREP bit for active low or active high assertion of the signal.

21.5.12 EIM Access Termination

EIM is monitoring the corresponding CSx control signal every time variable latency access or dtack access is performed toward the external device.

In variable latency accesses, the Watchdog Timer (WDOG-1) counts BCLK cycles. If it reaches the wdog_limit (according to the WDOG_LIMIT bit field in the WCR) before the device signals can drive/sample new data, the controller will terminate the access and generate an error response transfer toward the Master.

In dtack access, WDOG-1 counts ACLK cycles instead of BCLK and it reaches the wdog_limit before the device asserts the dtack signal, the controller will terminate the access and generate an error response transfer toward the Master.

WDOG-1 can be disabled by WDOG_EN bit in the WCR.

21.5.13 Error Conditions

The following conditions cause an error (AXI error or IPS error) response signal:

- AXI errors
 - Access to a disabled chip select - access to a mapped chip select address space where the CSEN bit in the corresponding chip select Configuration Register is clear
 - Access to a non mapped address - access to an address that is not mapped to any CS.
 - User access to a supervisor-protected chip select address space (the SP bit in the corresponding chip select Configuration Register is set)
 - User access in fixed mode access
 - User performs write access to write protected chip select
 - First write data ID and write address ID do not match. (No data is written to the memory.)
 - First Write Data ID and write address ID match but one or more of the other Write data IDs does not match the First Write data ID (data is written to memory according)
 - Access duration to external device from CSx signal assertion is 128/256/512/1024 cycles (access is terminated by the controller) - This error can be disabled by software.
- IPS errors
 - User read or write access to a reserved/non-valid address in the EIM Configuration Register

21.5.14 DTACK Mode

In DTACK mode, the EIM uses DTACK signal as an indication of when to end the access.

DTACK is an asynchronous edge/level sensitive signal. DTACK polarity is configurable by the DAP bit in CsxGCR2 (default value is 0).

In this case, EIM begins the access and after a few cycles (according DAPS field) and waits until DTACK (after synchronization) becomes asserted, then samples the data in read access and completes the current data access (see [Figure 21-15](#), [Figure 21-16](#) & [Figure 21-17](#)).

If more than one data is needed, CS will be negated between access (CSREC field is not zero) and the AXI burst access will be split into single accesses (see [Figure 21-19](#)).

21.5.15 EIM_GRANT / EIM_BUSY Handshake Description

Prior to executing command to one of the external device (chip select), EIM assert EIM_BUSY signal (1'b1) and checks the EIM_GRANT signal status.

If EIM_GRANT signal is high, it indicates external data bus is not used by other slaves (NAND Flash Controller) and EIM may start to execute the access. If EIM_GRANT is low, EIM waits until it is set (1'b1) before executing the access.

EIM keeps EIM_BUSY signal set until it completes the access toward the external device.

Once EIM_GRANT signal is set, it can not be reset until EIM_BUSY signal is cleared by EIM.

NOTE

In 16-bit Muxed EIM doesn't use the data bus, therefore there is no sharing of the data bus with NFC. EIM doesn't wait for EIM_GRANT signal from NFC and doesn't assert the EIM_BUSY signal.

21.5.16 LPMD / LPACK Handshake Description

These signals are used for frequency and/or voltage change, and for entering low power mode during normal operation of the EIM. Before any change can take place, the controller and all the relevant external devices should be in idle state, which means no access or data transfer is in process.

LPMD input signal is asserted once EIM detects the assertion of LPMD, all ready signals of the AXI channels are negated, and EIM is not sampling new accesses. It finishes all the ongoing accesses and already pending ones. When EIM is in idle state, the LPACK output signal is asserted. EIM will stay in idle state and the LPACK signal will stay asserted until the LPMD signal is negated.

21.5.17 Endianness

Big and Little endianness are supported by the controller according to the following table.

Table 21-7. EIM Out/in Data in Case AXI Out/in Data is 0xB3B2B1B0

Endian mode	AXI access	AXI address [1:0]	Port size and used bits								
			Word port				Half word port			Byte port	
			[31:24]	[23:16]	[15:8]	[7:0]	External address [0]	[31:24] ([15:8])	[23:16] ([7:0])	External address [1:0]	[31:24] ([23:16]) ([15:8]) ([7:0])
Big	Word	0	0xB3	0xB2	0xB1	0xB0	0	0xB3	0xB2	0	0xB3
							1			1	0xB2
							2	0xB1	0xB0	2	0xB1
							3			3	0xB0
	Half Word	0			0xB1	0xB0	0	0xB3	0xB2	0	0xB3
							1			1	0xB2
							2	0xB3	0xB2	2	0xB1
							3			3	0xB0
	Byte	0			0xB1	0xB0	0		0xB3	0	0xB3
							1		0xB2	1	0xB2
							2	0xB2		2	0xB1
							3	0xB3		3	0xB0
Little	Word	0	0xB3	0xB2	0xB1	0xB0	0	0xB1	0xB0	0	0xB0
							1			1	0xB1
							2	0xB3	0xB2	2	0xB2
							3			3	0xB3
	Half Word	0			0xB1	0xB0	0	0xB1	0xB0	0	0xB0
							1			1	0xB1
							2	0xB3	0xB2	2	0xB2
							3			3	0xB3
	Byte	0			0xB1	0xB0	0		0xB0	0	0xB0
							1		0xB1	1	0xB1
							2	0xB2		2	0xB2
							3	0xB3		3	0xB3

21.5.18 Strobe Signal Use

The strobe signal is toggling according to address/data valid condition on the external bus for read and write accesses, and for both synchronous and asynchronous modes.

At any time point when address/data is valid on the external bus, the strobe signal will generate a positive edge, which can be used to sample the external data and control signal.

NOTE

Strobe signal for read data is active (RL + 1) cycles after data on external bus is valid.

21.6 Initialization Information**21.6.1 Booting from EIM**

EIM is ready to work with CS0 after the hardware reset, but it has been configured for very slow access (for boot purposes), with additional setup and hold time.

Other CSs are disabled by hardware reset. Therefore, all CSs must be properly initialized before use in writing values to the corresponding chip select configuration registers.

DSZ[1:0] and MUM fields are set according to EIM_BOOT [2:0] block inputs.

21.7 Typical Application

Application note uses following functions to illustrate EIM and memory accesses:

- WR16(address, data) is a 16 bit write access
- WR32(address, data) is a 32 bit write access
- RD16(address, data) is a 16 bit read access
- RD32(address, data) is a 32 bit read access
- WR_I(address, data, delta, counter) is a write data sequence, there $data(i+1) = data(i) + delta$
- COMMAND_SEQUENCE
- CHECK_STATUS

NOTE

COMMAND_SEQUENCE and CHECK_STATUS are described in [AMD Flash Utility](#), [Intel Sibley Flash Utility](#), [MDOC Device Utility](#), [Samsung OneNAND Utility](#), and [Spansion Flash Utility](#).

All addresses are byte addresses. "CS0" is a Chip Select 0 base address. "EIM_" is a prefix of EIM's registers. 'h is a prefix of hexadecimal constant. "/" is a comment beginning. csba[cs] is a dimension of CS base addresses. "addr" means an address offset in current CS address space. Examples use CS0 address space, but it may apply to any CS except for boot mode functionality.

Configuration examples were verified with the memory models listed below and may require some adjustments for other family members.

21.7.1 Access to Intel Sibley Flash

The following configurations are intended to Sibley family muxed and non-muxed devices.

21.7.1.1 Intel Sibley Flash Asynchronous Mode Configuration

- WR32('EIM_CS0GCR1,'h00210081);
- WR32('EIM_CS0RCR1,'h0e020000);
- WR32('EIM_CS0RCR2,'h00000000);
- WR32('EIM_CS0WCR1,'h0704a040);

21.7.1.2 Intel Sibley Flash Synchronous Mode Configuration

Configuration used for 133 MHz synchronous access to flash:

```
// Set memory to synchronous read mode
WR16('CS0+('h5903<<1), 'h0060);
WR16('CS0+('h5903<<1), 'h0003);
WR16('CS0+('h0000<<1), 'h00ff);
// Set EIM configuration to synchronous timing
WR32('EIM_CS0GCR1, 'h50214225);           // 133 MHz
WR32('EIM_CS0RCR1, 'h0c000000);         // 12 cycles on memory
```

Configuration used for 66 MHz synchronous access to muxed flash:

```
// Set memory to synchronous read mode
WR16('CS0+('h3103<<1), 'h0060);
WR16('CS0+('h3103<<1), 'h0003);
WR16('CS0+('h0000<<1), 'h00ff);
//-----
// Set EIM configuration to synchronous timing
WR32('EIM_CS0GCR1, 'h5021122d);           // 66 MHz
WR32('EIM_CS0RCR1, 'h07000000);         // 7cycles on memory
```

21.7.1.3 Intel Sibley Flash Utility

```
// Single data word programming to addr
WR16('CS0+addr, 'h0060);           // Unlock
WR16('CS0+addr, 'h00d0);
WR16('CS0+addr, 'h0041);
WR16('CS0+addr, data);
WR16('CS0+caddr, 'h0070);           // Read Status command
while('CS0+data[7] == 0)           // Wait / Polling
    RD16('CS0+addr, data);         // Read status
RD16('CS0+addr, data);             // Read status
```

```

    WR16('CS0+'h0000,'h00ff);
// Write buffer programming
    WR16('CS0+addr,'h0060);           // Unlock
    WR16('CS0+addr,'h00d0);
    data = 0;
    WR16('CS0+addr, 'h0070);         // Read Status command
    while(data[7] == 0)              // Wait
        RD16('CS0+addr, data);      // Read status
    WR16('CS0+'h0000,'h00ff);
    WR16('CS0+addr,'h00e9);         // Write Buffer command
    WR16('CS0+addr,255);           // Word counter (<256)
    for(i=0; i<'h200; i = i + 'h40)
        WR_I('CS0+addr+i, data+((i>2)*'h0010_0001), 'h0010_0001, 16); // Data
    WR16('CS0+addr,'h00d0);         // Write Confirm command
    data = 0;
    while(data[7] == 0)              // Wait
        RD16('CS0+addr, data);      // Read status
    RD16('CS0+addr, data);          // Read status
    WR16('CS0+'h0000,'h00ff);

```

21.7.2 Access to MDOC Device

The following configurations are intended to MDOC H3 device.

21.7.2.1 MDOC Device Boot

To boot from the MDOC device the ERRST bit should be configured to 1, so that EIM will hold the first read access to CS0 until the MDOC asserts the RDY signal.

21.7.2.2 MDOC Device Asynchronous Mode Configuration

```

// Non-muxed mode
WR32('EIM_CS0GCR1,'h00410081);
WR32('EIM_CS0RCR1,'h0e121010);
WR32('EIM_CS0RCR2,'h00000000);
WR32('EIM_CS0WCR1,'h12092492);
// Muxed mode
WR32('EIM_CS0GCR1,'h00410081);
WR32('EIM_CS0RCR1,'h0e121010);
WR32('EIM_CS0RCR2,'h00000000);
WR32('EIM_CS0WCR1,'h12092492);

```

21.7.2.3 MDOC Device Utility

```

// Read Manufacturer ID and Device ID
    RE16('CS0+'h9400,'h4833);
    RE16('CS0+'h9422,'hb7cc);

```

21.7.3 Access to Micron PSRAM

The following configurations are intended to mt45w4mw16bfb_706.

21.7.3.1 Micron PSRAM Asynchronous Mode Configuration

```
// 16 bit memory
WR32('EIM_CS0GCR1,'h403104b1);
WR32('EIM_CS0RCR1,'h0b010000);
WR32('EIM_CS0RCR2,'h00000008);
WR32('EIM_CS0WCR1,'h0b040040);
// 32 bit memory
WR32('EIM_CS0GCR1,'h403304b1);
WR32('EIM_CS0RCR1,'h0f010000);
WR32('EIM_CS0RCR2,'h00000008);
WR32('EIM_CS0WCR1,'h0f040040);
```

21.7.3.2 Micron PSRAM Synchronous Mode Configuration

```
// 16 bit memory
WR32('EIM_CS0GCR1,'h403104b1);
WR32('EIM_CS0WCR1,'h0b040000);
WR16('CS0+('h85947<<1),'h0040); // memory configuration
WR32('EIM_CS0GCR1,'h4021_5487); // fixed latency memory wrap 4
WR32('EIM_CS0RCR1,'h04000000);
WR32('EIM_CS0RCR2,'h00000008);
WR32('EIM_CS0WCR1,'h04000000);
// 32 bit memory
WR32('EIM_CS0GCR1,'h6003_04f1);
WR32('EIM_CS0WCR1,'h0b04_0000);
WR32('CS0+('h85947<<2),'h0040); // memory configuration
WR32('EIM_CS0GCR1,'h4003_1487); // var latency memory inc. page size 128
WR32('EIM_CS0RCR1,'h04000000);
WR32('EIM_CS0RCR2,'h00000008);
WR32('EIM_CS0WCR1,'h04000000);
```

21.7.4 Access to Samsung OneNAND

Mentioned below are the configurations intended for Samsung OneNAND muxed and non-muxed devices.

21.7.4.1 Samsung OneNAND Boot

There are two ways to boot from Samsung OneNAND. In the first way, the ERRST bit is set to 0 and the user has to poll the interrupt status in the OneNAND interrupt register (or set interrupt handler there). In the second way, the ERRST bit is set to 1 and the user should enable the device interrupt output before the first read from CS0 access is issued.

Load sectors 2,3 to DataRAM, page 0 done in the next example:

- WR16('CS0+('hF241<<1),'h0); // Clear interrupt status
- WR16('CS0+('hF100<<1),'h0); // block[8:0] address
- WR16('CS0+('hF107<<1),'h2); // sector[1:0] and page[7:2] addresses
- WR16('CS0+('hF200<<1),'h802); // buffer[11:8] address and counter[1:0]
- WR16('CS0+('hF101<<1),'h0); // DDP choose
- WR16('CS0+('hF220<<1),'h0); // Set command

21.7.4.2 Samsung OneNAND Asynchronous Mode Configuration

```
// Non-muxed memory
WR32('EIM_CS0GCR1,'h00410081);
WR32('EIM_CS0RCR1,'h0b010000);
WR32('EIM_CS0RCR2,'h00000000);
WR32('EIM_CS0WCR1,'h0c092480);
// Muxed memory
WR32('EIM_CS0GCR1,'h00410089);
WR32('EIM_CS0RCR1,'h0b010000);
WR32('EIM_CS0RCR2,'h00000000);
WR32('EIM_CS0WCR1,'h0c092480);
```

21.7.4.3 Samsung OneNAND Synchronous Mode Configuration

Set memory and EIM to synchronous read mode is shown in the next example:

```
WR16('CS0+('hF221<<1),'hc0e0); // Synchronous read, 4 clk latency
WR32('EIM_CS0GCR1,'h50412405); // 44 MHz (non-muxed)
WR32('EIM_CS0RCR1,'h05010000);
```

The muxed Samsung OneNAND supports synchronous write, too:

```
// Set memory & EIM to synchronous read and write mode
WR16('CS0+('hF221<<1),'hc0f2); // Sync. read and write, 4 clk latency
WR32('EIM_CS0GCR1,'h5041240f); // 44 MHz
WR32('EIM_CS0RCR1,'h05010000);
WR32('EIM_CS0WCR1,'h05040000);
```

21.7.4.4 Samsung OneNAND Utility

The following utility algorithms are used on the Samsung OneNAND:

```
// Unlock Block command
WR16('CS0+('hF100<<1),'h0); // DFS
WR16('CS0+('hF100<<1),'h0); // DBS
WR16('CS0+('hF24c<<1),'h2); // SBA - block number (2)
WR16('CS0+('hF241<<1),'h0); // Clear interrupt status
WR16('CS0+('hF220<<1),'h23); // Unlock command
data = 'h0;
while(!(data & 'h0004)) // Polling
    RD32('WIAR, data); // Read status
// Erase block command
WR16('CS0+('hF100<<1),'h2); // DFS and block ([8:0]) address
WR16('CS0+('hF101<<1),'h0); // DBS
WR16('CS0+('hF241<<1),'h0); // Clear interrupt status
```

Typical Application

```
        WR16 ('CS0+('hF220<<1), 'h94);           // Erase command
data = 'h0;
while (!(data &'h0004))                          // Wait
    RD32('WIAR, data); // Read status
// Program page command
WR16 ('CS0+('hF100<<1), 'h2);                    // DFS and block[8:0] address
WR16 ('CS0+('hF107<<1), 'h0);                    // sector[1:0] and page[7:2] addresses
WR16 ('CS0+('hF200<<1), 'h800);                 // buffer[11:8] address and counter[1:0]
WR16 ('CS0+('hF241<<1), 'h0);                    // Clear interrupt status
WR16 ('CS0+('hF220<<1), 'h80);                 // Program command
data = 'h0;
while (!(data &'h0004))                          // Wait
    RD32('WIAR, data); // Read status
```

21.7.5 Access to Samsung UtRAM

Below mentioned configurations are intended for Samsung UtRAM.

21.7.5.1 Samsung UtRAM Asynchronous Mode Configuration

```
WR32 ('EIM_CS0GCR1, 'h400104b1);
WR32 ('EIM_CS0RCR1, 'h0a010000);
WR32 ('EIM_CS0RCR2, 'h00000008);
WR32 ('EIM_CS0WCR1, 'h0b040040);
```

21.7.5.2 Samsung UtRAM Synchronous Mode Configuration

```
RD16 ('CS0+('hff_ffff<<1), data);              // command sequence
RD16 ('CS0+('hff_ffff<<1), data);
RD16 ('CS0+('hff_ffff<<1), data);
RD16 ('CS0+('hff_feff<<1), data);
RD16 ('CS0+('h00_82a0<<1), data);              // memory sync. configuration
WR32 ('EIM_CS0GCR1, 'h4021_53b7);              // fixed latency memory wrap 32
WR32 ('EIM_CS0RCR1, 'h0500_0000);
WR32 ('EIM_CS0WCR1, 'h0300_0000);
```

21.7.6 Access to Spansion Flash

Below mentioned configurations are intended for Spansion Flash.

21.7.6.1 Spansion Flash Asynchronous Mode Configuration

```
WR32 ('EIM_CS0GCR1, 'h00410081);
WR32 ('EIM_CS0RCR1, 'h0a018000);
WR32 ('EIM_CS0RCR2, 'h00000000);
WR32 ('EIM_CS0WCR1, 'h0704a240);
WR16 ('CS0+('hF220<<1), 'h94);                 // Erase command
data = 'h0;
while (!(data &'h0004))                          // Wait
    RD32('WIAR, data); // Read status
// Program page command
```



```

WR16 ('CS0+('hF100<<1), 'h2);           // DFS and block[8:0] address
WR16 ('CS0+('hF107<<1), 'h0);           // sector[1:0] and page[7:2] addresses
WR16 ('CS0+('hF200<<1), 'h800);         // buffer[11:8] address and counter[1:0]
WR16 ('CS0+('hF241<<1), 'h0);           // Clear interrupt status
WR16 ('CS0+('hF220<<1), 'h80);         // Program command
data = 'h0;
while (!(data & 'h0004))                 // Wait
    RD32 ('WIAR, data); // Read status

```

21.7.6.2 Spansion Flash Synchronous Mode Configuration

```

WR16 ('CS0+('h0555<<1), 'h00aa); // command sequence
WR16 ('CS0+('h02aa<<1), 'h0055);
WR16 ('CS0+('h0555<<1), 'hd0);
WR16 ('CS0+('h0000<<1), 'hle4); // memory sync. configuration
WR32 ('EIM_CS0GCR1, 'h50411325); // 66 MHz
WR32 ('EIM_CS0RCR1, 'h05000000); // 5 cycles on memory

```

21.7.6.3 Spansion Flash Utility

```

// Single word programming
COMMAND_SEQUENCE(cs, 16, 'ha0); // single word programming
WR16 ('CS0+addr, data);
CHECK_STATUS ('CS0+addr, data, 16, 1, errst);
// Write buffer programming
COMMAND_SEQUENCE(0, 16, 'h25); // write buffer programming
WR16 ('CS0+addr, 'h001f); // counter-1
WR_I ('CS0+addr, data, 'h0010_0001, 16); // data
WR16 ('CS0+addr, 'h0029); // write buffer to flash
CHECK_STATUS ('CS0+addr+'h3e, data[31:16]+'h00f0, 16, 1, errst);

```

There `COMMAND_SEQUENCE` and `CHECK_STATUS` are next functions:

```

task COMMAND_SEQUENCE;
    input [2:0]    cs;
    input [7:0]   port_size;
    input [31:0]  code;
begin
    if (port_size == 16)
        begin
            WR16 (csba[cs]+('h0555<<1), 'h00aa);
            WR16 (csba[cs]+('h02aa<<1), 'h0055);
            WR16 (csba[cs]+('h0555<<1), code);
        end
    else
        begin
            WR32 (csba[cs]+('h0555<<2), 'h00aa);
            WR32 (csba[cs]+('h02aa<<2), 'h0055);
            WR32 (csba[cs]+('h0555<<2), code);
        end
end
endtask
task CHECK_STATUS;
    input [31:0]  addr;
    input [31:0]  edata;
    input [7:0]   port_size;
    input [7:0]   opcode;
    output [7:0]  errst;
    reg [31:0]    data;
    reg [31:0]    data3;
begin
    errst = 0;

```

Typical Application

```
    data = 0;
    data3 = 0;
while(!(data == edata) && !errst) // Wait operation
begin: BR_EN
RD16(addr, data); // Read status
if(data[7] != edata[7])
begin
if(data[5] == 1)
begin
RD16(addr, data3);
RD16(addr, data);
if(data[6] != data3[6])
begin
$display("CHECK_STATUS: Error timeout on single data program");
errst = 1;
disable BR_EN;
end
end
else
begin
if(opcode == 2)
if(data[1] == 1)
begin
RD16(addr, data3);
if(port_size == 32)
RD32(addr, data);
else
RD16(addr, data);
if(data[1] == 1 && data != edata)
begin
$display("CHECK_STATUS: Error on write buffer");
errst =3;
disable BR_EN;
end
end
end
end
else
begin
RD16(addr, data3);
if(port_size == 32)
RD32(addr, data);
else
begin
RD16(addr, data);
edata[31:16] = 16'h0;
end
if(data != edata)
begin
$display("CHECK_STATUS: Error in data write on single data program");
errst =2;
disable BR_EN;
end
end
end
end
endtask
```

21.7.7 8 bit support

This section details the pin connections for Intel mode and Motorola mode.

Intel Mode - For intel mode use the following connection:

Table 21-8. Intel Mode pin connections

Arm platform Pin	EIM Pin	Notes
ADS#	IPP_DO_ADV_B	WAL = 1,RAL = 1
W/R	IPP_DO_BE_B	WBED = 1
WR#	WE#	
RD#	OE#	

Mot. Mode - For intel mode use the following connection:

Table 21-9. Motorola Mode pin connections

Arm platform Pin	EIM Pin	Notes
AS#	IPP_DO_CS_B	
R/W#	WE#	
LDS#	BE#	

21.8 External Bus Timing Diagrams

The following timing diagrams show the timing of accesses to memory or a peripheral with different timing parameters. All examples done for CS0, but are valid for any others chip select. BE means one from current used BE[3:0].

21.8.1 Asynchronous Read Memory Accesses Timing Diagram

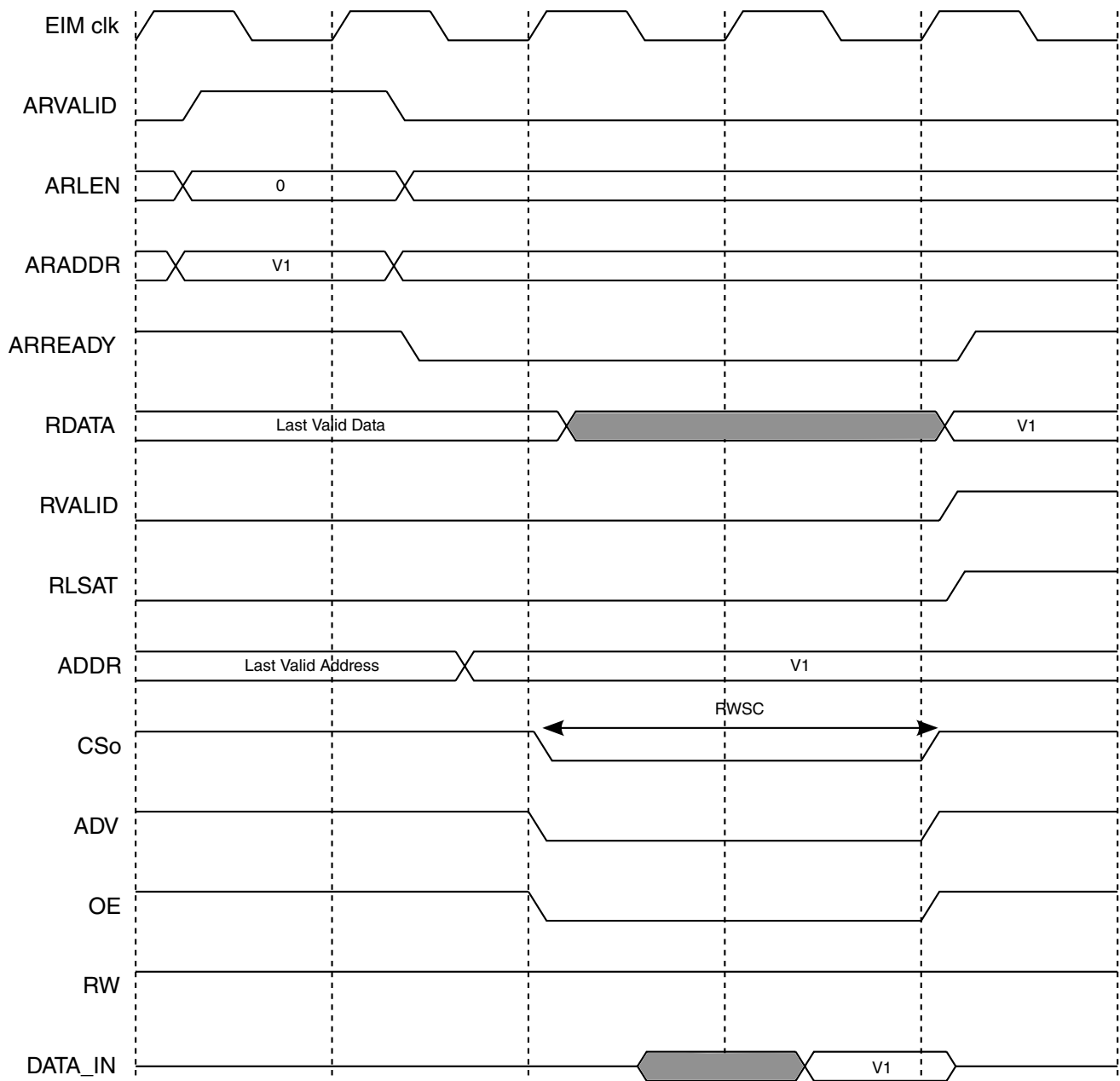

Figure 21-2. Read Access, RWSC=2,RCSA=0,OEA=0,RCSN=0,OEN=0, RAL=1

21.8.2 Asynchronous Write Memory Accesses Timing Diagram

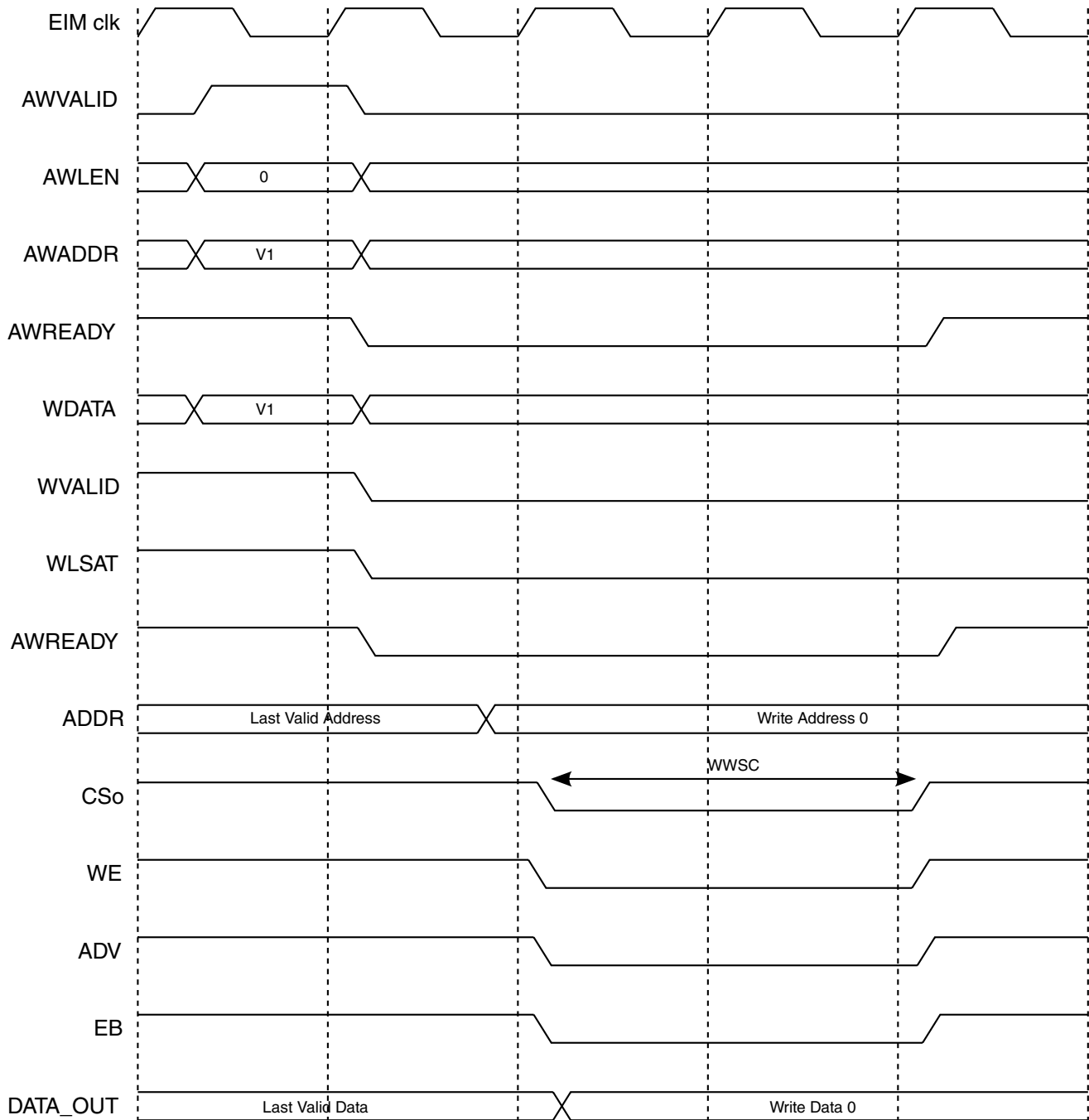

Figure 21-3. Write Access, $WWSC=2$, $WCSA=0$, $WEA=0$, $WCSN=0$, $WEN=0$, $BEA=0$, $BEN=0$, $WAL=1$

21.8.3 Asynchronous Read/Write Memory Accesses Timing Diagram

External Bus Timing Diagrams

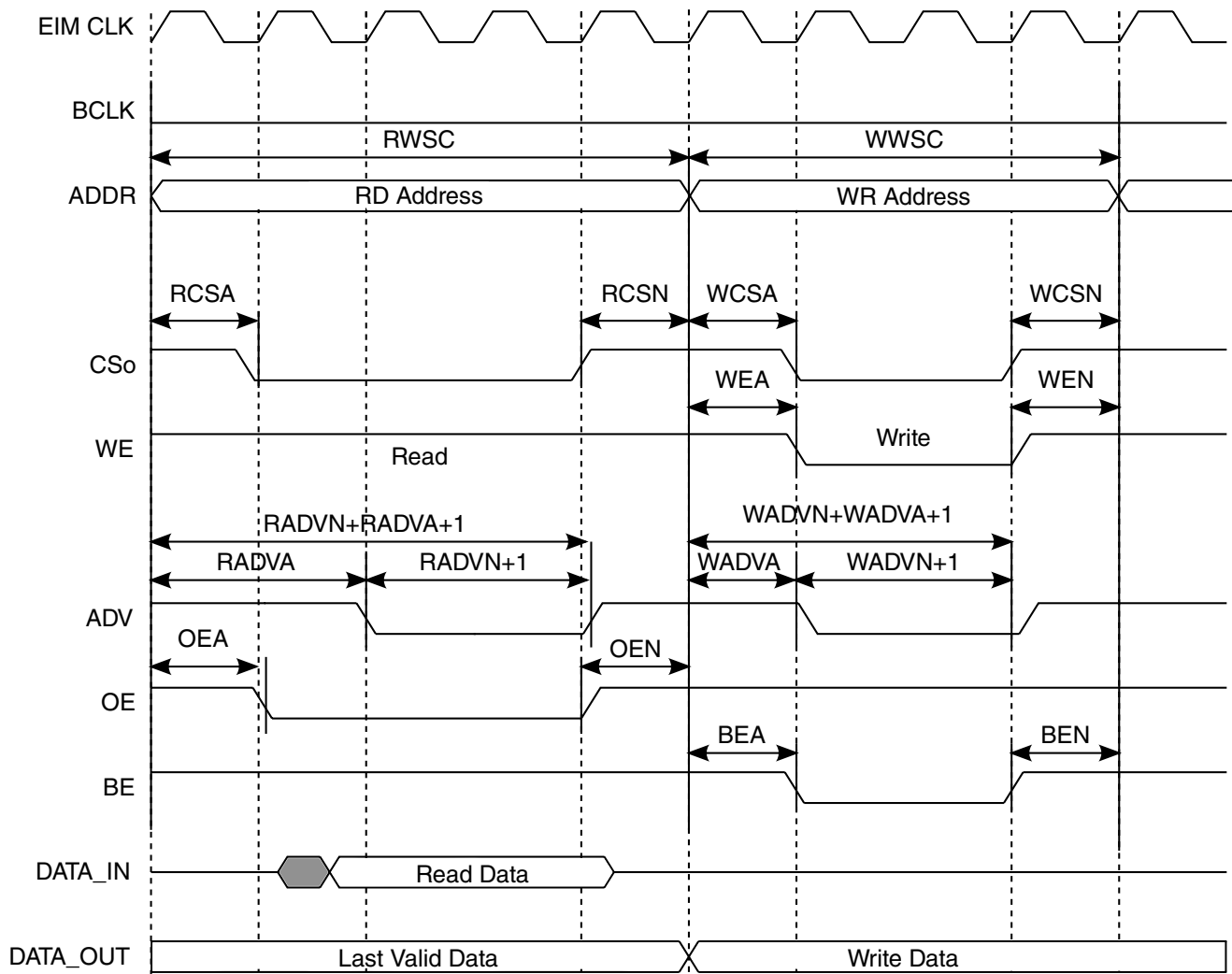

Figure 21-4.

RCSA=1,RADVA=2,OEA=1,RADVN=1,RCSN=1,OEN=1,WCSA=1,WEA=1,WADVA=1,BEA=1,WADVN=1,WCSN=1,WEN=1,BEN=1

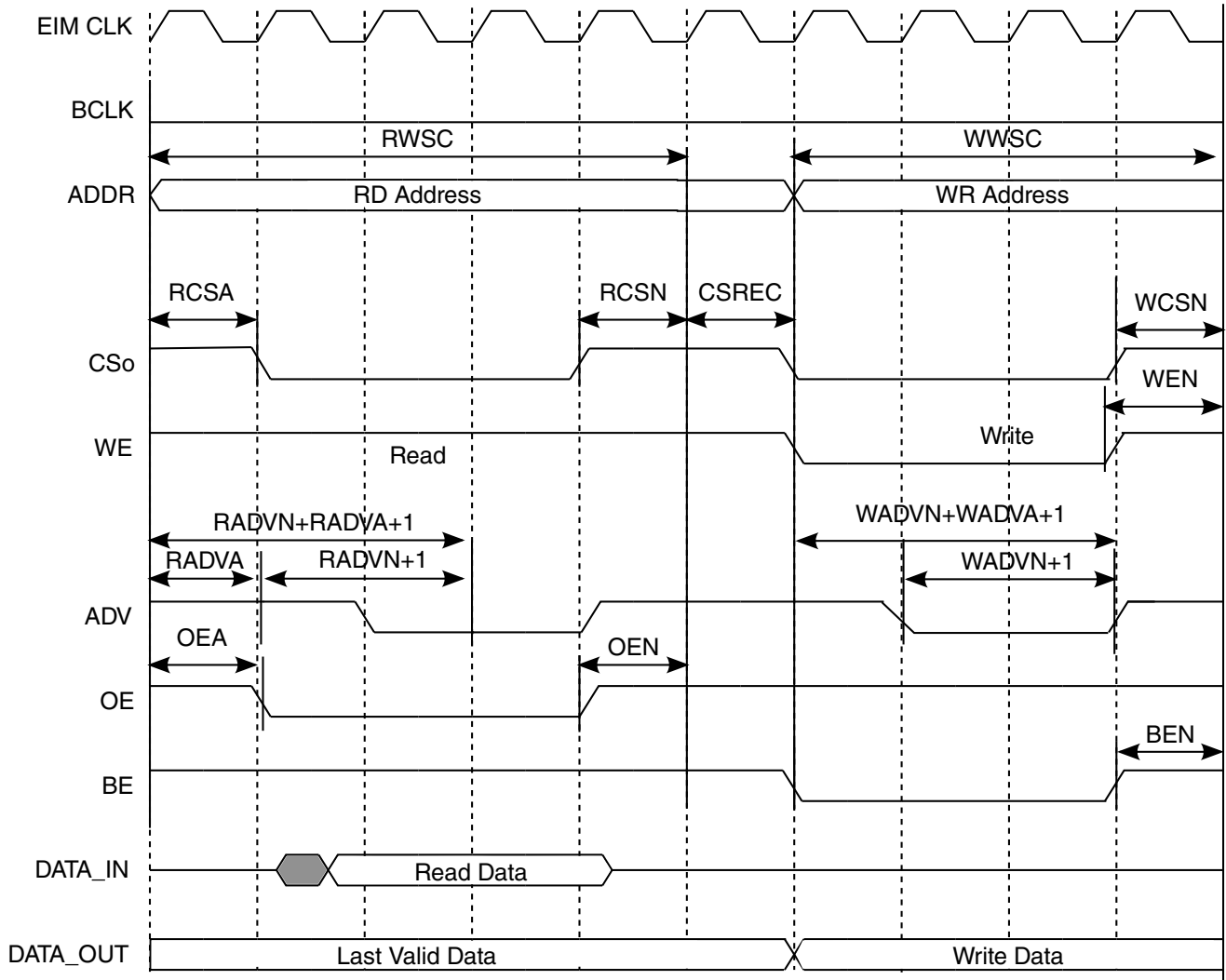

Figure 21-5.

RWSC=5,RCSA=1,RCSN=1,RADVA=1,RADVN=1,OEA=1,OEN=1,WWSC=4,WCSA=0,WCSN=1,WEA=0,WEN=1,WADVA=1,WADVN=1,BEA=0,BEN=1,CSREC=1

21.8.4 Asynchronous Read/Write Using RAL, WAL and CSREC

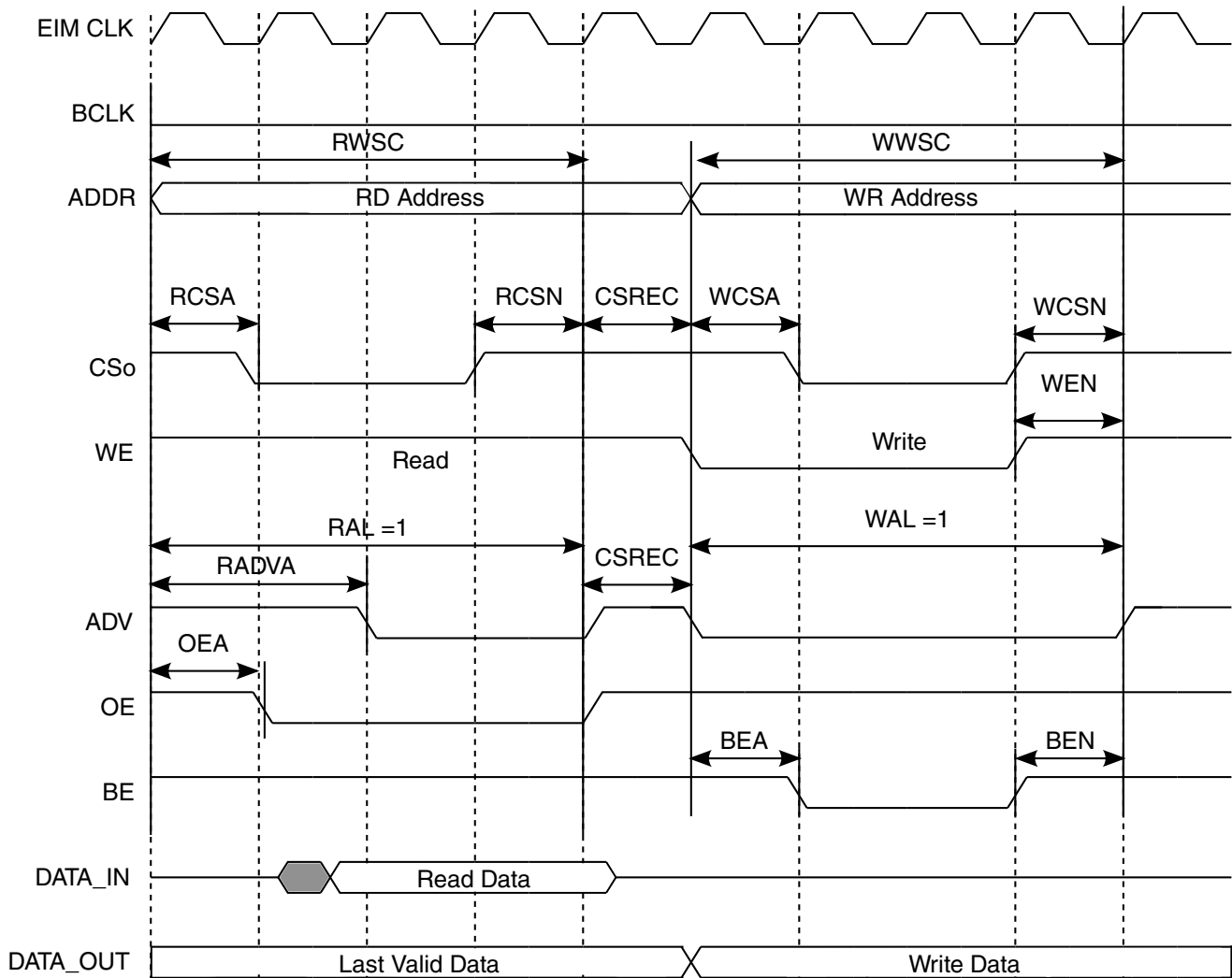

Figure 21-6.

RAL=1,RCSN=1,RADVA=2,OEA=1,RCSN=1,CSREC=1,WCSA=1,WEA=0,WADVA=0,BEA=1,WAL=1,WCSN=1,WEN=1,BEN=1

21.8.5 Consecutive Asynchronous Write Memory Accesses Timing Diagram

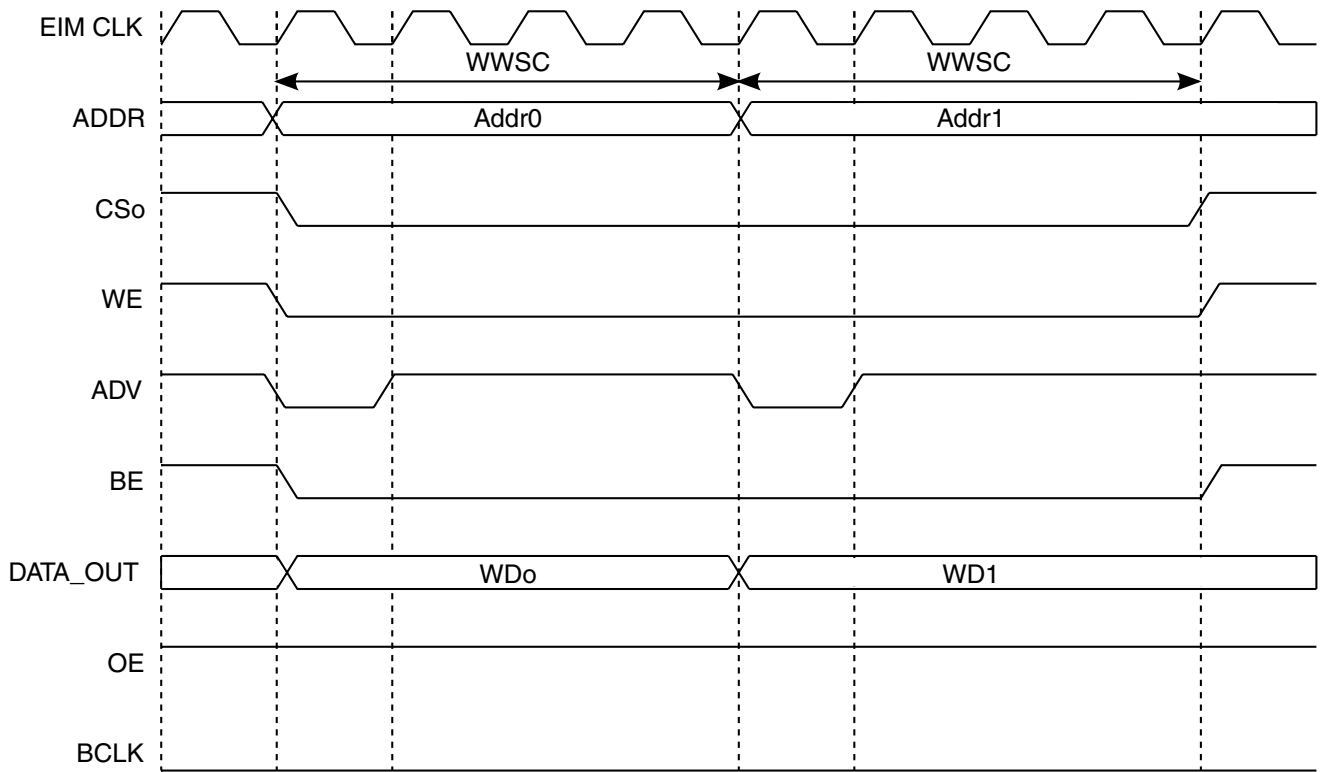

Figure 21-7.

WWSC=4, WCSA=0, WEA=0, WADVA=0, BEA=0, WCSN=0, WEN=0, WADV=0, BEN=0, CSRE
C=0

External Bus Timing Diagrams

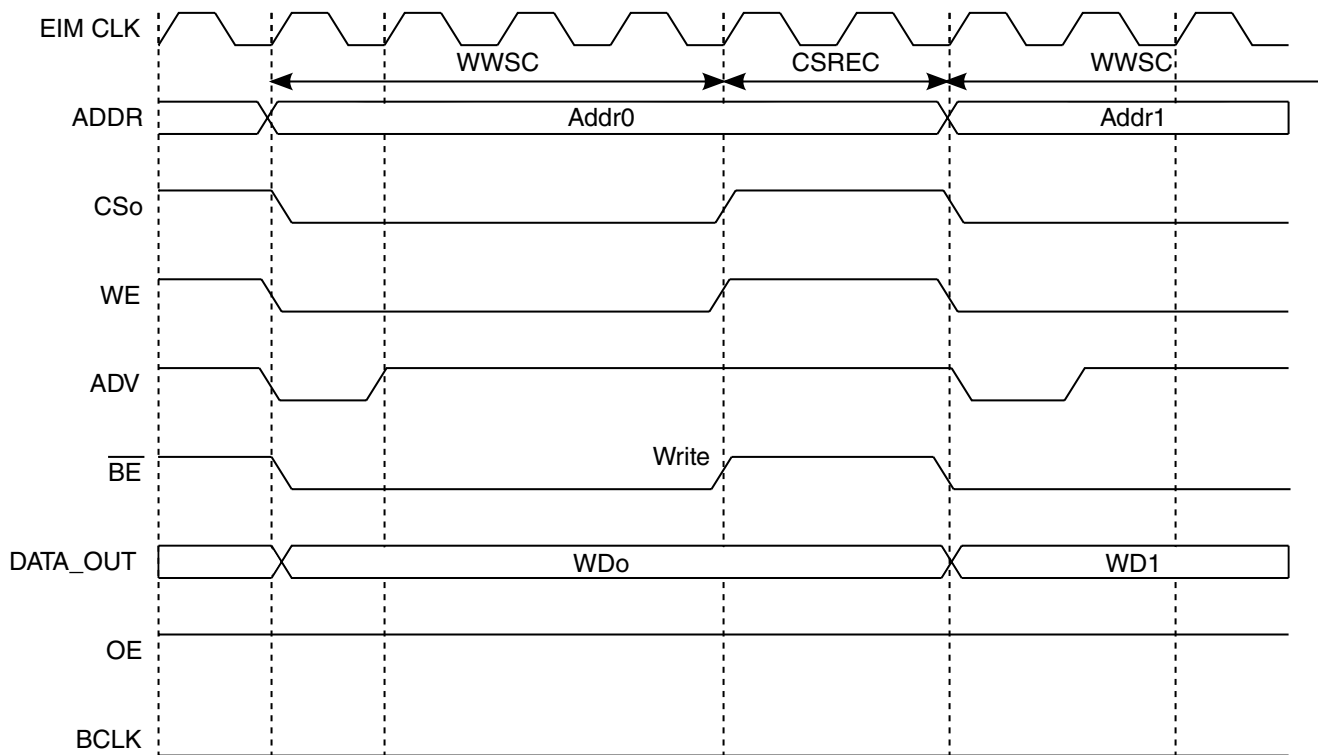

Figure 21-8.

WWSC=4,WCSA=0,WEA=0,WADVA=0,BEA=0,WCSN=0,WEN=0,WADV=0,BEN=0,CSRE C=2

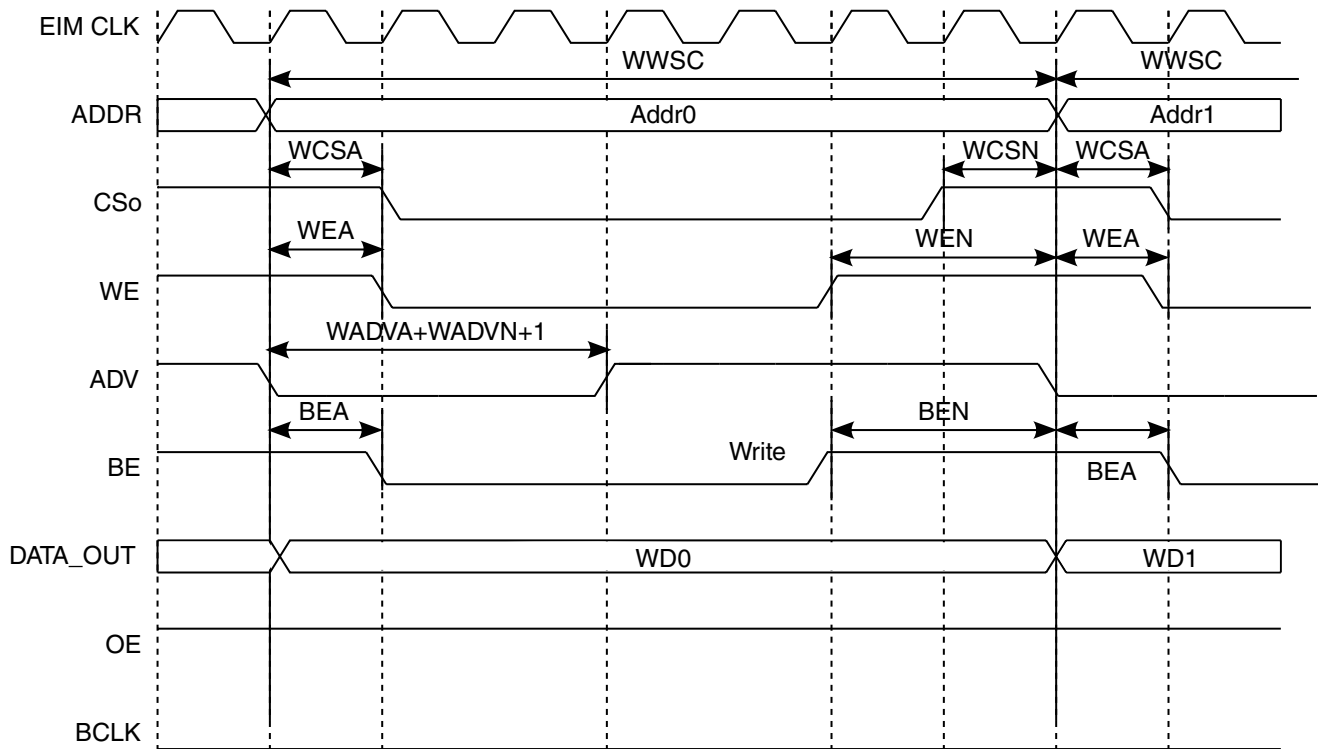

Figure 21-9.

WWSC=7,WCSA=1,WCSN=1,WEA=1,WEN=2,WADVA=0,WADVn=2,BEA=1,BEN=2

21.8.6 Consecutive Asynchronous Read Memory Accesses Timing Diagram

External Bus Timing Diagrams

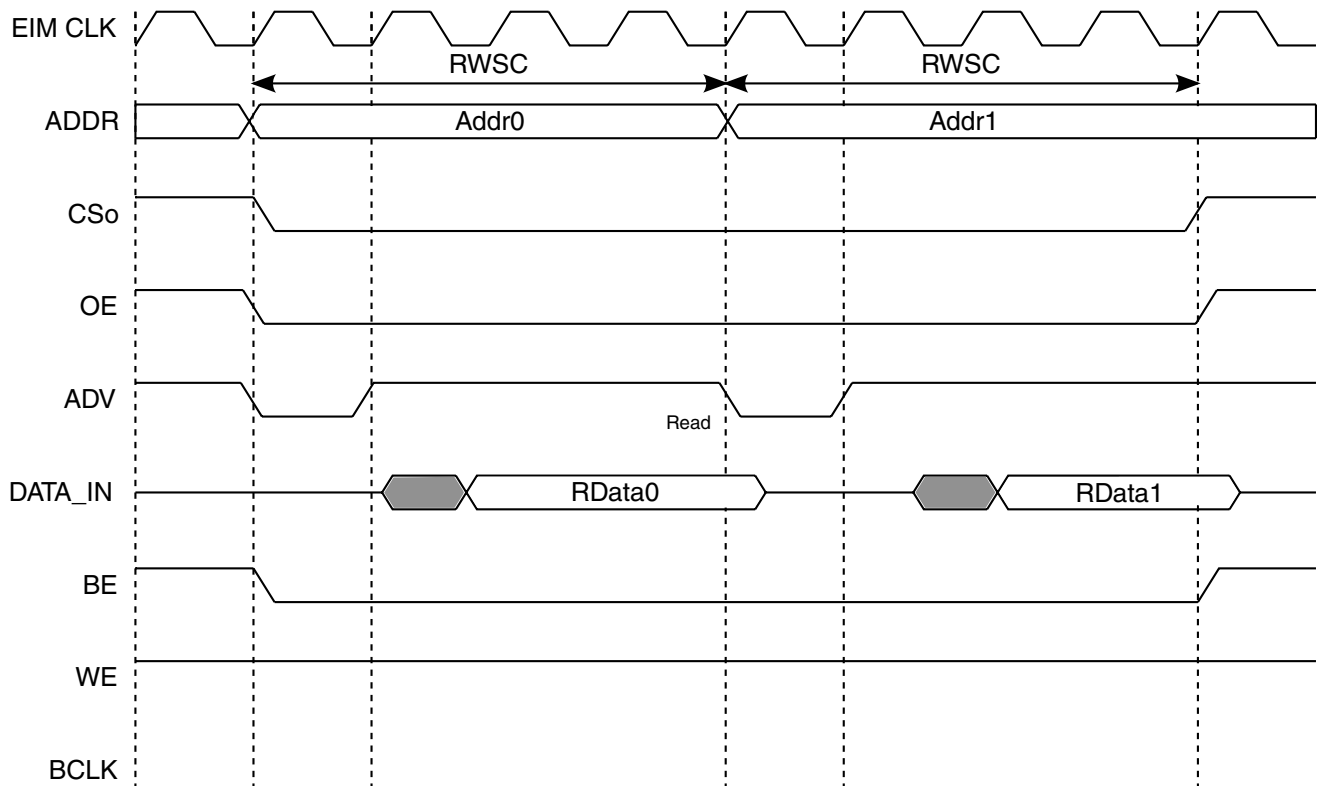

Figure 21-10. RWSC=4, RCSA=0, OEA=0, RADVA=0, RCSN=0, OEN=0, RADVN=0, CSREC=0

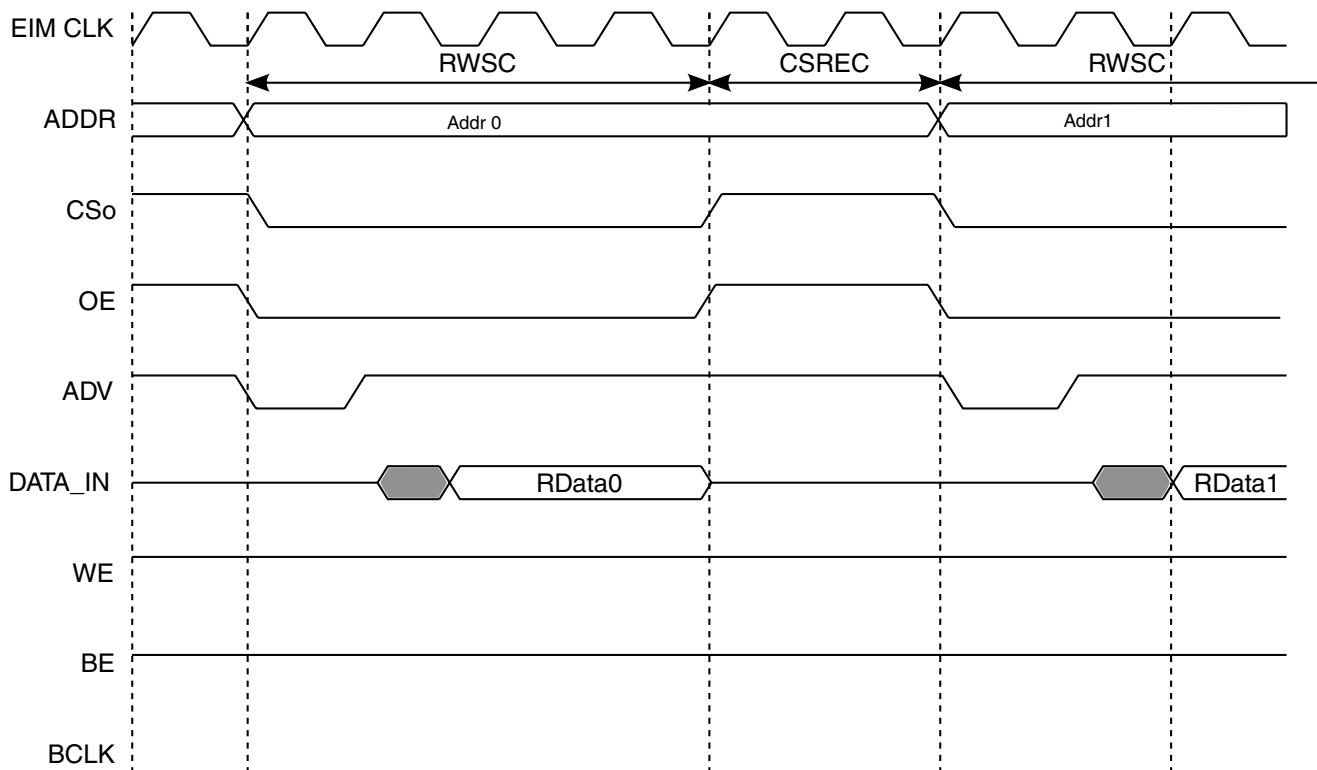

Figure 21-11. RWSC=4, RCSA=0, OEA=0, RADVA=0, RCSN=0, OEN=0, RADVN=0, CSREC=2

21.8.7 Burst (Synchronous Mode) Read Memory Accesses Timing Diagram - BCD=0

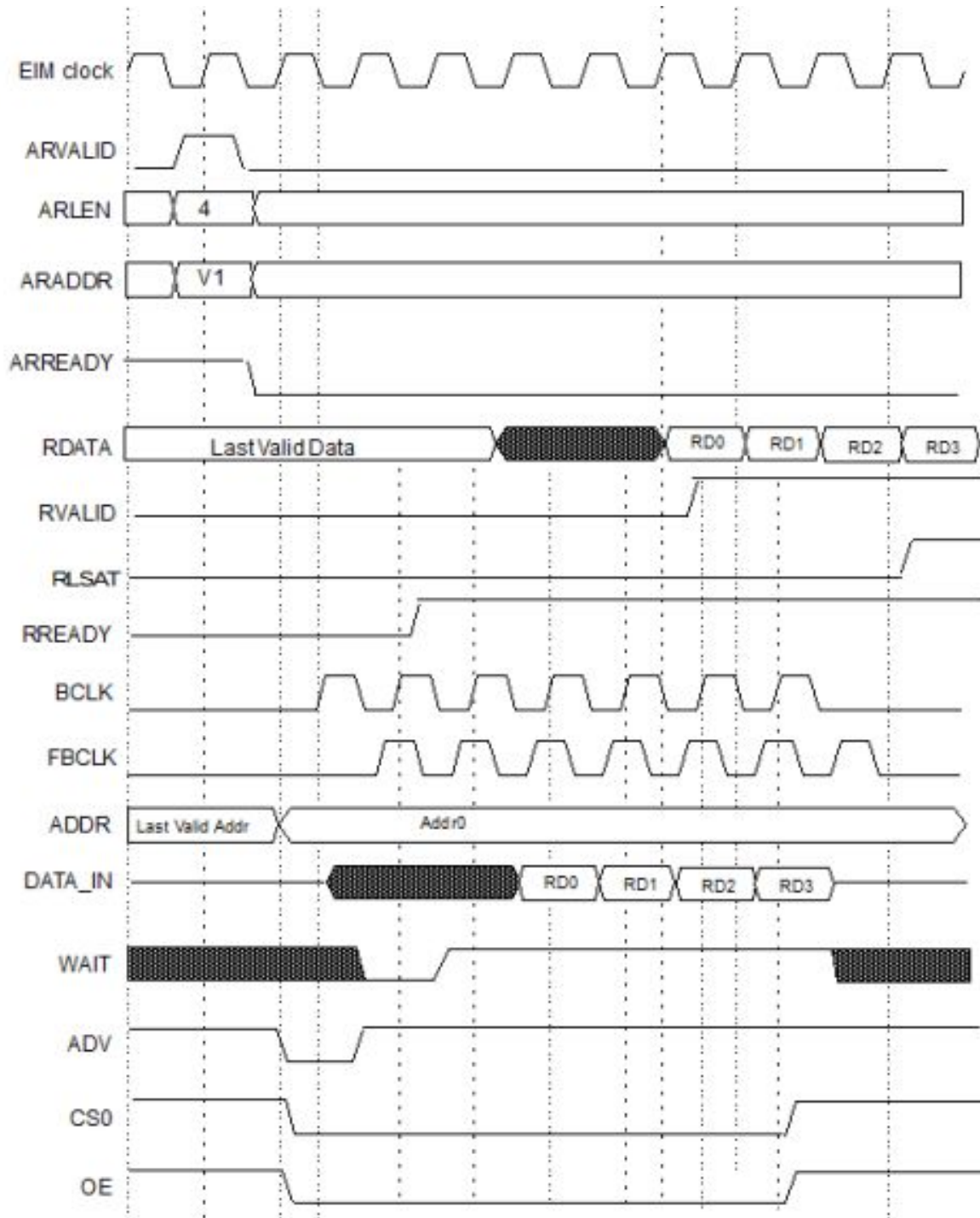

Figure 21-12. SRD=1,BCD=0,BCS=0,RWSC=1,RADVA=0,RADVN=0,RFL=0,RL=0

21.8.8 Burst (Synchronous Mode) Read Memory Accesses Timing Diagram - BCD=1

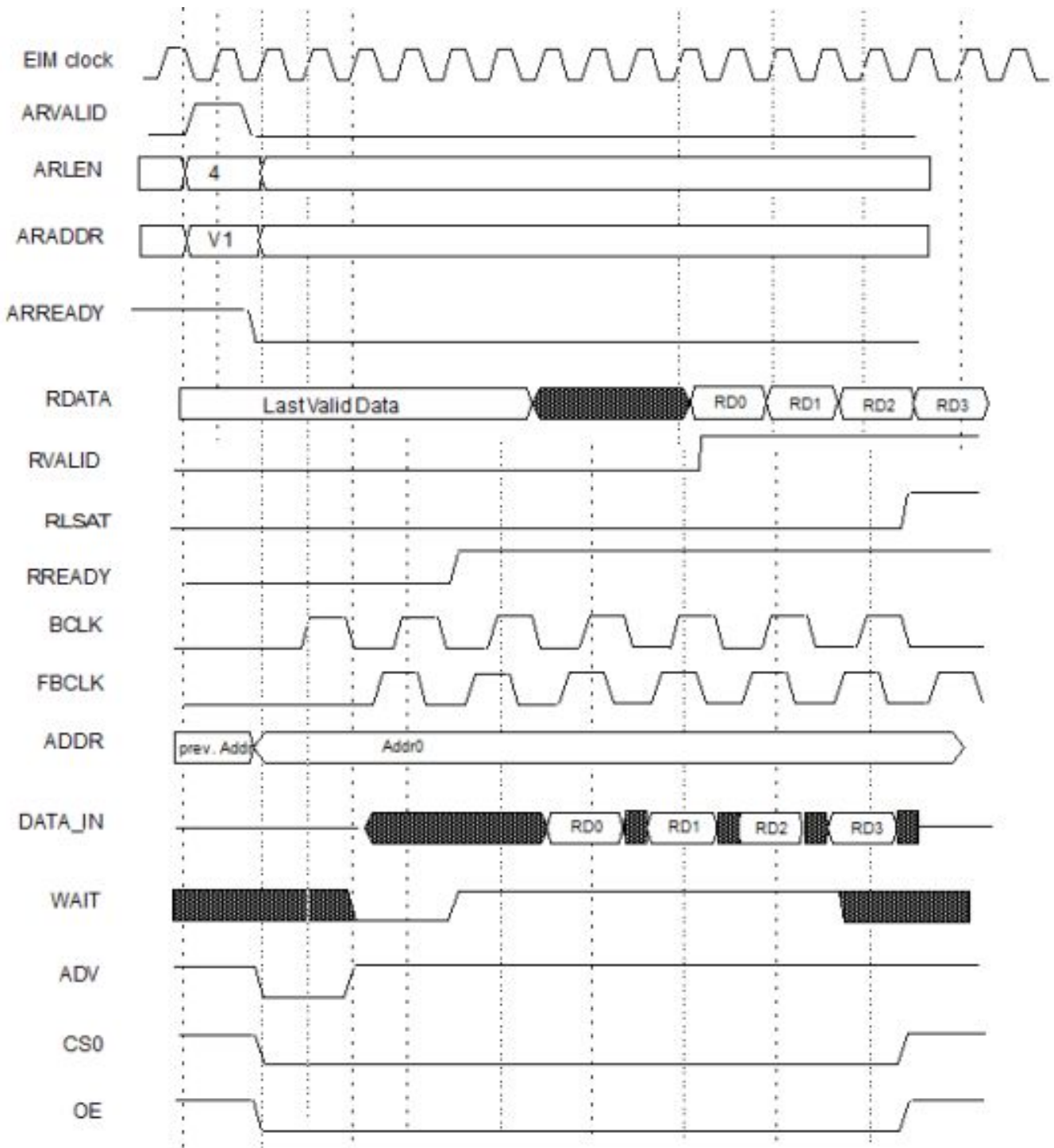
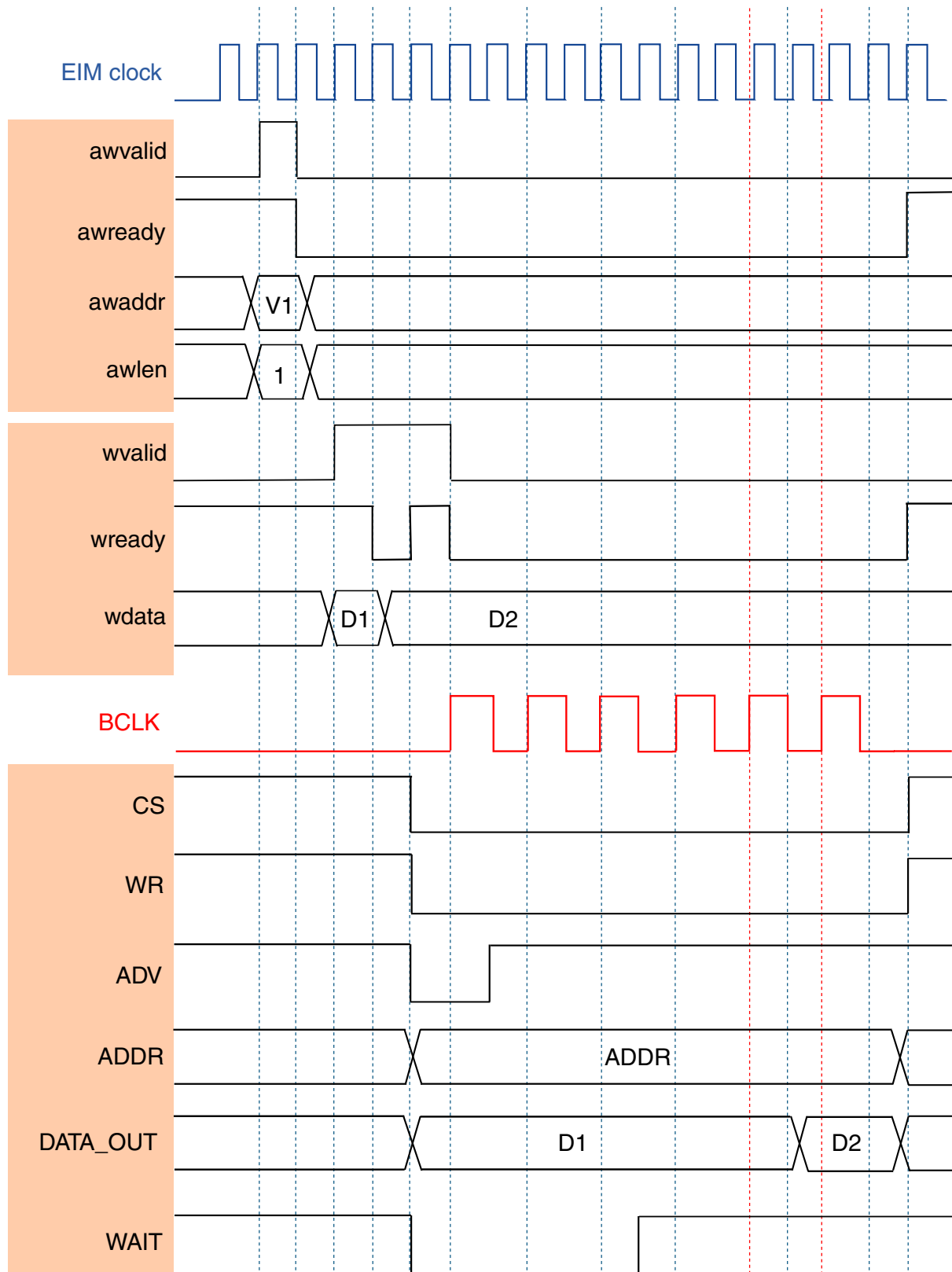

Figure 21-13. BCD=1, RL = 3

21.8.9 Burst (Synchronous Mode) Write Memory Access Timing - BCD=1



21.8.10 Asynchronous Page Mode Access

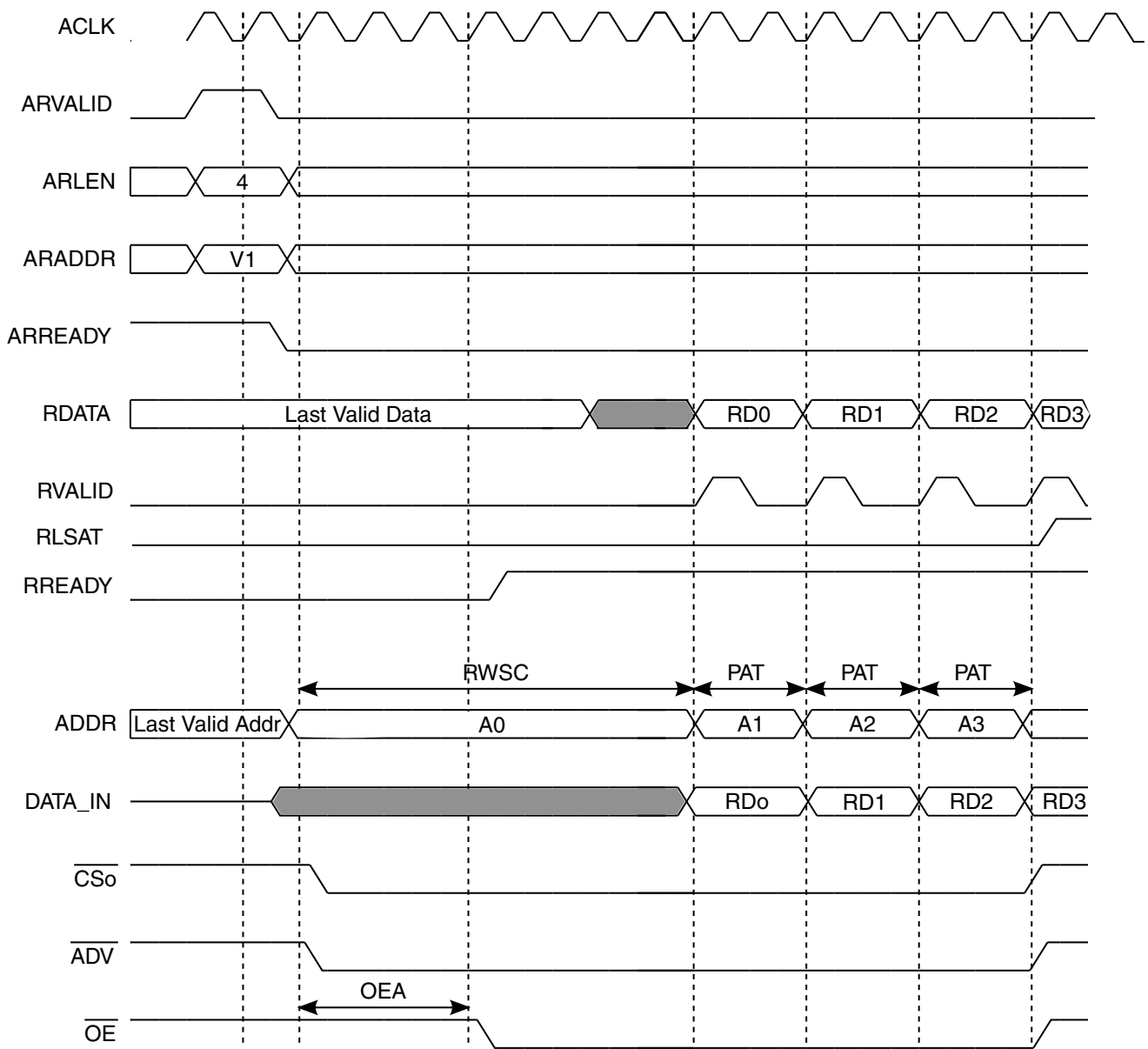

Figure 21-14. PAT = 2

21.8.11 DTACK Mode - AXI Single Access

External Bus Timing Diagrams

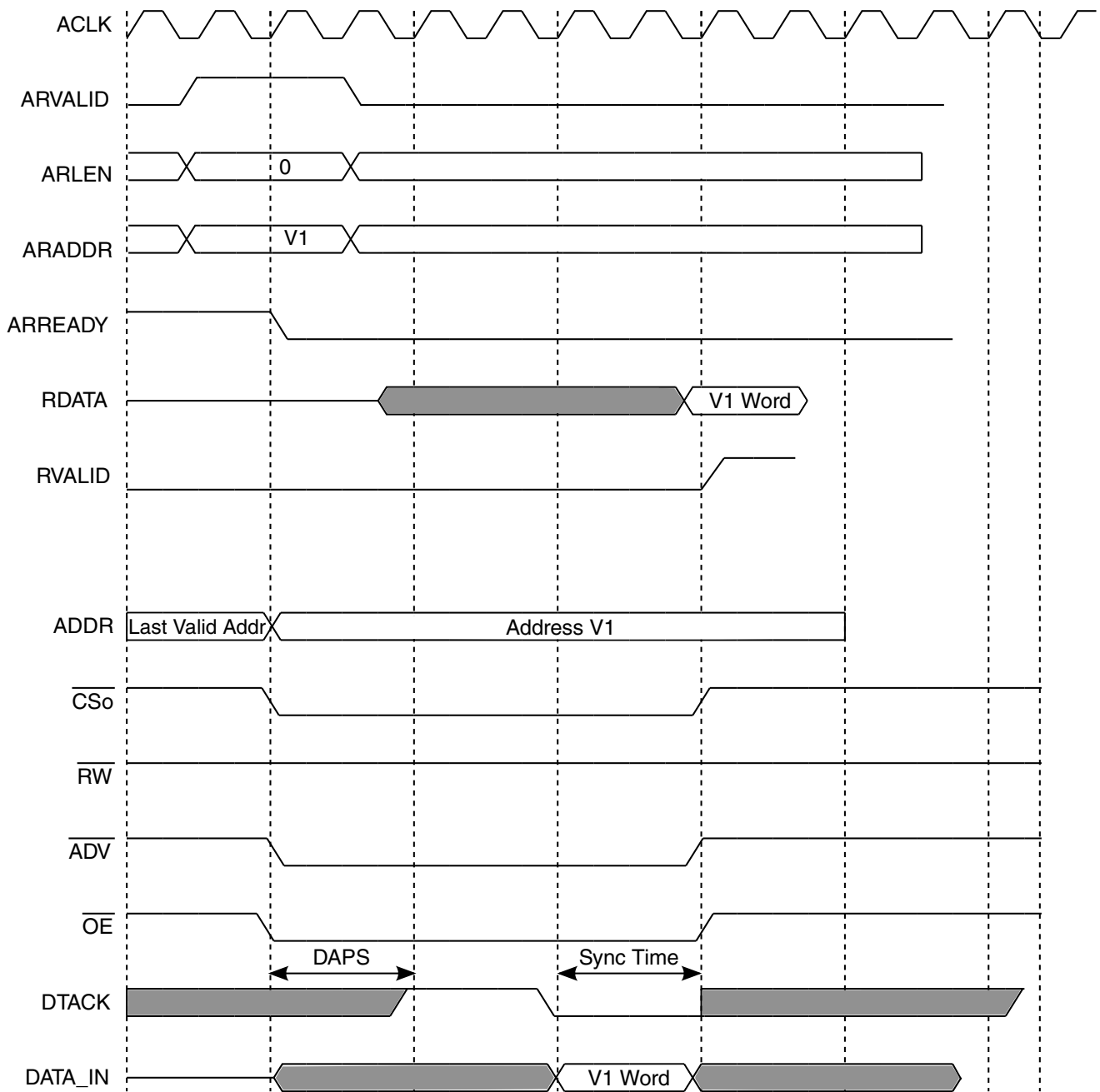

Figure 21-15. DAPS = 2

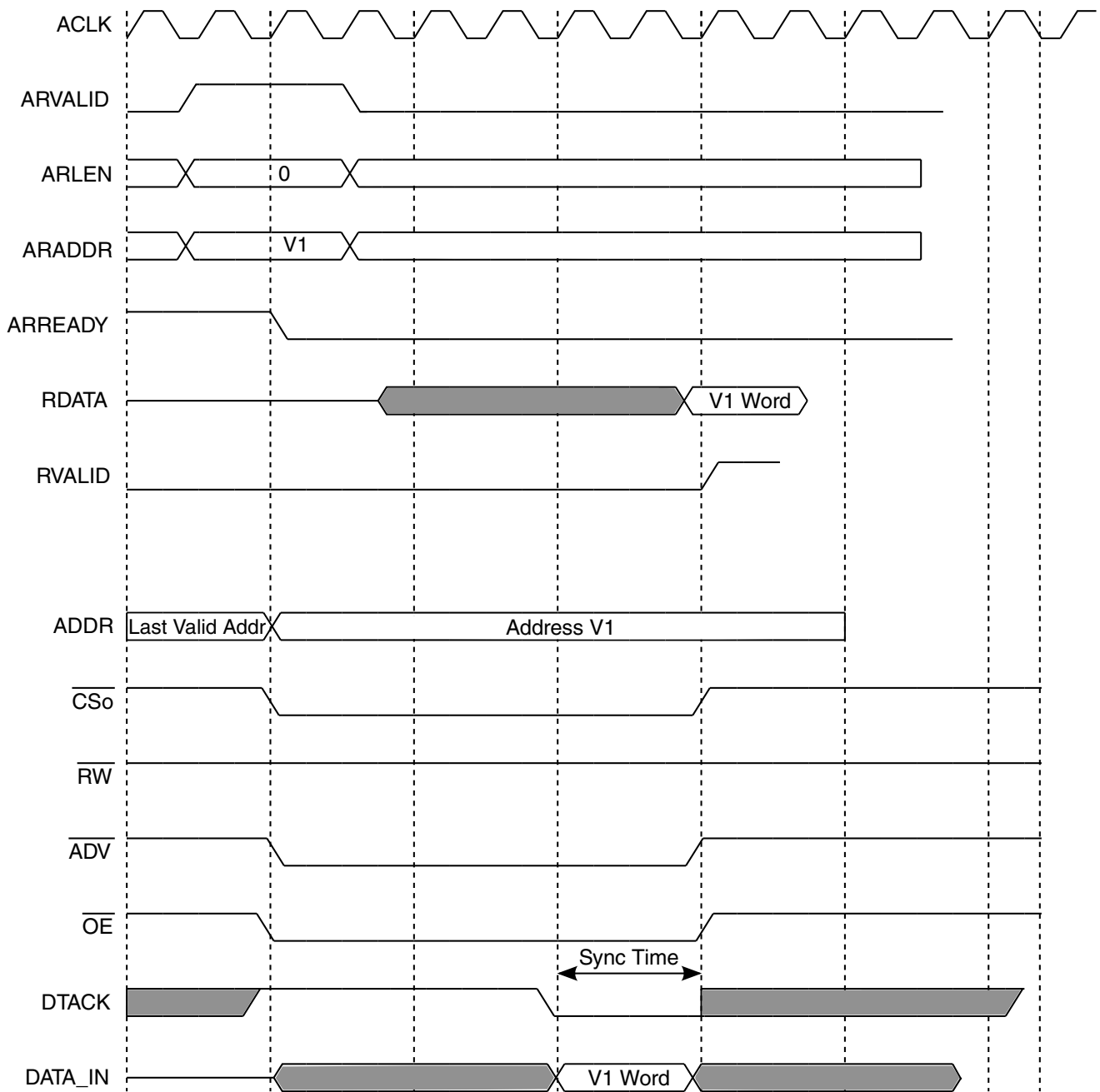

Figure 21-16. DAPS = 0

External Bus Timing Diagrams

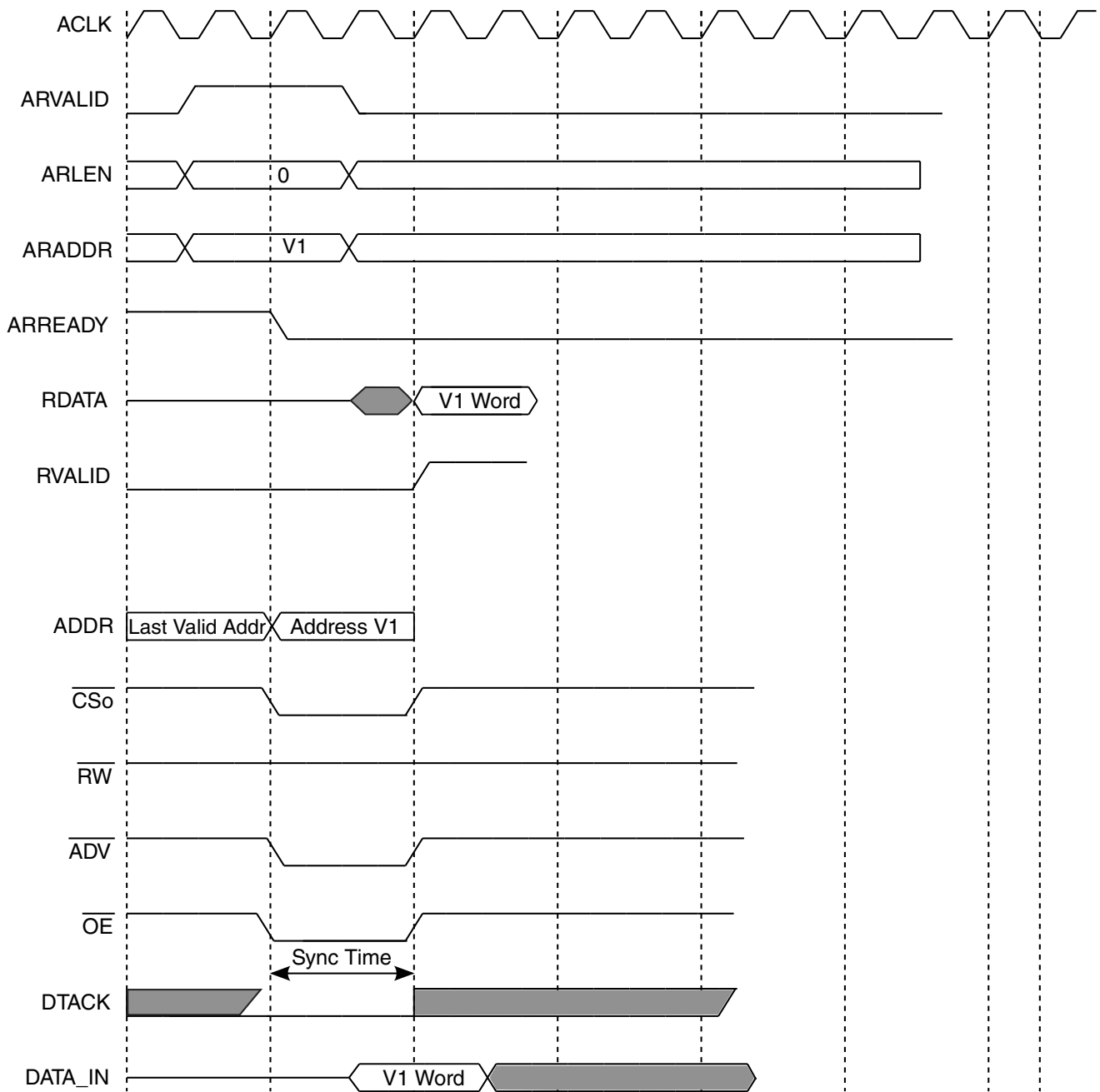

Figure 21-17. DAPS = 0

21.8.12 DTACK Mode - AXI Single Write Access

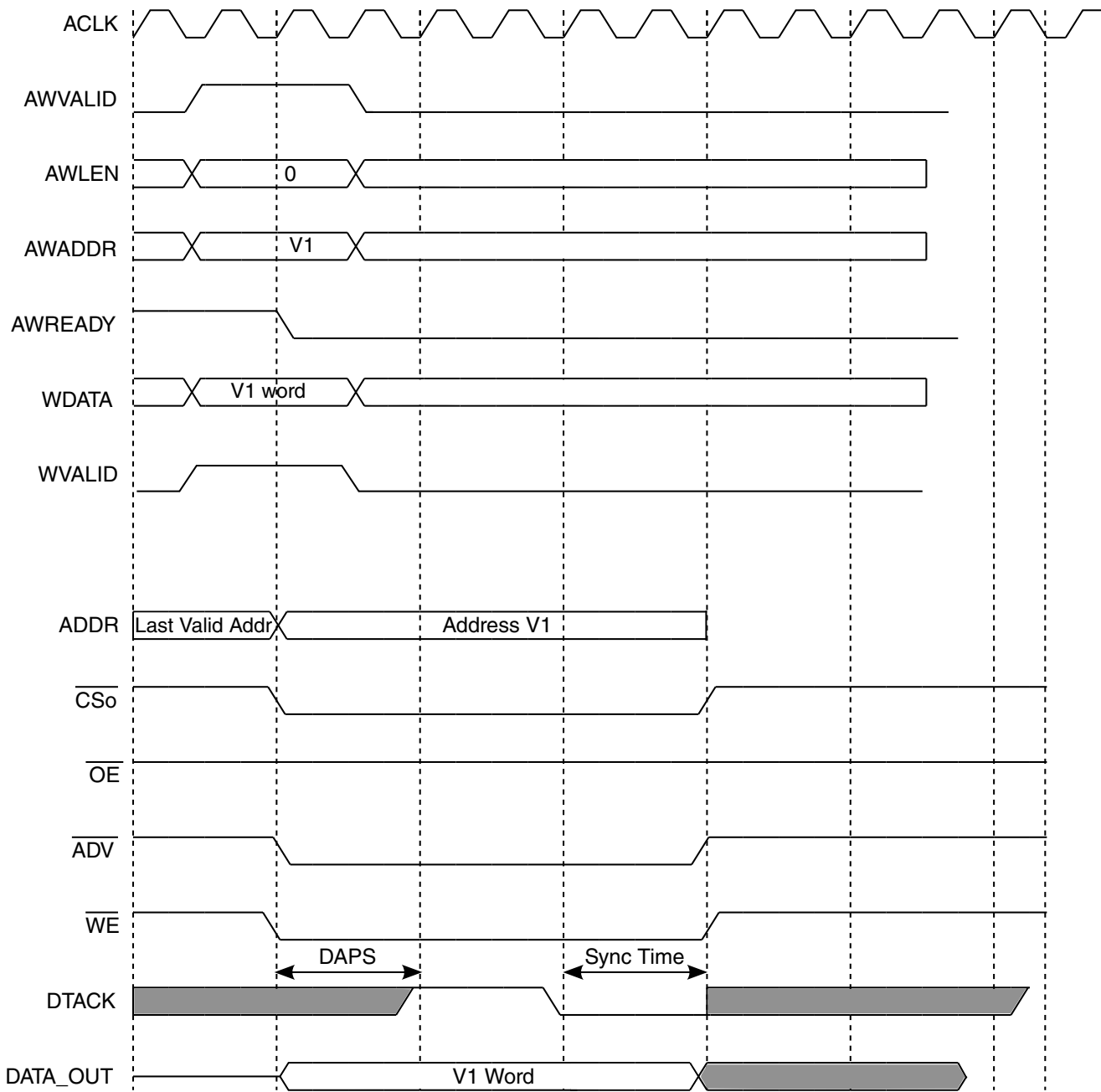

Figure 21-18. DAPS = 2

21.8.13 DTACK Mode - AXI Burst Access

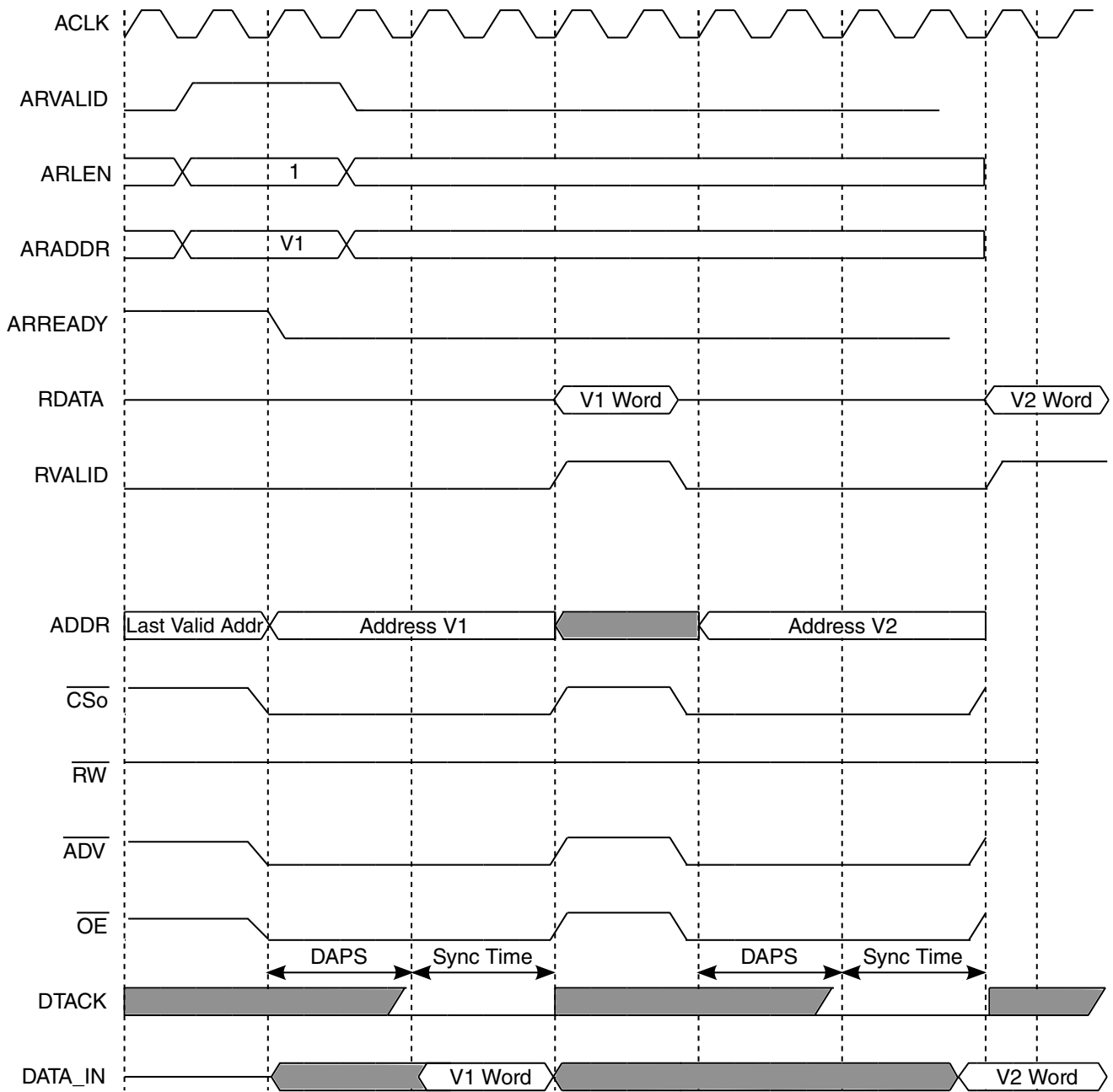

Figure 21-19. DAPS = 2 CSREC = 2

21.9 EIM Memory Map/Register Definition

The EIM includes 33 user-accessible 32-bit registers. The the EIM Configuration Register (EIM_WCR) contains control bits that configure the EIM for certain operation modes.

The 160 bits used to control Individual Chip Select are divided into five registers:

- Chip Select n General Configuration Register 1 (EIM_CSnGCR1)
- Chip Select n General Configuration Register 2 (EIM_CSnGCR2)
- Chip Select n Read Configuration Register 1 (EIM_CSnRCR1)
- Chip Select n Read Configuration Register 2 (EIM_CSnRCR2)
- Chip Select n Write Configuration Register (EIM_CSnWCR)

In addition there are 3 general registers: EIM_WCR, EIM_WIAR, and EIM_EAR.

NOTE

- All EIM registers are sampled by IPG_CLK_S, therefore IPG_CLK_S must be active when accessing through IP bus.
- Read access from all registers (except EIM_WIAR and EIM_EAR) will generate one IPG_XFR_WAIT cycle.
- Read access from EIM_WIAR and EIM_EAR will generate six IPG_XFR_WAIT cycles.
- Write access to all registers (except EIM_EAR) will generate three IPG_XFR_WAIT cycles.
- Write access to EIM_EAR will generate six IPG_XFR_WAIT cycles.

EIM memory map

Absolute address (hex)	Register name	Width (in bits)	Access	Reset value	Section/page
21B_8000	Chip Select n General Configuration Register 1 (EIM_CS0GCR1)	32	R/W	0001_0080h	21.9.1/869
21B_8004	Chip Select n General Configuration Register 2 (EIM_CS0GCR2)	32	R/W	0000_1000h	21.9.2/873
21B_8008	Chip Select n Read Configuration Register 1 (EIM_CS0RCR1)	32	R/W	0000_0000h	21.9.3/875
21B_800C	Chip Select n Read Configuration Register 2 (EIM_CS0RCR2)	32	R/W	0000_0000h	21.9.4/877
21B_8010	Chip Select n Write Configuration Register 1 (EIM_CS0WCR1)	32	R/W	0000_0000h	21.9.5/879
21B_8014	Chip Select n Write Configuration Register 2 (EIM_CS0WCR2)	32	R/W	0000_0000h	21.9.6/882
21B_8018	Chip Select n General Configuration Register 1 (EIM_CS1GCR1)	32	R/W	0001_0080h	21.9.1/869

Table continues on the next page...

EIM memory map (continued)

Absolute address (hex)	Register name	Width (in bits)	Access	Reset value	Section/page
21B_801C	Chip Select n General Configuration Register 2 (EIM_CS1GCR2)	32	R/W	0000_1000h	21.9.2/873
21B_8020	Chip Select n Read Configuration Register 1 (EIM_CS1RCR1)	32	R/W	0000_0000h	21.9.3/875
21B_8024	Chip Select n Read Configuration Register 2 (EIM_CS1RCR2)	32	R/W	0000_0000h	21.9.4/877
21B_8028	Chip Select n Write Configuration Register 1 (EIM_CS1WCR1)	32	R/W	0000_0000h	21.9.5/879
21B_802C	Chip Select n Write Configuration Register 2 (EIM_CS1WCR2)	32	R/W	0000_0000h	21.9.6/882
21B_8030	Chip Select n General Configuration Register 1 (EIM_CS2GCR1)	32	R/W	0001_0080h	21.9.1/869
21B_8034	Chip Select n General Configuration Register 2 (EIM_CS2GCR2)	32	R/W	0000_1000h	21.9.2/873
21B_8038	Chip Select n Read Configuration Register 1 (EIM_CS2RCR1)	32	R/W	0000_0000h	21.9.3/875
21B_803C	Chip Select n Read Configuration Register 2 (EIM_CS2RCR2)	32	R/W	0000_0000h	21.9.4/877
21B_8040	Chip Select n Write Configuration Register 1 (EIM_CS2WCR1)	32	R/W	0000_0000h	21.9.5/879
21B_8044	Chip Select n Write Configuration Register 2 (EIM_CS2WCR2)	32	R/W	0000_0000h	21.9.6/882
21B_8048	Chip Select n General Configuration Register 1 (EIM_CS3GCR1)	32	R/W	0001_0080h	21.9.1/869
21B_804C	Chip Select n General Configuration Register 2 (EIM_CS3GCR2)	32	R/W	0000_1000h	21.9.2/873
21B_8050	Chip Select n Read Configuration Register 1 (EIM_CS3RCR1)	32	R/W	0000_0000h	21.9.3/875
21B_8054	Chip Select n Read Configuration Register 2 (EIM_CS3RCR2)	32	R/W	0000_0000h	21.9.4/877
21B_8058	Chip Select n Write Configuration Register 1 (EIM_CS3WCR1)	32	R/W	0000_0000h	21.9.5/879
21B_805C	Chip Select n Write Configuration Register 2 (EIM_CS3WCR2)	32	R/W	0000_0000h	21.9.6/882
21B_8060	Chip Select n General Configuration Register 1 (EIM_CS4GCR1)	32	R/W	0001_0080h	21.9.1/869
21B_8064	Chip Select n General Configuration Register 2 (EIM_CS4GCR2)	32	R/W	0000_1000h	21.9.2/873
21B_8068	Chip Select n Read Configuration Register 1 (EIM_CS4RCR1)	32	R/W	0000_0000h	21.9.3/875
21B_806C	Chip Select n Read Configuration Register 2 (EIM_CS4RCR2)	32	R/W	0000_0000h	21.9.4/877
21B_8070	Chip Select n Write Configuration Register 1 (EIM_CS4WCR1)	32	R/W	0000_0000h	21.9.5/879

Table continues on the next page...

EIM memory map (continued)

Absolute address (hex)	Register name	Width (in bits)	Access	Reset value	Section/page
21B_8074	Chip Select n Write Configuration Register 2 (EIM_CS4WCR2)	32	R/W	0000_0000h	21.9.6/882
21B_8078	Chip Select n General Configuration Register 1 (EIM_CS5GCR1)	32	R/W	0001_0080h	21.9.1/869
21B_807C	Chip Select n General Configuration Register 2 (EIM_CS5GCR2)	32	R/W	0000_1000h	21.9.2/873
21B_8080	Chip Select n Read Configuration Register 1 (EIM_CS5RCR1)	32	R/W	0000_0000h	21.9.3/875
21B_8084	Chip Select n Read Configuration Register 2 (EIM_CS5RCR2)	32	R/W	0000_0000h	21.9.4/877
21B_8088	Chip Select n Write Configuration Register 1 (EIM_CS5WCR1)	32	R/W	0000_0000h	21.9.5/879
21B_808C	Chip Select n Write Configuration Register 2 (EIM_CS5WCR2)	32	R/W	0000_0000h	21.9.6/882
21B_8090	EIM Configuration Register (EIM_WCR)	32	R/W	See section	21.9.7/883

21.9.1 Chip Select n General Configuration Register 1 (EIM_CS_nGCR1)

Address: 21B_8000h base + 0h offset + (24d × i), where i=0d to 5d

Bit	31	30	29	28	27	26	25	24	23	22	21	20	19	18	17	16
R	PSZ				WP	GBC			AUS	CSREC			SP	DSZ		
W																
Reset	0	0	0	0	0	0	0	0	0	0	0	0	0	0	0	1
Bit	15	14	13	12	11	10	9	8	7	6	5	4	3	2	1	0
R	BCS		BCD		WC	BL			CREP	CRE	RFL	WFL	MUM	SRD	SWR	CSSEN
W																
Reset	0	0	0	0	0	0	0	0	1	0	0	0	0	0	0	0

EIM_CS_nGCR1 field descriptions

Field	Description
31–28 PSZ	Page Size. This bit field indicates memory page size in words (word is defined by the DSZ field). PSZ is used when fix latency mode is applied, WFL=1 for sync. write accesses, RFL=1 for sync. Read accesses. When working in fix latency mode WAIT signal from the external device is not being monitored, PSZ is used to determine if page boundary is reached and renewal of access is preformed. This bit field is ignored when sync. Mode is disabled or fix latency mode is not being used for write or read access separately.

Table continues on the next page...

EIM_CS n GCR1 field descriptions (continued)

Field	Description
	<p>It can be valid for both access type, read or write, or only for one type, according to configuration. PSZ is cleared by a hardware reset.</p> <p>0000 8 words page size 0001 16 words page size 0010 32 words page size 0011 64 words page size 0100 128 words page size 0101 256 words page size 0110 512 words page size 0111 1024 (1k) words page size 1000 2048 (2k) words page size 1001 - 1111 Reserved</p>
27 WP	<p>Write Protect. This bit prevents writes to the address range defined by the corresponding chip select. WP is cleared by a hardware reset.</p> <p>0 Writes are allowed in the memory range defined by chip. 1 Writes are prohibited. All attempts to write to an address mapped by this chip select result in a error response and no assertion of the chip select output.</p>
26–24 GBC	<p>Gap Between Chip Selects. This bit field, according to the settings shown below, determines the minimum time between end of access to the current chip select and start of access to different chip select. GBC is cleared by a hardware reset.</p> <p>Example settings:</p> <p>000 minimum of 0 EIM clock cycles before next access from different chip select (async. mode only) 001 minimum of 1 EIM clock cycles before next access from different chip select 010 minimum of 2 EIM clock cycles before next access from different chip select 111 minimum of 7 EIM clock cycles before next access from different chip select</p>
23 AUS	<p>Address UnShifted. This bit indicates an unshifted mode for address assertion for the relevant chip select accesses. AUS bit is cleared by hardware reset.</p> <p>0 Address shifted according to port size (DSZ config) (128 Mbyte maximum supported memory density). 1 Address unshifted (32 Mbyte maximum supported memory density).</p>
22–20 CSREC	<p>CS Recovery. This bit field, according to the settings shown below, determines the minimum pulse width of CS, OE, and WE control signals before executing a new back to back access to the same chip select. CSREC is cleared by a hardware reset.</p> <p>NOTE: The reset value for EIM_CS0GCR1, CSREC[2:0] is 0b110. For EIM_CS1GCR1 - EIM_CS5GCR, the reset value is 0b000.</p> <p>Example settings:</p> <p>000 0 EIM clock cycles minimum width of CS, OE and WE signals (read async. mode only) 001 1 EIM clock cycles minimum width of CS, OE and WE signals 010 2 EIM clock cycles minimum width of CS, OE and WE signals 111 7 EIM clock cycles minimum width of CS, OE and WE signals</p>
19 SP	<p>Supervisor Protect. This bit prevents accesses to the address range defined by the corresponding chip select when the access is attempted in the User mode. SP is cleared by a hardware reset.</p>

Table continues on the next page...

EIM_CS n GCR1 field descriptions (continued)

Field	Description
	<p>0 User mode accesses are allowed in the memory range defined by chip select.</p> <p>1 User mode accesses are prohibited. All attempts to access an address mapped by this chip select in User mode results in an error response and no assertion of the chip select output.</p>
18–16 DSZ	<p>Data Port Size. This bit field defines the width of an external device's data port as shown below.</p> <p>NOTE: Only async. access supported for 8 bit port.</p> <p>NOTE: The reset value for EIM_CS0GCR1, DSZ[2] = 0, DSZ[1:0] = EIM_BOOT[1:0]. For EIM_CS1GCR1 - EIM_CS5GCR1, the reset value is 0b001.</p> <p>000 Reserved.</p> <p>001 16 bit port resides on DATA[15:0]</p> <p>010 16 bit port resides on DATA[31:16]</p> <p>011 32 bit port resides on DATA[31:0]</p> <p>100 8 bit port resides on DATA[7:0]</p> <p>101 8 bit port resides on DATA[15:8]</p> <p>110 8 bit port resides on DATA[23:16]</p> <p>111 8 bit port resides on DATA[31:24]</p>
15–14 BCS	<p>Burst Clock Start. When SRD=1 or SWR=1, this bit field determines the number of EIM clock cycles delay from start of access before the first rising edge of BCLK is generated.</p> <p>When BCD=0 value of BCS=0 results in a half clock delay after the start of access. For other values of BCD a one clock delay after the start of access is applied, not an immediate assertion. BCS is cleared by a hardware reset.</p> <p>00 0 EIM clock cycle additional delay</p> <p>01 1 EIM clock cycle additional delay</p> <p>10 2 EIM clock cycle additional delay</p> <p>11 3 EIM clock cycle additional delay</p>
13–12 BCD	<p>Burst Clock Divisor. This bit field contains the value used to program the burst clock divisor for BCLK generation. It is used to divide the internal EIMbus frequency. BCD is cleared by a hardware reset.</p> <p>NOTE: For other then the mentioned below frequency such as 104 MHz, EIM clock (input clock) should be adjust accordingly.</p> <p>00 Divide EIM clock by 1</p> <p>01 Divide EIM clock by 2</p> <p>10 Divide EIM clock by 3</p> <p>11 Divide EIM clock by 4</p>
11 WC	<p>Write Continuous. The WI bit indicates that write access to the memory are always continuous accesses regardless of the BL field value. WI is cleared by hardware reset.</p> <p>0 Write access burst length occurs according to BL value.</p> <p>1 Write access burst length is continuous.</p>
10–8 BL	<p>Burst Length. The BL bit field indicates memory burst length in words (word is defined by the DSZ field) and should be properly initialized for mixed wrap/increment accesses support. Continuous BL value corresponds to continuous burst length setting of the external memory device. For fix memory burst size, type is always wrap. In case not matching wrap boundaries in both the memory (BL field) and Master access on the current address, EIM update address on the external device address bus and regenerates the access.</p> <p>BL is cleared by a hardware reset.</p>

Table continues on the next page...

EIM_CS n GCR1 field descriptions (continued)

Field	Description
	<p>When APR=1, Page Read Mode is applied, BL determine the number of words within the read page burst. BL is cleared by a hardware reset for EIM_CS0GCR1 - EIM_CS5GCR1.</p> <p>000 4 words Memory wrap burst length (read page burst size when APR = 1) 001 8 words Memory wrap burst length (read page burst size when APR = 1) 010 16 words Memory wrap burst length (read page burst size when APR = 1) 011 32 words Memory wrap burst length (read page burst size when APR = 1) 100 Continuous burst length (2 words read page burst size when APR = 1) 101 Reserved 110 Reserved 111 Reserved</p>
7 CREP	<p>Configuration Register Enable Polarity. This bit indicates CRE memory pin assertion state, active-low or active-high, while executing a memory register set command to the external device (PSRAM memory type). CREP is set by a hardware reset.</p> <p>NOTE: Whenever PSRAM is connected the CREP value must be correct also for accesses where CRE is disabled.</p> <p>For Non-PSRAM memory CREP value should be 1.</p> <p>0 CRE signal is active low 1 CRE signal is active high</p>
6 CRE	<p>Configuration Register Enable. This bit indicates CRE memory pin state while executing a memory register set command to PSRAM external device. CRE is cleared by a hardware reset.</p> <p>0 CRE signal use is disable 1 CRE signal use is enable</p>
5 RFL	<p>Read Fix Latency. This bit field determine if the controller is monitoring the WAIT signal from the External device connected to the chip select (handshake mode - fix or variable data latency) or if it start sampling data according to RWSC field, it only valid in synchronous mode. RFL is cleared by a hardware reset.</p> <p>When RFL=1 Burst access is terminated on page boundary and resume on the following page according to BL bit field configuration, because WAIT signal is not monitored from the external device.</p> <p>0 the External device WAIT signal is being monitored, and it reflect the external data bus state 1 the state of the External devices is determined internally (Fix latency mode only)</p>
4 WFL	<p>Write Fix Latency. This bit field determine if the controller is monitoring the WAIT signal from the External device connected to the chip select (handshake mode - fix or variable data latency) or if it start data transfer according to WWSC field, it only valid in synchronous mode. WFL is cleared by a hardware reset.</p> <p>When WFL=1 Burst access is terminated on page boundary and resume on the following page according to BL bit field configuration, because WAIT signal is not monitored from the external device</p> <p>0 the External device WAIT signal is being monitored, and it reflect the external data bus state 1 the state of the External devices is determined internally (Fix latency mode only)</p>
3 MUM	<p>Multiplexed Mode. This bit determines the address/data multiplexed mode for asynchronous and synchronous accesses for 8 bit, 16 bit or 32 bit devices (DSZ config. dependent).</p> <p>NOTE: The reset value for EIM_CS0GCR1[MUM] = EIM_BOOT[2]. For EIM_CS1GCR1 - EIM_CS5GCR1 the reset value is 0.</p> <p>0 Multiplexed Mode disable 1 Multiplexed Mode enable</p>

Table continues on the next page...

EIM_CS n GCR1 field descriptions (continued)

Field	Description
2 SRD	<p>Synchronous Read Data. This bit field determine the read accesses mode to the External device of the chip select. The External device should be configured to the same mode as this bit implicates. SRD is cleared by a hardware reset.</p> <p>NOTE: Sync. accesses supported only for 16/32 bit port.</p> <p>0 read accesses are in Asynchronous mode 1 read accesses are in Synchronous mode</p>
1 SWR	<p>Synchronous Write Data. This bit field determine the write accesses mode to the External device of the chip select. The External device should be configured to the same mode as this bit implicates. SWR is cleared by a hardware reset.</p> <p>NOTE: Sync. accesses supported only for 16/32 bit port.</p> <p>0 write accesses are in Asynchronous mode 1 write accesses are in Synchronous mode</p>
0 CSEN	<p>CS Enable. This bit controls the operation of the chip select pin. CSEN is set by a hardware reset for CSGCR0 to allow external boot operation. CSEN is cleared by a hardware reset to CSGCR1-CSGCR5.</p> <p>NOTE: Reset value for EIM_CS0GCR1 for CSEN is 1. For EIM_CS1GCR1-CS1GCR5 reset value is 0.</p> <p>0 Chip select function is disabled; attempts to access an address mapped by this chip select results in an error respond and no assertion of the chip select output 1 Chip select is enabled, and is asserted when presented with a valid access.</p>

21.9.2 Chip Select n General Configuration Register 2 (EIM_CS n GCR2)

Address: 21B_8000h base + 4h offset + (24d \times i), where i=0d to 5d

Bit	31	30	29	28	27	26	25	24	23	22	21	20	19	18	17	16
R	0															
W	[Reserved]															
Reset	0	0	0	0	0	0	0	0	0	0	0	0	0	0	0	0
Bit	15	14	13	12	11	10	9	8	7	6	5	4	3	2	1	0
R	0		MUX16_BYP_ GRANT	0		DAP	DAE	DAPS					0		ADH	
W	[Reserved]			[Reserved]		[Reserved]	[Reserved]	[Reserved]					[Reserved]		[Reserved]	
Reset	0	0	0	1	0	0	0	0	0	0	0	0	0	0	0	0

EIM_CS_nGCR2 field descriptions

Field	Description
31–13 Reserved	This read-only field is reserved and always has the value 0.
12 MUX16_BYP_ GRANT	Muxed 16 bypass grant. This bit when asserted causes EIM to bypass the grant/ack. arbitration with NFC (only for 16 bit muxed mode accesses). 0 EIM waits for grant before driving a 16 bit muxed mode access to the memory. 1 EIM ignores the grant signal and immediately drives a 16 bit muxed mode access to the memory.
11–10 Reserved	This read-only field is reserved and always has the value 0.
9 DAP	Data Acknowledge Polarity. This bit indicates DTACK memory pin assertion state, active-low or active-high, while executing an async access using DTACK signal from the external device. DAP is cleared by a hardware reset. 0 DTACK signal is active high 1 DTACK signal is active low
8 DAE	Data Acknowledge Enable. This bit indicates external device is using DTACK pin as strobe/terminator of an async. access. DTACK signal may be used only in asynchronous single read (APR=0) or write accesses. DTACK poling start point is set by DAPS bit field. polarity of DTACK is set by DAP bit field. DAE is cleared by a hardware reset. 0 DTACK signal use is disable 1 DTACK signal use is enable
7–4 DAPS	Data Acknowledge Poling Start. This bit field determine the starting point of DTACK input signal polling. DAPS is used only in asynchronous single read or write accesses. NOTE: Since DTACK is an async. signal the start point of DTACK signal polling is at least 3 cycles after the start of access. DAPS is cleared by a hardware reset. Example settings: 0000 3 EIM clk cycle between start of access and first \overline{DTACK} check 0001 4 EIM clk cycles between start of access and first \overline{DTACK} check 0010 5 EIM clk cycles between start of access and first \overline{DTACK} check 0111 10 EIM clk cycles between start of access and first \overline{DTACK} check 1011 14 EIM clk cycles between start of access and first DTACK check 1111 18 EIM clk cycles between start of access and first DTACK check
3–2 Reserved	This read-only field is reserved and always has the value 0.
ADH	Address hold time - This bit field determine the address hold time after ADV negation when mum = 1 (muxed mode). When mum = 0 this bit has no effect. For read accesses the field determines when the pads direction will be switched. NOTE: Reset value for EIM_CS0GCR2 for ADH is 10. For EIM_CS1GCR2-EIM_CS5GCR2 reset value is 00. 00 0 cycle after ADV negation 01 1 cycle after ADV negation 10 2 cycle after ADV negation 11 Reserved

21.9.3 Chip Select n Read Configuration Register 1 (EIM_CS_nRCR1)

Address: 21B_8000h base + 8h offset + (24d × i), where i=0d to 5d

Bit	31	30	29	28	27	26	25	24	23	22	21	20	19	18	17	16				
R	0								0	RADVA			RAL	RADVN						
W	0								0	0			0	0						
Reset	0	0	0	0	0	0	0	0	0	0	0	0	0	0	0	0				
Bit	15	14	13	12	11	10	9	8	7	6	5	4	3	2	1	0				
R	0				OEA				0	OEN				0	RCSA			0	RCSN	
W	0				0				0	0				0	0		0			
Reset	0	0	0	0	0	0	0	0	0	0	0	0	0	0	0	0				

EIM_CS_nRCR1 field descriptions

Field	Description
31–30 Reserved	This read-only field is reserved and always has the value 0.
29–24 RWSC	<p>Read Wait State Control. This bit field programs the number of wait-states, according to the settings shown below, for synchronous or asynchronous read access to the external device connected to the chip select.</p> <p>When SRD=1 and RFL=0, RWSC indicates the number of burst clock (BCLK) cycles from the start of an access, before the controller can start sample data. Since WAIT signal can be asserted one cycle before the first data can be sampled, the controller starts evaluating the WAIT signal state one cycle before, this is referred as handshake mode or variable latency mode.</p> <p>When SRD=1 and RFL=1, RWSC indicates the number of burst clock (BCLK) cycles from the start of an access, until the external device is ready for data transfer, this is referred as fix latency mode.</p> <p>When SRD=0, RFL bit is ignored, RWSC indicates the asynchronous access length and the number of EIM clock cycles from the start of access until the external device is ready for data transfer.</p> <p>RWSC is cleared by a hardware reset.</p> <p>NOTE: The reset value for EIM_CS0RCR1, RWSC[5:0] = 0b011100. For CG1RCR1 - CS1RCR5 the reset value is 0b000000.</p> <p>Example settings:</p> <p>000000 Reserved 000001 RWSC value is 1 000010 RWSC value is 2 111101 RWSC value is 61 111110 RWSC value is 62 111111 RWSC value is 63</p>
23 Reserved	This read-only field is reserved and always has the value 0.
22–20 RADVA	<p>ADV Assertion. This bit field determines when ADV signal is asserted for synchronous or asynchronous read modes according to the settings shown below. RADVA is cleared by a hardware reset.</p> <p>Example settings:</p> <p>000 0 EIM clock cycles between beginning of access and ADV assertion</p>

Table continues on the next page...

EIM_CS n RCR1 field descriptions (continued)

Field	Description
	001 1 EIM clock cycles between beginning of access and ADV assertion 010 2 EIM clock cycles between beginning of access and ADV assertion 111 7 EIM clock cycles between beginning of access and ADV assertion
19 RAL	Read ADV Low. This bit field determine ADV signal negation time. When RAL=1, RADVN bit field is ignored and ADV signal will stay asserted until end of access. When RAL=0 negation of ADV signal is according to RADVN bit field configuration.
18–16 RADVN	ADV Negation. This bit field determines when ADV signal to memory is negated during read accesses. When SRD=1 (synchronous read mode), ADV negation occurs according to the following formula: (RADVN + RADVA + BCD + BCS + 1) EIM clock cycles from start of access. When asynchronous read mode is applied (SRD=0) and RAL=0 ADV negation occurs according to the following formula: (RADVN + RADVA + 1) EIM clock cycles from start of access. RADVN is cleared by a hardware reset. NOTE: the reset value for EIM_CS0RCR1[RADVN] = 2. For EIM_CS1RCR1 - EIM_CS5RCR1, the reset value is 0b000. NOTE: This field should be configured so ADV negation will occur before the end of access. For ADV negation at the same time with the end of access user should RAL bit.
15 Reserved	This read-only field is reserved and always has the value 0.
14–12 OEA	OE Assertion. This bit field determines when OE signal are asserted during read cycles (synchronous or asynchronous mode), according to the settings shown below. OEA is cleared by a hardware reset. In muxed mode OE assertion occurs (OEA + RADVN + RADVA + ADH +1) EIM clock cycles from start of access. NOTE: The reset value for EIM_CS0RCR1[OEA] is 0b000 if EIM_BOOT[2] = 0. If EIM_BOOT[2] is 1, the reset value for EIM_CS0RCR1 is 0b010. The reset value of this field for EIM_CS1RCR1 - EIM_CS5RCR1 is 0b000. Example settings: 000 0 EIM clock cycles between beginning of access and OE assertion 001 1 EIM clock cycles between beginning of access and OE assertion 010 2 EIM clock cycles between beginning of access and OE assertion 111 7 EIM clock cycles between beginning of access and OE assertion
11 Reserved	This read-only field is reserved and always has the value 0.
10–8 OEN	OE Negation. This bit field determines when OE signal is negated during read cycles in asynchronous single mode only (SRD=0 and APR = 0), according to the settings shown below. This bit field is ignored when SRD=1. OEN is cleared by a hardware reset. Example settings: 000 0 EIM clock cycles between end of access and OE negation 001 1 EIM clock cycles between end of access and OE negation 010 2 EIM clock cycles between end of access and OE negation 111 7 EIM clock cycles between end of access and OE negation
7 Reserved	This read-only field is reserved and always has the value 0.
6–4 RCSA	Read CS Assertion. This bit field determines when CS signal is asserted during read cycles (synchronous or asynchronous mode), according to the settings shown below. RCSA is cleared by a hardware reset.

Table continues on the next page...

EIM_CS n RRCR1 field descriptions (continued)

Field	Description
	<p>Example settings:</p> <p>000 0 EIM clock cycles between beginning of read access and CS assertion</p> <p>001 1 EIM clock cycles between beginning of read access and CS assertion</p> <p>010 2 EIM clock cycles between beginning of read access and CS assertion</p> <p>111 7 EIM clock cycles between beginning of read access and CS assertion</p>
3 Reserved	This read-only field is reserved and always has the value 0.
RCSN	<p>Read CS Negation. This bit field determines when CS signal is negated during read cycles in asynchronous single mode only (SRD=0 and APR = 0), according to the settings shown below. This bit field is ignored when SRD=1. RCSN is cleared by a hardware reset.</p> <p>Example settings:</p> <p>000 0 EIM clock cycles between end of read access and CS negation</p> <p>001 1 EIM clock cycles between end of read access and CS negation</p> <p>010 2 EIM clock cycles between end of read access and CS negation</p> <p>111 7 EIM clock cycles between end of read access and CS negation</p>

21.9.4 Chip Select n Read Configuration Register 2 (EIM_CS n RRCR2)

Address: 21B_8000h base + Ch offset + (24d × i), where i=0d to 5d

Bit	31	30	29	28	27	26	25	24	23	22	21	20	19	18	17	16
R	0															
W																
Reset	0	0	0	0	0	0	0	0	0	0	0	0	0	0	0	0
Bit	15	14	13	12	11	10	9	8	7	6	5	4	3	2	1	0
R	APR	PAT		0		RL		0	RBEA		RBE	RBEN				
W																
Reset	0	0	0	0	0	0	0	0	0	0	0	0	0	0	0	0

EIM_CS n RRCR2 field descriptions

Field	Description
31–16 Reserved	This read-only field is reserved and always has the value 0.
15 APR	<p>Asynchronous Page Read. This bit field determine the asynchronous read mode to the external device. When APR=0, the async. read access is done as single word (where word is defined by the DSZ field). when APR=1, the async. read access executed as page read. page size is according to BL field config., RCSN,RBEN,OEN and RADVN are being ignored.</p> <p>APR is cleared by a hardware reset for EIM_CS1GCR1 - EIM_CS5GCR1.</p> <p>NOTE: SRD=0 and MUM=0 must apply when APR=1</p>

Table continues on the next page...

EIM_CS n RRCR2 field descriptions (continued)

Field	Description
14–12 PAT	<p>Page Access Time. This bit field is used in Asynchronous Page Read mode only (APR=1). the initial access is set by RWSC as in regular asynchronous mode. the consecutive address assertions width determine by PAT field according to the settings shown below. when APR=0 this field is ignored.</p> <p>PAT is cleared by a hardware reset for EIM_CS1GCR1 - EIM_CS5GCR1.</p> <p>000 Address width is 2 EIM clock cycles 001 Address width is 3 EIM clock cycles 010 Address width is 4 EIM clock cycles 011 Address width is 5 EIM clock cycles 100 Address width is 6 EIM clock cycles 101 Address width is 7 EIM clock cycles 110 Address width is 8 EIM clock cycles 111 Address width is 9 EIM clock cycles</p>
11–10 Reserved	This read-only field is reserved and always has the value 0.
9–8 RL	<p>Read Latency. This bit field indicates cycle latency when executing a synchronous read operation.</p> <p>The fields holds the feedback clock loop delay in aclk cycle units.</p> <p>This field is cleared by a hardware reset.</p> <p>00 Feedback clock loop delay is up to 1 cycle for BCD = 0 or 1.5 cycles for BCD != 0 01 Feedback clock loop delay is up to 2 cycles for BCD = 0 or 2.5 cycles for BCD != 0 10 Feedback clock loop delay is up to 3 cycles for BCD = 0 or 3.5 cycles for BCD != 0 11 Feedback clock loop delay is up to 4 cycles for BCD = 0 or 4.5 cycles for BCD != 0</p>
7 Reserved	This read-only field is reserved and always has the value 0.
6–4 RBEA	<p>Read BE Assertion. This bit field determines when BE signal is asserted during read cycles (synchronous or asynchronous mode), according to the settings shown below. RBEA is cleared by a hardware reset.</p> <p>Example settings:</p> <p>000 0 EIM clock cycles between beginning of read access and BE assertion 001 1 EIM clock cycles between beginning of read access and BE assertion 010 2 EIM clock cycles between beginning of read access and BE assertion 111 7 EIM clock cycles between beginning of read access and BE assertion</p>
3 RBE	<p>Read BE enable. This bit field determines if BE will be asserted during read access.</p> <p>0 - BE are disabled during read access. 1- BE are enable during read access according to value of RBEA and RBEN bit fields.</p>
RBEN	<p>Read BE Negation. This bit field determines when BE signal is negated during read cycles in asynchronous single mode only (SRD=0 and APR=0), according to the settings shown below. This bit field is ignored when SRD=1. RBEN is cleared by a hardware reset.</p> <p>Example settings:</p> <p>000 0 EIM clock cycles between end of read access and BE negation 001 1 EIM clock cycles between end of read access and BE negation 010 2 EIM clock cycles between end of read access and BE negation 111 7 EIM clock cycles between end of read access and BE negation</p>

21.9.5 Chip Select n Write Configuration Register 1 (EIM_CSnWCR1)

Address: 21B_8000h base + 10h offset + (24d × i), where i=0d to 5d

Bit	31	30	29	28	27	26	25	24	23	22	21	20	19	18	17	16
R																
W																
Reset	0	0	0	0	0	0	0	0	0	0	0	0	0	0	0	0
Bit	15	14	13	12	11	10	9	8	7	6	5	4	3	2	1	0
R																
W																
Reset	0	0	0	0	0	0	0	0	0	0	0	0	0	0	0	0

EIM_CSnWCR1 field descriptions

Field	Description
31 WAL	Write ADV Low. This bit field determine ADV signal negation time in write accesses. When WAL=1, WADVN bit field is ignored and ADV signal will stay asserted until end of access. When WAL=0 negation of ADV signal is according to WADVN bit field configuration.
30 WBED	Write Byte Enable Disable. When asserted this bit prevent from IPP_DO_BE_B[x] to be asserted during write accesses. This bit is cleared by hardware reset.
29–24 WWSC	<p>Write Wait State Control. This bit field programs the number of wait-states, according to the settings shown below, for synchronous or asynchronous write access to the external device connected to the chip select.</p> <p>When SWR=1 and WFL=0, WWSC indicates the number of burst clock (BCLK) cycles from the start of an access, before the memory can sample the first data. Since WAIT signal can be asserted one cycle before the first data can be sampled, the controller starts evaluating the WAIT signal state one cycle before, this is referred as handshake mode or variable latency mode.</p> <p>When SWR=1 and WFL=1, WWSC indicates the number of burst clock (BCLK) cycles from the start of an access, until the external device is ready for data transfer, this is referred as fix latency mode.</p> <p>When SWR=0, WFL bit is ignored, WWSC indicates the asynchronous access length and the number of EIM clock cycles from the start of access until the external device is ready for data transfer.</p> <p>WWSC is cleared by a hardware reset.</p> <p>NOTE: The reset value for EIM_CS0WCR1, WWSC[5:0] = 0b011100. For EIM_CS1WCR1 - EIM_CS5WCR1, the reset value of this field is 0b000000.</p> <p>Example settings:</p> <p>000000 Reserved 000001 WWSC value is 1 000010 WWSC value is 2 000011 WWSC value is 3 111111 WWSC value is 63</p>

Table continues on the next page...

EIM_CS n WCR1 field descriptions (continued)

Field	Description
23–21 WADVA	<p>ADV Assertion. This bit field determines when ADV signal is asserted for synchronous or asynchronous write modes according to the settings shown below. WADVA is cleared by a hardware reset.</p> <p>Example settings:</p> <p>000 0 EIM clock cycles between beginning of access and ADV assertion 001 1 EIM clock cycles between beginning of access and ADV assertion 010 2 EIM clock cycles between beginning of access and ADV assertion 111 7 EIM clock cycles between beginning of access and ADV assertion</p>
20–18 WADVN	<p>ADV Negation. This bit field determines when ADV signal to memory is negated during write accesses.</p> <p>When SWR=1 (synchronous write mode), ADV negation occurs according to the following formula: (WADVN + WADVA + BCD + BCS + 1) EIM clock cycles.</p> <p>When asynchronous read mode is applied (SWR=0) ADV negation occurs according to the following formula: (WADVN + WADVA + 1) EIM clock cycles.</p> <p>NOTE: Reset value for EIM_CS0WCR for WADVN is 2. For EIM_CS1WCR - EIM_CS5WCR reset value is 000.</p> <p>NOTE: This field should be configured so ADV negation will occur before the end of access. For ADV negation at the same time as the end of access, S/W should set the WAL bit.</p>
17–15 WBEA	<p>BE Assertion. This bit field determines when BE signal is asserted during write cycles in async. mode only (SWR=0), according to the settings shown below. BEA is cleared by a hardware reset.</p> <p>NOTE: Reset value for EIM_CS0WCR for WBEA is 2. For EIM_CS1WCR - EIM_CS5WCR reset value is 000.</p> <p>Example settings:</p> <p>000 0 EIM clock cycles between beginning of access and BE assertion 001 1 EIM clock cycles between beginning of access and BE assertion 010 2 EIM clock cycles between beginning of access and BE assertion 111 7 EIM clock cycles between beginning of access and BE assertion</p>
14–12 WBEN	<p>BE[3:0] Negation. This bit field determines when BE[3:0] bus signal is negated during write cycles in async. mode only (SWR=0), according to the settings shown below. This bit field is ignored when SWR=1. BEN is cleared by a hardware reset.</p> <p>NOTE: Reset value for EIM_CS0WCR for WBEN is 2. For EIM_CS1WCR - EIM_CS5WCR reset value is 000.</p> <p>Example settings:</p> <p>000 0 EIM clock cycles between end of access and WE negation 001 1 EIM clock cycles between end of access and WE negation 010 2 EIM clock cycles between end of access and WE negation 111 7 EIM clock cycles between end of access and WE negation</p>
11–9 WEA	<p>WE Assertion. This bit field determines when WE signal is asserted during write cycles (synchronous or asynchronous mode), according to the settings shown below. This bit field is ignored when executing a read access to the external device. WEA is cleared by a hardware reset.</p> <p>NOTE: Reset value for EIM_CS0WCR for WEA is 2. For EIM_CS1WCR - EIM_CS5WCR reset value is 000.</p> <p>Example settings:</p>

Table continues on the next page...

EIM_CS n WCR1 field descriptions (continued)

Field	Description
	000 0 EIM clock cycles between beginning of access and WE assertion 001 1 EIM clock cycles between beginning of access and WE assertion 010 2 EIM clock cycles between beginning of access and WE assertion 111 7 EIMclock cycles between beginning of access and WE assertion
8–6 WEN	WE Negation. This bit field determines when WE signal is negated during write cycles in asynchronous mode only (SWR=0), according to the settings shown below. This bit field is ignored when SWR=1. WEN is cleared by a hardware reset. NOTE: Reset value for EIM_CS0WCR for WEN is 2. For EIM_CS1WCR - EIM_CS5WCR reset value is 000. Example settings: 000 0 EIM clock cycles between beginning of access and WE assertion 001 1 EIM clock cycles between beginning of access and WE assertion 010 2 EIM clock cycles between beginning of access and WE assertion 111 7 EIM clock cycles between beginning of access and WE assertion
5–3 WCSA	Write CS Assertion. This bit field determines when CS signal is asserted during write cycles (synchronous or asynchronous mode), according to the settings shown below.this bit field is ignored when executing a read access to the external device. WCSA is cleared by a hardware reset. Example settings: 000 0 EIM clock cycles between beginning of write access and CS assertion 001 1 EIM clock cycles between beginning of write access and CS assertion 010 2 EIM clock cycles between beginning of write access and CS assertion 111 7 EIMclock cycles between beginning of write access and CS assertion
WCSN	Write CS Negation. This bit field determines when CS signal is negated during write cycles in asynchronous mode only (SWR=0), according to the settings shown below. This bit field is ignored when SWR=1. WCSN is cleared by a hardware reset. Example settings: 000 0 EIM clock cycles between end of read access and CS negation 001 1 EIM clock cycles between end of read access and CS negation 010 2 EIM clock cycles between end of read access and CS negation 111 7 EIM clock cycles between end of read access and CS negation

21.9.6 Chip Select n Write Configuration Register 2 (EIM_CS_nWCR2)

Address: 21B_8000h base + 14h offset + (24d × i), where i=0d to 5d

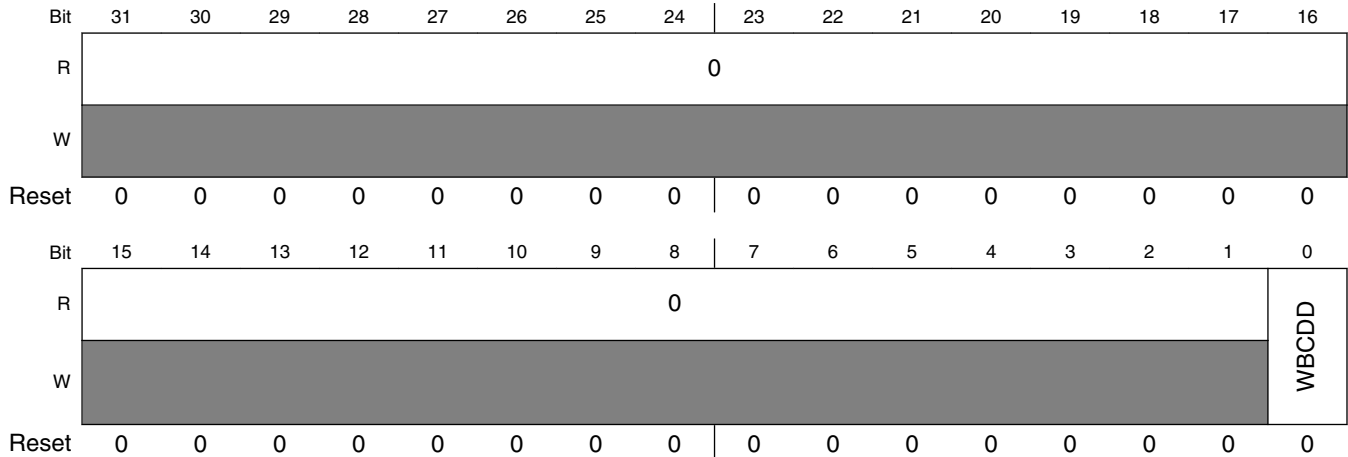

EIM_CS_nWCR2 field descriptions

Field	Description
31–1 Reserved	This read-only field is reserved and always has the value 0.
0 WBCDD	Write Burst Clock Divisor Decrement. If this bit is asserted and BCD value is 0 sync. write access will be preformed as if BCD value is 1. When this bit is negated or BCD value is not 0 this bit has no affect. This bit is cleared by hardware reset.

21.9.7 EIM Configuration Register (EIM_WCR)

Address: 21B_8000h base + 90h offset = 21B_8090h

Bit	31	30	29	28	27	26	25	24	23	22	21	20	19	18	17	16
R	0															
W	[Reserved]															
Reset	0	0	0	0	0	0	0	0	0	0	0	0	0	0	0	0
Hardware Reset	0	0	0	0	0	0	0	0	0	0	0	0	0	0	0	0

Bit	15	14	13	12	11	10	9	8	7	6	5	4	3	2	1	0
R	0				FRUN_ACLK_EN	WDOG_LIMIT	WDOG_EN	0		INTPOL	INTEN	CONT_BCLK_SEL	GBCD	BCM		
W	[Reserved]							[Reserved]							[Reserved]	
Reset	0	0	0	0	0	0	0	0	0	0	1	0	0	0	0	0
Hardware Reset	0	0	0	0	0	0	0	0	0	0	1	0	0	0	0	0

EIM_WCR field descriptions

Field	Description
31–12 Reserved	Reserved This read-only field is reserved and always has the value 0.
11 FRUN_ACLK_EN	Free run ACLK enable
10–9 WDOG_LIMIT	Memory Watchdog (WDOG) cycle limit. This bit field determines the number of BCLK cycles (ACLK cycles in dtack mode) before the WDOG counter terminates the access and send an error response to the master. 00 128 BCLK cycles 01 256 BCLK cycles 10 512 BCLK cycles 11 1024 BCLK cycles
8 WDOG_EN	Memory WDOG enable. This bit controls the operation of the wdog counter that terminates the EIM access. 0 Memory WDOG is Disabled 1 Memory WDOG is Enabled

Table continues on the next page...

EIM_WCR field descriptions (continued)

Field	Description
7-6 Reserved	This read-only field is reserved and always has the value 0.
5 INTPOL	Interrupt Polarity. This bit field determines the polarity of the external device interrupt. 0 External interrupt polarity is active low 1 External interrupt polarity is active high
4 INTEN	Interrupt Enable. When this bit is set the External signal RDY_INT as active interrupt. When interrupt occurs, INT bit at the WCR will be set and t EIM_EXT_INT signal will be asserted correspondingly. This bit is cleared by a hardware reset. 0 External interrupt Disable 1 External interrupt Enable
3 CONT_BCLK_SEL	Continuous BCLK select When this bit is set BCLK pin output continuous clock. Otherwise, BCLK will output clock only when nesserary. 0 BCLK When nesserary 1 BCLK Continuous
2-1 GBCD	General Burst Clock Divisor. When BCM bit is set, this bit field contains the value used to program the burst clock divisor for Continuous BCLK generation. The other BCD bit fields for each chip select are ignored. It is used to divide the internal AXI bus frequency. When BCM=0 GBCD bit field has no influence. GBCD is cleared by a hardware reset. 00 Divide EIM clock by 1 01 Divide EIM clock by 2 10 Divide EIM clock by 3 11 Divide EIM clock by 4
0 BCM	Burst Clock Mode. This bit selects the burst clock mode of operation. It is used for system debug mode. BCM is cleared by a hardware reset. NOTE: The BCLK frequency in this mode is according to GBCD bit field. NOTE: The BCLK phase is opposite to the EIM clock in this mode if GBCD is 0. NOTE: This bit should be used only in async. accesses. No sync access can be executed if this bit is set. NOTE: When this bit is set bcd field shouldn't be configured to 0. 0 The burst clock runs only when accessing a chip select range with the SWR/SRD bits set. When the burst clock is not running it remains in a logic 0 state. When the burst clock is running it is configured by the BCD and BCS bit fields in the chip select Configuration Register. 1 The burst clock runs whenever ACLK is active (independent of chip select configuration)

Chapter 22

10/100-Mbps Ethernet MAC (ENET)

22.1 Introduction

The MAC-NET core, in conjunction with a 10/100-Mbit/s MAC, implements layer 3 network acceleration functions. These functions are designed to accelerate the processing of various common networking protocols, such as IP, TCP, UDP, and ICMP, providing wire speed services to client applications.

22.2 Overview

The core implements a dual-speed 10/100-Mbit/s Ethernet MAC compliant with the IEEE802.3-2002 standard. The MAC layer provides compatibility with half- or full-duplex 10/100-Mbit/s Ethernet LANs.

The MAC operation is fully programmable and can be used in Network Interface Card (NIC), bridging, or switching applications. The core implements the remote network monitoring (RMON) counters according to IETF RFC 2819.

The core also implements a hardware acceleration block to optimize the performance of network controllers providing TCP/IP, UDP, and ICMP protocol services. The acceleration block performs critical functions in hardware, which are typically implemented with large software overhead.

The core implements programmable embedded FIFOs that can provide buffering on the receive path for lossless flow control.

Advanced power management features are available with magic packet detection and programmable power-down modes.

A unified DMA (uDMA), internal to the ENET module, optimizes data transfer between the ENET core and the SoC, and supports an enhanced buffer descriptor programming model to support IEEE 1588 functionality.

The programmable Ethernet MAC with IEEE 1588 integrates a standard IEEE 802.3 Ethernet MAC with a time-stamping module. The IEEE 1588 standard provides accurate clock synchronization for distributed control nodes for industrial automation applications.

22.2.1 Features

The MAC-NET core includes the following features.

22.2.1.1 Ethernet MAC features

- Implements the full 802.3 specification with preamble/SFD generation, frame padding generation, CRC generation and checking
- Supports zero-length preamble
- Dynamically configurable to support 10/100-Mbit/s operation
- Supports 10/100 Mbit/s full-duplex and configurable half-duplex operation
- Compliant with the AMD magic packet detection with interrupt for node remote power management
- Seamless interface to commercial ethernet PHY devices via one of the following:
 - a 4-bit Media Independent Interface (MII) operating at 2.5/25 MHz.
 - a 4-bit non-standard MII-Lite (MII without the CRS and COL signals) operating at 2.5/25 MHz.
 - a 2-bit Reduced MII (RMII) operating at 50 MHz.
- Simple 64-Bit FIFO user-application interface
- CRC-32 checking at full speed with optional forwarding of the frame check sequence (FCS) field to the client
- CRC-32 generation and append on transmit or forwarding of user application provided FCS selectable on a per-frame basis
- In full-duplex mode:
 - Implements automated pause frame (802.3 x31A) generation and termination, providing flow control without user application intervention
 - Pause quanta used to form pause frames — dynamically programmable
 - Pause frame generation additionally controllable by user application offering flexible traffic flow control
 - Optional forwarding of received pause frames to the user application
 - Implements standard flow-control mechanism
- In half-duplex mode: provides full collision support, including jamming, backoff, and automatic retransmission
- Supports VLAN-tagged frames according to IEEE 802.1Q
- Programmable MAC address: Insertion on transmit; discards frames with mismatching destination address on receive (except broadcast and pause frames)

- Programmable promiscuous mode support to omit MAC destination address checking on receive
- Multicast and unicast address filtering on receive based on 64-entry hash table, reducing higher layer processing load
- Programmable frame maximum length providing support for any standard or proprietary frame length
- Statistics indicators for frame traffic and errors (alignment, CRC, length) and pause frames providing for IEEE 802.3 basic and mandatory management information database (MIB) package and remote network monitoring (RFC 2819)
- Simple handshake user application FIFO interface with fully programmable depth and threshold levels
- Provides separate status word for each received frame on the user interface providing information such as frame length, frame type, VLAN tag, and error information
- Multiple internal loopback options
- MDIO master interface for PHY device configuration and management supports two programmable MDIO base addresses, and standard (IEEE 802.3 Clause 22) and extended (Clause 45) MDIO frame formats
- Supports legacy FEC buffer descriptors
- Interrupt coalescing reduces the number of interrupts generated by the MAC, reducing CPU loading

22.2.1.2 IP protocol performance optimization features

- Operates on TCP/IP and UDP/IP and ICMP/IP protocol data or IP header only
- Enables wire-speed processing
- Supports IPv4 and IPv6
- Transparent passing of frames of other types and protocols
- Supports VLAN tagged frames according to IEEE 802.1q with transparent forwarding of VLAN tag and control field
- Automatic IP-header and payload (protocol specific) checksum calculation and verification on receive
- Automatic IP-header and payload (protocol specific) checksum generation and automatic insertion on transmit configurable on a per-frame basis
- Supports IP and TCP, UDP, ICMP data for checksum generation and checking
- Supports full header options for IPv4 and TCP protocol headers

- Provides IPv6 support to datagrams with base header only — datagrams with extension headers are passed transparently unmodified/unchecked
- Provides statistics information for received IP and protocol errors
- Configurable automatic discard of erroneous frames
- Configurable automatic host-to-network (RX) and network-to-host (TX) byte order conversion for IP and TCP/UDP/ICMP headers within the frame
- Configurable padding remove for short IP datagrams on receive
- Configurable Ethernet payload alignment to allow for 32-bit word-aligned header and payload processing
- Programmable store-and-forward operation with clock and rate decoupling FIFOs

22.2.1.3 IEEE 1588 features

- Supports all IEEE 1588 frames.
- Allows reference clock to be chosen independently of network speed.
- Software-programmable precise time-stamping of ingress and egress frames
- Timer monitoring capabilities for system calibration and timing accuracy management
- Precise time-stamping of external events with programmable interrupt generation
- Programmable event and interrupt generation for external system control
- Supports hardware- and software-controllable timer synchronization.
- Provides a 4-channel IEEE 1588 timer. Each channel supports input capture and output compare using the 1588 counter.

22.2.2 Block diagram

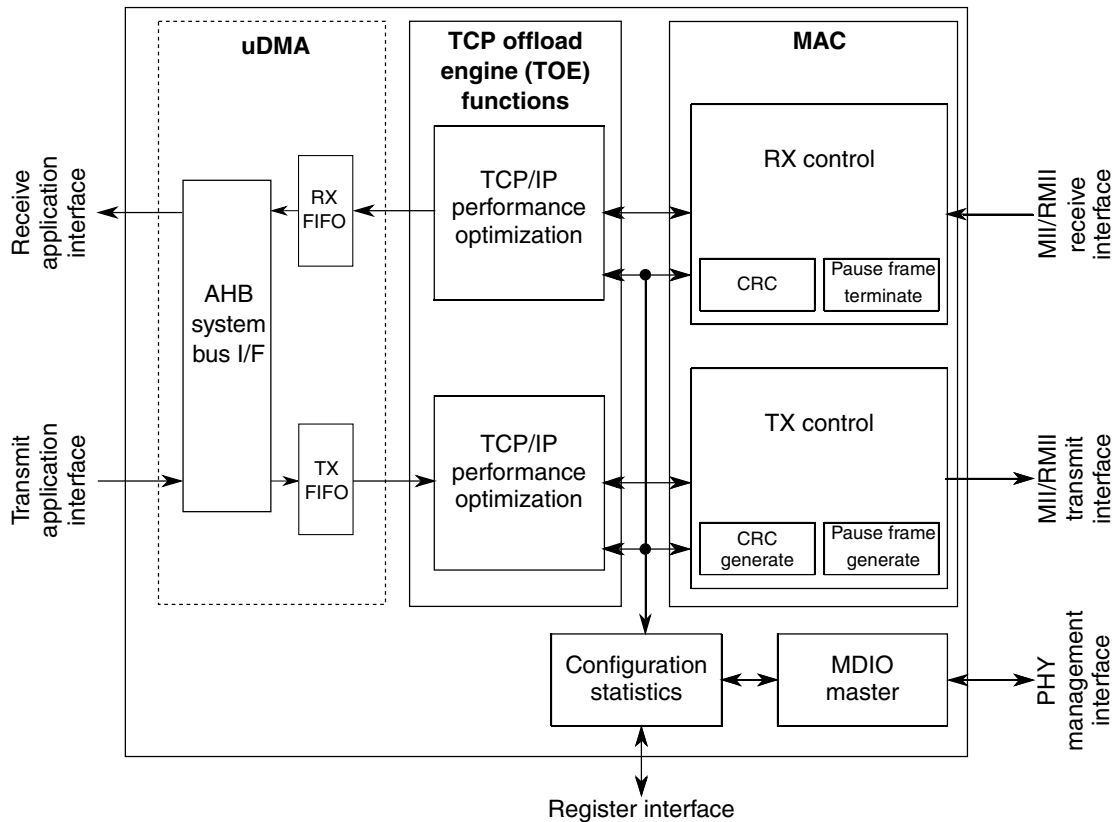

Figure 22-1. Ethernet MAC-NET core block diagram

22.3 External Signals

The table found here describes the external signals of ENET.

Table 22-1. ENET1 External Signals

Signal	Description	Mode	Pad	Alt Mode	Direction
ENET1_1588_EVENT0_IN	Capture/compare block input/output event bus signal. When configured for capture and a rising edge is detected, the current timer value is latched and transferred into the corresponding ENET_TCCRn register for inspection by software. When configured for compare, the corresponding signal 1588_EVENT is asserted for one cycle when the timer reaches the compare value programmed in register ENET_TCCRn. An interrupt or DMA request can be triggered if the corresponding bit in	MII / RMII / RGMII	SD3_DATA7	ALT6	IO

Table continues on the next page...

Table 22-1. ENET1 External Signals (continued)

Signal	Description	Mode	Pad	Alt Mode	Direction
	ENET_TCSRn[TIE] or ENET_TCSRn[TDRE] is set.				
ENET1_1588_EVENT0_OUT	Capture/compare block input/output event bus signal. When configured for capture and a rising edge is detected, the current timer value is latched and transferred into the corresponding ENET_TCCRn register for inspection by software. When configured for compare, the corresponding signal 1588_EVENT is asserted for one cycle when the timer reaches the compare value programmed in register ENET_TCCRn. An interrupt or DMA request can be triggered if the corresponding bit in ENET_TCSRn[TIE] or ENET_TCSRn[TDRE] is set.	MII / RMII / RGMII	SD3_DATA6	ALT6	IO
ENET1_1588_EVENT1_IN	Capture/compare block input/output event bus signal. When configured for capture and a rising edge is detected, the current timer value is latched and transferred into the corresponding ENET_TCCRn register for inspection by software. When configured for compare, the corresponding signal 1588_EVENT is asserted for one cycle when the timer reaches the compare value programmed in register ENET_TCCRn. An interrupt or DMA request can be triggered if the corresponding bit in ENET_TCSRn[TIE] or ENET_TCSRn[TDRE] is set.	MII / RMII / RGMII	SD1_DATA0	ALT6	IO
ENET1_1588_EVENT1_OUT	Capture/compare block input/output event bus signal. When configured for capture and a rising edge is detected, the current timer value is latched and transferred into the corresponding ENET_TCCRn register for inspection by software. When configured for compare, the corresponding signal 1588_EVENT is asserted for one cycle when the timer reaches the compare value programmed in register ENET_TCCRn. An interrupt or DMA request can be triggered if the corresponding bit in ENET_TCSRn[TIE] or ENET_TCSRn[TDRE] is set.	MII / RMII / RGMII	SD1_DATA1	ALT6	IO

Table continues on the next page...

Table 22-1. ENET1 External Signals (continued)

Signal	Description	Mode	Pad	Alt Mode	Direction
ENET1_1588_EVENT2_IN	Capture/compare block input/output event bus signal. When configured for capture and a rising edge is detected, the current timer value is latched and transferred into the corresponding ENET_TCCRn register for inspection by software. When configured for compare, the corresponding signal 1588_EVENT is asserted for one cycle when the timer reaches the compare value programmed in register ENET_TCCRn. An interrupt or DMA request can be triggered if the corresponding bit in ENET_TCSRn[TIE] or ENET_TCSRn[TDRE] is set.	MII / RMII / RGMII	LCD1_CLK	ALT3	IO
ENET1_1588_EVENT2_OUT	Capture/compare block input/output event bus signal. When configured for capture and a rising edge is detected, the current timer value is latched and transferred into the corresponding ENET_TCCRn register for inspection by software. When configured for compare, the corresponding signal 1588_EVENT is asserted for one cycle when the timer reaches the compare value programmed in register ENET_TCCRn. An interrupt or DMA request can be triggered if the corresponding bit in ENET_TCSRn[TIE] or ENET_TCSRn[TDRE] is set.	MII / RMII / RGMII	LCD1_DATA20	ALT3	IO
ENET1_1588_EVENT3_IN	Capture/compare block input/output event bus signal. When configured for capture and a rising edge is detected, the current timer value is latched and transferred into the corresponding ENET_TCCRn register for inspection by software. When configured for compare, the corresponding signal 1588_EVENT is asserted for one cycle when the timer reaches the compare value programmed in register ENET_TCCRn. An interrupt or DMA request can be triggered if the corresponding bit in ENET_TCSRn[TIE] or ENET_TCSRn[TDRE] is set.	MII / RMII / RGMII	LCD1_ENABLE	ALT3	IO
ENET1_1588_EVENT3_OUT	Capture/compare block input/output event bus signal. When configured for capture and a rising edge is	MII / RMII / RGMII	LCD1_DATA21	ALT3	IO

Table continues on the next page...

Table 22-1. ENET1 External Signals (continued)

Signal	Description	Mode	Pad	Alt Mode	Direction
	detected, the current timer value is latched and transferred into the corresponding ENET_TCCRn register for inspection by software. When configured for compare, the corresponding signal 1588_EVENT is asserted for one cycle when the timer reaches the compare value programmed in register ENET_TCCRn. An interrupt or DMA request can be triggered if the corresponding bit in ENET_TCSRn[TIE] or ENET_TCSRn[TDRE] is set.				
ENET1_COL	Asserted upon detection of a collision and remains asserted while the collision persists. This signal is not defined for full duplex mode.	MII	ENET1_COL	ALT0	IO
ENET1_CRS	Carrier sense. When asserted, indicates transmit or receive medium is not idle. In RMII mode, this signal is present on the ENET_RX_EN pin.	MII	ENET1_CRS	ALT0	IO
ENET1_MDC	Output clock provides a timing reference to the PHY for data transfers on the MDIO signal.	MII / RMII	ENET1_MDC	ALT0	IO
			ENET2_COL	ALT1	
			GPIO1_IO04	ALT2	
ENET1_MDIO	Transfers control information between the external PHY and the media access controller. Data is synchronous to MDC. This signal is an input after reset.	MII / RMII	ENET1_MDIO	ALT0	IO
			ENET2_CRS	ALT1	
			GPIO1_IO05	ALT2	
ENET1_REF_CLK1	In RMII mode, this signal is the reference clock for receive, transmit, and the control interface.	RMII	ENET1_TX_CLK	ALT1	IO
			GPIO1_IO05	ALT4	
ENET1_REF_CLK_25M	25 MHz Reference Clock	-	ENET1_RX_CLK	ALT1	IO
			GPIO1_IO03	ALT2	
ENET1_RGMII_RXC	In MII mode, provides a timing reference for RX_EN, RX_DATA[3:0], and RX_ER. In RGMII mode, provides a timing reference for RX_DATA[3:0] and RX_CTL.	RGMII	RGMII1_RXC	ALT0	IO
ENET1_RGMII_TXC	Serial output Ethernet data. Only valid during TX_EN assertion.	RGMII	RGMII1_TXC	ALT0	IO
ENET1_RX_CLK	In MII mode, provides a timing reference for RX_EN, RX_DATA[3:0], and RX_ER. In RGMII mode, provides a timing reference for RX_DATA[3:0] and RX_CTL.	MII	ENET1_RX_CLK	ALT0	IO

Table continues on the next page...

Table 22-1. ENET1 External Signals (continued)

Signal	Description	Mode	Pad	Alt Mode	Direction
ENET1_RX_DATA0	Contains the Ethernet input data transferred from the PHY to the media-access controller when RX_EN is asserted.	MII / RMII / RGMII	RGMI11_RD0	ALT0	IO
ENET1_RX_DATA1	Contains the Ethernet input data transferred from the PHY to the media-access controller when RX_EN is asserted.	MII / RMII / RGMII	RGMI11_RD1	ALT0	IO
ENET1_RX_DATA2	Contains the Ethernet input data transferred from the PHY to the media-access controller when RX_EN is asserted.	MII / RGMII	RGMI11_RD2	ALT0	IO
ENET1_RX_DATA3	Contains the Ethernet input data transferred from the PHY to the media-access controller when RX_EN is asserted.	MII / RGMII	RGMI11_RD3	ALT0	IO
ENET1_RX_EN	Asserting this input indicates the PHY has valid nibbles present on the MII. RX_EN must remain asserted from the first recovered nibble of the frame through to the last nibble. Asserting RX_EN must start no later than the SFD and exclude any EOF. In RMII mode, this pin also generates the CRS signal. In RGMII mode, contains RXDV on the rising edge of RX_CLK, and a logical derivative of RX_EV and RX_ER (RX_EV XOR RX_ER) on the falling edge of RX_CLK.	MII / RMII / RGMII	RGMI11_RX_CTL	ALT0	IO
ENET1_RX_ER	When asserted with RXDV, indicates the PHY detects an error in the current frame.	MII / RMII	RGMI11_RXC	ALT1	IO
ENET1_TX_CLK	Input clock, which provides a timing reference for TX_EN, TX_DATA[3:0], and TX_ER.	MII	ENET1_TX_CLK	ALT0	IO
ENET1_TX_DATA0	Serial output Ethernet data. Only valid during TX_EN assertion.	MII / RMII / RGMII	RGMI11_TD0	ALT0	IO
ENET1_TX_DATA1	Serial output Ethernet data. Only valid during TX_EN assertion.	MII / RMII / RGMII	RGMI11_TD1	ALT0	IO
ENET1_TX_DATA2	Serial output Ethernet data. Only valid during TX_EN assertion.	MII / RGMII	RGMI11_TD2	ALT0	IO
ENET1_TX_DATA3	Serial output Ethernet data. Only valid during TX_EN assertion.	MII / RGMII	RGMI11_TD3	ALT0	IO
ENET1_TX_EN	Indicates when valid nibbles are present on the MII. This signal is asserted with the first nibble of a preamble and is deasserted before the first TX_CLK following the final nibble of the frame. In RGMII mode,	MII / RMII / RGMII	RGMI11_TX_CTL	ALT0	IO

Table continues on the next page...

Table 22-1. ENET1 External Signals (continued)

Signal	Description	Mode	Pad	Alt Mode	Direction
	contains TX_EN on the rising edge of TX_CTL, and a logical derivative of TX_EN and TX_ER (TX_EN XOR TX_ER) on the falling edge of TX_CTL.				
ENET1_TX_ER	When asserted for one or more clock cycles while TXEN is also asserted, PHY sends one or more illegal symbols.	MII	RGMI11_TXC	ALT1	IO

Table 22-2. ENET2 External Signals

Signal	Description	Mode	Pad	Alt Mode	Direction
ENET2_1588_EVENT0_IN	Capture/compare block input/output event bus signal. When configured for capture and a rising edge is detected, the current timer value is latched and transferred into the corresponding ENET_TCCRn register for inspection by software. When configured for compare, the corresponding signal 1588_EVENT is asserted for one cycle when the timer reaches the compare value programmed in register ENET_TCCRn. An interrupt or DMA request can be triggered if the corresponding bit in ENET_TCSRn[TIE] or ENET_TCSRn[TDRE] is set.	MII / RMII / RGMII	SD3_DATA4	ALT6	IO
ENET2_1588_EVENT0_OUT	Capture/compare block input/output event bus signal. When configured for capture and a rising edge is detected, the current timer value is latched and transferred into the corresponding ENET_TCCRn register for inspection by software. When configured for compare, the corresponding signal 1588_EVENT is asserted for one cycle when the timer reaches the compare value programmed in register ENET_TCCRn. An interrupt or DMA request can be triggered if the corresponding bit in ENET_TCSRn[TIE] or ENET_TCSRn[TDRE] is set.	MII / RMII / RGMII	SD3_DATA5	ALT6	IO
ENET2_1588_EVENT1_IN	Capture/compare block input/output event bus signal. When configured for capture and a rising	MII / RMII / RGMII	SD1_CMD	ALT6	IO

Table continues on the next page...

Table 22-2. ENET2 External Signals (continued)

Signal	Description	Mode	Pad	Alt Mode	Direction
	edge is detected, the current timer value is latched and transferred into the corresponding ENET_TCCRn register for inspection by software. When configured for compare, the corresponding signal 1588_EVENT is asserted for one cycle when the timer reaches the compare value programmed in register ENET_TCCRn. An interrupt or DMA request can be triggered if the corresponding bit in ENET_TCSRn[TIE] or ENET_TCSRn[TDRE] is set.				
ENET2_1588_EVENT1_OUT	Capture/compare block input/output event bus signal. When configured for capture and a rising edge is detected, the current timer value is latched and transferred into the corresponding ENET_TCCRn register for inspection by software. When configured for compare, the corresponding signal 1588_EVENT is asserted for one cycle when the timer reaches the compare value programmed in register ENET_TCCRn. An interrupt or DMA request can be triggered if the corresponding bit in ENET_TCSRn[TIE] or ENET_TCSRn[TDRE] is set.	MII / RMII / RGMII	SD1_CLK	ALT6	IO
ENET2_1588_EVENT2_IN	Capture/compare block input/output event bus signal. When configured for capture and a rising edge is detected, the current timer value is latched and transferred into the corresponding ENET_TCCRn register for inspection by software. When configured for compare, the corresponding signal 1588_EVENT is asserted for one cycle when the timer reaches the compare value programmed in register ENET_TCCRn. An interrupt or DMA request can be triggered if the corresponding bit in ENET_TCSRn[TIE] or ENET_TCSRn[TDRE] is set.	MII / RMII / RGMII	LCD1_HSYNC	ALT3	IO
ENET2_1588_EVENT2_OUT	Capture/compare block input/output event bus signal. When configured for capture and a rising	MII / RMII / RGMII	LCD1_DATA22	ALT3	IO

Table continues on the next page...

Table 22-2. ENET2 External Signals (continued)

Signal	Description	Mode	Pad	Alt Mode	Direction
	edge is detected, the current timer value is latched and transferred into the corresponding ENET_TCCRn register for inspection by software. When configured for compare, the corresponding signal 1588_EVENT is asserted for one cycle when the timer reaches the compare value programmed in register ENET_TCCRn. An interrupt or DMA request can be triggered if the corresponding bit in ENET_TCSRn[TIE] or ENET_TCSRn[TDRE] is set.				
ENET2_1588_EVENT3_IN	Capture/compare block input/output event bus signal. When configured for capture and a rising edge is detected, the current timer value is latched and transferred into the corresponding ENET_TCCRn register for inspection by software. When configured for compare, the corresponding signal 1588_EVENT is asserted for one cycle when the timer reaches the compare value programmed in register ENET_TCCRn. An interrupt or DMA request can be triggered if the corresponding bit in ENET_TCSRn[TIE] or ENET_TCSRn[TDRE] is set.	MII / RMII / RGMII	LCD1_VSYNC	ALT3	IO
ENET2_1588_EVENT3_OUT	Capture/compare block input/output event bus signal. When configured for capture and a rising edge is detected, the current timer value is latched and transferred into the corresponding ENET_TCCRn register for inspection by software. When configured for compare, the corresponding signal 1588_EVENT is asserted for one cycle when the timer reaches the compare value programmed in register ENET_TCCRn. An interrupt or DMA request can be triggered if the corresponding bit in ENET_TCSRn[TIE] or ENET_TCSRn[TDRE] is set.	MII / RMII / RGMII	LCD1_DATA23	ALT3	IO
ENET2_COL	Asserted upon detection of a collision and remains asserted while the collision persists. This	MII	ENET2_COL	ALT0	IO

Table continues on the next page...

Table 22-2. ENET2 External Signals (continued)

Signal	Description	Mode	Pad	Alt Mode	Direction
	signal is not defined for full duplex mode.				
ENET2_CRS	Carrier sense. When asserted, indicates transmit or receive medium is not idle. In RMII mode, this signal is present on the ENET_RX_EN pin.	MII	ENET2_CRS	ALT0	IO
ENET2_MDC	Output clock provides a timing reference to the PHY for data transfers on the MDIO signal.	MII / RMII	ENET1_COL	ALT1	IO
			ENET1_MDC	ALT1	
			GPIO1_IO06	ALT2	
			KEY_COL4	ALT1	
ENET2_MDIO	Transfers control information between the external PHY and the mediaaccess controller. Data is synchronous to MDC. This signal is an input after reset.	MII / RMII	ENET1_CRS	ALT1	IO
			ENET1_MDIO	ALT1	
			GPIO1_IO07	ALT2	
			KEY_ROW4	ALT1	
ENET2_REF_CLK2	In RMII mode, this signal is the reference clock for receive, transmit, and the control interface.	RMII	ENET2_TX_CLK	ALT1	IO
			GPIO1_IO04	ALT4	
ENET2_REF_CLK_25M	25M Reference Clock	-	ENET2_RX_CLK	ALT1	IO
ENET2_RGMII_RXC	In MII mode, provides a timing reference for RX_EN, RX_DATA[3:0], and RX_ER. In RGMII mode, provides a timing reference for RX_DATA[3:0] and RX_CTL.	RGMII	RGMII2_RXC	ALT0	IO
ENET2_RGMII_TXC	Serial output Ethernet data. Only valid during TX_EN assertion.	RGMII	RGMII2_TXC	ALT0	IO
ENET2_RX_CLK	In MII mode, provides a timing reference for RX_EN, RX_DATA[3:0], and RX_ER. In RGMII mode, provides a timing reference for RX_DATA[3:0] and RX_CTL.	MII	ENET2_RX_CLK	ALT0	IO
ENET2_RX_DATA0	Contains the Ethernet input data transferred from the PHY to the media-access controller when RX_EN is asserted.	MII / RMII / RGMII	RGMII2_RD0	ALT0	IO
ENET2_RX_DATA1	Contains the Ethernet input data transferred from the PHY to the media-access controller when RX_EN is asserted.	MII / RMII / RGMII	RGMII2_RD1	ALT0	IO
ENET2_RX_DATA2	Contains the Ethernet input data transferred from the PHY to the media-access controller when RX_EN is asserted.	MII / RGMII	RGMII2_RD2	ALT0	IO
ENET2_RX_DATA3	Contains the Ethernet input data transferred from the PHY to the	MII / RGMII	RGMII2_RD3	ALT0	IO

Table continues on the next page...

Table 22-2. ENET2 External Signals (continued)

Signal	Description	Mode	Pad	Alt Mode	Direction
	media-access controller when RX_EN is asserted.				
ENET2_RX_EN	Asserting this input indicates the PHY has valid nibbles present on the MII. RX_EN must remain asserted from the first recovered nibble of the frame through to the last nibble. Asserting RX_EN must start no later than the SFD and exclude any EOF. In RMII mode, this pin also generates the CRS signal. In RGMII mode, contains RXDV on the rising edge of RX_CLK, and a logical derivative of RX_EV and RX_ER (RX_EV XOR RX_ER) on the falling edge of RX_CLK.	MII / RMII / RGMII	RGMI2_RX_CTL	ALT0	IO
ENET2_RX_ER	When asserted with RXDV, indicates the PHY detects an error in the current frame.	MII / RMII	RGMI2_RXC	ALT1	IO
ENET2_TX_CLK	Input clock, which provides a timing reference for TX_EN, TX_DATA[3:0], and TX_ER.	MII	ENET2_TX_CLK	ALT0	IO
ENET2_TX_DATA0	Serial output Ethernet data. Only valid during TX_EN assertion.	MII / RMII / RGMII	RGMI2_TD0	ALT0	IO
ENET2_TX_DATA1	Serial output Ethernet data. Only valid during TX_EN assertion.	MII / RMII / RGMII	RGMI2_TD1	ALT0	IO
ENET2_TX_DATA2	Serial output Ethernet data. Only valid during TX_EN assertion.	MII / RGMII	RGMI2_TD2	ALT0	IO
ENET2_TX_DATA3	Serial output Ethernet data. Only valid during TX_EN assertion.	MII / RGMII	RGMI2_TD3	ALT0	IO
ENET2_TX_EN	Indicates when valid nibbles are present on the MII. This signal is asserted with the first nibble of a preamble and is deasserted before the first TX_CLK following the final nibble of the frame. In RGMII mode, contains TX_EN on the rising edge of TX_CTL, and a logical derivative of TX_EN and TX_ER (TX_EN XOR TX_ER) on the falling edge of TX_CTL.	MII / RMII / RGMII	RGMI2_TX_CTL	ALT0	IO
ENET2_TX_ER	When asserted for one or more clock cycles while TXEN is also asserted, PHY sends one or more illegal symbols.	MII	RGMI2_TXC	ALT1	IO

22.4 Clocks

The table found here describes the clock sources for ENET. Please see for clock setting, configuration and gating information.

22.5 Memory map/register definition

ENET registers must be read or written with 32-bit accesses. Non-32 bit accesses will terminate with an error.

Reserved bits should be written with 0 and ignored on read. Unused registers read zero and a write has no effect.

This table shows Ethernet registers organization.

Table 22-3. Register map summary

Offset Address	Section	Description
0x0000 – 0x01FF	Configuration	Core control and status registers
0x0200 – 0x03FF	Statistics counters	MIB and Remote Network Monitoring (RFC 2819) registers
0x0400 – 0x0430	1588 control	1588 adjustable timer (TSM) and 1588 frame control
0x0600 – 0x07FC	Capture/Compare block	Registers for the Capture/Compare block

ENET memory map

Absolute address (hex)	Register name	Width (in bits)	Access	Reset value	Section/page
20B_4004	Interrupt Event Register (ENET2_EIR)	32	w1c	0000_0000h	22.5.1/908
20B_4008	Interrupt Mask Register (ENET2_EIMR)	32	R/W	0000_0000h	22.5.2/911
20B_4010	Receive Descriptor Active Register (ENET2_RDAR)	32	R/W	0000_0000h	22.5.3/914
20B_4014	Transmit Descriptor Active Register (ENET2_TDAR)	32	R/W	0000_0000h	22.5.4/915
20B_4024	Ethernet Control Register (ENET2_ECR)	32	R/W	See section	22.5.5/916
20B_4040	MII Management Frame Register (ENET2_MMFR)	32	R/W	0000_0000h	22.5.6/918
20B_4044	MII Speed Control Register (ENET2_MSCR)	32	R/W	0000_0000h	22.5.7/918
20B_4064	MIB Control Register (ENET2_MIBC)	32	R/W	C000_0000h	22.5.8/921
20B_4084	Receive Control Register (ENET2_RCR)	32	R/W	05EE_0001h	22.5.9/922
20B_40C4	Transmit Control Register (ENET2_TCR)	32	R/W	0000_0000h	22.5.10/925
20B_40E4	Physical Address Lower Register (ENET2_PALR)	32	R/W	0000_0000h	22.5.11/927
20B_40E8	Physical Address Upper Register (ENET2_PAUR)	32	R/W	0000_8808h	22.5.12/927

Table continues on the next page...

ENET memory map (continued)

Absolute address (hex)	Register name	Width (in bits)	Access	Reset value	Section/page
20B_40EC	Opcode/Pause Duration Register (ENET2_OPD)	32	R/W	0001_0000h	22.5.13/ 928
20B_40F0	Transmit Interrupt Coalescing Register (ENET2_TXIC)	32	R/W	0000_0000h	22.5.14/ 928
20B_4100	Receive Interrupt Coalescing Register (ENET2_RXIC)	32	R/W	0000_0000h	22.5.15/ 929
20B_4118	Descriptor Individual Upper Address Register (ENET2_IAUR)	32	R/W	0000_0000h	22.5.16/ 930
20B_411C	Descriptor Individual Lower Address Register (ENET2_IALR)	32	R/W	0000_0000h	22.5.17/ 931
20B_4120	Descriptor Group Upper Address Register (ENET2_GAUR)	32	R/W	0000_0000h	22.5.18/ 931
20B_4124	Descriptor Group Lower Address Register (ENET2_GALR)	32	R/W	0000_0000h	22.5.19/ 932
20B_4144	Transmit FIFO Watermark Register (ENET2_TFWR)	32	R/W	0000_0000h	22.5.20/ 932
20B_4180	Receive Descriptor Ring Start Register (ENET2_RDSR)	32	R/W	0000_0000h	22.5.21/ 933
20B_4184	Transmit Buffer Descriptor Ring Start Register (ENET2_TDSR)	32	R/W	0000_0000h	22.5.22/ 934
20B_4188	Maximum Receive Buffer Size Register (ENET2_MRBR)	32	R/W	0000_0000h	22.5.23/ 935
20B_4190	Receive FIFO Section Full Threshold (ENET2_RSFL)	32	R/W	0000_0000h	22.5.24/ 936
20B_4194	Receive FIFO Section Empty Threshold (ENET2_RSEM)	32	R/W	0000_0000h	22.5.25/ 936
20B_4198	Receive FIFO Almost Empty Threshold (ENET2_RAEM)	32	R/W	0000_0004h	22.5.26/ 937
20B_419C	Receive FIFO Almost Full Threshold (ENET2_RAFL)	32	R/W	0000_0004h	22.5.27/ 937
20B_41A0	Transmit FIFO Section Empty Threshold (ENET2_TSEM)	32	R/W	0000_0000h	22.5.28/ 938
20B_41A4	Transmit FIFO Almost Empty Threshold (ENET2_TAEM)	32	R/W	0000_0004h	22.5.29/ 938
20B_41A8	Transmit FIFO Almost Full Threshold (ENET2_TAFL)	32	R/W	0000_0008h	22.5.30/ 939
20B_41AC	Transmit Inter-Packet Gap (ENET2_TIPG)	32	R/W	0000_000Ch	22.5.31/ 939
20B_41B0	Frame Truncation Length (ENET2_FTRL)	32	R/W	0000_07FFh	22.5.32/ 940
20B_41C0	Transmit Accelerator Function Configuration (ENET2_TACC)	32	R/W	0000_0000h	22.5.33/ 940
20B_41C4	Receive Accelerator Function Configuration (ENET2_RACC)	32	R/W	0000_0000h	22.5.34/ 941

Table continues on the next page...

ENET memory map (continued)

Absolute address (hex)	Register name	Width (in bits)	Access	Reset value	Section/page
20B_4200	Reserved Statistic Register (ENET2_RMON_T_DROP)	32	R	0000_0000h	22.5.35/942
20B_4204	Tx Packet Count Statistic Register (ENET2_RMON_T_PACKETS)	32	R	0000_0000h	22.5.36/943
20B_4208	Tx Broadcast Packets Statistic Register (ENET2_RMON_T_BC_PKT)	32	R	0000_0000h	22.5.37/943
20B_420C	Tx Multicast Packets Statistic Register (ENET2_RMON_T_MC_PKT)	32	R	0000_0000h	22.5.38/944
20B_4210	Tx Packets with CRC/Align Error Statistic Register (ENET2_RMON_T_CRC_ALIGN)	32	R	0000_0000h	22.5.39/944
20B_4214	Tx Packets Less Than Bytes and Good CRC Statistic Register (ENET2_RMON_T_UNDERSIZE)	32	R	0000_0000h	22.5.40/944
20B_4218	Tx Packets GT MAX_FL bytes and Good CRC Statistic Register (ENET2_RMON_T_OVERSIZE)	32	R	0000_0000h	22.5.41/945
20B_421C	Tx Packets Less Than 64 Bytes and Bad CRC Statistic Register (ENET2_RMON_T_FRAG)	32	R	0000_0000h	22.5.42/945
20B_4220	Tx Packets Greater Than MAX_FL bytes and Bad CRC Statistic Register (ENET2_RMON_T_JAB)	32	R	0000_0000h	22.5.43/946
20B_4224	Tx Collision Count Statistic Register (ENET2_RMON_T_COL)	32	R	0000_0000h	22.5.44/946
20B_4228	Tx 64-Byte Packets Statistic Register (ENET2_RMON_T_P64)	32	R	0000_0000h	22.5.45/947
20B_422C	Tx 65- to 127-byte Packets Statistic Register (ENET2_RMON_T_P65TO127)	32	R	0000_0000h	22.5.46/947
20B_4230	Tx 128- to 255-byte Packets Statistic Register (ENET2_RMON_T_P128TO255)	32	R	0000_0000h	22.5.47/948
20B_4234	Tx 256- to 511-byte Packets Statistic Register (ENET2_RMON_T_P256TO511)	32	R	0000_0000h	22.5.48/948
20B_4238	Tx 512- to 1023-byte Packets Statistic Register (ENET2_RMON_T_P512TO1023)	32	R	0000_0000h	22.5.49/949
20B_423C	Tx 1024- to 2047-byte Packets Statistic Register (ENET2_RMON_T_P1024TO2047)	32	R	0000_0000h	22.5.50/949
20B_4240	Tx Packets Greater Than 2048 Bytes Statistic Register (ENET2_RMON_T_P_GTE2048)	32	R	0000_0000h	22.5.51/950
20B_4244	Tx Octets Statistic Register (ENET2_RMON_T_OCTETS)	32	R	0000_0000h	22.5.52/950
20B_4248	Reserved Statistic Register (ENET2_IEEE_T_DROP)	32	R	0000_0000h	22.5.53/950
20B_424C	Frames Transmitted OK Statistic Register (ENET2_IEEE_T_FRAME_OK)	32	R	0000_0000h	22.5.54/951
20B_4250	Frames Transmitted with Single Collision Statistic Register (ENET2_IEEE_T_1COL)	32	R	0000_0000h	22.5.55/951
20B_4254	Frames Transmitted with Multiple Collisions Statistic Register (ENET2_IEEE_T_MCOL)	32	R	0000_0000h	22.5.56/952

Table continues on the next page...

ENET memory map (continued)

Absolute address (hex)	Register name	Width (in bits)	Access	Reset value	Section/page
20B_4258	Frames Transmitted after Deferral Delay Statistic Register (ENET2_IEEE_T_DEF)	32	R	0000_0000h	22.5.57/952
20B_425C	Frames Transmitted with Late Collision Statistic Register (ENET2_IEEE_T_LCOL)	32	R	0000_0000h	22.5.58/952
20B_4260	Frames Transmitted with Excessive Collisions Statistic Register (ENET2_IEEE_T_EXCOL)	32	R	0000_0000h	22.5.59/953
20B_4264	Frames Transmitted with Tx FIFO Underrun Statistic Register (ENET2_IEEE_T_MACERR)	32	R	0000_0000h	22.5.60/953
20B_4268	Frames Transmitted with Carrier Sense Error Statistic Register (ENET2_IEEE_T_CSERR)	32	R	0000_0000h	22.5.61/954
20B_426C	Reserved Statistic Register (ENET2_IEEE_T_SQE)	32	R (reads 0)	0000_0000h	22.5.62/954
20B_4270	Flow Control Pause Frames Transmitted Statistic Register (ENET2_IEEE_T_FDXFC)	32	R	0000_0000h	22.5.63/954
20B_4274	Octet Count for Frames Transmitted w/o Error Statistic Register (ENET2_IEEE_T_OCTETS_OK)	32	R	0000_0000h	22.5.64/955
20B_4284	Rx Packet Count Statistic Register (ENET2_RMON_R_PACKETS)	32	R	0000_0000h	22.5.65/955
20B_4288	Rx Broadcast Packets Statistic Register (ENET2_RMON_R_BC_PKT)	32	R	0000_0000h	22.5.66/956
20B_428C	Rx Multicast Packets Statistic Register (ENET2_RMON_R_MC_PKT)	32	R	0000_0000h	22.5.67/956
20B_4290	Rx Packets with CRC/Align Error Statistic Register (ENET2_RMON_R_CRC_ALIGN)	32	R	0000_0000h	22.5.68/956
20B_4294	Rx Packets with Less Than 64 Bytes and Good CRC Statistic Register (ENET2_RMON_R_UNDERSIZE)	32	R	0000_0000h	22.5.69/957
20B_4298	Rx Packets Greater Than MAX_FL and Good CRC Statistic Register (ENET2_RMON_R_OVERSIZE)	32	R	0000_0000h	22.5.70/957
20B_429C	Rx Packets Less Than 64 Bytes and Bad CRC Statistic Register (ENET2_RMON_R_FRAG)	32	R	0000_0000h	22.5.71/958
20B_42A0	Rx Packets Greater Than MAX_FL Bytes and Bad CRC Statistic Register (ENET2_RMON_R_JAB)	32	R	0000_0000h	22.5.72/958
20B_42A4	Reserved Statistic Register (ENET2_RMON_R_RESVD_0)	32	R (reads 0)	0000_0000h	22.5.73/958
20B_42A8	Rx 64-Byte Packets Statistic Register (ENET2_RMON_R_P64)	32	R	0000_0000h	22.5.74/959
20B_42AC	Rx 65- to 127-Byte Packets Statistic Register (ENET2_RMON_R_P65TO127)	32	R	0000_0000h	22.5.75/959
20B_42B0	Rx 128- to 255-Byte Packets Statistic Register (ENET2_RMON_R_P128TO255)	32	R	0000_0000h	22.5.76/960
20B_42B4	Rx 256- to 511-Byte Packets Statistic Register (ENET2_RMON_R_P256TO511)	32	R	0000_0000h	22.5.77/960
20B_42B8	Rx 512- to 1023-Byte Packets Statistic Register (ENET2_RMON_R_P512TO1023)	32	R	0000_0000h	22.5.78/960

Table continues on the next page...

ENET memory map (continued)

Absolute address (hex)	Register name	Width (in bits)	Access	Reset value	Section/page
20B_42BC	Rx 1024- to 2047-Byte Packets Statistic Register (ENET2_RMON_R_P1024TO2047)	32	R	0000_0000h	22.5.79/961
20B_42C0	Rx Packets Greater than 2048 Bytes Statistic Register (ENET2_RMON_R_P_GTE2048)	32	R	0000_0000h	22.5.80/961
20B_42C4	Rx Octets Statistic Register (ENET2_RMON_R_OCTETS)	32	R	0000_0000h	22.5.81/962
20B_42C8	Frames not Counted Correctly Statistic Register (ENET2_IEEE_R_DROP)	32	R	0000_0000h	22.5.82/962
20B_42CC	Frames Received OK Statistic Register (ENET2_IEEE_R_FRAME_OK)	32	R	0000_0000h	22.5.83/962
20B_42D0	Frames Received with CRC Error Statistic Register (ENET2_IEEE_R_CRC)	32	R	0000_0000h	22.5.84/963
20B_42D4	Frames Received with Alignment Error Statistic Register (ENET2_IEEE_R_ALIGN)	32	R	0000_0000h	22.5.85/963
20B_42D8	Receive FIFO Overflow Count Statistic Register (ENET2_IEEE_R_MACERR)	32	R	0000_0000h	22.5.86/964
20B_42DC	Flow Control Pause Frames Received Statistic Register (ENET2_IEEE_R_FDXFC)	32	R	0000_0000h	22.5.87/964
20B_42E0	Octet Count for Frames Received without Error Statistic Register (ENET2_IEEE_R_OCTETS_OK)	32	R	0000_0000h	22.5.88/964
20B_4400	Adjustable Timer Control Register (ENET2_ATCR)	32	R/W	0000_0000h	22.5.89/965
20B_4404	Timer Value Register (ENET2_ATVR)	32	R/W	0000_0000h	22.5.90/967
20B_4408	Timer Offset Register (ENET2_ATOFF)	32	R/W	0000_0000h	22.5.91/967
20B_440C	Timer Period Register (ENET2_ATPER)	32	R/W	3B9A_CA00h	22.5.92/967
20B_4410	Timer Correction Register (ENET2_ATCOR)	32	R/W	0000_0000h	22.5.93/968
20B_4414	Time-Stamping Clock Period Register (ENET2_ATINC)	32	R/W	0000_0000h	22.5.94/969
20B_4418	Timestamp of Last Transmitted Frame (ENET2_ATSTMP)	32	R	0000_0000h	22.5.95/969
20B_4604	Timer Global Status Register (ENET2_TGSR)	32	R/W	0000_0000h	22.5.96/970
20B_4608	Timer Control Status Register (ENET2_TCSR0)	32	R/W	0000_0000h	22.5.97/971
20B_460C	Timer Compare Capture Register (ENET2_TCCR0)	32	R/W	0000_0000h	22.5.98/972
20B_4610	Timer Control Status Register (ENET2_TCSR1)	32	R/W	0000_0000h	22.5.97/971
20B_4614	Timer Compare Capture Register (ENET2_TCCR1)	32	R/W	0000_0000h	22.5.98/972

Table continues on the next page...

ENET memory map (continued)

Absolute address (hex)	Register name	Width (in bits)	Access	Reset value	Section/page
20B_4618	Timer Control Status Register (ENET2_TCSR2)	32	R/W	0000_0000h	22.5.97/971
20B_461C	Timer Compare Capture Register (ENET2_TCCR2)	32	R/W	0000_0000h	22.5.98/972
20B_4620	Timer Control Status Register (ENET2_TCSR3)	32	R/W	0000_0000h	22.5.97/971
20B_4624	Timer Compare Capture Register (ENET2_TCCR3)	32	R/W	0000_0000h	22.5.98/972
218_8004	Interrupt Event Register (ENET1_EIR)	32	w1c	0000_0000h	22.5.1/908
218_8008	Interrupt Mask Register (ENET1_EIMR)	32	R/W	0000_0000h	22.5.2/911
218_8010	Receive Descriptor Active Register (ENET1_RDAR)	32	R/W	0000_0000h	22.5.3/914
218_8014	Transmit Descriptor Active Register (ENET1_TDAR)	32	R/W	0000_0000h	22.5.4/915
218_8024	Ethernet Control Register (ENET1_ECR)	32	R/W	See section	22.5.5/916
218_8040	MII Management Frame Register (ENET1_MMFR)	32	R/W	0000_0000h	22.5.6/918
218_8044	MII Speed Control Register (ENET1_MSCR)	32	R/W	0000_0000h	22.5.7/918
218_8064	MIB Control Register (ENET1_MIBC)	32	R/W	C000_0000h	22.5.8/921
218_8084	Receive Control Register (ENET1_RCR)	32	R/W	05EE_0001h	22.5.9/922
218_80C4	Transmit Control Register (ENET1_TCR)	32	R/W	0000_0000h	22.5.10/925
218_80E4	Physical Address Lower Register (ENET1_PALR)	32	R/W	0000_0000h	22.5.11/927
218_80E8	Physical Address Upper Register (ENET1_PAUR)	32	R/W	0000_8808h	22.5.12/927
218_80EC	Opcode/Pause Duration Register (ENET1_OPD)	32	R/W	0001_0000h	22.5.13/928
218_80F0	Transmit Interrupt Coalescing Register (ENET1_TXIC)	32	R/W	0000_0000h	22.5.14/928
218_8100	Receive Interrupt Coalescing Register (ENET1_RXIC)	32	R/W	0000_0000h	22.5.15/929
218_8118	Descriptor Individual Upper Address Register (ENET1_IAUR)	32	R/W	0000_0000h	22.5.16/930
218_811C	Descriptor Individual Lower Address Register (ENET1_IALR)	32	R/W	0000_0000h	22.5.17/931
218_8120	Descriptor Group Upper Address Register (ENET1_GAUR)	32	R/W	0000_0000h	22.5.18/931
218_8124	Descriptor Group Lower Address Register (ENET1_GALR)	32	R/W	0000_0000h	22.5.19/932
218_8144	Transmit FIFO Watermark Register (ENET1_TFWR)	32	R/W	0000_0000h	22.5.20/932
218_8180	Receive Descriptor Ring Start Register (ENET1_RDSR)	32	R/W	0000_0000h	22.5.21/933
218_8184	Transmit Buffer Descriptor Ring Start Register (ENET1_TDSR)	32	R/W	0000_0000h	22.5.22/934

Table continues on the next page...

ENET memory map (continued)

Absolute address (hex)	Register name	Width (in bits)	Access	Reset value	Section/page
218_8188	Maximum Receive Buffer Size Register (ENET1_MRBR)	32	R/W	0000_0000h	22.5.23/935
218_8190	Receive FIFO Section Full Threshold (ENET1_RSFL)	32	R/W	0000_0000h	22.5.24/936
218_8194	Receive FIFO Section Empty Threshold (ENET1_RSEM)	32	R/W	0000_0000h	22.5.25/936
218_8198	Receive FIFO Almost Empty Threshold (ENET1_RAEM)	32	R/W	0000_0004h	22.5.26/937
218_819C	Receive FIFO Almost Full Threshold (ENET1_RAFL)	32	R/W	0000_0004h	22.5.27/937
218_81A0	Transmit FIFO Section Empty Threshold (ENET1_TSEM)	32	R/W	0000_0000h	22.5.28/938
218_81A4	Transmit FIFO Almost Empty Threshold (ENET1_TAEM)	32	R/W	0000_0004h	22.5.29/938
218_81A8	Transmit FIFO Almost Full Threshold (ENET1_TAFL)	32	R/W	0000_0008h	22.5.30/939
218_81AC	Transmit Inter-Packet Gap (ENET1_TIPG)	32	R/W	0000_000Ch	22.5.31/939
218_81B0	Frame Truncation Length (ENET1_FTRL)	32	R/W	0000_07FFh	22.5.32/940
218_81C0	Transmit Accelerator Function Configuration (ENET1_TACC)	32	R/W	0000_0000h	22.5.33/940
218_81C4	Receive Accelerator Function Configuration (ENET1_RACC)	32	R/W	0000_0000h	22.5.34/941
218_8200	Reserved Statistic Register (ENET1_RMON_T_DROP)	32	R	0000_0000h	22.5.35/942
218_8204	Tx Packet Count Statistic Register (ENET1_RMON_T_PACKETS)	32	R	0000_0000h	22.5.36/943
218_8208	Tx Broadcast Packets Statistic Register (ENET1_RMON_T_BC_PKT)	32	R	0000_0000h	22.5.37/943
218_820C	Tx Multicast Packets Statistic Register (ENET1_RMON_T_MC_PKT)	32	R	0000_0000h	22.5.38/944
218_8210	Tx Packets with CRC/Align Error Statistic Register (ENET1_RMON_T_CRC_ALIGN)	32	R	0000_0000h	22.5.39/944
218_8214	Tx Packets Less Than Bytes and Good CRC Statistic Register (ENET1_RMON_T_UNDERSIZE)	32	R	0000_0000h	22.5.40/944
218_8218	Tx Packets GT MAX_FL bytes and Good CRC Statistic Register (ENET1_RMON_T_OVERSIZE)	32	R	0000_0000h	22.5.41/945
218_821C	Tx Packets Less Than 64 Bytes and Bad CRC Statistic Register (ENET1_RMON_T_FRAG)	32	R	0000_0000h	22.5.42/945
218_8220	Tx Packets Greater Than MAX_FL bytes and Bad CRC Statistic Register (ENET1_RMON_T_JAB)	32	R	0000_0000h	22.5.43/946
218_8224	Tx Collision Count Statistic Register (ENET1_RMON_T_COL)	32	R	0000_0000h	22.5.44/946

Table continues on the next page...

ENET memory map (continued)

Absolute address (hex)	Register name	Width (in bits)	Access	Reset value	Section/page
218_8228	Tx 64-Byte Packets Statistic Register (ENET1_RMON_T_P64)	32	R	0000_0000h	22.5.45/ 947
218_822C	Tx 65- to 127-byte Packets Statistic Register (ENET1_RMON_T_P65TO127)	32	R	0000_0000h	22.5.46/ 947
218_8230	Tx 128- to 255-byte Packets Statistic Register (ENET1_RMON_T_P128TO255)	32	R	0000_0000h	22.5.47/ 948
218_8234	Tx 256- to 511-byte Packets Statistic Register (ENET1_RMON_T_P256TO511)	32	R	0000_0000h	22.5.48/ 948
218_8238	Tx 512- to 1023-byte Packets Statistic Register (ENET1_RMON_T_P512TO1023)	32	R	0000_0000h	22.5.49/ 949
218_823C	Tx 1024- to 2047-byte Packets Statistic Register (ENET1_RMON_T_P1024TO2047)	32	R	0000_0000h	22.5.50/ 949
218_8240	Tx Packets Greater Than 2048 Bytes Statistic Register (ENET1_RMON_T_P_GTE2048)	32	R	0000_0000h	22.5.51/ 950
218_8244	Tx Octets Statistic Register (ENET1_RMON_T_OCTETS)	32	R	0000_0000h	22.5.52/ 950
218_8248	Reserved Statistic Register (ENET1_IEEE_T_DROP)	32	R	0000_0000h	22.5.53/ 950
218_824C	Frames Transmitted OK Statistic Register (ENET1_IEEE_T_FRAME_OK)	32	R	0000_0000h	22.5.54/ 951
218_8250	Frames Transmitted with Single Collision Statistic Register (ENET1_IEEE_T_1COL)	32	R	0000_0000h	22.5.55/ 951
218_8254	Frames Transmitted with Multiple Collisions Statistic Register (ENET1_IEEE_T_MCOL)	32	R	0000_0000h	22.5.56/ 952
218_8258	Frames Transmitted after Deferral Delay Statistic Register (ENET1_IEEE_T_DEF)	32	R	0000_0000h	22.5.57/ 952
218_825C	Frames Transmitted with Late Collision Statistic Register (ENET1_IEEE_T_LCOL)	32	R	0000_0000h	22.5.58/ 952
218_8260	Frames Transmitted with Excessive Collisions Statistic Register (ENET1_IEEE_T_EXCOL)	32	R	0000_0000h	22.5.59/ 953
218_8264	Frames Transmitted with Tx FIFO Underrun Statistic Register (ENET1_IEEE_T_MACERR)	32	R	0000_0000h	22.5.60/ 953
218_8268	Frames Transmitted with Carrier Sense Error Statistic Register (ENET1_IEEE_T_CSERR)	32	R	0000_0000h	22.5.61/ 954
218_826C	Reserved Statistic Register (ENET1_IEEE_T_SQE)	32	R (reads 0)	0000_0000h	22.5.62/ 954
218_8270	Flow Control Pause Frames Transmitted Statistic Register (ENET1_IEEE_T_FDXFC)	32	R	0000_0000h	22.5.63/ 954
218_8274	Octet Count for Frames Transmitted w/o Error Statistic Register (ENET1_IEEE_T_OCTETS_OK)	32	R	0000_0000h	22.5.64/ 955
218_8284	Rx Packet Count Statistic Register (ENET1_RMON_R_PACKETS)	32	R	0000_0000h	22.5.65/ 955
218_8288	Rx Broadcast Packets Statistic Register (ENET1_RMON_R_BC_PKT)	32	R	0000_0000h	22.5.66/ 956

Table continues on the next page...

ENET memory map (continued)

Absolute address (hex)	Register name	Width (in bits)	Access	Reset value	Section/page
218_828C	Rx Multicast Packets Statistic Register (ENET1_RMON_R_MC_PKT)	32	R	0000_0000h	22.5.67/ 956
218_8290	Rx Packets with CRC/Align Error Statistic Register (ENET1_RMON_R_CRC_ALIGN)	32	R	0000_0000h	22.5.68/ 956
218_8294	Rx Packets with Less Than 64 Bytes and Good CRC Statistic Register (ENET1_RMON_R_UNDERSIZE)	32	R	0000_0000h	22.5.69/ 957
218_8298	Rx Packets Greater Than MAX_FL and Good CRC Statistic Register (ENET1_RMON_R_OVERSIZE)	32	R	0000_0000h	22.5.70/ 957
218_829C	Rx Packets Less Than 64 Bytes and Bad CRC Statistic Register (ENET1_RMON_R_FRAG)	32	R	0000_0000h	22.5.71/ 958
218_82A0	Rx Packets Greater Than MAX_FL Bytes and Bad CRC Statistic Register (ENET1_RMON_R_JAB)	32	R	0000_0000h	22.5.72/ 958
218_82A4	Reserved Statistic Register (ENET1_RMON_R_RESVD_0)	32	R (reads 0)	0000_0000h	22.5.73/ 958
218_82A8	Rx 64-Byte Packets Statistic Register (ENET1_RMON_R_P64)	32	R	0000_0000h	22.5.74/ 959
218_82AC	Rx 65- to 127-Byte Packets Statistic Register (ENET1_RMON_R_P65TO127)	32	R	0000_0000h	22.5.75/ 959
218_82B0	Rx 128- to 255-Byte Packets Statistic Register (ENET1_RMON_R_P128TO255)	32	R	0000_0000h	22.5.76/ 960
218_82B4	Rx 256- to 511-Byte Packets Statistic Register (ENET1_RMON_R_P256TO511)	32	R	0000_0000h	22.5.77/ 960
218_82B8	Rx 512- to 1023-Byte Packets Statistic Register (ENET1_RMON_R_P512TO1023)	32	R	0000_0000h	22.5.78/ 960
218_82BC	Rx 1024- to 2047-Byte Packets Statistic Register (ENET1_RMON_R_P1024TO2047)	32	R	0000_0000h	22.5.79/ 961
218_82C0	Rx Packets Greater than 2048 Bytes Statistic Register (ENET1_RMON_R_P_GTE2048)	32	R	0000_0000h	22.5.80/ 961
218_82C4	Rx Octets Statistic Register (ENET1_RMON_R_OCTETS)	32	R	0000_0000h	22.5.81/ 962
218_82C8	Frames not Counted Correctly Statistic Register (ENET1_IEEE_R_DROP)	32	R	0000_0000h	22.5.82/ 962
218_82CC	Frames Received OK Statistic Register (ENET1_IEEE_R_FRAME_OK)	32	R	0000_0000h	22.5.83/ 962
218_82D0	Frames Received with CRC Error Statistic Register (ENET1_IEEE_R_CRC)	32	R	0000_0000h	22.5.84/ 963
218_82D4	Frames Received with Alignment Error Statistic Register (ENET1_IEEE_R_ALIGN)	32	R	0000_0000h	22.5.85/ 963
218_82D8	Receive FIFO Overflow Count Statistic Register (ENET1_IEEE_R_MACERR)	32	R	0000_0000h	22.5.86/ 964
218_82DC	Flow Control Pause Frames Received Statistic Register (ENET1_IEEE_R_FDXFC)	32	R	0000_0000h	22.5.87/ 964
218_82E0	Octet Count for Frames Received without Error Statistic Register (ENET1_IEEE_R_OCTETS_OK)	32	R	0000_0000h	22.5.88/ 964

Table continues on the next page...

ENET memory map (continued)

Absolute address (hex)	Register name	Width (in bits)	Access	Reset value	Section/page
218_8400	Adjustable Timer Control Register (ENET1_ATCR)	32	R/W	0000_0000h	22.5.89/ 965
218_8404	Timer Value Register (ENET1_ATVR)	32	R/W	0000_0000h	22.5.90/ 967
218_8408	Timer Offset Register (ENET1_ATOFF)	32	R/W	0000_0000h	22.5.91/ 967
218_840C	Timer Period Register (ENET1_ATPER)	32	R/W	3B9A_CA00h	22.5.92/ 967
218_8410	Timer Correction Register (ENET1_ATCOR)	32	R/W	0000_0000h	22.5.93/ 968
218_8414	Time-Stamping Clock Period Register (ENET1_ATINC)	32	R/W	0000_0000h	22.5.94/ 969
218_8418	Timestamp of Last Transmitted Frame (ENET1_ATSTMP)	32	R	0000_0000h	22.5.95/ 969
218_8604	Timer Global Status Register (ENET1_TGSR)	32	R/W	0000_0000h	22.5.96/ 970
218_8608	Timer Control Status Register (ENET1_TCSR0)	32	R/W	0000_0000h	22.5.97/ 971
218_860C	Timer Compare Capture Register (ENET1_TCCR0)	32	R/W	0000_0000h	22.5.98/ 972
218_8610	Timer Control Status Register (ENET1_TCSR1)	32	R/W	0000_0000h	22.5.97/ 971
218_8614	Timer Compare Capture Register (ENET1_TCCR1)	32	R/W	0000_0000h	22.5.98/ 972
218_8618	Timer Control Status Register (ENET1_TCSR2)	32	R/W	0000_0000h	22.5.97/ 971
218_861C	Timer Compare Capture Register (ENET1_TCCR2)	32	R/W	0000_0000h	22.5.98/ 972
218_8620	Timer Control Status Register (ENET1_TCSR3)	32	R/W	0000_0000h	22.5.97/ 971
218_8624	Timer Compare Capture Register (ENET1_TCCR3)	32	R/W	0000_0000h	22.5.98/ 972

22.5.1 Interrupt Event Register (ENETx_EIR)

When an event occurs that sets a bit in EIR, an interrupt occurs if the corresponding bit in the interrupt mask register (EIMR) is also set. Writing a 1 to an EIR bit clears it; writing 0 has no effect. This register is cleared upon hardware reset.

NOTE

TxBD[INT] and RxBD[INT] must be set to 1 to allow setting the corresponding EIR register flags in enhanced mode,

ENET_ECR[EN1588] = 1. Legacy mode does not require these flags to be enabled.

Address: Base address + 4h offset

Bit	31	30	29	28	27	26	25	24	23	22	21	20	19	18	17	16
R	0	BABR	BABT	GRA	TXF	TXB	RXF	RXB	MII	EBERR	LC	RL	UN	PLR	WAKEUP	TS_AVAIL
W		w1c	w1c	w1c	w1c	w1c	w1c	w1c	w1c	w1c	w1c	w1c	w1c	w1c	w1c	w1c
Reset	0	0	0	0	0	0	0	0	0	0	0	0	0	0	0	0
Bit	15	14	13	12	11	10	9	8	7	6	5	4	3	2	1	0
R	TS_TIMER															
W	w1c	0	0		0		0					0				
Reset	0	0	0	0	0	0	0	0	0	0	0	0	0	0	0	0

ENETx_EIR field descriptions

Field	Description
31 Reserved	This field is reserved. This read-only field is reserved and always has the value 0.
30 BABR	Babbling Receive Error Indicates a frame was received with length in excess of RCR[MAX_FL] bytes.
29 BAPT	Babbling Transmit Error Indicates the transmitted frame length exceeds RCR[MAX_FL] bytes. Usually this condition is caused when a frame that is too long is placed into the transmit data buffer(s). Truncation does not occur.
28 GRA	Graceful Stop Complete This interrupt is asserted after the transmitter is put into a pause state after completion of the frame currently being transmitted. See Graceful Transmit Stop (GTS) for conditions that lead to graceful stop. NOTE: The GRA interrupt is asserted only when the TX transitions into the stopped state. If this bit is cleared by writing 1 and the TX is still stopped, the bit is not set again.
27 TXF	Transmit Frame Interrupt Indicates a frame has been transmitted and the last corresponding buffer descriptor has been updated.
26 TXB	Transmit Buffer Interrupt Indicates a transmit buffer descriptor has been updated.

Table continues on the next page...

ENETx_EIR field descriptions (continued)

Field	Description
25 RXF	Receive Frame Interrupt Indicates a frame has been received and the last corresponding buffer descriptor has been updated.
24 RXB	Receive Buffer Interrupt Indicates a receive buffer descriptor is not the last in the frame has been updated.
23 MII	MII Interrupt. Indicates that the MII has completed the data transfer requested.
22 EBERR	Ethernet Bus Error Indicates a system bus error occurred when a uDMA transaction is underway. When this bit is set, ECR[ETHEREN] is cleared, halting frame processing by the MAC. When this occurs, software must ensure proper actions, possibly resetting the system, to resume normal operation.
21 LC	Late Collision Indicates a collision occurred beyond the collision window (slot time) in half-duplex mode. The frame truncates with a bad CRC and the remainder of the frame is discarded.
20 RL	Collision Retry Limit Indicates a collision occurred on each of 16 successive attempts to transmit the frame. The frame is discarded without being transmitted and transmission of the next frame commences. This error can only occur in half-duplex mode.
19 UN	Transmit FIFO Underrun Indicates the transmit FIFO became empty before the complete frame was transmitted. NOTE: In situations where the device has various masters generating high traffic, a FIFO underrun can occur on the transmit FIFO. To avoid transmit FIFO underrun, store and forward can be enabled in ENET_TFWR[STRFWD]. See STRFWD. Also, a higher priority can be set for ENET traffic using available means on the central bus fabric connecting the ENET module.
18 PLR	Payload Receive Error Indicates a frame was received with a payload length error. See Frame Length/Type Verification: Payload Length Check for more information.
17 WAKEUP	Node Wakeup Request Indication Read-only status bit to indicate that a magic packet has been detected. Will act only if ECR[MAGICEN] is set.
16 TS_AVAIL	Transmit Timestamp Available Indicates that the timestamp of the last transmitted timing frame is available in the ATSTMP register.
15 TS_TIMER	Timestamp Timer The adjustable timer reached the period event. A period event interrupt can be generated if ATCR[PEREN] is set and the timer wraps according to the periodic setting in the ATPER register. Set the timer period value before setting ATCR[PEREN].
14–13 Reserved	This field is reserved. This write-only field is reserved. It must always be written with the value 0.
12 Reserved	This field is reserved. This write-only field is reserved. It must always be written with the value 0.

Table continues on the next page...

ENETx_EIR field descriptions (continued)

Field	Description
11–9 Reserved	This field is reserved. This write-only field is reserved. It must always be written with the value 0.
8 Reserved	This field is reserved. This write-only field is reserved. It must always be written with the value 0.
Reserved	This field is reserved. This write-only field is reserved. It must always be written with the value 0.

22.5.2 Interrupt Mask Register (ENETx_EIMR)

EIMR controls which interrupt events are allowed to generate actual interrupts. A hardware reset clears this register. If the corresponding bits in the EIR and EIMR registers are set, an interrupt is generated. The interrupt signal remains asserted until a 1 is written to the EIR field (write 1 to clear) or a 0 is written to the EIMR field.

Address: Base address + 8h offset

Bit	31	30	29	28	27	26	25	24	23	22	21	20	19	18	17	16
R																
W	0	BABR	BABT	GRA	TXF	TXB	RXF	RXB	MII	EBERR	LC	RL	UN	PLR	WAKEUP	TS_AVAIL
Reset	0	0	0	0	0	0	0	0	0	0	0	0	0	0	0	0
Bit	15	14	13	12	11	10	9	8	7	6	5	4	3	2	1	0
R																
W	TS_TIMER	0	0	0	0	0	0	0	0	0	0	0	0	0	0	0
Reset	0	0	0	0	0	0	0	0	0	0	0	0	0	0	0	0

ENETx_EIMR field descriptions

Field	Description
31 Reserved	This field is reserved. This write-only field is reserved. It must always be written with the value 0.
30 BABR	BABR Interrupt Mask Corresponds to interrupt source EIR[BABR] and determines whether an interrupt condition can generate an interrupt. At every module clock, the EIR samples the signal generated by the interrupting source. The corresponding EIR BABR field reflects the state of the interrupt signal even if the corresponding EIMR field is cleared. 0 The corresponding interrupt source is masked. 1 The corresponding interrupt source is not masked.

Table continues on the next page...

ENETx_EIMR field descriptions (continued)

Field	Description
29 BABT	<p>BABT Interrupt Mask</p> <p>Corresponds to interrupt source EIR[BABT] and determines whether an interrupt condition can generate an interrupt. At every module clock, the EIR samples the signal generated by the interrupting source. The corresponding EIR BABT field reflects the state of the interrupt signal even if the corresponding EIMR field is cleared.</p> <p>0 The corresponding interrupt source is masked. 1 The corresponding interrupt source is not masked.</p>
28 GRA	<p>GRA Interrupt Mask</p> <p>Corresponds to interrupt source EIR[GRA] and determines whether an interrupt condition can generate an interrupt. At every module clock, the EIR samples the signal generated by the interrupting source. The corresponding EIR GRA field reflects the state of the interrupt signal even if the corresponding EIMR field is cleared.</p> <p>0 The corresponding interrupt source is masked. 1 The corresponding interrupt source is not masked.</p>
27 TXF	<p>TXF Interrupt Mask</p> <p>Corresponds to interrupt source EIR[TXF] and determines whether an interrupt condition can generate an interrupt. At every module clock, the EIR samples the signal generated by the interrupting source. The corresponding EIR TXF field reflects the state of the interrupt signal even if the corresponding EIMR field is cleared.</p> <p>0 The corresponding interrupt source is masked. 1 The corresponding interrupt source is not masked.</p>
26 TXB	<p>TXB Interrupt Mask</p> <p>Corresponds to interrupt source EIR[TXB] and determines whether an interrupt condition can generate an interrupt. At every module clock, the EIR samples the signal generated by the interrupting source. The corresponding EIR TXF field reflects the state of the interrupt signal even if the corresponding EIMR field is cleared.</p> <p>0 The corresponding interrupt source is masked. 1 The corresponding interrupt source is not masked.</p>
25 RXF	<p>RXF Interrupt Mask</p> <p>Corresponds to interrupt source EIR[RXF] and determines whether an interrupt condition can generate an interrupt. At every module clock, the EIR samples the signal generated by the interrupting source. The corresponding EIR RXF field reflects the state of the interrupt signal even if the corresponding EIMR field is cleared.</p>
24 RXB	<p>RXB Interrupt Mask</p> <p>Corresponds to interrupt source EIR[RXB] and determines whether an interrupt condition can generate an interrupt. At every module clock, the EIR samples the signal generated by the interrupting source. The corresponding EIR RXB field reflects the state of the interrupt signal even if the corresponding EIMR field is cleared.</p>
23 MII	<p>MII Interrupt Mask</p> <p>Corresponds to interrupt source EIR[MII] and determines whether an interrupt condition can generate an interrupt. At every module clock, the EIR samples the signal generated by the interrupting source. The</p>

Table continues on the next page...

ENETx_EIMR field descriptions (continued)

Field	Description
	corresponding EIR MII field reflects the state of the interrupt signal even if the corresponding EIMR field is cleared.
22 EBERR	EBERR Interrupt Mask Corresponds to interrupt source EIR[EBERR] and determines whether an interrupt condition can generate an interrupt. At every module clock, the EIR samples the signal generated by the interrupting source. The corresponding EIR EBERR field reflects the state of the interrupt signal even if the corresponding EIMR field is cleared.
21 LC	LC Interrupt Mask Corresponds to interrupt source EIR[LC] and determines whether an interrupt condition can generate an interrupt. At every module clock, the EIR samples the signal generated by the interrupting source. The corresponding EIR LC field reflects the state of the interrupt signal even if the corresponding EIMR field is cleared.
20 RL	RL Interrupt Mask Corresponds to interrupt source EIR[RL] and determines whether an interrupt condition can generate an interrupt. At every module clock, the EIR samples the signal generated by the interrupting source. The corresponding EIR RL field reflects the state of the interrupt signal even if the corresponding EIMR field is cleared.
19 UN	UN Interrupt Mask Corresponds to interrupt source EIR[UN] and determines whether an interrupt condition can generate an interrupt. At every module clock, the EIR samples the signal generated by the interrupting source. The corresponding EIR UN field reflects the state of the interrupt signal even if the corresponding EIMR field is cleared.
18 PLR	PLR Interrupt Mask Corresponds to interrupt source EIR[PLR] and determines whether an interrupt condition can generate an interrupt. At every module clock, the EIR samples the signal generated by the interrupting source. The corresponding EIR PLR field reflects the state of the interrupt signal even if the corresponding EIMR field is cleared.
17 WAKEUP	WAKEUP Interrupt Mask Corresponds to interrupt source EIR[WAKEUP] register and determines whether an interrupt condition can generate an interrupt. At every module clock, the EIR samples the signal generated by the interrupting source. The corresponding EIR WAKEUP field reflects the state of the interrupt signal even if the corresponding EIMR field is cleared.
16 TS_AVAIL	TS_AVAIL Interrupt Mask Corresponds to interrupt source EIR[TS_AVAIL] register and determines whether an interrupt condition can generate an interrupt. At every module clock, the EIR samples the signal generated by the interrupting source. The corresponding EIR TS_AVAIL field reflects the state of the interrupt signal even if the corresponding EIMR field is cleared.
15 TS_TIMER	TS_TIMER Interrupt Mask Corresponds to interrupt source EIR[TS_TIMER] register and determines whether an interrupt condition can generate an interrupt. At every module clock, the EIR samples the signal generated by the interrupting source. The corresponding EIR TS_TIMER field reflects the state of the interrupt signal even if the corresponding EIMR field is cleared.
14–13 Reserved	This field is reserved. This write-only field is reserved. It must always be written with the value 0.

Table continues on the next page...

ENETx_EIMR field descriptions (continued)

Field	Description
12 Reserved	This field is reserved. This write-only field is reserved. It must always be written with the value 0.
11–9 Reserved	This field is reserved. This write-only field is reserved. It must always be written with the value 0.
8 Reserved	This field is reserved. This write-only field is reserved. It must always be written with the value 0.
Reserved	This field is reserved. This write-only field is reserved. It must always be written with the value 0.

22.5.3 Receive Descriptor Active Register (ENETx_RDAR)

RDAR is a command register, written by the user, to indicate that the receive descriptor ring has been updated, that is, that the driver produced empty receive buffers with the empty bit set.

Address: Base address + 10h offset

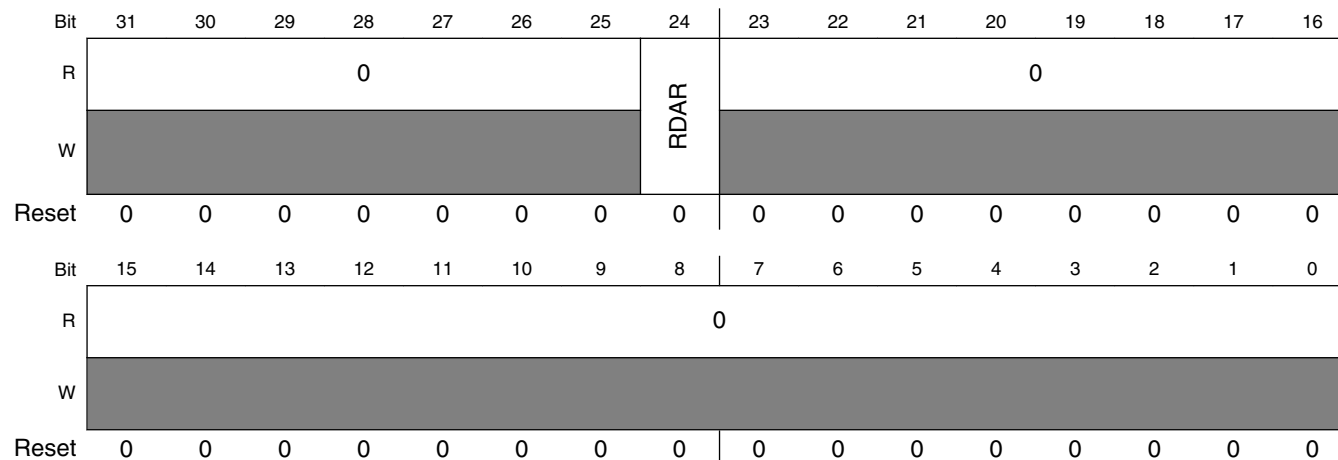

ENETx_RDAR field descriptions

Field	Description
31–25 Reserved	This field is reserved. This read-only field is reserved and always has the value 0.
24 RDAR	Receive Descriptor Active Always set to 1 when this register is written, regardless of the value written. This field is cleared by the MAC device when no additional empty descriptors remain in the receive ring. It is also cleared when ECR[ETHEREN] transitions from set to cleared or when ECR[RESET] is set.
Reserved	This field is reserved. This read-only field is reserved and always has the value 0.

22.5.4 Transmit Descriptor Active Register (ENETx_TDAR)

The TDAR is a command register that the user writes to indicate that the transmit descriptor ring has been updated, that is, that transmit buffers have been produced by the driver with the ready bit set in the buffer descriptor.

The TDAR register is cleared at reset, when ECR[ETHEREN] transitions from set to cleared, or when ECR[RESET] is set.

Address: Base address + 14h offset

Bit	31	30	29	28	27	26	25	24	23	22	21	20	19	18	17	16
R	0							TDAR	0							
W	[Shaded]								[Shaded]							
Reset	0	0	0	0	0	0	0	0	0	0	0	0	0	0	0	0
Bit	15	14	13	12	11	10	9	8	7	6	5	4	3	2	1	0
R	0															
W	[Shaded]															
Reset	0	0	0	0	0	0	0	0	0	0	0	0	0	0	0	0

ENETx_TDAR field descriptions

Field	Description
31–25 Reserved	This field is reserved. This read-only field is reserved and always has the value 0.
24 TDAR	Transmit Descriptor Active Always set to 1 when this register is written, regardless of the value written. This bit is cleared by the MAC device when no additional ready descriptors remain in the transmit ring. Also cleared when ECR[ETHEREN] transitions from set to cleared or when ECR[RESET] is set.
Reserved	This field is reserved. This read-only field is reserved and always has the value 0.

22.5.5 Ethernet Control Register (ENETx_ECR)

ECR is a read/write user register, though hardware may also alter fields in this register. It controls many of the high level features of the Ethernet MAC, including legacy FEC support through the EN1588 field.

Address: Base address + 24h offset

Bit	31	30	29	28	27	26	25	24	23	22	21	20	19	18	17	16
R	Reserved														Reserved	
W	Reserved														Reserved	
Reset	0	1	1	1	0	0	0	0	0	0	0	0	0	0	0	0
Bit	15	14	13	12	11	10	9	8	7	6	5	4	3	2	1	0
R	Reserved				Reserved	Reserved	Reserved	DBSWP	Reserved	DBGEN	0	EN1588	SLEEP	MAGICEN	ETHEREN	RESET
W	Reserved				Reserved	Reserved	Reserved	DBSWP	Reserved	DBGEN	0	EN1588	SLEEP	MAGICEN	ETHEREN	RESET
Reset	0	0	0	0	0	0	0	0	0	0	0	0	0	0	0	0

ENETx_ECR field descriptions

Field	Description
31–18 Reserved	This field is reserved. Always write 0111000000000b to this field.
17–12 Reserved	This field is reserved. Always write 0 to this field.
11 Reserved	This field is reserved. Always write 0 to this field.
10 Reserved	This field is reserved. Always write 0 to this field.
9 Reserved	This field is reserved. Always write 0 to this field.
8 DBSWP	Descriptor Byte Swapping Enable Swaps the byte locations of the buffer descriptors. NOTE: This field must be written to 1 after reset. 0 The buffer descriptor bytes are not swapped to support big-endian devices. 1 The buffer descriptor bytes are swapped to support little-endian devices.
7 Reserved	This field is reserved. Always write 0 to this field.
6 DBGEN	Debug Enable Enables the MAC to enter hardware freeze mode when the device enters debug mode.

Table continues on the next page...

ENETx_ECR field descriptions (continued)

Field	Description
	0 MAC continues operation in debug mode. 1 MAC enters hardware freeze mode when the processor is in debug mode.
5 Reserved	This field is reserved. This write-only field is reserved. It must always be written with the value 0.
4 EN1588	EN1588 Enable Enables enhanced functionality of the MAC. 0 Legacy FEC buffer descriptors and functions enabled. 1 Enhanced frame time-stamping functions enabled.
3 SLEEP	Sleep Mode Enable 0 Normal operating mode. 1 Sleep mode.
2 MAGICEN	Magic Packet Detection Enable Enables/disables magic packet detection. NOTE: MAGICEN is relevant only if the SLEEP field is set. If MAGICEN is set, changing the SLEEP field enables/disables sleep mode and magic packet detection. NOTE: EIMR[WAKEUP] must be written to one if Magic packet wakeup is programmed to wake up the chip from low power mode. 0 Magic detection logic disabled. 1 The MAC core detects magic packets and asserts EIR[WAKEUP] when a frame is detected.
1 ETHEREN	Ethernet Enable Enables/disables the Ethernet MAC. When the MAC is disabled, the buffer descriptors for an aborted transmit frame are not updated. The uDMA, buffer descriptor, and FIFO control logic are reset, including the buffer descriptor and FIFO pointers. Hardware clears this field under the following conditions: <ul style="list-style-type: none"> • RESET is set by software • An error condition causes the EBERR field to set. NOTE: <ul style="list-style-type: none"> • ETHEREN must be set at the very last step during ENET configuration/setup/initialization, only <i>after</i> all other ENET-related registers have been configured. • If ETHEREN is cleared to 0 by software then next time ETHEREN is set, the EIR interrupts must cleared to 0 due to previous pending interrupts. 0 Reception immediately stops and transmission stops after a bad CRC is appended to any currently transmitted frame. 1 MAC is enabled, and reception and transmission are possible.
0 RESET	Ethernet MAC Reset When this field is set, it clears the ETHEREN field.

22.5.6 MII Management Frame Register (ENETx_MMFR)

Writing to MMFR triggers a management frame transaction to the PHY device unless MSCR is programmed to zero.

If MSCR is changed from zero to non-zero during a write to MMFR, an MII frame is generated with the data previously written to the MMFR. This allows MMFR and MSCR to be programmed in either order if MSCR is currently zero.

If the MMFR register is written while frame generation is in progress, the frame contents are altered. Software must use the EIR[MII] interrupt indication to avoid writing to the MMFR register while frame generation is in progress.

Address: Base address + 40h offset

Bit	31	30	29	28	27	26	25	24	23	22	21	20	19	18	17	16	15	14	13	12	11	10	9	8	7	6	5	4	3	2	1	0
R																																
W	ST	OP	PA			RA			TA		DATA																					
Reset	0	0	0	0	0	0	0	0	0	0	0	0	0	0	0	0	0	0	0	0	0	0	0	0	0	0	0	0	0	0	0	0

ENETx_MMFR field descriptions

Field	Description
31–30 ST	Start Of Frame Delimiter See Table 22-41 (Clause 22) or Table 22-43 (Clause 45) for correct value.
29–28 OP	Operation Code See Table 22-41 (Clause 22) or Table 22-43 (Clause 45) for correct value.
27–23 PA	PHY Address See Table 22-41 (Clause 22) or Table 22-43 (Clause 45) for correct value.
22–18 RA	Register Address See Table 22-41 (Clause 22) or Table 22-43 (Clause 45) for correct value.
17–16 TA	Turn Around This field must be programmed to 10 to generate a valid MII management frame.
DATA	Management Frame Data This is the field for data to be written to or read from the PHY register.

22.5.7 MII Speed Control Register (ENETx_MSCR)

MSCR provides control of the MII clock (MDC pin) frequency and allows a preamble drop on the MII management frame.

The MII_SPEED field must be programmed with a value to provide an MDC frequency of less than or equal to 2.5 MHz to be compliant with the IEEE 802.3 MII specification. The MII_SPEED must be set to a non-zero value to source a read or write management frame. After the management frame is complete, the MSCR register may optionally be cleared to turn off MDC. The MDC signal generated has a 50% duty cycle except when MII_SPEED changes during operation. This change takes effect following a rising or falling edge of MDC.

For example, if the internal module clock (that is, peripheral bus clock) is 25 MHz, programming MII_SPEED to 0x4 results in an MDC as given in the following equation:

$$\text{MII clock frequency} = 25 \text{ MHz} / ((4 + 1) \times 2) = 2.5 \text{ MHz}$$

The following table shows the optimum values for MII_SPEED as a function of IPS bus clock frequency.

Table 22-4. Programming Examples for MSCR

Internal module clock frequency	MSCR [MII_SPEED]	MDC frequency
25 MHz	0x4	2.50 MHz
33 MHz	0x6	2.36 MHz
40 MHz	0x7	2.50 MHz
50 MHz	0x9	2.50 MHz
66 MHz	0xD	2.36 MHz

Address: Base address + 44h offset

Bit	31	30	29	28	27	26	25	24	23	22	21	20	19	18	17	16
R	0															
W																
Reset	0	0	0	0	0	0	0	0	0	0	0	0	0	0	0	0
Bit	15	14	13	12	11	10	9	8	7	6	5	4	3	2	1	0
R	0					HOLDTIME			DIS_	MII_SPEED						0
W																
Reset	0	0	0	0	0	0	0	0	0	0	0	0	0	0	0	0

ENETx_MSCR field descriptions

Field	Description
31–11 Reserved	This field is reserved. This read-only field is reserved and always has the value 0.
10–8 HOLDTIME	Hold time On MDIO Output IEEE802.3 clause 22 defines a minimum of 10 ns for the hold time on the MDIO output. Depending on the host bus frequency, the setting may need to be increased. 000 1 internal module clock cycle 001 2 internal module clock cycles

Table continues on the next page...

ENETx_MSCR field descriptions (continued)

Field	Description
	010 3 internal module clock cycles 111 8 internal module clock cycles
7 DIS_PRE	Disable Preamble Enables/disables prepending a preamble to the MII management frame. The MII standard allows the preamble to be dropped if the attached PHY devices do not require it. 0 Preamble enabled. 1 Preamble (32 ones) is not prepended to the MII management frame.
6-1 MII_SPEED	MII Speed Controls the frequency of the MII management interface clock (MDC) relative to the internal module clock. A value of 0 in this field turns off MDC and leaves it in low voltage state. Any non-zero value results in the MDC frequency of: $1/((\text{MII_SPEED} + 1) \times 2)$ of the internal module clock frequency
0 Reserved	This field is reserved. This read-only field is reserved and always has the value 0.

22.5.8 MIB Control Register (ENETx_MIBC)

MIBC is a read/write register controlling and observing the state of the MIB block. Access this register to disable the MIB block operation or clear the MIB counters. The MIB_DIS field resets to 1.

Address: Base address + 64h offset

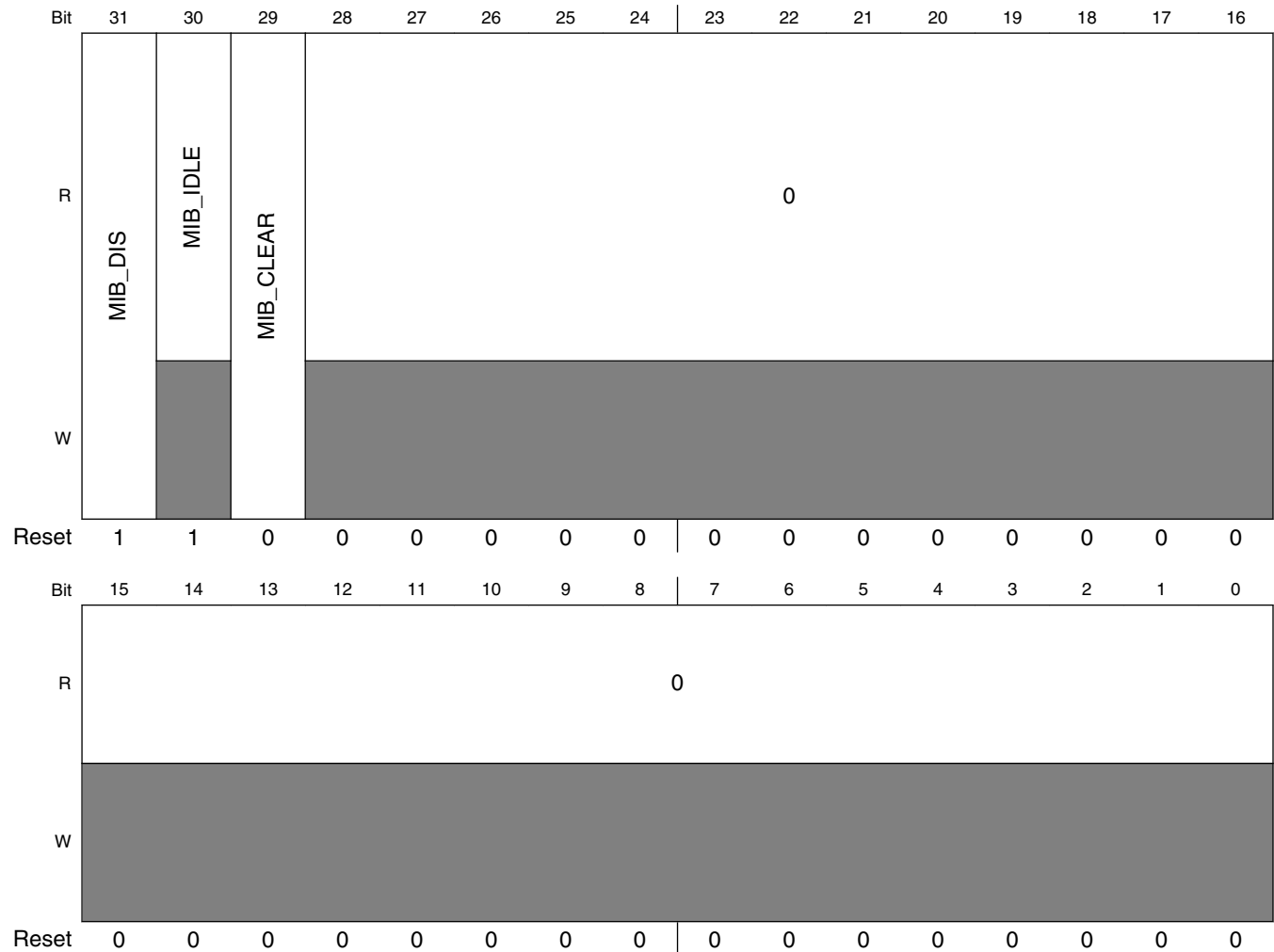

ENETx_MIBC field descriptions

Field	Description
31 MIB_DIS	Disable MIB Logic If this control field is set, 0 MIB logic is enabled. 1 MIB logic is disabled. The MIB logic halts and does not update any MIB counters.
30 MIB_IDLE	MIB Idle

Table continues on the next page...

ENETx_MIBC field descriptions (continued)

Field	Description
	0 The MIB block is updating MIB counters. 1 The MIB block is not currently updating any MIB counters.
29 MIB_CLEAR	MIB Clear NOTE: This field is not self-clearing. To clear the MIB counters set and then clear this field. 0 See note above. 1 All statistics counters are reset to 0.
Reserved	This field is reserved. This read-only field is reserved and always has the value 0.

22.5.9 Receive Control Register (ENETx_RCR)

Address: Base address + 84h offset

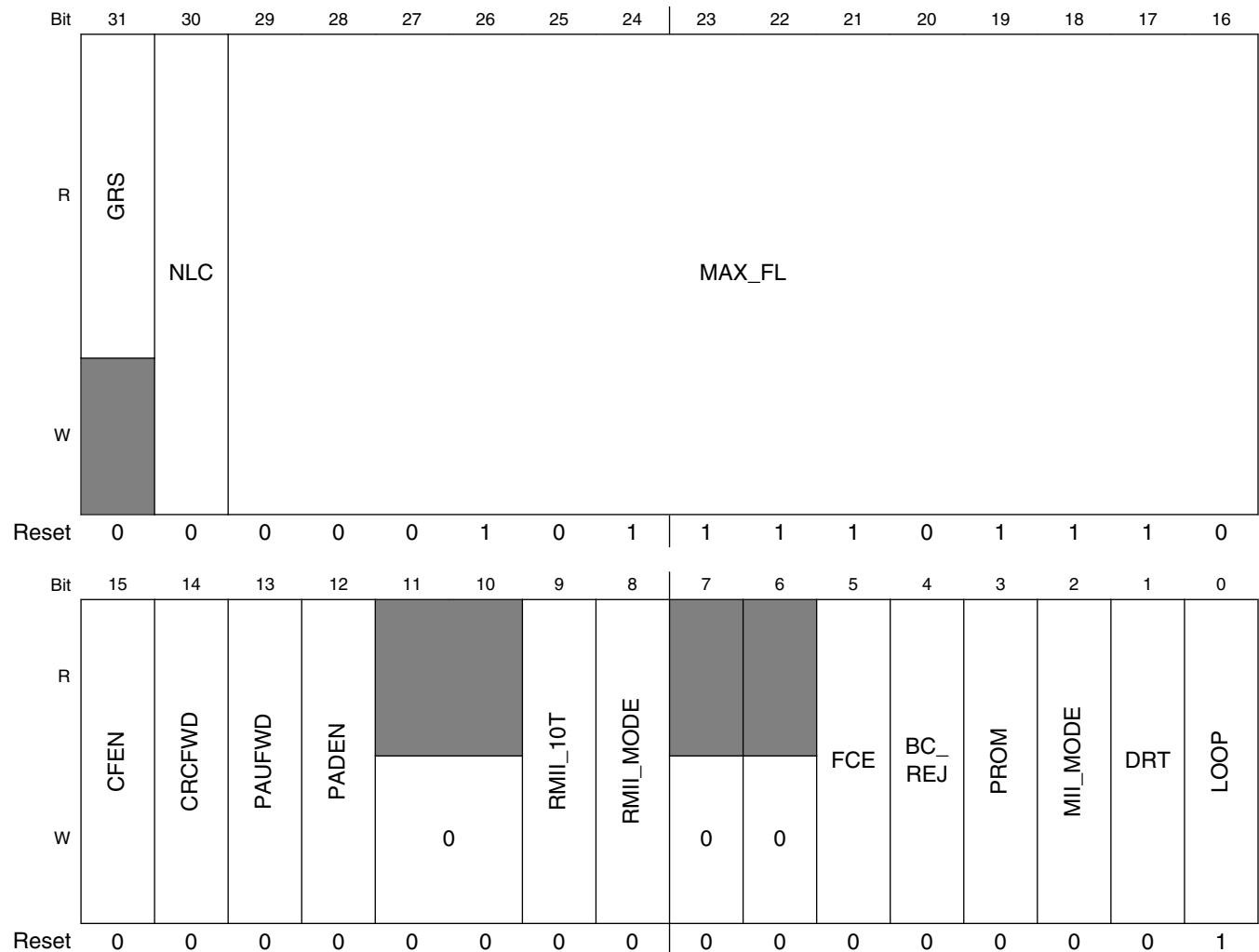

ENETx_RCR field descriptions

Field	Description
31 GRS	Graceful Receive Stopped Read-only status indicating that the MAC receive datapath is stopped.
30 NLC	Payload Length Check Disable Enables/disables a payload length check. 0 The payload length check is disabled. 1 The core checks the frame's payload length with the frame length/type field. Errors are indicated in the EIR[PLR] field.
29–16 MAX_FL	Maximum Frame Length Resets to decimal 1518. Length is measured starting at DA and includes the CRC at the end of the frame. Transmit frames longer than MAX_FL cause the BABT interrupt to occur. Receive frames longer than MAX_FL cause the BABR interrupt to occur and set the LG field in the end of frame receive buffer descriptor. The recommended default value to be programmed is 1518 or 1522 if VLAN tags are supported.
15 CFEN	MAC Control Frame Enable Enables/disables the MAC control frame. 0 MAC control frames with any opcode other than 0x0001 (pause frame) are accepted and forwarded to the client interface. 1 MAC control frames with any opcode other than 0x0001 (pause frame) are silently discarded.
14 CRCFWD	Terminate/Forward Received CRC Specifies whether the CRC field of received frames is transmitted or stripped. NOTE: If padding function is enabled (PADEN = 1), CRCFWD is ignored and the CRC field is checked and always terminated and removed. 0 The CRC field of received frames is transmitted to the user application. 1 The CRC field is stripped from the frame.
13 PAUFWD	Terminate/Forward Pause Frames Specifies whether pause frames are terminated or forwarded. 0 Pause frames are terminated and discarded in the MAC. 1 Pause frames are forwarded to the user application.
12 PADEN	Enable Frame Padding Remove On Receive Specifies whether the MAC removes padding from received frames. 0 No padding is removed on receive by the MAC. 1 Padding is removed from received frames.
11–10 Reserved	This field is reserved. This write-only field is reserved. It must always be written with the value 0.
9 RMII_10T	Enables 10-Mbit/s mode of the RMII . 0 100-Mbit/s operation. 1 10-Mbit/s operation.

Table continues on the next page...

ENETx_RCR field descriptions (continued)

Field	Description
8 RMII_MODE	<p>RMII Mode Enable</p> <p>Specifies whether the MAC is configured for MII mode or RMII operation .</p> <p>0 MAC configured for MII mode. 1 MAC configured for RMII operation.</p>
7 Reserved	<p>This field is reserved.</p> <p>This write-only field is reserved. It must always be written with the value 0.</p>
6 Reserved	<p>This field is reserved.</p> <p>This write-only field is reserved. It must always be written with the value 0.</p>
5 FCE	<p>Flow Control Enable</p> <p>If set, the receiver detects PAUSE frames. Upon PAUSE frame detection, the transmitter stops transmitting data frames for a given duration.</p>
4 BC_REJ	<p>Broadcast Frame Reject</p> <p>If set, frames with destination address (DA) equal to 0xFFFF_FFFF_FFFF are rejected unless the PROM field is set. If BC_REJ and PROM are set, frames with broadcast DA are accepted and the MISS (M) is set in the receive buffer descriptor.</p>
3 PROM	<p>Promiscuous Mode</p> <p>All frames are accepted regardless of address matching.</p> <p>0 Disabled. 1 Enabled.</p>
2 MII_MODE	<p>Media Independent Interface Mode</p> <p>This field must always be set.</p> <p>0 Reserved. 1 MII or RMII mode, as indicated by the RMII_MODE field.</p>
1 DRT	<p>Disable Receive On Transmit</p> <p>0 Receive path operates independently of transmit (i.e., full-duplex mode). Can also be used to monitor transmit activity in half-duplex mode. 1 Disable reception of frames while transmitting. (Normally used for half-duplex mode.)</p>
0 LOOP	<p>Internal Loopback</p> <p>This is an MII internal loopback, therefore MII_MODE must be written to 1 and RMII_MODE must be written to 0.</p> <p>0 Loopback disabled. 1 Transmitted frames are looped back internal to the device and transmit MII output signals are not asserted. DRT must be cleared.</p>

22.5.10 Transmit Control Register (ENETx_TCR)

TCR is read/write and configures the transmit block. This register is cleared at system reset. FDEN can only be modified when ECR[ETHEREN] is cleared.

Address: Base address + C4h offset

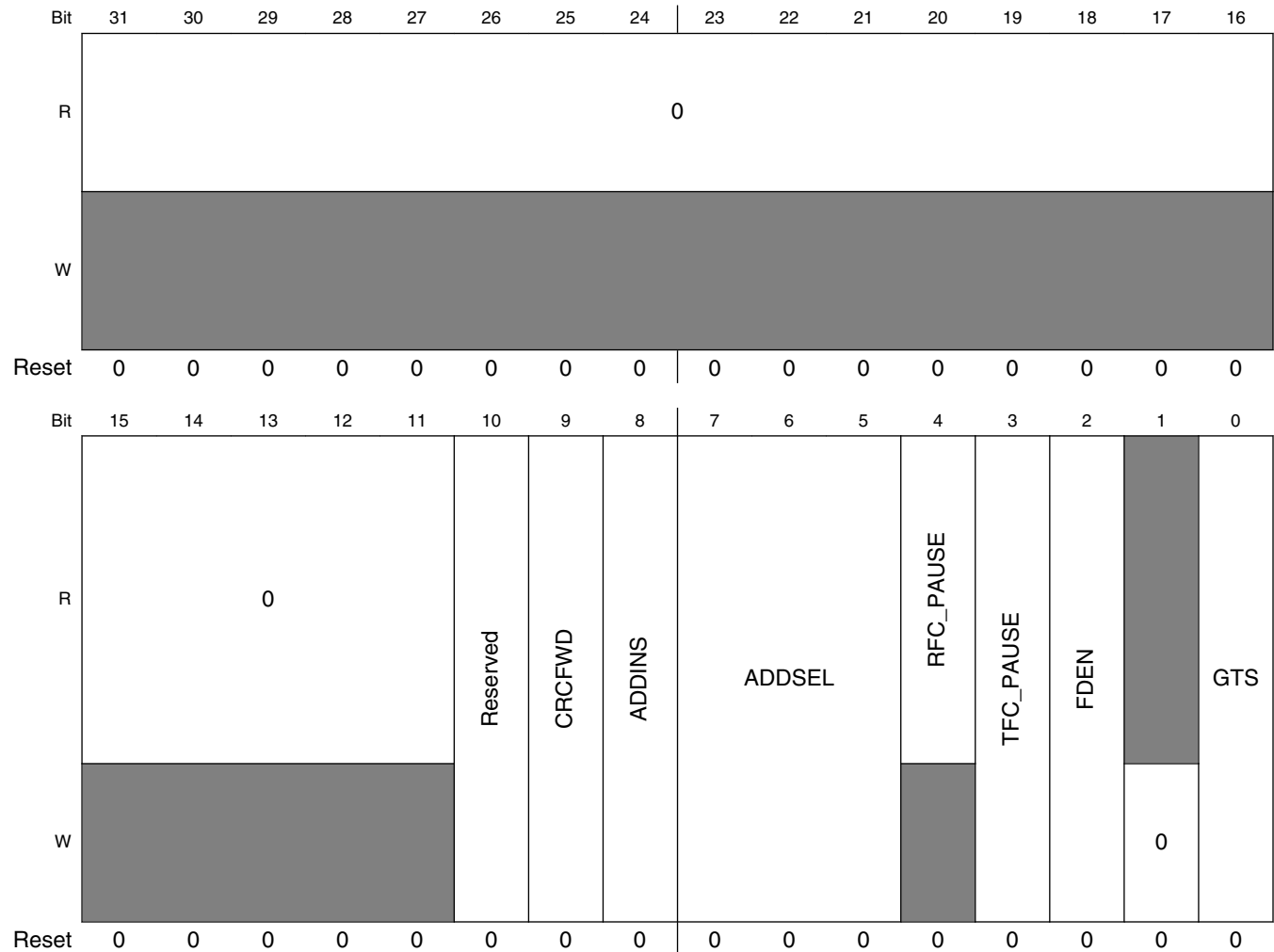

ENETx_TCR field descriptions

Field	Description
31–11 Reserved	This field is reserved. This read-only field is reserved and always has the value 0.
10 Reserved	This field is reserved. This field is read/write and must be set to 0.
9 CRCFWD	Forward Frame From Application With CRC 0 TxBD[TC] controls whether the frame has a CRC from the application. 1 The transmitter does not append any CRC to transmitted frames, as it is expecting a frame with CRC from the application.

Table continues on the next page...

ENETx_TCR field descriptions (continued)

Field	Description
8 ADDINS	Set MAC Address On Transmit 0 The source MAC address is not modified by the MAC. 1 The MAC overwrites the source MAC address with the programmed MAC address according to ADDSEL.
7-5 ADDSEL	Source MAC Address Select On Transmit If ADDINS is set, indicates the MAC address that overwrites the source MAC address. 000 Node MAC address programmed on PADDR1/2 registers. 100 Reserved. 101 Reserved. 110 Reserved.
4 RFC_PAUSE	Receive Frame Control Pause This status field is set when a full-duplex flow control pause frame is received and the transmitter pauses for the duration defined in this pause frame. This field automatically clears when the pause duration is complete.
3 TFC_PAUSE	Transmit Frame Control Pause Pauses frame transmission. When this field is set, EIR[GRA] is set. With transmission of data frames stopped, the MAC transmits a MAC control PAUSE frame. Next, the MAC clears TFC_PAUSE and resumes transmitting data frames. If the transmitter pauses due to user assertion of GTS or reception of a PAUSE frame, the MAC may continue transmitting a MAC control PAUSE frame. 0 No PAUSE frame transmitted. 1 The MAC stops transmission of data frames after the current transmission is complete.
2 FDEN	Full-Duplex Enable If this field is set, frames transmit independent of carrier sense and collision inputs. Only modify this bit when ECR[ETHEREN] is cleared.
1 Reserved	This field is reserved. This write-only field is reserved. It must always be written with the value 0.
0 GTS	Graceful Transmit Stop When this field is set, MAC stops transmission after any frame currently transmitted is complete and EIR[GRA] is set. If frame transmission is not currently underway, the GRA interrupt is asserted immediately. After transmission finishes, clear GTS to restart. The next frame in the transmit FIFO is then transmitted. If an early collision occurs during transmission when GTS is set, transmission stops after the collision. The frame is transmitted again after GTS is cleared. There may be old frames in the transmit FIFO that transmit when GTS is reasserted. To avoid this, clear ECR[ETHEREN] following the GRA interrupt.

22.5.11 Physical Address Lower Register (ENETx_PALR)

PALR contains the lower 32 bits (bytes 0, 1, 2, 3) of the 48-bit address used in the address recognition process to compare with the destination address (DA) field of receive frames with an individual DA. In addition, this register is used in bytes 0 through 3 of the six-byte source address field when transmitting PAUSE frames.

Address: Base address + E4h offset

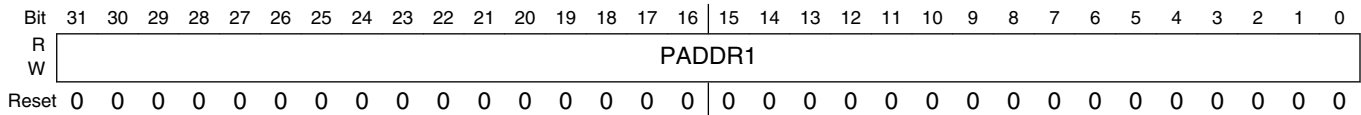

ENETx_PALR field descriptions

Field	Description
PADDR1	Pause Address Bytes 0 (bits 31:24), 1 (bits 23:16), 2 (bits 15:8), and 3 (bits 7:0) of the 6-byte individual address are used for exact match and the source address field in PAUSE frames.

22.5.12 Physical Address Upper Register (ENETx_PAUR)

PAUR contains the upper 16 bits (bytes 4 and 5) of the 48-bit address used in the address recognition process to compare with the destination address (DA) field of receive frames with an individual DA. In addition, this register is used in bytes 4 and 5 of the six-byte source address field when transmitting PAUSE frames. Bits 15:0 of PAUR contain a constant type field (0x8808) for transmission of PAUSE frames.

Address: Base address + E8h offset

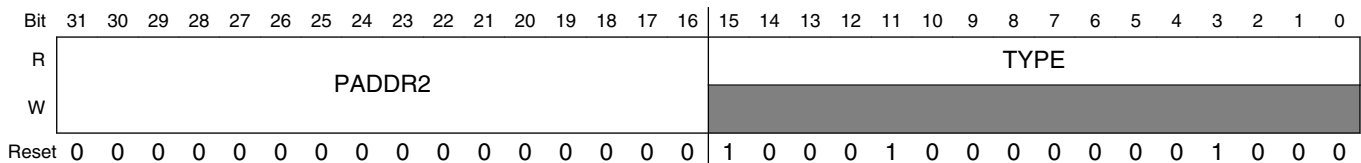

ENETx_PAUR field descriptions

Field	Description
31–16 PADDR2	Bytes 4 (bits 31:24) and 5 (bits 23:16) of the 6-byte individual address used for exact match, and the source address field in PAUSE frames.
TYPE	Type Field In PAUSE Frames These fields have a constant value of 0x8808.

22.5.13 Opcode/Pause Duration Register (ENETx_OPD)

OPD is read/write accessible. This register contains the 16-bit opcode and 16-bit pause duration fields used in transmission of a PAUSE frame. The opcode field is a constant value, 0x0001. When another node detects a PAUSE frame, that node pauses transmission for the duration specified in the pause duration field. The lower 16 bits of this register are not reset and you must initialize it.

Address: Base address + ECh offset

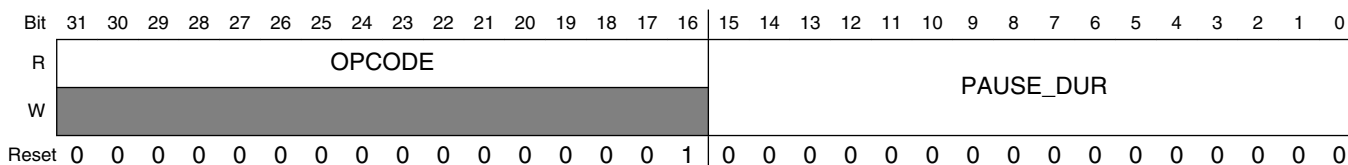

ENETx_OPD field descriptions

Field	Description
31–16 OPCODE	Opcode Field In PAUSE Frames These fields have a constant value of 0x0001.
PAUSE_DUR	Pause Duration Pause duration field used in PAUSE frames.

22.5.14 Transmit Interrupt Coalescing Register (ENETx_TXIC)

See [Interrupt coalescence](#) for more information.

Address: Base address + F0h offset

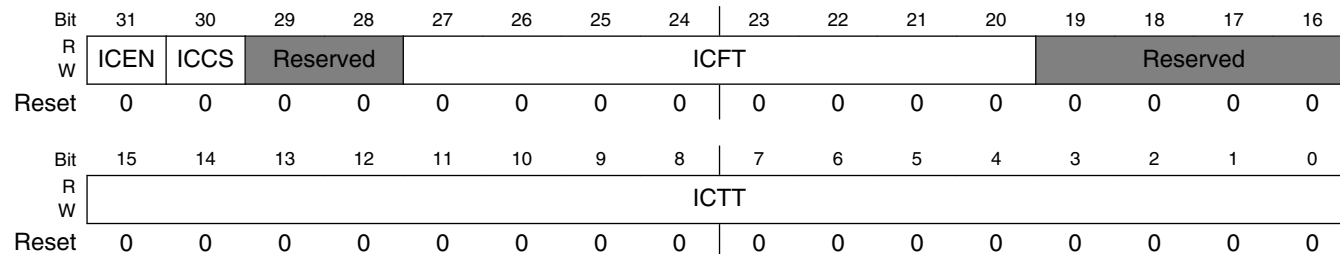

ENETx_TXIC field descriptions

Field	Description
31 ICEN	Interrupt Coalescing Enable

Table continues on the next page...

ENETx_TXIC field descriptions (continued)

Field	Description
	0 Disable Interrupt coalescing. 1 Enable Interrupt coalescing.
30 ICCS	Interrupt Coalescing Timer Clock Source Select 0 Use MII/GMII TX clocks. 1 Use ENET system clock.
29–28 Reserved	This field must be set to 0. This field is reserved.
27–20 ICFT	Interrupt coalescing frame count threshold This value determines the number of frames needed to be transmitted for raising an interrupt. Frame counter restarts after reaching this threshold value or after the expiring of the coalescing timer. Must be greater than zero to avoid unpredictable behavior.
19–16 Reserved	This field must be set to 0. This field is reserved.
ICTT	Interrupt coalescing timer threshold Interrupt coalescing timer threshold in units of 64 clock periods. This value determines the maximum amount of time after transmitting a frame before raising an interrupt. The threshold timer is disabled after expiring or number of frame transmission defined by ICFT and starts again upon transmission of the next first frame. Must be greater than zero to avoid unpredictable behavior.

22.5.15 Receive Interrupt Coalescing Register (ENETx_RXIC)

See [Interrupt coalescence](#) for more information.

Address: Base address + 100h offset

Bit	31	30	29	28	27	26	25	24	23	22	21	20	19	18	17	16
R																
W	ICEN	ICCS	Reserved						ICFT					Reserved		
Reset	0	0	0	0	0	0	0	0	0	0	0	0	0	0	0	0
Bit	15	14	13	12	11	10	9	8	7	6	5	4	3	2	1	0
R																
W									ICTT							
Reset	0	0	0	0	0	0	0	0	0	0	0	0	0	0	0	0

ENETx_RXIC field descriptions

Field	Description
31 ICEN	Interrupt Coalescing Enable 0 Disable Interrupt coalescing. 1 Enable Interrupt coalescing.

Table continues on the next page...

ENETx_RXIC field descriptions (continued)

Field	Description
30 ICCS	Interrupt Coalescing Timer Clock Source Select 0 Use MII/GMII TX clocks. 1 Use ENET system clock.
29–28 Reserved	This field must be set to 0. This field is reserved.
27–20 ICFT	Interrupt coalescing frame count threshold This value determines the number of frames needed to be received for raising an interrupt. Frame counter restarts after reaching this threshold value or after the expiring of the coalescing timer. Must be greater than zero to avoid unpredictable behavior.
19–16 Reserved	This field must be set to 0. This field is reserved.
ICTT	Interrupt coalescing timer threshold Interrupt coalescing timer threshold in units of 64 clock periods. This value determines the maximum amount of time after receiving a frame before raising an interrupt. The threshold timer is disabled after expiring or number of frame reception defined by ICFT and starts again upon reception of the next first frame. Must be greater than zero to avoid unpredictable behavior.

22.5.16 Descriptor Individual Upper Address Register (ENETx_IAUR)

IAUR contains the upper 32 bits of the 64-bit individual address hash table. The address recognition process uses this table to check for a possible match with the destination address (DA) field of receive frames with an individual DA. This register is not reset and you must initialize it.

Address: Base address + 118h offset

Bit	31	30	29	28	27	26	25	24	23	22	21	20	19	18	17	16	15	14	13	12	11	10	9	8	7	6	5	4	3	2	1	0
R																																
W																																
Reset	0	0	0	0	0	0	0	0	0	0	0	0	0	0	0	0	0	0	0	0	0	0	0	0	0	0	0	0	0	0	0	0

ENETx_IAUR field descriptions

Field	Description
IADDR1	Contains the upper 32 bits of the 64-bit hash table used in the address recognition process for receive frames with a unicast address. Bit 31 of IADDR1 contains hash index bit 63. Bit 0 of IADDR1 contains hash index bit 32.

22.5.17 Descriptor Individual Lower Address Register (ENETx_IALR)

IALR contains the lower 32 bits of the 64-bit individual address hash table. The address recognition process uses this table to check for a possible match with the DA field of receive frames with an individual DA. This register is not reset and you must initialize it.

Address: Base address + 11Ch offset

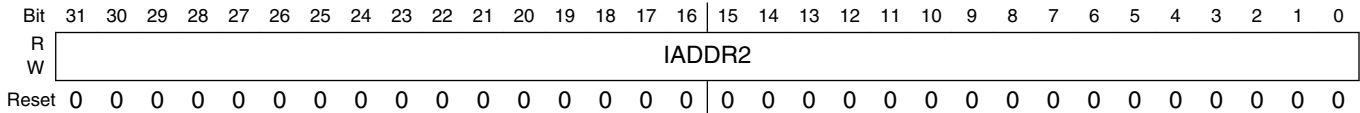

ENETx_IALR field descriptions

Field	Description
IADDR2	Contains the lower 32 bits of the 64-bit hash table used in the address recognition process for receive frames with a unicast address. Bit 31 of IADDR2 contains hash index bit 31. Bit 0 of IADDR2 contains hash index bit 0.

22.5.18 Descriptor Group Upper Address Register (ENETx_GAUR)

GAUR contains the upper 32 bits of the 64-bit hash table used in the address recognition process for receive frames with a multicast address. You must initialize this register.

Address: Base address + 120h offset

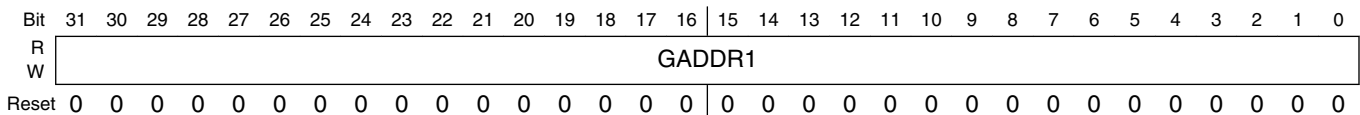

ENETx_GAUR field descriptions

Field	Description
GADDR1	Contains the upper 32 bits of the 64-bit hash table used in the address recognition process for receive frames with a multicast address. Bit 31 of GADDR1 contains hash index bit 63. Bit 0 of GADDR1 contains hash index bit 32.

22.5.19 Descriptor Group Lower Address Register (ENETx_GALR)

GALR contains the lower 32 bits of the 64-bit hash table used in the address recognition process for receive frames with a multicast address. You must initialize this register.

Address: Base address + 124h offset

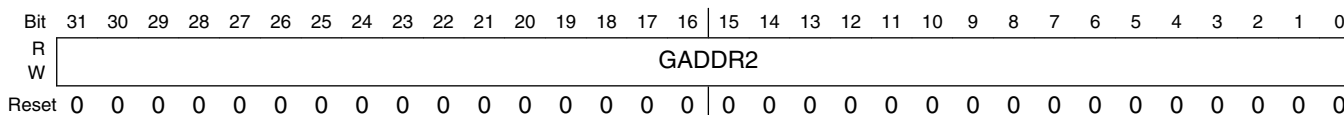

ENETx_GALR field descriptions

Field	Description
GADDR2	Contains the lower 32 bits of the 64-bit hash table used in the address recognition process for receive frames with a multicast address. Bit 31 of GADDR2 contains hash index bit 31. Bit 0 of GADDR2 contains hash index bit 0.

22.5.20 Transmit FIFO Watermark Register (ENETx_TFWR)

If TFWR[STRFWD] is cleared, TFWR[TFWR] controls the amount of data required in the transmit FIFO before transmission of a frame can begin. This allows you to minimize transmit latency (TFWR = 00 or 01) or allow for larger bus access latency (TFWR = 11) due to contention for the system bus. Setting the watermark to a high value minimizes the risk of transmit FIFO underrun due to contention for the system bus. The byte counts associated with the TFWR field may need to be modified to match a given system requirement, for example, worst-case bus access latency by the transmit data uDMA channel.

When the FIFO level reaches the value the TFWR field and when the STR_FWD is set to '0', the MAC transmit control logic starts frame transmission even before the end-of-frame is available in the FIFO (cut-through operation).

If a complete frame has a size smaller than the threshold programmed with TFWR, the MAC also transmits the Frame to the line.

To enable store and forward on the Transmit path, set STR_FWD to '1'. In this case, the MAC starts to transmit data only when a complete frame is stored in the Transmit FIFO.

Address: Base address + 144h offset

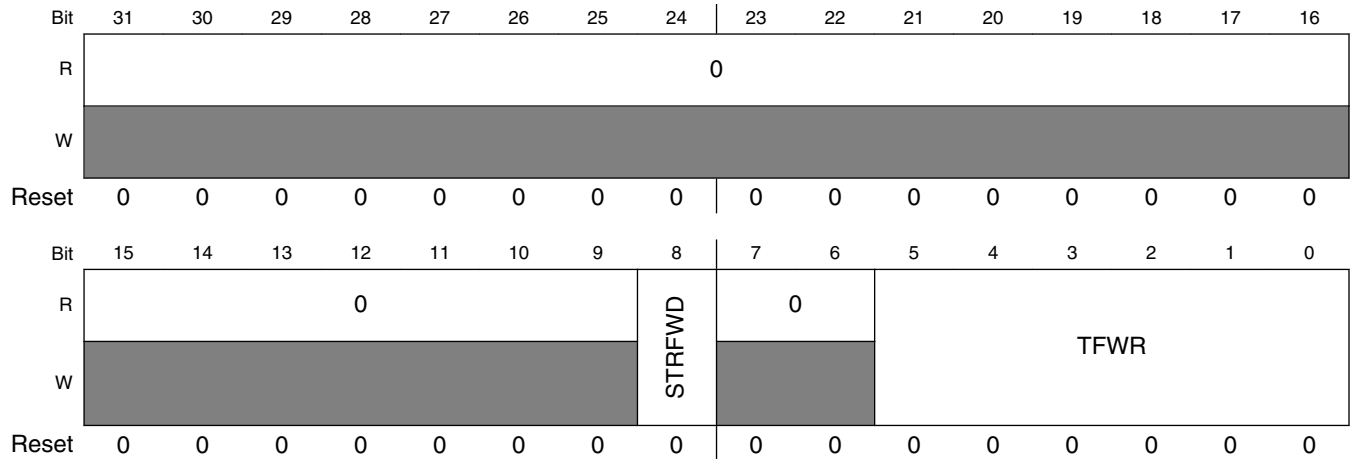

ENETx_TFWR field descriptions

Field	Description
31–9 Reserved	This field is reserved. This read-only field is reserved and always has the value 0.
8 STRFWD	Store And Forward Enable 0 Reset. The transmission start threshold is programmed in TFWR[TFWR]. 1 Enabled.
7–6 Reserved	This field is reserved. This read-only field is reserved and always has the value 0.
TFWR	Transmit FIFO Write If TFWR[STRFWD] is cleared, this field indicates the number of bytes, in steps of 64 bytes, written to the transmit FIFO before transmission of a frame begins. NOTE: If a frame with less than the threshold is written, it is still sent independently of this threshold setting. The threshold is relevant only if the frame is larger than the threshold given. 000000 64 bytes written. 000001 64 bytes written. 000010 128 bytes written. 000011 192 bytes written. 011111 1984 bytes written.

22.5.21 Receive Descriptor Ring Start Register (ENETx_RDSR)

RDSR points to the beginning of the circular receive buffer descriptor queue in external memory. This pointer must be 64-bit aligned (bits 2–0 must be zero); however, for optimal performance the pointer should be 512-bit aligned, that is, evenly divisible by 64.

NOTE

This register must be initialized prior to operation

Memory map/register definition

Address: Base address + 180h offset

Bit	31	30	29	28	27	26	25	24		23	22	21	20	19	18	17	16
R	R_DES_START																
W																	
Reset	0	0	0	0	0	0	0	0		0	0	0	0	0	0	0	0
Bit	15	14	13	12	11	10	9	8		7	6	5	4	3	2	1	0
R	R_DES_START															0	
W															0		
Reset	0	0	0	0	0	0	0	0		0	0	0	0	0	0	0	0

ENETx_RDSR field descriptions

Field	Description
31–3 R_DES_START	Pointer to the beginning of the receive buffer descriptor queue.
2 Reserved	This field is reserved. This write-only field is reserved. It must always be written with the value 0.
Reserved	This field is reserved. This read-only field is reserved and always has the value 0.

22.5.22 Transmit Buffer Descriptor Ring Start Register (ENETx_TDSR)

TDSR provides a pointer to the beginning of the circular transmit buffer descriptor queue in external memory. This pointer must be 64-bit aligned (bits 2–0 must be zero); however, for optimal performance the pointer should be 512-bit aligned, that is, evenly divisible by 64.

NOTE

This register must be initialized prior to operation.

Address: Base address + 184h offset

Bit	31	30	29	28	27	26	25	24		23	22	21	20	19	18	17	16
R	X_DES_START																
W																	
Reset	0	0	0	0	0	0	0	0		0	0	0	0	0	0	0	0
Bit	15	14	13	12	11	10	9	8		7	6	5	4	3	2	1	0
R	X_DES_START															0	
W															0		
Reset	0	0	0	0	0	0	0	0		0	0	0	0	0	0	0	0

ENETx_TDSR field descriptions

Field	Description
31–3 X_DES_START	Pointer to the beginning of the transmit buffer descriptor queue.
2 Reserved	This field is reserved. This write-only field is reserved. It must always be written with the value 0.
Reserved	This field is reserved. This read-only field is reserved and always has the value 0.

22.5.23 Maximum Receive Buffer Size Register (ENETx_MRBR)

The MRBR is a user-programmable register that dictates the maximum size of all receive buffers. This value should take into consideration that the receive CRC is always written into the last receive buffer.

- R_BUF_SIZE is concatenated with the four least-significant bits of this register and are used as the maximum receive buffer size.
- To allow one maximum size frame per buffer, MRBR must be set to RCR[MAX_FL] or larger.
- To properly align the buffer, MRBR must be evenly divisible by 64. To ensure this, set the lower two bits of R_BUF_SIZE to zero. The lower four bits of this register are already set to zero by the device.
- To minimize bus usage (descriptor fetches), set MRBR greater than or equal to 256 bytes.

NOTE

This register must be initialized before operation.

Address: Base address + 188h offset

Bit	31	30	29	28	27	26	25	24	23	22	21	20	19	18	17	16	15	14	13	12	11	10	9	8	7	6	5	4	3	2	1	0
R	0																R_BUF_SIZE										0					
W	0																0										0					
Reset	0	0	0	0	0	0	0	0	0	0	0	0	0	0	0	0	0	0	0	0	0	0	0	0	0	0	0	0	0	0	0	

ENETx_MRBR field descriptions

Field	Description
31–14 Reserved	This field is reserved. This read-only field is reserved and always has the value 0.
13–4 R_BUF_SIZE	Receive buffer size in bytes. This value, concatenated with the four least-significant bits of this register (which are always zero), is the effective maximum receive buffer size.
Reserved	This field, which is always zero, is the four least-significant bits of the maximum receive buffer size. This field is reserved. This read-only field is reserved and always has the value 0.

22.5.24 Receive FIFO Section Full Threshold (ENETx_RSFL)

Address: Base address + 190h offset

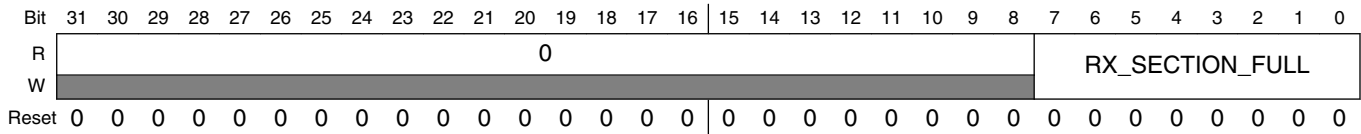

ENETx_RSFL field descriptions

Field	Description
31–8 Reserved	This field is reserved. This read-only field is reserved and always has the value 0.
RX_SECTION_FULL	Value Of Receive FIFO Section Full Threshold Value, in 64-bit words, of the receive FIFO section full threshold. Clear this field to enable store and forward on the RX FIFO. When programming a value greater than 0 (cut-through operation), it must be greater than RAEM[RX_ALMOST_EMPTY]. When the FIFO level reaches the value in this field, data is available in the Receive FIFO (cut-through operation).

22.5.25 Receive FIFO Section Empty Threshold (ENETx_RSEM)

Address: Base address + 194h offset

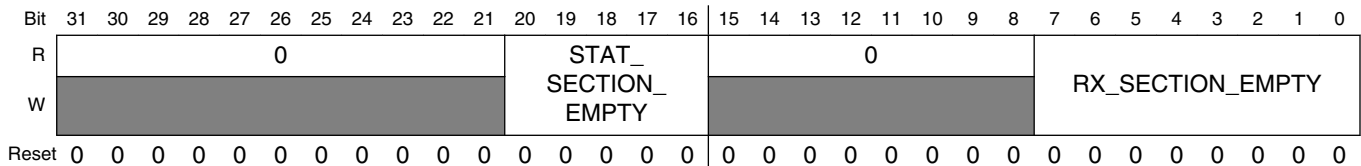

ENETx_RSEM field descriptions

Field	Description
31–21 Reserved	This field is reserved. This read-only field is reserved and always has the value 0.
20–16 STAT_SECTION_EMPTY	RX Status FIFO Section Empty Threshold Defines number of frames in the receive FIFO, independent of its size, that can be accepted. If the limit is reached, reception will continue normally, however a pause frame will be triggered to indicate a possible congestion to the remote device to avoid FIFO overflow. A value of 0 disables automatic pause frame generation
15–8 Reserved	This field is reserved. This read-only field is reserved and always has the value 0.
RX_SECTION_EMPTY	Value Of The Receive FIFO Section Empty Threshold Value, in 64-bit words, of the receive FIFO section empty threshold. When the FIFO has reached this level, a pause frame will be issued.

Table continues on the next page...

ENETx_RSEM field descriptions (continued)

Field	Description
	<p>A value of 0 disables automatic pause frame generation.</p> <p>When the FIFO level goes below the value programmed in this field, an XON pause frame is issued to indicate the FIFO congestion is cleared to the remote Ethernet client.</p> <p>NOTE: The section-empty threshold indications from both FIFOs are OR'ed to cause XOFF pause frame generation.</p>

22.5.26 Receive FIFO Almost Empty Threshold (ENETx_RAEM)

Address: Base address + 198h offset

Bit	31	30	29	28	27	26	25	24	23	22	21	20	19	18	17	16	15	14	13	12	11	10	9	8	7	6	5	4	3	2	1	0
R	0																RX_ALMOST_EMPTY															
W																																
Reset	0	0	0	0	0	0	0	0	0	0	0	0	0	0	0	0	0	0	0	0	0	0	0	0	0	0	0	0	0	1	0	0

ENETx_RAEM field descriptions

Field	Description
31–8 Reserved	<p>This field is reserved.</p> <p>This read-only field is reserved and always has the value 0.</p>
RX_ALMOST_EMPTY	<p>Value Of The Receive FIFO Almost Empty Threshold</p> <p>Value, in 64-bit words, of the receive FIFO almost empty threshold. When the FIFO level reaches the value programmed in this field and the end-of-frame has not been received for the frame yet, the core receive read control stops FIFO read (and subsequently stops transferring data to the MAC client application). It continues to deliver the frame, if again more data than the threshold or the end-of-frame is available in the FIFO. A minimum value of 4 should be set.</p>

22.5.27 Receive FIFO Almost Full Threshold (ENETx_RAFL)

Address: Base address + 19Ch offset

Bit	31	30	29	28	27	26	25	24	23	22	21	20	19	18	17	16	15	14	13	12	11	10	9	8	7	6	5	4	3	2	1	0
R	0																RX_ALMOST_FULL															
W																																
Reset	0	0	0	0	0	0	0	0	0	0	0	0	0	0	0	0	0	0	0	0	0	0	0	0	0	0	0	0	0	1	0	0

ENETx_RAFL field descriptions

Field	Description
31–8 Reserved	<p>This field is reserved.</p> <p>This read-only field is reserved and always has the value 0.</p>
RX_ALMOST_FULL	Value Of The Receive FIFO Almost Full Threshold

Table continues on the next page...

ENETx_RAFL field descriptions (continued)

Field	Description
	Value, in 64-bit words, of the receive FIFO almost full threshold. When the FIFO level comes close to the maximum, so that there is no more space for at least RX_ALMOST_FULL number of words, the MAC stops writing data in the FIFO and truncates the received frame to avoid FIFO overflow. The corresponding error status will be set when the frame is delivered to the application. A minimum value of 4 should be set.

22.5.28 Transmit FIFO Section Empty Threshold (ENETx_TSEM)

Address: Base address + 1A0h offset

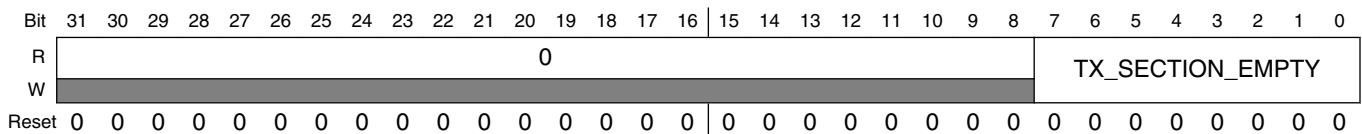

ENETx_TSEM field descriptions

Field	Description
31–8 Reserved	This field is reserved. This read-only field is reserved and always has the value 0.
TX_SECTION_EMPTY	Value Of The Transmit FIFO Section Empty Threshold Value, in 64-bit words, of the transmit FIFO section empty threshold. See Transmit FIFO for more information.

22.5.29 Transmit FIFO Almost Empty Threshold (ENETx_TAEM)

Address: Base address + 1A4h offset

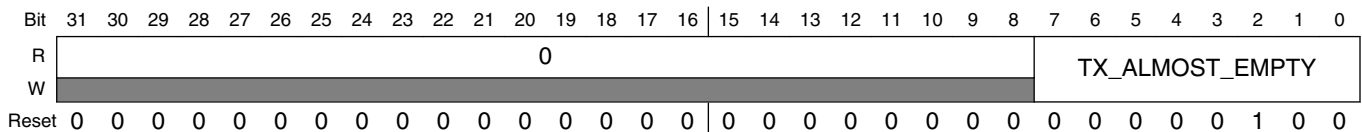

ENETx_TAEM field descriptions

Field	Description
31–8 Reserved	This field is reserved. This read-only field is reserved and always has the value 0.
TX_ALMOST_EMPTY	Value of Transmit FIFO Almost Empty Threshold Value, in 64-bit words, of the transmit FIFO almost empty threshold. When the FIFO level reaches the value programmed in this field, and no end-of-frame is available for the frame, the MAC transmit logic, to avoid FIFO underflow, stops reading the FIFO and transmits a frame with an MII error indication. See Transmit FIFO for more information. A minimum value of 4 should be set.

22.5.30 Transmit FIFO Almost Full Threshold (ENETx_TAFL)

Address: Base address + 1A8h offset

Bit	31	30	29	28	27	26	25	24	23	22	21	20	19	18	17	16	15	14	13	12	11	10	9	8	7	6	5	4	3	2	1	0
R	0																TX_ALMOST_FULL															
W																																
Reset	0	0	0	0	0	0	0	0	0	0	0	0	0	0	0	0	0	0	0	0	0	0	0	0	0	0	0	0	1	0	0	0

ENETx_TAFL field descriptions

Field	Description
31–8 Reserved	This field is reserved. This read-only field is reserved and always has the value 0.
TX_ALMOST_FULL	<p>Value Of The Transmit FIFO Almost Full Threshold</p> <p>Value, in 64-bit words, of the transmit FIFO almost full threshold. A minimum value of six is required . A recommended value of at least 8 should be set allowing a latency of two clock cycles to the application. If more latency is required the value can be increased as necessary (latency = TAFL - 5).</p> <p>When the FIFO level comes close to the maximum, so that there is no more space for at least TX_ALMOST_FULL number of words, the pin ff_tx_rdy is deasserted. If the application does not react on this signal, the FIFO write control logic, to avoid FIFO overflow, truncates the current frame and sets the error status. As a result, the frame will be transmitted with an GMII/MII error indication. See Transmit FIFO for more information.</p> <p>NOTE: A FIFO overflow is a fatal error and requires a global reset on the transmit datapath or at least deassertion of ETHEREN.</p>

22.5.31 Transmit Inter-Packet Gap (ENETx_TIPG)

Address: Base address + 1ACh offset

Bit	31	30	29	28	27	26	25	24	23	22	21	20	19	18	17	16	15	14	13	12	11	10	9	8	7	6	5	4	3	2	1	0	
R	0																IPG																
W																																	
Reset	0	0	0	0	0	0	0	0	0	0	0	0	0	0	0	0	0	0	0	0	0	0	0	0	0	0	0	0	0	1	1	0	0

ENETx_TIPG field descriptions

Field	Description
31–5 Reserved	This field is reserved. This read-only field is reserved and always has the value 0.
IPG	<p>Transmit Inter-Packet Gap</p> <p>Indicates the IPG, in bytes, between transmitted frames. Valid values range from 8 to 26. If the written value is less than 8 or greater than 26, the internal (effective) IPG is 12.</p> <p>NOTE: The IPG value read will be the value that was written, even if it is out of range.</p>

22.5.32 Frame Truncation Length (ENETx_FTRL)

Address: Base address + 1B0h offset

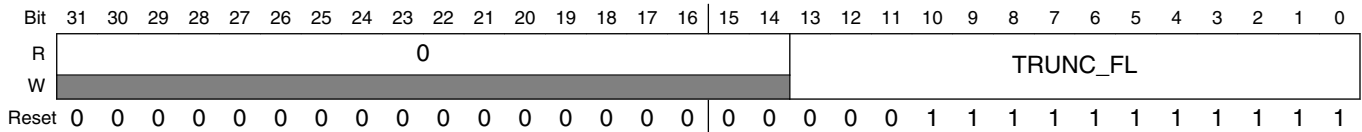

ENETx_FTRL field descriptions

Field	Description
31–14 Reserved	This field is reserved. This read-only field is reserved and always has the value 0.
TRUNC_FL	Frame Truncation Length Indicates the value a receive frame is truncated, if it is greater than this value. Must be greater than or equal to RCR[MAX_FL]. NOTE: Truncation happens at TRUNC_FL. However, when truncation occurs, the application (FIFO) may receive less data, guaranteeing that it never receives more than the set limit.

22.5.33 Transmit Accelerator Function Configuration (ENETx_TACC)

TACC controls accelerator actions when sending frames. The register can be changed before or after each frame, but it must remain unmodified during frame writes into the transmit FIFO.

The TFWR[STRFWD] field must be set to use the checksum feature.

Address: Base address + 1C0h offset

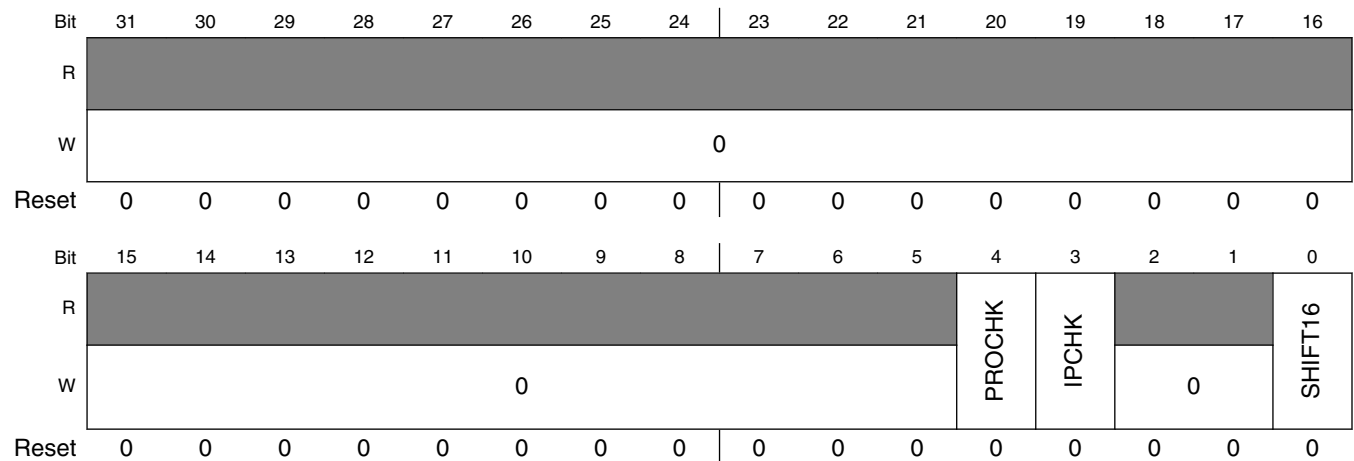

ENETx_TACC field descriptions

Field	Description
31–5 Reserved	This field is reserved. This write-only field is reserved. It must always be written with the value 0.
4 PROCHK	Enables insertion of protocol checksum. 0 Checksum not inserted. 1 If an IP frame with a known protocol is transmitted, the checksum is inserted automatically into the frame. The checksum field must be cleared. The other frames are not modified.
3 IPCHK	Enables insertion of IP header checksum. 0 Checksum is not inserted. 1 If an IP frame is transmitted, the checksum is inserted automatically. The IP header checksum field must be cleared. If a non-IP frame is transmitted the frame is not modified.
2–1 Reserved	This field is reserved. This write-only field is reserved. It must always be written with the value 0.
0 SHIFT16	TX FIFO Shift-16 0 Disabled. 1 Indicates to the transmit data FIFO that the written frames contain two additional octets before the frame data. This means the actual frame begins at bit 16 of the first word written into the FIFO. This function allows putting the frame payload on a 32-bit boundary in memory, as the 14-byte Ethernet header is extended to a 16-byte header.

22.5.34 Receive Accelerator Function Configuration (ENETx_RACC)

Address: Base address + 1C4h offset

Bit	31	30	29	28	27	26	25	24	23	22	21	20	19	18	17	16
R	[Reserved]															
W	0															
Reset	0	0	0	0	0	0	0	0	0	0	0	0	0	0	0	0
Bit	15	14	13	12	11	10	9	8	7	6	5	4	3	2	1	0
R	[Reserved]								SHIFT16	LINEDIS	[Reserved]			PRODIS	IPDIS	PADREM
W	0								SHIFT16	LINEDIS	0			PRODIS	IPDIS	PADREM
Reset	0	0	0	0	0	0	0	0	0	0	0	0	0	0	0	0

ENETx_RACC field descriptions

Field	Description
31–8 Reserved	This field is reserved. This write-only field is reserved. It must always be written with the value 0.

Table continues on the next page...

ENETx_RACC field descriptions (continued)

Field	Description
7 SHIFT16	<p>RX FIFO Shift-16</p> <p>When this field is set, the actual frame data starts at bit 16 of the first word read from the RX FIFO aligning the Ethernet payload on a 32-bit boundary.</p> <p>NOTE: This function only affects the FIFO storage and has no influence on the statistics, which use the actual length of the frame received.</p> <p>0 Disabled. 1 Instructs the MAC to write two additional bytes in front of each frame received into the RX FIFO.</p>
6 LINEDIS	<p>Enable Discard Of Frames With MAC Layer Errors</p> <p>0 Frames with errors are not discarded. 1 Any frame received with a CRC, length, or PHY error is automatically discarded and not forwarded to the user application interface.</p>
5-3 Reserved	<p>This field is reserved. This write-only field is reserved. It must always be written with the value 0.</p>
2 PRODIS	<p>Enable Discard Of Frames With Wrong Protocol Checksum</p> <p>0 Frames with wrong checksum are not discarded. 1 If a TCP/IP, UDP/IP, or ICMP/IP frame is received that has a wrong TCP, UDP, or ICMP checksum, the frame is discarded. Discarding is only available when the RX FIFO operates in store and forward mode (RSFL cleared).</p>
1 IPDIS	<p>Enable Discard Of Frames With Wrong IPv4 Header Checksum</p> <p>0 Frames with wrong IPv4 header checksum are not discarded. 1 If an IPv4 frame is received with a mismatching header checksum, the frame is discarded. IPv6 has no header checksum and is not affected by this setting. Discarding is only available when the RX FIFO operates in store and forward mode (RSFL cleared).</p>
0 PADREM	<p>Enable Padding Removal For Short IP Frames</p> <p>0 Padding not removed. 1 Any bytes following the IP payload section of the frame are removed from the frame.</p>

22.5.35 Reserved Statistic Register (ENETx_RMON_T_DROP)

Address: Base address + 200h offset

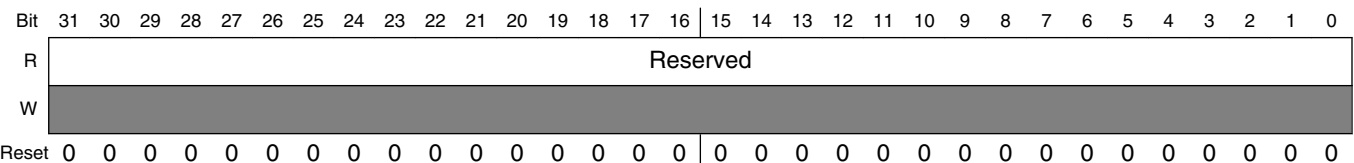

ENETx_RMON_T_DROP field descriptions

Field	Description
Reserved	<p>This read-only field always has the value 0.</p> <p>This field is reserved.</p>

22.5.36 Tx Packet Count Statistic Register (ENETx_RMON_T_PACKETS)

Address: Base address + 204h offset

Bit	31	30	29	28	27	26	25	24	23	22	21	20	19	18	17	16	15	14	13	12	11	10	9	8	7	6	5	4	3	2	1	0			
R	0																TXPKTS																		
W	[Shaded]																																		
Reset	0	0	0	0	0	0	0	0	0	0	0	0	0	0	0	0	0	0	0	0	0	0	0	0	0	0	0	0	0	0	0	0	0	0	0

ENETx_RMON_T_PACKETS field descriptions

Field	Description
31–16 Reserved	This field is reserved. This read-only field is reserved and always has the value 0.
TXPKTS	Packet count Transmit packet count

22.5.37 Tx Broadcast Packets Statistic Register (ENETx_RMON_T_BC_PKT)

RMON Tx Broadcast Packets

Address: Base address + 208h offset

Bit	31	30	29	28	27	26	25	24	23	22	21	20	19	18	17	16	15	14	13	12	11	10	9	8	7	6	5	4	3	2	1	0				
R	0																TXPKTS																			
W	[Shaded]																																			
Reset	0	0	0	0	0	0	0	0	0	0	0	0	0	0	0	0	0	0	0	0	0	0	0	0	0	0	0	0	0	0	0	0	0	0	0	0

ENETx_RMON_T_BC_PKT field descriptions

Field	Description
31–16 Reserved	This field is reserved. This read-only field is reserved and always has the value 0.
TXPKTS	Broadcast packets

22.5.38 Tx Multicast Packets Statistic Register (ENETx_RMON_T_MC_PKT)

Address: Base address + 20Ch offset

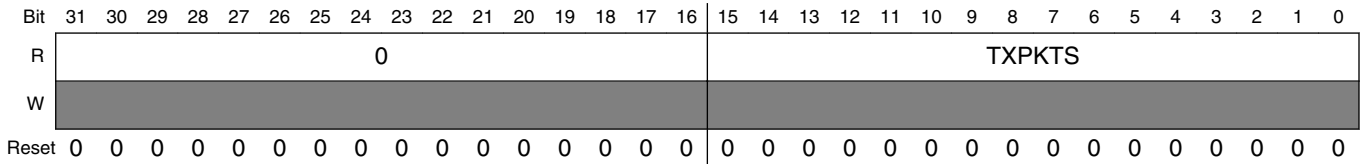

ENETx_RMON_T_MC_PKT field descriptions

Field	Description
31–16 Reserved	This field is reserved. This read-only field is reserved and always has the value 0.
TXPKTS	Multicast packets

22.5.39 Tx Packets with CRC/Align Error Statistic Register (ENETx_RMON_T_CRC_ALIGN)

Address: Base address + 210h offset

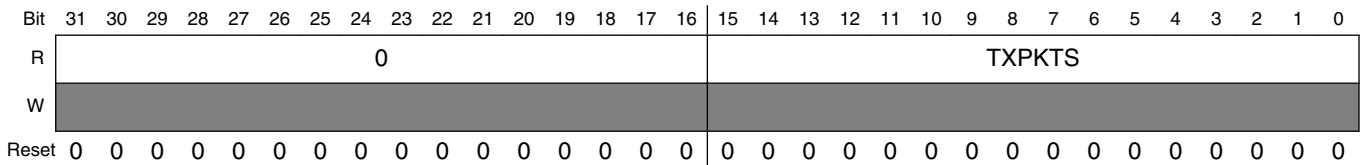

ENETx_RMON_T_CRC_ALIGN field descriptions

Field	Description
31–16 Reserved	This field is reserved. This read-only field is reserved and always has the value 0.
TXPKTS	Packets with CRC/align error

22.5.40 Tx Packets Less Than Bytes and Good CRC Statistic Register (ENETx_RMON_T_UNDERSIZE)

Address: Base address + 214h offset

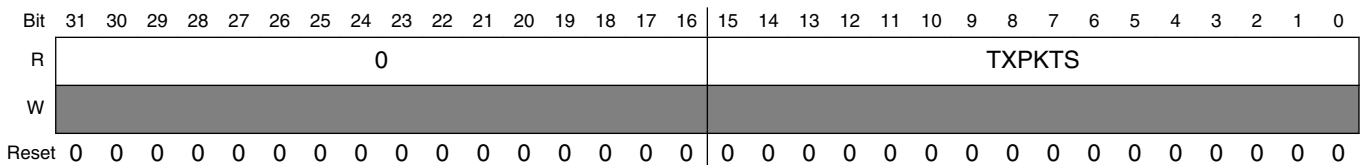

ENETx_RMON_T_UNDERSIZE field descriptions

Field	Description
31–16 Reserved	This field is reserved. This read-only field is reserved and always has the value 0.
TXPKTS	Number of transmit packets less than 64 bytes with good CRC

22.5.41 Tx Packets GT MAX_FL bytes and Good CRC Statistic Register (ENETx_RMON_T_OVERSIZE)

Address: Base address + 218h offset

Bit	31	30	29	28	27	26	25	24	23	22	21	20	19	18	17	16	15	14	13	12	11	10	9	8	7	6	5	4	3	2	1	0
R	0																TXPKTS															
W	[Shaded]																															
Reset	0	0	0	0	0	0	0	0	0	0	0	0	0	0	0	0	0	0	0	0	0	0	0	0	0	0	0	0	0	0	0	0

ENETx_RMON_T_OVERSIZE field descriptions

Field	Description
31–16 Reserved	This field is reserved. This read-only field is reserved and always has the value 0.
TXPKTS	Number of transmit packets greater than MAX_FL bytes with good CRC

22.5.42 Tx Packets Less Than 64 Bytes and Bad CRC Statistic Register (ENETx_RMON_T_FRAG)

Address: Base address + 21Ch offset

Bit	31	30	29	28	27	26	25	24	23	22	21	20	19	18	17	16	15	14	13	12	11	10	9	8	7	6	5	4	3	2	1	0
R	0																TXPKTS															
W	[Shaded]																															
Reset	0	0	0	0	0	0	0	0	0	0	0	0	0	0	0	0	0	0	0	0	0	0	0	0	0	0	0	0	0	0	0	0

ENETx_RMON_T_FRAG field descriptions

Field	Description
31–16 Reserved	This field is reserved. This read-only field is reserved and always has the value 0.
TXPKTS	Number of packets less than 64 bytes with bad CRC

22.5.43 Tx Packets Greater Than MAX_FL bytes and Bad CRC Statistic Register (ENETx_RMON_T_JAB)

Address: Base address + 220h offset

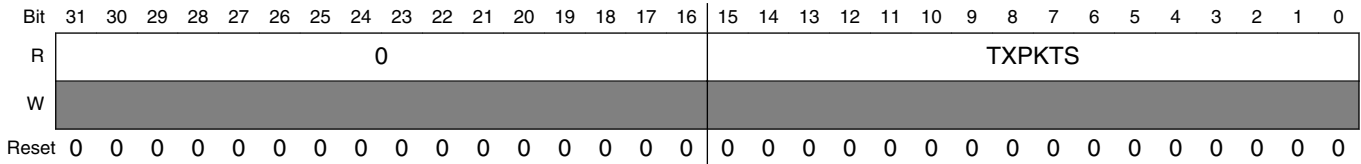

ENETx_RMON_T_JAB field descriptions

Field	Description
31–16 Reserved	This field is reserved. This read-only field is reserved and always has the value 0.
TXPKTS	Number of transmit packets greater than MAX_FL bytes and bad CRC

22.5.44 Tx Collision Count Statistic Register (ENETx_RMON_T_COL)

Address: Base address + 224h offset

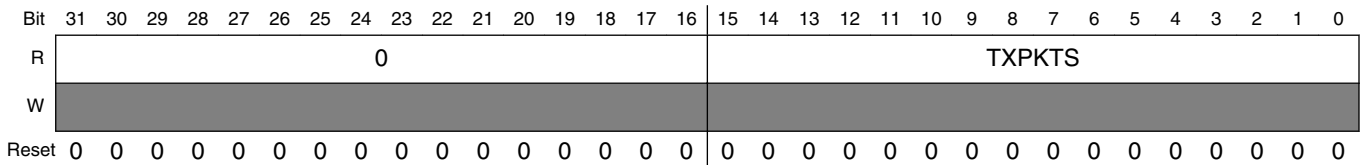

ENETx_RMON_T_COL field descriptions

Field	Description
31–16 Reserved	This field is reserved. This read-only field is reserved and always has the value 0.
TXPKTS	Number of transmit collisions

22.5.45 Tx 64-Byte Packets Statistic Register (ENETx_RMON_T_P64)

Address: Base address + 228h offset

Bit	31	30	29	28	27	26	25	24	23	22	21	20	19	18	17	16	15	14	13	12	11	10	9	8	7	6	5	4	3	2	1	0					
R	0																TXPKTS																				
W	[Shaded]																																				
Reset	0	0	0	0	0	0	0	0	0	0	0	0	0	0	0	0	0	0	0	0	0	0	0	0	0	0	0	0	0	0	0	0	0	0	0	0	0

ENETx_RMON_T_P64 field descriptions

Field	Description
31–16 Reserved	This field is reserved. This read-only field is reserved and always has the value 0.
TXPKTS	Number of 64-byte transmit packets

22.5.46 Tx 65- to 127-byte Packets Statistic Register (ENETx_RMON_T_P65TO127)

Address: Base address + 22Ch offset

Bit	31	30	29	28	27	26	25	24	23	22	21	20	19	18	17	16	15	14	13	12	11	10	9	8	7	6	5	4	3	2	1	0						
R	0																TXPKTS																					
W	[Shaded]																																					
Reset	0	0	0	0	0	0	0	0	0	0	0	0	0	0	0	0	0	0	0	0	0	0	0	0	0	0	0	0	0	0	0	0	0	0	0	0	0	0

ENETx_RMON_T_P65TO127 field descriptions

Field	Description
31–16 Reserved	This field is reserved. This read-only field is reserved and always has the value 0.
TXPKTS	Number of 65- to 127-byte transmit packets

22.5.47 Tx 128- to 255-byte Packets Statistic Register (ENETx_RMON_T_P128TO255)

Address: Base address + 230h offset

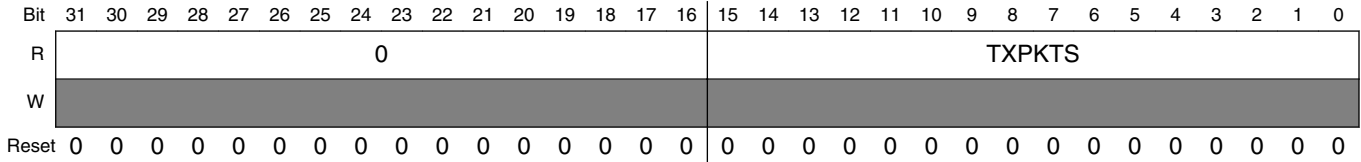

ENETx_RMON_T_P128TO255 field descriptions

Field	Description
31–16 Reserved	This field is reserved. This read-only field is reserved and always has the value 0.
TXPKTS	Number of 128- to 255-byte transmit packets

22.5.48 Tx 256- to 511-byte Packets Statistic Register (ENETx_RMON_T_P256TO511)

Address: Base address + 234h offset

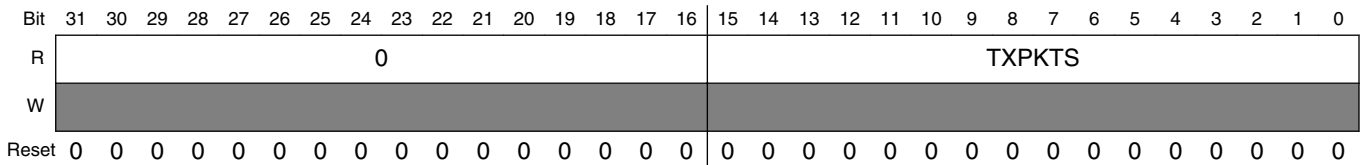

ENETx_RMON_T_P256TO511 field descriptions

Field	Description
31–16 Reserved	This field is reserved. This read-only field is reserved and always has the value 0.
TXPKTS	Number of 256- to 511-byte transmit packets

22.5.49 Tx 512- to 1023-byte Packets Statistic Register (ENETx_RMON_T_P512TO1023)

Address: Base address + 238h offset

Bit	31	30	29	28	27	26	25	24	23	22	21	20	19	18	17	16	15	14	13	12	11	10	9	8	7	6	5	4	3	2	1	0
R	0																TXPKTS															
W	[Shaded]																															
Reset	0	0	0	0	0	0	0	0	0	0	0	0	0	0	0	0	0	0	0	0	0	0	0	0	0	0	0	0	0	0	0	0

ENETx_RMON_T_P512TO1023 field descriptions

Field	Description
31–16 Reserved	This field is reserved. This read-only field is reserved and always has the value 0.
TXPKTS	Number of 512- to 1023-byte transmit packets

22.5.50 Tx 1024- to 2047-byte Packets Statistic Register (ENETx_RMON_T_P1024TO2047)

Address: Base address + 23Ch offset

Bit	31	30	29	28	27	26	25	24	23	22	21	20	19	18	17	16	15	14	13	12	11	10	9	8	7	6	5	4	3	2	1	0
R	0																TXPKTS															
W	[Shaded]																															
Reset	0	0	0	0	0	0	0	0	0	0	0	0	0	0	0	0	0	0	0	0	0	0	0	0	0	0	0	0	0	0	0	0

ENETx_RMON_T_P1024TO2047 field descriptions

Field	Description
31–16 Reserved	This field is reserved. This read-only field is reserved and always has the value 0.
TXPKTS	Number of 1024- to 2047-byte transmit packets

22.5.51 Tx Packets Greater Than 2048 Bytes Statistic Register (ENETx_RMON_T_P_GTE2048)

Address: Base address + 240h offset

Bit	31	30	29	28	27	26	25	24	23	22	21	20	19	18	17	16	15	14	13	12	11	10	9	8	7	6	5	4	3	2	1	0																
R	0																TXPKTS																															
W	[Shaded]																																															
Reset	0	0	0	0	0	0	0	0	0	0	0	0	0	0	0	0	0	0	0	0	0	0	0	0	0	0	0	0	0	0	0	0	0	0	0	0	0	0	0	0	0	0	0	0	0	0	0	0

ENETx_RMON_T_P_GTE2048 field descriptions

Field	Description
31–16 Reserved	This field is reserved. This read-only field is reserved and always has the value 0.
TXPKTS	Number of transmit packets greater than 2048 bytes

22.5.52 Tx Octets Statistic Register (ENETx_RMON_T_OCTETS)

Address: Base address + 244h offset

Bit	31	30	29	28	27	26	25	24	23	22	21	20	19	18	17	16	15	14	13	12	11	10	9	8	7	6	5	4	3	2	1	0																
R	TXOCTS																																															
W	[Shaded]																																															
Reset	0	0	0	0	0	0	0	0	0	0	0	0	0	0	0	0	0	0	0	0	0	0	0	0	0	0	0	0	0	0	0	0	0	0	0	0	0	0	0	0	0	0	0	0	0	0	0	0

ENETx_RMON_T_OCTETS field descriptions

Field	Description
TXOCTS	Number of transmit octets

22.5.53 Reserved Statistic Register (ENETx_IEEE_T_DROP)

Address: Base address + 248h offset

Bit	31	30	29	28	27	26	25	24	23	22	21	20	19	18	17	16	15	14	13	12	11	10	9	8	7	6	5	4	3	2	1	0																
R	Reserved																																															
W	[Shaded]																																															
Reset	0	0	0	0	0	0	0	0	0	0	0	0	0	0	0	0	0	0	0	0	0	0	0	0	0	0	0	0	0	0	0	0	0	0	0	0	0	0	0	0	0	0	0	0	0	0	0	0

ENETx_IEEE_T_DROP field descriptions

Field	Description
Reserved	This read-only field always has the value 0. This field is reserved.

22.5.54 Frames Transmitted OK Statistic Register (ENETx_IEEE_T_FRAME_OK)

Address: Base address + 24Ch offset

Bit	31	30	29	28	27	26	25	24	23	22	21	20	19	18	17	16	15	14	13	12	11	10	9	8	7	6	5	4	3	2	1	0
R	0																COUNT															
W	[Shaded]																															
Reset	0	0	0	0	0	0	0	0	0	0	0	0	0	0	0	0	0	0	0	0	0	0	0	0	0	0	0	0	0	0	0	0

ENETx_IEEE_T_FRAME_OK field descriptions

Field	Description
31–16 Reserved	This field is reserved. This read-only field is reserved and always has the value 0.
COUNT	Number of frames transmitted OK NOTE: Does not increment for the broadcast frames when broadcast reject is enabled and promiscuous mode is disabled within the receive control register (RCR).

22.5.55 Frames Transmitted with Single Collision Statistic Register (ENETx_IEEE_T_1COL)

Address: Base address + 250h offset

Bit	31	30	29	28	27	26	25	24	23	22	21	20	19	18	17	16	15	14	13	12	11	10	9	8	7	6	5	4	3	2	1	0
R	0																COUNT															
W	[Shaded]																															
Reset	0	0	0	0	0	0	0	0	0	0	0	0	0	0	0	0	0	0	0	0	0	0	0	0	0	0	0	0	0	0	0	0

ENETx_IEEE_T_1COL field descriptions

Field	Description
31–16 Reserved	This field is reserved. This read-only field is reserved and always has the value 0.
COUNT	Number of frames transmitted with one collision

22.5.56 Frames Transmitted with Multiple Collisions Statistic Register (ENETx_IEEE_T_MCOL)

Address: Base address + 254h offset

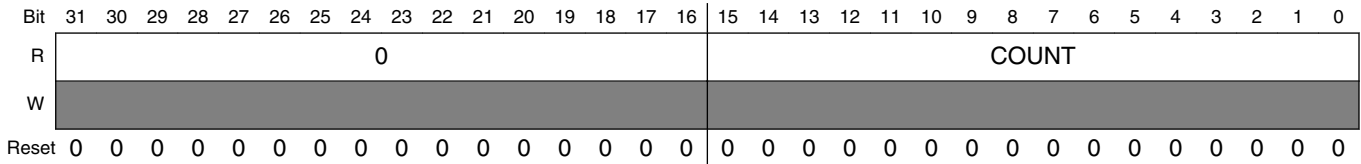

ENETx_IEEE_T_MCOL field descriptions

Field	Description
31–16 Reserved	This field is reserved. This read-only field is reserved and always has the value 0.
COUNT	Number of frames transmitted with multiple collisions

22.5.57 Frames Transmitted after Deferral Delay Statistic Register (ENETx_IEEE_T_DEF)

Address: Base address + 258h offset

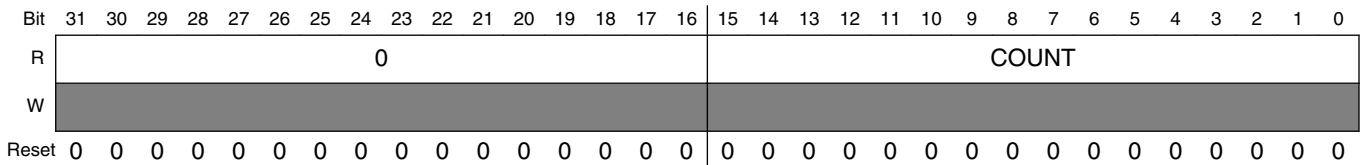

ENETx_IEEE_T_DEF field descriptions

Field	Description
31–16 Reserved	This field is reserved. This read-only field is reserved and always has the value 0.
COUNT	Number of frames transmitted with deferral delay

22.5.58 Frames Transmitted with Late Collision Statistic Register (ENETx_IEEE_T_LCOL)

Address: Base address + 25Ch offset

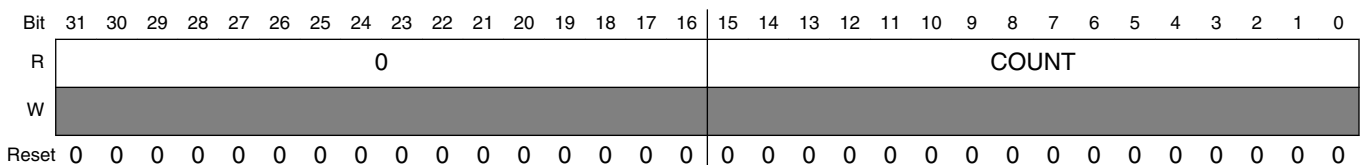

ENETx_IEEE_T_LCOL field descriptions

Field	Description
31–16 Reserved	This field is reserved. This read-only field is reserved and always has the value 0.
COUNT	Number of frames transmitted with late collision

22.5.59 Frames Transmitted with Excessive Collisions Statistic Register (ENETx_IEEE_T_EXCOL)

Address: Base address + 260h offset

Bit	31	30	29	28	27	26	25	24	23	22	21	20	19	18	17	16	15	14	13	12	11	10	9	8	7	6	5	4	3	2	1	0
R	0																COUNT															
W	[Shaded]																															
Reset	0	0	0	0	0	0	0	0	0	0	0	0	0	0	0	0	0	0	0	0	0	0	0	0	0	0	0	0	0	0	0	0

ENETx_IEEE_T_EXCOL field descriptions

Field	Description
31–16 Reserved	This field is reserved. This read-only field is reserved and always has the value 0.
COUNT	Number of frames transmitted with excessive collisions

22.5.60 Frames Transmitted with Tx FIFO Underrun Statistic Register (ENETx_IEEE_T_MACERR)

Address: Base address + 264h offset

Bit	31	30	29	28	27	26	25	24	23	22	21	20	19	18	17	16	15	14	13	12	11	10	9	8	7	6	5	4	3	2	1	0
R	0																COUNT															
W	[Shaded]																															
Reset	0	0	0	0	0	0	0	0	0	0	0	0	0	0	0	0	0	0	0	0	0	0	0	0	0	0	0	0	0	0	0	0

ENETx_IEEE_T_MACERR field descriptions

Field	Description
31–16 Reserved	This field is reserved. This read-only field is reserved and always has the value 0.
COUNT	Number of frames transmitted with transmit FIFO underrun

22.5.61 Frames Transmitted with Carrier Sense Error Statistic Register (ENETx_IEEE_T_CSERR)

Address: Base address + 268h offset

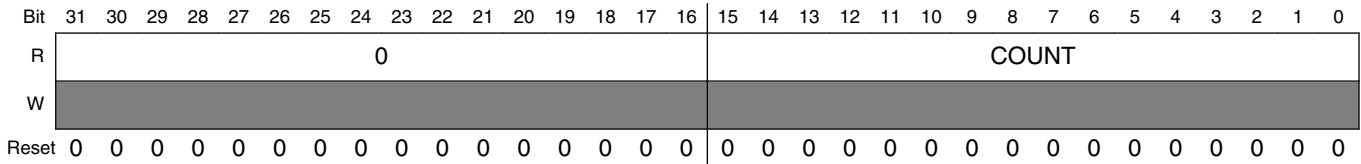

ENETx_IEEE_T_CSERR field descriptions

Field	Description
31–16 Reserved	This field is reserved. This read-only field is reserved and always has the value 0.
COUNT	Number of frames transmitted with carrier sense error

22.5.62 Reserved Statistic Register (ENETx_IEEE_T_SQE)

Address: Base address + 26Ch offset

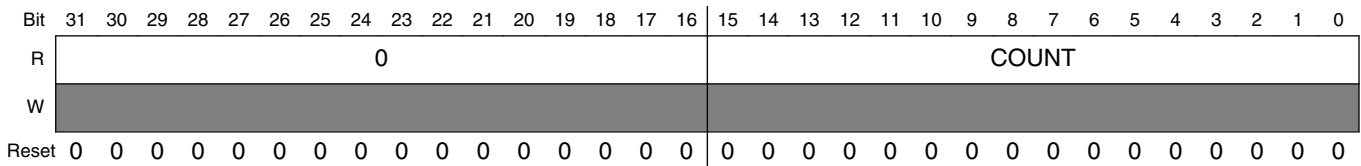

ENETx_IEEE_T_SQE field descriptions

Field	Description
31–16 Reserved	This field is reserved. This read-only field is reserved and always has the value 0.
COUNT	This read-only field is reserved and always has the value 0. NOTE: Counter not implemented as no SQE information is available.

22.5.63 Flow Control Pause Frames Transmitted Statistic Register (ENETx_IEEE_T_FDXFC)

Address: Base address + 270h offset

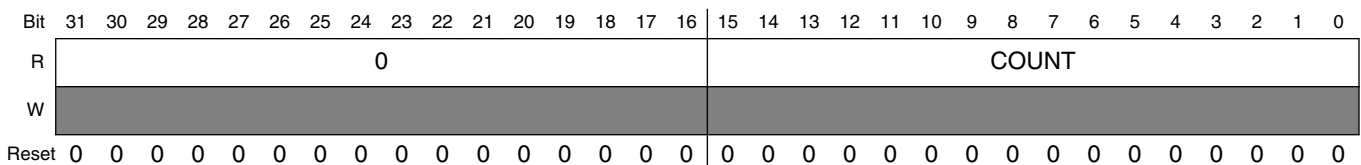

ENETx_IEEE_T_FDXFC field descriptions

Field	Description
31–16 Reserved	This field is reserved. This read-only field is reserved and always has the value 0.
COUNT	Number of flow-control pause frames transmitted

22.5.64 Octet Count for Frames Transmitted w/o Error Statistic Register (ENETx_IEEE_T_OCTETS_OK)

Address: Base address + 274h offset

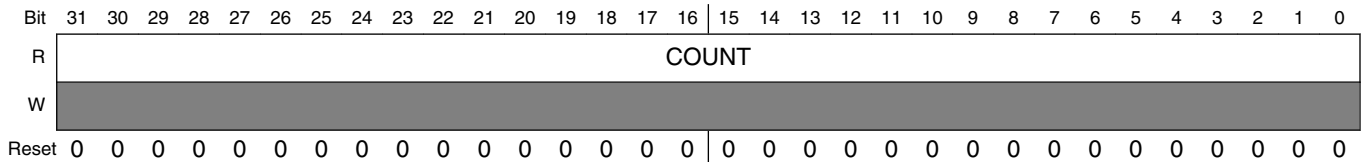
**ENETx_IEEE_T_OCTETS_OK field descriptions**

Field	Description
COUNT	Octet count for frames transmitted without error NOTE Counts total octets (includes header and FCS fields).

22.5.65 Rx Packet Count Statistic Register (ENETx_RMON_R_PACKETS)

Address: Base address + 284h offset

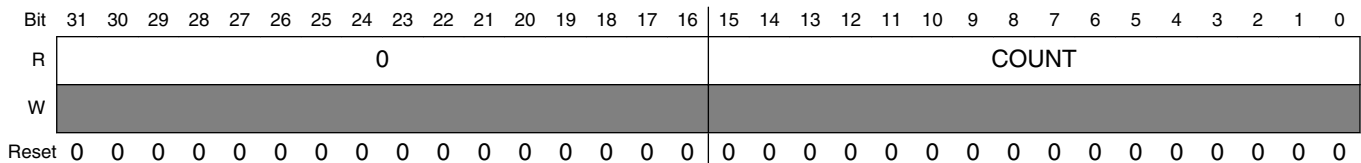
**ENETx_RMON_R_PACKETS field descriptions**

Field	Description
31–16 Reserved	This field is reserved. This read-only field is reserved and always has the value 0.
COUNT	Number of packets received

22.5.66 Rx Broadcast Packets Statistic Register (ENETx_RMON_R_BC_PKT)

Address: Base address + 288h offset

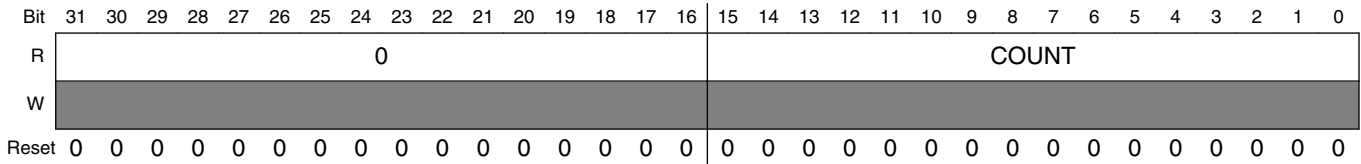

ENETx_RMON_R_BC_PKT field descriptions

Field	Description
31–16 Reserved	This field is reserved. This read-only field is reserved and always has the value 0.
COUNT	Number of receive broadcast packets

22.5.67 Rx Multicast Packets Statistic Register (ENETx_RMON_R_MC_PKT)

Address: Base address + 28Ch offset

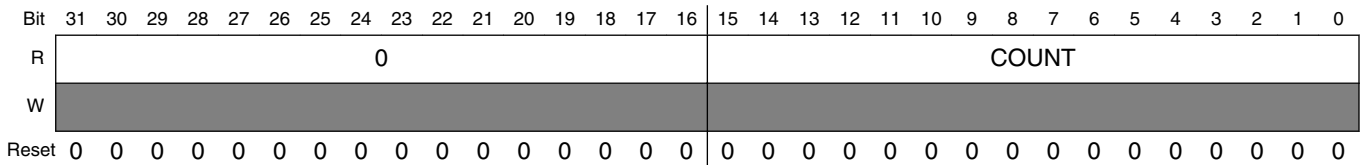

ENETx_RMON_R_MC_PKT field descriptions

Field	Description
31–16 Reserved	This field is reserved. This read-only field is reserved and always has the value 0.
COUNT	Number of receive multicast packets

22.5.68 Rx Packets with CRC/Align Error Statistic Register (ENETx_RMON_R_CRC_ALIGN)

Address: Base address + 290h offset

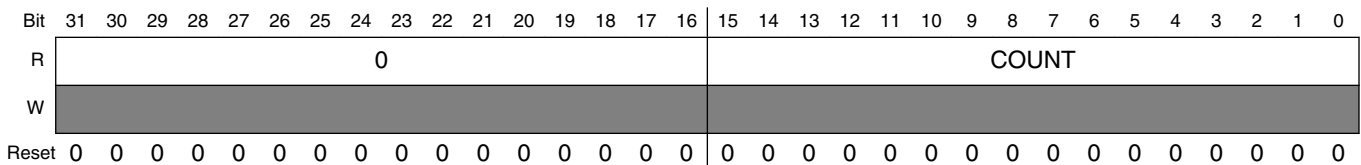

ENETx_RMON_R_CRC_ALIGN field descriptions

Field	Description
31–16 Reserved	This field is reserved. This read-only field is reserved and always has the value 0.
COUNT	Number of receive packets with CRC or align error

22.5.69 Rx Packets with Less Than 64 Bytes and Good CRC Statistic Register (ENETx_RMON_R_UNDERSIZE)

Address: Base address + 294h offset

Bit	31	30	29	28	27	26	25	24	23	22	21	20	19	18	17	16	15	14	13	12	11	10	9	8	7	6	5	4	3	2	1	0
R	0																COUNT															
W	[Shaded]																															
Reset	0	0	0	0	0	0	0	0	0	0	0	0	0	0	0	0	0	0	0	0	0	0	0	0	0	0	0	0	0	0	0	0

ENETx_RMON_R_UNDERSIZE field descriptions

Field	Description
31–16 Reserved	This field is reserved. This read-only field is reserved and always has the value 0.
COUNT	Number of receive packets with less than 64 bytes and good CRC

22.5.70 Rx Packets Greater Than MAX_FL and Good CRC Statistic Register (ENETx_RMON_R_OVERSIZE)

Address: Base address + 298h offset

Bit	31	30	29	28	27	26	25	24	23	22	21	20	19	18	17	16	15	14	13	12	11	10	9	8	7	6	5	4	3	2	1	0
R	0																COUNT															
W	[Shaded]																															
Reset	0	0	0	0	0	0	0	0	0	0	0	0	0	0	0	0	0	0	0	0	0	0	0	0	0	0	0	0	0	0	0	0

ENETx_RMON_R_OVERSIZE field descriptions

Field	Description
31–16 Reserved	This field is reserved. This read-only field is reserved and always has the value 0.
COUNT	Number of receive packets greater than MAX_FL and good CRC

22.5.71 Rx Packets Less Than 64 Bytes and Bad CRC Statistic Register (ENETx_RMON_R_FRAG)

Address: Base address + 29Ch offset

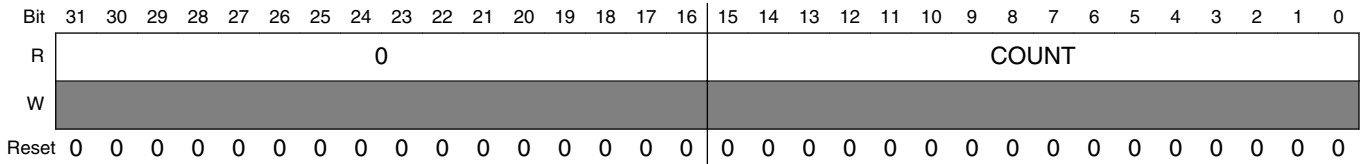

ENETx_RMON_R_FRAG field descriptions

Field	Description
31–16 Reserved	This field is reserved. This read-only field is reserved and always has the value 0.
COUNT	Number of receive packets with less than 64 bytes and bad CRC

22.5.72 Rx Packets Greater Than MAX_FL Bytes and Bad CRC Statistic Register (ENETx_RMON_R_JAB)

Address: Base address + 2A0h offset

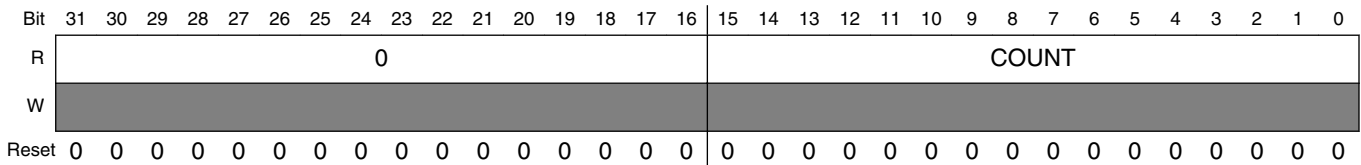

ENETx_RMON_R_JAB field descriptions

Field	Description
31–16 Reserved	This field is reserved. This read-only field is reserved and always has the value 0.
COUNT	Number of receive packets greater than MAX_FL and bad CRC

22.5.73 Reserved Statistic Register (ENETx_RMON_R_RESVD_0)

Address: Base address + 2A4h offset

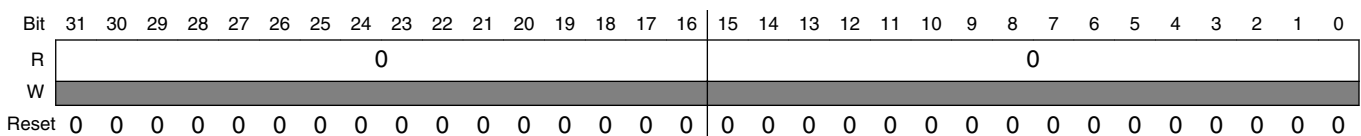

ENETx_RMON_R_RESVD_0 field descriptions

Field	Description
31–16 Reserved	This field is reserved. This read-only field is reserved and always has the value 0.
Reserved	This field is reserved. This read-only field is reserved and always has the value 0.

22.5.74 Rx 64-Byte Packets Statistic Register (ENETx_RMON_R_P64)

Address: Base address + 2A8h offset

Bit	31	30	29	28	27	26	25	24	23	22	21	20	19	18	17	16	15	14	13	12	11	10	9	8	7	6	5	4	3	2	1	0
R	0																COUNT															
W	[Shaded]																															
Reset	0	0	0	0	0	0	0	0	0	0	0	0	0	0	0	0	0	0	0	0	0	0	0	0	0	0	0	0	0	0	0	0

ENETx_RMON_R_P64 field descriptions

Field	Description
31–16 Reserved	This field is reserved. This read-only field is reserved and always has the value 0.
COUNT	Number of 64-byte receive packets

22.5.75 Rx 65- to 127-Byte Packets Statistic Register (ENETx_RMON_R_P65TO127)

Address: Base address + 2ACh offset

Bit	31	30	29	28	27	26	25	24	23	22	21	20	19	18	17	16	15	14	13	12	11	10	9	8	7	6	5	4	3	2	1	0
R	0																COUNT															
W	[Shaded]																															
Reset	0	0	0	0	0	0	0	0	0	0	0	0	0	0	0	0	0	0	0	0	0	0	0	0	0	0	0	0	0	0	0	0

ENETx_RMON_R_P65TO127 field descriptions

Field	Description
31–16 Reserved	This field is reserved. This read-only field is reserved and always has the value 0.
COUNT	Number of 65- to 127-byte receive packets

22.5.76 Rx 128- to 255-Byte Packets Statistic Register (ENETx_RMON_R_P128TO255)

Address: Base address + 2B0h offset

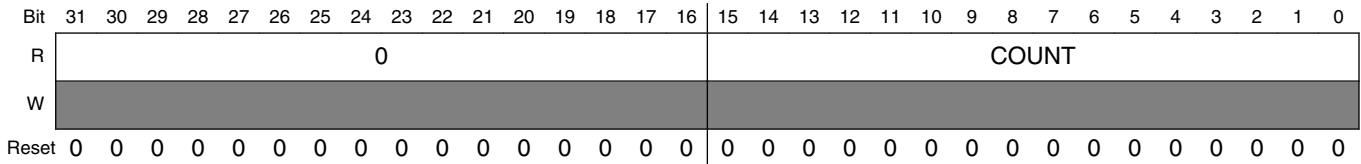

ENETx_RMON_R_P128TO255 field descriptions

Field	Description
31–16 Reserved	This field is reserved. This read-only field is reserved and always has the value 0.
COUNT	Number of 128- to 255-byte receive packets

22.5.77 Rx 256- to 511-Byte Packets Statistic Register (ENETx_RMON_R_P256TO511)

Address: Base address + 2B4h offset

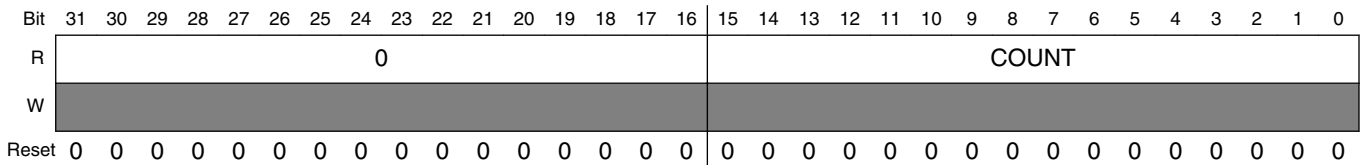

ENETx_RMON_R_P256TO511 field descriptions

Field	Description
31–16 Reserved	This field is reserved. This read-only field is reserved and always has the value 0.
COUNT	Number of 256- to 511-byte receive packets

22.5.78 Rx 512- to 1023-Byte Packets Statistic Register (ENETx_RMON_R_P512TO1023)

Address: Base address + 2B8h offset

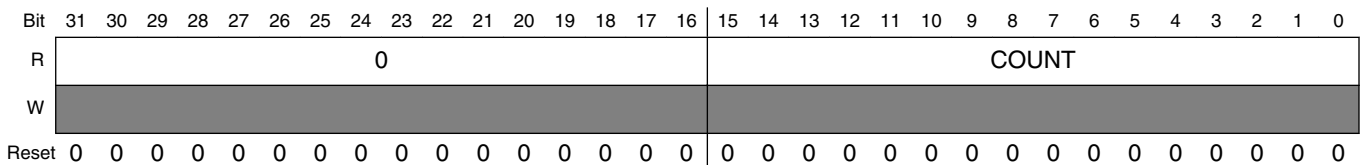

ENETx_RMON_R_P512TO1023 field descriptions

Field	Description
31–16 Reserved	This field is reserved. This read-only field is reserved and always has the value 0.
COUNT	Number of 512- to 1023-byte receive packets

22.5.79 Rx 1024- to 2047-Byte Packets Statistic Register (ENETx_RMON_R_P1024TO2047)

Address: Base address + 2BCh offset

Bit	31	30	29	28	27	26	25	24	23	22	21	20	19	18	17	16	15	14	13	12	11	10	9	8	7	6	5	4	3	2	1	0
R	0																COUNT															
W	[Shaded]																															
Reset	0	0	0	0	0	0	0	0	0	0	0	0	0	0	0	0	0	0	0	0	0	0	0	0	0	0	0	0	0	0	0	0

ENETx_RMON_R_P1024TO2047 field descriptions

Field	Description
31–16 Reserved	This field is reserved. This read-only field is reserved and always has the value 0.
COUNT	Number of 1024- to 2047-byte receive packets

22.5.80 Rx Packets Greater than 2048 Bytes Statistic Register (ENETx_RMON_R_P_GTE2048)

Address: Base address + 2C0h offset

Bit	31	30	29	28	27	26	25	24	23	22	21	20	19	18	17	16	15	14	13	12	11	10	9	8	7	6	5	4	3	2	1	0
R	0																COUNT															
W	[Shaded]																															
Reset	0	0	0	0	0	0	0	0	0	0	0	0	0	0	0	0	0	0	0	0	0	0	0	0	0	0	0	0	0	0	0	0

ENETx_RMON_R_P_GTE2048 field descriptions

Field	Description
31–16 Reserved	This field is reserved. This read-only field is reserved and always has the value 0.
COUNT	Number of greater-than-2048-byte receive packets

22.5.81 Rx Octets Statistic Register (ENETx_RMON_R_OCTETS)

Address: Base address + 2C4h offset

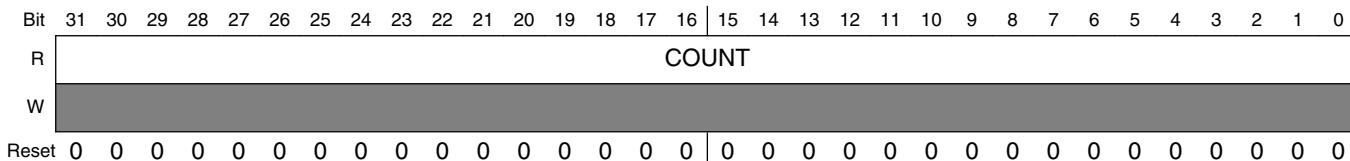

ENETx_RMON_R_OCTETS field descriptions

Field	Description
COUNT	Number of receive octets

22.5.82 Frames not Counted Correctly Statistic Register (ENETx_IEEE_R_DROP)

Counter increments if a frame with invalid or missing SFD character is detected and has been dropped. None of the other counters increments if this counter increments.

Address: Base address + 2C8h offset

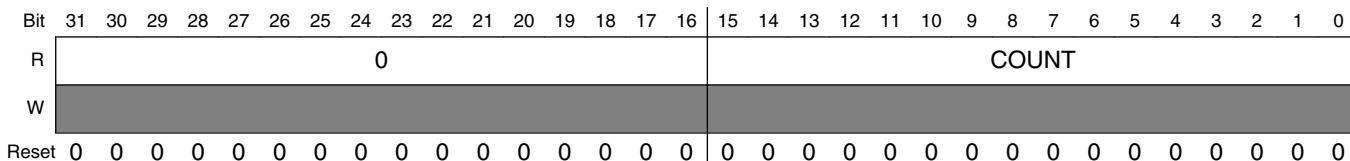

ENETx_IEEE_R_DROP field descriptions

Field	Description
31–16 Reserved	This field is reserved. This read-only field is reserved and always has the value 0.
COUNT	Frame count

22.5.83 Frames Received OK Statistic Register (ENETx_IEEE_R_FRAME_OK)

Address: Base address + 2CCh offset

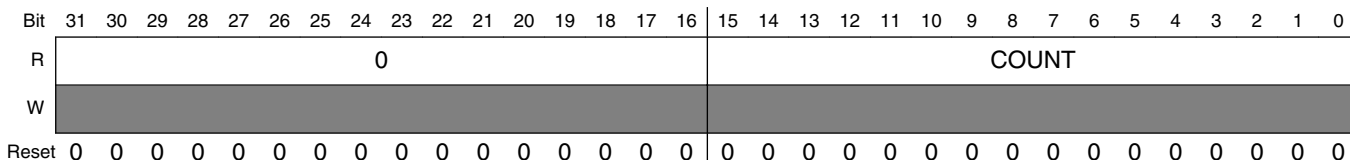

ENETx_IEEE_R_FRAME_OK field descriptions

Field	Description
31–16 Reserved	This field is reserved. This read-only field is reserved and always has the value 0.
COUNT	Number of frames received OK

22.5.84 Frames Received with CRC Error Statistic Register (ENETx_IEEE_R_CRC)

Address: Base address + 2D0h offset

Bit	31	30	29	28	27	26	25	24	23	22	21	20	19	18	17	16	15	14	13	12	11	10	9	8	7	6	5	4	3	2	1	0
R	0																COUNT															
W	[Shaded]																															
Reset	0	0	0	0	0	0	0	0	0	0	0	0	0	0	0	0	0	0	0	0	0	0	0	0	0	0	0	0	0	0	0	0

ENETx_IEEE_R_CRC field descriptions

Field	Description
31–16 Reserved	This field is reserved. This read-only field is reserved and always has the value 0.
COUNT	Number of frames received with CRC error

22.5.85 Frames Received with Alignment Error Statistic Register (ENETx_IEEE_R_ALIGN)

Address: Base address + 2D4h offset

Bit	31	30	29	28	27	26	25	24	23	22	21	20	19	18	17	16	15	14	13	12	11	10	9	8	7	6	5	4	3	2	1	0
R	0																COUNT															
W	[Shaded]																															
Reset	0	0	0	0	0	0	0	0	0	0	0	0	0	0	0	0	0	0	0	0	0	0	0	0	0	0	0	0	0	0	0	0

ENETx_IEEE_R_ALIGN field descriptions

Field	Description
31–16 Reserved	This field is reserved. This read-only field is reserved and always has the value 0.
COUNT	Number of frames received with alignment error

22.5.86 Receive FIFO Overflow Count Statistic Register (ENETx_IEEE_R_MACERR)

Address: Base address + 2D8h offset

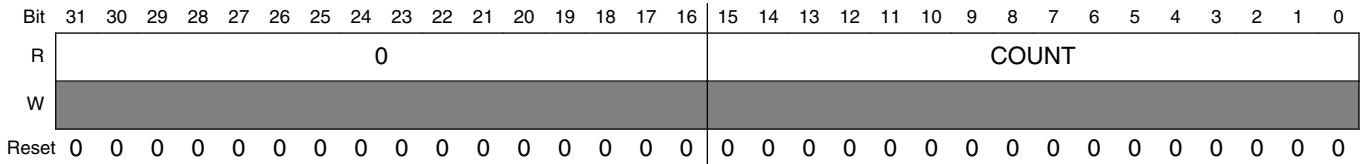

ENETx_IEEE_R_MACERR field descriptions

Field	Description
31–16 Reserved	This field is reserved. This read-only field is reserved and always has the value 0.
COUNT	Receive FIFO overflow count

22.5.87 Flow Control Pause Frames Received Statistic Register (ENETx_IEEE_R_FDXFC)

Address: Base address + 2DCh offset

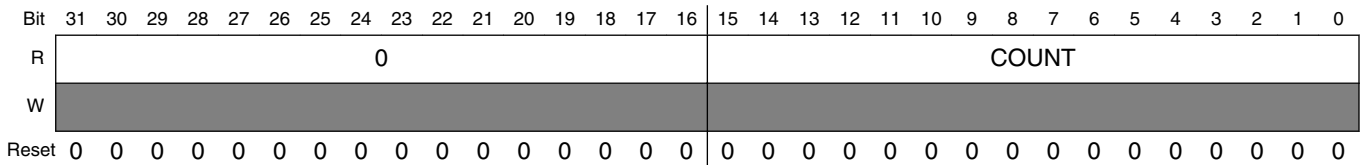

ENETx_IEEE_R_FDXFC field descriptions

Field	Description
31–16 Reserved	This field is reserved. This read-only field is reserved and always has the value 0.
COUNT	Number of flow-control pause frames received

22.5.88 Octet Count for Frames Received without Error Statistic Register (ENETx_IEEE_R_OCTETS_OK)

Address: Base address + 2E0h offset

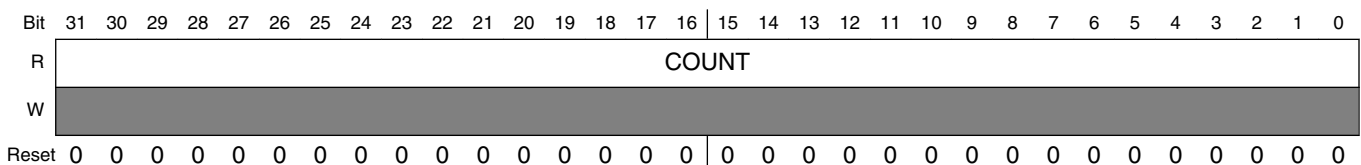

ENETx_IEEE_R_OCTETS_OK field descriptions

Field	Description
COUNT	Number of octets for frames received without error NOTE: Counts total octets (includes header and FCS fields). Does not increment for the broadcast frames when broadcast reject is enabled and promiscuous mode is disabled within the receive control register (RCR).

22.5.89 Adjustable Timer Control Register (ENETx_ATCR)

ATCR command fields can trigger the corresponding events directly. It is not necessary to preserve any of the configuration fields when a command field is set in the register, that is, no read-modify-write is required.

NOTE

The CAPTURE and RESTART fields and bits 12 and 10 must be 0 in order to write to the other fields in this register.

Address: Base address + 400h offset

Bit	31	30	29	28	27	26	25	24	23	22	21	20	19	18	17	16
R	0															
W	[Shaded]															
Reset	0	0	0	0	0	0	0	0	0	0	0	0	0	0	0	0
Bit	15	14	13	12	11	10	9	8	7	6	5	4	3	2	1	0
R	0	[Shaded]	[Shaded]	[Shaded]	[Shaded]	[Shaded]	[Shaded]	[Shaded]	[Shaded]	[Shaded]	[Shaded]	[Shaded]	[Shaded]	[Shaded]	[Shaded]	[Shaded]
W	[Shaded]	[Shaded]	SLAVE	Reserved	CAPTURE	Reserved	RESTART	0	PINPER	0	1	PEREN	OFFRST	OFFEN	0	EN
Reset	0	0	0	0	0	0	0	0	0	0	0	0	0	0	0	0

ENETx_ATCR field descriptions

Field	Description
31–14 Reserved	This field is reserved. This read-only field is reserved and always has the value 0.
13 SLAVE	Enable Timer Slave Mode 0 The timer is active and all configuration fields in this register are relevant. 1 The internal timer is disabled and the externally provided timer value is used. All other fields, except CAPTURE, in this register have no effect. CAPTURE can still be used to capture the current timer value.
12 Reserved	This field is reserved. Always write 0 to this field.

Table continues on the next page...

ENETx_ATCR field descriptions (continued)

Field	Description
11 CAPTURE	<p>Capture Timer Value</p> <p>When this field is set, all other fields are ignored during a write. This field automatically clears to 0 after the command completes.</p> <p>0 No effect. 1 The current time is captured and can be read from the ATVR register.</p>
10 Reserved	<p>This field is reserved. Always write 0 to this field.</p>
9 RESTART	<p>Reset Timer</p> <p>Resets the timer to zero. This has no effect on the counter enable. If the counter is enabled when this field is set, the timer is reset to zero and starts counting from there. When set, all other fields are ignored during a write. This field automatically clears to 0 after the command completes.</p>
8 Reserved	<p>This field is reserved.</p>
7 PINPER	<p>Enables event signal output assertion on period event.</p> <p>NOTE: Not all devices contain the event signal output. See the chip configuration details.</p> <p>0 Disable. 1 Enable.</p>
6 Reserved	<p>This field is reserved.</p>
5 Reserved	<p>This field is reserved.</p> <p>NOTE: This field must be written always with one.</p>
4 PEREN	<p>Enable Periodical Event</p> <p>0 Disable. 1 A period event interrupt can be generated (EIR[TS_TIMER]) and the event signal output is asserted when the timer wraps around according to the periodic setting ATPER. The timer period value must be set before setting this bit.</p> <p>NOTE: Not all devices contain the event signal output. See the chip configuration details.</p>
3 OFFRST	<p>Reset Timer On Offset Event</p> <p>0 The timer is not affected and no action occurs, besides clearing OFFEN, when the offset is reached. 1 If OFFEN is set, the timer resets to zero when the offset setting is reached. The offset event does not cause a timer interrupt.</p>
2 OFFEN	<p>Enable One-Shot Offset Event</p> <p>0 Disable. 1 The timer can be reset to zero when the given offset time is reached (offset event). The field is cleared when the offset event is reached, so no further event occurs until the field is set again. The timer offset value must be set before setting this field.</p>
1 Reserved	<p>This field is reserved.</p>
0 EN	<p>Enable Timer</p>

Table continues on the next page...

ENETx_ATCR field descriptions (continued)

Field	Description
0	The timer stops at the current value.
1	The timer starts incrementing.

22.5.90 Timer Value Register (ENETx_ATVR)

Address: Base address + 404h offset

Bit	31	30	29	28	27	26	25	24	23	22	21	20	19	18	17	16	15	14	13	12	11	10	9	8	7	6	5	4	3	2	1	0		
R																																		
W																																		
Reset	0	0	0	0	0	0	0	0	0	0	0	0	0	0	0	0	0	0	0	0	0	0	0	0	0	0	0	0	0	0	0	0	0	0

ENETx_ATVR field descriptions

Field	Description
ATIME	A write sets the timer. A read returns the last captured value. To read the current value, issue a capture command (i.e., set ATCR[CAPTURE]) prior to reading this register.

22.5.91 Timer Offset Register (ENETx_ATOFF)

Address: Base address + 408h offset

Bit	31	30	29	28	27	26	25	24	23	22	21	20	19	18	17	16	15	14	13	12	11	10	9	8	7	6	5	4	3	2	1	0		
R																																		
W																																		
Reset	0	0	0	0	0	0	0	0	0	0	0	0	0	0	0	0	0	0	0	0	0	0	0	0	0	0	0	0	0	0	0	0	0	0

ENETx_ATOFF field descriptions

Field	Description
OFFSET	Offset value for one-shot event generation. When the timer reaches the value, an event can be generated to reset the counter. If the increment value in ATINC is given in true nanoseconds, this value is also given in true nanoseconds.

22.5.92 Timer Period Register (ENETx_ATPER)

Address: Base address + 40Ch offset

Bit	31	30	29	28	27	26	25	24	23	22	21	20	19	18	17	16	15	14	13	12	11	10	9	8	7	6	5	4	3	2	1	0	
R																																	
W																																	
Reset	0	0	1	1	1	0	1	1	1	0	0	1	1	0	1	0	1	1	0	0	1	0	1	0	0	0	0	0	0	0	0	0	0

ENETx_ATPER field descriptions

Field	Description
PERIOD	<p>Value for generating periodic events. Each instance the timer reaches this value, the period event occurs and the timer restarts. If the increment value in ATINC is given in true nanoseconds, this value is also given in true nanoseconds. The value should be initialized to 1,000,000,000 (1×10⁹) to represent a timer wrap around of one second. The increment value set in ATINC should be set to the true nanoseconds of the period of clock ts_clk, hence implementing a true 1 second counter.</p> <p>NOTE: The value of PERIOD has the following constraint: $2^{32} - \text{ENET_ATINC}[\text{INC_COR}] - 3 \times \text{ENET_ATINC}[\text{INC}] \geq \text{PERIOD} > 0.$</p>

22.5.93 Timer Correction Register (ENETx_ATCOR)

Address: Base address + 410h offset

Bit	31	30	29	28	27	26	25	24	23	22	21	20	19	18	17	16
R	0	COR														
W																
Reset	0	0	0	0	0	0	0	0	0	0	0	0	0	0	0	0
Bit	15	14	13	12	11	10	9	8	7	6	5	4	3	2	1	0
R	COR															
W																
Reset	0	0	0	0	0	0	0	0	0	0	0	0	0	0	0	0

ENETx_ATCOR field descriptions

Field	Description
31 Reserved	<p>This field is reserved. This read-only field is reserved and always has the value 0.</p>
COR	<p>Correction Counter Wrap-Around Value</p> <p>Defines after how many timer clock cycles (ts_clk) the correction counter should be reset and trigger a correction increment on the timer. The amount of correction is defined in ATINC[INC_CORR]. A value of 0 disables the correction counter and no corrections occur.</p> <p>NOTE: This value is given in clock cycles, not in nanoseconds as all other values.</p>

22.5.94 Time-Stamping Clock Period Register (ENETx_ATINC)

Address: Base address + 414h offset

Bit	31	30	29	28	27	26	25	24	23	22	21	20	19	18	17	16
R	0															
W																
Reset	0	0	0	0	0	0	0	0	0	0	0	0	0	0	0	0
Bit	15	14	13	12	11	10	9	8	7	6	5	4	3	2	1	0
R	0	INC_CORR							0	INC						
W																
Reset	0	0	0	0	0	0	0	0	0	0	0	0	0	0	0	0

ENETx_ATINC field descriptions

Field	Description
31–15 Reserved	This field is reserved. This read-only field is reserved and always has the value 0.
14–8 INC_CORR	Correction Increment Value This value is added every time the correction timer expires (every clock cycle given in ATCOR). A value less than INC slows down the timer. A value greater than INC speeds up the timer.
7 Reserved	This field is reserved. This read-only field is reserved and always has the value 0.
INC	Clock Period Of The Timestamping Clock (ts_clk) In Nanoseconds The timer increments by this amount each clock cycle. For example, set to 10 for 100 MHz, 8 for 125 MHz, 5 for 200 MHz. NOTE: For highest precision, use a value that is an integer fraction of the period set in ATPER.

22.5.95 Timestamp of Last Transmitted Frame (ENETx_ATSTMP)

Address: Base address + 418h offset

Bit	31	30	29	28	27	26	25	24	23	22	21	20	19	18	17	16	15	14	13	12	11	10	9	8	7	6	5	4	3	2	1	0
R	TIMESTAMP																															
W																																
Reset	0	0	0	0	0	0	0	0	0	0	0	0	0	0	0	0	0	0	0	0	0	0	0	0	0	0	0	0	0	0	0	0

ENETx_ATSTMP field descriptions

Field	Description
TIMESTAMP	Timestamp of the last frame transmitted by the core that had TxBD[TS] set . This register is only valid when EIR[TS_AVAIL] is set.

22.5.96 Timer Global Status Register (ENETx_TGSR)

Address: Base address + 604h offset

Bit	31	30	29	28	27	26	25	24		23	22	21	20	19	18	17	16
R	0																
W																	
Reset	0	0	0	0	0	0	0	0		0	0	0	0	0	0	0	0
Bit	15	14	13	12	11	10	9	8		7	6	5	4	3	2	1	0
R	0												TF3	TF2	TF1	TF0	
W													w1c	w1c	w1c	w1c	
Reset	0	0	0	0	0	0	0	0		0	0	0	0	0	0	0	0

ENETx_TGSR field descriptions

Field	Description
31–4 Reserved	This field is reserved. This read-only field is reserved and always has the value 0.
3 TF3	Copy Of Timer Flag For Channel 3 0 Timer Flag for Channel 3 is clear 1 Timer Flag for Channel 3 is set
2 TF2	Copy Of Timer Flag For Channel 2 0 Timer Flag for Channel 2 is clear 1 Timer Flag for Channel 2 is set
1 TF1	Copy Of Timer Flag For Channel 1 0 Timer Flag for Channel 1 is clear 1 Timer Flag for Channel 1 is set
0 TF0	Copy Of Timer Flag For Channel 0 0 Timer Flag for Channel 0 is clear 1 Timer Flag for Channel 0 is set

22.5.97 Timer Control Status Register (ENETx_TCSRn)

Address: Base address + 608h offset + (8d × i), where i=0d to 3d

Bit	31	30	29	28	27	26	25	24	23	22	21	20	19	18	17	16
R	0															
W																
Reset	0	0	0	0	0	0	0	0	0	0	0	0	0	0	0	0
Bit	15	14	13	12	11	10	9	8	7	6	5	4	3	2	1	0
R	TPWC						0		TF	TIE	TMODE				0	TDRE
W									w1c							
Reset	0	0	0	0	0	0	0	0	0	0	0	0	0	0	0	0

ENETx_TCSRn field descriptions

Field	Description
31–16 Reserved	This field is reserved. This read-only field is reserved and always has the value 0.
15–11 TPWC	<p>Timer PulseWidth Control</p> <p>Specifies the pulse width associated with TMODE values of 1110 or 11X1. Updating this field takes a few cycles to register because it is synchronized to the 1588 clock. When changing this field:</p> <ol style="list-style-type: none"> 1. Always disable the channel and read the TMODE field to verify that the channel is disabled. 2. Set TPWC to the desired value. 3. Reenable the channel. <p>00000 Pulse width is one 1588-clock cycle. 00001 Pulse width is two 1588-clock cycles. 00010 Pulse width is three 1588-clock cycles. 00011 Pulse width is four 1588-clock cycles. 11111 Pulse width is 32 1588-clock cycles.</p>
10–8 Reserved	This field is reserved. This read-only field is reserved and always has the value 0.
7 TF	<p>Timer Flag</p> <p>Sets when input capture or output compare occurs. This flag is double buffered between the module clock and 1588 clock domains. When this field is 1, it can be cleared to 0 by writing 1 to it.</p> <p>0 Input Capture or Output Compare has not occurred. 1 Input Capture or Output Compare has occurred.</p>
6 TIE	<p>Timer Interrupt Enable</p> <p>0 Interrupt is disabled 1 Interrupt is enabled</p>
5–2 TMODE	Timer Mode

Table continues on the next page...

ENETx_TCSRn field descriptions (continued)

Field	Description
	Updating the Timer Mode field takes a few cycles to register because it is synchronized to the 1588 clock. The version of Timer Mode returned on a read is from the 1588 clock domain. When changing Timer Mode, always disable the channel and read this register to verify the channel is disabled first.
	0000 Timer Channel is disabled.
	0001 Timer Channel is configured for Input Capture on rising edge.
	0010 Timer Channel is configured for Input Capture on falling edge.
	0011 Timer Channel is configured for Input Capture on both edges.
	0100 Timer Channel is configured for Output Compare - software only.
	0101 Timer Channel is configured for Output Compare - toggle output on compare.
	0110 Timer Channel is configured for Output Compare - clear output on compare.
	0111 Timer Channel is configured for Output Compare - set output on compare.
	1000 Reserved
	1010 Timer Channel is configured for Output Compare - clear output on compare, set output on overflow.
	10X1 Timer Channel is configured for Output Compare - set output on compare, clear output on overflow.
	110X Reserved
	1110 Timer Channel is configured for Output Compare - pulse output low on compare for 1 to 32 1588-clock cycles as specified by TPWC.
	1111 Timer Channel is configured for Output Compare - pulse output high on compare for 1 to 32 1588-clock cycles as specified by TPWC.
1 Reserved	This field is reserved. This read-only field is reserved and always has the value 0.
0 TDRE	Timer DMA Request Enable 0 DMA request is disabled 1 DMA request is enabled

22.5.98 Timer Compare Capture Register (ENETx_TCCRn)

Address: Base address + 60Ch offset + (8d × i), where i=0d to 3d

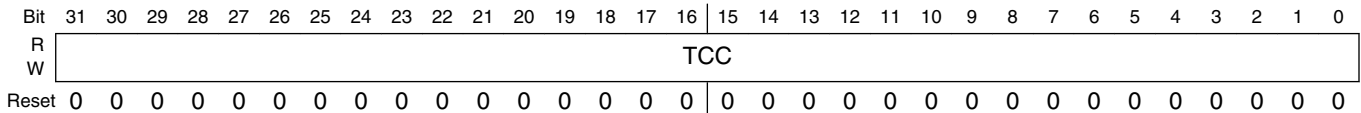

ENETx_TCCRn field descriptions

Field	Description
TCC	Timer Capture Compare This register is double buffered between the module clock and 1588 clock domains. When configured for compare, the 1588 clock domain updates with the value in the module clock domain whenever the Timer Channel is first enabled and on each subsequent compare. Write to this register with the first compare value before enabling the Timer Channel. When the Timer Channel is enabled, write the second compare value either immediately, or at least before the first compare occurs. After each compare, write the next compare value before the previous compare occurs and before clearing the Timer Flag.

ENETx_TCCR_n field descriptions (continued)

Field	Description
	<p>The compare occurs one 1588 clock cycle after the IEEE 1588 Counter increments past the compare value in the 1588 clock domain. If the compare value is less than the value of the 1588 Counter when the Timer Channel is first enabled, then the compare does not occur until following the next overflow of the 1588 Counter. If the compare value is greater than the IEEE 1588 Counter when the 1588 Counter overflows, or the compare value is less than the value of the IEEE 1588 Counter after the overflow, then the compare occurs one 1588 clock cycle following the overflow.</p> <p>When configured for capture, the value of the IEEE 1588 Counter is captured into the 1588 clock domain and then updated into the module clock domain, provided the Timer Flag is clear. Always read the capture value before clearing the Timer Flag.</p>

22.6 Functional description

This section provides a complete functional description of the MAC-NET core.

22.6.1 Ethernet MAC frame formats

The IEEE 802.3 standard defines the Ethernet frame format as follows:

- Minimum length of 64 bytes
- Maximum length of 1518 bytes excluding the preamble and the start frame delimiter (SFD) bytes

An Ethernet frame consists of the following fields:

- Seven bytes preamble
- Start frame delimiter (SFD)
- Two address fields
- Length or type field
- Data field
- Frame check sequence (CRC value)

Functional description

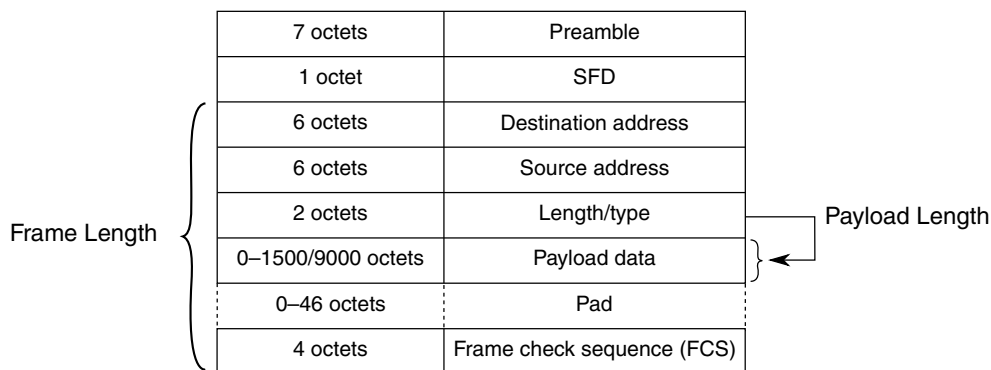

Figure 22-2. MAC frame format overview

Optionally, MAC frames can be VLAN-tagged with an additional four-byte field inserted between the MAC source address and the type/length field. VLAN tagging is defined by the IEEE P802.1q specification. VLAN-tagged frames have a maximum length of 1522 bytes, excluding the preamble and the SFD bytes.

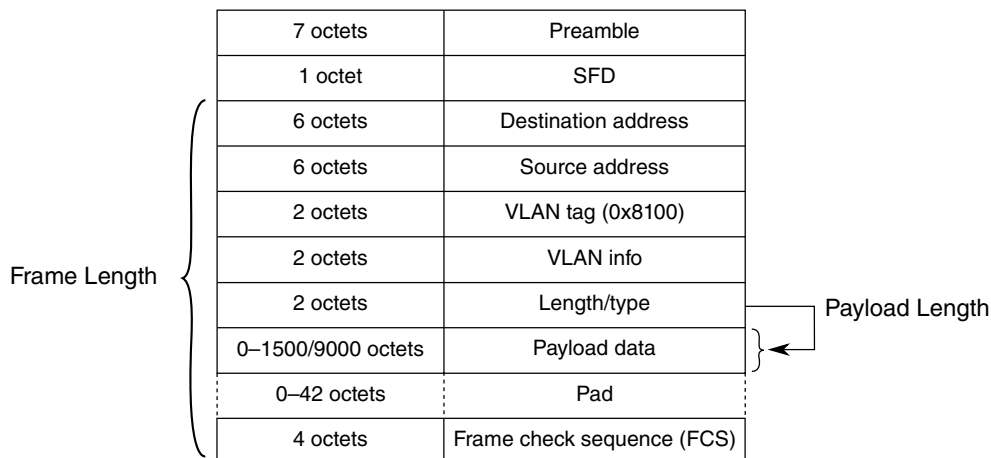

Figure 22-3. VLAN-tagged MAC frame format overview

Table 22-5. MAC frame definition

Term	Description
Frame length	Defines the length, in octets, of the complete frame without preamble and SFD. A frame has a valid length if it contains at least 64 octets and does not exceed the programmed maximum length.
Payload length	The length/type field indicates the length of the frame's payload section. The most significant byte is sent/received first. <ul style="list-style-type: none"> If the length/type field is set to a value less than 46, the payload is padded so that the minimum frame length requirement (64 bytes) is met. For VLAN-tagged frames, a value less than 42 indicates a padded frame. If the length/type field is set to a value larger than the programmed frame maximum length (e.g. 1518) it is interpreted as a type field.
Destination and source address	48-bit MAC addresses. The least significant byte is sent/received first and the first two least significant bits of the MAC address distinguish MAC frames, as detailed in MAC address check .

Note

Although the IEEE specification defines a maximum frame length, the MAC core provides the flexibility to program any value for the frame maximum length.

22.6.1.1 Pause Frames

The receiving device generates a pause frame to indicate a congestion to the emitting device, which should stop sending data.

Pause frames are indicated by the length/type set to 0x8808. The two first bytes of a pause frame following the type, defines a 16-bit opcode field set to 0x0001 always. A 16-bit pause quanta is defined in the frame payload bytes 2 (P1) and 3 (P2) as defined in the following table. The P1 pause quanta byte is the most significant.

Table 22-6. Pause Frame Format (Values in Hex)

1	2	3	4	5	6	7	8	9	10	11	12	13	14
55	55	55	55	55	55	55	D5	01	80	C2	00	00	01
Preamble							SFD	Multicast Destination Address					
15	16	17	18	19	20	21	22	23	24	25	26	27–68	
00	00	00	00	00	00	88	08	00	01	hi	lo	00	
Source Address						Type		Opcode		P1	P2	pad (42)	
69	70	71	72										
26	6B	AE	0A										
CRC-32													

There is no payload length field found within a pause frame and a pause frame is always padded with 42 bytes (0x00).

If a pause frame with a pause value greater than zero (XOFF condition) is received, the MAC stops transmitting data as soon the current frame transfer is completed. The MAC stops transmitting data for the value defined in pause quanta. One pause quanta fraction refers to 512 bit times.

If a pause frame with a pause value of zero (XON condition) is received, the transmitter is allowed to send data immediately (see [Full-duplex flow control operation](#) for details).

22.6.1.2 Magic packets

A magic packet is a unicast, multicast, or broadcast packet, which carries a defined sequence in the payload section.

Magic packets are received and inspected only under specific conditions as described in [Magic packet detection](#).

The defined sequence to decode a magic packet is formed with a synchronization stream which consists of six consecutive 0xFF bytes, and is followed by sequence of sixteen consecutive unicast MAC addresses of the node to be awakened.

This sequence can be located anywhere in the magic packet payload. The magic packet is formed with a standard Ethernet header, optional padding, and CRC.

22.6.2 IP and higher layers frame format

The following sections use the term datagram to describe the protocol specific data unit that is found within the payload section of its container entity.

For example, an IP datagram specifies the payload section of an Ethernet frame. A TCP datagram specifies the payload section within an IP datagram.

22.6.2.1 Ethernet types

IP datagrams are carried in the payload section of an Ethernet frame. The Ethernet frame type/length field discriminates several datagram types.

The following table lists the types of interest:

Table 22-7. Ethernet type value examples

Type	Description
0x8100	VLAN-tagged frame. The actual type is found 4 octets later in the frame.
0x0800	IPv4
0x0806	ARP
0x86DD	IPv6

22.6.2.2 IPv4 datagram format

The following figure shows the IP Version 4 (IPv4) header, which is located at the beginning of an IP datagram. It is organized in 32-bit words. The first byte sent/received is the leftmost byte of the first word (in other words, version/IHL field).

The IP header can contain further options, which are always padded if necessary to guarantee the payload following the header is aligned to a 32-bit boundary.

The IP header is immediately followed by the payload, which can contain further protocol headers (for example, TCP or UDP, as indicated by the protocol field value). The complete IP datagram is transported in the payload section of an Ethernet frame.

Table 22-8. IPv4 header format

31	30	29	28	27	26	25	24	23	22	21	20	19	18	17	16	15	14	13	12	11	10	9	8	7	6	5	4	3	2	1	0
Version				IHL				TOS				Length																			
Fragment ID								Flags				Fragment offset																			
TTL				Protocol				Header checksum																							
Source address																Destination address															
Options																															

Table 22-9. IPv4 header fields

Field name	Description
Version	4-bit IP version information. 0x4 for IPv4 frames.
IHL	4-bit Internet header length information. Determines number of 32-bit words found within the IP header. If no options are present, the default value is 0x5.
TOS	Type of service/DiffServ field.
Length	Total length of the datagram in bytes, including all octets of header and payload.
Fragment ID, flags, fragment offset	Fields used for IP fragmentation.
TTL	Time-to-live. In effect, is decremented at each router arrival. If zero, datagram must be discarded.
Protocol	Identifier of protocol that follows in the datagram.
Header checksum	Checksum of IP header. For computational purposes, this field's value is zero.
Source address	Source IP address.
Destination address	Destination IP address.

22.6.2.3 IPv6 datagram format

The following figure shows the IP version 6 (IPv6) header, which is located at the beginning of an IP datagram. It is organized in 32-bit words and has a fixed length of ten words (40 bytes). The next header field identifies the type of the header that follows the IPv6 header. It is defined similar to the protocol identifier within IPv4, with new definitions for identifying extension headers. These headers can be inserted between the IPv6 header and the protocol header, which will shift the protocol header accordingly. The accelerator currently only supports IPv6 without extension headers (in other words, the next header specifies TCP, UDP, or ICMP).

Functional description

The first byte sent/received is the leftmost byte of the first word (in other words, version/traffic class fields).

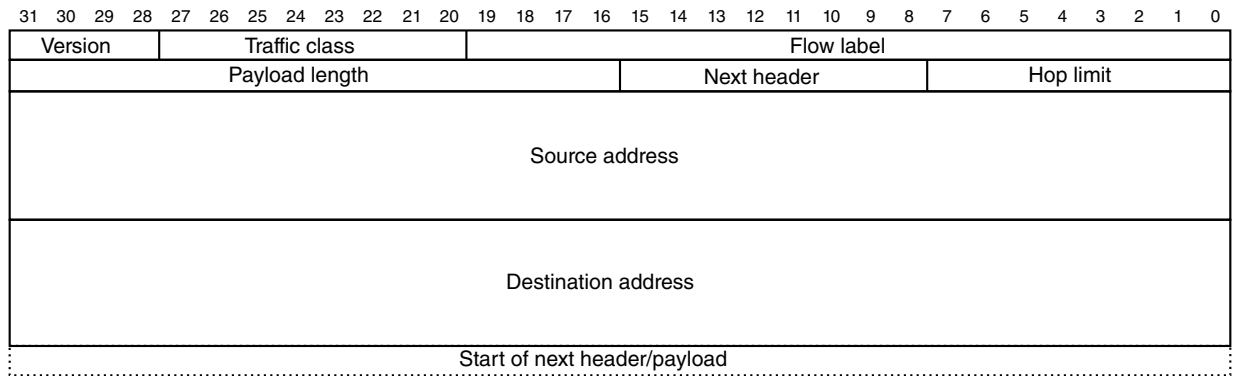

Figure 22-4. IPv6 header format

Table 22-10. IPv6 header fields

Field name	Description
Version	4-bit IP version information. 0x6 for all IPv6 frames.
Traffic class	8-bit field defining the traffic class.
Flow label	20-bit flow label identifying frames of the same flow.
Payload length	16-bit length of the datagram payload in bytes. It includes all octets following the IPv6 header.
Next header	Identifies the header that follows the IPv6 header. This can be the protocol header or any IPv6 defined extension header.
Hop limit	Hop counter, decremented by one by each station that forwards the frame. If hop limit is 0 the frame must be discarded.
Source address	128-bit IPv6 source address.
Destination address	128-bit IPv6 destination address.

22.6.2.4 Internet Control Message Protocol (ICMP) datagram format

An internet control message protocol (ICMP) is found following the IP header, if the protocol identifier is 1. The ICMP datagram has a four-octet header followed by additional message data.

Table 22-11. ICMP header format

31	30	29	28	27	26	25	24	23	22	21	20	19	18	17	16	15	14	13	12	11	10	9	8	7	6	5	4	3	2	1	0
Type				Code								Checksum																			
ICMP message data																															

Table 22-12. IP header fields

Field name	Description
Type	8-bit type information
Code	8-bit code that is related to the message type
Checksum	16-bit one's complement checksum over the complete ICMP datagram

22.6.2.5 User Datagram Protocol (UDP) datagram format

A user datagram protocol header is found after the IP header, when the protocol identifier is 17.

The payload of the datagram is after the UDP header. The header byte order follows the conventions given for the IP header above.

Table 22-13. UDP header format

31	30	29	28	27	26	25	24	23	22	21	20	19	18	17	16	15	14	13	12	11	10	9	8	7	6	5	4	3	2	1	0
Source port												Destination port																			
Length												Checksum																			

Table 22-14. UDP header fields

Field name	Description
Source port	Source application port
Destination port	Destination application port
Length	Length of user data which immediately follows the header, including the UDP header (that is, minimum value is 8)
Checksum	Checksum over the complete datagram and some IP header information

22.6.2.6 TCP datagram format

A TCP header is found following the IP header, when the protocol identifier has a value of 6.

The TCP payload immediately follows the TCP header.

Table 22-15. TCP header format

31	30	29	28	27	26	25	24	23	22	21	20	19	18	17	16	15	14	13	12	11	10	9	8	7	6	5	4	3	2	1	0
Source port												Destination port																			

Table continues on the next page...

Table 22-15. TCP header format (continued)

Sequence number			
Acknowledgement number			
Offset	Reserved	Flags	Window
Checksum		Urgent pointer	
Options			

Table 22-16. TCP header fields

Field name	Description
Source port	Source application port
Destination port	Destination application port
Sequence number	Transmit sequence number
Ack. number	Receive sequence number
Offset	Data offset, which is number of 32-bit words within TCP header — if no options selected, defaults to value of 5
Flags	URG, ACK, PSH, RST, SYN, FIN flags
Window	TCP receive window size information
Checksum	Checksum over the complete datagram (TCP header and data) and IP header information
Options	Additional 32-bit words for protocol options

22.6.3 IEEE 1588 message formats

The following sections describe the IEEE 1588 message formats.

22.6.3.1 Transport encapsulation

The precision time protocol (PTP) datagrams are encapsulated in Ethernet frames using the UDP/IP transport mechanism, or optionally, with the newer 1588v2 directly in Ethernet frames (layer 2).

Typically, multicast addresses are used to allow efficient distribution of the synchronization messages.

22.6.3.1.1 UDP/IP

The 1588 messages (v1 and v2) can be transported using UDP/IP multicast messages.

Table 22-17 shows IP multicast groups defined for PTP. The table also shows their respective MAC layer multicast address mapping according to RFC 1112 (last three octets of IP follow the fixed value of 01-00-5E).

Table 22-17. UDP/IP multicast domains

Name	IP Address	MAC Address mapping
DefaultPTPdomain	224.0.1.129	01-00-5E-00-01-81
AlternatePTPdomain1	224.0.1.130	01-00-5E-00-01-82
AlternatePTPdomain2	224.0.1.131	01-00-5E-00-01-83
AlternatePTPdomain3	224.0.1.132	01-00-5E-00-01-84

Table 22-18. UDP port numbers

Message type	UDP port	Note
Event	319	Used for SYNC and DELAY_REQUEST messages
General	320	All other messages (for example, follow-up, delay-response)

22.6.3.1.2 Native Ethernet (PTPv2)

In addition to using UDP/IP frames, IEEE 1588v2 defines a native Ethernet frame format that uses ethertype = 0x88F7. The payload of the Ethernet frame immediately contains the PTP datagram, starting with the PTPv2 header.

Besides others, version 2 adds a peer delay mechanism to allow delay measurements between individual point-to-point links along a path over multiple nodes. The following multicast domains are also defined in PTPv2.

Table 22-19. PTPv2 multicast domains

Name	MAC address
Normal messages	01-1B-19-00-00-00
Peer delay messages	01-80-C2-00-00-0E

22.6.3.2 PTP header

All PTP frames contain a common header that determines the protocol version and the type of message, which defines the remaining content of the message.

All multi-octet fields are transmitted in big-endian order (the most significant byte is transmitted/received first).

Functional description

The last four bits of versionPTP are at the same position (second byte) for PTPv1 and PTPv2 headers. This allows accurate identification by inspecting the first two bytes of the message.

22.6.3.2.1 PTPv1 header

Table 22-20. Common PTPv1 message header

Offset	Octets	Bits							
		7	6	5	4	3	2	1	0
0	2	versionPTP = 0x0001							
2	2	versionNetwork							
4	16	subdomain							
20	1	messageType							
21	1	sourceCommunicationTechnology							
22	6	sourceUuid							
28	2	sourcePortId							
30	2	sequenceId							
32	1	control							
33	1	0x00							
34	2	flags							
36	4	reserved							

The type of message is encoded in the messageType and control fields as shown in [Table 22-21](#) :

Table 22-21. PTPv1 message type identification

messageType	control	Message Name	Message
0x01	0x0	SYNC	Event message
0x01	0x1	DELAY_REQ	Event message
0x02	0x2	FOLLOW_UP	General message
0x02	0x3	DELAY_RESP	General message
0x02	0x4	MANAGEMENT	General message
other	other	—	Reserved

The field sequenceId is used to non-ambiguously identify a message.

22.6.3.2.2 PTPv2 header

Table 22-22. Common PTPv2 message header

Offset	Octets	Bits							
		7	6	5	4	3	2	1	0
0	1	transportSpecific				messageId			
1	1	reserved				versionPTP = 0x2			
2	2	messageLength							
4	1	domainNumber							
5	1	reserved							
6	2	flags							
8	8	correctionField							
16	4	reserved							
20	10	sourcePortIdentity							
30	2	sequenceId							
32	1	control							
33	1	logMeanMessageInterval							

The type of message is encoded in the field messageId as follows:

Table 22-23. PTPv2 message type identification

messageId	Message name	Message
0x0	SYNC	Event message
0x1	DELAY_REQ	Event message
0x2	PATH_DELAY_REQ	Event message
0x3	PATH_DELAY_RESP	Event message
0x4–0x7	—	Reserved
0x8	FOLLOW_UP	General message
0x9	DELAY_RESP	General message
0xa	PATH_DELAY_FOLLOW_UP	General message
0xb	ANNOUNCE	General message
0xc	SIGNALING	General message
0xd	MANAGEMENT	General message

The PTPv2 flags field contains further details on the type of message, especially if one-step or two-step implementations are used. The one- or two-step implementation is controlled by the TWO_STEP bit in the first octet of the flags field as shown below. Reserved bits are cleared.

Table 22-24. PTPv2 message flags field definitions

Bit	Name	Description
0	ALTERNATE_MASTER	See IEEE 1588 Clause 17.4
1	TWO_STEP	1 Two-step clock 0 One-step clock
2	UNICAST	1 Transport layer address uses a unicast destination address 0 Multicast is used
3	—	Reserved
4	—	Reserved
5	Profile specific	
6	Profile specific	
7	—	Reserved

22.6.4 MAC receive

The MAC receive engine performs the following tasks:

- Check frame framing
- Remove frame preamble and frame SFD field
- Discard frame based on frame destination address field
- Terminate pause frames
- Check frame length
- Remove payload padding if it exists
- Calculate and verify CRC-32
- Write received frames in the core receive FIFO

If the MAC is programmed to operate in half-duplex mode, it will also check if the frame is received with a collision.

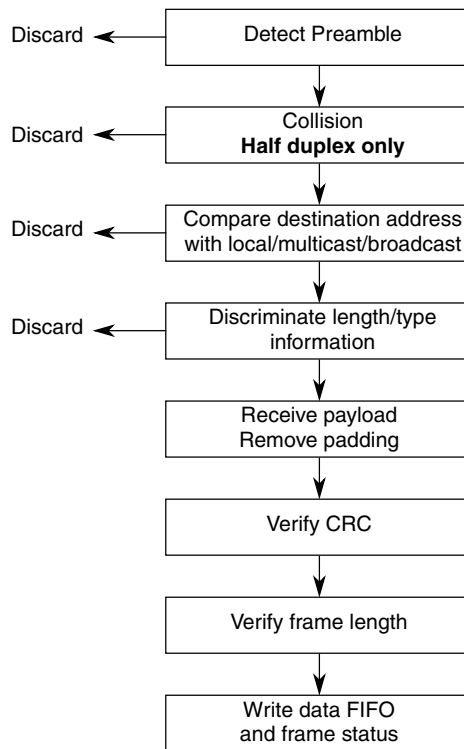

Figure 22-5. MAC receive flow

22.6.4.1 Collision detection in half-duplex mode

If the packet is received with a collision detected during reception of the first 64 bytes, the packet is discarded (if frame size was less than ~14 octets) or transmitted to the user application with an error and RxBD[CE] set.

22.6.4.2 Preamble processing

The IEEE 802.3 standard allows a maximum size of 56 bits (seven bytes) for the preamble, while the MAC core allows any preamble length, including zero length preamble.

The MAC core checks for the start frame delimiter (SFD) byte. If the next byte of the preamble, which is different from 0x55, is not 0xD5, the frame is discarded.

Although the IEEE specification dictates that the inner-packet gap should be at least 96 bits, the MAC core is designed to accept frames separated by only 64 10/100-Mbit/s operation (MII) bits.

The MAC core removes the preamble and SFD bytes.

22.6.4.3 MAC address check

The destination address bit 0 differentiates between multicast and unicast addresses.

- If bit 0 is 0, the MAC address is an individual (unicast) address.
- If bit 0 is 1, the MAC address defines a group (multicast) address.
- If all 48 bits of the MAC address are set, it indicates a broadcast address.

22.6.4.3.1 Unicast address check

If a unicast address is received, the destination MAC address is compared to the node MAC address programmed by the host in the PADDR1/2 registers.

If the destination address matches any of the programmed MAC addresses, the frame is accepted.

If Promiscuous mode is enabled ($RCR[PROM] = 1$) no address checking is performed and all unicast frames are accepted.

22.6.4.3.2 Multicast and unicast address resolution

The hash table algorithm used in the group and individual hash filtering operates as follows.

- The 48-bit destination address is mapped into one of 64 bits, represented by 64 bits in $ENETn_GAUR/GALR$ (group address hash match) or $ENETn_IAUR/IALR$ (individual address hash match).
- This mapping is performed by passing the 48-bit address through the on-chip 32-bit CRC generator and selecting the six most significant bits of the CRC-encoded result to generate a number between 0 and 63.
- The msb of the CRC result selects $ENETn_GAUR$ (msb = 1) or $ENETn_GALR$ (msb = 0).
- The five lsbs of the hash result select the bit within the selected register.
- If the CRC generator selects a bit set in the hash table, the frame is accepted; else, it is rejected.

For example, if eight group addresses are stored in the hash table and random group addresses are received, the hash table prevents roughly 56/64 (or 87.5%) of the group address frames from reaching memory. Those that do reach memory must be further filtered by the processor to determine if they truly contain one of the eight desired addresses.

The effectiveness of the hash table declines as the number of addresses increases.

The user must initialize the hash table registers. Use this CRC32 polynomial to compute the hash:

- $FCS(x) = x^{32} + x^{26} + x^{23} + x^{22} + x^{16} + x^{12} + x^{11} + x^{10} + x^8 + x^7 + x^5 + x^4 + x^2 + x^1 + 1$

If Promiscuous mode is enabled ($ENETn_RCR[PROM] = 1$) all unicast and multicast frames are accepted regardless of $ENETn_GAUR/GALR$ and $ENETn_IAUR/IALR$ settings.

22.6.4.3.3 Broadcast address reject

All broadcast frames are accepted if BC_REJ is cleared or $ENETn_RCR[PROM]$ is set. If $PROM$ is cleared when $ENETn_RCR[BC_REJ]$ is set, all broadcast frames are rejected.

Table 22-25. Broadcast address reject programming

PROM	BC_REJ	Broadcast frames
0	0	Accepted
0	1	Rejected
1	0	Accepted
1	1	Accepted

22.6.4.3.4 Miss-bit implementation

For higher layer filtering purposes, $RxBD[M]$ indicates an address miss when the MAC operates in promiscuous mode and accepts a frame that would otherwise be rejected.

If a group/individual hash or exact match does not occur and Promiscuous mode is enabled ($RCR[PROM] = 1$), the frame is accepted and the M bit is set in the buffer descriptor; otherwise, the frame is rejected.

This means the status bit is set in any of the following conditions during Promiscuous mode:

- A broadcast frame is received when BC_REJ is set
- A unicast is received that does not match either:

- Node address (PALR[PADDR1] and PAUR[PADDR2])
- Hash table for unicast (IAUR[IADDR1] and IALR[IADDR2])
- A multicast is received that does not match the GAUR[GADDR1] and GALR[GADDR2] hash table entries

22.6.4.4 Frame length/type verification: payload length check

If the length/type is less than 0x600 and NLC is set, the MAC checks the payload length and reports any error in the frame status word and interrupt bit PLR.

If the length/type is greater than or equal to 0x600, the MAC interprets the field as a type and no payload length check is performed.

The length check is performed on VLAN and stacked VLAN frames. If a padded frame is received, no length check can be performed due to the extended frame payload because padded frames can never have a payload length error.

22.6.4.5 Frame length/type verification: frame length check

When the receive frame length exceeds MAX_FL bytes, the BABR interrupt is generated and the RxBD[LG] bit is set.

The frame is not truncated unless the frame length exceeds the value programmed in ENET n _FTRL[TRUNC_FL]. If the frame is truncated, RxBD[TR] is set. In addition, a truncated frame always has the CRC error indication set (RxBD[CR]).

22.6.4.6 VLAN frames processing

VLAN frames have a length/type field set to 0x8100 immediately followed by a 16-Bit VLAN control information field.

VLAN-tagged frames are received as normal frames because the VLAN tag is not interpreted by the MAC function, and are pushed complete with the VLAN tag to the user application. If the length/type field of the VLAN-tagged frame, which is found four octets later in the frame, is less than 42, the padding is removed. In addition, the frame status word (RxBD[NO]) indicates that the current frame is VLAN tagged.

22.6.4.7 Pause frame termination

The receive engine terminates pause frames and does not transfer them to the receive FIFO. The quanta is extracted and sent to the MAC transmit path via a small internal clock rate decoupling asynchronous FIFO.

The quanta is written only if a correct CRC and frame length are detected by the control state machine. If not, the quanta is discarded and the MAC transmit path is not paused.

Good pause frames are ignored if ENET n _RCR[FCE] is cleared and are forwarded to the client interface when ENET n _RCR[PAUFWD] is set.

22.6.4.8 CRC check

The CRC-32 field is checked and forwarded to the core FIFO interface if ENET n _RCR[CRCFWD] is cleared and ENET n _RCR[PADEN] is set.

When CRCFWD is set (regardless of PADEN), the CRC-32 field is checked and terminated (not transmitted to the FIFO).

The CRC polynomial, as specified in the 802.3 standard, is:

- $FCS(x) = x^{32} + x^{26} + x^{23} + x^{22} + x^{16} + x^{12} + x^{11} + x^{10} + x^8 + x^7 + x^5 + x^4 + x^2 + x^1 + 1$

The 32 bits of the CRC value are placed in the frame check sequence (FCS) field with the x^{31} term as right-most bit of the first octet. The CRC bits are thus received in the following order: $x^{31}, x^{30}, \dots, x^1, x^0$.

If a CRC error is detected, the frame is marked invalid and RxBD[CR] is set.

22.6.4.9 Frame padding removal

When a frame is received with a payload length field set to less than 46 (42 for VLAN-tagged frames and 38 for frames with stacked VLANs), the zero padding can be removed before the frame is written into the data FIFO depending on the setting of ENET n _RCR[PADEN].

Note

If a frame is received with excess padding (in other words, the length field is set as mentioned above, but the frame has more than 64 octets) and padding removal is enabled, then the

padding is removed as normal and no error is reported if the frame is otherwise correct (for example: good CRC, less than maximum length, and no other error).

22.6.5 MAC transmit

Frame transmission starts when the transmit FIFO holds enough data.

After a transfer starts, the MAC transmit function performs the following tasks:

- Generates preamble and SFD field before frame transmission
- Generates XOFF pause frames if the receive FIFO reports a congestion or if `ENETn_TCR[TFC_PAUSE]` is set with `ENETn_OPD[PAUSE_DUR]` set to a non-zero value
- Generates XON pause frames if the receive FIFO congestion condition is cleared or if `TFC_PAUSE` is set with `PAUSE_DUR` cleared
- Suspends Ethernet frame transfer (XOFF) if a non-zero pause quanta is received from the MAC receive path
- Adds padding to the frame if required
- Calculates and appends CRC-32 to the transmitted frame
- Sends the frame with correct inter-packet gap (IPG) (deferring)

When the MAC is configured to operate in half-duplex mode, the following additional tasks are performed:

- Collision detection
- Frame retransmit after back-off timer expires

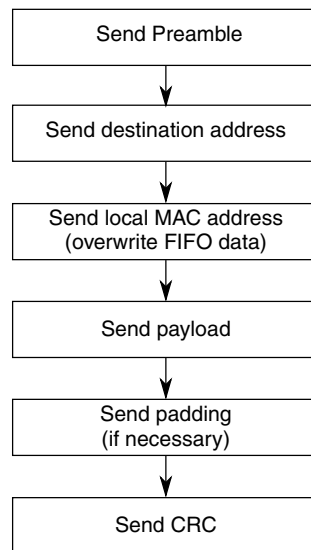

Figure 22-6. Frame transmit overview

22.6.5.1 Frame payload padding

The IEEE specification defines a minimum frame length of 64 bytes.

If the frame sent to the MAC from the user application has a size smaller than 60 bytes, the MAC automatically adds padding bytes (0x00) to comply with the Ethernet minimum frame length specification. Transmit padding is always performed and cannot be disabled.

If the MAC is not allowed to append a CRC (TxBD[TC] = 1), the user application is responsible for providing frames with a minimum length of 64 octets.

22.6.5.2 MAC address insertion

On each frame received from the core transmit FIFO interface, the source MAC address is either:

- Replaced by the address programmed in the PADDR1/2 fields (ENET n _TCR[ADDINS] = 1)
- Transparently forwarded to the Ethernet line (ENET n _TCR[ADDINS] = 0)

22.6.5.3 CRC-32 generation

The CRC-32 field is optionally generated and appended at the end of a frame.

The CRC polynomial, as specified in the 802.3 standard, is:

- $FCS(x) = x^{32} + x^{26} + x^{23} + x^{22} + x^{16} + x^{12} + x^{11} + x^{10} + x^8 + x^7 + x^5 + x^4 + x^2 + x^1 + 1$

The 32 bits of the CRC value are placed in the FCS field so that the x^{31} term is the right-most bit of the first octet. The CRC bits are thus transmitted in the following order: x^{31} , x^{30} , ..., x^1 , x^0 .

22.6.5.4 Inter-packet gap (IPG)

In full-duplex mode, after frame transmission and before transmission of a new frame, an IPG (programmed in `ENETn_TIPG`) is maintained. The minimum IPG can be programmed between 8 and 26 byte-times (64 and 208 bit-times).

In half-duplex mode, the core constantly monitors the line. Actual transmission of the data onto the network occurs only if it has been idle for a 96-bit time period, and any back-off time requirements have been satisfied. In accordance with the standard, the core begins to measure the IPG from CRS de-assertion.

22.6.5.5 Collision detection and handling — half-duplex operation only

A collision occurs on a half-duplex network when concurrent transmissions from two or more nodes take place. During transmission, the core monitors the line condition and detects a collision when the PHY device asserts COL.

When the core detects a collision while transmitting, it stops transmission of the data and transmits a 32-bit jam pattern. If the collision is detected during the preamble or the SFD transmission, the jam pattern is transmitted after completing the SFD, which results in a minimum 96-bit fragment. The jam pattern is a fixed pattern that is not compared to the actual frame CRC, and has a very low probability (0.532) of having a jam pattern identical to the CRC.

If a collision occurs before transmission of 64 bytes (including preamble and SFD), the MAC core waits for the backoff period and retransmits the packet data (stored in a 64-byte re-transmit buffer) that has already been sent on the line. The backoff period is generated from a pseudo-random process (truncated binary exponential backoff).

If a collision occurs after transmission of 64 bytes (including preamble and SFD), the MAC discards the remainder of the frame, optionally sets the LC interrupt bit, and sets `TxBD[LCE]`.

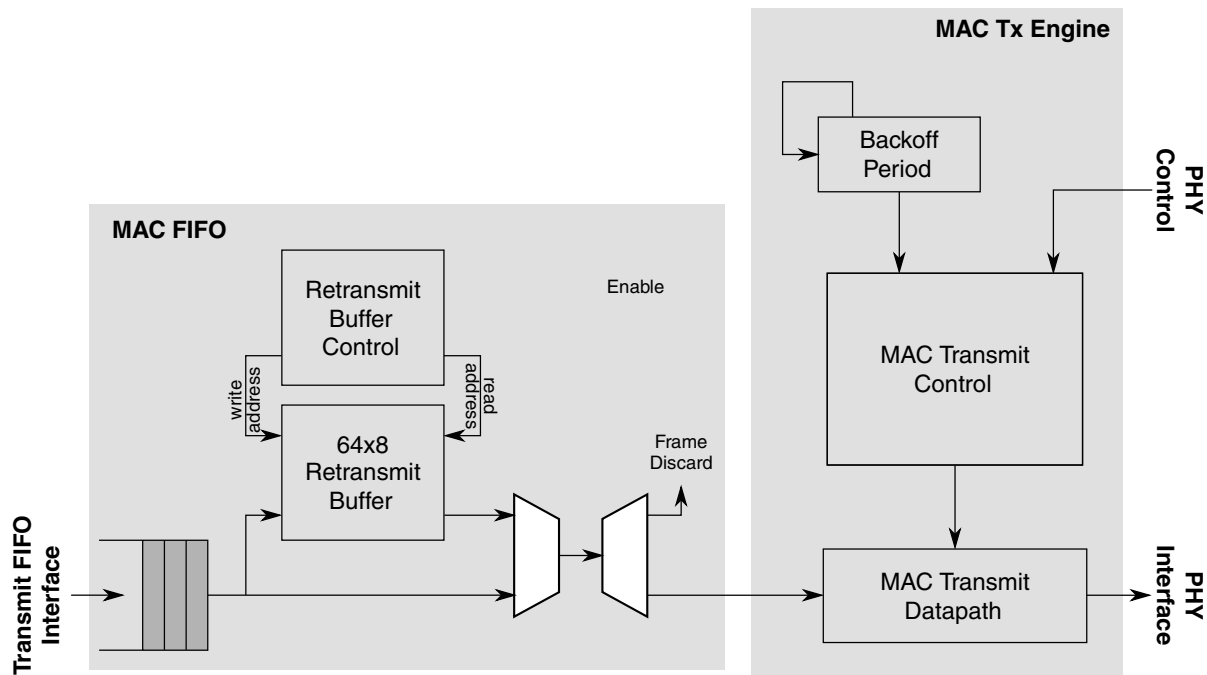

Figure 22-7. Packet re-transmit overview

The backoff time is represented by an integer multiple of slot times. One slot is equal to a 512-bit time period. The number of the delay slot times, before the n^{th} re-transmission attempt, is chosen as a uniformly-distributed random integer in the range:

- $0 < r < 2^k$
- $k = \min(n, N)$; where n is the number of retransmissions and $N = 10$

For example, after the first collision, the backoff period is 0 or 1 slot time. If a collision occurs on the first retransmission, the backoff period is 0, 1, 2, or 3, and so on.

The maximum backoff time (in 512-bit time slots) is limited by $N = 10$ as specified in the IEEE 802.3 standard.

If a collision occurs after 16 consecutive retransmissions, the core reports an excessive collision condition (ENET n _EIR[RL] interrupt field and TxBD[EE]) and discards the current packet from the FIFO.

In networks violating the standard requirements, a collision may occur after transmission of the first 64 bytes. In this case, the core stops the current packet transmission and discards the rest of the packet from the transmit FIFO. The core resumes transmission with the next packet available in the core transmit FIFO.

warning

Ethernet PHYs that support the SQE Test, or "heartbeat," feature must disable this feature. When this feature is enabled,

the PHY asserts the collision signal after a frame is transmitted to indicate to the ENET that the PHY's collision logic is working. This may cause data corruption in the next frame from the ENET. This corrupted frame contains up to 21 zero bytes which start somewhere within the MAC destination address field. The ENET, however, will still generate a good FCS (CRC-32) but with corrupted data.

22.6.6 Full-duplex flow control operation

Three conditions are handled by the core's flow control engine:

- Remote device congestion — The remote device connected to the same Ethernet segment as the core reports congestion and requests that the core stop sending data.
- Core FIFO congestion — When the core's receive FIFO reaches a user-programmable threshold (RX section empty), the core sends a pause frame back to the remote device requesting the data transfer to stop.
- Local device congestion — Any device connected to the core can request (typically, via the host processor) the remote device to stop transmitting data.

22.6.6.1 Remote device congestion

When the MAC transmit control gets a valid pause quanta from the receive path and if `ENETn_RCR[FCE]` is set, the MAC transmit logic:

- Completes the transfer of the current frame.
- Stops sending data for the amount of time specified by the pause quanta in 512 bit time increments.
- Sets `ENETn_TCR[RFC_PAUSE]`.

Frame transfer resumes when the time specified by the quanta expires and if no new quanta value is received, or if a new pause frame with a quanta value set to 0x0000 is received. The MAC also resets `RFC_PAUSE` to zero.

If `ENETn_RCR[FCE]` cleared, the MAC ignores received pause frames.

Optionally and independent of `ENETn_RCR[FCE]`, pause frames are forwarded to the client interface if `PAUFWD` is set.

22.6.6.2 Local device/FIFO congestion

The MAC transmit engine generates pause frames when the local receive FIFO is not able to receive more than a pre-defined number of words (FIFO programmable threshold) or when pause frame generation is requested by the local host processor.

- To generate a pause frame, the host processor sets ENET n _TCR[TFC_PAUSE]. A single pause frame is generated when the current frame transfer is completed and TFC_PAUSE is automatically cleared. Optionally, an interrupt is generated.
- An XOFF pause frame is generated when the receive FIFO asserts its section empty flag (internal). An XOFF pause frame is generated automatically, when the current frame transfer completes.
- An XON pause frame is generated when the receive FIFO deasserts its section empty flag (internal). An XON pause frame is generated automatically, when the current frame transfer completes.

When an XOFF pause frame is generated, the pause quanta (payload byte P1 and P2) is filled with the value programmed in ENET n _OPD[PAUSE_DUR].

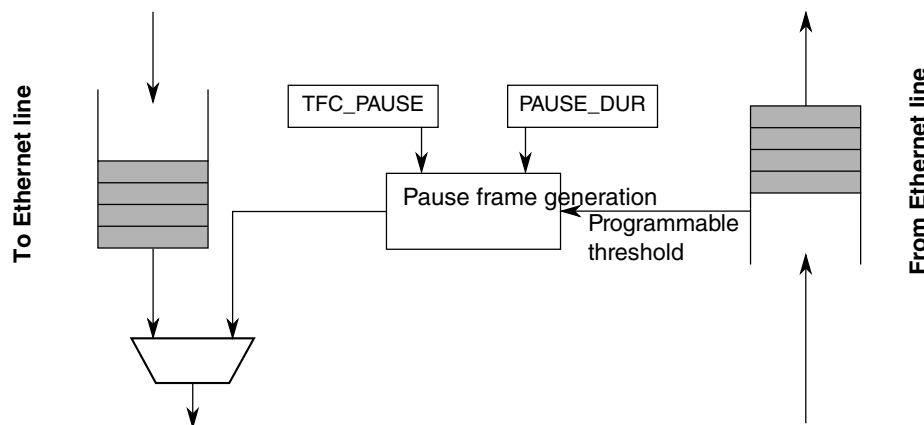

Figure 22-8. Pause frame generation overview

Note

Although the flow control mechanism should prevent any FIFO overflow on the MAC core receive path, the core receive FIFO is protected. When an overflow is detected on the receive FIFO, the current frame is truncated with an error indication set in the frame status word. The frame should subsequently be discarded by the user application.

22.6.7 Magic packet detection

Magic packet detection wakes a node that is put in power-down mode by the node management agent. Magic packet detection is supported only if the MAC is configured in sleep mode.

22.6.7.1 Sleep mode

To put the MAC in Sleep mode, set ENET n _ECR[SLEEP]. At the same time ENET n _ECR[MAGICEN] should also be set to enable magic packet detection.

In addition, if ENET is enabled, write 1 to ENET n _ECR[SLEEP] before entering into low power mode.

When the MAC is in Sleep mode:

- The transmit logic is disabled.
- The FIFO receive/transmit functions are disabled.
- The receive logic is kept in Normal mode, but it ignores all traffic from the line except magic packets. They are detected so that a remote agent can wake the node.

22.6.7.2 Magic packet detection

The core is designed to detect magic packets (see [Magic packets](#)) with the destination address set to:

- Any multicast address
- The broadcast address
- The unicast address programmed in PADDR1/2

When a magic packet is detected, EIR[WAKEUP] is set and none of the statistic registers are incremented.

22.6.7.3 Wakeup

When a magic packet is detected, indicated by ENET n _EIR[WAKEUP], ENET n _ECR[SLEEP] should be cleared to resume normal operation of the MAC. Clearing the SLEEP bit automatically masks ENET n _ECR[MAGICEN], disabling magic packet detection.

22.6.8 IP accelerator functions

The following sections describe the IP accelerator functions.

22.6.8.1 Checksum calculation

The IP and ICMP, TCP, UDP checksums are calculated with one's complement arithmetic summing up 16-bit values.

- For ICMP, the checksum is calculated over the complete ICMP datagram, in other words without IP header.
- For TCP and UDP, the checksums contain the header and data sections and values from the IP header, which can be seen as a pseudo-header that is not actually present in the data stream.

Table 22-26. IPv4 pseudo-header for checksum calculation

31	30	29	28	27	26	25	24	23	22	21	20	19	18	17	16	15	14	13	12	11	10	9	8	7	6	5	4	3	2	1	0
Source address																															
Destination address																															
Zero				Protocol				TCP/UDP length																							

Table 22-27. IPv6 pseudo-header for checksum calculation

31	30	29	28	27	26	25	24	23	22	21	20	19	18	17	16	15	14	13	12	11	10	9	8	7	6	5	4	3	2	1	0
Source address																															
Destination address																															
TCP/UDP length																															
Zero												Next header																			

The TCP/UDP length value is the length of the TCP or UDP datagram, which is equal to the payload of an IP datagram. It is derived by subtracting the IP header length from the complete IP datagram length that is given in the IP header (IPv4), or directly taken from the IP header (IPv6). The protocol field is the corresponding value from the IP header. The Zero fields are all zeroes.

For IPv6, the complete 128-bit addresses are considered. The next header value identifies the upper layer protocol as either TCP or UDP. It may differ from the next header value of the IPv6 header if extension headers are inserted before the protocol header.

The checksum calculation uses 16-bit words in network byte order: The first byte sent/received is the MSB, and the second byte sent/received is the LSB of the 16-bit value to add to the checksum. If the frame ends on an odd number of bytes, a zero byte is appended for checksum calculation only, and is not actually transmitted.

22.6.8.2 Additional padding processing

According to IEEE 802.3, any Ethernet frame must have a minimum length of 64 octets.

The MAC usually removes padding on receive when a frame with length information is received. Because IP frames have a type value instead of length, the MAC does not remove padding for short IP frames, as it is not aware of the frame contents.

The IP accelerator function can be configured to remove the Ethernet padding bytes that might follow the IP datagram.

On transmit, the MAC automatically adds padding as necessary to fill any frame to a 64-byte length.

22.6.8.3 32-bit Ethernet payload alignment

The data FIFOs allow inserting two additional arbitrary bytes in front of a frame. This extends the 14-byte Ethernet header to a 16-byte header, which leads to alignment of the Ethernet payload, following the Ethernet header, on a 32-bit boundary.

This function can be enabled for transmit and receive independently with the corresponding SHIFT16 bits in the ENET_n_TACC and ENET_n_RACC registers.

When enabled, the valid frame data is arranged as shown in [Table 22-28](#).

Table 22-28. 64-bit interface data structure with SHIFT16 enabled

63	56	55	48	47	40	39	32	31	24	23	16	15	8	7	0
----	----	----	----	----	----	----	----	----	----	----	----	----	---	---	---

Table continues on the next page...

Table 22-28. 64-bit interface data structure with SHIFT16 enabled (continued)

Byte 5	Byte 4	Byte 3	Byte 2	Byte 1	Byte 0	Any value	Any value
Byte 13	Byte 12	Byte 11	Byte 10	Byte 9	Byte 8	Byte 7	Byte 6
...							

22.6.8.3.1 Receive processing

When `ENETn_RACC[SHIFT16]` is set, each frame is received with two additional bytes in front of the frame.

The user application must ignore these first two bytes and find the first byte of the frame in bits 23–16 of the first word from the RX FIFO.

Note

SHIFT16 must be set during initialization and kept set during the complete operation, because it influences the FIFO write behavior.

22.6.8.3.2 Transmit processing

When `ENETn_TACC[SHIFT16]` is set, the first two bytes of the first word written (bits 15–0) are discarded immediately by the FIFO write logic.

The SHIFT16 bit can be enabled/disabled for each frame individually if required, but can be changed only between frames.

22.6.8.4 Received frame discard

Because the receive FIFO must be operated in store and forward mode (`ENETn_RSFL` cleared), received frames can be discarded based on the following errors:

- The MAC function receives the frame with an error:
 - The frame has an invalid payload length
 - Frame length is greater than `MAX_FL`
 - Frame received with a CRC-32 error
 - Frame truncated due to receive FIFO overflow
 - Frame is corrupted as PHY signaled an error (`RX_ERR` asserted during reception)

- An IP frame is detected and the IP header checksum is wrong
- An IP frame with a valid IP header and a valid IP header checksum is detected, the protocol is known but the protocol-specific checksum is wrong

If one of the errors occurs and the IP accelerator function is configured to discard frames (ENET n _RACC), the frame is automatically discarded. Statistics are maintained normally and are not affected by this discard function.

22.6.8.5 IPv4 fragments

When an IPv4 IP fragment frame is received, only the IP header is inspected and its checksum verified. 32-bit alignment operates the same way on fragments as it does on normal IP frames, as specified above.

The IP fragment frame payload is not inspected for any protocol headers. As such, a protocol header would only exist in the very first fragment. To assist in protocol-specific checksum verification, the one's-complement sum is calculated on the IP payload (all bytes following the IP header) and provided with the frame status word.

The frame fragment status field (RxB D [FRAG]) is set to indicate a fragment reception, and the one's-complement sum of the IP payload is available in RxB D [Payload checksum].

Note

After all fragments have been received and reassembled, the application software can take advantage of the payload checksum delivered with the frame's status word to calculate the protocol-specific checksum of the datagram.

For example, if a TCP payload is delivered by multiple IP fragments, the application software can calculate the pseudo-header checksum value from the first fragment, and add the payload checksums delivered with the status for all fragments to verify the TCP datagram checksum.

22.6.8.6 IPv6 support

The following sections describe the IPv6 support.

22.6.8.6.1 Receive processing

An Ethernet frame of type 0x86DD identifies an IP Version 6 frame (IPv6) frame. If an IPv6 frame is received, the first IP header is inspected (first ten words), which is available in every IPv6 frame.

If the receive SHIFT16 function is enabled, the IP header is aligned on a 32-bit boundary allowing more efficient processing (see [32-bit Ethernet payload alignment](#)).

For TCP and UDP datagrams, the pseudo-header checksum calculation is performed and verified.

To assist in protocol-specific checksum verification, the one's-complement sum is always calculated on the IP payload (all bytes following the IP header) and provided with the frame status word. For example, if extension headers were present, their sums can be subtracted in software from the checksum to isolate the TCP/UDP datagram checksum, if required.

22.6.8.6.2 Transmit processing

For IPv6 transmission, the SHIFT16 function is supported to process 32-bit aligned datagrams.

IPv6 has no IP header checksum; therefore, the IP checksum insertion configuration is ignored.

The protocol checksum is inserted only if the next header of the IP header is a known protocol (TCP, UDP, or ICMP). If a known protocol is detected, the checksum over all bytes following the IP header is calculated and inserted in the correct position.

The pseudo-header checksum calculation is performed for TCP and UDP datagrams accordingly.

22.6.9 Resets and stop controls

The following sections describe the resets and stop controls.

22.6.9.1 Hardware reset

To reset the Ethernet module, set ENET n _ECR[RESET].

22.6.9.2 Soft reset

When ENET n _ECR[ETHER_EN] is cleared during operation, the following occurs:

- uDMA, buffer descriptor, and FIFO control logic are reset, including the buffer descriptor and FIFO pointers.
- A currently ongoing transmit is terminated by asserting TXER to the PHY.
- A currently ongoing transmit FIFO write from the application is terminated by stopping the write to the FIFO, and all further data from the application is ignored. All subsequent writes are ignored until re-enabled.
- A currently ongoing receive FIFO read is terminated. The RxB D has arbitrary values in this case.

22.6.9.3 Hardware freeze

When the processor enters debug mode and ECR[DBGEN] is set, the MAC enters a freeze state where it stops all transmit and receive activities gracefully.

The following happens when the MAC enters hardware freeze:

- A currently ongoing receive transaction on the receive application interface is completed as normal. No further frames are read from the FIFO.
- A currently ongoing transmit transaction on the transmit application interface is completed as normal (in other words, until writing end-of-packet (EOP)).
- A currently ongoing frame receive is completed normally, after which no further frames are accepted from the MII.
- A currently ongoing frame transmit is completed normally, after which no further frames are transmitted.

22.6.9.4 Graceful stop

During a graceful stop, any currently ongoing transactions are completed normally and no further frames are accepted. The MAC can resume from a graceful stop without the need for a reset (for example, clearing ETHER_EN is not required).

The following conditions lead to a graceful stop of the MAC transmit or receive datapaths.

22.6.9.4.1 Graceful transmit stop (GTS)

When gracefully stopped, the MAC is no longer reading frame data from the transmit FIFO and has completed any ongoing transmission.

In any of the following conditions, the transmit datapath stops after an ongoing frame transmission has been completed normally.

- ENET n _TCR[GTS] is set by software.
- ENET n _TCR[TFC_PAUSE] is set by software requesting a pause frame transmission. The status (and register bit) is cleared after the pause frame has been sent.
- A pause frame was received stopping the transmitter. The stopped situation is terminated when the pause timer expires or a pause frame with zero quanta is received.
- MAC is placed in Sleep mode by software or the processor entering Stop mode (see [Sleep mode](#)).
- The MAC is in Hardware Freeze mode.

When the transmitter has reached its stopped state, the following events occur:

- The GRA interrupt is asserted, when transitioned into stopped.
- In Hardware Freeze mode, the GRA interrupt does not wait for the application write completion and asserts when the transmit state machine (in other words, line side of TX FIFO) reaches its stopped state.

22.6.9.4.2 Graceful receive stop (GRS)

When gracefully stopped, the MAC is no longer writing frames into the receive FIFO.

The receive datapath stops after any ongoing frame reception has been completed normally, if any of the following conditions occur:

- MAC is placed in Sleep mode either by the software or the processor is in Stop mode). The MAC continues to receive frames and search for magic packets if enabled (see [Magic packet detection](#)). However, no frames are written into the receive FIFO, and therefore are not forwarded to the application.
- The MAC is in Hardware Freeze mode. The MAC does not accept any frames from the MII.

When the receive datapath is stopped, the following events occur:

- If the RX is in the stopped state, RCR[GRS] is set
- The GRA interrupt is asserted when the transmitter and receiver are stopped
- Any ongoing receive transaction to the application (RX FIFO read) continues normally until the frame end of package (EOP) is reached. After this, the following occurs:
 - When Sleep mode is active, all further frames are discarded, flushing the RX FIFO
 - In Hardware Freeze mode, no further frames are delivered to the application and they stay in the receive FIFO.

Note

The assertion of GRS does not wait for an ongoing FIFO read transaction on the application side of the FIFO (FIFO read).

22.6.9.4.3 Graceful stop interrupt (GRA)

The graceful stopped interrupt (GRA) is asserted for the following conditions:

- In Sleep mode, the interrupt asserts only after both TX and RX datapaths are stopped.
- In Hardware Freeze mode, the interrupt asserts only after both TX and RX datapaths are stopped.
- The MAC transmit datapath is stopped for any other condition (GTS, TFC_PAUSE, pause received).

The GRA interrupt is triggered only once when the stopped state is entered. If the interrupt is cleared while the stop condition persists, no further interrupt is triggered.

22.6.10 IEEE 1588 functions

To allow for IEEE 1588 or similar time synchronization protocol implementations, the MAC is combined with a time-stamping module to support precise time-stamping of incoming and outgoing frames. Set `ENETn_ECR[EN1588]` to enable 1588 support.

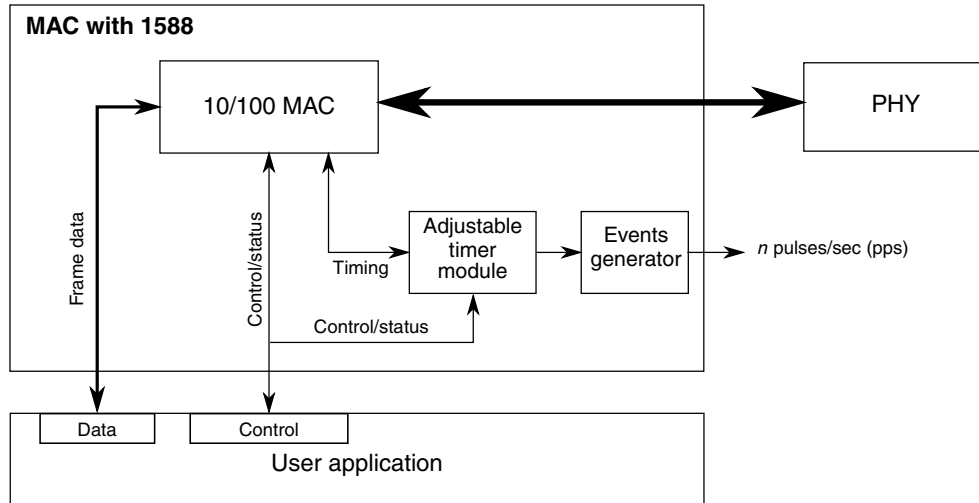

Figure 22-9. IEEE 1588 functions overview

22.6.10.1 Adjustable timer module

The adjustable timer module (TSM) implements the free-running counter (FRC), which generates the timestamps. The FRC operates with the time-stamping clock, which can be set to any value depending on your system requirements.

Through dedicated correction logic, the timer can be adjusted to allow synchronization to a remote master and provide a synchronized timing reference to the local system. The timer can be configured to cause an interrupt after a fixed time period, to allow synchronization of software timers or perform other synchronized system functions.

The timer is typically used to implement a period of one second; hence, its value ranges from 0 to $(1 \times 10^9) - 1$. The period event can trigger an interrupt, and software can maintain the seconds and hours time values as necessary.

22.6.10.1.1 Adjustable timer implementation

The adjustable timer consists of a programmable counter/accumulator and a correction counter. The periods of both counters and their increment rates are freely configurable, allowing very fine tuning of the timer.

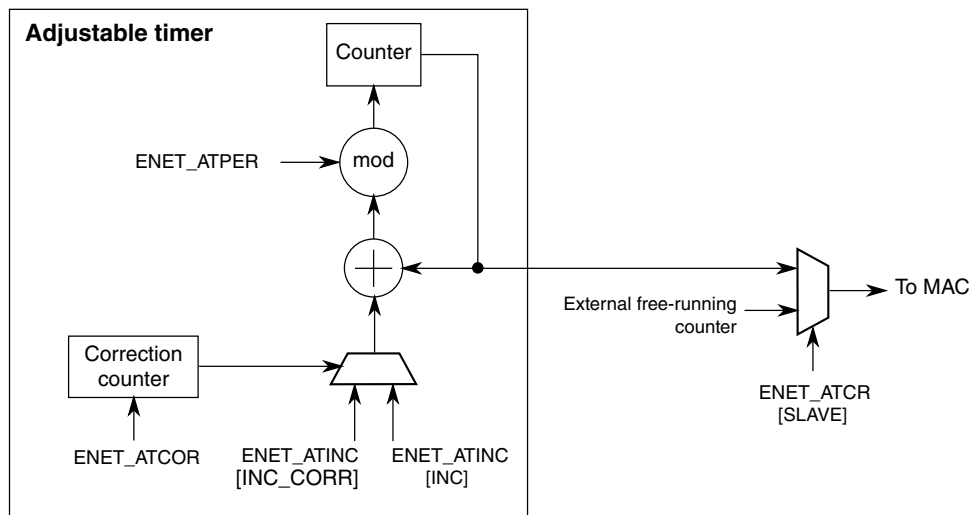

Figure 22-10. Adjustable timer implementation detail

The counter produces the current time. During each time-stamping clock cycle, a constant value is added to the current time as programmed in $ENET_n_ATINC$. The value depends on the chosen time-stamping clock frequency. For example, if it operates at 125 MHz, setting the increment to eight represents 8 ns.

The period, configured in $ENET_n_ATPER$, defines the modulo when the counter wraps. In a typical implementation, the period is set to 1×10^9 so that the counter wraps every second, and hence all timestamps represent the absolute nanoseconds within the one second period. When the period is reached, the counter wraps to start again respecting the period modulo. This means it does not necessarily start from zero, but instead the counter is loaded with the value $(Current + Inc - (1 \times 10^9))$, assuming the period is set to 1×10^9 .

The correction counter operates fully independently, and increments by one with each time-stamping clock cycle. When it reaches the value configured in $ENET_n_ATCOR$, it restarts and instructs the timer once to increment by the correction value, instead of the normal value.

The normal and correction increments are configured in $ENET_n_ATINC$. To speed up the timer, set the correction increment more than the normal increment value. To slow down the timer, set the correction increment less than the normal increment value.

The correction counter only defines the distance of the corrective actions, not the amount. This allows very fine corrections and low jitter (in the range of 1 ns) independent of the chosen clock frequency.

By enabling slave mode ($ENET_n_ATCR[SLAVE] = 1$), the timer is ignored and the current time is externally provided from one of the external modules. See the Chip Configuration details for which clock source is used. This is useful if multiple modules

within the system must operate from a single timer. When slave mode is enabled, you still must set ENET n _ATINC[INC] to the value of the master, since it is used for internal comparisons.

22.6.10.2 Transmit timestamping

Only 1588 event frames need to be time-stamped on transmit. The client application (for example, the MAC driver) should detect 1588 event frames and set TxBD[TS] together with the frame.

If TxBD[TS] is set, the MAC records the timestamp for the frame in ENET n _ATSTMP. ENET n _EIR[TS_AVAIL] is set to indicate that a new timestamp is available.

Software implements a handshaking procedure by setting TxBD[TS] when it transmits the frame for which a timestamp is needed, and then waits for ENET n _EIR[TS_AVAIL] to determine when the timestamp is available. The timestamp is then read from ENET n _ATSTMP. This is done for all event frames. Other frames do not use TxBD[TS] and, therefore, do not interfere with the timestamp capture.

22.6.10.3 Receive timestamping

When a frame is received, the MAC latches the value of the timer when the frame's start of frame delimiter (SFD) field is detected, and provides the captured timestamp on RxBD[1588 timestamp]. This is done for all received frames.

22.6.10.4 Time synchronization

The adjustable timer module is available to synchronize the local clock of a node to a remote master. It implements a free running 32-bit counter, and also contains an additional correction counter.

The correction counter increases or decreases the rate of the free running counter, enabling very fine granular changes of the timer for synchronization, yet adding only very low jitter when performing corrections.

The application software implements, in a slave scenario, the required control algorithm, setting the correction to compensate for local oscillator drifts and locking the timer to the remote master clock on the network.

The timer and all timestamp-related information should be configured to show the true nanoseconds value of a second (in other words, the timer is configured to have a period of one second). Hence, the values range from 0 to $(1 \times 10^9) - 1$. In this application, the seconds counter is implemented in software using an interrupt function that is executed when the nanoseconds counter wraps at 1×10^9 .

22.6.10.5 Input Capture and Output Compare

The Input Capture Output Compare block can be used to provide precise hardware timing for input and output events.

22.6.10.5.1 Input capture

The $TCCR_n$ capture registers latch the time value when the corresponding external event occurs. An event can be a rising-, falling-, or either-edge of one of the 1588_TMR_n signals. An event will cause the corresponding $TCSR_n[TF]$ timer flag to be set, indicating that an input capture has occurred. If the corresponding interrupt is enabled with the $TCSR_n[TIE]$ field, an interrupt can be generated.

22.6.10.5.2 Output compare

The $TCCR_n$ compare registers are loaded with the time at which the corresponding event should occur. When the ENET free-running counter value matches the output compare reference value in the $TCCR_n$ register, the corresponding flag, $TCSR_n[TF]$, is set, indicating that an output compare has occurred. The corresponding interrupt, if enabled by $TCSR_n[TIE]$, will be generated. The corresponding 1588_TMR_n output signal will be asserted according to $TCSR_n[TMODE]$.

22.6.10.5.3 DMA requests

A DMA request can be enabled by setting $TCSR_n[TDRE]$. The corresponding DMA request is generated when the $TCSR_n[TF]$ timer flag is set. When the DMA has completed, the corresponding $TCSR_n[TF]$ flag is cleared.

22.6.11 FIFO thresholds

The core FIFO thresholds are fully programmable to dynamically change the FIFO operation.

For example, store and forward transfer can be enabled by a simple change in the FIFO threshold registers.

The thresholds are defined in 64-bit words.

The receive and transmit FIFOs both have a depth of 256 words.

22.6.11.1 Receive FIFO

Four programmable thresholds are available, which can be set to any value to control the core operation as follows.

Table 22-29. Receive FIFO thresholds definition

Register	Description
ENET n _RSFL [RX_SECTION_F ULL]	<p>When the FIFO level reaches the ENETn_RSFL value, the MAC status signal is asserted to indicate that data is available in the receive FIFO (cut-through operation). Once asserted, if the FIFO empties below the threshold set with ENETn_RAEM and if the end-of-frame is not yet stored in the FIFO, the status signal is deasserted again.</p> <p>If a frame has a size smaller than the threshold (in other words, an end-of-frame is available for the frame), the status is also asserted.</p> <p>To enable store and forward on the receive path, clear ENETn_RSFL. The MAC status signal is asserted only when a complete frame is stored in the receive FIFO.</p> <p>When programming a non-zero value to ENETn_RSFL (cut-through operation) it should be greater than ENETn_RAEM.</p>
ENET n _RAEM [RX_ALMOST_E MPTY]	<p>When the FIFO level reaches the ENETn_RAEM value, and the end-of-frame has not been received, the core receive read control stops the FIFO read (and subsequently stops transferring data to the MAC client application).</p> <p>It continues to deliver the frame, if again more data than the threshold or the end-of-frame is available in the FIFO.</p> <p>Set ENETn_RAEM to a minimum of six.</p>
ENET n _RAFL [RX_ALMOST_F ULL]	<p>When the FIFO level approaches the maximum and there is no more space remaining for at least ENETn_RAFL number of words, the MAC control logic stops writing data in the FIFO and truncates the receive frame to avoid FIFO overflow.</p> <p>The corresponding error status is set when the frame is delivered to the application.</p> <p>Set ENETn_RAFL to a minimum of 4.</p>
ENET n _RSEM [RX_SECTION_E MPTY]	<p>When the FIFO level reaches the ENETn_RSEM value, an indication is sent to the MAC transmit logic, which generates an XOFF pause frame. This indicates FIFO congestion to the remote Ethernet client.</p> <p>When the FIFO level goes below the value programmed in ENETn_RSEM, an indication is sent to the MAC transmit logic, which generates an XON pause frame. This indicates the FIFO congestion is cleared to the remote Ethernet client.</p> <p>Clearing ENETn_RSEM disables any pause frame generation.</p>

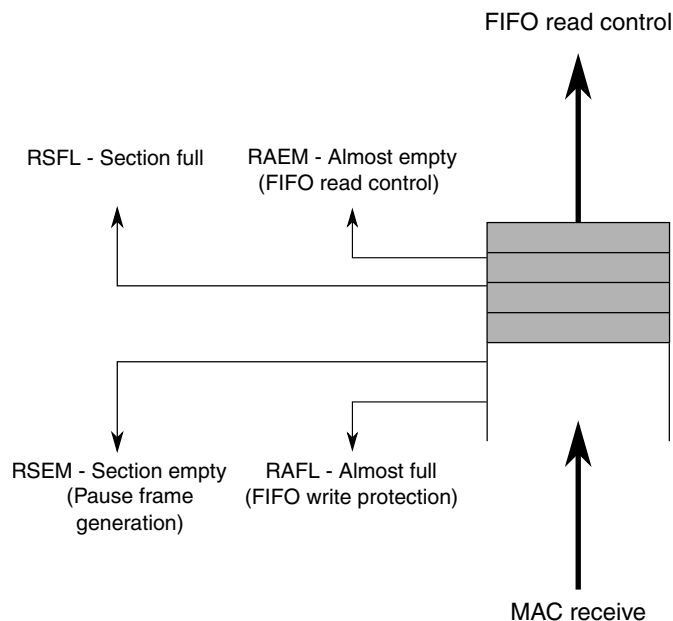

Figure 22-11. Receive FIFO overview

22.6.11.2 Transmit FIFO

Four programmable thresholds are available which control the core operation as described below.

Table 22-30. Transmit FIFO thresholds definition

Register	Description
ENET _n _TAEM [TX_ALMOST_EMPTY]	When the FIFO level reaches the ENET _n _TAEM value and no end-of-frame is available for the frame, the MAC transmit logic avoids a FIFO underflow by stopping FIFO reads and transmitting the Ethernet frame with an MII error indication. Set ENET _n _TAEM to a minimum of 4.
ENET _n _TAFL [TX_ALMOST_FULL]	When the FIFO level approaches the maximum, so that there is no more space for at least ENET _n _TAFL number of words, the MAC deasserts its control signal to the application. If the application does not react on this signal, the FIFO write control logic avoids FIFO overflow by truncating the current frame and setting the error status. As a result, the frame is transmitted with an MII error indication. Set ENET _n _TAFL to a minimum of 4. Larger values allow more latency for the application to react on the MAC control signal deassertion, before the frame is truncated. A typical setting is 8, which offers 3–4 clock cycles of latency to the application to react on the MAC control signal deassertion.
ENET _n _TSEM [TX_SECTION_EMPTY]	When the FIFO level reaches the ENET _n _TSEM value, a MAC status signal is deasserted to indicate that the transmit FIFO is getting full. This gives the ENET module an indication to slow or stop its write transaction to avoid a buffer overflow. This is a pure indication function to the application. It has no effect within the MAC. When ENET _n _TSEM is 0, the signal is never deasserted.
ENET _n _TFWR	When the FIFO level reaches the ENET _n _TFWR value and when STRFWD is cleared, the MAC transmit control logic starts frame transmission before the end-of-frame is available in the FIFO (cut-through operation).

Table 22-30. Transmit FIFO thresholds definition

Register	Description
	<p>If a complete frame has a size smaller than the ENET_n_TFWR threshold, the MAC also transmits the frame to the line.</p> <p>To enable store and forward on the transmit path, set STRFWD. In this case, the MAC starts to transmit data only when a complete frame is stored in the transmit FIFO.</p>

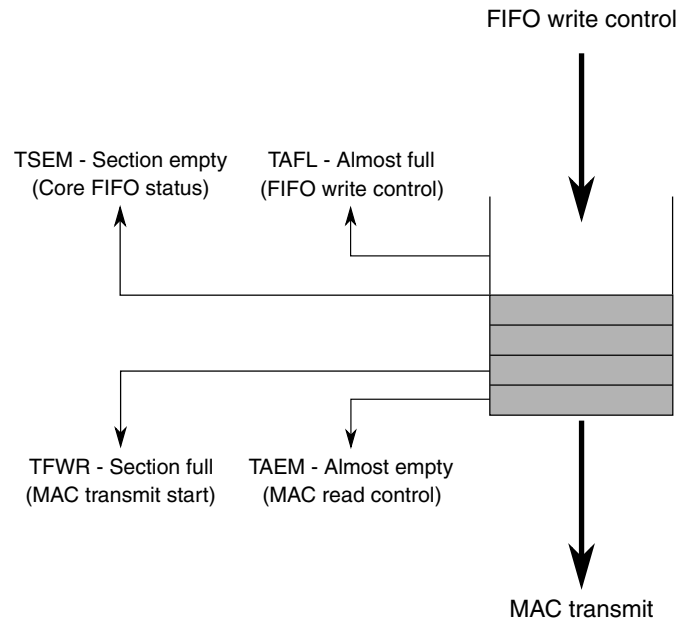
**Figure 22-12. Transmit FIFO overview**

22.6.12 Loopback options

The core implements external and internal loopback options, which are controlled by the ENET_n_RCR register fields found here.

The core implements external and internal loopback options, which are controlled by the following ENET_n_RCR register fields:

Table 22-31. Loopback options

Register field	Description
LOOP	<p>Internal MII loopback. The MAC transmit is returned to the MAC receive. No data is transmitted to the external interfaces.</p> <p>In MII internal loopback, MII_TXCLK and MII_RXCLK must be provided with a clock signal (2.5 MHz for 10 Mbit/s, and 25 MHz for 100 Mbit/s)</p>

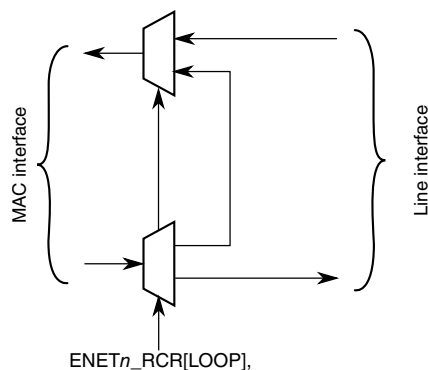

Figure 22-13. Loopback options

22.6.13 Legacy buffer descriptors

To support the Ethernet controller on previous chips, legacy FEC buffer descriptors are available. To enable legacy support, write 0 to ENETn_ECR[1588EN].

NOTE

- The legacy buffer descriptor tables show the byte order for little-endian chips. **DBSWP** must be set to 1 after reset to enable little-endian mode.

22.6.13.1 Legacy receive buffer descriptor

The following table shows the legacy FEC receive buffer descriptor. [Table 22-35](#) contains the descriptions for each field.

Table 22-32. Legacy FEC receive buffer descriptor (RxBD)

	Byte 1								Byte 0							
	15	14	13	12	11	10	9	8	7	6	5	4	3	2	1	0
Offset + 0	Data length															
Offset + 2	E	RO1	W	RO2	L	—	—	M	BC	MC	LG	NO	—	CR	OV	TR
Offset + 4	Rx data buffer pointer — low halfword															
Offset + 6	Rx data buffer pointer — high halfword															

22.6.13.2 Legacy transmit buffer descriptor

The following table shows the legacy FEC transmit buffer descriptor. [Table 22-37](#) contains the descriptions for each field.

Table 22-33. Legacy FEC transmit buffer descriptor (TxBD)

	Byte 1								Byte 0							
	15	14	13	12	11	10	9	8	7	6	5	4	3	2	1	0
Offset + 0	Data Length															
Offset + 2	R	TO1	W	TO2	L	TC	ABC ¹	—	—	—	—	—	—	—	—	—
Offset + 4	Tx Data Buffer Pointer — low halfword															
Offset + 6	Tx Data Buffer Pointer — high halfword															

1. This field is not supported by the uDMA.

22.6.14 Enhanced buffer descriptors

This section provides a description of the enhanced operation of the driver/uDMA via the buffer descriptors.

It is followed by a detailed description of the receive and transmit descriptor fields. To enable the enhanced features, set ENET_n_ECR[1588EN].

NOTE

The enhanced buffer descriptor tables show the byte order for little-endian chips. [DBSWP](#) must be set to 1 after reset to enable little-endian mode.

22.6.14.1 Enhanced receive buffer descriptor

The following table shows the enhanced uDMA receive buffer descriptor. [Table 22-35](#) contains the descriptions for each field.

Table 22-34. Enhanced uDMA receive buffer descriptor (RxBD)

	Byte 1								Byte 0							
	15	14	13	12	11	10	9	8	7	6	5	4	3	2	1	0
Offset + 0	Data length															
Offset + 2	E	RO1	W	RO2	L	—	—	M	BC	MC	LG	NO	—	CR	OV	TR
Offset + 4	Rx data buffer pointer – low halfword															
Offset + 6	Rx data buffer pointer – high halfword															

Table continues on the next page...

Table 22-34. Enhanced uDMA receive buffer descriptor (RxBD) (continued)

Offset + 8	VPCP		—	—	—	—	—	—	—	ICE	PCR	—	VLAN	IPV6	FRA
Offset + A	ME	—	—	—	—	PE	CE	UC	INT	—	—	—	—	—	—
Offset + C	Payload checksum														
Offset + E	Header length					—	—	—	Protocol type						
Offset + 10	—	—	—	—	—	—	—	—	—	—	—	—	—	—	—
Offset + 12	BDU	—	—	—	—	—	—	—	—	—	—	—	—	—	—
Offset + 14	1588 timestamp – low halfword														
Offset + 16	1588 timestamp – high halfword														
Offset + 18	—	—	—	—	—	—	—	—	—	—	—	—	—	—	—
Offset + 1A	—	—	—	—	—	—	—	—	—	—	—	—	—	—	—
Offset + 1C	—	—	—	—	—	—	—	—	—	—	—	—	—	—	—
Offset + 1E	—	—	—	—	—	—	—	—	—	—	—	—	—	—	—

Table 22-35. Receive buffer descriptor field definitions

Word	Field	Description
Offset + 0	15–0 Data Length	Data length. Written by the MAC. Data length is the number of octets written by the MAC into this BD's data buffer if L is cleared (the value is equal to EMRBR), or the length of the frame including CRC if L is set. It is written by the MAC once as the BD is closed.
Offset + 2	15 E	Empty. Written by the MAC (= 0) and user (= 1). 0 The data buffer associated with this BD is filled with received data, or data reception has aborted due to an error condition. The status and length fields have been updated as required. 1 The data buffer associated with this BD is empty, or reception is currently in progress.
Offset + 2	14 RO1	Receive software ownership. This field is reserved for use by software. This read/write field is not modified by hardware, nor does its value affect hardware.
Offset + 2	13 W	Wrap. Written by user. 0 The next buffer descriptor is found in the consecutive location. 1 The next buffer descriptor is found at the location defined in ENET _n _RDSR.
Offset + 2	12 RO2	Receive software ownership. This field is reserved for use by software. This read/write field is not modified by hardware, nor does its value affect hardware.
Offset + 2	11 L	Last in frame. Written by the uDMA. 0 The buffer is not the last in a frame. 1 The buffer is the last in a frame.
Offset + 2	10–9	Reserved, must be cleared.
Offset + 2	8 M	Miss. Written by the MAC. This field is set by the MAC for frames accepted in promiscuous mode, but flagged as a miss by the internal address recognition. Therefore, while in promiscuous mode, you can use this field to quickly determine whether the frame was destined to this station. This field is valid only if the L and PROM bits are set. 0 The frame was received because of an address recognition hit. 1 The frame was received because of promiscuous mode.

Table continues on the next page...

Table 22-35. Receive buffer descriptor field definitions (continued)

Word	Field	Description
		The information needed for this field comes from the promiscuous_miss(ff_rx_err_stat[26]) sideband signal.
Offset + 2	7 BC	Set if the DA is broadcast (FFFF_FFFF_FFFF).
Offset + 2	6 MC	Set if the DA is multicast and not BC.
Offset + 2	5 LG	Receive frame length violation. Written by the MAC. A frame length greater than RCR[MAX_FL] was recognized. This field is valid only if the L field is set. The receive data is not altered in any way unless the length exceeds TRUNC_FL bytes.
Offset + 2	4 NO	Receive non-octet aligned frame. Written by the MAC. A frame that contained a number of bits not divisible by 8 was received, and the CRC check that occurred at the preceding byte boundary generated an error or a PHY error occurred. This field is valid only if the L field is set. If this field is set, the CR field is not set.
Offset + 2	3	Reserved, must be cleared.
Offset + 2	2 CR	Receive CRC or frame error. Written by the MAC. This frame contains a PHY or CRC error and is an integral number of octets in length. This field is valid only if the L field is set.
Offset + 2	1 OV	Overflow. Written by the MAC. A receive FIFO overrun occurred during frame reception. If this field is set, the other status fields, M, LG, NO, and CR, lose their normal meaning and are zero. This field is valid only if the L field is set.
Offset + 2	0 TR	Set if the receive frame is truncated (frame length >TRUNC_FL). If the TR field is set, the frame must be discarded and the other error fields must be ignored because they may be incorrect.
Offset + 4	15–0 Data buffer pointer low	Receive data buffer pointer, low halfword
Offset + 6	15–0 Data buffer pointer high	Receive data buffer pointer, high halfword ¹
Offset + 8	15–13 VPCP	VLAN priority code point. This field is written by the uDMA to indicate the frame priority level. Valid values are from 0 (best effort) to 7 (highest). This value can be used to prioritize different classes of traffic (e.g., voice, video, data). This field is only valid if the L field is set.
Offset + 8	12–6	Reserved, must be cleared.
Offset + 8	5 ICE	IP header checksum error. This is an accelerator option. This field is written by the uDMA. Set when either a non-IP frame is received or the IP header checksum was invalid. An IP frame with less than 3 bytes of payload is considered to be an invalid IP frame. This field is only valid if the L field is set.
Offset + 8	4 PCR	Protocol checksum error. This is an accelerator option. This field is written by the uDMA. Set when the checksum of the protocol is invalid or an unknown protocol is found and checksumming could not be performed. This field is only valid if the L field is set.
Offset + 8	3	Reserved, must be cleared.
Offset + 8	2 VLAN	VLAN. This is an accelerator option. This field is written by the uDMA. It means that the frame has a VLAN tag. This field is valid only if the L field is set.

Table continues on the next page...

Table 22-35. Receive buffer descriptor field definitions (continued)

Word	Field	Description
Offset + 8	1 IPV6	IPV6 Frame. This field is written by the uDMA. This field indicates that the frame has an IPv6 frame type. If this field is not set it means that an IPv4 or other protocol frame was received. This field is valid only if the L field is set.
Offset + 8	0 FRAG	IPv4 Fragment. This is an accelerator option. This field is written by the uDMA. It indicates that the frame is an IPv4 fragment frame. This field is only valid when the L field is set.
Offset + A	15 ME	MAC error. This field is written by the uDMA. This field means that the frame stored in the system memory was received with an error (typically, a receive FIFO overflow). This field is only valid when the L field is set.
Offset + A	14–11	Reserved, must be cleared.
Offset + A	10 PE	PHY Error. This field is written by the uDMA. Set to "1" when the frame was received with an Error character on the PHY interface. The frame is invalid. This field is valid only when the L field is set.
Offset + A	9 CE	Collision. This field is written by the uDMA. Set when the frame was received with a collision detected during reception. The frame is invalid and sent to the user application. This field is valid only when the L field is set.
Offset + A	8 UC	Unicast. This field is written by the uDMA, and means that the frame is unicast. This field is valid regardless of whether the L field is set.
Offset + A	7 INT	Generate RXB/RXF interrupt. This field is set by the user to indicate that the uDMA is to generate an interrupt on the <i>dma_int_rxb / dma_int_rxfevent</i> .
Offset + A	6–0	Reserved, must be cleared.
Offset + C	15–0 Payload checksum	Internet payload checksum. This is an accelerator option. It is the one's complement sum of the payload section of the IP frame. The sum is calculated over all data following the IP header until the end of the IP payload. This field is valid only when the L field is set.
Offset + E	15–11 Header length	Header length. This is an accelerator option. This field is written by the uDMA. This field is the sum of 32-bit words found within the IP and its following protocol headers. If an IP datagram with an unknown protocol is found, then the value is the length of the IP header. If no IP frame or an erroneous IP header is found, the value is 0. The following values are minimum values if no header options exist in the respective headers: <ul style="list-style-type: none"> • ICMP/IP: 6 (5 IP header, 1 ICMP header) • UDP/IP: 7 (5 IP header, 2 UDP header) • TCP/IP: 10 (5 IP header, 5 TCP header) This field is only valid if the L field is set.
Offset + E	10–8	Reserved, must be cleared.
Offset + E	7–0 Protocol type	Protocol type. This is an accelerator option. The 8-bit protocol field found within the IP header of the frame. It is valid only when ICE is cleared. This field is valid only when the L field is set.
Offset + 10	15–0	Reserved, must be cleared.
Offset + 12	15 BDU	Last buffer descriptor update done. Indicates that the last BD data has been updated by uDMA. This field is written by the user (=0) and uDMA (=1).
Offset + 12	14–0	Reserved, must be cleared.
Offset + 14	15–0	This value is written by the uDMA. It is only valid if the L field is set.
Offset + 16		

Table continues on the next page...

Table 22-35. Receive buffer descriptor field definitions (continued)

Word	Field	Description
	1588 timestamp	
Offset + 18 – Offset + 1E	15–0	Reserved, must be cleared.

- The receive buffer pointer, containing the address of the associated data buffer, must always be evenly divisible by 64. The buffer must reside in memory external to the MAC. The Ethernet controller never modifies this value.

22.6.14.2 Enhanced transmit buffer descriptor

Table 22-36. Enhanced transmit buffer descriptor (TxBD)

	Byte 1								Byte 0							
	15	14	13	12	11	10	9	8	7	6	5	4	3	2	1	0
Offset + 0	Data length															
Offset + 2	R	TO1	W	TO2	L	TC	—	—	—	—	—	—	—	—	—	—
Offset + 4	Tx Data Buffer Pointer – low halfword															
Offset + 6	Tx Data Buffer Pointer – high halfword															
Offset + 8	TXE	—	UE	EE	FE	LCE	OE	TSE	—	—	—	—	—	—	—	—
Offset + A	—	INT	TS	PINS	IINS	—	—	—	—	—	—	—	—	—	—	—
Offset + C	—	—	—	—	—	—	—	—	—	—	—	—	—	—	—	—
Offset + E	—	—	—	—	—	—	—	—	—	—	—	—	—	—	—	—
Offset + 10	—	—	—	—	—	—	—	—	—	—	—	—	—	—	—	—
Offset + 12	BDU	—	—	—	—	—	—	—	—	—	—	—	—	—	—	—
Offset + 14	1588 timestamp – low halfword															
Offset + 16	1588 timestamp – high halfword															
Offset + 18	—	—	—	—	—	—	—	—	—	—	—	—	—	—	—	—
Offset + 1A	—	—	—	—	—	—	—	—	—	—	—	—	—	—	—	—
Offset + 1C	—	—	—	—	—	—	—	—	—	—	—	—	—	—	—	—
Offset + 1E	—	—	—	—	—	—	—	—	—	—	—	—	—	—	—	—

Table 22-37. Enhanced transmit buffer descriptor field definitions

Word	Field	Description
Offset + 0	15–0 Data Length	Data length, written by user. Data length is the number of octets the MAC should transmit from this BD's data buffer. It is never modified by the MAC.
Offset + 2	15 R	Ready. Written by the MAC and you.

Table continues on the next page...

Table 22-37. Enhanced transmit buffer descriptor field definitions (continued)

Word	Field	Description
		<p>0 The data buffer associated with this BD is not ready for transmission. You are free to manipulate this BD or its associated data buffer. The MAC clears this field after the buffer has been transmitted or after an error condition is encountered.</p> <p>1 The data buffer, prepared for transmission by you, has not been transmitted or currently transmits. You may write no fields of this BD after this field is set.</p>
Offset + 2	14 TO1	Transmit software ownership. This field is reserved for software use. This read/write field is not modified by hardware and its value does not affect hardware.
Offset + 2	13 W	Wrap. Written by user. <p>0 The next buffer descriptor is found in the consecutive location</p> <p>1 The next buffer descriptor is found at the location defined in ETDSR.</p>
Offset + 2	12 TO2	Transmit software ownership. This field is reserved for use by software. This read/write field is not modified by hardware and its value does not affect hardware.
Offset + 2	11 L	Last in frame. Written by user. <p>0 The buffer is not the last in the transmit frame</p> <p>1 The buffer is the last in the transmit frame</p>
Offset + 2	10 TC	Transmit CRC. Written by user, and valid only when L is set. <p>0 End transmission immediately after the last data byte</p> <p>1 Transmit the CRC sequence after the last data byte</p> <p>This field is valid only when the L field is set.</p>
Offset + 2	9 ABC	Append bad CRC. Note: This field is not supported by the uDMA and is ignored.
Offset + 2	8–0	Reserved, must be cleared.
Offset + 4	15–0 Data buffer pointer low	Tx data buffer pointer, low halfword
Offset + 6	15–0 Data buffer pointer high	Tx data buffer pointer, high halfword. The buffer must reside in memory external to the MAC. This value is never modified by the Ethernet controller. NOTE: For optimal performance, make the transmit buffer pointer evenly divisible by 64.
Offset + 8	15 TXE	Transmit error occurred. This field is written by the uDMA. This field indicates that there was a transmit error of some sort reported with the frame. Effectively this field is an OR of the other error fields including UE, EE, FE, LCE, OE, and TSE. This field is valid only when the L field is set.
Offset + 8	14	Reserved, must be cleared.
Offset + 8	13 UE	Underflow error. This field is written by the uDMA. This field indicates that the MAC reported an underflow error on transmit. This field is valid only when the L field is set.
Offset + 8	12 EE	Excess Collision error. This field is written by the uDMA. This field indicates that the MAC reported an excess collision error on transmit. This field is valid only when the L field is set.

Table continues on the next page...

Table 22-37. Enhanced transmit buffer descriptor field definitions (continued)

Word	Field	Description
Offset + 8	11 FE	Frame with error. This field is written by the uDMA. This field indicates that the MAC reported that the uDMA reported an error when providing the packet. This field is valid only when the L field is set.
Offset + 8	10 LCE	Late collision error. This field is written by the uDMA. This field indicates that the MAC reported that there was a Late Collision on transmit. This field is valid only when the L field is set.
Offset + 8	9 OE	Overflow error. This field is written by the uDMA. This field indicates that the MAC reported that there was a FIFO overflow condition on transmit. This field is only valid when the L field is set.
Offset + 8	8 TSE	Timestamp error. This field is written by the uDMA. This field indicates that the MAC reported a different frame type than a timestamp frame. This field is valid only when the L field is set.
Offset + 8	7–0	Reserved, must be cleared.
Offset + A	15	Reserved, must be cleared.
Offset + A	14 INT	Generate interrupt flags. This field is written by the user. This field is valid regardless of the L field and must be the same for all EBD for a given frame. The uDMA does not update this value.
Offset + A	13 TS	Timestamp. This field is written by the user. This indicates that the uDMA is to generate a timestamp frame to the MAC. This field is valid regardless of the L field and must be the same for all EBD for the given frame. The uDMA does not update this value.
Offset + A	12 PINS	Insert protocol specific checksum. This field is written by the user. If set, the MAC's IP accelerator calculates the protocol checksum and overwrites the corresponding checksum field with the calculated value. The checksum field must be cleared by the application generating the frame. The uDMA does not update this value. This field is valid regardless of the L field and must be the same for all EBD for a given frame.
Offset + A	11 IINS	Insert IP header checksum. This field is written by the user. If set, the MAC's IP accelerator calculates the IP header checksum and overwrites the corresponding header field with the calculated value. The checksum field must be cleared by the application generating the frame. The uDMA does not update this value. This field is valid regardless of the L field and must be the same for all EBD for a given frame.
Offset + A	10–0	Reserved, must be cleared.
Offset + C	15–0	Reserved, must be cleared.
Offset + E	15–0	Reserved, must be cleared.
Offset + 10	15–0	Reserved, must be cleared.
Offset + 12	15 BDU	Last buffer descriptor update done. Indicates that the last BD data has been updated by uDMA. This field is written by the user (=0) and uDMA (=1).
Offset + 12	14–0	Reserved, must be cleared.
Offset + 14	15–0	This value is written by the uDMA . It is valid only when the L field is set.
Offset + 16	1588 timestamp	
Offset + 18–Offset + 1E	15–0	Reserved, must be cleared.

22.6.15 Client FIFO application interface

The FIFO interface is completely asynchronous from the Ethernet line, and the transmit and receive interface can operate at a different clock rate.

All transfers to/from the user application are handled independently of the core operation, and the core provides a simple interface to user applications based on a two-signal handshake.

22.6.15.1 Data structure description

The data structure defined in the following tables for the FIFO interface must be respected to ensure proper data transmission on the Ethernet line. Byte 0 is sent to and received from the line first.

Table 22-38. FIFO interface data structure

	63	56 55	48 47	40 39	32 31	24 23	16 15	8 7	0
Word 0	Byte 7	Byte 6	Byte 5	Byte 4	Byte 3	Byte 2	Byte 1	Byte 0	
Word 1	Byte 15	Byte 14	Byte 13	Byte 12	Byte 11	Byte 10	Byte 9	Byte 8	
...	...								

The size of a frame on the FIFO interface may not be a modulo of 64-bit.

The user application may not care about the Ethernet frame formats in full detail. It needs to provide and receive an Ethernet frame with the following structure:

- Ethernet MAC destination address
- Ethernet MAC source address
- Optional 802.1q VLAN tag (VLAN type and info field)
- Ethernet length/type field
- Payload

Frames on the FIFO interface do not contain preamble and SFD fields, which are inserted and discarded by the MAC on transmit and receive, respectively.

- On receive, CRC and frame padding can be stripped or passed through transparently.
- On transmit, padding and CRC can be provided by the user application, or appended automatically by the MAC independently for each frame. No size restrictions apply.

Note

On transmit, if ENET n _TCR[ADDINS] is set, bytes 6–11 of each frame can be set to any value, since the MAC overwrites the bytes with the MAC address programmed in the ENET n _PAUR and ENET n _PALR registers.

Table 22-39. FIFO interface frame format

Byte number	Field
0–5	Destination MAC address
6–11	Source MAC address
12–13	Length/type field
14–N	Payload data

VLAN-tagged frames are supported on both transmit and receive, and implement additional information (VLAN type and info).

Table 22-40. FIFO interface VLAN frame format

Byte number	Field
0–5	Destination MAC address
6–11	Source MAC address
12–15	VLAN tag and info
16–17	Length/type field
18–N	Payload data

Note

The standard defines that the LSB of the MAC address is sent/received first, while for all the other header fields — in other words, length/type, VLAN tag, VLAN info, and pause quanta — the MSB is sent/received first.

22.6.15.2 Data structure examples

Functional description

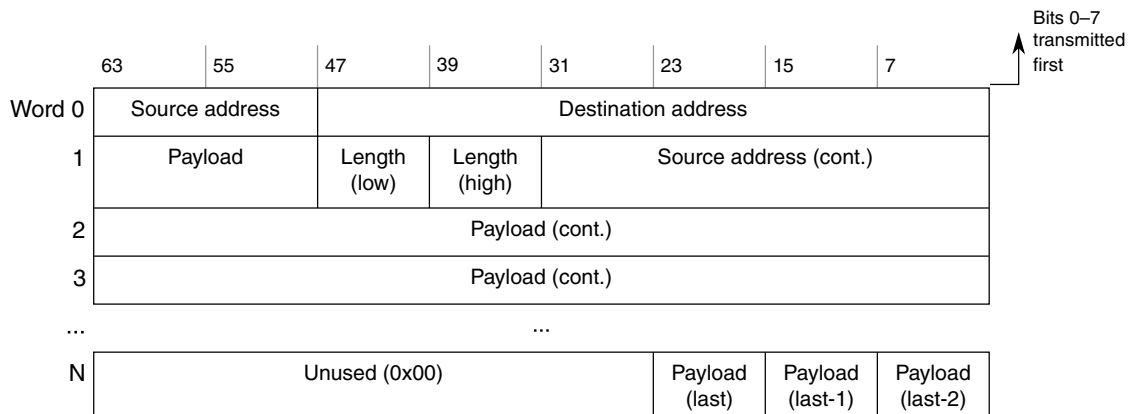

Figure 22-14. Normal Ethernet frame 64-bit mapping example

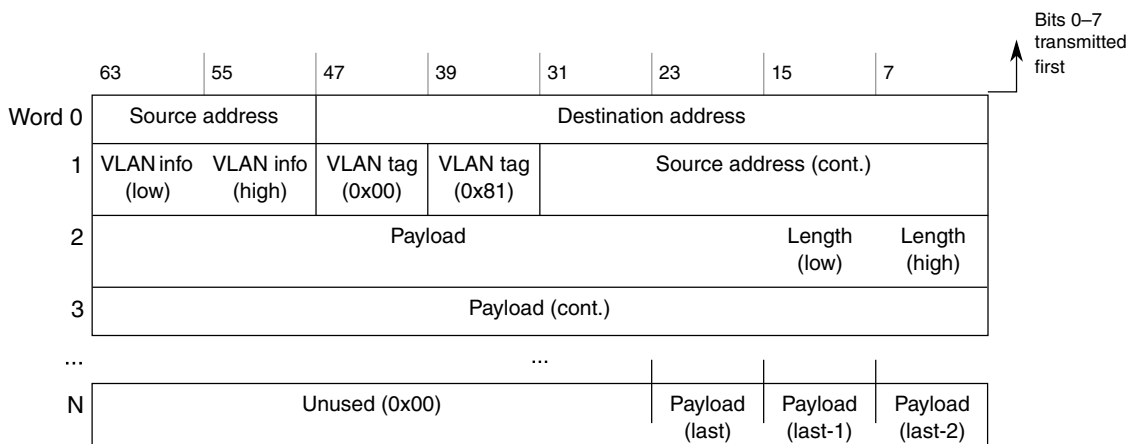

Figure 22-15. VLAN-tagged frame 64-bit mapping example

If CRC forwarding is enabled (CRCFWD = 0), the last four valid octets of the frame contain the FCS field. The non-significant bytes of the last word can have any value.

22.6.15.3 Frame status

A MAC layer status word and an accelerator status word is available in the receive buffer descriptor.

See [Enhanced buffer descriptors](#) for details.

The status is available with each frame with the last data of the frame.

If the frame status contains a MAC layer error (for example, CRC or length error), RxB[ME] is also set with the last data of the frame.

22.6.16 FIFO protection

The following sections describe the FIFO protection mechanisms.

22.6.16.1 Transmit FIFO underflow

During a frame transfer, when the transmit FIFO reaches the almost empty threshold with no end-of-frame indication stored in the FIFO, the MAC logic:

- Stops reading data from the FIFO
- Asserts the MII error signal (MII_TXER) (1 in Figure 22-16) to indicate that the fragment already transferred is not valid
- Deasserts the MII transmit enable signal (MII_TXEN) to terminate the frame transfer (2)

After an underflow, when the application completes the frame transfer (3), the MAC transmit logic discards any new data available in the FIFO until the end of packet is reached (4) and sets the enhanced TxBD[UE] field.

The MAC starts to transfer data on the MII interface when the application sends a new frame with a start of frame indication (5).

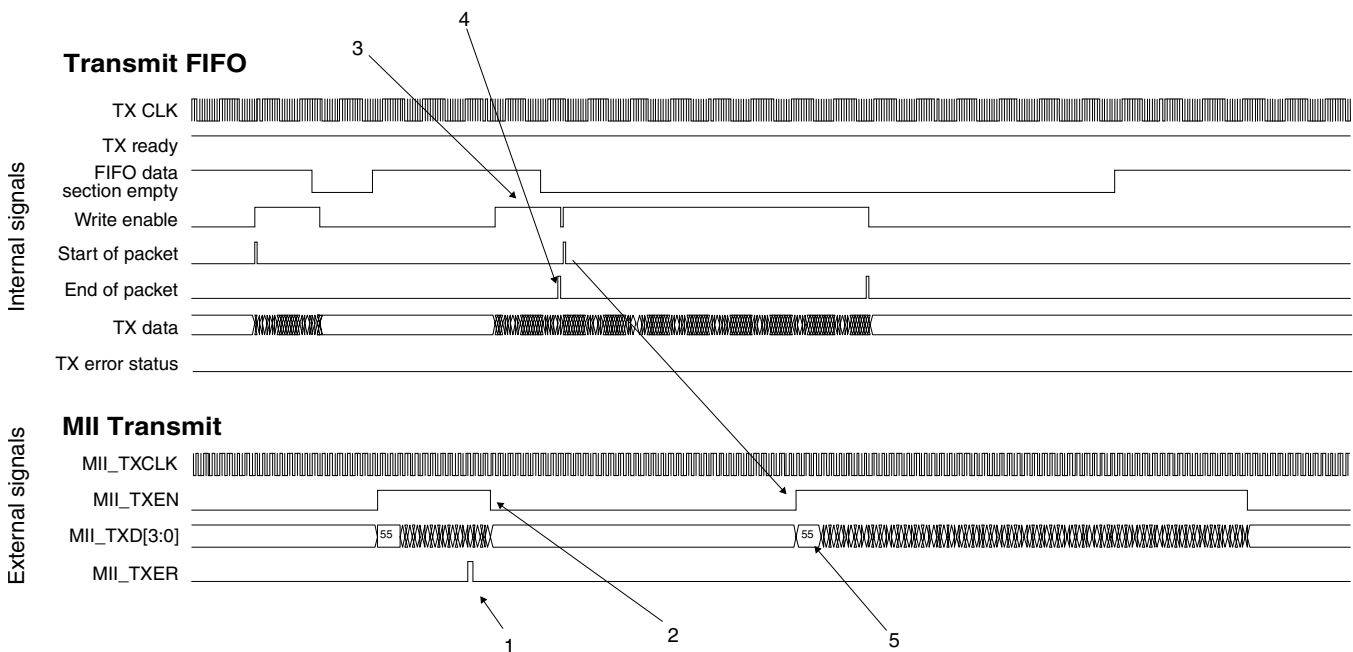

Figure 22-16. Transmit FIFO underflow protection

22.6.16.2 Transmit FIFO overflow

On the transmit path, when the FIFO reaches the programmable almost full threshold, the internal MAC ready signal is deasserted. The application should stop sending new data.

However, if the application keeps sending data, the transmit FIFO overflows, corrupting contents that were previously stored. The core logic sets the enhanced TxBD[OE] field for the next frame transmitted to indicate this overflow occurrence.

Note

Overflow is a fatal error and must be addressed by resetting the core or clearing ENET $_n$ _ECR[ETHER_EN], to clear the FIFOs and prepare for normal operation again.

22.6.16.3 Receive FIFO overflow

During a frame reception, if the client application is not able to receive data (1), the MAC receive control truncates the incoming frame when the FIFO reaches the programmable almost-full threshold to avoid an overflow.

The frame is subsequently received on the FIFO interface with an error indication (enhanced RxBD[ME] field set together with receive end-of-packet) (2) with the truncation error status field set (3).

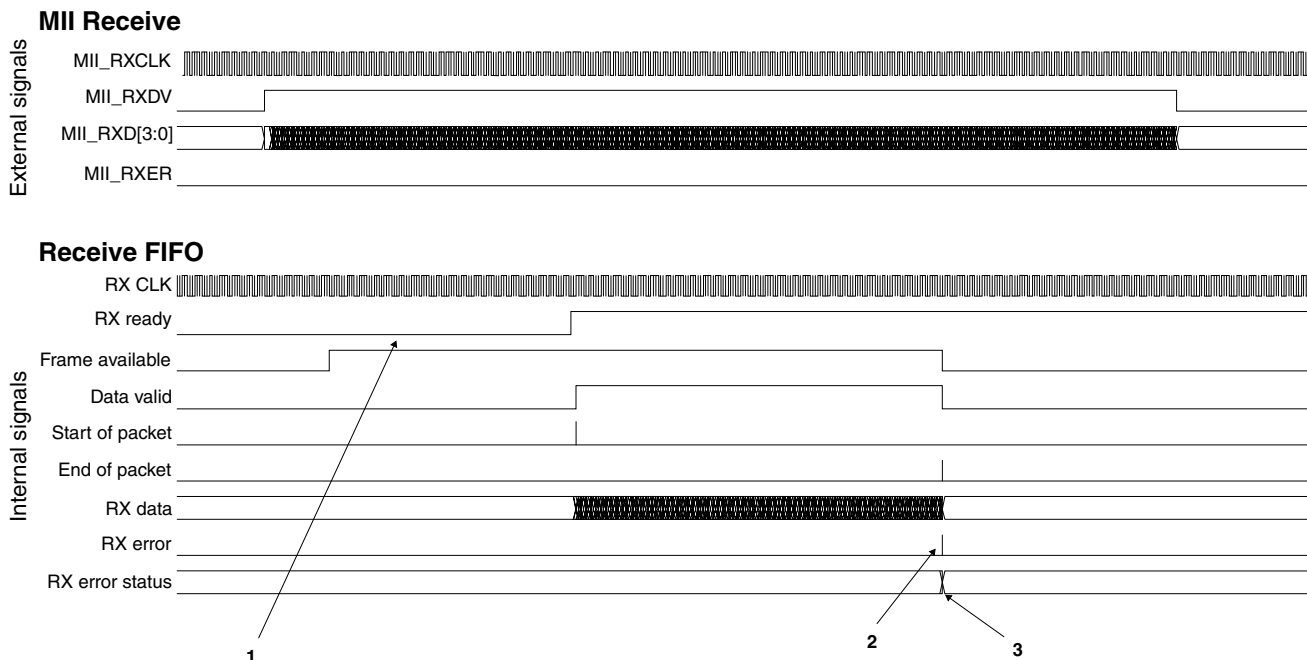

Figure 22-17. Receive FIFO overflow protection

22.6.17 PHY management interface

The MDIO interface is a two-wire management interface. The MDIO management interface implements a standardized method to access the PHY device management registers.

The core implements a master MDIO interface, which can be connected to up to 32 PHY devices.

22.6.17.1 MDIO clause 22 frame format

The core MDIO master controller communicates with the slave (PHY device) using frames that are defined in the following table.

A complete frame has a length of 64 bits made up of an optional 32-bit preamble, 14-bit command, 2-bit bus direction change, and 16-bit data. Each bit is transferred on the rising edge of the MDIO clock (MDC signal). The MDIO data signal is tri-stated between frames.

The core PHY management interface supports the standard MDIO specification (IEEE 802.3 Clause 22).

Table 22-41. MDIO clause 22 frame structure

ST	OP	PHYADR	REGADR	TA	DATA
----	----	--------	--------	----	------

Table 22-42. MDIO frame field descriptions

Field	Description
ST (2 bits)	Start indication field, programmed with ENET n _MMFR[ST] and equal to 01 for Standard MDIO (Clause 22).
OP (2 bits)	Opcode defines type of operation. Programmed with ENET n _MMFR[OP]. 01 Write operation 10 Read operation
PHYADR (5 bits)	Five-bit PHY device address, programmed with ENET n _MMFR[PA]. Up to 32 devices can be addressed.
REGADR (5 bits)	Five-bit register address, programmed with ENET n _MMFR[RA]. Each PHY can implement up to 32 registers.
TA (2 bits)	Turnaround time, programmed with ENET n _MMFR[TA]. Two bit-times are reserved for read operations to switch the data bus from write to read. The PHY device presents its register contents in the data phase and drives the bus from the second bit of the turnaround phase.
Data	Data, set by ENET n _MMFR[DATA]. Written to or read from the PHY

Table 22-42. MDIO frame field descriptions

Field	Description
(16 bits)	

22.6.17.2 MDIO clause 45 frame format

The extended MDIO frame structure defined in IEEE 802.3 Clause 45 introduces indirect addressing. First, a write transaction to an address register is done, followed by a write or read transaction which will put the 16-bit data in the register or retrieve the register contents respectively. A preamble of 32 bits of logical ones is sent prior to every transaction. The MDIO data signal is tri-stated between frames.

The extended MDIO defines four transactions, which are determined by the two-bit opcode field.

Table 22-43. MDIO clause 45 frame structure

ST	OP	PRTAD	DEVAD	TA	ADDR/DATA
----	----	-------	-------	----	-----------

All bits are transmitted from left to right (Preamble bits first) and all fields have their Most-Significant bit sent first (leftmost in above table). The complete frame has a length of 64 bits (32-bit preamble, 14-bit command, 2-bit bus direction change, 16-bit data). Each bit is transferred with the rising edge of the MDIO clock (MDC).

The fields and transactions are summarized in the following tables.

Table 22-44. MDIO clause 45 frame field descriptions

Field	Description
ST	Start indication. Indicates the end of the preamble and start of the frame. This value is 00 for extended MDIO (Clause 45) frames.
OP	Opcode defines if a read or write operation is performed and is programmed with ENET _n _MMFR[OP]. See Table 22-45 for more information. 00 Address write 01 Write operation 10 Read inc. operation 11 Read operation
PRTAD	The port address specifies a MDIO port. Each Port can have up to 32 devices which each can have a separate set of registers.
DEVAD	Device address. Up to 32 devices can be addressed (within a port).
TA	Turnaround time, programmed with ENET _n _MMFR[TA]. Two bit-times are reserved for read operations to switch the data bus from write to read. The PHY device presents its register contents in the data phase and drives the bus from the second bit of the turnaround phase.

Table continues on the next page...

Table 22-44. MDIO clause 45 frame field descriptions (continued)

Field	Description
ADDR/DATA	16-bit address (for address write) or data, set by ENET n _MMFR[DATA], written to or read from the PHY.

Table 22-45. MDIO Clause 45 Transactions

Transaction Type	Description
Address	A write transaction to the internal address register of the device/port. The data section of the frame contains the value to be stored in the device's internal address "pointer" register for further transactions.
Write	Data write to a register. The 16 bit data will be written to the register identified by the device-internal address.
Read	Data is read from the register identified by the device-internal address.
Read inc.	Read with address postincrement. The register identified by the device-internal address is read. After this, the device-internal address is incremented. If the address register is all '1' (0xFFFF) no increment is done (i.e. increment does not wrap around).

22.6.17.3 MDIO clock generation

The MDC clock is generated from the internal bus clock (i.e., IPS bus clock) divided by the value programmed in ENET n _MSCR[MII_SPEED].

22.6.17.4 MDIO operation

To perform an MDIO access, set the MDIO command register (ENET n _MMFR) according to the description provided in MII Management Frame Register (ENET n _MMFR).

To check when the programmed access completes, read the ENET n _EIR[MII] field.

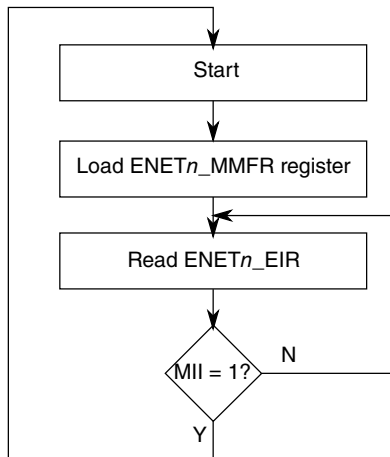

Figure 22-18. MDIO access overview

22.6.18 Ethernet interfaces

The following Ethernet interfaces are implemented:

- Fast Ethernet MII (Media Independent Interface)
- RMII 10/100 using interface converters/gaskets

The following table shows how to configure ENET registers to select each interface.

Mode	RCR[RMII_10T]	RCR[RMII_MODE]
MII - 10 Mbit/s	—	0
MII - 100 Mbit/s	—	0
RMII - 10 Mbit/s	1	1
RMII - 100 Mbit/s	0	1

22.6.18.1 RMII interface

In RMII receive mode, for normal reception following assertion of CRS_DV, RXD[1:0] is 00 until the receiver determines that the receive event has a proper start-of-stream delimiter (SSD).

The preamble appears (RXD[1:0]=01) and the MACs begin capturing data following detection of SFD.

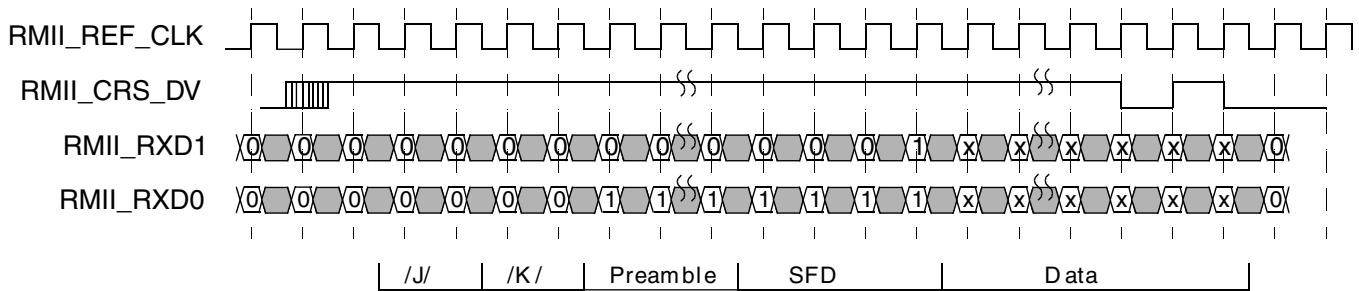

Figure 22-19. RMII receive operation

If a false carrier is detected (bad SSD), then RXD[1:0] is 10 until the end of the receive event. This is a unique pattern since a false carrier can only occur at the beginning of a packet where the preamble is decoded (RXD[1:0] = 01).

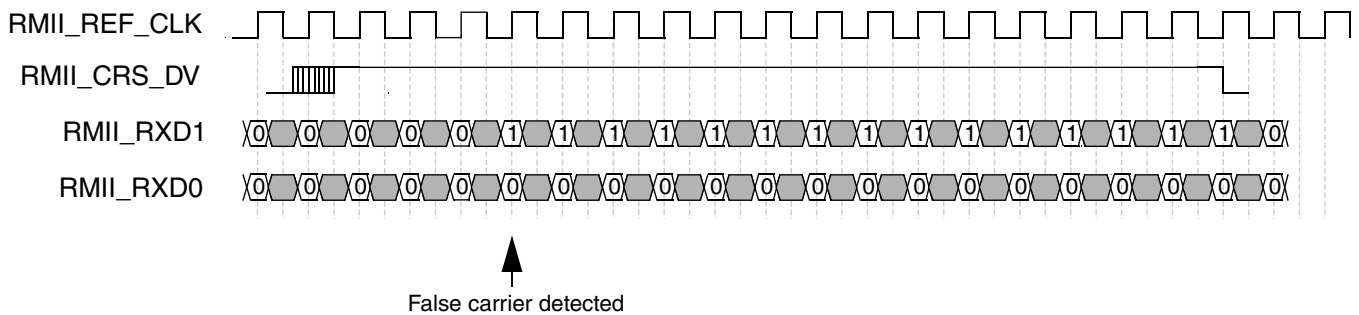

Figure 22-20. RMII receive operation with false carrier

In RMII transmit mode, TXD[1:0] provides valid data for each REF_CLK period while TXEN is asserted.

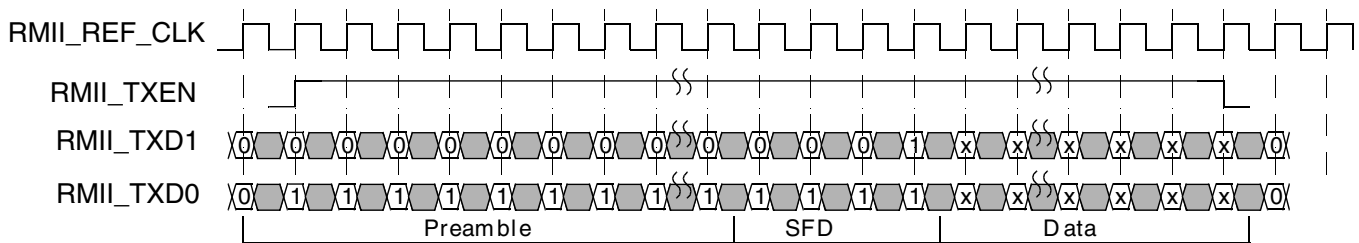

Figure 22-21. RMII transmit operation

22.6.18.2 MII Interface — transmit

On transmit, all data transfers are synchronous to MII_TXCLK rising edge. The MII data enable signal MII_TXEN is asserted to indicate the start of a new frame, and remains asserted until the last byte of the frame is present on the MII_TXD[3:0] bus.

Between frames, MII_TXEN remains deasserted.

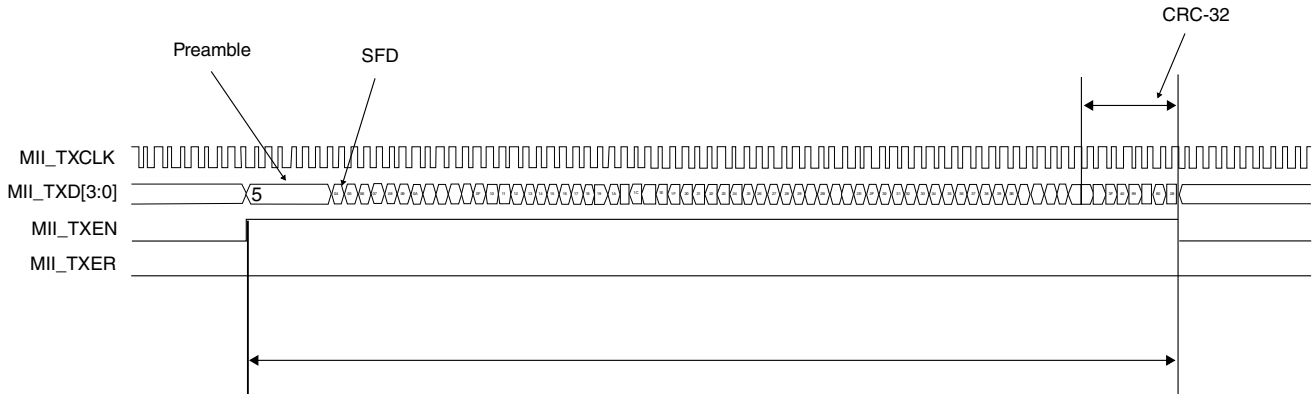

Figure 22-22. MII transmit operation

If a frame is received on the FIFO interface with an error (for example, RxBD[ME] set) the frame is subsequently transmitted with the MII_TXER error signal for one clock cycle at any time during the packet transfer.

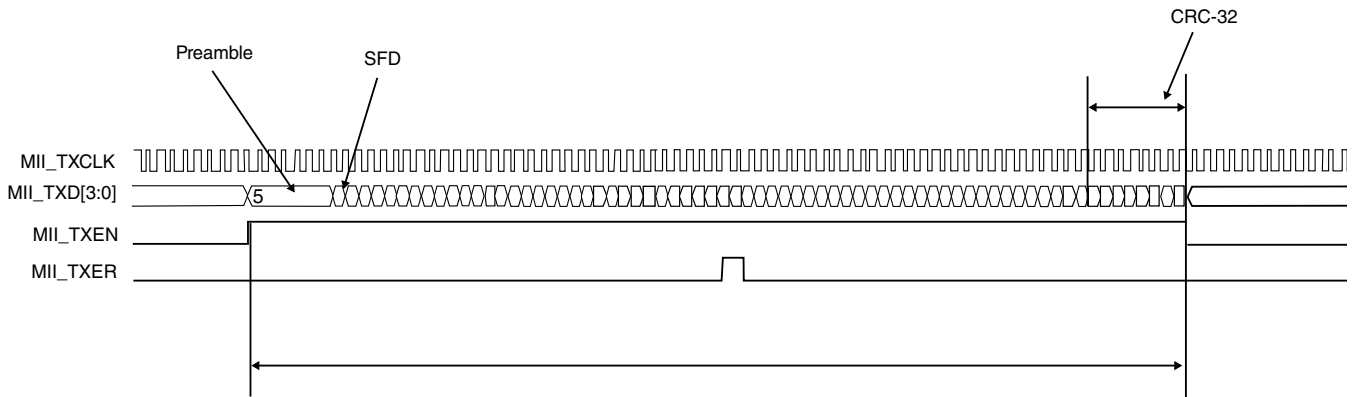

Figure 22-23. MII transmit operation — errored frame

22.6.18.2.1 Transmit with collision — half-duplex

When a collision is detected during a frame transmission (MII_COL asserted), the MAC stops the current transmission, sends a 32-bit jam pattern, and re-transmits the current frame.

(See [Collision detection in half-duplex mode](#) for details)

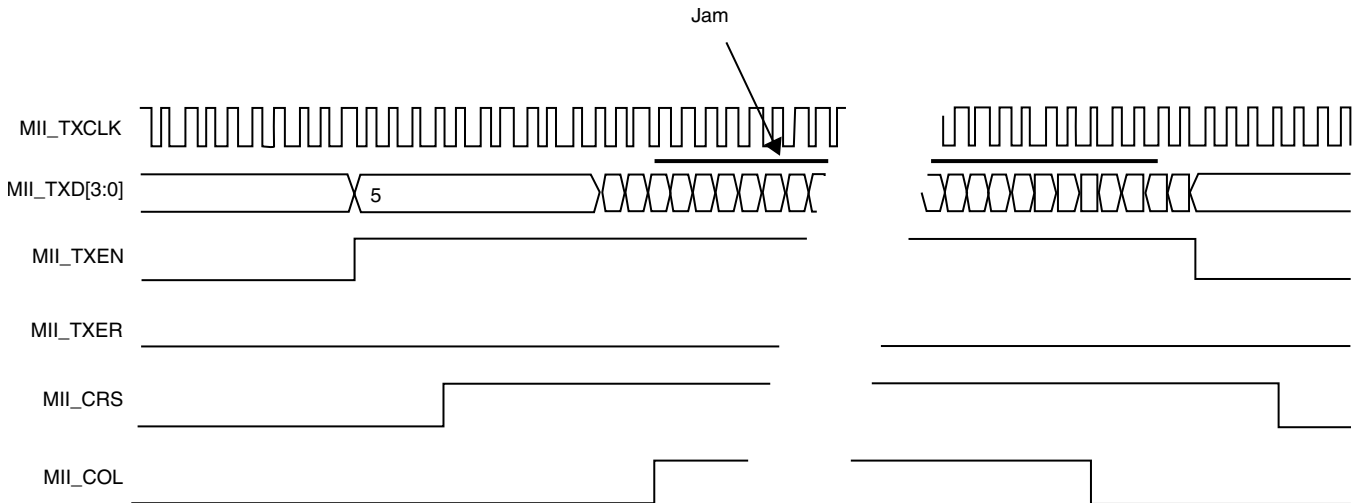

Figure 22-24. MII transmit operation — transmission with collision

22.6.18.3 MII interface — receive

On receive, all signals are sampled on the MII_RXCLK rising edge. The MII data enable signal, MII_RXDV, is asserted by the PHY to indicate the start of a new frame and remains asserted until the last byte of the frame is present on MII_RXD[3:0] bus.

Between frames, MII_RXDV remains deasserted.

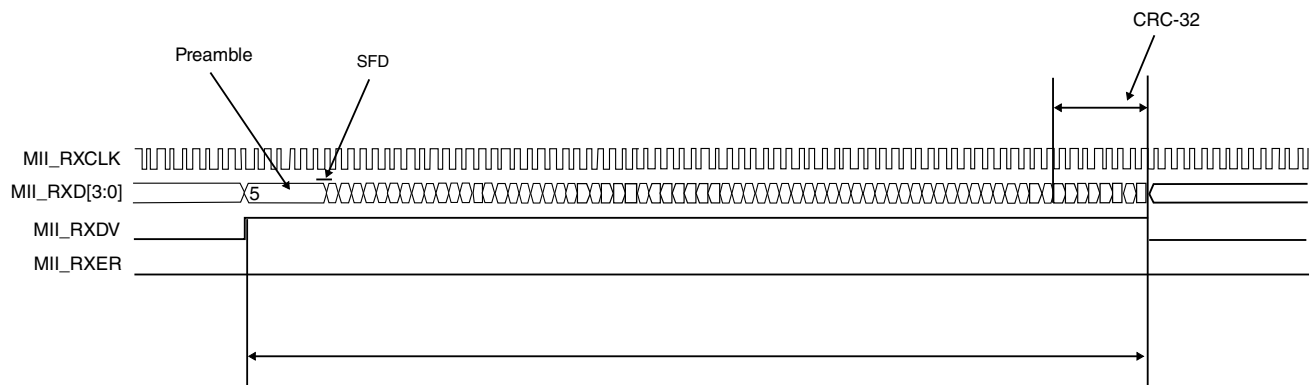

Figure 22-25. MII receive operation

Functional description

If the PHY detects an error on the frame received from the line, the PHY asserts the MII error signal, MII_RXER, for at least one clock cycle at any time during the packet transfer.

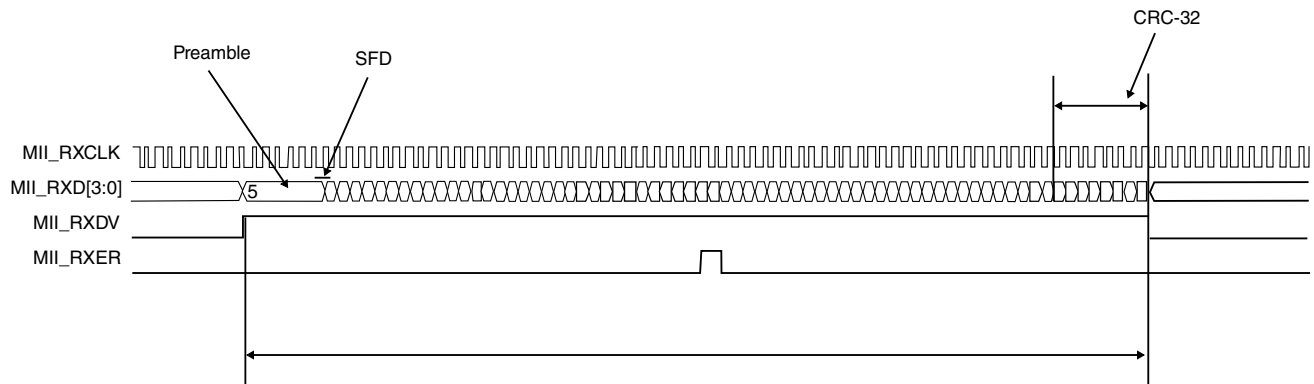

Figure 22-26. MII receive operation — errored frame

A frame received on the MII interface with a PHY error indication is subsequently transferred on the FIFO interface with RxBD[ME] set.

22.6.19 Interrupt coalescence

The purpose of the interrupt coalescing is to reduce the number of interrupts generated by the MAC so as to reduce the CPU loading.

To facilitate this interrupt coalescing, these registers are available with the same control and configuration fields.

- [Transmit Interrupt Coalescing Register \(ENET_TXIC\)](#)
- [Receive Interrupt Coalescing Register \(ENET_RXIC\)](#)

When coalescing is enabled by asserting the corresponding ICEN field and such interrupt is also enabled by the corresponding interrupt mask of the EIMR register, the MAC generates an interrupt when the threshold number of frames is reached (defined by ICFT) or when the threshold timer expires (defined by ICTT).

When coalescing is disabled by de-asserting ICEN, but interrupt is enabled by the corresponding interrupt mask of the EIMR register, the MAC generates an interrupt as they are received without using coalescing. Interrupt coalescing is done for each transmit and receive queue/class independently.

22.6.19.1 Interrupt coalescence setup

Interrupt coalescence supports both legacy and enhanced BDs. The following guidelines are recommended when setting up interrupt coalescence.

- When the MAC is configured for enhanced (IEEE 1588) mode, that is, enhanced BDs:
 - Set the INT bit in the enhanced received buffer descriptor to one.
 - Set the INT bit in the enhanced transmit buffer descriptor(s) to one.
- Clear the TXB and RXB fields in the EIMR register.

22.6.19.2 Updating the frame count threshold on-the-fly

To update the ICFT field in the RXIC and TXIC registers:

1. Disable interrupt coalescence by clearing the appropriate ICEN field. This will allow the internal interrupt coalescence counter to reset to zero.

NOTE

When disabling interrupt coalescence, if an interrupt event is pending, that is, the interrupt counter is not zero, then an interrupt will occur.

2. Write the new threshold value to the ICFT field.
3. Set ICEN to one.

NOTE

The ICFT field can be updated on-the-fly without disabling the ICEN field. The hardware interrupt will continue and there is a possibility that an interrupt will occur depending on the state of the hardware counter and the previous ICFT value.

22.6.19.3 Updating the timer threshold on-the-fly

To update the ICTT field in the RXIC and TXIC registers:

1. Disable interrupt coalescence by clearing the appropriate ICEN field. This will allow the internal interrupt coalescence counter to reset to zero.

NOTE

When disabling interrupt coalescence, if an interrupt event is pending, that is, the interrupt counter is not zero, then an interrupt will occur.

2. Write the new timer value to the ICTT field.
3. Set ICEN to one.

Chapter 23

Electrophoretic Display Controller (EPDC)

23.1 Overview

This chapter describes the architecture of the EPDC. It provides a detailed description of the block for digital design and software driver development.

The EPDC is a feature-rich, low power and high performance direct drive active matrix EPD controller. It is specifically designed to drive E•INK™ EPD panels supporting a wide variety of TFT backplanes. The goal of the EPDC is to provide an efficient SoC integration of this functionality for e-paper applications, allowing a significant BOM cost saving over an external solution, while reaching much higher levels of performance at lower power. The EPDC module is defined in the context of an optimized HW/SW partitioning and works in conjunction with the PXP IP module to form a complete display processing solution.

The key features of the EPDC are as follows:

- TFT resolutions up to 4096 x 4096 pixels with 20 Hz refresh (programmable up to 8191 x 8191)
- TFT resolutions up to 1650 x 2332 pixels at 106 Hz refresh
- Industry standard bus interfaces (AMBA AXI and APB)
- Up to 5-bit pixel representation for up to 32 greyscale levels
- Up to 64 concurrent updates with partial update support, except for 32(5-bit) grey level panel for which only 16 concurrent updates can be used
- Automatic collision handling when used in conjunction with the i.MX device driver
- Flexible direct drive TFT interface supporting next generation source driver, gate driver and panel architectures, including LVDS, DDR and multi-level source drivers
- Unified generic configurable timing mode (Pigeon Mode) available on most panel timing control signals
- High performance pixel pipeline architecture to guarantee refresh performance at high pixel rates without the need for high internal clocking
- Ability to process multiple updates asynchronously to refresh/update operations with ability to intercept each frame scan will multiple update requests

Overview

- Performance tuning capabilities which can interface with SoC level memory arbitration mechanisms further guaranteeing frame refresh operation
- Decoupled clocking architecture allowing for independent and asynchronous clock sources for memory bus, peripheral bus and pixel clock domains
- Full and partial update mode support
- Support for up to 256 waveform modes, also support optimal waveform auto-selection based on grey level of the pixels being updated
- Low power mode operation via architectural clock gating
- Update buffer analysis functions to get information like collision rectangle, grey level

23.1.1 EPDC Block Diagram

The top-level view of the EPDC is shown in the following figure.

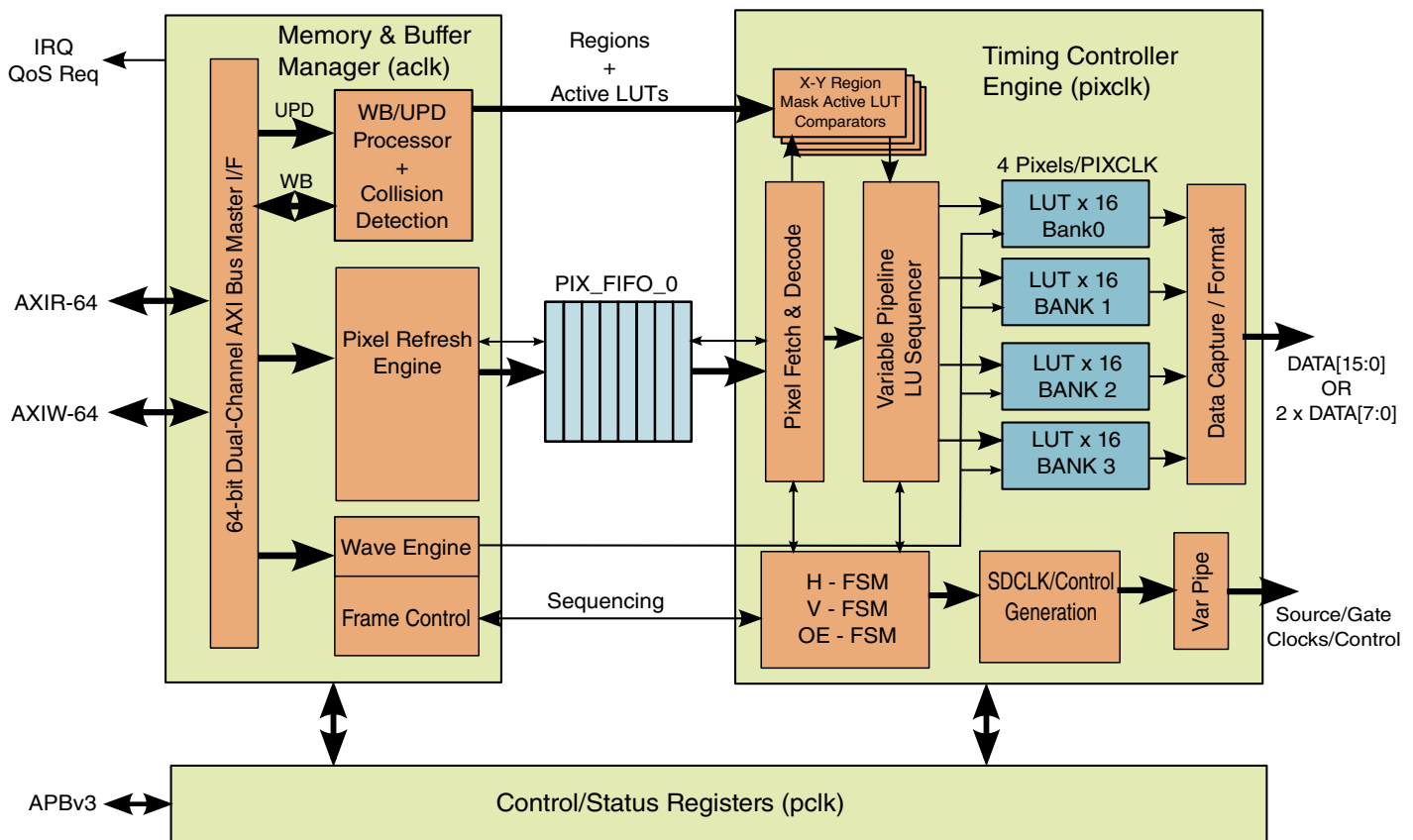

Figure 23-1. EPDC Top-Level Block Diagram

The EPD function can be separated into two major asynchronous processes. The first is the front end portion which is responsible for processing display updates. The second is the function of driving waveforms to the TFT panel in order to update the screen contents (the refresh operation). The EPDC is comprised of two major submodules (MBM and TCE) which mirror the architectural split in the EPD algorithm. These submodules communicate through a number of control/sequencing signals and data (through the pixel FIFOs and LUT memories):

- **Memory and Buffer Manager (MBM):** This submodule is responsible for all memory-related operations and LUT life cycle control, which involves the frame count management for all updates. This module is clocked by both *aclk* and *pixclk*. It also encapsulates the APB register interface which is clocked by *aclk* too.
- **Timing Control Engine (TCE):** This submodule is responsible for performing TFT scan frame refreshes. It is clocked by *pixclk*. It also houses the LUT memory system.

23.2 External Signals

The following table describes the external signals of EPDC:

23.3 Programming Model

From an application perspective, the EPDC HW/SW solution aims to abstract much of the details of driving an EPD display from the user space.

This is achieved through a blend of HW features and the kernel-level SW driver implementation of the EPD frame buffer. The scope of this chapter mostly pertains to EPDC HW but in order to correctly define the context of the programming model, certain assumptions about the driver architecture (including use of the eXPX IP) are described below.

23.3.1 Assumptions

The scope of the EPDC does not include certain functions performed by the driver and application layer.

These features are as follows:

- **Maintenance of update and collision lists.** This includes, but is not limited to, responsibility for managing update order. Updates are processed in the order they are received by the EPDC. Actual start times of multiple updates can occur on the same

frame scan. All pixels contained within an update will always begin on the same frame scan.

- Border control. This function is assumed to be performed by a GPIO functionality.
- EPD Panel Power Management. It is assumed that the driver and application layers will control the panel PMIC functions including relevant interfaces such as I²C and 4-wire power sequencing signals.
- Reading and decompression of the waveform file. This is assumed to be unpacked, reformatted and written to system memory into a form that is easily accessed by the EPDC.
- Waveform mode selection. The EPDC provides a mechanism through its histogram analysis feature (which can be run as part of any frame/region processing operations) to allow the SW driver to characterize the region/buffer in terms of gray-map content. For example, EPDC can determine if the update region (considering only those pixels undergoing a transition) contains only 2, 4, 8 or 16 gray levels, HW can automatically select waveform mode according to a programmed LUT holding mapping between grey level and waveform mode. SW driver can also manually choose the appropriate waveform update mode (e.g., when doing an update to repair ghosting artifacts).

23.3.2 Register Space (Write/Set/Clear/Toggle)

The EPDC registers utilize four word address locations per 32-bit register.

For control registers (especially interrupts), this provides for a unique address for the following operations:

- Write (0x0). The base address of the register allows full writes to the 32-bit register.
- Set (0x4). This address allows a set operation on the register or its fields; writing a 1 to a register bit/field with the set address will set that bit. Writing a 0 to the set address has no effect.
- Clear (0x8). This address allows a clear operation on the register or its fields; writing a 1 to a register bit/field with the clear address will clear that bit or field.

NOTE

Interrupt status bits (such as those contained in EPDC_IRQ) must be cleared with the clear address only. Writing to the EPDC_IRQ register with a 0 will not clear the interrupt status/source. Writing a 0 to the clear address has no effect.

- Toggle (0xc). This address allows a toggle operation on the register or its fields; writing a 1 to a register bit/field with the toggle address will invert the state of that bit/field. This address is especially useful because it provides the ability to perform a

read-modify-write operation with a single write operation. Writing a 0 to the toggle address has no effect.

23.3.3 Interrupts

23.3.3.1 Interrupt Sources

The EPDC contains 72 (64 of LUT completes IRQs and 8 of common IRQs) unique interrupt sources. Each interrupt source has an interrupt status bit captured in EPDC_IRQ /EPDC_IRQ1/EPDC_IRQ2 .

When an interrupt event occurs, the appropriate bit within the EPDC_IRQ* register is set by the EPDC. Each of the bits in EPDC_IRQ is first AND'ed with its enable bit (in EPDC_IRQ_MASK*), and then the masked bits are logically OR'ed together to generate the final output.

23.3.3.2 Enabling/Masking Interrupts

Each of the EPDC interrupt sources can be individually enabled through the bits in the EPDC_IRQ_MASK* register.

Even if an interrupt source is masked out (IRQ_EN bit set to 0), its status will still be available in the EPDC_IRQ* register. The difference is that it does not result in the interrupt line being asserted.

23.3.3.3 Handling/Clearing Interrupts

When the software driver is entered as a result of an EPDC interrupt it should read the EPDC_IRQ* interrupt status register.

Because multiple interrupts may have fired, in the case of a collision for example, both WB_CMPLT_IRQ and LUT_COL_IRQ fields of EPDC_IRQ will be set. Once the interrupt has been handled, the driver should clear the interrupt source by writing to the CLEAR address (see [Register Space \(Write/Set/Clear/Toggle\)](#) for details).

When collision has occurred and the LUT_COL_IRQ bit is set, SW will handle the collision and clear LUT_COL_IRQ. Please note HW will also clear the entire EPDC_STATUS_COL* register at the sametime on LUT_COL_IRQ clearing by SW.

23.3.4 Controller Setup

Before screen update operations can be performed, the EPDC should be configured appropriately.

These rudimentary setup operations include:

- Waveform data must be present in memory (in a format that is consistent with the method in which the EPDC accesses it). Because the format of the waveform data is supplier proprietary information, it is not discussed in this chapter.
- Configuring the panel architecture parameters (source and gate-driver configuration)
- Configuring line and frame timing parameters
- Initializing the working buffer and panel

23.3.4.1 Memory Requirements

EPDC requires continuous access to the unpacked waveform data, the update region buffer, and its working buffer.

These are all expected to reside in system memory (typically external DRAM). As such, each has particular requirements:

- The Working Buffer (WB), which is pointed to by EPDC_WB_ADDR, must have EPDC_RES[HORIZONTAL] x EPDC_RES[VERTICAL] x 2 bytes allocated. This buffer is used by the EPDC to process updates and perform TFT refresh operations.
 - EPDC_RES[HORIZONTAL] mod 4 must equal to 0 for memory allocation calculations because the EPDC constructs each line of the working buffer at a 64-bit boundary.
- The Update Buffer, which is pointed to by EPDC_UPD_ADDR (and can be redefined with a different address for each update), must have the following allocation in memory:
 - a. when stride feature not enabled
 - EPDC_UPD_SIZE[HEIGHT] x EPDC_UPD_SIZE[WIDTH] bytes
 - Note that EPDC_UPD_SIZE[WIDTH] mod 8 must equal to 0 for memory allocation purposes. This means that for the address size allocation, the WIDTH field must be rounded up to the nearest number so that it can be divided by 8. This is because the EPDC reads each line of the update buffer at a 64-bit boundary (it should be noted that this is consistent with the ePXP IP output). The actual value programmed for the update can be at the pixel granularity.
 - b. when stride feature enabled

- EPDC_UPD_SIZE[HEIGHT] x EPDC_UPD_STRIDE bytes
 - EPDC_UPD_SIZE[WIDTH] is used to reflect valid bytes in a line with EPDC_UPD_STRIDE pixels, STRIDE >= WIDTH
 - no alignment requirement on line start or end, no padding necessary unless STRIDE > WIDTH
- The waveform data set size is a function of mode count, number of temperature tables and number of frames required for each temperature-compensated mode.

In summary, the memory requirements are as follows (in bytes):

- $WB\text{-roundup4}(EPDC_RES[HORIZONTAL]) \times EPDC_RES[VERTICAL] \times 2$
- when stride feature not enabled: $UPD\text{-}N \times \text{roundup8}(EPDC_UPD_SIZE[WIDTH]) \times EPDC_UPD_SIZE[HEIGHT]$
 - N = the number of update requests currently being managed by the i.MX EPD driver (that is, the driver may maintain a list of updates in memory which it uses to feed the EPDC).
- when stride feature enabled: $UPD\text{-}N \times EPDC_UPD_STRIDE \times EPDC_UPD_SIZE[HEIGHT]$

23.3.4.2 Panel Architecture Configuration

The EPDC is designed to directly drive EPD panels which typically expose the source and gate driver IC interfaces (these are often abstracted in traditional displays such as TFT-LCD).

The source and gate driver ICs are responsible for driving the TFT matrix. There are variations in both the panel architectures and the underlying source and gate driver IC functionality.

All the key configuration parameters are defined in the EPDC_RES, EPDC_FORMAT, EPDC_TCE_CTRL, EPDC_TCE_SDCFG and EPDC_TCE_GDCFG registers as follows.

- EPDC_RES:
 - HORIZONTAL: The panel horizontal resolution (in pixels). The horizontal resolution must be an integer multiple of the source driver PIXELS_PER_SDCLK value. It also must be an integer multiple of the PIXELS_PER_CE value.
 - VERTICAL: The panel vertical resolution (in pixels). This can be any integer value.
- EPDC_FORMAT:
 - DEFAULT_TFT_PIXEL: This field should almost always be left at 0x00. This register field is used as the value for the TFT pixel during a frame scan when a

pixel is not being updated. This condition is commonplace especially when using partial updates or updates which do not encompass the entire screen resolution. This value must always correspond to the state the source driver should see when no voltage change is needed. Incorrectly setting this value will damage the EPD material.

- **TFT_PIXEL_FORMAT**: This enumerated field defines the width of the TFT pixel. The TFT pixel is defined as the per-pixel voltage control value. The most common pixel format is 2B (2 bits per pixel). Panels which support source driver voltage modulation (multi-level voltage control) should use the 4B format. For source drivers that support 7 levels, the 4B format can be used and the unused DATA output pins should be left floating at the board level connection (specifically DATA3, 7, 11, 15). The 2BV and 4BV are variations which require the waveform data to supply a 2-bit VCOM value for each pixel.
- **EPDC_TCE_CTRL**:
 - **SDDO_WIDTH**: This selects 8- or 16-bit DATA operation using enumerations 8-bit and 16-bit. This field is used to describe useful data for panels that support LVDS. DATA[15:8] would be used to drive differential data. In these modes, SDDO_WIDTH would be set to 8-bit.
 - **VCOM_MODE, VCOM_VAL**: This VCOM_MODE bit allows the EPDC to either use the VCOM value supplied in the waveform or a software programmable value defined in the VCOM_VAL field, for panels which support VCOM modulation.
 - **DDR_MODE**: This mode-bit should be set for panels which expect source-driver data to be available on both edges of the SDCLK. This is common place for panels that support differential signaling, but the feature is not limited to LVDS panels. For example, the EPDC supports DDR modes which make full use of DATA[15:0]. In these modes, DDR_MODE = 1 and LVDS_MODE = 0.
 - **LVDS_MODE**: This mode always requires DDR_MODE to be set. When this mode bit is set, differential signaling is enabled such that DATA[15:8] always drives the inverse of the pixel data which is presented on DATA[7:0]. Because LVDS source-drivers use 2 pins per data-bit, they are typically configured to work in DDR mode. Differential signaling is also supported on the SDCE pins (as an option selected by LVDS_MODE_CE). In this mode SDCE[9:5] are used to drive the inverse differential signals for SDCE[4:0].
 - **LVDS_MODE_CE**: When LVDS_MODE is set, this bit can also be set to allow SDCE[9:5] to act as differential pairs for each SDCE[4:0].
 - **PIXELS_PER_SDCLK**: This is a key configuration and timing parameter. Each source driver latches a number of TFT pixels per shift clock period (SDCLK). This register defines how many pixels are driven per SDCLK period. When DDR_MODE = 1, pixels are driven on both edges of the clock, so this value must be adjusted accordingly. See for the required values per mode.

- EPDC_TCE_SDCFG:
 - SDCLK_HOLD: Holds the SDCLK low during the LINE_BEGIN time. The purpose of this field is to allow the user to set a LINE_BEGIN time which is not an integer multiple of SDCLKs (for fine tuning the line-time).
 - SDSHR: Defines the value of the SDSHR output signal which determines the source driver output order mapping.
 - NUM_CE: Defines the total number of source driver chip-enables (must be 1-10). This number doesn't always correspond to the number of source drivers in the panel. Many panels require only a single chip-enable signal which is active during the entire line data time. This signal is often called SPH (Horizontal Start Pulse) in such cases.
 - PIXELS_PER_CE: This register defines the span of each chip-enable expressed in pixels. For panels that utilize a single global CE, this value should be set to the horizontal resolution of the panel.
 - SDDO_REFORMAT: This enumerated field allows for TFT-pixel level reordering within DATA. For most panels it is recommended to set SDDO_REFORMAT to the REVERSE_PIXELS enumeration.
 - SDDO_INVERT: When this field is set, the values on DATA are inverted relative to the values extracted from the waveform LUT operations.
- EPDC_TCE_GDCFG:
 - GDRL: Defines the value of the GDRL output signal which determines the gate driver pulse shift direction.
 - GDOE_MODE: This field selects between two possible methods for driving the GDOE signal. When GDOE_MODE = 0, the GDOE output is always driven during the frame scan time, except during FRAME_SYNC when it is driven low. When GDOE_MODE = 1, the GDOE signal mimics the GDCLK signal but is only active during the frame-data time (FD). For most panels the recommended setting is 0.
 - GDSP_MODE: This field selects between two possible methods for driving the GDSP signal. When GDSP_MODE = 0, the GDSP signal is driven on the first line clock time of the FRAME_BEGIN time. The signal is driven for one GDCLK period (same as line time), and can be shifted using the GDSP_OFFSET control. When GDSP_MODE = 1, GDSP is active during the entire FRAME_SYNC time, and GDSP_OFFSET has not effect in this mode.

23.3.4.3 TFT Panel Timing Configuration

The EPDC provides a simple primary set of registers to define TFT line and frame (refresh) timing.

In addition to these, there are also low-level timing and polarity registers to provide additional flexibility in dealing with future TFT architectures.

The following figure shows how the horizontal and vertical timing is defined in terms of the various timing parameters. When configuring the TFT timing, the following goals should be met:

- Arrive at a refresh rate that matches the waveform requirement (for example, 50 Hz for 50 Hz waveform). The refresh rate is defined as the time between each frame sync event and can be expressed as a multiple of the line timing and the total number of vertical lines.
- Meet the various timing requirements of the gate and source driver clock and control signals (the blanking period provide an infrastructure for controlling these).
- Stay below the maximum source-driver clock (usually referred to as CL) frequency.
- Arrive at a source driver clock frequency which in turn defines the exact pixel frequency. In most cases, E-INK™ provides the expected SDCLK frequency.
- Meet the line-timing (LT) requirements of the E-INK panels and their associated waveforms.

For proper waveform performance, it is critical to match the refresh frequency to that required by the waveform and associated panel. Deviation from this frequency results in short term inaccuracy of color and in the long term, complete loss of coherency between the EPDC's internal representation of color and the physical representation on the screen.

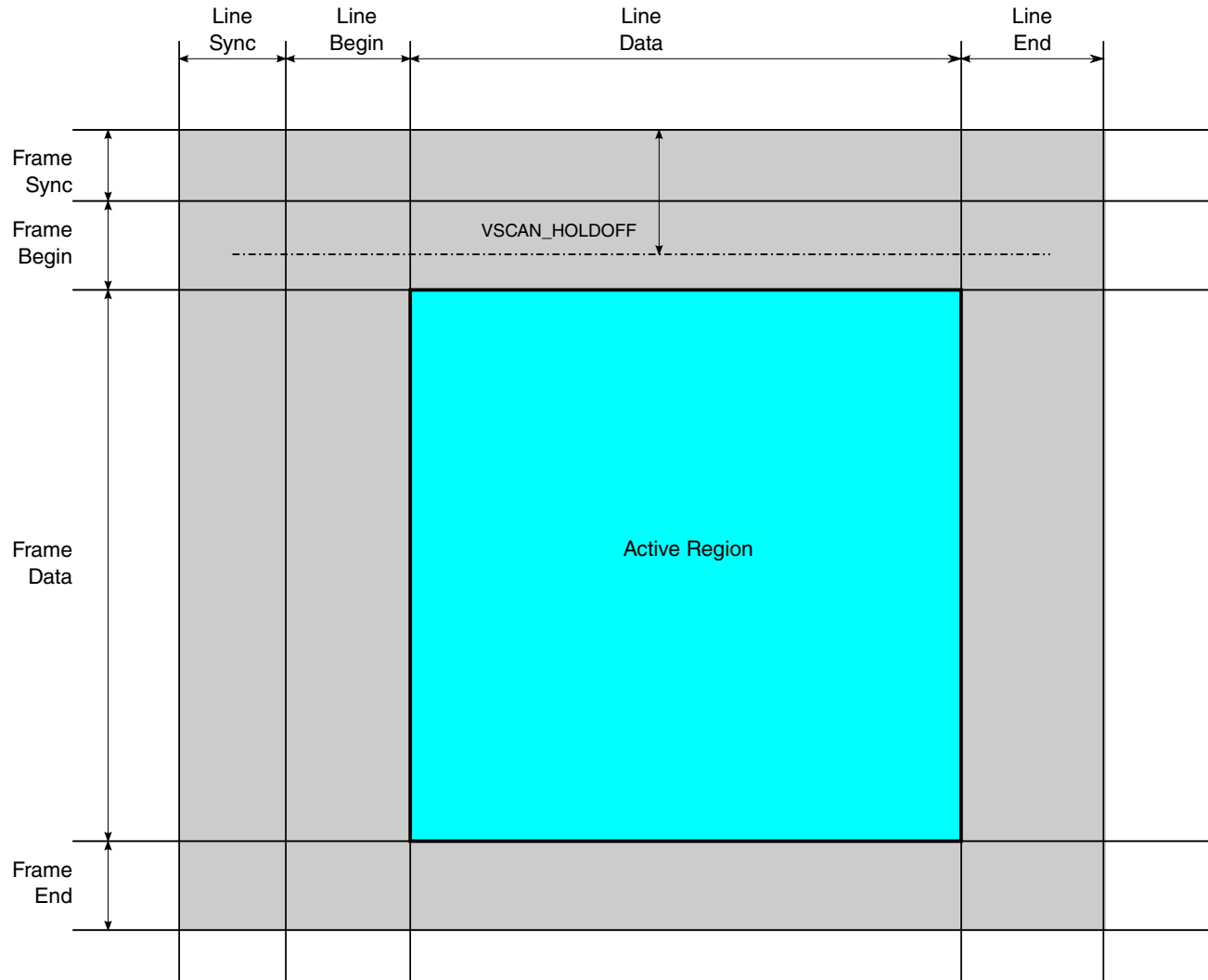

Figure 23-2. Frame Timing

The following equations define the timing of the panel scan frame (where LT = line-timing and FT = frame-timing):

$$LT = TPIXCLK (LS + LB + (HRES \times \left(\frac{\text{Ratio}}{\text{PIXELSPERSDCLK}} \right) + LE)$$

$$FT = LT \times (FS + FB + VRES + LE)$$

Ratio is defined between the internal PIXCLK and the external source driver clock SDCLK. The ratio is automatically determined by the EPDC according to . A simple method to determine the ratio is as follows:

- When $DDR_MODE = 1$, $RATIO = 4$
- When $DDR_MODE = 0$
 - If $PIXELS_PER_SDCLK = 8$, $RATIO = 4$
 - Else, $RATIO = 2$

Typically it is recommended to seed these equations with an estimated (or provided) SDCLK frequency and adjust the various timings until the desired refresh rate is attained.

The following figure shows line timing for cases, where $DDR_MODE = 0$ (those cases where data is only sampled by the source driver on the rising edge of SDCLK). Depending on the mode (see), the ratio is a function of TFT pixel width and $PIXELS_PER_SDCLK$, so the timings are shown generically. For the purposes of this diagram, $RATIO$ can either be 2 or 4.

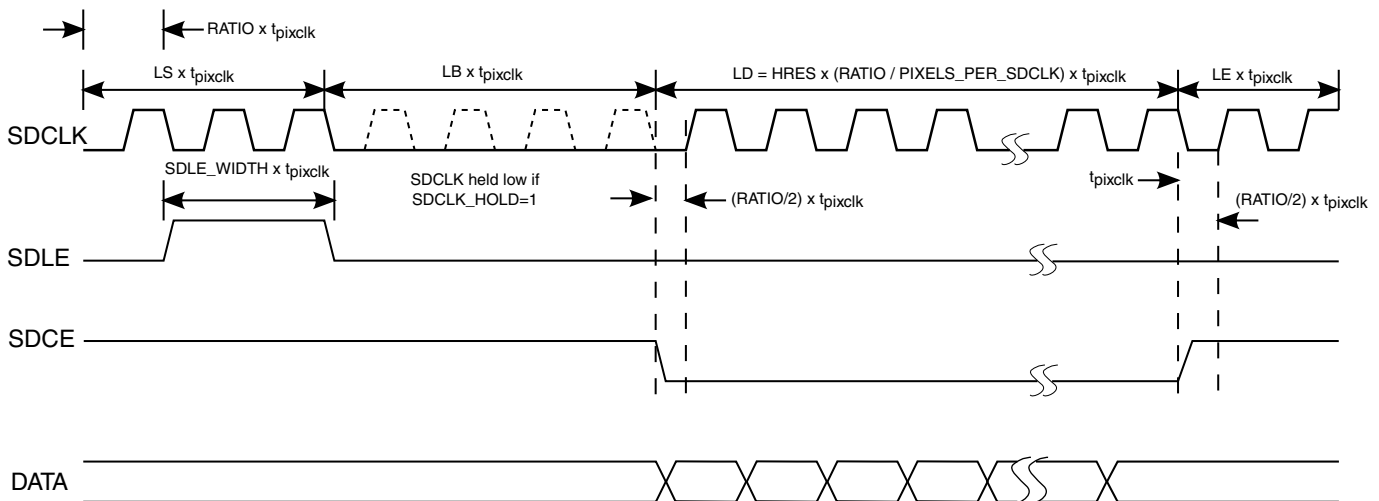

Figure 23-3. Line Timing ($DDR_MODE = 0$)

As per , when $DDR_MODE=1$ (for example, for source drivers that require data to be driven on each edge of SDCLK), the $RATIO$ is always set to 4. The timing for such cases is shown in the figure below.

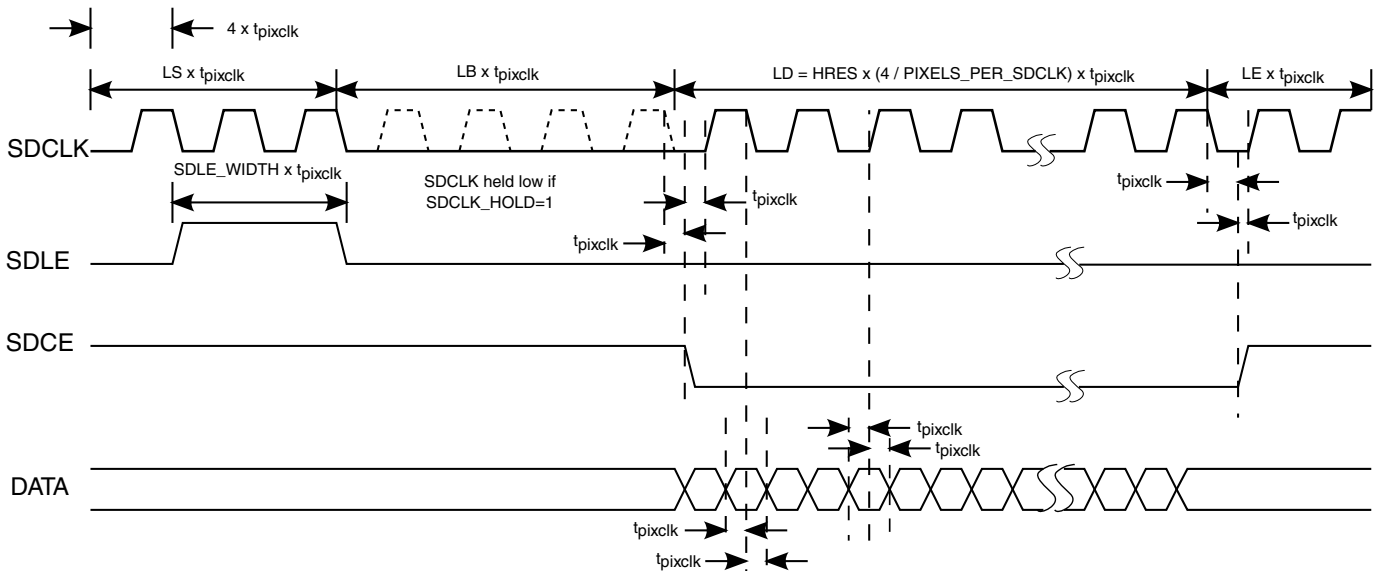

Figure 23-4. Line Timing (DDR_MODE = 1) - RATIO = 4

Vertical timing or frame timing (FT) is always expressed in terms of line timing (LT). This is shown in the following figure, followed by a detailed view of the GDCLK timing (which has programmable duty cycle to allow programming of gate-on/gate-off time) in [Figure 23-6](#). The following important points should be noted in regard to gate driver timing:

- All gate driver timing signals are independently referenced to the LINE_SYNC leading edge (this includes GDCLK_OFFSET, GDSP_OFFSET, and GDOE_OFFSET).
- GDSP_OFFSET is only supported for GDSP_MODE = 1
- For GDOE_MODE = 1, if GDOE is expected to be delayed relative to GDCLK, the GDOE_OFFSET value should be set at a value appropriately greater than GDCLK_OFFSET.
- All offset settings are programmed in terms of PIXCLK cycles.
- By default, if all offset values are set to 0, the gate driver signals are always one PIXCLK cycle delayed from the LINE_SYNC leading edge.
- The LINE_SYNC leading edge doesn't depend on the LINE_SYNC_WIDTH value. In cases where LINE_SYNC_WIDTH is set to some value that is less than LINE_SYNC, a virtual leading edge which determines the line start time still exists.

Programming Model

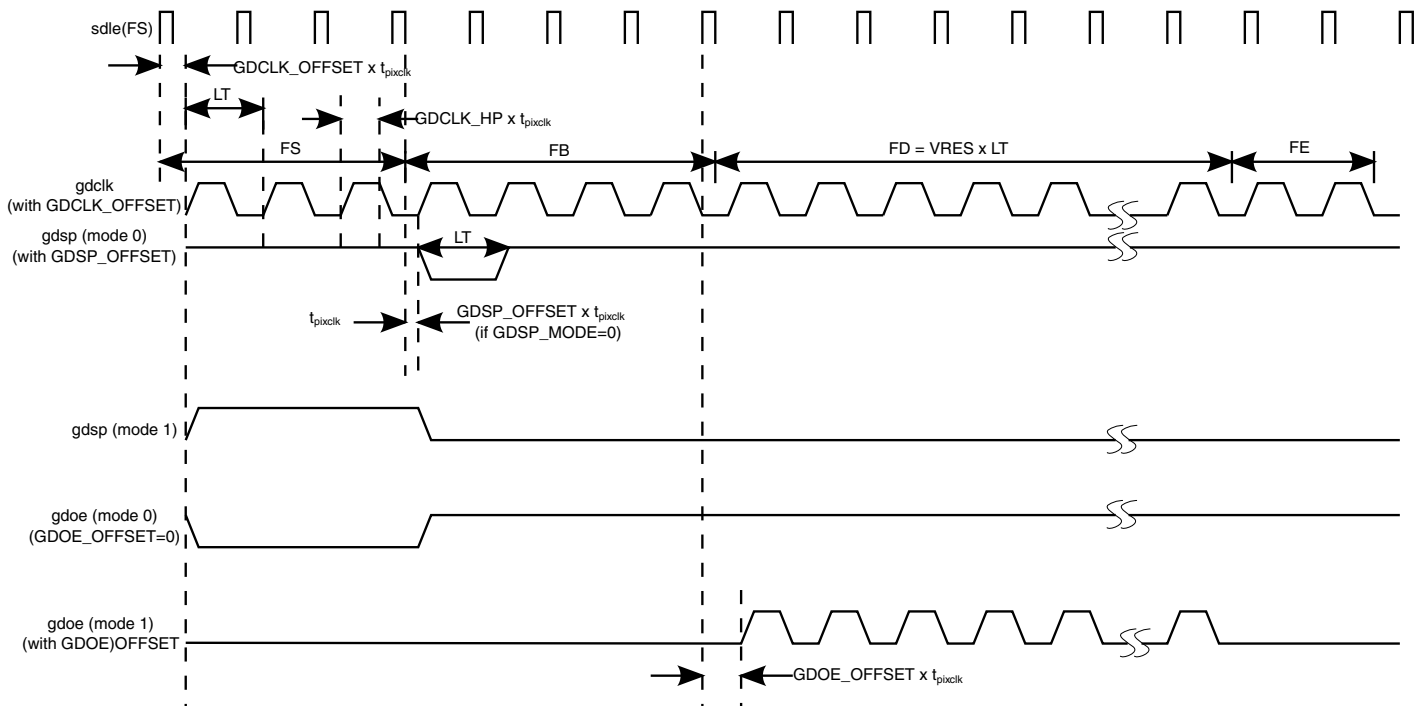

Figure 23-5. Frame Timing (Vertical)

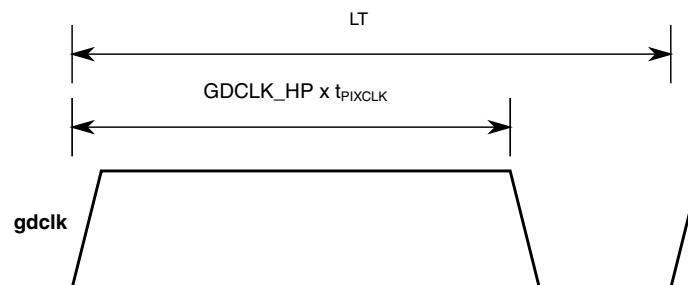

Figure 23-6. GDCLK Duty Cycle

An example calculation based on the 800 x 600 E-INK 6" panel with 50 Hz waveforms is shown be:

- `PIXELS_PER_SDCLK = 4`
- Ratio = 2 (2 bpp, 8-bit single-ended, SDR per)
- `tPIXCLK = 17.64 MHz` (assuming available chip clock frequency)
- `LS = 20 x tPIXCLK`
- `LB = 8 x tPIXCLK`
- `LD = 800 x (2/4) x tPIXCLK = 400 x tPIXCLK`
- `LE = 142 x tPIXCLK`
- `LT = (20 + 8 + 400 + 142) x tPIXCLK = 32.31293 uS`

`LINE_SYNC_WIDTH` does not affect line timing. It should be set to the same value as `LINE_SYNC`, unless `LB` and `LE` are short and it is used to shorten the width of `SDLE` whilst still maintaining the same line-timing.

It is important to meet the target line time of the panel which was 32.312 μ s. Then the frame-rate can be calculated and given the vertical timings:

- $FS = 4 \times LT$
- $FB = 4 \times LT$
- $FD = 600 \times LT$
- $FE = 10 \times LT$
- $FT = (4 + 4 + 600 + 10) \times LT = 50.07665 \text{ Hz}$

In addition to this, E-INK panels require a particular duty cycle for the GDCLK signal which is specified as gate-on-time and gate-off-time. The sum of gate-off and gate-on should equal LT and the value of gate-on can be programmed through HW_EPDC_TCE_TIMING2[GDCLK_HP], or GDCLK High-Pulse time.

23.3.4.4 Source Driver and Pixel Clock Configuration

The EPDC supports a number of source driver architectures. Each architecture forces a particular shift clock pixel rate.

In addition to this, the selection of the architecture requires a particular clock ratio between the internal pixel clock (pixclk) and external shift clock EPDC_SDCLK. The table below outlines the various configurations and clock ratios. It also lists the relevant register settings for this configuration.

Table 23-1. Interface Modes

High-Level Mode	EPDC_DATA pins used	HW_EPDC_FORMAT [TFT_PIXEL_FORMAT]	HW_EPDC_TCE_CTRL [PIXELS_PER_SDCLK]	HW_EPDC_TCE_CTRL [LVDS_MODE]	HW_EPDC_TCE_CTRL [DDR_MODE]	HW_EPDC_TCE_CTRL [SDDO_WIDTH]	Required PIXCLK (RATIO)
2bpp, 8-bit single-ended, SDR	[7:0]	2B[V]	FOUR	0	0	8BIT	SDCLK x 2
2bpp, 16-bit single-ended, SDR	[15:0]	2B[V]	EIGHT	0	0	16BIT	SDCLK x 4
2bpp, 8-bit, DDR (LVDS option)	[7:0],[15:8]	2B[V]	EIGHT	110	1	8BIT	SDCLK x 4
4bpp, 8-bit single-ended, SDR	[7:0]	4B[V]	TWO	0	0	8BIT	SDCLK x 2
4bpp, 16-bit, single-ended SDR	[15:0]	4B[V]	FOUR	0	0	16BIT	SDCLK x 2

Table continues on the next page...

Table 23-1. Interface Modes (continued)

High-Level Mode	EPDC_DATA pins used	HW_EPDC_FORMAT [TFT_PIXEL_FORMAT]	HW_EPDC_TCE_CTRL [PIXELS_PER_SDCLK]	HW_EPDC_TCE_CTRL [LVDS_MODE]	HW_EPDC_TCE_CTRL [DDR_MODE]	HW_EPDC_TCE_CTRL [SDDO_WIDTH]	Required PIXCLK (RATIO)
4bpp, 8-bit, DDR (LVDS option)	[7:0],[15:8]	4B[V]	FOUR	110	1	8BIT	SDCLK x 4
4bpp, 16-bit, single-ended, DDR	[15:0]	4B[V]	EIGHT	0	1	16BIT	SDCLK x 4

23.3.4.5 Initializing the Display

Because of the nature of the EPD technology, a typical scenario would involve the EPDC's working buffer (WB) being maintained in system memory. In such power states (where memory is maintained), it is not required to initialize the display (even if the EPD panel had been powered off for example).

In low-power modes where system memory is not maintained, there are two possible methods to initialize the display.

The first method includes initialization from an unknown state and the second mode simply requires software to load the last state of the WB into memory and configure the EPDC to point to it.

23.3.4.5.1 Reset/Clocks and Buffer Preparation

In cases in which the user wants to initialize the screen to a new known state, the following sequence should be followed. Assume that all relevant display power supplies are active.

First, the user must complete a soft reset sequence which includes enabling the main EPDC block-level clock gate. This sequence is described in the example code below. Setting SFTRST enables the CLKGATE. In order to correctly cycle reset values through pipeline registers, the CLKGATE bit stays asserted for some finite amount of time before it sets. After this time, it is safe to clear both the SFTRST and CLKGATE. The example below shows a typical use of these registers.

```
EPDC_CTRL_SET(BM_EPDC_CTRL_SFTRST);
while (!EPDC_CTRL.B.CLKGATE);
EPDC_CTRL_CLR(BM_EPDC_CTRL_SFTRST | BM_EPDC_CTRL_CLKGATE);
while (EPDC_CTRL_RD() & (BM_EPDC_CTRL_SFTRST | BM_EPDC_CTRL_CLKGATE));
```

Before any display update is performed, the waveform address and working buffer (WB) pointers must be set (both must be aligned to a 64-bit double long word address):

- EPDC_WVADDR: Must point to the base address of the waveform data (managed by the i.MX driver)
- EPDC_WB_ADDR: An area of memory must be assigned for the EPDC's working buffer (WB). Once assigned, this memory space should be reserved purely for the use of the EPDC. The requirements for the memory allocation are described in [Memory Requirements](#).

After this, the various panel configuration parameters must be set including resolutions, source and gate driver formats, TFT and buffer pixel formats.

23.3.4.5.2 Performing an Initialization Display Update

Once all the panel timing and format parameters are defined, a command sequence must be sent to the EPDC with the properties found here.

- Update size must be full screen resolution
- HW_EPDC_UPD_CTRL[UPDATE_MODE] must be set to FULL
- HW_EPDC_UPD_CTRL[WAVEFORM_MODE] must be set to the INIT waveform (typically 0x00)
- HW_EPDC_UPD_CTRL[USE_FIXED] must be set
- HW_EPDC_UPD_FIXED[FIXNP_EN], FIXCP_EN must be set to 1, and FIXNP and FIXCP must be set to 0xFF

The use of HW_EPDC_UPD_FIXED allows the EPDC working buffer to be primed to a state that matches the result of the initialization waveform.

If the application loads the previous WB of the EPDC, these steps are not necessary.

23.3.5 Update Buffer Analysis Functions

EPDC can perform several analyses on the update buffer.

The information collected during processing will be reported to the register after update buffer processing is complete.

- **Collision Rectangle Detection**

For a collided update buffer, this function will report a minimal rectangle that can cover all collided pixels.

When a collision occurs, it's possible that not all, but only part of that update buffer generate a collision, so only the pixels inside a minimal collision rectangle need to be re-submitted.

Details of minimal collision rectangle reported in UPD_COL_CORD/
UPD_COL_SIZE.

- **Grey Level Detection (histogram)**

This function reports the minimal grey level that covers all pixels and which must be updated. This histogram differs from that of PXP; here we ignore those pixels which need no update, while the PXP histogram is calculated on the whole update buffer. The histogram feature is capable of reporting a histogram for 1, 2, 4, 8, or 16 grey levels. The valid grey levels value should be programmed into the HIST(1/2/4/8/16)_PARAM registers before using this functionality.

- **Dry-Run Mode**

Dry-Run mode allows the user to run an update for the purpose of obtaining information without performing any real action. This mode is enabled by setting UPD_CTRL[DRY_RUN] = 1 when writing UPD_CTRL register .

In this mode, Update Buffer will be read and checked against the current Working Buffer. As with a normal update, an interrupt will be generated when the Working Buffer processing completes.

Several pieces of information about the update can then be acquired from the EPDC registers: whether a collision occurred, the minimal collision area, and histogram data.. However, the result (Next Pixel, LUT info) will not be written back into the Working Buffer for further panel scan operation, nor will the LUT waveform be loaded.

The LUT resource specified by UPD_CTRL[LUT_SEL] is not used here; the user can start this dry-run update when no LUTs are available.

23.3.6 Waveform Mode Selection (AUTOWV)

This function is provided to support waveform selection based on the grey level (histogram) information collected during the update buffer processing stage.

Then AUTOWV LUT is provided to hold a mapping between the grey level of NP(pixel value from update buffer) and optimal waveform mode. This LUT mapping should be programmed before using this function by writing into the AUTOWV_LUT register with AUTOWV_LUT[ADDR]="grey level", AUTOWV_LUT[DATA]="waveform mode" for each possible grey level reported by the EPDC histogram.

After AUTOWV_LUT is programmed, AUTOWV mode can be enabled by setting UPD_CTRL[AUTOWV]=1. When enabling AUTOWV, the waveform mode written into UPD_CTRL[WAVEFORM_MODE] will be ignored and the loading waveform will initially be put on hold.

After the Update Buffer processing completes, EPDC reports the minimal grey level, retrieves the mapped waveform mode from AUTOWV LUT, and writes it back into UPD_CTRL[WAVEFORM_MODE].

If the user also sets UPD_CTRL[DRY_RUN], EPDC will be finished at this point.

Otherwise, EPDC continues with the following, depending upon the UPD_CTRL[AUTOWV_PAUSE] setting:

1. UPD_CTRL[AUTOWV_PAUSE] = 0, AUTO MODE)

EPDC will begin waveform loading immediately without any software interaction

2. UPD_CTRL[AUTOWV_PAUSE] = 1, MANUAL MODE)

EPDC waits for software to decide whether the selected waveform is ok, then if necessary software can use some other criteria to select a waveform mode. After software selects the waveform mode, it writes again into UPD_CTRL with final waveform mode, and waveform loading then panel scan will start.

NOTE

AUTOWV_PAUSE is extended for general use so that it can be used independent of AUTOWV feature. Regardless of whether AUTOWV is enabled or not, the user can send updates with AUTOWV_PAUSE=1. EPDC will stop after WB processing and pause before LUT loading and panel scan. Software can explicitly do that latter by writing to UPD_CTRL with AUTOWV_PAUSE=0. EPDC will ignore the Update Buffer for this time, and kick off the LUT loading and panel scanning. This feature allows SW modification to the working buffer after EPDC hardware has finished processing it.

23.3.7 Panel Interface Generator (Pigeon Mode)

There are seventeen panel interface signal outputs (DATA/SDCLK not included), each of them with dedicated timing purpose as default. This is called "Legacy Mode".

Pigeon Mode is a timing mode which can be independently enabled on any of the seventeen timing signals, with a unified flexible configuration. Signals within pigeon mode can be programmed into any supported signals, and are interchangeable.

The following are the legacy timing signals which support pigeon mode:

- PIGEON[00] - SDCE0
- PIGEON[01] - SDCE1
- PIGEON[02] - SDCE2
- PIGEON[03] - SDCE3
- PIGEON[04] - SDCE4
- PIGEON[05] - SDCE5
- PIGEON[06] - SDCE6
- PIGEON[07] - SDCE7
- PIGEON[08] - SDCE8
- PIGEON[09] - SDCE9
- PIGEON[10] - SDOE
- PIGEON[11] - SDL3
- PIGEON[12] - SDOEZ
- PIGEON[13] - SDOED
- PIGEON[14] - GDSP
- PIGEON[15] - GDOE

Working Theory

Each pigeon signal has one local counter with a configurable start point and incremental condition. It will be compared to configuration register value for signal assertion/de-assertion control, plus delta offset for data alignment and other options like polarity/logic operation. A detailed running scenario is as follows:

1. Start local counter on the MASK rising edge (reference point/start point)
2. Increment on event selected through INC_SEL
3. Count and match SET_CNT: assert signal, reset counter
(SET_CNT==0 means assert immediately on MASK's rising edge)
4. Count and match CLR_CNT: de-assert signal, stop counter
(CLR_CNT==0 means de-assert on MASK's falling edge)

NOTE

When local counter is running, further changes to MASK are not cared unless CLR_CNT==0

MASK - start point for local counter

Created using any combination of below options (ANDed)

1. STATE_MASK = (FS|FB|FD|FE) AND (LS|LB|LD|LE)

8 bits to select in which vertical/horizontal state your counter starts ticking. This is the most common use-case because timing signals generally relate to scan states.

For example, for a line timing signal start on Line Begin phase during Frame Begin/ Frame Data lines, use the configuration below:

Table 23-2. STATE_MASK combinations

STATE_MASK	LS	LB =1	LD	LE
FS				
FB =1		X		
FD =1		X		
FE				

2. MASK_CNT/MASK_CNT_SEL(global counter)

Sometimes a more accurate reference point is required, such as "line 20 in a frame", or "line 12 in Frame Begin state" or "pixel 23 in LD phase". For such use-cases, several Global Counters shared by all pigeons are provided. Global counter type (line counter/frame counter/state counter, etc.) is selected using MASK_CNT_SEL, when global counter matches the MASK_CNT value. The pigeon local counter will start ticking.

3. Use another pigeon signal as mask (SIG_LOGIC=MASK)

For some tightly coupled signals it is possible to use one as a reference to generate another.

INC_SEL- select local counter tick event

1. pclk - pixel clk
2. line - line start pulse
3. frame - frame start pulse
4. another - another pigeon signal

OFFSET- offset on pclk basis

Some signals need to come out slightly earlier or later than programmed. For example, the CE type signal usually aligns with the Line Data phase, but some panels need it as one cycle pulse before Line Data. The user can set `OFFSET` to a negative value to achieve this.

Global Counters (selectable through `MASK_CNT_SEL`)

- `HCNT / VCNT`
 - normal pclk counter / line counter
- `HSTATE_CNT / VSTATE_CNT`
 - similar to above, but reset when state changes
- `HSTATE_CYCLE / VSTATE_CYCLE`

(see figure below for definition of `CYCLE/PERIOD/CNT`)

Some panels have multiple Gate Drivers/Source Drivers, so Frame Data / Line Data state may be further split to match each driver, and signals such as `CE[n]` are only valid during part `n` of Line Data. For such signals, use `HW_EPDC_PIGEON_CTRL.*_PERIOD` to specify `PERIOD` where `CNT` is reset and `CYCLE` is included. Then the user can select `CYCLE` as `MASK_CNT` to generate mask for `CE[n]`.

- `FRAME_CNT / FRAME_CYCLE` (only for frame-crossing signals)

frame cycle counter doesn't have a reset condition; use `HW_EPDC_PIGEON_CTRL1.FRAME_CNT_CYCLES` to reset it.

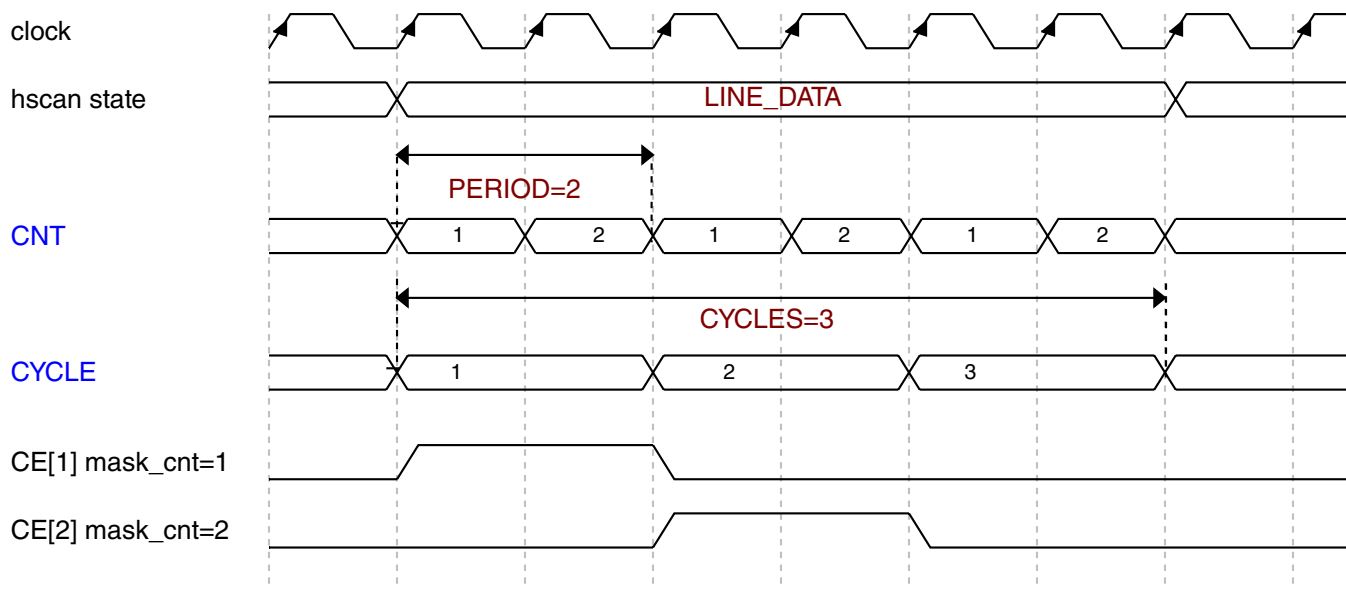

Figure 23-7. Definition of CNT, CYCLE, PERIOD

The following are register settings for the figure above:

- `HW_EPDC_PIGEON_CTRL0.LD_PERIOD=2`
- `MASK_CNT_SEL = 1 // HSTATE_CYCLE`
- `MASK_CNT = 1 // CE[1]`
- `MASK_CNT = 2 // CE[2]`

23.3.8 Display Update Programming

The EPDC is designed to communicate with the kernel driver through the interrupts and status registers.

The driver entry is always assumed to occur as a result of an interrupt.

23.3.8.1 Initiating a Display Update

The typical flow for performing a display update involves the following:

- `EPDC_STATUS[WB_BUSY]` must be 0. The EPDC cannot process new updates if it is currently processing an update.
- `EPDC_STATUS[LUTS_BUSY]` must be 0. The EPDC cannot accept new updates if all LUT resources are currently active.

Assuming both conditions above are met, an update request is programmed in the following manner (it is important to note that the last step must be writing to EPDC_UPD_CTRL which initiates the display update).

The following steps can be performed before WB_BUSY and LUTS_BUSY are clear:

- At this time it is assumed that the correct temperature is selected and written to EPDC_TEMP.
- EPDC_UPD_ADDR must be set to the 8-bit buffer for the update **if stride feature not enabled (when enabled stride feature, no requirement on align)**. This buffer must be aligned to a 64-bit word address. In addition, each line address must begin at a 64-bit word address. Both criteria can be met by utilizing the PXP pixel processing engine which always aligns lines at a 64-bit raster (see [Memory Requirements](#) for details).
- EPDC_UPD_CORD defines the insertion co-ordinate into the panel resolution.
- EPDC_UPD_SIZE defines the dimension of the update (pixels).
- EPDC_UPD_FIXED is used for panel initialization or rectangular fill operations.

Writing the EPDC_UPD_CTRL register initiates a display update:

- USE_FIXED-This field is set when EPDC_UPD_FIXED is used.
- LUT_SEL-The driver should read EPDC_STATUS_NEXLUT[NEXT_LUT] (qualified by NEXT_LUT_VALID) to select an available LUT to assign this update.
- WAVEFORM_MODE selects the E-INK waveform mode (for example, INIT, DU, GC16 and so on). The number corresponds to the waveform number in the waveform specification document.
- UPDATE_MODE selects one of two enumerated updated modes.
 - FULL-In this mode, all pixels defined in the update rectangle have the waveform applied.
 - PARTIAL-In this mode, the EPDC shall only apply the waveform to pixels which are changing, otherwise the EPDC_FORMAT[DEFAULT_TFT_PIXEL] is applied to the pixels which are not changing.

23.3.8.2 Update Processing and Collisions

After the update is initiated (by writing EPDC_UPD_CTRL), the EPDC performs update-buffer processing. This involves processing this update region into its working buffer (WB).

During this time, the EPDC also performs collision detection. At the end of the WB processing, the EPDC asserts the WB_CMPLT_IRQ interrupt. If a collision is detected, the LUT_COL_IRQ interrupt status bit will also be asserted.

The EPDC performs image updates to the EPD by applying waveforms to individual pixels. Waveforms are applied to groups of pixels (ranging from a single pixel to the entire display). Each individual update request is bound to a rectangle. Each pixel within this rectangle has a waveform applied to it using the waveform and update mode specified in EPDC_UPD_CTRL. After this process is initiated, a waveform takes an amount of time to complete which is usually determined by the specifications of the waveform mode. For proper display operation and optimum performance, a waveform must not be interrupted once it has begun.

A collision is defined simply as the interruption of the application of waveform to a pixel or group of pixels. As such, it must be avoided. Because the waveforms take a finite amount of time to complete, the EPDC provides a mechanism to automatically manage collisions, which allows the application to perform multiple updates resulting in a richer user experience without having to be cognizant of the panel and waveform characteristics.

Depending on the update mode (FULL or PARTIAL) a collision is defined as follows:

- For a full-update mode, a collision is defined as the temporal and spatial union of rectangles pertaining to active unique update requests. An active update is one which is still in the process of being updated (that is, a waveform is being applied).
- For a partial-update mode, a collision is defined as the temporal, spatial and differential union of pixels pertaining to unique update requests which are active. The difference between a full-updated and a partial-updated collision is that in the latter case, the collision state occurs only if the next-pixel states differ between the updates. Thus, two partial-update rectangles may intersect, but if all of the pixels in the intersecting update regions are being updated to the same gray-state, the original update and associated LUT/waveform are not disturbed and the intersection does not constitute a collision.
- It should be noted that collisions may be a one-to-many effect. In the case of partial updates, there may be a spatial and temporal union of rectangles with no differential pixel-level union. A subsequent update however might form such a pixel-level differential union to all active updates. Since each update pertains to an active LUT, these many collided updates are referred to as victim LUTs. The update/LUT that caused the collision is referred to as the aggressor LUT.

An example of a partial-update mode collision is shown in the following figure. Each update encompasses the outer rectangle which meets the criteria of the spatial union. The red areas show the pixels which are currently transitioning to gray (from update 1) but need to transition to white (in update 2). These pixels meet the criteria of the differential union and lastly in the temporal domain, the period of time where LUT0 and LUT1 overlap is the temporal union. The pixels that did not change (grey and green areas in the LUT assignment box) are not part of the collision area. In the case of the gray

overlapping pixels, LUT0 can continue to update. In the case of the white pixels (which were previously inactive) a new LUT (if available) can be assigned and forms the green region. Note that a subsequent update could potentially collide with the green pixels in update 2.

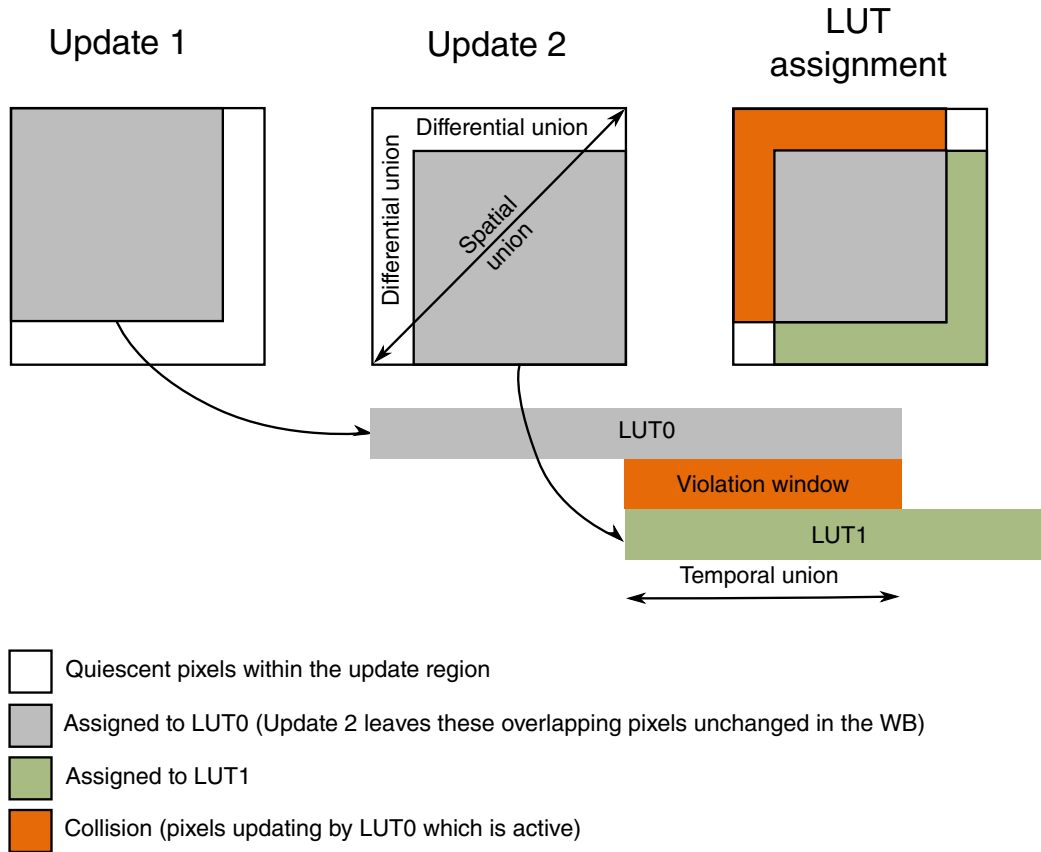

Figure 23-8. Partial Update Collision Handling

NOTE

For FULL update modes, a collision occurs at any intersection of active rectangles/LUTs because in FULL update mode, all pixels within the update rectangle have the waveform applied (even if pixel values are not changing).

It can be seen that when collision is detected (during the WB update process), the EPDC will "block" the collided pixels being updated, and any pixels which are not collided will be assigned to the requested LUT process. When a collision occurs, the EPDC will raise the LUT_COL_IRQ interrupt status bit (this will always happen in conjunction with WB_CMPLT_IRQ).

Because the driver is always entered via an interrupt, when the EPDC interrupt fires, driver should not only check for WB_CMPLT_IRQ but also for the LUT_COL_IRQ status bit within the EPDC_IRQ register. If LUT_COL_IRQ is set, this means that a

collision has occurred. If this is the case the driver should check the value of the EPDC_STATUS_COL register. This register contains one bit for each LUT that has been collided with, that is, it holds the vector of the victim LUTs as a result of the last update LUT. Since the driver knows the value of the LUT of the last update, it can store this update LUT value along with this associated victim LUT vector in a collision list.

Because the EPDC can drive up to 16 concurrent updates (which can be overlapping when using PARTIAL mode updates), a unique interrupt status bit is provided per LUT so that when an update completes (physically completes the waveform), the SW driver can know which LUT completed. In addition to the LUT completion interrupts (which are mapped into the EPDC_IRQ[LUTn_CMPLT_IRQ] interrupt status bits), the current state of each LUT can also be read from the EPDC_STATUS_LUTS status register.

The driver can use the LUT status interrupts in conjunction with EPDC_STATUS_LUTS to perform regular checks on the completion of victim LUTs against the vectors stored for each colliding LUT in the collision list. The driver may also choose to serialize updates such that it might wait until all victim LUTs have completed before re-issuing the colliding update.

The figure below shows a more extended sequence of a collision. In this case there are a series of updates coming from the application layer. They are A, B, C and D. Updates A, B, and C are set without any collision. When update D is requested a collision is detected. Using the interrupt status collision registers, the SW-driver stores D in a collision-list. For that list entry it also store B which is the victim LUT. It uses this information to check when a LUT completes to see if the victim LUTs for any update in the collision list have completed. If they have completed (through a LUT completion interrupt), the SW-driver then sends this update (D in this case) again to the EPDC. It should be noted that from the application perspective it appears that all updates A, B, C and D have been accepted, that is, the collision handling is completely hidden from user-space. Using the collision detection and LUT status interrupts, the application (in conjunction with the driver) could also choose to completely serialize the requests (such that between the first and second D update, no other update is accepted).

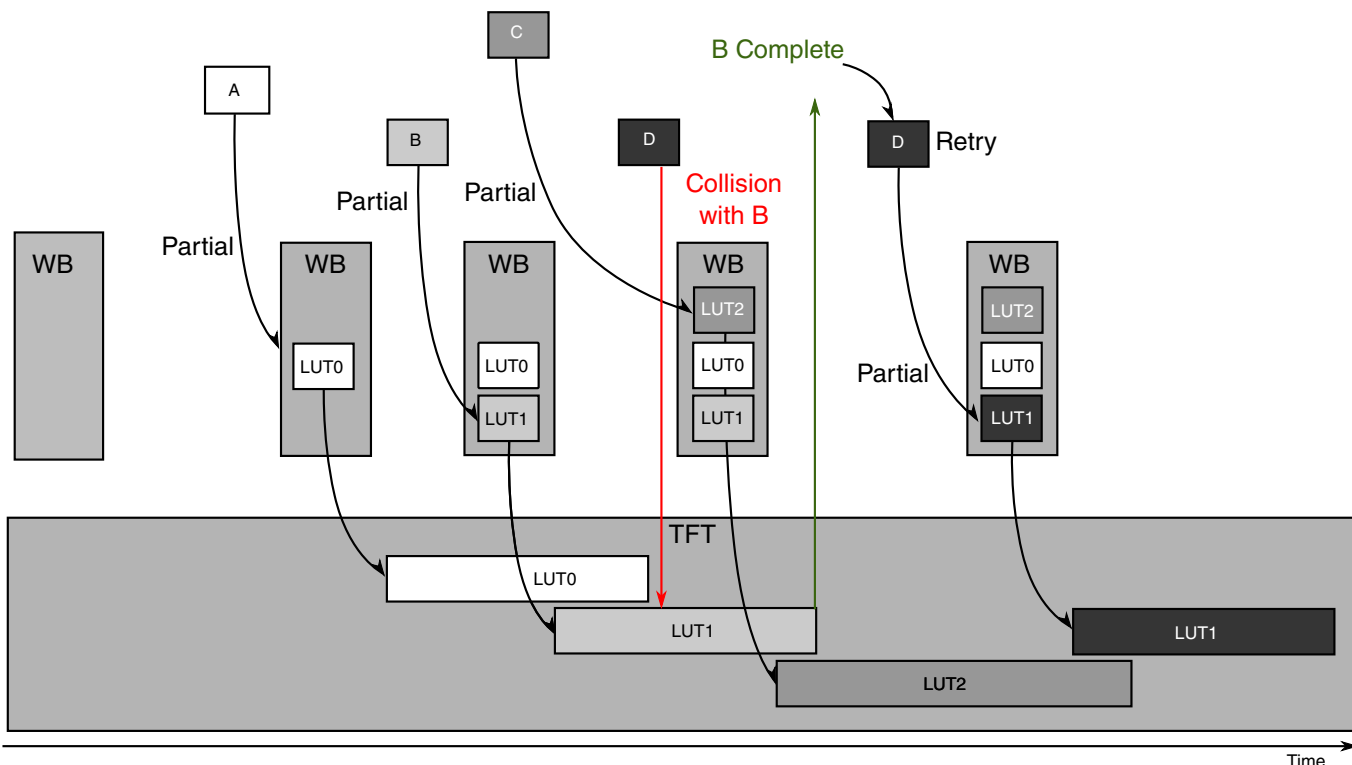

Figure 23-9. Collision Sequence

23.3.8.3 Multiple Update Flow

In most applications, such as e-book readers, besides full-screen page turns, user interfaces require multiple updates to be performed.

Examples of this include cursors, pen input, drop-down menus (with highlighting) and other movable graphical objects. Each update takes such a limited amount of time to complete (up to 1 second depending on the waveform mode) that it would be too prohibitive to only process updates serially.

As described in [Initiating a Display Update](#), there are two conditions that must be met before the SW driver can issue a new update request:

- The Working buffer (WB) update process must be complete.
- There must be an available LUT.

Assuming a free LUT is available, the EPDC is designed to have the capability to start new updates at each TFT frame scan (even being able to commence multiple updates within a frame scan blanking period). The general flow for sequential updates (concurrent or serialized) is shown in the following figure.

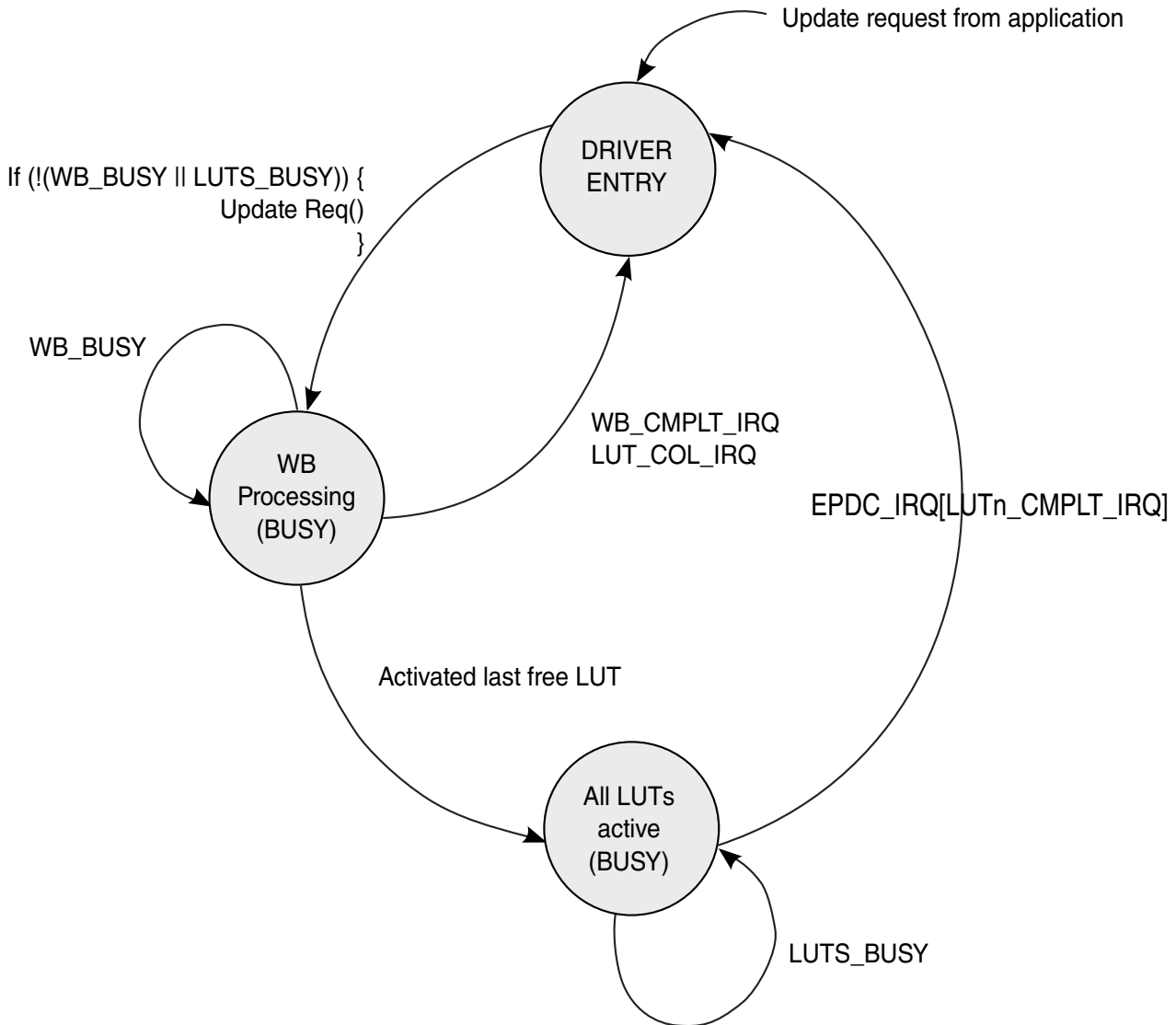

Figure 23-10. Driver Update Flow

This flow assumes that the driver is entered via interrupts. The two busy states are shown to illustrate the conditions under which the driver will not issue new updates. In general, the driver should be throttled by the `WB_CMPLT_IRQ` interrupt. Because the EPDC can support up to 64 concurrent updates, it is possible to re-enter the update-request (shown as `Update_Req()` in the figure above) any-time that the WB is not busy (even though LUTs are active and the display is being updated). It is possible that when there are 63 LUTs currently active and a new update is sent, there will be a `WB_CMPLT_IRQ` interrupt issued, but the driver at that time would be in a busy state (because `LUTS_BUSY` is signaled). The driver will be re-entered on the next `LUTn_CMPLT_IRQ` interrupt during which time it can issue a new update (since `WB_BUSY` and `LUTS_BUSY` status bits are low).

The update-processing process (which is controlled by the MBM module) is asynchronous to the actual TFT refresh operations (which carry out the physical screen updates), so there is no particular relationship between the WB_BUSY status and the state of the screen update. In contrast, the LUTn_CMPLT_IRQ interrupt status and EPDC_STATUS_LUTS provide the status of the physical waveform update. This means that when LUTn_CMPLT_IRQ interrupt fires, it means that the last physical TFT frame scan just completed for that update/LUT.

The EPDC implements proprietary methods to efficiently process the WB such that the WB processing time (the time from the SW driver writing EPDC_UPD_CTRL to EPDC_IRQ[WB_CMPLT_IRQ] fires), is dependent on the size of the update rectangle. This allows smaller updates to be processed faster. In most EPD applications, this is ideal because it's typically smaller sprites that require the fastest performance. In addition, the EPDC implements methods to allow store pending updates and activate them on the next available frame-scan. For example, if the TFT scanning is currently in the active region and during this time a series of small update requests are sent, the EPDC can begin all of those updates on the next available blanking period.

The figure below shows an example of two larger update requests, one to LUT4 and one to LUT5. These update requests are shown in the context of active LUTs and thus active frame scan times. The time when both WB_BUSY and LUT_BUSY is high are defined as "blocking" because no new updates can be accepted. It should also be noted that new updates are physically commenced by the EPDC on blanking periods. From a SW programming model perspective, the EPDC_STATUS_LUTS[LUTn_STATUS] is activated immediately upon the update request being written to the EPDC. The physical frame-scanning for this particular update does not being commenced until the next available frame scan.

It should be noted that updates and WB processing can actually occur during the blanking period (or can begin in the active scan time and continue into the blanking period). For this reason, the EPDC provides some tuning controls via EPDC_TCE_CTRL[VSCAN_HOLDOFF] such that more time can be given to finish processing update request and less time "locking down" the set of LUTs that will be activated for the upcoming active scan. The EPDC will start to pre-fill its refresh pixel FIFOs after the VSCAN_HOLDOFF period. Its possible to tune this value to allow the minimum time for the pixel FIFO pre-fill operation (making sure that refresh under-runs do not occur). If a pixel-FIFO under-run occurs, EPDC_IRQ[TCE_UNDERRUN_IRQ] will fire.

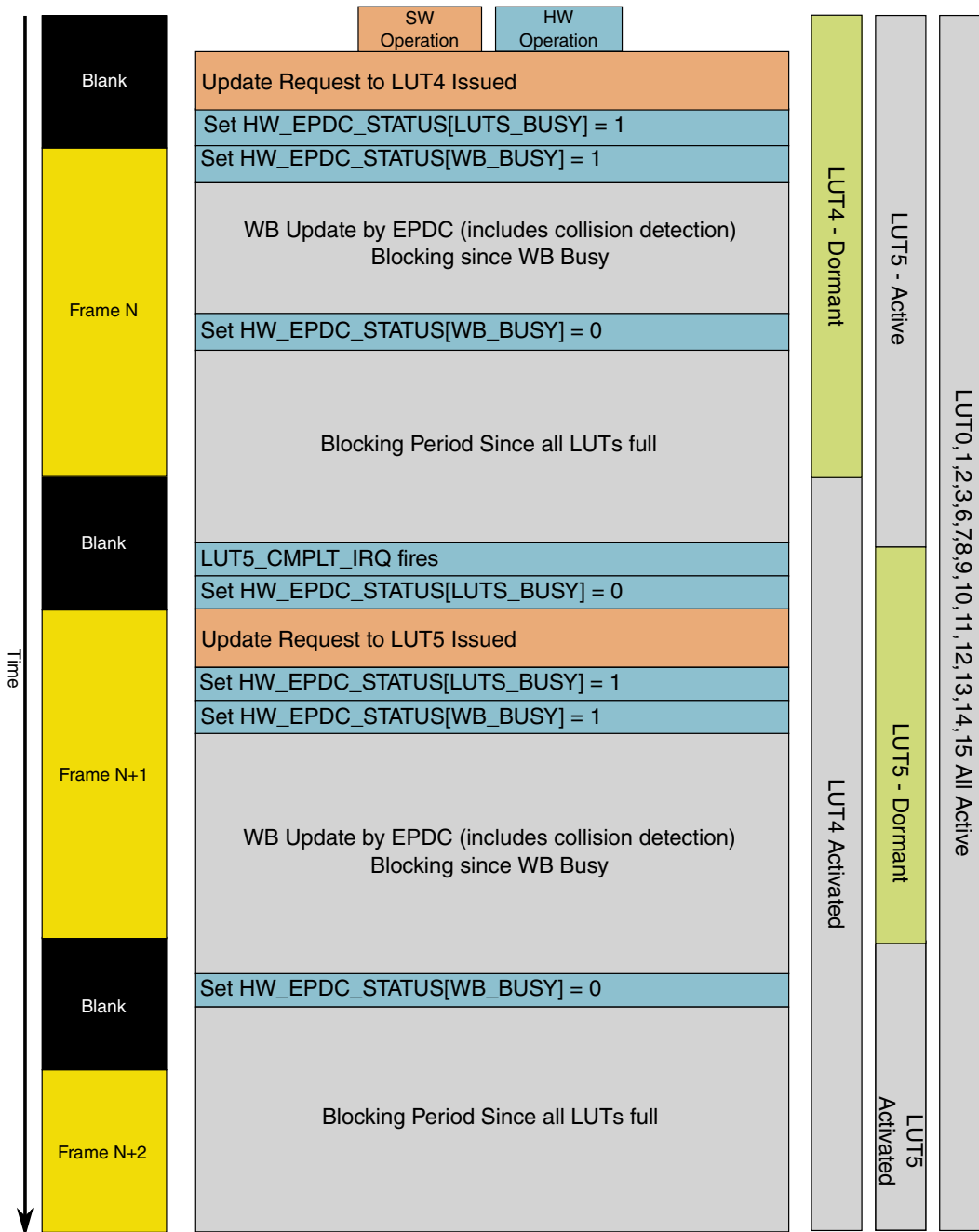

Figure 23-11. Temporal Flow of Update Processing

23.3.9 Architectural Clock Gating (Low Power Mode)

As with most modern IP, the EPDC contains low-level hardware controlled automatic clock gating throughout the design.

These clock gating elements typically gate clocks locally for individual or groups of sequential elements (flip flops) when these registers are not currently active.

This tier of clock gating is useful for reducing power during active operation of the EPDC.

Most e-paper applications utilizing EPDs involve the processor and display controller to be a low-power inactive state in most of the time. This is because EPDs only require refresh operations when the display content is being updated. As such, in between update operations, the EPDC provides a module level clock-gating feature that can be controlled by the SW driver as part of a higher-level power management solution.

The EPDC module can have all its clocks completely gated-off by the setting of EPDC_CTRL[CLKGATE]. There are a couple of considerations that the SW driver must adhere to before placing the EPDC into this low power state:

- All active LUTs (updates) must complete
- Any TFT operations must be complete (including any final blanking operations)

In order to maximize display update frequency (the ability accept new updates during each frame scan), the LUT completion interrupts fire on the end of the last frame's active scan period for that update. This means that the TCE still must complete the final FRAME_END blanking time to guarantee coherency of its state machines with the panel state (receiving the final LUT completion IRQ is not enough to determine that the EPDC can have all of its clocks shut down). Based on this, the EPDC provides the necessary interrupt and status bits to allow the driver to correctly perform the clock-gating operation by using the following method:

- Once the final EPDC_IRQ[LUTn_CMPLT_IRQ] is reached, the driver should enable the TCE_IDLE interrupt mask bit via EPDC_IRQ_MASK[TCE_IDLE_IRQ_EN], unmask other interrupts and return.
- Once the final blanking time of the last LUT (FRAME_END time) is completed and the TCE reaches its idle state, the EPDC will assert the EPDC_IRQ[TCE_IDLE_IRQ] interrupt which will cause the driver to re-enter. At this point, the SW knows that the EPDC is in a completely idle state and can perform a set on EPDC_CTRL[CLKGATE].

Alternative implementations of the driver could simply involve polling for the EPDC_IRQ[TCE_IDLE_IRQ] interrupt status bit (which operates regardless of the interrupt being masked or not) before setting the clock gate (this prevents two iterations of interrupt based driver-entry, but requires a wait loop in the interrupt handler which might be undesirable).

It should be noted that the time interval between the last LUTs LUTn_CMPLT_IRQ time and TCE_IDLE_IRQ interrupt is equal to the FRAME_END time.

When the application is ready to send more updates, the driver can immediately re-enable the EPDC by un-gating the module-level clock by clearing the EPDC_CTRL[CLKGATE] field. This un-gating of the clock is instant and the driver is free to immediately send update requests.

23.3.10 Performance Tuning and Considerations

The EPDC is designed to meet the performance requirements of the most demanding e-paper applications. These performance targets must be met in the context of highly integrated SoCs.

In such a context, system memory is typically shared across multiple masters including the Arm platform. Because of this, there is no guarantee of latency from system memory. EPDC provides a number of mechanisms to deal with this as well as some ability to tune various parameters allowing the user to trade-off between update processing performance and refresh functionality.

23.3.10.1 Memory and Bus Bandwidth Requirements

The EPDC MBM module contains up to 6 internal AXI requesting functions (5 read and 1 write). These are arbitrated internally before being sent to the SoC memory system.

The EPDC interfaces to the SoC bus system via a dual-channel 64-bit AXI bus master port. The following table shows the various internal requesters and their properties. Note that there are two round-robin (RR) loops. Because there is only one write source, and the EPDC supports dual-channel AXI, there is no arbitration on the WB write operations.

Table 23-3. EPDC Bus Requestor Profiles

Operation	Priority	Burst Length (x8 Bytes)	Maximum Outstanding Transactions	FIFO size
Waveform LUT read	0	8	2	16x68
WB pixel read FIFO0 (refresh)	RR 1	8 or 16	8	256x64
WB pixel read FIFO1 (refresh)	RR 1	8 or 16	8	256x64
WB read for update processing	RR 2	8	2	16x64
WB write for update processing	N/A	8	2	16x64
UPD read for update processing	RR 2	8	2	16x64

As described in [Memory Requirements](#), it can be seen that all lines in a buffer are padded to the nearest 8 byte boundary. This is important to be noted for the bandwidth calculations. The maximum bandwidth scenario involves processing a full-screen update

while performing refresh operations, but refresh operations always have the highest priority. Based on this, the memory bandwidth required by the EPDC is a function of the refresh pixel rate which in turn is a function of resolution, frame-rate and blanking/active time.

The refresh bandwidth can be calculated as follows:

Active Time = Active time of the frame-scan time as a fraction (for example, 0.8)

Frame Rate = TFT frame refresh rate (Hz) (for example, 106 Hz)

Bandwidth (MB/s) = roundup4(EPDC_RES[HORIZONTAL]) x
EPDC_RES[VERTICAL] x Frame Rate x (1/Active Time) x 2 x (1/1024²)

For example, a panel with resolution 2048 x 1536 with 106 Hz refresh and estimated 80% active time, 20% blanking time, the refresh bandwidth is:

$BW \text{ (MB/S)} = 2048 \times 1536 \times 106 \times (1/0.8) \times 2 \times (1/1024^2) = 795 \text{ MB/s}$

(Note that $2048 \bmod 4 = 0$.)

The WB requires 2 bytes per pixel.

Remaining bandwidth is used for other operations. Because update processing operations are not real-time (they do not necessarily have to occur at the refresh frame-rate), the time required to perform the update can be calculated as a function of the available bandwidth (actual bandwidth minus refresh bandwidth) and the update size.

23.3.10.2 Pixel Latency FIFO

The EPDC contains one working buffer latency FIFO which is used to load working buffer pixel data which is used by the TCE to perform the panel refresh operations.

The FIFO is sized at 1024 pixels each in order to provide significant system memory latency tolerance. The pixel FIFO is dedicated for the main screen.

Under no circumstance should the EPDC pixel FIFO reach an under-run condition. The EPDC provides an interrupt status bit to flag such a condition (TCE_UNDERRUN_IRQ). During development, this interrupt must be enabled. The pixel values stored in the FIFO are using by the TCE to perform look-up operations (from the LUTs) to generate TFT voltage control pixels. If an under-run occurs, the result will be unknown data being used as the source for the look-ups, which can damage the panel.

23.3.10.3 Basic Watermarking Control

The EPDC provides a basic pixel pre-fetching control mechanism that is applied to the beginning of a new update (from an idle state). This control is provided by EPDC_FIFOCTRL[FIFO_INIT_LEVEL].

The control allows the value to be set between 0-255, with a reset value of 128. Because the internal width of the FIFO holds 4-pixels per entry, the actual number of pixels is $(\text{FIFO_INIT_LEVEL}+1) \times 4$.

The EPDC uses this value to pre-fill the pixel latency FIFO(s) to this level before the TCE commences the refresh operations which drive the update to the panel. This control has no effect on the FIFO(s) when the EPDC is performing sequential frame-scans.

It must be noted that this value must be set less than $(\text{EPDC_RES}[\text{VERTICAL}] \times \text{EPDC_RE}[\text{HORIZONTAL}]) / 4$.

23.3.10.4 Update/Refresh Tuning (VSCAN_HOLD OFF)

During active frame-scan time, the EPDC provides the ability to process and display new update requests, because all pixels in the WB pertaining to a particular update are bound to a single LUT.

Until all pixels pertaining to that update have been processed in the WB, its LUT cannot be activated. As shown in [Figure 23-11](#), the blanking period provides time to pre-load the pixel FIFOs and for completing WB processing updates and loading the associated frame of waveform data into LUT memories.

The EPDC_TCE_CTRL[VSCAN_HOLD OFF] control field allows control over the vertical blanking period allotment for working buffer processing and pre-loading of the pixel FIFO. The time window defined by VSCAN_HOLD OFF is allotted for working-buffer processing and LUT loading (of newly processed updates). The remainder of the time is allotted for pre-filling the pixel FIFO.

Note that aggressive use of VSCAN_HOLD OFF can result in pixel FIFO under-run as the FIFO pre-fill time is compromised.

23.3.10.5 System-Level Arbitration Control

As previously mentioned, the TCE refresh operation is time critical.

Because the EPDC is designed to be integrated into a multimaster SoC, system memory is shared between multiple requesters in the system.

The EPDC provides a dynamic Quality of Service (QoS) priority elevation mechanism that can be leveraged at the SoC level.

The EPDC_FIFOCTRL registers can be used to drive the `epdc_panic` output signal during times when the EPDC requests require priority elevation. As long as `epdc_panic` is asserted, transaction requests from the EPDC will have their priority elevated at the SoC-level bus arbitration control points.

The registers and associated functionality are as follows:

- EPDC_FIFOCTRL[ENABLE_PRIORITY] must be set to enable `epdc_panic` functionality.
- EPDC_FIFOCTRL[FIFO_L_LEVEL] determines FIFO threshold which causes `epdc_panic` to assert when crossed.
- EPDC_FIFOCTRL[FIFO_H_LEVEL] once `epdc_panic` has been asserted due to the pixel FIFO(s) crossing FIFO_L_LEVEL, this value, which must be set higher than FIFO_L_LEVEL, determines the point at which `epdc_panic` will de-assert as the FIFO(s) fills.

Note that the delta between FIFO_H_LEVEL and FIFO_L_LEVEL is intended as a de-bounce mechanism. The purpose is to avoid a constant panic situation, which would cause thrashing of the `epdc_panic` signal.

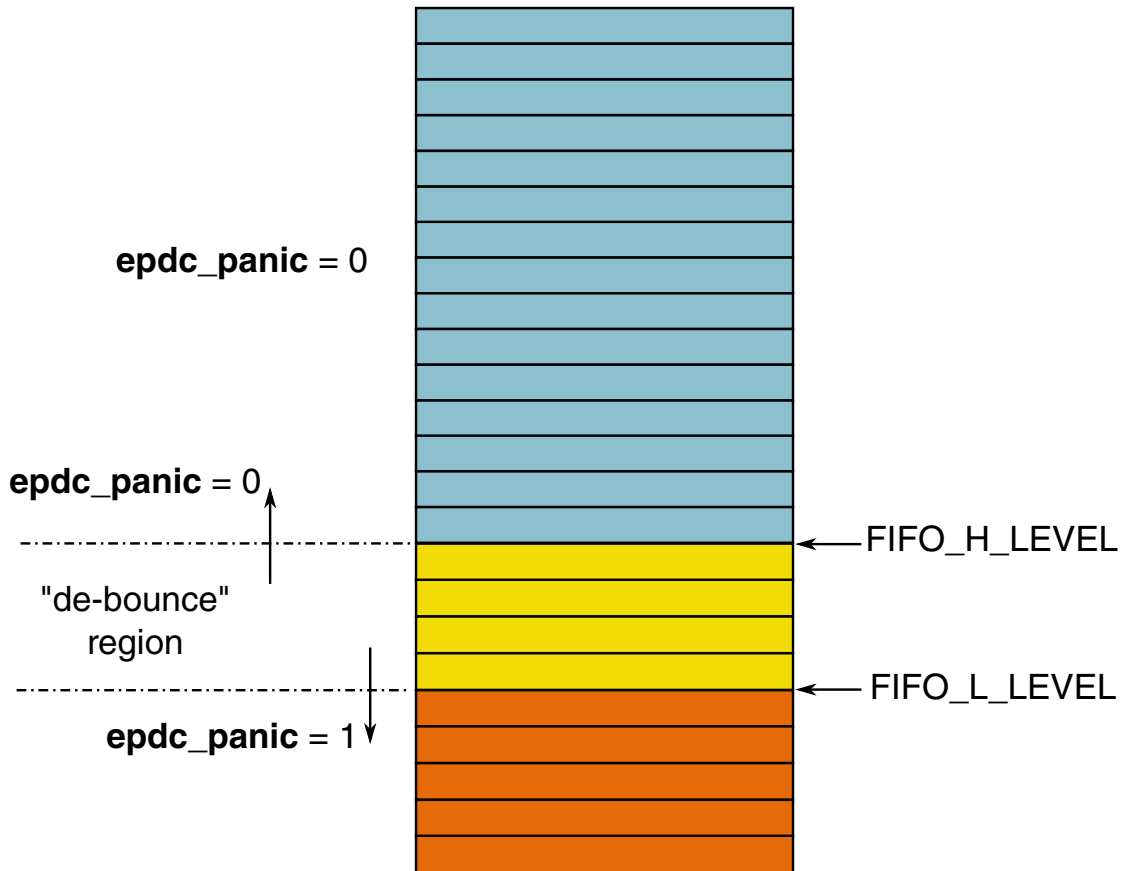

Figure 23-12. FIFO Priority Elevation

23.4 EPDC Memory Map/Register Definition

EPDC Register Format Summary

EPDC memory map

Absolute address (hex)	Register name	Width (in bits)	Access	Reset value	Section/page
228_C000	EPDC Control Register (EPDC_CTRL)	32	R/W	C000_0000h	23.4.1/1080
228_C004	EPDC Control Register (EPDC_CTRL_SET)	32	R/W	C000_0000h	23.4.1/1080
228_C008	EPDC Control Register (EPDC_CTRL_CLR)	32	R/W	C000_0000h	23.4.1/1080
228_C00C	EPDC Control Register (EPDC_CTRL_TOG)	32	R/W	C000_0000h	23.4.1/1080
228_C010	EPDC Working Buffer Address for TCE (EPDC_WB_ADDR_TCE)	32	R/W	0000_0000h	23.4.2/1082
228_C020	EPDC Waveform Address Pointer (EPDC_WVADDR)	32	R/W	0000_0000h	23.4.3/1082
228_C030	EPDC Working Buffer Address (EPDC_WB_ADDR)	32	R/W	0000_0000h	23.4.4/1083

Table continues on the next page...

EPDC memory map (continued)

Absolute address (hex)	Register name	Width (in bits)	Access	Reset value	Section/page
228_C040	EPDC Screen Resolution (EPDC_RES)	32	R/W	0000_0000h	23.4.5/1083
228_C050	EPDC Format Control Register (EPDC_FORMAT)	32	R/W	0000_0000h	23.4.6/1084
228_C054	EPDC Format Control Register (EPDC_FORMAT_SET)	32	R/W	0000_0000h	23.4.6/1084
228_C058	EPDC Format Control Register (EPDC_FORMAT_CLR)	32	R/W	0000_0000h	23.4.6/1084
228_C05C	EPDC Format Control Register (EPDC_FORMAT_TOG)	32	R/W	0000_0000h	23.4.6/1084
228_C060	Working Buffer Field Setting (EPDC_WB_FIELD0)	32	R/W	0000_8AA5h	23.4.7/1086
228_C070	Working Buffer Field Setting (EPDC_WB_FIELD1)	32	R/W	0000_A003h	23.4.8/1087
228_C080	Working Buffer Field Setting (EPDC_WB_FIELD2)	32	R/W	0000_C443h	23.4.9/1088
228_C090	Working Buffer Field Setting (EPDC_WB_FIELD3)	32	R/W	0000_6880h	23.4.10/1089
228_C0A0	EPDC FIFO control register (EPDC_FIFCTRL)	32	R/W	0080_0000h	23.4.11/1089
228_C0A4	EPDC FIFO control register (EPDC_FIFCTRL_SET)	32	R/W	0080_0000h	23.4.11/1089
228_C0A8	EPDC FIFO control register (EPDC_FIFCTRL_CLR)	32	R/W	0080_0000h	23.4.11/1089
228_C0AC	EPDC FIFO control register (EPDC_FIFCTRL_TOG)	32	R/W	0080_0000h	23.4.11/1089
228_C100	EPDC Update Region Address (EPDC_UPD_ADDR)	32	R/W	0000_0000h	23.4.12/1090
228_C110	EPDC Update Region Stride (EPDC_UPD_STRIDE)	32	R/W	0000_0000h	23.4.13/1091
228_C120	EPDC Update Command Co-ordinate (EPDC_UPD_CORD)	32	R/W	0000_0000h	23.4.14/1092
228_C140	EPDC Update Command Size (EPDC_UPD_SIZE)	32	R/W	0000_0000h	23.4.15/1092
228_C160	EPDC Update Command Control (EPDC_UPD_CTRL)	32	R/W	0000_0000h	23.4.16/1093
228_C164	EPDC Update Command Control (EPDC_UPD_CTRL_SET)	32	R/W	0000_0000h	23.4.16/1093
228_C168	EPDC Update Command Control (EPDC_UPD_CTRL_CLR)	32	R/W	0000_0000h	23.4.16/1093
228_C16C	EPDC Update Command Control (EPDC_UPD_CTRL_TOG)	32	R/W	0000_0000h	23.4.16/1093
228_C180	EPDC Update Fixed Pixel Control (EPDC_UPD_FIXED)	32	R/W	0000_0000h	23.4.17/1094
228_C184	EPDC Update Fixed Pixel Control (EPDC_UPD_FIXED_SET)	32	R/W	0000_0000h	23.4.17/1094
228_C188	EPDC Update Fixed Pixel Control (EPDC_UPD_FIXED_CLR)	32	R/W	0000_0000h	23.4.17/1094
228_C18C	EPDC Update Fixed Pixel Control (EPDC_UPD_FIXED_TOG)	32	R/W	0000_0000h	23.4.17/1094

Table continues on the next page...

EPDC memory map (continued)

Absolute address (hex)	Register name	Width (in bits)	Access	Reset value	Section/page
228_C1A0	EPDC Temperature Register (EPDC_TEMP)	32	R/W	0000_0000h	23.4.18/ 1095
228_C1C0	Waveform Mode Lookup Table Control Register. (EPDC_AUTOWV_LUT)	32	R/W	0000_0000h	23.4.19/ 1095
228_C1E0	EPDC LUT Standby Register for LUT 31~0 (EPDC_LUT_STANDBY1)	32	R/W	0000_0000h	23.4.20/ 1096
228_C1E4	EPDC LUT Standby Register for LUT 31~0 (EPDC_LUT_STANDBY1_SET)	32	R/W	0000_0000h	23.4.20/ 1096
228_C1E8	EPDC LUT Standby Register for LUT 31~0 (EPDC_LUT_STANDBY1_CLR)	32	R/W	0000_0000h	23.4.20/ 1096
228_C1EC	EPDC LUT Standby Register for LUT 31~0 (EPDC_LUT_STANDBY1_TOG)	32	R/W	0000_0000h	23.4.20/ 1096
228_C1F0	EPDC LUT Standby Register for LUT 63~32 (EPDC_LUT_STANDBY2)	32	R/W	0000_0000h	23.4.21/ 1096
228_C1F4	EPDC LUT Standby Register for LUT 63~32 (EPDC_LUT_STANDBY2_SET)	32	R/W	0000_0000h	23.4.21/ 1096
228_C1F8	EPDC LUT Standby Register for LUT 63~32 (EPDC_LUT_STANDBY2_CLR)	32	R/W	0000_0000h	23.4.21/ 1096
228_C1FC	EPDC LUT Standby Register for LUT 63~32 (EPDC_LUT_STANDBY2_TOG)	32	R/W	0000_0000h	23.4.21/ 1096
228_C200	EPDC Timing Control Engine Control Register (EPDC_TCE_CTRL)	32	R/W	0000_0010h	23.4.22/ 1096
228_C204	EPDC Timing Control Engine Control Register (EPDC_TCE_CTRL_SET)	32	R/W	0000_0010h	23.4.22/ 1096
228_C208	EPDC Timing Control Engine Control Register (EPDC_TCE_CTRL_CLR)	32	R/W	0000_0010h	23.4.22/ 1096
228_C20C	EPDC Timing Control Engine Control Register (EPDC_TCE_CTRL_TOG)	32	R/W	0000_0010h	23.4.22/ 1096
228_C220	EPDC Timing Control Engine Source-Driver Config Register (EPDC_TCE_SDCFG)	32	R/W	0000_0000h	23.4.23/ 1099
228_C224	EPDC Timing Control Engine Source-Driver Config Register (EPDC_TCE_SDCFG_SET)	32	R/W	0000_0000h	23.4.23/ 1099
228_C228	EPDC Timing Control Engine Source-Driver Config Register (EPDC_TCE_SDCFG_CLR)	32	R/W	0000_0000h	23.4.23/ 1099
228_C22C	EPDC Timing Control Engine Source-Driver Config Register (EPDC_TCE_SDCFG_TOG)	32	R/W	0000_0000h	23.4.23/ 1099
228_C240	EPDC Timing Control Engine Gate-Driver Config Register (EPDC_TCE_GDCFG)	32	R/W	0000_0000h	23.4.24/ 1100
228_C244	EPDC Timing Control Engine Gate-Driver Config Register (EPDC_TCE_GDCFG_SET)	32	R/W	0000_0000h	23.4.24/ 1100
228_C248	EPDC Timing Control Engine Gate-Driver Config Register (EPDC_TCE_GDCFG_CLR)	32	R/W	0000_0000h	23.4.24/ 1100
228_C24C	EPDC Timing Control Engine Gate-Driver Config Register (EPDC_TCE_GDCFG_TOG)	32	R/W	0000_0000h	23.4.24/ 1100

Table continues on the next page...

EPDC memory map (continued)

Absolute address (hex)	Register name	Width (in bits)	Access	Reset value	Section/page
228_C260	EPDC Timing Control Engine Horizontal Timing Register 1 (EPDC_TCE_HSCAN1)	32	R/W	0000_0000h	23.4.25/1101
228_C264	EPDC Timing Control Engine Horizontal Timing Register 1 (EPDC_TCE_HSCAN1_SET)	32	R/W	0000_0000h	23.4.25/1101
228_C268	EPDC Timing Control Engine Horizontal Timing Register 1 (EPDC_TCE_HSCAN1_CLR)	32	R/W	0000_0000h	23.4.25/1101
228_C26C	EPDC Timing Control Engine Horizontal Timing Register 1 (EPDC_TCE_HSCAN1_TOG)	32	R/W	0000_0000h	23.4.25/1101
228_C280	EPDC Timing Control Engine Horizontal Timing Register 2 (EPDC_TCE_HSCAN2)	32	R/W	0000_0000h	23.4.26/1101
228_C284	EPDC Timing Control Engine Horizontal Timing Register 2 (EPDC_TCE_HSCAN2_SET)	32	R/W	0000_0000h	23.4.26/1101
228_C288	EPDC Timing Control Engine Horizontal Timing Register 2 (EPDC_TCE_HSCAN2_CLR)	32	R/W	0000_0000h	23.4.26/1101
228_C28C	EPDC Timing Control Engine Horizontal Timing Register 2 (EPDC_TCE_HSCAN2_TOG)	32	R/W	0000_0000h	23.4.26/1101
228_C2A0	EPDC Timing Control Engine Vertical Timing Register (EPDC_TCE_VSCAN)	32	R/W	0000_0000h	23.4.27/1102
228_C2A4	EPDC Timing Control Engine Vertical Timing Register (EPDC_TCE_VSCAN_SET)	32	R/W	0000_0000h	23.4.27/1102
228_C2A8	EPDC Timing Control Engine Vertical Timing Register (EPDC_TCE_VSCAN_CLR)	32	R/W	0000_0000h	23.4.27/1102
228_C2AC	EPDC Timing Control Engine Vertical Timing Register (EPDC_TCE_VSCAN_TOG)	32	R/W	0000_0000h	23.4.27/1102
228_C2C0	EPDC Timing Control Engine OE timing control Register (EPDC_TCE_OE)	32	R/W	0000_0000h	23.4.28/1102
228_C2C4	EPDC Timing Control Engine OE timing control Register (EPDC_TCE_OE_SET)	32	R/W	0000_0000h	23.4.28/1102
228_C2C8	EPDC Timing Control Engine OE timing control Register (EPDC_TCE_OE_CLR)	32	R/W	0000_0000h	23.4.28/1102
228_C2CC	EPDC Timing Control Engine OE timing control Register (EPDC_TCE_OE_TOG)	32	R/W	0000_0000h	23.4.28/1102
228_C2E0	EPDC Timing Control Engine Driver Polarity Register (EPDC_TCE_POLARITY)	32	R/W	0000_001Eh	23.4.29/1103
228_C2E4	EPDC Timing Control Engine Driver Polarity Register (EPDC_TCE_POLARITY_SET)	32	R/W	0000_001Eh	23.4.29/1103
228_C2E8	EPDC Timing Control Engine Driver Polarity Register (EPDC_TCE_POLARITY_CLR)	32	R/W	0000_001Eh	23.4.29/1103
228_C2EC	EPDC Timing Control Engine Driver Polarity Register (EPDC_TCE_POLARITY_TOG)	32	R/W	0000_001Eh	23.4.29/1103
228_C300	EPDC Timing Control Engine Timing Register 1 (EPDC_TCE_TIMING1)	32	R/W	0000_0000h	23.4.30/1104
228_C304	EPDC Timing Control Engine Timing Register 1 (EPDC_TCE_TIMING1_SET)	32	R/W	0000_0000h	23.4.30/1104

Table continues on the next page...

EPDC memory map (continued)

Absolute address (hex)	Register name	Width (in bits)	Access	Reset value	Section/page
228_C308	EPDC Timing Control Engine Timing Register 1 (EPDC_TCE_TIMING1_CLR)	32	R/W	0000_0000h	23.4.30/1104
228_C30C	EPDC Timing Control Engine Timing Register 1 (EPDC_TCE_TIMING1_TOG)	32	R/W	0000_0000h	23.4.30/1104
228_C310	EPDC Timing Control Engine Timing Register 2 (EPDC_TCE_TIMING2)	32	R/W	0000_0001h	23.4.31/1105
228_C314	EPDC Timing Control Engine Timing Register 2 (EPDC_TCE_TIMING2_SET)	32	R/W	0000_0001h	23.4.31/1105
228_C318	EPDC Timing Control Engine Timing Register 2 (EPDC_TCE_TIMING2_CLR)	32	R/W	0000_0001h	23.4.31/1105
228_C31C	EPDC Timing Control Engine Timing Register 2 (EPDC_TCE_TIMING2_TOG)	32	R/W	0000_0001h	23.4.31/1105
228_C320	EPDC Timing Control Engine Timing Register 3 (EPDC_TCE_TIMING3)	32	R/W	0000_0001h	23.4.32/1106
228_C324	EPDC Timing Control Engine Timing Register 3 (EPDC_TCE_TIMING3_SET)	32	R/W	0000_0001h	23.4.32/1106
228_C328	EPDC Timing Control Engine Timing Register 3 (EPDC_TCE_TIMING3_CLR)	32	R/W	0000_0001h	23.4.32/1106
228_C32C	EPDC Timing Control Engine Timing Register 3 (EPDC_TCE_TIMING3_TOG)	32	R/W	0000_0001h	23.4.32/1106
228_C380	EPDC Pigeon Mode Control Register 0 (EPDC_PIGEON_CTRL0)	32	R/W	0000_0000h	23.4.33/1106
228_C384	EPDC Pigeon Mode Control Register 0 (EPDC_PIGEON_CTRL0_SET)	32	R/W	0000_0000h	23.4.33/1106
228_C388	EPDC Pigeon Mode Control Register 0 (EPDC_PIGEON_CTRL0_CLR)	32	R/W	0000_0000h	23.4.33/1106
228_C38C	EPDC Pigeon Mode Control Register 0 (EPDC_PIGEON_CTRL0_TOG)	32	R/W	0000_0000h	23.4.33/1106
228_C390	EPDC Pigeon Mode Control Register 1 (EPDC_PIGEON_CTRL1)	32	R/W	0000_0000h	23.4.34/1107
228_C394	EPDC Pigeon Mode Control Register 1 (EPDC_PIGEON_CTRL1_SET)	32	R/W	0000_0000h	23.4.34/1107
228_C398	EPDC Pigeon Mode Control Register 1 (EPDC_PIGEON_CTRL1_CLR)	32	R/W	0000_0000h	23.4.34/1107
228_C39C	EPDC Pigeon Mode Control Register 1 (EPDC_PIGEON_CTRL1_TOG)	32	R/W	0000_0000h	23.4.34/1107
228_C3C0	EPDC IRQ Mask Register for LUT 0~31 (EPDC_IRQ_MASK1)	32	R/W	0000_0000h	23.4.35/1107
228_C3C4	EPDC IRQ Mask Register for LUT 0~31 (EPDC_IRQ_MASK1_SET)	32	R/W	0000_0000h	23.4.35/1107
228_C3C8	EPDC IRQ Mask Register for LUT 0~31 (EPDC_IRQ_MASK1_CLR)	32	R/W	0000_0000h	23.4.35/1107
228_C3CC	EPDC IRQ Mask Register for LUT 0~31 (EPDC_IRQ_MASK1_TOG)	32	R/W	0000_0000h	23.4.35/1107

Table continues on the next page...

EPDC memory map (continued)

Absolute address (hex)	Register name	Width (in bits)	Access	Reset value	Section/page
228_C3D0	EPDC IRQ Mask Register for LUT 32~63 (EPDC_IRQ_MASK2)	32	R/W	0000_0000h	23.4.36/1108
228_C3D4	EPDC IRQ Mask Register for LUT 32~63 (EPDC_IRQ_MASK2_SET)	32	R/W	0000_0000h	23.4.36/1108
228_C3D8	EPDC IRQ Mask Register for LUT 32~63 (EPDC_IRQ_MASK2_CLR)	32	R/W	0000_0000h	23.4.36/1108
228_C3DC	EPDC IRQ Mask Register for LUT 32~63 (EPDC_IRQ_MASK2_TOG)	32	R/W	0000_0000h	23.4.36/1108
228_C3E0	EPDC Interrupt Register for LUT 0~31 (EPDC_IRQ1)	32	R/W	0000_0000h	23.4.37/1108
228_C3E4	EPDC Interrupt Register for LUT 0~31 (EPDC_IRQ1_SET)	32	R/W	0000_0000h	23.4.37/1108
228_C3E8	EPDC Interrupt Register for LUT 0~31 (EPDC_IRQ1_CLR)	32	R/W	0000_0000h	23.4.37/1108
228_C3EC	EPDC Interrupt Register for LUT 0~31 (EPDC_IRQ1_TOG)	32	R/W	0000_0000h	23.4.37/1108
228_C3F0	EPDC Interrupt Register for LUT 32~63 (EPDC_IRQ2)	32	R/W	0000_0000h	23.4.38/1108
228_C3F4	EPDC Interrupt Register for LUT 32~63 (EPDC_IRQ2_SET)	32	R/W	0000_0000h	23.4.38/1108
228_C3F8	EPDC Interrupt Register for LUT 32~63 (EPDC_IRQ2_CLR)	32	R/W	0000_0000h	23.4.38/1108
228_C3FC	EPDC Interrupt Register for LUT 32~63 (EPDC_IRQ2_TOG)	32	R/W	0000_0000h	23.4.38/1108
228_C400	EPDC IRQ Mask Register (EPDC_IRQ_MASK)	32	R/W	0000_0000h	23.4.39/1109
228_C404	EPDC IRQ Mask Register (EPDC_IRQ_MASK_SET)	32	R/W	0000_0000h	23.4.39/1109
228_C408	EPDC IRQ Mask Register (EPDC_IRQ_MASK_CLR)	32	R/W	0000_0000h	23.4.39/1109
228_C40C	EPDC IRQ Mask Register (EPDC_IRQ_MASK_TOG)	32	R/W	0000_0000h	23.4.39/1109
228_C420	EPDC Interrupt Register (EPDC_IRQ)	32	R/W	0000_0000h	23.4.40/1110
228_C424	EPDC Interrupt Register (EPDC_IRQ_SET)	32	R/W	0000_0000h	23.4.40/1110
228_C428	EPDC Interrupt Register (EPDC_IRQ_CLR)	32	R/W	0000_0000h	23.4.40/1110
228_C42C	EPDC Interrupt Register (EPDC_IRQ_TOG)	32	R/W	0000_0000h	23.4.40/1110
228_C440	EPDC Status Register - LUTs (EPDC_STATUS_LUTS1)	32	R/W	0000_0000h	23.4.41/1111
228_C444	EPDC Status Register - LUTs (EPDC_STATUS_LUTS1_SET)	32	R/W	0000_0000h	23.4.41/1111

Table continues on the next page...

EPDC memory map (continued)

Absolute address (hex)	Register name	Width (in bits)	Access	Reset value	Section/page
228_C448	EPDC Status Register - LUTs (EPDC_STATUS_LUTS1_CLR)	32	R/W	0000_0000h	23.4.41/ 1111
228_C44C	EPDC Status Register - LUTs (EPDC_STATUS_LUTS1_TOG)	32	R/W	0000_0000h	23.4.41/ 1111
228_C450	EPDC Status Register - LUTs (EPDC_STATUS_LUTS2)	32	R/W	0000_0000h	23.4.42/ 1112
228_C454	EPDC Status Register - LUTs (EPDC_STATUS_LUTS2_SET)	32	R/W	0000_0000h	23.4.42/ 1112
228_C458	EPDC Status Register - LUTs (EPDC_STATUS_LUTS2_CLR)	32	R/W	0000_0000h	23.4.42/ 1112
228_C45C	EPDC Status Register - LUTs (EPDC_STATUS_LUTS2_TOG)	32	R/W	0000_0000h	23.4.42/ 1112
228_C460	EPDC Status Register - Next Available LUT (EPDC_STATUS_NEXTLUT)	32	R/W	0000_013Fh	23.4.43/ 1112
228_C480	EPDC LUT Collision Status (EPDC_STATUS_COL1)	32	R/W	0000_0000h	23.4.44/ 1114
228_C484	EPDC LUT Collision Status (EPDC_STATUS_COL1_SET)	32	R/W	0000_0000h	23.4.44/ 1114
228_C488	EPDC LUT Collision Status (EPDC_STATUS_COL1_CLR)	32	R/W	0000_0000h	23.4.44/ 1114
228_C48C	EPDC LUT Collision Status (EPDC_STATUS_COL1_TOG)	32	R/W	0000_0000h	23.4.44/ 1114
228_C490	EPDC LUT Collision Status (EPDC_STATUS_COL2)	32	R/W	0000_0000h	23.4.45/ 1114
228_C494	EPDC LUT Collision Status (EPDC_STATUS_COL2_SET)	32	R/W	0000_0000h	23.4.45/ 1114
228_C498	EPDC LUT Collision Status (EPDC_STATUS_COL2_CLR)	32	R/W	0000_0000h	23.4.45/ 1114
228_C49C	EPDC LUT Collision Status (EPDC_STATUS_COL2_TOG)	32	R/W	0000_0000h	23.4.45/ 1114
228_C4A0	EPDC General Status Register (EPDC_STATUS)	32	R	0000_0008h	23.4.46/ 1115
228_C4A4	EPDC General Status Register (EPDC_STATUS_SET)	32	R	0000_0008h	23.4.46/ 1115
228_C4A8	EPDC General Status Register (EPDC_STATUS_CLR)	32	R	0000_0008h	23.4.46/ 1115
228_C4AC	EPDC General Status Register (EPDC_STATUS_TOG)	32	R	0000_0008h	23.4.46/ 1115
228_C4C0	EPDC Collision Region Co-ordinate (EPDC_UPD_COL_CORD)	32	R/W	0000_0000h	23.4.47/ 1116
228_C4E0	EPDC Collision Region Size (EPDC_UPD_COL_SIZE)	32	R/W	0000_0000h	23.4.48/ 1117
228_C600	1-level Histogram Parameter Register. (EPDC_HIST1_PARAM)	32	R/W	0000_0000h	23.4.49/ 1117

Table continues on the next page...

EPDC memory map (continued)

Absolute address (hex)	Register name	Width (in bits)	Access	Reset value	Section/page
228_C610	2-level Histogram Parameter Register. (EPDC_HIST2_PARAM)	32	R/W	0000_0F00h	23.4.50/ 1118
228_C620	4-level Histogram Parameter Register. (EPDC_HIST4_PARAM)	32	R/W	0F0A_0500h	23.4.51/ 1119
228_C630	8-level Histogram Parameter 0 Register. (EPDC_HIST8_PARAM0)	32	R/W	0604_0200h	23.4.52/ 1119
228_C640	8-level Histogram Parameter 1 Register. (EPDC_HIST8_PARAM1)	32	R/W	0F0D_0B09h	23.4.53/ 1120
228_C650	16-level Histogram Parameter 0 Register. (EPDC_HIST16_PARAM0)	32	R/W	0302_0100h	23.4.54/ 1121
228_C660	16-level Histogram Parameter Register. (EPDC_HIST16_PARAM1)	32	R/W	0706_0504h	23.4.55/ 1122
228_C670	16-level Histogram Parameter Register. (EPDC_HIST16_PARAM2)	32	R/W	0B0A_0908h	23.4.56/ 1122
228_C680	16-level Histogram Parameter Register. (EPDC_HIST16_PARAM3)	32	R/W	0F0E_0D0Ch	23.4.57/ 1123
228_C700	EPDC General Purpose I/O Debug register (EPDC_GPIO)	32	R/W	0000_0000h	23.4.58/ 1124
228_C704	EPDC General Purpose I/O Debug register (EPDC_GPIO_SET)	32	R/W	0000_0000h	23.4.58/ 1124
228_C708	EPDC General Purpose I/O Debug register (EPDC_GPIO_CLR)	32	R/W	0000_0000h	23.4.58/ 1124
228_C70C	EPDC General Purpose I/O Debug register (EPDC_GPIO_TOG)	32	R/W	0000_0000h	23.4.58/ 1124
228_C7F0	EPDC Version Register (EPDC_VERSION)	32	R/W	0300_0000h	23.4.59/ 1125
228_C800	Panel Interface Signal Generator Register 0_0 (EPDC_PIGEON_0_0)	32	R/W	0000_0F00h	23.4.60/ 1126
228_C810	Panel Interface Signal Generator Register 0_1 (EPDC_PIGEON_0_1)	32	R/W	0000_0000h	23.4.61/ 1127
228_C820	Panel Interface Signal Generator Register 0_1 (EPDC_PIGEON_0_2)	32	R/W	0000_0000h	23.4.62/ 1127
228_C840	Panel Interface Signal Generator Register 1_0 (EPDC_PIGEON_1_0)	32	R/W	0000_0F00h	23.4.63/ 1128
228_C850	Panel Interface Signal Generator Register 1_1 (EPDC_PIGEON_1_1)	32	R/W	0000_0000h	23.4.64/ 1129
228_C860	Panel Interface Signal Generator Register 1_1 (EPDC_PIGEON_1_2)	32	R/W	0000_0000h	23.4.65/ 1130
228_C880	Panel Interface Signal Generator Register 2_0 (EPDC_PIGEON_2_0)	32	R/W	0000_0F00h	23.4.66/ 1130
228_C890	Panel Interface Signal Generator Register 2_1 (EPDC_PIGEON_2_1)	32	R/W	0000_0000h	23.4.67/ 1132
228_C8A0	Panel Interface Signal Generator Register 2_1 (EPDC_PIGEON_2_2)	32	R/W	0000_0000h	23.4.68/ 1132

Table continues on the next page...

EPDC memory map (continued)

Absolute address (hex)	Register name	Width (in bits)	Access	Reset value	Section/page
228_C8C0	Panel Interface Signal Generator Register 3_0 (EPDC_PIGEON_3_0)	32	R/W	0000_0F00h	23.4.69/1133
228_C8D0	Panel Interface Signal Generator Register 3_1 (EPDC_PIGEON_3_1)	32	R/W	0000_0000h	23.4.70/1134
228_C8E0	Panel Interface Signal Generator Register 3_1 (EPDC_PIGEON_3_2)	32	R/W	0000_0000h	23.4.71/1134
228_C900	Panel Interface Signal Generator Register 4_0 (EPDC_PIGEON_4_0)	32	R/W	0000_0F00h	23.4.72/1135
228_C910	Panel Interface Signal Generator Register 4_1 (EPDC_PIGEON_4_1)	32	R/W	0000_0000h	23.4.73/1136
228_C920	Panel Interface Signal Generator Register 4_1 (EPDC_PIGEON_4_2)	32	R/W	0000_0000h	23.4.74/1137
228_C940	Panel Interface Signal Generator Register 5_0 (EPDC_PIGEON_5_0)	32	R/W	0000_0F00h	23.4.75/1137
228_C950	Panel Interface Signal Generator Register 5_1 (EPDC_PIGEON_5_1)	32	R/W	0000_0000h	23.4.76/1139
228_C960	Panel Interface Signal Generator Register 5_1 (EPDC_PIGEON_5_2)	32	R/W	0000_0000h	23.4.77/1139
228_C980	Panel Interface Signal Generator Register 6_0 (EPDC_PIGEON_6_0)	32	R/W	0000_0F00h	23.4.78/1140
228_C990	Panel Interface Signal Generator Register 6_1 (EPDC_PIGEON_6_1)	32	R/W	0000_0000h	23.4.79/1141
228_C9A0	Panel Interface Signal Generator Register 6_1 (EPDC_PIGEON_6_2)	32	R/W	0000_0000h	23.4.80/1141
228_C9C0	Panel Interface Signal Generator Register 7_0 (EPDC_PIGEON_7_0)	32	R/W	0000_0F00h	23.4.81/1142
228_C9D0	Panel Interface Signal Generator Register 7_1 (EPDC_PIGEON_7_1)	32	R/W	0000_0000h	23.4.82/1143
228_C9E0	Panel Interface Signal Generator Register 7_1 (EPDC_PIGEON_7_2)	32	R/W	0000_0000h	23.4.83/1144
228_CA00	Panel Interface Signal Generator Register 8_0 (EPDC_PIGEON_8_0)	32	R/W	0000_0F00h	23.4.84/1144
228_CA10	Panel Interface Signal Generator Register 8_1 (EPDC_PIGEON_8_1)	32	R/W	0000_0000h	23.4.85/1146
228_CA20	Panel Interface Signal Generator Register 8_1 (EPDC_PIGEON_8_2)	32	R/W	0000_0000h	23.4.86/1146
228_CA40	Panel Interface Signal Generator Register 9_0 (EPDC_PIGEON_9_0)	32	R/W	0000_0F00h	23.4.87/1147
228_CA50	Panel Interface Signal Generator Register 9_1 (EPDC_PIGEON_9_1)	32	R/W	0000_0000h	23.4.88/1148
228_CA60	Panel Interface Signal Generator Register 9_1 (EPDC_PIGEON_9_2)	32	R/W	0000_0000h	23.4.89/1148
228_CA80	Panel Interface Signal Generator Register 10_0 (EPDC_PIGEON_10_0)	32	R/W	0000_0F00h	23.4.90/1149

Table continues on the next page...

EPDC memory map (continued)

Absolute address (hex)	Register name	Width (in bits)	Access	Reset value	Section/page
228_CA90	Panel Interface Signal Generator Register 10_1 (EPDC_PIGEON_10_1)	32	R/W	0000_0000h	23.4.91/1150
228_CAA0	Panel Interface Signal Generator Register 10_1 (EPDC_PIGEON_10_2)	32	R/W	0000_0000h	23.4.92/1151
228_CAC0	Panel Interface Signal Generator Register 11_0 (EPDC_PIGEON_11_0)	32	R/W	0000_0F00h	23.4.93/1151
228_CAD0	Panel Interface Signal Generator Register 11_1 (EPDC_PIGEON_11_1)	32	R/W	0000_0000h	23.4.94/1153
228_CAE0	Panel Interface Signal Generator Register 11_1 (EPDC_PIGEON_11_2)	32	R/W	0000_0000h	23.4.95/1153
228_CB00	Panel Interface Signal Generator Register 12_0 (EPDC_PIGEON_12_0)	32	R/W	0000_0F00h	23.4.96/1154
228_CB10	Panel Interface Signal Generator Register 12_1 (EPDC_PIGEON_12_1)	32	R/W	0000_0000h	23.4.97/1155
228_CB20	Panel Interface Signal Generator Register 12_1 (EPDC_PIGEON_12_2)	32	R/W	0000_0000h	23.4.98/1155
228_CB40	Panel Interface Signal Generator Register 13_0 (EPDC_PIGEON_13_0)	32	R/W	0000_0F00h	23.4.99/1156
228_CB50	Panel Interface Signal Generator Register 13_1 (EPDC_PIGEON_13_1)	32	R/W	0000_0000h	23.4.100/1157
228_CB60	Panel Interface Signal Generator Register 13_1 (EPDC_PIGEON_13_2)	32	R/W	0000_0000h	23.4.101/1158
228_CB80	Panel Interface Signal Generator Register 14_0 (EPDC_PIGEON_14_0)	32	R/W	0000_0F00h	23.4.102/1158
228_CB90	Panel Interface Signal Generator Register 14_1 (EPDC_PIGEON_14_1)	32	R/W	0000_0000h	23.4.103/1160
228_CBA0	Panel Interface Signal Generator Register 14_1 (EPDC_PIGEON_14_2)	32	R/W	0000_0000h	23.4.104/1160
228_CBC0	Panel Interface Signal Generator Register 15_0 (EPDC_PIGEON_15_0)	32	R/W	0000_0F00h	23.4.105/1161
228_CBD0	Panel Interface Signal Generator Register 15_1 (EPDC_PIGEON_15_1)	32	R/W	0000_0000h	23.4.106/1162
228_CBE0	Panel Interface Signal Generator Register 15_1 (EPDC_PIGEON_15_2)	32	R/W	0000_0000h	23.4.107/1162
228_CC00	Panel Interface Signal Generator Register 16_0 (EPDC_PIGEON_16_0)	32	R/W	0000_0F00h	23.4.108/1163
228_CC10	Panel Interface Signal Generator Register 16_1 (EPDC_PIGEON_16_1)	32	R/W	0000_0000h	23.4.109/1164
228_CC20	Panel Interface Signal Generator Register 16_1 (EPDC_PIGEON_16_2)	32	R/W	0000_0000h	23.4.110/1165

23.4.1 EPDC Control Register (EPDC_CTRLn)

EPDC Main control register

This register controls various high-level functions of the EPDC

EXAMPLE

```

/* Reset */
__raw_writel(EPDC_CTRL_SFTRST, EPDC_CTRL_SET);
while (!(__raw_readl(EPDC_CTRL) & EPDC_CTRL_CLKGATE))
;
__raw_writel(EPDC_CTRL_SFTRST, EPDC_CTRL_CLEAR);

/* Enable clock gating (clear to enable) */
__raw_writel(EPDC_CTRL_CLKGATE, EPDC_CTRL_CLEAR);
while (__raw_readl(EPDC_CTRL) & (EPDC_CTRL_SFTRST | EPDC_CTRL_CLKGATE))
;

/* EPDC_CTRL */
reg_val = __raw_readl(EPDC_CTRL);
reg_val &= ~EPDC_CTRL_UPD_DATA_SWIZZLE_MASK;
reg_val |= EPDC_CTRL_UPD_DATA_SWIZZLE_NO_SWAP;
reg_val &= ~EPDC_CTRL_LUT_DATA_SWIZZLE_MASK;
reg_val |= EPDC_CTRL_LUT_DATA_SWIZZLE_NO_SWAP;
__raw_writel(reg_val, EPDC_CTRL_SET);

```

Address: 228_C000h base + 0h offset + (4d × i), where i=0d to 3d

Bit	31	30	29	28	27	26	25	24	23	22	21	20	19	18	17	16
R	SFTRST		CLKGATE		Reserved											
Reset	1	1	0	0	0	0	0	0	0	0	0	0	0	0	0	0
Bit	15	14	13	12	11	10	9	8	7	6	5	4	3	2	1	0
R	Reserved								UPD_DATA_SWIZZLE		LUT_DATA_SWIZZLE		Reserved			
Reset	0	0	0	0	0	0	0	0	0	0	0	0	0	0	0	0

EPDC_CTRL_n field descriptions

Field	Description
31 SFTRST	Set this bit to zero to enable normal EPDC operation. Set this bit to one (default) to disable clocking with the EPDC and hold it in its reset (lowest power) state. This bit can be turned on and then off to reset the EPDC block to its default state.
30 CLKGATE	This bit must be set to zero for normal operation. When set to one it gates off the clocks to the block.
29–8 -	This field is reserved. Reserved.
7–6 UPD_DATA_SWIZZLE	Specifies how to swap the bytes for the UPD data before the WB construction. Please note this swizzle operate right after data fetch from bus, no matter it's aligned access or not. Supported configurations: 0x0 NO_SWAP — No byte swapping.(Little endian) 0x1 ALL_BYTES_SWAP — Swizzle all bytes, swap bytes 0,3 and 1,2 (aka Big Endian). 0x2 HWD_SWAP — Swap half-words. 0x3 HWD_BYTE_SWAP — Swap bytes within each half-word.

Table continues on the next page...

EPDC_CTRLn field descriptions (continued)

Field	Description
5-4 LUT_DATA_SWIZZLE	Specifies how to swap the bytes for the LUT data before store to LUTRAM. Supported configurations: 0x0 NO_SWAP — No byte swapping.(Little endian) 0x1 ALL_BYTES_SWAP — Swizzle all bytes, swap bytes 0,3 and 1,2 (aka Big Endian). 0x2 HWD_SWAP — Swap half-words. 0x3 HWD_BYTE_SWAP — Swap bytes within each half-word.
-	This field is reserved. Reserved.

23.4.2 EPDC Working Buffer Address for TCE (EPDC_WB_ADDR_TCE)

EPDC Working Buffer Address for TCE

Address: 228_C000h base + 10h offset = 228_C010h

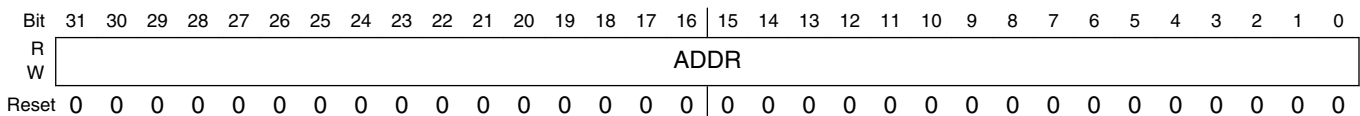

EPDC_WB_ADDR_TCE field descriptions

Field	Description
ADDR	Address for EPDC working buffer. This address must be a aligned to a 64-bit double-word boundary.

23.4.3 EPDC Waveform Address Pointer (EPDC_WVADDR)

EPDC Waveform Address Pointer

EXAMPLE

```

/* Reset */
__raw_writel(EPDC_CTRL_SFTRST, EPDC_CTRL_SET);
while (!(__raw_readl(EPDC_CTRL) & EPDC_CTRL_CLKGATE))
;
__raw_writel(EPDC_CTRL_SFTRST, EPDC_CTRL_CLEAR);

/* Enable clock gating (clear to enable) */
__raw_writel(EPDC_CTRL_CLKGATE, EPDC_CTRL_CLEAR);
while (__raw_readl(EPDC_CTRL) & (EPDC_CTRL_SFTRST | EPDC_CTRL_CLKGATE))
;

/* EPDC_CTRL */
reg_val = __raw_readl(EPDC_CTRL);
reg_val &= ~EPDC_CTRL_UPD_DATA_SWIZZLE_MASK;
reg_val |= EPDC_CTRL_UPD_DATA_SWIZZLE_NO_SWAP;
    
```

```
reg_val &= ~EPDC_CTRL_LUT_DATA_SWIZZLE_MASK;
reg_val |= EPDC_CTRL_LUT_DATA_SWIZZLE_NO_SWAP;
__raw_writel(reg_val, EPDC_CTRL_SET);
```

Address: 228_C000h base + 20h offset = 228_C020h

Bit	31	30	29	28	27	26	25	24	23	22	21	20	19	18	17	16	15	14	13	12	11	10	9	8	7	6	5	4	3	2	1	0
R																																
W																																
Reset	0	0	0	0	0	0	0	0	0	0	0	0	0	0	0	0	0	0	0	0	0	0	0	0	0	0	0	0	0	0	0	0

EPDC_WVADDR field descriptions

Field	Description
ADDR	Start address of waveform tables. This address needs to be aligned to a 64-bit word boundary.

23.4.4 EPDC Working Buffer Address (EPDC_WB_ADDR)

EPDC Working Buffer Address

This register points to the address of current working buffer.

Address: 228_C000h base + 30h offset = 228_C030h

Bit	31	30	29	28	27	26	25	24	23	22	21	20	19	18	17	16	15	14	13	12	11	10	9	8	7	6	5	4	3	2	1	0
R																																
W																																
Reset	0	0	0	0	0	0	0	0	0	0	0	0	0	0	0	0	0	0	0	0	0	0	0	0	0	0	0	0	0	0	0	0

EPDC_WB_ADDR field descriptions

Field	Description
ADDR	Address for EPDC working buffer. This address must be aligned to a 64-bit double-word boundary.

23.4.5 EPDC Screen Resolution (EPDC_RES)

EPDC Screen Resolution.

This register defines the horizontal and vertical resolution of the target display panel

Address: 228_C000h base + 40h offset = 228_C040h

Bit	31	30	29	28	27	26	25	24	23	22	21	20	19	18	17	16	15	14	13	12	11	10	9	8	7	6	5	4	3	2	1	0
R																																
W																																
Reset	0	0	0	0	0	0	0	0	0	0	0	0	0	0	0	0	0	0	0	0	0	0	0	0	0	0	0	0	0	0	0	0

EPDC_RES field descriptions

Field	Description
31-29 -	This field is reserved. Reserved.
28-16 VERTICAL	Vertical Resolution (in pixels)
15-13 -	This field is reserved. Reserved.
HORIZONTAL	Horizontal Resolution (in pixels)

23.4.6 EPDC Format Control Register (EPDC_FORMATn)

EPDC Pixel format control register. Defines formats for buffer and TFT pixels.

This register controls various functions throughout the digital portion of the chip.

EXAMPLE

```

/* EPDC_FORMAT - 2bit TFT and 4bit Buf pixel format */
reg_val = EPDC_FORMAT_TFT_PIXEL_FORMAT_2BIT
          | EPDC_FORMAT_BUF_PIXEL_FORMAT_P4N
          | ((0x0 << EPDC_FORMAT_DEFAULT_TFT_PIXEL_OFFSET) &
            EPDC_FORMAT_DEFAULT_TFT_PIXEL_MASK);
__raw_writel(reg_val, EPDC_FORMAT);
    
```

Address: 228_C000h base + 50h offset + (4d × i), where i=0d to 3d

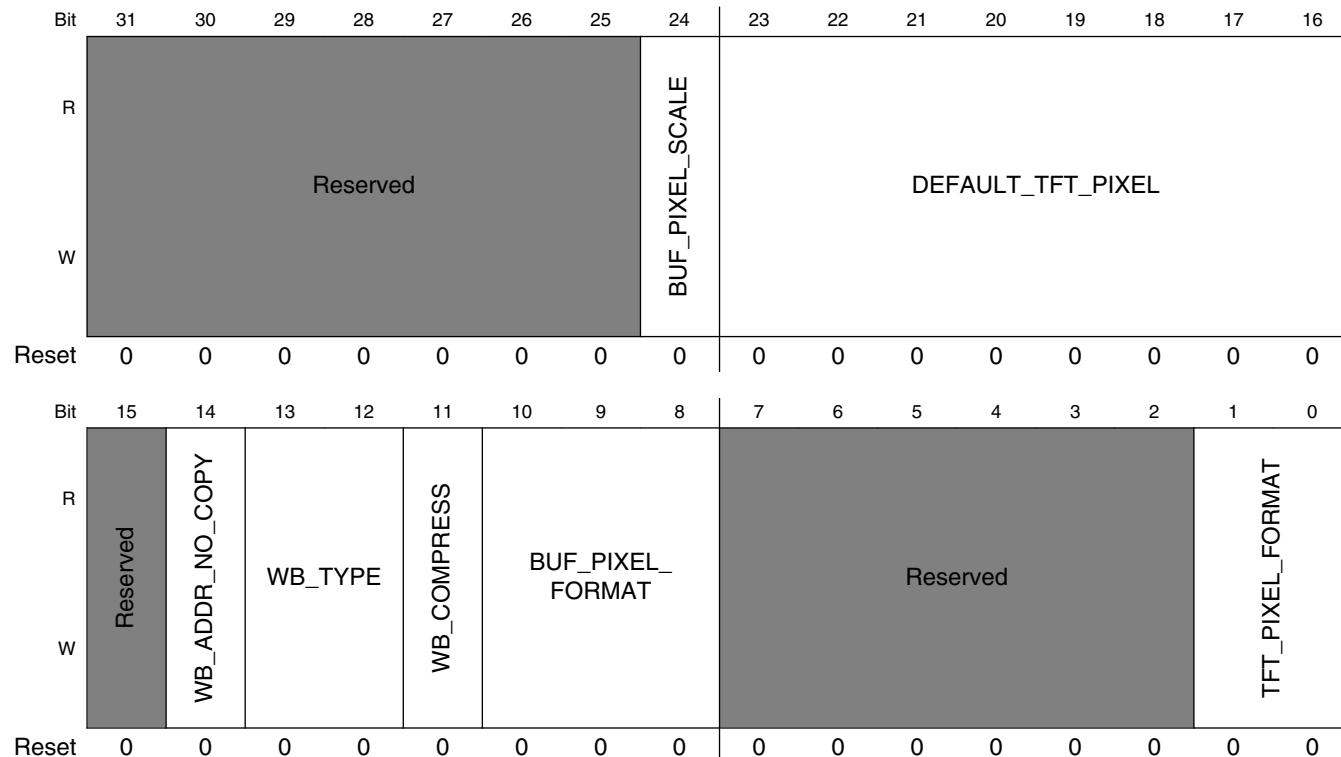

EPDC_FORMAT n field descriptions

Field	Description
31–25 -	This field is reserved. Reserved.
24 BUF_PIXEL_ SCALE	Selects method of conversion from 8-bit input 0x0 TRUNCATE — Use Truncate method (LSB) 0x1 ROUND — Use rounding method (with saturation)
23–16 DEFAULT_TFT_ PIXEL	Default TFT pixel value. This value is used as the source-driver voltage value (TFT-pixel) for either partial-updates where a pixel has not changed or for any part of the screen which is not being updated during active frame scans.
15 -	This field is reserved. Reserved.
14 WB_ADDR_NO_ COPY	1 means do not automatically copy WB_ADDR to WB_ADDR_TCE before starting every frame
13–12 WB_TYPE	00 WB_INTERNAL — internal Working Buffer written by EPDC itself 01 WB_WAVEFORM — working buffer is actually holding waveform 10 WB_EXTERNAL16 — 16bit working buffer written by PXP or CPU 11 WB_EXTERNAL32 — 32bit working buffer written by PXP or CPU
11 WB_COMPRESS	whether the working buffer is compressed, only available on WB_FORMAT=EXTERNAL16/32 mode
10–8 BUF_PIXEL_ FORMAT	this field is deprecated in EPDCv3, replaced by WB_FIELDx where we can specify width for each field EPDC Input Buffer Pixel format. All update buffers are expected to have 8-bit grayscale pixels. This register defines which MSB's of those pixels are used. It must be noted that this format must match the waveform (e.g. P4N is not compatible with 3-bit waveforms) 0x2 P2N — 2-bit pixel 0x3 P3N — 3-bit pixel 0x4 P4N — 4-bit pixel 0x5 P5N — 5-bit pixel
7–2 -	This field is reserved. Reserved.
TFT_PIXEL_ FORMAT	EPDC TFT Pixel Format. This defines how many bits of the SDDO bus are required per pixel. This field must be consistent with the waveform and panel architecture. 0x0 2B — 2-bit 0x1 2BV — 2-bit and VCOM 0x2 4B — 4-bit 0x3 4BV — 4-bit and VCOM

23.4.7 Working Buffer Field Setting (EPDC_WB_FIELD0)

specify the pixel fields mapping from working buffer to lut index : WB[FROM +LEN:FROM] =>LUT [TO+LEN:TO]

Address: 228_C000h base + 60h offset = 228_C060h

Bit	31	30	29	28	27	26	25	24	23	22	21	20	19	18	17	16
R	FIXED								Reserved						USE_FIXED	
W																
Reset	0	0	0	0	0	0	0	0	0	0	0	0	0	0	0	0
Bit	15	14	13	12	11	10	9	8	7	6	5	4	3	2	1	0
R	USAGE			FROM					TO				LEN			
W																
Reset	1	0	0	0	1	0	1	0	1	0	1	0	0	1	0	1

EPDC_WB_FIELD0 field descriptions

Field	Description
31–24 FIXED	used to either force field into a fixed value, or compare to wb field to mask off the pixel
23–18 -	This field is reserved. Reserved
17–16 USE_FIXED	usage of the FIXED value 00 NO_FIXED — not using FIXED field 01 USE_FIXED — set this field to a FIXED value which specified by FIXED[31:24] 10 NE_FIXED — mask off this pixel if this field is non equal to FIXED[31:24] 11 EQ_FIXED — mask off this pixel if this field is equal to FIXED[31:24]
15–13 USAGE	000 NOT_USED — NOT USED 011 PARTIAL — PARTIAL (won't contribute to lut lookup index) 100 LUT — LUT 101 CP — CP 110 NP — NP 111 PTS — PTS
12–8 FROM	Source Field's LSB
7–4 TO	Target Field's LSB
LEN	Field length minus 1 (0x0 means length=1, 0xf means length=16)

23.4.8 Working Buffer Field Setting (EPDC_WB_FIELD1)

specify the pixel fields mapping from working buffer to lut index : WB[FROM +LEN:FROM] =>LUT [TO+LEN:TO]

Address: 228_C000h base + 70h offset = 228_C070h

Bit	31	30	29	28	27	26	25	24	23	22	21	20	19	18	17	16
R	FIXED								Reserved						USE_FIXED	
W																
Reset	0	0	0	0	0	0	0	0	0	0	0	0	0	0	0	0
Bit	15	14	13	12	11	10	9	8	7	6	5	4	3	2	1	0
R	USAGE			FROM				TO				LEN				
W																
Reset	1	0	1	0	0	0	0	0	0	0	0	0	0	0	1	1

EPDC_WB_FIELD1 field descriptions

Field	Description
31–24 FIXED	used to either force field into a fixed value, or compare to wb field to mask off the pixel
23–18 -	This field is reserved. Reserved
17–16 USE_FIXED	usage of the FIXED value 00 NO_FIXED — not using FIXED field 01 USE_FIXED — set this field to a FIXED value which specified by FIXED[31:24] 10 NE_FIXED — mask off this pixel if this field is non equal to FIXED[31:24] 11 EQ_FIXED — mask off this pixel if this field is equal to FIXED[31:24]
15–13 USAGE	000 NOT_USED — NOT USED 011 PARTIAL — PARTIAL 100 LUT — LUT 101 CP — CP 110 NP — NP 111 PTS — PTS
12–8 FROM	Source Field's LSB
7–4 TO	Target Field's LSB
LEN	Field length minus 1 (0x0 means length=1, 0xf means length=16)

23.4.9 Working Buffer Field Setting (EPDC_WB_FIELD2)

specify the pixel fields mapping from working buffer to lut index : WB[FROM +LEN:FROM] =>LUT [TO+LEN:TO]

Address: 228_C000h base + 80h offset = 228_C080h

Bit	31	30	29	28	27	26	25	24	23	22	21	20	19	18	17	16
R	FIXED								Reserved						USE_FIXED	
W																
Reset	0	0	0	0	0	0	0	0	0	0	0	0	0	0	0	0
Bit	15	14	13	12	11	10	9	8	7	6	5	4	3	2	1	0
R	USAGE			FROM				TO				LEN				
W																
Reset	1	1	0	0	0	1	0	0	0	1	0	0	0	0	1	1

EPDC_WB_FIELD2 field descriptions

Field	Description
31–24 FIXED	used to either force field into a fixed value, or compare to wb field to mask off the pixel
23–18 -	This field is reserved. Reserved
17–16 USE_FIXED	usage of the FIXED value 00 NO_FIXED — not using FIXED field 01 USE_FIXED — set this field to a FIXED value which specified by FIXED[31:24] 10 NE_FIXED — mask off this pixel if this field is non equal to FIXED[31:24] 11 EQ_FIXED — mask off this pixel if this field is equal to FIXED[31:24]
15–13 USAGE	000 NOT_USED — NOT USED 011 PARTIAL — PARTIAL 100 LUT — LUT 101 CP — CP 110 NP — NP 111 PTS — PTS
12–8 FROM	Source Field's LSB
7–4 TO	Target Field's LSB
LEN	Field length minus 1 (0x0 means length=1, 0xf means length=16)

23.4.10 Working Buffer Field Setting (EPDC_WB_FIELD3)

specify the pixel fields mapping from working buffer to lut index : WB[FROM +LEN:FROM] =>LUT [TO+LEN:TO]

Address: 228_C000h base + 90h offset = 228_C090h

Bit	31	30	29	28	27	26	25	24	23	22	21	20	19	18	17	16
R	FIXED								Reserved						USE_FIXED	
W																
Reset	0	0	0	0	0	0	0	0	0	0	0	0	0	0	0	0
Bit	15	14	13	12	11	10	9	8	7	6	5	4	3	2	1	0
R	USAGE			FROM				TO				LEN				
W																
Reset	0	1	1	0	1	0	0	0	1	0	0	0	0	0	0	0

EPDC_WB_FIELD3 field descriptions

Field	Description
31–24 FIXED	used to either force field into a fixed value, or compare to wb field to mask off the pixel
23–18 -	This field is reserved. Reserved
17–16 USE_FIXED	usage of the FIXED value 00 NO_FIXED — not using FIXED field 01 USE_FIXED — set this field to a FIXED value which specified by FIXED[31:24] 10 NE_FIXED — mask off this pixel if this field is non equal to FIXED[31:24] 11 EQ_FIXED — mask off this pixel if this field is equal to FIXED[31:24]
15–13 USAGE	000 NOT_USED — NOT USED 011 PARTIAL — PARTIAL 100 LUT — LUT 101 CP — CP 110 NP — NP 111 PTS — PTS
12–8 FROM	Source Field's LSB
7–4 TO	Target Field's LSB
LEN	Field length minus 1 (0x0 means length=1, 0xf means length=16)

23.4.11 EPDC FIFO control register (EPDC_FIFOCTRLn)

Allows for programmability of pixel FIFO watermarks used in conjunction with system arbitration hardware

This register houses FIFO control bits

EXAMPLE

```

/* EPDC_FIFOCTRL (disabled) */
reg_val =
    ((100 << EPDC_FIFOCTRL_FIFO_INIT_LEVEL_OFFSET) &
     EPDC_FIFOCTRL_FIFO_INIT_LEVEL_MASK)
    | ((200 << EPDC_FIFOCTRL_FIFO_H_LEVEL_OFFSET) &
     EPDC_FIFOCTRL_FIFO_H_LEVEL_MASK)
    | ((100 << EPDC_FIFOCTRL_FIFO_L_LEVEL_OFFSET) &
     EPDC_FIFOCTRL_FIFO_L_LEVEL_MASK);
__raw_writel(reg_val, EPDC_FIFOCTRL);
    
```

Address: 228_C000h base + A0h offset + (4d × i), where i=0d to 3d

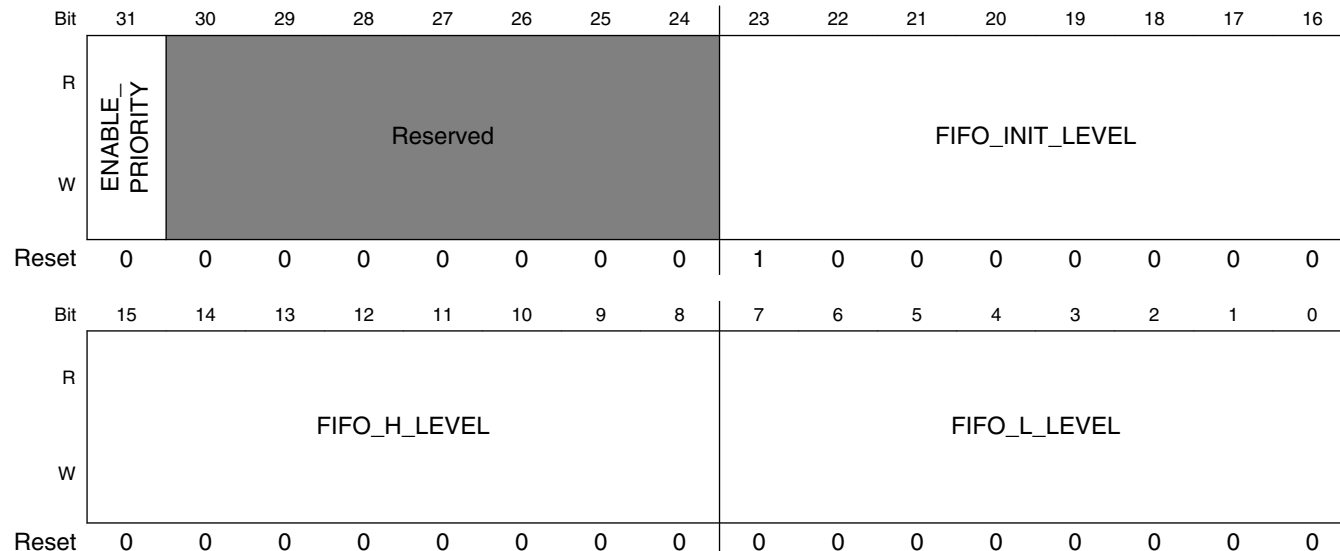

EPDC_FIFOCTRLn field descriptions

Field	Description
31 ENABLE_PRIORITY	Enable watermark-based priority elevation mechanism. 1=Enabled, 0=Disabled. (Only applies to FIFO_H_LEVEL and FIFO_L_LEVEL)
30-24 -	This field is reserved. Reserved.
23-16 FIFO_INIT_LEVEL	This register sets the watermark for the pixel-fifo.
15-8 FIFO_H_LEVEL	Upper level value of FIFO watermark. Must be greater than FIFO_L_LEVEL. When the pixel FIFO reaches this level or above, the priority elevation request is negated
FIFO_L_LEVEL	Lower level value of FIFO watermark. When the pixel FIFO reaches this level or below, the priority elevation request is asserted.

23.4.12 EPDC Update Region Address (EPDC_UPD_ADDR)

EPDC Update Region Address

The address alignment depends on whether the update region stride register (EPDC_UPD_STRIDE) is set or not.

If EPDC_UPD_STRIDE is zero, the update region address must start and end on the 8-byte aligned addresses.

If EPDC_UPD_STRIDE is non-zero, the update region address can start and/or end on any byte addressing. But aligned address still recommended to get best bus performance.

EXAMPLE1

```
/* no update stride case */
u32 stride = 0;
u32 addr = 0x100; /* 8-byte aligned */
__raw_writel(stride, EPDC_UPD_STRIDE);
__raw_writel(addr, EPDC_UPD_ADDR);
```

EXAMPLE2

```
/* update stride = 345 */
u32 stride = 345;
u32 addr = 0x123; /* 8-byte unaligned is OK */
__raw_writel(stride, EPDC_UPD_STRIDE);
__raw_writel(addr, EPDC_UPD_ADDR);
```

Address: 228_C000h base + 100h offset = 228_C100h

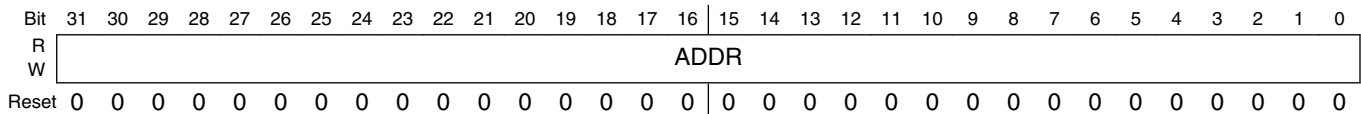

EPDC_UPD_ADDR field descriptions

Field	Description
ADDR	Address for incoming region update. This address points to update region which will be processed into the working buffer.

23.4.13 EPDC Update Region Stride (EPDC_UPD_STRIDE)

EPDC Update Region Stride

When UPD_STRIDE==0 (stride feature disabled), UPD buffer line must start from 64-bit boundary and end on 64-bit boundary(padding if not). When UPD_STRIDE!=0 (stride feature enabled), UPD buffer line can start or end on any byte address, UPD_WIDTH should be set to real line bytes count as normal, while UPD_STRIDE set to byte distance between two lines' start.

EXAMPLE

see details on stride feature introduction

EPDC Memory Map/Register Definition

Address: 228_C000h base + 110h offset = 228_C110h

Bit	31	30	29	28	27	26	25	24	23	22	21	20	19	18	17	16	15	14	13	12	11	10	9	8	7	6	5	4	3	2	1	0
R																																
W																																
Reset	0	0	0	0	0	0	0	0	0	0	0	0	0	0	0	0	0	0	0	0	0	0	0	0	0	0	0	0	0	0	0	0

EPDC_UPD_STRIDE field descriptions

Field	Description
STRIDE	line stride for incoming region update

23.4.14 EPDC Update Command Co-ordinate (EPDC_UPD_CORD)

EPDC Update Command Co-ordinate

This register is used for setting up the coordinate of a new update region.

Address: 228_C000h base + 120h offset = 228_C120h

Bit	31	30	29	28	27	26	25	24	23	22	21	20	19	18	17	16	15	14	13	12	11	10	9	8	7	6	5	4	3	2	1	0
R																																
W	Reserved	YCORD														Reserved	XCORD															
Reset	0	0	0	0	0	0	0	0	0	0	0	0	0	0	0	0	0	0	0	0	0	0	0	0	0	0	0	0	0	0	0	0

EPDC_UPD_CORD field descriptions

Field	Description
31–29 -	This field is reserved. Reserved.
28–16 YCORD	Y co-ordinate for incoming region update
15–13 -	This field is reserved. Reserved.
XCORD	X co-ordinate for incoming region update

23.4.15 EPDC Update Command Size (EPDC_UPD_SIZE)

EPDC Update Command Size

This register sets up the size of an update region.

Address: 228_C000h base + 140h offset = 228_C140h

Bit	31	30	29	28	27	26	25	24	23	22	21	20	19	18	17	16	15	14	13	12	11	10	9	8	7	6	5	4	3	2	1	0
R																																
W	Reserved	HEIGHT														Reserved	WIDTH															
Reset	0	0	0	0	0	0	0	0	0	0	0	0	0	0	0	0	0	0	0	0	0	0	0	0	0	0	0	0	0	0	0	0

EPDC_UPD_SIZE field descriptions

Field	Description
31–29 -	This field is reserved. Reserved.
28–16 HEIGHT	Height (in pixels)
15–13 -	This field is reserved. Reserved.
WIDTH	Width (in pixels)

23.4.16 EPDC Update Command Control (EPDC_UPD_CTRLn)

EPDC Update Command Control.

Writing to this registers triggers and update request operation.

Address: 228_C000h base + 160h offset + (4d × i), where i=0d to 3d

Bit	31	30	29	28	27	26	25	24	23	22	21	20	19	18	17	16
R	USE_FIXED	Reserved								LUT_SEL						
W		Reserved								LUT_SEL						
Reset	0	0	0	0	0	0	0	0	0	0	0	0	0	0	0	0
Bit	15	14	13	12	11	10	9	8	7	6	5	4	3	2	1	0
R	WAVEFORM_MODE								Reserved		STANDBY	NO_LUT_CANCEL	PAUSE	AUTOWW	DRY_RUN	UPDATE_MODE
W	WAVEFORM_MODE								Reserved		STANDBY	NO_LUT_CANCEL	PAUSE	AUTOWW	DRY_RUN	UPDATE_MODE
Reset	0	0	0	0	0	0	0	0	0	0	0	0	0	0	0	0

EPDC_UPD_CTRLn field descriptions

Field	Description
31 USE_FIXED	Use fixed pixel values (requires programming of EPDC_UPD_FIXED)
30–22 -	This field is reserved. Reserved.
21–16 LUT_SEL	LUT select 0-63
15–8 WAVEFORM_MODE	Waveform Mode 0-255

Table continues on the next page...

EPDC_UPD_CTRLn field descriptions (continued)

Field	Description
7-6 -	This field is reserved. Reserved.
5 STANDBY	
4 NO_LUT_CANCEL	EPDC will cancel LUT loading for void update (no real update needed because of partial or collision), set this bit to 1 to disable this feature
3 PAUSE	0x0 AUTO — epdc will analyze update buffer, report histogram, then update waveform mode using the programmed mode mapping in AUTOWV_LUT and start LUT loading 0x1 MANUAL — epdc will analyze update buffer, report histogram, then pause and waiting software to write again with selected waveform mode to start lut loading
2 AUTOWV	enable automatical waveform mode selection
1 DRY_RUN	Enable Dry Run mode(set to 1). WB won't be updated in this mode, and lut_sel will be ignored, so actually you don't need to wait for LUT available to use this feature
0 UPDATE_MODE	Update Mode 0x0 PARTIAL — Partial Update : only process changed pixels in region 0x1 FULL — Full Update : process all pixels in region

23.4.17 EPDC Update Fixed Pixel Control (EPDC_UPD_FIXEDn)

EPDC Update Control register for fixed-pixel updates (enabled via EPDC_UPD_CTRL[USE_FIXED])

Address: 228_C000h base + 180h offset + (4d × i), where i=0d to 3d

Bit	31	30	29	28	27	26	25	24	23	22	21	20	19	18	17	16
R	FIXNP_EN	FIXCP_EN	Reserved													
W																
Reset	0	0	0	0	0	0	0	0	0	0	0	0	0	0	0	0
Bit	15	14	13	12	11	10	9	8	7	6	5	4	3	2	1	0
R	FIXNP								FIXCP							
W																
Reset	0	0	0	0	0	0	0	0	0	0	0	0	0	0	0	0

EPDC_UPD_FIXED n field descriptions

Field	Description
31 FIXNP_EN	If set to 1, current updated region has the NP value defined by FIXNP
30 FIXCP_EN	If set to 1, current updated region has the CP value defined by FIXCP
29–16 -	This field is reserved. Reserved.
15–8 FIXNP	NP value if fixenp_en is set to 1. Data in Y8 format.
FIXCP	CP value if fixecp_en is set to 1. Data in Y8 format.

23.4.18 EPDC Temperature Register (EPDC_TEMP)

EPDC Temperature Compensation Register

Address: 228_C000h base + 1A0h offset = 228_C1A0h

Bit	31	30	29	28	27	26	25	24	23	22	21	20	19	18	17	16	15	14	13	12	11	10	9	8	7	6	5	4	3	2	1	0
R																																
W																																
	TEMPERATURE																															
Reset	0	0	0	0	0	0	0	0	0	0	0	0	0	0	0	0	0	0	0	0	0	0	0	0	0	0	0	0	0	0	0	0

EPDC_TEMP field descriptions

Field	Description
TEMPERATURE	Temperature Value. This value is simply an index (not a temperature value). The index is used by the EPDC to access the correct temperature compensated waveform.

**23.4.19 Waveform Mode Lookup Table Control Register.
(EPDC_AUTOWV_LUT)**

This register is used to access the waveform mode lookup table.

DATA -> AUTOWV_LUT[ADDR] : Writing this reg with 'ADDR' and 'DATA' info will get 'DATA' written to AUTOWV_LUT mem indexed with 'ADDR'

Address: 228_C000h base + 1C0h offset = 228_C1C0h

Bit	31	30	29	28	27	26	25	24	23	22	21	20	19	18	17	16	15	14	13	12	11	10	9	8	7	6	5	4	3	2	1	0						
R																																						
W	Reserved																DATA										Reserved										ADDR	
Reset	0	0	0	0	0	0	0	0	0	0	0	0	0	0	0	0	0	0	0	0	0	0	0	0	0	0	0	0	0	0	0	0						

EPDC_AUTOWV_LUT field descriptions

Field	Description
31–24 -	This field is reserved. Reserved, always set to zero.
23–16 DATA	DATA
15–3 -	This field is reserved. Reserved, always set to zero.
ADDR	ADDR

23.4.20 EPDC LUT Standby Register for LUT 31~0 (EPDC_LUT_STANDBY1n)

Address: 228_C000h base + 1E0h offset + (4d × i), where i=0d to 3d

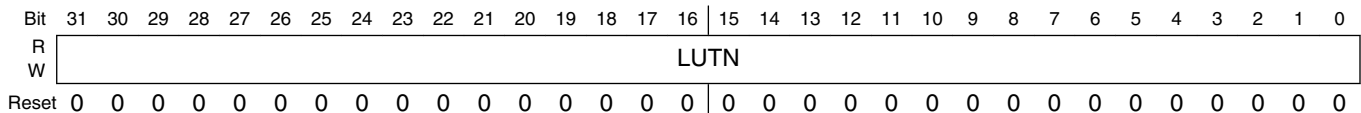

EPDC_LUT_STANDBY1n field descriptions

Field	Description
LUTN	LUT 0~31 standby control

23.4.21 EPDC LUT Standby Register for LUT 63~32 (EPDC_LUT_STANDBY2n)

Address: 228_C000h base + 1F0h offset + (4d × i), where i=0d to 3d

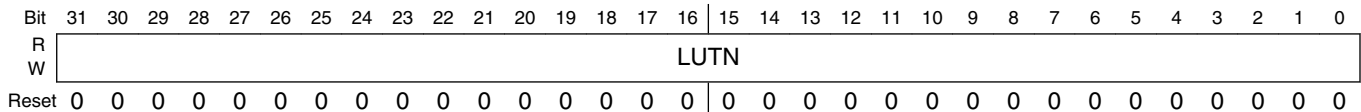

EPDC_LUT_STANDBY2n field descriptions

Field	Description
LUTN	LUT 32~64 Standby Control

23.4.22 EPDC Timing Control Engine Control Register (EPDC_TCE_CTRLn)

TCE general control register

This register houses Horizontal scan timing. Note that line data length is derived from EPDC_RES.

Address: 228_C000h base + 200h offset + (4d × i), where i=0d to 3d

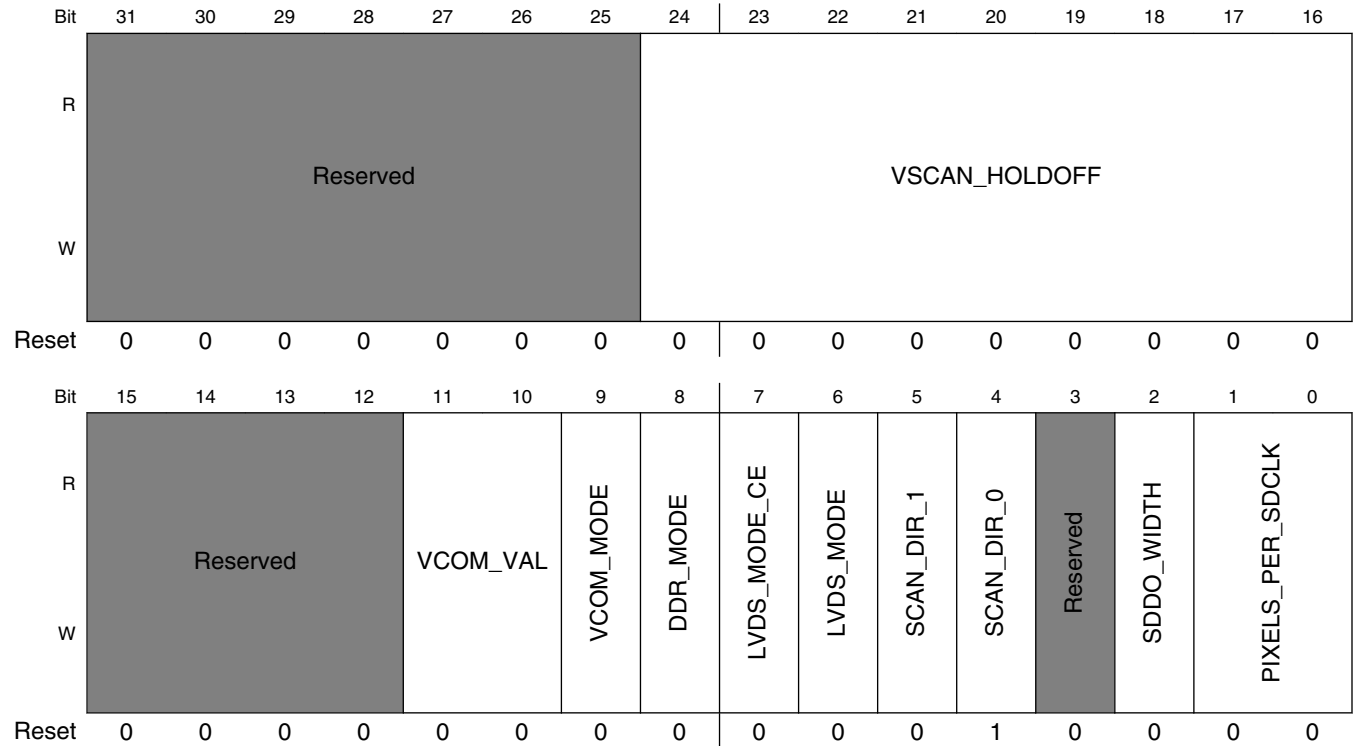

EPDC_TCE_CTRLn field descriptions

Field	Description
31–25 -	This field is reserved. Reserved.
24–16 VSCAN_HOLDOFF	This period (expressed in vertical lines), sets the portion of the vertical blanking available for new LUTs to be activated. The remainder of the blanking period is reserved for pre-filling the TCE pixel FIFOs. Increasing this value allows for multiple smaller updates to be intercepted by the current frame scan. This number should not exceed FRAME_END+FRAME_SYNC+FRAME_BEGIN. Increasing this value can improve the ability for any given update to intercept the next available frame-scan. Excessive values can result in TCE FIFO under-runs.
15–12 -	This field is reserved. Reserved.
11–10 VCOM_VAL	When VCOM_MODE = MANUAL, this value is used to manually set the VCOM value for the VCOM[1:0] pins
9 VCOM_MODE	This field determines the method used to drive the VCOM signal. 0x0 MANUAL — VCOM Value is set manually using VCOM_VAL field 0x1 AUTO — VCOM Value is used from waveform
8 DDR_MODE	If set, SDDO data is driven on both positive and negative edges of SDCLK. Note that this mode is not supported when SDDO_BUS_FORMAT=16BIT and LVDS is not used. This must always be set when LVDS_MODE is set.

Table continues on the next page...

EPDC_TCE_CTRLn field descriptions (continued)

Field	Description
7 LVDS_MODE_CE	If set (together with LVDS_MODE=1), SDCE[9:5] shall be driven as the differential inverse of SDCE[4:0]. In this mode the EPDC only supports 5 CE lines.
6 LVDS_MODE	If set, the upper 8-bit of the SDDO bus are used for LVDS differential signalling. Note that this can only be used when SDDO_BUS_FORMAT is set to 16BIT, i.e. LVDS signaling is not supported with an 8-bit SDDO interface. Note that for LVDS_MODE, DDR_MODE must also be set.
5 SCAN_DIR_1	Determines scan direction for each half of the TFT panel 0x1 UP — Scan this region from bottom to top 0x0 DOWN — Scan this region from top to bottom
4 SCAN_DIR_0	Determines scan direction for each half of the TFT panel 0x1 UP — Scan this region from bottom to top 0x0 DOWN — Scan this region from top to bottom
3 -	This field is reserved. Reserved
2 SDDO_WIDTH	Selects either 8 or 16 bit SDDO bus format 0x0 8BIT — Connect to 8-bit source driver 0x1 16BIT — Connct to 16-bit source driver
PIXELS_PER_SDCLK	Number of TFT pixels per SDCLK period. Note that this value forms the division of the PIXCLK to generate the SDCLK such that SDCLK = PIXCLK/PIXELS_PER_SDCLK. 0x0 RESERVED — Reserved 0x1 TWO — Two TFT-pixels per SDCLK 0x2 FOUR — Four TFT-pixels per SDCLK 0x3 EIGHT — Eight TFT-pixels per SDCLK

23.4.23 EPDC Timing Control Engine Source-Driver Config Register (EPDC_TCE_SDCFGn)

Source-driver configuration register

Address: 228_C000h base + 220h offset + (4d × i), where i=0d to 3d

Bit	31	30	29	28	27	26	25	24	23	22	21	20	19	18	17	16
R	Reserved										SDCLK_HOLD		NUM_CE			
W												SDSHR				
Reset	0	0	0	0	0	0	0	0	0	0	0	0	0	0	0	0
Bit	15	14	13	12	11	10	9	8	7	6	5	4	3	2	1	0
R	SDDO_REFORMAT		SDDO_INVERT	PIXELS_PER_CE												
W																
Reset	0	0	0	0	0	0	0	0	0	0	0	0	0	0	0	0

EPDC_TCE_SDCFGn field descriptions

Field	Description
31–22 -	This field is reserved. Reserved.
21 SDCLK_HOLD	Setting this bit to 1 holds the SDCLK low during LINE_BEGIN
20 SDSHR	Value for source-driver shift direction output port
19–16 NUM_CE	Number of source driver IC chip-enables. Must be 1-10
15–14 SDDO_REFORMAT	This register defines the various re-formatting options to enable more flexibility in the source-driver interface: 0x0 STANDARD — No change. 0x1 FLIP_PIXELS — Reverses the order of the pixels on SDDO. This register setting is sensitive to the TFT pixel width (TFT_PIXEL_FORMAT), e.g. for TFT_PIXEL_FORMAT=2B on an 8-bit bus P3,P2,P1,P0 becomes P0,P1,P2,P3, whereas with TFT_PIXEL_FORMAT=4B, on an 8-bit bus, P1,P0 becomes P0,P1
13 SDDO_INVERT	Setting this bit to 1 reverses the polarity of each SDDO bit so 0xAAAA in 16-bit mode for example becomes 0x5555. This setting can be made in addition to the SDDO_REFORMAT register setting.
PIXELS_PER_CE	Number of pixels (outputs) per source-driver IC. Please note that EPDC_RES[HORIZONTAL] must be an integer multiple of PINS_PER_CE.

23.4.24 EPDC Timing Control Engine Gate-Driver Config Register (EPDC_TCE_GDCFGn)

This register houses gate-driver configuration.

Address: 228_C000h base + 240h offset + (4d × i), where i=0d to 3d

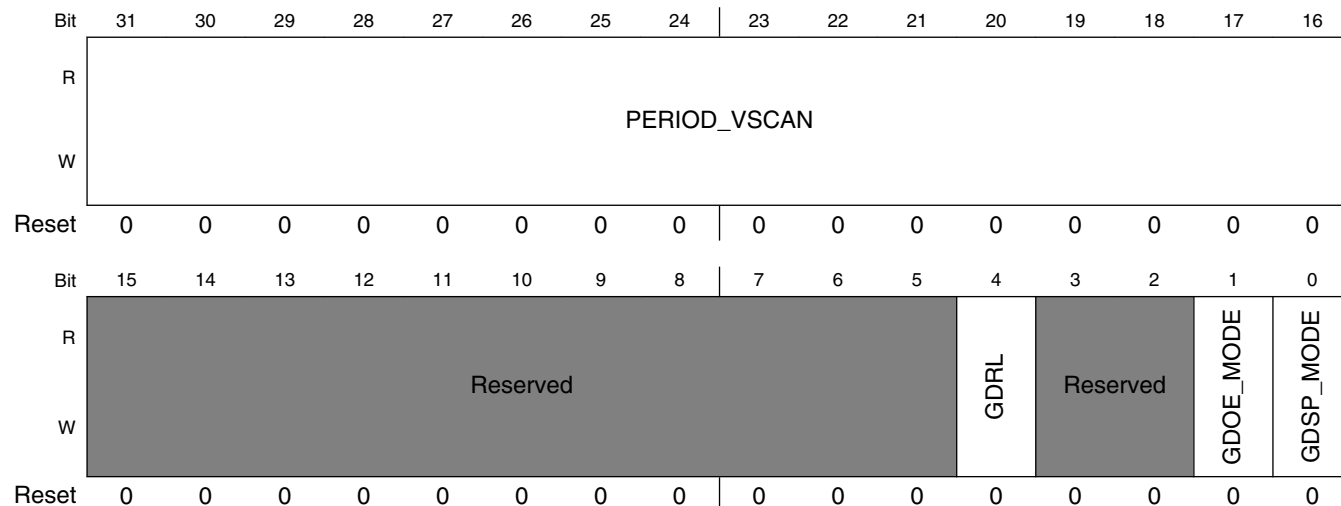

EPDC_TCE_GDCFGn field descriptions

Field	Description
31–16 PERIOD_VSCAN	when vscan state is splitted, this reg defines the counter period
15–5 -	This field is reserved. Reserved.
4 GDRL	Value for gate-driver right/left shift output port
3–2 -	This field is reserved. Reserved.
1 GDOE_MODE	Selects method for driving GDOE signal. When set to 0, GDOE is driven at all times during the frame-scan except FRAME_SYNC. When set to 1, GDOE is driven as a delayed version of GDCLK delayed by EPDC_TCE_TIMING3[GDOE_OFFSET].
0 GDSP_MODE	Selects method for driving GDSP pulse. When set to 0, GDSP is is always fixed to have a pulse width of one line-time. When set to 1, GDSP has a pulse-width determined by the FRAME_SYNC setting. Note that GDSP_MODE=1 is not compatible with the GDSP_OFFSET function

23.4.25 EPDC Timing Control Engine Horizontal Timing Register 1 (EPDC_TCE_HSCAN1n)

Horizontal scan timing registers. Note that all timing values are expressed in terms of the EPDC's internal PIXCLK, which depending on the PIXELS_PER_SDCLK register setting is either 2:1 or 4:1

This register houses Horizontal scan timing. Note that line data length is derived from EPDC_RES.

Address: 228_C000h base + 260h offset + (4d × i), where i=0d to 3d

Bit	31	30	29	28	27	26	25	24	23	22	21	20	19	18	17	16	15	14	13	12	11	10	9	8	7	6	5	4	3	2	1	0
R																																
W																																
Reset	0	0	0	0	0	0	0	0	0	0	0	0	0	0	0	0	0	0	0	0	0	0	0	0	0	0	0	0	0	0	0	0

EPDC_TCE_HSCAN1n field descriptions

Field	Description
31–28 -	This field is reserved. Reserved.
27–16 LINE_SYNC_WIDTH	Number of PIXCLK cycles for the SDLE active time. Note that this value cannot be larger than LINE_SYNC and must be greater than 0. Typically it is recommended to set this value to be the same as LINE_SYNC
15–12 -	This field is reserved. Reserved.
LINE_SYNC	Number of PIXCLK cycles for line sync duration. Note that this value encompasses the LINE_SYNC_WIDTH duration. This value must be programmed to a multiple of SDCLK cycles

23.4.26 EPDC Timing Control Engine Horizontal Timing Register 2 (EPDC_TCE_HSCAN2n)

Horizontal scan timing registers. Note that all timing values are expressed in terms of the EPDC's internal PIXCLK, which depending on the PIXELS_PER_SDCLK register setting is either 2:1 or 4:1

This register houses Horizontal scan timing. Note that line data length is derived from EPDC_RES.

Address: 228_C000h base + 280h offset + (4d × i), where i=0d to 3d

Bit	31	30	29	28	27	26	25	24	23	22	21	20	19	18	17	16	15	14	13	12	11	10	9	8	7	6	5	4	3	2	1	0
R																																
W																																
Reset	0	0	0	0	0	0	0	0	0	0	0	0	0	0	0	0	0	0	0	0	0	0	0	0	0	0	0	0	0	0	0	0

EPDC_TCE_HSCAN2n field descriptions

Field	Description
31–28 -	This field is reserved. Reserved.
27–16 LINE_END	Number of PIXCLK cycles for line end duration. This defines the duration from the de-assertion of SDCE and assertion of the next SDLE.
15–12 -	This field is reserved. Reserved.
LINE_BEGIN	Number of PIXCLK cycles for line begin duration. This defines the interval between de-assertion of SDLE and assertion of the SDCE signals. This value must be programmed to a multiple of SDCLK cycles

23.4.27 EPDC Timing Control Engine Vertical Timing Register (EPDC_TCE_VSCANn)

Vertical scan timing registers

This register houses vertical scan timing. Note that frame data length is derived from EPDC_RES.

Address: 228_C000h base + 2A0h offset + (4d × i), where i=0d to 3d

Bit	31	30	29	28	27	26	25	24	23	22	21	20	19	18	17	16	15	14	13	12	11	10	9	8	7	6	5	4	3	2	1	0
R																																
W																																
Reset	0	0	0	0	0	0	0	0	0	0	0	0	0	0	0	0	0	0	0	0	0	0	0	0	0	0	0	0	0	0	0	

EPDC_TCE_VSCANn field descriptions

Field	Description
31–24 -	This field is reserved. Reserved.
23–16 FRAME_END	Number of lines for frame end duration.
15–8 FRAME_BEGIN	Number of lines for frame begin duration.
FRAME_SYNC	Number of lines for frame sync duration.

23.4.28 EPDC Timing Control Engine OE timing control Register (EPDC_TCE_OEn)

This register contain delay programming values for the SDOEZ and SDOED source driver control signals

This register contain delay programming values for the SDOZ and SDOE source driver control signals

Address: 228_C000h base + 2C0h offset + (4d × i), where i=0d to 3d

Bit	31	30	29	28	27	26	25	24	23	22	21	20	19	18	17	16	15	14	13	12	11	10	9	8	7	6	5	4	3	2	1	0
R	SDOED_WIDTH								SDOED_DLY								SDOEZ_WIDTH								SDOEZ_DLY							
W																																
Reset	0	0	0	0	0	0	0	0	0	0	0	0	0	0	0	0	0	0	0	0	0	0	0	0	0	0	0	0	0	0	0	0

EPDC_TCE_OEn field descriptions

Field	Description
31–24 SDOED_WIDTH	Number of PIXCLK cycles from SDOED high to SDOED falling (Must be greater than 0)
23–16 SDOED_DLY	Number of PIXCLK cycles from SDOEZ low to SDOED rising (Must be greater than 0)
15–8 SDOEZ_WIDTH	Number of PIXCLK cycles from SDOEZ high to SDOEZ falling (Must be greater than 0)
SDOEZ_DLY	Number of PIXCLK cycles from SDLE falling edge to SDOEZ rising (Must be greater than 0)

23.4.29 EPDC Timing Control Engine Driver Polarity Register (EPDC_TCE_POLARITYn)

This registers allows for programming the polarity of source/gate driver control signals

This register houses FIFO control bits

Address: 228_C000h base + 2E0h offset + (4d × i), where i=0d to 3d

Bit	31	30	29	28	27	26	25	24	23	22	21	20	19	18	17	16
R	Reserved															
W																
Reset	0	0	0	0	0	0	0	0	0	0	0	0	0	0	0	0
Bit	15	14	13	12	11	10	9	8	7	6	5	4	3	2	1	0
R	Reserved								GDSP_POL	GDOE_POL	SDOE_POL	SDLE_POL	SDCE_POL			
W																
Reset	0	0	0	0	0	0	0	0	0	0	0	1	1	1	1	0

EPDC_TCE_POLARITYn field descriptions

Field	Description
31–5 -	This field is reserved. Reserved.
4 GDSP_POL	0 = Active Low, 1 = Active High. Applies to the GDSP output

Table continues on the next page...

EPDC_TCE_POLARITY n field descriptions (continued)

Field	Description
3 GDOE_POL	0 = Active Low, 1 = Active High. Applies to the GDOE output
2 SDOE_POL	0 = Active Low, 1 = Active High. Applies to the SDOE. Does not apply to SDOEZ and SDOED outputs
1 SDLE_POL	0 = Active Low, 1 = Active High. Applies to the SDLE output
0 SDCE_POL	0 = Active Low, 1 = Active High. Applies to all 10 SDCE outputs

23.4.30 EPDC Timing Control Engine Timing Register 1 (EPDC_TCE_TIMING $1n$)

This register contains various timing adjustment controls

This register houses general purpose timing adjustment registers

Address: 228_C000h base + 300h offset + (4d × i), where i=0d to 3d

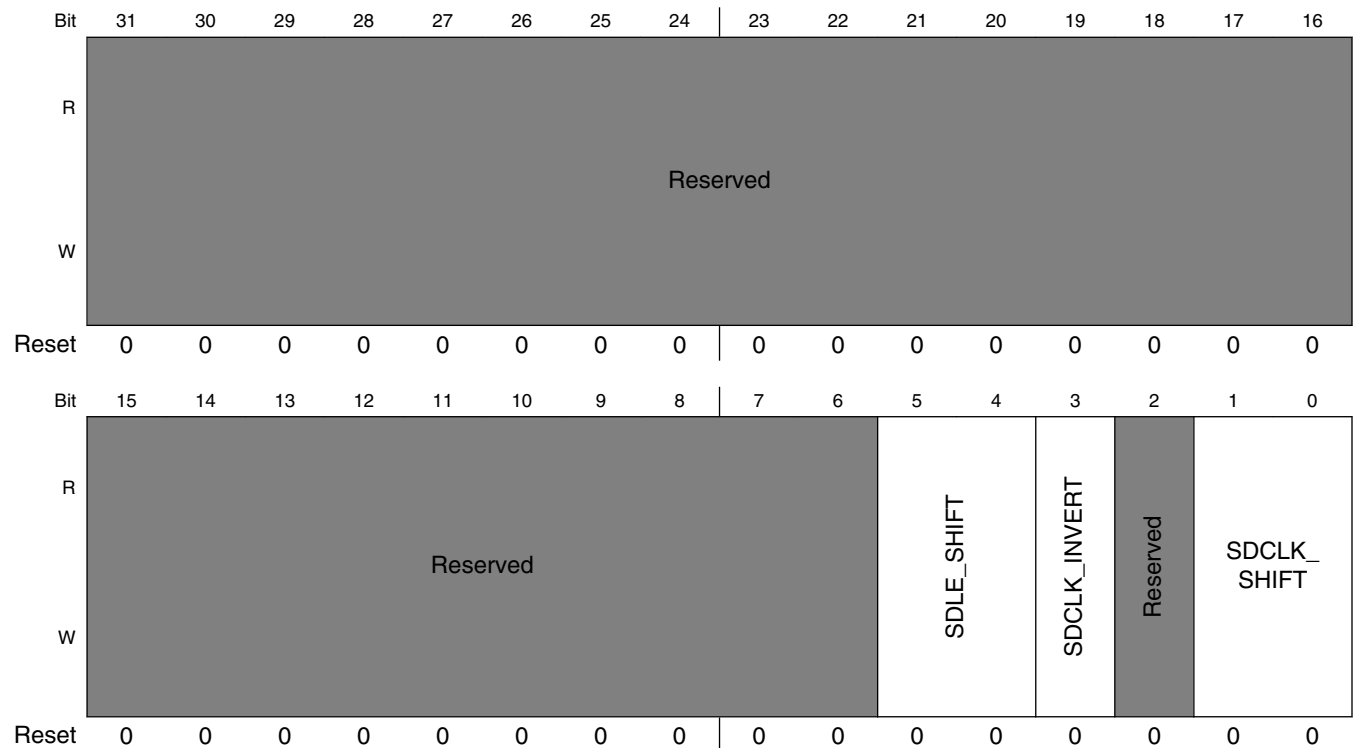

EPDC_TCE_TIMING $1n$ field descriptions

Field	Description
31–6 -	This field is reserved. Reserved.

Table continues on the next page...

EPDC_TCE_TIMING1n field descriptions (continued)

Field	Description
5–4 SDLE_SHIFT	This register can be used to implement additional timing setup/hold adjustment of source driver signals by adjusting the SDCLK up to 3 PIXCLK cycles 0x0 NONE — No shift of SDLE 0x1 ONE — Shift SDLE 1 pixclk cycle 0x2 TWO — Shift SDLE 2 pixclk cycles 0x3 THREE — Shift SDLE 3 pixclk cycles
3 SDCLK_INVERT	Invert phase of SDCLK
2 -	This field is reserved. Reserved.
SDCLK_SHIFT	This register can be used to implement additional timing setup/hold adjustment of source driver signals by adjusting the SDCLK up to 4 cycles 0x0 NONE — No shift of SDCLK 0x1 ONE — Shift SDCLK 1 pixclk cycle 0x2 TWO — Shift SDCLK 2 pixclk cycles 0x3 THREE — Shift SDCLK 3 pixclk cycles

23.4.31 EPDC Timing Control Engine Timing Register 2 (EPDC_TCE_TIMING2n)

This register contains various timing adjustment controls

This register houses general purpose timing adjustment registers

Address: 228_C000h base + 310h offset + (4d × i), where i=0d to 3d

Bit	31	30	29	28	27	26	25	24	23	22	21	20	19	18	17	16	15	14	13	12	11	10	9	8	7	6	5	4	3	2	1	0
R																																
W																																
Reset	0	0	0	0	0	0	0	0	0	0	0	0	0	0	0	0	0	0	0	0	0	0	0	0	0	0	0	0	0	0	0	1

EPDC_TCE_TIMING2n field descriptions

Field	Description
31–16 GDCLK_HP	This register controls the GDCLK high-pulse width. It is expressed by N PIXCLKs where N=1 to 65535. Note that GDCLK will always have a period equal to the line-clock timing. A value of 0 is not supported. It is recommended that this value be set to at least a half line-clock time. For panels which use GDCLK to drive GDOE, this high-pulse width should be set to cover the majority of the line timing
GDSP_OFFSET	This register allows the user to shift the GDSP pulse by N PIXCLKs where N=1 to 65535. Note that GDSP will always have a pulse width equivalent to the line-clock timing. A value of 0 is not supported.

23.4.32 EPDC Timing Control Engine Timing Register 3 (EPDC_TCE_TIMING3n)

This register contains various timing adjustment controls

This register houses general purpose timing adjustment registers

Address: 228_C000h base + 320h offset + (4d × i), where i=0d to 3d

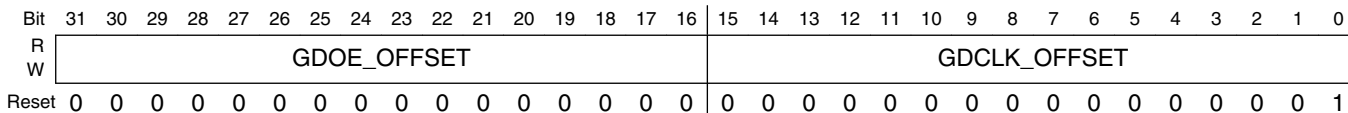

EPDC_TCE_TIMING3n field descriptions

Field	Description
31–16 GDOE_OFFSET	When using GDOE_MODE=1, this register sets the delay from GDCLK to the GDOE in terms of N PIXCLK cycles
GDCLK_OFFSET	This register allows the user to shift the GDCLK from the line time by N PIXCLK cycles.

23.4.33 EPDC Pigeon Mode Control Register 0 (EPDC_PIGEON_CTRL0n)

This register contains global counter settings for Pigeon Mode

This register houses general purpose timing adjustment registers

Address: 228_C000h base + 380h offset + (4d × i), where i=0d to 3d

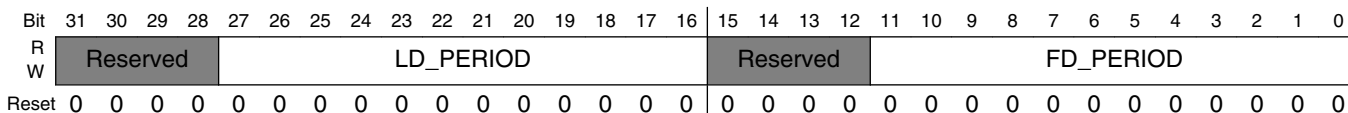

EPDC_PIGEON_CTRL0n field descriptions

Field	Description
31–28 -	This field is reserved. Reserved.
27–16 LD_PERIOD	period of pclk counter during LD phase
15–12 -	This field is reserved. Reserved.
FD_PERIOD	period of line counter during FD phase

23.4.34 EPDC Pigeon Mode Control Register 1 (EPDC_PIGEON_CTRL1n)

This register contains global counter setting for pigeon mode

This register houses general purpose timing adjustment registers

Address: 228_C000h base + 390h offset + (4d × i), where i=0d to 3d

Bit	31	30	29	28	27	26	25	24	23	22	21	20	19	18	17	16	15	14	13	12	11	10	9	8	7	6	5	4	3	2	1	0
R																																
W																																
Reset	0	0	0	0	0	0	0	0	0	0	0	0	0	0	0	0	0	0	0	0	0	0	0	0	0	0	0	0	0	0	0	0

EPDC_PIGEON_CTRL1n field descriptions

Field	Description
31–28 -	This field is reserved. Reserved.
27–16 FRAME_CNT_ CYCLES	max cycles of frame counter
15–12 -	This field is reserved. Reserved.
FRAME_CNT_ PERIOD	period of frame counter

23.4.35 EPDC IRQ Mask Register for LUT 0~31 (EPDC_IRQ_MASK1n)

Controls masking EPDC LUT complete interrupts

This register controls LUT0~31 IRQ masks for EPDC interrupts

Address: 228_C000h base + 3C0h offset + (4d × i), where i=0d to 3d

Bit	31	30	29	28	27	26	25	24	23	22	21	20	19	18	17	16	15	14	13	12	11	10	9	8	7	6	5	4	3	2	1	0
R																																
W																																
Reset	0	0	0	0	0	0	0	0	0	0	0	0	0	0	0	0	0	0	0	0	0	0	0	0	0	0	0	0	0	0	0	0

EPDC_IRQ_MASK1n field descriptions

Field	Description
LUTN_CMPLT_ IRQ_EN	LUT0~31 Complete Interrupt Enable

23.4.36 EPDC IRQ Mask Register for LUT 32~63 (EPDC_IRQ_MASK2n)

Controls masking EPDC LUT complete interrupts

This register controls LUT0~31 IRQ masks for EPDC interrupts

Address: 228_C000h base + 3D0h offset + (4d × i), where i=0d to 3d

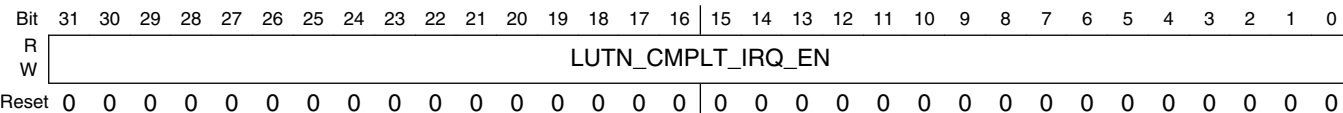

EPDC_IRQ_MASK2n field descriptions

Field	Description
LUTN_CMPLT_IRQ_EN	LUT32~64 Complete Interrupt Enable

23.4.37 EPDC Interrupt Register for LUT 0~31 (EPDC_IRQ1n)

EPDC LUT Completion IRQs. The IRQ for a specific LUT is triggered when it's corresponding physical update is completed on the screen. Each interrupt has a corresponding mask register in EPDC_IRQ_MASK

This register houses the interrupt bits for the LUT Completions

Address: 228_C000h base + 3E0h offset + (4d × i), where i=0d to 3d

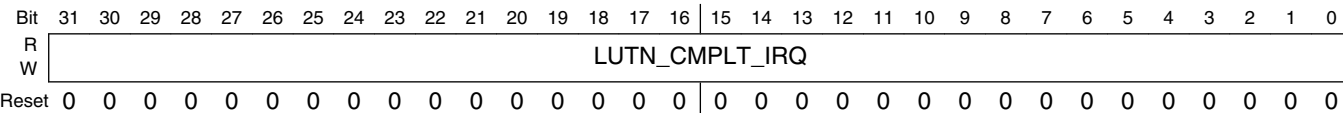

EPDC_IRQ1n field descriptions

Field	Description
LUTN_CMPLT_IRQ	LUT 0~31 Complete Interrupt

23.4.38 EPDC Interrupt Register for LUT 32~63 (EPDC_IRQ2n)

EPDC LUT Completion IRQs. The IRQ for a specific LUT is triggered when it's corresponding physical update is completed on the screen. Each interrupt has a corresponding mask register in EPDC_IRQ_MASK

This register houses the interrupt bits for the LUT Completions

Address: 228_C000h base + 3F0h offset + (4d × i), where i=0d to 3d

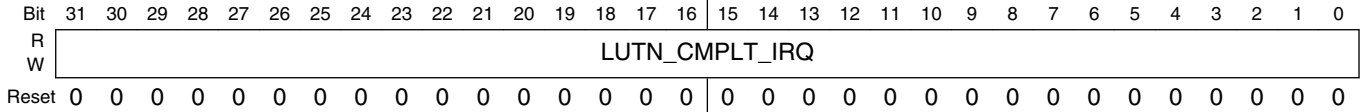

EPDC_IRQ2n field descriptions

Field	Description
LUTN_CMPLT_IRQ	LUT 32~64 Complete Interrupt

23.4.39 EPDC IRQ Mask Register (EPDC_IRQ_MASKn)

Controls masking for all EPDC interrupts

This register controls IRQ masks for all EPDC interrupts

Address: 228_C000h base + 400h offset + (4d × i), where i=0d to 3d

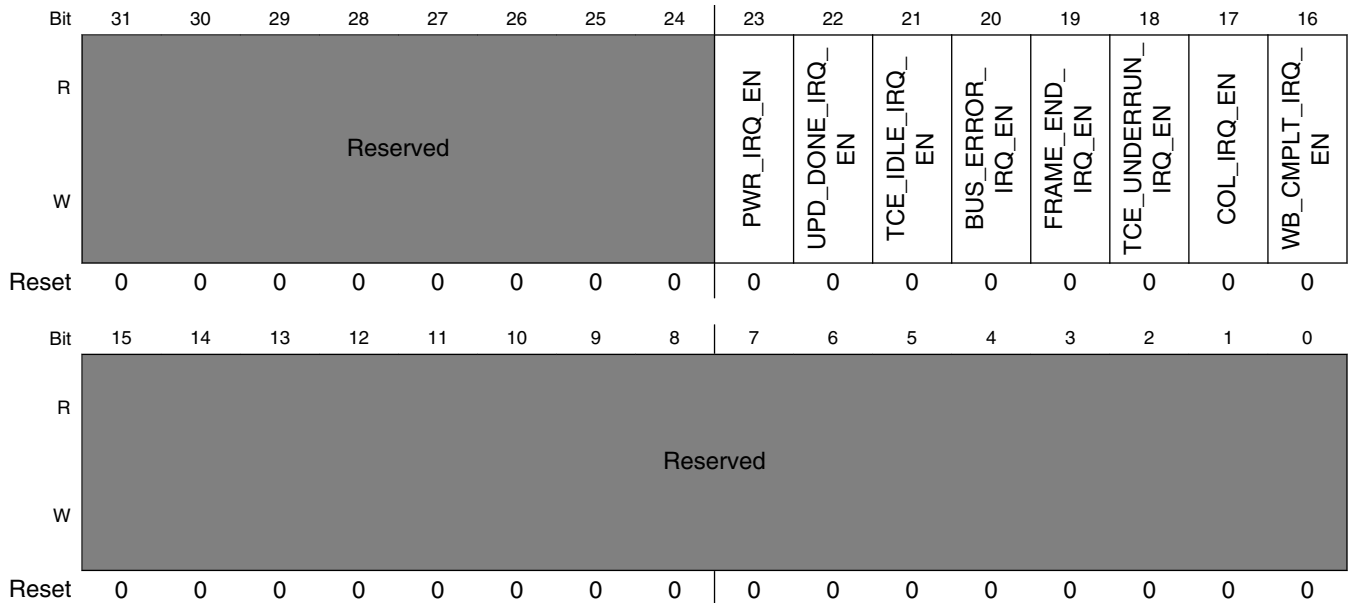

EPDC_IRQ_MASKn field descriptions

Field	Description
31-24 -	This field is reserved. Reserved.
23 PWR_IRQ_EN	Enable power interrupt

Table continues on the next page...

EPDC_IRQ_MASK_n field descriptions (continued)

Field	Description
22 UPD_DONE_IRQ_EN	Enable UPD complete interrupt
21 TCE_IDLE_IRQ_EN	Enable TCE Idle interrupt detection.
20 BUS_ERROR_IRQ_EN	Enable AXI BUS ERROR interrupt detection.
19 FRAME_END_IRQ_EN	If this bit is set, EPDC will assert the current frame end interrupt. This irq is only available during updating period.
18 TCE_UNDERRUN_IRQ_EN	Enable pixel FIFO under-run condition detection.
17 COL_IRQ_EN	Enable collision detection interrupts for all LUTs
16 WB_CMPLT_IRQ_EN	Enable WB complete interrupt
-	This field is reserved. Reserved.

23.4.40 EPDC Interrupt Register (EPDC_IRQ_n)

EPDC LUT Completion IRQs. The IRQ for a specific LUT is triggered when it's corresponding physical update is completed on the screen. Each interrupt has a corresponding mask register in EPDC_IRQ_MASK

This register houses the interrupt bits for the LUT Completions

Address: 228_C000h base + 420h offset + (4d × i), where i=0d to 3d

Bit	31	30	29	28	27	26	25	24	23	22	21	20	19	18	17	16
R	Reserved								PWR_IRQ	UPD_DONE_IRQ	TCE_IDLE_IRQ	BUS_ERROR_IRQ	FRAME_END_IRQ	TCE_UNDERRUN_IRQ	LUT_COL_IRQ	WB_CMPLT_IRQ
W	Reserved															
Reset	0	0	0	0	0	0	0	0	0	0	0	0	0	0	0	0

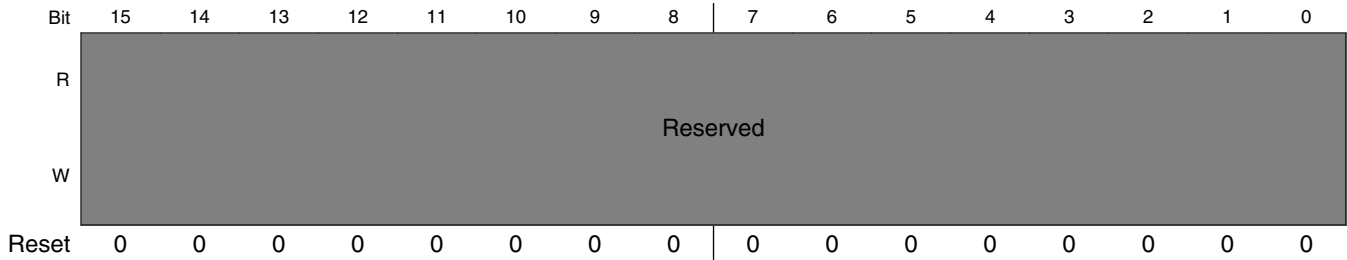

EPDC_IRQn field descriptions

Field	Description
31–24 -	This field is reserved. Reserved.
23 PWR_IRQ	Power Interrupt
22 UPD_DONE_IRQ	Working buffer process complete Interrupt
21 TCE_IDLE_IRQ	Interrupt to indicate that the TCE has completed TFT frame scans and is in an idle state.
20 BUS_ERROR_IRQ	Interrupt to indicate AXI BUS error occurs.
19 FRAME_END_IRQ	Interrupt to indicate EPDC has completed the current frame and is in the vertical blanking period.
18 TCE_UNDERRUN_IRQ	Interrupt to indicate that a pixel FIFO under-run has occurred.
17 LUT_COL_IRQ	Collision detection interrupt. Check EPDC_STATUS_COL.
16 WB_CMPLT_IRQ	Working buffer process complete Interrupt
-	This field is reserved. Reserved.

23.4.41 EPDC Status Register - LUTs (EPDC_STATUS_LUTS1n)

EPDC Status Register - LUTS 0~31

Address: 228_C000h base + 440h offset + (4d × i), where i=0d to 3d

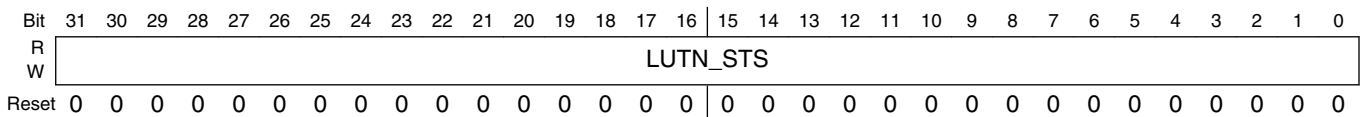

EPDC_STATUS_LUTS1n field descriptions

Field	Description
LUTN_STS	LUT 0~31 Status : 1=ACTIVE, 0=IDLE

23.4.42 EPDC Status Register - LUTs (EPDC_STATUS_LUTS2n)

EPDC Status Register - LUTS 0~31

Address: 228_C000h base + 450h offset + (4d × i), where i=0d to 3d



EPDC_STATUS_LUTS2n field descriptions

Field	Description
LUTN_STS	LUT 32~63 Status : 1=ACTIVE, 0=IDLE

23.4.43 EPDC Status Register - Next Available LUT (EPDC_STATUS_NEXTLUT)

Holds value of next available LUT. Can be used for fast LUT assignment. This value can be read and then used in an update command as part of the EPDC_UPD_CTRL register write

The DIGCTL Status Register provides a read-only view to various input conditions and internal states.

Address: 228_C000h base + 460h offset = 228_C460h

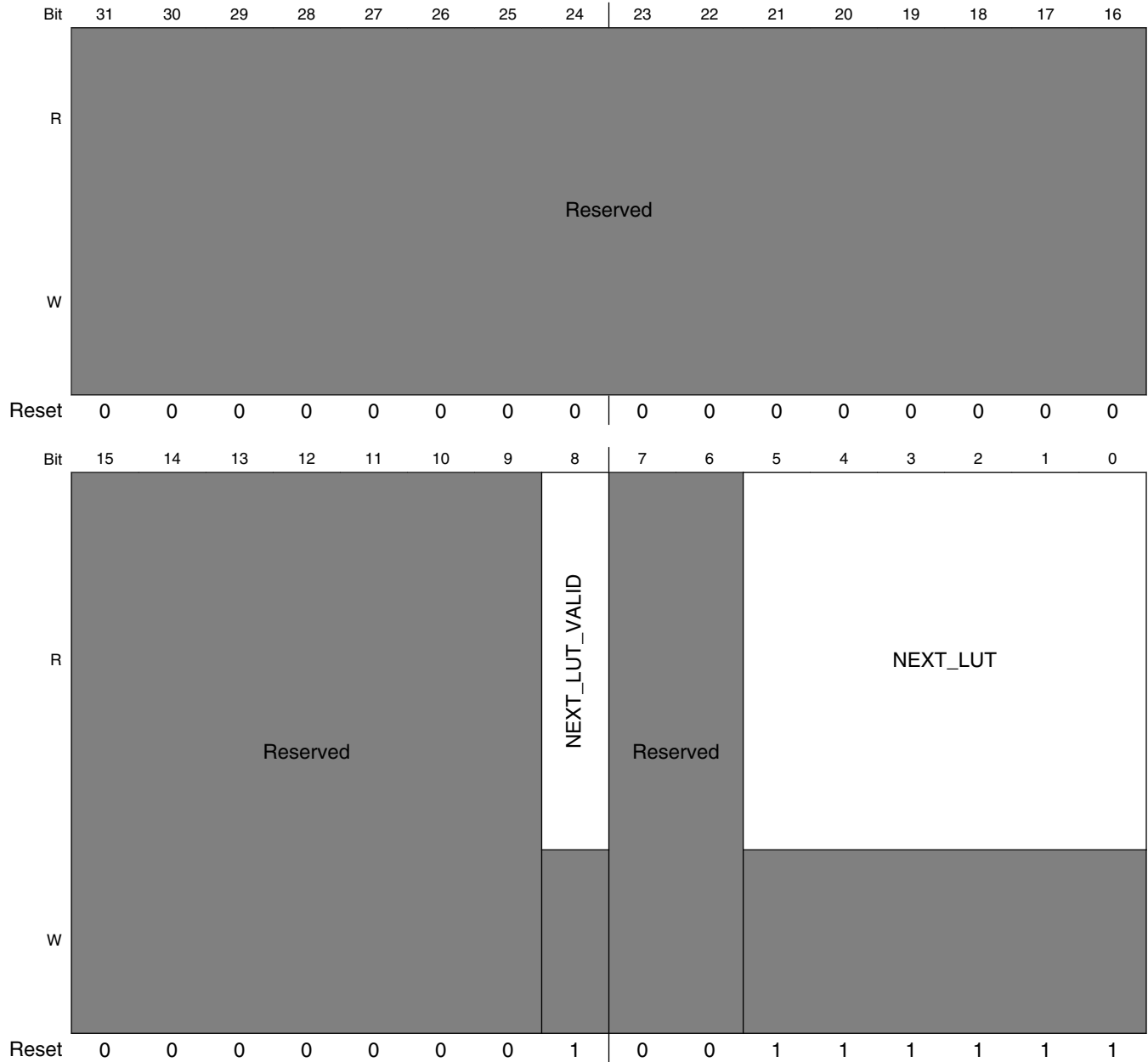

EPDC_STATUS_NEXTLUT field descriptions

Field	Description
31–9 -	This field is reserved. Reserved.
8 NEXT_LUT_VALID	This bitfield can be used to check against a LUTs full condition
7–6 -	This field is reserved. Reserved.
NEXT_LUT	Next available LUT value

23.4.44 EPDC LUT Collision Status (EPDC_STATUS_COL1n)

EPDC LUT Collision Status Register and works in conjunction with EPDC_IRQ[LUT_COL_IRQ]. When a collision occurs the interrupt is set and all status bits are set for LUTs which were touched by the collision. It does not set the bit for the LUT which caused the collision. There is a single interrupt mask which is used to control all the IRQ bits in this register (in EPDC_IRQ_MASK). Note that a collision caused by a LUT which was set-up for no collision detection will not trigger any collision LUT IRQ or status update. Note that clearing the interrupt bit EPDC_IRQ[LUT_COL_IRQ] clears this register

Address: 228_C000h base + 480h offset + (4d × i), where i=0d to 3d

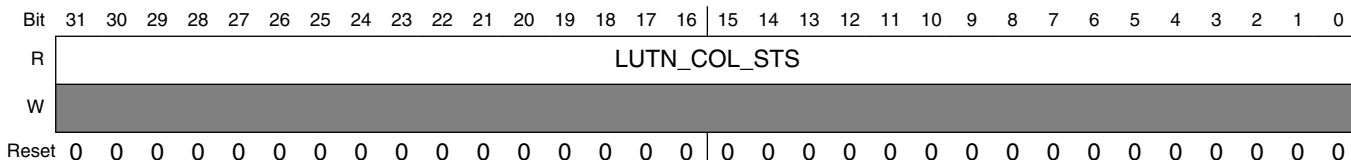

EPDC_STATUS_COL1n field descriptions

Field	Description
LUTN_COL_STS	LUTn Collision Status

23.4.45 EPDC LUT Collision Status (EPDC_STATUS_COL2n)

EPDC LUT Collision Status Register and works in conjunction with EPDC_IRQ[LUT_COL_IRQ]. When a collision occurs the interrupt is set and all status bits are set for LUTs which were touched by the collision. It does not set the bit for the LUT which caused the collision. There is a single interrupt mask which is used to control all the IRQ bits in this register (in EPDC_IRQ_MASK). Note that a collision caused by a LUT which was set-up for no collision detection will not trigger any collision LUT IRQ or status update. Note that clearing the interrupt bit EPDC_IRQ[LUT_COL_IRQ] clears this register

Address: 228_C000h base + 490h offset + (4d × i), where i=0d to 3d

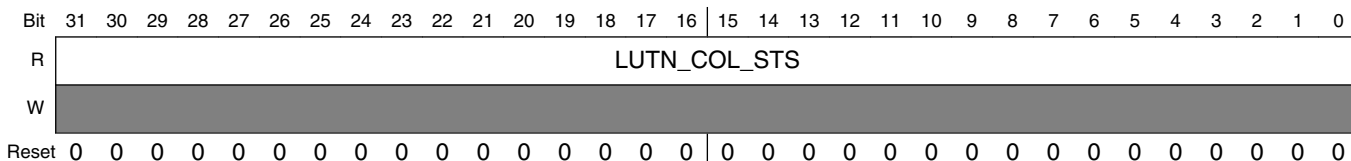

EPDC_STATUS_COL2n field descriptions

Field	Description
LUTN_COL_STS	LUTn Collision Status

23.4.46 EPDC General Status Register (EPDC_STATUSn)

Register to house non LUT specific status bits

This register houses general status bits

Address: 228_C000h base + 4A0h offset + (4d × i), where i=0d to 3d

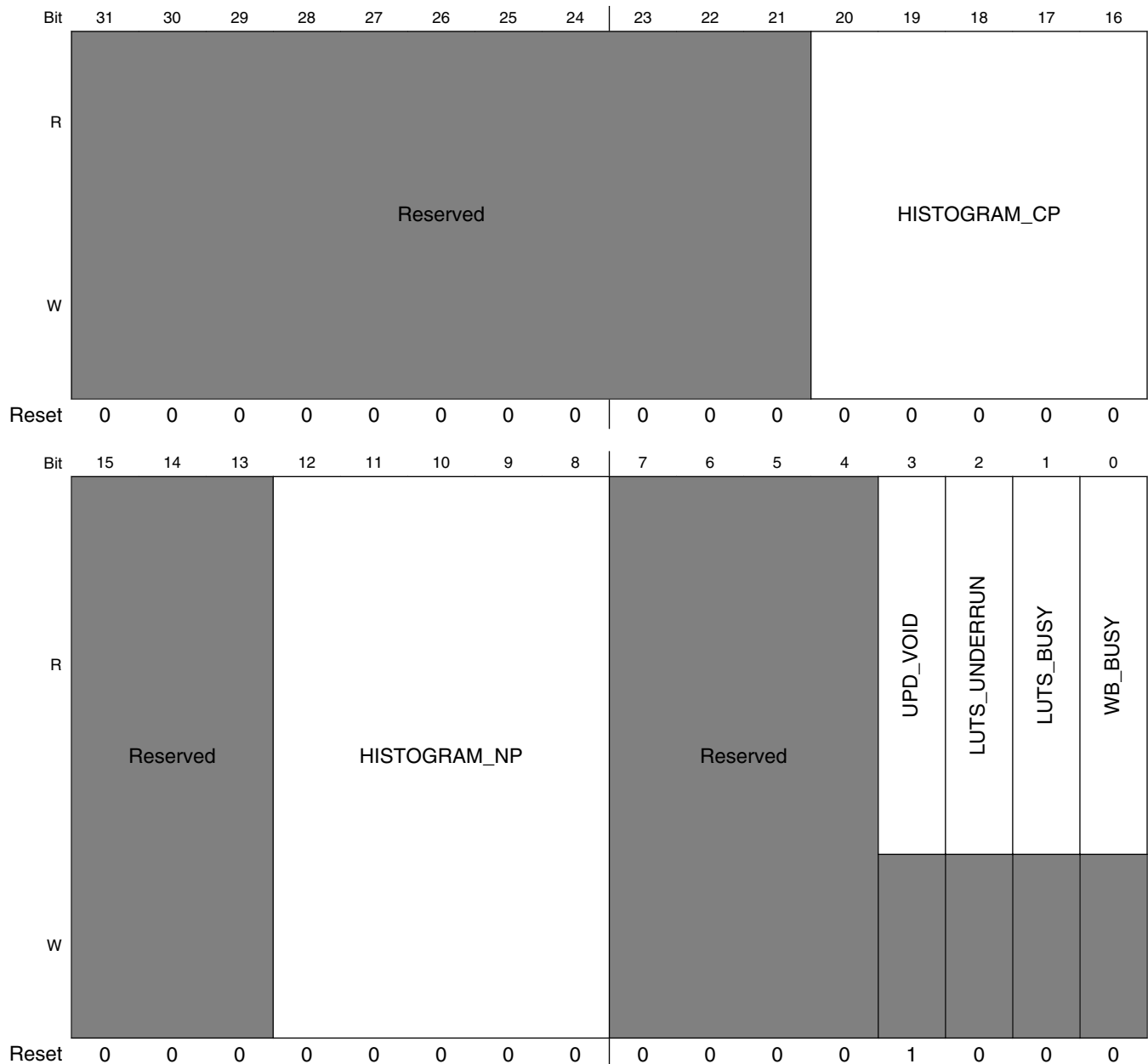

EPDC_STATUSn field descriptions

Field	Description
31–21 -	This field is reserved. Reserved.
20–16 HISTOGRAM_ CP	Indicates which histogram matched the existing bitmap(CP). Bit[0] indicates that the bitmap pixels were fully contained within the HIST1 (single color) histogram. Bit[1] indicates that the bitmap pixels were fully contained within the HIST2 (black / white) histogram. Bit[2] indicates that the bitmap pixels were fully contained within the HIST4 (2-bit grayscale) histogram. Bit[3] indicates that the bitmap pixels were fully contained within the HIST8 (3-bit grayscale) histogram. Bit[4] indicates that the bitmap pixels were fully contained within the HIST16 (4-bit grayscale) histogram.
15–13 -	This field is reserved. Reserved.
12–8 HISTOGRAM_ NP	Indicates which histogram matched the processed bitmap(NP). Bit[0] indicates that the bitmap pixels were fully contained within the HIST1 (single color) histogram. Bit[1] indicates that the bitmap pixels were fully contained within the HIST2 (black / white) histogram. Bit[2] indicates that the bitmap pixels were fully contained within the HIST4 (2-bit grayscale) histogram. Bit[3] indicates that the bitmap pixels were fully contained within the HIST8 (3-bit grayscale) histogram. Bit[4] indicates that the bitmap pixels were fully contained within the HIST16 (4-bit grayscale) histogram.
7–4 -	This field is reserved. Reserved.
3 UPD_VOID	Indicates that the update buffer is void. This means either no pixels need updating or all pixels requiring updating were collided.
2 LUTS_ UNDERRUN	Provides a summary status of LUT fill. 1= not enough time for active luts read during blanking period before vscan_holdoff. 0=complete all active luts fill during blanking period before VSCAN_HOLDOFF.
1 LUTS_BUSY	Provides a summary status of LUTs. 1= All LUTs are busy, 0= LUTs are available
0 WB_BUSY	Working buffer process is busy cannot accept new update requests. When WB_BUSY is 1, software should wait for the WB_CMPLT_IRQ interrupt. When this interrupt occurs WB_BUSY is cleared immediately. This is a real-time status of the process.

23.4.47 EPDC Collision Region Co-ordinate (EPDC_UPD_COL_CORD)

EPDC Collision Region Co-ordinate, cleared when new update issued

This register only valid after WB completion and collision happens.

Address: 228_C000h base + 4C0h offset = 228_C4C0h

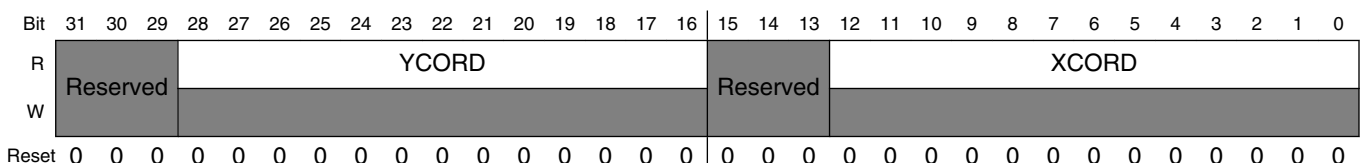

EPDC_UPD_COL_CORD field descriptions

Field	Description
31–29 -	This field is reserved. Reserved.
28–16 YCORD	Y co-ordinate for collision region of the latest completed update
15–13 -	This field is reserved. Reserved.
XCORD	X co-ordinate for collision region of the latest completed update

23.4.48 EPDC Collision Region Size (EPDC_UPD_COL_SIZE)

EPDC Collision Region Size of the latest completed update cleared when new update issued

This register only valid after WB completion and collision happens.

Address: 228_C000h base + 4E0h offset = 228_C4E0h

Bit	31	30	29	28	27	26	25	24	23	22	21	20	19	18	17	16	15	14	13	12	11	10	9	8	7	6	5	4	3	2	1	0
R	Reserved			HEIGHT													Reserved		WIDTH													
W	Reserved																Reserved															
Reset	0	0	0	0	0	0	0	0	0	0	0	0	0	0	0	0	0	0	0	0	0	0	0	0	0	0	0	0	0	0	0	0

EPDC_UPD_COL_SIZE field descriptions

Field	Description
31–29 -	This field is reserved. Reserved.
28–16 HEIGHT	Height (in pixels)
15–13 -	This field is reserved. Reserved.
WIDTH	Width (in pixels)

**23.4.49 1-level Histogram Parameter Register.
(EPDC_HIST1_PARAM)**

This register specifies the valid values for a 1-level(single color) histogram. If all pixels in a bitmap is only one color, STATUS[0] will be set at the end of frame processing. All comparator values should be programmed such that they are consistent with the TFT_PIXEL_FORMAT control field.

EPDC Memory Map/Register Definition

Address: 228_C000h base + 600h offset = 228_C600h

Bit	31	30	29	28	27	26	25	24	23	22	21	20	19	18	17	16	15	14	13	12	11	10	9	8	7	6	5	4	3	2	1	0
R	Reserved																VALUE0															
W	Reserved																VALUE0															
Reset	0	0	0	0	0	0	0	0	0	0	0	0	0	0	0	0	0	0	0	0	0	0	0	0	0	0	0	0	0	0	0	0

EPDC_HIST1_PARAM field descriptions

Field	Description
31–5 RSVD	This field is reserved. Reserved, always set to zero.
VALUE0	value for 1-level histogram

23.4.50 2-level Histogram Parameter Register. (EPDC_HIST2_PARAM)

This register specifies the valid values for a 2-level histogram. If all pixels in a bitmap match these two values, STATUS[0] will be set at the end of frame processing. All comparator values should be programmed such that they are consistent with the TFT_PIXEL_FORMAT control field.

Address: 228_C000h base + 610h offset = 228_C610h

Bit	31	30	29	28	27	26	25	24	23	22	21	20	19	18	17	16	15	14	13	12	11	10	9	8	7	6	5	4	3	2	1	0
R	Reserved																Reserved	VALUE1				Reserved	VALUE0									
W	Reserved																Reserved	VALUE1				Reserved	VALUE0									
Reset	0	0	0	0	0	0	0	0	0	0	0	0	0	0	0	0	0	0	0	0	1	1	1	1	0	0	0	0	0	0	0	0

EPDC_HIST2_PARAM field descriptions

Field	Description
31–16 RSVD	This field is reserved. Reserved, always set to zero.
15–13 -	This field is reserved. Reserved, always set to zero.
12–8 VALUE1	White value for 2-level histogram
7–5 -	This field is reserved. Reserved, always set to zero.
VALUE0	Black value for 2-level histogram

23.4.51 4-level Histogram Parameter Register. (EPDC_HIST4_PARAM)

This register specifies the valid values for a 4-level histogram. If all pixels in a bitmap match these two values, STATUS[1] will be set at the end of frame processing. All comparator values should be programmed such that they are consistent with the TFT_PIXEL_FORMAT control field.

Address: 228_C000h base + 620h offset = 228_C620h

Bit	31	30	29	28	27	26	25	24	23	22	21	20	19	18	17	16	15	14	13	12	11	10	9	8	7	6	5	4	3	2	1	0
R																																
W																																
Reset	0	0	0	0	1	1	1	1	0	0	0	0	1	0	1	0	0	0	0	0	0	1	0	1	0	0	0	0	0	0	0	

EPDC_HIST4_PARAM field descriptions

Field	Description
31–29 -	This field is reserved. Reserved, always set to zero.
28–24 VALUE3	GRAY3 (White) value for 4-level histogram
23–21 -	This field is reserved. Reserved, always set to zero.
20–16 VALUE2	GRAY2 value for 4-level histogram
15–13 -	This field is reserved. Reserved, always set to zero.
12–8 VALUE1	GRAY1 value for 4-level histogram
7–5 -	This field is reserved. Reserved, always set to zero.
VALUE0	GRAY0 (Black) value for 4-level histogram

23.4.52 8-level Histogram Parameter 0 Register. (EPDC_HIST8_PARAM0)

This register specifies four of the valid values for an 8-level histogram. If all pixels in a bitmap match these two values, STATUS[2] will be set at the end of frame processing. All comparator values should be programmed such that they are consistent with the TFT_PIXEL_FORMAT control field.

EPDC Memory Map/Register Definition

Address: 228_C000h base + 630h offset = 228_C630h

Bit	31	30	29	28	27	26	25	24	23	22	21	20	19	18	17	16	15	14	13	12	11	10	9	8	7	6	5	4	3	2	1	0
R																																
W																																
Reset	0	0	0	0	0	1	1	0	0	0	0	0	0	1	0	0	0	0	0	0	0	0	1	0	0	0	0	0	0	0	0	

EPDC_HIST8_PARAM0 field descriptions

Field	Description
31–29 -	This field is reserved. Reserved, always set to zero.
28–24 VALUE3	GRAY3 value for 8-level histogram
23–21 -	This field is reserved. Reserved, always set to zero.
20–16 VALUE2	GRAY2 value for 8-level histogram
15–13 -	This field is reserved. Reserved, always set to zero.
12–8 VALUE1	GRAY1 value for 8-level histogram
7–5 -	This field is reserved. Reserved, always set to zero.
VALUE0	GRAY0 (Black) value for 8-level histogram

23.4.53 8-level Histogram Parameter 1 Register. (EPDC_HIST8_PARAM1)

This register specifies four of the valid values for an 8-level histogram. If all pixels in a bitmap match these two values, STATUS[2] will be set at the end of frame processing. All comparator values should be programmed such that they are consistent with the TFT_PIXEL_FORMAT control field.

Address: 228_C000h base + 640h offset = 228_C640h

Bit	31	30	29	28	27	26	25	24	23	22	21	20	19	18	17	16	15	14	13	12	11	10	9	8	7	6	5	4	3	2	1	0
R																																
W																																
Reset	0	0	0	0	1	1	1	1	0	0	0	0	1	1	0	1	0	0	0	0	1	0	1	1	0	0	0	0	1	0	0	1

EPDC_HIST8_PARAM1 field descriptions

Field	Description
31–29 -	This field is reserved. Reserved, always set to zero.
28–24 VALUE7	GRAY7 (White) value for 8-level histogram

Table continues on the next page...

EPDC_HIST8_PARAM1 field descriptions (continued)

Field	Description
23–21 -	This field is reserved. Reserved, always set to zero.
20–16 VALUE6	GRAY6 value for 8-level histogram
15–13 -	This field is reserved. Reserved, always set to zero.
12–8 VALUE5	GRAY5 value for 8-level histogram
7–5 -	This field is reserved. Reserved, always set to zero.
VALUE4	GRAY4 value for 8-level histogram

**23.4.54 16-level Histogram Parameter 0 Register.
(EPDC_HIST16_PARAM0)**

This register specifies four of the valid values for a 16-level histogram. If all pixels in a bitmap match these two values, STATUS[3] will be set at the end of frame processing. All comparator values should be programmed such that they are consistent with the TFT_PIXEL_FORMAT control field.

Address: 228_C000h base + 650h offset = 228_C650h

Bit	31	30	29	28	27	26	25	24	23	22	21	20	19	18	17	16	15	14	13	12	11	10	9	8	7	6	5	4	3	2	1	0
R																																
W																																
Reset	0	0	0	0	0	0	1	1	0	0	0	0	0	0	0	1	0	0	0	0	0	0	0	1	0	0	0	0	0	0	0	

EPDC_HIST16_PARAM0 field descriptions

Field	Description
31–29 -	This field is reserved. Reserved, always set to zero.
28–24 VALUE3	GRAY3 value for 16-level histogram
23–21 -	This field is reserved. Reserved, always set to zero.
20–16 VALUE2	GRAY2 value for 16-level histogram
15–13 -	This field is reserved. Reserved, always set to zero.
12–8 VALUE1	GRAY1 value for 16-level histogram
7–5 -	This field is reserved. Reserved, always set to zero.
VALUE0	GRAY0 (Black) value for 16-level histogram

23.4.55 16-level Histogram Parameter Register. (EPDC_HIST16_PARAM1)

This register specifies four of the valid values for a 16-level histogram. If all pixels in a bitmap match these two values, STATUS[3] will be set at the end of frame processing. All comparator values should be programmed such that they are consistent with the TFT_PIXEL_FORMAT control field.

Address: 228_C000h base + 660h offset = 228_C660h

Bit	31	30	29	28	27	26	25	24	23	22	21	20	19	18	17	16	15	14	13	12	11	10	9	8	7	6	5	4	3	2	1	0
R																																
W																																
Reset	0	0	0	0	0	1	1	1	0	0	0	0	0	1	1	0	0	0	0	0	0	1	0	1	0	0	0	0	0	1	0	0

EPDC_HIST16_PARAM1 field descriptions

Field	Description
31–29 -	This field is reserved. Reserved, always set to zero.
28–24 VALUE7	GRAY7 value for 16-level histogram
23–21 -	This field is reserved. Reserved, always set to zero.
20–16 VALUE6	GRAY6 value for 16-level histogram
15–13 -	This field is reserved. Reserved, always set to zero.
12–8 VALUE5	GRAY5 value for 16-level histogram
7–5 -	This field is reserved. Reserved, always set to zero.
VALUE4	GRAY4 value for 16-level histogram

23.4.56 16-level Histogram Parameter Register. (EPDC_HIST16_PARAM2)

This register specifies four of the valid values for a 16-level histogram. If all pixels in a bitmap match these two values, STATUS[3] will be set at the end of frame processing. All comparator values should be programmed such that they are consistent with the TFT_PIXEL_FORMAT control field.

Address: 228_C000h base + 670h offset = 228_C670h

Bit	31	30	29	28	27	26	25	24	23	22	21	20	19	18	17	16	15	14	13	12	11	10	9	8	7	6	5	4	3	2	1	0
R																																
W																																
Reset	0	0	0	0	1	0	1	1	0	0	0	0	1	0	1	0	0	0	0	0	1	0	0	1	0	0	0	0	1	0	0	0

EPDC_HIST16_PARAM2 field descriptions

Field	Description
31–29 -	This field is reserved. Reserved, always set to zero.
28–24 VALUE11	GRAY11 value for 16-level histogram
23–21 -	This field is reserved. Reserved, always set to zero.
20–16 VALUE10	GRAY10 value for 16-level histogram
15–13 -	This field is reserved. Reserved, always set to zero.
12–8 VALUE9	GRAY9 value for 16-level histogram
7–5 -	This field is reserved. Reserved, always set to zero.
VALUE8	GRAY8 value for 16-level histogram

**23.4.57 16-level Histogram Parameter Register.
(EPDC_HIST16_PARAM3)**

This register specifies four of the valid values for a 16-level histogram. If all pixels in a bitmap match these two values, STATUS[3] will be set at the end of frame processing. All comparator values should be programmed such that they are consistent with the TFT_PIXEL_FORMAT control field.

Address: 228_C000h base + 680h offset = 228_C680h

Bit	31	30	29	28	27	26	25	24	23	22	21	20	19	18	17	16	15	14	13	12	11	10	9	8	7	6	5	4	3	2	1	0
R																																
W																																
Reset	0	0	0	0	1	1	1	1	0	0	0	0	1	1	1	0	0	0	0	0	1	1	0	1	0	0	0	0	1	1	0	0

EPDC_HIST16_PARAM3 field descriptions

Field	Description
31–29 -	This field is reserved. Reserved, always set to zero.
28–24 VALUE15	GRAY15 (White) value for 16-level histogram

Table continues on the next page...

EPDC_HIST16_PARAM3 field descriptions (continued)

Field	Description
23–21 -	This field is reserved. Reserved, always set to zero.
20–16 VALUE14	GRAY14 value for 16-level histogram
15–13 -	This field is reserved. Reserved, always set to zero.
12–8 VALUE13	GRAY13 value for 16-level histogram
7–5 -	This field is reserved. Reserved, always set to zero.
VALUE12	GRAY12 value for 16-level histogram

23.4.58 EPDC General Purpose I/O Debug register (EPDC_GPIOn)

GPIO register to control ipp_epdc_bdr[1:0], ipp_epdc_pwr[3:0] and ipp_epdc_pwrcom output signals

Houses software control signal registers

Address: 228_C000h base + 700h offset + (4d × i), where i=0d to 3d

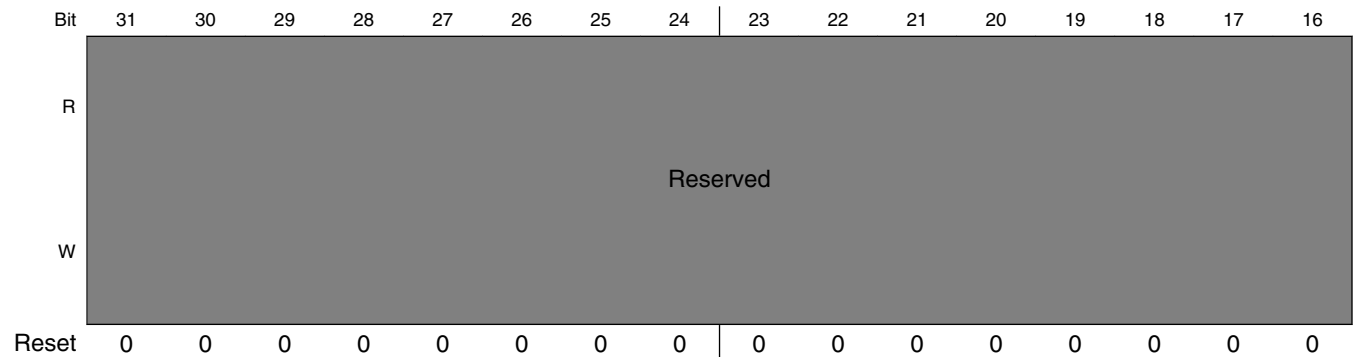

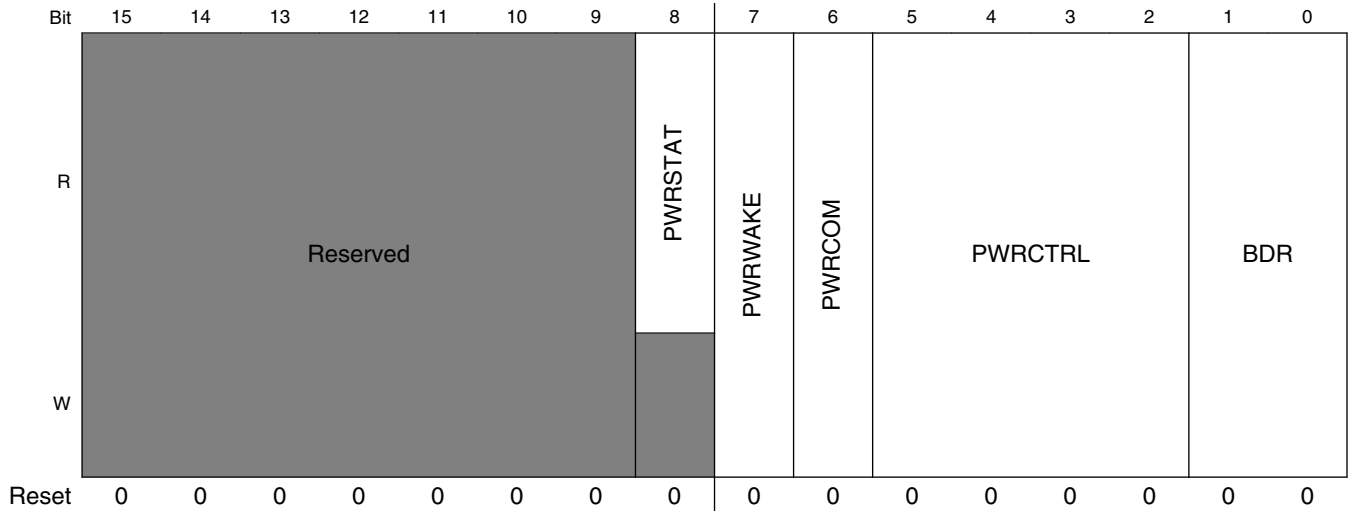

EPDC_GPIOn field descriptions

Field	Description
31–9 -	This field is reserved. Reserved.
8 PWRSTAT	reflect ipp_epdc_pwrstat input
7 PWRWAKE	Controls ipp_epdc_pwrwake output
6 PWRCOM	Controls ipp_epdc_pwrcom output
5–2 PWRCTRL	Controls ipp_epdc_pwrctrl[3:0] output
BDR	Controls ipp_epdc_bdr[1:0] output

23.4.59 EPDC Version Register (EPDC_VERSION)

This register reflects the version number for the EPDC.

EXAMPLE

No Example.

Address: 228_C000h base + 7F0h offset = 228_C7F0h

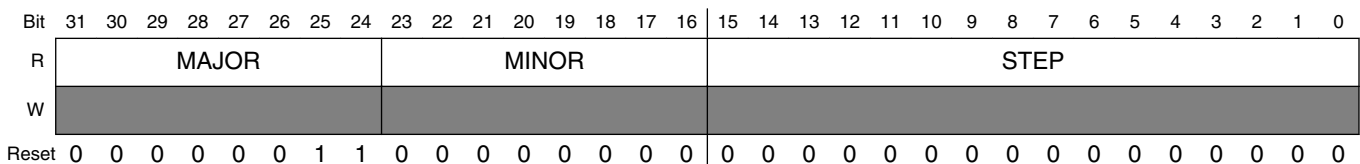

EPDC_VERSION field descriptions

Field	Description
31–24 MAJOR	Fixed read-only value reflecting the MAJOR field of the RTL version.
23–16 MINOR	Fixed read-only value reflecting the MINOR field of the RTL version.
STEP	Fixed read-only value reflecting the stepping of the RTL version.

23.4.60 Panel Interface Signal Generator Register 0_0 (EPDC_PIGEON_0_0)

parameters for timing signal generation

Address: 228_C000h base + 800h offset = 228_C800h

Bit	31	30	29	28	27	26	25	24	23	22	21	20	19	18	17	16
R																
W	STATE_MASK								MASK_CNT							
Reset	0	0	0	0	0	0	0	0	0	0	0	0	0	0	0	0
Bit	15	14	13	12	11	10	9	8	7	6	5	4	3	2	1	0
R																
W	MASK_CNT				MASK_CNT_SEL				OFFSET				INC_SEL		POL	EN
Reset	0	0	0	0	1	1	1	1	0	0	0	0	0	0	0	0

EPDC_PIGEON_0_0 field descriptions

Field	Description
31–24 STATE_MASK	state_mask = (FSIFBIFDIFE) and (LSILBILDILE) , select any combination of scan states as reference point for local counter to start ticking 0x1 FS — FRAME SYNC 0x2 FB — FRAME BEGIN 0x4 FD — FRAME DATA 0x8 FE — FRAME END 0x10 LS — LINE SYNC 0x20 LB — LINE BEGIN 0x40 LD — LINE DATA 0x80 LE — LINE END
23–12 MASK_CNT	When the global counter selected through MASK_CNT_SEL matches value in this reg, pigeon local counter start ticking. 0=disable
11–8 MASK_CNT_SEL	select global counters as mask condition, use together with MASK_CNT 0x0 HSTATE_CNT — pclk counter within one hscan state 0x1 HSTATE_CYCLE — pclk cycle within one hscan state 0x2 VSTATE_CNT — line counter within one vscan state 0x3 VSTATE_CYCLE — line cycle within one vscan state 0x4 FRAME_CNT — frame counter

Table continues on the next page...

EPDC_PIGEON_0_0 field descriptions (continued)

Field	Description
	0x5 FRAME_CYCLE — frame cycle 0x6 HCNT — horizontal counter (pclk counter within one line) 0x7 VCNT — vertical counter (line counter within one frame)
7–4 OFFSET	offset on pclk unit. 0=align with data, positive value means delay, minus value mean ahead. Supported range depends on panel mode
3–2 INC_SEL	event to increment local counter 0x0 PCLK — pclk 0x1 LINE — line start pulse 0x2 FRAME — frame start pulse 0x3 SIG_ANOTHER — use another signal as tick event
1 POL	polarity of signal output 0x0 ACTIVE_HIGH — normal signal (active high) 0x1 ACTIVE_LOW — inverted signal (active low)
0 EN	enable pigeon mode on this signal

23.4.61 Panel Interface Signal Generator Register 0_1 (EPDC_PIGEON_0_1)

parameters for timing signal generation

Address: 228_C000h base + 810h offset = 228_C810h

Bit	31	30	29	28	27	26	25	24	23	22	21	20	19	18	17	16	15	14	13	12	11	10	9	8	7	6	5	4	3	2	1	0
R	CLR_CNT																SET_CNT															
W																																
Reset	0	0	0	0	0	0	0	0	0	0	0	0	0	0	0	0	0	0	0	0	0	0	0	0	0	0	0	0	0	0	0	0

EPDC_PIGEON_0_1 field descriptions

Field	Description
31–16 CLR_CNT	deassert signal output when counter match this value 0x0 CLEAR_USING_MASK — keep active until mask off
SET_CNT	assert signal output when counter match this value 0x0 START_ACTIVE — start as active

23.4.62 Panel Interface Signal Generator Register 0_1 (EPDC_PIGEON_0_2)

parameters for timing signal generation

EPDC Memory Map/Register Definition

Address: 228_C000h base + 820h offset = 228_C820h

Bit	31	30	29	28	27	26	25	24	23	22	21	20	19	18	17	16	15	14	13	12	11	10	9	8	7	6	5	4	3	2	1	0
R	Reserved																SIG_ANOTHER				SIG_LOGIC											
W	Reserved																SIG_ANOTHER				SIG_LOGIC											
Reset	0	0	0	0	0	0	0	0	0	0	0	0	0	0	0	0	0	0	0	0	0	0	0	0	0	0	0	0	0	0	0	0

EPDC_PIGEON_0_2 field descriptions

Field	Description
31–9 -	This field is reserved. Reserved.
8–4 SIG_ANOTHER	select another signal for logic operation or as mask or counter tick event
SIG_LOGIC	logic operation with another signal sigout : final output signal of this generator mask : final mask of this generator this_sig : intermediate signal of this generator before logic operation other_masks : intermediate mask result of this generator before logic operation sig_another : signal selected other generators 0x0 DIS — no logic operation 0x1 AND — sigout = sig_another AND this_sig 0x2 OR — sigout = sig_another OR this_sig 0x3 MASK — mask = sig_another AND other_masks

23.4.63 Panel Interface Signal Generator Register 1_0 (EPDC_PIGEON_1_0)

parameters for timing signal generation

Address: 228_C000h base + 840h offset = 228_C840h

Bit	31	30	29	28	27	26	25	24	23	22	21	20	19	18	17	16
R	STATE_MASK								MASK_CNT							
W	STATE_MASK								MASK_CNT							
Reset	0	0	0	0	0	0	0	0	0	0	0	0	0	0	0	0

Bit	15	14	13	12	11	10	9	8	7	6	5	4	3	2	1	0
R	MASK_CNT				MASK_CNT_SEL				OFFSET				INC_SEL	POL	EN	
W	MASK_CNT				MASK_CNT_SEL				OFFSET				INC_SEL	POL	EN	
Reset	0	0	0	0	1	1	1	1	0	0	0	0	0	0	0	0

EPDC_PIGEON_1_0 field descriptions

Field	Description
31–24 STATE_MASK	state_mask = (FSIFBIFDIFE) and (LSILBILDILE) , select any combination of scan states as reference point for local counter to start ticking 0x1 FS — FRAME SYNC

Table continues on the next page...

EPDC_PIGEON_1_0 field descriptions (continued)

Field	Description
	0x2 FB — FRAME BEGIN 0x4 FD — FRAME DATA 0x8 FE — FRAME END 0x10 LS — LINE SYNC 0x20 LB — LINE BEGIN 0x40 LD — LINE DATA 0x80 LE — LINE END
23–12 MASK_CNT	When the global counter selected through MASK_CNT_SEL matches value in this reg, pigeon local counter start ticking. 0=disable
11–8 MASK_CNT_SEL	select global counters as mask condition, use together with MASK_CNT 0x0 HSTATE_CNT — pclk counter within one hscan state 0x1 HSTATE_CYCLE — pclk cycle within one hscan state 0x2 VSTATE_CNT — line counter within one vscan state 0x3 VSTATE_CYCLE — line cycle within one vscan state 0x4 FRAME_CNT — frame counter 0x5 FRAME_CYCLE — frame cycle 0x6 HCNT — horizontal counter (pclk counter within one line) 0x7 VCNT — vertical counter (line counter within one frame)
7–4 OFFSET	offset on pclk unit. 0=align with data, positive value means delay, minus value mean ahead. Supported range depends on panel mode
3–2 INC_SEL	event to increment local counter 0x0 PCLK — pclk 0x1 LINE — line start pulse 0x2 FRAME — frame start pulse 0x3 SIG_ANOTHER — use another signal as tick event
1 POL	polarity of signal output 0x0 ACTIVE_HIGH — normal signal (active high) 0x1 ACTIVE_LOW — inverted signal (active low)
0 EN	enable pigeon mode on this signal

23.4.64 Panel Interface Signal Generator Register 1_1 (EPDC_PIGEON_1_1)

parameters for timing signal generation

Address: 228_C000h base + 850h offset = 228_C850h

Bit	31	30	29	28	27	26	25	24	23	22	21	20	19	18	17	16	15	14	13	12	11	10	9	8	7	6	5	4	3	2	1	0
R																																
W	CLR_CNT																SET_CNT															
Reset	0	0	0	0	0	0	0	0	0	0	0	0	0	0	0	0	0	0	0	0	0	0	0	0	0	0	0	0	0	0	0	0

EPDC_PIGEON_1_1 field descriptions

Field	Description
31–16 CLR_CNT	deassert signal output when counter match this value 0x0 CLEAR_USING_MASK — keep active until mask off
SET_CNT	assert signal output when counter match this value 0x0 START_ACTIVE — start as active

23.4.65 Panel Interface Signal Generator Register 1_1 (EPDC_PIGEON_1_2)

parameters for timing signal generation

Address: 228_C000h base + 860h offset = 228_C860h

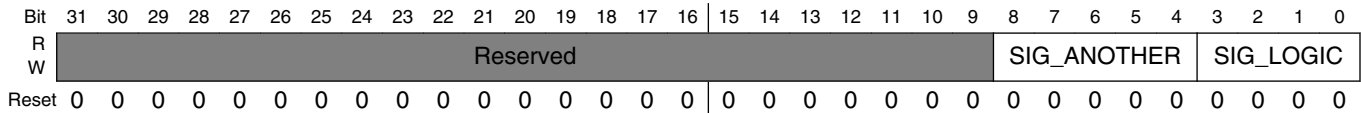

EPDC_PIGEON_1_2 field descriptions

Field	Description
31–9 -	This field is reserved. Reserved.
8–4 SIG_ANOTHER	select another signal for logic operation or as mask or counter tick event
SIG_LOGIC	logic operation with another signal sigout : final output signal of this generator mask : final mask of this generator this_sig : intermediate signal of this generator before logic operation other_masks : intermediate mask result of this generator before logic operation sig_another : signal selected other generators 0x0 DIS — no logic operation 0x1 AND — sigout = sig_another AND this_sig 0x2 OR — sigout = sig_another OR this_sig 0x3 MASK — mask = sig_another AND other_masks

23.4.66 Panel Interface Signal Generator Register 2_0 (EPDC_PIGEON_2_0)

parameters for timing signal generation

Address: 228_C000h base + 880h offset = 228_C880h

Bit	31	30	29	28	27	26	25	24	23	22	21	20	19	18	17	16
R																
W	STATE_MASK								MASK_CNT							
Reset	0	0	0	0	0	0	0	0	0	0	0	0	0	0	0	0
Bit	15	14	13	12	11	10	9	8	7	6	5	4	3	2	1	0
R																
W	MASK_CNT				MASK_CNT_SEL				OFFSET				INC_SEL		POL	EN
Reset	0	0	0	0	1	1	1	1	0	0	0	0	0	0	0	0

EPDC_PIGEON_2_0 field descriptions

Field	Description
31–24 STATE_MASK	state_mask = (FSIFBIFDIFE) and (LSILBILDILE) , select any combination of scan states as reference point for local counter to start ticking 0x1 FS — FRAME SYNC 0x2 FB — FRAME BEGIN 0x4 FD — FRAME DATA 0x8 FE — FRAME END 0x10 LS — LINE SYNC 0x20 LB — LINE BEGIN 0x40 LD — LINE DATA 0x80 LE — LINE END
23–12 MASK_CNT	When the global counter selected through MASK_CNT_SEL matches value in this reg, pigeon local counter start ticking. 0=disable
11–8 MASK_CNT_SEL	select global counters as mask condition, use together with MASK_CNT 0x0 HSTATE_CNT — pclk counter within one hscan state 0x1 HSTATE_CYCLE — pclk cycle within one hscan state 0x2 VSTATE_CNT — line counter within one vscan state 0x3 VSTATE_CYCLE — line cycle within one vscan state 0x4 FRAME_CNT — frame counter 0x5 FRAME_CYCLE — frame cycle 0x6 HCNT — horizontal counter (pclk counter within one line) 0x7 VCNT — vertical counter (line counter within one frame)
7–4 OFFSET	offset on pclk unit. 0=aligne with data, positive value means delay, minus value mean ahead. Supported range depends on panel mode
3–2 INC_SEL	event to incrment local counter 0x0 PCLK — pclk 0x1 LINE — line start pulse 0x2 FRAME — frame start pulse 0x3 SIG_ANOTHER — use another signal as tick event
1 POL	polarity of signal output 0x0 ACTIVE_HIGH — normal signal (active high) 0x1 ACTIVE_LOW — inverted signal (active low)
0 EN	enable pigeon mode on this signal

23.4.67 Panel Interface Signal Generator Register 2_1 (EPDC_PIGEON_2_1)

parameters for timing signal generation

Address: 228_C000h base + 890h offset = 228_C890h

Bit	31	30	29	28	27	26	25	24	23	22	21	20	19	18	17	16	15	14	13	12	11	10	9	8	7	6	5	4	3	2	1	0
R																																
W	CLR_CNT																SET_CNT															
Reset	0	0	0	0	0	0	0	0	0	0	0	0	0	0	0	0	0	0	0	0	0	0	0	0	0	0	0	0	0	0	0	0

EPDC_PIGEON_2_1 field descriptions

Field	Description
31–16 CLR_CNT	deassert signal output when counter match this value 0x0 CLEAR_USING_MASK — keep active until mask off
SET_CNT	assert signal output when counter match this value 0x0 START_ACTIVE — start as active

23.4.68 Panel Interface Signal Generator Register 2_1 (EPDC_PIGEON_2_2)

parameters for timing signal generation

Address: 228_C000h base + 8A0h offset = 228_C8A0h

Bit	31	30	29	28	27	26	25	24	23	22	21	20	19	18	17	16	15	14	13	12	11	10	9	8	7	6	5	4	3	2	1	0
R																																
W	Reserved																SIG_ANOTHER				SIG_LOGIC											
Reset	0	0	0	0	0	0	0	0	0	0	0	0	0	0	0	0	0	0	0	0	0	0	0	0	0	0	0	0	0	0	0	0

EPDC_PIGEON_2_2 field descriptions

Field	Description
31–9 -	This field is reserved. Reserved.
8–4 SIG_ANOTHER	select another signal for logic operation or as mask or counter tick event
SIG_LOGIC	logic operation with another signal sigout : final output signal of this generator mask : final mask of this generator this_sig : intermediate signal of this generator before logic operation other_masks : intermediate mask result of this generator before logic operation

Table continues on the next page...

EPDC_PIGEON_2_2 field descriptions (continued)

Field	Description
	sig_another : signal selected other generators
0x0	DIS — no logic operation
0x1	AND — sigout = sig_another AND this_sig
0x2	OR — sigout = sig_another OR this_sig
0x3	MASK — mask = sig_another AND other_masks

23.4.69 Panel Interface Signal Generator Register 3_0 (EPDC_PIGEON_3_0)

parameters for timing signal generation

Address: 228_C000h base + 8C0h offset = 228_C8C0h

Bit	31	30	29	28	27	26	25	24	23	22	21	20	19	18	17	16
R	STATE_MASK								MASK_CNT							
W																
Reset	0	0	0	0	0	0	0	0	0	0	0	0	0	0	0	0
Bit	15	14	13	12	11	10	9	8	7	6	5	4	3	2	1	0
R	MASK_CNT				MASK_CNT_SEL				OFFSET				INC_SEL		POL	EN
W																
Reset	0	0	0	0	1	1	1	1	0	0	0	0	0	0	0	0

EPDC_PIGEON_3_0 field descriptions

Field	Description
31–24 STATE_MASK	state_mask = (FSIFBIFDIFE) and (LSILBILDILE) , select any combination of scan states as reference point for local counter to start ticking 0x1 FS — FRAME SYNC 0x2 FB — FRAME BEGIN 0x4 FD — FRAME DATA 0x8 FE — FRAME END 0x10 LS — LINE SYNC 0x20 LB — LINE BEGIN 0x40 LD — LINE DATA 0x80 LE — LINE END
23–12 MASK_CNT	When the global counter selected through MASK_CNT_SEL matches value in this reg, pigeon local counter start ticking. 0=disable
11–8 MASK_CNT_SEL	select global counters as mask condition, use together with MASK_CNT 0x0 HSTATE_CNT — pclk counter within one hscan state 0x1 HSTATE_CYCLE — pclk cycle within one hscan state 0x2 VSTATE_CNT — line counter within one vscan state 0x3 VSTATE_CYCLE — line cycle within one vscan state 0x4 FRAME_CNT — frame counter

Table continues on the next page...

EPDC_PIGEON_3_0 field descriptions (continued)

Field	Description
	0x5 FRAME_CYCLE — frame cycle 0x6 HCNT — horizontal counter (pclk counter within one line) 0x7 VCNT — vertical counter (line counter within one frame)
7-4 OFFSET	offset on pclk unit. 0=align with data, positive value means delay, minus value mean ahead. Supported range depends on panel mode
3-2 INC_SEL	event to increment local counter 0x0 PCLK — pclk 0x1 LINE — line start pulse 0x2 FRAME — frame start pulse 0x3 SIG_ANOTHER — use another signal as tick event
1 POL	polarity of signal output 0x0 ACTIVE_HIGH — normal signal (active high) 0x1 ACTIVE_LOW — inverted signal (active low)
0 EN	enable pigeon mode on this signal

23.4.70 Panel Interface Signal Generator Register 3_1 (EPDC_PIGEON_3_1)

parameters for timing signal generation

Address: 228_C000h base + 8D0h offset = 228_C8D0h

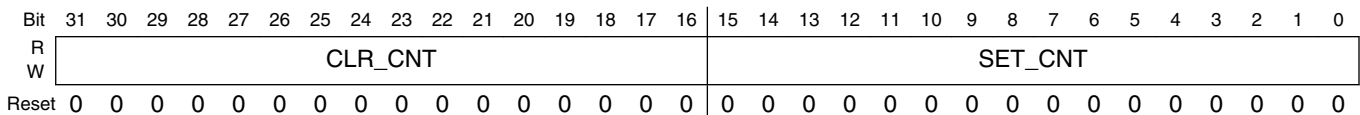

EPDC_PIGEON_3_1 field descriptions

Field	Description
31-16 CLR_CNT	deassert signal output when counter match this value 0x0 CLEAR_USING_MASK — keep active until mask off
SET_CNT	assert signal output when counter match this value 0x0 START_ACTIVE — start as active

23.4.71 Panel Interface Signal Generator Register 3_1 (EPDC_PIGEON_3_2)

parameters for timing signal generation

Address: 228_C000h base + 8E0h offset = 228_C8E0h

Bit	31	30	29	28	27	26	25	24	23	22	21	20	19	18	17	16	15	14	13	12	11	10	9	8	7	6	5	4	3	2	1	0
R	Reserved																SIG_ANOTHER				SIG_LOGIC											
W																																
Reset	0	0	0	0	0	0	0	0	0	0	0	0	0	0	0	0	0	0	0	0	0	0	0	0	0	0	0	0	0	0	0	0

EPDC_PIGEON_3_2 field descriptions

Field	Description
31–9 -	This field is reserved. Reserved.
8–4 SIG_ANOTHER	select another signal for logic operation or as mask or counter tick event
SIG_LOGIC	logic operation with another signal sigout : final output signal of this generator mask : final mask of this generator this_sig : intermediate signal of this generator before logic operation other_masks : intermediate mask result of this generator before logic operation sig_another : signal selected other generators 0x0 DIS — no logic operation 0x1 AND — sigout = sig_another AND this_sig 0x2 OR — sigout = sig_another OR this_sig 0x3 MASK — mask = sig_another AND other_masks

23.4.72 Panel Interface Signal Generator Register 4_0 (EPDC_PIGEON_4_0)

parameters for timing signal generation

Address: 228_C000h base + 900h offset = 228_C900h

Bit	31	30	29	28	27	26	25	24	23	22	21	20	19	18	17	16
R	STATE_MASK								MASK_CNT							
W																
Reset	0	0	0	0	0	0	0	0	0	0	0	0	0	0	0	0

Bit	15	14	13	12	11	10	9	8	7	6	5	4	3	2	1	0
R	MASK_CNT				MASK_CNT_SEL				OFFSET				INC_SEL	POL	EN	
W																
Reset	0	0	0	0	1	1	1	1	0	0	0	0	0	0	0	0

EPDC_PIGEON_4_0 field descriptions

Field	Description
31–24 STATE_MASK	state_mask = (FSIFBIFDIFE) and (LSILBILDILE) , select any combination of scan states as reference point for local counter to start ticking 0x1 FS — FRAME SYNC

Table continues on the next page...

EPDC_PIGEON_4_0 field descriptions (continued)

Field	Description
	0x2 FB — FRAME BEGIN 0x4 FD — FRAME DATA 0x8 FE — FRAME END 0x10 LS — LINE SYNC 0x20 LB — LINE BEGIN 0x40 LD — LINE DATA 0x80 LE — LINE END
23–12 MASK_CNT	When the global counter selected through MASK_CNT_SEL matches value in this reg, pigeon local counter start ticking. 0=disable
11–8 MASK_CNT_SEL	select global counters as mask condition, use together with MASK_CNT 0x0 HSTATE_CNT — pclk counter within one hscan state 0x1 HSTATE_CYCLE — pclk cycle within one hscan state 0x2 VSTATE_CNT — line counter within one vscan state 0x3 VSTATE_CYCLE — line cycle within one vscan state 0x4 FRAME_CNT — frame counter 0x5 FRAME_CYCLE — frame cycle 0x6 HCNT — horizontal counter (pclk counter within one line) 0x7 VCNT — vertical counter (line counter within one frame)
7–4 OFFSET	offset on pclk unit. 0=align with data, positive value means delay, minus value mean ahead. Supported range depends on panel mode
3–2 INC_SEL	event to increment local counter 0x0 PCLK — pclk 0x1 LINE — line start pulse 0x2 FRAME — frame start pulse 0x3 SIG_ANOTHER — use another signal as tick event
1 POL	polarity of signal output 0x0 ACTIVE_HIGH — normal signal (active high) 0x1 ACTIVE_LOW — inverted signal (active low)
0 EN	enable pigeon mode on this signal

23.4.73 Panel Interface Signal Generator Register 4_1 (EPDC_PIGEON_4_1)

parameters for timing signal generation

Address: 228_C000h base + 910h offset = 228_C910h

Bit	31	30	29	28	27	26	25	24	23	22	21	20	19	18	17	16	15	14	13	12	11	10	9	8	7	6	5	4	3	2	1	0
R																																
W	CLR_CNT																SET_CNT															
Reset	0	0	0	0	0	0	0	0	0	0	0	0	0	0	0	0	0	0	0	0	0	0	0	0	0	0	0	0	0	0	0	0

EPDC_PIGEON_4_1 field descriptions

Field	Description
31–16 CLR_CNT	deassert signal output when counter match this value 0x0 CLEAR_USING_MASK — keep active until mask off
SET_CNT	assert signal output when counter match this value 0x0 START_ACTIVE — start as active

23.4.74 Panel Interface Signal Generator Register 4_1 (EPDC_PIGEON_4_2)

parameters for timing signal generation

Address: 228_C000h base + 920h offset = 228_C920h

Bit	31	30	29	28	27	26	25	24	23	22	21	20	19	18	17	16	15	14	13	12	11	10	9	8	7	6	5	4	3	2	1	0
R	Reserved																SIG_ANOTHER				SIG_LOGIC											
W	Reserved																SIG_ANOTHER				SIG_LOGIC											
Reset	0	0	0	0	0	0	0	0	0	0	0	0	0	0	0	0	0	0	0	0	0	0	0	0	0	0	0	0	0	0	0	0

EPDC_PIGEON_4_2 field descriptions

Field	Description
31–9 -	This field is reserved. Reserved.
8–4 SIG_ANOTHER	select another signal for logic operation or as mask or counter tick event
SIG_LOGIC	logic operation with another signal sigout : final output signal of this generator mask : final mask of this generator this_sig : intermediate signal of this generator before logic operation other_masks : intermediate mask result of this generator before logic operation sig_another : signal selected other generators 0x0 DIS — no logic operation 0x1 AND — sigout = sig_another AND this_sig 0x2 OR — sigout = sig_another OR this_sig 0x3 MASK — mask = sig_another AND other_masks

23.4.75 Panel Interface Signal Generator Register 5_0 (EPDC_PIGEON_5_0)

parameters for timing signal generation

EPDC Memory Map/Register Definition

Address: 228_C000h base + 940h offset = 228_C940h

Bit	31	30	29	28	27	26	25	24	23	22	21	20	19	18	17	16
R	STATE_MASK								MASK_CNT							
W																
Reset	0	0	0	0	0	0	0	0	0	0	0	0	0	0	0	0
Bit	15	14	13	12	11	10	9	8	7	6	5	4	3	2	1	0
R	MASK_CNT				MASK_CNT_SEL				OFFSET				INC_SEL	POL	EN	
W																
Reset	0	0	0	0	1	1	1	1	0	0	0	0	0	0	0	0

EPDC_PIGEON_5_0 field descriptions

Field	Description
31–24 STATE_MASK	state_mask = (FSIFBIFDIFE) and (LSILBILDILE) , select any combination of scan states as reference point for local counter to start ticking 0x1 FS — FRAME SYNC 0x2 FB — FRAME BEGIN 0x4 FD — FRAME DATA 0x8 FE — FRAME END 0x10 LS — LINE SYNC 0x20 LB — LINE BEGIN 0x40 LD — LINE DATA 0x80 LE — LINE END
23–12 MASK_CNT	When the global counter selected through MASK_CNT_SEL matches value in this reg, pigeon local counter start ticking. 0=disable
11–8 MASK_CNT_SEL	select global counters as mask condition, use together with MASK_CNT 0x0 HSTATE_CNT — pclk counter within one hscan state 0x1 HSTATE_CYCLE — pclk cycle within one hscan state 0x2 VSTATE_CNT — line counter within one vscan state 0x3 VSTATE_CYCLE — line cycle within one vscan state 0x4 FRAME_CNT — frame counter 0x5 FRAME_CYCLE — frame cycle 0x6 HCNT — horizontal counter (pclk counter within one line) 0x7 VCNT — vertical counter (line counter within one frame)
7–4 OFFSET	offset on pclk unit. 0=aligne with data, positive value means delay, minus value mean ahead. Supported range depends on panel mode
3–2 INC_SEL	event to incrment local counter 0x0 PCLK — pclk 0x1 LINE — line start pulse 0x2 FRAME — frame start pulse 0x3 SIG_ANOTHER — use another signal as tick event
1 POL	polarity of signal output 0x0 ACTIVE_HIGH — normal signal (active high) 0x1 ACTIVE_LOW — inverted signal (active low)
0 EN	enable pigeon mode on this signal

23.4.76 Panel Interface Signal Generator Register 5_1 (EPDC_PIGEON_5_1)

parameters for timing signal generation

Address: 228_C000h base + 950h offset = 228_C950h

Bit	31	30	29	28	27	26	25	24	23	22	21	20	19	18	17	16	15	14	13	12	11	10	9	8	7	6	5	4	3	2	1	0
R																																
W	CLR_CNT																SET_CNT															
Reset	0	0	0	0	0	0	0	0	0	0	0	0	0	0	0	0	0	0	0	0	0	0	0	0	0	0	0	0	0	0	0	0

EPDC_PIGEON_5_1 field descriptions

Field	Description
31–16 CLR_CNT	deassert signal output when counter match this value 0x0 CLEAR_USING_MASK — keep active until mask off
SET_CNT	assert signal output when counter match this value 0x0 START_ACTIVE — start as active

23.4.77 Panel Interface Signal Generator Register 5_1 (EPDC_PIGEON_5_2)

parameters for timing signal generation

Address: 228_C000h base + 960h offset = 228_C960h

Bit	31	30	29	28	27	26	25	24	23	22	21	20	19	18	17	16	15	14	13	12	11	10	9	8	7	6	5	4	3	2	1	0
R																																
W	Reserved																SIG_ANOTHER				SIG_LOGIC											
Reset	0	0	0	0	0	0	0	0	0	0	0	0	0	0	0	0	0	0	0	0	0	0	0	0	0	0	0	0	0	0	0	0

EPDC_PIGEON_5_2 field descriptions

Field	Description
31–9 -	This field is reserved. Reserved.
8–4 SIG_ANOTHER	select another signal for logic operation or as mask or counter tick event
SIG_LOGIC	logic operation with another signal sigout : final output signal of this generator mask : final mask of this generator this_sig : intermediate signal of this generator before logic operation other_masks : intermediate mask result of this generator before logic operation

Table continues on the next page...

EPDC_PIGEON_5_2 field descriptions (continued)

Field	Description
	sig_another : signal selected other generators
0x0	DIS — no logic operation
0x1	AND — sigout = sig_another AND this_sig
0x2	OR — sigout = sig_another OR this_sig
0x3	MASK — mask = sig_another AND other_masks

23.4.78 Panel Interface Signal Generator Register 6_0 (EPDC_PIGEON_6_0)

parameters for timing signal generation

Address: 228_C000h base + 980h offset = 228_C980h

Bit	31	30	29	28	27	26	25	24	23	22	21	20	19	18	17	16
R	STATE_MASK								MASK_CNT							
W																
Reset	0	0	0	0	0	0	0	0	0	0	0	0	0	0	0	0
Bit	15	14	13	12	11	10	9	8	7	6	5	4	3	2	1	0
R	MASK_CNT				MASK_CNT_SEL				OFFSET				INC_SEL	POL	EN	
W																
Reset	0	0	0	0	1	1	1	1	0	0	0	0	0	0	0	0

EPDC_PIGEON_6_0 field descriptions

Field	Description
31–24 STATE_MASK	state_mask = (FSIFBIFDIFE) and (LSILBILDILE) , select any combination of scan states as reference point for local counter to start ticking 0x1 FS — FRAME SYNC 0x2 FB — FRAME BEGIN 0x4 FD — FRAME DATA 0x8 FE — FRAME END 0x10 LS — LINE SYNC 0x20 LB — LINE BEGIN 0x40 LD — LINE DATA 0x80 LE — LINE END
23–12 MASK_CNT	When the global counter selected through MASK_CNT_SEL matches value in this reg, pigeon local counter start ticking. 0=disable
11–8 MASK_CNT_SEL	select global counters as mask condition, use together with MASK_CNT 0x0 HSTATE_CNT — pclk counter within one hscan state 0x1 HSTATE_CYCLE — pclk cycle within one hscan state 0x2 VSTATE_CNT — line counter within one vscan state 0x3 VSTATE_CYCLE — line cycle within one vscan state 0x4 FRAME_CNT — frame counter

Table continues on the next page...

EPDC_PIGEON_6_0 field descriptions (continued)

Field	Description
	0x5 FRAME_CYCLE — frame cycle 0x6 HCNT — horizontal counter (pclk counter within one line) 0x7 VCNT — vertical counter (line counter within one frame)
7–4 OFFSET	offset on pclk unit. 0=align with data, positive value means delay, minus value mean ahead. Supported range depends on panel mode
3–2 INC_SEL	event to increment local counter 0x0 PCLK — pclk 0x1 LINE — line start pulse 0x2 FRAME — frame start pulse 0x3 SIG_ANOTHER — use another signal as tick event
1 POL	polarity of signal output 0x0 ACTIVE_HIGH — normal signal (active high) 0x1 ACTIVE_LOW — inverted signal (active low)
0 EN	enable pigeon mode on this signal

23.4.79 Panel Interface Signal Generator Register 6_1 (EPDC_PIGEON_6_1)

parameters for timing signal generation

Address: 228_C000h base + 990h offset = 228_C990h

Bit	31	30	29	28	27	26	25	24	23	22	21	20	19	18	17	16	15	14	13	12	11	10	9	8	7	6	5	4	3	2	1	0
R	CLR_CNT																SET_CNT															
W																																
Reset	0	0	0	0	0	0	0	0	0	0	0	0	0	0	0	0	0	0	0	0	0	0	0	0	0	0	0	0	0	0	0	0

EPDC_PIGEON_6_1 field descriptions

Field	Description
31–16 CLR_CNT	deassert signal output when counter match this value 0x0 CLEAR_USING_MASK — keep active until mask off
SET_CNT	assert signal output when counter match this value 0x0 START_ACTIVE — start as active

23.4.80 Panel Interface Signal Generator Register 6_1 (EPDC_PIGEON_6_2)

parameters for timing signal generation

EPDC Memory Map/Register Definition

Address: 228_C000h base + 9A0h offset = 228_C9A0h

Bit	31	30	29	28	27	26	25	24	23	22	21	20	19	18	17	16	15	14	13	12	11	10	9	8	7	6	5	4	3	2	1	0
R	Reserved																SIG_ANOTHER				SIG_LOGIC											
W	Reserved																SIG_ANOTHER				SIG_LOGIC											
Reset	0	0	0	0	0	0	0	0	0	0	0	0	0	0	0	0	0	0	0	0	0	0	0	0	0	0	0	0	0	0	0	0

EPDC_PIGEON_6_2 field descriptions

Field	Description
31–9 -	This field is reserved. Reserved.
8–4 SIG_ANOTHER	select another signal for logic operation or as mask or counter tick event
SIG_LOGIC	logic operation with another signal sigout : final output signal of this generator mask : final mask of this generator this_sig : intermediate signal of this generator before logic operation other_masks : intermediate mask result of this generator before logic operation sig_another : signal selected other generators 0x0 DIS — no logic operation 0x1 AND — sigout = sig_another AND this_sig 0x2 OR — sigout = sig_another OR this_sig 0x3 MASK — mask = sig_another AND other_masks

23.4.81 Panel Interface Signal Generator Register 7_0 (EPDC_PIGEON_7_0)

parameters for timing signal generation

Address: 228_C000h base + 9C0h offset = 228_C9C0h

Bit	31	30	29	28	27	26	25	24	23	22	21	20	19	18	17	16
R	STATE_MASK								MASK_CNT							
W	STATE_MASK								MASK_CNT							
Reset	0	0	0	0	0	0	0	0	0	0	0	0	0	0	0	0

Bit	15	14	13	12	11	10	9	8	7	6	5	4	3	2	1	0
R	MASK_CNT				MASK_CNT_SEL				OFFSET				INC_SEL	POL	EN	
W	MASK_CNT				MASK_CNT_SEL				OFFSET				INC_SEL	POL	EN	
Reset	0	0	0	0	1	1	1	1	0	0	0	0	0	0	0	0

EPDC_PIGEON_7_0 field descriptions

Field	Description
31–24 STATE_MASK	state_mask = (FSIFBIFDIFE) and (LSILBILDILE) , select any combination of scan states as reference point for local counter to start ticking 0x1 FS — FRAME SYNC

Table continues on the next page...

EPDC_PIGEON_7_0 field descriptions (continued)

Field	Description
	0x2 FB — FRAME BEGIN 0x4 FD — FRAME DATA 0x8 FE — FRAME END 0x10 LS — LINE SYNC 0x20 LB — LINE BEGIN 0x40 LD — LINE DATA 0x80 LE — LINE END
23–12 MASK_CNT	When the global counter selected through MASK_CNT_SEL matches value in this reg, pigeon local counter start ticking. 0=disable
11–8 MASK_CNT_SEL	select global counters as mask condition, use together with MASK_CNT 0x0 HSTATE_CNT — pclk counter within one hscan state 0x1 HSTATE_CYCLE — pclk cycle within one hscan state 0x2 VSTATE_CNT — line counter within one vscan state 0x3 VSTATE_CYCLE — line cycle within one vscan state 0x4 FRAME_CNT — frame counter 0x5 FRAME_CYCLE — frame cycle 0x6 HCNT — horizontal counter (pclk counter within one line) 0x7 VCNT — vertical counter (line counter within one frame)
7–4 OFFSET	offset on pclk unit. 0=align with data, positive value means delay, minus value mean ahead. Supported range depends on panel mode
3–2 INC_SEL	event to increment local counter 0x0 PCLK — pclk 0x1 LINE — line start pulse 0x2 FRAME — frame start pulse 0x3 SIG_ANOTHER — use another signal as tick event
1 POL	polarity of signal output 0x0 ACTIVE_HIGH — normal signal (active high) 0x1 ACTIVE_LOW — inverted signal (active low)
0 EN	enable pigeon mode on this signal

23.4.82 Panel Interface Signal Generator Register 7_1 (EPDC_PIGEON_7_1)

parameters for timing signal generation

Address: 228_C000h base + 9D0h offset = 228_C9D0h

Bit	31	30	29	28	27	26	25	24	23	22	21	20	19	18	17	16	15	14	13	12	11	10	9	8	7	6	5	4	3	2	1	0
R																																
W	CLR_CNT																SET_CNT															
Reset	0	0	0	0	0	0	0	0	0	0	0	0	0	0	0	0	0	0	0	0	0	0	0	0	0	0	0	0	0	0	0	0

EPDC_PIGEON_7_1 field descriptions

Field	Description
31–16 CLR_CNT	deassert signal output when counter match this value 0x0 CLEAR_USING_MASK — keep active until mask off
SET_CNT	assert signal output when counter match this value 0x0 START_ACTIVE — start as active

23.4.83 Panel Interface Signal Generator Register 7_1 (EPDC_PIGEON_7_2)

parameters for timing signal generation

Address: 228_C000h base + 9E0h offset = 228_C9E0h

Bit	31	30	29	28	27	26	25	24	23	22	21	20	19	18	17	16	15	14	13	12	11	10	9	8	7	6	5	4	3	2	1	0
R	Reserved																SIG_ANOTHER				SIG_LOGIC											
W	Reserved																SIG_ANOTHER				SIG_LOGIC											
Reset	0	0	0	0	0	0	0	0	0	0	0	0	0	0	0	0	0	0	0	0	0	0	0	0	0	0	0	0	0	0	0	0

EPDC_PIGEON_7_2 field descriptions

Field	Description
31–9 -	This field is reserved. Reserved.
8–4 SIG_ANOTHER	select another signal for logic operation or as mask or counter tick event
SIG_LOGIC	logic operation with another signal sigout : final output signal of this generator mask : final mask of this generator this_sig : intermediate signal of this generator before logic operation other_masks : intermediate mask result of this generator before logic operation sig_another : signal selected other generators 0x0 DIS — no logic operation 0x1 AND — sigout = sig_another AND this_sig 0x2 OR — sigout = sig_another OR this_sig 0x3 MASK — mask = sig_another AND other_masks

23.4.84 Panel Interface Signal Generator Register 8_0 (EPDC_PIGEON_8_0)

parameters for timing signal generation

Address: 228_C000h base + A00h offset = 228_CA00h

Bit	31	30	29	28	27	26	25	24	23	22	21	20	19	18	17	16
R	STATE_MASK								MASK_CNT							
W																
Reset	0	0	0	0	0	0	0	0	0	0	0	0	0	0	0	0
Bit	15	14	13	12	11	10	9	8	7	6	5	4	3	2	1	0
R	MASK_CNT				MASK_CNT_SEL				OFFSET				INC_SEL	POL	EN	
W																
Reset	0	0	0	0	1	1	1	1	0	0	0	0	0	0	0	0

EPDC_PIGEON_8_0 field descriptions

Field	Description
31–24 STATE_MASK	state_mask = (FSIFBIFDIFE) and (LSILBILDILE) , select any combination of scan states as reference point for local counter to start ticking 0x1 FS — FRAME SYNC 0x2 FB — FRAME BEGIN 0x4 FD — FRAME DATA 0x8 FE — FRAME END 0x10 LS — LINE SYNC 0x20 LB — LINE BEGIN 0x40 LD — LINE DATA 0x80 LE — LINE END
23–12 MASK_CNT	When the global counter selected through MASK_CNT_SEL matches value in this reg, pigeon local counter start ticking. 0=disable
11–8 MASK_CNT_SEL	select global counters as mask condition, use together with MASK_CNT 0x0 HSTATE_CNT — pclk counter within one hscan state 0x1 HSTATE_CYCLE — pclk cycle within one hscan state 0x2 VSTATE_CNT — line counter within one vscan state 0x3 VSTATE_CYCLE — line cycle within one vscan state 0x4 FRAME_CNT — frame counter 0x5 FRAME_CYCLE — frame cycle 0x6 HCNT — horizontal counter (pclk counter within one line) 0x7 VCNT — vertical counter (line counter within one frame)
7–4 OFFSET	offset on pclk unit. 0=aligne with data, positive value means delay, minus value mean ahead. Supported range depends on panel mode
3–2 INC_SEL	event to incrment local counter 0x0 PCLK — pclk 0x1 LINE — line start pulse 0x2 FRAME — frame start pulse 0x3 SIG_ANOTHER — use another signal as tick event
1 POL	polarity of signal output 0x0 ACTIVE_HIGH — normal signal (active high) 0x1 ACTIVE_LOW — inverted signal (active low)
0 EN	enable pigeon mode on this signal

23.4.85 Panel Interface Signal Generator Register 8_1 (EPDC_PIGEON_8_1)

parameters for timing signal generation

Address: 228_C000h base + A10h offset = 228_CA10h

Bit	31	30	29	28	27	26	25	24	23	22	21	20	19	18	17	16	15	14	13	12	11	10	9	8	7	6	5	4	3	2	1	0
R																																
W	CLR_CNT																SET_CNT															
Reset	0	0	0	0	0	0	0	0	0	0	0	0	0	0	0	0	0	0	0	0	0	0	0	0	0	0	0	0	0	0	0	0

EPDC_PIGEON_8_1 field descriptions

Field	Description
31–16 CLR_CNT	deassert signal output when counter match this value 0x0 CLEAR_USING_MASK — keep active until mask off
SET_CNT	assert signal output when counter match this value 0x0 START_ACTIVE — start as active

23.4.86 Panel Interface Signal Generator Register 8_1 (EPDC_PIGEON_8_2)

parameters for timing signal generation

Address: 228_C000h base + A20h offset = 228_CA20h

Bit	31	30	29	28	27	26	25	24	23	22	21	20	19	18	17	16	15	14	13	12	11	10	9	8	7	6	5	4	3	2	1	0
R																									SIG_ANOTHER		SIG_LOGIC					
W	Reserved																															
Reset	0	0	0	0	0	0	0	0	0	0	0	0	0	0	0	0	0	0	0	0	0	0	0	0	0	0	0	0	0	0	0	0

EPDC_PIGEON_8_2 field descriptions

Field	Description
31–9 -	This field is reserved. Reserved.
8–4 SIG_ANOTHER	select another signal for logic operation or as mask or counter tick event
SIG_LOGIC	logic operation with another signal sigout : final output signal of this generator mask : final mask of this generator this_sig : intermediate signal of this generator before logic operation other_masks : intermediate mask result of this generator before logic operation

Table continues on the next page...

EPDC_PIGEON_8_2 field descriptions (continued)

Field	Description
	sig_another : signal selected other generators
0x0	DIS — no logic operation
0x1	AND — sigout = sig_another AND this_sig
0x2	OR — sigout = sig_another OR this_sig
0x3	MASK — mask = sig_another AND other_masks

23.4.87 Panel Interface Signal Generator Register 9_0 (EPDC_PIGEON_9_0)

parameters for timing signal generation

Address: 228_C000h base + A40h offset = 228_CA40h

Bit	31	30	29	28	27	26	25	24	23	22	21	20	19	18	17	16
R	STATE_MASK								MASK_CNT							
W																
Reset	0	0	0	0	0	0	0	0	0	0	0	0	0	0	0	0
Bit	15	14	13	12	11	10	9	8	7	6	5	4	3	2	1	0
R	MASK_CNT				MASK_CNT_SEL				OFFSET				INC_SEL		POL	EN
W																
Reset	0	0	0	0	1	1	1	1	0	0	0	0	0	0	0	0

EPDC_PIGEON_9_0 field descriptions

Field	Description
31–24 STATE_MASK	state_mask = (FSIFBIFDIFE) and (LSILBILDILE) , select any combination of scan states as reference point for local counter to start ticking 0x1 FS — FRAME SYNC 0x2 FB — FRAME BEGIN 0x4 FD — FRAME DATA 0x8 FE — FRAME END 0x10 LS — LINE SYNC 0x20 LB — LINE BEGIN 0x40 LD — LINE DATA 0x80 LE — LINE END
23–12 MASK_CNT	When the global counter selected through MASK_CNT_SEL matches value in this reg, pigeon local counter start ticking. 0=disable
11–8 MASK_CNT_SEL	select global counters as mask condition, use together with MASK_CNT 0x0 HSTATE_CNT — pclk counter within one hscan state 0x1 HSTATE_CYCLE — pclk cycle within one hscan state 0x2 VSTATE_CNT — line counter within one vscan state 0x3 VSTATE_CYCLE — line cycle within one vscan state 0x4 FRAME_CNT — frame counter

Table continues on the next page...

EPDC_PIGEON_9_0 field descriptions (continued)

Field	Description
	0x5 FRAME_CYCLE — frame cycle 0x6 HCNT — horizontal counter (pclk counter within one line) 0x7 VCNT — vertical counter (line counter within one frame)
7-4 OFFSET	offset on pclk unit. 0=align with data, positive value means delay, minus value mean ahead. Supported range depends on panel mode
3-2 INC_SEL	event to increment local counter 0x0 PCLK — pclk 0x1 LINE — line start pulse 0x2 FRAME — frame start pulse 0x3 SIG_ANOTHER — use another signal as tick event
1 POL	polarity of signal output 0x0 ACTIVE_HIGH — normal signal (active high) 0x1 ACTIVE_LOW — inverted signal (active low)
0 EN	enable pigeon mode on this signal

23.4.88 Panel Interface Signal Generator Register 9_1 (EPDC_PIGEON_9_1)

parameters for timing signal generation

Address: 228_C000h base + A50h offset = 228_CA50h

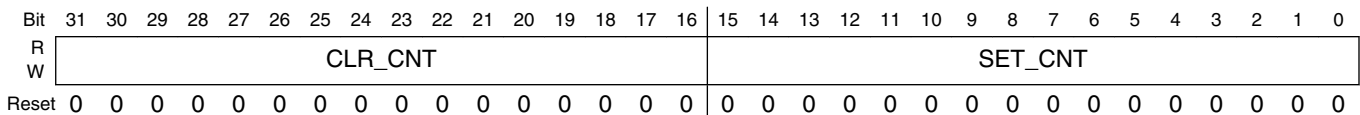

EPDC_PIGEON_9_1 field descriptions

Field	Description
31-16 CLR_CNT	deassert signal output when counter match this value 0x0 CLEAR_USING_MASK — keep active until mask off
SET_CNT	assert signal output when counter match this value 0x0 START_ACTIVE — start as active

23.4.89 Panel Interface Signal Generator Register 9_1 (EPDC_PIGEON_9_2)

parameters for timing signal generation

Address: 228_C000h base + A60h offset = 228_CA60h

Bit	31	30	29	28	27	26	25	24	23	22	21	20	19	18	17	16	15	14	13	12	11	10	9	8	7	6	5	4	3	2	1	0
R	Reserved																SIG_ANOTHER				SIG_LOGIC											
W																																
Reset	0	0	0	0	0	0	0	0	0	0	0	0	0	0	0	0	0	0	0	0	0	0	0	0	0	0	0	0	0	0	0	0

EPDC_PIGEON_9_2 field descriptions

Field	Description
31–9 -	This field is reserved. Reserved.
8–4 SIG_ANOTHER	select another signal for logic operation or as mask or counter tick event
SIG_LOGIC	logic operation with another signal sigout : final output signal of this generator mask : final mask of this generator this_sig : intermediate signal of this generator before logic operation other_masks : intermediate mask result of this generator before logic operation sig_another : signal selected other generators 0x0 DIS — no logic operation 0x1 AND — sigout = sig_another AND this_sig 0x2 OR — sigout = sig_another OR this_sig 0x3 MASK — mask = sig_another AND other_masks

23.4.90 Panel Interface Signal Generator Register 10_0 (EPDC_PIGEON_10_0)

parameters for timing signal generation

Address: 228_C000h base + A80h offset = 228_CA80h

Bit	31	30	29	28	27	26	25	24	23	22	21	20	19	18	17	16
R	STATE_MASK								MASK_CNT							
W																
Reset	0	0	0	0	0	0	0	0	0	0	0	0	0	0	0	0

Bit	15	14	13	12	11	10	9	8	7	6	5	4	3	2	1	0
R	MASK_CNT				MASK_CNT_SEL				OFFSET				INC_SEL	POL	EN	
W																
Reset	0	0	0	0	1	1	1	1	0	0	0	0	0	0	0	0

EPDC_PIGEON_10_0 field descriptions

Field	Description
31–24 STATE_MASK	state_mask = (FSIFBIFDIFE) and (LSILBILDILE) , select any combination of scan states as reference point for local counter to start ticking 0x1 FS — FRAME SYNC

Table continues on the next page...

EPDC_PIGEON_10_0 field descriptions (continued)

Field	Description
	0x2 FB — FRAME BEGIN 0x4 FD — FRAME DATA 0x8 FE — FRAME END 0x10 LS — LINE SYNC 0x20 LB — LINE BEGIN 0x40 LD — LINE DATA 0x80 LE — LINE END
23–12 MASK_CNT	When the global counter selected through MASK_CNT_SEL matches value in this reg, pigeon local counter start ticking. 0=disable
11–8 MASK_CNT_SEL	select global counters as mask condition, use together with MASK_CNT 0x0 HSTATE_CNT — pclk counter within one hscan state 0x1 HSTATE_CYCLE — pclk cycle within one hscan state 0x2 VSTATE_CNT — line counter within one vscan state 0x3 VSTATE_CYCLE — line cycle within one vscan state 0x4 FRAME_CNT — frame counter 0x5 FRAME_CYCLE — frame cycle 0x6 HCNT — horizontal counter (pclk counter within one line) 0x7 VCNT — vertical counter (line counter within one frame)
7–4 OFFSET	offset on pclk unit. 0=align with data, positive value means delay, minus value mean ahead. Supported range depends on panel mode
3–2 INC_SEL	event to increment local counter 0x0 PCLK — pclk 0x1 LINE — line start pulse 0x2 FRAME — frame start pulse 0x3 SIG_ANOTHER — use another signal as tick event
1 POL	polarity of signal output 0x0 ACTIVE_HIGH — normal signal (active high) 0x1 ACTIVE_LOW — inverted signal (active low)
0 EN	enable pigeon mode on this signal

23.4.91 Panel Interface Signal Generator Register 10_1 (EPDC_PIGEON_10_1)

parameters for timing signal generation

Address: 228_C000h base + A90h offset = 228_CA90h

Bit	31	30	29	28	27	26	25	24	23	22	21	20	19	18	17	16	15	14	13	12	11	10	9	8	7	6	5	4	3	2	1	0
R																																
W	CLR_CNT																SET_CNT															
Reset	0	0	0	0	0	0	0	0	0	0	0	0	0	0	0	0	0	0	0	0	0	0	0	0	0	0	0	0	0	0	0	0

EPDC_PIGEON_10_1 field descriptions

Field	Description
31–16 CLR_CNT	deassert signal output when counter match this value 0x0 CLEAR_USING_MASK — keep active until mask off
SET_CNT	assert signal output when counter match this value 0x0 START_ACTIVE — start as active

23.4.92 Panel Interface Signal Generator Register 10_1 (EPDC_PIGEON_10_2)

parameters for timing signal generation

Address: 228_C000h base + AA0h offset = 228_CAA0h

Bit	31	30	29	28	27	26	25	24	23	22	21	20	19	18	17	16	15	14	13	12	11	10	9	8	7	6	5	4	3	2	1	0
R	Reserved																SIG_ANOTHER				SIG_LOGIC											
W	Reserved																SIG_ANOTHER				SIG_LOGIC											
Reset	0	0	0	0	0	0	0	0	0	0	0	0	0	0	0	0	0	0	0	0	0	0	0	0	0	0	0	0	0	0	0	0

EPDC_PIGEON_10_2 field descriptions

Field	Description
31–9 -	This field is reserved. Reserved.
8–4 SIG_ANOTHER	select another signal for logic operation or as mask or counter tick event
SIG_LOGIC	logic operation with another signal sigout : final output signal of this generator mask : final mask of this generator this_sig : intermediate signal of this generator before logic operation other_masks : intermediate mask result of this generator before logic operation sig_another : signal selected other generators 0x0 DIS — no logic operation 0x1 AND — sigout = sig_another AND this_sig 0x2 OR — sigout = sig_another OR this_sig 0x3 MASK — mask = sig_another AND other_masks

23.4.93 Panel Interface Signal Generator Register 11_0 (EPDC_PIGEON_11_0)

parameters for timing signal generation

EPDC Memory Map/Register Definition

Address: 228_C000h base + AC0h offset = 228_CAC0h

Bit	31	30	29	28	27	26	25	24	23	22	21	20	19	18	17	16
R	STATE_MASK								MASK_CNT							
W																
Reset	0	0	0	0	0	0	0	0	0	0	0	0	0	0	0	0
Bit	15	14	13	12	11	10	9	8	7	6	5	4	3	2	1	0
R	MASK_CNT				MASK_CNT_SEL				OFFSET				INC_SEL	POL	EN	
W																
Reset	0	0	0	0	1	1	1	1	0	0	0	0	0	0	0	0

EPDC_PIGEON_11_0 field descriptions

Field	Description
31–24 STATE_MASK	state_mask = (FSIFBIFDIFE) and (LSILBILDILE) , select any combination of scan states as reference point for local counter to start ticking 0x1 FS — FRAME SYNC 0x2 FB — FRAME BEGIN 0x4 FD — FRAME DATA 0x8 FE — FRAME END 0x10 LS — LINE SYNC 0x20 LB — LINE BEGIN 0x40 LD — LINE DATA 0x80 LE — LINE END
23–12 MASK_CNT	When the global counter selected through MASK_CNT_SEL matches value in this reg, pigeon local counter start ticking. 0=disable
11–8 MASK_CNT_SEL	select global counters as mask condition, use together with MASK_CNT 0x0 HSTATE_CNT — pclk counter within one hscan state 0x1 HSTATE_CYCLE — pclk cycle within one hscan state 0x2 VSTATE_CNT — line counter within one vscan state 0x3 VSTATE_CYCLE — line cycle within one vscan state 0x4 FRAME_CNT — frame counter 0x5 FRAME_CYCLE — frame cycle 0x6 HCNT — horizontal counter (pclk counter within one line) 0x7 VCNT — vertical counter (line counter within one frame)
7–4 OFFSET	offset on pclk unit. 0=aligne with data, positive value means delay, minus value mean ahead. Supported range depends on panel mode
3–2 INC_SEL	event to incrment local counter 0x0 PCLK — pclk 0x1 LINE — line start pulse 0x2 FRAME — frame start pulse 0x3 SIG_ANOTHER — use another signal as tick event
1 POL	polarity of signal output 0x0 ACTIVE_HIGH — normal signal (active high) 0x1 ACTIVE_LOW — inverted signal (active low)
0 EN	enable pigeon mode on this signal

23.4.94 Panel Interface Signal Generator Register 11_1 (EPDC_PIGEON_11_1)

parameters for timing signal generation

Address: 228_C000h base + AD0h offset = 228_CAD0h

Bit	31	30	29	28	27	26	25	24	23	22	21	20	19	18	17	16	15	14	13	12	11	10	9	8	7	6	5	4	3	2	1	0
R																																
W	CLR_CNT																SET_CNT															
Reset	0	0	0	0	0	0	0	0	0	0	0	0	0	0	0	0	0	0	0	0	0	0	0	0	0	0	0	0	0	0	0	0

EPDC_PIGEON_11_1 field descriptions

Field	Description
31–16 CLR_CNT	deassert signal output when counter match this value 0x0 CLEAR_USING_MASK — keep active until mask off
SET_CNT	assert signal output when counter match this value 0x0 START_ACTIVE — start as active

23.4.95 Panel Interface Signal Generator Register 11_1 (EPDC_PIGEON_11_2)

parameters for timing signal generation

Address: 228_C000h base + AE0h offset = 228_CAE0h

Bit	31	30	29	28	27	26	25	24	23	22	21	20	19	18	17	16	15	14	13	12	11	10	9	8	7	6	5	4	3	2	1	0
R																																
W	Reserved																SIG_ANOTHER				SIG_LOGIC											
Reset	0	0	0	0	0	0	0	0	0	0	0	0	0	0	0	0	0	0	0	0	0	0	0	0	0	0	0	0	0	0	0	0

EPDC_PIGEON_11_2 field descriptions

Field	Description
31–9 -	This field is reserved. Reserved.
8–4 SIG_ANOTHER	select another signal for logic operation or as mask or counter tick event
SIG_LOGIC	logic operation with another signal sigout : final output signal of this generator mask : final mask of this generator this_sig : intermediate signal of this generator before logic operation other_masks : intermediate mask result of this generator before logic operation

Table continues on the next page...

EPDC_PIGEON_11_2 field descriptions (continued)

Field	Description
	sig_another : signal selected other generators
0x0	DIS — no logic operation
0x1	AND — sigout = sig_another AND this_sig
0x2	OR — sigout = sig_another OR this_sig
0x3	MASK — mask = sig_another AND other_masks

23.4.96 Panel Interface Signal Generator Register 12_0 (EPDC_PIGEON_12_0)

parameters for timing signal generation

Address: 228_C000h base + B00h offset = 228_CB00h

Bit	31	30	29	28	27	26	25	24	23	22	21	20	19	18	17	16
R	STATE_MASK								MASK_CNT							
W																
Reset	0	0	0	0	0	0	0	0	0	0	0	0	0	0	0	0
Bit	15	14	13	12	11	10	9	8	7	6	5	4	3	2	1	0
R	MASK_CNT				MASK_CNT_SEL				OFFSET				INC_SEL	POL	EN	
W																
Reset	0	0	0	0	1	1	1	1	0	0	0	0	0	0	0	0

EPDC_PIGEON_12_0 field descriptions

Field	Description
31–24 STATE_MASK	state_mask = (FSIFBIFDIFE) and (LSILBILDILE) , select any combination of scan states as reference point for local counter to start ticking 0x1 FS — FRAME SYNC 0x2 FB — FRAME BEGIN 0x4 FD — FRAME DATA 0x8 FE — FRAME END 0x10 LS — LINE SYNC 0x20 LB — LINE BEGIN 0x40 LD — LINE DATA 0x80 LE — LINE END
23–12 MASK_CNT	When the global counter selected through MASK_CNT_SEL matches value in this reg, pigeon local counter start ticking. 0=disable
11–8 MASK_CNT_SEL	select global counters as mask condition, use together with MASK_CNT 0x0 HSTATE_CNT — pclk counter within one hscan state 0x1 HSTATE_CYCLE — pclk cycle within one hscan state 0x2 VSTATE_CNT — line counter within one vscan state 0x3 VSTATE_CYCLE — line cycle within one vscan state 0x4 FRAME_CNT — frame counter

Table continues on the next page...

EPDC_PIGEON_12_0 field descriptions (continued)

Field	Description
	0x5 FRAME_CYCLE — frame cycle 0x6 HCNT — horizontal counter (pclk counter within one line) 0x7 VCNT — vertical counter (line counter within one frame)
7–4 OFFSET	offset on pclk unit. 0=align with data, positive value means delay, minus value mean ahead. Supported range depends on panel mode
3–2 INC_SEL	event to increment local counter 0x0 PCLK — pclk 0x1 LINE — line start pulse 0x2 FRAME — frame start pulse 0x3 SIG_ANOTHER — use another signal as tick event
1 POL	polarity of signal output 0x0 ACTIVE_HIGH — normal signal (active high) 0x1 ACTIVE_LOW — inverted signal (active low)
0 EN	enable pigeon mode on this signal

23.4.97 Panel Interface Signal Generator Register 12_1 (EPDC_PIGEON_12_1)

parameters for timing signal generation

Address: 228_C000h base + B10h offset = 228_CB10h

Bit	31	30	29	28	27	26	25	24	23	22	21	20	19	18	17	16	15	14	13	12	11	10	9	8	7	6	5	4	3	2	1	0
R	CLR_CNT																SET_CNT															
W																																
Reset	0	0	0	0	0	0	0	0	0	0	0	0	0	0	0	0	0	0	0	0	0	0	0	0	0	0	0	0	0	0	0	0

EPDC_PIGEON_12_1 field descriptions

Field	Description
31–16 CLR_CNT	deassert signal output when counter match this value 0x0 CLEAR_USING_MASK — keep active until mask off
SET_CNT	assert signal output when counter match this value 0x0 START_ACTIVE — start as active

23.4.98 Panel Interface Signal Generator Register 12_1 (EPDC_PIGEON_12_2)

parameters for timing signal generation

EPDC Memory Map/Register Definition

Address: 228_C000h base + B20h offset = 228_CB20h

Bit	31	30	29	28	27	26	25	24	23	22	21	20	19	18	17	16	15	14	13	12	11	10	9	8	7	6	5	4	3	2	1	0
R	Reserved																SIG_ANOTHER				SIG_LOGIC											
W	Reserved																SIG_ANOTHER				SIG_LOGIC											
Reset	0	0	0	0	0	0	0	0	0	0	0	0	0	0	0	0	0	0	0	0	0	0	0	0	0	0	0	0	0	0	0	0

EPDC_PIGEON_12_2 field descriptions

Field	Description
31–9 -	This field is reserved. Reserved.
8–4 SIG_ANOTHER	select another signal for logic operation or as mask or counter tick event
SIG_LOGIC	logic operation with another signal sigout : final output signal of this generator mask : final mask of this generator this_sig : intermediate signal of this generator before logic operation other_masks : intermediate mask result of this generator before logic operation sig_another : signal selected other generators 0x0 DIS — no logic operation 0x1 AND — sigout = sig_another AND this_sig 0x2 OR — sigout = sig_another OR this_sig 0x3 MASK — mask = sig_another AND other_masks

23.4.99 Panel Interface Signal Generator Register 13_0 (EPDC_PIGEON_13_0)

parameters for timing signal generation

Address: 228_C000h base + B40h offset = 228_CB40h

Bit	31	30	29	28	27	26	25	24	23	22	21	20	19	18	17	16
R	STATE_MASK								MASK_CNT							
W	STATE_MASK								MASK_CNT							
Reset	0	0	0	0	0	0	0	0	0	0	0	0	0	0	0	0

Bit	15	14	13	12	11	10	9	8	7	6	5	4	3	2	1	0
R	MASK_CNT				MASK_CNT_SEL				OFFSET				INC_SEL	POL	EN	
W	MASK_CNT				MASK_CNT_SEL				OFFSET				INC_SEL	POL	EN	
Reset	0	0	0	0	1	1	1	1	0	0	0	0	0	0	0	0

EPDC_PIGEON_13_0 field descriptions

Field	Description
31–24 STATE_MASK	state_mask = (FSIFBIFDIFE) and (LSILBILDILE) , select any combination of scan states as reference point for local counter to start ticking 0x1 FS — FRAME SYNC

Table continues on the next page...

EPDC_PIGEON_13_0 field descriptions (continued)

Field	Description
	0x2 FB — FRAME BEGIN 0x4 FD — FRAME DATA 0x8 FE — FRAME END 0x10 LS — LINE SYNC 0x20 LB — LINE BEGIN 0x40 LD — LINE DATA 0x80 LE — LINE END
23–12 MASK_CNT	When the global counter selected through MASK_CNT_SEL matches value in this reg, pigeon local counter start ticking. 0=disable
11–8 MASK_CNT_SEL	select global counters as mask condition, use together with MASK_CNT 0x0 HSTATE_CNT — pclk counter within one hscan state 0x1 HSTATE_CYCLE — pclk cycle within one hscan state 0x2 VSTATE_CNT — line counter within one vscan state 0x3 VSTATE_CYCLE — line cycle within one vscan state 0x4 FRAME_CNT — frame counter 0x5 FRAME_CYCLE — frame cycle 0x6 HCNT — horizontal counter (pclk counter within one line) 0x7 VCNT — vertical counter (line counter within one frame)
7–4 OFFSET	offset on pclk unit. 0=align with data, positive value means delay, minus value mean ahead. Supported range depends on panel mode
3–2 INC_SEL	event to increment local counter 0x0 PCLK — pclk 0x1 LINE — line start pulse 0x2 FRAME — frame start pulse 0x3 SIG_ANOTHER — use another signal as tick event
1 POL	polarity of signal output 0x0 ACTIVE_HIGH — normal signal (active high) 0x1 ACTIVE_LOW — inverted signal (active low)
0 EN	enable pigeon mode on this signal

23.4.100 Panel Interface Signal Generator Register 13_1 (EPDC_PIGEON_13_1)

parameters for timing signal generation

Address: 228_C000h base + B50h offset = 228_CB50h

Bit	31	30	29	28	27	26	25	24	23	22	21	20	19	18	17	16	15	14	13	12	11	10	9	8	7	6	5	4	3	2	1	0
R																																
W	CLR_CNT																SET_CNT															
Reset	0	0	0	0	0	0	0	0	0	0	0	0	0	0	0	0	0	0	0	0	0	0	0	0	0	0	0	0	0	0	0	0

EPDC_PIGEON_13_1 field descriptions

Field	Description
31–16 CLR_CNT	deassert signal output when counter match this value 0x0 CLEAR_USING_MASK — keep active until mask off
SET_CNT	assert signal output when counter match this value 0x0 START_ACTIVE — start as active

23.4.101 Panel Interface Signal Generator Register 13_1 (EPDC_PIGEON_13_2)

parameters for timing signal generation

Address: 228_C000h base + B60h offset = 228_CB60h

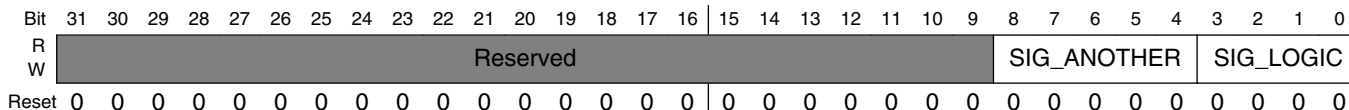

EPDC_PIGEON_13_2 field descriptions

Field	Description
31–9 -	This field is reserved. Reserved.
8–4 SIG_ANOTHER	select another signal for logic operation or as mask or counter tick event
SIG_LOGIC	logic operation with another signal sigout : final output signal of this generator mask : final mask of this generator this_sig : intermediate signal of this generator before logic operation other_masks : intermediate mask result of this generator before logic operation sig_another : signal selected other generators 0x0 DIS — no logic operation 0x1 AND — sigout = sig_another AND this_sig 0x2 OR — sigout = sig_another OR this_sig 0x3 MASK — mask = sig_another AND other_masks

23.4.102 Panel Interface Signal Generator Register 14_0 (EPDC_PIGEON_14_0)

parameters for timing signal generation

Address: 228_C000h base + B80h offset = 228_CB80h

Bit	31	30	29	28	27	26	25	24	23	22	21	20	19	18	17	16
R	STATE_MASK								MASK_CNT							
W																
Reset	0	0	0	0	0	0	0	0	0	0	0	0	0	0	0	0
Bit	15	14	13	12	11	10	9	8	7	6	5	4	3	2	1	0
R	MASK_CNT				MASK_CNT_SEL				OFFSET				INC_SEL	POL	EN	
W																
Reset	0	0	0	0	1	1	1	1	0	0	0	0	0	0	0	0

EPDC_PIGEON_14_0 field descriptions

Field	Description
31–24 STATE_MASK	state_mask = (FSIFBIFDIFE) and (LSILBILDILE) , select any combination of scan states as reference point for local counter to start ticking 0x1 FS — FRAME SYNC 0x2 FB — FRAME BEGIN 0x4 FD — FRAME DATA 0x8 FE — FRAME END 0x10 LS — LINE SYNC 0x20 LB — LINE BEGIN 0x40 LD — LINE DATA 0x80 LE — LINE END
23–12 MASK_CNT	When the global counter selected through MASK_CNT_SEL matches value in this reg, pigeon local counter start ticking. 0=disable
11–8 MASK_CNT_SEL	select global counters as mask condition, use together with MASK_CNT 0x0 HSTATE_CNT — pclk counter within one hscan state 0x1 HSTATE_CYCLE — pclk cycle within one hscan state 0x2 VSTATE_CNT — line counter within one vscan state 0x3 VSTATE_CYCLE — line cycle within one vscan state 0x4 FRAME_CNT — frame counter 0x5 FRAME_CYCLE — frame cycle 0x6 HCNT — horizontal counter (pclk counter within one line) 0x7 VCNT — vertical counter (line counter within one frame)
7–4 OFFSET	offset on pclk unit. 0=aligne with data, positive value means delay, minus value mean ahead. Supported range depends on panel mode
3–2 INC_SEL	event to incrment local counter 0x0 PCLK — pclk 0x1 LINE — line start pulse 0x2 FRAME — frame start pulse 0x3 SIG_ANOTHER — use another signal as tick event
1 POL	polarity of signal output 0x0 ACTIVE_HIGH — normal signal (active high) 0x1 ACTIVE_LOW — inverted signal (active low)
0 EN	enable pigeon mode on this signal

23.4.103 Panel Interface Signal Generator Register 14_1 (EPDC_PIGEON_14_1)

parameters for timing signal generation

Address: 228_C000h base + B90h offset = 228_CB90h

Bit	31	30	29	28	27	26	25	24	23	22	21	20	19	18	17	16	15	14	13	12	11	10	9	8	7	6	5	4	3	2	1	0
R																																
W	CLR_CNT																SET_CNT															
Reset	0	0	0	0	0	0	0	0	0	0	0	0	0	0	0	0	0	0	0	0	0	0	0	0	0	0	0	0	0	0	0	0

EPDC_PIGEON_14_1 field descriptions

Field	Description
31–16 CLR_CNT	deassert signal output when counter match this value 0x0 CLEAR_USING_MASK — keep active until mask off
SET_CNT	assert signal output when counter match this value 0x0 START_ACTIVE — start as active

23.4.104 Panel Interface Signal Generator Register 14_1 (EPDC_PIGEON_14_2)

parameters for timing signal generation

Address: 228_C000h base + BA0h offset = 228_CBA0h

Bit	31	30	29	28	27	26	25	24	23	22	21	20	19	18	17	16	15	14	13	12	11	10	9	8	7	6	5	4	3	2	1	0
R																																
W	Reserved																SIG_ANOTHER				SIG_LOGIC											
Reset	0	0	0	0	0	0	0	0	0	0	0	0	0	0	0	0	0	0	0	0	0	0	0	0	0	0	0	0	0	0	0	0

EPDC_PIGEON_14_2 field descriptions

Field	Description
31–9 -	This field is reserved. Reserved.
8–4 SIG_ANOTHER	select another signal for logic operation or as mask or counter tick event
SIG_LOGIC	logic operation with another signal sigout : final output signal of this generator mask : final mask of this generator this_sig : intermediate signal of this generator before logic operation other_masks : intermediate mask result of this generator before logic operation

Table continues on the next page...

EPDC_PIGEON_14_2 field descriptions (continued)

Field	Description
	sig_another : signal selected other generators
0x0	DIS — no logic operation
0x1	AND — sigout = sig_another AND this_sig
0x2	OR — sigout = sig_another OR this_sig
0x3	MASK — mask = sig_another AND other_masks

23.4.105 Panel Interface Signal Generator Register 15_0 (EPDC_PIGEON_15_0)

parameters for timing signal generation

Address: 228_C000h base + BC0h offset = 228_CBC0h

Bit	31	30	29	28	27	26	25	24	23	22	21	20	19	18	17	16
R	STATE_MASK								MASK_CNT							
W																
Reset	0	0	0	0	0	0	0	0	0	0	0	0	0	0	0	0
Bit	15	14	13	12	11	10	9	8	7	6	5	4	3	2	1	0
R	MASK_CNT				MASK_CNT_SEL				OFFSET				INC_SEL		POL	EN
W																
Reset	0	0	0	0	1	1	1	1	0	0	0	0	0	0	0	0

EPDC_PIGEON_15_0 field descriptions

Field	Description
31–24 STATE_MASK	state_mask = (FSIFBIFDIFE) and (LSILBILDILE) , select any combination of scan states as reference point for local counter to start ticking 0x1 FS — FRAME SYNC 0x2 FB — FRAME BEGIN 0x4 FD — FRAME DATA 0x8 FE — FRAME END 0x10 LS — LINE SYNC 0x20 LB — LINE BEGIN 0x40 LD — LINE DATA 0x80 LE — LINE END
23–12 MASK_CNT	When the global counter selected through MASK_CNT_SEL matches value in this reg, pigeon local counter start ticking. 0=disable
11–8 MASK_CNT_SEL	select global counters as mask condition, use together with MASK_CNT 0x0 HSTATE_CNT — pclk counter within one hscan state 0x1 HSTATE_CYCLE — pclk cycle within one hscan state 0x2 VSTATE_CNT — line counter within one vscan state 0x3 VSTATE_CYCLE — line cycle within one vscan state 0x4 FRAME_CNT — frame counter

Table continues on the next page...

EPDC_PIGEON_15_0 field descriptions (continued)

Field	Description
	0x5 FRAME_CYCLE — frame cycle 0x6 HCNT — horizontal counter (pclk counter within one line) 0x7 VCNT — vertical counter (line counter within one frame)
7-4 OFFSET	offset on pclk unit. 0=align with data, positive value means delay, minus value mean ahead. Supported range depends on panel mode
3-2 INC_SEL	event to increment local counter 0x0 PCLK — pclk 0x1 LINE — line start pulse 0x2 FRAME — frame start pulse 0x3 SIG_ANOTHER — use another signal as tick event
1 POL	polarity of signal output 0x0 ACTIVE_HIGH — normal signal (active high) 0x1 ACTIVE_LOW — inverted signal (active low)
0 EN	enable pigeon mode on this signal

23.4.106 Panel Interface Signal Generator Register 15_1 (EPDC_PIGEON_15_1)

parameters for timing signal generation

Address: 228_C000h base + BD0h offset = 228_CBD0h

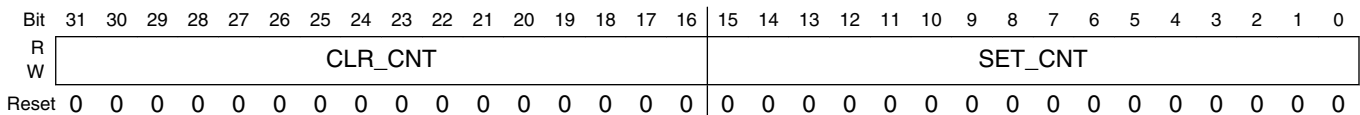

EPDC_PIGEON_15_1 field descriptions

Field	Description
31-16 CLR_CNT	deassert signal output when counter match this value 0x0 CLEAR_USING_MASK — keep active until mask off
SET_CNT	assert signal output when counter match this value 0x0 START_ACTIVE — start as active

23.4.107 Panel Interface Signal Generator Register 15_1 (EPDC_PIGEON_15_2)

parameters for timing signal generation

Address: 228_C000h base + BE0h offset = 228_CBE0h

Bit	31	30	29	28	27	26	25	24	23	22	21	20	19	18	17	16	15	14	13	12	11	10	9	8	7	6	5	4	3	2	1	0
R	Reserved																SIG_ANOTHER				SIG_LOGIC											
W	Reserved																SIG_ANOTHER				SIG_LOGIC											
Reset	0	0	0	0	0	0	0	0	0	0	0	0	0	0	0	0	0	0	0	0	0	0	0	0	0	0	0	0	0	0	0	0

EPDC_PIGEON_15_2 field descriptions

Field	Description
31–9 -	This field is reserved. Reserved.
8–4 SIG_ANOTHER	select another signal for logic operation or as mask or counter tick event
SIG_LOGIC	logic operation with another signal sigout : final output signal of this generator mask : final mask of this generator this_sig : intermediate signal of this generator before logic operation other_masks : intermediate mask result of this generator before logic operation sig_another : signal selected other generators 0x0 DIS — no logic operation 0x1 AND — sigout = sig_another AND this_sig 0x2 OR — sigout = sig_another OR this_sig 0x3 MASK — mask = sig_another AND other_masks

23.4.108 Panel Interface Signal Generator Register 16_0 (EPDC_PIGEON_16_0)

parameters for timing signal generation

Address: 228_C000h base + C00h offset = 228_CC00h

Bit	31	30	29	28	27	26	25	24	23	22	21	20	19	18	17	16
R	STATE_MASK								MASK_CNT							
W	STATE_MASK								MASK_CNT							
Reset	0	0	0	0	0	0	0	0	0	0	0	0	0	0	0	0

Bit	15	14	13	12	11	10	9	8	7	6	5	4	3	2	1	0
R	MASK_CNT				MASK_CNT_SEL				OFFSET				INC_SEL	POL	EN	
W	MASK_CNT				MASK_CNT_SEL				OFFSET				INC_SEL	POL	EN	
Reset	0	0	0	0	1	1	1	1	0	0	0	0	0	0	0	0

EPDC_PIGEON_16_0 field descriptions

Field	Description
31–24 STATE_MASK	state_mask = (FSIFBIFDIFE) and (LSILBILDILE) , select any combination of scan states as reference point for local counter to start ticking 0x1 FS — FRAME SYNC

Table continues on the next page...

EPDC_PIGEON_16_0 field descriptions (continued)

Field	Description
	0x2 FB — FRAME BEGIN 0x4 FD — FRAME DATA 0x8 FE — FRAME END 0x10 LS — LINE SYNC 0x20 LB — LINE BEGIN 0x40 LD — LINE DATA 0x80 LE — LINE END
23–12 MASK_CNT	When the global counter selected through MASK_CNT_SEL matches value in this reg, pigeon local counter start ticking. 0=disable
11–8 MASK_CNT_SEL	select global counters as mask condition, use together with MASK_CNT 0x0 HSTATE_CNT — pclk counter within one hscan state 0x1 HSTATE_CYCLE — pclk cycle within one hscan state 0x2 VSTATE_CNT — line counter within one vscan state 0x3 VSTATE_CYCLE — line cycle within one vscan state 0x4 FRAME_CNT — frame counter 0x5 FRAME_CYCLE — frame cycle 0x6 HCNT — horizontal counter (pclk counter within one line) 0x7 VCNT — vertical counter (line counter within one frame)
7–4 OFFSET	offset on pclk unit. 0=align with data, positive value means delay, minus value mean ahead. Supported range depends on panel mode
3–2 INC_SEL	event to increment local counter 0x0 PCLK — pclk 0x1 LINE — line start pulse 0x2 FRAME — frame start pulse 0x3 SIG_ANOTHER — use another signal as tick event
1 POL	polarity of signal output 0x0 ACTIVE_HIGH — normal signal (active high) 0x1 ACTIVE_LOW — inverted signal (active low)
0 EN	enable pigeon mode on this signal

23.4.109 Panel Interface Signal Generator Register 16_1 (EPDC_PIGEON_16_1)

parameters for timing signal generation

Address: 228_C000h base + C10h offset = 228_CC10h

Bit	31	30	29	28	27	26	25	24	23	22	21	20	19	18	17	16	15	14	13	12	11	10	9	8	7	6	5	4	3	2	1	0
R																																
W	CLR_CNT																SET_CNT															
Reset	0	0	0	0	0	0	0	0	0	0	0	0	0	0	0	0	0	0	0	0	0	0	0	0	0	0	0	0	0	0	0	0

EPDC_PIGEON_16_1 field descriptions

Field	Description
31–16 CLR_CNT	deassert signal output when counter match this value 0x0 CLEAR_USING_MASK — keep active until mask off
SET_CNT	assert signal output when counter match this value 0x0 START_ACTIVE — start as active

23.4.110 Panel Interface Signal Generator Register 16_1 (EPDC_PIGEON_16_2)

parameters for timing signal generation

Address: 228_C000h base + C20h offset = 228_CC20h

Bit	31	30	29	28	27	26	25	24	23	22	21	20	19	18	17	16	15	14	13	12	11	10	9	8	7	6	5	4	3	2	1	0
R	Reserved																SIG_ANOTHER				SIG_LOGIC											
W	Reserved																SIG_ANOTHER				SIG_LOGIC											
Reset	0	0	0	0	0	0	0	0	0	0	0	0	0	0	0	0	0	0	0	0	0	0	0	0	0	0	0	0	0	0	0	

EPDC_PIGEON_16_2 field descriptions

Field	Description
31–9 -	This field is reserved. Reserved.
8–4 SIG_ANOTHER	select another signal for logic operation or as mask or counter tick event
SIG_LOGIC	logic operation with another signal sigout : final output signal of this generator mask : final mask of this generator this_sig : intermediate signal of this generator before logic operation other_masks : intermediate mask result of this generator before logic operation sig_another : signal selected other generators 0x0 DIS — no logic operation 0x1 AND — sigout = sig_another AND this_sig 0x2 OR — sigout = sig_another OR this_sig 0x3 MASK — mask = sig_another AND other_masks

Chapter 24

Enhanced Periodic Interrupt Timer (EPIT)

24.1 Overview

EPIT is a 32-bit set-and-forget timer that is capable of providing precise interrupts at regular intervals with minimal processor intervention. EPIT begins counting after it is enabled by software.

The following figure shows the EPIT block diagram.

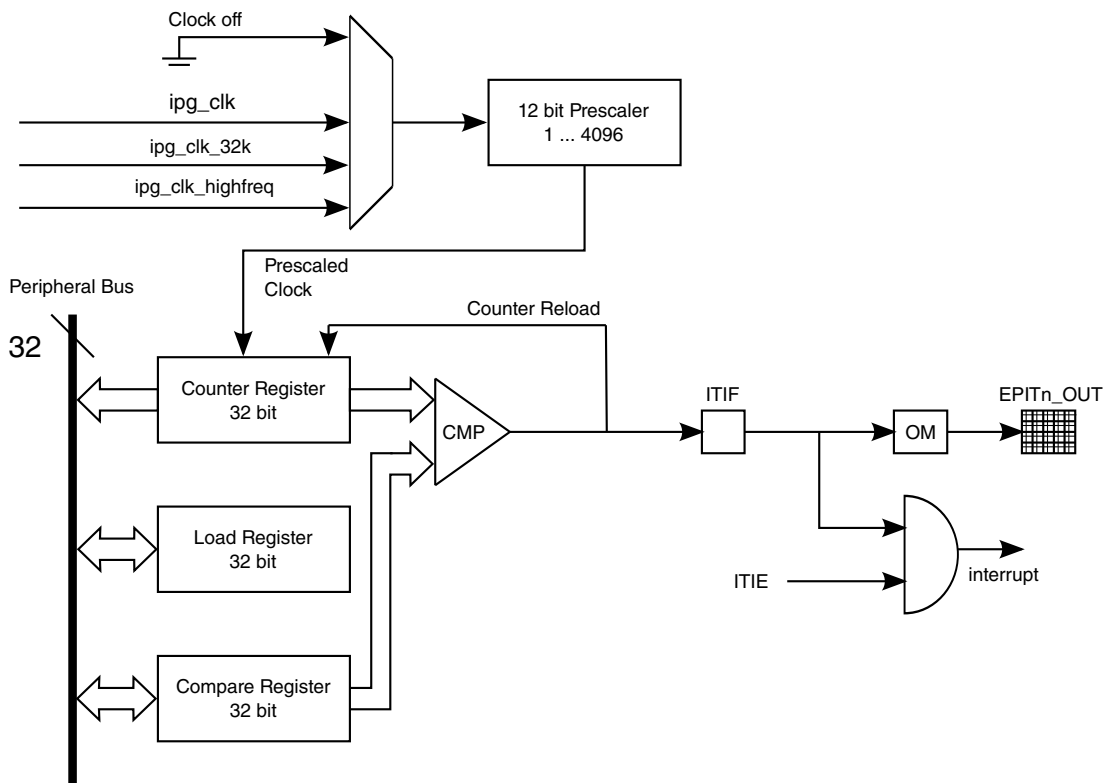

Figure 24-1. EPIT block diagram

24.1.1 EPIT features

EPIT has the following key features:

- 32-bit down counter with clock source selection
- 12-bit prescaler for division of input clock frequency
- Counter value that can be programmed on the fly
- Can be programmed to be active during low-power and debug modes
- Interrupt generation when counter reaches the compare value

24.1.2 EPIT modes and operations

EPIT supports the following modes: set-and-forget and free running. See the following sections for more information.

- [Operating in set-and-forget mode](#)
- [Operating in free-running mode](#)

See [Operations](#) for a description of the operations that EPIT supports.

24.2 External signals

The following table describes EPIT's I/O signals.

Table 24-1. EPIT External Signals

Signal	Description	Pad	Mode	Direction
EPIT1_OUT	Indicate the occurrence of EPIT1 output compare event through a specified transition.	UART3_RX_DATA	ALT8	O
		JTAG_TMS	ALT8	O
EPIT2_OUT	Indicate the occurrence of EPIT2 output compare event through a specified transition.	UART3_CTS_B	ALT8	O
		JTAG_TDO	ALT8	O

24.3 Clocks

The table found here describes the clock sources for EPIT.

Please see [Clock Controller Module \(CCM\)](#) for clock setting, configuration and gating information.

Table 24-2. EPIT Clocks

Clock name	Clock Root	Description
ipg_clk	ipg_clk_root	Peripheral clock
ipg_clk_32k	ckil_sync_clk_root	Low-frequency reference clock (32 kHz)
ipg_clk_highfreq	perclk_clk_root	High-frequency reference clock
ipg_clk_s	ipg_clk_root	Peripheral access clock

The clock that feeds the prescaler can be selected from among the following sources:

- **High-frequency reference clock (ipg_clk_highfreq)**

This clock is provided by the Clock Control Module (CCM). This clock remains on during low-power mode when the peripheral clock is turned off, allowing EPIT to use this clock in low-power mode. In normal mode, the CCM synchronizes this clock to ahb_clk; in low-power mode, CCM switches to an unsynchronized version.

- **Low-frequency reference clock (ipg_clk_32k)**

This 32 kHz reference clock is provided by the CCM. This clock remains on in low-power mode when the peripheral clock is turned off, so EPIT can use this clock during low-power mode. In normal mode, the CCM synchronizes this clock to ahb_clk; in low-power mode, CCM switches to an unsynchronized version. This clock is derived from the external 32 kHz crystal.

- **Peripheral clock (ipg_clk)**

This is the peripheral clock (PER Clock) which is provided (and optionally gated) by the CCM. This clock is typically used in normal operations. In low-power modes, if the EPIT is programmed to be disabled (via STOPEN or WAITEN), then the peripheral clock can be switched off.

The clock input source is determined by the CLKSRC field in the control register. The clock input to the prescaler can also be disabled by setting CLKSRC to 0b00. **This field value should only be changed after first disabling the EPIT by clearing the EN bit in the EPIT_EPITCR.** For other programming requirements that apply while changing clock source, refer section [Change of Clock Source](#).

The PRESCALER field in the control register is used to select the divide ratio of the input clock that drives the main counter. The prescaler can divide the input clock by a value between 1 and 4096. A change in the value of the PRESCALER field is immediately reflected on its output clock frequency. The following figure shows the timing for a change in the prescaler value.

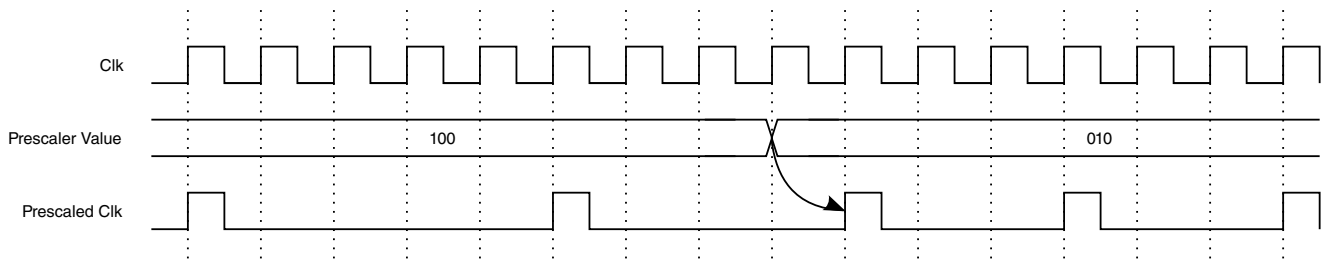

Figure 24-2. Prescaler Value Change Diagram

24.4 Functional Description

This section provides a complete functional description of the block.

24.4.1 Operating modes

EPIT can operate in either set-and-forget or free-running mode. Use EPIT_CR[RLD] to select the desired mode.

24.4.1.1 Operating in set-and-forget mode

To select this mode of operation, set the RLD bit in the control register (EPIT_CR).

In this mode, the counter obtains its data from the load register (EPIT_LR); it cannot be written to directly from the block data bus. Whenever the counter reaches zero, the value in EPIT_LR is loaded into the counter. This value is then decremented to zero.

To directly initialize the counter instead of waiting for the count to reach zero, set the EPIT counter overwrite enable bit (EPIT_CR[IOVW]) and write to EPIT_LR with the required initialization value.

24.4.1.2 Operating in free-running mode

To select this mode of operation, clear the RLD bit.

In this mode, the counter rolls over from 0000 0000h to FFFF FFFFh without reloading from the modulus register. After rolling over, the counter continues counting down.

To directly initialize the counter, set the EPIT counter overwrite enable bit (EPIT_EPITCL[IOVW]) and write to EPIT_EPITLR with the required initialization value.

24.4.2 Operations

EPIT has a single 32-bit down counter, which starts counting when the block is enabled by software.

The start value of the counter is loaded from the EPIT load register, which can be written to at any time by the processor. The value in the compare register determines the time that the interrupt occurs.

When EPIT is disabled (EN = 0), both the main counter and the prescaler counter freeze their count at their current count values. When EPIT is re-enabled (EN = 1), the ENMOD bit, which is a RW bit, decides the counter value:

- If ENMOD is set, the main counter is loaded with the load value (If RLD = 1)/ FFFF FFFFh (If RLD = 0) and the prescaler counter is reset (000h).
- If ENMOD is cleared, both main counter and prescaler counter restart counting from their frozen values.

If EPIT is programmed to be disabled in a low-power mode (STOP/WAIT), both the main counter and the prescaler counter freeze at their current count values when EPIT enters low-power mode. When EPIT exits the low-power mode, both the main counter and the prescaler counter start counting from their frozen values regardless of the ENMOD bit.

A hardware reset resets all EPIT registers to their respective reset values. There is a software reset which has the same effect on all registers except for the EN, ENMOD, STOPEN and WAITEN bits in the control register. The state of these bits are not affected by software reset. A software reset can be asserted even when the EPIT is disabled.

24.4.3 Compare Event

When the programmed value of EPIT_EPITCMPR matches the value in EPIT_EPITCNR a compare status flag is set, and an interrupt is generated if the OCIEN bit is set in the control register.

Functional Description

The compare output pin is set, cleared, toggled, or not affected at all depending on the setting of the output mode (OM) bits in the control register. If an interrupt is required at rollover (when the counter value reaches 0x0000_0000 and the new value is loaded) then the compare register value should be set equal to the load register value in set-and-forget mode, or equal to 0xFFFF_FFFF in free-running mode.

The following figure shows the timing for a compare event and interrupt.

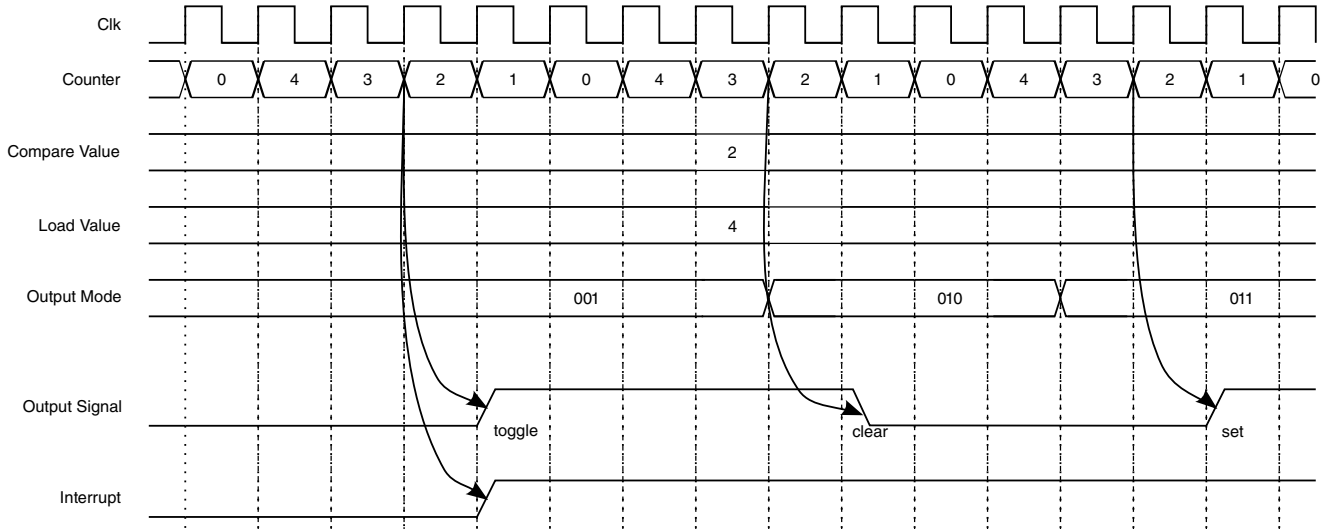

Figure 24-3. Compare Event and Interrupt Timing Diagram

EPIT will generate a compare event in the next count if the EPITx_CNR from the previous count equals the new EPITx_CMPR configured before re-enabling the EPIT in the next count. Even in case a new start counter value was updated in EPITx_LR before re-enabling the EPIT for the next round. To avoid this, configure the EPITx_CMPR to previous EPITx_CNR+1. Or, in set and forget mode, configure EPITx_LR with IOVW=1, before disabling EPIT. Also can do an extra disable/enable iteration to clear OCIF and update EPITx_CNR.

24.4.3.1 Counter Value Overwrite

The EPIT counter value can be overwritten to acquire a desired value at any point of time. The procedure for this is to set the IOVW bit in the control register and then write the desired value into the load register.

This results in the load register acquiring that value and also the counter being overwritten with it. If the EPIT is running the counter resumes counting from the overwritten value.

24.4.3.2 Low-Power Mode Behavior

The EPIT timer's behavior in low-power modes depends on which clock source is being used.

If the selected clock source is available and the corresponding low-power enable bit is set, then the EPIT continues to function in the low-power mode. If the EPIT is programmed to be disabled in a low-power mode (STOP/WAIT), then main counter and the prescaler counter freeze at the current count values when the EPIT enters low-power mode. When the EPIT exits the low-power mode, both main counter and prescaler counter start counting from their frozen values irrespective of the ENMOD bit.

24.4.3.3 Debug Mode Behavior

In debug mode, the user has the option to run or halt the EPIT timers. If the DBGGEN bit is reset in the EPIT Control Register, the timer is halted.

When debug mode is exited, the timer operation reverts to what it was prior to entering debug mode.

24.5 Initialization/ Application Information

24.5.1 Change of Clock Source

The CLKSRC field in EPIT_EPITCR determines the clock source. This field value should be changed only after disabling the EPIT (EN = 0).

Below is the software sequence which must be followed while changing clock source.

1. Disable the EPIT - set EN=0 in EPIT_EPITCR.
2. Disable EPIT output - program OM=00 in the EPIT_EPITCR.
3. Disable EPIT interrupts.
4. Program CLKSRC to desired clock source in EPIT_EPITCR.
5. Clear the EPIT status register (EPIT_EPITSR), that is, write "1" to clear (w1c).
6. Set ENMOD= 1 in the EPIT_EPITCR, to bring the EPIT Counter to defined state (EPIT_EPITLR value or 0xFFFF_FFFF).
7. Enable EPIT - set (EN=1) in the EPIT_EPITCR
8. Enable the EPIT interrupts.

24.6 EPIT Memory Map/Register Definition

The EPIT includes five user-accessible 32-bit registers. The following table summarizes these registers and their addresses.

Peripheral bus write access to the EPIT control register (EPITCR) and the EPIT load register (EPITLR) results in one cycle of wait state, while other valid peripheral bus accesses are with 0 wait state.

EPIT memory map

Absolute address (hex)	Register name	Width (in bits)	Access	Reset value	Section/page
20D_0000	Control register (EPIT1_CR)	32	R/W	0000_0000h	24.6.1/1174
20D_0004	Status register (EPIT1_SR)	32	R/W	0000_0000h	24.6.2/1177
20D_0008	Load register (EPIT1_LR)	32	R/W	FFFF_FFFFh	24.6.3/1177
20D_000C	Compare register (EPIT1_CMPR)	32	R/W	0000_0000h	24.6.4/1178
20D_0010	Counter register (EPIT1_CNR)	32	R	FFFF_FFFFh	24.6.5/1178
20D_4000	Control register (EPIT2_CR)	32	R/W	0000_0000h	24.6.1/1174
20D_4004	Status register (EPIT2_SR)	32	R/W	0000_0000h	24.6.2/1177
20D_4008	Load register (EPIT2_LR)	32	R/W	FFFF_FFFFh	24.6.3/1177
20D_400C	Compare register (EPIT2_CMPR)	32	R/W	0000_0000h	24.6.4/1178
20D_4010	Counter register (EPIT2_CNR)	32	R	FFFF_FFFFh	24.6.5/1178

24.6.1 Control register (EPITx_CR)

The EPIT control register (EPIT_CR) is used to configure the operating settings of the EPIT. It contains the clock division prescaler value and also the interrupt enable bit. Additionally, it contains other control bits which are described below.

Peripheral Bus Write access to EPIT Control Register (EPIT_CR) results in one cycle of the wait state, while other valid peripheral bus accesses are with 0 wait state.

Address: Base address + 0h offset

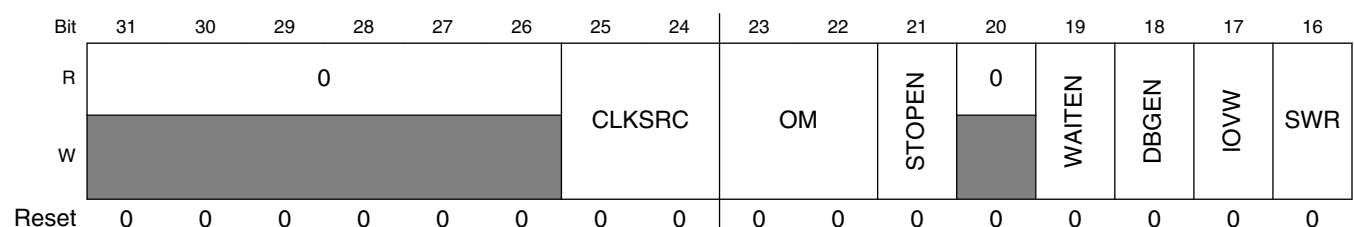

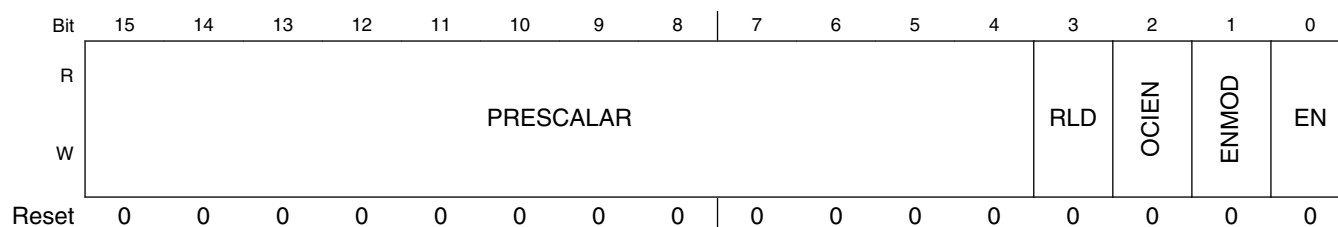

EPITx_CR field descriptions

Field	Description
31–26 Reserved	This read-only field is reserved and always has the value 0.
25–24 CLKSRC	Select clock source These bits determine which clock input is to be selected for running the counter. This field value should only be changed when the EPIT is disabled by clearing the EN bit in this register. For other programming requirements while changing clock source, refer to Change of Clock Source . 00 Clock is off 01 Peripheral clock 10 High-frequency reference clock 11 Low-frequency reference clock
23–22 OM	EPIT output mode. This bit field determines the mode of EPIT output on the output pin. 00 EPIT output is disconnected from pad 01 Toggle output pin 10 Clear output pin 11 Set output pin
21 STOPEN	EPIT stop mode enable. This read/write control bit enables the operation of the EPIT during stop mode. This bit is reset by a hardware reset and unaffected by software reset. 0 EPIT is disabled in stop mode 1 EPIT is enabled in stop mode
20 Reserved	This read-only field is reserved and always has the value 0.
19 WAITEN	This read/write control bit enables the operation of the EPIT during wait mode. This bit is reset by a hardware reset. A software reset does not affect this bit. 0 EPIT is disabled in wait mode 1 EPIT is enabled in wait mode
18 DBGEN	This bit is used to keep the EPIT functional in debug mode. When this bit is cleared, the input clock is gated off in debug mode. This bit is reset by hardware reset. A software reset does not affect this bit. 0 Inactive in debug mode 1 Active in debug mode
17 IOVW	EPIT counter overwrite enable. This bit controls the counter data when the modulus register is written. When this bit is set, all writes to the load register overwrites the counter contents and the counter starts subsequently counting down from the programmed value. 0 Write to load register does not result in counter value being overwritten. 1 Write to load register results in immediate overwriting of counter value.

Table continues on the next page...

EPITx_CR field descriptions (continued)

Field	Description
16 SWR	<p>Software reset. The EPIT is reset when this bit is set to 1. It is a self clearing bit. This bit is set when the block is in reset state and is cleared when the reset procedure is over. Setting this bit resets all the registers to their reset values, except for the EN, ENMOD, STOPEN, WAITEN and DBGEN bits in this control register</p> <p>0 EPIT is out of reset 1 EPIT is undergoing reset</p>
15–4 PRESCALAR	<p>Counter clock prescaler value. This bit field determines the prescaler value by which the clock is divided before it goes to the counter</p> <p>0x000 Divide by 1 0x001 Divide by 2... 0xFFFF Divide by 4096</p>
3 RLD	<p>Counter reload control.</p> <p>This bit is cleared by hardware reset. It decides the counter functionality, whether to run in free-running mode or set-and-forget mode.</p> <p>0 When the counter reaches zero it rolls over to 0xFFFF_FFFF (free-running mode) 1 When the counter reaches zero it reloads from the modulus register (set-and-forget mode)</p>
2 OCIEN	<p>Output compare interrupt enable.</p> <p>This bit enables the generation of interrupt on occurrence of compare event.</p> <p>0 Compare interrupt disabled 1 Compare interrupt enabled</p>
1 ENMOD	<p>EPIT enable mode.</p> <p>When EPIT is disabled (EN=0), both main counter and prescaler counter freeze their count at current count values. ENMOD bit is a r/w bit that determines the counter value when the EPIT is enabled again by setting EN bit. If ENMOD bit is set, then main counter is loaded with the load value (If RLD=1)/ 0xFFFF_FFFF (If RLD=0) and prescaler counter is reset, when EPIT is enabled (EN=1). If ENMOD is programmed to 0 then both main counter and prescaler counter restart counting from their frozen values when EPIT is enabled (EN=1). If EPIT is programmed to be disabled in a low-power mode (STOP/WAIT/DEBUG), then both the main counter and the prescaler counter freeze at their current count values when EPIT enters low-power mode. When EPIT exits the low-power mode, both main counter and prescaler counter start counting from their frozen values irrespective of the ENMOD bit. This bit is reset by a hardware reset. A software reset does not affect this bit.</p> <p>0 Counter starts counting from the value it had when it was disabled. 1 Counter starts count from load value (RLD=1) or 0xFFFF_FFFF (If RLD=0)</p>
0 EN	<p>This bit enables the EPIT. EPIT counter and prescaler value when EPIT is enabled (EN = 1), is dependent upon ENMOD and RLD bit as described for ENMOD bit. It is recommended that all registers be properly programmed before setting this bit. This bit is reset by a hardware reset. A software reset does not affect this bit.</p> <p>0 EPIT is disabled 1 EPIT is enabled</p>

24.6.2 Status register (EPITx_SR)

The EPIT status register (EPIT_SR) has a single status bit for the output compare event. The bit is a write 1 to clear bit.

Address: Base address + 4h offset

Bit	31	30	29	28	27	26	25	24		23	22	21	20	19	18	17	16
R	0																
W																	
Reset	0	0	0	0	0	0	0	0		0	0	0	0	0	0	0	0
Bit	15	14	13	12	11	10	9	8		7	6	5	4	3	2	1	0
R	0															OCIF	
W																w1c	
Reset	0	0	0	0	0	0	0	0		0	0	0	0	0	0	0	0

EPITx_SR field descriptions

Field	Description
31–1 Reserved	This read-only field is reserved and always has the value 0.
0 OCIF	Output compare interrupt flag. This bit is the interrupt flag that is set when the content of counter equals the content of the compare register (EPIT_CMPR). The bit is a write 1 to clear bit. 0 Compare event has not occurred 1 Compare event occurred

24.6.3 Load register (EPITx_LR)

The EPIT load register (EPIT_LR) contains the value that is to be loaded into the counter when EPIT counter reaches zero if the RLD bit in EPIT_CR is set. If the IOVW bit in the EPIT_CR is set then a write to this register overwrites the value of the EPIT counter register in addition to updating this registers value. This overwrite feature is active even if the RLD bit is not set.

Address: Base address + 8h offset

Bit	31	30	29	28	27	26	25	24	23	22	21	20	19	18	17	16		15	14	13	12	11	10	9	8	7	6	5	4	3	2	1	0
R	LOAD																																
W																																	
Reset	1	1	1	1	1	1	1	1	1	1	1	1	1	1	1	1		1	1	1	1	1	1	1	1	1	1	1	1	1	1	1	1

EPITx_LR field descriptions

Field	Description
LOAD	Load value. Value that is loaded into the counter at the start of each count cycle.

24.6.4 Compare register (EPITx_CMPR)

The EPIT compare register (EPIT_CMPR) holds the value that determines when a compare event is generated.

Address: Base address + Ch offset

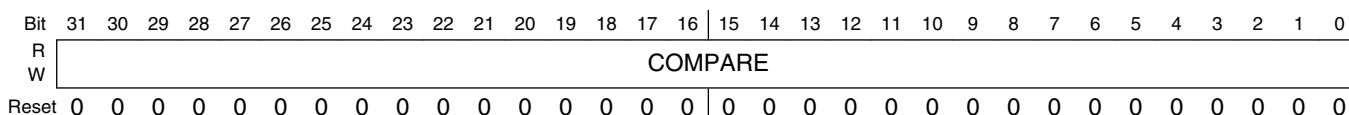

EPITx_CMPR field descriptions

Field	Description
COMPARE	Compare Value. When the counter value equals this bit field value a compare event is generated.

24.6.5 Counter register (EPITx_CNR)

The EPIT counter register (EPIT_CNR) contains the current count value and can be read at any time without disturbing the counter. This is a read-only register and any attempt to write into it generates a transfer error. But if the IOVW bit in EPIT_CR is set, the value of this register can be overwritten with a write to EPIT_LR. This change is reflected when this register is subsequently read.

Address: Base address + 10h offset

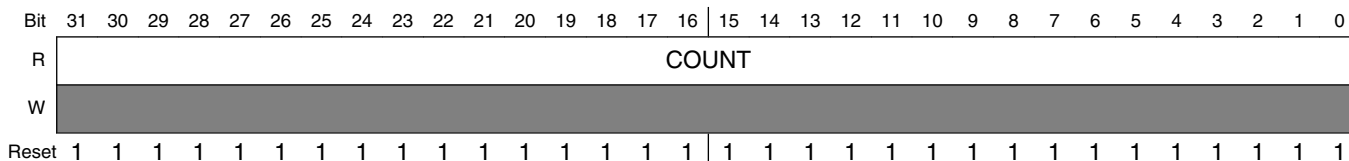

EPITx_CNR field descriptions

Field	Description
COUNT	Counter value. This contains the current value of the counter.

Chapter 25

Enhanced Serial Audio Interface (ESAI)

25.1 Overview

The Enhanced Serial Audio Interface (ESAI) provides a full-duplex serial port for serial communication with a variety of serial devices, including industry-standard codecs, Sony/Phillips Digital Interface (SPDIF) transceivers, and other DSPs.

The ESAI consists of independent transmitter and receiver sections, each section with its own clock generator. It is a superset of the 56300 Family ESSI peripheral and of the 56000 Family SAI peripheral.

All serial transfers in the module are synchronized to a clock. Additional synchronization signals are used to delineate the word frames. The normal mode of operation is used to transfer data at a periodic rate, one word per period. The network mode is similar in that it is also intended for periodic transfers; however, it supports up to 32 words (time slots) per period. This mode can be used to build time division multiplexed (TDM) networks. In contrast, the on-demand mode is intended for non-periodic transfers of data and to transfer data serially at high speed when the data becomes available.

The following figure shows the ESAI block diagram.

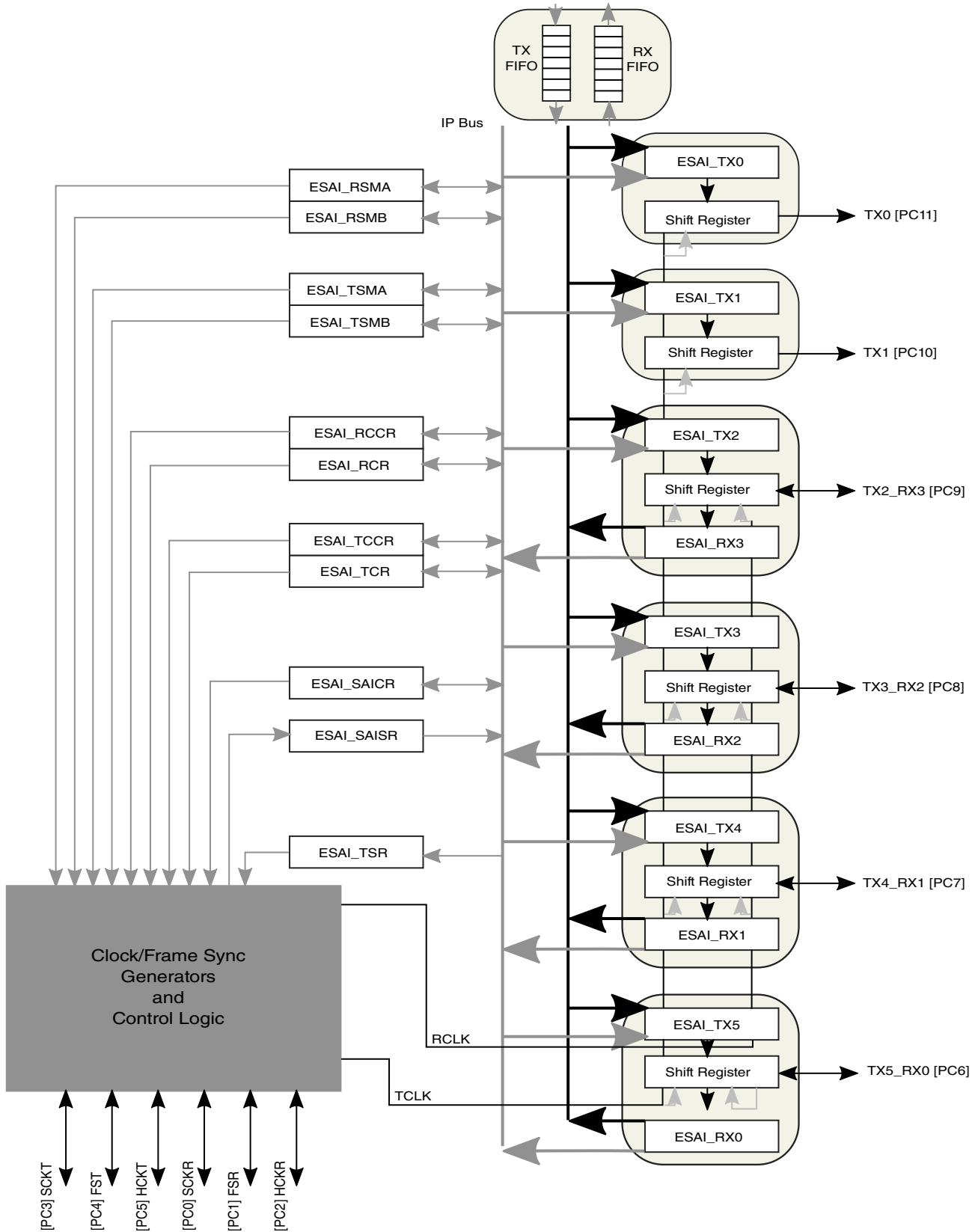

Figure 25-1. ESAI Block Diagram

25.1.1 Features

- Independent (asynchronous mode) or shared (synchronous mode) transmit and receive sections with separate or shared internal/external clocks and frame syncs, operating in Master or Slave mode.
- Up to six transmitters and four receivers with TX2_RX3, TX3_RX2, TX4_RX1, and TX5_RX0 pins shared by transmitters 2 to 5 and receivers 0 to 3. TX0 AND TX1 pins are used by transmitters 0 and 1 only.
- Programmable data interface modes such as I2S, LSB aligned, MSB aligned
- Programmable word length (8, 12, 16, 20 or 24bits)
- Flexible selection between system clock or external oscillator as input clock source, programmable internal clock divider and frame sync generation
- AC97 support
- Time Slot Mask Registers for reduced ARM platform overhead (for both Transmit and Receive)
- 128-word Transmit FIFO shared by six transmitters
- 128-word Receive FIFO shared by four receivers

25.1.2 Modes of Operation

ESAI has three basic operating modes and many data/operation formats.

ESAI operating mode are selected by the ESAI control registers (ESAI_TCCR, ESAI_TCR, ESAI_RCCR, ESAI_RCR, and ESAI_SAICR). The main operating modes are described in the following section.

25.1.2.1 Normal/Network/On-Demand Mode Selection

Selecting between the normal mode and network mode is accomplished by clearing or setting the TMOD0-TMOD1 bits in the ESAI_TCR register for the transmitter section, as well as in the RMOD0-RMOD1 bits in the ESAI_RCR register for the receiver section.

For normal mode, the ESAI functions with one data word of I/O per frame (per enabled transmitter or receiver). The normal mode is typically used to transfer data to or from a single device.

For the network mode, 2 to 32 time slots per frame may be selected. During each frame, 0 to 32 data words of I/O may be received or transmitted. In either case, the transfers are periodic. The frame sync signal indicates the first time slot in the frame. Network mode is typically used in time division multiplexed (TDM) networks of codecs, DSPs with multiple words per frame, or multi-channel devices.

Selecting the network mode and setting the frame rate divider to zero (DC=00000) selects the on-demand mode. This special case does not generate a periodic frame sync. A frame sync pulse is generated only when data is available to transmit. The on-demand mode requires that the transmit frame sync be internal (output) and the receive frame sync be external (input). Therefore, for simplex operation, the synchronous mode could be used; however, for full-duplex operation, the asynchronous mode must be used. Data transmission that is data driven is enabled by writing data into each TX. Although the ESAI is double buffered, only one word can be written to each TX, even if the transmit shift register is empty. The receive and transmit interrupts function as usual using TDE and RDF; however, transmit underruns are impossible for on-demand transmission and are disabled.

25.1.2.2 Synchronous/Asynchronous Operating Modes

The transmit and receive sections of the ESAI may be synchronous or asynchronous, that is, the transmitter and receiver sections may use common clock and synchronization signals (synchronous operating mode), or they may have their own separate clock and sync signals (asynchronous operating mode).

The SYN bit in the ESAI_SAICR register selects synchronous or asynchronous operation. Because the ESAI is designed to operate either synchronously or asynchronously, separate receive and transmit interrupts are provided.

When SYN is cleared, the ESAI transmitter and receiver clocks and frame sync sources are independent. If SYN is set, the ESAI transmitter and receiver clocks and frame sync come from the transmitter section (either external or internal sources).

Data clock and frame sync signals can be generated internally by the ARM Core or may be obtained from external sources. If internally generated, the ESAI clock generator is used to derive high frequency clock, bit clock and frame sync signals from the ARM Core internal system clock.

25.1.2.3 Frame Sync Selection

The frame sync can be either a bit-long or word-long signal.

The transmitter frame format is defined by the TFSL bit in the ESAI_TCR register. The receiver frame format is defined by the RFSL bit in the ESAI_RCR register.

1. In the word-long frame sync format, the frame sync signal is asserted during the entire word data transfer period. This frame sync length is compatible with codecs, SPI serial peripherals, serial A/D and D/A converters, shift registers and telecommunication PCM serial I/O.
2. In the bit-long frame sync format, the frame sync signal is asserted for one bit clock immediately before the data transfer period. This frame sync length is compatible with Intel and National components, codecs and telecommunication PCM serial I/O.

The relative timing of the word length frame sync as referred to the data word is specified by the TFSR bit in the ESAI_TCR register for the transmitter section and by the RFSR bit in the ESAI_RCR register for the receive section. The word length frame sync may be generated (or expected) with the first bit of the data word, or with the last bit of the previous word. TFSR and RFSR are ignored when a bit length frame sync is selected.

Polarity of the frame sync signal may be defined as positive (asserted high) or negative (asserted low). The TFSP bit in the ESAI_TCCR register specifies the polarity of the frame sync for the transmitter section. The RFSP bit in the ESAI_RCCR register specifies the polarity of the frame sync for the receiver section.

The ESAI receiver looks for a receive frame sync leading edge (trailing edge if RFSP is set) only when the previous frame is completed. If the frame sync goes high before the frame is completed (or before the last bit of the frame is received in the case of a bit frame sync or a word length frame sync with RFSR set), the current frame sync is not recognized, and the receiver is internally disabled until the next frame sync. Frames do not have to be adjacent, that is, a new frame sync does not have to immediately follow the previous frame. Gaps of arbitrary periods can occur between frames. Enabled transmitters are tri-stated during these gaps.

When operating in the synchronous mode (SYN=1), all clocks including the frame sync are generated by the transmitter section.

25.1.2.4 Shift Direction Selection

Some data formats, such as those used by codecs, specify MSB first while other data formats, such as the AES-EBU digital audio interface, specify LSB first.

The MSB/LSB first selection is made by programming RSHFD bit in the ESAI_RCR register for the receiver section and by programming the TSHFD bit in the ESAI_TCR register for the transmitter section.

25.2 External Signals

Three to twelve pins are required for operation, depending on the operating mode selected and the number of transmitters and receivers enabled.

The TX0 and TX1 pins are used by transmitters 0 and 1 only. The TX2_RX3, TX3_RX2, TX4_RX1, and TX5_RX0 pins are shared by transmitters 2 to 5 with receivers 0 to 3. The actual mode of operation is selected under software control. All transmitters operate fully synchronized under control of the same transmitter clock signals. All receivers operate fully synchronized under control of the same receiver clock signals.

The following table describes the external signals of ESAI:

25.2.1 Serial Transmit 0 Data Pin

TX0 is used for transmitting data from the ESAI_TX0 serial transmit shift register.

TX0 is an output when data is being transmitted from the ESAI_TX0 shift register. In the on-demand mode with an internally generated bit clock, the TX0 pin becomes high impedance for a full clock period after the last data bit has been transmitted, assuming another data word does not follow immediately. If a data word follows immediately, there is no high-impedance interval.

TX0 may be programmed as a disconnected pin (PC11) when the ESAI TX0 function is not being used. See [Table 25-13](#).

25.2.2 Serial Transmit 1 Data Pin

TX1 is used for transmitting data from the ESAI_TX1 serial transmit shift register.

TX1 is an output when data is being transmitted from the ESAI_TX1 shift register. In the on-demand mode with an internally generated bit clock, the TX1 pin becomes high impedance for a full clock period after the last data bit has been transmitted, assuming another data word does not follow immediately. If a data word follows immediately, there is no high-impedance interval.

TX1 may be programmed as a disconnected pin (PC10) when the ESAI TX1 function is not being used. See [Table 25-13](#).

25.2.3 Serial Transmit 2/Receive 3 Data Pin

TX2_RX3 is used as the TX2 for transmitting data from the ESAI_TX2 serial transmit shift register when programmed as a transmitter pin, or as the RX3 signal for receiving serial data to the ESAI_RX3 serial receive shift register when programmed as a receiver pin.

TX2_RX3 is an input when data is being received by the ESAI_RX3 shift register. TX2_RX3 is an output when data is being transmitted from the ESAI_TX2 shift register. In the on-demand mode with an internally generated bit clock, the TX2_RX3 pin becomes high impedance for a full clock period after the last data bit has been transmitted, assuming another data word does not follow immediately. If a data word follows immediately, there is no high-impedance interval.

TX2_RX3 may be programmed as a disconnected pin (PC9) when the ESAI TX2 and RX3 functions are not being used. See [Table 25-13](#).

25.2.4 Serial Transmit 3/Receive 2 Data Pin

TX3_RX2 is used as the TX3 signal for transmitting data from the ESAI_TX3 serial transmit shift register when programmed as a transmitter pin, or as the RX2 signal for receiving serial data to the ESAI_RX2 serial receive shift register when programmed as a receiver pin.

TX3_RX2 is an input when data is being received by the ESAI_RX2 shift register. TX3_RX2 is an output when data is being transmitted from the ESAI_TX3 shift register. In the on-demand mode with an internally generated bit clock, the TX3_RX2 pin becomes high impedance for a full clock period after the last data bit has been transmitted, assuming another data word does not follow immediately. If a data word follows immediately, there is no high-impedance interval.

TX3_RX2 may be programmed as a disconnected pin (PC8) when the ESAI TX3 and RX2 functions are not being used. See [Table 25-13](#).

25.2.5 Serial Transmit 4/Receive 1 Data Pin

TX4_RX1 is used as the TX4 signal for transmitting data from the ESAI_TX4 serial transmit shift register when programmed as transmitter pin, or as the RX1 signal for receiving serial data to the RX1 serial receive shift register when programmed as a receiver pin.

TX4_RX1 is an input when data is being received by the ESAI_RX1 shift register. TX4_RX1 is an output when data is being transmitted from the ESAI_TX4 shift register. In the on-demand mode with an internally generated bit clock, the TX4_RX1 pin becomes high impedance for a full clock period after the last data bit has been transmitted, assuming another data word does not follow immediately. If a data word follows immediately, there is no high-impedance interval.

TX4_RX1 may be programmed as a disconnected pin (PC7) when the ESAI TX4 and RX1 functions are not being used. See [Table 25-13](#).

25.2.6 Serial Transmit 5/Receive 0 Data Pin

TX5_RX0 is used as the TX5 signal for transmitting data from the ESAI_TX5 serial transmit shift register when programmed as transmitter pin, or as the RX0 signal for receiving serial data to the ESAI_RX0 serial shift register when programmed as a receiver pin.

TX5_RX0 is an input when data is being received by the ESAI_RX0 shift register. TX5_RX0 is an output when data is being transmitted from the ESAI_TX5 shift register. In the on-demand mode with an internally generated bit clock, the TX5_RX0 pin becomes high impedance for a full clock period after the last data bit has been transmitted, assuming another data word does not follow immediately. If a data word follows immediately, there is no high-impedance interval.

TX5_RX0 may be programmed as a disconnected pin (PC6) when the ESAI TX5 and RX0 functions are not being used. See [Table 25-13](#).

25.2.7 Receiver Serial Clock

SCKR is a bidirectional pin providing the receivers serial bit clock for the ESAI interface.

The direction of this pin is determined by the RCKD bit in the ESAI_RCCR register. The SCKR operates as a clock input or output used by all the enabled receivers in the asynchronous mode (SYN = 0), or as serial flag 0 pin in the synchronous mode (SYN = 1).

When this pin is configured as serial flag pin, its direction is determined by the RCKD bit in the ESAI_RCCR register. When configured as the output flag OF0, this pin reflects the value of the OF0 bit in the ESAI_SAICR register, and the data in the OF0 bit shows up at the pin synchronized to the frame sync being used by the transmitter and receiver

sections. When this pin is configured as the input flag IF0, the data value at the pin is stored in the IF0 bit in the ESAI_SAISR register, synchronized by the frame sync in normal mode or the slot in network mode.

SCKR may be programmed as a disconnected pin (PC0) when the ESAI SCKR function is not being used. See [Table 25-13](#).

NOTE

Although the external ESAI serial clocks can be independent of and asynchronous to the internal ESAI system clock, the external ESAI serial clock cannot exceed the internal ESAI system clock divided by 6.

For SCKR pin mode definitions, see [Table 25-10](#).

The table below provides a list of asynchronous-mode receiver clock sources. For more information about EXTAL/ESAI clocking control bits (ERI, ERO), refer to [ESAI Control Register \(ESAI_ECR\)](#).

Table 25-1. Receiver Clock Sources (Asynchronous Mode Only)

RHCKD	RFSD	RCKD	ERI	ERO	Receiver Bit Clock Source	OUTPUTS		
0	0	0	N/A	N/A	SCKR	-	-	-
0	0	1	N/A	N/A	HCKR	-	-	SCKR
0	1	0	N/A	N/A	SCKR	-	FSR	-
0	1	1	N/A	N/A	HCKR	-	FSR	SCKR
1	0	0	0	0	SCKR	HCKR	-	-
1	0	0	0	1	SCKR	HCKR	-	-
1	0	0	1	0	SCKR	HCKR	-	-
1	0	0	1	1	SCKR	HCKR	-	-
1	0	1	0	0	Fsys ¹	HCKR	-	SCKR
1	0	1	0	1	Fsys	HCKR	-	SCKR
1	0	1	1	0	EXTAL ²	HCKR	-	SCKR
1	0	1	1	1	EXTAL	HCKR	-	SCKR
1	1	0	0	0	SCKR	HCKR	FSR	-
1	1	0	0	1	SCKR	HCKR	FSR	-
1	1	0	1	0	SCKR	HCKR	FSR	-
1	1	0	1	1	SCKR	HCKR	FSR	-
1	1	1	0	0	Fsys	HCKR	FSR	SCKR
1	1	1	0	1	Fsys	HCKR	FSR	SCKR
1	1	1	1	0	EXTAL	HCKR	FSR	SCKR
1	1	1	1	1	EXTAL	HCKR	FSR	SCKR

¹Fsys = ipg_clk_esai

Table 25-1. Receiver Clock Sources (Asynchronous Mode Only)

RHCKD	RFSD	RCKD	ERI	ERO	Receiver Bit Clock Source	OUTPUTS		
EXTAL is the on-chip clock source other than ipg_clk_esai ESAI system clock, and it is from esai_clk_root in CCM.								

25.2.8 Transmitter Serial Clock

SCKT is a bidirectional pin providing the transmitters serial bit clock for the ESAI interface.

The direction of this pin is determined by the TCKD bit in the ESAI_TCCR register. The SCKT is a clock input or output used by all the enabled transmitters in the asynchronous mode (SYN = 0) or by all the enabled transmitters and receivers in the synchronous mode (SYN = 1).

The following table provides a list of asynchronous-mode transmitter clock sources.

Table 25-2. Transmitter Clock Sources (Asynchronous Mode Only)

THCKD	TFSD	TCKD	ETI	ETO	Transmitter Bit Clock Source	OUTPUTS		
0	0	0	N/A	N/A	SCKT	-	-	-
0	0	1	N/A	N/A	HCKT	-	-	SCKT
0	1	0	N/A	N/A	SCKT	-	FST	-
0	1	1	N/A	N/A	HCKT	-	FST	SCKT
1	0	0	0	0	SCKT	HCKT	-	-
1	0	0	0	1	SCKT	HCKT	-	-
1	0	0	1	0	SCKT	HCKT	-	-
1	0	0	1	1	SCKT	HCKT	-	-
1	0	1	0	0	Fsys ¹	HCKT	-	SCKT
1	0	1	0	1	Fsys	HCKT	-	SCKT
1	0	1	1	0	EXTAL ²	HCKT	-	SCKT
1	0	1	1	1	EXTAL	HCKT	-	SCKT
1	1	0	0	0	SCKR	HCKT	FST	-
1	1	0	0	1	SCKR	HCKT	FST	-
1	1	0	1	0	SCKR	HCKT	FST	-
1	1	0	1	1	SCKR	HCKT	FST	-
1	1	1	0	0	Fsys	HCKT	FST	SCKT
1	1	1	0	1	Fsys	HCKT	FST	SCKT
1	1	1	1	0	EXTAL	HCKT	FST	SCKT

Table continues on the next page...

**Table 25-2. Transmitter Clock Sources (Asynchronous Mode Only)
(continued)**

THCKD	TFSD	TCKD	ETI	ETO	Transmitter Bit Clock Source	OUTPUTS		
1	1	1	1	1	EXTAL	HCKT	FST	SCKT
Fsys = ipg_clk_esai								
EXTAL is the on-chip clock sources other than ipg_clk_easi ESAI system clock, and it is from esai_clk_root in CCM								

SCKT may be programmed as a disconnected pin (PC3) when the ESAI SCKT function is not being used. See [Table 25-13](#).

For more information about EXTAL/ESAI clocking control bits (ETI, ETO), see [ESAI Control Register \(ESAI_ECR\)](#).

NOTE

Although the external ESAI serial clocks can be independent of and asynchronous to the internal ESAI system clock, the external ESAI serial clock cannot exceed the internal ESAI system clock divided by 6.

25.2.9 Frame Sync for Receiver

FSR is a bidirectional pin providing the receivers frame sync signal for the ESAI interface. The direction of this pin is determined by the RFSD bit in ESAI_RCR register.

In the asynchronous mode (SYN=0), the FSR pin operates as the frame sync input or output used by all the enabled receivers. In the synchronous mode (SYN=1), it operates as either the serial flag 1 pin (TEBE=0), or as the transmitter external buffer enable control (TEBE=1, RFSD=1). For FSR pin mode definitions, see [Table 25-11](#); for receiver clock signals, see [Table 25-1](#).

When this pin is configured as serial flag pin, its direction is determined by the RFSD bit in the ESAI_RCCR register. When configured as the output flag OF1, this pin reflects the value of the OF1 bit in the ESAI_SAICR register, and the data in the OF1 bit shows up at the pin synchronized to the frame sync being used by the transmitter and receiver sections. When configured as the input flag IF1, the data value at the pin is stored in the IF1 bit in the ESAI_SAISR register, synchronized by the frame sync in normal mode or the slot in network mode.

FSR may be programmed as a disconnected pin (PC1) when the ESAI FSR function is not being used. See [Table 25-13](#).

25.2.10 Frame Sync for Transmitter

FST is a bidirectional pin providing the frame sync for both the transmitters and receivers in the synchronous mode (SYN=1) and for the transmitters only in asynchronous mode (SYN=0).

See [Table 25-2](#). The direction of this pin is determined by the TFSD bit in the ESAI_TCCR register. When configured as an output, this pin is the internally generated frame sync signal. When configured as an input, this pin receives an external frame sync signal for the transmitters (and the receivers in synchronous mode).

FST may be programmed as a disconnected pin (PC4) when the ESAI FST function is not being used. See [Table 25-13](#).

25.2.11 High Frequency Clock for Transmitter

HCKT is a bidirectional pin providing the transmitters high frequency clock for the ESAI interface.

The direction of this pin is determined by the THCKD bit in the ESAI_TCCR register. In the asynchronous mode (SYN=0), the HCKT pin operates as the high frequency clock input or output used by all enabled transmitters. In the synchronous mode (SYN=1), it operates as the high frequency clock input or output used by all enabled transmitters and receivers. When programmed as input this pin is used as an alternative high frequency clock source to the ESAI transmitter rather than the ARM Core main clock. When programmed as output it can serve as a high frequency sample clock (to external DACs for example) or as an additional system clock (see [Table 25-2](#)).

HCKT may be programmed as a disconnected pin (PC5) when the ESAI HCKT function is not being used. See [Table 25-13](#).

25.2.12 High Frequency Clock for Receiver

HCKR is a bidirectional pin providing the receivers high frequency clock for the ESAI interface.

The direction of this pin is determined by the RHCKD bit in the ESAI_RCCR register. In the asynchronous mode (SYN=0), the HCKR pin operates as the high frequency clock input or output used by all the enabled receivers. In the synchronous mode (SYN=1), it operates as the serial flag 2 pin. For HCKR pin mode definitions, see [Table 25-12](#); for receiver clock signals, see [Table 25-1](#).

When this pin is configured as serial flag pin, its direction is determined by the RHCKD bit in the ESAI_RCCR register. When configured as the output flag OF2, this pin reflects the value of the OF2 bit in the ESAI_SAICR register, and the data in the OF2 bit shows up at the pin synchronized to the frame sync being used by the transmitter and receiver sections. When configured as the input flag IF2, the data value at the pin is stored in the IF2 bit in the ESAI_SAISR register, synchronized by the frame sync in normal mode or the slot in network mode.

HCKR may be programmed as a disconnected pin (PC2) when the ESAI HCKR function is not being used. See [Table 25-13](#).

25.2.13 Serial I/O Flags

Three ESAI pins (FSR, SCKR and HCKR) are available as serial I/O flags when the ESAI is operating in the synchronous mode (SYN=1).

Their operation is controlled by RCKD, RFSD, TEBE bits in the ESAI_RCR, ESAI_RCCR and ESAI_SAICR registers. The output data bits (OF2, OF1 and OF0) and the input data bits (IF2, IF1 and IF0) are double buffered to/from the HCKR, FSR and SCKR pins. Double buffering the flags keeps them in sync with the TX and RX data lines.

Each flag can be separately programmed. Flag 0 (SCKR pin) direction is selected by RCKD, RCKD=1 for output and RCKD=0 for input. Flag 1 (FSR pin) is enabled when the pin is not configured as external transmitter buffer enable (TEBE=0) and its direction is selected by RFSD, RFSD=1 for output and RFSD=0 for input. Flag 2 (HCKR pin) direction is selected by RHCKD, RHCKD=1 for output and RHCKD=0 for input.

When programmed as input flags, the SCKR, FSR and HCKR logic values, respectively, are latched at the same time as the first bit of the receive data word is sampled. Because the input was latched, the signal on the input flag pin (SCKR, FSR or HCKR) can change without affecting the input flag until the first bit of the next receive data word. When the received data words are transferred to the receive data registers, the input flag latched values are then transferred to the IF0, IF1 and IF2 bits in the SAISR register, where they may be read by software.

When programmed as output flags, the SCKR, FSR and HCKR logic values are driven by the contents of the OF0, OF1 and OF2 bits in the ESAI_SAICR register respectively, and they are driven when the transmit data registers are transferred to the transmit shift registers. The value on SCKR, FSR and HCKR is stable from the time the first bit of the transmit data word is transmitted until the first bit of the next transmit data word is transmitted. Software may change the OF0-OF2 values thus controlling the SCKR, FSR and HCKR pin values for each transmitted word. The normal sequence for setting output flags when transmitting data is as follows: wait for TDE (transmitter empty) to be set; first write the flags, and then write the transmit data to the transmit registers. OF0, OF1, and OF2 are double buffered so that the flag states appear on the pins when the transmit data is transferred to the transmit shift register, that is, the flags are synchronous with the data.

25.3 Clocks

The table found here describes the clock sources for ESAI.

Please see clock control block for clock setting, configuration and gating information.

Table 25-3. ESAI Clocks

Clock name	Clock Root	Description
extal_clk	esai_clk_root	ESAI system clock
ipg_clk_esai	ahb_clk_root	Bus clock
ipg_clk_s	ipg_clk_root	Peripheral access clock
mem_clk	ahb_clk_root	Mem clock

25.4 Functional Description

This section provides a complete functional description of the block.

25.4.1 ESAI After Reset

Hardware or software reset clears the port control register bits and the port direction control register bits, which configure all ESAI I/O pins as disconnected and both ESAI FIFOs are also in reset state.

The ESAI is in personal reset state while all ESAI pins are programmed as disconnected, and it is active only if at least one of the ESAI I/O pins is programmed as an ESAI pin.

25.4.2 ESAI Interrupt Requests

The ESAI can generate eight different interrupt requests.

Ordered from the highest to the lowest priority):

1. ESAI Receive Data with Exception Status

Occurs when the receive exception interrupt is enabled (REIE=1 in the RCR register), at least one of the enabled receive data registers is full (RDF=1) and a receiver overrun error has occurred (ROE=1 in the SAISR register). ROE is cleared by first reading the SAISR and then reading all the enabled receive data registers.

2. ESAI Receive Even Data

Occurs when the receive even slot data interrupt is enabled (REDIE=1), at least one of the enabled receive data registers is full (RDF=1), the data is from an even slot (REDF=1) and no exception has occurred (ROE=0 or REIE=0).

Reading all enabled receiver data registers clears RDF and REDF.

3. ESAI Receive Data

Occurs when the receive interrupt is enabled (RIE=1), at least one of the enabled receive data registers is full (RDF=1), no exception has occurred (ROE=0 or REIE=0) and no even slot interrupt has occurred (REDF=0 or REDIE=0). Reading all enabled receiver data registers clears RDF.

4. ESAI Receive Last Slot Interrupt

Occurs, if enabled (RLIE=1), after the last slot of the frame ended (in network mode only) regardless of the receive mask register setting. The receive last slot interrupt may be used for resetting the receive mask slot register, reconfiguring the DMA channels and reassigning data memory pointers. Using the receive last slot interrupt guarantees that the previous frame was serviced with the previous setting and the new frame is serviced with the new setting without synchronization problems. Note that the maximum receive last slot interrupt service time should not exceed N-1 ESAI bits service time (where N is the number of bits in a slot).

5. ESAI Transmit Data with Exception Status

Occurs when the transmit exception interrupt is enabled (TEIE=1), at least one transmit data register of the enabled transmitters is empty (TDE=1) and a transmitter underrun error has occurred (TUE=1). TUE is cleared by first reading the SAISR and then writing to all the enabled transmit data registers, or to the TSR register.

6. ESAI Transmit Last Slot Interrupt

Occurs, if enabled (TLIE=1), at the start of the last slot of the frame in network mode regardless of the transmit mask register setting. The transmit last slot interrupt may be used for resetting the transmit mask slot register, reconfiguring the DMA channels and reassigning data memory pointers. Using the transmit last slot interrupt guarantees that the previous frame was serviced with the previous setting and the new frame is serviced with the new setting without synchronization problems. Note that the maximum transmit last slot interrupt service time should not exceed N-1 ESAI bits service time (where N is the number of bits in a slot).

7. ESAI Transmit Even Data

Occurs when the transmit even slot data interrupt is enabled (TEDIE=1), at least one of the enabled transmit data registers is empty (TDE=1), the slot is an even slot (TEDE=1) and no exception has occurred (TUE=0 or TEIE=0). Writing to all the TX registers of the enabled transmitters or to TSR clears this interrupt request.

8. ESAI Transmit Data

Occurs when the transmit interrupt is enabled (TIE=1), at least one of the enabled transmit data registers is empty (TDE=1), no exception has occurred (TUE=0 or TEIE=0) and no even slot interrupt has occurred (TEDE=0 or TEDIE=0). Writing to all the TX registers of the enabled transmitters, or to the TSR clears this interrupt request.

25.4.3 ESAI DMA Requests from the FIFOs

The ESAI can generate two different DMA requests:

1. ESAI Transmit FIFO Empty - Asserts when the number of empty slots in the ESAI transmit FIFO exceeds the threshold programmed in the ESAI Transmit FIFO Configuration Register (TFCR). Automatically negates when the number of empty slots is less than the threshold programmed in the ESAI Transmit FIFO Configuration Register.
2. ESAI Receive FIFO Full - Asserts when the number of data words in the ESAI receive FIFO exceeds the threshold programmed in the ESAI Receive FIFO Configuration Register (RFCR). Automatically negates when the number of words is less than the threshold programmed in the ESAI Receive FIFO Configuration Register.

25.4.4 ESAI Transmit and Receive Shift Registers

25.4.4.1 ESAI Transmit Shift Registers

The transmit shift registers contain the data being transmitted.

See [Figure 25-2](#) and [Figure 25-3](#).

Data is shifted out to the serial transmit data pins by the selected (internal/external) bit clock when the associated frame sync I/O is asserted.

The number of bits shifted out before the shift registers are considered empty and may be written to again can be 8, 12, 16, 20, 24 or 32 bits (determined by the slot length control bits in the TCR register). Data is shifted out of these registers MSB first if TSHFD=0 and LSB first if TSHFD=1.

Functional Description

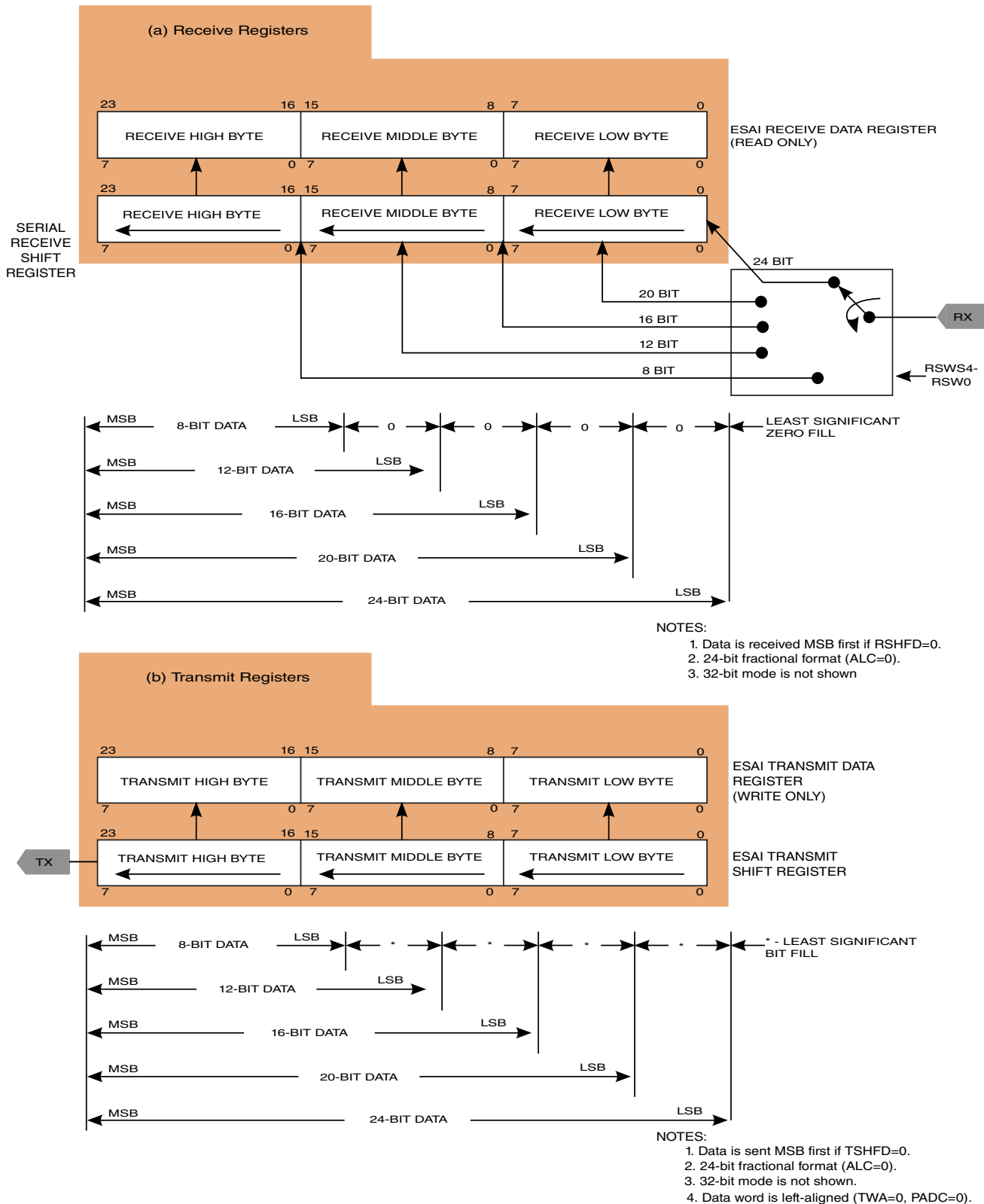

Figure 25-2. ESAI Data Path Programming Model ([R/T]SHFD=0)

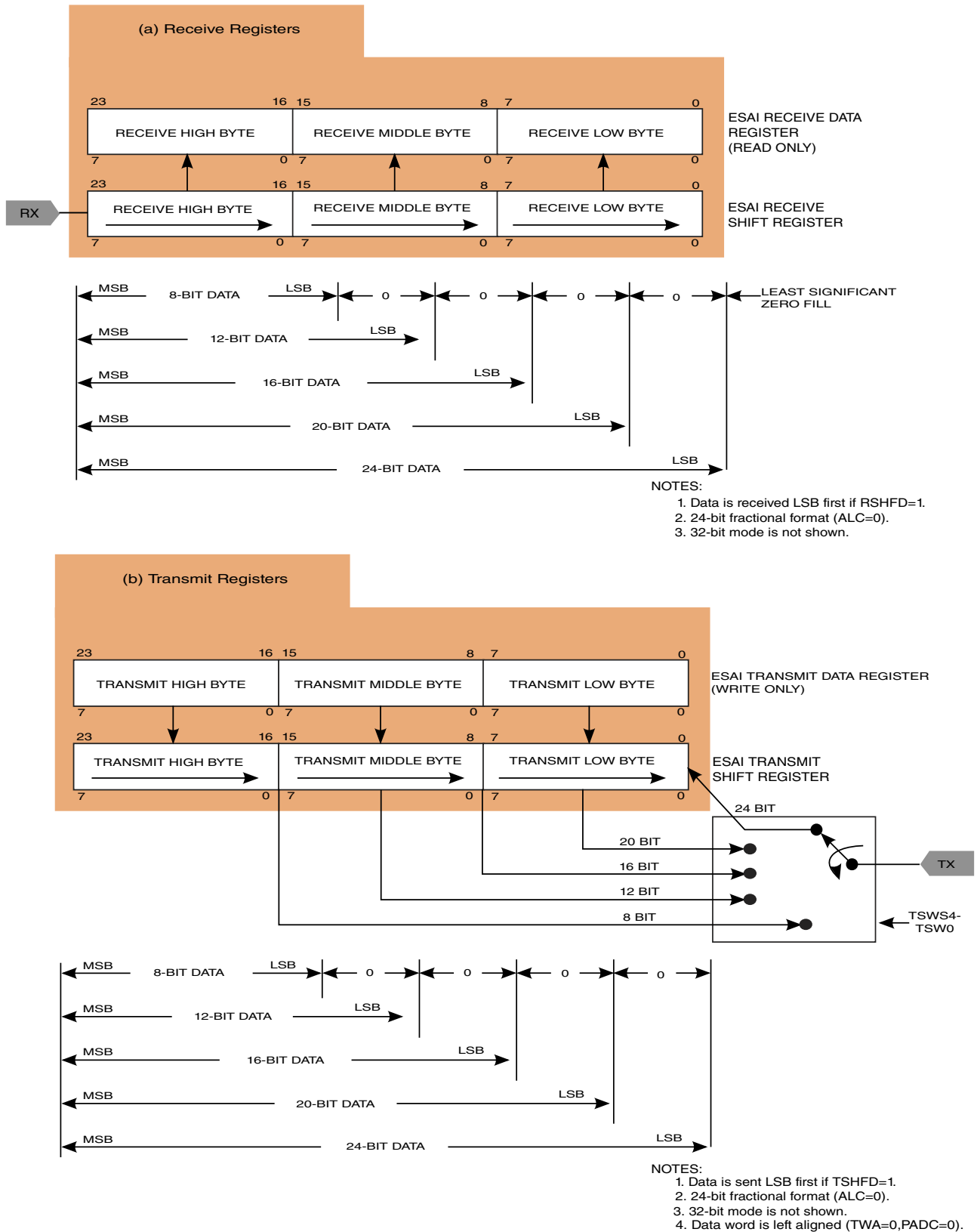

Figure 25-3. ESAI Data Path Programming Model ([R/T]SHFD=1)

25.4.4.2 ESAI Receive Shift Registers

The receive shift registers (Figure 25-2 and Figure 25-3) receive the incoming data from the serial receive data pins. Data is shifted in by the selected (internal/external) bit clock when the associated frame sync I/O is asserted. Data is assumed to be received MSB first if RSHFD=0 and LSB first if RSHFD=1. Data is transferred to the ESAI receive data registers after 8, 12, 16, 20, 24, or 32 serial clock cycles were counted, depending on the slot length control bits in the ESAI_RCR register.

25.5 Initialization Information

25.5.1 ESAI Initialization

The correct way to initialize the ESAI is as follows:

1. Enable the ESAI logic clock by asserting bit 0 of ESAI Control Register (ESAI_ECR[0]).
2. Hardware, software, ESAI individual reset. Note that asserting bit 1 of ESAI Control Register only reset the ESAI core logic, including configuration registers, but not the ESAI FIFOs.
3. Reset ESAI FIFOs by asserting bit 1 of ESAI_TFCR and ESAI_RFCR.
4. Clear the ESAI_TSMA/ESAI_TSMB.
5. Program ESAI control registers. (The transmit/receive enable bits of TCR/RCR should not be set.)
6. Program ESAI FIFOs via TFCR and RFCR. (Enable Transmit/Receive FIFO, enable transmitters/receivers, transmit initialization and set Transmit FIFO/Receive FIFO watermark.)
7. Write initial words to ESAI Transmit Data Register (ESAI_ETDR), at least one word per enabled transmitter slot but as many as desired. For example 4 channels with 2 slot-per-channel are enabled, then 8 words need to be written into ESAI_ETDR
8. Remove ESAI personal reset by configuring ESAI_PCRC and ESAI_PRRC.
9. Enabled Transmitters/Receivers in ESAI_TCR/ESAI_RCR.
10. Configure time slot registers, first set ESAI_TSMB, then ESAI_TSMA.

During program execution, all ESAI pins may be defined disconnected, causing the ESAI to stop serial activity and enter the individual reset state.

All status bits of the interface are set to their reset state however, the control bits are not affected. This procedure allows the programmer to reset the ESAI separately from the other internal peripherals. During individual reset, internal DMA accesses to the data registers of the ESAI are not valid and data read is undefined.

The programmer must use an individual ESAI reset when changing the ESAI control registers (except for TEIE, REIE, TLIE, RLIE, TIE, RIE, TE0-TE5, RE0-RE3) to ensure proper operation of the interface.

NOTE

If the ESAI receiver section is already operating with some of the receivers and enabling additional receivers on the fly, that is, without first putting the ESAI receiver in the personal reset state by setting their REx control bits, it will result in erroneous data being received as the first data word for the newly enabled receivers.

25.5.2 ESAI Initialization Examples

25.5.2.1 Initializing the ESAI using Personal Reset

1. Enable the ESAI logic clock by setting bit 0 of ESAI Control Register(ESAI_ECR[0]).
2. The ESAI should be in its personal reset state (ESAI_PCRC = 0x000 and ESAI_PRRC = 0x000). In the personal reset state, both the transmitter and receiver sections of the ESAI are simultaneously reset. The TPR bit in the ESAI_TCR register may be used to reset just the transmitter section. The RPR bit in the ESAI_RCR register may be used to reset just the receiver section.
3. Clear the ESAI_TSMA/ESAI_TSMB and ESAI_RSMA/ESAI_RSMB.
4. Configure the control registers (ESAI_TCCR, ESAI_TCR, ESAI_RCCR, ESAI_RCR) and ESAI FIFOs configuration Registers (ESAI_TFCR, ESAI_RFCR) according to the operating mode, but do not enable transmitters (TE5-TE0 = 0x0) or receivers (RE3-RE0 = 0x0). It is possible to set the interrupt enable bits which are in use during the operation (no interrupt occurs).
5. Enable the ESAI by setting the ESAI_PCRC and ESAI_PRRC register bits according to pins which are in use during operation.
6. Write initial words to ESAI Transmit Data Register (ESAI_ETDR), at least one word per enabled transmitter slot but as many as desired. For example 4 channels with 2 slot-per-channel are enabled, then 8 words need to be written into ESAI_ETDR. This step is needed even if DMA is used to service the transmitters.
7. Enable the transmitters and receivers.

8. Configure time slot registers, first set ESAI_TSMB, then ESAI_TSMA, then ESAI_RSMB, then ESAI_RSMA.
9. From now on ESAI can be serviced either by polling, interrupts, or DMA.

Operation proceeds as follows:

- For internally generated clock and frame sync, these signals are active immediately after ESAI is enabled (step 4 above).
- Data is received only when one of the receive enable (REx) bits is set and after the occurrence of frame sync signal (either internally or externally generated).
- Data is transmitted only when the transmitter enable (TE_x) bit is set and after the occurrence of frame sync signal (either internally or externally generated). The transmitter outputs remain tri-stated after TE_x bit is set until the frame sync occurs.

25.5.2.2 Initializing the ESAI Transmitter Section

1. It is assumed that the ESAI is operational; that is, at least one pin is defined as an ESAI pin.
2. Enable the ESAI logic clock by setting bit 0 of ESAI Control Register(ESAI_ECR[0])
3. The transmitter section should be in its individual reset state (TPR = 1) and also reset the ESAI Transmit FIFO (ESAI_TFCR[1] = 1).
4. Clear the ESAI_TSMA/ESAI_TSMB.
5. Configure the control registers ESAI_TCCR and ESAI_TCR according to the operating mode, configure the Transmit FIFO Configuration Register (bring transmit FIFO out of reset, enable Transmit FIFO, enable transmitters, transmit initialization and set watermark). Make sure to clear the transmitter enable bits (TE0-TE5). TPR must remain set.
6. Take the transmitter section out of the individual reset state by clearing TPR.
7. Write initial words to ESAI Transmit Data Register (ESAI_ETDR), at least one word per enabled transmitter slot but as many as desired. For example 4 channels with 2 slot-per-channel are enabled, then 8 words need to be written into ESAI_ETDR
8. Enable the transmitters by setting their TE bits.
9. Configure time slot registers, first set ESAI_TSMB, then ESAI_TSMA.
10. Data is transmitted only when the transmitter enable (TE_x) bit is set and after the occurrence of frame sync signal (either internally or externally generated). The transmitter outputs remain tri-stated after TE_x bit is set until the frame sync occurs.
11. From now on the transmitters are operating and can be serviced either by polling, interrupts, or DMA.

25.5.2.3 Initializing the ESAI Receiver Section

1. It is assumed that the ESAI is operational; that is, at least one pin is defined as an ESAI pin.
2. Enable the ESAI logic clock by setting bit 0 of ESAI Control Register (ESAI_ECR[0])
3. The receiver section should be in its individual reset state (RPR = 1) and also reset the ESAI Receive FIFO (ESAI_RFCR[1] = 1).
4. Clear the ESAI_RSMA/ESAI_RSMB.
5. Configure the control registers ESAI_RCCR and ESAI_RCR according to the operating mode, configure the Receive FIFO Configuration Register (bring receive FIFO out of reset, enable Receive FIFO, receivers, and set watermark). Making sure to clear the receiver enable bits (RE0-RE3). RPR must remain set.
6. Take the receiver section out of the individual reset state by clearing RPR.
7. Enable the receivers by setting their RE bits.
8. Configure time slot registers, first set ESAI_RSMB, then set ESAI_RSMA.
9. From now on the receivers are operating and can be serviced either by polling, interrupts, or DMA.

25.6 ESAI Memory Map/Register Definition

ESAI memory map

Absolute address (hex)	Register name	Width (in bits)	Access	Reset value	Section/page
202_4000	ESAI Transmit Data Register (ESAI_ETDR)	32	W (always reads 0)	0000_0000h	25.6.1/1203
202_4004	ESAI Receive Data Register (ESAI_ERDR)	32	R	0000_0000h	25.6.2/1203
202_4008	ESAI Control Register (ESAI_ECR)	32	R/W	0000_0000h	25.6.3/1204
202_400C	ESAI Status Register (ESAI_ESR)	32	R	0000_0000h	25.6.4/1205
202_4010	Transmit FIFO Configuration Register (ESAI_TFCR)	32	R/W	0000_0000h	25.6.5/1206
202_4014	Transmit FIFO Status Register (ESAI_TFSR)	32	R	0000_0000h	25.6.6/1208
202_4018	Receive FIFO Configuration Register (ESAI_RFCR)	32	R/W	0000_0000h	25.6.7/1209
202_401C	Receive FIFO Status Register (ESAI_RFSR)	32	R	0000_0000h	25.6.8/1211
202_4080	Transmit Data Register n (ESAI_TX0)	32	W (always reads 0)	0000_0000h	25.6.9/1212
202_4084	Transmit Data Register n (ESAI_TX1)	32	W (always reads 0)	0000_0000h	25.6.9/1212

Table continues on the next page...

ESAI memory map (continued)

Absolute address (hex)	Register name	Width (in bits)	Access	Reset value	Section/page
202_4088	Transmit Data Register n (ESAI_TX2)	32	W (always reads 0)	0000_0000h	25.6.9/1212
202_408C	Transmit Data Register n (ESAI_TX3)	32	W (always reads 0)	0000_0000h	25.6.9/1212
202_4090	Transmit Data Register n (ESAI_TX4)	32	W (always reads 0)	0000_0000h	25.6.9/1212
202_4094	Transmit Data Register n (ESAI_TX5)	32	W (always reads 0)	0000_0000h	25.6.9/1212
202_4098	ESAI Transmit Slot Register (ESAI_TSR)	32	W (always reads 0)	0000_0000h	25.6.10/1212
202_40A0	Receive Data Register n (ESAI_RX0)	32	R	0000_0000h	25.6.11/1213
202_40A4	Receive Data Register n (ESAI_RX1)	32	R	0000_0000h	25.6.11/1213
202_40A8	Receive Data Register n (ESAI_RX2)	32	R	0000_0000h	25.6.11/1213
202_40AC	Receive Data Register n (ESAI_RX3)	32	R	0000_0000h	25.6.11/1213
202_40CC	Serial Audio Interface Status Register (ESAI_SAISR)	32	R	0000_0000h	25.6.12/1214
202_40D0	Serial Audio Interface Control Register (ESAI_SAICR)	32	R/W	0000_0000h	25.6.13/1216
202_40D4	Transmit Control Register (ESAI_TCR)	32	R/W	0000_0000h	25.6.14/1219
202_40D8	Transmit Clock Control Register (ESAI_TCCR)	32	R/W	0000_0000h	25.6.15/1227
202_40DC	Receive Control Register (ESAI_RCR)	32	R/W	0000_0000h	25.6.16/1231
202_40E0	Receive Clock Control Register (ESAI_RCCR)	32	R/W	0000_0000h	25.6.17/1235
202_40E4	Transmit Slot Mask Register A (ESAI_TSMA)	32	R/W	0000_FFFFh	25.6.18/1238
202_40E8	Transmit Slot Mask Register B (ESAI_TSMB)	32	R/W	0000_FFFFh	25.6.19/1239
202_40EC	Receive Slot Mask Register A (ESAI_RSMA)	32	R/W	0000_FFFFh	25.6.20/1240
202_40F0	Receive Slot Mask Register B (ESAI_RSMB)	32	R/W	0000_FFFFh	25.6.21/1241
202_40F8	Port C Direction Register (ESAI_PPRC)	32	R/W	0000_0000h	25.6.22/1242

Table continues on the next page...

ESAI memory map (continued)

Absolute address (hex)	Register name	Width (in bits)	Access	Reset value	Section/page
202_40FC	Port C Control Register (ESAI_PCRC)	32	R/W	0000_0000h	25.6.23/ 1242

25.6.1 ESAI Transmit Data Register (ESAI_ETDR)

Address: 202_4000h base + 0h offset = 202_4000h

Bit	31	30	29	28	27	26	25	24	23	22	21	20	19	18	17	16	15	14	13	12	11	10	9	8	7	6	5	4	3	2	1	0
R	0																															
W	ETDR																															
Reset	0	0	0	0	0	0	0	0	0	0	0	0	0	0	0	0	0	0	0	0	0	0	0	0	0	0	0	0	0	0	0	0

ESAI_ETDR field descriptions

Field	Description
ETDR	ESAI Transmit Data Register. Writing to this register stores the data written into the ESAI Transmit FIFO. Writing to this register when the Transmit FIFO is full causes the data written to be lost (the existing data within the FIFO is not overwritten). When multiple ESAI transmitters are enabled, the data for each transmitter must be interleaved from lowest transmitter to highest transmitter (for example, if transmitters 0, 2 and 3 are enabled then data must be written as follows: transmitter #0, transmitter #2, transmitter #3, transmitter #0, transmitter #2, transmitter #3, transmitter #0, etc). Data within the ESAI Transmit FIFO is passed to the ESAI transmit shifter registers as defined by the Transmit Word Alignment configuration bits.

25.6.2 ESAI Receive Data Register (ESAI_ERDR)

Address: 202_4000h base + 4h offset = 202_4004h

Bit	31	30	29	28	27	26	25	24	23	22	21	20	19	18	17	16	15	14	13	12	11	10	9	8	7	6	5	4	3	2	1	0
R	ERDR																															
W																																
Reset	0	0	0	0	0	0	0	0	0	0	0	0	0	0	0	0	0	0	0	0	0	0	0	0	0	0	0	0	0	0	0	0

ESAI_ERDR field descriptions

Field	Description
ERDR	ESAI Receive Data Register. Reading this register returns the data within the ESAI Receive FIFO. Reading this register when the Receive FIFO is empty returns the last valid data word. When multiple ESAI receivers are enabled, the data for each receiver is interleaved from lowest receiver to highest receiver (for example, if receivers 0, 2 and 3 are enabled then data is returned as follows: receiver #0, receiver #2, receiver #3, receiver #0, receiver #2, receiver #3, receiver #0, etc). Data is passed from the ESAI receive shift registers to the ESAI Receive FIFO as defined by the Receiver Word Alignment configuration bits either zero or sign-extended based on the Receive Extension control bit.

25.6.3 ESAI Control Register (ESAI_ECR)

Address: 202_4000h base + 8h offset = 202_4008h

Bit	31	30	29	28	27	26	25	24	23	22	21	20	19	18	17	16
R	0												ETI	ETO	ERI	ERO
W	[Shaded]															
Reset	0	0	0	0	0	0	0	0	0	0	0	0	0	0	0	0
Bit	15	14	13	12	11	10	9	8	7	6	5	4	3	2	1	0
R	0														ERST	ESAIEN
W	[Shaded]															
Reset	0	0	0	0	0	0	0	0	0	0	0	0	0	0	0	0

ESAI_ECR field descriptions

Field	Description
31–20 Reserved	This field is reserved. This read-only field is reserved and always has the value 0.
19 ETI	EXTAL Transmitter In. Mux EXTAL in place of the High Frequency Transmitter Clock input pin. HCKT can still be used to drive a divided down EXTAL or as GPIO. 0 HCKT pin has normal function. 1 EXTAL muxed into HCKT input.
18 ETO	EXTAL Transmitter Out. Drive the EXTAL input on the High Frequency Transmitter Clock pin. 0 HCKT pin has normal function. 1 EXTAL driven onto HCKT pin.
17 ERI	EXTAL Receiver In. Mux EXTAL in place of the High Frequency Receiver Clock input pin. HCKR can still be used to drive a divided down EXTAL or as GPIO. 0 HCKR pin has normal function. 1 EXTAL muxed into HCKR input.
16 ERO	EXTAL Receiver Out. Drive the EXTAL input on the High Frequency Receiver Clock pin. 0 HCKR pin has normal function. 1 EXTAL driven onto HCKR pin.
15–2 Reserved	This field is reserved. This read-only field is reserved and always has the value 0.
1 ERST	ESAI Reset. Reset the ESAI core logic (including configuration registers) but not the ESAI FIFOs. 0 ESAI not reset. 1 ESAI reset.
0 ESAIEN	ESAI Enable. Enables/disables the ESAI logic clock. Enable the ESAI before reading or writing other ESAI registers.

Table continues on the next page...

ESAI_ECR field descriptions (continued)

Field	Description
0	ESAI disabled.
1	ESAI enabled.

25.6.4 ESAI Status Register (ESAI_ESR)

Address: 202_4000h base + Ch offset = 202_400Ch

Bit	31	30	29	28	27	26	25	24		23	22	21	20	19	18	17	16
R	0																
W																	
Reset	0	0	0	0	0	0	0	0		0	0	0	0	0	0	0	0
Bit	15	14	13	12	11	10	9	8		7	6	5	4	3	2	1	0
R	0				TINIT	RFF	TFE	TLS	TDE	TED	TD	RLS	RDE	RED	RD		
W																	
Reset	0	0	0	0	0	0	0	0		0	0	0	0	0	0	0	0

ESAI_ESR field descriptions

Field	Description
31–11 Reserved	This field is reserved. This read-only field is reserved and always has the value 0.
10 TINIT	Transmit Initialization. Indicates that the Transmit FIFO is writing the first word for each enabled transmitter into the Transmit Data Registers. This bit sets when the Transmit FIFO is enabled (provided Transmit Initialization is enabled) and clears after the Transmit Data Registers have been initialized. The Transmit Enable bits in the Transmit Control Register should not be set until this flag has cleared. 0 Transmitter has finished initializing the Transmit Data Registers (or Transmit FIFO is not enabled or Transmit Initialization is not enabled). 1 Transmitter has not finished initializing the Transmit Data Registers.
9 RFF	Receive FIFO Full. Indicates that the number of data words in the Receive FIFO has equaled or exceeded the Receive FIFO Watermark. This flag also drives the ESAI Receiver DMA request line. ESAI FIFO DMA requests see ESAI DMA Requests from the FIFOs . 0 Number of words in Receive FIFO less than Receive FIFO watermark. 1 Number of words in Receive FIFO is equal to or greater than Receive FIFO watermark.
8 TFE	Transmit FIFO Empty. Indicates that the number of empty slots in the Transmit FIFO has met or exceeded the Transmit FIFO Watermark. This flag also drives the ESAI Transmitter DMA request line. ESAI FIFO DMA request see ESAI DMA Requests from the FIFOs . 0 Number of empty slots in Transmit FIFO less than Transmit FIFO watermark. 1 Number of empty slots in Transmit FIFO is equal to or greater than Transmit FIFO watermark.
7 TLS	Transmit Last Slot. Reading this register when TLS is set will negate the Transmit Last Slot interrupt. 0 TLS is not the highest priority active interrupt. 1 TLS is the highest priority active interrupt.

Table continues on the next page...

ESAI_ESR field descriptions (continued)

Field	Description
6 TDE	Transmit Data Exception. 0 TDE is not the highest priority active interrupt. 1 TDE is the highest priority active interrupt.
5 TED	Transmit Even Data. 0 TED is not the highest priority active interrupt. 1 TED is the highest priority active interrupt.
4 TD	Transmit Data. 0 TD is not the highest priority active interrupt. 1 TD is the highest priority active interrupt.
3 RLS	Receive Last Slot. Reading this register when RLS is set will negate the Receive Last Slot interrupt. 0 RLS is not the highest priority active interrupt. 1 RLS is the highest priority active interrupt.
2 RDE	Receive Data Exception. 0 RDE is not the highest priority active interrupt. 1 RDE is the highest priority active interrupt.
1 RED	Receive Even Data. 0 RED is not the highest priority active interrupt. 1 RED is the highest priority active interrupt.
0 RD	Receive Data. 0 RD is not the highest priority active interrupt. 1 RD is the highest priority active interrupt.

25.6.5 Transmit FIFO Configuration Register (ESAI_TFCR)

Address: 202_4000h base + 10h offset = 202_4010h

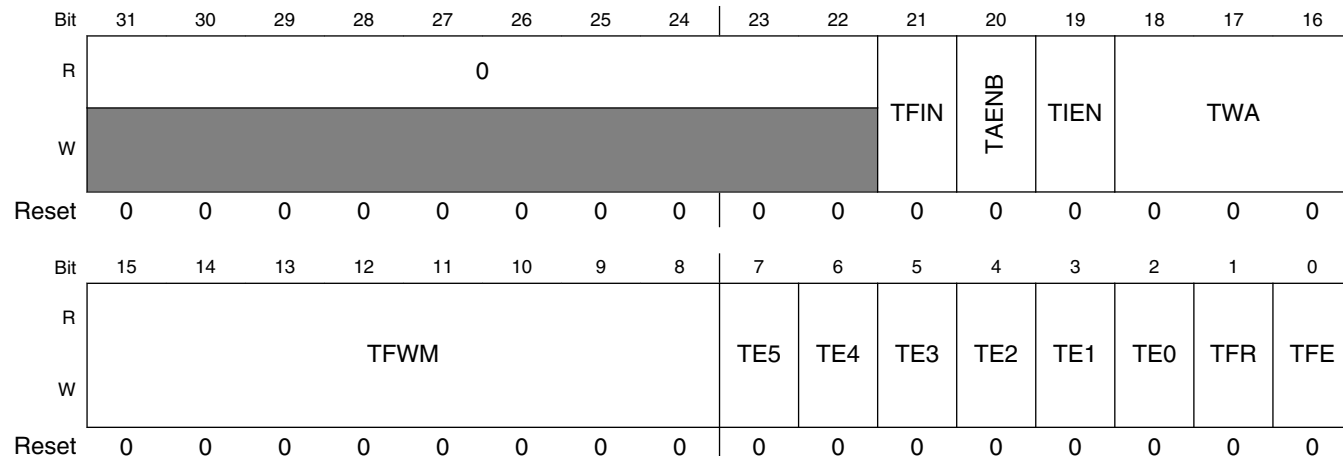

ESAI_TFCR field descriptions

Field	Description
31–22 Reserved	This field is reserved. This read-only field is reserved and always has the value 0.
21 TFIN	Tx FIFO Interrupt Enable Generate an interrupt if the "Tx FIFO Empty" flag is set. Indicate the number of empty slots in the Tx FIFO has met or exceed watermark.
20 TAENB	Tx FIFO Align Enable Disable Tx FIFO slot align function when set.
19 TIEN	Transmitter Initialization Enable. Enables the initialization of the Transmit Data Registers when the Transmitter FIFO is enabled. TIEN=1 is recommended. 0 Transmit Data Registers are not initialized from the FIFO once the Transmit FIFO is enabled. Software must manually initialize the Transmit Data Registers separately. 1 Transmit Data Registers are initialized from the FIFO once the Transmit FIFO is enabled.
18–16 TWA	Transmit Word Alignment. Configures the alignment of the data written into the ESAI Transmit Data Register and then passed to the relevant 24 bit Transmit shift register. NOTE: The settings shown below assume TCR[TWA]=0, TCR[PADC]=1 and TCR[TSHFD]=0. 000 MSB of data is bit 31. Data bits 7-0 are ignored when passed to transmit shift register. 001 MSB of data is bit 27. Data bits 3-0 are ignored when passed to transmit shift register. 010 MSB of data is bit 23. 011 MSB of data is bit 19. Bottom 4 bits of transmit shift register are zeroed. 100 MSB of data is bit 15. Bottom 8 bits of transmit shift register are zeroed. 101 MSB of data is bit 11. Bottom 12 bits of transmit shift register are zeroed. 110 MSB of data is bit 7. Bottom 16 bits of transmit shift register are zeroed. 111 MSB of data is bit 3. Bottom 20 bits of transmit shift register are zeroed.
15–8 TFWM	Transmit FIFO Watermark. These bits configure the threshold at which the Transmit FIFO Empty flag will set. The TFE is set when the number of empty slots in the Transmit FIFO equal or exceed the selected threshold.
7 TE5	Transmitter #5 FIFO Enable. This bit enables transmitter #5 to use the Transmit FIFO. Do not change this bit when the Transmitter FIFO is enabled. 0 Transmitter #5 is not using the Transmit FIFO. 1 Transmitter #5 is using the Transmit FIFO.
6 TE4	Transmitter #4 FIFO Enable. This bit enables transmitter #4 to use the Transmit FIFO. Do not change this bit when the Transmitter FIFO is enabled. 0 Transmitter #4 is not using the Transmit FIFO. 1 Transmitter #4 is using the Transmit FIFO.
5 TE3	Transmitter #3 FIFO Enable. This bit enables transmitter #3 to use the Transmit FIFO. Do not change this bit when the Transmitter FIFO is enabled. 0 Transmitter #3 is not using the Transmit FIFO. 1 Transmitter #3 is using the Transmit FIFO.
4 TE2	Transmitter #2 FIFO Enable. This bit enables transmitter #2 to use the Transmit FIFO. Do not change this bit when the Transmitter FIFO is enabled. 0 Transmitter #2 is not using the Transmit FIFO. 1 Transmitter #2 is using the Transmit FIFO.

Table continues on the next page...

ESAI_TFCR field descriptions (continued)

Field	Description
3 TE1	Transmitter #1 FIFO Enable. This bit enables transmitter #1 to use the Transmit FIFO. Do not change this bit when the Transmitter FIFO is enabled. 0 Transmitter #1 is not using the Transmit FIFO. 1 Transmitter #1 is using the Transmit FIFO.
2 TE0	Transmitter #0 FIFO Enable. This bit enables transmitter #0 to use the Transmit FIFO. Do not change this bit when the Transmitter FIFO is enabled. 0 Transmitter #0 is not using the Transmit FIFO. 1 Transmitter #0 is using the Transmit FIFO.
1 TFR	Transmit FIFO Reset. This bit resets the Transmit FIFO pointers. 0 Transmit FIFO not reset. 1 Transmit FIFO reset.
0 TFE	Transmit FIFO Enable. This bit enables the use of the Transmit FIFO. 0 Transmit FIFO disabled. 1 Transmit FIFO enabled.

25.6.6 Transmit FIFO Status Register (ESAI_TFSR)

Address: 202_4000h base + 14h offset = 202_4014h

Bit	31	30	29	28	27	26	25	24	23	22	21	20	19	18	17	16
R	0															
W	[Greyed out]															
Reset	0	0	0	0	0	0	0	0	0	0	0	0	0	0	0	0
Bit	15	14	13	12	11	10	9	8	7	6	5	4	3	2	1	0
R	0	NTFO			0	NTFI			TFCNT							
W	[Greyed out]															
Reset	0	0	0	0	0	0	0	0	0	0	0	0	0	0	0	0

ESAI_TFSR field descriptions

Field	Description
31–15 Reserved	This field is reserved. This read-only field is reserved and always has the value 0.
14–12 NTFO	Next Transmitter FIFO Out. Indicates which Transmit Data Register receives the top word of the Transmit FIFO. This will usually equal the lowest enabled transmitter, unless the transmit FIFO is empty. 000 Transmitter #0 receives next word from the Transmit FIFO. 001 Transmitter #1 receives next word from the Transmit FIFO. 010 Transmitter #2 receives next word from the Transmit FIFO. 011 Transmitter #3 receives next word from the Transmit FIFO.

Table continues on the next page...

ESAI_TFSR field descriptions (continued)

Field	Description
	100 Transmitter #4 receives next word from the Transmit FIFO. 101 Transmitter #5 receives next word from the Transmit FIFO. 110 Reserved. 111 Reserved.
11 Reserved	This field is reserved. This read-only field is reserved and always has the value 0.
10–8 NTFI	Next Transmitter FIFO In. Indicates which transmitter receives the next word written to the FIFO. 000 Transmitter #0 receives next word written to the Transmit FIFO. 001 Transmitter #1 receives next word written to the Transmit FIFO. 010 Transmitter #2 receives next word written to the Transmit FIFO. 011 Transmitter #3 receives next word written to the Transmit FIFO. 100 Transmitter #4 receives next word written to the Transmit FIFO. 101 Transmitter #5 receives next word written to the Transmit FIFO. 110 Reserved. 111 Reserved.
TFCNT	Transmit FIFO Counter. These bits indicate the number of data words stored in the Transmit FIFO.

25.6.7 Receive FIFO Configuration Register (ESAI_RFCR)

Address: 202_4000h base + 18h offset = 202_4018h

Bit	31	30	29	28	27	26	25	24	23	22	21	20	19	18	17	16	
R	0																
W											RFIN	RAENB	REXT	RWA			
Reset	0	0	0	0	0	0	0	0	0	0	0	0	0	0	0	0	
Bit	15	14	13	12	11	10	9	8	7	6	5	4	3	2	1	0	
R									0								
W	RFWM										RE3	RE2	RE1	RE0	RFR	RFE	
Reset	0	0	0	0	0	0	0	0	0	0	0	0	0	0	0	0	

ESAI_RFCR field descriptions

Field	Description
31–22 Reserved	This field is reserved. This read-only field is reserved and always has the value 0.
21 RFIN	Rx FIFO Interrupt Enable Generate an interrupt if the "Rx FIFO Empty" flag is set. Indicate the number of data in the Rx FIFO has met or exceed water mark.

Table continues on the next page...

ESAI_RFCR field descriptions (continued)

Field	Description
20 RAENB	Rx FIFO Align Enable Disable Rx FIFO slot align function when set.
19 REXT	Receive Extension. Enables the receive data to be returned sign extended when the Receive Word Alignment is configured to return data where the MSB is not aligned with bit 31. 0 Receive data is zero extended. 1 Receive data is sign extended.
18–16 RWA	Receive Word Alignment. Configures the alignment of the data passed from the relevant 24 bit Receive shift register and read out the ESAI Receive Data Register. 000 MSB of data is at bit 31. Data bits 7-0 are zeroed. 001 MSB of data is at bit 27. Data bits 3-0 are zeroed. 010 MSB of data is at bit 23. 011 MSB of data is at bit 19. Data bits 3-0 from receive shift register are ignored. 100 MSB of data is at bit 15. Data bits 7-0 from receive shift register are ignored. 101 MSB of data is at bit 11. Data bits 11-0 from receive shift register are ignored. 110 MSB of data is at bit 7. Data bits 15-0 from receive shift register are ignored. 111 MSB of data is at bit 3. Data bits 19-0 from receive shift register are ignored.
15–8 RFWM	Receive FIFO Watermark. These bits configure the threshold at which the Receive FIFO Full flag will set. The RFF is set when the number of words in the Receive FIFO equal or exceed the selected threshold. It can be set to a non-zero value.
7–6 Reserved	This field is reserved. This read-only field is reserved and always has the value 0.
5 RE3	Receiver #3 FIFO Enable. This bit enables receiver #3 to use the Receive FIFO. Do not change this bit when the Receiver FIFO is enabled. 0 Receiver #3 is not using the Receive FIFO. 1 Receiver #3 is using the Receive FIFO.
4 RE2	Receiver #2 FIFO Enable. This bit enables receiver #2 to use the Receive FIFO. Do not change this bit when the Receiver FIFO is enabled. 0 Receiver #2 is not using the Receive FIFO. 1 Receiver #2 is using the Receive FIFO.
3 RE1	Receiver #1 FIFO Enable. This bit enables receiver #1 to use the Receive FIFO. Do not change this bit when the Receiver FIFO is enabled. 0 Receiver #1 is not using the Receive FIFO. 1 Receiver #1 is using the Receive FIFO.
2 RE0	Receiver #0 FIFO Enable. This bit enables receiver #0 to use the Receive FIFO. Do not change this bit when the Receiver FIFO is enabled. 0 Receiver #0 is not using the Receive FIFO. 1 Receiver #0 is using the Receive FIFO.
1 RFR	Receive FIFO Reset. This bit resets the Receive FIFO pointers. 0 Receive FIFO not reset. 1 Receive FIFO reset.
0 RFE	Receive FIFO Enable. This bit enables the use of the Receive FIFO.

Table continues on the next page...

ESAI_RFCR field descriptions (continued)

Field	Description
0	Receive FIFO disabled.
1	Receive FIFO enabled.

25.6.8 Receive FIFO Status Register (ESAI_RFSR)

Address: 202_4000h base + 1Ch offset = 202_401Ch

Bit	31	30	29	28	27	26	25	24	23	22	21	20	19	18	17	16
R	0															
W																
Reset	0	0	0	0	0	0	0	0	0	0	0	0	0	0	0	0
Bit	15	14	13	12	11	10	9	8	7	6	5	4	3	2	1	0
R	0	NRFI		0	NRFO		RFCNT									
W																
Reset	0	0	0	0	0	0	0	0	0	0	0	0	0	0	0	0

ESAI_RFSR field descriptions

Field	Description
31–14 Reserved	This field is reserved. This read-only field is reserved and always has the value 0.
13–12 NRFI	Next Receiver FIFO In. Indicates which Receiver Data Register the Receive FIFO will load next. This will usually equal the lowest enabled receiver, unless the receive FIFO is full. 00 Receiver #0 returns next word to the Receive FIFO. 01 Receiver #1 returns next word to the Receive FIFO. 10 Receiver #2 returns next word to the Receive FIFO. 11 Receiver #3 returns next word to the Receive FIFO.
11–10 Reserved	This field is reserved. This read-only field is reserved and always has the value 0.
9–8 NRFO	Next Receiver FIFO Out. Indicates which receiver returns the top word of the Receive FIFO. 00 Receiver #0 returns next word from the Receive FIFO. 01 Receiver #1 returns next word from the Receive FIFO. 10 Receiver #2 returns next word from the Receive FIFO. 11 Receiver #3 returns next word from the Receive FIFO.
RFCNT	Receive FIFO Counter. These bits indicate the number of data words stored in the Receive FIFO.

25.6.9 Transmit Data Register n (ESAI_TXn)

ESAI_TX5, ESAI_TX4, ESAI_TX3, ESAI_TX2, ESAI_TX1 and ESAI_TX0 are 32-bit write-only registers. Data to be transmitted is written into these registers and is automatically transferred to the transmit shift registers (Figure 25-2 and Figure 25-3). The data written (8, 12, 16, 20, or 24 bits) should occupy the most significant portion of the TXn according to the ALC control bit setting. The unused bits (least significant portion and the 8 most significant bits when ALC=1) of the TXn are don't care bits. The Core is interrupted whenever the TXn becomes empty if the transmit data register empty interrupt has been enabled.

Address: 202_4000h base + 80h offset + (4d × i), where i=0d to 5d

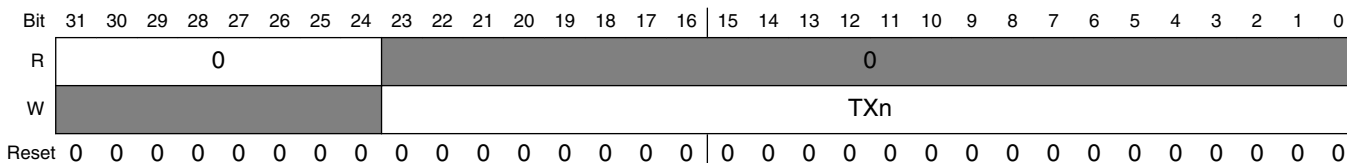

ESAI_TXn field descriptions

Field	Description
31–24 Reserved	This field is reserved. This read-only field is reserved and always has the value 0.
TXn	Stores the data to be transmitted and is automatically transferred to the transmit shift registers. See ESAI Transmit Shift Registers .

25.6.10 ESAI Transmit Slot Register (ESAI_TSR)

Address: 202_4000h base + 98h offset = 202_4098h

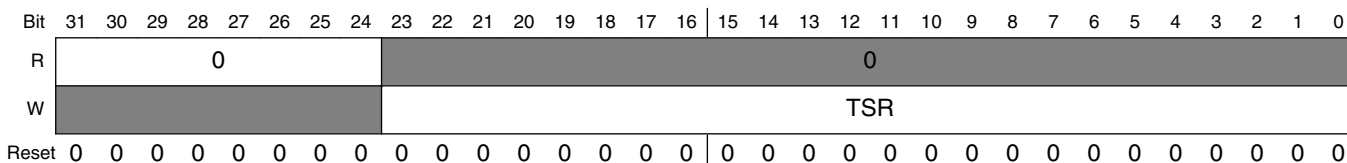

ESAI_TSR field descriptions

Field	Description
31–24 Reserved	This field is reserved. This read-only field is reserved and always has the value 0.

Table continues on the next page...

ESAI_TSR field descriptions (continued)

Field	Description
TSR	The write-only Transmit Slot Register (ESAI_TSR) is effectively a null data register that is used when the data is not to be transmitted in the available transmit time slot. The transmit data pins of all the enabled transmitters are in the high-impedance state for the respective time slot where TSR has been written. The Transmitter External Buffer Enable pin (FSR pin when SYN=1, TEBE=1, RFSD=1) disables the external buffers during the slot when the ESAI_TSR register has been written.

25.6.11 Receive Data Register n (ESAI_RXn)

ESAI_RX3, ESAI_RX2, ESAI_RX1, and ESAI_RX0 are 32-bit read-only registers that accept data from the receive shift registers when they become full (Figure 25-2 and Figure 25-3). The data occupies the most significant portion of the receive data registers, according to the ALC control bit setting. The unused bits (least significant portion and 8 most significant bits when ALC=1) read as zeros. The Core is interrupted whenever RXn becomes full if the associated interrupt is enabled.

Address: 202_4000h base + A0h offset + (4d × i), where i=0d to 3d

Bit	31	30	29	28	27	26	25	24	23	22	21	20	19	18	17	16	15	14	13	12	11	10	9	8	7	6	5	4	3	2	1	0
R	0								RXn																							
W	0																															
Reset	0	0	0	0	0	0	0	0	0	0	0	0	0	0	0	0	0	0	0	0	0	0	0	0	0	0	0	0	0	0	0	0

ESAI_RXn field descriptions

Field	Description
31–24 Reserved	This field is reserved. This read-only field is reserved and always has the value 0.
RXn	Accept data from the receive shift registers when they become full See ESAI Receive Shift Registers

25.6.12 Serial Audio Interface Status Register (ESAI_SAISR)

The Status Register (ESAI_SAISR) is a read-only status register used by the ARM Core to read the status and serial input flags of the ESAI.

Address: 202_4000h base + CCh offset = 202_40CCh

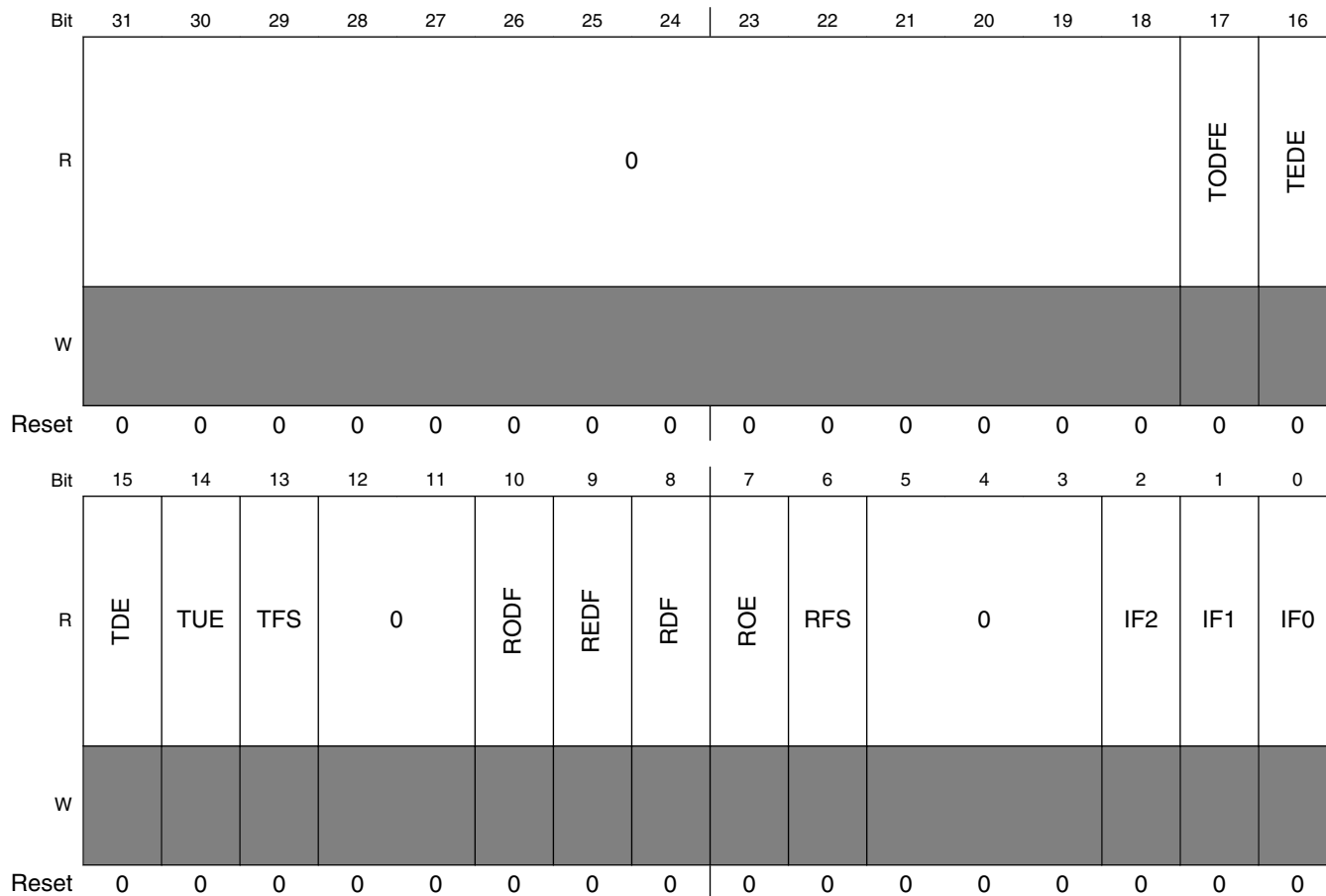

ESAI_SAISR field descriptions

Field	Description
31–18 Reserved	This field is reserved. This read-only field is reserved and always has the value 0.
17 TODFE	ESAI_SAISR Transmit Odd-Data Register Empty. When set, TODFE indicates that the enabled transmitter data registers became empty at the beginning of an odd time slot. Odd time slots are all odd-numbered slots (1, 3, 5, and so on). Time slots are numbered from zero to N-1, where N is the number of time slots in the frame. This flag is set when the contents of the transmit data register of all the enabled transmitters are transferred to the transmit shift registers; it is also set for a TSR disabled time slot period in network mode (as if data were being transmitted after the TSR was written). When set, TODFE indicates that data should be written to all the TX registers of the enabled transmitters or to the transmit slot register (ESAI_TSR). TODFE is cleared when the Core writes to all the transmit data registers of the

Table continues on the next page...

ESAI_SAISR field descriptions (continued)

Field	Description
	enabled transmitters, or when the Core writes to the TSR to disable transmission of the next time slot. If TIE is set, an ESAI transmit data interrupt request is issued when TODFE is set. Hardware, software, ESAI individual reset clear TODFE.
16 TEDE	ESAI_SAISR Transmit Even-Data Register Empty. When set, TEDE indicates that the enabled transmitter data registers became empty at the beginning of an even time slot. Even time slots are all even-numbered slots (0, 2, 4, 6, etc.). Time slots are numbered from zero to N-1, where N is the number of time slots in the frame. The zero time slot is considered even. This flag is set when the contents of the transmit data register of all the enabled transmitters are transferred to the transmit shift registers; it is also set for a TSR disabled time slot period in network mode (as if data were being transmitted after the TSR was written). When set, TEDE indicates that data should be written to all the TX registers of the enabled transmitters or to the transmit slot register (ESAI_TSR). TEDE is cleared when the Core writes to all the transmit data registers of the enabled transmitters, or when the Core writes to the TSR to disable transmission of the next time slot. If TIE is set, an ESAI transmit data interrupt request is issued when TEDE is set. Hardware, software, ESAI individual reset clear TEDE.
15 TDE	ESAI_SAISR Transmit Data Register Empty. TDE is set when the contents of the transmit data register of all the enabled transmitters are transferred to the transmit shift registers; it is also set for a TSR disabled time slot period in network mode (as if data were being transmitted after the TSR was written). When set, TDE indicates that data should be written to all the TX registers of the enabled transmitters or to the transmit slot register (ESAI_TSR). TDE is cleared when the Core writes to all the transmit data registers of the enabled transmitters, or when the Core writes to the TSR to disable transmission of the next time slot. If TIE is set, an ESAI transmit data interrupt request is issued when TDE is set. Hardware, software, ESAI individual reset clear TDE.
14 TUE	ESAI_SAISR Transmit Underrun Error Flag. TUE is set when at least one of the enabled serial transmit shift registers is empty (no new data to be transmitted) and a transmit time slot occurs. When a transmit underrun error occurs, the previous data (which is still present in the TX registers that were not written) is retransmitted. If TEIE is set, an ESAI transmit data with exception (underrun error) interrupt request is issued when TUE is set. Hardware, software, ESAI individual reset clear TUE. TUE is also cleared by reading the ESAI_SAISR with TUE set, followed by writing to all the enabled transmit data registers or to ESAI_TSR.
13 TFS	ESAI_SAISR Transmit Frame Sync Flag. When set, TFS indicates that a transmit frame sync occurred in the current time slot. TFS is set at the start of the first time slot in the frame and cleared during all other time slots. Data written to a transmit data register during the time slot when TFS is set is transmitted (in network mode), if the transmitter is enabled, during the second time slot in the frame. TFS is useful in network mode to identify the start of a frame. TFS is cleared by hardware, software, ESAI individual reset. TFS is valid only if at least one transmitter is enabled, that is, one or more of TE0, TE1, TE2, TE3, TE4 and TE5 are set. (In normal mode, TFS always reads as a one when transmitting data because there is only one time slot per frame - the "frame sync" time slot)
12–11 Reserved	This field is reserved. This read-only field is reserved and always has the value 0.
10 RODF	ESAI_SAISR Receive Odd-Data Register Full. When set, RODF indicates that the received data in the receive data registers of the enabled receivers have arrived during an odd time slot when operating in the network mode. Odd time slots are all odd-numbered slots (1, 3, 5, and so on). Time slots are numbered from zero to N-1, where N is the number of time slots in the frame. RODF is set when the contents of the receive shift registers are transferred to the receive data registers. RODF is cleared when the Core reads all the enabled receive data registers or cleared by hardware, software, ESAI individual resets.
9 REDF	ESAI_SAISR Receive Even-Data Register Full. When set, REDF indicates that the received data in the receive data registers of the enabled receivers have arrived during an even time slot when operating in the network mode. Even time slots are all even-numbered slots (0, 2, 4, 6, and so on). Time slots are numbered from zero to N-1, where N is the number of time slots in the frame. The zero time slot is considered even. REDF is set when the contents of the receive shift registers are transferred to the receive data registers. REDF is cleared when the Core reads all the enabled receive data registers or

Table continues on the next page...

ESAI_SAISR field descriptions (continued)

Field	Description
	cleared by hardware, software, ESAI individual resets. If REDIE is set, an ESAI receive even slot data interrupt request is issued when REDF is set.
8 RDF	ESAI_SAISR Receive Data Register Full. RDF is set when the contents of the receive shift register of an enabled receiver is transferred to the respective receive data register. RDF is cleared when the Core reads the receive data register of all enabled receivers or cleared by hardware, software, ESAI individual reset. If RIE is set, an ESAI receive data interrupt request is issued when RDF is set.
7 ROE	ESAI_SAISR Receive Overrun Error Flag. The ROE flag is set when the serial receive shift register of an enabled receiver is full and ready to transfer to its receiver data register (RXn) and the register is already full (RDF=1). If REIE is set, an ESAI receive data with exception (overrun error) interrupt request is issued when ROE is set. Hardware, software, ESAI individual reset clear ROE. ROE is also cleared by reading the SAISR with ROE set, followed by reading all the enabled receive data registers.
6 RFS	ESAI_SAISR Receive Frame Sync Flag. When set, RFS indicates that a receive frame sync occurred during reception of the words in the receiver data registers. This indicates that the data words are from the first slot in the frame. When RFS is clear and a word is received, it indicates (only in the network mode) that the frame sync did not occur during reception of that word. RFS is cleared by hardware, software, ESAI individual reset. RFS is valid only if at least one of the receivers is enabled (REx=1). (In normal mode, RFS always reads as a one when reading data because there is only one time slot per frame - the "frame sync" time slot)
5-3 Reserved	This field is reserved. This read-only field is reserved and always has the value 0.
2 IF2	ESAI_SAISR Serial Input Flag 2. The IF2 bit is enabled only when the HCKR pin is defined as ESAI in the Port Control Register, SYN=1 and RHCKD=0, indicating that HCKR is an input flag and the synchronous mode is selected. Data present on the HCKR pin is latched during reception of the first received data bit after frame sync is detected. The IF2 bit is updated with this data when the receive shift registers are transferred into the receiver data registers. IF2 reads as a zero when it is not enabled. Hardware, software, ESAI individual reset clear IF2.
1 IF1	ESAI_SAISR Serial Inout Flag 1. The IF1 bit is enabled only when the FSR pin is defined as ESAI in the Port Control Register, SYN =1, RFSD=0 and TEBE=0, indicating that FSR is an input flag and the synchronous mode is selected. Data present on the FSR pin is latched during reception of the first received data bit after frame sync is detected. The IF1 bit is updated with this data when the receiver shift registers are transferred into the receiver data registers. IF1 reads as a zero when it is not enabled. Hardware, software, ESAI individual reset clear IF1.
0 IF0	ESAI_SAISR Serial Input Flag 0. The IF0 bit is enabled only when the SCKR pin is defined as ESAI in the Port Control Register, SYN=1 and RCKD=0, indicating that SCKR is an input flag and the synchronous mode is selected. Data present on the SCKR pin is latched during reception of the first received data bit after frame sync is detected. The IF0 bit is updated with this data when the receiver shift registers are transferred into the receiver data registers. IF0 reads as a zero when it is not enabled. Hardware, software, ESAI individual reset clear IF0.

25.6.13 Serial Audio Interface Control Register (ESAI_SAICR)

The read/write Common Control Register (ESAI_SAICR) contains control bits for functions that affect both the receive and transmit sections of the ESAI.

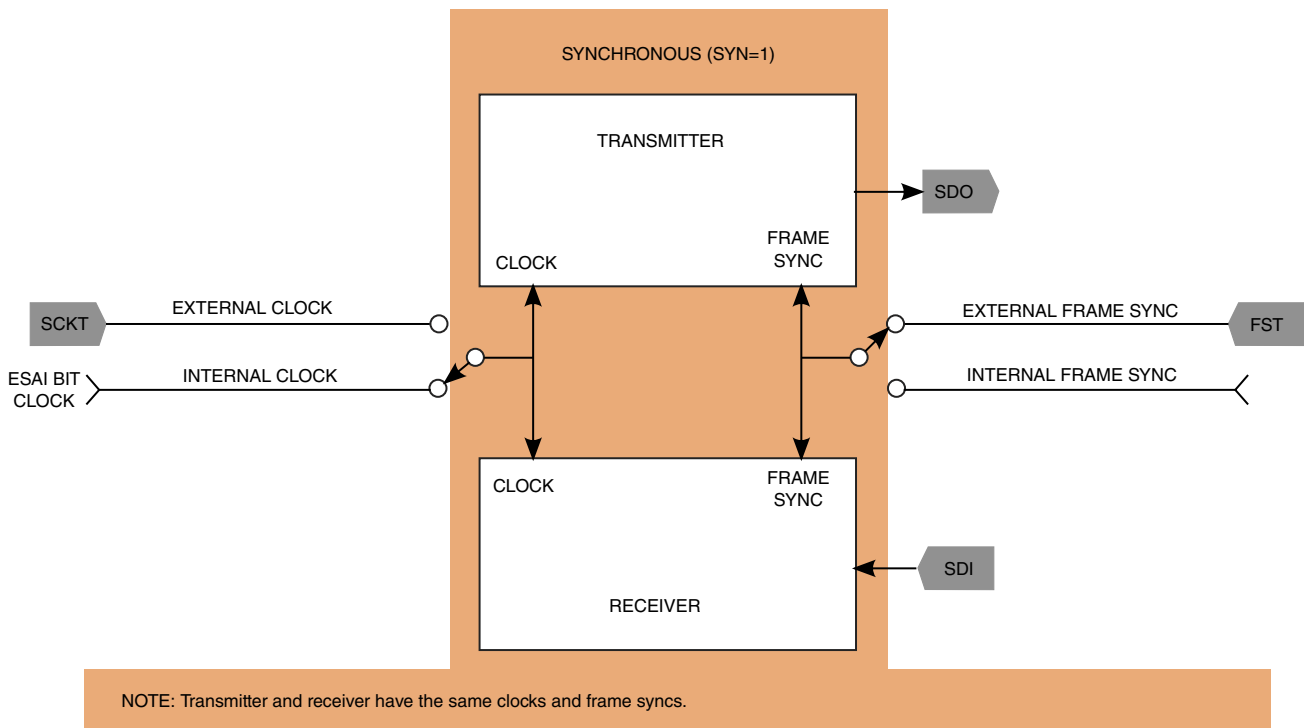
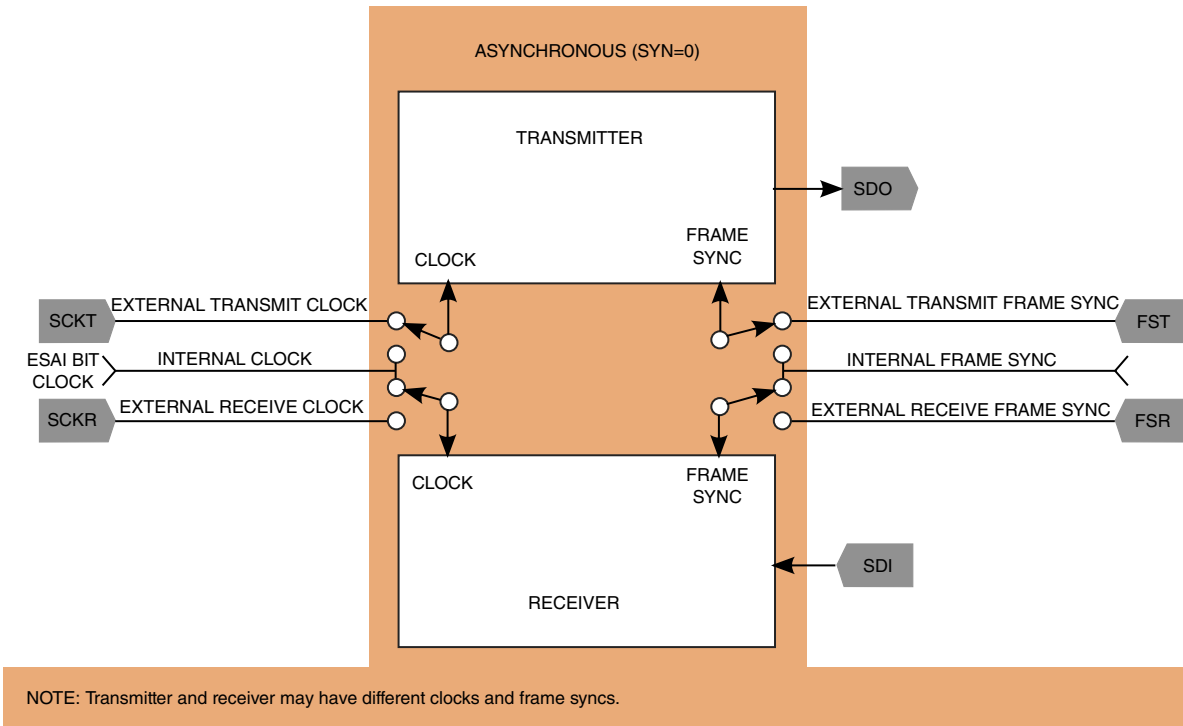

Figure 25-4. SAICR SYN Bit Operation

ESAI Memory Map/Register Definition

Address: 202_4000h base + D0h offset = 202_40D0h

Bit	31	30	29	28	27	26	25	24	23	22	21	20	19	18	17	16	
R	0																
W																	
Reset	0	0	0	0	0	0	0	0	0	0	0	0	0	0	0	0	
Bit	15	14	13	12	11	10	9	8	7	6	5	4	3	2	1	0	
R	0								ALC	TEBE	SYN	0			OF2	OF1	OF0
W																	
Reset	0	0	0	0	0	0	0	0	0	0	0	0	0	0	0	0	

ESAI_SAICR field descriptions

Field	Description
31–9 Reserved	This field is reserved. This read-only field is reserved and always has the value 0.
8 ALC	ESAI_SAICR Alignment Control. The ESAI is designed for 24-bit fractional data, thus shorter data words are left aligned to the MSB (bit 23). Some applications use 16-bit fractional data. In those cases, shorter data words may be left aligned to bit 15. The Alignment Control (ALC) bit supports these applications. If ALC is set, transmitted and received words are left aligned to bit 15 in the transmit and receive shift registers. If ALC is cleared, transmitted and received word are left aligned to bit 23 in the transmit and receive shift registers. While ALC is set, 20-bit and 24-bit words may not be used, and word length control should specify 8-, 12-, or 16-bit words; otherwise, results are unpredictable.
7 TEBE	ESAI_SAICR Transmit External Buffer Enable. The Transmitter External Buffer Enable (TEBE) bit controls the function of the FSR pin when in the synchronous mode. If the ESAI is configured for operation in the synchronous mode (SYN=1), and TEBE is set while FSR pin is configured as an output (RFSD=1), the FSR pin functions as the transmitter external buffer enable control to enable the use of an external buffers on the transmitter outputs. If TEBE is cleared, the FSR pin functions as the serial I/O flag 1. See Port C Control Register for a summary of the effects of TEBE on the FSR pin.
6 SYN	ESAI_SAICR Synchronous Mode Selection. The Synchronous Mode Selection (SYN) bit controls whether the receiver and transmitter sections of the ESAI operate synchronously or asynchronously with respect to each other (see Port C Control Register). When SYN is cleared, the asynchronous mode is chosen and independent clock and frame sync signals are used for the transmit and receive sections. When SYN is set, the synchronous mode is chosen and the transmit and receive sections use common clock and frame sync signals. When in the synchronous mode (SYN=1), the transmit and receive sections use the transmitter section clock generator as the source of the clock and frame sync for both sections. Also, the receiver clock pins SCKR, FSR and HCKR now operate as I/O flags. Refer to Table 25-10 , Table 25-11 , and Table 25-12 for the effects of SYN on the receiver clock pins.
5–3 Reserved	This field is reserved. This read-only field is reserved and always has the value 0.
2 OF2	ESAI_SAICR Serial Output Flag 2. The Serial Output Flag 2 (OF2) is a data bit used to hold data to be send to the OF2 pin. When the ESAI is in the synchronous clock mode (SYN=1), the HCKR pin is configured as the ESAI flag 2. If the receiver high frequency clock direction bit (RHCKD) is set, the HCKR pin is the output flag OF2, and data present in the OF2 bit is written to the OF2 pin at the beginning of the frame in normal mode or at the beginning of the next time slot in network mode.
1 OF1	ESAI_SAICR Serial Output Flag 1. The Serial Output Flag 1 (OF1) is a data bit used to hold data to be send to the OF1 pin. When the ESAI is in the synchronous clock mode (SYN=1), the FSR pin is configured as the ESAI flag 1. If the receiver frame sync direction bit (RFSD) is set and the TEBE bit is cleared, the FSR pin is the output flag OF1, and data present in the OF1 bit is written to the OF1 pin at the beginning of the frame in normal mode or at the beginning of the next time slot in network mode.

Table continues on the next page...

ESAI_SAICR field descriptions (continued)

Field	Description
0 OF0	ESAI_SAICR Serial Output Flag 0. The Serial Output Flag 0 (OF0) is a data bit used to hold data to be sent to the OF0 pin. When the ESAI is in the synchronous clock mode (SYN=1), the SCKR pin is configured as the ESAI flag 0. If the receiver serial clock direction bit (RCKD) is set, the SCKR pin is the output flag OF0, and data present in the OF0 bit is written to the OF0 pin at the beginning of the frame in normal mode or at the beginning of the next time slot in network mode.

25.6.14 Transmit Control Register (ESAI_TCR)

The read/write Transmit Control Register (ESAI_TCR) controls the ESAI transmitter section. Interrupt enable bits for the transmitter section are provided in this control register. Operating modes are also selected in this register.

Table 25-4. Transmit Network Mode Selection

TMOD1	TMOD0	TDC4-TDC0	Transmitter Network Mode
0	0	0x0-0x1F	Normal Mode
0	1	0x0	On-Demand Mode
0	1	0x1-0x1F	Network Mode
1	0	X	Reserved
1	1	0x0C	AC97

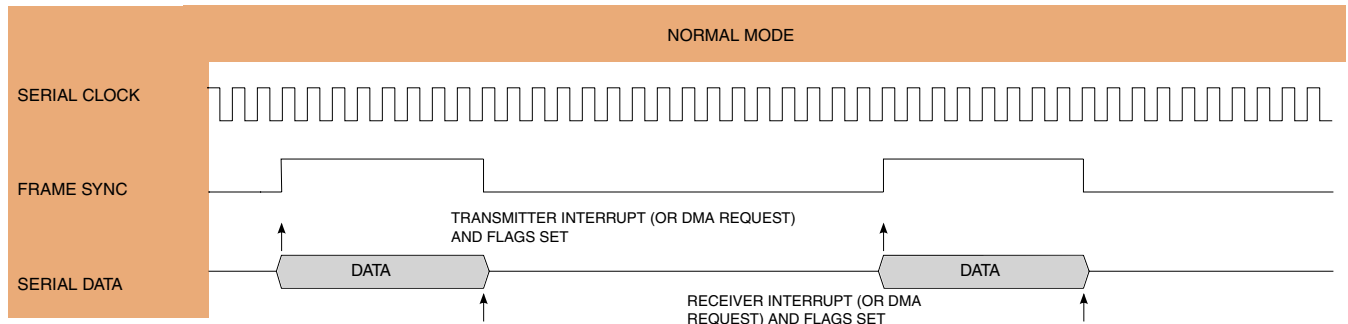

NOTE: Interrupts occur and data is transferred once per frame sync.

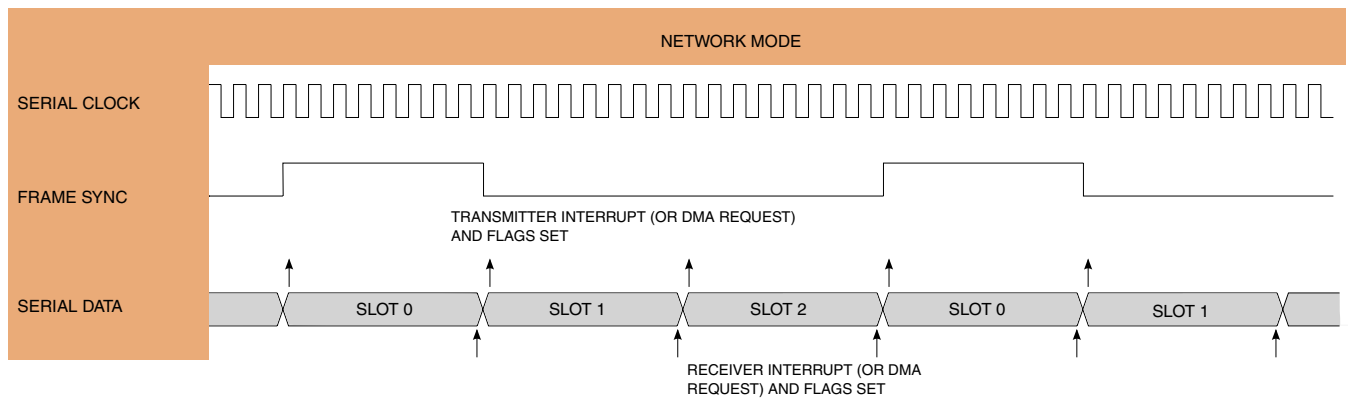

NOTE: Interrupts occur and a word may be transferred at every time slot.

Figure 25-5. Normal and Network Operation

Table 25-5. ESAI Transmit Slot and Word Length Selection

TSWS4	TSWS3	TSWS2	TSWS1	TSWS0	SLOT LENGTH	WORD LENGTH
0	0	0	0	0	8	8
0	0	1	0	0	12	8
0	0	0	0	1		12
0	1	0	0	0	16	8
0	0	1	0	1		12
0	0	0	1	0		16
0	1	1	0	0	20	8
0	1	0	0	1		12
0	0	1	1	0		16
0	0	0	1	1		20
1	0	0	0	0	24	8
0	1	1	0	1		12
0	1	0	1	0		16
0	0	1	1	1		20

Table continues on the next page...

**Table 25-5. ESAI Transmit Slot and Word Length Selection
(continued)**

TSWS4	TSWS3	TSWS2	TSWS1	TSWS0	SLOT LENGTH	WORD LENGTH
1	1	1	1	0		24
1	1	0	0	0	32	8
1	0	1	0	1		12
1	0	0	1	0		16
0	1	1	1	1		20
1	1	1	1	1		24
0	1	0	1	1		Reserved
0	1	1	1	0		
1	0	0	0	1		
1	0	0	1	1		
1	0	1	0	0		
1	0	1	1	0		
1	0	1	1	1		
1	1	0	0	1		
1	1	0	1	0		
1	1	0	1	1		
1	1	1	0	0		
1	1	1	0	0		
1	1	1	0	1		

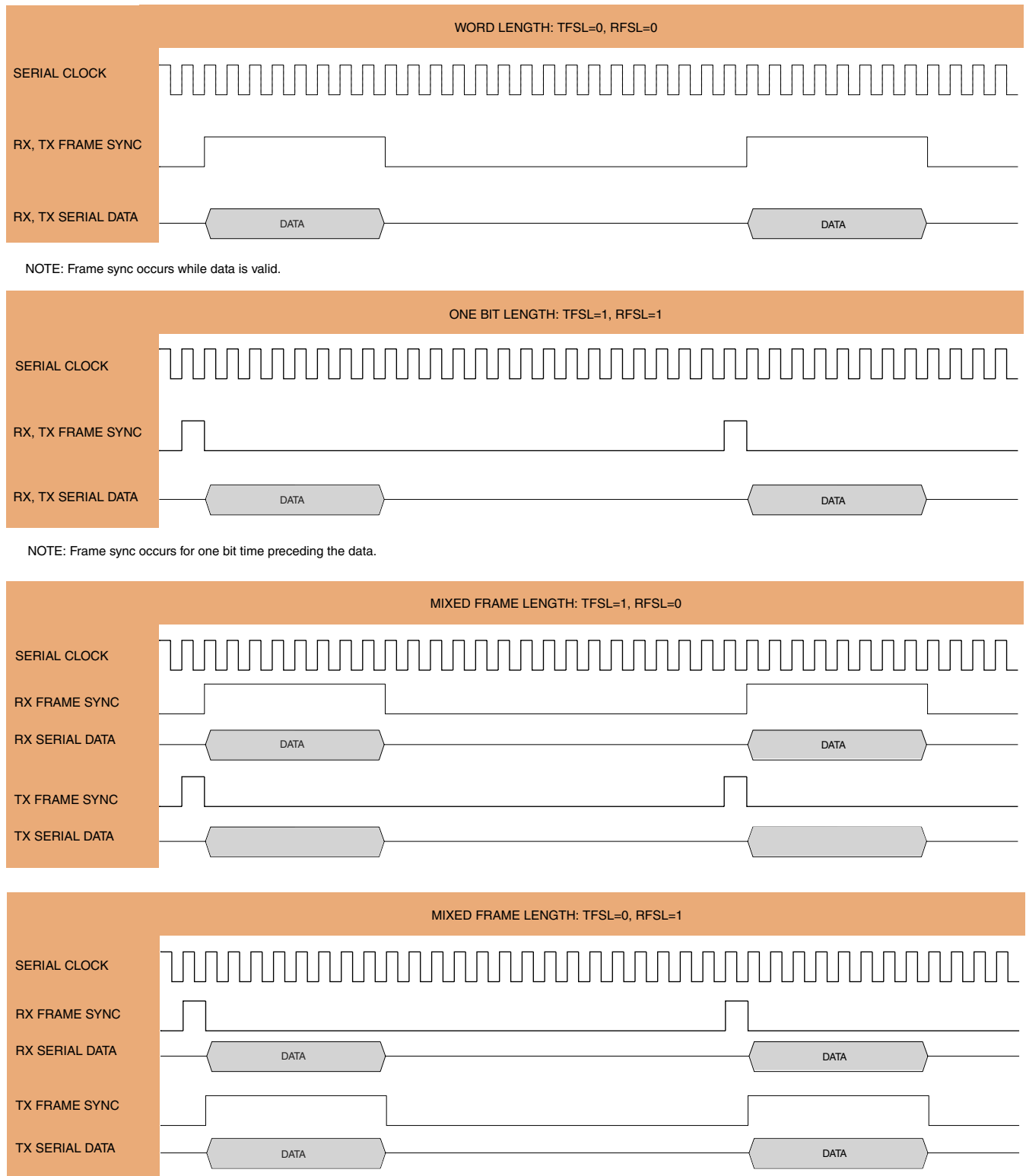

NOTE: Frame sync occurs while data is valid.

NOTE: Frame sync occurs for one bit time preceding the data.

Figure 25-6. Frame Length Selection

Address: 202_4000h base + D4h offset = 202_40D4h

Bit	31	30	29	28	27	26	25	24	23	22	21	20	19	18	17	16
R	0								TLIE	TIE	TEDIE	TEIE	TPR	0	PADC	TFSR
W	[Shaded]													[Shaded]		
Reset	0	0	0	0	0	0	0	0	0	0	0	0	0	0	0	0
Bit	15	14	13	12	11	10	9	8	7	6	5	4	3	2	1	0
R	TFSL	TSWS				TMOD		TWA	TSHFD	TE5	TE4	TE3	TE2	TE1	TE0	
W																
Reset	0	0	0	0	0	0	0	0	0	0	0	0	0	0	0	0

ESAI_TCR field descriptions

Field	Description
31–24 Reserved	This field is reserved. This read-only field is reserved and always has the value 0.
23 TLIE	ESAI_TCR Transmit Last Slot Interrupt Enable. TLIE enables an interrupt at the beginning of last slot of a frame in network mode. When TLIE is set the Core is interrupted at the start of the last slot in a frame in network mode regardless of the transmit mask register setting. When TLIE is cleared the transmit last slot interrupt is disabled. TLIE is disabled when TDC=0x00000 (on-demand mode). The use of the transmit last slot interrupt is described in ESAI Interrupt Requests .
22 TIE	ESAI_TCR Transmit Interrupt Enable. The Core is interrupted when TIE and the TDE flag in the ESAI_SAISR status register are set. When TIE is cleared, this interrupt is disabled. Writing data to all the data registers of the enabled transmitters or to ESAI_TSR clears TDE, thus clearing the interrupt. Transmit interrupts with exception have higher priority than normal transmit data interrupts, therefore if exception occurs (TUE is set) and TEIE is set, the ESAI requests an ESAI transmit data with exception interrupt from the interrupt controller.
21 TEDIE	ESAI_TCR Transmit Even Slot Data Interrupt Enable. The TEDIE control bit is used to enable the transmit even slot data interrupts. If TEDIE is set, the transmit even slot data interrupts are enabled. If TEDIE is cleared, the transmit even slot data interrupts are disabled. A transmit even slot data interrupt request is generated if TEDIE is set and the TEDE status flag in the ESAI_SAISR status register is set. Even time slots are all even-numbered time slots (0, 2, 4, etc.) when operating in network mode. The zero time slot in the frame is marked by the frame sync signal and is considered to be even. Writing data to all the data registers of the enabled transmitters or to ESAI_TSR clears the TEDE flag, thus servicing the interrupt. Transmit interrupts with exception have higher priority than transmit even slot data interrupts, therefore if exception occurs (TUE is set) and TEIE is set, the ESAI requests an ESAI transmit data with exception interrupt from the interrupt controller.
20 TEIE	ESAI_TCR Transmit Exception Interrupt Enable. When TEIE is set, the Core is interrupted when both TDE and TUE in the ESAI_SAISR status register are set. When TEIE is cleared, this interrupt is disabled. Reading the ESAI_SAISR status register followed by writing to all the data registers of the enabled transmitters clears TUE, thus clearing the pending interrupt.
19 TPR	ESAI_TCR Transmit Section Personal Reset. The TPR control bit is used to put the transmitter section of the ESAI in the personal reset state. The receiver section is not affected. When TPR is cleared, the transmitter section may operate normally. When TPR is set, the transmitter section enters the personal reset state immediately. When in the personal reset state, the status bits are reset to the same state as after hardware reset. The control bits are not affected by the personal reset state. The transmitter data pins are tri-stated while in the personal reset state; if a stable logic level is desired, the transmitter data pins should be defined as GPIO outputs, or external pull-up or pull-down resistors should be used. The

Table continues on the next page...

ESAI_TCR field descriptions (continued)

Field	Description
	transmitter clock outputs drive zeroes while in the personal reset state. Note that to leave the personal reset state by clearing TPR, the procedure described in ESAI Initialization Examples should be followed.
18 Reserved	This field is reserved. This read-only field is reserved and always has the value 0.
17 PADC	ESAI_TCR Transmit Zero Padding Control. When PADC is cleared, zero padding is disabled. When PADC is set, zero padding is enabled. PADC, in conjunction with the TCR[TWA] control bit, determines the way that padding is done for operating modes where the word length is less than the slot length. See the TCR[TWA] bit description in bit 7 for more details. Because the data word is shorter than the slot length, the data word is extended until achieving the slot length, according to the following rule: If the data word is left-aligned (TCR[TWA]=0), and zero padding is disabled (PADC=0), the last data bit is repeated after the data word has been transmitted. If zero padding is enabled (PADC=1), zeroes are transmitted after the data word has been transmitted. If the data word is right-aligned (TCR[TWA]=1), and zero padding is disabled (PADC=0), the first data bit is repeated before the transmission of the data word. If zero padding is enabled (PADC=1), zeroes are transmitted before the transmission of the data word.
16 TFSR	ESAI_TCR Transmit Frame Sync Relative Timing. TFSR determines the relative timing of the transmit frame sync signal as referred to the serial data lines, for a word length frame sync only (TFSL=0). When TFSR is cleared the word length frame sync occurs together with the first bit of the data word of the first slot. When TFSR is set the word length frame sync starts one serial clock cycle earlier, that is, together with the last bit of the previous data word.
15 TFSL	ESAI_TCR Transmit Frame Sync Length. The TFSL bit selects the length of frame sync to be generated or recognized. If TFSL is cleared, a word-length frame sync is selected. If TFSL is set, a 1-bit clock period frame sync is selected. See Figure 1-21 for examples of frame length selection.
14–10 TSWS	ESAI_TCR Tx Slot and Word Length Select (TSWS4-TSWS0). The TSWS4-TSWS0 bits are used to select the length of the slot and the length of the data words being transferred through the ESAI. The word length must be equal to or shorter than the slot length. The possible combinations are shown in Table 25-5 . See also the ESAI data path programming model in Figure 25-2 and Figure 25-3 .
9–8 TMOD	ESAI_TCR Transmit Network Mode Control (TMOD1-TMOD0). The TMOD1 and TMOD0 bits are used to define the network mode of ESAI transmitters, as shown in Table 25-5 . In the normal mode, the frame rate divider determines the word transfer rate - one word is transferred per frame sync during the frame sync time slot, as shown in Figure 25-5 . In network mode, it is possible to transfer a word for every time slot, as shown in Figure 25-5 . For further details, refer to Modes of Operation In order to comply with AC-97 specifications, TSWS4-TSWS0 should be set to 00011 (20-bit slot, 20-bit word length), TFSL and TFSR should be cleared, and TDC4-TDC0 should be set to 0x0C (13 words in frame). If TMOD=0b11 and the above recommendations are followed, the first slot and word will be 16 bits long, and the next 12 slots and words will be 20 bits long, as required by the AC97 protocol.
7 TWA	ESAI_TCR Transmit Word Alignment Control. The Transmitter Word Alignment Control (TCR[TWA]) bit defines the alignment of the data word in relation to the slot. This is relevant for the cases where the word length is shorter than the slot length. If TCR[TWA] is cleared, the data word is left-aligned in the slot frame during transmission. If TCR[TWA] is set, the data word is right-aligned in the slot frame during transmission. Because the data word is shorter than the slot length, the data word is extended until achieving the slot length, according to the following rule: If the data word is left-aligned (TCR[TWA]=0), and zero padding is disabled (PADC=0), the last data bit is repeated after the data word has been transmitted. If zero padding is enabled (PADC=1), zeroes are transmitted after the data word has been transmitted.

Table continues on the next page...

ESAI_TCR field descriptions (continued)

Field	Description
	If the data word is right-aligned (TCR[TWA]=1), and zero padding is disabled (PADC=0), the first data bit is repeated before the transmission of the data word. If zero padding is enabled (PADC=1), zeroes are transmitted before the transmission of the data word.
6 TSHFD	ESAI_TCR Transmit Shift Direction. The TSHFD bit causes the transmit shift registers to shift data out MSB first when TSHFD equals zero or LSB first when TSHFD equals one (see Figure 25-2 and Figure 25-3).
5 TE5	<p>ESAI_TCR ESAI Transmit 5 Enable. TE5 enables the transfer of data from ESAI_TX5 to the transmit shift register #5. When TE5 is set and a frame sync is detected, the transmit #5 portion of the ESAI is enabled for that frame. When TE5 is cleared, the transmitter #5 is disabled after completing transmission of data currently in the ESAI transmit shift register. Data can be written to ESAI_TX5 when TE5 is cleared but the data is not transferred to the transmit shift register #5.</p> <p>The SDO5/SDI0 pin is the data input pin for ESAI_RX0 if TE5 is cleared and RE0 in the ESAI_RCR register is set. If both RE0 and TE5 are cleared, the transmitter and receiver are disabled, and the pin is tri-stated. Both RE0 and TE5 should not be set at the same time.</p> <p>The normal mode transmit enable sequence is to write data to one or more transmit data registers before setting TEx. The normal transmit disable sequence is to clear TEx, TIE and TEIE after TDE equals one.</p> <p>In the network mode, the operation of clearing TE5 and setting it again disables the transmitter #5 after completing transmission of the current data word until the beginning of the next frame. During that time period, the SDO5/SDI0 pin remains in the high-impedance state. The on-demand mode transmit enable sequence can be the same as the normal mode, or TE5 can be left enabled.</p>
4 TE4	<p>ESAI_TCR ESAI Transmit 4 Enable. TE4 enables the transfer of data from ESAI_TX4 to the transmit shift register #4. When TE4 is set and a frame sync is detected, the transmit #4 portion of the ESAI is enabled for that frame. When TE4 is cleared, the transmitter #4 is disabled after completing transmission of data currently in the ESAI transmit shift register. Data can be written to ESAI_TX4 when TE4 is cleared but the data is not transferred to the transmit shift register #4.</p> <p>The SDO4/SDI1 pin is the data input pin for ESAI_RX1 if TE4 is cleared and RE1 in the RCR register is set. If both RE1 and TE4 are cleared, the transmitter and receiver are disabled, and the pin is tri-stated. Both RE1 and TE4 should not be set at the same time.</p> <p>The normal mode transmit enable sequence is to write data to one or more transmit data registers before setting TEx. The normal transmit disable sequence is to clear TEx, TIE and TEIE after TDE equals one.</p> <p>In the network mode, the operation of clearing TE4 and setting it again disables the transmitter #4 after completing transmission of the current data word until the beginning of the next frame. During that time period, the SDO4/SDI1 pin remains in the high-impedance state. The on-demand mode transmit enable sequence can be the same as the normal mode, or TE4 can be left enabled.</p>
3 TE3	<p>ESAI_TCR ESAI Transmit 3 Enable. TE3 enables the transfer of data from ESAI_TX3 to the transmit shift register #3. When TE3 is set and a frame sync is detected, the transmit #3 portion of the ESAI is enabled for that frame. When TE3 is cleared, the transmitter #3 is disabled after completing transmission of data currently in the ESAI transmit shift register. Data can be written to ESAI_TX3 when TE3 is cleared but the data is not transferred to the transmit shift register #3.</p> <p>The SDO3/SDI2 pin is the data input pin for ESAI_RX2 if TE3 is cleared and RE2 in the ESAI_RCR register is set. If both RE2 and TE3 are cleared, the transmitter and receiver are disabled, and the pin is tri-stated. Both RE2 and TE3 should not be set at the same time.</p> <p>The normal mode transmit enable sequence is to write data to one or more transmit data registers before setting TEx. The normal transmit disable sequence is to clear TEx, TIE and TEIE after TDE equals one.</p> <p>In the network mode, the operation of clearing TE3 and setting it again disables the transmitter #3 after completing transmission of the current data word until the beginning of the next frame. During that time period, the SDO3/SDI2 pin remains in the high-impedance state. The on-demand mode transmit enable sequence can be the same as the normal mode, or TE3 can be left enabled.</p>

Table continues on the next page...

ESAI_TCR field descriptions (continued)

Field	Description
<p>2 TE2</p>	<p>ESAI_TCR ESAI Transmit 2 Enable. TE2 enables the transfer of data from ESAI_TX2 to the transmit shift register #2. When TE2 is set and a frame sync is detected, the transmit #2 portion of the ESAI is enabled for that frame. When TE2 is cleared, the transmitter #2 is disabled after completing transmission of data currently in the ESAI transmit shift register. Data can be written to ESAI_TX2 when TE2 is cleared but the data is not transferred to the transmit shift register #2.</p> <p>The SDO2/SDI3 pin is the data input pin for ESAI_RX3 if TE2 is cleared and RE3 in the ESAI_RCR register is set. If both RE3 and TE2 are cleared, the transmitter and receiver are disabled, and the pin is tri-stated. Both RE3 and TE2 should not be set at the same time.</p> <p>The normal mode transmit enable sequence is to write data to one or more transmit data registers before setting TEx. The normal transmit disable sequence is to clear TEx, TIE and TEIE after TDE equals one.</p> <p>In the network mode, the operation of clearing TE2 and setting it again disables the transmitter #2 after completing transmission of the current data word until the beginning of the next frame. During that time period, the SDO2/SDI3 pin remains in the high-impedance state. The on-demand mode transmit enable sequence can be the same as the normal mode, or TE2 can be left enabled.</p>
<p>1 TE1</p>	<p>ESAI_TCR ESAI Transmit 1 Enable. TE1 enables the transfer of data from TX1 to the transmit shift register #1. When TE1 is set and a frame sync is detected, the transmit #1 portion of the ESAI is enabled for that frame. When TE1 is cleared, the transmitter #1 is disabled after completing transmission of data currently in the ESAI transmit shift register. The SDO1 output is tri-stated, and any data present in TX1 is not transmitted, that is, data can be written to TX1 with TE1 cleared, but data is not transferred to the transmit shift register #1.</p> <p>The normal mode transmit enable sequence is to write data to one or more transmit data registers before setting TEx. The normal transmit disable sequence is to clear TEx, TIE and TEIE after TDE equals one.</p> <p>In the network mode, the operation of clearing TE1 and setting it again disables the transmitter #1 after completing transmission of the current data word until the beginning of the next frame. During that time period, the SDO1 pin remains in the high-impedance state. The on-demand mode transmit enable sequence can be the same as the normal mode, or TE1 can be left enabled.</p>
<p>0 TE0</p>	<p>ESAI_TCR ESAI Transmit 0 Enable. TE0 enables the transfer of data from ESAI_TX0 to the transmit shift register #0. When TE0 is set and a frame sync is detected, the transmit #0 portion of the ESAI is enabled for that frame. When TE0 is cleared, the transmitter #0 is disabled after completing transmission of data currently in the ESAI transmit shift register. The SDO0 output is tri-stated, and any data present in ESAI_TX0 is not transmitted, that is, data can be written to ESAI_TX0 with TE0 cleared, but data is not transferred to the transmit shift register #0.</p> <p>The normal mode transmit enable sequence is to write data to one or more transmit data registers before setting TEx. The normal transmit disable sequence is to clear TEx, TIE and TEIE after TDE equals one.</p> <p>In the network mode, the operation of clearing TE0 and setting it again disables the transmitter #0 after completing transmission of the current data word until the beginning of the next frame. During that time period, the SDO0 pin remains in the high-impedance state. The on-demand mode transmit enable sequence can be the same as the normal mode, or TE0 can be left enabled.</p>

25.6.15 Transmit Clock Control Register (ESAI_TCCR)

The read/write Transmitter Clock Control Register (ESAI_TCCR) controls the ESAI transmitter clock generator bit and frame sync rates, the bit clock and high frequency clock sources and the directions of the HCKT, FST and SCKT signals. In the synchronous mode (SYN=1), the bit clock defined for the transmitter determines the receiver bit clock as well. ESAI_TCCR also controls the number of words per frame for the serial data. Hardware and software reset clear all the bits of the ESAI_TCCR register.

Care should be taken in asynchronous mode whenever the frame sync clock (FSR, FST) is not sourced directly from its associated bit clock (SCKR, SCKT). Proper phase relationships must be maintained between these clocks in order to guarantee proper operation of the ESAI.

NOTE

ARM Core clock is ipg_clk_esai in block ESAI which is from CCM's ahb_clk_root.

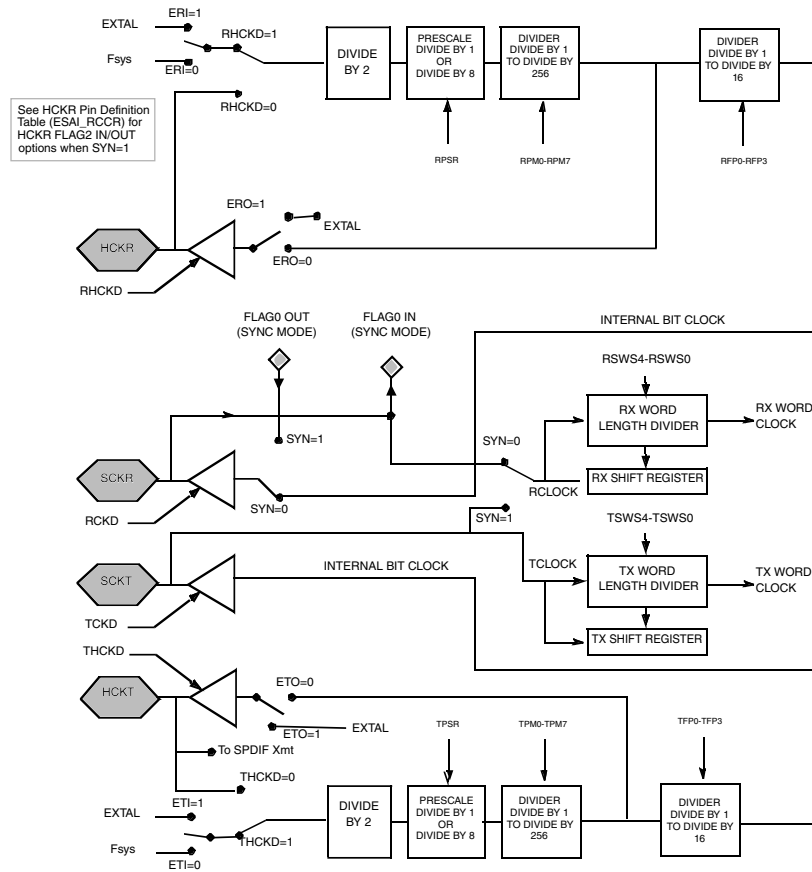

Figure 25-7. ESAI Clock Generator Functional Block Diagram

NOTE

1. ETI, ETO, ERI and ERO bit descriptions are covered in [ESAI Control Register \(ESAI_ECR\)](#).
2. Fsys is the ESAI system 133 MHz clock.
3. EXTAL is the on-chip clock sources other than ESAI system 133MHz clock.

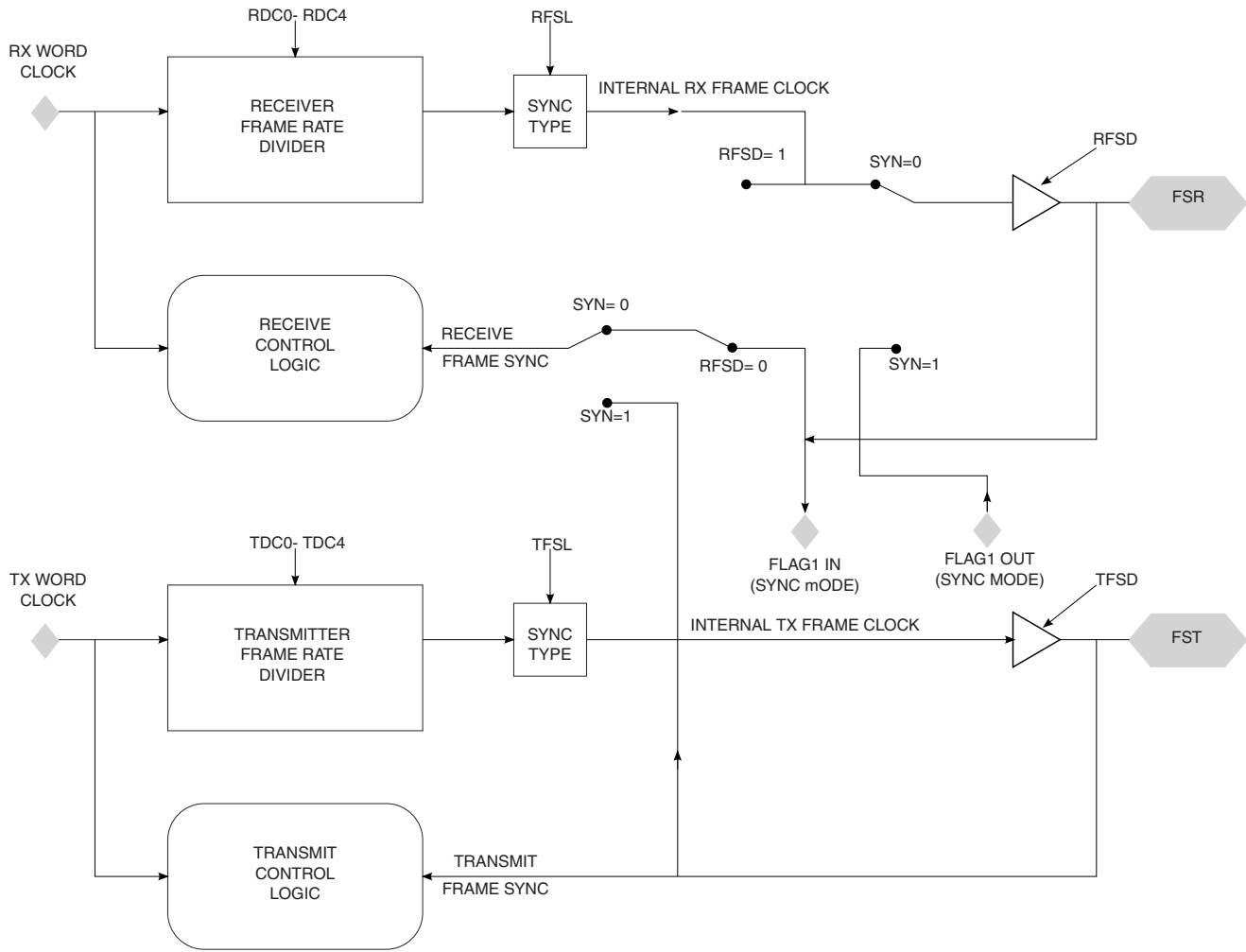

Figure 25-8. ESAI Frame Sync Generator Functional Block Diagram

Table 25-6. Transmitter High Frequency Clock Divider

TFP3-TFP0	Divide Ratio
0x0	1
0x1	2
0x2	3
0x3	4
...	...
0xF	16

ESAI Memory Map/Register Definition

Address: 202_4000h base + D8h offset = 202_40D8h

Bit	31	30	29	28	27	26	25	24	23	22	21	20	19	18	17	16
R	0								THCKD	TFSD	TCKD	THCKP	TFSP	TCKP	TFP	
W																
Reset	0	0	0	0	0	0	0	0	0	0	0	0	0	0	0	0
Bit	15	14	13	12	11	10	9	8	7	6	5	4	3	2	1	0
R	TFP		TDC				TPSR		TPM							
W																
Reset	0	0	0	0	0	0	0	0	0	0	0	0	0	0	0	0

ESAI_TCCR field descriptions

Field	Description
31–24 Reserved	This field is reserved. This read-only field is reserved and always has the value 0.
23 THCKD	ESAI_TCCR Transmit High Frequency Clock Direction. THCKD controls the direction of the HCKT pin. When THCKD is cleared, HCKT is an input; when THCKD is set, HCKT is an output (see Table 25-2).
22 TFSD	ESAI_TCCR Transmit Frame Sync Signal Direction. TFSD controls the direction of the FST pin. When TFSD is cleared, FST is an input; when TFSD is set, FST is an output (see Table 25-2).
21 TCKD	ESAI_TCCR Transmit Clock Source Direction. The Transmitter Clock Source Direction (TCKD) bit selects the source of the clock signal used to clock the transmit shift registers in the asynchronous mode (SYN=0) and the transmit shift registers and the receive shift registers in the synchronous mode (SYN=1). When TCKD is set, the internal clock source becomes the bit clock for the transmit shift registers and word length divider and is the output on the SCKT pin. When TCKD is cleared, the clock source is external; the internal clock generator is disconnected from the SCKT pin, and an external clock source may drive this pin (see Table 25-2).
20 THCKP	ESAI_TCCR Transmit High Frequency Clock Polarity The Transmitter High Frequency Clock Polarity (THCKP) bit controls the polarity of the HCKT. 0 - Normal polarity 1 - Inverted polarity
19 TFSP	ESAI_TCCR Transmit Frame Sync Polarity. The Transmitter Frame Sync Polarity (TFSP) bit determines the polarity of the transmit frame sync signal. When TFSP is cleared, the frame sync signal polarity is positive, that is, the frame start is indicated by a high level on the frame sync pin. When TFSP is set, the frame sync signal polarity is negative, that is, the frame start is indicated by a low level on the frame sync pin.
18 TCKP	ESAI_TCCR Transmit Clock Polarity. The Transmitter Clock Polarity (TCKP) bit controls on which bit clock edge data and frame sync are clocked out and latched in. If TCKP is cleared the data and the frame sync are clocked out on the rising edge of the transmit bit clock and latched in on the falling edge of the transmit bit clock. If TCKP is set the falling edge of the transmit clock is used to clock the data out and frame sync and the rising edge of the transmit clock is used to latch the data and frame sync in.
17–14 TFP	ESAI_TCCR Tx High Frequency Clock Divider. The TFP3-TFP0 bits control the divide ratio of the transmitter high frequency clock to the transmitter serial bit clock when the source of the high frequency clock and the bit clock is the internal ARM Core clock. When the HCKT input is being driven from an external high frequency clock, the TFP3-TFP0 bits specify an additional division ratio in the clock divider chain. Table 25-6 shows the specification for the divide ratio. Figure 25-7 shows the ESAI high frequency clock generator functional diagram.

Table continues on the next page...

ESAI_TCCR field descriptions (continued)

Field	Description
13–9 TDC	<p>ESAI_TCCR Tx Frame Rate Divider Control. The TDC4-TDC0 bits control the divide ratio for the programmable frame rate dividers used to generate the transmitter frame clocks.</p> <p>In network mode, this ratio may be interpreted as the number of words per frame minus one. The divide ratio may range from 2 to 32 (TDC=0x00001 to 0x11111) for network mode. A divide ratio of one (TDC=0x00000) in network mode is a special case (on-demand mode).</p> <p>In normal mode, this ratio determines the word transfer rate. The divide ratio may range from 1 to 32 (TDC=0x00000 to 0x11111) for normal mode. In normal mode, a divide ratio of 1 (TDC=0x00000) provides continuous periodic data word transfers. A bit-length frame sync (TFSL=1) must be used in this case.</p> <p>The ESAI frame sync generator functional diagram is shown in Figure 25-8</p>
8 TPSR	<p>ESAI_TCCR Transmit Prescaler Range. The TPSR bit controls a fixed divide-by-eight prescaler in series with the variable prescaler. This bit is used to extend the range of the prescaler for those cases where a slower bit clock is desired. When TPSR is set, the fixed prescaler is bypassed. When TPSR is cleared, the fixed divide-by-eight prescaler is operational (see Figure 25-7). The maximum internally generated bit clock frequency is $F_{sys}/6$; the minimum internally generated bit clock frequency is $F_{sys}/(2 \times 8 \times 256 \times 16) = F_{sys}/65536$.</p> <p>NOTE: Do not use the combination TPSR = 1 and TPM7-RPM0 = 0x00, which causes synchronization problems when using the internal core clock as source (THCKD = 1 or TCKD = 1).</p>
TPM	<p>ESAI_TCCR Transmit Prescale Modulus Select. The TPM7-TPM0 bits specify the divide ratio of the prescale divider in the ESAI transmitter clock generator. A divide ratio from 1 to 256 (TPM=0x00 to 0xFF) may be selected. The bit clock output is available at the transmit serial bit clock (SCKT) pin. The bit clock output is also available internally for use as the bit clock to shift the transmit and receive shift registers. The ESAI transmit clock generator functional diagram is shown in Figure 25-7.</p>

25.6.16 Receive Control Register (ESAI_RCR)

The read/write Receive Control Register (ESAI_RCR) controls the ESAI receiver section. Interrupt enable bits for the receivers are provided in this control register. The receivers are enabled in this register (0,1,2 or 3 receivers can be enabled) if the input data pin is not used by a transmitter. Operating modes are also selected in this register.

Table 25-7. ESAI Receive Network Mode Selection

RMOD1	RMOD0	RDC4-RDC0	Receiver Network Mode
0	0	0x0-0x1F	Normal Mode
0	1	0x0	On-Demand Mode
0	1	0x1-0x1F	Network Mode
1	0	X	Reserved
1	1	0x0C	AC97

Table 25-8. ESAI Receive Slot and Word Length Selection

RSWS4	RSWS3	RSWS2	RSWS1	RSWS0	SLOT LENGTH	WORD LENGTH
0	0	0	0	0	8	8
0	0	1	0	0	12	8
0	0	0	0	1		12
0	1	0	0	0	16	8
0	0	1	0	1		12
0	0	0	1	0		16
0	1	1	0	0	20	8
0	1	0	0	1		12
0	0	1	1	0		16
0	0	0	1	1		20
1	0	0	0	0	24	8
0	1	1	0	1		12
0	1	0	1	0		16
0	0	1	1	1		20
1	1	1	1	0		24
1	1	0	0	0	32	8
1	0	1	0	1		12
1	0	0	1	0		16
0	1	1	1	1		20
1	1	1	1	1		24
0	1	0	1	1	Reserved	
0	1	1	1	0		
1	0	0	0	1		
1	0	0	1	1		
1	0	1	0	0		
1	0	1	1	0		
1	0	1	1	1		
1	1	0	0	1		
1	1	0	1	0		
1	1	0	1	1		
1	1	1	0	0		
1	1	1	0	1		
1	1	1	1	0		
1	1	1	0	1		

Address: 202_4000h base + DCh offset = 202_40DCh

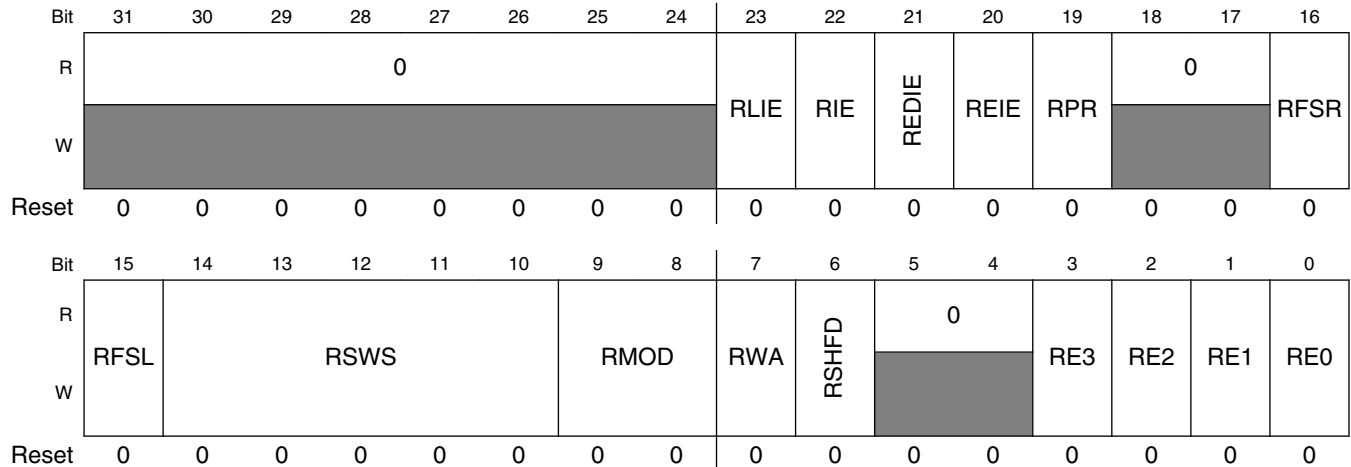

ESAI_RCR field descriptions

Field	Description
31–24 Reserved	This field is reserved. This read-only field is reserved and always has the value 0.
23 RLIE	ESAI_RCR Receive Last Slot Interrupt Enable. RLIE enables an interrupt after the last slot of a frame ended in network mode only. When RLIE is set the Core is interrupted after the last slot in a frame ended regardless of the receive mask register setting. When RLIE is cleared the receive last slot interrupt is disabled. Hardware and software reset clear RLIE. RLIE is disabled when RDC=00000 (on-demand mode). The use of the receive last slot interrupt is described in ESAI Interrupt Requests .
22 RIE	ESAI_RCR Receive Interrupt Enable. The Core is interrupted when RIE and the RDF flag in the ESAI_SAISR status register are set. When RIE is cleared, this interrupt is disabled. Reading the receive data registers of the enabled receivers clears RDF, thus clearing the interrupt. Receive interrupts with exception have higher priority than normal receive data interrupts, therefore if exception occurs (ROE is set) and REIE is set, the ESAI requests an ESAI receive data with exception interrupt from the interrupt controller.
21 REDIE	ESAI_RCR Receive Even Slot Data Interrupt Enable. The REDIE control bit is used to enable the receive even slot data interrupts. If REDIE is set, the receive even slot data interrupts are enabled. If REDIE is cleared, the receive even slot data interrupts are disabled. A receive even slot data interrupt request is generated if REDIE is set and the REDF status flag in the ESAI_SAISR status register is set. Even time slots are all even-numbered time slots (0, 2, 4, etc.) when operating in network mode. The zero time slot is marked by the frame sync signal and is considered to be even. Reading all the data registers of the enabled receivers clears the REDF flag, thus servicing the interrupt. Receive interrupts with exception have higher priority than receive even slot data interrupts, therefore if exception occurs (ROE is set) and REIE is set, the ESAI requests an ESAI receive data with exception interrupt from the interrupt controller.
20 REIE	ESAI_RCR Receive Exception Interrupt Enable. When REIE is set, the Core is interrupted when both RDF and ROE in the ESAI_SAISR status register are set. When REIE is cleared, this interrupt is disabled. Reading the ESAI_SAISR status register followed by reading the enabled receivers data registers clears ROE, thus clearing the pending interrupt.
19 RPR	ESAI_RCR Receiver Section Personal Reset. The RPR control bit is used to put the receiver section of the ESAI in the personal reset state. The transmitter section is not affected. When RPR is cleared, the receiver section may operate normally. When RPR is set, the receiver section enters the personal reset state immediately. When in the personal reset state, the status bits are reset to the same state as after hardware reset. The control bits are not affected by the personal reset state. The receiver data pins are disconnected while in the personal reset state.

Table continues on the next page...

ESAI_RCR field descriptions (continued)

Field	Description
	NOTE: To leave the personal reset state by clearing RPR, the procedure described in ESAI Initialization Examples should be followed.
18–17 Reserved	This field is reserved. This read-only field is reserved and always has the value 0.
16 RFSR	ESAI_RCR Receiver Frame Sync Relative Timing. RFSR determines the relative timing of the receive frame sync signal as referred to the serial data lines, for a word length frame sync only. When RFSR is cleared the word length frame sync occurs together with the first bit of the data word of the first slot. When RFSR is set the word length frame sync starts one serial clock cycle earlier, that is, together with the last bit of the previous data word.
15 RFSL	ESAI_RCR Receiver Frame Sync Length. The RFSL bit selects the length of the receive frame sync to be generated or recognized. If RFSL is cleared, a word-length frame sync is selected. If RFSL is set, a 1-bit clock period frame sync is selected. Refer to Figure 25-6 for examples of frame length selection.
14–10 RSWS	ESAI_RCR Receiver Slot and Word Select. The RSWS4-RSWS0 bits are used to select the length of the slot and the length of the data words being received through the ESAI. The word length must be equal to or shorter than the slot length. The possible combinations are shown in Table 25-8 . See also the ESAI data path programming model in Figure 25-2 and Figure 25-3 .
9–8 RMOD	ESAI_RCR Receiver Network Mode Control. The RMOD1 and RMOD0 bits are used to define the network mode of the ESAI receivers, as shown in Table 25-7 . In the normal mode, the frame rate divider determines the word transfer rate - one word is transferred per frame sync during the frame sync time slot, as shown in Figure 25-5 . In network mode, it is possible to transfer a word for every time slot, as shown in Figure 25-5 . For more details, see Modes of Operation . In order to comply with AC-97 specifications, RSWS4-RSWS0 should be set to 0x00011 (20-bit slot, 20-bit word); RFSL and RFSR should be cleared, and RDC4-RDC0 should be set to 0x0C (13 words in frame).
7 RWA	ESAI_RCR Receiver Word Alignment Control. The Receiver Word Alignment Control (RWA) bit defines the alignment of the data word in relation to the slot. This is relevant for the cases where the word length is shorter than the slot length. If RWA is cleared, the data word is assumed to be left-aligned in the slot frame. If RWA is set, the data word is assumed to be right-aligned in the slot frame. If the data word is shorter than the slot length, the data bits which are not in the data word field are ignored. For data word lengths of less than 24 bits, the data word is right-extended with zeroes before being stored in the receive data registers.
6 RSHFD	ESAI_RCR Receiver Shift Direction. The RSHFD bit causes the receiver shift registers to shift data in MSB first when RSHFD is cleared or LSB first when RSHFD is set (see Figure 25-2 and Figure 25-3).
5–4 Reserved	This field is reserved. This read-only field is reserved and always has the value 0.
3 RE3	ESAI_RCR ESAI Receiver 3 Enable. When RE3 is set and TE2 is cleared, the ESAI receiver 3 is enabled and samples data at the SDO2/SDI3 pin. ESAI_TX2 and ESAI_RX3 should not be enabled at the same time (RE3=1 and TE2=1). When RE3 is cleared, receiver 3 is disabled by inhibiting data transfer into ESAI_RX3. If this bit is cleared while receiving a data word, the remainder of the word is shifted in and transferred to the ESAI_RX3 data register. If RE3 is set while some of the other receivers are already in operation, the first data word received in ESAI_RX3 will be invalid and must be discarded.
2 RE2	ESAI_RCR ESAI Receiver 2 Enable. When RE2 is set and TE3 is cleared, the ESAI receiver 2 is enabled and samples data at the SDO3/SDI2 pin. ESAI_TX3 and ESAI_RX2 should not be enabled at the same time (RE2=1 and TE3=1). When RE2 is cleared, receiver 2 is disabled by inhibiting data transfer into ESAI_RX2. If this bit is cleared while receiving a data word, the remainder of the word is shifted in and transferred to the ESAI_RX2 data register. If RE2 is set while some of the other receivers are already in operation, the first data word received in ESAI_RX2 will be invalid and must be discarded.

Table continues on the next page...

ESAI_RCR field descriptions (continued)

Field	Description
1 RE1	ESAI_RCR ESAI Receiver 1 Enable. When RE1 is set and TE4 is cleared, the ESAI receiver 1 is enabled and samples data at the SDO4/SDI1 pin. ESAI_TX4 and ESAI_RX1 should not be enabled at the same time (RE1=1 and TE4=1). When RE1 is cleared, receiver 1 is disabled by inhibiting data transfer into ESAI_RX1. If this bit is cleared while receiving a data word, the remainder of the word is shifted in and transferred to the ESAI_RX1 data register. If RE1 is set while some of the other receivers are already in operation, the first data word received in ESAI_RX1 will be invalid and must be discarded.
0 RE0	ESAI_RCR ESAI Receiver 0 Enable. When RE0 is set and TE5 is cleared, the ESAI receiver 0 is enabled and samples data at the SDO5/SDI0 pin. ESAI_TX5 and ESAI_RX0 should not be enabled at the same time (RE0=1 and TE5=1). When RE0 is cleared, receiver 0 is disabled by inhibiting data transfer into ESAI_RX0. If this bit is cleared while receiving a data word, the remainder of the word is shifted in and transferred to the ESAI_RX0 data register. If RE0 is set while some of the other receivers are already in operation, the first data word received in ESAI_RX0 will be invalid and must be discarded.

25.6.17 Receive Clock Control Register (ESAI_RCCR)

The read/write Receiver Clock Control Register (ESAI_RCCR) controls the ESAI receiver clock generator bit and frame sync rates, word length, and number of words per frame for the serial data. The ESAI_RCCR control bits are described in the following paragraphs.

NOTE

ARM Core clock is ipg_clk_esai in block ESAI which is from CCM's ahb_clk_root.

Table 25-9. Receiver High Frequency Clock Divider

RFP3-RFP0	Divide Ratio
0x0	1
0x1	2
0x2	3
0x3	4
...	...
0xF	16

Table 25-10. SCKR Pin Definition Table

Control Bits		SCKR PIN
SYN	RCKD	
0	0	SCKR input

Table continues on the next page...

Table 25-10. SCKR Pin Definition Table (continued)

Control Bits		SCKR PIN
SYN	RCKD	
0	1	SCKR output
1	0	IF0
1	1	OF0

Table 25-11. FSR Pin Definition Table

Control Bits			FSR Pin
SYN	TEBE	RFSD	
0	X	0	FSR input
0	X	1	FSR output
1	0	0	IF1
1	0	1	OF1
1	1	0	reserved
1	1	1	Transmitter Buffer Enable

Table 25-12. HCKR Pin Definition Table

Control Bits		HCKR PIN
SYN	RHCKD	
0	0	HCKR input
0	1	HCKR output
1	0	IF2
1	1	OF2

Address: 202_4000h base + E0h offset = 202_40E0h

Bit	31	30	29	28	27	26	25	24	23	22	21	20	19	18	17	16
R	0								RHCKD	RFSD	RCKD	RHCKP	RFSP	RCKP	RFP	
W	[Shaded]															
Reset	0	0	0	0	0	0	0	0	0	0	0	0	0	0	0	0
Bit	15	14	13	12	11	10	9	8	7	6	5	4	3	2	1	0
R	RFP		RDC					RPSR	RPM							
W																
Reset	0	0	0	0	0	0	0	0	0	0	0	0	0	0	0	0

ESAI_RCCR field descriptions

Field	Description
31–24 Reserved	This field is reserved. This read-only field is reserved and always has the value 0.
23 RHCKD	<p>ESAI_RCCR Receiver High Frequency Clock Direction. The Receiver High Frequency Clock Direction (RHCKD) bit selects the source of the receiver high frequency clock when in the asynchronous mode (SYN=0) and the IF2/OF2 flag direction in the synchronous mode (SYN=1).</p> <p>In the asynchronous mode, when RHCKD is set, the internal clock generator becomes the source of the receiver high frequency clock and is the output on the HCKR pin. In the asynchronous mode, when RHCKD is cleared, the receiver high frequency clock source is external; the internal clock generator is disconnected from the HCKR pin, and an external clock source may drive this pin.</p> <p>When RHCKD is cleared, HCKR is an input; when RHCKD is set, HCKR is an output.</p> <p>In the synchronous mode when RHCKD is set, the HCKR pin becomes the OF2 output flag. If RHCKD is cleared, the HCKR pin becomes the IF2 input flag. Refer to Table 25-1 and Table 25-12.</p>
22 RFSD	<p>ESAI_RCCR Receiver Frame Sync Signal Direction. The Receiver Frame Sync Signal Direction (RFSD) bit selects the source of the receiver frame sync signal when in the asynchronous mode (SYN=0) and the IF1/OF1/Transmitter Buffer Enable flag direction in the synchronous mode (SYN=1).</p> <p>In the asynchronous mode, when RFSD is set, the internal clock generator becomes the source of the receiver frame sync and is the output on the FSR pin. In the asynchronous mode, when RFSD is cleared, the receiver frame sync source is external; the internal clock generator is disconnected from the FSR pin, and an external clock source may drive this pin.</p> <p>In the synchronous mode when RFSD is set, the FSR pin becomes the OF1 output flag or the Transmitter Buffer Enable, according to the TEBE control bit. If RFSD is cleared, the FSR pin becomes the IF1 input flag. Refer to Table 25-1 and Table 25-11.</p>
21 RCKD	<p>ESAI_RCCR Receiver Clock Source Direction. The Receiver Clock Source Direction (RCKD) bit selects the source of the clock signal used to clock the receive shift register in the asynchronous mode (SYN=0) and the IF0/OF0 flag direction in the synchronous mode (SYN=1).</p> <p>In the asynchronous mode, when RCKD is set, the internal clock source becomes the bit clock for the receive shift registers and word length divider and is the output on the SCKR pin. In the asynchronous mode when RCKD is cleared, the clock source is external; the internal clock generator is disconnected from the SCKR pin, and an external clock source may drive this pin.</p> <p>In the synchronous mode when RCKD is set, the SCKR pin becomes the OF0 output flag. If RCKD is cleared, the SCKR pin becomes the IF0 input flag. Refer to Table 25-1 and Table 25-10.</p>
20 RHCKP	ESAI_RCCR Receiver High Frequency Clock Polarity. The Receiver High Frequency Clock Polarity (RHCKP) bit controls on which bit clock edge data and frame sync are clocked out and latched in. If RHCKP is cleared the data and the frame sync are clocked out on the rising edge of the receive high frequency bit clock and the frame sync is latched in on the falling edge of the receive bit clock. If RHCKP is set the falling edge of the receive clock is used to clock the data and frame sync out and the rising edge of the receive clock is used to latch the frame sync in.
19 RFSP	ESAI_RCCR Receiver Frame Sync Polarity. The Receiver Frame Sync Polarity (RFSP) determines the polarity of the receive frame sync signal. When RFSP is cleared the frame sync signal polarity is positive, that is, the frame start is indicated by a high level on the frame sync pin. When RFSP is set the frame sync signal polarity is negative, that is, the frame start is indicated by a low level on the frame sync pin.
18 RCKP	The Receiver Clock Polarity (RCKP) bit controls on which bit clock edge data and frame sync are clocked out and latched in. If RCKP is cleared the data and the frame sync are clocked out on the rising edge of the receive bit clock and the frame sync is latched in on the falling edge of the receive bit clock. If RCKP is set the falling edge of the receive clock is used to clock the data and frame sync out and the rising edge of the receive clock is used to latch the frame sync in.
17–14 RFP	ESAI_RCCR Rx High Frequency Clock Divider. The RFP3-RFP0 bits control the divide ratio of the receiver high frequency clock to the receiver serial bit clock when the source of the receiver high frequency clock and the bit clock is the internal Arm Core clock. When the HCKR input is being driven

Table continues on the next page...

ESAI_RCCR field descriptions (continued)

Field	Description
	from an external high frequency clock, the RFP3-RFP0 bits specify an additional division ration in the clock divider chain. Table 25-9 provides the specification of the divide ratio. Figure 25-7 shows the ESAI high frequency generator functional diagram.
13–9 RDC	<p>ESAI_RCCR Rx Frame Rate Divider Control. The RDC4-RDC0 bits control the divide ratio for the programmable frame rate dividers used to generate the receiver frame clocks.</p> <p>In network mode, this ratio may be interpreted as the number of words per frame minus one. The divide ratio may range from 2 to 32 (RDC=0x00001 to 0x11111) for network mode. A divide ratio of one (RDC=0x00000) in network mode is a special case (on-demand mode).</p> <p>In normal mode, this ratio determines the word transfer rate. The divide ratio may range from 1 to 32 (RDC=0x00000 to 0x11111) for normal mode. In normal mode, a divide ratio of one (RDC=0x00000) provides continuous periodic data word transfers. A bit-length frame sync (RFSL=1) must be used in this case.</p> <p>The ESAI frame sync generator functional diagram is shown in Figure 25-8.</p>
8 RPSR	ESAI_RCCR Receiver Prescaler Range. The RPSR controls a fixed divide-by-eight prescaler in series with the variable prescaler. This bit is used to extend the range of the prescaler for those cases where a slower bit clock is desired. When RPSR is set, the fixed prescaler is bypassed. When RPSR is cleared, the fixed divide-by-eight prescaler is operational (see Figure 25-7). The maximum internally generated bit clock frequency is $F_{sys}/6$, the minimum internally generated bit clock frequency is $F_{sys}/(2 \times 8 \times 256 \times 16) = F_{sys}/65536$. (Do not use the combination RPSR=1 and RPM7-RPM0 =0x00, which causes synchronization problems when using the internal Core clock as source (RHCKD=1 or RCKD=1))
RPM	ESAI_RCCR Receiver Prescale Modulus Select. The RPM7-RPM0 bits specify the divide ratio of the prescale divider in the ESAI receiver clock generator. A divide ratio from 1 to 256 (RPM=0x00 to 0xFF) may be selected. The bit clock output is available at the receiver serial bit clock (SCKR) pin. The bit clock output is also available internally for use as the bit clock to shift the receive shift registers. The ESAI receive clock generator functional diagram is shown in Figure 25-7 .

25.6.18 Transmit Slot Mask Register A (ESAI_TSMA)

The Transmit Slot Mask Register A together with Transmit Slot Mask Register B (ESAI_TSMA and ESAI_TSMB) are two read/write registers used by the transmitters in network mode to determine for each slot whether to transmit a data word and generate a transmitter empty condition (TDE=1), or to tri-state the transmitter data pins. Fields ESAI_TSMA[TS] and ESAI_TSMB[TS] are concatenated to form the 32-bit field TS[31:0]. Bit number n in TS is the enable/disable control bit for transmission in slot number n.

Address: 202_4000h base + E4h offset = 202_40E4h

Bit	31	30	29	28	27	26	25	24	23	22	21	20	19	18	17	16	15	14	13	12	11	10	9	8	7	6	5	4	3	2	1	0
R	0																TS															
W	1																1															
Reset	0	0	0	0	0	0	0	0	0	0	0	0	0	0	0	0	1	1	1	1	1	1	1	1	1	1	1	1	1	1	1	1

ESAI_TSMA field descriptions

Field	Description
31–16 Reserved	This field is reserved. This read-only field is reserved and always has the value 0.
TS	<p>Lower 16 bits of TS</p> <p>When bit number N in ESAI_TSMA is cleared, all the transmit data pins of the enabled transmitters are tri-stated during transmit time slot number N. The data is still transferred from the transmit data registers to the transmit shift registers but neither the TDE nor the TUE flags are set. This means that during a disabled slot, no transmitter empty interrupt is generated. The Core is interrupted only for enabled slots. Data that is written to the transmit data registers when servicing this request is transmitted in the next enabled transmit time slot.</p> <p>When bit number N in ESAI_TSMA register is set, the transmit sequence is as usual: data is transferred from the TX registers to the shift registers and transmitted during slot number N, and the TDE flag is set.</p> <p>Using the slot mask in ESAI_TSMA does not conflict with using TSR. Even if a slot is enabled in ESAI_TSMA, the user may choose to write to TSR instead of writing to the transmit data registers TXn. This causes all the transmit data pins of the enabled transmitters to be tri-stated during the next slot.</p> <p>Data written to the ESAI_TSMA affects the next frame transmission. The frame being transmitted is not affected by this data and would comply to the last ESAI_TSMA setting. Data read from ESAI_TSMA returns the last written data.</p> <p>After hardware or software reset, the ESAI_TSMA register is preset to 0x0000FFFF, which means that all 16 possible slots are enabled for data transmission.</p> <p>When operating in normal mode, bit 0 of the ESAI_TSMA register must be set, otherwise no output is generated.</p>

25.6.19 Transmit Slot Mask Register B (ESAI_TSMB)

The Transmit Slot Mask Register B together with Transmit Slot Mask Register A (ESAI_TSMA and ESAI_TSMB) are two read/write registers used by the transmitters in network mode to determine for each slot whether to transmit a data word and generate a transmitter empty condition (TDE=1), or to tri-state the transmitter data pins. Fields ESAI_TSMA[TS] and ESAI_TSMB[TS] are concatenated to form the 32-bit field TS[31:0]. Bit number n in TS is the enable/disable control bit for transmission in slot number n.

Address: 202_4000h base + E8h offset = 202_40E8h

Bit	31	30	29	28	27	26	25	24	23	22	21	20	19	18	17	16	15	14	13	12	11	10	9	8	7	6	5	4	3	2	1	0
R	0																TS															
W	0																1															
Reset	0	0	0	0	0	0	0	0	0	0	0	0	0	0	0	0	1	1	1	1	1	1	1	1	1	1	1	1	1	1	1	1

ESAI_TSMB field descriptions

Field	Description
31–16 Reserved	This field is reserved. This read-only field is reserved and always has the value 0.
TS	<p>When bit number N in ESAI_TSMB is cleared, all the transmit data pins of the enabled transmitters are tri-stated during transmit time slot number N. The data is still transferred from the transmit data registers to the transmit shift registers but neither the TDE nor the TUE flags are set. This means that during a disabled slot, no transmitter empty interrupt is generated. The Core is interrupted only for enabled slots. Data that is written to the transmit data registers when servicing this request is transmitted in the next enabled transmit time slot.</p> <p>When bit number N in ESAI_TSMB register is set, the transmit sequence is as usual: data is transferred from the TX registers to the shift registers and transmitted during slot number N, and the TDE flag is set.</p> <p>Using the slot mask in ESAI_TSMB does not conflict with using TSR. Even if a slot is enabled in TSMB, the user may chose to write to TSR instead of writing to the transmit data registers TXn. This causes all the transmit data pins of the enabled transmitters to be tri-stated during the next slot.</p> <p>Data written to the ESAI_TSMB affects the next frame transmission. The frame being transmitted is not affected by this data and would comply to the last ESAI_TSMB setting. Data read from ESAI_TSMB returns the last written data.</p> <p>After hardware or software reset, the ESAI_TSMB register is preset to 0x0000FFFF, which means that all 16 possible slots are enabled for data transmission.</p>

25.6.20 Receive Slot Mask Register A (ESAI_RSMA)

The Receive Slot Mask Register A together with Receive Slot Mask Register B (ESAI_RSMA and ESAI_RSMB) are two read/write registers used by the receiver in network mode to determine for each slot whether to receive a data word and generate a receiver full condition (RDF=1), or to ignore the received data. Fields ESAI_RSMA[RS] and ESAI_RSMB[RS] are concatenated to form the 32-bit field RS[31:0]. Bit number n in RS is an enable/disable control bit for receiving data in slot number n.

Address: 202_4000h base + ECh offset = 202_40ECh

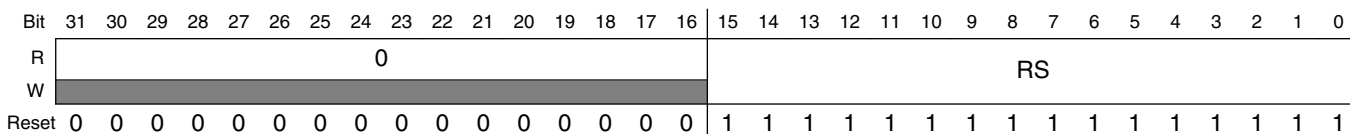

ESAI_RSMA field descriptions

Field	Description
31–16 Reserved	This field is reserved. This read-only field is reserved and always has the value 0.
RS	When bit number N in the ESAI_RSMA register is cleared, the data from the enabled receivers input pins are shifted into their receive shift registers during slot number N. The data is not transferred from the receive shift registers to the receive data registers, and neither the RDF nor the ROE flag is set. This

Table continues on the next page...

ESAI_RSMA field descriptions (continued)

Field	Description
	<p>means that during a disabled slot, no receiver full interrupt is generated. The Core is interrupted only for enabled slots.</p> <p>When bit number N in the ESAI_RSMA is set, the receive sequence is as usual: data which is shifted into the enabled receivers shift registers is transferred to the receive data registers and the RDF flag is set.</p> <p>Data written to the ESAI_RSMA affects the next received frame. The frame being received is not affected by this data and would comply to the last ESAI_RSMA setting. Data read from ESAI_RSMA returns the last written data.</p> <p>After hardware or software reset, the ESAI_RSMA register is preset to 0x0000FFFF, which means that all 16 possible slots are enabled for data reception.</p> <p>When operating in normal mode, bit 0 of the ESAI_RSMA register must be set to one, otherwise no input is received.</p>

25.6.21 Receive Slot Mask Register B (ESAI_RSMB)

The Receive Slot Mask Register B together with Receive Slot Mask Register A (ESAI_RSMA and ESAI_RSMB) are two read/write registers used by the receiver in network mode to determine for each slot whether to receive a data word and generate a receiver full condition (RDF=1), or to ignore the received data. Fields ESAI_RSMA[RS] and ESAI_RSMB[RS] are concatenated to form the 32-bit field RS[31:0]. Bit number n in RS is an enable/disable control bit for receiving data in slot number n.

Address: 202_4000h base + F0h offset = 202_40F0h

Bit	31	30	29	28	27	26	25	24	23	22	21	20	19	18	17	16	15	14	13	12	11	10	9	8	7	6	5	4	3	2	1	0
R	0																RS															
W	0																1															
Reset	0	0	0	0	0	0	0	0	0	0	0	0	0	0	0	0	1	1	1	1	1	1	1	1	1	1	1	1	1	1	1	1

ESAI_RSMB field descriptions

Field	Description
31–16 Reserved	<p>This field is reserved.</p> <p>This read-only field is reserved and always has the value 0.</p>
RS	<p>When bit number N in the ESAI_RSMB register is cleared, the data from the enabled receivers input pins are shifted into their receive shift registers during slot number N. The data is not transferred from the receive shift registers to the receive data registers, and neither the RDF nor the ROE flag is set. This means that during a disabled slot, no receiver full interrupt is generated. The Core is interrupted only for enabled slots.</p> <p>When bit number N in the ESAI_RSMB is set, the receive sequence is as usual: data which is shifted into the enabled receivers shift registers is transferred to the receive data registers and the RDF flag is set.</p> <p>Data written to the ESAI_RSMB affects the next received frame. The frame being received is not affected by this data and would comply to the last ESAI_RSMB setting. Data read from ESAI_RSMB returns the last written data.</p>

Table continues on the next page...

ESAI_RSMB field descriptions (continued)

Field	Description
	After hardware or software reset, the ESAI_RSMB register is preset to 0x0000FFFF, which means that all 16 possible slots are enabled for data reception.

25.6.22 Port C Direction Register (ESAI_PPRC)

There are two registers to control the ESAI personal reset status: Port C Direction Register (ESAI_PPRC) and Port C Control Register (ESAI_PCRC).

The read/write 32-bit Port C Direction Register (ESAI_PPRC) in conjunction with the Port C Control Register (ESAI_PCRC) controls the functionality of the ESAI personal reset state. [Table 25-13](#) provides the port pin configurations. Hardware and software reset clear all ESAI_PPRC bits.

Address: 202_4000h base + F8h offset = 202_40F8h

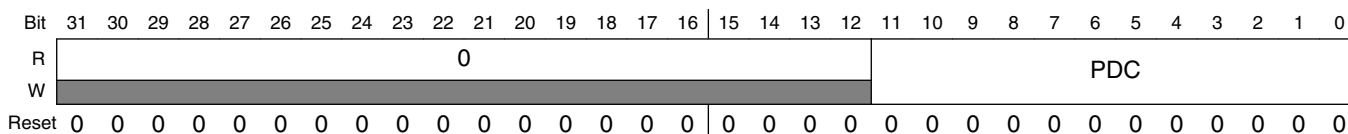

ESAI_PPRC field descriptions

Field	Description
31–12 Reserved	This field is reserved. This read-only field is reserved and always has the value 0.
PDC	See Table 25-13 .

25.6.23 Port C Control Register (ESAI_PCRC)

The read/write 32-bit Port C Control Register (ESAI_PCRC) in conjunction with the Port C Direction Register (ESAI_PPRC) controls the functionality of the ESAI personal reset state. Each of the PC(11:0) bits controls the functionality of the corresponding port pin. [Table 25-13](#) provides the port pin configurations. Hardware and software reset clear all ESAI_PCRC bits.

Table 25-13. PCRC and PPRC Bits Functionality

PDC[i]	PC[i]	Port Pin[i] Function
0	0	Disconnected
1	1	ESAI

Address: 202_4000h base + FCh offset = 202_40FCh

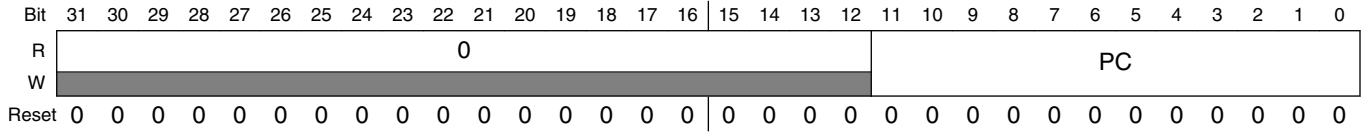

ESAI_PCRCh field descriptions

Field	Description
31–12 Reserved	This field is reserved. This read-only field is reserved and always has the value 0.
PC	See Table 25-13 .

Chapter 26

Flexible Controller Area Network (FLEXCAN)

26.1 Overview

The Flexible Controller Area Network (FLEXCAN) module is a communication controller implementing the CAN protocol according to the CAN 2.0B protocol specification.

The CAN protocol was primarily designed to be used as a vehicle serial data bus meeting the specific requirements of this field: real-time processing, reliable operation in the EMI environment of a vehicle, cost-effectiveness and required bandwidth. The FLEXCAN module is a full implementation of the CAN protocol specification, which supports both standard and extended message frames. 64 Message Buffers are supported by the Flexcan module.

26.1.1 Block Diagram

A general block diagram is shown in the figure below, which describes the main sub-blocks implemented in the FLEXCAN module, including the associated memory for storing Mailboxes, Rx Global Mask Registers, Rx Individual Mask Registers, Rx FIFO and Rx FIFO ID Filters.

Support for 64 Mailboxes and 6-deep Rx FIFO is provided. The functions of the sub-modules are described in subsequent sections.

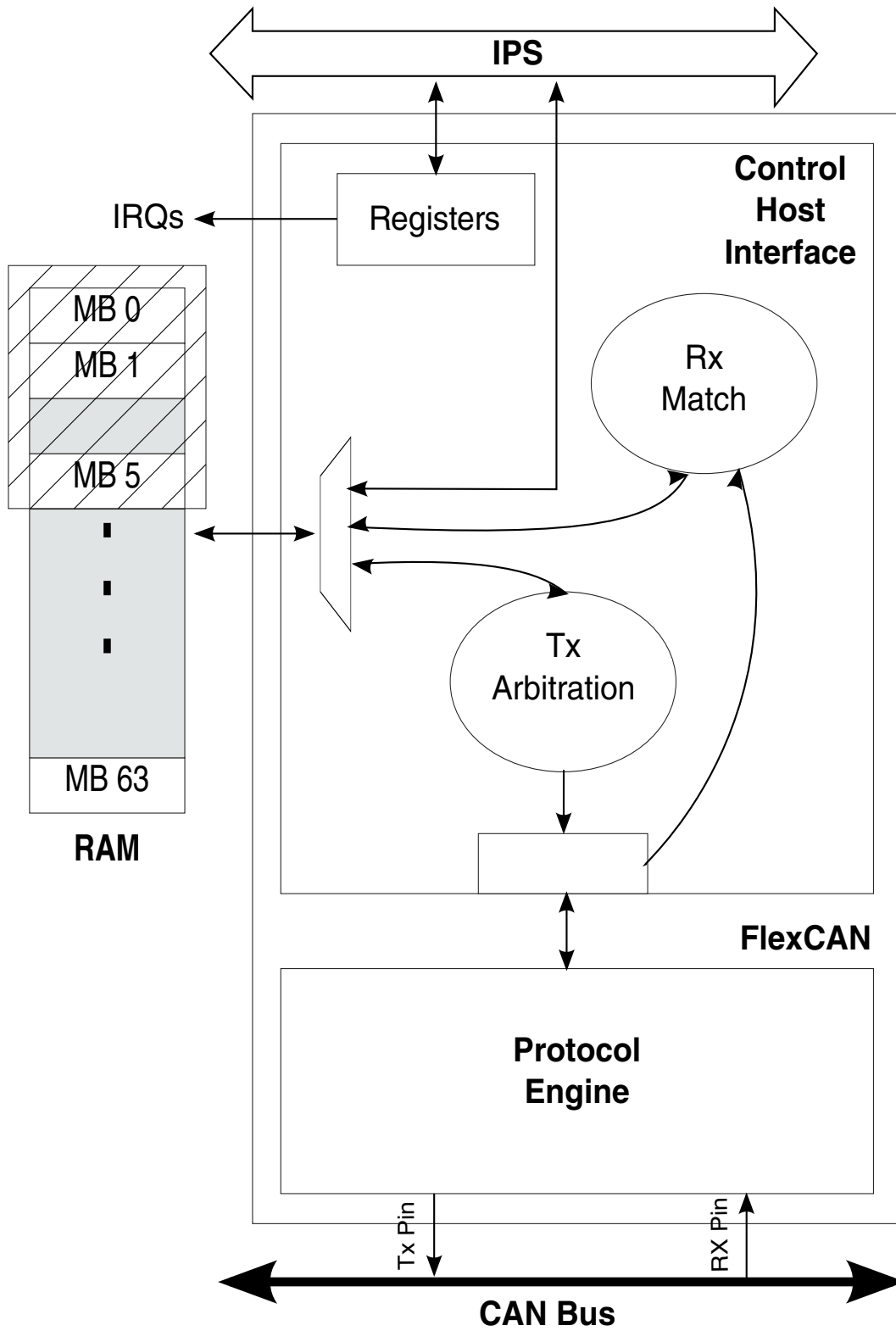

Figure 26-1. FLEXCAN Block Diagram

26.1.2 FLEXCAN Module Features

The FLEXCAN module includes these distinctive legacy features:

- Version 2.0B
 - Standard data and remote frames
 - Extended data and remote frames
 - Zero to eight bytes data length
 - Programmable bit rate up to 1 Mb/sec
 - Content-related addressing
- Flexible Mailboxes of eight bytes data length
- Each Mailbox is configurable as Rx or Tx, all supporting standard and extended messages
- Individual Rx Mask Registers per Mailbox
- Full featured Rx FIFO with storage capacity for 6 frames and internal pointer handling
- Transmission abort capability
- Powerful Rx FIFO ID filtering, capable of matching incoming IDs against either 128 extended, 256 standard or 512 partial (8 bits) IDs, with up to 32 individual masking capability
- 100% backwards compatibility with previous FLEXCAN version
- Unused structures space can be used as general purpose RAM space
- Listen only mode capability
- Programmable loop-back mode supporting self-test operation
- Programmable transmission priority scheme: lowest ID, lowest buffer number or highest priority
- Time Stamp based on 16-bit free-running timer
- Global network time, synchronized by a specific message
- Maskable interrupts independent of the transmission medium (an external transceiver is assumed)
- Short latency time due to an arbitration scheme for high-priority messages
- Low power modes, with programmable wake up on bus activity
- Configurable Glitch filter width to filter the noise on CAN bus when waking up
- Remote request frames may be handled automatically or by software.
- ID filter configuration in Normal Mode
- CAN bit time settings and configuration bits can only be written in Freeze Mode
- Tx mailbox status (Lowest priority buffer or empty buffer)
- SYNC bit status to inform that the module is synchronous with CAN bus
- CRC status for transmitted message
- Selectable priority between Mailboxes and Rx FIFO during matching process

26.1.3 Modes of Operation

The FLEXCAN module has four functional modes: Normal Mode (User and Supervisor), Freeze Mode, Listen-Only Mode and Loop-Back Mode. There are also two low power modes: Disable Mode and Stop Mode.

- Normal Mode (User or Supervisor):

In Normal Mode, the module operates receiving and/or transmitting message frames, errors are handled normally and all the CAN Protocol functions are enabled. User and Supervisor Modes differ in the access to some restricted control registers.

- Freeze Mode:

It is enabled when the FRZ bit in the MCR Register is asserted. If enabled, Freeze Mode is entered when the HALT bit in MCR is set or when Debug Mode is requested at MCU level and the FRZ_ACK bit in the MCR Register is asserted by the FlexCAN. In this mode, no transmission or reception of frames is done and synchronicity to the CAN bus is lost. See [Freeze Mode](#) for more information.

- Listen-Only Mode:

The module enters this mode when the LOM bit in the Control Register is asserted. In this mode, transmission is disabled, all error counters are frozen and the module operates in a CAN Error Passive mode. Only messages acknowledged by another CAN station will be received. If FLEXCAN detects a message that has not been acknowledged, it will flag a BIT0 error (without changing the REC), as if it was trying to acknowledge the message.

- Loop-Back Mode:

The module enters this mode when the LPB bit in the Control Register is asserted. In this mode, FLEXCAN performs an internal loop back that can be used for self test operation. The bit stream output of the transmitter is internally fed back to the receiver input. The FLEXCAN_RX input pin is ignored and the FLEXCAN_TX output goes to the recessive state (logic '1'). FLEXCAN behaves as it normally does when transmitting and treats its own transmitted message as a message received from a remote node. In this mode, FLEXCAN ignores the bit sent during the ACK slot in the CAN frame acknowledge field to ensure proper reception of its own message. Both transmit and receive interrupts are generated.

- Module Disable Mode:

This low power mode is entered when the MDIS bit in the MCR Register is asserted and the LPM_ACK is asserted by the FlexCAN. When disabled, the module requests to disable the clocks to the CAN Protocol Engine and Controller Host Interface sub-modules. Exit from this mode is done by negating the MDIS bit in the MCR Register. See [Module Disable Mode](#) for more information.

- Stop Mode:

This low power mode is entered when Stop Mode is requested at Arm level and the LPM_ACK bit in the MCR Register is asserted by the FlexCAN. When in Stop Mode, the module puts itself in an inactive state and then informs the Arm that the clocks can be shut down globally. Exit from this mode happens when the Stop Mode request is removed or when activity is detected on the CAN bus and the Self Wake Up mechanism is enabled. See [Stop Mode](#) for more information.

26.2 External Signals

The FLEXCAN module has two I/O signals.

Table 26-1. FLEXCAN External Signals

Signal	Description	Pad	Mode	Direction
FLEXCAN1_RX	FLEXCAN receive pin. This pin is the receive pin from the CAN bus transceiver. Dominant state is represented by logic level '0'. Recessive state is represented by logic level '1'.	ENET1_RX_DATA1	ALT4	I
		LCD_DATA09	ALT8	
		SD1_DATA1	ALT3	
		UART3_RTS_B	ALT2	
FLEXCAN1_TX	FLEXCAN transmit pin. This pin is the transmit pin to the CAN bus transceiver. Dominant state is represented by logic level '0'. Recessive state is represented by logic level '1'.	ENET1_RX_DATA0	ALT4	O
		LCD_DATA08	ALT8	
		SD1_DATA0	ALT3	
		UART3_CTS_B	ALT2	
FLEXCAN2_RX	FLEXCAN receive pin. This pin is the receive pin from the CAN bus transceiver. Dominant state is represented by logic level '0'. Recessive state is represented by logic level '1'.	ENET1_TX_DATA0	ALT4	I
		LCD_DATA11	ALT8	
		SD1_DATA3	ALT3	
		UART2_RTS_B	ALT2	
FLEXCAN2_TX	FLEXCAN transmit pin. This pin is the transmit pin to the CAN bus transceiver. Dominant state is represented by logic level '0'. Recessive state is represented by logic level '1'.	ENET1_RX_EN	ALT4	O
		LCD_DATA10	ALT8	
		SD1_DATA2	ALT3	
		UART2_CTS_B	ALT2	

26.3 Clocks

The table found here describes the clock sources for FLEXCAN.

Please see Clock Controller Module (CCM) for clock setting, configuration and gating information.

Table 26-2. FLEXCAN Clocks

Clock name	Clock Root	Description
ipg_clk	ipg_clk_root	Peripheral clock
ipg_clk_chi	ipg_clk_root	CHI clock
ipg_clk_pe	can_clk_root	Protocol Engine clock
ipg_clk_pe_nogate	can_clk_root	Protocol Engine clock (no gating)
ipg_clk_s	ipg_clk_root	Peripheral access clock
mem_ram_CLK	ipg_clk_root	RAM clock

26.4 Message Buffer Structure

Message Buffer Address: Base + 0x0080-0x047C.

The Message Buffer structure used by the FLEXCAN module is represented in the following table.

Both Extended and Standard Frames (29-bit Identifier and 11-bit Identifier, respectively) used in the CAN specification are represented.

Each individual Message buffer is formed by 16 bytes.

Table 26-3. Message Buffer Structure

	31	30	29	28	27	26	25	24	23	22	21	20	19	18	17	16	15	14	13	12	11	10	9	8	7	6	5	4	3	2	1	0
0x0				CODE										DLC				TIME STAMP														
				S	I	R	D							R	E																	
0x4	PRIO		ID Standard								ID Extended																					
0x8	DATA BYTE 0				DATA BYTE 1				DATA BYTE 2				DATA BYTE 3																			
0xC	DATA BYTE 4				DATA BYTE 5				DATA BYTE 6				DATA BYTE 7																			

CODE - Message Buffer Code

This 4-bit field can be accessed (read or write) by the CPU and by the FLEXCAN module itself, as part of the message buffer matching and arbitration process. The encoding is shown in the following tables. See [Functional Description](#) for additional information.

Table 26-4. Message Buffer Code for Rx buffers

CODE Description	Rx Code BEFORE receive New Frame	SRV ¹	Rx Code AFTER successful reception ²	RRS ³	Comment
0b0000: INACTIVE- MB is not active.	INACTIVE	-	-	-	MB does not participate in the matching process.
0b0100: EMPTY - MB is active and empty.	EMPTY	-	FULL	-	When a frame is received successfully (after move-in process. Refer to Move-in for details), the CODE field is automatically updated to FULL.
0b0010: FULL - MB is full.	FULL	Yes	FULL	-	The act of reading the C/S word followed by unlocking the MB (SRV) does not make the code return to EMPTY. It remains FULL. If a new frame is moved to the MB after the MB was serviced, the code still remains FULL. Refer to Matching Process for matching details related to FULL code.
		No	OVERRUN	-	If the MB is FULL and a new frame is moved to this MB before the CPU services it, the CODE field is automatically updated to OVERRUN. Refer to Matching Process for details about overrun behavior.
0b0110: OVERRUN - MB is being overwritten into a full buffer.	OVERRUN	Yes	FULL	-	If the CODE field indicates OVERRUN and CPU has serviced the MB, when a new frame is moved to the MB, the code returns to FULL.
		No	OVERRUN	-	If the CODE field already indicates OVERRUN, and another new frame must be moved, the MB will be overwritten again, and the code will remain OVERRUN. Refer to Matching Process for details about overrun behavior.
0b1010: RANSWER ⁴ - A frame was configured to recognize a Remote Request Frame and transmit a Response Frame in return.	RANSWER	-	TANSWER(0b1110)	0	A Remote Answer was configured to recognize a remote request frame received, after that a MB is set to transmit a response frame. The code is automatically changed to TANSWER (0b1110). Refer to Matching Process for details. If CTRL2[RRS] is negated, transmit a response frame whenever a remote request frame with the same ID is received.
			-	1	This code is ignored during matching and arbitration process. Refer to Matching Process for details.

Table continues on the next page...

Table 26-4. Message Buffer Code for Rx buffers (continued)

CODE Description	Rx Code BEFORE receive New Frame	SRV ¹	Rx Code AFTER successful reception ²	RRS ³	Comment
CODE[0]=1b1: BUSY - FlexCAN is updating the contents of the MB. The CPU must not access the MB.	BUSY ⁵	-	FULL	-	Indicates that the MB is being updated, it will be negated automatically and does not interfere on the next CODE.
			OVERRUN	-	

1. SRV: Serviced MB. MB was read and unlocked by reading TIMER or other MB.
2. A frame is considered successful reception after the frame to be moved to MB (move-in process). Refer to [Move-in](#) for details)
3. Remote Request Stored bit from CTRL2 register. Refer to [CTRL2](#) for details.
4. Code 4'b1010 is not considered as a Tx and a MB with this code should not to be aborted.
5. Note that for Tx MBs, the BUSY bit should be ignored upon read, except when AEN bit is set in the MCR register. If this bit is asserted, the corresponding MB does not participate in the matching process.

Table 26-5. Message Buffer Code for Tx buffers

CODE Description	Tx Code BEFORE tx frame	MB RTR	Tx Code AFTER successful transmission	Comment
0b1000: INACTIVE - MB is not active	INACTIVE	-	-	MB does not participate in the arbitration process.
0b1001: ABORT - MB is aborted	ABORT	-	-	MB does not participate in the arbitration process.
0b1100: DATA - MB is a Tx Data Frame (MB RTR must be 0)	DATA	0	INACTIVE	Transmit data frame unconditionally once. After transmission, the MB automatically returns to the INACTIVE state.
0b1100: REMOTE - MB is a Tx Remote Request Frame (MB RTR must be 1)	REMOTE	1	EMPTY	Transmit remote request frame unconditionally once. After transmission, the MB automatically becomes an Rx Empty MB with the same ID.
0b1110: TANSWER - MB is a Tx Response Frame from an incoming Remote Request Frame	TANSWER	-	RANSWER	This is an intermediate code that is automatically written to the MB by the CHI as a result of match to a remote request frame. The remote response frame will be transmitted unconditionally once and then the code will automatically return to RANSWER (0b1010). The CPU can also write this code with the same effect. The remote response frame can be either a data frame or another remote request frame depending on the RTR bit value. Refer to Matching Process and Arbitration process for details.

SRR - Substitute Remote Request

Fixed recessive bit, used only in extended format. It must be set to '1' by the user for transmission (Tx Buffers) and will be stored with the value received on the CAN bus for Rx receiving buffers. It can be received as either recessive or dominant. If FLEXCAN receives this bit as dominant, then it is interpreted as arbitration loss.

1= Recessive value is compulsory for transmission in Extended Format frames

0= Dominant is not a valid value for transmission in Extended Format frames

IDE - ID Extended Bit

This bit identifies whether the frame format is standard or extended. It is also used as part of the reception filter.

1= Frame format is extended

0= Frame format is standard

RTR - Remote Transmission Request

This bit affects the behavior of Remote Frames and is part of the reception filter. Refer to the tables above and RRS bit in [Control 2 Register \(FLEXCAN_CTRL2\)](#) for additional details.

If FLEXCAN transmits this bit as '1' (recessive) and receives it as '0' (dominant), it is interpreted as arbitration loss. If this bit is transmitted as '0' (dominant), then if it is received as '1' (recessive), the FLEXCAN module treats it as bit error. If the value received matches the value transmitted, it is considered as a successful bit transmission.

1= Indicates the current MB has a Remote Frame to be transmitted if MB is Tx. If the MB is Rx then incoming Remote Request Frames may be stored.

0= Indicates the current MB has a Data Frame to be transmitted. In Rx MB it may be considered in matching processes.

DLC - Length of Data in Bytes

This 4-bit field is the length (in bytes) of the Rx or Tx data, which is located in offset 0x08 through 0x0F of the MB space (see the first table above). In reception, this field is written by the FLEXCAN module, copied from the DLC (Data Length Code) field of the received frame. In transmission, this field is written by the Arm and corresponds to the DLC field value of the frame to be transmitted. When RTR=1, the Frame to be transmitted is a Remote Frame and does not include the data field, regardless of the Length field. The DLC field indicates which DATA BYTES are valid as shown in the table below.

TIME STAMP - Free-Running Counter Time Stamp

This 16-bit field is a copy of the Free-Running Timer, captured for Tx and Rx frames at the time when the beginning of the Identifier field appears on the CAN bus.

PRIOR - Local priority

This 3-bit field is only used when MCR[LPRIO_EN] bit is asserted and it only makes sense for Tx mailboxes. These bits are not transmitted. They are appended to the regular ID to define the transmission priority. See [Arbitration process](#).

ID - Frame Identifier

In Standard Frame format, only the 11 most significant bits (28 to 18) are used for frame identification in both receive and transmit cases. The 18 least significant bits are ignored. In Extended Frame format, all bits are used for frame identification in both receive and transmit cases.

DATA BYTE 0-7 - Data Field

Up to eight bytes can be used for a data frame.

For Rx frames, the data is stored as it is received from the CAN bus. DATA BYTE (n) is valid only if *n* is less than DLC as shown in the table below.

For Tx frames, the CPU prepares the data field to be transmitted within the frame.

Table 26-6. DATA BYTEs validity

DLC	Valid DATA BYTEs
0	none
1	DATA BYTE 0
2	DATA BYTE 0-1
3	DATA BYTE 0-2
4	DATA BYTE 0-3
5	DATA BYTE 0-4
6	DATA BYTE 0-5
7	DATA BYTE 0-6
8	DATA BYTE 0-7

26.5 Rx FIFO Structure

When the MCR[RFEN] bit is set, the memory area from 0x80 to 0xDC (which is normally occupied by MBs 0 to 5) is used by the reception FIFO engine.

The region 0x80-0x8C contains the output of the FIFO which must be read by the CPU as a Message Buffer. This output contains the oldest message received and not read yet. The region 0x90-0xDC is reserved for internal use of the FIFO engine.

An additional memory area, that starts at 0xE0 and may extend up to 0x2DC (normally occupied by MBs 6 up to 37) depending on the CTRL2[RFFN] field setting, contains the ID Filter Table (configurable from 8 to 128 memory positions) that specifies filtering criteria for accepting frames into the FIFO. [Table 26-7](#) shows the Rx FIFO data structure.

Each ID Filter Table Element occupies an entire 32-bit word and can be compounded by one, two or four Identifier Acceptance Filters (IDAF) depending on the MCR[IDAM] field setting. [Table 26-8](#), [Table 26-9](#) and [Table 26-10](#) show the IDAF indexation. [Table 26-11](#) show the three different formats that the IDAF can assume, depending on the MCR[IDAM] field setting. Note that all elements of the table must have the same format. See [Rx FIFO](#) for more information.

Out of reset, the ID Filter Table flexible memory area defaults to 0xE0 and only extends to 0xFC, which corresponds to MBs 6 to 7 for RFFN=0.

Table 26-7. Rx FIFO Structure

	31	30	29	28	27	26	25	24	23	22	21	20	19	18	17	16	15	14	13	12	11	10	9	8	7	6	5	4	3	2	1	0	
0x80											S	I	R	DLC				TIME STAMP															
											R	D	T																				
											R	E	R																				
0x84											ID Standard						ID Extended																
0x88											Data Byte 0						Data Byte 1						Data Byte 2						Data Byte 3				
0x8C	Data Byte 4						Data Byte 5						Data Byte 6						Data Byte 7														
0x90 to 0xDC	Reserved																																
0xE0	ID Filter Table Element 0																																
0xE4	ID Filter Table Element 1																																
0xE8 to 0x2D 4	ID Filter Table Elements 2 through 125																																
0x2D 8	ID Filter Table Element 126																																
0x2D C	ID Filter Table Element 127																																

Table 26-11. Identifier Acceptance Filter Format A,B and C

(Std/Ext = 31-24)	(Std/Ext = 23-16)	(Std/Ext = 15-8)	(Std/Ext = 7-0)
-------------------	-------------------	------------------	-----------------

RTR - Remote Frame

This bit specifies whether Remote Request Frames are accepted into the FIFO if they match the target ID in Formats A and B. If Format C is chosen the acceptance does not depend on whether the frame is a Remote Request Frame or not.

1= Remote Frames can be accepted and data frames are rejected

0= Remote Frames are rejected and data frames can be accepted

IDE - Extended Frame

Specifies if either Extended or Standard Format frames are accepted into the FIFO if they match the target ID in Formats A and B. If Format C is chosen the acceptance does not depend on whether the frame is of the Extended or Standard Format.

1= Extended frames can be accepted and standard frames are rejected

0= Extended frames are rejected and standard frames can be accepted

RXIDA - Rx Frame Identifier (Format A)

Specifies an ID to be used as acceptance criteria for the FIFO. In the Standard Format (IDAF's or incoming frame's IDE bit is negated), only the 11 most significant bits (29 to 19) are used for frame identification. In the Extended Format (both IDAF's and incoming frame's IDE are asserted), all bits are used.

RXIDB_0, RXIDB_1 - Rx Frame Identifier (Format B)

Specifies an ID to be used as acceptance criteria for the FIFO. In the Standard Format (IDAF's or incoming frame's IDE bit is negated), the 11 most significant bits (29 to 19 and 13 to 3) are used for frame identification. In the Extended Format (both IDAF's and incoming frame's IDE are asserted), all 14 bits of the field are compared with the 14 most significant bits of the Identifier of the incoming frame. The 15 least significant bits of the Identifier of an incoming Extended Format frame do not affect the acceptance.

RXIDC_0, RXIDC_1, RXIDC_2, RXIDC_3 - Rx Frame Identifier (Format C)

Specifies an ID to be used as acceptance criteria for the FIFO. In both Standard Format and Extended Format, all 8 bits of the field are compared to the 8 most significant bits of the Identifier of the incoming frame. The 3 least significant bits of the Identifier of an incoming Standard Format frame and the 21 least significant bits of the Identifier of an incoming Extended Format frame do not affect the acceptance.

26.6 Functional Description

This section provides a complete functional description of the block.

26.6.1 Functional Overview

The FLEXCAN module is a CAN protocol engine with a very flexible mailbox system for transmitting and receiving CAN frames. The mailbox system consists of a set of 64 Message Buffers (MB) that store configuration and control data, time stamp, message ID and data (see [Message Buffer Structure](#)). The memory corresponding to the first 38 MBs can be configured to support a FIFO reception scheme with a powerful ID filtering mechanism, capable of checking incoming frames against a table of IDs (up to 128 extended IDs or 256 standard IDs or 512 8-bit ID slices), with individual mask register for up to 32 ID Filter Table elements. Simultaneous reception through FIFO and mailbox is supported. For mailbox reception, a *matching* algorithm makes it possible to store received frames only into MBs that have the same ID. A masking scheme makes it possible to match the ID programmed on the MB with a range of Identifiers on received CAN frames. For transmission, an *arbitration* algorithm decides the prioritization of MBs to be transmitted based on the message ID (optionally augmented by 3 local priority bits) or the MB ordering.

Before proceeding with the functional description, an important concept must be explained. A Message Buffer is said to be "active" at a given time if it can participate in both the Matching and Arbitration processes. An Rx MB with a 0b0000 code is inactive (refer to [Table 26-4](#)). Similarly, a Tx MB with a 0b1000 or 0b1001 code is also inactive (refer to [Table 26-5](#)).

26.6.2 Transmit Process

In order to transmit a CAN frame, the CPU must prepare a Message Buffer for transmission by executing the procedure found here.

1. Check if the respective interruption bit is set and clear it.
2. If the MB is active (transmission pending), write the ABORT code (0b1001) to the CODE field of the Control and Status word to request an abortion of the transmission. Wait for the corresponding IFLAG to be asserted by polling the IFLAG register or by the interrupt request if enabled by the respective IMASK. Then read back the CODE field to check if the transmission was aborted or transmitted (see [Transmission Abort Mechanism](#)). If backwards compatibility is desired (MCR[AEN]

bit negated), just write the INACTIVE code (0b1000) to the CODE field to inactivate the MB but then the pending frame may be transmitted without notification (see [Message Buffer Inactivation](#)).

3. Write the ID word.
4. Write the data bytes.
5. Write the DLC, Control and Code fields of the Control and Status word to activate the MB.

Once the MB is activated, it will participate into the arbitration process and eventually be transmitted according to its priority.

At the end of the successful transmission, the value of the Free Running Timer at the time of the second bit of frame's Identifier field is written into the MB's Time Stamp field, the CODE field in the Control and Status word is updated, the CRC Register is updated, a status flag is set in the Interrupt Flag Register and an interrupt is generated if allowed by the corresponding Interrupt Mask Register bit. The new CODE field after transmission depends on the code that was used to activate the MB in step four (see [Table 26-4](#) and [Table 26-5](#) in [Message Buffer Structure](#)).

When the Abort feature is enabled (MCR[AEN] bit is asserted), after the Interrupt Flag is asserted for a Mailbox configured as transmit buffer, the Mailbox is blocked, therefore the CPU is not able to update it until it negates the Interrupt Flag. It means that the CPU must clear the corresponding IFLAG before starting to prepare this MB for a new transmission or reception.

26.6.3 Arbitration process

The arbitration process scans the Mailboxes searching the Tx one that holds the message to be sent in the next opportunity. This Mailbox is called the *arbitration winner*.

The scan starts from the lowest Mailbox number and runs toward the higher ones.

The arbitration process is triggered in the following events:

- From the CRC field of the CAN frame. The start point depends on the CTRL2[TASD] field value. See [Control 2 Register \(FLEXCAN_CTRL2\)](#) for details.
- During the error delimiter field of the CAN frame
- During the Overload Delimiter field of a CAN frame.
- When the winner is inactivated and the CAN bus has still not reached the first bit of the Intermission field.
- When Arm write to the C/S word of a winner MB and the CAN bus has still not reached the first bit of the Intermission field.
- When CHI is in Idle state and Arm writes to the C/S word of any MB.

Functional Description

- When FlexCAN exits Bus Off state
- Upon leaving Freeze Mode or Low Power Mode

If the arbitration process does not manage to evaluate all Mailboxes before the CAN bus has reached the first bit of the Intermission field the temporary arbitration winner is invalidated and the FlexCAN will not compete for the CAN bus in the next opportunity.

The arbitration process selects the winner among the active Tx Mailboxes at the end of the scan according to both CTRL1[LBUF] and MCR[LPRIO_EN] bits settings.

26.6.3.1 Lowest Mailbox number first

If CTRL1[LBUF] bit is asserted the first (lowest number) active Tx Mailbox found is the arbitration winner. MCR[LPRIO_EN] bit has no effect when CTRL1[LBUF] is asserted.

26.6.3.2 Highest Mailbox priority first

If CTRL1[LBUF] bit is negated then the arbitration process searches the active Tx Mailbox with the highest priority, and this Mailbox would have a higher probability to win the arbitration on CAN bus.

The sequence of bits considered for this arbitration is called the *arbitration value* of the Mailbox. The highest priority Tx Mailbox is the one that has the least arbitration value among all Tx Mailboxes.

If two or more Mailboxes have equivalent arbitration values the lowest Mailbox number is the arbitration winner.

The composition of the arbitration value depends on MCR[LPRIO_EN] bit setting.

26.6.3.2.1 Local Priority disabled

If MCR[LPRIO_EN] bit is negated the arbitration value is built in the exact sequence of bits as they would be transmitted in a CAN frame (see [Table 26-12](#)) in such a way that the Local Priority is disabled.

Table 26-12. Composition of the arbitration value when Local Priority is disabled

Format	Mailbox Arbitration Value (32 bits)				
Standard (IDE = 0)	Standard ID (11 bits)	RTR (1 bit)	IDE (1 bit)	- (18 bits)	- (1 bit)
Extended (IDE = 1)	Extended ID[28:18] (11 bits)	SRR (1 bit)	IDE (1 bit)	Extended ID[17:0] (18 bits)	RTR (1 bit)

26.6.3.2.2 Local Priority enabled

If Local Priority is desired MCR[LPRIO_EN] must be asserted.

In this case the Mailbox PRIO field is included at the very left of the arbitration value (see the table below).

Table 26-13. Composition of the arbitration value when Local Priority is enabled

Format	Mailbox Arbitration Value (35 bits)					
Standard (IDE = 0)	PRIO (3 bits)	Standard ID (11 bits)	RTR (1 bit)	IDE (1 bit)	- (18 bits)	- (1 bit)
Extended (IDE = 1)	PRIO (3 bits)	Extended ID[28:18](11 bits)	SRR (1 bit)	IDE (1 bit)	Extended ID[17:0] (18 bits)	RTR (1 bit)

As the PRIO field is the most significant part of the arbitration value Mailboxes with low PRIO values have higher priority than Mailboxes with high PRIO values regardless the rest of their arbitration values.

Note that the PRIO field is not part of the frame on the CAN bus. Its purpose is only to affect the internal arbitration process.

Once the arbitration winner is found, its content is copied to a hidden auxiliary MB called Tx Serial Message Buffer (Tx SMB), which has the same structure as a normal MB but is not user accessible. This operation is called "move-out" and after it is done, write access to the corresponding MB is blocked (if the AEN bit in MCR is asserted). The write access is released in the following events:

- After the MB is transmitted
- FlexCAN enters in Freeze Mode or Bus Off
- FlexCAN loses the bus arbitration or there is an error during the transmission

At the first opportunity window on the CAN bus, the message on the Tx SMB is transmitted according to the CAN protocol rules. FlexCAN transmits up to eight data bytes, even if the DLC (Data Length Code) field value is greater than that.

Arbitration process can be triggered in the following situations:

- During Rx and Tx frames from CAN CRC field to end of frame. Arbitration start point depends on instantiation parameters NUMBER_OF_MB and T ASD. Additionally, T ASD value may be changed (see [Control 2 Register \(FLEXCAN_CTRL2\)](#)) to optimize the arbitration start point.
- During CAN Bus Off state from TX_ERR_CNT=124 to 128. Arbitration start point depends on instantiation parameters NUMBER_OF_MB and T ASD. Additionally,

TASD value may be changed(see [Control 2 Register \(FLEXCAN_CTRL2\)](#)) to optimize the arbitration start point.

- During C/S write by CPU in Bus Idle. First C/S write starts arbitration process and a second C/S write during this same arbitration restarts the process. If other C/S writes are performed, Tx arbitration process is pending. If there is no arbitration winner after arbitration process has finished, then TX arbitration machine begins a new arbitration process.
- Arbitration winner deactivation during a valid arbitration window.
- Upon Leave Freeze Mode. If there is a re-synchronization during WaitForBusIdle arbitration process is restarted.

Arbitration process stops in the following situation:

- All Mailboxes were scanned.
- A Tx active Mailbox is found in case of Lowest Buffer feature enabled.
- Arbitration winner inactivation or abort during any arbitration process.
- There was not enough time to finish Tx arbitration process. For instance, a deactivation was performed near the end of frame). In this case arbitration process is pending.
- Error or Overload flag in the bus.
- Low Power or Freeze Mode request in Idle state

Arbitration is considered pending as described below:

- It was not possible to finish arbitration process in time.
- C/S write during arbitration if write is performed in a MB which number is lower than the Tx arbitration pointer.
- Any C/S write if there is no Tx Arbitration process in progress.
- Rx Match has just updated a Rx Code to Tx Code.
- Entering Bus off state.

C/S write during arbitration has the following effect:

- If C/S write is performed in the arbitration winner, a new process is restarted immediately.
- C/S write during arbitration if write is performed in a MB which number is higher than the Tx arbitration pointer.

26.6.4 Receive Process

To be able to receive CAN frames into a Mailbox, the CPU must prepare it for reception by executing the steps listed here.

1. If the Mailbox is active (either Tx or Rx) inactivate the Mailbox (see [Message Buffer Inactivation](#)), preferably with a *safe inactivation* (see [Transmission Abort Mechanism](#));
2. Write the ID word;
3. Write the EMPTY code (0b0100) to the CODE field of the Control and Status word to activate the Mailbox.

Once the Mailbox is activated in the third step, it will be able to receive frames that match the programmed filter. At the end of a successful reception, the Mailbox is updated by the *move-in process* (see [Move-in](#)) as follows:

1. The received Data field (8 bytes at most) is stored;
2. The received Identifier field is stored;
3. The value of the Free Running Timer at the time of the second bit of frame's Identifier field is written into the Mailbox Time Stamp field;
4. The received SRR, IDE, RTR and DLC fields are stored;
5. The CODE field in the Control and Status word is updated. (see [Table 26-4](#) and [Table 26-5](#) in Section [Message Buffer Structure](#))
6. A status flag is set in the Interrupt Flag Register and an interrupt is generated if allowed by the corresponding Interrupt Mask Register bit.

The recommended way for the CPU servicing (read) the frame received in a Mailbox is using the following procedure:

1. Read the Control and Status word of that Mailbox;
2. Check if the BUSY bit is deasserted, indicating that the Mailbox is locked. Repeat step 1) while it is asserted. See [Message Buffer Lock Mechanism](#);
3. Read the contents of the Mailbox. Once Mailbox is locked now, its contents won't be modified by FlexCAN Move-in processes. See [Move-in](#);
4. Acknowledge the proper flag at IFLAG registers;
5. Read the Free Running Timer. It is optional but recommended to unlock Mailbox as soon as possible and make it available for reception.

The CPU should synchronize to frame reception by the status flag bit for the specific Mailbox in one of the IFLAG Registers and not by the CODE field of that Mailbox. Polling the CODE field does not work because once a frame was received and the CPU services the Mailbox (by reading the C/S word followed by unlocking the Mailbox), the CODE field will not return to EMPTY. It will remain FULL. If the CPU tries to workaround this behavior by writing to the C/S word to force an EMPTY code after reading the Mailbox without a prior *safe inactivation*, a newly received message matching the filter of that Mailbox may be lost.

In summary: never do polling by reading directly the C/S word of the Mailboxes. Instead, read the IFLAG registers.

Note that the received frame's Identifier field is always stored in the matching Mailbox, thus the contents of the ID field in a Mailbox may change if the match was due to masking. Note also that FlexCAN does receive frames transmitted by itself if there exists a matching Rx Mailbox, provided the MCR[SRX_DIS] bit is not asserted. If MCR[SRX_DIS] bit is asserted, FlexCAN will not store messages transmitted by itself in any MB, even if it contains a matching MB, and no interrupt flag or interrupt signal will be generated due to the frame reception.

To be able to receive CAN messages through the Rx FIFO, the CPU must enable and configure the Rx FIFO during Freeze Mode(see [Rx FIFO](#)). Upon receiving the Frames Available in Rx FIFO interrupt(see [Interrupt Masks 1 Register \(FLEXCAN_IMASK1\)](#), bit IFLAG[BUF5I] - Frames available in Rx FIFO), the CPU should service the received frame using the following procedure:

1. Read the Control and Status word (optional - needed only if a mask was used for IDE and RTR bits);
2. Read the ID field (optional - needed only if a mask was used);
3. Read the Data field;
4. Read the RXFIR register (optional);
5. Clear the Frames Available in Rx FIFO interrupt by writing 1 to IFLAG[BUF5I] bit (mandatory - releases the MB and allows the CPU to read the next Rx FIFO entry)

26.6.5 Matching Process

The matching process scans the MB memory looking for Rx MBs programmed with the same ID as the one received from the CAN bus. If the FIFO is enabled, the priority of scanning can be selected between Mailboxes and FIFO filters. In any case, the matching starts from the lowest number Message Buffer toward the higher ones. If no match is found within the first structure then the other is scanned subsequently. In the event that the FIFO is full, the matching algorithm will always look for a matching MB outside the FIFO region.

As the frame is being received, it is stored in a hidden auxiliary MB called Rx Serial Message Buffer (Rx SMB).

The matching process start point depends on the following conditions:

- if the received frame is a remote frame, the start point is the CRC field of the frame;
- if the received frame is a data frame with DLC field equal to zero, the start point is the CRC field of the frame;
- if the received frame is a data frame with DLC field different than zero, the start point is the DATA field of the frame;

If a matching ID is found in the FIFO table or in one of the Mailboxes, the contents of the SMB will be transferred to the FIFO or to the matched Mailbox by the move-in process. If any CAN protocol error is detected then no match results will be transferred to the FIFO or to the matched Mailbox at the end of reception.

The matching process scans all matching elements of both Rx FIFO (if enabled) and active Rx Mailboxes (CODE is EMPTY, FULL, OVERRUN or RANSWER) in search of a successful comparison with the matching elements of the Rx SMB that is receiving the frame on the CAN bus. The SMB has the same structure of a Mailbox. The reception structures (Rx FIFO or Mailboxes) associated with the matching elements that had a successful comparison are the *matched structures*. The *matching winner* is selected at the end of the scan among those matched structures and depends on conditions described ahead. Refer to the following table for details.

Table 26-14. Matching architecture

Structure	SMB[RTR]	CTRL2[RRS]	CTRL2[EACEN]	MB[IDE]	MB[RTR]	MB[ID] ¹	MB[CODE]
Mailbox	0	-	0	cmp ²	no_cmp ³	cmp_msk ⁴	EMPTY or FULL or OVERRUN
Mailbox	0	-	1	cmp_msk	cmp_msk	cmp_msk	EMPTY or FULL or OVERRUN
Mailbox	1	0	-	cmp	no_cmp	cmp	RANSWER
Mailbox	1	1	0	cmp	no_cmp	cmp_msk	EMPTY or FULL or OVERRUN
Mailbox	1	1	1	cmp_msk	cmp_msk	cmp_msk	EMPTY or FULL or OVERRUN
FIFO ⁵	-	-	-	cmp_msk	cmp_msk	cmp_msk	-

1. For Mailbox structure, If SMB[IDE] is asserted, the ID is 29 bits (ID Standard + ID Extended). In case of SMB[IDE] to be negated, the ID is only 11 bits (ID Standard). Please, refer to [Message Buffer Structure](#) for ID details. For FIFO structure, the ID depends on IDAM. Please, refer to [Rx FIFO Structure](#) for IDAM details.
2. cmp: Compares the SMB contents with the MB contents regardless the masks.
3. no_cmp: The SMB contents are not compared with the MB contents.
4. cmp_msk: Compares the SMB contents with MB contents taking into account the masks.
5. SMB[IDE] and SMB[RTR] are not taken into account when IDAM is type C.

A reception structure is *free-to-receive* when any of the following conditions is satisfied:

- the CODE field of the Mailbox is EMPTY;
- the CODE field of the Mailbox is either FULL or OVERRUN and it has already been serviced (the C/S word was read by the Arm and unlocked as described in [Message Buffer Lock Mechanism](#));

Functional Description

- the CODE field of the Mailbox is either FULL or OVERRUN and an inactivation is performed. (see [Message Buffer Inactivation](#))
- the Rx FIFO is not full.

The scan order for Mailboxes and Rx FIFO is from the matching element with lowest number to the higher ones.

The matching winner search for Mailboxes is affected by the MCR[IRMQ] bit. If it is negated the matching winner is the first matched Mailbox regardless if it is free-to-receive or not . If it is asserted, the matching winner is selected according to the priority below:

1. the first free-to-receive matched Mailbox;
2. the last non free-to-receive matched Mailbox.

It is possible to select the priority of scan between Mailboxes and Rx FIFO by the CTRL2[MRP] bit.

If the selected priority is Rx FIFO first:

- if the Rx FIFO is a matched structure and is free-to-receive then the Rx FIFO is the matching winner regardless of the scan for Mailboxes;
- otherwise (the Rx FIFO is not a matched structure or is not free-to-receive), then the matching winner is searched among Mailboxes as described above.

If the selected priority is Mailboxes first:

- if a free-to-receive matched Mailbox is found, it is the matching winner regardless the scan for Rx FIFO;
- if no matched Mailbox is found, then the matching winner is searched in the scan for the Rx FIFO;
- if both conditions above are not satisfied and a non free-to-receive matched Mailbox is found then the matching winner determination is conditioned by the MCR[IRMQ] bit:
 - if MCR[IRMQ] bit is negated the matching winner is the first matched Mailbox;
 - if MCR[IRMQ] bit is asserted the matching winner is the Rx FIFO if it is a free-to-receive matched structure, otherwise the matching winner is the last non free-to-receive matched Mailbox.

Please, refer to the table below for a summary of matching possibilities.

If a non-safe Mailbox inactivation (see [Message Buffer Inactivation](#)) occurs during matching process and the Mailbox inactivated is the temporary matching winner then the temporary matching winner is invalidated. The matching elements scan is not stopped nor

restarted, it continues normally. The consequence is that the current matching process works as if the matching elements compared before the inactivation did not exist, therefore a message may be lost.

Suppose, for example, that the FIFO is disabled, IRMQ is enabled and there are two MBs with the same ID, and FlexCAN starts receiving messages with that ID. Let us say that these MBs are the second and the fifth in the array. When the first message arrives, the matching algorithm will find the first match in MB number 2. The code of this MB is EMPTY, so the message is stored there. When the second message arrives, the matching algorithm will find MB number 2 again, but it is not "free-to-receive", so it will keep looking and find MB number 5 and store the message there. If yet another message with the same ID arrives, the matching algorithm finds out that there are no matching MBs that are "free-to-receive", so it decides to overwrite the last matched MB, which is number 5. In doing so, it sets the CODE field of the MB to indicate OVERRUN.

Table 26-15. Matching Possibilities and Resulting Reception Structures

RFEN	IRMQ	MRP	Matched in MB	Matched in FIFO	Reception Structure	Description
No FIFO, only MB, match is always MB first						
0	0	X ¹	None ²	- ³	None	Frame lost by no match
0	0	X	Free ⁴	-	FirstMB	
0	1	X	None	-	None	Frame lost by no match
0	1	X	Free	-	FirstMB	
0	1	X	NotFree	-	LastMB	Overrun
FIFO enabled, no match in FIFO is as if FIFO does not exist						
1	0	X	None	None ⁵	None	Frame lost by no match
1	0	X	Free	None	FirstMB	
1	1	X	None	None	None	Frame lost by no match
1	1	X	Free	None	FirstMB	
1	1	X	NotFree	None	LastMB	Overrun
FIFO enabled, Queue disabled						
1	0	0	X	NotFull ⁶	FIFO	
1	0	0	None	Full ⁷	None	Frame lost by FIFO full (FIFO Overflow)
1	0	0	Free	Full	FirstMB	
1	0	0	NotFree	Full	FirstMB	
1	0	1	None	NotFull	FIFO	
1	0	1	None	Full	None	Frame lost by FIFO full (FIFO Overflow)
1	0	1	Free	X	FirstMB	
1	0	1	NotFree	X	FirstMB	Overrun
FIFO enabled, Queue enabled						
1	1	0	X	NotFull	FIFO	
1	1	0	None	Full	None	Frame lost by FIFO full (FIFO Overflow)

Table continues on the next page...

**Table 26-15. Matching Possibilities and Resulting Reception Structures
(continued)**

RFEN	IRMQ	MRP	Matched in MB	Matched in FIFO	Reception Structure	Description
1	1	0	Free	Full	FirstMB	
1	1	0	NotFree	Full	LastMB	Overrun
1	1	1	None	NotFull	FIFO	
1	1	1	Free	X	FirstMB	
1	1	1	NotFree	NotFull	FIFO	
1	1	1	NotFree	Full	LastMB	Overrun

1. It is a don't care condition.
2. Matched in MB "None" means that the frame has not matched any MB (free-to-receive or non-free-to-receive).
3. It is a forbidden condition.
4. Matched in MB "Free" means that the frame matched at least one MB free-to-receive regardless it has matched MBs non-free-to-receive.
5. Matched in FIFO "None" means that the frame has not matched any filter in FIFO. It is as the FIFO didn't exist (CTRL2[RFEN]=0).
6. Matched in FIFO "NotFull" means that the frame has matched a FIFO filter and has empty slots to receive it.
7. Matched in FIFO "Full" means that the frame has matched a FIFO filter but couldn't store it because it has no empty slots to receive it.

The ability to match the same ID in more than one MB can be exploited to implement a reception queue (in addition to the full featured FIFO) to allow more time for Arm to service the MBs. By programming more than one MB with the same ID, received messages will be queued into the MBs. Arm can examine the Time Stamp field of the MBs to determine the order in which the messages arrived.

Matching to a range of IDs is possible by using ID Acceptance Masks. FlexCAN supports individual masking per MB. Please refer to [Rx Mailboxes Global Mask Register \(FLEXCAN_RXMGMASK\)](#). During the matching algorithm, if a mask bit is asserted, then the corresponding ID bit is compared. If the mask bit is negated, the corresponding ID bit is "don't care". Please note that the Individual Mask Registers are implemented in RAM, so they are not initialized out of reset. Also, they can only be programmed while the module is in Freeze Mode,, otherwise they are blocked by hardware.

FlexCAN also supports an alternate masking scheme with only four mask registers (RGXMASK, RX14MASK, RX15MASK and RXFGMASK) for backward compatibility. This alternate masking scheme is enabled when the IRMQ bit in the MCR Register is negated.

26.6.6 Move Process

There are two types of move process, namely move-in and move-out.

26.6.6.1 Move-in

The move-in process is the copy of a message received by an Rx SMB to a Rx Mailbox or FIFO that has matched it. If the move destination is the Rx FIFO, attributes of the message are also copied to the RXFIR FIFO. Each Rx SMB has its own move-in process, but only one is performed at a given time as described ahead. The move-in starts only when the message held by the Rx SMB has a corresponding matching winner (see [Matching Process](#)) and all of the following conditions are true:

- the CAN bus has reached or let past either:
 - the second bit of Intermission field next to the frame that carried the message that is in the Rx SMB;
 - the first bit of an overload frame next to the frame that carried the message that is in the Rx SMB;
- there is no ongoing matching process;
- the destination Mailbox is not locked by Arm;
- there is no ongoing move-in process from another Rx SMB. If more than one move-in processes are to be started at the same time both are performed and the newest substitutes the oldest.

The term *pending move-in* is used throughout the document and stands for a move-to-be that still does not satisfy all of the aforementioned conditions.

The move-in is cancelled and the Rx SMB is able to receive another message if any of the following conditions is satisfied:

- the destination Mailbox is inactivated after the CAN bus has reached the first bit of Intermission field next to the frame that carried the message and its matching process has finished;
- there is a previous pending move-in to the same destination Mailbox.
- the Rx SMB is receiving a frame transmitted by the FlexCAN itself and the self-reception is disabled;
- any CAN protocol error is detected.

Note that the pending move-in is not cancelled if the module enters in Freeze or Low Power Mode. It only stays on hold waiting for exiting Low Power Mode and to be unlocked. If an MB is unlocked during Freeze Mode, the move-in happens immediately.

The move-in process consists of the following steps:

1. if the message is destined to the Rx FIFO, push IDHIT into the RXFIR FIFO;
2. reads the words DATA0-3 and DATA4-7 from the Rx SMB;
3. writes it in the words DATA0-3 and DATA4-7 of the Rx Mailbox;

4. reads the words Control/Status and ID from the Rx SMB;
5. writes it in the words Control/Status and ID of the Rx Mailbox, updating the CODE field according to [Table 26-4](#).

The move-in process is not atomic, in such a way that it is immediately cancelled by the inactivation of the destination Mailbox (see [Message Buffer Inactivation](#)) and in this case the Mailbox may be left partially updated, thus incoherent. The exception is if the move-in destination is an Rx FIFO Message Buffer, then the process cannot be cancelled.

The BUSY Bit (least significant bit of the CODE field) of the destination Message Buffer is asserted while the move-in is being performed in such a way that Arm beware that the Message Buffer content is temporarily incoherent.

26.6.6.2 Move-out

The move-out process is the copy of the content from a Tx Mailbox to the Tx SMB when a message for transmission is available (see [Arbitration process](#)). The move-out occurs in the following conditions:

- the first bit of Intermission field;
- during Bus off field when TX Error Counter is in the 124 to 128 range;
- during BusIdle field;
- during Wait For Bus Idle field.

The move-out process is not atomic. Only Arm has priority to access the memory concurrently out of BusIdle state. In BusIdle, the move-out has the lowest priority to the concurrent memory accesses.

26.6.7 Data Coherence

In order to maintain data coherency and FlexCAN proper operation, the Arm must obey the rules described in the [Transmit Process](#) and [Receive Process](#).

Any form of Arm accessing an MB structure within FlexCAN other than those specified may cause FlexCAN to behave in an unpredictable way.

26.6.7.1 Transmission Abort Mechanism

The abort mechanism provides a safe way to request the abortion of a pending transmission. A feedback mechanism is provided to inform Arm if the transmission was aborted or if the frame could not be aborted and was transmitted instead.

In order to abort a transmission, Arm must write a specific abort code (0b1001) to the CODE field of the Control and Status word. The active MBs configured as transmission must be aborted first and then they may be updated. If the abort code is written to a Mailbox that is currently being transmitted, or to a Mailbox that was already loaded into the SMB for transmission, the write operation is blocked and the MB is kept active, but the abort request is captured and kept pending until one of the following conditions are satisfied:

- The module loses the bus arbitration
- There is an error during the transmission
- The module is put into Freeze Mode
- The module enters in BusOff state
- There is an overload frame

If none of conditions above are reached, the MB is transmitted correctly, the interrupt flag is set in the IFLAG register and an interrupt to the Arm is generated (if enabled). The abort request is automatically cleared when the interrupt flag is set. In the other hand, if one of the above conditions is reached, the frame is not transmitted, therefore the abort code is written into the CODE field, the interrupt flag is set in the IFLAG and an interrupt is (optionally) generated to Arm.

If Arm writes the ABORT code before the transmission begins internally, then the write operation is not blocked, therefore the MB is updated and the interrupt flag is set. In this way Arm just needs to read the abort code to make sure the active MB was *safely inactivated*. Although the AEN bit is asserted and Arm wrote the abort code, in this case the MB is inactivated and not aborted, because the transmission did not start yet. One Mailbox is only aborted when the abort request is captured and kept pending until one of the previous conditions are satisfied.

The abort procedure can be summarized as follows:

1. Arm checks the corresponding IFLAG and clears it, if asserted.
2. Arm writes 0b1001 into the CODE field of the C/S word.
3. Arm waits for the corresponding IFLAG indicating that the frame was either transmitted or aborted.
4. Arm reads the CODE field to check if the frame was either transmitted (CODE=0b1000) or aborted (CODE=0b1001).
5. It is necessary to clear the corresponding IFLAG in order to allow the MB to be reconfigured.

26.6.7.2 Message Buffer Inactivation

Inactivation is a mechanism provided to protect the Mailbox against updates by the FlexCAN internal processes, thus allowing Arm to rely on Mailbox data coherence after having updated it, even in Normal Mode.

If a Mailbox is inactivated it does not participate neither in the arbitration nor in the matching process until it is reactivated. See [Transmit Process](#) and [Receive Process](#) for more detailed instruction on how to inactivate and reactivate a Mailbox.

In order to inactivate a Mailbox Arm must update its CODE field to INACTIVE (either 0b0000 or 0b1000).

As the user is not able to synchronize the CODE field update with the FlexCAN internal processes an inactivation can lead to undesirable results:

- a frame in the bus that matches the filtering of the inactivated Rx Mailbox may be lost without notice, even if there are other Mailboxes with the same filter;
- a frame containing the message within the inactivated Tx Mailbox may be transmitted without notice.

In order to eliminate such risk and perform a *safe inactivation* Arm must use the following mechanism along with the inactivation itself:

- for Tx Mailboxes, the Transmission Abort (see [Transmission Abort Mechanism](#));

The inactivation automatically unlocks the Mailbox (see [Message Buffer Lock Mechanism](#)).

Message Buffers that are part of the Rx FIFO cannot be inactivated. There is no write protection on FIFO region by FlexCAN. Arm must keep the data coherence into FIFO region when RFEN is asserted.

26.6.7.3 Message Buffer Lock Mechanism

Besides MB inactivation, FlexCAN has another data coherence mechanism for the receive process. When Arm reads the Control and Status word of an Rx MB with codes FULL or OVERRUN, FlexCAN assumes that Arm wants to read the whole MB in an atomic operation, and thus it sets an internal lock flag for that MB. The lock is released when Arm reads the Free Running Timer (global unlock operation), or when it reads the Control and Status word of another MB regardless of its code or when Arm writes into C/S word from locked MB. The MB locking is done to prevent a new frame to be written into the MB while Arm is reading it.

The locking mechanism only applies to Rx MBs that are not part of FIFO and have a code different than INACTIVE (0b0000) or EMPTY¹ (0b0100). Also, Tx MBs can not be locked.

Suppose, for example, that the FIFO is disabled and the second and the fifth MBs of the array are programmed with the same ID, and FlexCAN has already received and stored messages into these two MBs. Suppose now that the Arm decides to read MB number 5 and at the same time another message with the same ID is arriving. When Arm reads the Control and Status word of MB number 5, this MB is locked. The new message arrives and the matching algorithm finds out that there are no "free-to-receive" MBs, so it decides to override MB number 5. However, this MB is locked, so the new message can not be written there. It will remain in the SMB waiting for the MB to be unlocked, and only then will be written to the MB. If the MB is not unlocked in time and yet another new message with the same ID arrives, then the new message overwrites the one on the SMB and there will be no indication of lost messages either in the CODE field of the MB or in the Error and Status Register.

While the message is being moved-in from the SMB to the MB, the BUSY bit on the CODE field is asserted. If Arm reads the Control and Status word and finds out that the BUSY bit is set, it should defer accessing the MB until the BUSY bit is negated.

If the BUSY bit is asserted or if the MB is empty, then reading the Control and Status word does not lock the MB.

Inactivation takes precedence over locking. If Arm inactivates a locked Rx Mailbox, then its lock status is negated and the Mailbox is marked as invalid for the current matching round. Any pending message on the SMB will not be transferred anymore to the Mailbox. An MB is unlocked when Arm reads the Free Running Timer Register (see [Free Running Timer Register \(FLEXCAN_TIMER\)](#)), or the C/S word of another MB.

Lock and unlock mechanisms have the same functionality in both Normal and Freeze modes.

An unlock during Normal or Freeze mode results in the move-in of the pending message. However, the move-in is postponed if an unlock occurs during any of the low power modes (see in [Modes of Operation](#) specific information on Module Disable or Stop modes) and it will take place only when the module resumes to Normal or Freeze modes.

26.6.8 Rx FIFO

The receive-only FIFO is enabled by asserting the RFEN bit in the MCR.

1. In previous FlexCAN versions, reading the C/S word locks the MB even if it is EMPTY. This behavior is maintained when the IRMQ bit is negated.

The reset value of this bit is zero to maintain software backward compatibility with previous versions of the module that did not have the FIFO feature. The FIFO is 6-message deep, therefore when the FIFO is enabled, the memory region occupied by the first 6 Message Buffers is reserved for use of the FIFO engine (see [Rx FIFO Structure](#)). Arm can read the received messages sequentially, in the order they were received, by repeatedly reading a Message Buffer structure at the output of the FIFO.

The IFLAG[BUF5I] (Frames available in Rx FIFO) is asserted when there is at least one frame available to be read from the FIFO. An interrupt is generated if it is enabled by the corresponding mask bit. Upon receiving the interrupt, Arm can read the message (accessing the output of the FIFO as a Message Buffer) and the RXFIR register and then clear the interrupt. If there are more messages in the FIFO the act of clearing the interrupt updates the output of the FIFO with the next message and update the RXFIR with the attributes of that message, reissuing the interrupt to Arm. Otherwise, the flag remains negated. The output of the FIFO is only valid when the IFLAG[BUF5I] is asserted.

The IFLAG[BUF6I] (Rx FIFO Warning) is asserted when the number of unread messages within the Rx FIFO is increased to 5 from 4 due to the reception of a new one, meaning that the Rx FIFO is almost full. The flag remains asserted until Arm clears it.

The IFLAG[BUF7I] (Rx FIFO Overflow) is asserted when an incoming message was lost because the Rx FIFO is full. Note that the flag will not be asserted when the Rx FIFO is full and the message was captured by a Mailbox. The flag remains asserted until the Arm clears it.

Clearing one of those three flags does not affect the state of the other two.

An interrupt is generated if an IFLAG bit is asserted and the corresponding mask bit is asserted too.

A powerful filtering scheme is provided to accept only frames intended for the target application, thus reducing the interrupt servicing work load. The filtering criteria is specified by programming a table of up to 128 32-bit registers, according to CTRL2[RFFN] setting, that can be configured to one of the following formats (see also [Rx FIFO Structure](#)):

- Format A: 128 IDAFs (extended or standard IDs including IDE and RTR)
- Format B: 256 IDAFs (standard IDs or extended 14-bit ID slices including IDE and RTR)
- Format C: 512 IDAFs (standard or extended 8-bit ID slices)

Every frame available in the FIFO has a corresponding IDHIT (Identifier Acceptance Filter Hit Indicator) that can be read by accessing the RXFIR register. The RXFIR[IDHIT] field refers to the message at the output of the FIFO and is valid whilst

the IFLAG[BUF5I] flag is asserted. The RXFIR register must be read only before clearing the flag, which guarantees that the information refers to the correct frame within the FIFO.

Up to thirty two elements of the ID Filter Table are individually affected by the Individual Mask Registers (RXIMR0 - RXIMR31), according to CTRL2[RFFN] setting (refer to [Control 2 Register \(FLEXCAN_CTRL2\)](#)), allowing very powerful filtering criteria to be defined. If the MCR[IRMQ] bit is negated (or if the RXIMR are not available for the particular MCU), then the FIFO ID Filter Table is affected by RXFGMASK.

26.6.9 CAN Protocol Related Features

26.6.9.1 Remote Frames

Remote frame is a special kind of frame. The user can program a mailbox to be a Remote Request Frame by writing the mailbox as Transmit with the RTR bit set to '1'. After the remote request frame is transmitted successfully, the mailbox becomes a Receive Message Buffer, with the same ID as before.

When a remote request frame is received by FlexCAN, it can be treated in three ways, depending on Remote Request Storing (CTRL2[RRS]) and Rx FIFO Enable (MCR[RFEN]) bits:

- If RRS is negated the frame's ID is compared to the IDs of the Transmit Message Buffers with the CODE field 0b1010. If there is a matching ID, then this mailbox frame will be transmitted. Note that if the matching mailbox has the RTR bit set, then FlexCAN will transmit a remote frame as a response. The received remote request frame is not stored in a receive buffer. It is only used to trigger a transmission of a frame in response. The mask registers are not used in remote frame matching, and all ID bits (except RTR) of the incoming received frame should match. In the case that a remote request frame was received and matched a mailbox, this message buffer immediately enters the internal arbitration process, but is considered as normal Tx mailbox, with no higher priority. The data length of this frame is independent of the DLC field in the remote frame that initiated its transmission.
- If RRS is asserted the frame's ID is compared to the IDs of the receive mailboxes with the CODE field 0b0100, 0b0010 or 0b0110. If there is a matching ID, then this mailbox will store the remote frame in the same fashion of a data frame. No

automatic remote response frame will be generated. The mask registers are used in the matching process.

- If RFEN is asserted FlexCAN will not generate an automatic response for remote request frames that match the FIFO filtering criteria. If the remote frame matches one of the target IDs, it will be stored in the FIFO and presented to the Arm. Note that for filtering formats A and B, it is possible to select whether remote frames are accepted or not. For format C, remote frames are always accepted (if they match the ID). Remote Request Frames are considered as normal frames, and generate a FIFO overflow when a successful reception occurs and the FIFO is already full.

26.6.9.2 Overload Frames

FLEXCAN does transmit overload frames due to detection of following conditions on CAN bus:

- Detection of a dominant bit in the first/second bit of Intermission
- Detection of a dominant bit at the 7th bit (last) of End of Frame field (Rx frames)
- Detection of a dominant bit at the 8th bit (last) of Error Frame Delimiter or Overload Frame Delimiter

26.6.9.3 Time Stamp

The value of the Free Running Timer is sampled at the beginning of the Identifier field on the CAN bus, and is stored at the end of "move-in" in the TIME STAMP field, providing network behavior with respect to time.

Note that the Free Running Timer can be reset upon a specific frame reception, enabling network time synchronization. Refer to TSYN description in [Control 1 Register \(FLEXCAN_CTRL1\)](#).

26.6.9.4 Protocol Timing

The FLEXCAN module supports a variety of means to setup bit timing parameters that are required by the CAN protocol. The Control Register has various fields used to control bit timing parameters: PRES DIV, PROPSEG, PSEG1, PSEG2 and RJW. See [Control 1 Register \(FLEXCAN_CTRL1\)](#).

The PRES DIV field controls a prescaler that generates the Serial Clock (Sclock), whose period defines the 'time quantum' used to compose the CAN waveform. A time quantum is the atomic unit of time handled by the CAN engine.

$$f_{Tq} = \frac{f_{CANCLK}}{(\text{Prescaler value})}$$

A bit time is subdivided into three segments² (reference [Table 26-16](#)):

- SYNC_SEG: This segment has a fixed length of one time quantum. Signal edges are expected to happen within this section.
- Time Segment 1: This segment includes the Propagation Segment and the Phase Segment 1 of the CAN standard. It can be programmed by setting the PROPSEG and the PSEG1 fields of the CTRL Register so that their sum (plus 2) is in the range of 4 to 16 time quanta.
- Time Segment 2: This segment represents the Phase Segment 2 of the CAN standard. It can be programmed by setting the PSEG2 field of the CTRL Register (plus 1) to be 2 to 8 time quanta long.

$$\text{Bit Rate} = \frac{f_{Tq}}{(\text{number of Time Quanta})}$$

2. For further explanation of the underlying concepts please refer to ISO/DIS 11519-1, Section 10.3. Reference also the Bosch CAN 2.0A/B protocol specification dated September 1991 for bit timing.

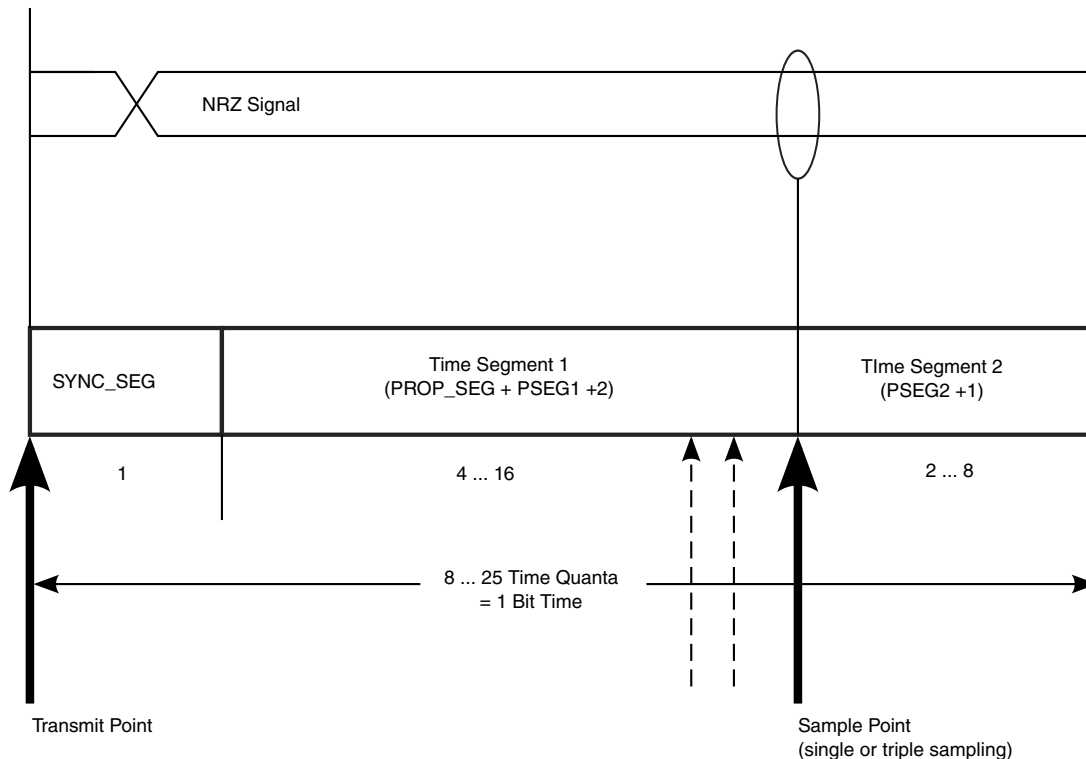

Figure 26-2. Segments within the Bit Time

Whenever CAN bit is used as a measure of duration (e.g. MCR[FRZ_ACK] and MCR[LPM_ACK] in [Module Configuration Register \(FLEXCAN_MCR\)](#)), the number of peripheral clocks in one CAN bit can be calculated as:

$$NCCP = \frac{f_{sys} \times [1 + (PSEG1 + 1) + (PSEG2 + 1) + (PROPSEG + 1)] \times (PRES DIV + 1)}{f_{CANCLK}}$$

where:

NCCP is the number of peripheral clocks in one CAN bit;

f_{CANCLK} is the Protocol Engine (PE) Clock in Hz;

f_{SYS} is the frequency of operation of the system (CHI) clock, in Hz;

PSEG1 is the value in CTRL1[PSEG1] field;

PSEG2 is the value in CTRL1[PSEG2] field;

PROPSEG is the value in CTRL1[PROPSEG] field;

PRES DIV is the value in CTRL1[PRES DIV] field.

For example, 180 CAN bits = 180 x NCCP peripheral clock periods.

Figure 26-2 gives an overview of the CAN compliant segment settings and the related parameter values.

Table 26-16. Time Segment Syntax

Syntax	Description
SYNC_SEG	System expects transitions to occur on the bus during this period.
Transmit Point	A node in transmit mode transfers a new value to the CAN bus at this point.
Sample Point	A node samples the bus at this point. If the three samples per bit option is selected, then this point marks the position of the third sample.

Table 26-17. CAN Standard Compliant Bit Time Segment Settings

Time Segment 1	Time Segment 2	Re-synchronization Jump Width
5 .. 10	2	1 .. 2
4 .. 11	3	1 .. 3
5 .. 12	4	1 .. 4
6 .. 13	5	1 .. 4
7 .. 14	6	1 .. 4
8 .. 15	7	1 .. 4
9 .. 16	8	1 .. 4

26.6.9.5 Arbitration and Matching Timing

During normal reception and transmission of frames, the matching, arbitration, move-in and move-out processes are executed during certain time windows inside the CAN frame, as shown in the following figures.

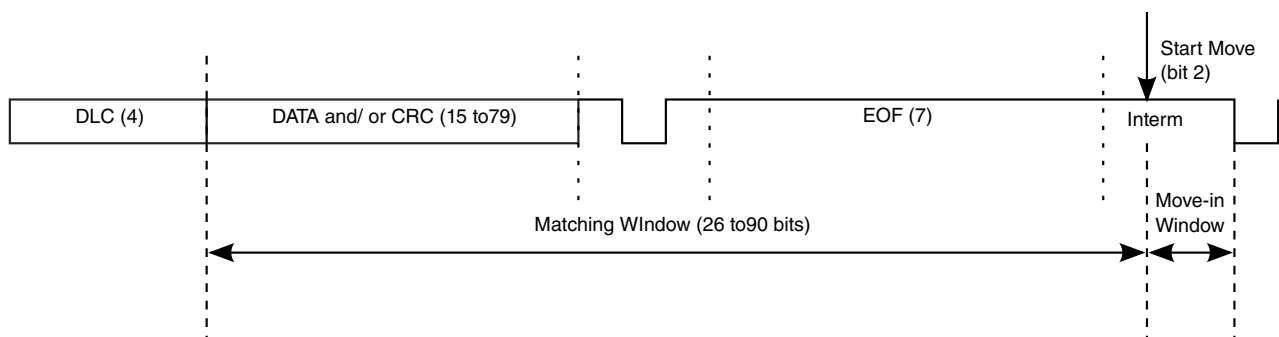

Figure 26-3. Matching and Move-In Time Windows

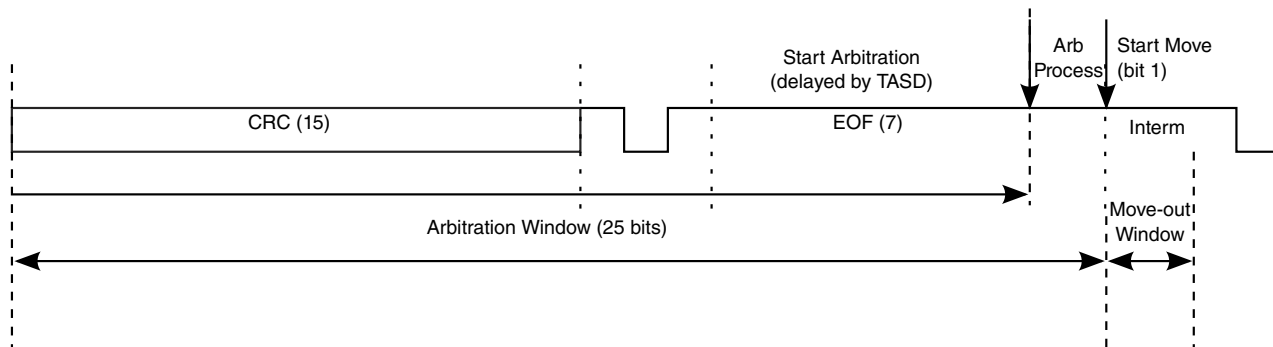

Figure 26-4. Arbitration and Move-Out Time Windows

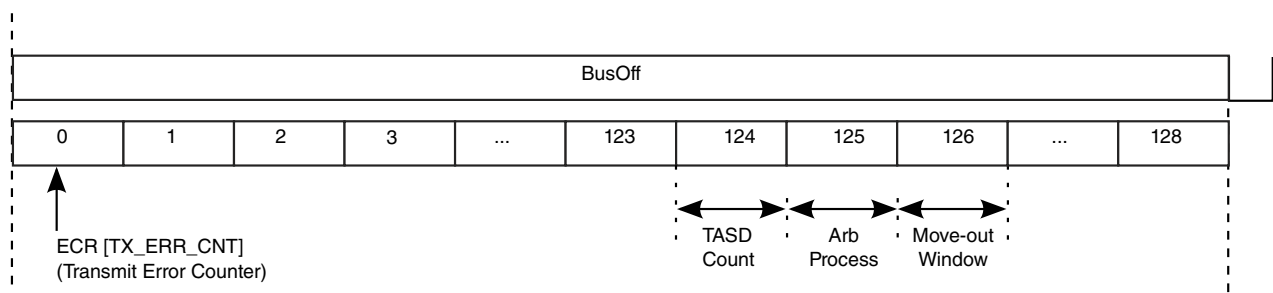

Figure 26-5. Arbitration at the end of Bus Off and Move-Out Time Windows

When doing matching and arbitration, FlexCAN needs to scan the whole Message Buffer memory during the available time window. In order to have sufficient time to do that, the following requirements must be observed:

- A valid CAN bit timing must be programmed, as indicated in [Table 26-17](#)
- The peripheral clock frequency can not be smaller than the oscillator clock frequency, i.e. the PLL can not be programmed to divide down the oscillator clock
- There must be a minimum ratio between the peripheral clock frequency and the CAN bit rate, as specified in the following table.

Table 26-18. Minimum Ratio Between Peripheral Clock Frequency and CAN Bit Rate

Number of Message Buffers	RFEN	Minimum Number of Peripheral Clocks per CAN bit
16 and 32	0	16
64	0	25
16	1	16
32	1	17
64	1	30

A direct consequence of the first requirement is that the minimum number of time quanta per CAN bit must be 8, so the oscillator clock frequency should be at least 8 times the CAN bit rate. The minimum frequency ratio specified in [Table 26-18](#) can be achieved by choosing a high enough peripheral clock frequency when compared to the oscillator clock frequency, or by adjusting one or more of the bit timing parameters (PRES DIV, PROPSEG, PSEG1, PSEG2). As an example, taking the case of 64 MBs, if the oscillator and peripheral clock frequencies are equal and the CAN bit timing is programmed to have 8 time quanta per bit, then the prescaler factor (PRES DIV + 1) should be at least 2. For prescaler factor equal to one and CAN bit timing with 8 time quanta per bit, the ratio between peripheral and oscillator clock frequencies should be at least 2.

26.6.10 Modes of Operation Details

The FlexCAN module has four functional modes (Normal Mode, Freeze Mode, Listen-Only Mode and Loop-Back Mode) and two low power modes (Disable Mode and Stop Mode). See in [Modes of Operation](#) an introductory description of all these modes of operation. The following sub-sections bring functional details on Freeze mode and the low power modes.

26.6.10.1 Freeze Mode

This mode is requested by Arm through the assertion of the HALT bit in the MCR Register or when the MCU is put into Debug Mode . In both cases it is also necessary that the FRZ bit is asserted in the MCR Register and the module is not in any of the low power modes (Disable, Stop). The acknowledgement is obtained through the assertion by the FlexCAN of FRZ_ACK bit in the same register. The Arm must only consider the FlexCAN in Freeze Mode when both request and acknowledgement conditions are satisfied.

When Freeze Mode is requested during transmission or reception, FlexCAN does the following:

- Waits to be in either Intermission, Passive Error, Bus Off or Idle state
- Waits for all internal activities like arbitration, matching, move-in and move-out to finish. Pending move-in is not taken in account
- Ignores the FLEXCAN_RX input pin and drives the FLEXCAN_TX pin as recessive
- Stops the prescaler, thus halting all CAN protocol activities
- Grants write access to the Error Counters Register, which is read-only in other modes
- Sets the NOT_RDY and FRZ_ACK bits in MCR

After requesting Freeze Mode, the user must wait for the FRZ_ACK bit to be asserted in MCR before executing any other action, otherwise FlexCAN may operate in an unpredictable way. In Freeze mode, all memory mapped registers are accessible, except for CTRL1[CLK_SRC] bit that can be read but cannot be written.

Exiting Freeze Mode is done in one of the following ways:

- Arm negates the FRZ bit in the MCR Register
- The Arm is removed from Debug Mode and the HALT bit is negated

The FRZ_ACK bit is negated after protocol engine recognizes the negation of freeze request. Once out of Freeze Mode, FlexCAN tries to re-synchronize to the CAN bus by waiting for 11 consecutive recessive bits.

26.6.10.2 Module Disable Mode

This low power mode is normally used to temporarily disable a complete FlexCAN block, with no power consumption. It is requested by the Arm through the assertion of the MDIS bit in the MCR Register and the acknowledgement is obtained through the assertion by the FlexCAN of the LPM_ACK bit in the same register. The Arm must only consider the FlexCAN in Disable Mode when both request and acknowledgement conditions are satisfied.

If the module is disabled during Freeze Mode, it requests to disable the clocks to the PE and CHI sub-modules, sets the LPM_ACK bit and negates the FRZ_ACK bit. The ability to shut down the clocks depends on how FlexCAN is integrated into the MCU. If the module is disabled during transmission or reception, FlexCAN does the following:

- Waits to be in either Idle or Bus Off state, or else waits for the third bit of Intermission and then checks it to be recessive
- Waits for all internal activities like arbitration, matching, move-in and move-out to finish. Pending move-in is not taken in account
- Ignores its FLEXCAN_RX input pin and drives its FLEXCAN_TX pin as recessive
- May shut down the clocks to the PE and CHI sub-modules, depending on how FlexCAN is integrated into the MCU
- Sets the NOT_RDY and LPM_ACK bits in MCR

The Bus Interface Unit continues to operate, enabling the Arm to access memory mapped registers, except the Rx Mailboxes Global Mask Registers, the Rx Buffer 14 Mask Register, the Rx Buffer 15 Mask Register, the Rx FIFO Global Mask Register. The Rx FIFO Information Register, the Message Buffers, the Rx Individual Mask Registers, and the reserved words within RAM may not be accessed when the module is in Disable Mode depending on how FlexCAN RAM is integrated into the Arm. Exiting from this

mode is done by negating the MDIS bit by Arm, which make FlexCAN requests to resume the clocks and negates the LPM_ACK bit after CAN protocol engine recognizes the negation of disable mode requested by Arm.

26.6.10.3 Stop Mode

This is a system low power mode in which system clocks can be stopped for maximum power savings. To enter stop mode, the CPU should manually assert a global Stop Mode request (see the CAN1_STOP_REQ and CAN2_STOP_REQ bit in the register IOMUXC_GPR4) and check the acknowledgement asserted by the FlexCAN (see the CAN1_STOP_ACK and CAN2_STOP_ACK in the register IOMUXC_GPR4). The CPU must only consider the FlexCAN in Stop Mode when both request and acknowledgement conditions are satisfied.

If FlexCAN receives the global Stop Mode request during Freeze Mode, it sets the LPM_ACK bit, negates the FRZ_ACK bit and then sends the Stop Acknowledge signal to the CPU, in order to shut down the clocks globally. If Stop Mode is requested during transmission or reception, FlexCAN does the following:

- Waits to be in either Idle or Bus Off state, or else waits for the third bit of Intermission and checks it to be recessive
- Waits for all internal activities like arbitration, matching, move-in and move-out to finish. Pending move-in is not taken in account
- Ignores its FLEXCAN_RX input pin and drives its FLEXCAN_TX pin as recessive
- Sets the NOT_RDY and LPM_ACK bits in MCR
- Sends a Stop Acknowledge signal to the CPU, so that it can shut down the clocks globally

Exiting Stop Mode is done in one of the following ways:

- Arm resuming the clocks and removing the Stop Mode request
- Arm resuming the clocks and Stop Mode request as a result of the Self Wake mechanism

In the Self Wake mechanism, if the SLF_WAK bit in MCR Register was set at the time FlexCAN entered Stop Mode, then upon detection of a recessive to dominant transition on the CAN bus, FlexCAN sets the WAK_INT bit in the ESR Register and, if enabled by the WAK_MSK bit in MCR, generates a Wake Up interrupt to the Arm. Upon receiving the interrupt, the Arm should resume the clocks and remove the Stop Mode request manually. FlexCAN will then wait for 11 consecutive recessive bits to synchronize to the CAN bus. As a consequence, it will not receive the frame that woke it up .

The sensitivity to CAN bus activity can be modified by applying a low-pass filter function to the FLEXCAN_RX input line while in Stop Mode. See the WAK_SRC bit in [Module Configuration Register \(FLEXCAN_MCR\)](#) . This feature can be used to protect FlexCAN from waking up due to short glitches on the CAN bus lines. Such glitches can result from electromagnetic interference within noisy environments, the glitch filter width can be set in [Glitch Filter Width Register \(FLEXCAN_GFWR\)](#).

26.6.11 Interrupts

The module can generate up to 70 interrupt sources (64 interrupts due to message buffers and 6 interrupts due to Ored interrupts from MBs, Bus Off, Error, Tx Warning, Rx Warning and Wake Up)).

The number of actual sources depends on the configured number of message buffers.

Each one of the message buffers can be an interrupt source, if its corresponding IMASK bit is set. There is no distinction between Tx and Rx interrupts for a particular buffer, under the assumption that the buffer is initialized for either transmission or reception. Each of the buffers has assigned a flag bit in the IFLAG Registers. The bit is set when the corresponding buffer completes a successful transmission/reception and is cleared when the Arm writes it to '1' (unless another interrupt is generated at the same time).

If the Rx FIFO is enabled (bit RFEN on MCR set), the interrupts corresponding to MBs 0 to 7 have a different behavior. Bit 7 of the IFLAG1 becomes the "FIFO Overflow" flag; bit 6 becomes the FIFO Warning flag, bit 5 becomes the "Frames Available in FIFO flag" and bits 4-0 are unused. See [Interrupt Flags 1 Register \(FLEXCAN_IFLAG1\)](#) for more information.

A combined interrupt for all MBs is also generated by an Or of all the interrupt sources from MBs. This interrupt gets generated when any of the Mailboxes or FIFO generates an interrupt. The Arm must read the IFLAG Registers to determine which MB or FIFO caused the interrupt.

The other 5 interrupt sources (Bus Off, Error, Tx Warning, Rx Warning and Wake Up generate interrupts like the MB ones, and can be read from both the Error and Status Register 1 and 2. The Bus Off, Error, Tx Warning and Rx Warning interrupt mask bits are located in the Control 1 Register and the Wake-Up interrupt mask bit is located in the MCR.

26.7 Initialization/Application Information

This section provide instructions for initializing the FLEXCAN module.

26.7.1 FLEXCAN Initialization Sequence

The FLEXCAN module may be reset in two ways:

- SOC level hard reset which resets all memory mapped registers asynchronously
- SOFT_RST bit in MCR, which resets some of the memory mapped registers synchronously

Soft reset is synchronous and has to follow an internal request/acknowledge procedure across clock domains. Therefore, it may take some time to fully propagate its effects. The SOFT_RST bit remains asserted while soft reset is pending, so software can poll this bit to know when the reset has completed. Also, soft reset can not be applied while clocks are shut down in any of the low power modes. The low power mode should be exited and the clocks resumed before applying soft reset.

After the module is enabled (MDIS bit negated), FLEXCAN automatically goes to Freeze Mode. In Freeze Mode, FLEXCAN is un-synchronized to the CAN bus, the HALT and FRZ bits in MCR Register are set, the internal state machines are disabled and the FRZ_ACK and NOT_RDY bits in the MCR Register are set. The FLEXCAN_TX pin is in recessive state and FLEXCAN does not initiate any transmission or reception of CAN frames. Note that the Message Buffers and the Rx Individual Mask Registers are not affected by reset, so they are not automatically initialized.

For any configuration change/initialization it is required that FLEXCAN is put into Freeze Mode. The following is a generic initialization sequence applicable to the FLEXCAN module:

- Initialize the Module Configuration Register
 - Enable the individual filtering per MB and reception queue features by setting the IRMQ bit
 - Enable the warning interrupts by setting the WRN_EN bit
 - If required, disable frame self reception by setting the SRX_DIS bit
 - Enable the FIFO by setting the RFEN bit
 - Enable the abort mechanism by setting the AEN bit
 - Enable the local priority feature by setting the LPRIO_EN bit
- Initialize the Control Register
 - Determine the bit timing parameters: PROPSEG, PSEG1, PSEG2, RJW
 - Determine the bit rate by programming the PRES DIV field
 - Determine the internal arbitration mode (LBUF bit)

- Initialize the Message Buffers
 - The Control and Status word of all Message Buffers must be initialized
 - If FIFO was enabled, the 8-entry ID table must be initialized
 - Other entries in each Message Buffer should be initialized as required
- Initialize the Rx Individual Mask Registers
- Set required interrupt mask bits in the IMASK Registers (for all MB interrupts), in CTRL Register (for Bus Off and Error interrupts) and in MCR Register for Wake-Up interrupt
- Negate the HALT bit in MCR

Starting with the last event, FLEXCAN attempts to synchronize to the CAN bus.

26.8 FLEXCAN Memory Map/Register Definition

The complete memory map for a FLEXCAN module with 64 MBs capability is shown in the following table. Each individual register is identified by its complete name and the corresponding mnemonic. The access type can be Supervisor (S) or Unrestricted (U). Most of the registers can be configured to have either Supervisor or Unrestricted access by programming the SUPV bit in the MCR Register. The MCR register allows only Supervisor access regardless the SUPV bit state.

The FLEXCAN module stores CAN messages for transmission and reception using a Mailboxes and Rx FIFO structure.

FLEXCAN memory map

Absolute address (hex)	Register name	Width (in bits)	Access	Reset value	Section/page
209_0000	Module Configuration Register (FLEXCAN1_MCR)	32	R/W	5980_000Fh	26.8.1/1293
209_0004	Control 1 Register (FLEXCAN1_CTRL1)	32	R/W	0000_0000h	26.8.2/1298
209_0008	Free Running Timer Register (FLEXCAN1_TIMER)	32	R/W	0000_0000h	26.8.3/1301
209_0010	Rx Mailboxes Global Mask Register (FLEXCAN1_RXMGMASK)	32	R/W	FFFF_FFFFh	26.8.4/1301
209_0014	Rx Buffer 14 Mask Register (FLEXCAN1_RX14MASK)	32	R/W	FFFF_FFFFh	26.8.5/1302
209_0018	Rx Buffer 15 Mask Register (FLEXCAN1_RX15MASK)	32	R/W	FFFF_FFFFh	26.8.6/1303
209_001C	Error Counter Register (FLEXCAN1_ECR)	32	R/W	0000_0000h	26.8.7/1304
209_0020	Error and Status 1 Register (FLEXCAN1_ESR1)	32	R/W	0000_0000h	26.8.8/1305
209_0024	Interrupt Masks 2 Register (FLEXCAN1_IMASK2)	32	R/W	0000_0000h	26.8.9/1309
209_0028	Interrupt Masks 1 Register (FLEXCAN1_IMASK1)	32	R/W	0000_0000h	26.8.10/1309

Table continues on the next page...

FLEXCAN memory map (continued)

Absolute address (hex)	Register name	Width (in bits)	Access	Reset value	Section/page
209_002C	Interrupt Flags 2 Register (FLEXCAN1_IFLAG2)	32	R/W	0000_0000h	26.8.11/ 1310
209_0030	Interrupt Flags 1 Register (FLEXCAN1_IFLAG1)	32	R/W	0000_0000h	26.8.12/ 1310
209_0034	Control 2 Register (FLEXCAN1_CTRL2)	32	R/W	0000_0000h	26.8.13/ 1312
209_0038	Error and Status 2 Register (FLEXCAN1_ESR2)	32	R	0000_0000h	26.8.14/ 1318
209_0044	CRC Register (FLEXCAN1_CRCCR)	32	R	0000_0000h	26.8.15/ 1320
209_0048	Rx FIFO Global Mask Register (FLEXCAN1_RXFGMASK)	32	R/W	FFFF_FFFFh	26.8.16/ 1321
209_004C	Rx FIFO Information Register (FLEXCAN1_RXFIR)	32	R	0000_0000h	26.8.17/ 1322
209_0880	Rx Individual Mask Registers (FLEXCAN1_RXIMR0)	32	R/W	0000_0000h	26.8.18/ 1323
209_0884	Rx Individual Mask Registers (FLEXCAN1_RXIMR1)	32	R/W	0000_0000h	26.8.18/ 1323
209_0888	Rx Individual Mask Registers (FLEXCAN1_RXIMR2)	32	R/W	0000_0000h	26.8.18/ 1323
209_088C	Rx Individual Mask Registers (FLEXCAN1_RXIMR3)	32	R/W	0000_0000h	26.8.18/ 1323
209_0890	Rx Individual Mask Registers (FLEXCAN1_RXIMR4)	32	R/W	0000_0000h	26.8.18/ 1323
209_0894	Rx Individual Mask Registers (FLEXCAN1_RXIMR5)	32	R/W	0000_0000h	26.8.18/ 1323
209_0898	Rx Individual Mask Registers (FLEXCAN1_RXIMR6)	32	R/W	0000_0000h	26.8.18/ 1323
209_089C	Rx Individual Mask Registers (FLEXCAN1_RXIMR7)	32	R/W	0000_0000h	26.8.18/ 1323
209_08A0	Rx Individual Mask Registers (FLEXCAN1_RXIMR8)	32	R/W	0000_0000h	26.8.18/ 1323
209_08A4	Rx Individual Mask Registers (FLEXCAN1_RXIMR9)	32	R/W	0000_0000h	26.8.18/ 1323
209_08A8	Rx Individual Mask Registers (FLEXCAN1_RXIMR10)	32	R/W	0000_0000h	26.8.18/ 1323
209_08AC	Rx Individual Mask Registers (FLEXCAN1_RXIMR11)	32	R/W	0000_0000h	26.8.18/ 1323
209_08B0	Rx Individual Mask Registers (FLEXCAN1_RXIMR12)	32	R/W	0000_0000h	26.8.18/ 1323
209_08B4	Rx Individual Mask Registers (FLEXCAN1_RXIMR13)	32	R/W	0000_0000h	26.8.18/ 1323
209_08B8	Rx Individual Mask Registers (FLEXCAN1_RXIMR14)	32	R/W	0000_0000h	26.8.18/ 1323

Table continues on the next page...

FLEXCAN memory map (continued)

Absolute address (hex)	Register name	Width (in bits)	Access	Reset value	Section/page
209_08BC	Rx Individual Mask Registers (FLEXCAN1_RXIMR15)	32	R/W	0000_0000h	26.8.18/1323
209_08C0	Rx Individual Mask Registers (FLEXCAN1_RXIMR16)	32	R/W	0000_0000h	26.8.18/1323
209_08C4	Rx Individual Mask Registers (FLEXCAN1_RXIMR17)	32	R/W	0000_0000h	26.8.18/1323
209_08C8	Rx Individual Mask Registers (FLEXCAN1_RXIMR18)	32	R/W	0000_0000h	26.8.18/1323
209_08CC	Rx Individual Mask Registers (FLEXCAN1_RXIMR19)	32	R/W	0000_0000h	26.8.18/1323
209_08D0	Rx Individual Mask Registers (FLEXCAN1_RXIMR20)	32	R/W	0000_0000h	26.8.18/1323
209_08D4	Rx Individual Mask Registers (FLEXCAN1_RXIMR21)	32	R/W	0000_0000h	26.8.18/1323
209_08D8	Rx Individual Mask Registers (FLEXCAN1_RXIMR22)	32	R/W	0000_0000h	26.8.18/1323
209_08DC	Rx Individual Mask Registers (FLEXCAN1_RXIMR23)	32	R/W	0000_0000h	26.8.18/1323
209_08E0	Rx Individual Mask Registers (FLEXCAN1_RXIMR24)	32	R/W	0000_0000h	26.8.18/1323
209_08E4	Rx Individual Mask Registers (FLEXCAN1_RXIMR25)	32	R/W	0000_0000h	26.8.18/1323
209_08E8	Rx Individual Mask Registers (FLEXCAN1_RXIMR26)	32	R/W	0000_0000h	26.8.18/1323
209_08EC	Rx Individual Mask Registers (FLEXCAN1_RXIMR27)	32	R/W	0000_0000h	26.8.18/1323
209_08F0	Rx Individual Mask Registers (FLEXCAN1_RXIMR28)	32	R/W	0000_0000h	26.8.18/1323
209_08F4	Rx Individual Mask Registers (FLEXCAN1_RXIMR29)	32	R/W	0000_0000h	26.8.18/1323
209_08F8	Rx Individual Mask Registers (FLEXCAN1_RXIMR30)	32	R/W	0000_0000h	26.8.18/1323
209_08FC	Rx Individual Mask Registers (FLEXCAN1_RXIMR31)	32	R/W	0000_0000h	26.8.18/1323
209_0900	Rx Individual Mask Registers (FLEXCAN1_RXIMR32)	32	R/W	0000_0000h	26.8.18/1323
209_0904	Rx Individual Mask Registers (FLEXCAN1_RXIMR33)	32	R/W	0000_0000h	26.8.18/1323
209_0908	Rx Individual Mask Registers (FLEXCAN1_RXIMR34)	32	R/W	0000_0000h	26.8.18/1323
209_090C	Rx Individual Mask Registers (FLEXCAN1_RXIMR35)	32	R/W	0000_0000h	26.8.18/1323
209_0910	Rx Individual Mask Registers (FLEXCAN1_RXIMR36)	32	R/W	0000_0000h	26.8.18/1323

Table continues on the next page...

FLEXCAN memory map (continued)

Absolute address (hex)	Register name	Width (in bits)	Access	Reset value	Section/page
209_0914	Rx Individual Mask Registers (FLEXCAN1_RXIMR37)	32	R/W	0000_0000h	26.8.18/1323
209_0918	Rx Individual Mask Registers (FLEXCAN1_RXIMR38)	32	R/W	0000_0000h	26.8.18/1323
209_091C	Rx Individual Mask Registers (FLEXCAN1_RXIMR39)	32	R/W	0000_0000h	26.8.18/1323
209_0920	Rx Individual Mask Registers (FLEXCAN1_RXIMR40)	32	R/W	0000_0000h	26.8.18/1323
209_0924	Rx Individual Mask Registers (FLEXCAN1_RXIMR41)	32	R/W	0000_0000h	26.8.18/1323
209_0928	Rx Individual Mask Registers (FLEXCAN1_RXIMR42)	32	R/W	0000_0000h	26.8.18/1323
209_092C	Rx Individual Mask Registers (FLEXCAN1_RXIMR43)	32	R/W	0000_0000h	26.8.18/1323
209_0930	Rx Individual Mask Registers (FLEXCAN1_RXIMR44)	32	R/W	0000_0000h	26.8.18/1323
209_0934	Rx Individual Mask Registers (FLEXCAN1_RXIMR45)	32	R/W	0000_0000h	26.8.18/1323
209_0938	Rx Individual Mask Registers (FLEXCAN1_RXIMR46)	32	R/W	0000_0000h	26.8.18/1323
209_093C	Rx Individual Mask Registers (FLEXCAN1_RXIMR47)	32	R/W	0000_0000h	26.8.18/1323
209_0940	Rx Individual Mask Registers (FLEXCAN1_RXIMR48)	32	R/W	0000_0000h	26.8.18/1323
209_0944	Rx Individual Mask Registers (FLEXCAN1_RXIMR49)	32	R/W	0000_0000h	26.8.18/1323
209_0948	Rx Individual Mask Registers (FLEXCAN1_RXIMR50)	32	R/W	0000_0000h	26.8.18/1323
209_094C	Rx Individual Mask Registers (FLEXCAN1_RXIMR51)	32	R/W	0000_0000h	26.8.18/1323
209_0950	Rx Individual Mask Registers (FLEXCAN1_RXIMR52)	32	R/W	0000_0000h	26.8.18/1323
209_0954	Rx Individual Mask Registers (FLEXCAN1_RXIMR53)	32	R/W	0000_0000h	26.8.18/1323
209_0958	Rx Individual Mask Registers (FLEXCAN1_RXIMR54)	32	R/W	0000_0000h	26.8.18/1323
209_095C	Rx Individual Mask Registers (FLEXCAN1_RXIMR55)	32	R/W	0000_0000h	26.8.18/1323
209_0960	Rx Individual Mask Registers (FLEXCAN1_RXIMR56)	32	R/W	0000_0000h	26.8.18/1323
209_0964	Rx Individual Mask Registers (FLEXCAN1_RXIMR57)	32	R/W	0000_0000h	26.8.18/1323
209_0968	Rx Individual Mask Registers (FLEXCAN1_RXIMR58)	32	R/W	0000_0000h	26.8.18/1323

Table continues on the next page...

FLEXCAN memory map (continued)

Absolute address (hex)	Register name	Width (in bits)	Access	Reset value	Section/page
209_096C	Rx Individual Mask Registers (FLEXCAN1_RXIMR59)	32	R/W	0000_0000h	26.8.18/1323
209_0970	Rx Individual Mask Registers (FLEXCAN1_RXIMR60)	32	R/W	0000_0000h	26.8.18/1323
209_0974	Rx Individual Mask Registers (FLEXCAN1_RXIMR61)	32	R/W	0000_0000h	26.8.18/1323
209_0978	Rx Individual Mask Registers (FLEXCAN1_RXIMR62)	32	R/W	0000_0000h	26.8.18/1323
209_097C	Rx Individual Mask Registers (FLEXCAN1_RXIMR63)	32	R/W	0000_0000h	26.8.18/1323
209_09E0	Glitch Filter Width Registers (FLEXCAN1_GFWR)	32	R/W	0000_007Fh	26.8.19/1323
209_4000	Module Configuration Register (FLEXCAN2_MCR)	32	R/W	5980_000Fh	26.8.1/1293
209_4004	Control 1 Register (FLEXCAN2_CTRL1)	32	R/W	0000_0000h	26.8.2/1298
209_4008	Free Running Timer Register (FLEXCAN2_TIMER)	32	R/W	0000_0000h	26.8.3/1301
209_4010	Rx Mailboxes Global Mask Register (FLEXCAN2_RXMGMASK)	32	R/W	FFFF_FFFFh	26.8.4/1301
209_4014	Rx Buffer 14 Mask Register (FLEXCAN2_RX14MASK)	32	R/W	FFFF_FFFFh	26.8.5/1302
209_4018	Rx Buffer 15 Mask Register (FLEXCAN2_RX15MASK)	32	R/W	FFFF_FFFFh	26.8.6/1303
209_401C	Error Counter Register (FLEXCAN2_ECR)	32	R/W	0000_0000h	26.8.7/1304
209_4020	Error and Status 1 Register (FLEXCAN2_ESR1)	32	R/W	0000_0000h	26.8.8/1305
209_4024	Interrupt Masks 2 Register (FLEXCAN2_IMASK2)	32	R/W	0000_0000h	26.8.9/1309
209_4028	Interrupt Masks 1 Register (FLEXCAN2_IMASK1)	32	R/W	0000_0000h	26.8.10/1309
209_402C	Interrupt Flags 2 Register (FLEXCAN2_IFLAG2)	32	R/W	0000_0000h	26.8.11/1310
209_4030	Interrupt Flags 1 Register (FLEXCAN2_IFLAG1)	32	R/W	0000_0000h	26.8.12/1310
209_4034	Control 2 Register (FLEXCAN2_CTRL2)	32	R/W	0000_0000h	26.8.13/1312
209_4038	Error and Status 2 Register (FLEXCAN2_ESR2)	32	R	0000_0000h	26.8.14/1318
209_4044	CRC Register (FLEXCAN2_CRCCR)	32	R	0000_0000h	26.8.15/1320
209_4048	Rx FIFO Global Mask Register (FLEXCAN2_RXFGMASK)	32	R/W	FFFF_FFFFh	26.8.16/1321
209_404C	Rx FIFO Information Register (FLEXCAN2_RXFIR)	32	R	0000_0000h	26.8.17/1322
209_4880	Rx Individual Mask Registers (FLEXCAN2_RXIMR0)	32	R/W	0000_0000h	26.8.18/1323
209_4884	Rx Individual Mask Registers (FLEXCAN2_RXIMR1)	32	R/W	0000_0000h	26.8.18/1323

Table continues on the next page...

FLEXCAN memory map (continued)

Absolute address (hex)	Register name	Width (in bits)	Access	Reset value	Section/page
209_4888	Rx Individual Mask Registers (FLEXCAN2_RXIMR2)	32	R/W	0000_0000h	26.8.18/1323
209_488C	Rx Individual Mask Registers (FLEXCAN2_RXIMR3)	32	R/W	0000_0000h	26.8.18/1323
209_4890	Rx Individual Mask Registers (FLEXCAN2_RXIMR4)	32	R/W	0000_0000h	26.8.18/1323
209_4894	Rx Individual Mask Registers (FLEXCAN2_RXIMR5)	32	R/W	0000_0000h	26.8.18/1323
209_4898	Rx Individual Mask Registers (FLEXCAN2_RXIMR6)	32	R/W	0000_0000h	26.8.18/1323
209_489C	Rx Individual Mask Registers (FLEXCAN2_RXIMR7)	32	R/W	0000_0000h	26.8.18/1323
209_48A0	Rx Individual Mask Registers (FLEXCAN2_RXIMR8)	32	R/W	0000_0000h	26.8.18/1323
209_48A4	Rx Individual Mask Registers (FLEXCAN2_RXIMR9)	32	R/W	0000_0000h	26.8.18/1323
209_48A8	Rx Individual Mask Registers (FLEXCAN2_RXIMR10)	32	R/W	0000_0000h	26.8.18/1323
209_48AC	Rx Individual Mask Registers (FLEXCAN2_RXIMR11)	32	R/W	0000_0000h	26.8.18/1323
209_48B0	Rx Individual Mask Registers (FLEXCAN2_RXIMR12)	32	R/W	0000_0000h	26.8.18/1323
209_48B4	Rx Individual Mask Registers (FLEXCAN2_RXIMR13)	32	R/W	0000_0000h	26.8.18/1323
209_48B8	Rx Individual Mask Registers (FLEXCAN2_RXIMR14)	32	R/W	0000_0000h	26.8.18/1323
209_48BC	Rx Individual Mask Registers (FLEXCAN2_RXIMR15)	32	R/W	0000_0000h	26.8.18/1323
209_48C0	Rx Individual Mask Registers (FLEXCAN2_RXIMR16)	32	R/W	0000_0000h	26.8.18/1323
209_48C4	Rx Individual Mask Registers (FLEXCAN2_RXIMR17)	32	R/W	0000_0000h	26.8.18/1323
209_48C8	Rx Individual Mask Registers (FLEXCAN2_RXIMR18)	32	R/W	0000_0000h	26.8.18/1323
209_48CC	Rx Individual Mask Registers (FLEXCAN2_RXIMR19)	32	R/W	0000_0000h	26.8.18/1323
209_48D0	Rx Individual Mask Registers (FLEXCAN2_RXIMR20)	32	R/W	0000_0000h	26.8.18/1323
209_48D4	Rx Individual Mask Registers (FLEXCAN2_RXIMR21)	32	R/W	0000_0000h	26.8.18/1323
209_48D8	Rx Individual Mask Registers (FLEXCAN2_RXIMR22)	32	R/W	0000_0000h	26.8.18/1323
209_48DC	Rx Individual Mask Registers (FLEXCAN2_RXIMR23)	32	R/W	0000_0000h	26.8.18/1323

Table continues on the next page...

FLEXCAN memory map (continued)

Absolute address (hex)	Register name	Width (in bits)	Access	Reset value	Section/page
209_48E0	Rx Individual Mask Registers (FLEXCAN2_RXIMR24)	32	R/W	0000_0000h	26.8.18/1323
209_48E4	Rx Individual Mask Registers (FLEXCAN2_RXIMR25)	32	R/W	0000_0000h	26.8.18/1323
209_48E8	Rx Individual Mask Registers (FLEXCAN2_RXIMR26)	32	R/W	0000_0000h	26.8.18/1323
209_48EC	Rx Individual Mask Registers (FLEXCAN2_RXIMR27)	32	R/W	0000_0000h	26.8.18/1323
209_48F0	Rx Individual Mask Registers (FLEXCAN2_RXIMR28)	32	R/W	0000_0000h	26.8.18/1323
209_48F4	Rx Individual Mask Registers (FLEXCAN2_RXIMR29)	32	R/W	0000_0000h	26.8.18/1323
209_48F8	Rx Individual Mask Registers (FLEXCAN2_RXIMR30)	32	R/W	0000_0000h	26.8.18/1323
209_48FC	Rx Individual Mask Registers (FLEXCAN2_RXIMR31)	32	R/W	0000_0000h	26.8.18/1323
209_4900	Rx Individual Mask Registers (FLEXCAN2_RXIMR32)	32	R/W	0000_0000h	26.8.18/1323
209_4904	Rx Individual Mask Registers (FLEXCAN2_RXIMR33)	32	R/W	0000_0000h	26.8.18/1323
209_4908	Rx Individual Mask Registers (FLEXCAN2_RXIMR34)	32	R/W	0000_0000h	26.8.18/1323
209_490C	Rx Individual Mask Registers (FLEXCAN2_RXIMR35)	32	R/W	0000_0000h	26.8.18/1323
209_4910	Rx Individual Mask Registers (FLEXCAN2_RXIMR36)	32	R/W	0000_0000h	26.8.18/1323
209_4914	Rx Individual Mask Registers (FLEXCAN2_RXIMR37)	32	R/W	0000_0000h	26.8.18/1323
209_4918	Rx Individual Mask Registers (FLEXCAN2_RXIMR38)	32	R/W	0000_0000h	26.8.18/1323
209_491C	Rx Individual Mask Registers (FLEXCAN2_RXIMR39)	32	R/W	0000_0000h	26.8.18/1323
209_4920	Rx Individual Mask Registers (FLEXCAN2_RXIMR40)	32	R/W	0000_0000h	26.8.18/1323
209_4924	Rx Individual Mask Registers (FLEXCAN2_RXIMR41)	32	R/W	0000_0000h	26.8.18/1323
209_4928	Rx Individual Mask Registers (FLEXCAN2_RXIMR42)	32	R/W	0000_0000h	26.8.18/1323
209_492C	Rx Individual Mask Registers (FLEXCAN2_RXIMR43)	32	R/W	0000_0000h	26.8.18/1323
209_4930	Rx Individual Mask Registers (FLEXCAN2_RXIMR44)	32	R/W	0000_0000h	26.8.18/1323
209_4934	Rx Individual Mask Registers (FLEXCAN2_RXIMR45)	32	R/W	0000_0000h	26.8.18/1323

Table continues on the next page...

FLEXCAN memory map (continued)

Absolute address (hex)	Register name	Width (in bits)	Access	Reset value	Section/page
209_4938	Rx Individual Mask Registers (FLEXCAN2_RXIMR46)	32	R/W	0000_0000h	26.8.18/ 1323
209_493C	Rx Individual Mask Registers (FLEXCAN2_RXIMR47)	32	R/W	0000_0000h	26.8.18/ 1323
209_4940	Rx Individual Mask Registers (FLEXCAN2_RXIMR48)	32	R/W	0000_0000h	26.8.18/ 1323
209_4944	Rx Individual Mask Registers (FLEXCAN2_RXIMR49)	32	R/W	0000_0000h	26.8.18/ 1323
209_4948	Rx Individual Mask Registers (FLEXCAN2_RXIMR50)	32	R/W	0000_0000h	26.8.18/ 1323
209_494C	Rx Individual Mask Registers (FLEXCAN2_RXIMR51)	32	R/W	0000_0000h	26.8.18/ 1323
209_4950	Rx Individual Mask Registers (FLEXCAN2_RXIMR52)	32	R/W	0000_0000h	26.8.18/ 1323
209_4954	Rx Individual Mask Registers (FLEXCAN2_RXIMR53)	32	R/W	0000_0000h	26.8.18/ 1323
209_4958	Rx Individual Mask Registers (FLEXCAN2_RXIMR54)	32	R/W	0000_0000h	26.8.18/ 1323
209_495C	Rx Individual Mask Registers (FLEXCAN2_RXIMR55)	32	R/W	0000_0000h	26.8.18/ 1323
209_4960	Rx Individual Mask Registers (FLEXCAN2_RXIMR56)	32	R/W	0000_0000h	26.8.18/ 1323
209_4964	Rx Individual Mask Registers (FLEXCAN2_RXIMR57)	32	R/W	0000_0000h	26.8.18/ 1323
209_4968	Rx Individual Mask Registers (FLEXCAN2_RXIMR58)	32	R/W	0000_0000h	26.8.18/ 1323
209_496C	Rx Individual Mask Registers (FLEXCAN2_RXIMR59)	32	R/W	0000_0000h	26.8.18/ 1323
209_4970	Rx Individual Mask Registers (FLEXCAN2_RXIMR60)	32	R/W	0000_0000h	26.8.18/ 1323
209_4974	Rx Individual Mask Registers (FLEXCAN2_RXIMR61)	32	R/W	0000_0000h	26.8.18/ 1323
209_4978	Rx Individual Mask Registers (FLEXCAN2_RXIMR62)	32	R/W	0000_0000h	26.8.18/ 1323
209_497C	Rx Individual Mask Registers (FLEXCAN2_RXIMR63)	32	R/W	0000_0000h	26.8.18/ 1323
209_49E0	Glitch Filter Width Registers (FLEXCAN2_GFWR)	32	R/W	0000_007Fh	26.8.19/ 1323

26.8.1 Module Configuration Register (FLEXCANx_MCR)

This register defines global system configurations, such as the module operation mode (e.g., low power) and maximum message buffer configuration.

FLEXCAN Memory Map/Register Definition

Address: Base address + 0h offset

Bit	31	30	29	28	27	26	25	24	23	22	21	20	19	18	17	16
R																
W																
Reset	0	1	0	1	1	0	0	1	1	0	0	0	0	0	0	0
	MDIS	FRZ	RFEN	HALT	NOT_RDY	WAK_MSK	SOFT_RST	FRZ_ACK	SUPV	SLF_WAK	WRN_EN	LPM_ACK	WAK_SRC	Reserved	SRX_DIS	IRMQ
Bit	15	14	13	12	11	10	9	8	7	6	5	4	3	2	1	0
R																
W																
Reset	0	0	0	0	0	0	0	0	0	0	0	0	1	1	1	1
	Reserved	Reserved	LPRIO_EN	AEN	Reserved	IDAM	Reserved	Reserved	Reserved	Reserved	Reserved	Reserved	Reserved	Reserved	MAXMB	MAXMB

FLEXCANx_MCR field descriptions

Field	Description
31 MDIS	<p>This bit controls whether FLEXCAN is enabled or not. When disabled, FLEXCAN shuts down the clocks to the CAN Protocol Interface and Message Buffer Management sub-modules. This is the only bit in MCR not affected by soft reset. See Module Disable Mode for more information.</p> <p>1 Disable the FLEXCAN module 0 Enable the FLEXCAN module</p>
30 FRZ	<p>The FRZ bit specifies the FLEXCAN behavior when the HALT bit in the MCR Register is set or when Debug Mode is requested at Arm level. When FRZ is asserted, FLEXCAN is enabled to enter Freeze Mode. Negation of this bit field causes FLEXCAN to exit from Freeze Mode.</p> <p>1 Enabled to enter Freeze Mode 0 Not enabled to enter Freeze Mode</p>
29 RFEN	<p>This bit controls whether the Rx FIFO feature is enabled or not. When RFEN is set, MBs 0 to 5 cannot be used for normal reception and transmission because the corresponding memory region (0x80-0xDC) is used by the FIFO engine as well as additional MBs (up to 32, depending on CTRL2[RFFN] setting) which are used as Rx FIFO ID Filter Table elements. RFEN also impacts the definition of the minimum number of peripheral clocks per CAN bit as described in Table 26-18 (see Arbitration and Matching Timing). This bit can only be written in Freeze mode as it is blocked by hardware in other modes.</p> <p>1 FIFO enabled 0 FIFO not enabled</p>
28 HALT	<p>Assertion of this bit puts the FLEXCAN module into Freeze Mode. The Arm should clear it after initializing the Message Buffers and Control Register. No reception or transmission is performed by FLEXCAN before this bit is cleared. Freeze Mode can not be entered while FLEXCAN is in any of the low power modes. See Freeze Mode for more information.</p> <p>1 Enters Freeze Mode if the FRZ bit is asserted. 0 No Freeze Mode request.</p>
27 NOT_RDY	<p>This read-only bit indicates that FLEXCAN is either in Disable Mode, Stop Mode or Freeze Mode. It is negated once FLEXCAN has exited these modes.</p> <p>1 FLEXCAN module is either in Disable Mode, Stop Mode or Freeze Mode 0 FLEXCAN module is either in Normal Mode, Listen-Only Mode or Loop-Back Mode</p>
26 WAK_MSK	<p>This bit enables the Wake Up Interrupt generation.</p> <p>1 Wake Up Interrupt is enabled 0 Wake Up Interrupt is disabled</p>
25 SOFT_RST	<p>When this bit is asserted, FlexCAN resets its internal state machines and some of the memory mapped registers. The following registers are reset: MCR (except the MDIS bit), TIMER, ECR, ESR1, ESR2, IMASK1, IMASK2, IFLAG1, IFLAG2 and CRCR. Configuration registers that control the interface to the CAN bus are not affected by soft reset. The following registers are unaffected: CTRL1, CTRL2, RXIMR0_RXIMR63, RXGMASK, RX14MASK, RX15MASK, RXFGMASK, RXFIR and all Message Buffers</p> <p>The SOFT_RST bit can be asserted directly by the Arm when it writes to the MCR Register. It may take some time to fully propagate its effect. The SOFT_RST bit remains asserted while reset is pending, and is automatically negated when reset completes. Therefore, software can poll this bit to know when the soft reset has completed.</p> <p>Soft reset cannot be applied while clocks are shut down in any of the low power modes. The module should be first removed from low power mode, and then soft reset can be applied.</p>

Table continues on the next page...

FLEXCANx_MCR field descriptions (continued)

Field	Description
	<p>1 Reset the registers 0 No reset request</p>
24 FRZ_ACK	<p>This read-only bit indicates that FLEXCAN is in Freeze Mode and its prescaler is stopped. The Freeze Mode request cannot be granted until current transmission or reception processes have finished. Therefore the software can poll the FRZ_ACK bit to know when FLEXCAN has actually entered Freeze Mode. If Freeze Mode request is negated, then this bit is negated once the FLEXCAN prescaler is running again. If Freeze Mode is requested while FLEXCAN is in any of the low power modes, then the FRZ_ACK bit will only be set when the low power mode is exited. See Freeze Mode for more information</p> <p>1 FLEXCAN in Freeze Mode, prescaler stopped 0 FLEXCAN not in Freeze Mode, prescaler running</p>
23 SUPV	<p>This bit configures some of the FLEXCAN registers to be either in Supervisor or User Mode. Reset value of this bit is '1', so the affected registers start with Supervisor access allowance only. This bit can only be written in Freeze mode as it is blocked by hardware in other modes.</p> <p>1 FlexCAN is in Supervisor Mode. Affected registers allow only Supervisor access. Unrestricted access behaves as though the access was done to an unimplemented register location 0 FlexCAN is in User Mode. Affected registers allow both Supervisor and Unrestricted accesses</p>
22 SLF_WAK	<p>This bit enables the Self Wake Up feature when FLEXCAN is in Stop Mode. If this bit had been asserted by the time FLEXCAN entered Stop Mode, then FLEXCAN will look for a recessive to dominant transition on the bus during these modes. If a transition from recessive to dominant is detected during Stop Mode, then FLEXCAN generates, if enabled to do so, a Wake Up interrupt to the Arm so that it can resume the clocks globally and FlexCAN can request to resume the clocks. This bit can not be written while the module is in Stop Mode.</p> <p>1 FLEXCAN Self Wake Up feature is enabled 0 FLEXCAN Self Wake Up feature is disabled</p>
21 WRN_EN	<p>When asserted, this bit enables the generation of the TWRN_INT and RWRN_INT flags in the Error and Status Register. If WRN_EN is negated, the TWRN_INT and RWRN_INT flags will always be zero, independent of the values of the error counters, and no warning interrupt will ever be generated. This bit can only be written in Freeze mode as it is blocked by hardware in other modes.</p> <p>1 TWRN_INT and RWRN_INT bits are set when the respective error counter transition from <96 to ≥ 96. 0 TWRN_INT and RWRN_INT bits are zero, independent of the values in the error counters.</p>
20 LPM_ACK	<p>This read-only bit indicates that FLEXCAN is either in Disable Mode or Stop Mode. Either of these low power modes can not be entered until all current transmission or reception processes have finished, so the Arm can poll the LPM_ACK bit to know when FLEXCAN has actually entered low power mode. See Module Disable Mode, and Stop Mode for more information</p> <p>1 FLEXCAN is either in Disable Mode, or Stop mode 0 FLEXCAN not in any of the low power modes</p>
19 WAK_SRC	<p>This bit defines whether the integrated low-pass filter is applied to protect the FLEXCAN_RX input from spurious wake up. See Stop Mode for more information. This bit can only be written in Freeze mode as it is blocked by hardware in other modes.</p> <p>1 FLEXCAN uses the filtered FLEXCAN_RX input to detect recessive to dominant edges on the CAN bus 0 FLEXCAN uses the unfiltered FLEXCAN_RX input to detect recessive to dominant edges on the CAN bus.</p>
18 -	<p>This field is reserved. Reserved</p>

Table continues on the next page...

FLEXCANx_MCR field descriptions (continued)

Field	Description
17 SRX_DIS	This bit defines whether FlexCAN is allowed to receive frames transmitted by itself. If this bit is asserted, frames transmitted by the module will not be stored in any MB, regardless if the MB is programmed with an ID that matches the transmitted frame, and no interrupt flag or interrupt signal will be generated due to the frame reception. This bit can only be written in Freeze mode as it is blocked by hardware in other modes. 1 Self reception disabled 0 Self reception enabled
16 IRMQ	This bit indicates whether Rx matching process will be based either on individual masking and queue or on masking scheme with RXMGMASK, RX14MASK and RX15MASK, RXFGMASK. This bit can only be written in Freeze mode as it is blocked by hardware in other modes. 1 Individual Rx masking and queue feature are enabled. 0 Individual Rx masking and queue feature are disabled. For backward compatibility, the reading of C/S word locks the MB even if it is EMPTY.
15–14 -	This field is reserved. Reserved
13 LPRIO_EN	This bit is provided for backwards compatibility reasons. It controls whether the local priority feature is enabled or not. It is used to extend the ID used during the arbitration process. With this extended ID concept, the arbitration process is done based on the full 32-bit word, but the actual transmitted ID still has 11-bit for standard frames and 29-bit for extended frames. This bit can only be written in Freeze mode as it is blocked by hardware in other modes. 1 Local Priority enabled 0 Local Priority disabled
12 AEN	This bit is supplied for backwards compatibility reasons. When asserted, it enables the Tx abort feature. This feature guarantees a safe procedure for aborting a pending transmission, so that no frame is sent in the CAN bus without notification. This bit can only be written in Freeze mode as it is blocked by hardware in other modes. Write Abort code into Rx Mailboxes can cause unpredictable results when the MCR[AEN] is asserted. 1 Abort enabled 0 Abort disabled
11–10 -	This field is reserved. Reserved
9–8 IDAM	This 2-bit field identifies the format of the elements of the Rx FIFO filter table, as shown below. Note that all elements of the table are configured at the same time by this field (they are all the same format). See Rx FIFO Structure . This bit can only be written in Freeze mode as it is blocked by hardware in other modes. 00 Format A One full ID (standard or extended) per ID filter Table element. 01 Format B Two full standard IDs or two partial 14-bit extended IDs per ID filter Table element. 10 Format C Four partial 8-bit IDs (standard or extended) per ID filter Table element. 11 Format D All frames rejected.
7 -	This field is reserved. Reserved
MAXMB	This 7-bit field defines the number of the last Message Buffers that will take part in the matching and arbitration processes. The reset value (0x0F) is equivalent to 16 MB configuration. This field can only be written in Freeze Mode as it is blocked by hardware in other modes Number of the last MB = MAXMB.

Table continues on the next page...

FLEXCANx_MCR field descriptions (continued)

Field	Description
	NOTE: Additionally, the value of MAXMB must encompass the FIFO size defined by CTRL2[RFFN] MAXMB also impacts the definition of the minimum number of peripheral clocks per CAN bit as described in Table 26-18 (see Arbitration and Matching Timing).

26.8.2 Control 1 Register (FLEXCANx_CTRL1)

This register is defined for specific FLEXCAN control features related to the CAN bus, such as bit-rate, programmable sampling point within an Rx bit, Loop Back Mode, Listen Only Mode, Bus Off recovery behavior and interrupt enabling (Bus-Off, Error, Warning). It also determines the Division Factor for the clock prescaler.

Address: Base address + 4h offset

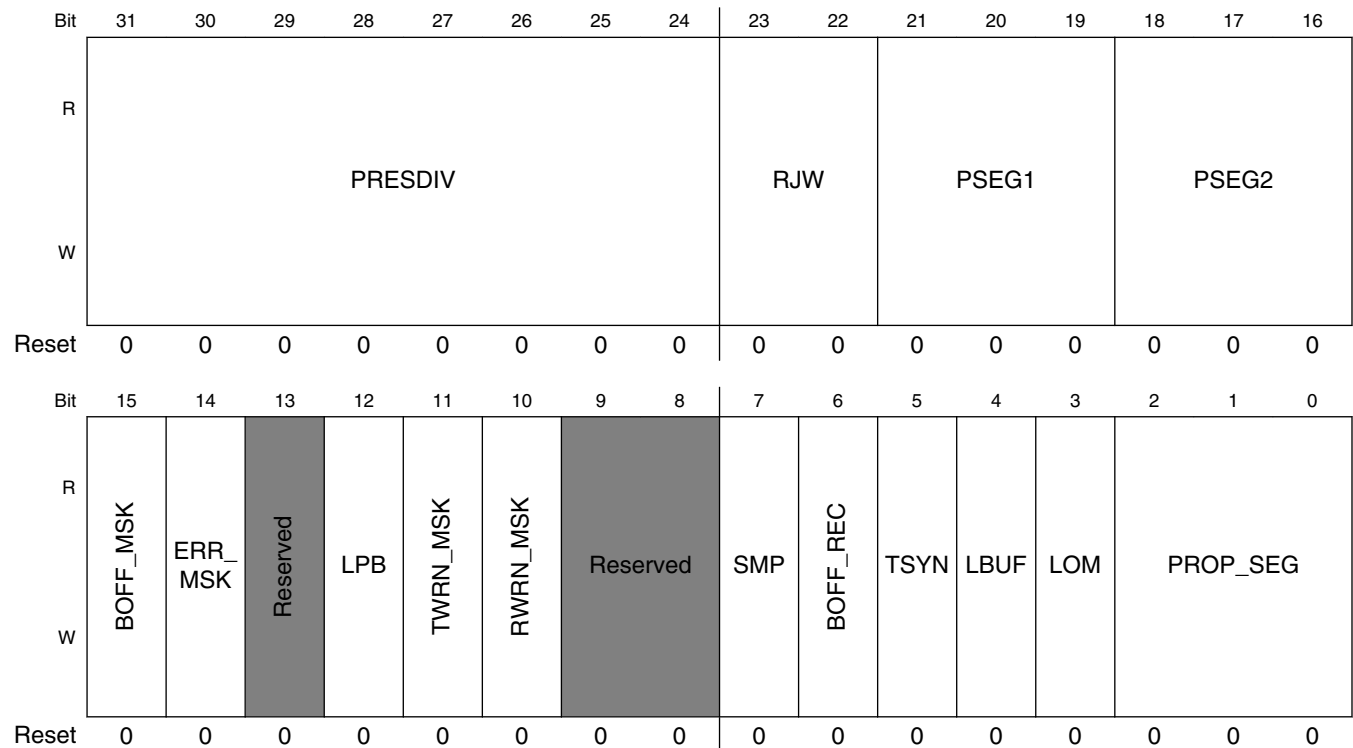

FLEXCANx_CTRL1 field descriptions

Field	Description
31–24 PRESDIV	This 8-bit field defines the ratio between the PE clock frequency and the Serial Clock (Sclock) frequency. The Sclock period defines the time quantum of the CAN protocol. For the reset value, the Sclock frequency is equal to the PE clock frequency. The Maximum value of this register is 0xFF, that gives a minimum Sclock frequency equal to the PE clock frequency divided by 256. For more information refer to Protocol Timing . This field can only be written in Freeze mode as it is blocked by hardware in other modes.

Table continues on the next page...

FLEXCANx_CTRL1 field descriptions (continued)

Field	Description
	Slock frequency = CPI clock frequency / (PRESDIV+1)
23–22 RJW	This 2-bit field defines the maximum number of time quanta ¹ that a bit time can be changed by one re-synchronization. The valid programmable values are 0-3. This field can only be written in Freeze mode as it is blocked by hardware in other modes Resync Jump Width = RJW + 1.
21–19 PSEG1	This 3-bit field defines the length of Phase Buffer Segment 1 in the bit time . The valid programmable values are 0-7. This field can only be written in Freeze mode as it is blocked by hardware in other modes Phase Buffer Segment 1 = (PSEG1 + 1) x Time-Quanta.
18–16 PSEG2	This 3-bit field defines the length of Phase Buffer Segment 2 in the bit time . The valid programmable values are 1-7. This field can only be written in Freeze mode as it is blocked by hardware in other modes Phase Buffer Segment 2 = (PSEG2 + 1) x Time-Quanta.
15 BOFF_MSK	This bit provides a mask for the Bus Off Interrupt. 1 Bus Off interrupt enabled 0 Bus Off interrupt disabled
14 ERR_MSK	This bit provides a mask for the Error Interrupt. 1 Error interrupt enabled 0 Error interrupt disabled
13 -	This field is reserved. Reserved
12 LPB	This bit configures FlexCAN to operate in Loop-Back Mode. In this mode, FlexCAN performs an internal loop back that can be used for self test operation. The bit stream output of the transmitter is fed back internally to the receiver input. The FLEXCAN_RX input pin is ignored and the FLEXCAN_TX output goes to the recessive state (logic '1'). FlexCAN behaves as it normally does when transmitting, and treats its own transmitted message as a message received from a remote node. In this mode, FlexCAN ignores the bit sent during the ACK slot in the CAN frame acknowledge field, generating an internal acknowledge bit to ensure proper reception of its own message. Both transmit and receive interrupts are generated. This bit can only be written in Freeze mode as it is blocked by hardware in other modes. 1 Loop Back enabled 0 Loop Back disabled
11 TWRN_MSK	This bit provides a mask for the Tx Warning Interrupt associated with the TWRN_INT flag in the Error and Status Register. This bit is read as zero when MCR[WRN_EN] bit is negated. This bit can only be written if MCR[WRN_EN] bit is asserted. 1 Tx Warning Interrupt enabled 0 Tx Warning Interrupt disabled
10 RWRN_MSK	This bit provides a mask for the Rx Warning Interrupt associated with the RWRN_INT flag in the Error and Status Register. This bit is read as zero when MCR[WRN_EN] bit is negated. This bit can only be written if MCR[WRN_EN] bit is asserted. 1 Rx Warning Interrupt enabled 0 Rx Warning Interrupt disabled
9–8 -	This field is reserved. Reserved
7 SMP	This bit defines the sampling mode of CAN bits at the FLEXCAN_RX. This bit can only be written in Freeze mode as it is blocked by hardware in other modes.

Table continues on the next page...

FLEXCANx_CTRL1 field descriptions (continued)

Field	Description
	<p>1 Three samples are used to determine the value of the received bit: the regular one (sample point) and 2 preceding samples, a majority rule is used</p> <p>0 Just one sample is used to determine the bit value</p>
6 BOFF_REC	<p>This bit defines how FLEXCAN recovers from Bus Off state. If this bit is negated, automatic recovering from Bus Off state occurs according to the CAN Specification 2.0B. If the bit is asserted, automatic recovering from Bus Off is disabled and the module remains in Bus Off state until the bit is negated by the user. If the negation occurs before 128 sequences of 11 recessive bits are detected on the CAN bus, then Bus Off recovery happens as if the BOFF_REC bit had never been asserted. If the negation occurs after 128 sequences of 11 recessive bits occurred, then FLEXCAN will re-synchronize to the bus by waiting for 11 recessive bits before joining the bus. After negation, the BOFF_REC bit can be re-asserted again during Bus Off, but it will only be effective the next time the module enters Bus Off. If BOFF_REC was negated when the module entered Bus Off, asserting it during Bus Off will not be effective for the current Bus Off recovery.</p> <p>1 Automatic recovering from Bus Off state disabled</p> <p>0 Automatic recovering from Bus Off state enabled, according to CAN Spec 2.0 part B</p>
5 TSYN	<p>This bit enables a mechanism that resets the free-running timer each time a message is received in Message Buffer 0. This feature provides means to synchronize multiple FLEXCAN stations with a special "SYNC" message (i.e., global network time). If the RFEN bit in MCR is set (FIFO enabled), the first available Mailbox, according to CTRL2[RFFN] setting, is used for timer synchronization instead of MB0. This bit can only be written in Freeze mode as it is blocked by hardware in other modes.</p> <p>1 Timer Sync feature enabled</p> <p>0 Timer Sync feature disabled</p>
4 LBUF	<p>This bit defines the ordering mechanism for Message Buffer transmission. When asserted, the LPRIO_EN bit does not affect the priority arbitration. This bit can only be written in Freeze mode as it is blocked by hardware in other modes.</p> <p>1 Lowest number buffer is transmitted first</p> <p>0 Buffer with highest priority is transmitted first</p>
3 LOM	<p>This bit configures FLEXCAN to operate in Listen Only Mode. In this mode, transmission is disabled, all error counters are frozen and the module operates in a CAN Error Passive mode. Only messages acknowledged by another CAN station will be received. If FLEXCAN detects a message that has not been acknowledged, it will flag a BIT0 error (without changing the REC), as if it was trying to acknowledge the message.</p> <p>Listen-Only Mode acknowledgement can be obtained by the state of ESR1[FLT_CONF] field which is Passive Error when Listen-Only Mode is entered. There can be some delay between the Listen-Only Mode request and acknowledge.</p> <p>This bit can only be written in Freeze mode as it is blocked by hardware in other modes.</p> <p>1 FLEXCAN module operates in Listen Only Mode</p> <p>0 Listen Only Mode is deactivated</p>
PROP_SEG	<p>This 3-bit field defines the length of the Propagation Segment in the bit time. The valid programmable values are 0-7. This field can only be written in Freeze mode as it is blocked by hardware in other modes</p> <p>Propagation Segment Time = (PROPSEG + 1) * Time-Quanta.</p> <p>Time-Quantum = one Sclock period.</p>

1. One time quantum is equal to the Sclock period.

26.8.3 Free Running Timer Register (FLEXCANx_TIMER)

This register represents a 16-bit free running counter that can be read and written by the Arm. The timer starts from \$0000 after Reset, counts linearly to \$FFFF, and wraps around.

The timer is clocked by the FLEXCAN bit-clock (which defines the baud rate on the CAN bus). During a message transmission/reception, it increments by one for each bit that is received or transmitted. When there is no message on the bus, it counts using the previously programmed baud rate. During Freeze Mode, disable, and stop mode, the timer is not incremented.

The timer value is captured at the beginning of the identifier field of any frame on the CAN bus. This captured value is written into the Time Stamp entry in a message buffer after a successful reception or transmission of a message.

If bit CTRL1[TSYN] is asserted the Timer is reset whenever a message is received in the first available Mailbox, according to CTRL2[RFFN] setting.

Arm can write to this register anytime. However, if the write occurs at the same time that the Timer is being reset by a reception in the first Mailbox, then the write value is discarded.

Reading this register affects the Mailbox Unlocking procedure. For additional details, refer to [Message Buffer Lock Mechanism](#).

Address: Base address + 8h offset

Bit	31	30	29	28	27	26	25	24	23	22	21	20	19	18	17	16	15	14	13	12	11	10	9	8	7	6	5	4	3	2	1	0
R	Reserved																TIMER															
W	Reserved																TIMER															
Reset	0	0	0	0	0	0	0	0	0	0	0	0	0	0	0	0	0	0	0	0	0	0	0	0	0	0	0	0	0	0	0	0

FLEXCANx_TIMER field descriptions

Field	Description
31–16 -	This field is reserved. Reserved
TIMER	TIMER

26.8.4 Rx Mailboxes Global Mask Register (FLEXCANx_RXMGMASK)

RXMGMASK is provided for legacy support. Asserting the MCR[IRMQ] bit causes the RXMGMASK Register to have no effect on the module operation.

RXMGMASK is used to mask the filter fields of all Rx MBs, excluding MBs 14-15, which have individual mask registers.

This register can only be written in Freeze mode as it is blocked by hardware in other modes.

Table 26-19. Rx Mailboxes Global Mask usage

SMB[RTR] ¹	CTRL2[RRS]	CTRL2[EACEN]	Mailbox filter fields			
			MB[RTR]	MB[IDE]	MB[ID]	reserved
0	-	0	- Note ²	- Note ³	MG[28:0]	MG[31:29]
0	-	1	MG[31]	MG[30]	MG[28:0]	MG[29]
1	0	-	-	-	-	MG[31:0]
1	1	0	-	-	MG[28:0]	MG[31:29]
1	1	1	MG[31]	MG[30]	MG[28:0]	MG[29]

1. RTR bit of the Incoming Frame. It is saved into an auxiliary MB called Rx Serial Message Buffer (Rx SMB).
2. If CTRL2[EACEN] bit is negated the RTR bit of Mailbox is never compared with the RTR bit of the Incoming Frame (Rx SMB[RTR]).
3. If CTRL2[EACEN] bit is negated the IDE bit of Mailbox is always compared with the IDE bit of the Incoming Frame (Rx SMB[IDE]).

Address: Base address + 10h offset

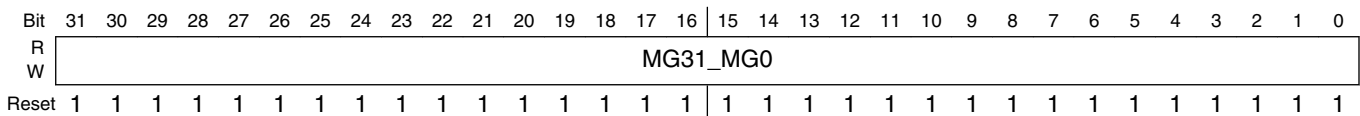

FLEXCANx_RXMGMASK field descriptions

Field	Description
MG31_MG0	<p>These bits mask the Mailbox filter bits as shown in the figure above. Note that the alignment with the ID word of the Mailbox is not perfect as the two most significant MG bits affect the fields RTR and IDE which are located in the Control and Status word of the Mailbox. Rx Mailboxes Global Mask Register (FLEXCAN_RXMGMASK) shows in detail which MG bits mask each Mailbox filter field.</p> <p>1 The corresponding bit in the filter is checked against the one received 0 the corresponding bit in the filter is "don't care"</p>

26.8.5 Rx Buffer 14 Mask Register (FLEXCANx_RX14MASK)

RX14MASK is provided for legacy support, asserting the MCR[IRMQ] bit causes the RX14MASK to have no effect on the module operation.

RX14MASK is used to mask the filter fields of Message Buffer 14.

This register can only be programmed while the module is in Freeze Mode as it is blocked by hardware in other modes.

Address: Base address + 14h offset

Bit	31	30	29	28	27	26	25	24	23	22	21	20	19	18	17	16	15	14	13	12	11	10	9	8	7	6	5	4	3	2	1	0
R																																
W																																
Reset	1	1	1	1	1	1	1	1	1	1	1	1	1	1	1	1	1	1	1	1	1	1	1	1	1	1	1	1	1	1	1	1

FLEXCANx_RX14MASK field descriptions

Field	Description
RX14M31_ RX14M0	<p>These bits mask Mailbox 14 filter bits in the same fashion as RXMGMASK masks other Mailboxes filters (see Rx Mailboxes Global Mask Register (FLEXCAN_RXMGMASK))</p> <p>1 The corresponding bit in the filter is checked 0 the corresponding bit in the filter is "don't care"</p>

26.8.6 Rx Buffer 15 Mask Register (FLEXCANx_RX15MASK)

RX15MASK is provided for legacy support, asserting the MCR[IRMQ] bit causes the RX15MASK Register to have no effect on the module operation.

RX15MASK is used to mask the filter fields of Message Buffer 15.

This register can only be programmed while the module is in Freeze Mode as it is blocked by hardware in other modes.

Address: Base address + 18h offset

Bit	31	30	29	28	27	26	25	24	23	22	21	20	19	18	17	16	15	14	13	12	11	10	9	8	7	6	5	4	3	2	1	0
R																																
W																																
Reset	1	1	1	1	1	1	1	1	1	1	1	1	1	1	1	1	1	1	1	1	1	1	1	1	1	1	1	1	1	1	1	1

FLEXCANx_RX15MASK field descriptions

Field	Description
RX15M31_ RX15M0	<p>These bits mask Mailbox 15 filter bits in the same fashion as RXMGMASK masks other Mailboxes filters (see Rx Mailboxes Global Mask Register (FLEXCAN_RXMGMASK)).</p> <p>1 The corresponding bit in the filter is checked 0 the corresponding bit in the filter is "don't care"</p>

26.8.7 Error Counter Register (FLEXCANx_ECR)

This register has 2 8-bit fields reflecting the value of two FLEXCAN error counters: Transmit Error Counter (Tx_Err_Counter field) and Receive Error Counter (Rx_Err_Counter field). The rules for increasing and decreasing these counters are described in the CAN protocol and are completely implemented in the FLEXCAN module. Both counters are read only except in Freeze Mode, where they can be written by the Arm.

FLEXCAN responds to any bus state as described in the protocol, e.g. transmit 'Error Active' or 'Error Passive' flag, delay its transmission start time ('Error Passive') and avoid any influence on the bus when in 'Bus Off' state. The following are the basic rules for FLEXCAN bus state transitions.

- If the value of Tx_Err_Counter or Rx_Err_Counter increases to be greater than or equal to 128, the FLT_CONF field in the Error and Status Register is updated to reflect 'Error Passive' state.
- If the FLEXCAN state is 'Error Passive', and either Tx_Err_Counter or Rx_Err_Counter decrements to a value less than or equal to 127 while the other already satisfies this condition, the FLT_CONF field in the Error and Status Register is updated to reflect 'Error Active' state.
- If the value of Tx_Err_Counter increases to be greater than 255, the FLT_CONF field in the Error and Status Register is updated to reflect 'Bus Off' state, and an interrupt may be issued. The value of Tx_Err_Counter is then reset to zero.
- If FLEXCAN is in 'Bus Off' state, then Tx_Err_Counter is cascaded together with another internal counter to count the 128th occurrences of 11 consecutive recessive bits on the bus. Hence, Tx_Err_Counter is reset to zero and counts in a manner where the internal counter counts 11 such bits and then wraps around while incrementing the Tx_Err_Counter. When Tx_Err_Counter reaches the value of 128, the FLT_CONF field in the Error and Status Register is updated to be 'Error Active' and both error counters are reset to zero. At any instance of dominant bit following a stream of less than 11 consecutive recessive bits, the internal counter resets itself to zero without affecting the Tx_Err_Counter value.
- If during system start-up, only one node is operating, then its Tx_Err_Counter increases in each message it is trying to transmit, as a result of acknowledge errors (indicated by the ACK_ERR bit in the Error and Status Register). After the transition to 'Error Passive' state, the Tx_Err_Counter does not increment anymore by acknowledge errors. Therefore the device never goes to the 'Bus Off' state.
- If the Rx_Err_Counter increases to a value greater than 127, it is not incremented further, even if more errors are detected while being a receiver. At the next

successful message reception, the counter is set to a value between 119 and 127 to resume to 'Error Active' state.

Address: Base address + 1Ch offset

Bit	31	30	29	28	27	26	25	24	23	22	21	20	19	18	17	16	15	14	13	12	11	10	9	8	7	6	5	4	3	2	1	0
R	Reserved																RX_ERR_COUNTER						TX_ERR_COUNTER									
W																																
Reset	0	0	0	0	0	0	0	0	0	0	0	0	0	0	0	0	0	0	0	0	0	0	0	0	0	0	0	0	0	0	0	0

FLEXCANx_ECR field descriptions

Field	Description
31–16 -	This field is reserved. Reserved
15–8 RX_ERR_COUNTER	Rx_Err_Counter
TX_ERR_COUNTER	Tx_Err_Counter

26.8.8 Error and Status 1 Register (FLEXCANx_ESR1)

This register reflects various error conditions, some general status of the device and it is the source of four interrupts to the Arm.

The Arm read action clears bits 15-10, therefore the reported *error conditions*(bits 15-10) are those that occurred since the last time the Arm read this register. Bits 9-3 are status bits .

Some bits in this register are read-only and some are not .

Table 26-20. FlexCAN State

SYNCH	IDLE	TX	RX	FlexCAN state
0	0	0	0	Not synchronized to CAN bus
1	1	x	x	Idle
1	0	1	0	Transmitting
1	0	0	1	Receiving
other combinations				Reserved

FLEXCAN Memory Map/Register Definition

Address: Base address + 20h offset

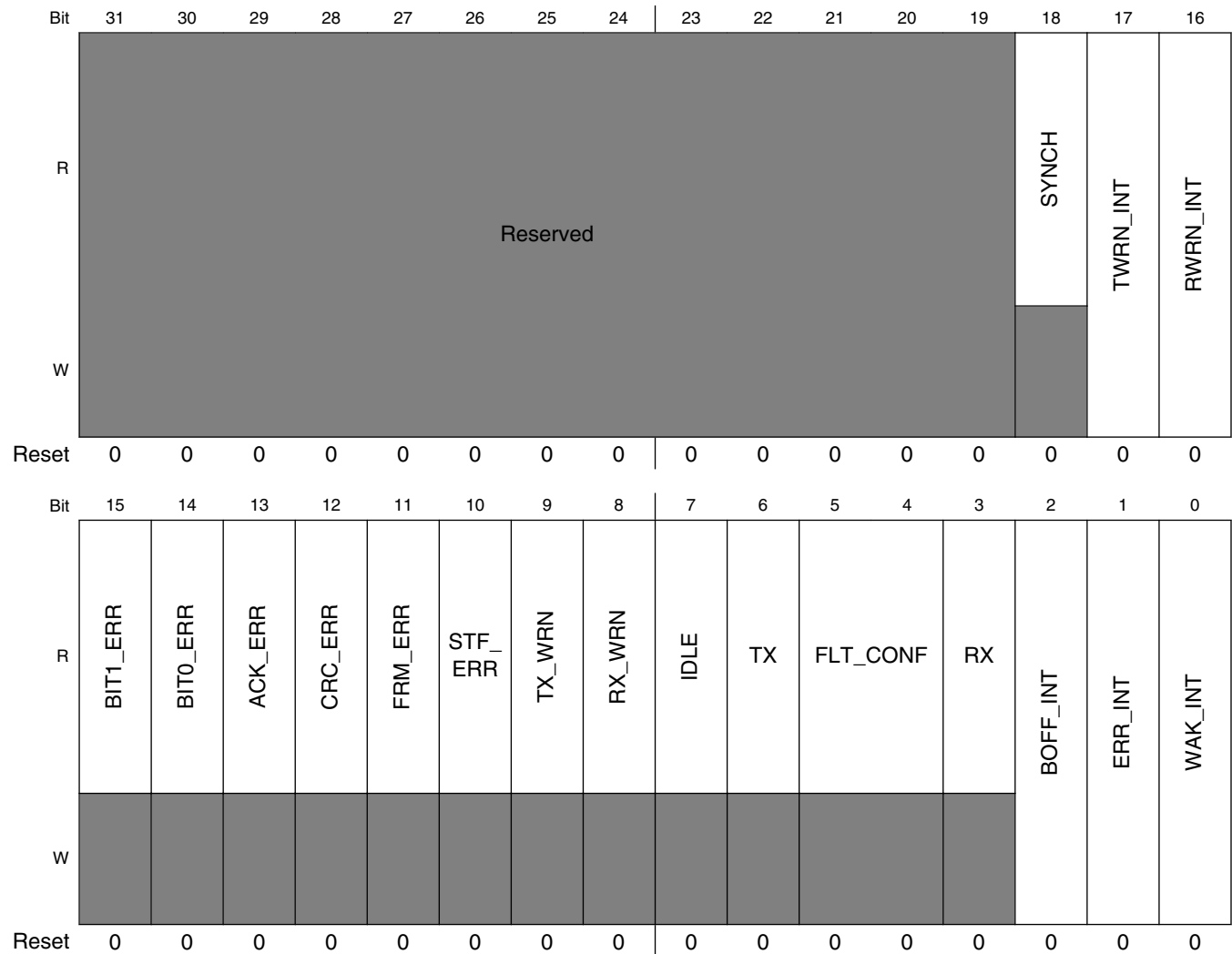

FLEXCANx_ESR1 field descriptions

Field	Description
31–19 -	This field is reserved. Reserved
18 SYNCH	This read-only flag indicates whether the FlexCAN is synchronized to the CAN bus and able to participate in the communication process. It is set and cleared by the FlexCAN. Refer to Table 26-20 1 FlexCAN is synchronized to the CAN bus 0 FlexCAN is not synchronized to the CAN bus
17 TWRN_INT	If the WRN_EN bit in MCR is asserted, the TWRN_INT bit is set when the TX_WRN flag transition from '0' to '1', meaning that the Tx error counter reached 96. If the corresponding mask bit in the Control Register (TWRN_MSK) is set, an interrupt is generated to the Arm. This bit is cleared by writing it to '1'. When WRN_EN is negated, this flag is masked. Arm must clear this flag before disabling the bit. Otherwise it will be set when the WRN_EN is set again. Writing '0' has no effect. This flag is not generated during "Bus Off" state. This bit is not updated during Freeze mode. 1 The Tx error counter transition from < 96 to >= 96 0 No such occurrence

Table continues on the next page...

FLEXCANx_ESR1 field descriptions (continued)

Field	Description
16 RWRN_INT	<p>If the WRN_EN bit in MCR is asserted, the RWRN_INT bit is set when the RX_WRN flag transition from '0' to '1', meaning that the Rx error counters reached 96. If the corresponding mask bit in the Control Register (RWRN_MSK) is set, an interrupt is generated to the Arm. This bit is cleared by writing it to '1'. When WRN_EN is negated, this flag is masked. Arm must clear this flag before disabling the bit. Otherwise it will be set when the WRN_EN is set again. Writing '0' has no effect. This bit is not updated during Freeze mode.</p> <p>1 The Rx error counter transition from < 96 to >= 96 0 No such occurrence</p>
15 BIT1_ERR	<p>This bit indicates when an inconsistency occurs between the transmitted and the received bit in a message.</p> <p>This bit is not set by a transmitter in case of arbitration field or ACK slot, or in case of a node sending a passive error flag that detects dominant bits.</p> <p>1 At least one bit sent as recessive is received as dominant 0 No such occurrence</p>
14 BIT0_ERR	<p>This bit indicates when an inconsistency occurs between the transmitted and the received bit in a message.</p> <p>1 At least one bit sent as dominant is received as recessive 0 No such occurrence</p>
13 ACK_ERR	<p>This bit indicates that an Acknowledge Error has been detected by the transmitter node, i.e., a dominant bit has not been detected during the ACK SLOT.</p> <p>1 An ACK error occurred since last read of this register 0 No such occurrence</p>
12 CRC_ERR	<p>This bit indicates that a CRC Error has been detected by the receiver node, i.e., the calculated CRC is different from the received.</p> <p>1 A CRC error occurred since last read of this register. 0 No such occurrence</p>
11 FRM_ERR	<p>This bit indicates that a Form Error has been detected by the receiver node, i.e., a fixed-form bit field contains at least one illegal bit.</p> <p>1 A Form Error occurred since last read of this register 0 No such occurrence</p>
10 STF_ERR	<p>This bit indicates that a Stuffing Error has been detected.</p> <p>1 A Stuffing Error occurred since last read of this register. 0 No such occurrence.</p>
9 TX_WRN	<p>This bit indicates when repetitive errors are occurring during message transmission.</p> <p>1 TX_Err_Counter ≥ 96 0 No such occurrence</p>
8 RX_WRN	<p>This bit indicates when repetitive errors are occurring during message reception.</p> <p>1 Rx_Err_Counter ≥ 96 0 No such occurrence</p>
7 IDLE	<p>This bit indicates when CAN bus is in IDLE state. Refer to Table 26-20.</p>

Table continues on the next page...

FLEXCANx_ESR1 field descriptions (continued)

Field	Description
	<p>1 CAN bus is now IDLE 0 No such occurrence</p>
6 TX	<p>This bit indicates if FLEXCAN is transmitting a message. Refer to Table 26-20.</p> <p>1 FLEXCAN is transmitting a message 0 FLEXCAN is receiving a message</p>
5-4 FLT_CONF	<p>If the LOM bit in the Control Register is asserted, after some delay that depends on the CAN bit timing the FLT_CONF field will indicate "Error Passive". The very same delay affects the way how FLT_CONF reflects an update to ECR register by the Arm. It may be necessary up to one CAN bit time to get them coherent again.</p> <p>Since the Control Register is not affected by soft reset, the FLT_CONF field will not be affected by soft reset if the LOM bit is asserted.</p> <p>This 2-bit field indicates the Confinement State of the FLEXCAN module, as shown in below:</p> <p>00 Error Active 01 Error Passive 1x Bus off</p>
3 RX	<p>This bit indicates if FlexCAN is receiving a message. Refer to Table 26-20.</p> <p>1 FLEXCAN is transmitting a message 0 FLEXCAN is receiving a message</p>
2 BOFF_INT	<p>This bit is set when FLEXCAN enters 'Bus Off' state. If the corresponding mask bit in the Control Register (BOFF_MSK) is set, an interrupt is generated to the Arm. This bit is cleared by writing it to '1'. Writing '0' has no effect.</p> <p>1 FLEXCAN module entered 'Bus Off' state 0 No such occurrence</p>
1 ERR_INT	<p>This bit indicates that at least one of the Error Bits (bits 15-10) is set. If the corresponding mask bit in the Control Register (ERR_MSK) is set, an interrupt is generated to the Arm. This bit is cleared by writing it to '1'. Writing '0' has no effect.</p> <p>1 Indicates setting of any Error Bit in the Error and Status Register 0 No such occurrence</p>
0 WAK_INT	<p>When FLEXCAN is Stop Mode and a recessive to dominant transition is detected on the CAN bus and if the WAK_MSK bit in the MCR Register is set, an interrupt is generated to the Arm. This bit is cleared by writing it to '1'. When SLF_WAK is negated, this flag is masked. Arm must clear this flag before disabling the bit. Otherwise it will be set when the SLF_WAK is set again. Writing '0' has no effect</p> <p>1 Indicates a recessive to dominant transition received on the CAN bus when the FLEXCAN module is in Stop Mode 0 No such occurrence</p>

26.8.9 Interrupt Masks 2 Register (FLEXCANx_IMASK2)

This register allows any number of a range of 32 Message Buffer Interrupts to be enabled or disabled. It contains one interrupt mask bit per buffer, enabling the Arm to determine which buffer generates an interrupt after a successful transmission or reception (i.e. when the corresponding IFLAG2 bit is set).

Address: Base address + 24h offset

Bit	31	30	29	28	27	26	25	24	23	22	21	20	19	18	17	16	15	14	13	12	11	10	9	8	7	6	5	4	3	2	1	0
R																																
W	BUF63M_BUF32M																															
Reset	0	0	0	0	0	0	0	0	0	0	0	0	0	0	0	0	0	0	0	0	0	0	0	0	0	0	0	0	0	0	0	0

FLEXCANx_IMASK2 field descriptions

Field	Description
BUF63M_BUF32M	<p>Each bit enables or disables the respective FLEXCAN Message Buffer (MB32 to MB63) Interrupt.</p> <p>Setting or clearing a bit in the IMASK2 Register can assert or negate an interrupt request, if the corresponding IFLAG2 bit is set.</p> <p>1 The corresponding buffer Interrupt is enabled 0 The corresponding buffer Interrupt is disabled</p>

26.8.10 Interrupt Masks 1 Register (FLEXCANx_IMASK1)

This register allows to enable or disable any number of a range of 32 Message Buffer Interrupts. It contains one interrupt mask bit per buffer, enabling the Arm to determine which buffer generates an interrupt after a successful transmission or reception (i.e., when the corresponding IFLAG1 bit is set).

Address: Base address + 28h offset

Bit	31	30	29	28	27	26	25	24	23	22	21	20	19	18	17	16	15	14	13	12	11	10	9	8	7	6	5	4	3	2	1	0
R																																
W	BUF31M_BUF0M																															
Reset	0	0	0	0	0	0	0	0	0	0	0	0	0	0	0	0	0	0	0	0	0	0	0	0	0	0	0	0	0	0	0	0

FLEXCANx_IMASK1 field descriptions

Field	Description
BUF31M_BUF0M	<p>Each bit enables or disables the respective FLEXCAN Message Buffer (MB0 to MB31) Interrupt.</p> <p>Setting or clearing a bit in the IMASK1 Register can assert or negate an interrupt request, if the corresponding IFLAG1 bit is set</p>

FLEXCANx_IMASK1 field descriptions (continued)

Field	Description
1	The corresponding buffer Interrupt is enabled
0	The corresponding buffer Interrupt is disabled

26.8.11 Interrupt Flags 2 Register (FLEXCANx_IFLAG2)

This register defines the flags for 32 Message Buffer interrupts. It contains one interrupt flag bit per buffer. Each successful transmission or reception sets the corresponding IFLAG2 bit. If the corresponding IMASK2 bit is set, an interrupt will be generated. The interrupt flag must be cleared by writing it to '1'. Writing '0' has no effect. Before updating MCR[MAXMB] field, Arm must treat the IFLAG2 bits which MB value is greater than the MCR[MAXMB] to be updated, otherwise they will keep set and be inconsistent with the amount of MBs available.

Address: Base address + 2Ch offset

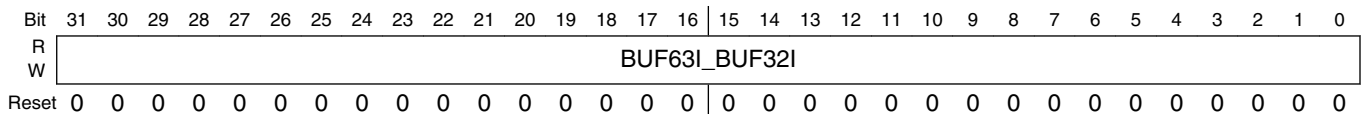

FLEXCANx_IFLAG2 field descriptions

Field	Description
BUF63I_BUF32I	Each bit flags the respective FLEXCAN Message Buffer (MB32 to MB63) interrupt.
1	The corresponding buffer has successfully completed transmission or reception
0	No such occurrence

26.8.12 Interrupt Flags 1 Register (FLEXCANx_IFLAG1)

This register defines the flags for 32 Message Buffer interrupts and FIFO interrupts. It contains one interrupt flag bit per buffer. Each successful transmission or reception sets the corresponding IFLAG1 bit. If the corresponding IMASK1 bit is set, an interrupt will be generated. The Interrupt flag must be cleared by writing it to '1'. Writing '0' has no effect.

When the RFEN bit in the MCR is set (Rx FIFO enabled), the function of the 8 least significant interrupt flags (BUF7I - BUF0I) is changed to support the FIFO operation. BUF7I, BUF6I and BUF5I indicate operating conditions of the FIFO, while BUF4I to BUF0I are not used. Before enabling the RFEN, Arm must service the IFLAG1 asserted

in the Rx FIFO region (see [Rx FIFO](#)). Otherwise, these IFLAGS will mistakenly show the related MBs now belonging to FIFO as having contents to be serviced. When the RFEN is negated, the FIFO flags must be cleared. The same care must be taken when a RFFN value is selected extending Rx FIFO filters beyond MB7 (see [Control 2 Register \(FLEXCAN_CTRL2\)](#)). For example, when RFFN is 0x8, the MB0-23 range is occupied by Rx FIFO filters and related IFLAGS must be cleared.

Before updating MCR[MAXMB] field, Arm must service the IFLAG1 which MB value is greater than the MCR[MAXMB] to be updated, otherwise they will keep set and be inconsistent with the amount of MBs available.

Address: Base address + 30h offset

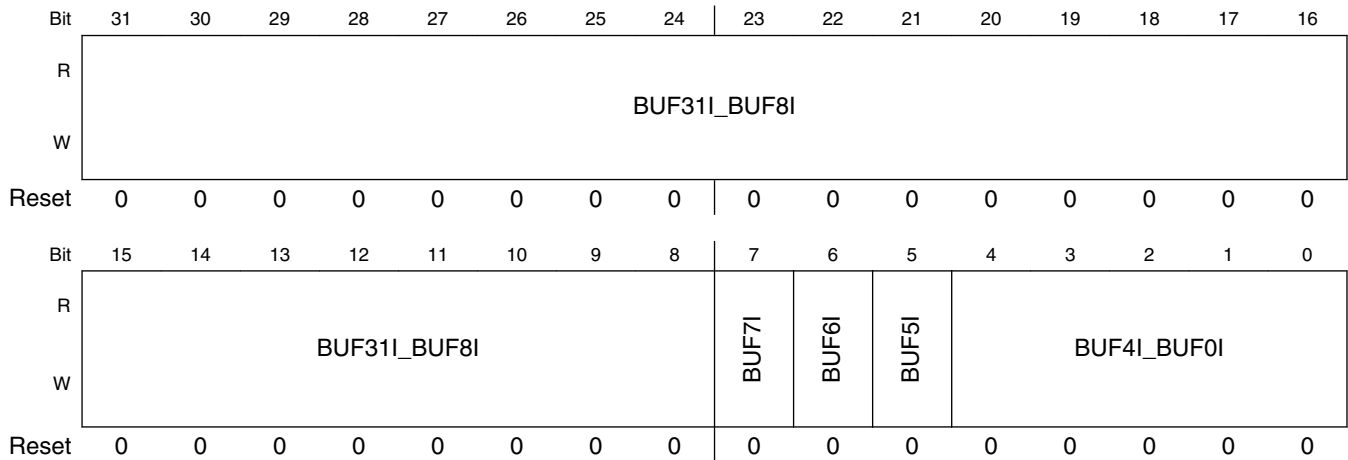

FLEXCANx_IFLAG1 field descriptions

Field	Description
31–8 BUF31I_BUF8I	Each bit flags the respective FLEXCAN Message Buffer (MB8 to MB31) interrupt. 1 The corresponding MB has successfully completed transmission or reception 0 No such occurrence
7 BUF7I	If the Rx FIFO is not enabled, this bit flags the interrupt for MB7. If the MCR[RFEN] bit is asserted, this flag indicates that a message was lost because Rx FIFO is full. Note that the flag will not be asserted when the Rx FIFO is full and the message was captured by a Mailbox. This flag is cleared by the FlexCAN whenever the bit MCR[RFEN] is changed by Arm writes. 1 MB7 completed transmission/reception or FIFO overflow 0 No such occurrence
6 BUF6I	If the Rx FIFO is not enabled, this bit flags the interrupt for MB6. If the MCR[RFEN] bit is asserted, this flag indicates when the number of unread messages within the Rx FIFO is increased to 5 from 4 due to the reception of a new one, meaning that the Rx FIFO is almost full. Note that if the flag is cleared while the number of unread messages is greater than 4 it will not assert again until the number of unread messages within the Rx FIFO is decreased to equal or less than 4. This flag is cleared by the FlexCAN whenever the bit MCR[RFEN] is changed by Arm writes.

Table continues on the next page...

FLEXCANx_IFLAG1 field descriptions (continued)

Field	Description
	1 MB6 completed transmission/reception or FIFO almost full 0 No such occurrence
5 BUF5I	If the Rx FIFO is not enabled, this bit flags the interrupt for MB5. If the Rx FIFO is enabled, this flag indicates that at least one frame is available to be read from the Rx FIFO. This flag is cleared by the FlexCAN whenever the bit MCR[RFEN] is changed by Arm writes. 1 MB5 completed transmission/reception or frames available in the FIFO 0 No such occurrence
BUF4I_BUF0I	If the Rx FIFO is not enabled, these bits flag the interrupts for MB0 to MB4 . If the Rx FIFO is enabled, these flags are not used and must be considered as reserved locations. These flags are cleared by the FlexCAN whenever the bit MCR[RFEN] is changed by Arm writes. 1 Corresponding MB completed transmission/reception 0 No such occurrence

26.8.13 Control 2 Register (FLEXCANx_CTRL2)

This register contains control bits for CAN errors, FIFO features and mode selection.

Table 26-21. Rx FIFO Filters

RFFN[3:0]	Number of Rx FIFO filters	Message Buffers occupied by Rx FIFO and ID Filter Table	Remaining Available Mailboxes ¹	Rx FIFO ID Filter Table Elements Affected by Rx Individual Masks ²	Rx FIFO ID Filter Table Elements Affected by Rx FIFO Global Mask ²
0x0	8	MB 0-7	MB 8-63	Elements 0-7	none
0x1	16	MB 0-9	MB 10-63	Elements 0-9	Elements 10-15
0x2	24	MB 0-11	MB 12-63	Elements 0-11	Elements 12-23
0x3	32	MB 0-13	MB 14-63	Elements 0-13	Elements 14-31
0x4	40	MB 0-15	MB 16-63	Elements 0-15	Elements 16-39
0x5	48	MB 0-17	MB 18-63	Elements 0-17	Elements 18-47
0x6	56	MB 0-19	MB 20-63	Elements 0-19	Elements 20-55
0x7	64	MB 0-21	MB 22-63	Elements 0-21	Elements 22-63
0x8	72	MB 0-23	MB 24-63	Elements 0-23	Elements 24-71
0x9	80	MB 0-25	MB 26-63	Elements 0-25	Elements 26-79
0xA	88	MB 0-27	MB 28-63	Elements 0-27	Elements 28-87
0xB	96	MB 0-29	MB 30-63	Elements 0-29	Elements 30-95
0xC	104	MB 0-31	MB 32-63	Elements 0-31	Elements 32-103
0xD	112	MB 0-33	MB 34-63	Elements 0-31	Elements 32-111
0xE	120	MB 0-35	MB 36-63	Elements 0-31	Elements 32-119
0xF	128	MB 0-37	MB 38-63	Elements 0-31	Elements 32-127

1. The number of the last remaining available mailboxes is defined by the MCR[MAXMB] field.
2. If Rx Individual Mask Registers are not enabled then all Rx FIFO filters are affected by the Rx FIFO Global Mask.

Each group of eight filters occupies a memory space equivalent to two Message Buffers which means that the more filters are implemented the less Mailboxes will be available.

Considering that the Rx FIFO occupies the memory space originally reserved for MB0-5, RFFN should be programmed with a value corresponding to a number of filters not greater than the number of available memory words which can be calculated as follows:

$$(\text{SETUP_MB} - 6) \times 4$$

where SETUP_MB is MAXMB.

The number of remaining Mailboxes available will be:

$$\text{SETUP_MB} - 8 - (\text{RFFN} \times 2)$$

If the Number of Rx FIFO Filters programmed through RFFN exceeds the SETUP_MB value, the exceeding ones will not be functional. Unshaded regions in [Table 26-22](#) indicate the valid combinations of MAXMB, RFEN and RFFN, shaded regions are not functional.

Table 26-22. Valid Combinations of MAXMB, RFEN and RFFN

RFF N	0	0	1	2	3	4	5	6	7	8	9	10	11	12	13	14	15
RFE N	0	1	1	1	1	1	1	1	1	1	1	1	1	1	1	1	1
MAX MB																	
0 - 6																	
7 - 8																	
9 - 10																	
11 - 12																	
13 - 14																	
15 - 16																	
17 - 18																	
19 - 20																	
21 - 22																	

Table continues on the next page...

Table 26-22. Valid Combinations of MAXMB, RFEN and RFFN (continued)

RFFN	0	0	1	2	3	4	5	6	7	8	9	10	11	12	13	14	15
RFEN	0	1	1	1	1	1	1	1	1	1	1	1	1	1	1	1	1
MAXMB																	
23 - 24																	
25 - 26																	
27 - 28																	
29 - 30																	
31 - 32																	
33 - 34																	
35 - 36																	
37 - 63																	

Address: Base address + 34h offset

Bit	31	30	29	28	27	26	25	24	23	22	21	20	19	18	17	16
R				WRMFRZ	RFFN				TASD				MRP	RRS	EACEN	
W	0	Reserved														
Reset	0	0	0	0	0	0	0	0	0	0	0	0	0	0	0	0
Bit	15	14	13	12	11	10	9	8	7	6	5	4	3	2	1	0
R	Reserved															
W	Reserved															
Reset	0	0	0	0	0	0	0	0	0	0	0	0	0	0	0	0

FLEXCANx_CTRL2 field descriptions

Field	Description
31 -	must be written as 0
30-29 -	This field is reserved. Reserved

Table continues on the next page...

FLEXCANx_CTRL2 field descriptions (continued)

Field	Description
28 WRMFRZ	<p>Enable unrestricted write access to FlexCAN memory in Freeze mode. This bit can only be written in Freeze mode and has no effect out of Freeze mode.</p> <p>1 Enable unrestricted write access to FlexCAN memory 0 Keep the write access restricted in some regions of FlexCAN memory</p>
27–24 RFFN	<p>This 4-bit field defines the number of Rx FIFO filters according to Table 26-21 . The maximum selectable number of filters is determined by the Arm. This field can only be written in Freeze mode as it is blocked by hardware in other modes. RFFN defines a number of Message Buffers occupied by Rx FIFO and ID Filter (see Table 26-21) that may not exceed the number of available Mailboxes present in module, defined by MCR[MAXMB]. Default RFFN value is 0x0, which leads to a total of 8 Rx FIFO filters, occupies the first 8 Message Buffers (MB 0-7) and makes available the next Message Buffers (MB 8-63) for Mailboxes. As a second example, when RFFN is set to 0xD, there will be 112 Rx FIFO filters, located in MB 0-33, and MB 34-63 are available for Mailboxes. Notice that, in this case, individual masks (RXIMR) will just cover Rx FIFO filters in 0-31 range, and filters 32-111 will use RXFGMASK. In case of reducing the number of last Message Buffers, MCR[MAXMB] (see Module Configuration Register (FLEXCAN_MCR)) can be adjusted by the application to minimum of 33, in order to give room to the Rx FIFO and its ID Filter Table defined by RFFN. On the contrary, if the application sets MCR[MAXMB] to 16, for instance, the maximum RFFN is limited to 0x4. RFFN also impacts the definition of the minimum number of peripheral clocks per CAN bit as described in Table 26-18 (see Arbitration and Matching Timing).</p>
23–19 TASD	<p>This 5-bit field indicates how many CAN bits the Tx arbitration process start point can be delayed from the first bit of CRC field on CAN bus. This field can only be written in Freeze mode as it is blocked by hardware in other modes.</p> <p>This field is useful to optimize the transmit performance based on factors such as: peripheral/serial clock ratio, CAN bit timing and number of MBs . The duration of an arbitration process, in terms of CAN bits, is directly proportional to the number of available MBs and CAN baud rate and inversely proportional to the peripheral clock frequency.</p> <p>The optimal arbitration timing is that in which the last MB is scanned right before the first bit of the Intermission field of a CAN frame. Therefore, if there are few MBs and the system/serial clock ratio is high and the CAN baud rate is low then the arbitration can be delayed and vice-versa.</p> <p>If TASD is 0 then the arbitration start is not delayed, thus Arm has less time to configure a Tx MB for the next arbitration, but more time is reserved for arbitration . In the other hand, if TASD is 24 then Arm can configure a Tx MB later and less time is reserved for arbitration.</p> <p>If too little time is reserved for arbitration the FlexCAN may be not able to find winner MBs in time to compete with other nodes for the CAN bus. If the arbitration ends too much time before the first bit of Intermission field then there is a chance that Arm reconfigure some Tx MBs and the winner MB is not the best to be transmitted.</p> <p>The reset value is different on various platforms, according to their peripheral clock frequency, number of MBs and target CAN baud rate.</p> <p>The optimal configuration for TASD can be calculated as:</p>

Table continues on the next page...

FLEXCANx_CTRL2 field descriptions (continued)

Field	Description
	$TASD = 25 - \left\{ \frac{f_{CANCLK} \times [MAXMB + 3 - (RFEN \times 8) - (RFEN \times RFFN \times 2)] \times 2}{f_{SYS} \times [1 + (PSEG1 + 1) + (PSEG2 + 1) + (PROPSEG + 1)] \times (PRES DIV + 1)} \right\}$ <p>where:</p> <p>f_{CANCLK} is the Protocol Engine (PE) Clock in Hz; PE clock is derived from CAN_CLK_ROOT in CCM. See the Clock controller module.</p> <p>f_{SYS} is the peripheral clock in Hz;</p> <p>MAXMB is the value in CTRL1[MAXMB] field;</p> <p>RFEN is the value in CTRL1[RFEN] bit;</p> <p>RFFN is the value in CTRL2[RFFN] field;</p> <p>PSEG1 is the value in CTRL1[PSEG1] field;</p> <p>PSEG2 is the value in CTRL1[PSEG2] field;</p> <p>PROPSEG is the value in CTRL1[PROPSEG] field;</p> <p>PRES DIV is the value in CTRL1[PRES DIV] field.</p> <p>Please refer to Arbitration process and Protocol Timing for more details.</p>
<p>18 MRP</p>	<p>If this bit is set the matching process starts from the Mailboxes and if no match occurs the matching continues on the Rx FIFO. This bit can only be written in Freeze mode as it is blocked by hardware in other modes.</p> <p>1 Matching starts from Mailboxes and continues on Rx FIFO 0 Matching starts from Rx FIFO and continues on Mailboxes</p>
<p>17 RRS</p>	<p>If this bit is asserted Remote Request Frame is submitted to a matching process and stored in the corresponding Message Buffer in the same fashion of a Data Frame. No automatic Remote Response Frame will be generated.</p> <p>If this bit is negated the Remote Request Frame is submitted to a matching process and an automatic Remote Response Frame is generated if a Message Buffer with CODE=0b1010 is found with the same ID.</p> <p>This bit can only be written in Freeze mode as it is blocked by hardware in other modes.</p> <p>1 Remote Request Frame is stored 0 Remote Response Frame is generated</p>
<p>16 EACEN</p>	<p>This bit controls the comparison of IDE and RTR bits within Rx Mailboxes filters with their corresponding bits in the incoming frame by the matching process. This bit does not affect matching for Rx FIFO. This bit can only be written in Freeze mode as it is blocked by hardware in other modes.</p> <p>1 Enables the comparison of both Rx Mailbox filter's IDE and RTR bit with their corresponding bits within the incoming frame. Mask bits do apply. 0 Rx Mailbox filter's IDE bit is always compared and RTR is never compared despite mask bits.</p>
<p>-</p>	<p>This field is reserved.</p>

Table continues on the next page...

FLEXCANx_CTRL2 field descriptions (continued)

Field	Description
	Reserved

26.8.14 Error and Status 2 Register (FLEXCANx_ESR2)

This register reflects various interrupt flags and some general status.

Address: Base address + 38h offset

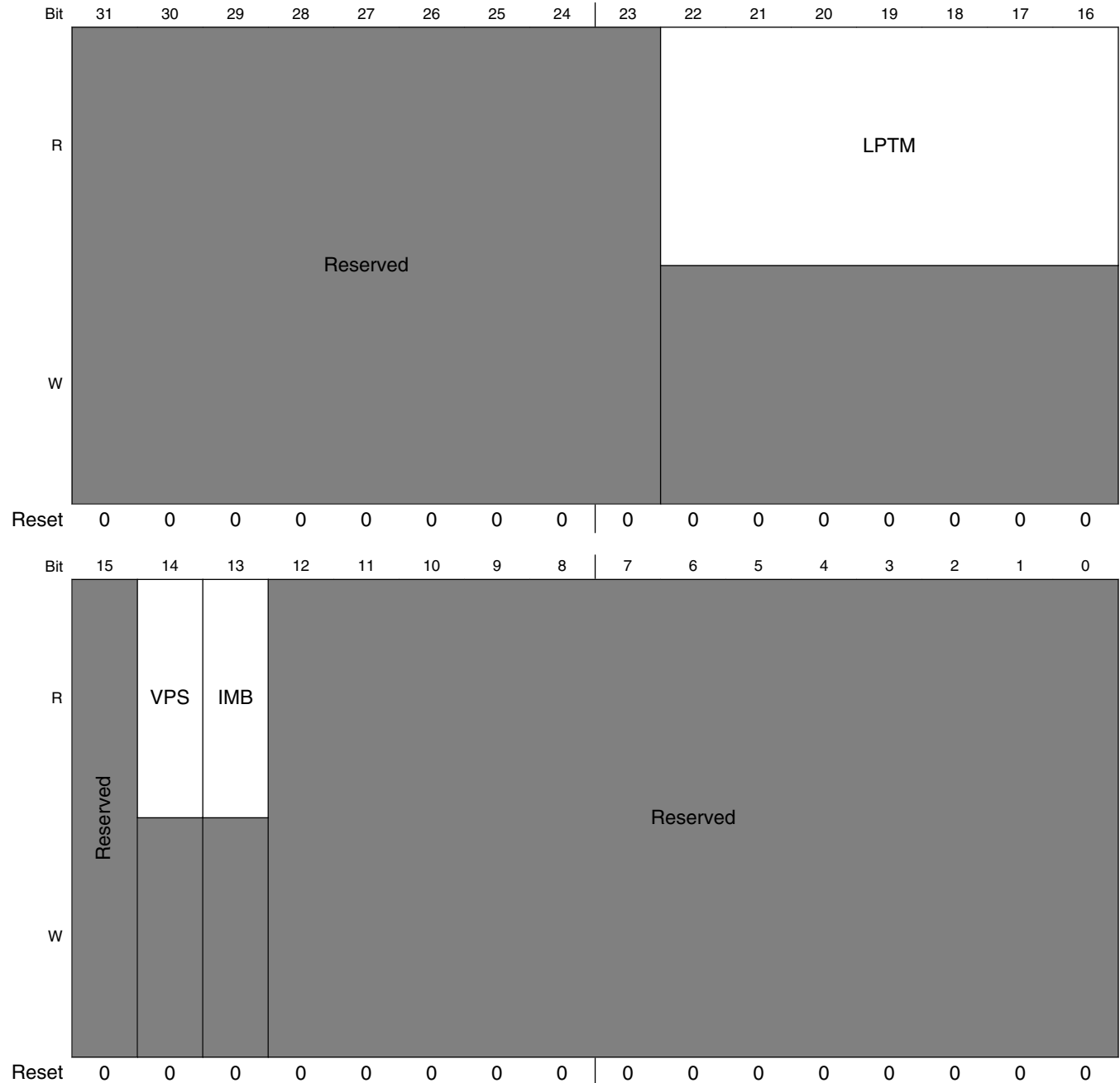

FLEXCANx_ESR2 field descriptions

Field	Description
31–23 -	This field is reserved. Reserved
22–16 LPTM	If ESR2[VPS] is asserted, this 7-bit field indicates the lowest number inactive Mailbox (refer to IMB bit description). If there is no inactive Mailbox then the Mailbox indicated depends on CTRL1[LBUF] bit value. If CTRL1[LBUF] bit is negated then the Mailbox indicated is the one which has the greatest arbitration value (see Highest Mailbox priority first). If CTRL1[LBUF] bit is asserted then the Mailbox indicated is the highest number active Tx Mailbox. If a Tx Mailbox is being transmitted it is not considered in LPTM calculation. If ESR2[IMB] is not asserted and a frame is transmitted successfully, LPTM is updated with its Mailbox number.
15 -	This field is reserved. Reserved
14 VPS	This bit indicates whether IMB and LPTM contents are currently valid or not. VPS is asserted upon every complete Tx arbitration process unless the Arm writes to Control and Status word of a Mailbox that has already been scanned (i.e. it is behind Tx Arbitration Pointer) during the Tx arbitration process. If there is no inactive Mailbox and only one Tx Mailbox which is being transmitted then VPS is not asserted. VPS is negated upon the start of every Tx arbitration process or upon a write to Control and Status word of any Mailbox. ESR2[VPS] is not affected by any Arm write into Control Status (C/S) of a MB which is blocked by abort mechanism. When MCR[AEN] is asserted, the abort code write in C/S of a MB that is been transmitted (pending abort), or any write attempt into a Tx MB with IFLAG set is blocked. 1 Contents of IMB and LPTM are valid 0 Contents of IMB and LPTM are invalid
13 IMB	If ESR2[VPS] is asserted, this bit indicates whether there is any inactive Mailbox (CODE field is either 0b1000 or 0b0000). This bit is asserted in the following cases: (1) During arbitration, if a LPTM is found and it is inactive. (2) If IMB is not asserted and a frame is transmitted successfully. (3) This bit is cleared in all start of arbitration (see Arbitration process). LPTM mechanism have the following behavior: if a MB is successfully transmitted and ESR2[IMB]=0 (no inactive Mailbox), then ESR2[VPS] and ESR2[IMB] are asserted and the index related to the MB just transmitted is loaded into ESR2[LPTM]. 1 If ESR2[VPS] is asserted, there is at least one inactive Mailbox. LPTM content is the number of the first one. 0 If ESR2[VPS] is asserted, the ESR2[LPTM] is not an inactive Mailbox.
-	This field is reserved. Reserved

26.8.15 CRC Register (FLEXCANx_CRCR)

This register provides information about the CRC of transmitted messages

Address: Base address + 44h offset

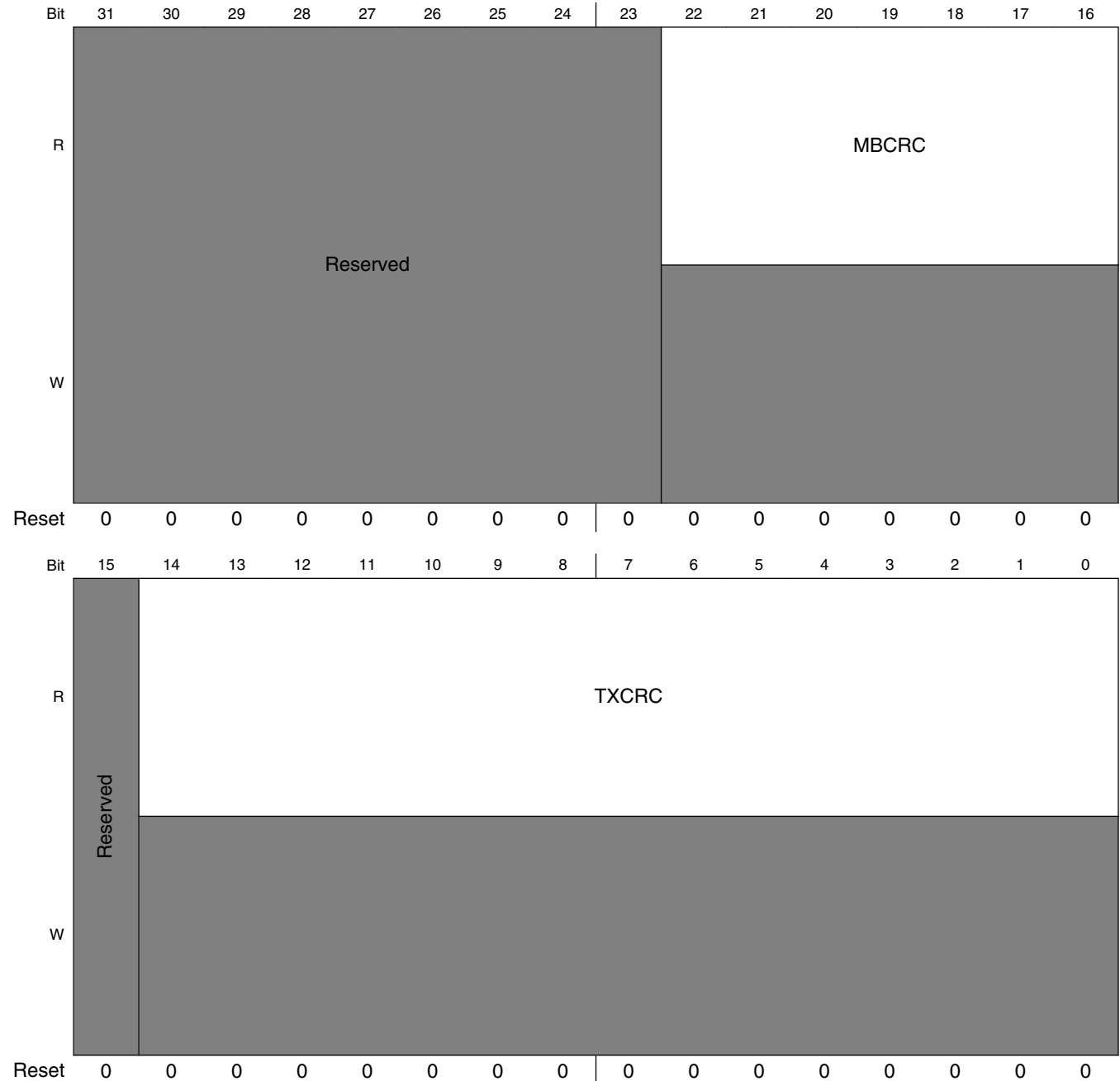

FLEXCANx_CRRCR field descriptions

Field	Description
31–23 -	This field is reserved. Reserved
22–16 MBCRC	This field indicates the number of the Mailbox corresponding to the value in TXCRC field.
15 -	This field is reserved. Reserved
TXCRC	This field indicates the CRC value of the last message transmitted. This field is updated at the same time the Tx Interrupt Flag is asserted.

26.8.16 Rx FIFO Global Mask Register (FLEXCANx_RXFGMASK)

If Rx FIFO is enabled RXFGMASK is used to mask the Rx FIFO ID Filter Table elements that do not have a corresponding RXIMR according to CTRL2[RFFN] field setting.

This register can only be written in Freeze Mode as it is blocked by hardware in other modes.

Table 26-23. Rx FIFO Global Mask usage

Rx FIFO ID Filter Table Elements Format (MCR[IDAM])	Identifier Acceptance Filter fields					
	RTR	IDE	RXIDA	RXIDB	RXIDC	reserved
A	FGM[31]	FGM[30]	FGM[29:1]	-	-	FGM[0]
B	FGM[31] FGM[15]	FGM[30] FGM[14]	-	FGM[29:16] FGM[13:0] 1	-	-
C	-	-	-	-	FGM[31:24] FGM[23:16] FGM[15:8] FGM[7:0] 2	-

1. If MCR[IDAM] field is equivalent to the format B only the fourteen most significant bits of the Identifier of the incoming frame are compared with the Rx FIFO filter.
2. If MCR[IDAM] field is equivalent to the format C only the eight most significant bits of the Identifier of the incoming frame are compared with the Rx FIFO filter.

FLEXCAN Memory Map/Register Definition

Address: Base address + 48h offset

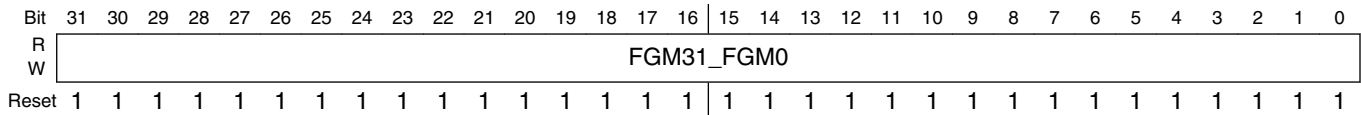

FLEXCANx_RXFGMASK field descriptions

Field	Description
FGM31_FGM0	<p>These bits mask the ID Filter Table elements bits in a perfect alignment. Rx FIFO Global Mask Register (FLEXCAN_RXFGMASK) shows in detail which FGM bits mask each IDAF field. Clear this register has the effect of disabling the ID Filter.</p> <p>1 The corresponding bit in the filter is checked 0 The corresponding bit in the filter is "don't care"</p>

26.8.17 Rx FIFO Information Register (FLEXCANx_RXFIR)

RXFIR provides information on Rx FIFO.

This register is the port through which Arm accesses the output of the RXFIR FIFO located in RAM. The RXFIR FIFO is written by the FlexCAN whenever a new message is moved into the Rx FIFO as well as its output is updated whenever the output of the Rx FIFO is updated with the next message. Refer to [Rx FIFO](#) to find instructions on reading this register.

Address: Base address + 4Ch offset

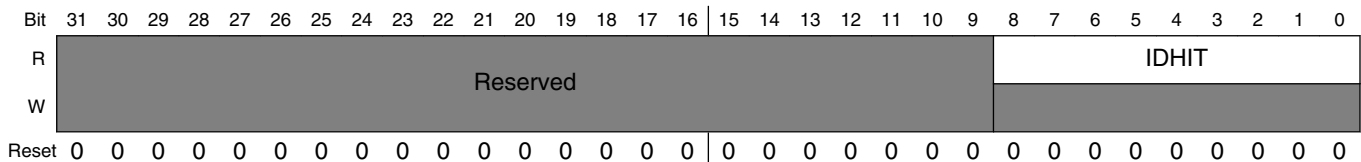

FLEXCANx_RXFIR field descriptions

Field	Description
31–9 -	This field is reserved. Reserved
IDHIT	This 9-bit field indicates which Identifier Acceptance Filter (see Rx FIFO Structure) was hit by the received message that is in the output of the Rx FIFO . (refer to Rx FIFO for details) If multiple filters match the incoming message ID then the first matching IDAF found (lowest number) by the matching process is indicated. This field is valid only while the IFLAG[BUF5I] is asserted.

26.8.18 Rx Individual Mask Registers (FLEXCANx_RXIMRn)

RXIMR are used as acceptance masks for ID filtering in Rx MBs and the Rx FIFO . If the Rx FIFO is not enabled, one mask register is provided for each available Mailbox, providing ID masking capability on a per Mailbox basis.

When the Rx FIFO is enabled (MCR[RFEN] bit is asserted), up to 32 Rx Individual Mask Registers can apply to the Rx FIFO ID Filter Table elements on a one-to-one correspondence depending on CTRL2[RFFN] setting. Refer to [Control 2 Register \(FLEXCAN_CTRL2\)](#) for details .

RXIMR can only be written by the Arm while the module is in Freeze Mode, otherwise they are blocked by hardware .

The Individual Rx Mask Registers are not affected by reset and must be explicitly initialized prior to any reception.

Address: Base address + 880h offset + (4d × i), where i=0d to 63d

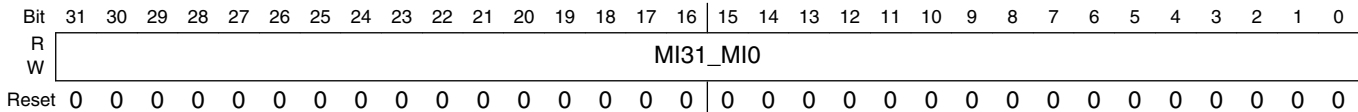

FLEXCANx_RXIMRn field descriptions

Field	Description
MI31_MIO	<p>These bits mask both Mailbox filter and Rx FIFO ID Filter Table element in distinct ways.</p> <p>For Mailbox filter refer to Rx Mailboxes Global Mask Register (FLEXCAN_RXMGMASK).</p> <p>For Rx FIFO ID Filter Table element refer to Rx FIFO Global Mask Register (FLEXCAN_RXFGMASK).</p> <p>1 The corresponding bit in the filter is checked 0 the corresponding bit in the filter is "don't care"</p>

26.8.19 Glitch Filter Width Registers (FLEXCANx_GFWR)

The Glitch Filter just takes effects when FLEXCAN enters the STOP mode.

Address: Base address + 9E0h offset

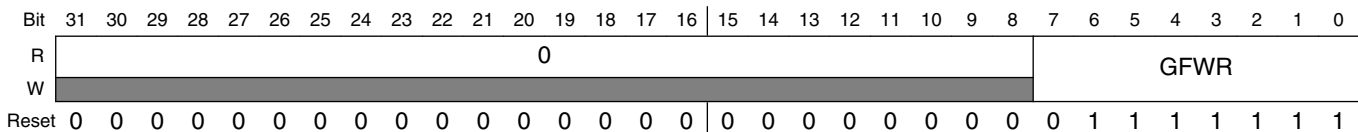

FLEXCANx_GFWR field descriptions

Field	Description
31–8 Reserved	This read-only field is reserved and always has the value 0.
GFWR	It determines the Glitch Filter Width. The width will be divided from Oscillator clock by GFWR values. By default, it is 5.33 μ s when the oscillator is 24 MHz. Filter Pulse Width = [(GFWR FIELD + 1) x (1 / Osc. Frequency)]

Chapter 27

General Power Controller (GPC)

27.1 Overview

The General Power Control (GPC) block includes the sub-blocks listed here.

- CPU [Power Gating Control \(PGC\)](#)

Each sub-block has its own IP registers.

GPC determines wake-up IRQ for exiting WAIT/STOP mode (with or without CPU power gating).

Figure 27-1. GPC Block Diagram

27.2 Clocks

The table found here describes the clock sources for GPC.

Please see [Clock Controller Module \(CCM\)](#) for clock setting, configuration and gating information.

Table 27-1. GPC Clocks

Clock name	Clock Root	Description
ipg_clk	ipg_clk_root	Peripheral clock
ipg_clk_s	ipg_clk_root	Peripheral access clock
pgc_clk	ipg_clk_root	PGC peripheral clock
sys_clk	ipg_clk_root	Module clock

27.3 Power Gating Control (PGC)

Power Gating (PGC) is applied to the ARM CPU only in STOP low power mode, after all essential CPU registers data are saved by ARM dormant procedure.

If any of the unmasked interrupts appears, CPU is powered up and clock restore request (exit from STOP mode) is sent to CCM.

PGC power down sequence:

- CCM sends power down request when the chip is about to enter stop mode. The user should define which modules will be powered down (PGCR registers of corresponding PGC module, bit 0).

PGC power up sequence:

- One of the power up irq is asserted.
- Power up request is asserted in GPC and in CCM.
- The Power Gated modules are powered up, according to PGC settings of appropriate module.

The Power Gated modules require reset after powering up. The next figure describes GPC-SRC handshake procedure for reset after power gating.

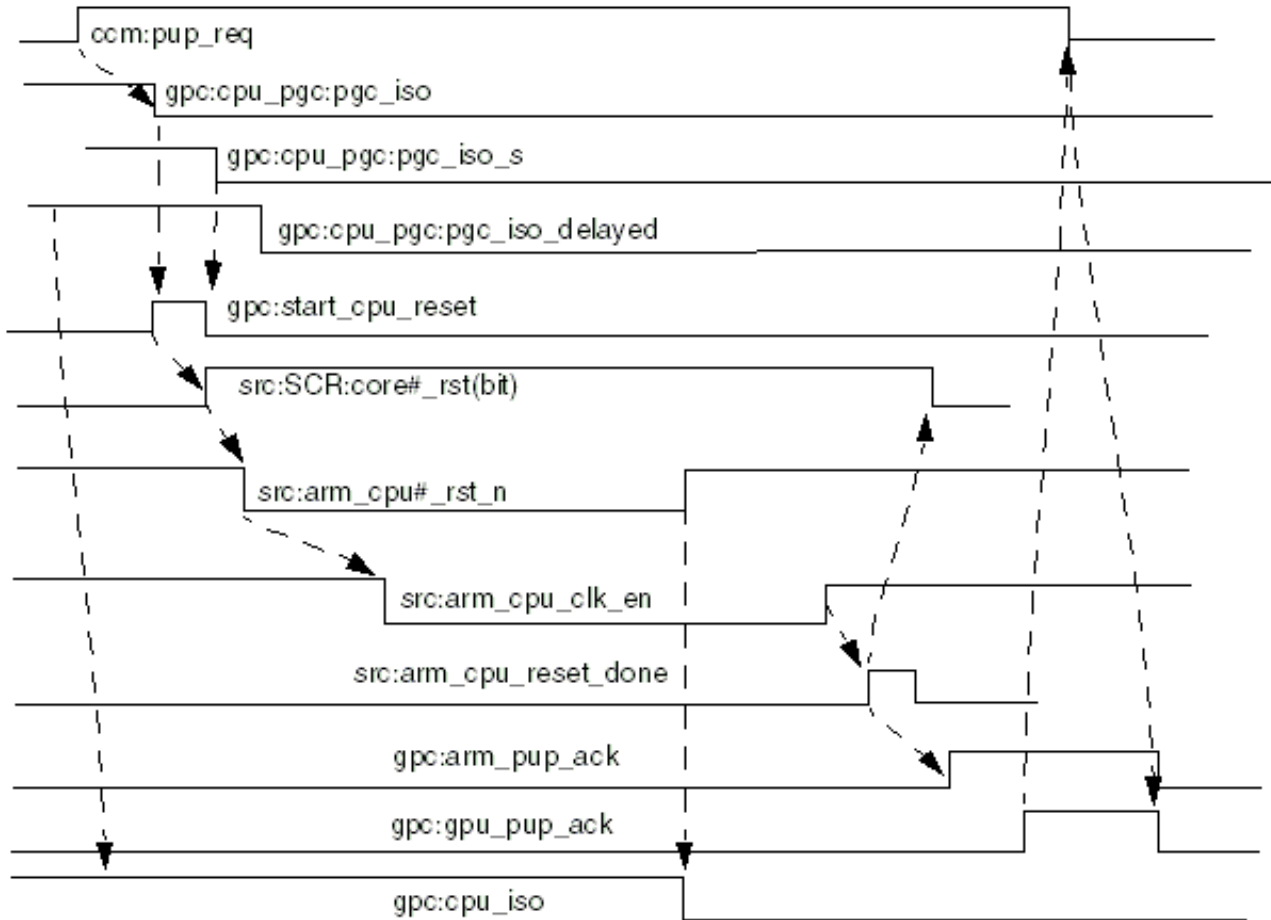

Figure 27-2. GPC-SRC handshake for reset after power gating

27.3.1 Overview

The Power Gating Controller (PGC) is a power management component that controls the power-down and power-up sequencing of individual subsystems.

The sequence timing is programmable using the PGC control registers. [Figure 27-3](#) shows PGC as part of the SoC's overall power management scheme.

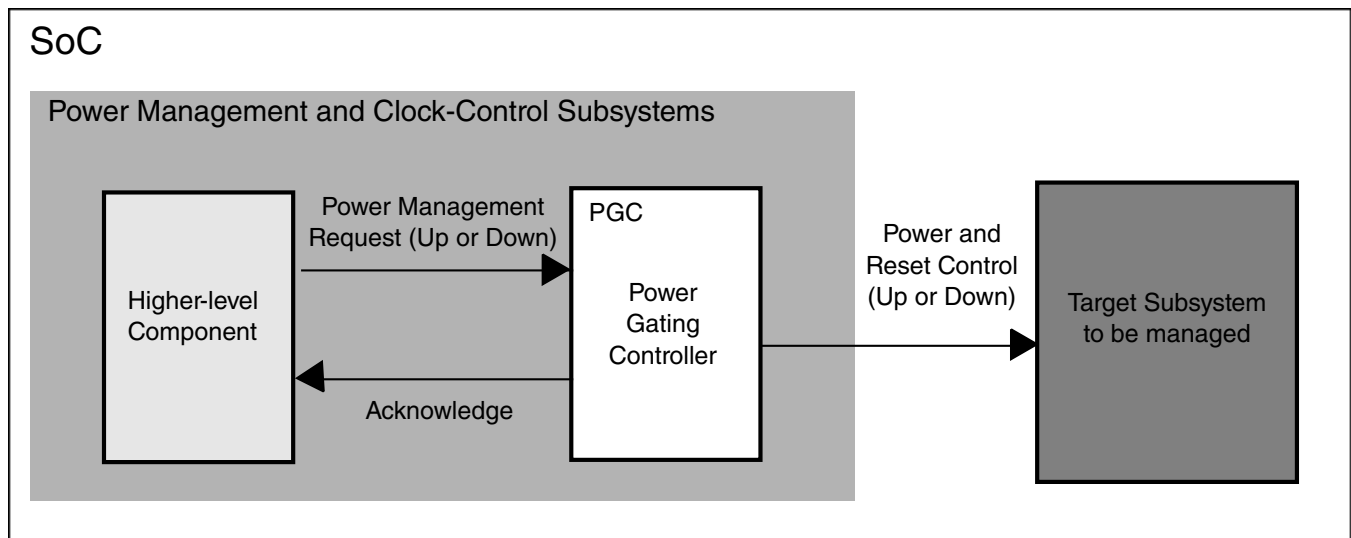

Figure 27-3. PGC Block Diagram

27.3.1.1 Features

Key features of the PGC include:

- Provides the ability to switch off power to a target subsystem.
- Generates power-up and power-down control sequences.
- Provides programmable registers to adjust the timing of the power control signals.

27.4 GPC Interrupt Controller (INTC)

The INTC (Interrupt Controller) detects an interrupt and generates the wakeup signal. It supports up to 128 interrupts.

27.4.1 Interrupt Controller features

The features of the GPC INTC are listed below.

Features:

- Supports up to 128 interrupts
- Provides an option to mask/unmask each interrupt
- Detects interrupts and generates the wake up signal
- 32-bits IP bus interface
- All registers are byte-accessible

27.5 GPC Memory Map/Register Definition

Detailed descriptions of each register can be found below.

GPC memory map

Absolute address (hex)	Register name	Width (in bits)	Access	Reset value	Section/page
20D_C000	GPC Interface control register (GPC_CNTR)	32	R/W	0052_0000h	27.5.1/1329
20D_C004	GPC Power Gating Register (GPC_PGR)	32	R/W	0000_0000h	27.5.2/1331
20D_C008	IRQ masking register 1 (GPC_IMR1)	32	R/W	0000_0000h	27.5.3/1332
20D_C00C	IRQ masking register 2 (GPC_IMR2)	32	R/W	0000_0000h	27.5.4/1332
20D_C010	IRQ masking register 3 (GPC_IMR3)	32	R/W	0000_0000h	27.5.5/1332
20D_C014	IRQ masking register 4 (GPC_IMR4)	32	R/W	0000_0000h	27.5.6/1333
20D_C018	IRQ status resister 1 (GPC_ISR1)	32	R	0000_0000h	27.5.7/1333
20D_C01C	IRQ status resister 2 (GPC_ISR2)	32	R	0000_0000h	27.5.8/1334
20D_C020	IRQ status resister 3 (GPC_ISR3)	32	R	0000_0000h	27.5.9/1334
20D_C024	IRQ status resister 4 (GPC_ISR4)	32	R	0000_0000h	27.5.10/1335

27.5.1 GPC Interface control register (GPC_CNTR)

Address: 20D_C000h base + 0h offset = 20D_C000h

Bit	31	30	29	28	27	26	25	24	23	22	21	20	19	18	17	16
R	0											1	0			
W	0									L2_PGE	GPCIRQM	0		VADC_EXT_PWD_N	VADC_ANALOG_OFF	Reserved
Reset	0	0	0	0	0	0	0	0	0	1	0	1	0	0	1	0

GPC Memory Map/Register Definition

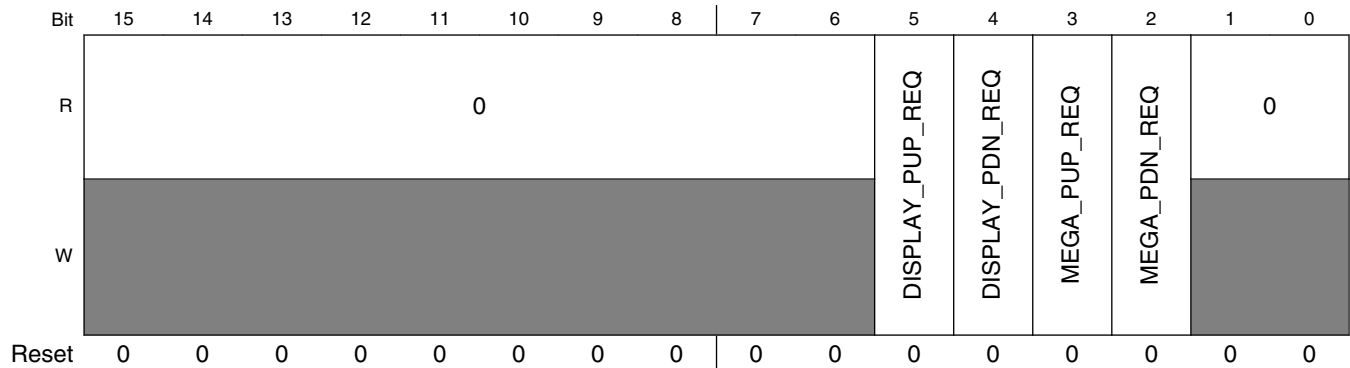

GPC_CNTR field descriptions

Field	Description
31–23 Reserved	This read-only field is reserved and always has the value 0.
22 L2_PGE	L2 Cache Power Gate Enable 1 L2 cache power gate off request, L2 cache will be power down once when CPU core is power down and will be hardware invalidated automatically when CPU core is re-power up 0 L2 cache will keep power on even if CPU core is power down and will not be hardware invalidated when CPU core is re-power up the reset value is 1'b1
21 GPCIRQM	GPC interrupt/event masking 1 interrupt/event is masked 0 not masked
20 Reserved	This read-only field is reserved and always has the value 1.
19 Reserved	This read-only field is reserved and always has the value 0.
18 VADC_EXT_PWD_N	VADC power down bit 0 — VADC power down 1 — VADC not power down
17 VADC_ANALOG_OFF	Indication to VADC whether the analog power to VADC is available or not 0 — VADC analog power is on 1 — VADC analog power is off
16 -	This field is reserved. Reserved
15–6 Reserved	This read-only field is reserved and always has the value 0.
5 DISPLAY_PUP_REQ	Display Power Up request. Self-cleared bit. NOTE: Software may directly control display power gate and utilize hardware control for reset sequence 1 Request Power Up sequence to start for Display 0 no request
4 DISPLAY_PDN_REQ	Display Power Down request. Self-cleared bit. NOTE: Software may directly control display power gate and utilize hardware control for reset sequence

Table continues on the next page...

GPC_CNTR field descriptions (continued)

Field	Description
	1 Request Power Down sequence to start for Display 0 no request
3 MEGA_PUP_ REQ	MEGA domain power up request. Self-clear bit. NOTE: Software may directly control display power gate and utilize hardware control for reset sequence. 0 — No Request 1 — Request power up sequence
2 MEGA_PDN_ REQ	MEGA domain power down request. Self-clear bit. NOTE: Software may directly control display power gate and utilize hardware control for reset sequence. Caution, MEGA domain is not allowed to power down when CPU is not powered down. 0 — No Request 1 — Request power down sequence
Reserved	This read-only field is reserved and always has the value 0.

27.5.2 GPC Power Gating Register (GPC_PGR)

Address: 20D_C000h base + 4h offset = 20D_C004h

Bit	31	30	29	28	27	26	25	24	23	22	21	20	19	18	17	16
R	0	DRCIC						0								
W	0															
Reset	0	0	0	0	0	0	0	0	0	0	0	0	0	0	0	0
Bit	15	14	13	12	11	10	9	8	7	6	5	4	3	2	1	0
R	0															
W	0															
Reset	0	0	0	0	0	0	0	0	0	0	0	0	0	0	0	0

GPC_PGR field descriptions

Field	Description
31 Reserved	This read-only field is reserved and always has the value 0.
30–29 DRCIC	Debug ref cir in mux control 00 ccm_cosr_1_clk_in 01 ccm_cosr_2_clk_in 10 restricted 11 restricted
Reserved	This read-only field is reserved and always has the value 0.

27.5.3 IRQ masking register 1 (GPC_IMR1)

IMR1 Register - masking of irq[63:32].

Address: 20D_C000h base + 8h offset = 20D_C008h

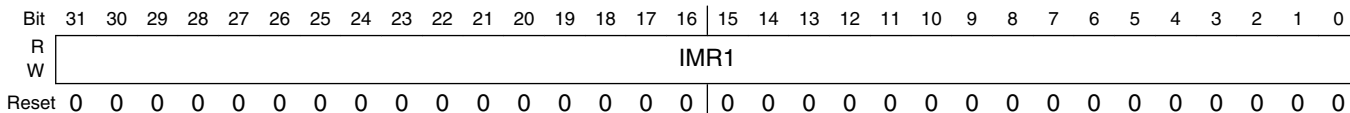

GPC_IMR1 field descriptions

Field	Description
IMR1	IRQ[63:32] masking bits: 1-irq masked, 0-irq is not masked

27.5.4 IRQ masking register 2 (GPC_IMR2)

IMR2 Register - masking of irq[95:64].

Address: 20D_C000h base + Ch offset = 20D_C00Ch

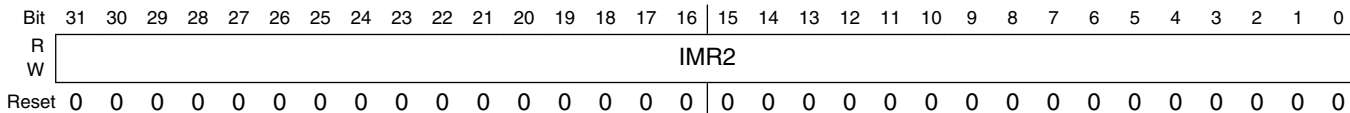

GPC_IMR2 field descriptions

Field	Description
IMR2	IRQ[95:64] masking bits: 1-irq masked, 0-irq is not masked

27.5.5 IRQ masking register 3 (GPC_IMR3)

IMR3 Register - masking of irq[127:96].

Address: 20D_C000h base + 10h offset = 20D_C010h

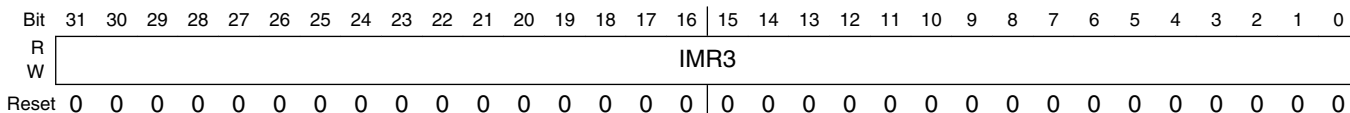

GPC_IMR3 field descriptions

Field	Description
IMR3	IRQ[127:96] masking bits: 1-irq masked, 0-irq is not masked

27.5.6 IRQ masking register 4 (GPC_IMR4)

IMR4 Register - masking of irq[159:128].

Address: 20D_C000h base + 14h offset = 20D_C014h

Bit	31	30	29	28	27	26	25	24	23	22	21	20	19	18	17	16	15	14	13	12	11	10	9	8	7	6	5	4	3	2	1	0
R	IMR4																															
W																																
Reset	0	0	0	0	0	0	0	0	0	0	0	0	0	0	0	0	0	0	0	0	0	0	0	0	0	0	0	0	0	0	0	0

GPC_IMR4 field descriptions

Field	Description
IMR4	IRQ[159:128] masking bits: 1-irq masked, 0-irq is not masked

27.5.7 IRQ status resister 1 (GPC_ISR1)

ISR1 Register - status of irq [63:32].

Address: 20D_C000h base + 18h offset = 20D_C018h

Bit	31	30	29	28	27	26	25	24	23	22	21	20	19	18	17	16	15	14	13	12	11	10	9	8	7	6	5	4	3	2	1	0
R	ISR1																															
W																																
Reset	0	0	0	0	0	0	0	0	0	0	0	0	0	0	0	0	0	0	0	0	0	0	0	0	0	0	0	0	0	0	0	0

GPC_ISR1 field descriptions

Field	Description
ISR1	IRQ[63:32] status, read only

27.5.8 IRQ status resister 2 (GPC_ISR2)

ISR2 Register - status of irq [95:64].

Address: 20D_C000h base + 1Ch offset = 20D_C01Ch

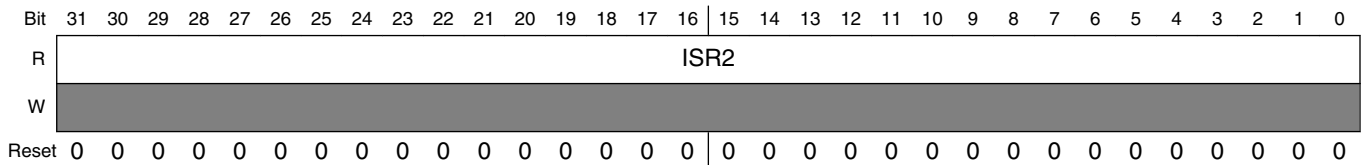

GPC_ISR2 field descriptions

Field	Description
ISR2	IRQ[95:64] status, read only

27.5.9 IRQ status resister 3 (GPC_ISR3)

ISR3 Register - status of irq [127:96].

Address: 20D_C000h base + 20h offset = 20D_C020h

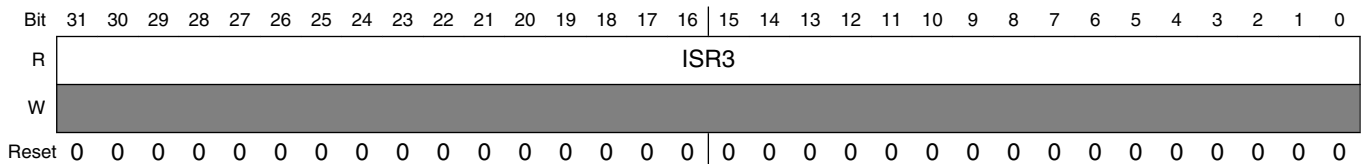

GPC_ISR3 field descriptions

Field	Description
ISR3	IRQ[127:96] status, read only

27.5.10 IRQ status resister 4 (GPC_ISR4)

ISR4 Register - status of irq [159:128].

Address: 20D_C000h base + 24h offset = 20D_C024h

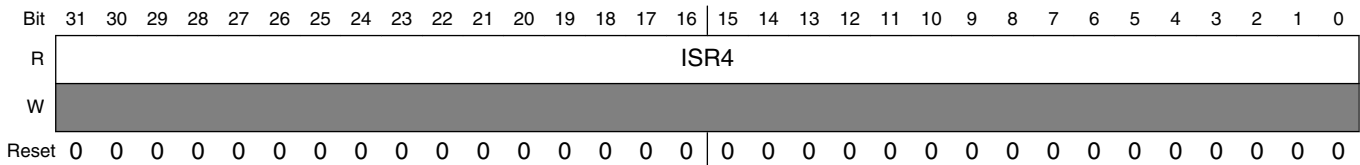

GPC_ISR4 field descriptions

Field	Description
ISR4	IRQ[159:128] status, read only

27.6 PGC Memory Map/Register Definition

The PGC registers can be accessed only in supervisor mode.

Attempts to access registers when not in supervisor mode or attempts to access an unimplemented address location might trigger a bus transfer error. (The hardware asserts the signal `ips_xfr_err` if the PGC has been integrated with `resp_sel` tied low.) In this case, software should take appropriate action (such as ignore the error, log the error, or initiate a soft reset).

All PGC registers are byte-accessible.

NOTE

The base address of each PGC module instantiation is specified in the GPC module. Absolute address values will be calculated by [GPC base address] + [PGC CPU/GPU/DISPLAY Offset].

PGC memory map

Absolute address (hex)	Register name	Width (in bits)	Access	Reset value	Section/page
20D_C220	PGC Mega Control Register (PGC_MEGA_CTRL)	32	R/W	0000_0000h	27.6.1/1336

Table continues on the next page...

PGC memory map (continued)

Absolute address (hex)	Register name	Width (in bits)	Access	Reset value	Section/page
20D_C224	PGC Mega Power Up Sequence Control Register (PGC_MEGA_PUPSCR)	32	R/W	0000_0F01h	27.6.2/1337
20D_C228	PGC Mega Pull Down Sequence Control Register (PGC_MEGA_PDNSCR)	32	R/W	0000_0101h	27.6.3/1337
20D_C22C	PGC Mega Power Gating Controller Status Register (PGC_MEGA_SR)	32	R/W	0000_0000h	27.6.4/1338
20D_C2A0	PGC CPU Control Register (PGC_CPU_CTRL)	32	R/W	0000_0000h	27.6.5/1339
20D_C2A4	PGC CPU Power Up Sequence Control Register (PGC_CPU_PUPSCR)	32	R/W	0000_0F01h	27.6.6/1339
20D_C2A8	PGC CPU Pull Down Sequence Control Register (PGC_CPU_PDNSCR)	32	R/W	0000_0101h	27.6.7/1340
20D_C2AC	PGC CPU Power Gating Controller Status Register (PGC_CPU_SR)	32	R/W	0000_0000h	27.6.8/1341

27.6.1 PGC Mega Control Register (PGC_MEGA_CTRL)

The PGCR enables the response to a power-down request.

Address: 20D_C000h base + 220h offset = 20D_C220h

Bit	31	30	29	28	27	26	25	24	23	22	21	20	19	18	17	16
R	0															
W	[Shaded]															
Reset	0	0	0	0	0	0	0	0	0	0	0	0	0	0	0	0
Bit	15	14	13	12	11	10	9	8	7	6	5	4	3	2	1	0
R	0															PCR
W	[Shaded]															[Shaded]
Reset	0	0	0	0	0	0	0	0	0	0	0	0	0	0	0	0

PGC_MEGA_CTRL field descriptions

Field	Description
31–1 Reserved	This read-only field is reserved and always has the value 0.
0 PCR	<p>Power Control</p> <p>NOTE: PCR must not change from power-down request (pdn_req) assertion until the target subsystem is completely powered up.</p> <p>0 Do not switch off power even if pdn_req is asserted.</p> <p>1 Switch off power when pdn_req is asserted.</p>

27.6.2 PGC Mega Power Up Sequence Control Register (PGC_MEGA_PUPSCR)

The PUPSCR contains the power-up timing parameters.

Address: 20D_C000h base + 224h offset = 20D_C224h

Bit	31	30	29	28	27	26	25	24	23	22	21	20	19	18	17	16	15	14	13	12	11	10	9	8	7	6	5	4	3	2	1	0
R	0																SW2ISO				0		SW									
W	0																0				0		0									
Reset	0	0	0	0	0	0	0	0	0	0	0	0	0	0	0	0	0	0	0	0	1	1	1	1	0	0	0	0	0	0	0	1

PGC_MEGA_PUPSCR field descriptions

Field	Description
31–14 Reserved	This read-only field is reserved and always has the value 0.
13–8 SW2ISO	After asserting power toggle on/off signal (switch_b), the PGC waits a number of IPG clocks equal to the value of SW2ISO before negating isolation. NOTE: SW2ISO must not be programmed to zero.
7–6 Reserved	This read-only field is reserved and always has the value 0.
SW	After a power-up request (pup_req assertion), the PGC waits a number of IPG clocks equal to the value of SW before asserting power toggle on/off signal (switch_b). NOTE: SW must not be programmed to zero. NOTE: The PGC clock is generated from the IPG_CLK_ROOT. for frequency configuration of the IPG_CLK_ROOT. See Clock Controller Module (CCM) .

27.6.3 PGC Mega Pull Down Sequence Control Register (PGC_MEGA_PDNSCR)

The PDNSCR contains the power-down timing parameters.

Address: 20D_C000h base + 228h offset = 20D_C228h

Bit	31	30	29	28	27	26	25	24	23	22	21	20	19	18	17	16	15	14	13	12	11	10	9	8	7	6	5	4	3	2	1	0	
R	0																ISO2SW				0		ISO										
W	0																0				0		0										
Reset	0	0	0	0	0	0	0	0	0	0	0	0	0	0	0	0	0	0	0	0	0	0	0	1	0	0	0	0	0	0	0	0	1

PGC_MEGA_PDNSCR field descriptions

Field	Description
31–14 Reserved	This read-only field is reserved and always has the value 0.
13–8 ISO2SW	After asserting isolation, the PGC waits a number of IPG clocks equal to the value of ISO2SW before negating power toggle on/off signal (switch_b). NOTE: ISO2SW must not be programmed to zero.
7–6 Reserved	This read-only field is reserved and always has the value 0.
ISO	After a power-down request (pdn_req assertion), the PGC waits a number of IPG clocks equal to the value of ISO before asserting isolation. NOTE: ISO must not be programmed to zero.

27.6.4 PGC Mega Power Gating Controller Status Register (PGC_MEGA_SR)

The SR contains the status parameters.

Address: 20D_C000h base + 22Ch offset = 20D_C22Ch

Bit	31	30	29	28	27	26	25	24		23	22	21	20	19	18	17	16
R	0																
W	[Shaded]																
Reset	0	0	0	0	0	0	0	0		0	0	0	0	0	0	0	0
Bit	15	14	13	12	11	10	9	8		7	6	5	4	3	2	1	0
R	0																
W	[Shaded]																
Reset	0	0	0	0	0	0	0	0		0	0	0	0	0	0	0	0

PGC_MEGA_SR field descriptions

Field	Description
31–1 Reserved	This read-only field is reserved and always has the value 0.
0 PSR	Power status. When in functional (or software-controlled debug) mode, PGC hardware sets PSR as soon as any of the power control output changes its state to one. Write one to clear this bit. Software should clear this bit after power up; otherwise, PSR continues to reflect the power status of the initial power down. 0 The target subsystem was not powered down for the previous power-down request. 1 The target subsystem was powered down for the previous power-down request.

27.6.5 PGC CPU Control Register (PGC_CPU_CTRL)

The PGCR enables the response to a power-down request.

Address: 20D_C000h base + 2A0h offset = 20D_C2A0h

Bit	31	30	29	28	27	26	25	24		23	22	21	20	19	18	17	16
R	0																
W	0																
Reset	0	0	0	0	0	0	0	0		0	0	0	0	0	0	0	0
Bit	15	14	13	12	11	10	9	8		7	6	5	4	3	2	1	0
R	0																
W	0																
Reset	0	0	0	0	0	0	0	0		0	0	0	0	0	0	0	0

PGC_CPU_CTRL field descriptions

Field	Description
31–1 Reserved	This read-only field is reserved and always has the value 0.
0 PCR	<p>Power Control</p> <p>NOTE: PCR must not change from power-down request (pdn_req) assertion until the target subsystem is completely powered up.</p> <p>0 Do not switch off power even if pdn_req is asserted.</p> <p>1 Switch off power when pdn_req is asserted.</p>

27.6.6 PGC CPU Power Up Sequence Control Register (PGC_CPU_PUPSCR)

The PUPSCR contains the power-up timing parameters.

Address: 20D_C000h base + 2A4h offset = 20D_C2A4h

Bit	31	30	29	28	27	26	25	24	23	22	21	20	19	18	17	16		15	14	13	12	11	10	9	8	7	6	5	4	3	2	1	0
R	0																SW2ISO				0		SW										
W	0																0				0		0										
Reset	0	0	0	0	0	0	0	0	0	0	0	0	0	0	0	0		0	0	0	0	1	1	1	1	0	0	0	0	0	0	0	1

PGC_CPU_PUPSCR field descriptions

Field	Description
31–14 Reserved	This read-only field is reserved and always has the value 0.
13–8 SW2ISO	<p>There are two different silicon revisions: 1.0 and 1.1 (defined by USB_ANALOG_DIGPROG).</p> <ul style="list-style-type: none"> For silicon revision 1.0: PGC waits for 2048*SW2ISO cycles of IPG_CLK before negating isolation. For silicon revision 1.1: <ul style="list-style-type: none"> SW[5] = 1: PGC waits for 64*SW2ISO cycles of IPG_CLK before negating isolation. SW[5] = 0: PGC waits for 2048*SW2ISO cycles of IPG_CLK before negating isolation. <p>NOTE: SW2ISO must not be programmed to zero. The SW2ISO value should be chosen such that the delay before negating isolation is greater than the LDO ramp-up time.</p>
7–6 Reserved	This read-only field is reserved and always has the value 0.
SW	<p>There are two different silicon revisions: 1.0 and 1.1 (defined by USB_ANALOG_DIGPROG). When IPG_CLK frequency is slow down in low power mode, it can set SW[5] to speed up ARM wakeup time.</p> <ul style="list-style-type: none"> For silicon revision 1.0: PGC waits for 2048*SW[5:0] cycles of IPG_CLK to switch on ARM power after pup_req is asserted. For silicon revision 1.1: <ul style="list-style-type: none"> SW[5] = 1: PGC waits for 64*SW[4:0] cycles of IPG_CLK to switch on ARM power after pup_req is asserted. SW[5] = 0: PGC waits for 2048*SW[4:0] cycles of IPG_CLK to switch on ARM power after pup_req is asserted. <p>NOTE: SW[4:0] can be programmed to zero.</p>

27.6.7 PGC CPU Pull Down Sequence Control Register (PGC_CPU_PDNSCR)

The PDNSCR contains the power-down timing parameters.

Address: 20D_C000h base + 2A8h offset = 20D_C2A8h

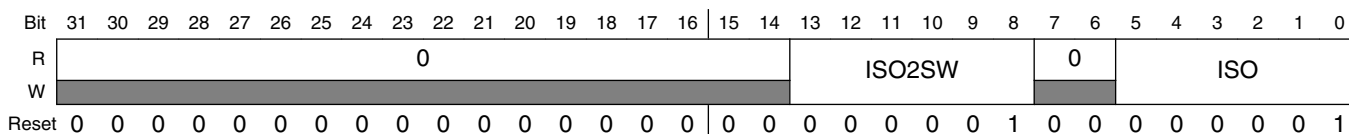

PGC_CPU_PDNSCR field descriptions

Field	Description
31–14 Reserved	This read-only field is reserved and always has the value 0.
13–8 ISO2SW	After asserting isolation, the PGC waits a number of 32k clocks equal to the value of ISO2SW before negating .

Table continues on the next page...

PGC_CPU_PDNSCR field descriptions (continued)

Field	Description
	NOTE: ISO2SW must not be programmed to zero.
7–6 Reserved	This read-only field is reserved and always has the value 0.
ISO	After a power-down request (pdn_req assertion), the PGC waits a number of 32k clocks equal to the value of ISO before asserting isolation. NOTE: ISO must not be programmed to zero.

27.6.8 PGC CPU Power Gating Controller Status Register (PGC_CPU_SR)

The SR contains the status parameters.

Address: 20D_C000h base + 2ACh offset = 20D_C2ACh

Bit	31	30	29	28	27	26	25	24	23	22	21	20	19	18	17	16
R	0															
W																
Reset	0	0	0	0	0	0	0	0	0	0	0	0	0	0	0	0
Bit	15	14	13	12	11	10	9	8	7	6	5	4	3	2	1	0
R	0															
W																
Reset	0	0	0	0	0	0	0	0	0	0	0	0	0	0	0	0

PGC_CPU_SR field descriptions

Field	Description
31–1 Reserved	This read-only field is reserved and always has the value 0.
0 PSR	Power status. When in functional (or software-controlled debug) mode, PGC hardware sets PSR as soon as any of the power control output changes its state to one. Write one to clear this bit. Software should clear this bit after power up; otherwise, PSR continues to reflect the power status of the initial power down. 0 The target subsystem was not powered down for the previous power-down request. 1 The target subsystem was powered down for the previous power-down request.

Chapter 28

General Purpose Input/Output (GPIO)

28.1 Overview

The GPIO general-purpose input/output peripheral provides dedicated general-purpose pins that can be configured as either inputs or outputs.

When configured as an output, it is possible to write to an internal register to control the state driven on the output pin. When configured as an input, it is possible to detect the state of the input by reading the state of an internal register. In addition, the GPIO peripheral can produce CORE interrupts.

The GPIO is one of the blocks controlling the IOMUX of the chip.

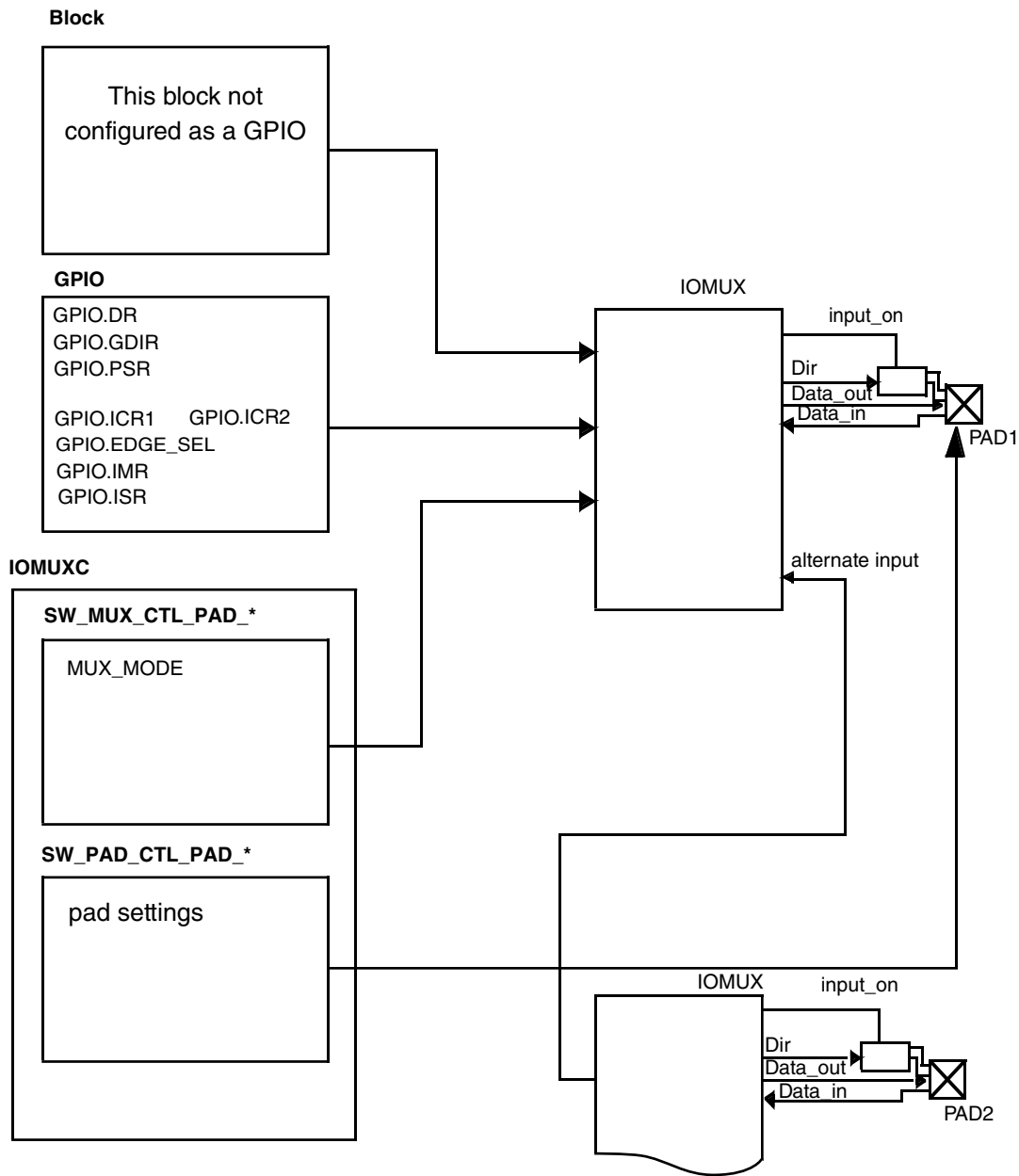

Figure 28-1. Chip IOMUX Scheme

The GPIO functionality is provided through eight registers, an edge-detect circuit, and interrupt generation logic.

The eight registers are:

- Data register (GPIO_DR)
- GPIO direction register (GPIO_GDIR)
- Pad sample register (GPIO_PSR)
- Interrupt control registers (GPIO_ICR1, GPIO_ICR2)

- Edge select register (GPIO_EDGE_SEL)
- Interrupt mask register (GPIO_IMR)
- Interrupt status register (GPIO_ISR)

These registers are described in detail in [GPIO Memory Map/Register Definition](#).

Each GPIO input has a dedicated edge-detect circuit which can be configured through software to detect rising edges, falling edges, logic low-levels or logic high-levels on the input signals. The outputs of the edge detect circuits are optionally masked by setting the corresponding bit in the interrupt mask register (GPIO_IMR). These qualified outputs are OR'ed together to generate two one-bit interrupt lines:

- Combined interrupt indication for GPIOx signals 0 - 15
- Combined interrupt indication for GPIOx signals 16 - 31

In addition, GPIO1 provides visibility to each of its 8 low order interrupt sources (i.e. GPIO1 interrupt n, for n = 0 – 7). However, individual interrupt indications from other GPIOx are not available.

The GPIO edge detection is described further in [Interrupt Control Unit](#).

The GPIO's overall functionality is described further in [GPIO Functional Description](#).

28.1.1 Block Diagram

The GPIO subsystem contains multiple GPIO blocks, which can generate and control up to 32 signals for general purpose.

A block diagram of the GPIO is shown in [Figure 28-2](#)

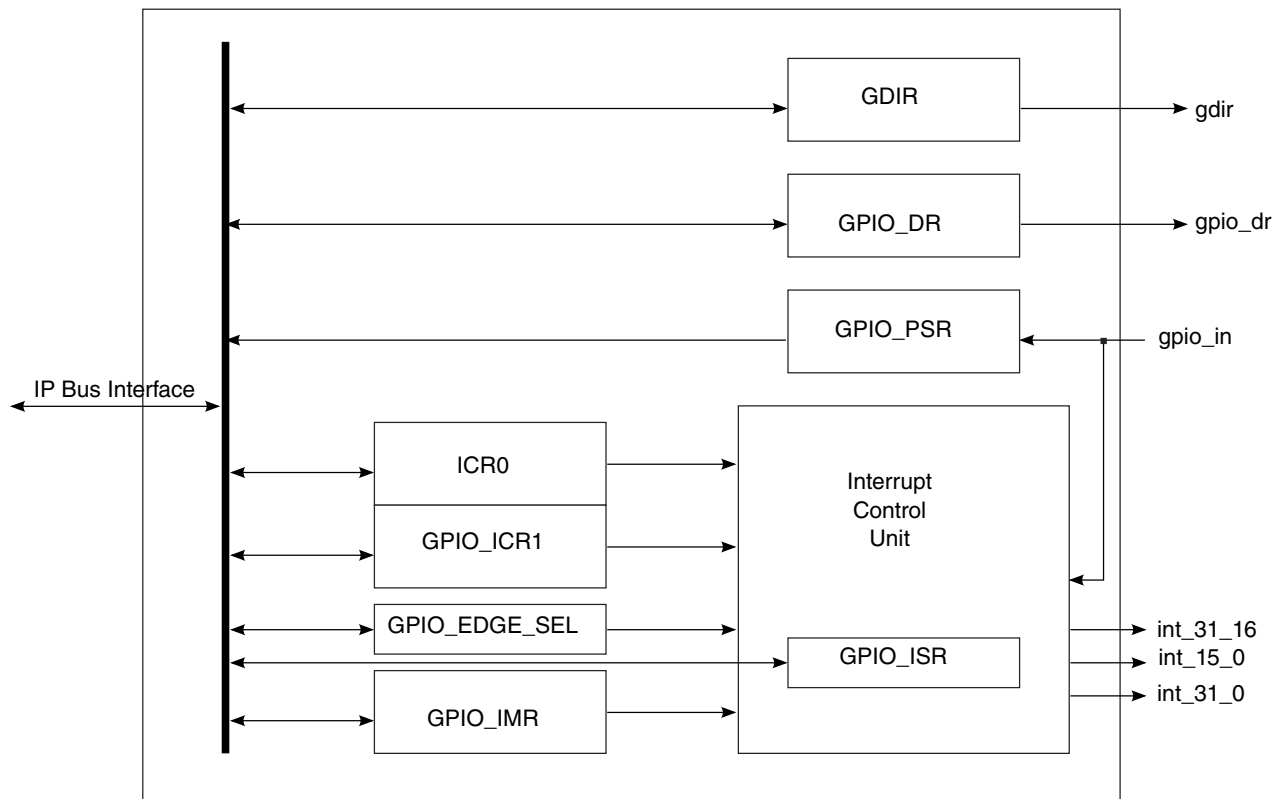

Figure 28-2. GPIO Block Diagram

28.1.2 Features

The GPIO includes the following features:

- General purpose input/output logic capabilities:
 - Drives specific data to output using the data register (GPIO_DR)
 - Controls the direction of the signal using the GPIO direction register (GPIO_GDIR)
 - Enables the core to sample the status of the corresponding inputs by reading the pad sample register (GPIO_PSR).
- GPIO interrupt capabilities:
 - Supports up to 32 interrupts
 - Identifies interrupt edges
 - Generates three active-high interrupts to the SoC interrupt controller

28.2 External Signals

The tables found here describe the external signals of GPIO.

Table 28-1. GPIO External Signals

Instance	Signal	Pad	Mode	Direction
GPIO1	IO0	GPIO1_IO00	ALT5	I/O
	IO1	GPIO1_IO01	ALT5	
	IO2	GPIO1_IO02	ALT5	
	IO3	GPIO1_IO03	ALT5	
	IO4	GPIO1_IO04	ALT5	
	IO5	GPIO1_IO05	ALT5	
	IO6	GPIO1_IO06	ALT5	
	IO7	GPIO1_IO07	ALT5	
	IO8	GPIO1_IO08	ALT5	
	IO9	GPIO1_IO09	ALT5	
	IO10	JTAG_MOD	ALT5	
	IO11	JTAG_TMS	ALT5	
	IO12	JTAG_TDO	ALT5	
	IO13	JTAG_TDI	ALT5	
	IO14	JTAG_TCK	ALT5	
	IO15	JTAG_TRST_B	ALT5	
	IO16	UART1_TX_DATA	ALT5	
	IO17	UART1_RX_DATA	ALT5	
	IO18	UART1_CTS_B	ALT5	
	IO19	UART1_RTS_B	ALT5	
	IO20	UART2_TX_DATA	ALT5	
	IO21	UART2_RX_DATA	ALT5	
	IO22	UART2_CTS_B	ALT5	
	IO23	UART2_RTS_B	ALT5	
	IO24	UART3_TX_DATA	ALT5	
	IO25	UART3_RX_DATA	ALT5	
	IO26	UART3_CTS_B	ALT5	
	IO27	UART3_RTS_B	ALT5	
	IO28	UART4_TX_DATA	ALT5	
	IO29	UART4_RX_DATA	ALT5	
	IO30	UART5_TX_DATA	ALT5	
IO31	UART5_RX_DATA	ALT5		
GPIO2	IO0	ENET1_RX_DATA0	ALT5	I/O
	IO1	ENET1_RX_DATA1	ALT5	
	IO2	ENET1_RX_EN	ALT5	
	IO3	ENET1_TX_DATA0	ALT5	

Table continues on the next page...

Table 28-1. GPIO External Signals (continued)

Instance	Signal	Pad	Mode	Direction		
	IO4	ENET1_TX_DATA1	ALT5			
	IO5	ENET1_TX_EN	ALT5			
	IO6	ENET1_TX_CLK	ALT5			
	IO7	ENET1_RX_ER	ALT5			
	IO8	ENET2_RX_DATA0	ALT5			
	IO9	ENET2_RX_DATA1	ALT5			
	IO10	ENET2_RX_EN	ALT5			
	IO11	ENET2_TX_DATA0	ALT5			
	IO12	ENET2_TX_DATA1	ALT5			
	IO13	ENET2_TX_EN	ALT5			
	IO14	ENET2_TX_CLK	ALT5			
	IO15	ENET2_RX_ER	ALT5			
	IO16	SD1_CMD	ALT5			
	IO17	SD1_CLK	ALT5			
	IO18	SD1_DATA0	ALT5			
	IO19	SD1_DATA1	ALT5			
	IO20	SD1_DATA2	ALT5			
	IO21	SD1_DATA3	ALT5			
	GPIO3	IO0	LCD_CLK		ALT5	I/O
		IO1	LCD_ENABLE		ALT5	
		IO2	LCD_HSYNC		ALT5	
IO3		LCD_VSYNC	ALT5			
IO4		LCD_RESET	ALT5			
IO5		LCD_DATA00	ALT5			
IO6		LCD_DATA01	ALT5			
IO7		LCD_DATA02	ALT5			
IO8		LCD_DATA03	ALT5			
IO9		LCD_DATA04	ALT5			
IO10		LCD_DATA05	ALT5			
IO11		LCD_DATA06	ALT5			
IO12		LCD_DATA07	ALT5			
IO13		LCD_DATA08	ALT5			
IO14		LCD_DATA09	ALT5			
IO15		LCD_DATA10	ALT5			
IO16		LCD_DATA11	ALT5			
IO17		LCD_DATA12	ALT5			
IO18		LCD_DATA13	ALT5			
IO19		LCD_DATA14	ALT5			
IO20		LCD_DATA15	ALT5			

Table continues on the next page...

Table 28-1. GPIO External Signals (continued)

Instance	Signal	Pad	Mode	Direction
	IO21	LCD_DATA16	ALT5	
	IO22	LCD_DATA17	ALT5	
	IO23	LCD_DATA18	ALT5	
	IO24	LCD_DATA19	ALT5	
	IO25	LCD_DATA20	ALT5	
	IO26	LCD_DATA21	ALT5	
	IO27	LCD_DATA22	ALT5	
	IO28	LCD_DATA23	ALT5	
GPIO4	IO0	NAND_RE_B	ALT5	I/O
	IO1	NAND_WE_B	ALT5	
	IO2	NAND_DATA00	ALT5	
	IO3	NAND_DATA01	ALT5	
	IO4	NAND_DATA02	ALT5	
	IO5	NAND_DATA03	ALT5	
	IO6	NAND_DATA04	ALT5	
	IO7	NAND_DATA05	ALT5	
	IO8	NAND_DATA06	ALT5	
	IO9	NAND_DATA07	ALT5	
	IO10	NAND_ALE	ALT5	
	IO11	NAND_WP_B	ALT5	
	IO12	NAND_READY_B	ALT5	
	IO13	NAND_CE0_B	ALT5	
	IO14	NAND_CE1_B	ALT5	
	IO15	NAND_CLE	ALT5	
	IO16	NAND_DQS	ALT5	
	IO17	CSI_MCLK	ALT5	
	IO18	CSI_PIXCLK	ALT5	
	IO19	CSI_VSYNC	ALT5	
	IO20	CSI_HSYNC	ALT5	
	IO21	CSI_DATA00	ALT5	
	IO22	CSI_DATA01	ALT5	
	IO23	CSI_DATA02	ALT5	
	IO24	CSI_DATA03	ALT5	
	IO25	CSI_DATA04	ALT5	
	IO26	CSI_DATA05	ALT5	
	IO27	CSI_DATA06	ALT5	
IO28	CSI_DATA07	ALT5		
GPIO5	IO0	SNVS_TAMPER0	No Muxing (ALT5)	I/O

Table continues on the next page...

Table 28-1. GPIO External Signals (continued)

Instance	Signal	Pad	Mode	Direction
	IO1	SNVS_TAMPER1	No Muxing (ALT5)	
	IO2	SNVS_TAMPER2	No Muxing (ALT5)	
	IO3	SNVS_TAMPER3	No Muxing (ALT5)	
	IO4	SNVS_TAMPER4	No Muxing (ALT5)	
	IO5	SNVS_TAMPER5	No Muxing (ALT5)	
	IO6	SNVS_TAMPER6	No Muxing (ALT5)	
	IO7	SNVS_TAMPER7	No Muxing (ALT5)	
	IO8	SNVS_TAMPER8	No Muxing (ALT5)	
	IO9	SNVS_TAMPER9	No Muxing (ALT5)	
	IO10	BOOT_MODE0	No Muxing (ALT5)	
	IO11	BOOT_MODE1	No Muxing (ALT5)	

28.3 Clocks

The table found here describes the clock sources for GPIO.

Please see the clock controller Module for clock setting, configuration and gating information.

Table 28-2. GPIO Clocks

Clock name	Clock Root	Description
ipg_clk_s	ipg_clk_root	Peripheral access clock

28.4 GPIO Functional Description

This section provides a complete functional description of the block.

28.4.1 GPIO Function

A GPIO signal can operate as a general-purpose input/output when the IOMUX is set to GPIO mode. Each GPIO signal may be independently configured as either an input or an output using the GPIO direction register (GPIO_GDIR).

When configured as an output (GPIO_GDIR bit = 1), the value in the data bit in the GPIO data register (GPIO_DR) is driven on the corresponding GPIO line. When a signal is configured as an input (GPIO_GDIR bit = 0), the state of the input can be read from the corresponding GPIO_PSR bit.

28.4.2 GPIO pad structure

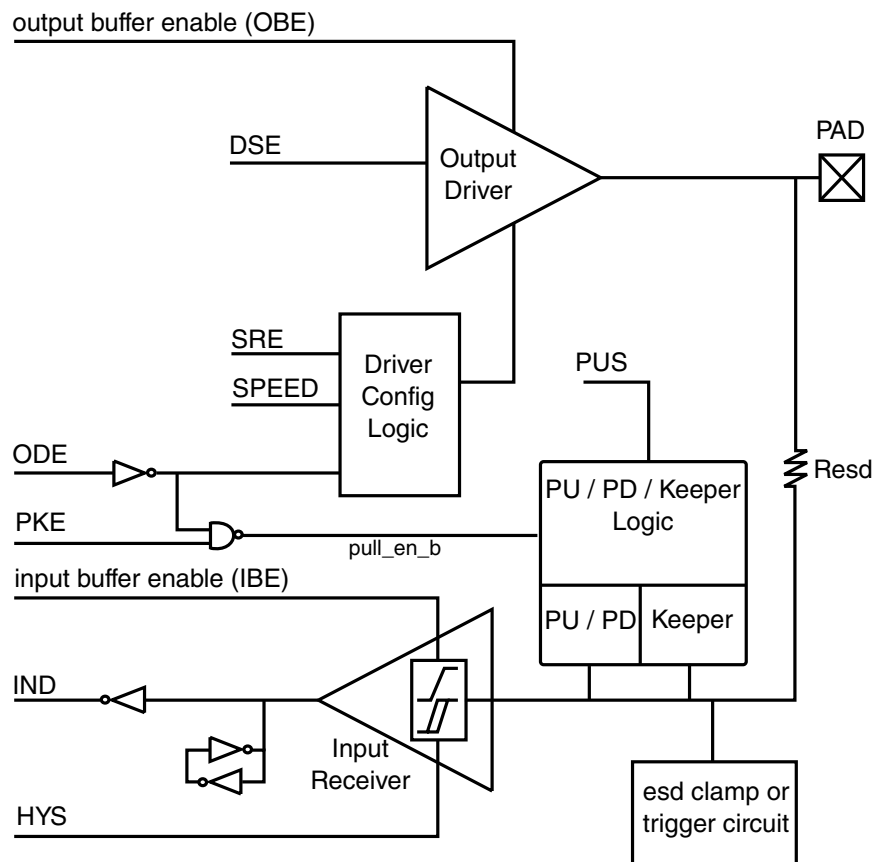

Figure 28-3. GPIO pad functional diagram

28.4.2.1 Input Driver

Input driver characteristics

- Selectable Schmitt trigger or CMOS input mode
- Keeper structure with buffer at the input receiver output to Core
- Receiver is tri-stated when I/O supply (OVDD) is powered down. (Keeper at receiver output keeps its previous state).

28.4.2.1.1 Schmitt trigger

The anti-jamming functionality of the Schmitt trigger is illustrated below.

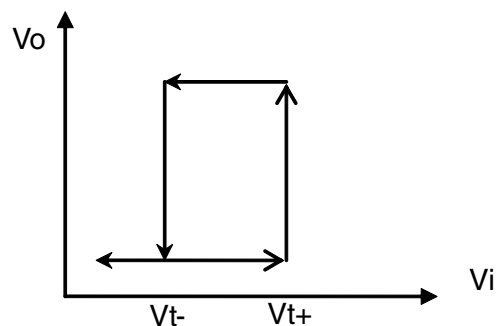

Figure 28-4. Schmitt trigger transfer characteristic

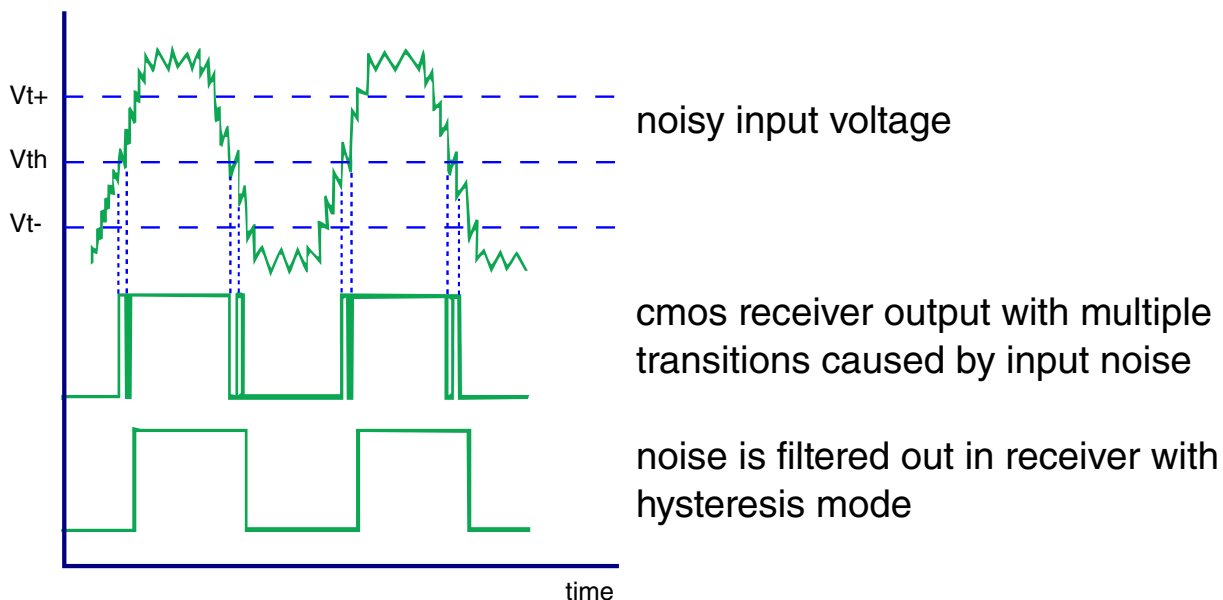

Figure 28-5. Receiver output in CMOS and hysteresis

28.4.2.1.2 Input keeper

A simple latch to hold the input value when OVDD is powered down, or the first inverter is tri-stated. Input buffer's keeper is always enabled for all the pads.

28.4.2.2 Output Driver

Output driver characteristics

- Selectable CMOS or open-drain output type
- Selectable pull-keeper enable signal to enable/disable the pull-up/down and output keeper
- Selectable pull-up resistors of 22K, 47K, 100K and a pull-down resistor of 100KOhm. Unsilicided P+ poly resistor is used to limit resistance variation to within +/- 20%.
- Pull-up, pull-down, and pad keeper are disabled in output mode.
- Seven drive strengths in each operating mode
- Additional 2-bit slew rate control to select between 50, 100, and 200 MHz IO cell operation range with reduced switching noise

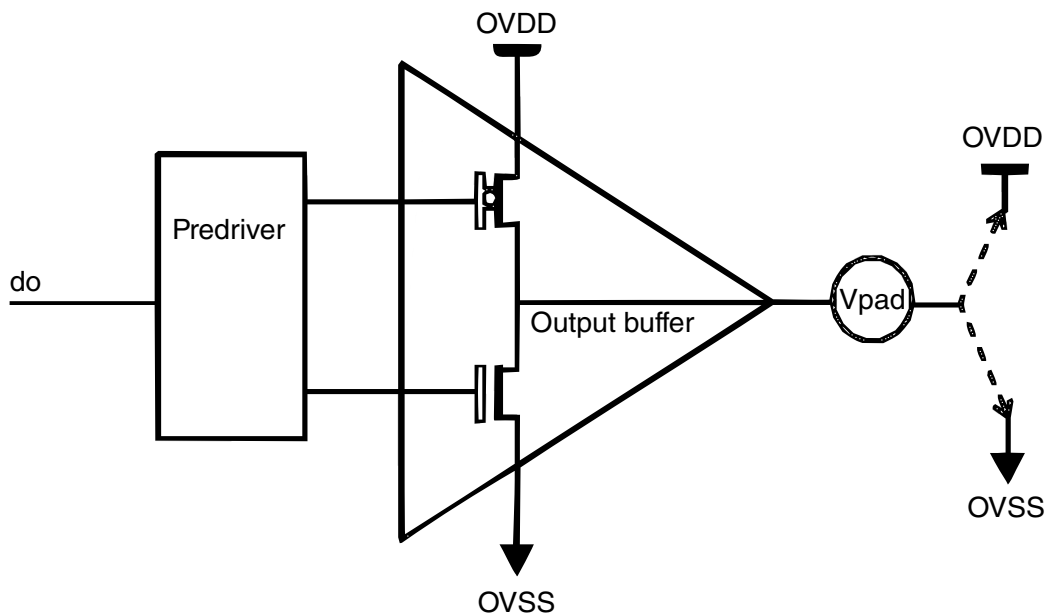

Figure 28-6. Output Driver Functional Diagram

28.4.2.2.1 Drive strength

Drive strength selection can be use to make the impedance matched and get better signal integrity.

28.4.2.2.2 Output keeper

A simple latch to hold the input value.

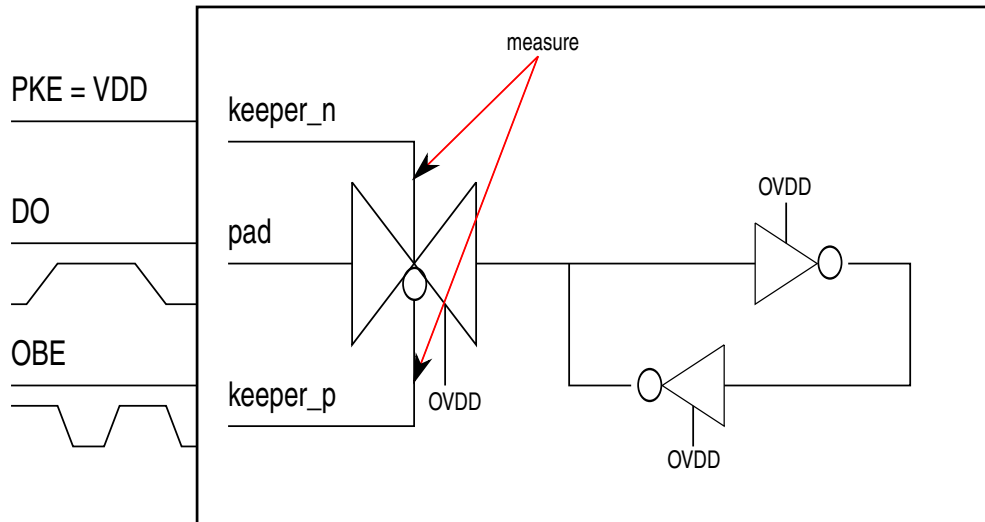

Figure 28-7. Keeper functional diagram

28.4.2.2.3 PU / PD / Keeper Logic

When Keeper is enabled, the pull-up and pull-down are disabled, and the output value of the pad depends on the Keeper. The output keeper is powered by OVDD. When the core VDD is powered down or the first inverter is tri-stated, the pad's state can be kept. Keeper and Pull can't be enabled together.

28.4.2.2.4 Open drain

Open drain is a circuit technique which allows multiple devices to communication over a single wire bi-directionally. Open drain drivers usually operate with an external or internal pull-up resistor that holds the signal line high until a device sinks enough current to pull the line low, usually used for a bus with multiple devices.

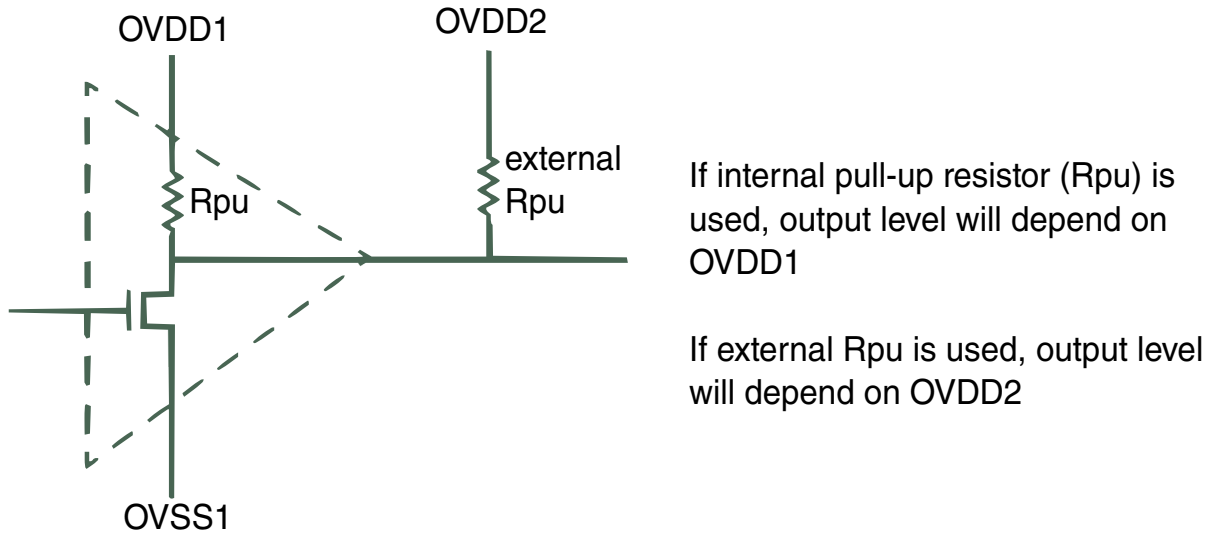

Figure 28-8. Output buffer in open drain mode

28.4.3 GPIO Programming

28.4.3.1 GPIO Read Mode

The programming sequence for reading input signals should be as follows:

1. Configure IOMUX to select GPIO mode (Via IOMUX Controller (IOMUXC)).
2. Configure GPIO direction register to input (GPIO_GDIR[GDIR] set to 0b).
3. Read value from data register/pad status register.

A pseudocode description to read [input3:input0] values is as follows:

```
// SET INPUTS TO GPIO MODE.
write sw_mux_ctl_<input0>_<input1>_<input2>_<input3>, 32'h00000000
// SET GDIR TO INPUT.
write GDIR[31:4,input3_bit, input2_bit, input1_bit, input0_bit,] 32'hxxxxxxxx0
// READ INPUT VALUE FROM DR.
read DR
// READ INPUT VALUE FROM PSR.
read PSR
```

NOTE

While the GPIO direction is set to input (GPIO_GDIR = 0), a read access to GPIO_DR does not return GPIO_DR data. Instead, it returns the GPIO_PSR data, which is the corresponding input signal value.

28.4.3.2 GPIO Write Mode

The programming sequence for driving output signals should be as follows:

1. Configure IOMUX to select GPIO mode (Via IOMUXC), also enable SION if need to read loopback pad value through PSR
2. Configure GPIO direction register to output (GPIO_GDIR[GDIR] set to 1b).
3. Write value to data register (GPIO_DR).

A pseudocode description to drive 4'b0101 on [output3:output0] is as follows:

```
// SET PADS TO GPIO MODE VIA IOMUX.
write sw_mux_ctl_pad_<output[0-3]>.mux_mode, <GPIO_MUX_MODE>
// Enable loopback so we can capture pad value into PSR in output mode
write sw_mux_ctl_pad_<output[0-3]>.sion, 1
// SET GDIR=1 TO OUTPUT BITS.
write GDIR[31:4,output3_bit,output2_bit, output1_bit, output0_bit,] 32'hxxxxxxxF
// WRITE OUTPUT VALUE=4'b0101 TO DR.
write DR, 32'hxxxxxxx5
// READ OUTPUT VALUE FROM PSR ONLY.
read_cmp PSR, 32'hxxxxxxx5
```

28.4.4 Interrupt Control Unit

In addition to the general-purpose input/output function, the edge-detect logic in the GPIO peripheral reflects whether a transition has occurred on a given GPIO signal that is configured as an input (GDIR bit = 0). The interrupt control registers (GPIO_ICR1 and GPIO_ICR2) may be used to independently configure the interrupt condition of each input signal (low-to-high transition, high-to-low transition, low, or high). For information about GPIO_ICR1 and GPIO_ICR2 settings, see [GPIO Memory Map/Register Definition](#).

The interrupt control unit is built of 32 interrupt control subunits, where each subunit handles a single interrupt line.

28.5 GPIO Memory Map/Register Definition

There are eight 32-bit GPIO registers. All registers are accessible from the IP interface. Only 32-bit access is supported.

The GPIO memory map is shown in the following table.

GPIO memory map

Absolute address (hex)	Register name	Width (in bits)	Access	Reset value	Section/page
209_C000	GPIO data register (GPIO1_DR)	32	R/W	0000_0000h	28.5.1/1358
209_C004	GPIO direction register (GPIO1_GDIR)	32	R/W	0000_0000h	28.5.2/1359
209_C008	GPIO pad status register (GPIO1_PSR)	32	R	0000_0000h	28.5.3/1359
209_C00C	GPIO interrupt configuration register1 (GPIO1_ICR1)	32	R/W	0000_0000h	28.5.4/1360
209_C010	GPIO interrupt configuration register2 (GPIO1_ICR2)	32	R/W	0000_0000h	28.5.5/1364
209_C014	GPIO interrupt mask register (GPIO1_IMR)	32	R/W	0000_0000h	28.5.6/1367
209_C018	GPIO interrupt status register (GPIO1_ISR)	32	w1c	0000_0000h	28.5.7/1368
209_C01C	GPIO edge select register (GPIO1_EDGE_SEL)	32	R/W	0000_0000h	28.5.8/1369
20A_0000	GPIO data register (GPIO2_DR)	32	R/W	0000_0000h	28.5.1/1358
20A_0004	GPIO direction register (GPIO2_GDIR)	32	R/W	0000_0000h	28.5.2/1359
20A_0008	GPIO pad status register (GPIO2_PSR)	32	R	0000_0000h	28.5.3/1359
20A_000C	GPIO interrupt configuration register1 (GPIO2_ICR1)	32	R/W	0000_0000h	28.5.4/1360
20A_0010	GPIO interrupt configuration register2 (GPIO2_ICR2)	32	R/W	0000_0000h	28.5.5/1364
20A_0014	GPIO interrupt mask register (GPIO2_IMR)	32	R/W	0000_0000h	28.5.6/1367
20A_0018	GPIO interrupt status register (GPIO2_ISR)	32	w1c	0000_0000h	28.5.7/1368
20A_001C	GPIO edge select register (GPIO2_EDGE_SEL)	32	R/W	0000_0000h	28.5.8/1369
20A_4000	GPIO data register (GPIO3_DR)	32	R/W	0000_0000h	28.5.1/1358
20A_4004	GPIO direction register (GPIO3_GDIR)	32	R/W	0000_0000h	28.5.2/1359
20A_4008	GPIO pad status register (GPIO3_PSR)	32	R	0000_0000h	28.5.3/1359
20A_400C	GPIO interrupt configuration register1 (GPIO3_ICR1)	32	R/W	0000_0000h	28.5.4/1360
20A_4010	GPIO interrupt configuration register2 (GPIO3_ICR2)	32	R/W	0000_0000h	28.5.5/1364
20A_4014	GPIO interrupt mask register (GPIO3_IMR)	32	R/W	0000_0000h	28.5.6/1367
20A_4018	GPIO interrupt status register (GPIO3_ISR)	32	w1c	0000_0000h	28.5.7/1368
20A_401C	GPIO edge select register (GPIO3_EDGE_SEL)	32	R/W	0000_0000h	28.5.8/1369
20A_8000	GPIO data register (GPIO4_DR)	32	R/W	0000_0000h	28.5.1/1358
20A_8004	GPIO direction register (GPIO4_GDIR)	32	R/W	0000_0000h	28.5.2/1359
20A_8008	GPIO pad status register (GPIO4_PSR)	32	R	0000_0000h	28.5.3/1359
20A_800C	GPIO interrupt configuration register1 (GPIO4_ICR1)	32	R/W	0000_0000h	28.5.4/1360
20A_8010	GPIO interrupt configuration register2 (GPIO4_ICR2)	32	R/W	0000_0000h	28.5.5/1364
20A_8014	GPIO interrupt mask register (GPIO4_IMR)	32	R/W	0000_0000h	28.5.6/1367
20A_8018	GPIO interrupt status register (GPIO4_ISR)	32	w1c	0000_0000h	28.5.7/1368
20A_801C	GPIO edge select register (GPIO4_EDGE_SEL)	32	R/W	0000_0000h	28.5.8/1369
20A_C000	GPIO data register (GPIO5_DR)	32	R/W	0000_0000h	28.5.1/1358
20A_C004	GPIO direction register (GPIO5_GDIR)	32	R/W	0000_0000h	28.5.2/1359
20A_C008	GPIO pad status register (GPIO5_PSR)	32	R	0000_0000h	28.5.3/1359
20A_C00C	GPIO interrupt configuration register1 (GPIO5_ICR1)	32	R/W	0000_0000h	28.5.4/1360
20A_C010	GPIO interrupt configuration register2 (GPIO5_ICR2)	32	R/W	0000_0000h	28.5.5/1364
20A_C014	GPIO interrupt mask register (GPIO5_IMR)	32	R/W	0000_0000h	28.5.6/1367

Table continues on the next page...

GPIO memory map (continued)

Absolute address (hex)	Register name	Width (in bits)	Access	Reset value	Section/page
20A_C018	GPIO interrupt status register (GPIO5_ISR)	32	w1c	0000_0000h	28.5.7/1368
20A_C01C	GPIO edge select register (GPIO5_EDGE_SEL)	32	R/W	0000_0000h	28.5.8/1369

28.5.1 GPIO data register (GPIOx_DR)

The 32-bit GPIO_DR register stores data that is ready to be driven to the output lines. If the IOMUXC is in GPIO mode and a given GPIO direction bit is set, then the corresponding DR bit is driven to the output. If a given GPIO direction bit is cleared, then a read of GPIO_DR reflects the value of the corresponding signal. Two wait states are required in read access for synchronization.

The results of a read of a DR bit depends on the IOMUXC input mode settings and the corresponding GDIR bit as follows:

- If GDIR[n] is set and IOMUXC input mode is GPIO, then reading DR[n] returns the contents of DR[n].
- If GDIR[n] is cleared and IOMUXC input mode is GPIO, then reading DR[n] returns the corresponding input signal's value.
- If GDIR[n] is set and IOMUXC input mode is not GPIO, then reading DR[n] returns the contents of DR[n].
- If GDIR[n] is cleared and IOMUXC input mode is not GPIO, then reading DR[n] always returns zero.

Address: Base address + 0h offset

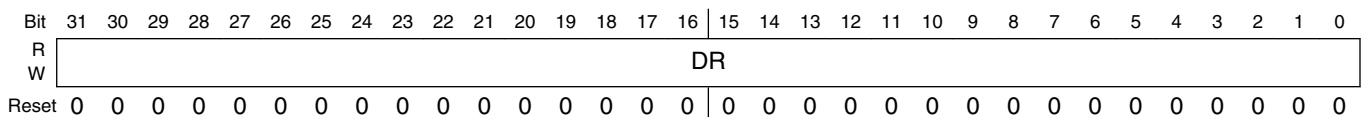

GPIOx_DR field descriptions

Field	Description
DR	<p>Data bits. This register defines the value of the GPIO output when the signal is configured as an output (GDIR[n]=1). Writes to this register are stored in a register. Reading GPIO_DR returns the value stored in the register if the signal is configured as an output (GDIR[n]=1), or the input signal's value if configured as an input (GDIR[n]=0).</p> <p>NOTE: The I/O multiplexer must be configured to GPIO mode for the GPIO_DR value to connect with the signal. Reading the data register with the input path disabled always returns a zero value.</p>

28.5.2 GPIO direction register (GPIOx_GDIR)

GPIO_GDIR functions as direction control when the IOMUXC is in GPIO mode. Each bit specifies the direction of a one-bit signal. The mapping of each DIR bit to a corresponding SoC signal is determined by the SoC's pin assignment and the IOMUX table. For more details consult the IOMUXC chapter.

Address: Base address + 4h offset

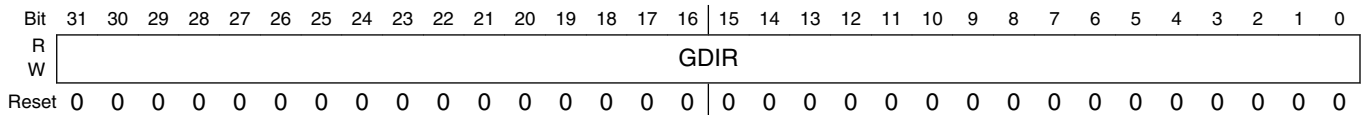

GPIOx_GDIR field descriptions

Field	Description
GDIR	<p>GPIO direction bits. Bit n of this register defines the direction of the GPIO[n] signal.</p> <p>NOTE: GPIO_GDIR affects only the direction of the I/O signal when the corresponding bit in the I/O MUX is configured for GPIO.</p> <p>0 INPUT — GPIO is configured as input.</p> <p>1 OUTPUT — GPIO is configured as output.</p>

28.5.3 GPIO pad status register (GPIOx_PSR)

GPIO_PSR is a read-only register. Each bit stores the value of the corresponding input signal (as configured in the IOMUX). This register is clocked with the ipg_clk_s clock, meaning that the input signal is sampled only when accessing this location. Two wait states are required any time this register is accessed for synchronization.

Address: Base address + 8h offset

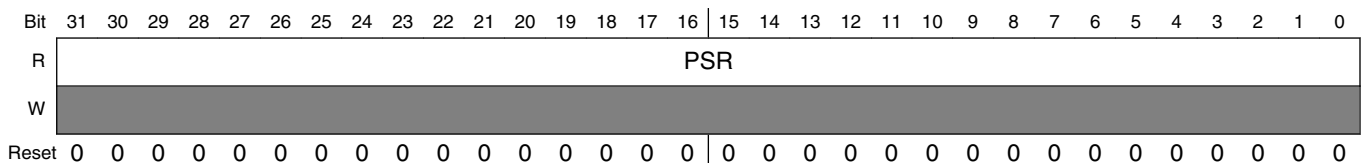

GPIOx_PSR field descriptions

Field	Description
PSR	GPIO pad status bits (status bits). Reading GPIO_PSR returns the state of the corresponding input signal.

GPIOx_PSR field descriptions (continued)

Field	Description
	Settings: NOTE: The IOMUXC must be configured to GPIO mode for GPIO_PSR to reflect the state of the corresponding signal.

28.5.4 GPIO interrupt configuration register1 (GPIOx_ICR1)

GPIO_ICR1 contains 16 two-bit fields, where each field specifies the interrupt configuration for a different input signal.

Address: Base address + Ch offset

Bit	31	30	29	28	27	26	25	24	23	22	21	20	19	18	17	16
R																
W																
Reset	0	0	0	0	0	0	0	0	0	0	0	0	0	0	0	0
Bit	15	14	13	12	11	10	9	8	7	6	5	4	3	2	1	0
R																
W																
Reset	0	0	0	0	0	0	0	0	0	0	0	0	0	0	0	0

GPIOx_ICR1 field descriptions

Field	Description
31–30 ICR15	Interrupt configuration 1 fields. This register controls the active condition of the interrupt function for GPIO interrupt 15. Settings: Bits ICRn[1:0] determine the interrupt condition for signal n as follows: 00 LOW_LEVEL — Interrupt n is low-level sensitive. 01 HIGH_LEVEL — Interrupt n is high-level sensitive. 10 RISING_EDGE — Interrupt n is rising-edge sensitive. 11 FALLING_EDGE — Interrupt n is falling-edge sensitive.
29–28 ICR14	Interrupt configuration 1 fields. This register controls the active condition of the interrupt function for GPIO interrupt 14. Settings: Bits ICRn[1:0] determine the interrupt condition for signal n as follows: 00 LOW_LEVEL — Interrupt n is low-level sensitive. 01 HIGH_LEVEL — Interrupt n is high-level sensitive. 10 RISING_EDGE — Interrupt n is rising-edge sensitive. 11 FALLING_EDGE — Interrupt n is falling-edge sensitive.
27–26 ICR13	Interrupt configuration 1 fields. This register controls the active condition of the interrupt function for GPIO interrupt 13.

Table continues on the next page...

GPIOx_ICR1 field descriptions (continued)

Field	Description
	<p>Settings:</p> <p>Bits ICRn[1:0] determine the interrupt condition for signal n as follows:</p> <p>00 LOW_LEVEL — Interrupt n is low-level sensitive. 01 HIGH_LEVEL — Interrupt n is high-level sensitive. 10 RISING_EDGE — Interrupt n is rising-edge sensitive. 11 FALLING_EDGE — Interrupt n is falling-edge sensitive.</p>
25–24 ICR12	<p>Interrupt configuration 1 fields. This register controls the active condition of the interrupt function for GPIO interrupt 12.</p> <p>Settings:</p> <p>Bits ICRn[1:0] determine the interrupt condition for signal n as follows:</p> <p>00 LOW_LEVEL — Interrupt n is low-level sensitive. 01 HIGH_LEVEL — Interrupt n is high-level sensitive. 10 RISING_EDGE — Interrupt n is rising-edge sensitive. 11 FALLING_EDGE — Interrupt n is falling-edge sensitive.</p>
23–22 ICR11	<p>Interrupt configuration 1 fields. This register controls the active condition of the interrupt function for GPIO interrupt 11.</p> <p>Settings:</p> <p>Bits ICRn[1:0] determine the interrupt condition for signal n as follows:</p> <p>00 LOW_LEVEL — Interrupt n is low-level sensitive. 01 HIGH_LEVEL — Interrupt n is high-level sensitive. 10 RISING_EDGE — Interrupt n is rising-edge sensitive. 11 FALLING_EDGE — Interrupt n is falling-edge sensitive.</p>
21–20 ICR10	<p>Interrupt configuration 1 fields. This register controls the active condition of the interrupt function for GPIO interrupt 10.</p> <p>Settings:</p> <p>Bits ICRn[1:0] determine the interrupt condition for signal n as follows:</p> <p>00 LOW_LEVEL — Interrupt n is low-level sensitive. 01 HIGH_LEVEL — Interrupt n is high-level sensitive. 10 RISING_EDGE — Interrupt n is rising-edge sensitive. 11 FALLING_EDGE — Interrupt n is falling-edge sensitive.</p>
19–18 ICR9	<p>Interrupt configuration 1 fields. This register controls the active condition of the interrupt function for GPIO interrupt 9.</p> <p>Settings:</p> <p>Bits ICRn[1:0] determine the interrupt condition for signal n as follows:</p> <p>00 LOW_LEVEL — Interrupt n is low-level sensitive. 01 HIGH_LEVEL — Interrupt n is high-level sensitive. 10 RISING_EDGE — Interrupt n is rising-edge sensitive. 11 FALLING_EDGE — Interrupt n is falling-edge sensitive.</p>
17–16 ICR8	<p>Interrupt configuration 1 fields. This register controls the active condition of the interrupt function for GPIO interrupt 8.</p> <p>Settings:</p>

Table continues on the next page...

GPIOx_ICR1 field descriptions (continued)

Field	Description
	<p>Bits ICRn[1:0] determine the interrupt condition for signal n as follows:</p> <p>00 LOW_LEVEL — Interrupt n is low-level sensitive. 01 HIGH_LEVEL — Interrupt n is high-level sensitive. 10 RISING_EDGE — Interrupt n is rising-edge sensitive. 11 FALLING_EDGE — Interrupt n is falling-edge sensitive.</p>
15–14 ICR7	<p>Interrupt configuration 1 fields. This register controls the active condition of the interrupt function for GPIO interrupt 7.</p> <p>Settings:</p> <p>Bits ICRn[1:0] determine the interrupt condition for signal n as follows:</p> <p>00 LOW_LEVEL — Interrupt n is low-level sensitive. 01 HIGH_LEVEL — Interrupt n is high-level sensitive. 10 RISING_EDGE — Interrupt n is rising-edge sensitive. 11 FALLING_EDGE — Interrupt n is falling-edge sensitive.</p>
13–12 ICR6	<p>Interrupt configuration 1 fields. This register controls the active condition of the interrupt function for GPIO interrupt 6.</p> <p>Settings:</p> <p>Bits ICRn[1:0] determine the interrupt condition for signal n as follows:</p> <p>00 LOW_LEVEL — Interrupt n is low-level sensitive. 01 HIGH_LEVEL — Interrupt n is high-level sensitive. 10 RISING_EDGE — Interrupt n is rising-edge sensitive. 11 FALLING_EDGE — Interrupt n is falling-edge sensitive.</p>
11–10 ICR5	<p>Interrupt configuration 1 fields. This register controls the active condition of the interrupt function for GPIO interrupt 5.</p> <p>Settings:</p> <p>Bits ICRn[1:0] determine the interrupt condition for signal n as follows:</p> <p>00 LOW_LEVEL — Interrupt n is low-level sensitive. 01 HIGH_LEVEL — Interrupt n is high-level sensitive. 10 RISING_EDGE — Interrupt n is rising-edge sensitive. 11 FALLING_EDGE — Interrupt n is falling-edge sensitive.</p>
9–8 ICR4	<p>Interrupt configuration 1 fields. This register controls the active condition of the interrupt function for GPIO interrupt 4.</p> <p>Settings:</p> <p>Bits ICRn[1:0] determine the interrupt condition for signal n as follows:</p> <p>00 LOW_LEVEL — Interrupt n is low-level sensitive. 01 HIGH_LEVEL — Interrupt n is high-level sensitive. 10 RISING_EDGE — Interrupt n is rising-edge sensitive. 11 FALLING_EDGE — Interrupt n is falling-edge sensitive.</p>
7–6 ICR3	<p>Interrupt configuration 1 fields. This register controls the active condition of the interrupt function for GPIO interrupt 3.</p> <p>Settings:</p> <p>Bits ICRn[1:0] determine the interrupt condition for signal n as follows:</p>

Table continues on the next page...

GPIOx_ICR1 field descriptions (continued)

Field	Description
	00 LOW_LEVEL — Interrupt n is low-level sensitive. 01 HIGH_LEVEL — Interrupt n is high-level sensitive. 10 RISING_EDGE — Interrupt n is rising-edge sensitive. 11 FALLING_EDGE — Interrupt n is falling-edge sensitive.
5–4 ICR2	Interrupt configuration 1 fields. This register controls the active condition of the interrupt function for GPIO interrupt 2. Settings: Bits ICRn[1:0] determine the interrupt condition for signal n as follows: 00 LOW_LEVEL — Interrupt n is low-level sensitive. 01 HIGH_LEVEL — Interrupt n is high-level sensitive. 10 RISING_EDGE — Interrupt n is rising-edge sensitive. 11 FALLING_EDGE — Interrupt n is falling-edge sensitive.
3–2 ICR1	Interrupt configuration 1 fields. This register controls the active condition of the interrupt function for GPIO interrupt 1. Settings: Bits ICRn[1:0] determine the interrupt condition for signal n as follows: 00 LOW_LEVEL — Interrupt n is low-level sensitive. 01 HIGH_LEVEL — Interrupt n is high-level sensitive. 10 RISING_EDGE — Interrupt n is rising-edge sensitive. 11 FALLING_EDGE — Interrupt n is falling-edge sensitive.
ICR0	Interrupt configuration 1 fields. This register controls the active condition of the interrupt function for GPIO interrupt 0. Settings: Bits ICRn[1:0] determine the interrupt condition for signal n as follows: 00 LOW_LEVEL — Interrupt n is low-level sensitive. 01 HIGH_LEVEL — Interrupt n is high-level sensitive. 10 RISING_EDGE — Interrupt n is rising-edge sensitive. 11 FALLING_EDGE — Interrupt n is falling-edge sensitive.

28.5.5 GPIO interrupt configuration register2 (GPIOx_ICR2)

GPIO_ICR2 contains 16 two-bit fields, where each field specifies the interrupt configuration for a different input signal.

Address: Base address + 10h offset

Bit	31	30	29	28	27	26	25	24	23	22	21	20	19	18	17	16
R																
W																
	ICR31		ICR30		ICR29		ICR28		ICR27		ICR26		ICR25		ICR24	
Reset	0	0	0	0	0	0	0	0	0	0	0	0	0	0	0	0
Bit	15	14	13	12	11	10	9	8	7	6	5	4	3	2	1	0
R																
W																
	ICR23		ICR22		ICR21		ICR20		ICR19		ICR18		ICR17		ICR16	
Reset	0	0	0	0	0	0	0	0	0	0	0	0	0	0	0	0

GPIOx_ICR2 field descriptions

Field	Description
31–30 ICR31	<p>Interrupt configuration 2 fields. This register controls the active condition of the interrupt function for GPIO interrupt 31.</p> <p>Settings:</p> <p>Bits ICRn[1:0] determine the interrupt condition for signal n as follows:</p> <p>00 LOW_LEVEL — Interrupt n is low-level sensitive. 01 HIGH_LEVEL — Interrupt n is high-level sensitive. 10 RISING_EDGE — Interrupt n is rising-edge sensitive. 11 FALLING_EDGE — Interrupt n is falling-edge sensitive.</p>
29–28 ICR30	<p>Interrupt configuration 2 fields. This register controls the active condition of the interrupt function for GPIO interrupt 30.</p> <p>Settings:</p> <p>Bits ICRn[1:0] determine the interrupt condition for signal n as follows:</p> <p>00 LOW_LEVEL — Interrupt n is low-level sensitive. 01 HIGH_LEVEL — Interrupt n is high-level sensitive. 10 RISING_EDGE — Interrupt n is rising-edge sensitive. 11 FALLING_EDGE — Interrupt n is falling-edge sensitive.</p>
27–26 ICR29	<p>Interrupt configuration 2 fields. This register controls the active condition of the interrupt function for GPIO interrupt 29.</p> <p>Settings:</p> <p>Bits ICRn[1:0] determine the interrupt condition for signal n as follows:</p> <p>00 LOW_LEVEL — Interrupt n is low-level sensitive. 01 HIGH_LEVEL — Interrupt n is high-level sensitive. 10 RISING_EDGE — Interrupt n is rising-edge sensitive. 11 FALLING_EDGE — Interrupt n is falling-edge sensitive.</p>

Table continues on the next page...

GPIOx_ICR2 field descriptions (continued)

Field	Description
25–24 ICR28	<p>Interrupt configuration 2 fields. This register controls the active condition of the interrupt function for GPIO interrupt 28.</p> <p>Settings:</p> <p>Bits ICRn[1:0] determine the interrupt condition for signal n as follows:</p> <p>00 LOW_LEVEL — Interrupt n is low-level sensitive. 01 HIGH_LEVEL — Interrupt n is high-level sensitive. 10 RISING_EDGE — Interrupt n is rising-edge sensitive. 11 FALLING_EDGE — Interrupt n is falling-edge sensitive.</p>
23–22 ICR27	<p>Interrupt configuration 2 fields. This register controls the active condition of the interrupt function for GPIO interrupt 27.</p> <p>Settings:</p> <p>Bits ICRn[1:0] determine the interrupt condition for signal n as follows:</p> <p>00 LOW_LEVEL — Interrupt n is low-level sensitive. 01 HIGH_LEVEL — Interrupt n is high-level sensitive. 10 RISING_EDGE — Interrupt n is rising-edge sensitive. 11 FALLING_EDGE — Interrupt n is falling-edge sensitive.</p>
21–20 ICR26	<p>Interrupt configuration 2 fields. This register controls the active condition of the interrupt function for GPIO interrupt 26.</p> <p>Settings:</p> <p>Bits ICRn[1:0] determine the interrupt condition for signal n as follows:</p> <p>00 LOW_LEVEL — Interrupt n is low-level sensitive. 01 HIGH_LEVEL — Interrupt n is high-level sensitive. 10 RISING_EDGE — Interrupt n is rising-edge sensitive. 11 FALLING_EDGE — Interrupt n is falling-edge sensitive.</p>
19–18 ICR25	<p>Interrupt configuration 2 fields. This register controls the active condition of the interrupt function for GPIO interrupt 25.</p> <p>Settings:</p> <p>Bits ICRn[1:0] determine the interrupt condition for signal n as follows:</p> <p>00 LOW_LEVEL — Interrupt n is low-level sensitive. 01 HIGH_LEVEL — Interrupt n is high-level sensitive. 10 RISING_EDGE — Interrupt n is rising-edge sensitive. 11 FALLING_EDGE — Interrupt n is falling-edge sensitive.</p>
17–16 ICR24	<p>Interrupt configuration 2 fields. This register controls the active condition of the interrupt function for GPIO interrupt 24.</p> <p>Settings:</p> <p>Bits ICRn[1:0] determine the interrupt condition for signal n as follows:</p> <p>00 LOW_LEVEL — Interrupt n is low-level sensitive. 01 HIGH_LEVEL — Interrupt n is high-level sensitive. 10 RISING_EDGE — Interrupt n is rising-edge sensitive. 11 FALLING_EDGE — Interrupt n is falling-edge sensitive.</p>

Table continues on the next page...

GPIOx_ICR2 field descriptions (continued)

Field	Description
15–14 ICR23	<p>Interrupt configuration 2 fields. This register controls the active condition of the interrupt function for GPIO interrupt 23.</p> <p>Settings:</p> <p>Bits ICRn[1:0] determine the interrupt condition for signal n as follows:</p> <p>00 LOW_LEVEL — Interrupt n is low-level sensitive. 01 HIGH_LEVEL — Interrupt n is high-level sensitive. 10 RISING_EDGE — Interrupt n is rising-edge sensitive. 11 FALLING_EDGE — Interrupt n is falling-edge sensitive.</p>
13–12 ICR22	<p>Interrupt configuration 2 fields. This register controls the active condition of the interrupt function for GPIO interrupt 22.</p> <p>Settings:</p> <p>Bits ICRn[1:0] determine the interrupt condition for signal n as follows:</p> <p>00 LOW_LEVEL — Interrupt n is low-level sensitive. 01 HIGH_LEVEL — Interrupt n is high-level sensitive. 10 RISING_EDGE — Interrupt n is rising-edge sensitive. 11 FALLING_EDGE — Interrupt n is falling-edge sensitive.</p>
11–10 ICR21	<p>Interrupt configuration 2 fields. This register controls the active condition of the interrupt function for GPIO interrupt 21.</p> <p>Settings:</p> <p>Bits ICRn[1:0] determine the interrupt condition for signal n as follows:</p> <p>00 LOW_LEVEL — Interrupt n is low-level sensitive. 01 HIGH_LEVEL — Interrupt n is high-level sensitive. 10 RISING_EDGE — Interrupt n is rising-edge sensitive. 11 FALLING_EDGE — Interrupt n is falling-edge sensitive.</p>
9–8 ICR20	<p>Interrupt configuration 2 fields. This register controls the active condition of the interrupt function for GPIO interrupt 20.</p> <p>Settings:</p> <p>Bits ICRn[1:0] determine the interrupt condition for signal n as follows:</p> <p>00 LOW_LEVEL — Interrupt n is low-level sensitive. 01 HIGH_LEVEL — Interrupt n is high-level sensitive. 10 RISING_EDGE — Interrupt n is rising-edge sensitive. 11 FALLING_EDGE — Interrupt n is falling-edge sensitive.</p>
7–6 ICR19	<p>Interrupt configuration 2 fields. This register controls the active condition of the interrupt function for GPIO interrupt 19.</p> <p>Settings:</p> <p>Bits ICRn[1:0] determine the interrupt condition for signal n as follows:</p> <p>00 LOW_LEVEL — Interrupt n is low-level sensitive. 01 HIGH_LEVEL — Interrupt n is high-level sensitive. 10 RISING_EDGE — Interrupt n is rising-edge sensitive. 11 FALLING_EDGE — Interrupt n is falling-edge sensitive.</p>

Table continues on the next page...

GPIOx_ICR2 field descriptions (continued)

Field	Description
5–4 ICR18	Interrupt configuration 2 fields. This register controls the active condition of the interrupt function for GPIO interrupt 18. Settings: Bits ICRn[1:0] determine the interrupt condition for signal n as follows: 00 LOW_LEVEL — Interrupt n is low-level sensitive. 01 HIGH_LEVEL — Interrupt n is high-level sensitive. 10 RISING_EDGE — Interrupt n is rising-edge sensitive. 11 FALLING_EDGE — Interrupt n is falling-edge sensitive.
3–2 ICR17	Interrupt configuration 2 fields. This register controls the active condition of the interrupt function for GPIO interrupt 17. Settings: Bits ICRn[1:0] determine the interrupt condition for signal n as follows: 00 LOW_LEVEL — Interrupt n is low-level sensitive. 01 HIGH_LEVEL — Interrupt n is high-level sensitive. 10 RISING_EDGE — Interrupt n is rising-edge sensitive. 11 FALLING_EDGE — Interrupt n is falling-edge sensitive.
ICR16	Interrupt configuration 2 fields. This register controls the active condition of the interrupt function for GPIO interrupt 16. Settings: Bits ICRn[1:0] determine the interrupt condition for signal n as follows: 00 LOW_LEVEL — Interrupt n is low-level sensitive. 01 HIGH_LEVEL — Interrupt n is high-level sensitive. 10 RISING_EDGE — Interrupt n is rising-edge sensitive. 11 FALLING_EDGE — Interrupt n is falling-edge sensitive.

28.5.6 GPIO interrupt mask register (GPIOx_IMR)

GPIO_IMR contains masking bits for each interrupt line.

Address: Base address + 14h offset

Bit	31	30	29	28	27	26	25	24	23	22	21	20	19	18	17	16	15	14	13	12	11	10	9	8	7	6	5	4	3	2	1	0
R																																
W																																
Reset	0	0	0	0	0	0	0	0	0	0	0	0	0	0	0	0	0	0	0	0	0	0	0	0	0	0	0	0	0	0	0	0

GPIOx_IMR field descriptions

Field	Description
IMR	Interrupt Mask bits. This register is used to enable or disable the interrupt function on each of the 32 GPIO signals.

GPIOx_IMR field descriptions (continued)

Field	Description
	Settings: Bit IMR[n] (n=0...31) controls interrupt n as follows: 0 MASKED — Interrupt n is disabled. 1 UNMASKED — Interrupt n is enabled.

28.5.7 GPIO interrupt status register (GPIOx_ISR)

The GPIO_ISR functions as an interrupt status indicator. Each bit indicates whether an interrupt condition has been met for the corresponding input signal. When an interrupt condition is met (as determined by the corresponding interrupt condition register field), the corresponding bit in this register is set. Two wait states are required in read access for synchronization. One wait state is required for reset.

Address: Base address + 18h offset

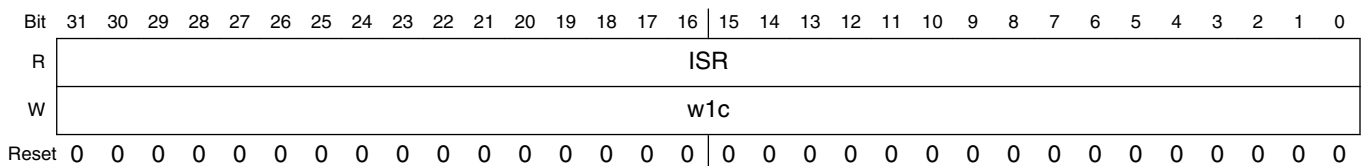

GPIOx_ISR field descriptions

Field	Description
ISR	Interrupt status bits - Bit n of this register is asserted (active high) when the active condition (as determined by the corresponding ICR bit) is detected on the GPIO input and is waiting for service. The value of this register is independent of the value in GPIO_IMR. When the active condition has been detected, the corresponding bit remains set until cleared by software. Status flags are cleared by writing a 1 to the corresponding bit position.

28.5.8 GPIO edge select register (GPIOx_EDGE_SEL)

GPIO_EDGE_SEL may be used to override the ICR registers' configuration. If the GPIO_EDGE_SEL bit is set, then a rising edge or falling edge in the corresponding signal generates an interrupt. This register provides backward compatibility. On reset all bits are cleared (ICR is not overridden).

Address: Base address + 1Ch offset

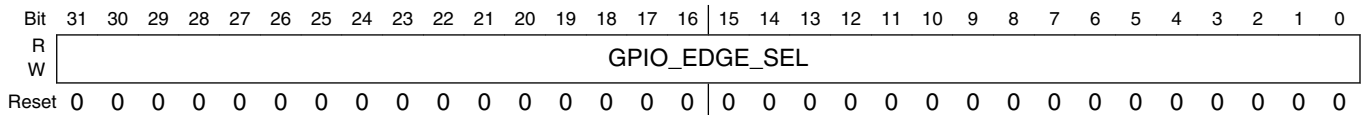

GPIOx_EDGE_SEL field descriptions

Field	Description
GPIO_EDGE_SEL	Edge select. When GPIO_EDGE_SEL[n] is set, the GPIO disregards the ICR[n] setting, and detects any edge on the corresponding input signal.

Chapter 29

General Purpose Media Interface (GPMI)

29.1 Overview

The GPMI controller is a flexible interface to supporting up to four NAND flash chip selects.

- ONFI3.2, DDR Mode, Samsung / Toshiba Toggle NAND protocol compatible.
- Fully configurable address and command behavior, providing support for future devices not yet specified.

The GPMI resides on the APBH. The GPMI also provides an interface to the BCH module to allow direct parity processing.

Registers are clocked on the HCLK domain. The I/O and pin timing are clocked on a dedicated GPMICLK domain. GPMICLK can be set to maximize I/O performance.

The following figure shows a block diagram of the GPMI controller.

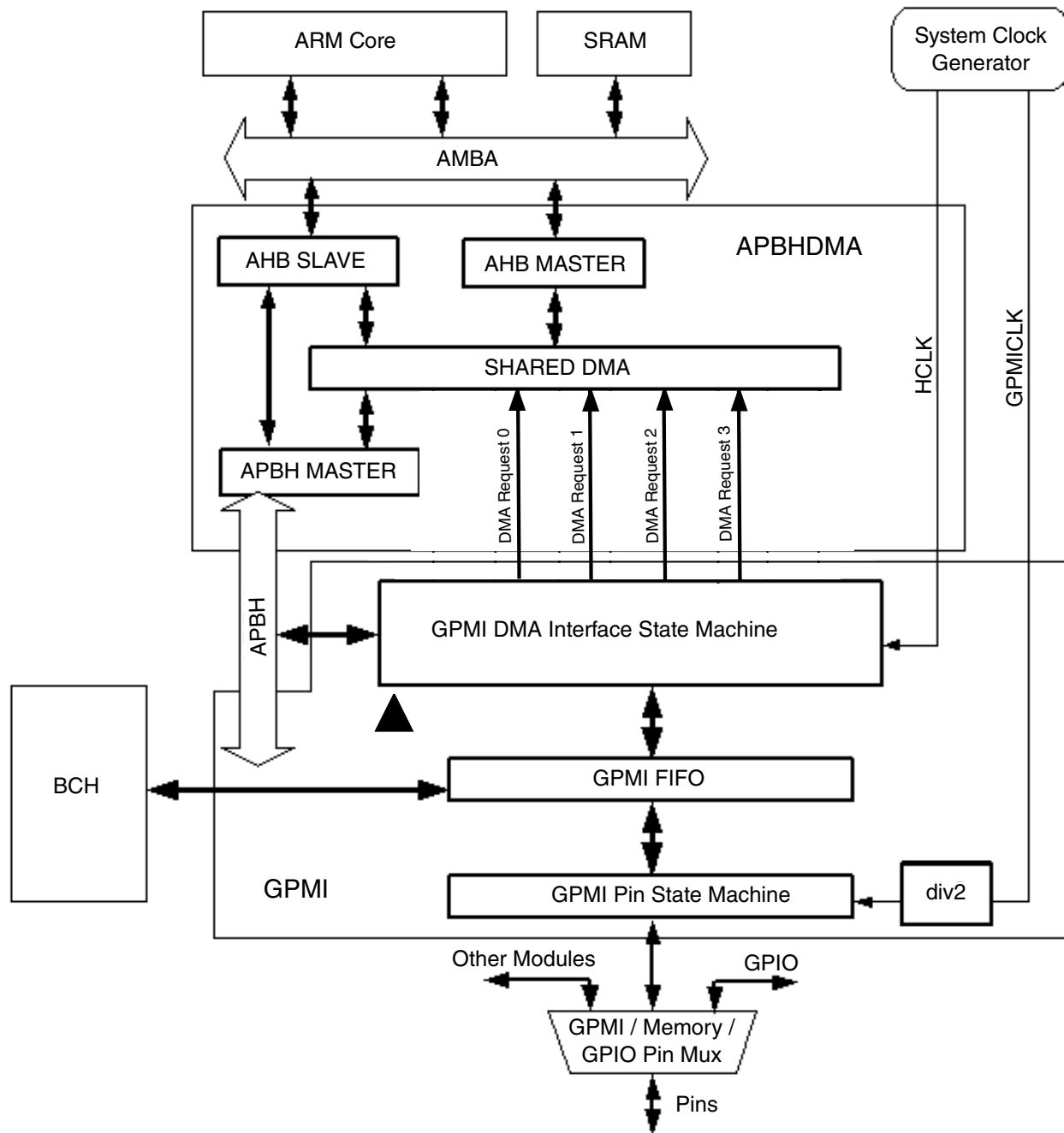

Figure 29-1. General-Purpose Media Interface Controller Block Diagram

29.2 External Signals

The table found here describes the external signals of GPMI.

Table 29-1. GPMI External Signals

Signal	Description	Pad	Mode	Direction
NAND_ALE	Address latch enable signal	NAND_ALE	ALT0	O
NAND_CE0_B	Chip enable signal	NAND_CE0_B	ALT0	O
NAND_CE1_B	Chip enable signal	NAND_CE1_B	ALT0	O
NAND_CE2_B	Chip enable signal	CSI_MCLK	ALT2	O
NAND_CE3_B	Chip enable signal	CSI_PIXCLK	ALT2	O
NAND_CLE	Command latch enable signal	NAND_CLE	ALT0	O
NAND_DATA00	Data signal	NAND_DATA00	ALT0	IO
NAND_DATA01	Data signal	NAND_DATA01	ALT0	IO
NAND_DATA02	Data signal	NAND_DATA02	ALT0	IO
NAND_DATA03	Data signal	NAND_DATA03	ALT0	IO
NAND_DATA04	Data signal	NAND_DATA04	ALT0	IO
NAND_DATA05	Data signal	NAND_DATA05	ALT0	IO
NAND_DATA06	Data signal	NAND_DATA06	ALT0	IO
NAND_DATA07	Data signal	NAND_DATA07	ALT0	IO
NAND_DQS	DQS signal	NAND_DQS	ALT0	IO
NAND_READY_B	Ready signal	NAND_READY_B	ALT0	IO
NAND_RE_B	Read enable signal	NAND_RE_B	ALT0	O
NAND_WE_B	Write enable signal	NAND_WE_B	ALT0	O
NAND_WP_B	Wait polarity signal	NAND_WP_B	ALT0	O

29.3 Clocks

The table found here describes the clock sources for GPMI.

Please see [Clock Controller Module \(CCM\)](#) for clock setting, configuration and gating information.

Table 29-2. GPMI Clocks

Clock name	Clock Root	Description
bch_input_apb_clk		BCH to APBH input clock
gpmi_bch_input_bch_clk		BCH input clock
gpmi_bch_input_gpmi_io_clk		GPMI IO input clock
gpmi_input_apb_clk		GPMI to APBH clock

29.4 GPMI NAND Mode

The general-purpose media interface has several features to efficiently support NAND:

- Individual chip select pins and ganged ready/busy pin for up to four NANDs.
- Individual state machine and DMA channel for each chip select.
- Special command modes work with DMA controller to perform all normal NAND functions without CPU intervention.
- Configurable timing based on a dedicated clock allows optimal balance of high NAND performance and low system power.

GPMI and DMA have been designed to handle complex multi-page operations without CPU intervention. The DMA uses a linked descriptor function with branching capability to automatically handle all of the operations needed to read/write multiple pages:

- **Data/Register Read/Write**-The GPMI can be programmed to read or write multiple cycles to the NAND address, command or data registers.
- **Wait for NAND Ready**-The GPMI's Wait-for-Ready mode can monitor the ready/busy signal of a single NAND flash and signal the DMA when the device has become ready. It also has a time-out counter and can indicate to the DMA that a time-out error has occurred. The DMAs can conditionally branch to a different descriptor in the case of an error.
- **Check Status**-The Read-and-Compare mode allows the GPMI to check NAND status against a reference. If an error is found, the GPMI can instruct the DMA to branch to an alternate descriptor, which attempts to fix the problem or asserts a CPU IRQ.

29.4.1 Multiple NAND Support

The GPMI supports up to four NAND chip selects, with ganged ready/busy pins. Since they share a data bus and control lines, the GPMI can only actively communicate with a single NAND at a time. However, all NANDs can concurrently perform internal read, write, or erase operations. With fast NAND flash and software support for concurrent NAND operations, this architecture allows the total throughput to approach the data bus speed, which can be as high as 50 MB/s (8-bit bus running at 50 MHz single clock edge) in asynchronous mode and 200MB/s (8-bit bus running at 100MHz both clock edges) in Source Synchronous mode.

There are two options for controlling the four NAND chip selects via the DMA interface. The first option is the one to one mapping, where the each DMA channel is tied to its own NAND chip select. For example DMA channel 'n' accesses only NAND attached to chip select 'n'. The second option is the decoupled mode where a DMA channel can access any or all NAND chip selects connected to the GPMI. A DMA channel will signify the NAND chip select it wants to access by writing its chip select value in the GPMI_CTRL0[CS] field and setting the GPMI_CTRL1[DECOUPLE_CS] to 1. This option is useful if software chooses to use only one DMA channel to access all the attached NAND devices.

29.4.2 GPMI NAND Timing and Clocking

The dedicated clock, GPMICK, is used as a timing reference for NAND flash I/O. Since various NANDs have different timing requirements, GPMICK may need to be adjusted for each application.

While the actual pin timings are limited by the NAND chips used and the I/O pad configuration, the GPMI can support data bus speeds of up to 200 MHz x 8 bits. The actual read/write strobe timing parameters are adjusted as indicated in the register descriptions in Memory Map.

29.4.3 Basic NAND Timing

29.4.3.1 NAND Asynchronous Timing

[Figure 29-3](#) and illustrates the operation of the output (from host to device) timing parameters in NAND ONFI asynchronous mode.

GPMI NAND Mode

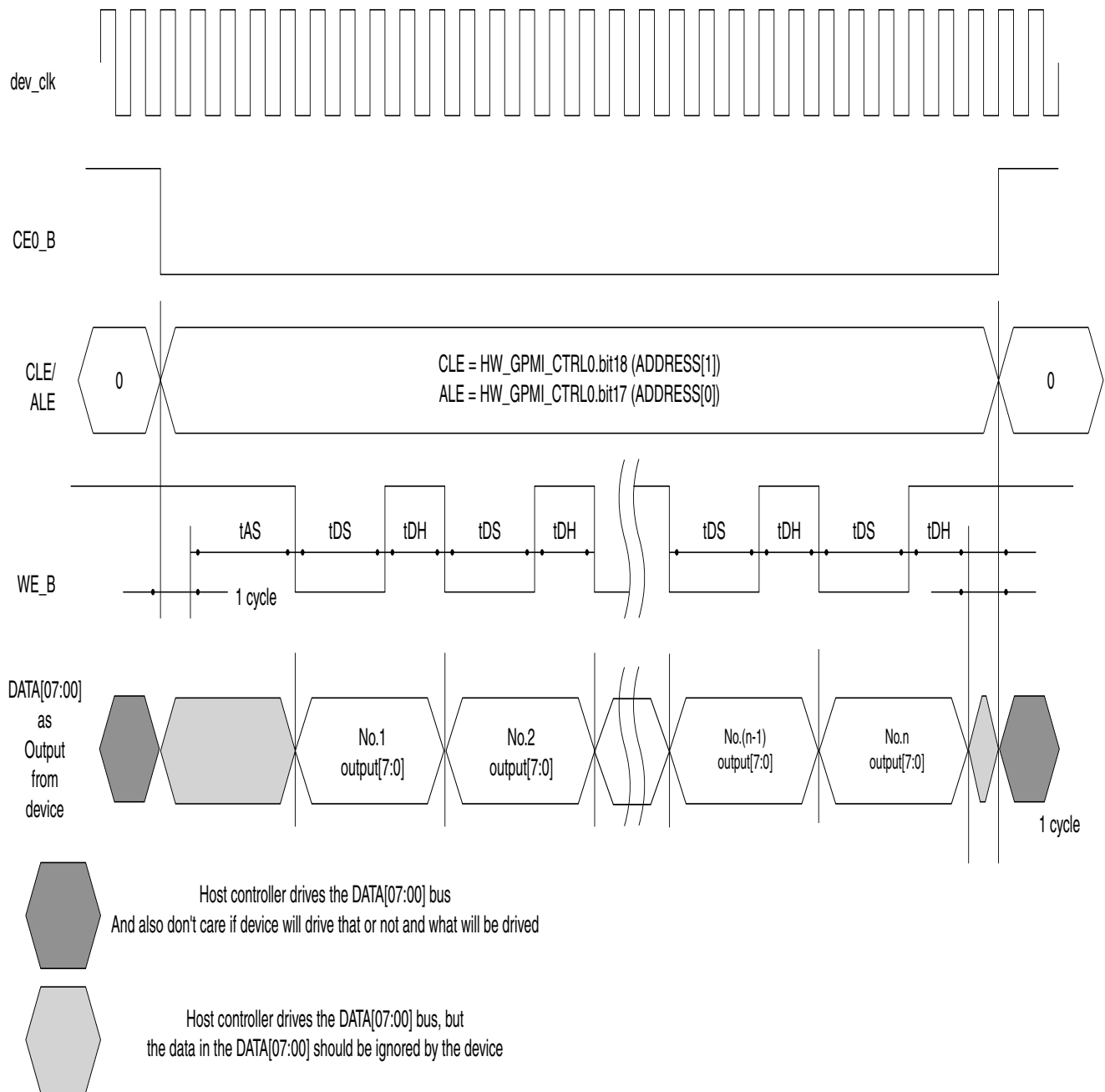

- t_{AS} is configurable by programming HW_GPMI_TIMING0 Address_Setup; in this example, Address_Setup = 4, t_{AS} is equal to 4 dev_clk cycles.
- t_{DS} is configurable by programming HW_GPMI_TIMING0 Data_Setup; in this example, Data_Setup = 3, t_{DS} is equal to 3 dev_clk cycles
- t_{DH} is configurable by programming HW_GPMI_TIMING0 Data_Hold; in this example, Data_Hold = 2, t_{DH} is equal to 2 dev_clk cycles
- $t_{AS}/t_{DS}/t_{DH}$ will extend, if the output data is not ready in device fifo.

Figure 29-2. Asynchronous Mode Basic Write Timing Diagram (command write, address write, or data write)

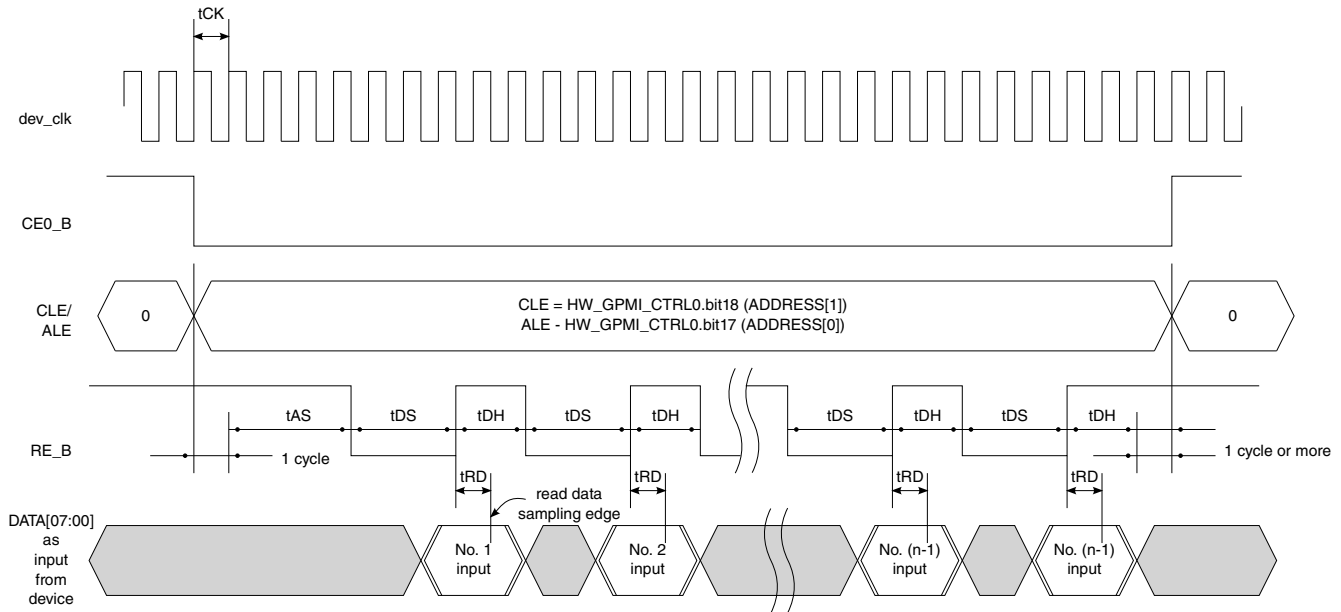

- tAS is configurable by programming HW_GPMI_TIMING0 Address_Setup; in this example, Address_Setup = 4, tAS is equal to 4 dev_clk cycles.
- tDS is configurable by programming HW_GPMI_TIMING0 Data_Setup; in this example, Data_Setup = 3, tDS is equal to 3 dev_clk cycles
- tDH is configurable by programming HW_GPMI_TIMING0 Data_Hold; in this example, Data_Hold = 2, tDH is equal to 2 dev_clk cycles
- tRD is the delay from RE_B rising edge to the read data sampling edge. If SDR DLL is not enabled, tRD is 0. If SDR DLL enabled, the delay depends on SDR DLL delay.
- tAS/tDS/tDH will extend, if the output data is not ready in device fifo.

 Host controller drives the DATA[07:00] bus
And also don't care if device will drive that or not and what will be driven

ONFI asynchronous mode basic read timing diagram
(data read)

Figure 29-3. ONFI Asynchronous Mode Basic Read Timing Diagram (data read)

29.4.3.2 NAND Asynchronous EDO Mode Timing

In high-speed NANDS, the read data may not be valid until after the read strobe (NAND_RE_B) deasserts. This is the case when the minimum tDS is programmed to achieve higher bandwidth.

The GPMI implements a feedback read strobe to sample the read data. The feedback read strobe can be delayed to support fast nand EDO (Extended Data Out) timing where the read strobe may deassert before the read data is valid, and read data is valid for some time after read strobe. Nand EDO timings is applied typically for read cycle frequency above 33 MHz. See [Figure 29-4](#).

The GPMI provides control over the amount of delay applied to the feedback read strobe. This delay depends on the maximum read access time (tREA) of the nand and the read pulse width (tRP) used to access the nand. tRP is specified by GPMI_TIMING0[DATA_SETUP] register. When (tREA + 4ns) is less than tRP, no

delay is required to sample to nand read data. (The 4ns provides adequate data setup time for the GPMI.) In this case set `GPMI_CTRL1[HALF_PERIOD] = 0;`
`GPMI_CTRL1[RDN_DELAY] = 0;` `GPMI_CTRL1[DLL_ENABLE] = 0.`

When $(t_{REA} + 4ns)$ is greater than or equal to t_{RP} , a delay of the feedback read strobe is required to sample to nand read data. This delay is equal to the difference between these two timings:

$$DELAY = t_{REA} + 4ns - t_{RP}.$$

Since the GPMI delay chain is limited to 6ns maximum, if $DELAY > 6ns$ then increase t_{RP} by increasing the value of `GPMI_TIMING0[DATA_SETUP]` until $DELAY$ is less than or equal to 6ns.

The GPMI programming for this $DELAY$ depends on the GPMICLK period. The GPMI DLL will not function properly if the GPMICLK period is greater than 12ns: disable the DLL if this is the case. If the GPMICLK period is greater than 6ns (and not greater than 12ns), set the `GPMI_CTRL1[HALF_PERIOD]=1;` This will cause the DLL reference period (RP) to be one-half of the GPMICLK period. If the GPMICLK period is 6ns or less then set the `GPMI_CTRL1[HALF_PERIOD]=0;` This will cause the DLL reference period (RP) to be equal to the GPMICLK period. $DELAY$ is a multiple (0 to 1.875) of RP.

The `GPMI_CTRL1[RDN_DELAY]` is encoded as a 1-bit integer and 3-bit fraction delay factor. $DELAY$ is a multiple of the delay factor and the reference period. See table below for details.

Table 29-3. RDN DELAY

HW_GPMI_CTRL1[RDN_DELAY]	Delay Factor
0	0.000
1	0.125
2	0.250
3	0.375
4	0.500
5	0.625
6	0.750
7	0.875
8	1.000
9	1.125
10	1.250
11	1.375
12	1.500
13	1.625

Table continues on the next page...

Table 29-3. RDN DELAY (continued)

HW_GPMI_CTRL1[RDN_DELAY]	Delay Factor
14	1.750
15	1.875

$DELAY = DelayFactor \times RP$ or $DELAY = GPMI_CTRL1[RDN_DELAY] \times 0.125 \times RP$.

Use this equation to calculate the value for GPMI_CTRL1[RDN_DELAY]. Then set GPMI_CTRL1[DLL_ENABLE]=1.

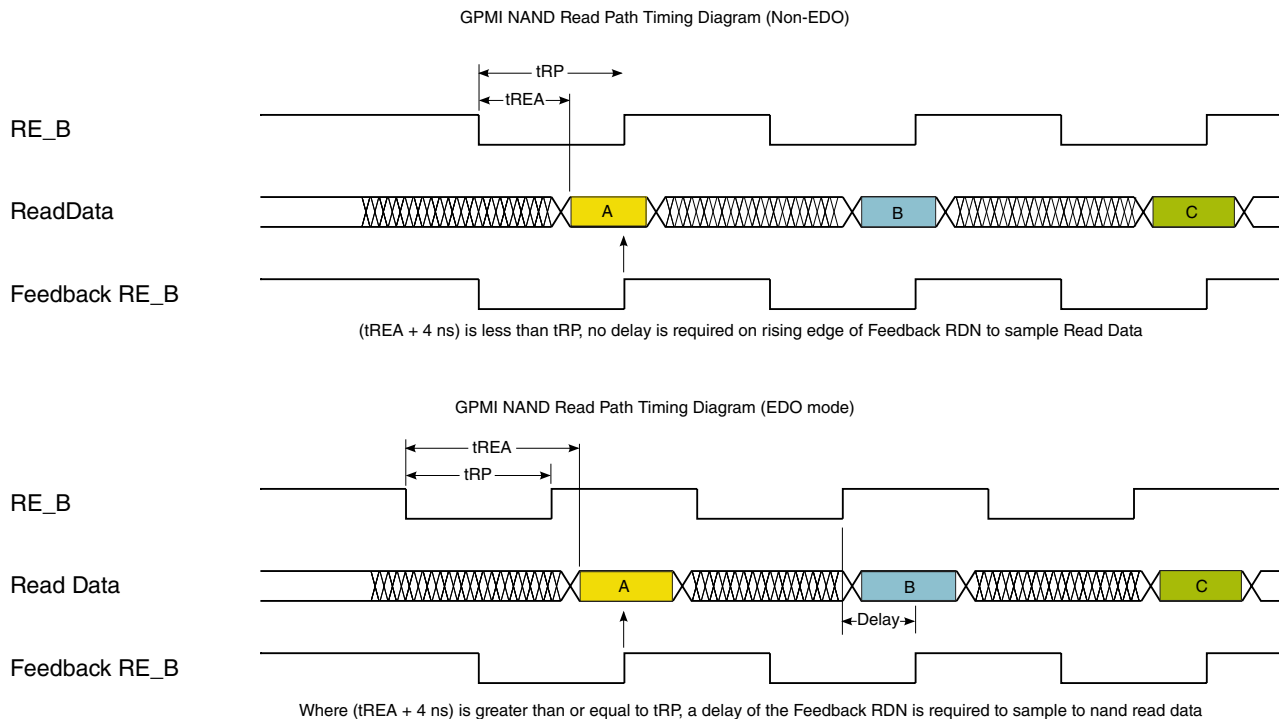

Figure 29-4. NAND Read Path Timing

For example, a NAND with $tRE_{max} = 20$ ns, $tRP_{min} = 12$ ns, and $tRC_{min} = 25$ ns (read cycle time) may be programmed as follows:

- GPMICK clock frequency: Consider $480/6 = 80$ MHz which is 12.5 ns clock period. This is too close to the minimum NAND spec if we program the data setup and hold to 1 GPMICK cycle. Consider $480/7 = 68.57$ MHz which is 14.58 ns clock period. With data setup and hold set to 1, we have a tRP of 14.58 ns and a tRC of 29.16 ns (good margins).
- Since $(tREA + 4ns)$ is greater than tRP , required $DELAY = tREA + 4ns - tRP = 20 + 4 - 14.58ns = 9.42$ ns.

- $\text{GPMI_CTRL1}[\text{HALF_PERIOD}] =$, since GPMI_CLK period is ns. So $\text{RP} = \text{GPMI_CLK period} = \text{ns}$.
- $\text{DELAY} = \text{GPMI_CTRL1}[\text{RDN_DELAY}] \times 0.125 \times \text{RP}$. $9.42 \text{ ns} = \text{GPMI_CTRL1}[\text{RDN_DELAY}] \times 0.125 \times \text{ns}$. $\text{GPMI_CTRL1}[\text{RDN_DELAY}] =$

NOTE

It is recommended that the drive strength of NAND_RE_B and NAND_WE_B output pins be set to 8 mA. This will reduce the transition time under heavy loads. Low transition times will be important when NAND interface read and write cycle times are below 30 ns. The other GPMI pins may remain at 4 mA, since their frequency is only up to half that of NAND_RE_B and NAND_WE_B.

29.4.3.3 NAND ONFI Source Synchronous Mode Timing**NOTE**

In the following figures, CLK shares the same pin as WE_B in Async Mode. And W/R# shares the same pin as RE_B in Async Mode.

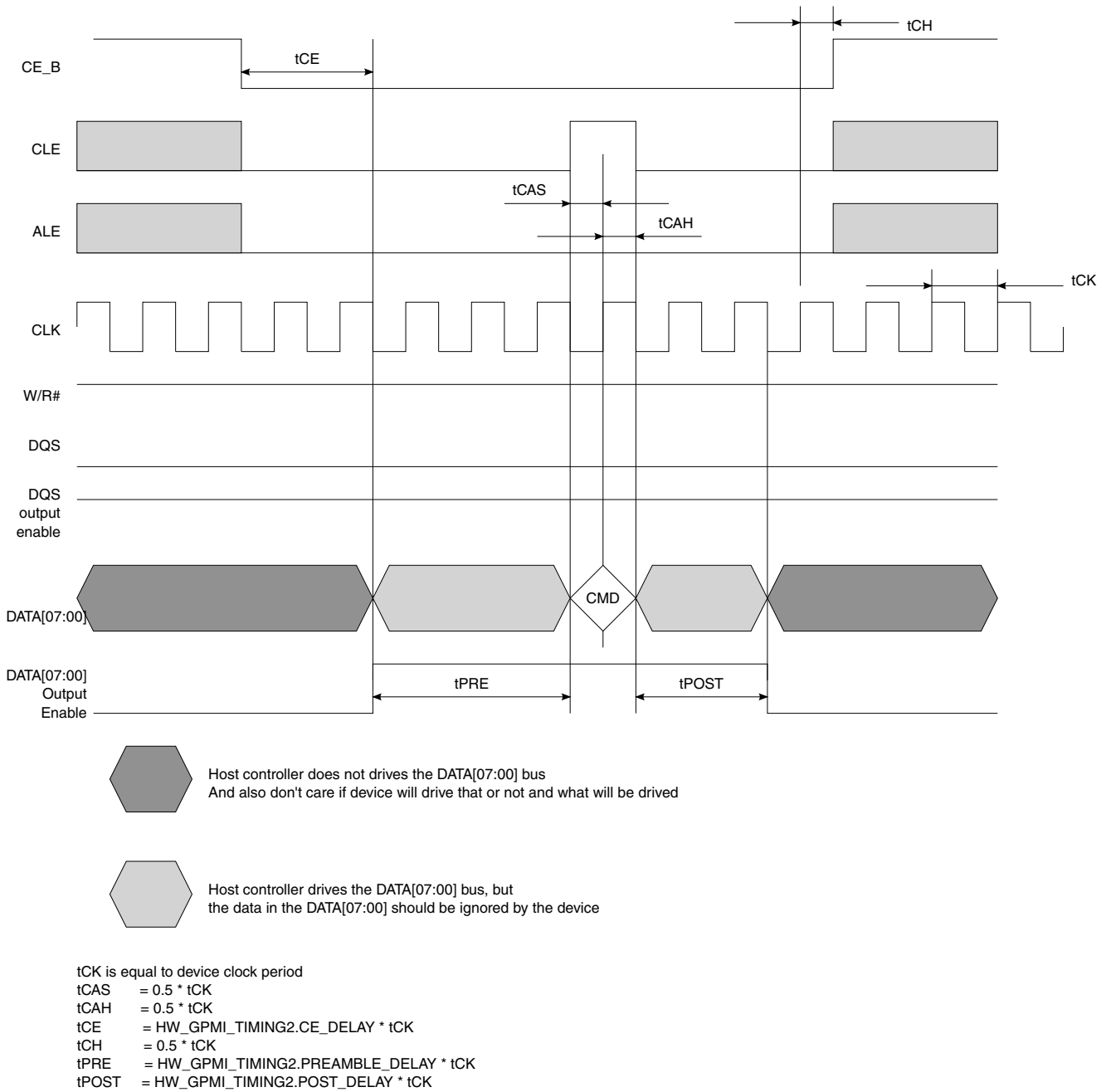
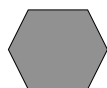
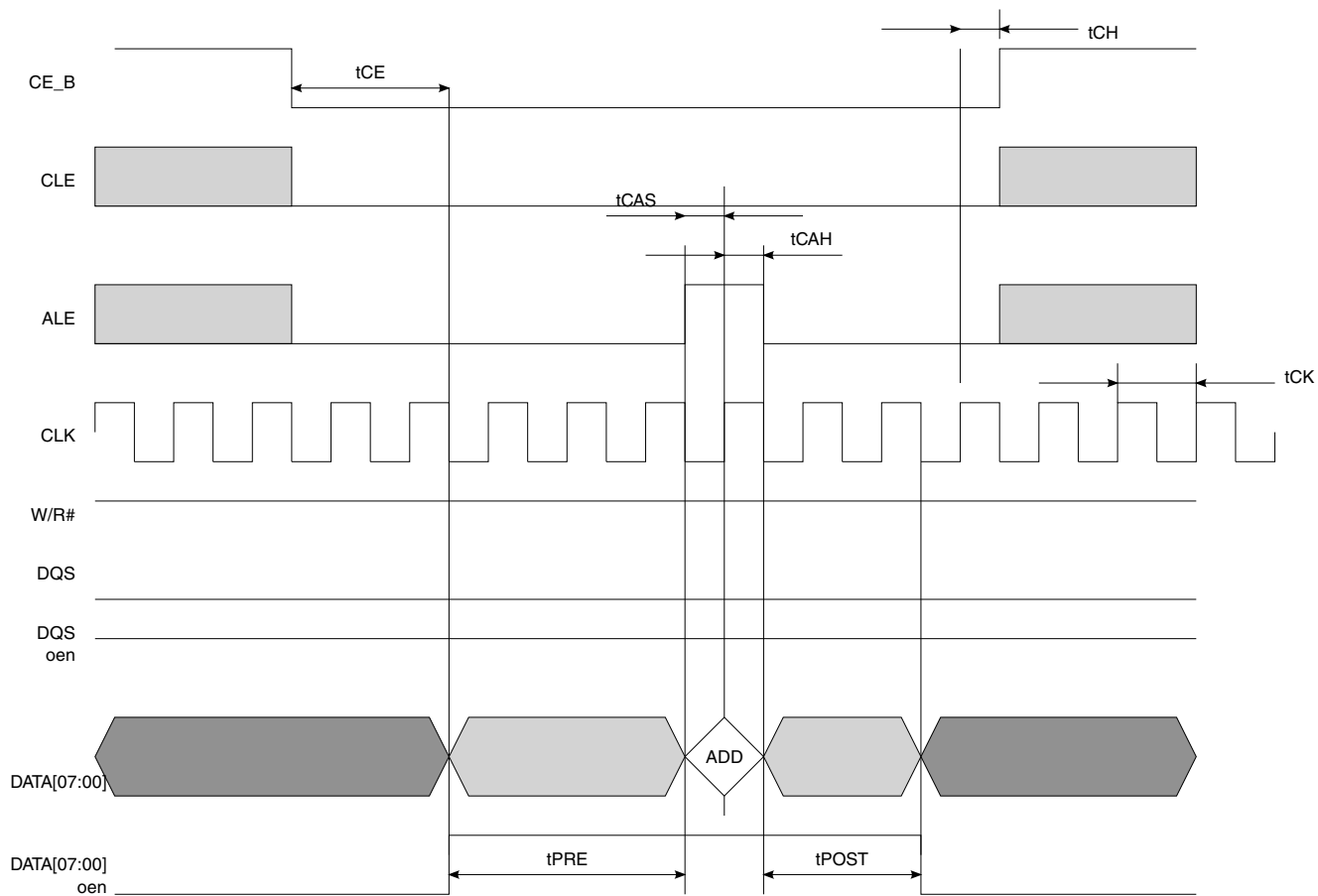
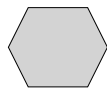

Figure 29-5. ONFI Source Synchronous Mode Basic Command Write Timing Diagram

GPMI NAND Mode



Host controller does not drives the DATA[07:00] bus
And also don't care if device will drive that or not and what will be driven.





Host controller drives the DATA[07:00] bus, but
the data in the DATA[07:00] should be ignored by the device

- t_{CK} is equal to device clock period
- $t_{CAS} = 0.5 * t_{CK}$
- $t_{CAH} = 0.5 * t_{CK}$
- $t_{CE} = HW_GPMI_TIMING2.CE_DELAY * t_{CK}$
- $t_{CH} = 0.5 * t_{CK}$
- $t_{PRE} = HW_GPMI_TIMING2.PREAMBLE_DELAY * t_{CK}$
- $t_{POST} = HW_GPMI_TIMING2.POST_DELAY * t_{CK}$

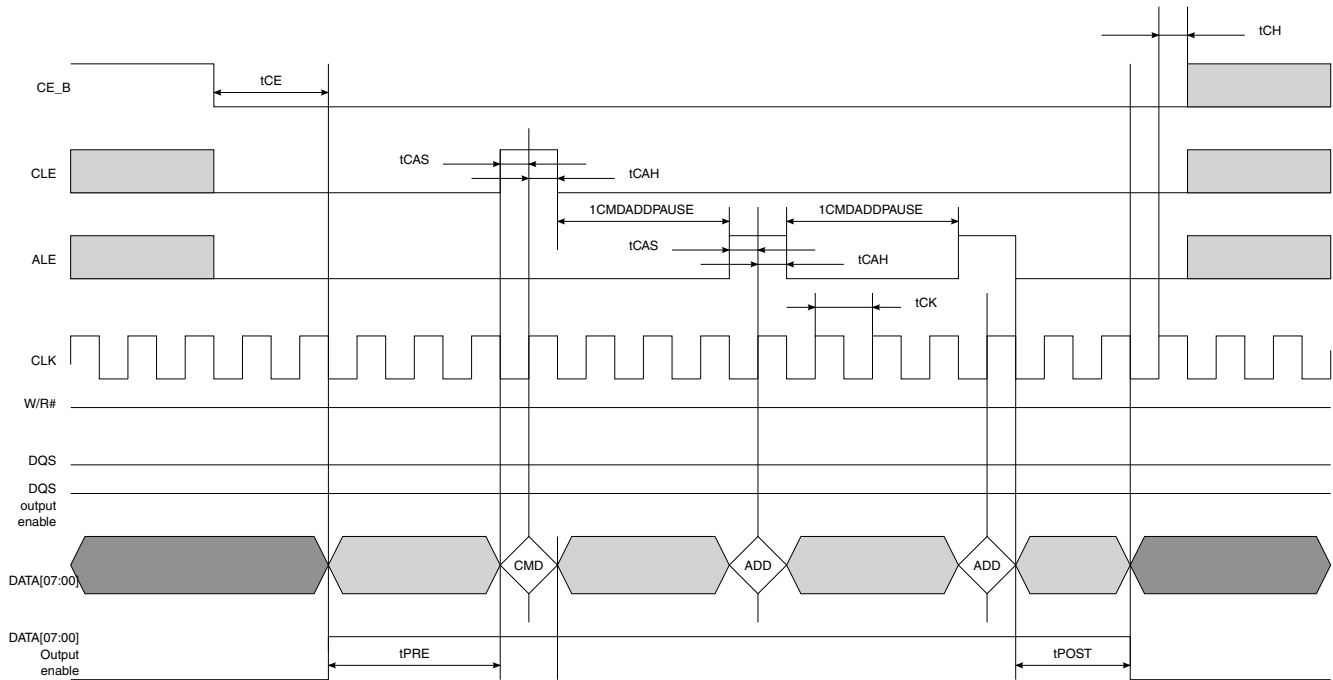
Figure 29-6. ONFI Source Synchronous Mode Basic Address Write Timing Diagram



 Host controller does not drive the DATA[07:00] bus
And also do not care if device will drive that or not and what will be driven.

 Host controller drives the DATA[07:00] bus, but
the data in the DATA[07:00] should be ignored by the device

tCK is equal to device clock period

tCAS = 0.5 * tCK

tCAH = 0.5 * tCK

tCE = HW_GPMI_TIMING2.CE_DELAY * tCK

tCH = 0.5 * tCK

tPRE = HW_GPMI_TIMING2.PREAMBLE_DELAY * tCK

tPOST = HW_GPMI_TIMING2.POST_DELAY * tCK

tCMDADDPAUSE = HW_GPMI_TIMING2.CMDADD_PAUSE * tCK

Figure 29-7. ONFI Source Synchronous Mode Command + Address Write Timing Diagram

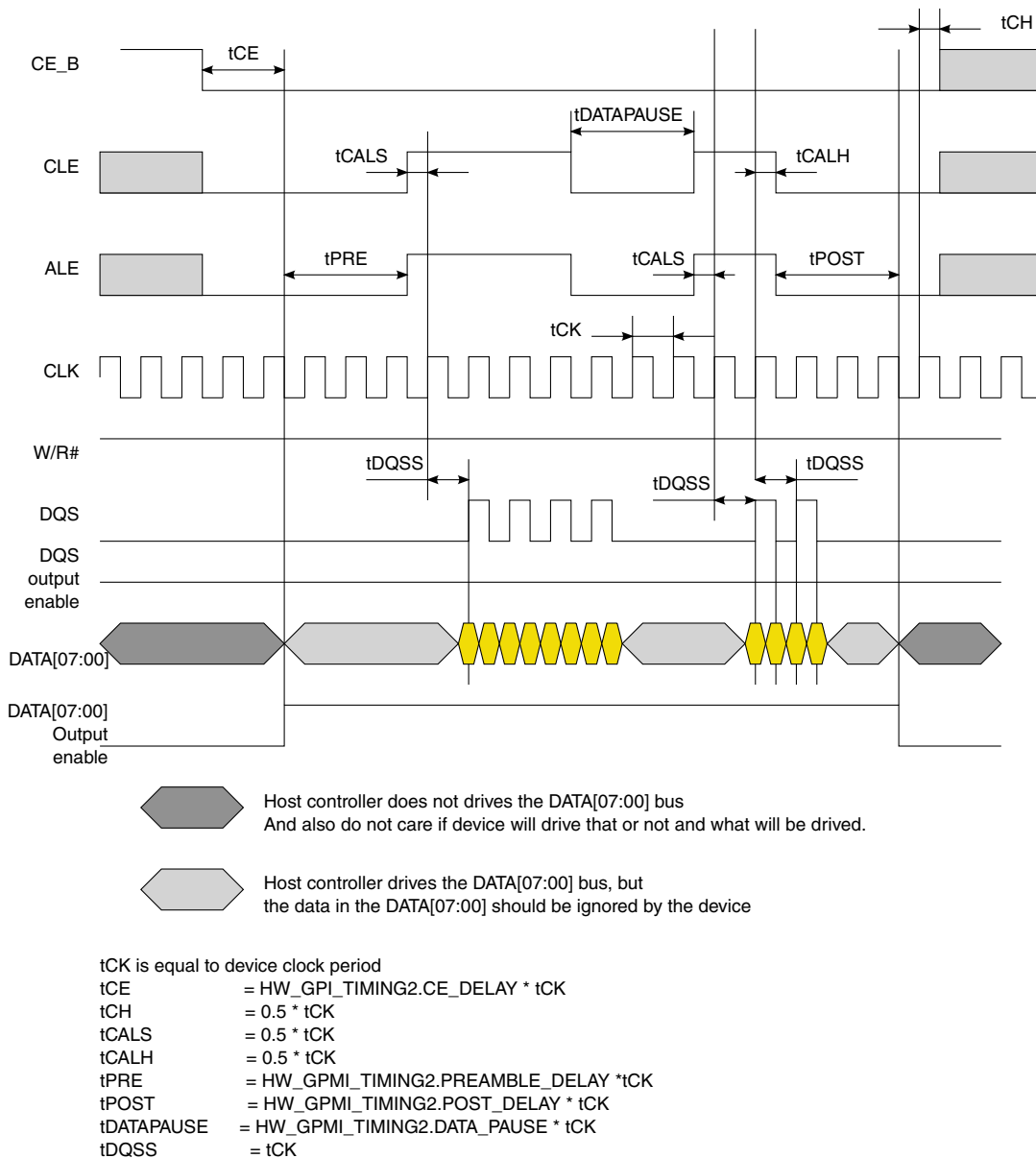

Figure 29-8. ONFI Source Synchronous Mode Data Write Timing Diagram

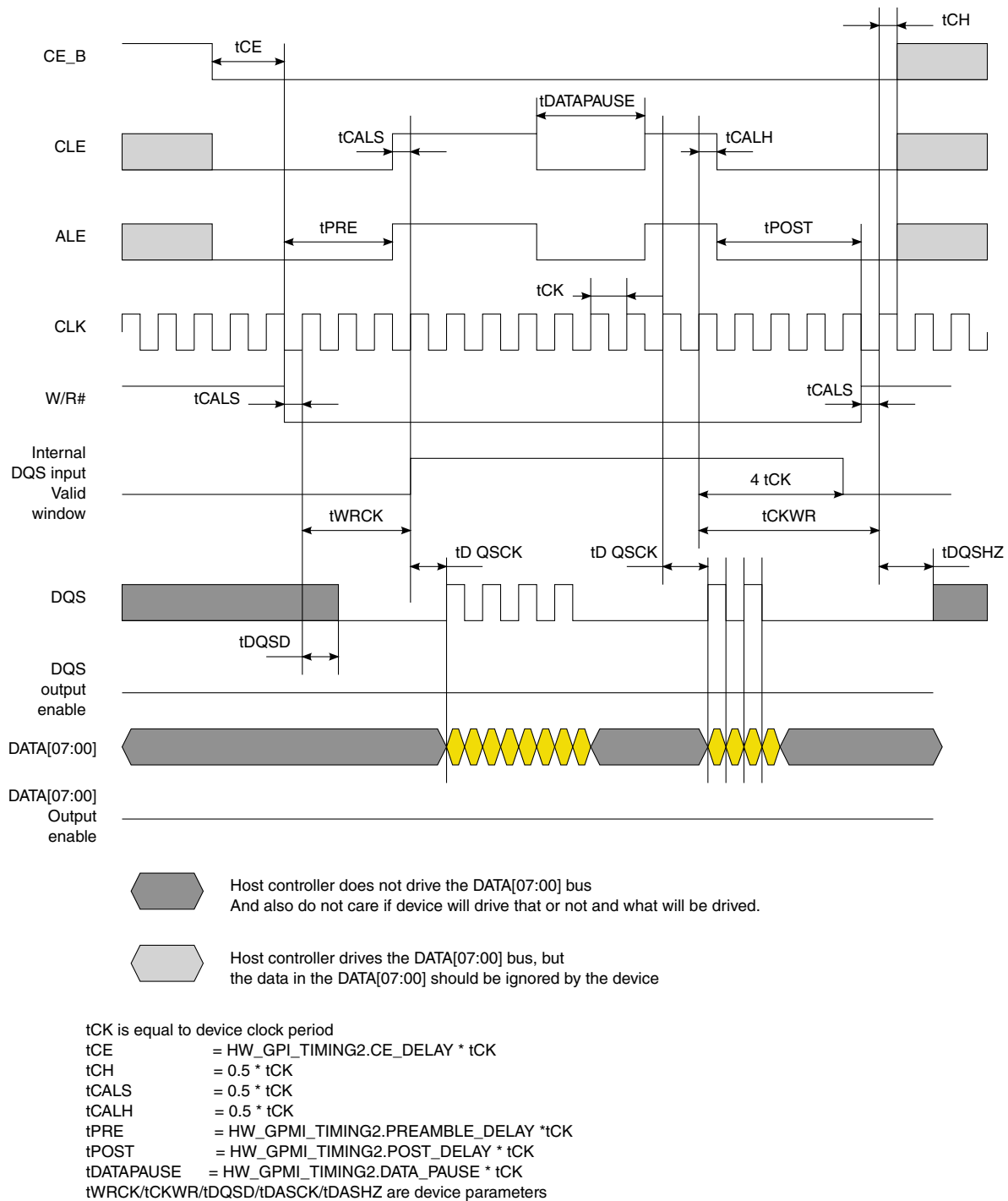

Figure 29-9. ONFI Source Synchronous Mode Data Read Timing Diagram

29.4.3.4 NAND Toggle Mode Timing

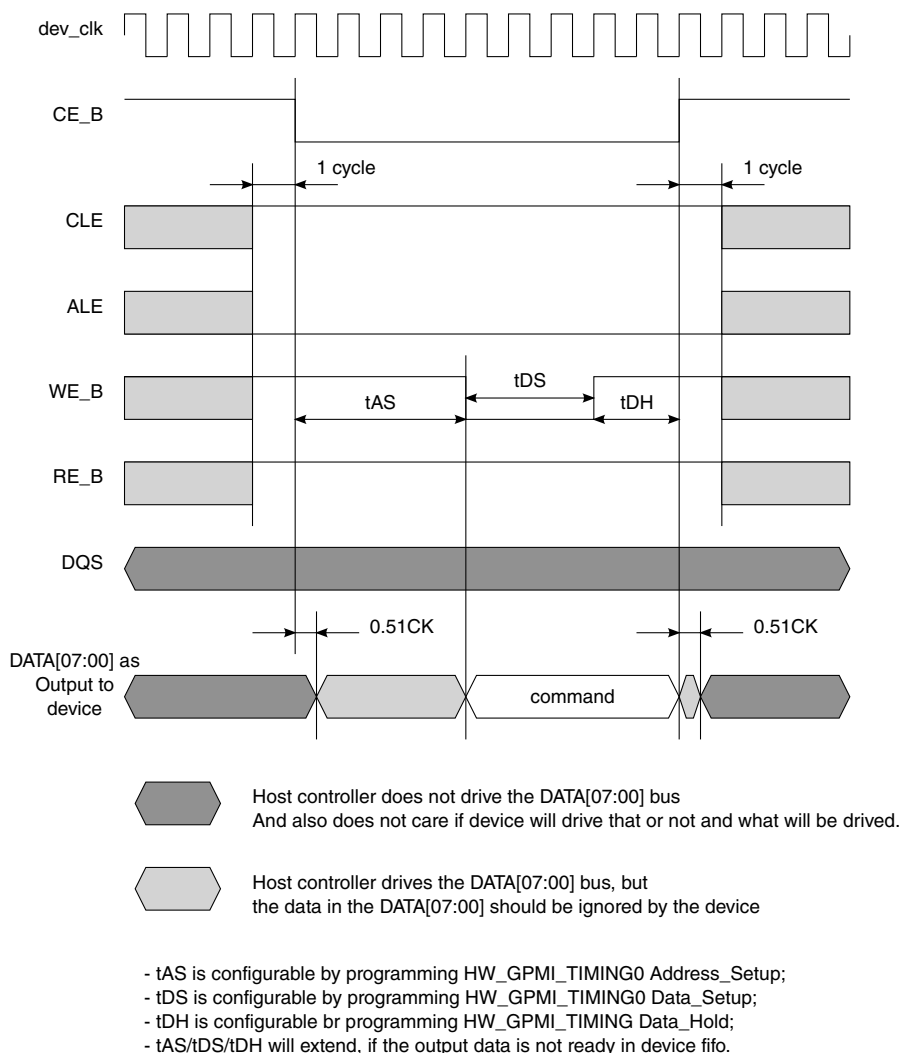

Figure 29-10. Samsung Toggle Mode Basic Command Write Timing Diagram

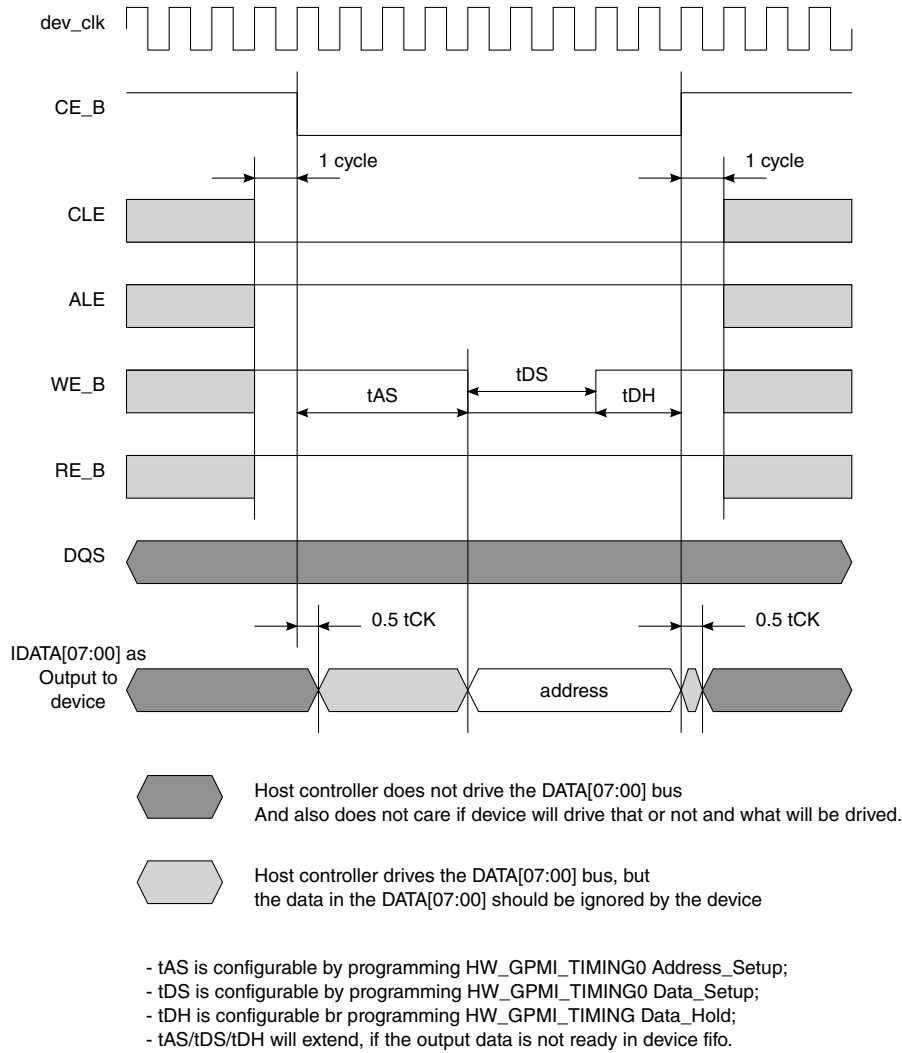

Figure 29-11. Samsung Toggle Mode Basic Address Write Timing Diagram

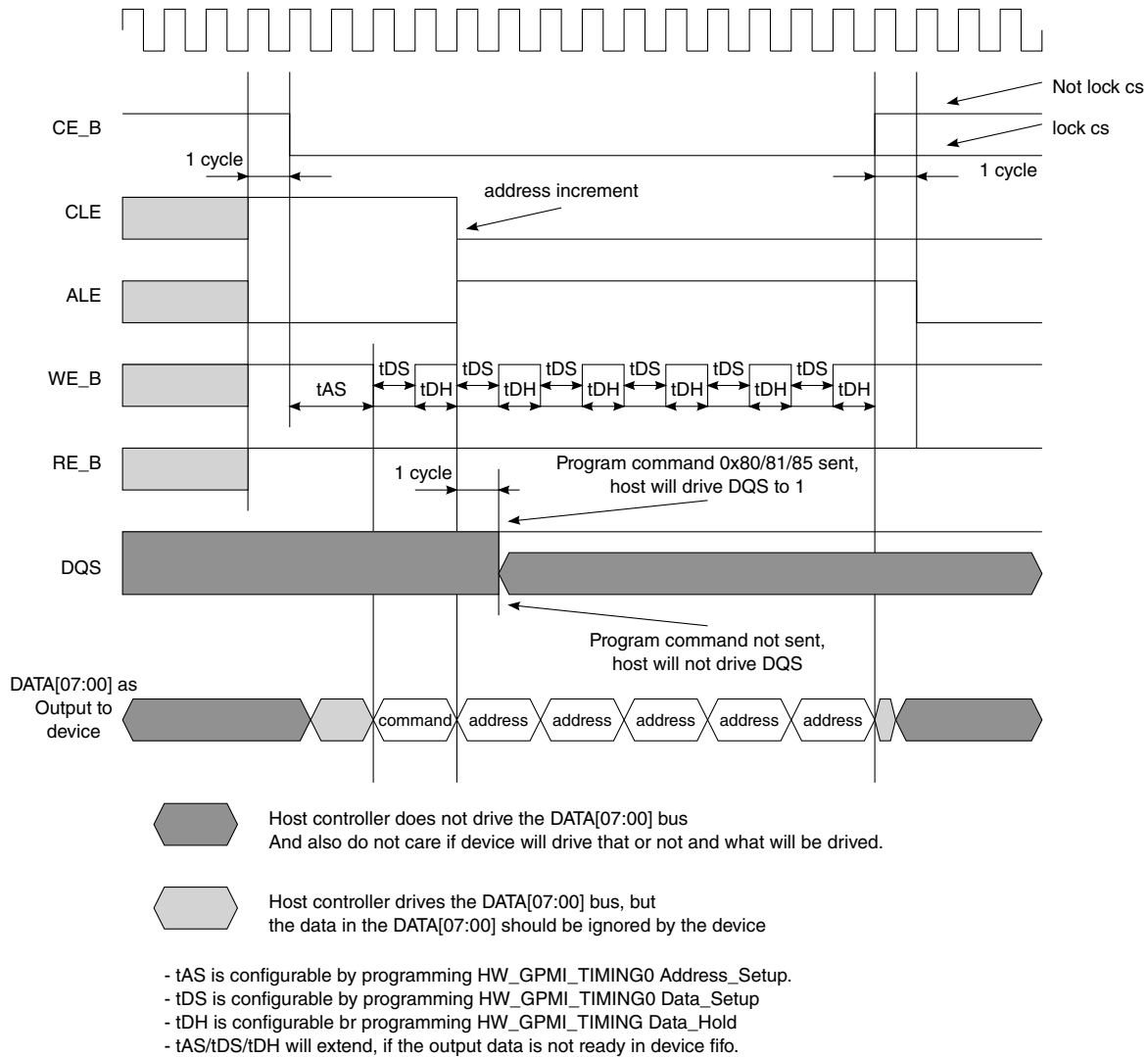

Figure 29-12. Samsung Toggle Mode Basic Command + Address Timing Diagram

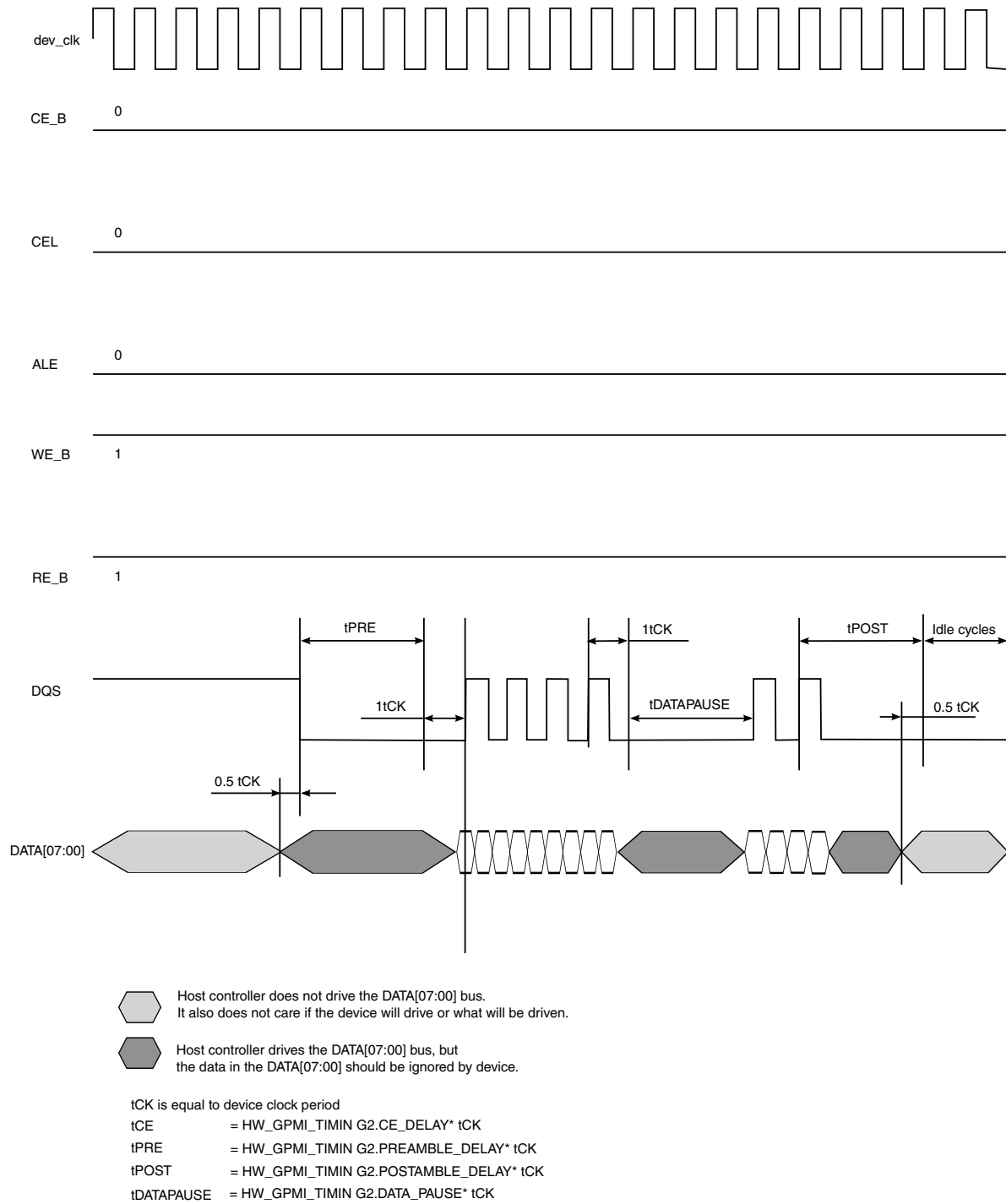

Figure 29-13. Toggle Mode Data Write Timing Diagram

GPMI NAND Mode

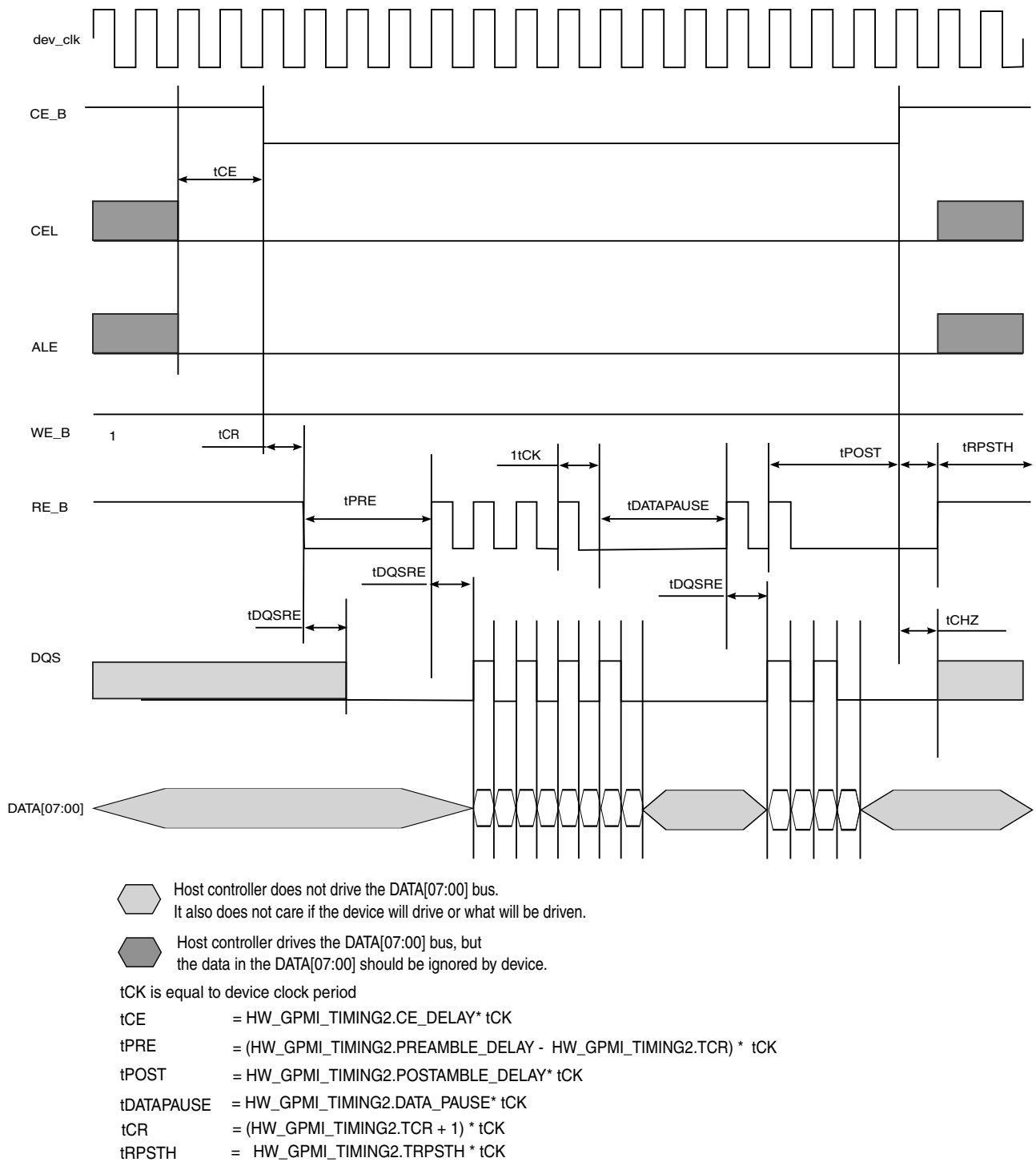

Figure 29-14. Toggle Mode Data Read Timing Diagram

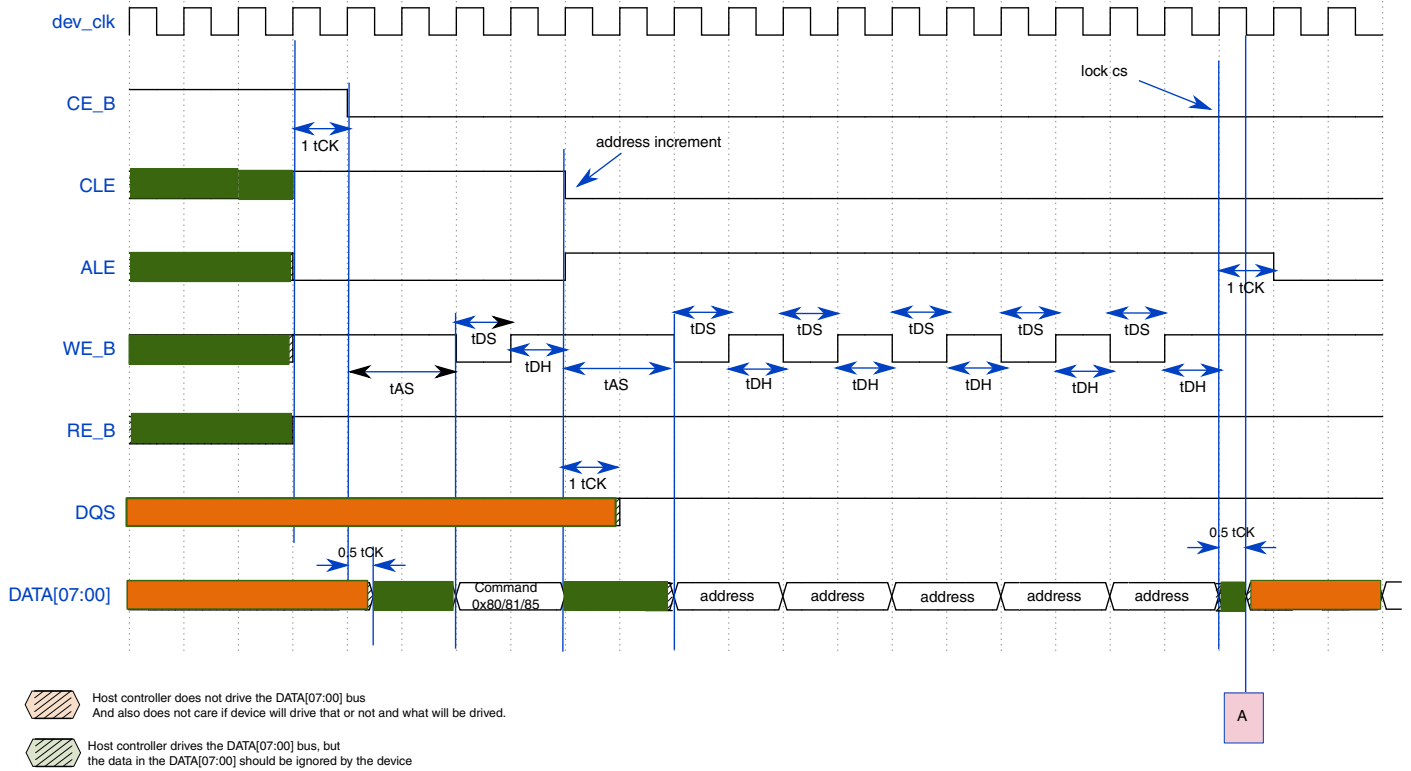

Figure 29-15. Toggle Mode Program Timing Diagram (A)

GPMI NAND Mode

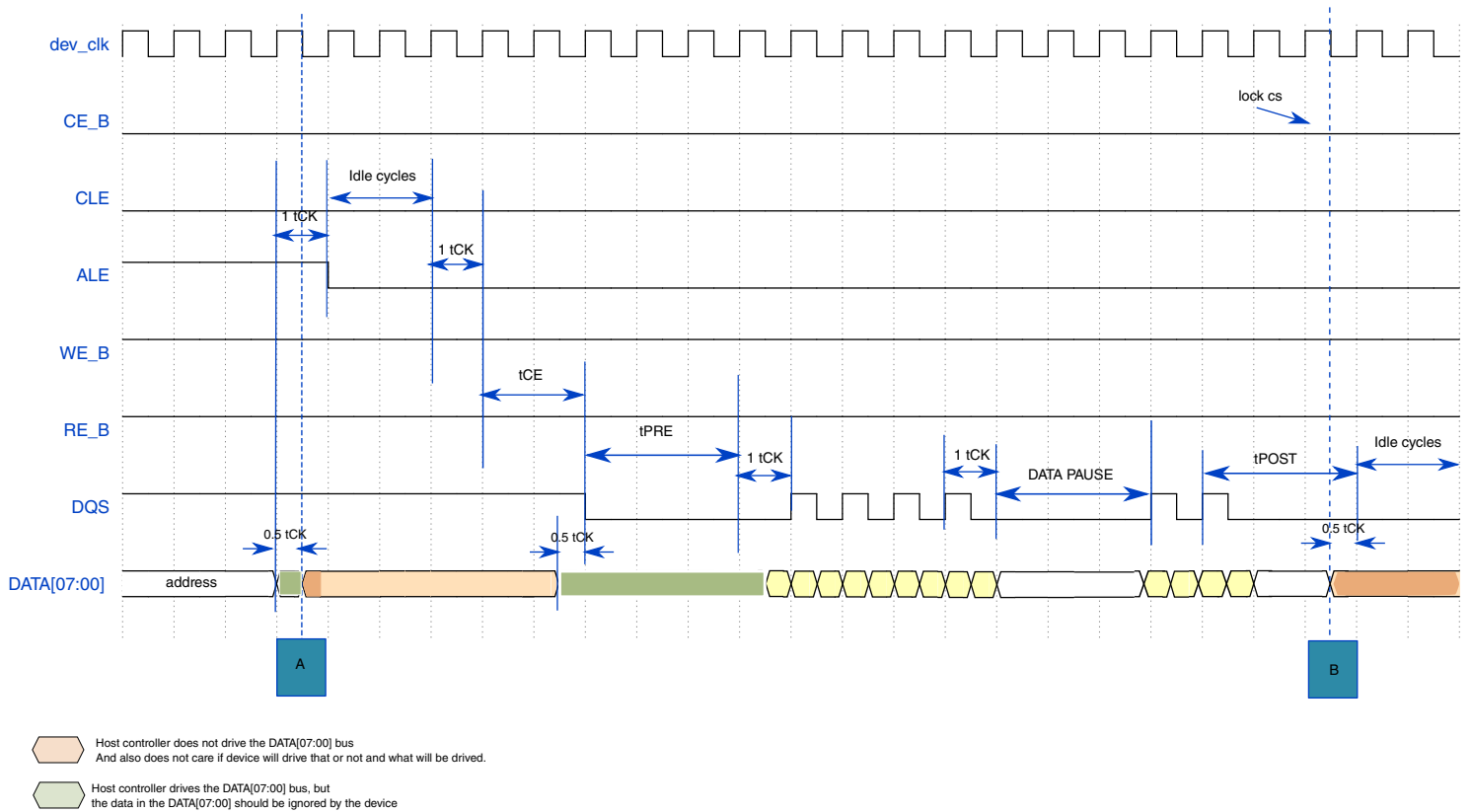

Figure 29-16. Toggle Mode Program Timing Diagram (B)

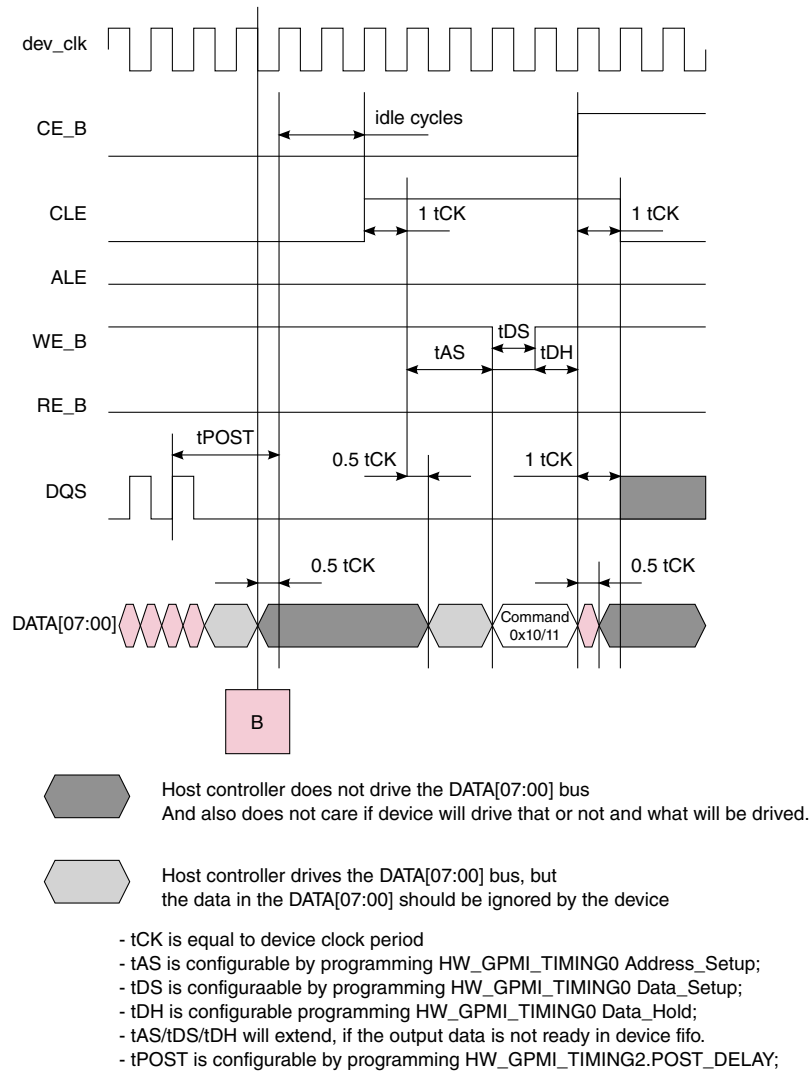

Figure 29-17. Toggle Mode Program Timing Diagram (C)

29.4.4 Hardware BCH Interface

The GPMI provides an interface to the BCH module. This reduces the SOC bus traffic and the software involvement.

When BCH ECC is enable, parity information is inserted on-the-fly during writes to 8-bit NAND devices. The BCH will supply payload and parity to the GPMI to write to the NAND. During NAND reads, parity is checked and ECC processing is performed after each read block. In this case the GPMI reads the NAND device and redirects the data and parity to the BCH module for ECC processing.

To program the BCH for NAND writes, remove the soft reset and clock gates from BCH_CTRL[SFTRST] and BCH_CTRL[CLKGATE]. The bulk of BCH programming is actually applied to the GPMI via PIO operations embedded in its DMA command structures. This has a subtle implication when writing to the GPMI ECC registers: access to these registers must be written in progressive register order. Thus, to write to the GPMI_ECCCOUNT register, write first (in order) to registers GPMI_CTRL0, GPMI_COMPARE, and GPMI_ECCCTRL before writing to GPMI_ECCCOUNT. These additional register writes need to be accounted for in the CMDWORDS field of the respective DMA channel command register.

NOTE

Note that the GPMI_PAYLOAD and GPMI_AUXILIARY pointers need to be word-aligned for proper ECC operation. If those pointers are non-word-aligned, then the BCH engine will not operate properly and could possibly corrupt system memory in the adjoining memory regions.

29.5 Behavior During Reset

A soft reset (SFTRST) can take multiple clock periods to complete, so do NOT set CLKGATE when setting SFTRST. The reset process gates the clocks automatically.

29.6 GPMI Memory Map/Register Definition

The following registers provide control for programmable elements of the GPMI module.

NOTE

All ATA or UDMA features are not supported for the chip.

GPMI memory map

Absolute address (hex)	Register name	Width (in bits)	Access	Reset value	Section/page
180_6000	GPMI Control Register 0 Description (GPMI_CTRL0)	32	R/W	C000_0000h	29.6.1/1396
180_6004	GPMI Control Register 0 Description (GPMI_CTRL0_SET)	32	R/W	C000_0000h	29.6.1/1396
180_6008	GPMI Control Register 0 Description (GPMI_CTRL0_CLR)	32	R/W	C000_0000h	29.6.1/1396
180_600C	GPMI Control Register 0 Description (GPMI_CTRL0_TOG)	32	R/W	C000_0000h	29.6.1/1396
180_6010	GPMI Compare Register Description (GPMI_COMPARE)	32	R/W	0000_0000h	29.6.2/1398

Table continues on the next page...

GPMI memory map (continued)

Absolute address (hex)	Register name	Width (in bits)	Access	Reset value	Section/page
180_6020	GPMI Integrated ECC Control Register Description (GPMI_ECCCTRL)	32	R/W	0000_0000h	29.6.3/1399
180_6024	GPMI Integrated ECC Control Register Description (GPMI_ECCCTRL_SET)	32	R/W	0000_0000h	29.6.3/1399
180_6028	GPMI Integrated ECC Control Register Description (GPMI_ECCCTRL_CLR)	32	R/W	0000_0000h	29.6.3/1399
180_602C	GPMI Integrated ECC Control Register Description (GPMI_ECCCTRL_TOG)	32	R/W	0000_0000h	29.6.3/1399
180_6030	GPMI Integrated ECC Transfer Count Register Description (GPMI_ECCCOUNT)	32	R/W	0000_0000h	29.6.4/1400
180_6040	GPMI Payload Address Register Description (GPMI_PAYLOAD)	32	R/W	0000_0000h	29.6.5/1400
180_6050	GPMI Auxiliary Address Register Description (GPMI_AUXILIARY)	32	R/W	0000_0000h	29.6.6/1401
180_6060	GPMI Control Register 1 Description (GPMI_CTRL1)	32	R/W	0004_0004h	29.6.7/1402
180_6064	GPMI Control Register 1 Description (GPMI_CTRL1_SET)	32	R/W	0004_0004h	29.6.7/1402
180_6068	GPMI Control Register 1 Description (GPMI_CTRL1_CLR)	32	R/W	0004_0004h	29.6.7/1402
180_606C	GPMI Control Register 1 Description (GPMI_CTRL1_TOG)	32	R/W	0004_0004h	29.6.7/1402
180_6070	GPMI Timing Register 0 Description (GPMI_TIMING0)	32	R/W	0001_0203h	29.6.8/1404
180_6080	GPMI Timing Register 1 Description (GPMI_TIMING1)	32	R/W	0000_0000h	29.6.9/1405
180_6090	GPMI Timing Register 2 Description (GPMI_TIMING2)	32	R/W	0302_3336h	29.6.10/1406
180_60A0	GPMI DMA Data Transfer Register Description (GPMI_DATA)	32	R/W	0000_0000h	29.6.11/1407
180_60B0	GPMI Status Register Description (GPMI_STAT)	32	R	0000_0005h	29.6.12/1407
180_60C0	GPMI Debug Information Register Description (GPMI_DEBUG)	32	R	0000_0000h	29.6.13/1410
180_60D0	GPMI Version Register Description (GPMI_VERSION)	32	R	0502_0000h	29.6.14/1410
180_60E0	GPMI Debug2 Information Register Description (GPMI_DEBUG2)	32	R/W	0000_F100h	29.6.15/1411
180_60F0	GPMI Debug3 Information Register Description (GPMI_DEBUG3)	32	R	0000_0000h	29.6.16/1414
180_6100	GPMI Double Rate Read DLL Control Register Description (GPMI_READ_DDR_DLL_CTRL)	32	R/W	0000_0038h	29.6.17/1414
180_6110	GPMI Double Rate Write DLL Control Register Description (GPMI_WRITE_DDR_DLL_CTRL)	32	R/W	0000_0038h	29.6.18/1416
180_6120	GPMI Double Rate Read DLL Status Register Description (GPMI_READ_DDR_DLL_STS)	32	R	0000_0000h	29.6.19/1418
180_6130	GPMI Double Rate Write DLL Status Register Description (GPMI_WRITE_DDR_DLL_STS)	32	R	0000_0000h	29.6.20/1419

29.6.1 GPMI Control Register 0 Description (GPMI_CTRL0n)

The GPMI control register 0 specifies the GPMI transaction to perform for the current command chain item.

Address: 180_6000h base + 0h offset + (4d × i), where i=0d to 3d

Bit	31	30	29	28	27	26	25	24	23	22	21	20	19	18	17	16
R																
W																
Reset	1	1	0	0	0	0	0	0	0	0	0	0	0	0	0	0
Bit	15	14	13	12	11	10	9	8	7	6	5	4	3	2	1	0
R	XFER_COUNT															
W																
Reset	0	0	0	0	0	0	0	0	0	0	0	0	0	0	0	0

GPMI_CTRL0n field descriptions

Field	Description
31 SFTRST	Set to zero for normal operation. When this bit is set to one (default), then the entire block is held in its reset state. This will not work if the CLKGATE bit is already set to '1'. CLKGATE must be cleared to '0' before issuing a soft reset. Also the GPMICLK must be running for this to work properly. RUN = 0x0 Allow GPMI to operate normally. RESET = 0x1 Hold GPMI in reset.
30 CLKGATE	Set this bit zero for normal operation. Setting this bit to one (default), gates all of the block level clocks off for minimizing AC energy consumption. RUN = 0x0 Allow GPMI to operate normally. NO_CLKS = 0x1 Do not clock GPMI gates in order to minimize power consumption.
29 RUN	The GPMI is busy running a command whenever this bit is set to '1'. The GPMI is idle whenever this bit set to zero. This can be set to one by a CPU write. In addition, the DMA sets this bit each time a DMA command has finished its PIO transfer phase. IDLE = 0x0 The GPMI is idle. BUSY = 0x1 The GPMI is busy running a command.

Table continues on the next page...

GPMI_CTRL0n field descriptions (continued)

Field	Description
28 DEV_IRQ_EN	When set to '1' and ATA_IRQ pin is asserted, the GPMI_IRQ output will assert.
27 LOCK_CS	For ATA/NAND mode: 0= Deassert chip select (CS) after RUN is complete. 1= Continue to assert chip select (CS) after RUN is complete. For Camera Mode: 0= Dont wait for VSYNC rising edge before capturing data. 1= Wait for VSYNC rising edge before capturing data (Camera mode only). DISABLED = 0x0 Deassert chip select (CS) after RUN is complete. ENABLED = 0x1 Continue to assert chip select (CS) after RUN is complete.
26 UDMA	DISABLED = 0x0 Use ATA-PIO mode on the external bus. ENABLED = 0x1 Use ATA-Ultra DMA mode on the external bus. 0 Use ATA-PIO mode on the external bus. 1 Use ATA-Ultra DMA mode on the external bus.
25–24 COMMAND_ MODE	WRITE = 0x0 Write mode. READ = 0x1 Read mode. READ_AND_COMPARE = 0x2 Read and Compare mode (setting sense flop). WAIT_FOR_READY = 0x3 Wait for Ready mode. For ATA WAIT_FOR_READY command set CS=01. 00 Write mode. 01 Read Mode. 10 Read and Compare Mode (setting sense flop). 11 Wait for Ready.
23 WORD_LENGTH	This bit should only be changed when RUN==0. Reserve = 0x0 Reserved. 8_BIT = 0x1 8-bit Data Bus mode. 0 Reserved. 1 8-bit Data Bus mode.
22–20 CS	Selects which chip select is active for this command. For ATA WAIT_FOR_READY command, this must be set to b01.
19–17 ADDRESS	Specifies the three address lines for ATA mode. In NAND mode, use A0 for CLE and A1 for ALE. NAND_DATA = 0x0 In NAND mode, this address is used to read and write data bytes. NAND_CLE = 0x1 In NAND mode, this address is used to write command bytes. NAND_ALE = 0x2 In NAND mode, this address is used to write address bytes.
16 ADDRESS_ INCREMENT	In ATA mode, the address will increment with each cycle. In NAND mode, the address will increment once, after the first cycle (going from CLE to ALE). DISABLED = 0x0 Address does not increment. ENABLED = 0x1 Increment address. 0 Address does not increment. 1 Increment address.
XFER_COUNT	Number of bytes to transfer for this command. A value of zero will transfer 64K bytes.

29.6.2 GPMI Compare Register Description (GPMI_COMPARE)

The GPMI compare register specifies the expect data and the xor mask for comparing to the status values read from the device. This register is used by the Read and Compare command.

GPMI_COMPARE 0x010

Address: 180_6000h base + 10h offset = 180_6010h

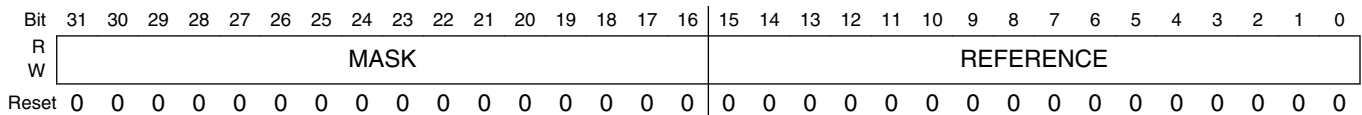

GPMI_COMPARE field descriptions

Field	Description
31–16 MASK	16-bit mask which is applied after the read data is XORed with the REFERENCE bit field.
REFERENCE	16-bit value which is XORed with data read from the NAND device.

29.6.3 GPMI Integrated ECC Control Register Description (GPMI_ECCCTRLn)

The GPMI ECC control register handles configuration of the integrated ECC accelerator.

Address: 180_6000h base + 20h offset + (4d × i), where i=0d to 3d

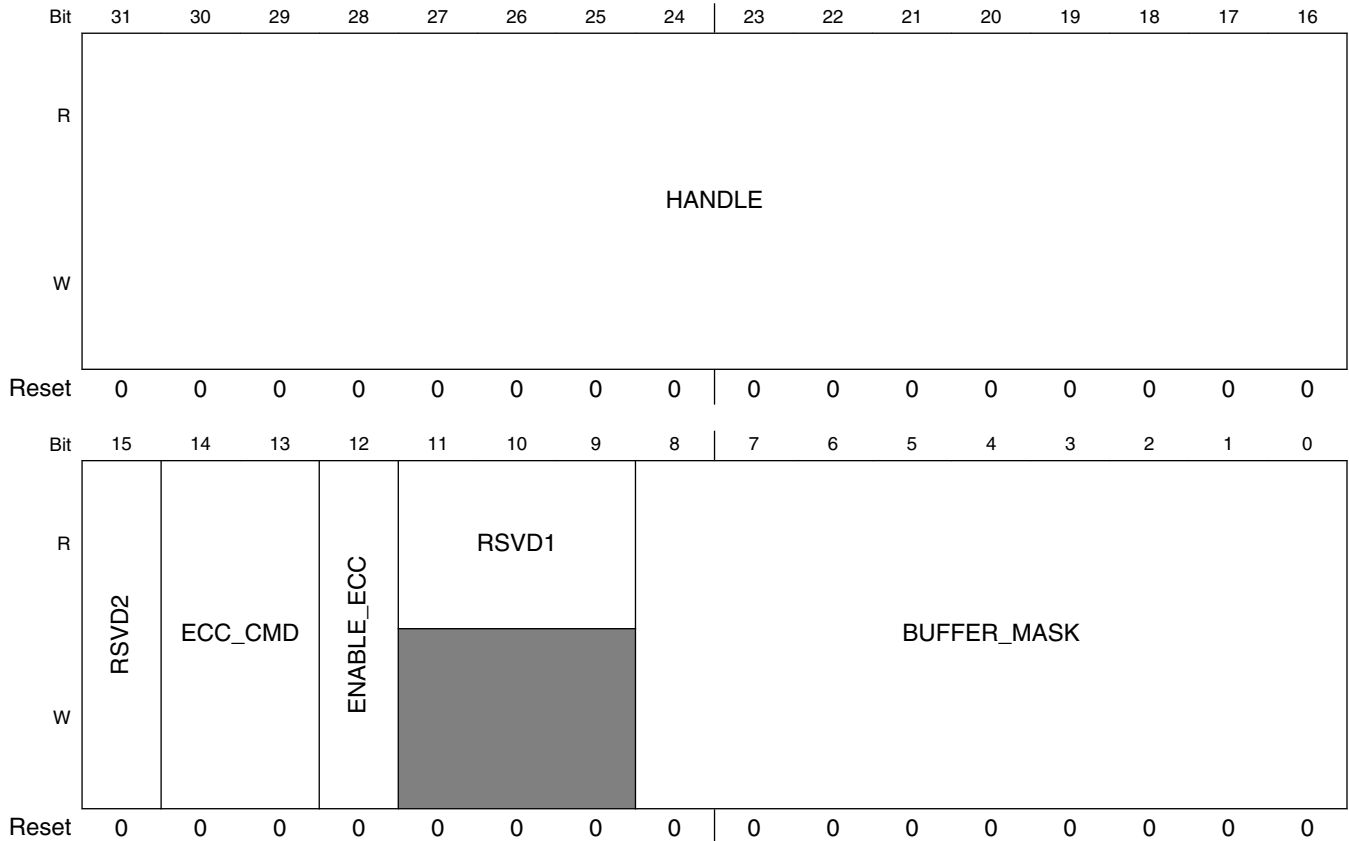

GPMI_ECCCTRLn field descriptions

Field	Description
31–16 HANDLE	This is a register available to software to attach an identifier to a transaction in progress. This handle will be available from the ECC register space when the completion interrupt occurs.
15 RSVD2	Always write zeroes to this bit field.
14–13 ECC_CMD	ECC Command information. DECODE = 0x0 Decode. ENCODE = 0x1 Encode. RESERVE2 = 0x2 Reserved. RESERVE3 = 0x3 Reserved.

Table continues on the next page...

GPMI_ECCCTRLn field descriptions (continued)

Field	Description
12 ENABLE_ECC	Enable ECC processing of GPMI transfers. ENABLE = 0x1 Use integrated ECC for read and write transfers. DISABLE = 0x0 Integrated ECC remains in idle.
11–9 RSVD1	Always write zeroes to this bit field.
BUFFER_MASK	ECC buffer information. The BCH error correction only allows two configurations of the buffer mask - software may either read just the first block on the flash page or the entire flash page. Write operations must be for the entire flash page. Invalid buffer mask values will cause the DMA descriptor command to be terminated. BCH_AUXONLY = 0x100 Set to request transfer from only the auxiliary buffer (block 0 on flash). BCH_PAGE = 0x1FF Set to request transfer to/from the entire page.

29.6.4 GPMI Integrated ECC Transfer Count Register Description (GPMI_ECCCOUNT)

The GPMI ECC Transfer Count Register contains the count of bytes that flow through the ECC subsystem.

GPMI_ECCCOUNT 0x030

Address: 180_6000h base + 30h offset = 180_6030h

Bit	31	30	29	28	27	26	25	24	23	22	21	20	19	18	17	16	15	14	13	12	11	10	9	8	7	6	5	4	3	2	1	0
R	RSVD2																COUNT															
W																																
Reset	0	0	0	0	0	0	0	0	0	0	0	0	0	0	0	0	0	0	0	0	0	0	0	0	0	0	0	0	0	0	0	0

GPMI_ECCCOUNT field descriptions

Field	Description
31–16 RSVD2	Always write zeroes to this bit field.
COUNT	Number of bytes to pass through ECC. This is the GPMI transfer count plus the syndrome count that will be inserted into the stream by the ECC. In DMA2ECC_MODE this count must match the GPMI_CTRL0_XFER_COUNT. A value of zero will transfer 64K words.

29.6.5 GPMI Payload Address Register Description (GPMI_PAYLOAD)

The GPMI payload address register specifies the location of the data buffers in system memory. This value must be word aligned.

GPMI_PAYLOAD 0x040

Address: 180_6000h base + 40h offset = 180_6040h

Bit	31	30	29	28	27	26	25	24		23	22	21	20	19	18	17	16
R	ADDRESS																
W	ADDRESS																
Reset	0	0	0	0	0	0	0	0		0	0	0	0	0	0	0	0
Bit	15	14	13	12	11	10	9	8		7	6	5	4	3	2	1	0
R	ADDRESS															RSVD0	
W	ADDRESS															RSVD0	
Reset	0	0	0	0	0	0	0	0		0	0	0	0	0	0	0	0

GPMI_PAYLOAD field descriptions

Field	Description
31–2 ADDRESS	Pointer to an array of one or more 512 byte payload buffers.
RSVD0	Always write zeroes to this bit field.

29.6.6 GPMI Auxiliary Address Register Description (GPMI_AUXILIARY)

The GPMI auxiliary address register specifies the location of the auxiliary buffers in system memory. This value must be word aligned.

GPMI_AUXILIARY 0x050

Address: 180_6000h base + 50h offset = 180_6050h

Bit	31	30	29	28	27	26	25	24		23	22	21	20	19	18	17	16
R	ADDRESS																
W	ADDRESS																
Reset	0	0	0	0	0	0	0	0		0	0	0	0	0	0	0	0
Bit	15	14	13	12	11	10	9	8		7	6	5	4	3	2	1	0
R	ADDRESS															RSVD0	
W	ADDRESS															RSVD0	
Reset	0	0	0	0	0	0	0	0		0	0	0	0	0	0	0	0

GPMI_AUXILIARY field descriptions

Field	Description
31–2 ADDRESS	Pointer to ECC control structure and meta-data storage.
RSVD0	Always write zeroes to this bit field.

29.6.7 GPMI Control Register 1 Description (GPMI_CTRL1n)

The GPMI control register 1 specifies additional control fields that are not used on a per-transaction basis.

Address: 180_6000h base + 60h offset + (4d × i), where i=0d to 3d

Bit	31	30	29	28	27	26	25	24	23	22	21	20	19	18	17	16
R	DEV_CLK_STOP	SSYNC_CLK_STOP	WRITE_CLK_STOP	TOGGLE_MODE	GPMI_CLK_DIV2_EN	UPDATE_CS	SSYNCMODE	DECOUPLE_CS	WRN_DLY_SEL		TEST_TRIGGER	TIMEOUT_IRQ_EN	GANGED_RDYBUSY	BCH_MODE	DLL_ENABLE	HALF_PERIOD
W																
Reset	0	0	0	0	0	0	0	0	0	0	0	0	0	1	0	0
Bit	15	14	13	12	11	10	9	8	7	6	5	4	3	2	1	0
R	RDN_DELAY				DMA2ECC_MODE	DEV_IRQ	TIMEOUT_IRQ	BURST_EN	ABORT_WAIT_REQUEST	ABORT_WAIT_FOR_READY_CHANNEL			DEV_RESET	ATA_IRQRDY_POLARITY	CAMERA_MODE	GPMI_MODE
W																
Reset	0	0	0	0	0	0	0	0	0	0	0	0	0	1	0	0

GPMI_CTRL1n field descriptions

Field	Description
31 DEV_CLK_STOP	set this bit to 1 will stop gpmi io working clk.
30 SSYNC_CLK_STOP	set this bit to 1 will stop the source synchronous mode clk.
29 WRITE_CLK_STOP	In onfi source synchronous mode, host may save power during the data write cycles by holding the CLK signal high (i.e. stopping the CLK). The host may only stop the CLK during data write, by setting this bit to 1, if the device supports this feature as indicated in the parameter page.
28 TOGGLE_MODE	enable samsung toggle mode.
27 GPMI_CLK_DIV2_EN	This bit should be reset to 0 in asynchronous mode. The frequency ratio of (device clock : ccm gpmi clock) will be (1 : 1). This bit should be set to 1, in source synchronous mode or toggle mode. The frequency ratio of (device clock : ccm gpmi clock) will be (1 : 2). enable the gpmi clk divider. 0x0 internal factor-2 clock divider is disabled 0x1 internal factor-2 clock divider is enabled.

Table continues on the next page...

GPMI_CTRL1n field descriptions (continued)

Field	Description
26 UPDATE_CS	force the CS value is be updated to external chip select pin, even GPMI is idle.
25 SSYNCMODE	source synchronous mode 1 or asynchronous mode 0. ASYNC = 0x0 Asynchronous mode. SSYNC = 0x1 Source Synchronous mode.
24 DECOUPLE_CS	Decouple Chip Select from DMA Channel. Setting this bit to 1 will allow a DMA channel to specify any value in the CTRL0_CS register field. Software can use one DMA channel to access all 8 Nand devices.
23–22 WRN_DLY_SEL	Since the GPMI write strobe (WRN) is a fast clock pin, the delay on this signal can be programmed to match the load on this pin. 0 = ~2ns; 1 = ~4ns; 2 = ~6ns; 3 = no delay.
21 TEST_TRIGGER	Test Trigger Enable 0 Disable 1 Enable
20 TIMEOUT_IRQ_EN	Setting this bit to '1' will enable timeout IRQ for transfers in ATA mode only, and for WAIT_FOR_READY commands in both ATA and Nand mode. The Device_Busy_Timeout value is used for this timeout.
19 GANGED_RDYBUSY	Set this bit to 1 will force all Nand RDY_BUSY inputs to be sourced from (tied to) RDY_BUSY0. This will free up all, except one, RDY_BUSY input pins.
18 BCH_MODE	This bit selects which error correction unit will access GPMI. This bit must always be set to '1', since only the BCH unit is available in this design.
17 DLL_ENABLE	Set this bit to 1 to enable the GPMI DLL. This is required for fast NAND reads (above 30 MHz read strobe). After setting this bit, wait 64 GPMI clock cycles for the DLL to lock before performing a NAND read.
16 HALF_PERIOD	Set this bit to 1 if the GPMI clock period is greater than 16ns for proper DLL operation. DLL_ENABLE must be zero while changing this field.
15–12 RDN_DELAY	This variable is a factor in the calculated delay to apply to the internal read strobe for correct read data sampling. The applied delay (AD) is between 0 and 1.875 times the reference period (RP). RP is one half of the GPMI clock period if HALF_PERIOD=1 otherwise it is the full GPMI clock period. The equation is: $AD = RDN_DELAY \times 0.125 \times RP$. This value must not exceed 16ns. This variable is used to achieve faster NAND access. For example if the Read Strobe is asserted from time 0 to 13ns but the read access time is 20ns, then choose AD=12ns will cause the data to be sampled at time 25ns (13+12) giving a 5ns data setup time. If RP=13ns then $RDN_DELAY = 12 / (0.125 \times 13ns)$ = 7.38 (0111b). DLL_ENABLE must be zero while changing this field.
11 DMA2ECC_MODE	This is mainly for testing HWECC without involving the Nand device. Setting this bit will cause DMA write data to redirected to HWECC module (instead of Nand Device) for encoding or decoding.
10 DEV_IRQ	This bit is set when an Interrupt is received from the ATA device. Write 0 to clear.
9 TIMEOUT_IRQ	This bit is set when a timeout occurs using the Device_Busy_Timeout value. Write 0 to clear.

Table continues on the next page...

GPMI_CTRL1n field descriptions (continued)

Field	Description
8 BURST_EN	When set to 1 each DMA request will generate a 4-transfer burst on the APB bus.
7 ABORT_WAIT_REQUEST	Request to abort "wait for ready" command on channel indicated by ABORT_WAIT_FOR_READY_CHANNEL. Hardware will clear this bit when abort is done.
6–4 ABORT_WAIT_FOR_READY_CHANNEL	Abort a wait for ready command on selected channel. Set the ABORT_WAIT_REQUEST to kick of operation.
3 DEV_RESET	ENABLED = 0x0 NANDF_WP_B(WPN) pin is held low (asserted). DISABLED = 0x1 NANDF_WP_B(WPN) pin is held high (de-asserted). 0 NANDF_WP_B pin is held low (asserted). 1 NANDF_WP_B pin is held high (de-asserted).
2 ATA_IRQRDY_POLARITY	For ATA MODE: Note NAND_RDY_BUSY[3:2] are not affected by this bit. ACTIVELOW = 0x0 ATA IORDY and IRQ are active low, or NAND_RDY_BUSY[1:0] are active low ready. ACTIVEHIGH = 0x1 ATA IORDY and IRQ are active high, or NAND_RDY_BUSY[1:0] are active high ready. 0 External ATA IORDY and IRQ are active low. 1 External ATA IORDY and IRQ are active high. For NAND MODE: 0 External RDY_BUSY[1] and RDY_BUSY[0] pins are ready when low and busy when high. 1 External RDY_BUSY[1] and RDY_BUSY[0] pins are ready when high and busy when low.
1 CAMERA_MODE	When set to 1 and ATA UDMA is enabled the UDMA interface becomes a camera interface.
0 GPMI_MODE	ATA mode is only supported on channel zero. If ATA mode is selected, then only channel three is available for NAND use. NAND = 0x0 NAND mode. ATA = 0x1 ATA mode. 0 NAND mode. 1 ATA mode.

29.6.8 GPMI Timing Register 0 Description (GPMI_TIMING0)

The GPMI timing register 0 specifies the timing parameters that are used by the cycle state machine to guarantee the various setup, hold and cycle times for the external media type.

GPMI_TIMING0 0x070

Address: 180_6000h base + 70h offset = 180_6070h

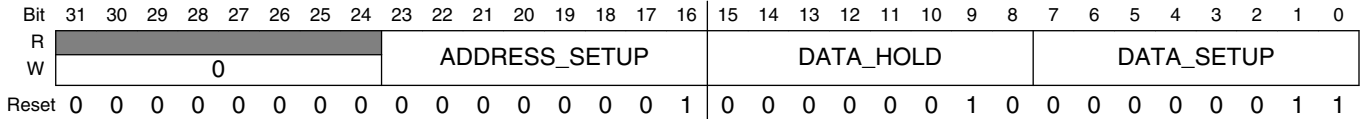

GPMI_TIMING0 field descriptions

Field	Description
31–24 RSVD1	Always write zeroes to this bit field.
23–16 ADDRESS_SETUP	Number of GPMICLK cycles that the CE/ADDR signals are active before a strobe is asserted. A value of zero is interpreted as 0. For ATA PIO modes this is known in the ATA7 specification as "Address valid to DIOR-/DIOW- setup"
15–8 DATA_HOLD	Data bus hold time in GPMICLK cycles. Also the time that the data strobe is de-asserted in a cycle. A value of zero is interpreted as 256. For ATA PIO modes this is known in the ATA7 specification as "DIOR-/DIOW- recovery time"
DATA_SETUP	Data bus setup time in GPMICLK cycles. Also the time that the data strobe is asserted in a cycle. This value must be greater than 2 for ATA devices that use IORDY to extend transfer cycles. A value of zero is interpreted as 256. For ATA PIO modes this is known in the ATA7 specification as ""DIOR-/DIOW-"

29.6.9 GPMI Timing Register 1 Description (GPMI_TIMING1)

The GPMI timing register 1 specifies the timeouts used when monitoring the NAND READY pin or the ATA IRQ and IOWAIT signals.

GPMI_TIMING1 0x080

Address: 180_6000h base + 80h offset = 180_6080h

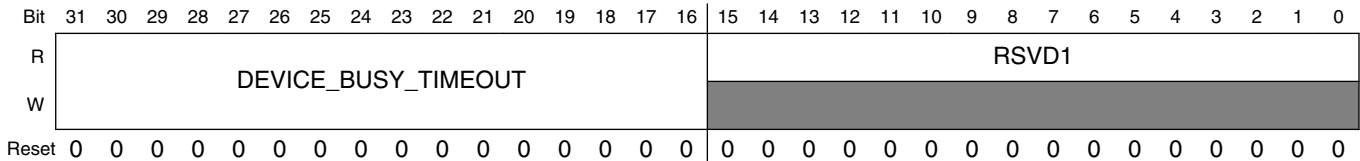

GPMI_TIMING1 field descriptions

Field	Description
31–16 DEVICE_BUSY_TIMEOUT	Timeout waiting for NAND Ready/Busy or ATA IRQ. Used in WAIT_FOR_READY mode. This value is the number of GPMI_CLK cycles multiplied by 4096.
RSVD1	Always write zeroes to this bit field.

29.6.10 GPMI Timing Register 2 Description (GPMI_TIMING2)

The GPMI timing register 2 specifies the double data rate timing parameters that are used by the cycle state machine to guarantee the various cs delay, pre-amble delay, post-amble delay, command/address delay, data delay, TCR, TRPSTH, and read latency cycle times for the external media type.

GPMI_TIMING2 0x090

Address: 180_6000h base + 90h offset = 180_6090h

Bit	31	30	29	28	27	26	25	24	23	22	21	20	19	18	17	16	15	14	13	12	11	10	9	8	7	6	5	4	3	2	1	0
R																																
W																																
Reset	0	0	0	0	0	0	1	1	0	0	0	0	0	0	1	0	0	0	1	1	0	0	1	1	0	0	1	1	0	1	1	0

GPMI_TIMING2 field descriptions

Field	Description
31–29 TRPSTH	Only for Toggle NAND timing control delay TRPSTH GPMICLK cycles for CEn_B high to RE_B high, A value of zero is interpreted as 8
28–27 TCR	Only for Toggle NAND timing control delay (TCR+1) GPMICLK cycles for CEn_B low to RE_B low, 0 is less than or equal to TCR, which is less than the PREAMBLE_DELAY
26–24 READ_LATENCY	This field is for double data rate read latency configuration. others READ LATENCY is 3 000 READ LATENCY is 0 001 READ LATENCY is 1 010 READ LATENCY is 2 011 READ LATENCY is 3 100 READ LATENCY is 4 101 READ LATENCY is 5
23–21 RSVD0	Always write zeroes to this bit field.
20–16 CE_DELAY	GPMI dealy from CEn assert to W/Rn changing edge. value of zero is interpreted as 32.
15–12 PREAMBLE_DELAY	GPMI pre-amble delay in GPMICLK cycles. A value of zero is interpreted as 16.
11–8 POSTAMBLE_DELAY	GPMI post-amble delay in GPMICLK cycles. A value of zero is interpreted as 16.
7–4 CMDADD_PAUSE	GPMI delay time from command or adres pause to command or address resume in GPMICLK cycles. A value of zero is interpreted as 16.
DATA_PAUSE	GPMI delay time from data pause to data resume in GPMICLK cycles. A value of zero is interpreted as 16.

29.6.11 GPMI DMA Data Transfer Register Description (GPMI_DATA)

The GPMI DMA data transfer register is used by the DMA to read or write data to or from the ATA/NAND control state machine.

GPMI_DATA 0x0A0

Address: 180_6000h base + A0h offset = 180_60A0h

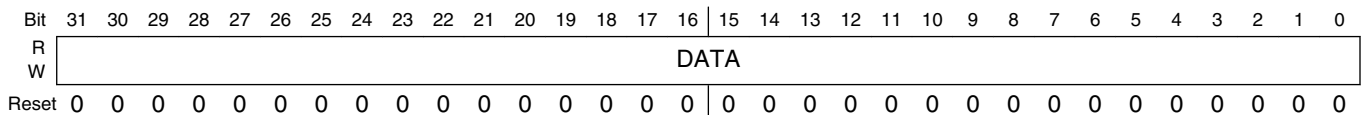

GPMI_DATA field descriptions

Field	Description
DATA	In 8-bit mode, one, two, three or four bytes can be accessed to send the same number of bus cycles.

29.6.12 GPMI Status Register Description (GPMI_STAT)

The GPMI control and status register provides a read back path for various operational states of the GPMI controller.

GPMI_STAT 0x0B0

Address: 180_6000h base + B0h offset = 180_60B0h

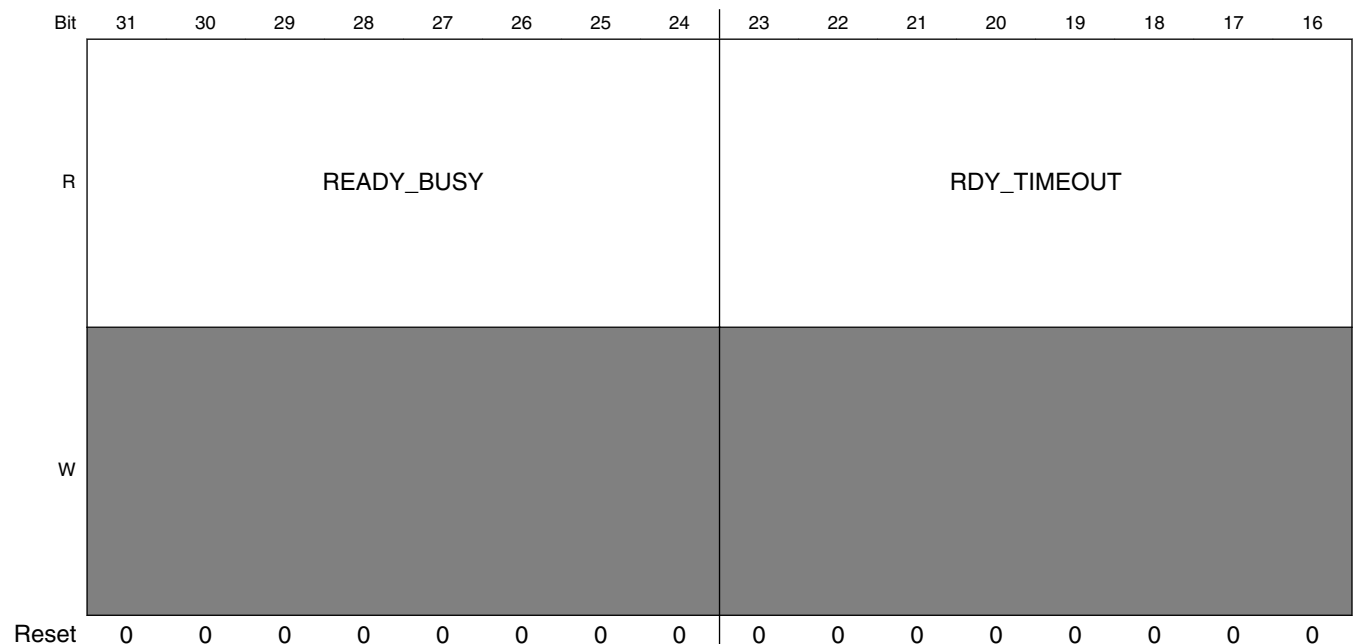

GPMI Memory Map/Register Definition

Bit	15	14	13	12	11	10	9	8	7	6	5	4	3	2	1	0
R	DEV7_ERROR	DEV6_ERROR	DEV5_ERROR	DEV4_ERROR	DEV3_ERROR	DEV2_ERROR	DEV1_ERROR	DEV0_ERROR	RSVD1			ATA_IRQ	INVALID_BUFFER_MASK	FIFO_EMPTY	FIFO_FULL	PRESENT
W																
Reset	0	0	0	0	0	0	0	0	0	0	0	0	0	1	0	1

GPMI_STAT field descriptions

Field	Description
31–24 READY_BUSY	Read-only view of NAND Ready_Busy Input pins.
23–16 RDY_TIMEOUT	<p>State of the RDY/BUSY Timeout Flags. When any bit is set to '1' in this field, it indicates that a time out has occurred while waiting for the ready state of the requested NAND device. Multiple bits may be set simultaneously.</p> <p>When GPMI_CTRL1_DECOUPLE_CS = 0, RDY_TIMEOUT[n] is associated with the NAND device on chip_select[n].</p> <p>When GPMI_CTRL1_DECOUPLE_CS = 1, these flags become associated to a DMA channel instead of a NAND device.</p> <p>For example if DMA channel 6 sends a WAIT_FOR_READY command for NAND Device 2, and a timeout occurred on READY_BUSY2, then READY_TIMEOUT[6] will be set instead of READY_TIMEOUT[2].</p>
15 DEV7_ERROR	<p>DMA channel 7 (Timeout or compare failure, depending on COMMAND_MODE).</p> <p>0 No error condition present on ATA/NAND Device accessed by DMA channel 7.</p> <p>1 An Error has occurred on ATA/NAND Device accessed by</p>

Table continues on the next page...

GPMI_STAT field descriptions (continued)

Field	Description
14 DEV6_ERROR	DMA channel 6 (Timeout or compare failure, depending on COMMAND_MODE). 0 No error condition present on ATA/NAND Device accessed by DMA channel 6. 1 An Error has occurred on ATA/NAND Device accessed by
13 DEV5_ERROR	DMA channel 5 (Timeout or compare failure, depending on COMMAND_MODE). 0 No error condition present on ATA/NAND Device accessed by DMA channel 5. 1 An Error has occurred on ATA/NAND Device accessed by
12 DEV4_ERROR	DMA channel 4 (Timeout or compare failure, depending on COMMAND_MODE). 0 No error condition present on ATA/NAND Device accessed by DMA channel 4. 1 An Error has occurred on ATA/NAND Device accessed by
11 DEV3_ERROR	DMA channel 3 (Timeout or compare failure, depending on COMMAND_MODE). 0 No error condition present on ATA/NAND Device accessed by DMA channel 3. 1 An Error has occurred on ATA/NAND Device accessed by
10 DEV2_ERROR	DMA channel 2 (Timeout or compare failure, depending on COMMAND_MODE). 0 No error condition present on ATA/NAND Device accessed by DMA channel 2. 1 An Error has occurred on ATA/NAND Device accessed by
9 DEV1_ERROR	DMA channel 1 (Timeout or compare failure, depending on COMMAND_MODE). 0 No error condition present on ATA/NAND Device accessed by DMA channel 1. 1 An Error has occurred on ATA/NAND Device accessed by
8 DEV0_ERROR	DMA channel 0 (Timeout or compare failure, depending on COMMAND_MODE). 0 No error condition present on ATA/NAND Device accessed by DMA channel 0. 1 An Error has occurred on ATA/NAND Device accessed by
7–5 RSVD1	Always write zeroes to this bit field.
4 ATA_IRQ	Status of the ATA_IRQ input pin.
3 INVALID_ BUFFER_MASK	Buffer Mask Validity bit. 0 ECC Buffer Mask is not invalid. 1 ECC Buffer Mask is invalid.
2 FIFO_EMPTY	NOT_EMPTY = 0x0 FIFO is not empty. EMPTY = 0x1 FIFO is empty. 0 FIFO is not empty. 1 FIFO is empty.
1 FIFO_FULL	NOT_FULL = 0x0 FIFO is not full. FULL = 0x1 FIFO is full. 0 FIFO is not full. 1 FIFO is full.
0 PRESENT	UNAVAILABLE = 0x0 GPMI is not present in this product. AVAILABLE = 0x1 GPMI is present in this product.

Table continues on the next page...

GPMI_STAT field descriptions (continued)

Field	Description
0	GPMI is not present in this product.
1	GPMI is present is in this product.

29.6.13 GPMI Debug Information Register Description (GPMI_DEBUG)

The GPMI debug information register provides a read back path for diagnostics to determine the current operating state of the GPMI controller.

GPMI_DEBUG 0x0C0

Address: 180_6000h base + C0h offset = 180_60C0h

Bit	31	30	29	28	27	26	25	24	23	22	21	20	19	18	17	16	15	14	13	12	11	10	9	8	7	6	5	4	3	2	1	0	
R	WAIT_FOR_READY_END								DMA_SENSE								DMAREQ								CMD_END								
W	[Shaded]																																
Reset	0	0	0	0	0	0	0	0	0	0	0	0	0	0	0	0	0	0	0	0	0	0	0	0	0	0	0	0	0	0	0	0	0

GPMI_DEBUG field descriptions

Field	Description
31–24 WAIT_FOR_READY_END	Read Only view of the Wait_For_Ready End toggle signals to DMA. One per channel
23–16 DMA_SENSE	Read-only view of sense state of the 8 DMA channels. A value of "1" in any bit position indicates that a read and compare command failed or a timeout occurred for the corresponding channel.
15–8 DMAREQ	Read-only view of DMA request line for 8 DMA channels. A toggle on any bit position indicates a DMA request for the corresponding channel.
CMD_END	Read Only view of the Command End toggle signals to DMA. One per channel

29.6.14 GPMI Version Register Description (GPMI_VERSION)

This register reflects the version number for the GPMI.

GPMI_VERSION 0x0D0

Address: 180_6000h base + D0h offset = 180_60D0h

Bit	31	30	29	28	27	26	25	24	23	22	21	20	19	18	17	16	15	14	13	12	11	10	9	8	7	6	5	4	3	2	1	0	
R	MAJOR								MINOR								STEP																
W	[Shaded]																																
Reset	0	0	0	0	0	0	1	0	1	0	0	0	0	0	0	0	0	0	0	0	0	0	0	0	0	0	0	0	0	0	0	0	0

GPMI_VERSION field descriptions

Field	Description
31–24 MAJOR	Fixed read-only value reflecting the MAJOR field of the RTL version.
23–16 MINOR	Fixed read-only value reflecting the MINOR field of the RTL version.
STEP	Fixed read-only value reflecting the stepping of the RTL version.

29.6.15 GPMI Debug2 Information Register Description (GPMI_DEBUG2)

The GPMI Debug2 information register provides a read back path for diagnostics to determine the current operating state of the GPMI controller.

GPMI_DEBUG2 0x0E0

Address: 180_6000h base + E0h offset = 180_60E0h

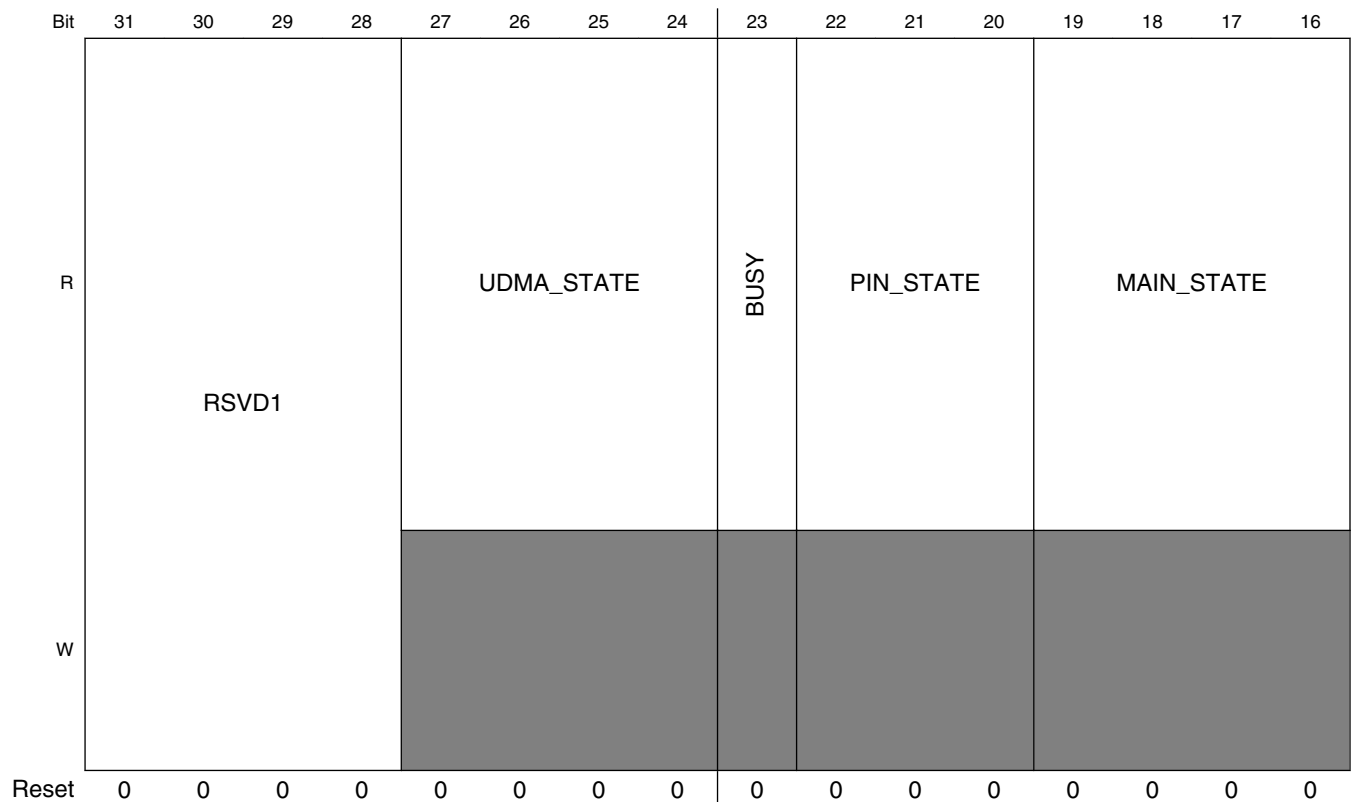

GPMI Memory Map/Register Definition

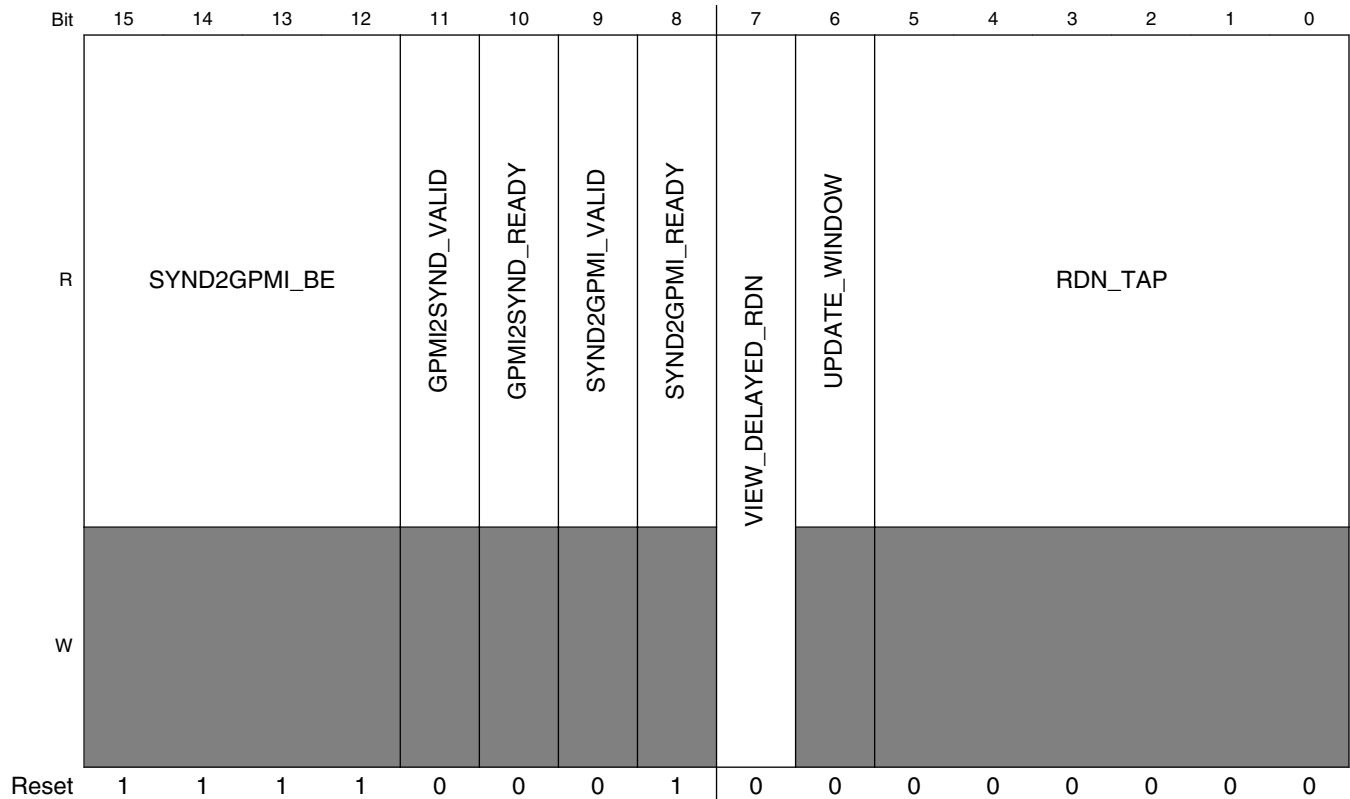

GPMI_DEBUG2 field descriptions

Field	Description
31-28 RSVD1	Always write zeroes to this bit field.
27-24 UDMA_STATE	USM_IDLE = 4'h0, idle USM_DMARQ = 4'h1, DMA req USM_ACK = 4'h2, DMA ACK USM_FIFO_E = 4'h3, Fifo empty USM_WPAUSE = 4'h4, WR DMA Paused by device USM_TSTRB = 4'h5, Toggle HSTROBE USM_CAPTUR = 4'h6, Capture Stage, (data sampled with DSTROBE is valid) USM_DATOUT = 4'h7, Change Burst DATAOUT USM_CRC = 4'h8, Source CRC to Device USM_WAIT_R = 4'h9, Waiting for DDMARDY- USM_END = 4'ha; Negate DMAACK (end of DMA) USM_WAIT_S = 4'hb, Waiting for DSTROBE USM_RPAUSE = 4'hc, Rd DMA Paused by Host USM_RSTOP = 4'hd, Rd DMA Stopped by Host USM_WTERM = 4'he, Wr DMA Termination State USM_RTERM = 4'hf, Rd DMA Termination state

Table continues on the next page...

GPMI_DEBUG2 field descriptions (continued)

Field	Description
23 BUSY	When asserted the GPMI is busy. Undefined results may occur if any registers are written when BUSY is asserted. DISABLED = 0x0 The GPMI is not busy. ENABLED = 0x1 The GPMI is busy.
22–20 PIN_STATE	parameter PSM_IDLE = 3'h0, PSM_BYTCNT = 3'h1, PSM_ADDR = 3'h2, PSM_STALL = 3'h3, PSM_STROBE = 3'h4, PSM_ATARDY = 3'h5, PSM_DHOLD = 3'h6, PSM_DONE = 3'h7. PSM_IDLE = 0x0 PSM_BYTCNT = 0x1 PSM_ADDR = 0x2 PSM_STALL = 0x3 PSM_STROBE = 0x4 PSM_ATARDY = 0x5 PSM_DHOLD = 0x6 PSM_DONE = 0x7
19–16 MAIN_STATE	parameter MSM_IDLE = 4'h0, MSM_BYTCNT = 4'h1, MSM_WAITFE = 4'h2, MSM_WAITFR = 4'h3, MSM_DMAREQ = 4'h4, MSM_DMAACK = 4'h5, MSM_WAITFF = 4'h6, MSM_LDFIFO = 4'h7, MSM_LDDMAR = 4'h8, MSM_RDCMP = 4'h9, MSM_DONE = 4'hA. MSM_IDLE = 0x0 MSM_BYTCNT = 0x1 MSM_WAITFE = 0x2 MSM_WAITFR = 0x3 MSM_DMAREQ = 0x4 MSM_DMAACK = 0x5 MSM_WAITFF = 0x6 MSM_LDFIFO = 0x7 MSM_LDDMAR = 0x8 MSM_RDCMP = 0x9 MSM_DONE = 0xA
15–12 SYND2GPMI_BE	Data byte enable Input from BCH.
11 GPMI2SYND_ VALID	Data handshake output to BCH.
10 GPMI2SYND_ READY	Data handshake output to BCH.
9 SYND2GPMI_ VALID	Data handshake Input from BCH.
8 SYND2GPMI_ READY	Data handshake Input from BCH.

Table continues on the next page...

GPMI_DEBUG2 field descriptions (continued)

Field	Description
7 VIEW_ DELAYED_RDN	Set to a 1 to select the delayed feedback RE_B to drive the GPMI_ADDR[0] (Nand CLE) pin. For debug purposes, this will allow you see if DLL is functioning properly.
6 UPDATE_ WINDOW	A 1 indicates that the DLL is busy generating the required delay.
RDN_TAP	This is the DLL tap calculated by the DLL controller. The selects the amount of delay form the DLL chain.

29.6.16 GPMI Debug3 Information Register Description (GPMI_DEBUG3)

The GPMI Debug3 information register provides a read back path for diagnostics to determine the current operating state of the GPMI controller.

GPMI_DEBUG3 0x0F0

Address: 180_6000h base + F0h offset = 180_60F0h

Bit	31	30	29	28	27	26	25	24	23	22	21	20	19	18	17	16	15	14	13	12	11	10	9	8	7	6	5	4	3	2	1	0
R	APB_WORD_CNTR																DEV_WORD_CNTR															
W	[Shaded]																															
Reset	0	0	0	0	0	0	0	0	0	0	0	0	0	0	0	0	0	0	0	0	0	0	0	0	0	0	0	0	0	0	0	0

GPMI_DEBUG3 field descriptions

Field	Description
31-16 APB_WORD_ CNTR	Reflects the number of bytes remains to be transferred on the APB bus.
DEV_WORD_ CNTR	Reflects the number of bytes remains to be transferred on the ATA/Nand bus.

29.6.17 GPMI Double Rate Read DLL Control Register Description (GPMI_READ_DDR_DLL_CTRL)

GPMI DDR Read Delay Loop Lock Control Register. This register provides programmability in DDR mode for data input timing and data formats.

GPMI_READ_DDR_DLL_CTRL 0x100

Address: 180_6000h base + 100h offset = 180_6100h

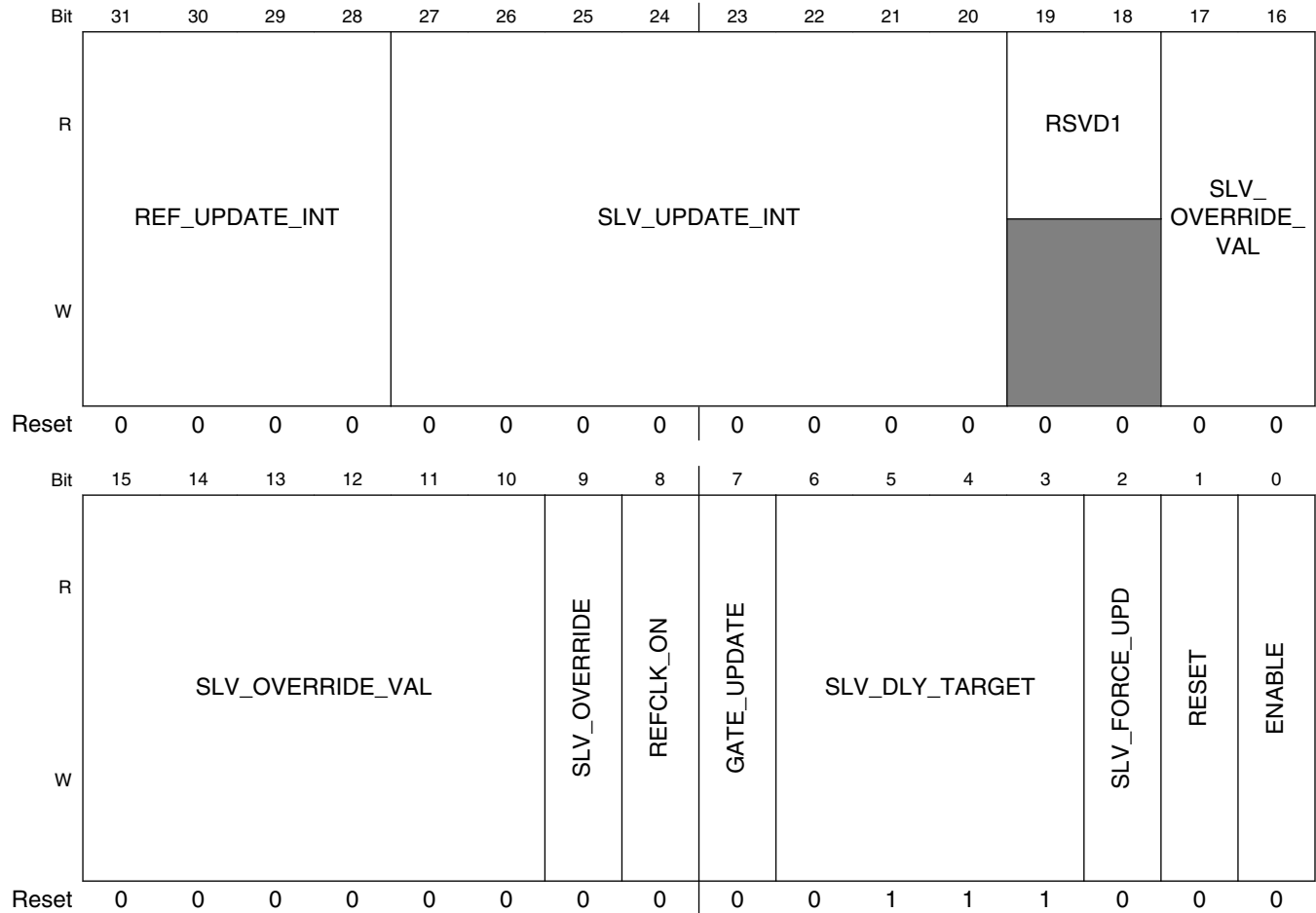

GPMI_READ_DDR_DLL_CTRL field descriptions

Field	Description
31–28 REF_UPDATE_INT	This field allows the user to add additional delay cycles to the DLL control loop (reference delay line control). By default, the DLL control loop shall update every two GPMICLK cycles. Programming this field results in a DLL control loop update interval of (2 + REF_UPDATE_INT) * GPMICLK. It should be noted that increasing the reference delay-line update interval reduces the ability of the DLL to adjust to fast changes in conditions that may effect the delay (such as voltage and temperature)
27–20 SLV_UPDATE_INT	Setting a value greater than 0 in this field, shall over-ride the default slave delay-line update interval of 256 GPMICLK cycles. A value of 0 results in an update interval of 256 GPMICLK cycles (default setting). A value of 0x0f results in 15 cycles and so on. Note that software can always cause an update of the slave-delay line using the SLV_FORCE_UPDATE register. Note that the slave delay line will also update automatically when the reference DLL transitions to a locked state (from an un-locked state).
19–18 RSVD1	Reserved
17–10 SLV_OVERRIDE_VAL	When SLV_OVERRIDE=1 This field is used to select 1 of 256 physical taps manually. A value of 0 selects tap 1, and a value of 0x7f selects tap 256.
9 SLV_OVERRIDE	Set this bit to 1 to Enable manual override for slave delay chain using SLV_OVERRIDE_VAL; to set 0 to disable manual override. This feature does not require the DLL to be enabled using the ENABLE bit. In fact to reduce power, if SLV_OVERRIDE is used, it is recommended to disable the DLL with ENABLE=0

Table continues on the next page...

GPMI_READ_DDR_DLL_CTRL field descriptions (continued)

Field	Description
8 REFCLK_ON	set this bit to 1 will turn on the reference clock
7 GATE_UPDATE	Setting this bit to 1, forces the slave delay line not update
6-3 SLV_DLY_TARGET	The delay target for the read clock is can be programmed in 1/16th increments of an GPMICLK half-period. So the input read-clock can be delayed relative input data from (GPMICLK/2)/16 to GPMICLK/2.
2 SLV_FORCE_UPD	Setting this bit to 1, forces the slave delay line to update to the DLL calibrated value immediately. The slave delay line shall update automatically based on the SLV_UPDATE_INT interval or when a DLL lock condition is sensed. Subsequent forcing of the slave-line update can only occur if SLV_FORCE_UP is set back to 0 and then asserted again (edge triggered).
1 RESET	Setting this bit to 1 force a reset on DLL. This will cause the DLL to lose lock and re-calibrate to detect an GPMICLK half period phase shift. This signal is used by the DLL as edge-sensitive, so in order to create a subsequent reset, RESET must be taken low and then asserted again.
0 ENABLE	Set this bit to 1 to enable the DLL and delay chain; otherwise; set to 0 to bypasses DLL. Note that using the slave delay line override feature with SLV_OVERRIDE and SLV_OVERRIDE_VAL, the DLL does not need to be enabled.

29.6.18 GPMI Double Rate Write DLL Control Register Description (GPMI_WRITE_DDR_DLL_CTRL)

GPMI DDR Write Delay Loop Lock Control Register. This register provides programmability in DDR mode for data output timing and data formats.

GPMI_WRITE_DDR_DLL_CTRL 0x110

Address: 180_6000h base + 110h offset = 180_6110h

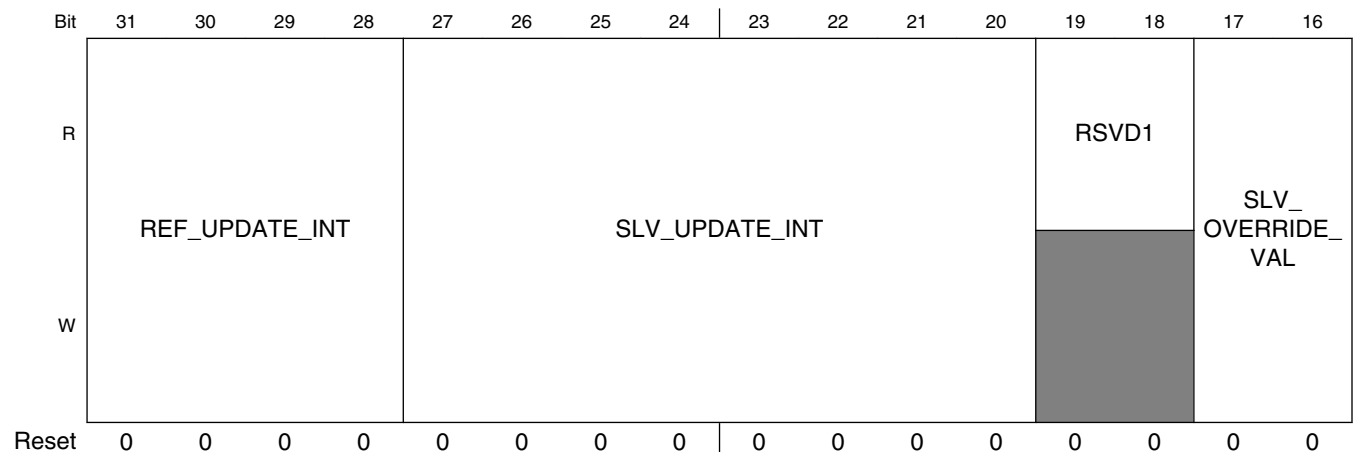

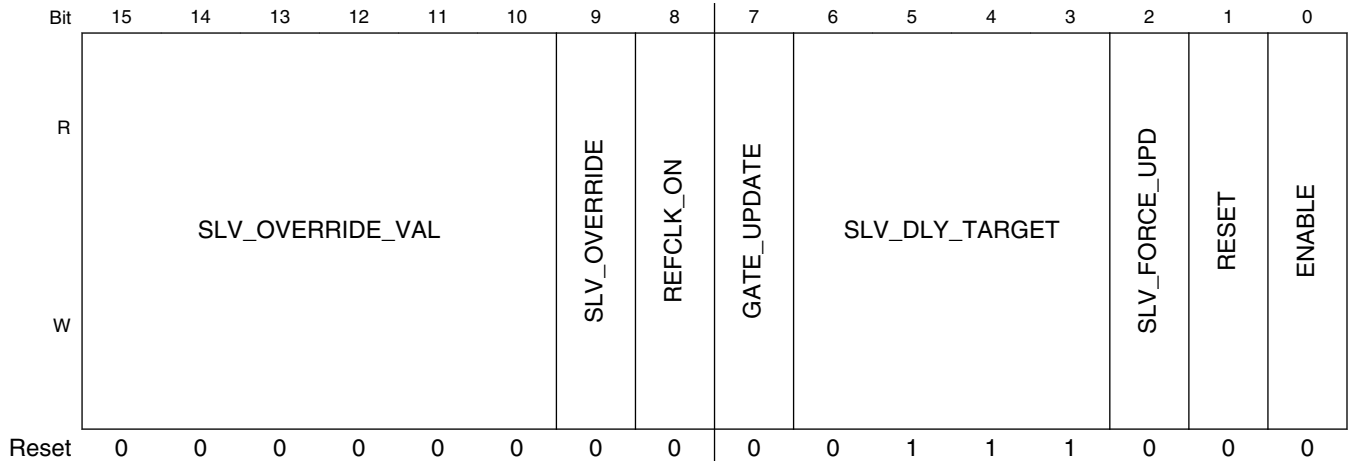

GPMI_WRITE_DDR_DLL_CTRL field descriptions

Field	Description
31–28 REF_UPDATE_INT	This field allows the user to add additional delay cycles to the DLL control loop (reference delay line control). By default, the DLL control loop shall update every two GPMICLK cycles. Programming this field results in a DLL control loop update interval of (2 + REF_UPDATE_INT) * GPMICLK. It should be noted that increasing the reference delay-line update interval reduces the ability of the DLL to adjust to fast changes in conditions that may effect the delay (such as voltage and temperature)
27–20 SLV_UPDATE_INT	Setting a value greater than 0 in this field, shall over-ride the default slave delay-line update interval of 256 GPMICLK cycles. A value of 0 results in an update interval of 256 GPMICLK cycles (default setting). A value of 0x0f results in 15 cycles and so on. Note that software can always cause an update of the slave-delay line using the SLV_FORCE_UPDATE register. Note that the slave delay line will also update automatically when the reference DLL transitions to a locked state (from an un-locked state).
19–18 RSVD1	Reserved
17–10 SLV_OVERRIDE_VAL	When SLV_OVERRIDE=1 This field is used to select 1 of 256 physical taps manually. A value of 0 selects tap 1, and a value of 0x7f selects tap 256.
9 SLV_OVERRIDE	Set this bit to 1 to Enable manual override for slave delay chain using SLV_OVERRIDE_VAL; to set 0 to disable manual override. This feature does not require the DLL to tbe enabled using the ENABLE bit. In fact to reduce power, if SLV_OVERRIDE is used, it is recommended to disable the DLL with ENABLE=0
8 REFCLK_ON	set this bit to 1 will turn on the reference clock
7 GATE_UPDATE	Setting this bit to 1, forces the slave delay line not update
6–3 SLV_DLY_TARGET	The delay target for the read clock can be programmed in 1/16th increments of an GPMICLK half-period. So the input read-clock can be delayed relative input data from (GPMICLK/2)/16 to GPMICLK/2.
2 SLV_FORCE_UPD	Setting this bit to 1, forces the slave delay line to update to the DLL calibrated value immediately. The slave delay line shall update automatically based on the SLV_UPDATE_INT interval or when a DLL lock condition is sensed. Subsequent forcing of the slave-line update can only occur if SLV_FORCE_UP is set back to 0 and then asserted again (edge triggered).
1 RESET	Setting this bit to 1 force a reset on DLL. This will cause the DLL to lose lock and re-calibrate to detect an GPMICLK half period phase shift. This signal is used by the DLL as edge-sensitive, so in order to create a subsequent reset, RESET must be taken low and then asserted again.
0 ENABLE	Set this bit to 1 to enable the DLL and delay chain; otherwise; set to 0 to bypasses DLL. Note that using the slave delay line override feature with SLV_OVERRIDE and SLV_OVERRIDE VAL, the DLL does not need to be enabled.

29.6.19 GPMI Double Rate Read DLL Status Register Description (GPMI_READ_DDR_DLL_STS)

GPMI Double Rate Read DLL Status Register, Read Only. GPMI DLL status fields are provided in this register.

GPMI_READ_DDR_DLL_STS 0x120

Address: 180_6000h base + 120h offset = 180_6120h

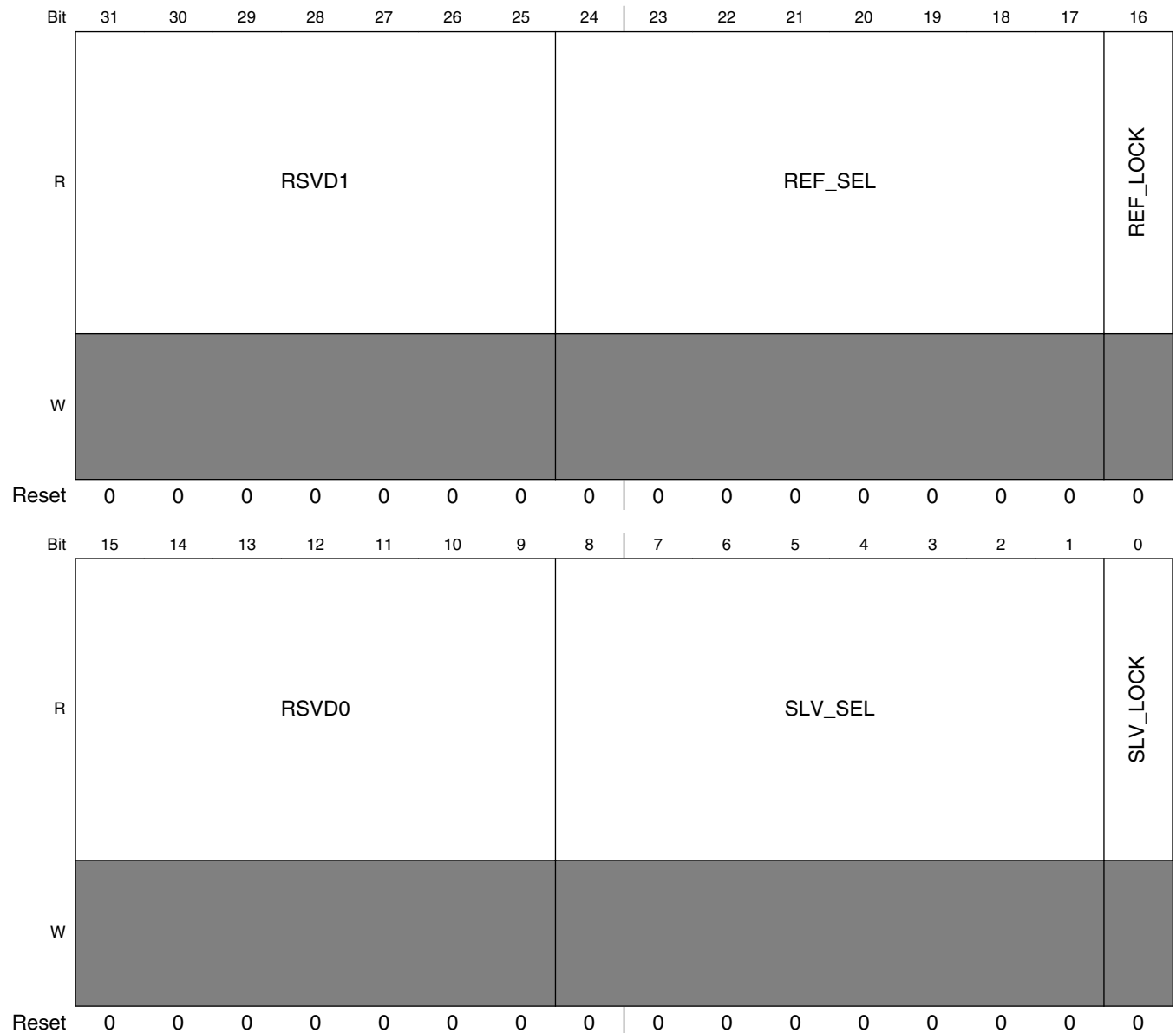

GPMI_READ_DDR_DLL_STS field descriptions

Field	Description
31–25 RSVD1	Reserved
24–17 REF_SEL	Reference delay line select status.
16 REF_LOCK	Reference DLL lock status. This signifies that the DLL has detected and locked to a half-phase GPMICLK shift, allowing the slave delay-line to perform programmed clock delays.
15–9 RSVD0	Reserved
8–1 SLV_SEL	Slave delay line select status
0 SLV_LOCK	Slave delay-line lock status. This signifies that a valid calibration has been set to the slave-delay line and that the slave-delay line is implementing the programmed delay value.

29.6.20 GPMI Double Rate Write DLL Status Register Description (GPMI_WRITE_DDR_DLL_STS)

GPMI Double Rate Write DLL Status Register, Read Only. GPMI DLL status fields are provided in this register.

GPMI_WRITE_DDR_DLL_STS 0x130

Address: 180_6000h base + 130h offset = 180_6130h

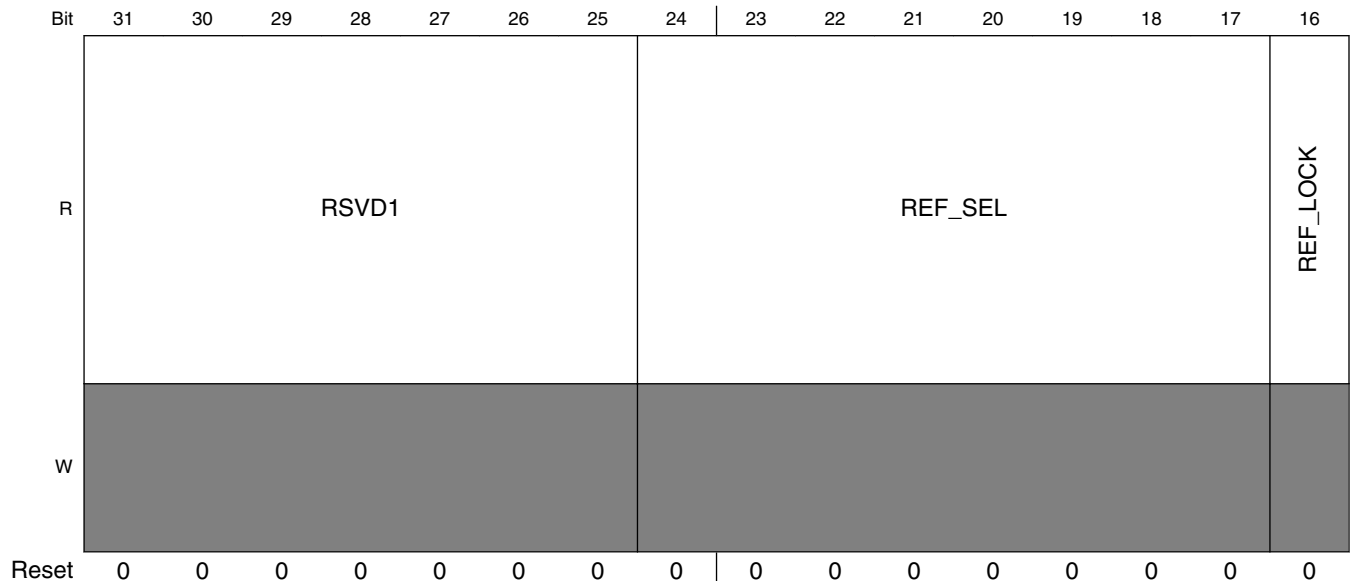

GPMI Memory Map/Register Definition

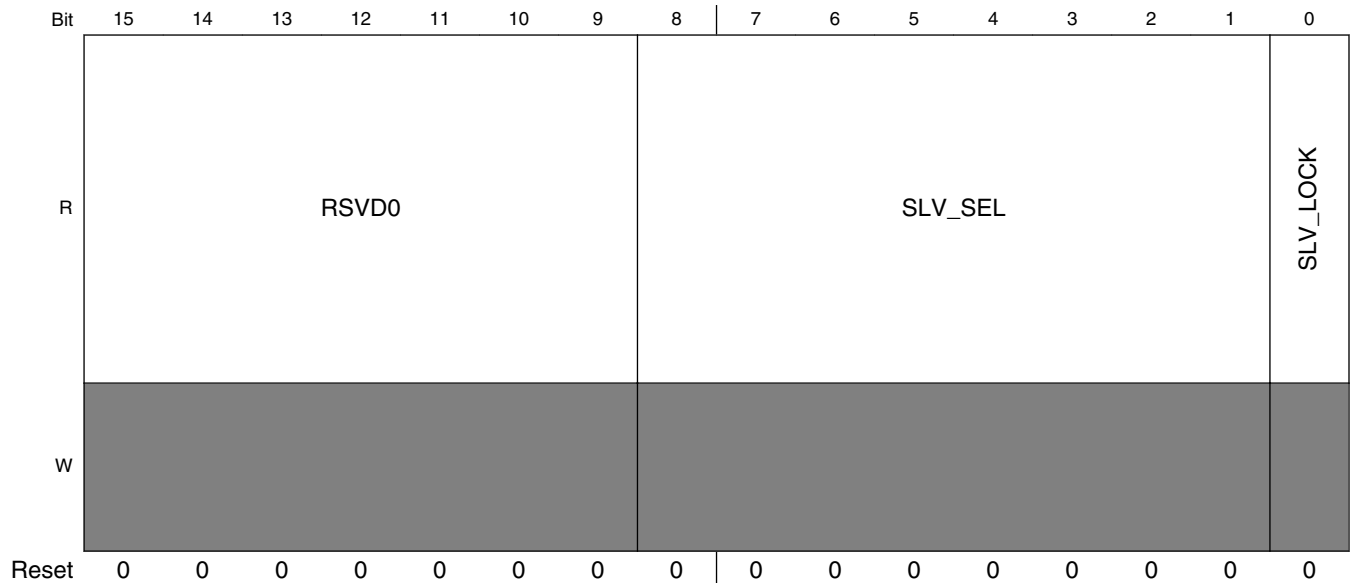

GPMI_WRITE_DDR_DLL_STS field descriptions

Field	Description
31–25 RSVD1	Reserved
24–17 REF_SEL	Reference delay line select status.
16 REF_LOCK	Reference DLL lock status. This signifies that the DLL has detected and locked to a half-phase GPMICK shift, allowing the slave delay-line to perform programmed clock delays.
15–9 RSVD0	Reserved
8–1 SLV_SEL	Slave delay line select status
0 SLV_LOCK	Slave delay-line lock status. This signifies that a valid calibration has been set to the slave-delay line and that the slave-delay line is implementing the programmed delay value.

Chapter 30

General Purpose Timer (GPT)

30.1 Overview

This chapter describes the General Purpose Timer (GPT) module interface. It is also a reference for software driver programming. The GPT has a 32-bit up-counter. The timer counter value can be captured in a register using an event on an external pin. The capture trigger can be programmed to be a rising or/and falling edge. The GPT can also generate an event on the output compare pins and an interrupt when the timer reaches a programmed value. The GPT has a 12-bit prescaler, which provides a programmable clock frequency derived from multiple clock sources.

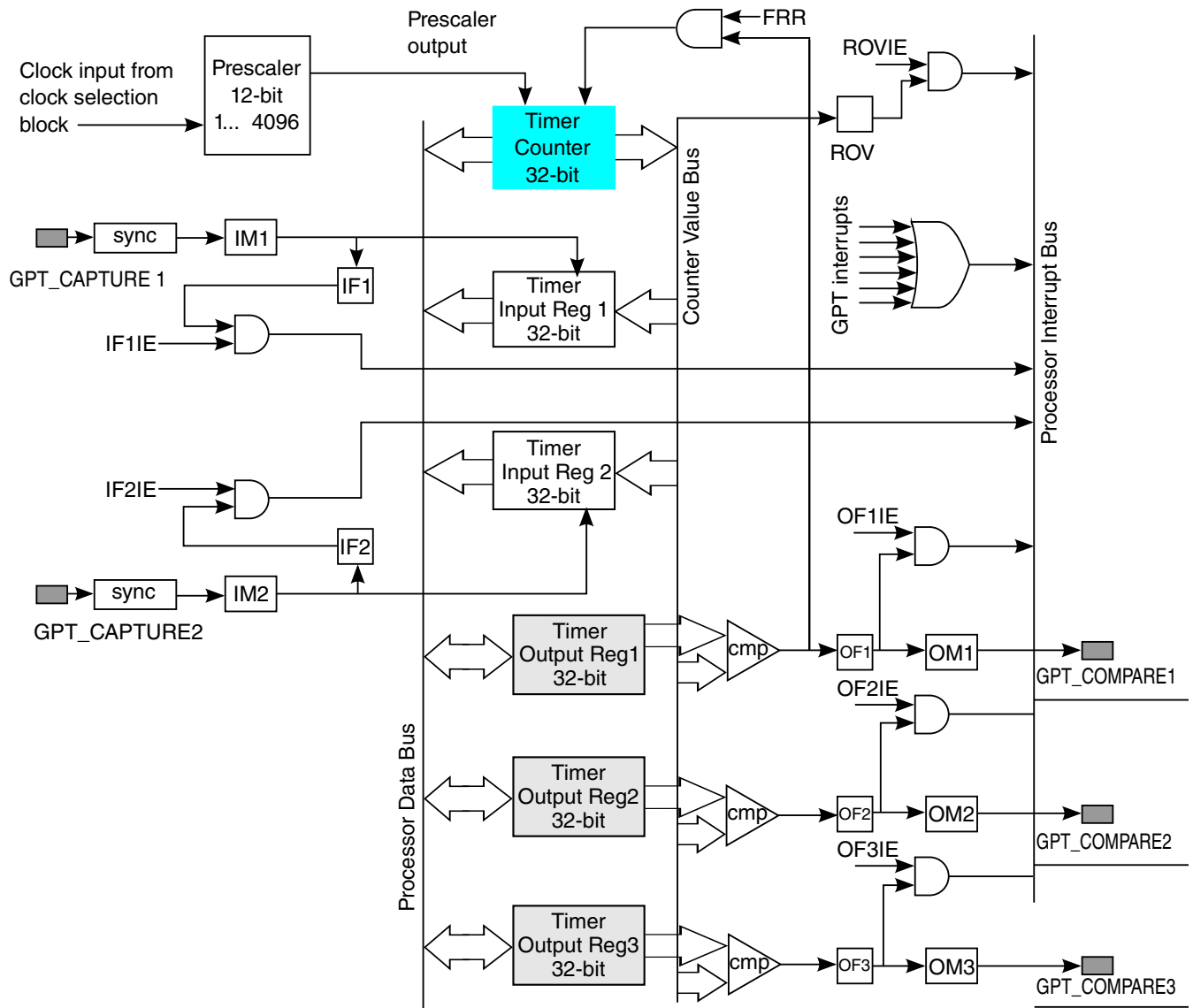

Figure 30-1. GPT Block Diagram

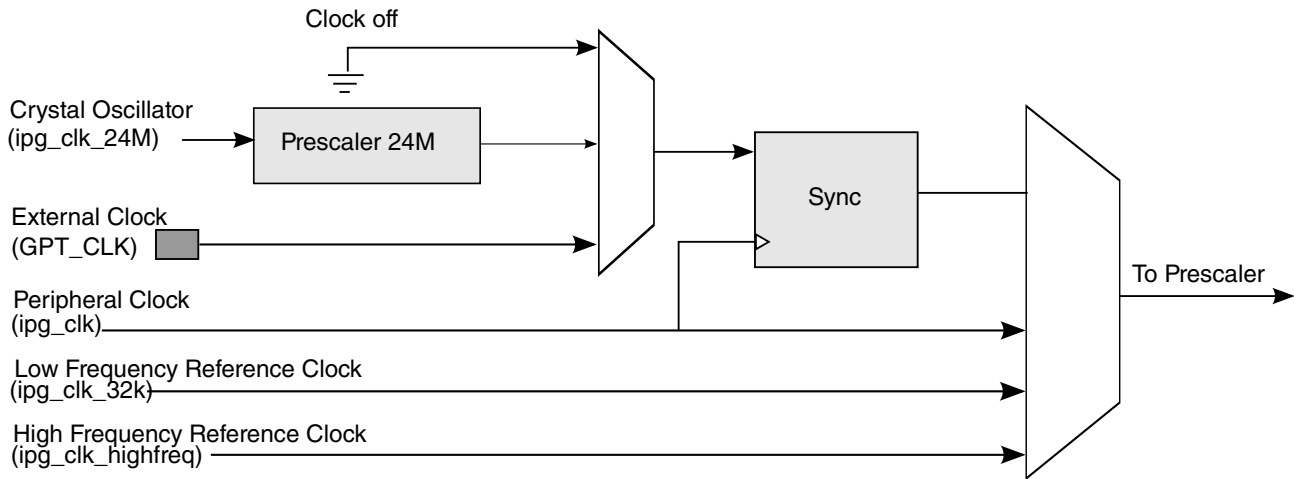

Figure 30-2. GPT Counter Clocks Diagram

30.1.1 Features

- One 32-bit up-counter with clock source selection, including external clock.
- Two input capture channels with a programmable trigger edge.
- Three output compare channels with a programmable output mode. A "forced compare" feature is also available.
- Can be programmed to be *active* in low power and debug modes.
- Interrupt generation at capture, compare, and rollover events.
- Restart or free-run modes for counter operations.

30.1.2 Modes and Operation

The GPT supports the modes described in the indicated sections:

- [Operating Modes](#)
 - [Restart Mode](#)
 - [Free-Run Mode](#)

30.2 External Signals

The GPT follows the IP Bus protocol for interfacing with the processor core. The GPT does not have *any interface signals with any other module inside the chip*, except for the clock and reset inputs (from the clock and reset controller module) and for the interrupt signals *to* the processor interrupt handler. There are functional and clock inputs, and functional output signals going outside the chip boundary.

The following table describes all block signals that connect off-chip.

Table 30-1. GPT External Signals

Signal	Description	Pad	Mode	Direction
GPT1_CLK	Input pin for an external clock that the counter can be operated at.	ENET1_TX_CLK	ALT8	I
		UART1_RX_DATA	ALT4	
GPT1_CAPTURE1	Input pin for a capture event for Input Capture Channel 1.	GPIO1_IO00	ALT1	I
		UART2_TX_DATA	ALT4	
GPT1_CAPTURE2	Input pin for a capture event for Input Capture Channel 2.	ENET1_RX_ER	ALT8	I
		UART2_RX_DATA	ALT4	
GPT1_COMPARE1	Output pin that indicates a "compare event" occurrence in Output Compare Channel 1.	GPIO1_IO01	ALT1	O
		UART1_TX_DATA	ALT4	
GPT1_COMPARE2	Output pin that indicates a "compare event" occurrence in Output Compare Channel 2.	GPIO1_IO02	ALT1	O
		UART2_CTS_B	ALT4	
GPT1_COMPARE3	Output pin that indicates a "compare event" occurrence in Output Compare Channel 3.	GPIO1_IO03	ALT1	O
		UART2_RTS_B	ALT4	
GPT2_CLK	Input pin for an external clock that the counter can be operated at.	JTAG_MODE	ALT1	I
		SD1_DATA1	ALT1	
GPT2_CAPTURE1	Input pin for a capture event for Input Capture Channel 1.	JTAG_TMS	ALT1	I
		SD1_DATA2	ALT1	
GPT2_CAPTURE2	Input pin for a capture event for Input Capture Channel 2.	JTAG_TDO	ALT1	I
		SD1_DATA3	ALT1	
GPT2_COMPARE1	Output pin that indicates a "compare event" occurrence in Output Compare Channel 1.	JTAG_TDI	ALT1	O
		SD1_CMD	ALT1	
GPT2_COMPARE2	Output pin that indicates a "compare event" occurrence in Output Compare Channel 2.	JTAG_TCK	ALT1	O
		SD1_CLK	ALT1	
GPT2_COMPARE3	Output pin that indicates a "compare event" occurrence in Output Compare Channel 3.	JTAG_TRST_B	ALT1	O
		SD1_DATA0	ALT1	

There are six signals (three input, three output) in the GPT module that *can be* connected to the chip pads.

30.2.1 External Clock Input

The GPT counter can be operated using an external clock from outside the device, and this is the input pin used for that purpose. The external clock input (GPT_CLK) is treated as asynchronous to the peripheral clock (ipg_clk). To ensure proper operations of GPT, the external clock input frequency should be less than 1/4 of frequency of the peripheral clock (ipg_clk). Hysteresis characteristics on this pad will be required because this is a clock input.

30.2.2 Input Capture Trigger Signals

The GPT counter value can be stored in a register, triggered by an event from *outside the device*. A positive or/and negative edge on these signals GPT_CAPTURE1 , GPT_CAPTURE2 can trigger this capture event. These signals are treated as asynchronous to the peripheral clock (ipg_clk). Only those transitions which occur *at least a single clock cycle* (the clock selected to run the counter) *after the previous recorded transition* are guaranteed to trigger a capture event.

30.2.3 Output Compare Signals

The output compare signals: GPT_COMPARE1, GPT_COMPARE2, GPT_COMPARE3, indicate that output compare events have gone through a specified transition.

30.3 Clocks

The clock that is input to the prescaler can be selected from 4 clock sources. The following table describes the clock sources for GPT. Please see Clock Controller Module (CCM) for clock setting, configuration and gating information.

Table 30-2. GPT Clocks

Clock name	Clock Root	Description
ipg_clk	ipg_clk_root	Peripheral clock
ipg_clk_32k	ckil_sync_clk_root	Low-frequency reference clock (32 kHz)
ipg_clk_highfreq	perclk_clk_root	High-frequency reference clock
ipg_clk_s	ipg_clk_root	Peripheral access clock

- High-Frequency Clock (ipg_clk_highfreq)

Provided by the Clock Controller Module (CCM), the High Frequency Clock is intended to be ON in Normal Power mode when the Peripheral Clock (ipg_clk) is turned OFF, thereby enabling the GPT to be operated using the High Frequency Clock *in Normal Power mode*. The CCM is expected to provide this clock *after* synchronizing it to the System Bus Clock (ahb_clk) in Normal functional mode; the CCM is also expected to switch to the *unsynchronized* version of the High Frequency Clock in a Low Power mode.

- Low-Reference Clock (ipg_clk_32k)

This 32 kHz Low Reference Clock (provided by the CCM) is intended to be ON in Low Power mode when the Peripheral Clock (ipg_clk) is turned OFF, thereby enabling the GPT to be operated using the Low Reference Clock in Low Power mode. The CCM is expected to provide the Low Reference Clock *after* synchronizing it to the System Bus Clock (ahb_clk) in Normal functional mode; the CCM is also expected to switch to the *unsynchronized* version of the Low Reference Clock in a Low Power mode.

- Peripheral Clock (ipg_clk)

If the Peripheral Clock (ipg_clk) or the External Clock (GPT_CLK) is selected (CLKSRC=001 or 011) as Clock Source, then the Peripheral Clock will be ON in normal GPT operations. In Low Power modes, if the GPT is programmed to be disabled (STOPEN or WAITEN or DOZEN=0), then the Peripheral Clock (ipg_clk) can be switched OFF.

- External Clock (GPT_CLK)

The External Clock comes from *outside the device* and can be selected to run the GPT counter. The External Clock is treated as *asynchronous to the Peripheral Clock*, (ipg_clk) and is synchronized to the Peripheral Clock (ipg_clk), *inside* the module. Therefore, the External Clock frequency is limited to < 1/4 frequency of the Peripheral Clock (ipg_clk), for proper GPT operations. Note that in Low Power modes, *if* the Peripheral Clock (ipg_clk) is not available, then the External Clock *cannot be used* to run the counter.

- Crystal Oscillator Clock (ipg_clk_24M)

This 24 MHz Crystal Oscillator Clock (provided by the CCM) is intended to be used against frequency change of Peripheral Clock (ipg_clk) changes to provide a more accurate timer clock for operation system. The CCM is expected to provide the 24 MHz Crystal Oscillator Clock *without* synchronizing it to the System Bus Clock (ahb_clk) in Normal functional mode. Synchronization is done in GPT module.

Before synchronization, the 24 MHz Crystal Oscillator Clock is divided by a 24 MHz clock prescaler, to make sure the clock frequency less than half of System Bus Clock (ahb_clk).

The clock input source is configured using the clock source field (CLKSRC, in the GPT_CR control register). The clock input to the prescaler can be disabled by programming the CLKSRC bits (of the GPT_CR control register) to 000. **The CLKSRC field value should be changed only after disabling the GPT** (by setting the EN bit in the GPT_CR to 0).

The PRESCALER field selects the divide ratio of the input clock that drives the main counter. The prescaler can divide the input clock by a value (from 1 to 4096) and can be changed *at any time*. A change in the value of the PRESCALER field *immediately affects* the output clock frequency.

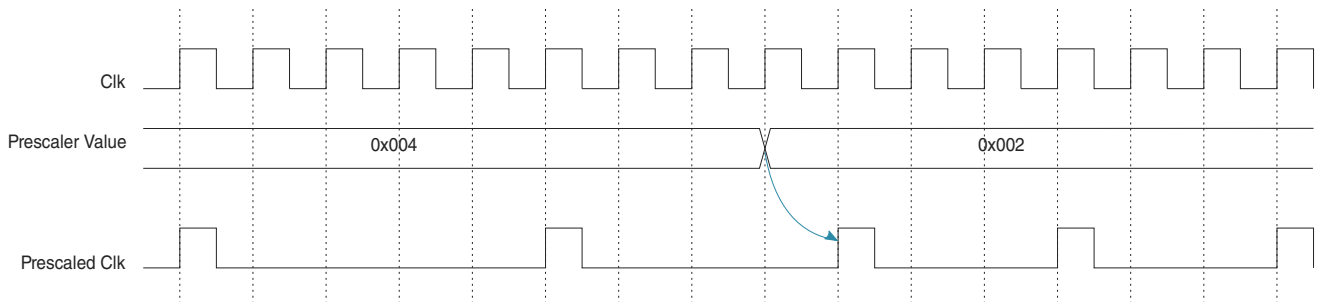

Figure 30-3. Prescaler Value Change Timing Diagram

30.4 Functional Description

This section provides a complete functional description of the GPT.

30.4.1 Operating Modes

The GPT counter can be programmed to work in either of two modes: Restart mode or Free-Run mode.

30.4.1.1 Restart Mode

In Restart mode (selectable through the GPT Control Register GPT_CR), when the counter reaches the compared value, the counter resets and starts again from 0x00000000. The Restart feature is associated only with Compare Channel 1.

Any write access to the Compare register of Channel 1 will reset the GPT counter. This is done to avoid possibly missing a compare event when compare value is changed from a higher value to lower value while counting is proceeding.

For the other two compare channels, when the compare event occurs the counter is *not reset*.

30.4.1.2 Free-Run Mode

In Free-Run mode, when compare events occur for all 3 channels, the counter is *not reset*; instead the counter continues to count until 0xffffffff, and then rolls over (to 0x00000000).

30.4.2 Operation

The General Purpose Timer (GPT) has a single counter (GPT_CNT) that is a 32-bit free-running *up-counter*, which starts counting *after it is enabled by software* (EN=1). The counter's clock source is the output of the prescaler labelled "Prescaler output" in [Figure 30-1](#).

- If the GPT timer is disabled (EN=0), then the Main Counter *and* Prescaler Counter freeze their current count values. The ENMOD bit determines the value of the GPT counter when the EN bit is set and the Counter is enabled again.
 - If the ENMOD bit is set (=1), then the Main Counter and Prescaler Counter values are reset to 0, when GPT is enabled (EN=1).
 - If ENMOD bit is programmed to 0, then the Main Counter and Prescaler Counter restart counting from their frozen values, when GPT is enabled again (EN=1).
- If GPT is programmed to be disabled in a low power mode (STOP/WAIT), then the Main Counter and Prescaler Counter freeze at their current count values *when* GPT enters low power mode. When GPT exits a low power mode, the Main Counter and Prescaler Counter start counting from their frozen values *regardless* of the ENMOD bit value. Note that the GPT_CNT can be read *at any time* by the processor, and that *both* Input Capture Channels use the *same* counter (GPT_CNT).

- A hardware reset resets all the GPT registers to their respective reset values. All registers except the Output Compare Registers (OCR1, OCR2, OCR3) obtain a value of 0x0. The Compare registers are reset to 0xFFFF_FFFF.
- The software reset (SWR bit in the GPT_CR control register) resets *all* of the register bits *except* the EN, ENMOD, STOPEN, WAITEN, and DBGEN bits. The state of these bits is not affected by a software reset. Note that a software reset can be given *while the GPT is disabled*.

30.4.2.1 Input Capture

There are two Input Capture Channels, and each Input Capture Channel has a dedicated capture pin, capture register and input edge detection/selection logic. Each input capture function has an associated status flag, and can cause the processor to make an interrupt service request.

When a selected edge transition occurs on an Input Capture pin, the contents of the GPT_CNT is captured on the corresponding capture register and the appropriate interrupt status flag is set. An interrupt request can be generated when the transition is detected *if* its corresponding enable bit is set (in the Interrupt Register). The capture can be programmed to occur on the input pin's rising edge, falling edge, on both rising and falling edges, or the capture can be disabled. The events are synchronized with the clock that was selected to run the counter. Only those transitions that occur at least one clock cycle (clock selected to run the counter) *after* the previous recorded transition will be guaranteed to trigger a capture event. There can be up to one clock cycle of uncertainty in the latching of the input transition. The Input Capture registers can be read *at any time* without affecting their values.

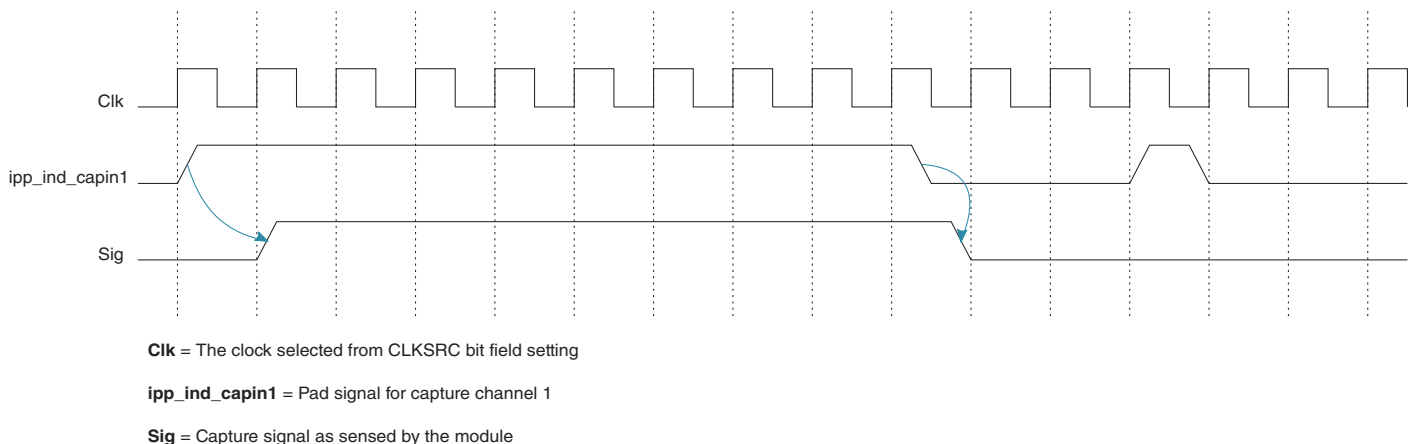

Figure 30-4. Input Capture Event Timing

30.4.2.2 Output Compare

The three Output Compare Channels *use the same counter* (GPT_CNT) as the Input Capture Channels. When the programmed content of an Output Compare register matches the value in GPT_CNT, an output compare status flag is set and an interrupt is generated (if the corresponding bit is set in the interrupt register). Consequently, the Output Compare timer pin will be set, cleared, toggled, not affected at all or provide an active-low pulse for one input clock period (subject to the restriction on the maximum frequency allowed on the pad) according to the mode bits (that were programmed).

There is also a "forced-compare" feature that allows the software to generate a compare event when required, *without the condition of the counter value that is equal to the compare value*. The action taken as a result of a forced compare is the same as when an output compare match occurs, *except that the status flags are not set and no interrupt can be generated*. Forced channels take programmed action immediately after the write to the force-compare bits. These bits are self-negating and always read as zeros.

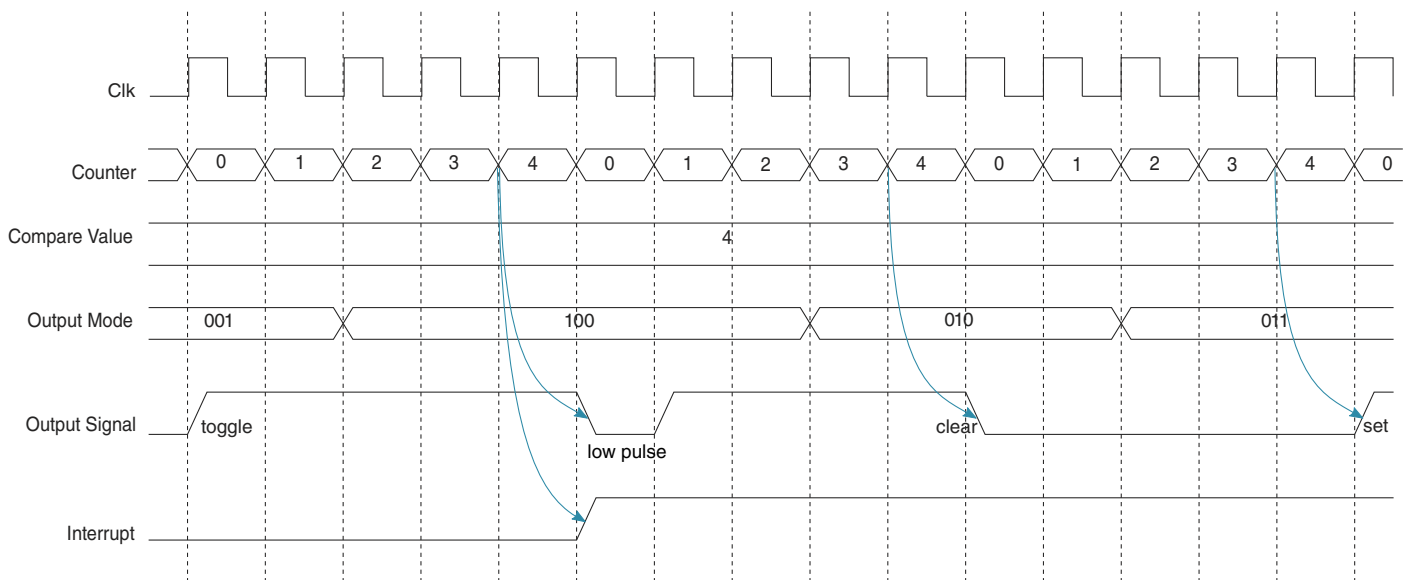

Figure 30-5. Output Compare and Interrupt Timing

30.4.2.3 Interrupts

There are 6 different interrupts that are generated by the GPT. If the selected clock for running the counter is available, then *all interrupts can be generated in Low Power and Debug modes*.

- Rollover Interrupt

The Rollover Interrupt is generated when the GPT counter reaches 0xffffffff, then resets to 0x00000000 and continues counting. The Rollover Interrupt is enabled by the ROVIE bit in the GPT_IR register; the associated status bit is the ROV bit in the GPT_SR register.

- Input Capture Interrupt 1, 2

After a capture event occurs, the associated Input Capture Channel generates an interrupt. The "capture event" interrupts are enabled by the IF2IE and IF1IE bits (in the GPT_IR register); the associated status bits are IF2 and IF1 (in the GPT_SR register). The capture of the counter value because of a capture event is *not affected by a pending capture interrupt*. The Capture register is updated with a new counter value when a capture event occurs, regardless of whether that Capture Channels' interrupt has been serviced or not.

- Output Compare Interrupt 1, 2, 3

After a compare event occurs, the associated Output Compare Channel generates an interrupt. The "compare event" interrupts are enabled by the OF3IE, OF2IE, and OF1IE bits (in the GPT_IR register); the associated status bits are OF3, OF2, and OF1 (in the GPT_SR register). A "forced compare" does not generate an interrupt.

A *cumulative* interrupt line is also present, which is asserted whenever any of the above interrupts are posted. The cumulative interrupt line has *no* associated enables or status bits.

30.4.2.4 Low Power Mode Behavior

In Low Power modes, if the clock from the selected clock source is available (except for the External Clock (GPT_CLK), which can be used *only if* the Peripheral Clock (ipg_clk) is available), the counter will continue to run depending on whether the control bit for that mode is set. If the clock is not present or if the corresponding low power bit in the GPT_CR control register is 0, the Main Counter and the Prescaler Counter freeze at their current values and resume counting (from their frozen values) when the Low Power mode is exited.

30.4.2.5 Debug Mode Behavior

In Debug mode, the modules in the device have the option of continuing to run or be halted.

- If the DBGEN bit is set, then the GPT timer will continue to run in Debug mode.
- If the DBGEN bit is not set (in the GPT_CR control register), then the GPT timer is halted.

30.5 Initialization/ Application Information

30.5.1 Selecting the Clock Source

The CLKSRC field in the GPT_CR register selects the clock source. The CLKSRC field value should be changed only after disabling the GPT (EN=0).

The software sequence to be followed while changing clock source is:

1. Disable GPT by setting EN=0 in GPT_CR register.
2. Disable GPT interrupt register (GPT_IR).
3. Configure Output Mode to unconnected/ disconnected—Write zeros in OM3, OM2, and OM1 in GPT_CR
4. Disable Input Capture Modes—Write zeros in IM1 and IM2 in GPT_CR
5. Change clock source CLKSRC to the desired value in GPT_CR register.
6. Assert the SWR bit in GPT_CR register.
7. Clear GPT status register (GPT_SR) (i.e., w1c).
8. Set ENMOD=1 in GPT_CR register, to bring GPT counter to 0x00000000.
9. Enable GPT (EN=1) in GPT_CR register.
10. Enable GPT interrupt register (GPT_IR).

30.6 GPT Memory Map/Register Definition

The GPT has 10 user-accessible 32-bit registers, which are used to configure, operate, and monitor the state of the GPT.

An IP bus write access to the GPT Control Register (GPT_CR) and the GPT Output Compare Register1 (GPT_OCR1) results in *one cycle of wait state*, while other valid IP bus accesses incur 0 wait states.

Irrespective of the Response Select signal value, a Write access to the GPT Status Registers (Read-only registers GPT_ICR1, GPT_ICR2, GPT_CNT) will generate a bus exception.

- If the Response Select signal is driven Low, then the Read/Write access to the *unimplemented* address space of GPT (*ips_addr* is greater than or equal to \$BASE + \$028) will generate a bus exception.
- If the Response Select is driven High, then the Read/Write access to the unimplemented address space of GPT will *not* generate any error response (like a bus exception).

GPT memory map

Absolute address (hex)	Register name	Width (in bits)	Access	Reset value	Section/page
209_8000	GPT Control Register (GPT1_CR)	32	R/W	0000_0000h	30.6.1/1434
209_8004	GPT Prescaler Register (GPT1_PR)	32	R/W	0000_0000h	30.6.2/1438
209_8008	GPT Status Register (GPT1_SR)	32	R/W	0000_0000h	30.6.3/1439
209_800C	GPT Interrupt Register (GPT1_IR)	32	R/W	0000_0000h	30.6.4/1440
209_8010	GPT Output Compare Register 1 (GPT1_OCR1)	32	R/W	FFFF_FFFFh	30.6.5/1441
209_8014	GPT Output Compare Register 2 (GPT1_OCR2)	32	R/W	FFFF_FFFFh	30.6.6/1442
209_8018	GPT Output Compare Register 3 (GPT1_OCR3)	32	R/W	FFFF_FFFFh	30.6.7/1442
209_801C	GPT Input Capture Register 1 (GPT1_ICR1)	32	R	0000_0000h	30.6.8/1443
209_8020	GPT Input Capture Register 2 (GPT1_ICR2)	32	R	0000_0000h	30.6.9/1443
209_8024	GPT Counter Register (GPT1_CNT)	32	R	0000_0000h	30.6.10/1444
20E_8000	GPT Control Register (GPT2_CR)	32	R/W	0000_0000h	30.6.1/1434
20E_8004	GPT Prescaler Register (GPT2_PR)	32	R/W	0000_0000h	30.6.2/1438
20E_8008	GPT Status Register (GPT2_SR)	32	R/W	0000_0000h	30.6.3/1439
20E_800C	GPT Interrupt Register (GPT2_IR)	32	R/W	0000_0000h	30.6.4/1440
20E_8010	GPT Output Compare Register 1 (GPT2_OCR1)	32	R/W	FFFF_FFFFh	30.6.5/1441
20E_8014	GPT Output Compare Register 2 (GPT2_OCR2)	32	R/W	FFFF_FFFFh	30.6.6/1442
20E_8018	GPT Output Compare Register 3 (GPT2_OCR3)	32	R/W	FFFF_FFFFh	30.6.7/1442
20E_801C	GPT Input Capture Register 1 (GPT2_ICR1)	32	R	0000_0000h	30.6.8/1443
20E_8020	GPT Input Capture Register 2 (GPT2_ICR2)	32	R	0000_0000h	30.6.9/1443
20E_8024	GPT Counter Register (GPT2_CNT)	32	R	0000_0000h	30.6.10/1444

30.6.1 GPT Control Register (GPTx_CR)

The GPT Control Register (GPT_CR) is used to program and configure GPT operations. An IP Bus Write to the GPT Control Register occurs after one cycle of wait state, while an IP Bus Read occurs after 0 wait states.

Address: Base address + 0h offset

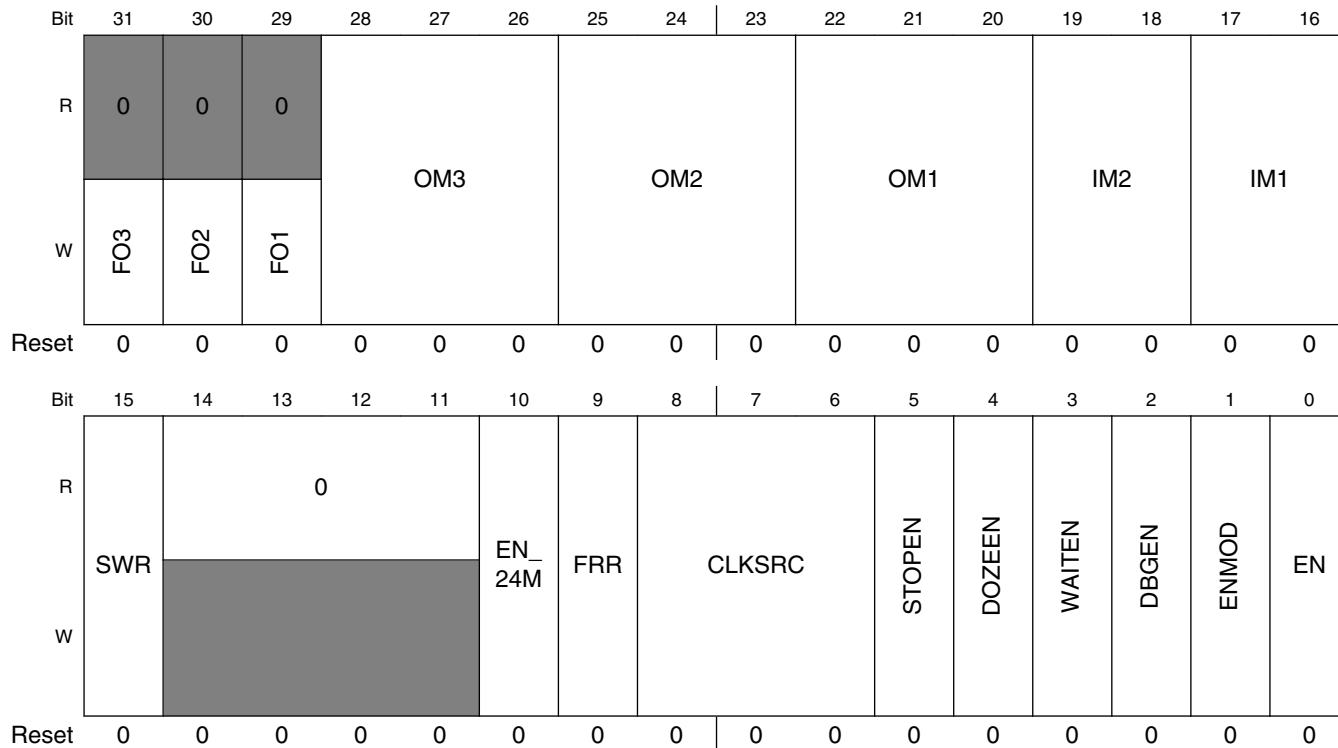

GPTx_CR field descriptions

Field	Description
31 FO3	FO3 Force Output Compare Channel 3 FO2 Force Output Compare Channel 2 FO1 Force Output Compare Channel 1 The FOn bit causes the pin action <i>programmed</i> for the timer Output Compare n pin (according to the OMn bits in this register). <ul style="list-style-type: none"> • The OFn flag (OF3, OF2, OF1) in the status register is not affected. • This bit is self-negating and always read as zero.
30 FO2	See FO3

Table continues on the next page...

GPTx_CR field descriptions (continued)

Field	Description
29 FO1	See F03
28–26 OM3	<p>OM3 (bits 28-26) controls the Output Compare Channel 3 operating mode.</p> <p>OM2 (bits 25-23) controls the Output Compare Channel 2 operating mode.</p> <p>OM1 (bits 22-20) controls the Output Compare Channel 1 operating mode.</p> <p>The OMn bits specify the response that a compare event will generate on the output pin of Output Compare Channel n.</p> <ul style="list-style-type: none"> The toggle, clear, and set options cause a change on the output pin <i>only</i> if a compare event occurs. When OMn is programmed as 1xx (active low pulse), the output pin is set to one immediately on the next input clock; a low pulse (that is an input clock in width) occurs when there is a compare event. Note that here, "input clock" refers to the clock selected by the CLKSRC bits of the GPT Control Register. <p>000 Output disconnected. No response on pin. 001 Toggle output pin 010 Clear output pin 011 Set output pin 1xx Generate an active low pulse (that is one input clock wide) on the output pin.</p>
25–23 OM2	See OM3
22–20 OM1	See OM3
19–18 IM2	<p>IM2 (bits 19-18, Input Capture Channel 2 operating mode)</p> <p>IM1 (bits 17-16, Input Capture Channel 1 operating mode)</p> <p>The IMn bit field determines the transition on the input pin (for Input capture channel n), which will trigger a capture event.</p> <p>00 capture disabled 01 capture on rising edge only 10 capture on falling edge only 11 capture on both edges</p>
17–16 IM1	See IM2
15 SWR	<p>Software reset.</p> <p>This is the software reset of the GPT module. It is a self-clearing bit.</p> <ul style="list-style-type: none"> The SWR bit is set when the module is in reset state. The SWR bit is cleared when the reset procedure finishes. Setting the SWR bit resets all of the registers to their default reset values, except for the EN, ENMOD, STOPEN, WAITEN, and DBGEN bits in the GPT Control Register (this control register). <p>0 GPT is not in reset state 1 GPT is in reset state</p>
14–11 Reserved	This read-only field is reserved and always has the value 0.
10 EN_24M	<p>Enable 24 MHz clock input from crystal.</p> <ul style="list-style-type: none"> A hardware reset resets the EN_24M bit. A software reset <i>does not affect</i> the EN_24M bit.

Table continues on the next page...

GPTx_CR field descriptions (continued)

Field	Description
	0 24M clock disabled 1 24M clock enabled
9 FRR	Free-Run or Restart mode. The FRR bit determines the behavior of the GPT when a compare event in channel 1 occurs. <ul style="list-style-type: none"> In Restart mode, after a compare event, the counter resets to 0x00000000 and resumes counting (after the occurrence of a compare event). In Free-Run mode, after a compare event, the counter continues counting until 0xFFFFFFFF and then rolls over to 0. 0 Restart mode 1 Free-Run mode
8–6 CLKSRC	Clock Source select. The CLKSRC bits select which clock will go to the prescaler (and subsequently be used to run the GPT counter). <ul style="list-style-type: none"> The CLKSRC bit field value should only be changed after disabling the GPT by clearing the EN bit in this register (GPT_CR). A software reset does not affect the CLKSRC bit. 000 No clock 001 Peripheral Clock (ipg_clk) 010 High Frequency Reference Clock (ipg_clk_highfreq) 011 External Clock 100 Low Frequency Reference Clock (ipg_clk_32k) 101 Crystal oscillator as Reference Clock (ipg_clk_24M) others Reserved
5 STOPEN	GPT Stop Mode enable. The STOPEN read/write control bit enables GPT operation <i>during Stop mode</i> . <ul style="list-style-type: none"> A hardware reset resets the STOPEN bit. A software reset <i>does not affect</i> the STOPEN bit. 0 GPT is disabled in Stop mode. 1 GPT is enabled in Stop mode.
4 DOZEEN	GPT Doze Mode Enable. <ul style="list-style-type: none"> A hardware reset resets the DOZEEN bit. A software reset <i>does not affect</i> the DOZEEN bit. 0 GPT is disabled in doze mode. 1 GPT is enabled in doze mode.
3 WAITEN	GPT Wait Mode enable. The WAITEN read/write control bit enables GPT operation <i>during Wait mode</i> . <ul style="list-style-type: none"> A hardware reset resets the WAITEN bit. A software reset <i>does not affect</i> the WAITEN bit. 0 GPT is disabled in wait mode. 1 GPT is enabled in wait mode.
2 DBGEN	GPT debug mode enable. The DBGEN read/write control bit enables GPT operation <i>during Debug mode</i> .

Table continues on the next page...

GPTx_CR field descriptions (continued)

Field	Description
	<ul style="list-style-type: none"> A hardware reset resets the DBGEN bit. A software reset <i>does not affect</i> the DBGEN bit. <p>0 GPT is disabled in debug mode. 1 GPT is enabled in debug mode.</p>
1 ENMOD	<p>GPT Enable mode.</p> <p>When the GPT is disabled (EN=0), then both the Main Counter and Prescaler Counter <i>freeze their current count values</i>. The ENMOD bit determines the value of the GPT counter when Counter is enabled again (if the EN bit is set).</p> <ul style="list-style-type: none"> If the ENMOD bit is 1, then the Main Counter and Prescaler Counter values are reset to 0 after GPT is enabled (EN=1). If the ENMOD bit is 0, then the Main Counter and Prescaler Counter restart counting <i>from their frozen values</i> after GPT is enabled (EN=1). If GPT is programmed to be disabled in a low power mode (STOP/WAIT), then the Main Counter and Prescaler Counter <i>freeze at their current count values</i> when the GPT enters low power mode. When GPT exits low power mode, the Main Counter and Prescaler Counter start counting from their frozen values, regardless of the ENMOD bit value. Setting the SWR bit will clear the Main Counter and Prescaler Counter values, regardless of the value of EN or ENMOD bits. A hardware reset resets the ENMOD bit. A software reset <i>does not affect</i> the ENMOD bit. <p>0 GPT counter will retain its value when it is disabled. 1 GPT counter value is reset to 0 when it is disabled.</p>
0 EN	<p>GPT Enable.</p> <p>The EN bit is the GPT module enable bit.</p> <p>Before setting the EN bit, we recommend that <i>all registers be properly programmed</i>.</p> <ul style="list-style-type: none"> A hardware reset resets the EN bit. A software reset <i>does not affect</i> the EN bit. <p>0 GPT is disabled. 1 GPT is enabled.</p>

30.6.2 GPT Prescaler Register (GPTx_PR)

The GPT Prescaler Register (GPT_PR) contains bits that determine the *divide value* of the clock that runs the counter.

Address: Base address + 4h offset

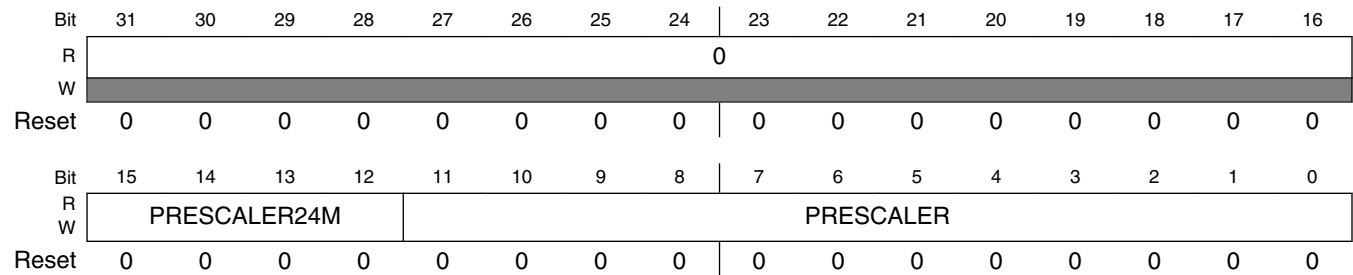

GPTx_PR field descriptions

Field	Description
31–16 Reserved	This read-only field is reserved and always has the value 0.
15–12 PRESCALER24M	<p>Prescaler bits.</p> <p>24M crystal clock is divided by [PRESCALER24M + 1] before selected by the CLKSRC field. If 24M crystal clock is not selected, this feild takes no effect.</p> <p>0x0 Divide by 1 0x1 Divide by 2 0xF Divide by 16</p>
PRESCALER	<p>Prescaler bits.</p> <p>The clock selected by the CLKSRC field is divided by [PRESCALER + 1], and then used to run the counter.</p> <ul style="list-style-type: none"> • A change in the value of the PRESCALER bits cause the Prescaler counter to reset and a new count period to start immediately. • See Figure 30-3 for the timing diagram. <p>0x000 Divide by 1 0x001 Divide by 2 0xFFFF Divide by 4096</p>

30.6.3 GPT Status Register (GPTx_SR)

The GPT Status Register (GPT_SR) contains bits that indicate that a counter has rolled over, and if any event has occurred on the Input Capture and Output Compare channels. The bits are cleared by writing a 1 to them.

Address: Base address + 8h offset

Bit	31	30	29	28	27	26	25	24	23	22	21	20	19	18	17	16
R	0															
W																
Reset	0	0	0	0	0	0	0	0	0	0	0	0	0	0	0	0
Bit	15	14	13	12	11	10	9	8	7	6	5	4	3	2	1	0
R	0								ROV	IF2	IF1	OF3	OF2	OF1		
W									w1c	w1c	w1c	w1c	w1c	w1c		
Reset	0	0	0	0	0	0	0	0	0	0	0	0	0	0	0	0

GPTx_SR field descriptions

Field	Description
31–6 Reserved	This read-only field is reserved and always has the value 0.
5 ROV	Rollover Flag. The ROV bit indicates that the counter has reached its <i>maximum possible value</i> and <i>rolled over</i> to 0 (from which the counter continues counting). The ROV bit is only set if the counter has reached 0xFFFFFFFF in both Restart and Free-Run modes. 0 Rollover has not occurred. 1 Rollover has occurred.
4 IF2	IF2 Input capture 2 Flag IF1 Input capture 1 Flag The IF n bit indicates that a capture event has occurred on Input Capture channel n . 0 Capture event has not occurred. 1 Capture event has occurred.
3 IF1	See IF2
2 OF3	OF3 Output Compare 3 Flag OF2 Output Compare 2 Flag OF1 Output Compare 1 Flag The OF n bit indicates that a compare event has occurred on Output Compare channel n . 0 Compare event has not occurred. 1 Compare event has occurred.

Table continues on the next page...

GPTx_SR field descriptions (continued)

Field	Description
1 OF2	See OF3
0 OF1	See OF3

30.6.4 GPT Interrupt Register (GPTx_IR)

The GPT Interrupt Register (GPT_IR) contains bits that control whether interrupts are generated after rollover, input capture and output compare events.

Address: Base address + Ch offset

Bit	31	30	29	28	27	26	25	24	23	22	21	20	19	18	17	16
R	0															
W	[Shaded]															
Reset	0	0	0	0	0	0	0	0	0	0	0	0	0	0	0	0
Bit	15	14	13	12	11	10	9	8	7	6	5	4	3	2	1	0
R	0															
W	[Shaded]								ROVIE	IF2IE	IF1IE	OF3IE	OF2IE	OF1IE		
Reset	0	0	0	0	0	0	0	0	0	0	0	0	0	0	0	0

GPTx_IR field descriptions

Field	Description
31–6 Reserved	This read-only field is reserved and always has the value 0.
5 ROVIE	Rollover Interrupt Enable. The ROVIE bit controls the Rollover interrupt. 0 Rollover interrupt is disabled. 1 Rollover interrupt enabled.
4 IF2IE	IF2IE Input capture 2 Interrupt Enable IF1IE Input capture 1 Interrupt Enable The IFnIE bit controls the IFnIE Input Capture n Interrupt Enable. 0 IF2IE Input Capture n Interrupt Enable is disabled. 1 IF2IE Input Capture n Interrupt Enable is enabled.

Table continues on the next page...

GPTx_IR field descriptions (continued)

Field	Description
3 IF1IE	See IF2IE
2 OF3IE	OF3IE Output Compare 3 Interrupt Enable OF2IE Output Compare 2 Interrupt Enable OF1IE Output Compare 1 Interrupt Enable The OF n IE bit controls the Output Compare Channel n interrupt. 0 Output Compare Channel n interrupt is disabled. 1 Output Compare Channel n interrupt is enabled.
1 OF2IE	See OF3IE
0 OF1IE	See OF3IE

30.6.5 GPT Output Compare Register 1 (GPTx_OCR1)

The GPT Compare Register 1 (GPT_OCR1) holds the value that determines when a compare event will be generated on Output Compare Channel 1. Any write access to the Compare register of Channel 1 while in Restart mode (FRR=0) will reset the GPT counter.

An IP Bus Write access to the GPT Output Compare Register1 (GPT_OCR1) occurs *after* one cycle of wait state; an IP Bus Read access occurs *immediately* (0 wait states).

Address: Base address + 10h offset

Bit	31	30	29	28	27	26	25	24	23	22	21	20	19	18	17	16	15	14	13	12	11	10	9	8	7	6	5	4	3	2	1	0		
R																		COMP																
W																																		
Reset	1	1	1	1	1	1	1	1	1	1	1	1	1	1	1	1	1	1	1	1	1	1	1	1	1	1	1	1	1	1	1	1		

GPTx_OCR1 field descriptions

Field	Description
COMP	Compare Value. When the counter value equals the COMP bit field value, a compare event is generated on Output Compare Channel 1.

30.6.6 GPT Output Compare Register 2 (GPTx_OCR2)

The GPT Compare Register 2 (GPT_OCR2) holds the value that determines when a compare event will be generated on Output Compare Channel 2.

Address: Base address + 14h offset

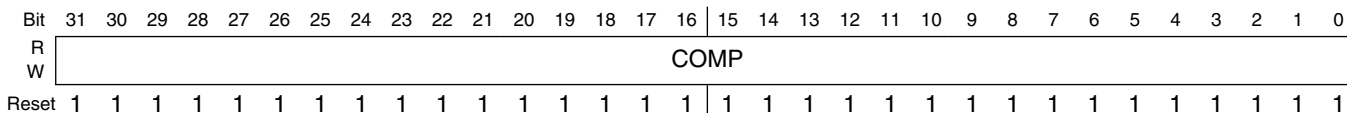

GPTx_OCR2 field descriptions

Field	Description
COMP	Compare Value. When the counter value equals the COMP bit field value, a compare event is generated on Output Compare Channel 2.

30.6.7 GPT Output Compare Register 3 (GPTx_OCR3)

The GPT Compare Register 3 (GPT_OCR3) holds the value that determines when a compare event will be generated on Output Compare Channel 3.

Address: Base address + 18h offset

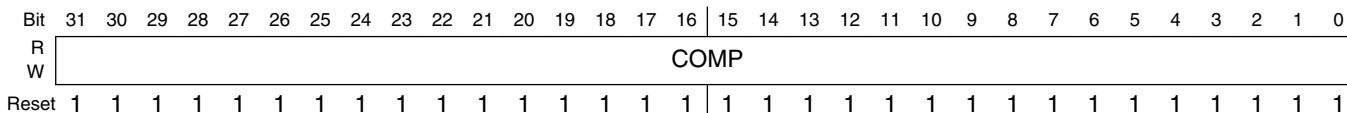

GPTx_OCR3 field descriptions

Field	Description
COMP	Compare Value. When the counter value equals the COMP bit field value, a compare event is generated on Output Compare Channel 3.

30.6.8 GPT Input Capture Register 1 (GPTx_ICR1)

The GPT Input Capture Register 1 (GPT_ICR1) is a read-only register that holds the value *that was in the counter during the last capture event* on Input Capture Channel 1.

Address: Base address + 1Ch offset

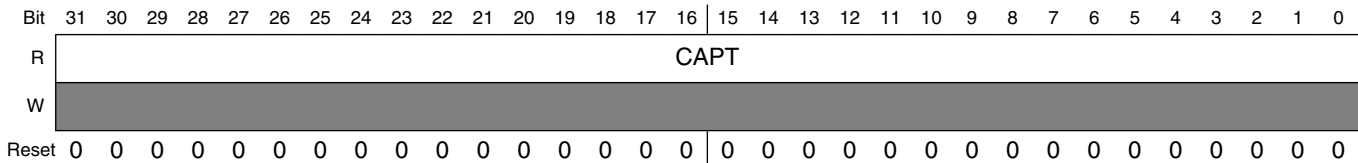

GPTx_ICR1 field descriptions

Field	Description
CAPT	Capture Value. After a capture event on Input Capture Channel 1 occurs, the current value of the counter is loaded into GPT Input Capture Register 1.

30.6.9 GPT Input Capture Register 2 (GPTx_ICR2)

The GPT Input capture Register 2 (GPT_ICR2) is a read-only register which holds the value that was in the counter during the last capture event on input capture channel 2.

Address: Base address + 20h offset

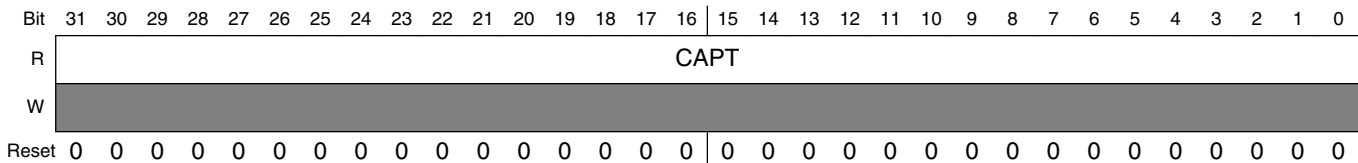

GPTx_ICR2 field descriptions

Field	Description
CAPT	Capture Value. After a capture event on Input Capture Channel 2 occurs, the current value of the counter is loaded into GPT Input Capture Register 2.

30.6.10 GPT Counter Register (GPTx_CNT)

The GPT Counter Register (GPT_CNT) is the main counter's register. GPT_CNT is a read-only register and can be read *without affecting the counting process* of the GPT.

Address: Base address + 24h offset

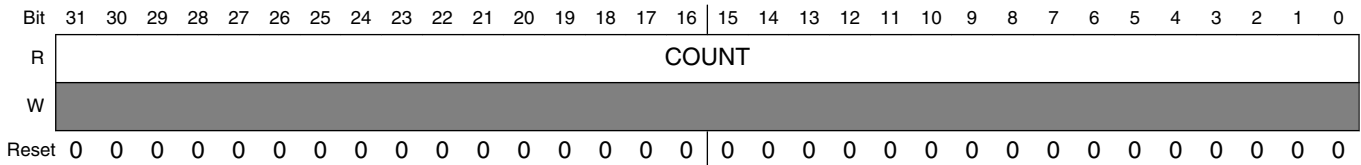

GPTx_CNT field descriptions

Field	Description
COUNT	Counter Value. The COUNT bits show the current count value of the GPT counter.

Chapter 31

I2C Controller (I2C)

31.1 Overview

This chapter describes block-level operation and programming of I2C. The chapter is intended for a block-driver software developer. To understand how the block is integrated at the SoC level, a system software developer should see discussions of the block in the appropriate SoC-level chapter(s).

References: This document assumes an understanding of the following document:

- *The I2C Bus Specification, Version 2.1*, by Philips Semiconductor

The Inter IC (I2C) provides functionality of a standard I2C slave and master. The I2C is designed to be compatible with the standard NXP I2C bus protocol.

NOTE

independent I2C channels are available.

I2C is a two-wire, bidirectional serial bus that provides a simple, efficient method of data exchange, minimizing the interconnection between devices. This bus is suitable for applications requiring occasional communications over a short distance between many devices. The flexible I2C standard allows additional devices to be connected to the bus for expansion and system development. See the connection diagram in the figure below.

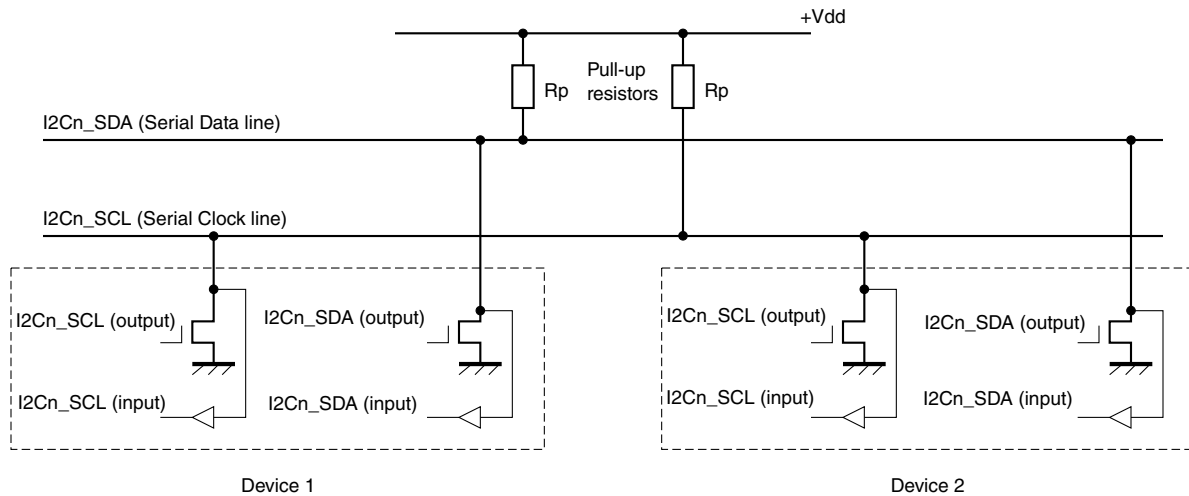

Figure 31-1. Connection of devices to I2C bus

The I2C interface speed is dependent on the I2C bus loading and timing characteristics. For pin requirement details, see *The I2C Bus Specification*. The I2C system is a true multimaster bus including arbitration and collision detection that prevents data corruption if multiple devices attempt to control the bus simultaneously. This feature supports complex applications with multiprocessor control and can be used for rapid testing and alignment of end products through external connections to an assembly-line computer. The figure below shows the block diagram of I2C.

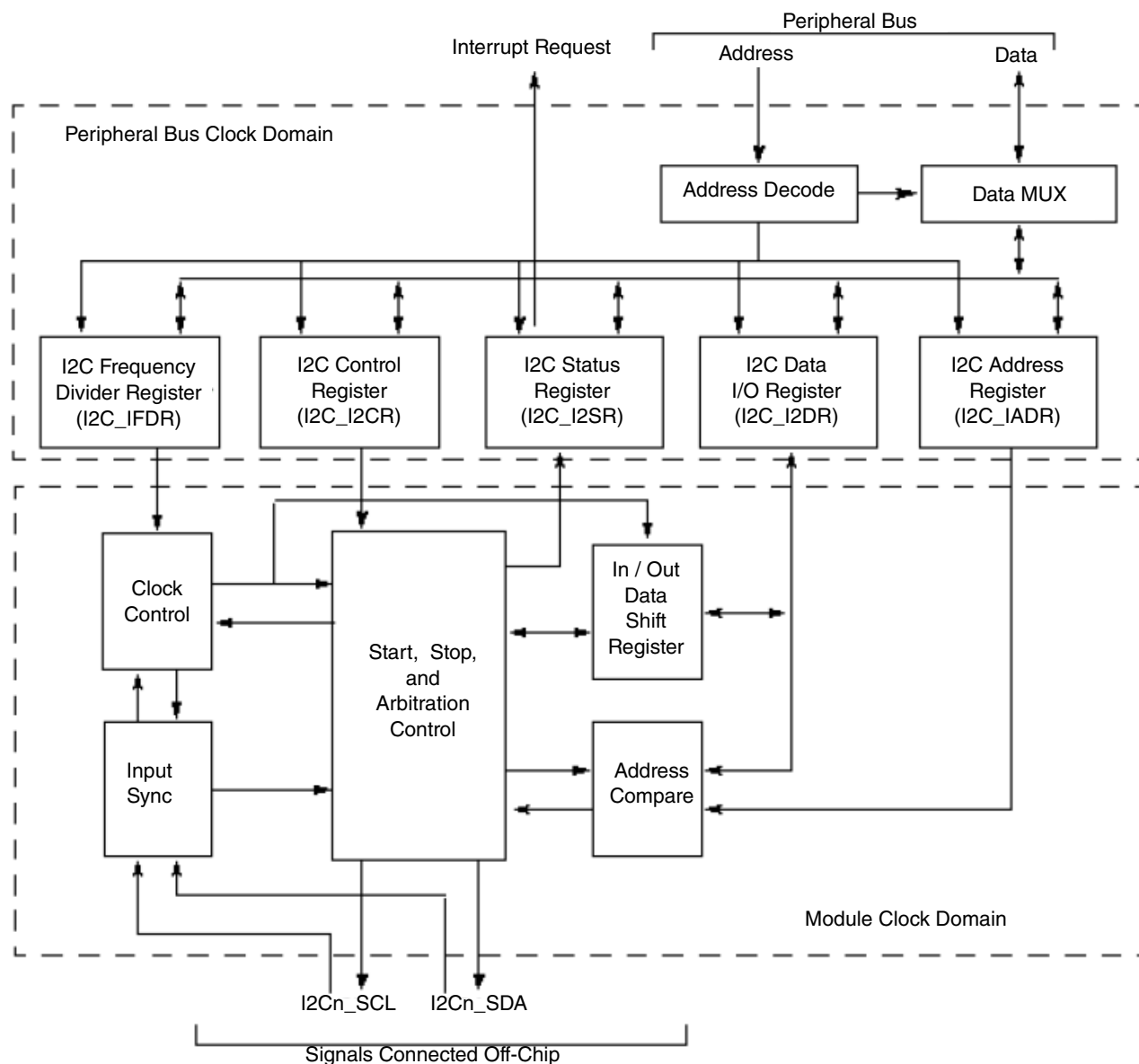

Figure 31-2. I2C block diagram

31.1.1 Features

The I2C has the following key features:

- Compatibility with I2C bus standard
- Multimaster operation
- Software programmability for one of 64 different serial clock frequencies
- Software-selectable acknowledge bit
- Interrupt-driven, byte-by-byte data transfer
- Arbitration-lost interrupt with automatic mode switching from master to slave

- Calling address identification interrupt
- Start and stop signal generation/detection
- Repeated Start signal generation
- Acknowledge bit generation/detection
- Bus-busy detection

31.1.2 Modes and operations

The I2C operates primarily in two functional modes: Standard mode and Fast mode.

- In Standard mode, I2C supports the data transfer rates up to 100 kbits/s.
- In Fast mode, data transfer rates up to 400 kbits/s can be achieved. Per block operation, there is no special configuration required for Fast or Standard mode. It is the data transfer rate that distinguishes Standard and Fast mode.

31.2 External Signals

This section discusses I2C signals that connect off-chip.

For I2C compliance, all devices connected to the I2Cn_SCL and I2Cn_SDA signals must have open-drain or open-collector outputs. The logic AND function is implemented on both lines with external pull-up resistors.

Inputs of I2Cn_SCL and I2Cn_SDA also need to be manually enabled by setting the SION bit in the IOMUX after the corresponding PADs are selected as I2C function.

The table below describes all I2C signals that connect off-chip.

Table 31-1. I2C External Signals

Signal	Description	Pad	Mode	Direction
I2C1_SCL	Serial Clock	CSI_PIXCLK	ALT3	IO
		GPIO1_IO02	ALT0	
		UART4_TX_DATA	ALT2	
I2C1_SDA	Serial Data	CSI_MCLK	ALT3	IO
		GPIO1_IO03	ALT0	
		UART4_RX_DATA	ALT2	
I2C2_SCL	Serial Clock	CSI_HSYNC	ALT3	IO
		GPIO1_IO00	ALT0	
		UART5_TX_DATA	ALT2	
I2C2_SDA	Serial Data	CSI_VSYNC	ALT3	IO

Table continues on the next page...

Table 31-1. I2C External Signals (continued)

Signal	Description	Pad	Mode	Direction
		GPIO1_IO01	ALT0	
		UART5_RX_DATA	ALT2	
I2C3_SCL	Serial Clock	ENET2_RX_DATA0	ALT3	IO
		LCD_DATA01	ALT4	
		UART1_TX_DATA	ALT2	
I2C3_SDA	Serial Data	ENET2_RX_DATA1	ALT3	IO
		LCD_DATA00	ALT4	
		UART1_RX_DATA	ALT2	
I2C4_SCL	Serial Clock	ENET2_RX_EN	ALT3	IO
		LCD_DATA03	ALT4	
		UART2_TX_DATA	ALT2	
I2C4_SDA	Serial Data	ENET2_TX_DATA0	ALT3	IO
		LCD_DATA02	ALT4	
		UART2_RX_DATA	ALT2	

31.3 Clocks

There are two input clocks for I2C.

The following table describes the clock sources for I2C. Please see [Clock Controller Module \(CCM\)](#) for clock setting, configuration and gating information.

Table 31-2. I2C Clocks

Clock name	Clock Root	Description
ipg_clk_patref	perclk_clk_root	Module clock
ipg_clk_s	ipg_clk_root	Peripheral access clock

- Peripheral clock: This clock is used for peripheral bus register read/writes.
- Module clock: This is the functional clock of the I2C. The serial bit clock frequency is derived from the module clock. The module clock and peripheral clocks are synchronous with each other. The minimum frequency of the module clock should be 12.8 MHz for Fast mode to achieve 400-kbps operation.

31.4 Functional description

This section provides a complete functional description of the block.

31.4.1 I2C system configuration

After a reset, the I2C defaults to Slave Receive operations. Thus, when not operating as a master or responding to a slave transmit address, the I2C defaults to the Slave Receive state.

For exceptions, see [Initialization sequence](#).

NOTE

The I2C is designed to be compatible with the Philips™ I2C bus protocol. For information on system configuration, protocol, and restrictions, see the *I2C Bus Specification*, version 2.1, by Philips Semiconductors. The I2C supports Standard and Fast modes only.

31.4.2 Arbitration procedure

If multiple devices simultaneously request the bus, the bus clock is determined by a synchronization procedure in which the low period equals the longest clock-low period among the devices, and the high period equals the shortest. A data arbitration procedure determines the relative priority of competing devices.

A device loses arbitration if it sends logic high while another sends logic low; it immediately switches to Slave Receive mode and stops driving I2Cn_SDA. In this case, the transition from master to Slave mode does not generate a Stop condition. Meanwhile, hardware sets the arbitration lost bit in the I2C Status register (I2C_I2SR[IAL] to indicate loss of arbitration).

31.4.3 Clock synchronization

Because wire-AND logic is used, a high-to-low transition on SCL affects devices connected to the bus. Devices start counting their low period when the master drives SCL low. When a device clock goes low, it holds SCL low until the Clock High state is reached. However, the low-to-high change in this device clock may not change the state of SCL if another device clock is still in its low period. Therefore, the device with the longest low period holds the synchronized clock SCL low.

Devices with shorter low periods enter a High Wait state during this time (see [Figure 31-3](#)). When all devices involved have counted off their low periods, the synchronized clock SCL is released and pulled high. There is then no difference between device clocks and the state of SCL, so all of the devices start counting their high periods. The first device to complete its high period pulls SCL low again.

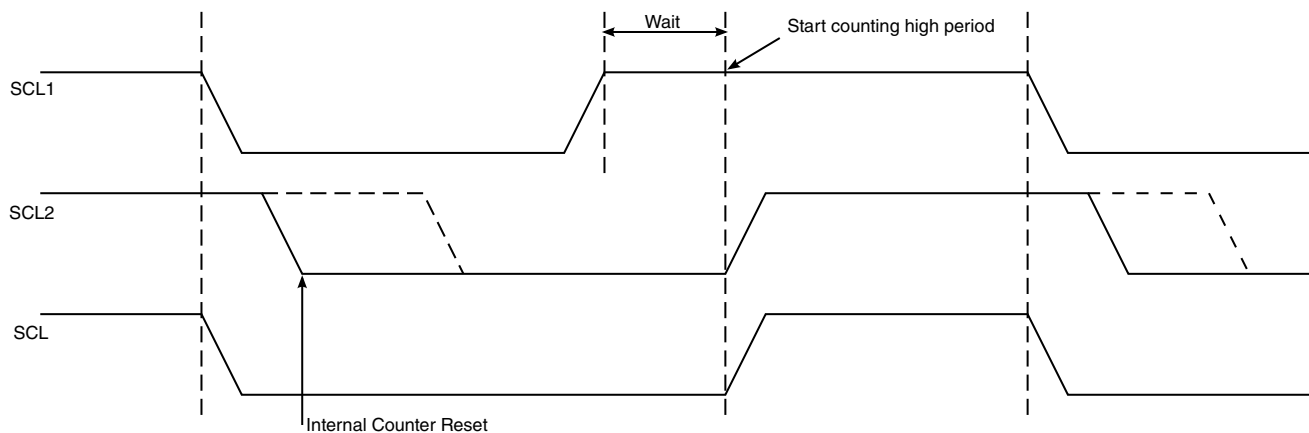

Figure 31-3. Synchronized clock SCL

31.4.4 Handshaking

The clock synchronization mechanism can be used as a handshake in data transfers. Slave devices can hold SCL low after completing one byte transfer (9 bits). In such a case, the clock mechanism halts the bus clock and forces the master clock into a Wait state until the slave releases SCL.

31.4.5 Clock stretching

Slaves can use the clock synchronization mechanism to slow down the transfer bit rate. After the master has driven SCL low, the slave can drive SCL low for the required period and then release it. If the slave SCL low period is longer than the master SCL low period, the resulting SCL bus signal low period is stretched.

31.4.6 Peripheral bus accesses

I2C is a 16-bit block. Only half-word accesses should be performed to the block.

31.4.7 Generation of transfer error on IP bus

If an address is received on the peripheral slave bus interface but it is not implemented, an access error is generated.

31.4.8 Reset

The I2C can be reset in the following ways:

- Global reset: A hard asynchronous reset of the whole I2C
- Software reset: An internal reset for the whole I2C (except for I2C_IADR and I2C_IFDR registers) initiated by deasserting the I2C_I2CR[IEN] bit

31.4.9 Interrupts

There is only one interrupt from the block, which is enabled by setting the I2C_I2CR[IIEN] bit.

The interrupt is generated in any one of the following conditions:

- One byte transfer is completed (the interrupt is set at the falling edge of the ninth clock).
- An address is received that matches its own specific address in Slave Receive mode.
- Arbitration is lost.

31.4.10 Byte order

The block only supports the Little-Endian mode.

31.5 Initialization

NOTE

Ensure the input select pins for IOMUXC are configured correctly for I2C.

31.5.1 Initialization sequence

Before the interface can transfer serial data, registers must be initialized, as listed here.

1. Set the data sampling rate (I2C_IFDR[IC]) to obtain SCL frequency from the system bus clock.
2. Update the address in the (I2C_IADR) to define its slave address (address can range from 0 to 0x7f).
3. Set the I2C enable bit (I2C_I2CR[IEN]) to enable the I2C bus interface system.
4. Modify the bits in the I2C_I2CR to select Master/Slave mode, Transmit/Receive mode, and Interrupt-Enable or not.

31.5.2 Generation of Start

After completion of the initialization procedure, serial data can be transmitted by selecting the Master Transmit mode. On a multimaster bus system, the busy bus (I2C_I2SR[IBB]) must be tested to determine whether the serial bus is free. If the bus is free (IBB = 0), the Start signal and the first byte (the slave address) can be sent. The data written to the data register comprises the address of the desired slave and the LSB indicates the transfer direction.

The free time between a Stop and the next Start condition is built into the hardware that generates the Start cycle. Depending on the relative frequencies of the system clock and the SCL period, it may be necessary to wait until the I2C is not busy after writing the calling address to the data register (I2C_I2DR), before proceeding to load data into the data register (I2C_I2DR).

31.5.3 Post-transfer software response

Sending or receiving a byte sets the data transferring bit (I2C_I2SR[ICF]), which indicates one byte of communication is finished. Upon completion, the interrupt status (I2C_I2SR[IIF]) is also set. An external interrupt is generated if the interrupt enable (I2C_I2CR[IIEN]) is set. The software must first clear the interrupt status (I2C_I2SR[IIF]) in the interrupt routine.

See the flow chart in [Figure 31-5](#).

The data transferring bit (I2C_I2SR[ICF]) is cleared either by reading from I2C_I2DR in Receive mode or by writing to this register in Transmit mode.

The software can service the I2C I/O in the main program by monitoring the interrupt status (I2C_I2SR[IIF]) if the interrupt enable is deasserted. In this case, the interrupt status should be polled in the data transferring bit (I2C_I2SR[ICF]) because the operation is different when arbitration is lost.

When an interrupt occurs at the end of the address cycle, the master is always in Transmit mode; that is, the address is sent. If Master Receive mode is required, then I2C_I2CR[MTX] should be toggled and a dummy read of the I2C_I2DR register must be executed to trigger receive data.

During Slave-mode address cycles (I2C_I2SR[IAAS] = 1), the slave read/write bit I2C_I2SR[SRW] is read to determine the direction of the next transfer. The transmit/receive bit (I2C_I2CR[MTX]) should also be programmed accordingly. For Slave-mode data cycles (IAAS = 0), SRW is invalid. MTX should be read to determine the current transfer direction.

31.5.4 Generation of Stop

A data transfer ends when the master signals a Stop, which can occur after all data is sent.

For a master receiver to terminate a data transfer, it must inform the slave transmitter by not acknowledging the last data byte. This is done by setting the transmit acknowledge bit (I2C_I2CR[TXAK]) before reading the next-to-last byte. Before the last byte is read, a Stop signal must be generated.

31.5.5 Generation of Repeated Start

After the data transfer, if the master still requires the bus, it can signal another Start followed by another slave address without signaling a Stop.

31.5.6 Slave mode

In the slave interrupt service routine (see [Figure 31-5](#)), the block addressed as slave bit (IAAS) should be tested to check if a calling of its own address has just been received. If IAAS is set, software should set the Transmit/Receive mode select bit (I2C_I2CR[MTX]) according to the I2C_I2SR[SRW]. Writing to the I2C_I2CR clears the IAAS automatically. The only time IAAS is read as set is from the interrupt at the end of the address cycle where an address match occurred; interrupts resulting from subsequent data transfers will have IAAS cleared. A data transfer can now be initiated by writing information to I2C_I2DR for slave transmits, or read from I2C_I2DR in Slave Receive mode. A dummy read of I2C_I2DR in Slave Receive mode releases SCL, allowing the master to send data.

In the slave transmitter routine, the receive acknowledge bit (I2C_I2SR[RXAK]) must be tested before sending the next byte of data. Setting RXAK means an end-of-data signal from the master receiver, after which the software must switch it from Transmit to Receiver mode. Reading the data register (I2C_I2DR) then releases SCL so the master can generate a Stop signal.

31.5.7 Arbitration lost

If several devices try to engage the bus at the same time, one becomes master. Hardware immediately switches devices that lose arbitration to Slave Receive mode. Data output to 12Cn_SDA stops, but 12Cn_SCL is still generated until the end of the byte during which arbitration is lost. An interrupt occurs at the falling edge of the ninth clock of this transfer if the arbitration is lost (I2C_I2SR[IAL] = 1), and the Slave mode is selected (I2C_I2CR[MSTA] = 0).

See the flow chart in [Figure 31-5](#).

If a device that is not a master tries to transmit or do a Start, hardware inhibits the transmission, clears MSTA without signaling a Stop, generates an interrupt to the Arm platform, and sets I2C_I2SR[IAL] to indicate a failed attempt to engage the bus. When considering these cases, the slave service routine should first test I2C_I2SR[IAL], and the software should clear it if it is set.

For Multimaster mode, when an I2C is enabled when the bus is busy and asserts Start, the I2C_I2SR[IAL] bit gets set only for 12Cn_SDA=0, 12Cn_SCL=0/1, 12Cn_SDA=1, and 12Cn_SCL=0; but not for 12Cn_SDA=1 and I2Cn_SCL=1, which is the equivalent of Bus Idle state.

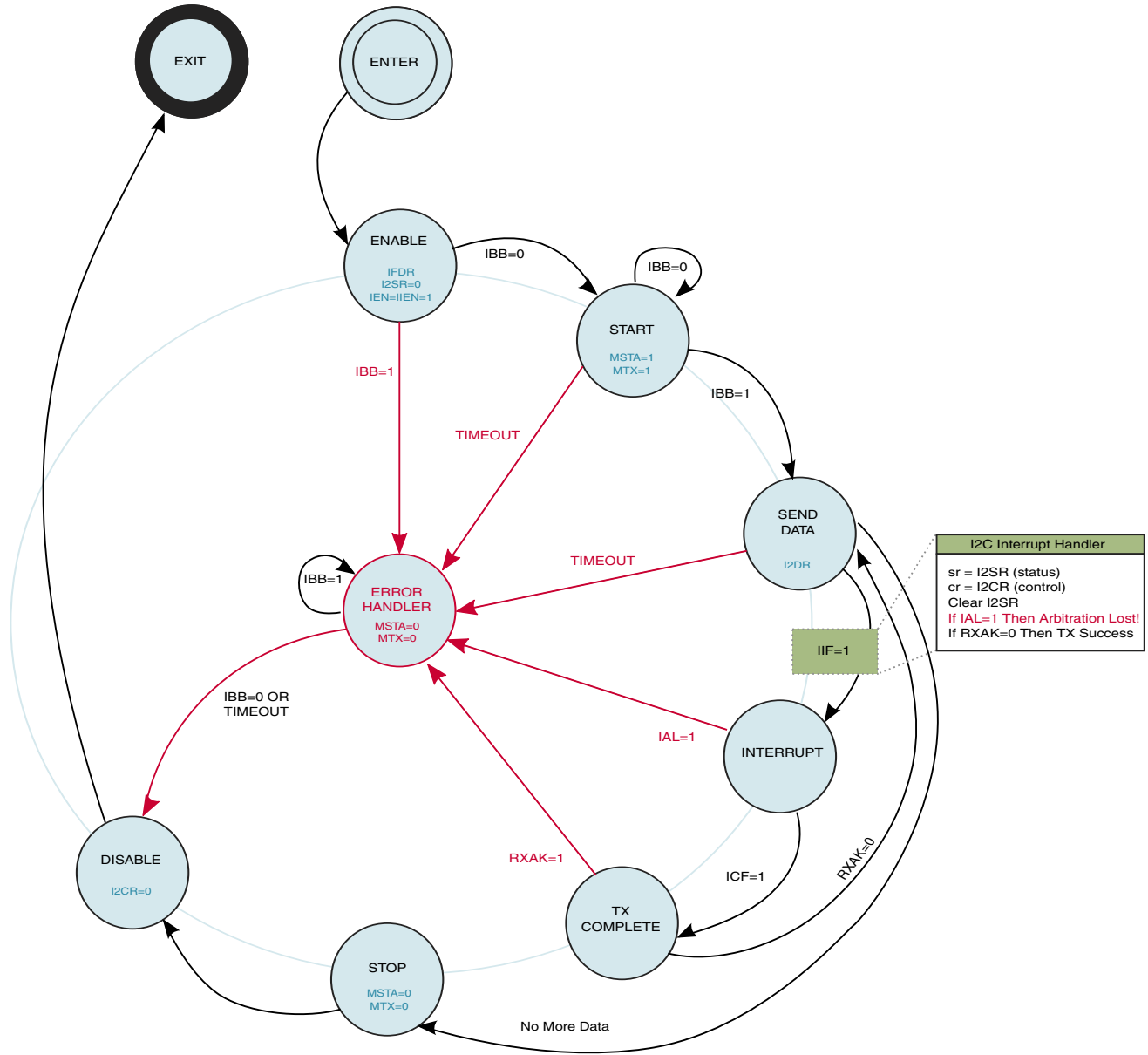

Figure 31-4. I2C Programming state diagram

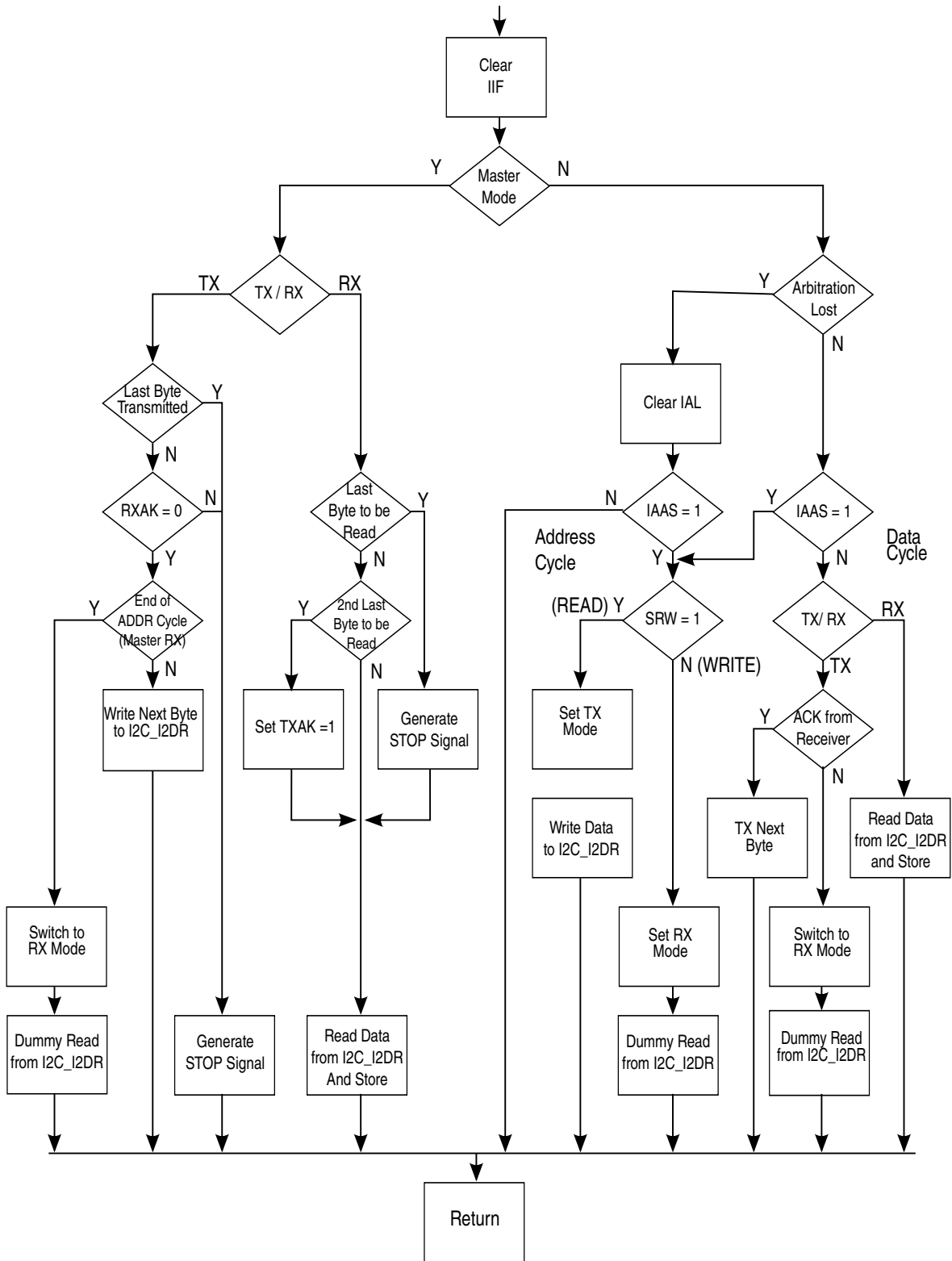

Figure 31-5. Flowchart of typical I2C interrupt routine

NOTE

For a Repeated Start only, the Stop-generation stage does not occur in Master mode. A loop repeats itself without stopping for the next start.

For Master Receive mode, I2C is programmed as Master Transmit during Address mode and after slave address transfer; the MTX bit should be cleared and a dummy read on the I2C_I2DR register should be performed so I2C can read the next receive data.

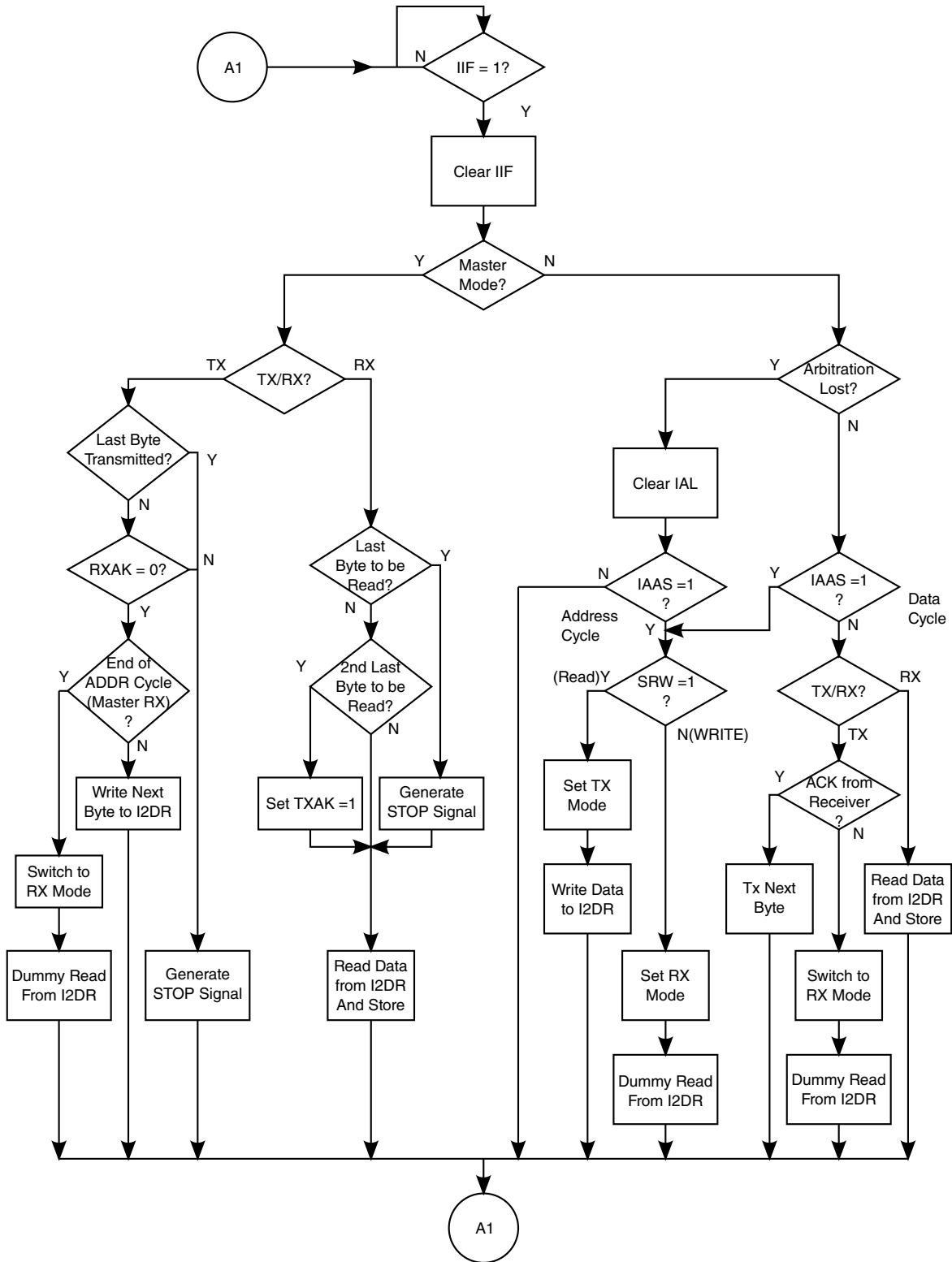

Figure 31-6. Flowchart for typical I2C polling routine

NOTE

The timeout value depends on the bus frequency at which I2C is operating. The minimum timeout for polling the IIF bit at a maximum I2C bus frequency of 400 kHz is $T_{min} = 25 \mu s$ ($=2.5 \times 10 \mu s$). This value can be calculated for any bus frequency. The formula is $T_{min} = 10/F_{SCL}$, where F_{SCL} is the frequency of the I2C clock (SCL).

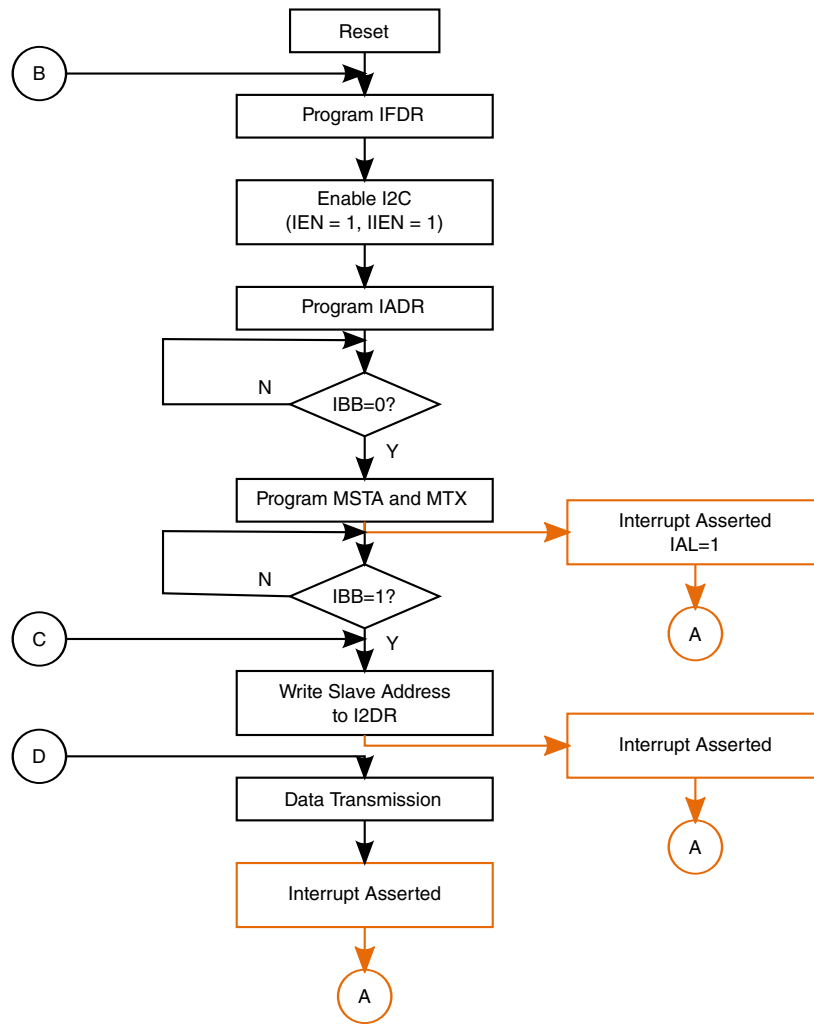

Figure 31-7. Detailed flowchart of a typical I2C Master Transmit mode, part 1

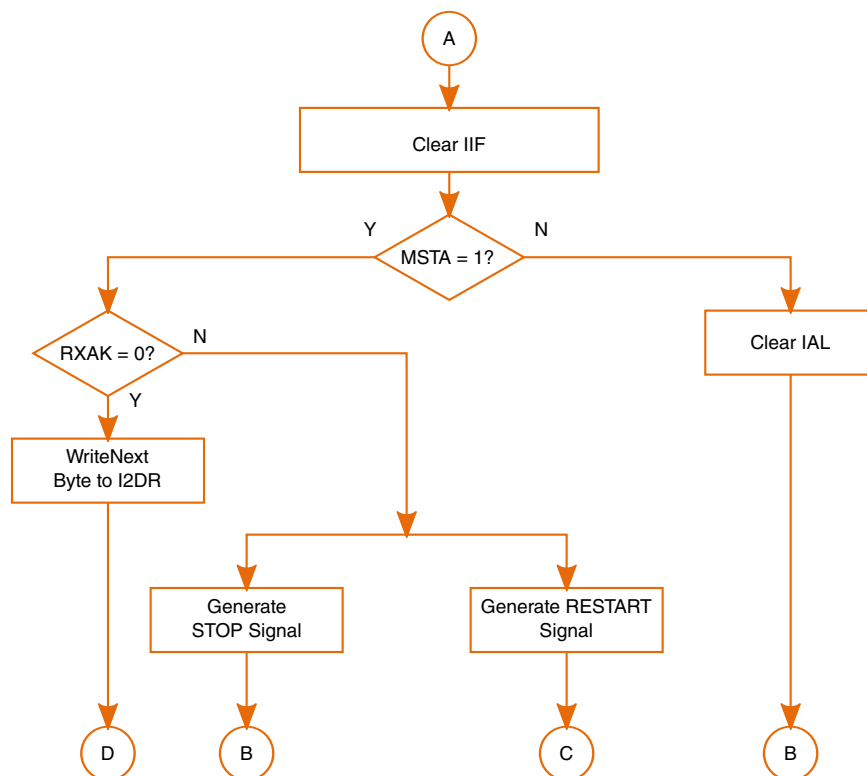

Figure 31-8. Detailed flowchart of a typical I2C Master Transmit mode, part 2

Figure 31-7 and Figure 31-8 show the Master Transmit mode operation with interrupt subroutine. If an interrupt is generated and the MSTA bit is 0, then bus arbitration is lost and IAL is set. Software can clear the IAL bit and reprogram I2C. If the MSTA bit is 1, then it is a transfer-generated interrupt. In this case, software can check the RXAK bit for a data receive acknowledgement by the slave and, accordingly, decide to do one of the following:

- Generate a STOP
- Generate a REPEATED START by writing to the I2C_I2CR register
- Perform the next data transfer by writing to the I2C_I2DR register

NOTE

The IBB bit is asserted by a Start condition on the bus, and it is deasserted by a Stop condition on the bus. Therefore, if arbitration is lost due to an unexpected Stop condition during transfer, then IBB is cleared. If arbitration is lost due to a data mismatch, then it is not cleared. Software should always clear the IEN bit and then set it if arbitration is lost.

31.6 Software restriction

Software should ensure that there is a delay of at least two module clock cycles after it sets the I2C_I2CR[RSTA] bit and before writing to the I2C_I2DR register. The maximum possible clock period of the module clock is 78 ns.

31.7 I2C Memory Map/Register Definition

The I2C contains five 16-bit registers.

NOTE

Registers at offsets 0x0002, 0x0006, 0x000A, and 0x000E are reserved for future additions.

I2C memory map

Absolute address (hex)	Register name	Width (in bits)	Access	Reset value	Section/page
21A_0000	I2C Address Register (I2C1_IADR)	16	R/W	0000h	31.7.1/1463
21A_0004	I2C Frequency Divider Register (I2C1_IFDR)	16	R/W	0000h	31.7.2/1463
21A_0008	I2C Control Register (I2C1_I2CR)	16	R/W	0000h	31.7.3/1465
21A_000C	I2C Status Register (I2C1_I2SR)	16	R/W	0081h	31.7.4/1466
21A_0010	I2C Data I/O Register (I2C1_I2DR)	16	R/W	0000h	31.7.5/1468
21A_4000	I2C Address Register (I2C2_IADR)	16	R/W	0000h	31.7.1/1463
21A_4004	I2C Frequency Divider Register (I2C2_IFDR)	16	R/W	0000h	31.7.2/1463
21A_4008	I2C Control Register (I2C2_I2CR)	16	R/W	0000h	31.7.3/1465
21A_400C	I2C Status Register (I2C2_I2SR)	16	R/W	0081h	31.7.4/1466
21A_4010	I2C Data I/O Register (I2C2_I2DR)	16	R/W	0000h	31.7.5/1468
21A_8000	I2C Address Register (I2C3_IADR)	16	R/W	0000h	31.7.1/1463
21A_8004	I2C Frequency Divider Register (I2C3_IFDR)	16	R/W	0000h	31.7.2/1463
21A_8008	I2C Control Register (I2C3_I2CR)	16	R/W	0000h	31.7.3/1465
21A_800C	I2C Status Register (I2C3_I2SR)	16	R/W	0081h	31.7.4/1466
21A_8010	I2C Data I/O Register (I2C3_I2DR)	16	R/W	0000h	31.7.5/1468
21F_8000	I2C Address Register (I2C4_IADR)	16	R/W	0000h	31.7.1/1463
21F_8004	I2C Frequency Divider Register (I2C4_IFDR)	16	R/W	0000h	31.7.2/1463
21F_8008	I2C Control Register (I2C4_I2CR)	16	R/W	0000h	31.7.3/1465
21F_800C	I2C Status Register (I2C4_I2SR)	16	R/W	0081h	31.7.4/1466
21F_8010	I2C Data I/O Register (I2C4_I2DR)	16	R/W	0000h	31.7.5/1468

31.7.1 I2C Address Register (I2Cx_IADR)

Address: Base address + 0h offset

Bit	15	14	13	12	11	10	9	8	7	6	5	4	3	2	1	0	
Read	0								ADR								0
Write																	
Reset	0	0	0	0	0	0	0	0	0	0	0	0	0	0	0	0	

I2Cx_IADR field descriptions

Field	Description
15–8 Reserved	This read-only field is reserved and always has the value 0.
7–1 ADR	Slave address. Contains the specific slave address to be used by the I2C. Slave mode is the default I2C mode for an address match on the bus. NOTE: The I2C_IADR holds the address to which the I2C responds when addressed as a slave. The slave address is not the address sent on the bus during the address transfer. The register is not reset by a software reset.
0 Reserved	This read-only field is reserved and always has the value 0.

31.7.2 I2C Frequency Divider Register (I2Cx_IFDR)

The I2C_IFDR provides a programmable prescaler to configure the clock for bit-rate selection. The register does not get reset by a software reset.

I2C clock is sourced from PERCLK_ROOT which is routed from IPG_CLK_ROOT. I2C clock frequency can easily be obtained by using the following formula:

I2C clock Frequency = (PERCLK_ROOT frequency)/(division factor corresponding to IFDR)

By default, IPG_CLK_ROOT and PERCLK_ROOT frequencies are set to 49.5 MHz, where the root clock is sourced from PLL2's PFD2. Obtaining the frequencies can be accomplished by:

$$\text{PLL2} = 528 \text{ MHz}$$

$$\text{PLL2_PFD2} = 528 \text{ MHz} * 18 / 24 = 396 \text{ MHz}$$

$$\text{IPG_CLK_ROOT} = (\text{PLL2_PFD2} / \text{ahb_podf}) / \text{ipg_podf} = (396 \text{ MHz}/4)/2 = 49.5 \text{ MHz}$$

$$\text{PER_CLK_ROOT} = \text{IPG_CLK_ROOT}/\text{perclk_podf} = 49.5 \text{ MHz}/1 = 49.5 \text{ MHz}$$

NOTE

The above calculation assumes that the default CCM register settings, routing, and division factors are used. If different routing, PFD values, and/or division factors are used, the user must adjust the parameters accordingly to calculate the correct clock frequency.

The following table describes the divider and register values for the register field "IC."

Table 31-3. I2C_IFDR Register Field Values

IC	Divider		IC	Divider		IC	Divider		IC	Divider
0x00	30		0x10	288		0x20	22		0x30	160
0x01	32		0x11	320		0x21	24		0x31	192
0x02	36		0x12	384		0x22	26		0x32	224
0x03	42		0x13	480		0x23	28		0x33	256
0x04	48		0x14	576		0x24	32		0x34	320
0x05	52		0x15	640		0x25	36		0x35	384
0x06	60		0x16	768		0x26	40		0x36	448
0x07	72		0x17	960		0x27	44		0x37	512
0x08	80		0x18	1152		0x28	48		0x38	640
0x09	88		0x19	1280		0x29	56		0x39	768
0x0A	104		0x1A	1536		0x2A	64		0x3A	896
0x0B	128		0x1B	1920		0x2B	72		0x3B	1024
0x0C	144		0x1C	2304		0x2C	80		0x3C	1280
0x0D	160		0x1D	2560		0x2D	96		0x3D	1536
0x0E	192		0x1E	3072		0x2E	112		0x3E	1792
0x0F	240		0x1F	3840		0x2F	128		0x3F	2048

Address: Base address + 4h offset

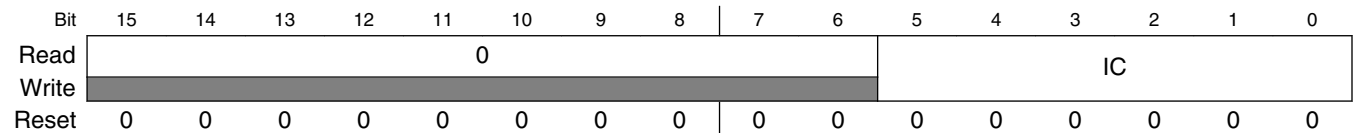

I2Cx_IFDR field descriptions

Field	Description
15–6 Reserved	This read-only field is reserved and always has the value 0.
IC	I2C clock rate. Prescales the clock for bit-rate selection. Due to potentially slow I2Cn_SCL and I2Cn_SDA rise and fall times, bus signals are sampled at the prescaler frequency. The serial bit clock frequency may be lower than IPG_CLK_ROOT divided by the divider shown in the I2C Data I/O Register. NOTE: The IC value should not be changed during the data transfer, however, it can be changed before a Repeat Start or Start programming sequence in I2C. The I2C protocol supports bit rates of up to 400 kbps. The IC bits need to be programmed in accordance with this constraint.

31.7.3 I2C Control Register (I2Cx_I2CR)

The I2C_I2CR is used to enable the I2C and the I2C interrupt. It also contains bits that govern operation as a slave or a master.

Address: Base address + 8h offset

Bit	15	14	13	12	11	10	9	8
Read	0							
Write								
Reset	0	0	0	0	0	0	0	0
Bit	7	6	5	4	3	2	1	0
Read						0	0	
Write	IEN	IEN	MSTA	MTX	TXAK	RSTA		
Reset	0	0	0	0	0	0	0	0

I2Cx_I2CR field descriptions

Field	Description
15–8 Reserved	This read-only field is reserved and always has the value 0.
7 IEN	I2C enable. Also controls the software reset of the entire I2C. Resetting the bit generates an internal reset to the block. If the block is enabled in the middle of a byte transfer, Slave mode ignores the current bus transfer and starts operating when the next Start condition is detected. Master mode is not aware that the bus is busy, so initiating a start cycle may corrupt the current bus cycle, ultimately causing either the current master or the I2C to lose arbitration. Subsequently, bus operation returns to normal. 0 The block is disabled, but registers can still be accessed. 1 The I2C is enabled. This bit must be set before any other I2C_I2CR bits have an effect.
6 I2EN	I2C interrupt enable. NOTE: If data is written during the Start condition, that is, just after setting the I2C_I2CR[MSTA] and I2C_I2CR[MTX] bits, then the ICF bit is cleared at the falling edge of SCLK after Start. If data is written after the Start condition and falling edge of SCLK, then the ICF bit is cleared as soon as data is written. 0 I2C interrupts are disabled, but the status flag I2C_I2SR[IIF] continues to be set when an Interrupt condition occurs. 1 I2C interrupts are enabled. An I2C interrupt occurs if I2C_I2SR[IIF] is also set.
5 MSTA	Master/Slave mode select bit. If the master loses arbitration, MSTa is cleared without generating a Stop signal. NOTE: The module clock should be on for writing to the MSTa bit. NOTE: The MSTa bit is cleared by software to generate a Stop condition; it can also be cleared by hardware when the I2C loses the bus arbitration.

Table continues on the next page...

I2Cx_I2CR field descriptions (continued)

Field	Description
	0 Slave mode. Changing MSTA from 1 to 0 generates a Stop and selects Slave mode. 1 Master mode. Changing MSTA from 0 to 1 signals a Start on the bus and selects Master mode.
4 MTX	Transmit/Receive mode select bit. Selects the direction of master and slave transfers. 0 Receive. When a slave is addressed, the software should set MTX according to the slave read/write bit in the I2C status register (I2C_I2SR[SRW]). 1 Transmit. In Master mode, MTX should be set according to the type of transfer required. Therefore, for address cycles, MTX is always 1.
3 TXAK	Transmit acknowledge enable. Specifies the value driven onto I2Cn_SDA during acknowledge cycles for both master and slave receivers. NOTE: Writing TXAK applies only when the I2C bus is a receiver. 0 An acknowledge signal is sent to the bus at the ninth clock bit after receiving one byte of data. 1 No acknowledge signal response is sent (that is, the acknowledge bit = 1).
2 RSTA	Repeat start. Always reads as 0. Attempting a repeat start without bus mastership causes loss of arbitration. 0 No repeat start 1 Generates a Repeated Start condition
Reserved	This read-only field is reserved and always has the value 0.

31.7.4 I2C Status Register (I2Cx_I2SR)

The I2C_I2SR contains bits that indicate transaction direction and status.

Address: Base address + Ch offset

Bit	15	14	13	12	11	10	9	8
Read	0							
Write								
Reset	0	0	0	0	0	0	0	0
Bit	7	6	5	4	3	2	1	0
Read	ICF	IAAS	IBB	IAL	0	SRW	IIF	RXAK
Write				IAL			IIF	
Reset	1	0	0	0	0	0	0	1

I2Cx_I2SR field descriptions

Field	Description
15–8 Reserved	This read-only field is reserved and always has the value 0.
7 ICF	Data transferring bit. While one byte of data is transferred, ICF is cleared. 0 Transfer is in progress. 1 Transfer is complete. This bit is set by the falling edge of the ninth clock of the last byte transfer.
6 IAAS	I2C addressed as a slave bit. The Arm platform is interrupted if the interrupt enable (I2C_I2CR[IEN]) is set. The Arm platform must check the slave read/write bit (SRW) and set its Transfer/Receive mode accordingly. Writing to I2C_I2CR clears this bit. 0 Not addressed 1 Addressed as a slave. Set when its own address (I2C_IADR) matches the calling address.
5 IBB	I2C bus busy bit. Indicates the status of the bus. NOTE: When I2C is enabled (I2C_I2CR[IEN] = 1), it continuously polls the bus data (SDA) and clock (SCL) signals to determine a Start or Stop condition. 0 Bus is idle. If a Stop signal is detected, IBB is cleared. 1 Bus is busy. When Start is detected, IBB is set.
4 IAL	Arbitration lost. Set by hardware in the following circumstances (IAL must be cleared by software by writing a "0" to it at the start of the interrupt service routine): <ul style="list-style-type: none"> I2Cn_SDA input samples low when the master drives high during an address or data-transmit cycle. I2Cn_SDA input samples low when the master drives high during the acknowledge bit of a data-receive cycle. For the above two cases, the bit is set at the falling edge of the ninth I2Cn_SCL clock during the ACK cycle. <ul style="list-style-type: none"> A Start cycle is attempted when the bus is busy. A Repeated Start cycle is requested in Slave mode. A Stop condition is detected when the master did not request it. NOTE: Software cannot set the bit. 0 No arbitration lost. 1 Arbitration is lost.
3 Reserved	This read-only field is reserved and always has the value 0.
2 SRW	Slave read/write. When the I2C is addressed as a slave, IAAS is set, and the slave read/write bit (SRW) indicates the value of the R/W command bit of the calling address sent from the master. SRW is valid only when a complete transfer has occurred, no other transfers have been initiated, and the I2C is a slave and has an address match. 0 Slave receive, master writing to slave 1 Slave transmit, master reading from slave
1 IIF	I2C interrupt. Must be cleared by the software by writing a "0" to it in the interrupt routine. NOTE: The software cannot set the bit. 0 No I2C interrupt pending. 1 An interrupt is pending.

Table continues on the next page...

I2Cx_I2SR field descriptions (continued)

Field	Description
	<p>This causes a processor interrupt request (if the interrupt enable is asserted [I IEN = 1]). The interrupt is set when one of the following occurs:</p> <ul style="list-style-type: none"> • One byte transfer is completed (the interrupt is set at the falling edge of the ninth clock). • An address is received that matches its own specific address in Slave Receive mode. • Arbitration is lost.
0 RXAK	<p>Received acknowledge. This is the value received from the I2Cn_SDA input for the acknowledge bit during a bus cycle.</p> <p>0 An "acknowledge" signal was received after the completion of an 8-bit data transmission on the bus. 1 A "No acknowledge" signal was detected at the ninth clock.</p>

31.7.5 I2C Data I/O Register (I2Cx_I2DR)

In Master Receive mode, reading the data register allows a read to occur and initiates the next byte to be received. In Slave mode, the same function is available after it is addressed.

Address: Base address + 10h offset

Bit	15	14	13	12	11	10	9	8	7	6	5	4	3	2	1	0
Read	0								DATA							
Write	0								0							
Reset	0	0	0	0	0	0	0	0	0	0	0	0	0	0	0	0

I2Cx_I2DR field descriptions

Field	Description
15–8 Reserved	This read-only field is reserved and always has the value 0.
DATA	<p>Data Byte. Holds the last data byte received or the next data byte to be transferred. Software writes the next data byte to be transmitted or reads the data byte received.</p> <p>NOTE: The core-written value in I2C_I2DR cannot be read back by the core. Only data written by the I2C bus side can be read.</p>

Chapter 32

IOMUX Controller (IOMUXC)

32.1 Overview

The IOMUX Controller (IOMUXC), together with the IOMUX, enables the IC to share one pad to several functional blocks. This sharing is done by multiplexing the pad's input and output signals.

Every module requires a specific pad setting (such as pull up or keeper), and for each pad, there are up to 8 muxing options (called ALT modes). The pad settings parameters are controlled by the IOMUXC.

The IOMUX consists only of combinatorial logic combined from several basic IOMUX cells. Each basic IOMUX cell handles only one pad signal's muxing.

[Figure 32-1](#) illustrates the IOMUX/IOMUXC connectivity in the system.

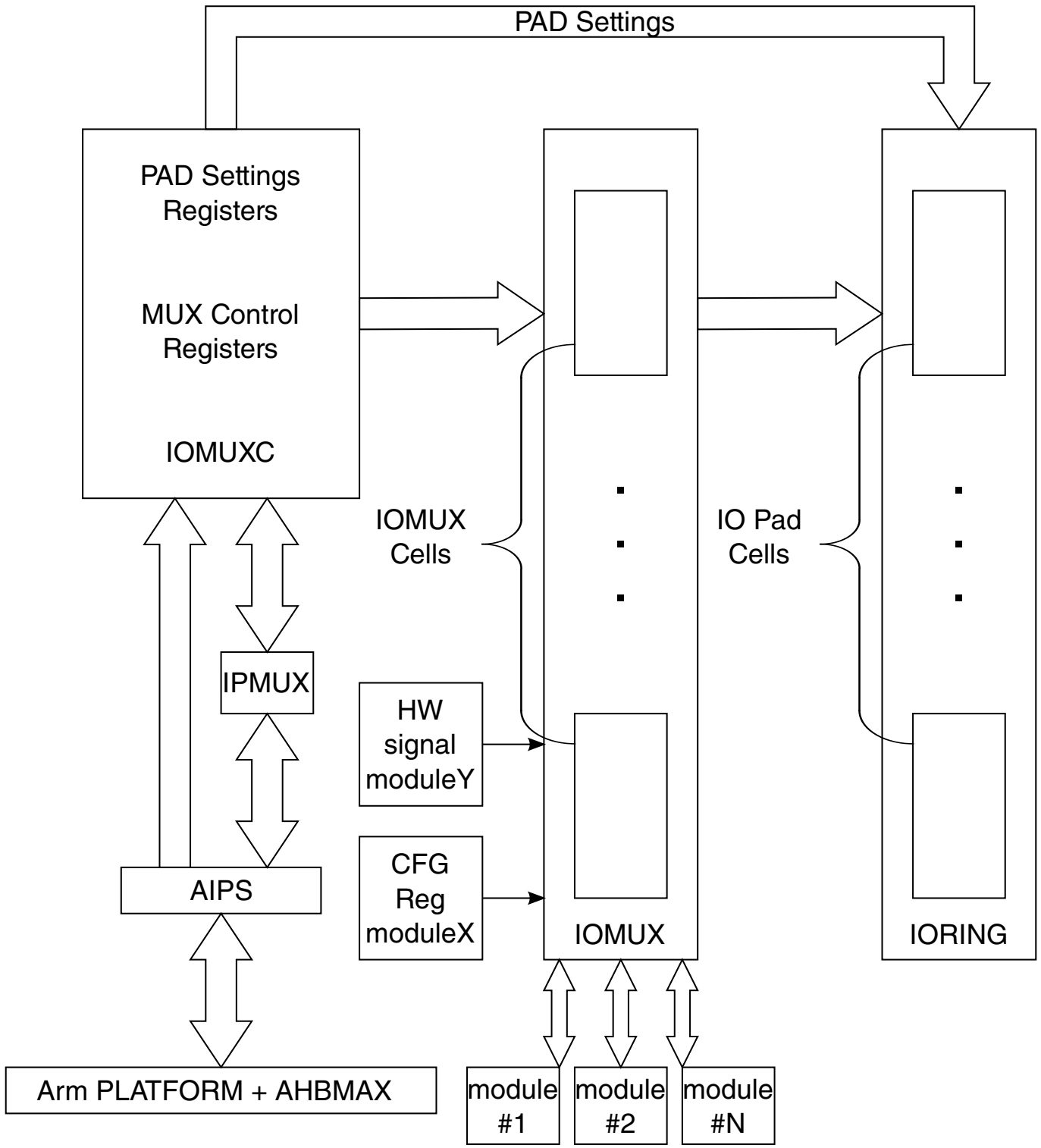

Figure 32-1. IOMUX SoC Level Block Diagram

32.1.1 Features

The IOMUXC features are:

- 32-bit software mux control registers (IOMUXC_SW_MUX_CTL_PAD_<PAD NAME> or IOMUXC_SW_MUX_CTL_GRP_<GROUP NAME>) to configure 1 of 8 alternate (ALT) MUX_MODE fields of each pad or a predefined group of pads and to enable the forcing of an input path of the pad(s) (SION bit).
- 32-bit software pad control registers (IOMUXC_SW_PAD_CTL_PAD_<PAD_NAME> or IOMUXC_SW_PAD_CTL_GRP_<GROUP NAME>) to configure specific pad settings of each pad, or a predefined group of pads.
- 32-bit general purpose registers - 14 (GPR0 to GPR13) 32-bit registers according to SoC requirements for any usage.
- 32-bit input select control registers to control the input path to a module when more than one pad drives this module input.

Each SW MUX/PAD CTL IOMUXC register handles only one pad or one pad's group.

Only the minimum number of registers required by software are implemented by hardware. For example, if only ALT0 and ALT1 modes are used on Pad x then only one bit register will be generated as the MUX_MODE control field in the software mux control register of Pad x.

The software mux control registers may allow the forcing of pads to become input (input path enabled) regardless of the functional direction driven. This may be useful for loopback and GPIO data capture.

32.2 Clocks

The table found here describes the clock sources for IOMUXC.

Please see [Clock Controller Module \(CCM\)](#) for clock setting, configuration and gating information.

Table 32-1. IOMUXC Clocks

Clock name	Clock Root	Description
ipt_clk_io		IO clock
ipg_clk_s	ipg_clk_root	Peripheral access clock

32.3 Functional description

This section provides a complete functional description of the block.

The IOMUXC consists of two sub-blocks:

- IOMUXC_REGISTERS includes all of the IOMUXC registers (see [Features](#)).
- IOMUXC_LOGIC includes all of the IOMUXC combinatorial logic (IP interface controls, address decoder, observability muxes).

The IOMUX consists of a number (about the number of pads in the SoC) of basic iomux_cell units. If only one functional mode is required for a specific pad, there is no need for IOMUX and the signals can be connected directly from the module to the I/O. The IOMUX cell is required whenever two or more functional modes are required for a specific pad or when one functional mode and the one test mode are required.

The basic iomux_cell design, which allows two levels of HW signal control (in ALT6 and ALT7 modes - ALT7 gets highest priority) is shown in [Figure 32-2](#).

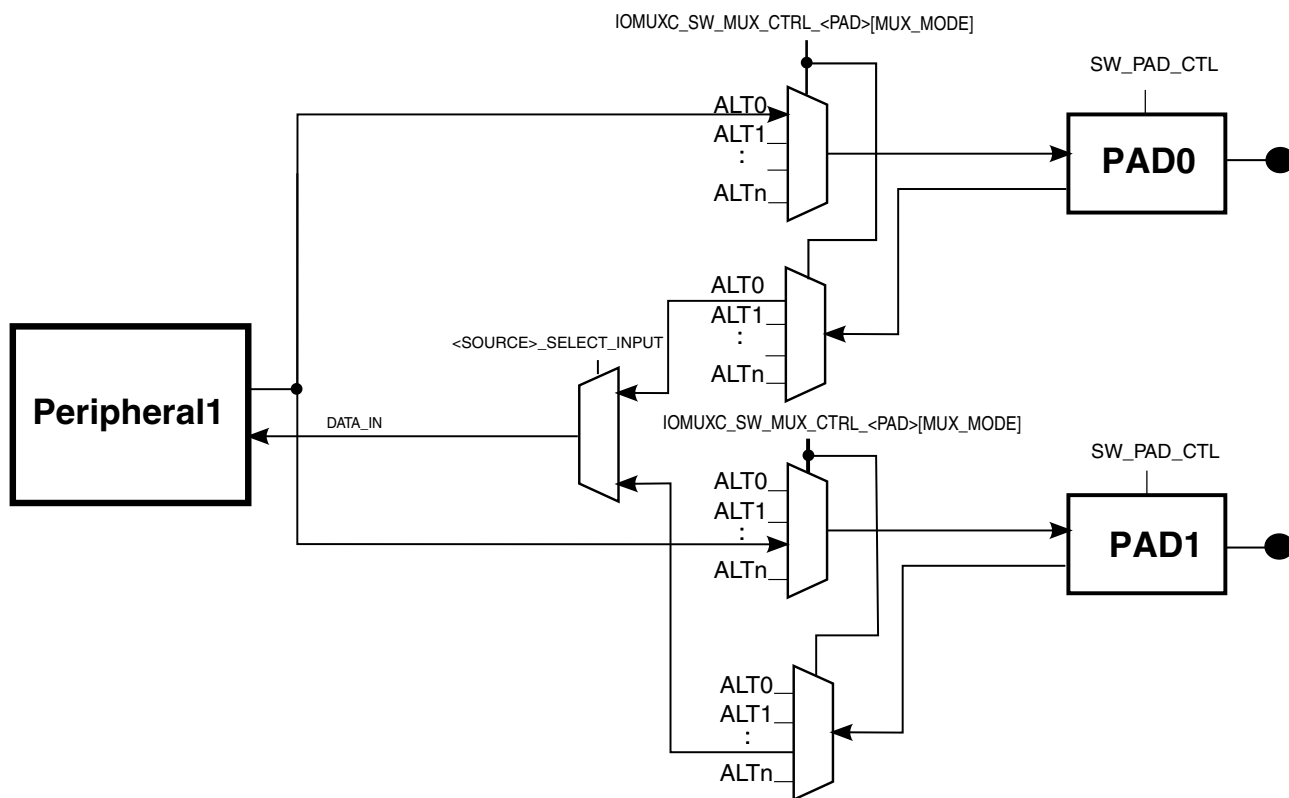

Figure 32-2. IOMUX Cell Block Diagram

32.3.1 ALT6 and ALT7 extended muxing modes

The ALT7 and ALT6 extended muxing modes allow any signal in the system (such as fuse, pad input, JTAG, or software register) to override any software configuration and to force the ALT6/ALT7 muxing mode.

It also allows an IOMUX software register to control a group of pads.

32.3.2 SW Loopback through SION bit

A limited option exists to override the default pad functionality and force the input path to be active (`ipp_ibe==1'b1`) regardless of the value driven by the corresponding module. This can be done by setting the SION (Software Input On) bit in the IOMUXC_SW_MUX_CTL register (when available) to "1".

Uses include:

- LoopBack - Module x drives the pad and also receives pad value as an input.
- GPIO Capture - Module x drives the pad and the value is captured by GPIO.

32.3.3 Daisy chain - multi pads driving same module input pin

In some cases, more than one pad may drive a single module input pin. Such cases require the addition of one more level of IOMUXing; all of these input signals are muxed, and a dedicated software controlled register controls the mux in order to select the required input path.

A module port involved in "daisy chain" requires two software configuration commands, one for selecting the mode for this pad (programmable via the IOMUXC_SW_MUX_CTL_<PAD> registers) and one for defining it as the input path (via the daisy chain registers).

This means that a module port involved in "daisy chain" requires two software configuration commands, one for selecting the mode for this pad (programmable via the IOMUXC_SW_MUX_CTL_<PAD> registers) and one for defining it as the input path (via the daisy chain registers). The daisy chain is illustrated in the figure below.

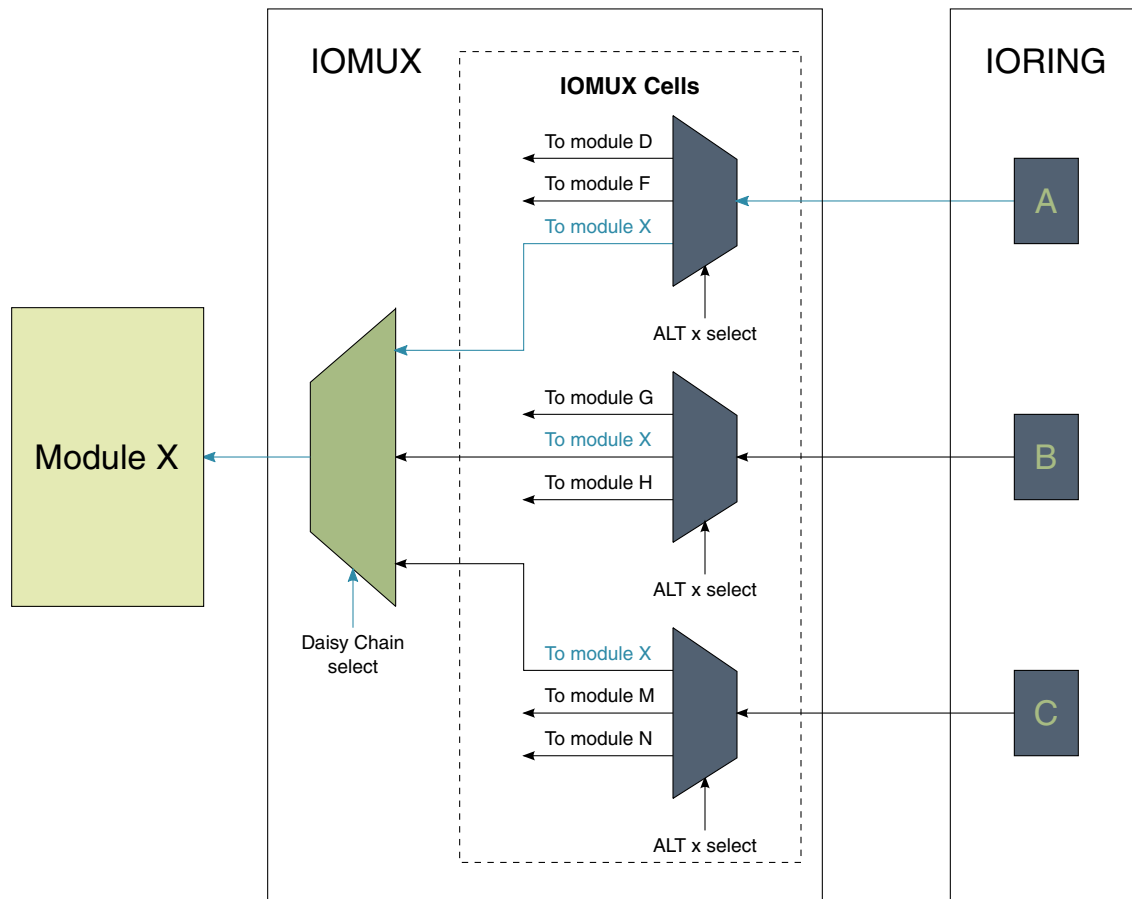

Figure 32-3. Daisy chain illustration

32.4 IOMUXC GPR Memory Map/Register Definition

IOMUXC_GPR memory map

Absolute address (hex)	Register name	Width (in bits)	Access	Reset value	Section/page
20E_4000	GPR0 General Purpose Register (IOMUXC_GPR_GPR0)	32	R/W	0000_0000h	32.4.1/1475
20E_4004	GPR1 General Purpose Register (IOMUXC_GPR_GPR1)	32	R/W	0F40_0005h	32.4.2/1478
20E_4008	GPR2 General Purpose Register (IOMUXC_GPR_GPR2)	32	R/W	0000_0000h	32.4.3/1481
20E_400C	GPR3 General Purpose Register (IOMUXC_GPR_GPR3)	32	R/W	0000_0FFFh	32.4.4/1484
20E_4010	GPR4 General Purpose Register (IOMUXC_GPR_GPR4)	32	R/W	0000_0000h	32.4.5/1487
20E_4014	GPR5 General Purpose Register (IOMUXC_GPR_GPR5)	32	R/W	0000_0000h	32.4.6/1490
20E_4024	GPR9 General Purpose Register (IOMUXC_GPR_GPR9)	32	R/W	0000_0000h	32.4.7/1493
20E_4028	GPR10 General Purpose Register (IOMUXC_GPR_GPR10)	32	R/W	0000_0007h	32.4.8/1494
20E_4038	GPR14 General Purpose Register (IOMUXC_GPR_GPR14)	32	R/W	0000_0000h	32.4.9/1495

32.4.1 GPR0 General Purpose Register (IOMUXC_GPR_GPR0)

GPR Register

Address: 20E_4000h base + 0h offset = 20E_4000h

Bit	31	30	29	28	27	26	25	24	23	22	21	20	19	18	17	16
R	Reserved									DMAREQ_MUX_SEL22	DMAREQ_MUX_SEL21	DMAREQ_MUX_SEL20	DMAREQ_MUX_SEL19	DMAREQ_MUX_SEL18	DMAREQ_MUX_SEL17	DMAREQ_MUX_SEL16
W	Reserved									DMAREQ_MUX_SEL22	DMAREQ_MUX_SEL21	DMAREQ_MUX_SEL20	DMAREQ_MUX_SEL19	DMAREQ_MUX_SEL18	DMAREQ_MUX_SEL17	DMAREQ_MUX_SEL16
Reset	0	0	0	0	0	0	0	0	0	0	0	0	0	0	0	0
Bit	15	14	13	12	11	10	9	8	7	6	5	4	3	2	1	0
R	DMAREQ_MUX_SEL15	DMAREQ_MUX_SEL14	DMAREQ_MUX_SEL13	DMAREQ_MUX_SEL12	DMAREQ_MUX_SEL11	DMAREQ_MUX_SEL10	DMAREQ_MUX_SEL9	DMAREQ_MUX_SEL8	DMAREQ_MUX_SEL7	DMAREQ_MUX_SEL6	DMAREQ_MUX_SEL5	DMAREQ_MUX_SEL4	DMAREQ_MUX_SEL3	DMAREQ_MUX_SEL2	DMAREQ_MUX_SEL1	DMAREQ_MUX_SEL0
W	DMAREQ_MUX_SEL15	DMAREQ_MUX_SEL14	DMAREQ_MUX_SEL13	DMAREQ_MUX_SEL12	DMAREQ_MUX_SEL11	DMAREQ_MUX_SEL10	DMAREQ_MUX_SEL9	DMAREQ_MUX_SEL8	DMAREQ_MUX_SEL7	DMAREQ_MUX_SEL6	DMAREQ_MUX_SEL5	DMAREQ_MUX_SEL4	DMAREQ_MUX_SEL3	DMAREQ_MUX_SEL2	DMAREQ_MUX_SEL1	DMAREQ_MUX_SEL0
Reset	0	0	0	0	0	0	0	0	0	0	0	0	0	0	0	0

IOMUXC_GPR_GPR0 field descriptions

Field	Description
31–23 -	Reserved This field is reserved.

Table continues on the next page...

IOMUXC_GPR_GPR0 field descriptions (continued)

Field	Description
22 DMAREQ_MUX_SEL22	Reserved
21 DMAREQ_MUX_SEL21	Reserved
20 DMAREQ_MUX_SEL20	Reserved
19 DMAREQ_MUX_SEL19	Reserved
18 DMAREQ_MUX_SEL18	Reserved
17 DMAREQ_MUX_SEL17	Reserved
16 DMAREQ_MUX_SEL16	Reserved
15 DMAREQ_MUX_SEL15	Selects between two possible sources for SDMA_EVENT[47]: 0 uart6.ipd_uart_tx_dmareq_b 1 esai.ipd_esai_tx_b
14 DMAREQ_MUX_SEL14	Selects between two possible sources for SDMA_EVENT[0]: 0 uart6.ipd_uart_rx_dmareq_b 1 esai.ipd_easi_rx_b
13 DMAREQ_MUX_SEL13	Selects between two possible sources for SDMA_EVENT[34]: 0 uart5.ipd_uart_rx_dmareq_b 1 epdc.epdc_irq
12 DMAREQ_MUX_SEL12	Reserved
11 DMAREQ_MUX_SEL11	Selects between two possible sources for SDMA_EVENT[46]: 0 uart8.ipd_uart_tx_dmareq_b 1 enet2.ipd_req_mac0_timer[1]
10 DMAREQ_MUX_SEL10	Selects between two possible sources for SDMA_EVENT[45]: 0 uart8.ipd_uart_rx_dmareq_b 1 enet2.ipd_req_mac0_timer[0]
9 DMAREQ_MUX_SEL9	Selects between two possible sources for SDMA_EVENT[44]: 0 uart7.ipd_uart_tx_dmareq_b 1 enet1.ipd_req_mac0_timer[1]

Table continues on the next page...

IOMUXC_GPR_GPR0 field descriptions (continued)

Field	Description
8 DMAREQ_MUX_SEL8	Selects between two possible sources for SDMA_EVENT[43]: 0 uart7.ipd_uart_rx_dmareq_b 1 enet1.ipd_req_mac0_timer[0]
7 DMAREQ_MUX_SEL7	Selects between two possible sources for SDMA_EVENT[13]: 0 adc2.ipd_req 1 tsc irq
6 DMAREQ_MUX_SEL6	Selects between two possible sources for SDMA_EVENT[24]: 0 gpt2.ipi_int_gpt 1 lcdif.lcdif_irq
5 DMAREQ_MUX_SEL5	Selects between two possible sources for SDMA_EVENT[16]: 0 epit1.ipi_int_epit_oc 1 csi.ipi_csi_int_b
4 DMAREQ_MUX_SEL4	Selects between two possible sources for SDMA_EVENT[10]: 0 ecspi4.ipd_req_cspi_tdma_b 1 i2c4.ipi_int_b
3 DMAREQ_MUX_SEL3	Selects between two possible sources for SDMA_EVENT[9]: 0 ecspi4.ipd_req_cspi_rdma_b 1 i2c3.ipi_int_b
2 DMAREQ_MUX_SEL2	Selects between two possible sources for SDMA_EVENT[8]: 0 ecspi3.ipd_req_cspi_tdma_b 1 i2c2.ipi_int_b
1 DMAREQ_MUX_SEL1	Selects between two possible sources for SDMA_EVENT[7]: 0 ecspi3.ipd_req_cspi_rdma_b 1 i2c1.ipi_int_b
0 DMAREQ_MUX_SEL0	Selects between two possible sources for SDMA_EVENT[2]: 0 epit2.ipi_int_epit_oc 1 pxp.pxp_irq

32.4.2 GPR1 General Purpose Register (IOMUXC_GPR_GPR1)

GPR Register

Address: 20E_4000h base + 4h offset = 20E_4004h

Bit	31	30	29	28	27	26	25	24	23	22	21	20	19	18	17	16
R	Reserved					ARMA7_CLK_AHB_EN	ARMA7_CLK_ATB_EN	ARMA7_CLK_APB_DBG_EN	TZASC1_BOOT_LOCK	EXC_MON	SAI3_MCLK_DIR	SAI2_MCLK_DIR	SAI1_MCLK_DIR	ENET2_TX_CLK_DIR	ENET1_TX_CLK_DIR	ADD_DS
W	Reserved					ARMA7_CLK_AHB_EN	ARMA7_CLK_ATB_EN	ARMA7_CLK_APB_DBG_EN	TZASC1_BOOT_LOCK	EXC_MON	SAI3_MCLK_DIR	SAI2_MCLK_DIR	SAI1_MCLK_DIR	ENET2_TX_CLK_DIR	ENET1_TX_CLK_DIR	ADD_DS
Reset	0	0	0	0	1	1	1	1	0	1	0	0	0	0	0	0
Bit	15	14	13	12	11	10	9	8	7	6	5	4	3	2	1	0
R	USB_EXP_MODE	ENET2_CLK_SEL	ENET1_CLK_SEL	GINT	ADDRS3[10]	ACT_CS3	ADDRS2[10]	ACT_CS2	ADDRS1[10]	ACT_CS1	ADDRS0[10]	ACT_CS0				
W	USB_EXP_MODE	ENET2_CLK_SEL	ENET1_CLK_SEL	GINT	ADDRS3[10]	ACT_CS3	ADDRS2[10]	ACT_CS2	ADDRS1[10]	ACT_CS1	ADDRS0[10]	ACT_CS0				
Reset	0	0	0	0	0	0	0	0	0	0	0	0	0	1	0	1

IOMUXC_GPR_GPR1 field descriptions

Field	Description
31–27 -	Reserved This field is reserved.
26 ARMA7_CLK_AHB_EN	ARM A7 platform AHB clock enable 0 AHB clock is not running (gated) 1 AHB clock is running (enabled)
25 ARMA7_CLK_ATB_EN	ARM A7 platform ATB clock enable 0 ATB clock is not running (gated) 1 ATB clock is running (enabled)
24 ARMA7_CLK_APB_DBG_EN	ARM A7 platform APB clock enable 0 APB clock is not running (gated) 1 APB clock is running (enabled)
23 TZASC1_BOOT_LOCK	TZASC-1 secure boot lock 0 secure boot lock is disabled 1 secure boot lock is enabled

Table continues on the next page...

IOMUXC_GPR_GPR1 field descriptions (continued)

Field	Description
22 EXC_MON	Exclusive monitor response select of illegal command 0 OKAY response 1 SLVError response (default)
21 SAI3_MCLK_DIR	LCD_CLK data direction control when sai3.MCLK is selected (ALT3) 0 LCD_CLK output driver is disabled when configured for ALT3 1 LCD_CLK output driver is enabled when configured for ALT3
20 SAI2_MCLK_DIR	SD1_CLK data direction control when sai2.MCLK is selected (ALT2) 0 SD1_CLK output driver is disabled when configured for ALT2 1 SD1_CLK output driver is enabled when configured for ALT2
19 SAI1_MCLK_DIR	LCD_DATA00 data direction control when sai1.MCLK is selected (ALT8) 0 LCD_DATA00 output driver is disabled when configured for ALT8 1 LCD_DATA00 output driver is enabled when configured for ALT8
18 ENET2_TX_CLK_DIR	ENET2_TX_CLK data direction control when anatop. ENET_REF_CLK2 is selected (ALT1) 0 ENET2_TX_CLK output driver is disabled when configured for ALT1 1 ENET2_TX_CLK output driver is enabled when configured for ALT1
17 ENET1_TX_CLK_DIR	ENET1_TX_CLK data direction control when anatop. ENET_REF_CLK1 is selected (ALT1) 0 ENET1_TX_CLK output driver is disabled when configured for ALT1 1 ENET1_TX_CLK output driver is enabled when configured for ALT1
16 ADD_DS	Setting ADD_DS to 0 will make the output driver of the SD3 pins ~10% stronger at highest drive strength (DSE=111). This is for use if the I/O buffer operation at WCS and 200 MHz is marginal. 0 output driver ~10% stronger 1 output driver is normal
15 USB_EXP_MODE	USB Exposure mode 0 Exposure mode is disabled. 1 Exposure mode is enabled.
14 ENET2_CLK_SEL	ENET2 reference clock mode select. 0 ENET2 TX reference clock driven by ref_enetpll. This clock is also output to pins via the IOMUX. ENET_REF_CLK2 function. 1 Gets ENET2 TX reference clk from the ENET2_TX_CLK pin. In this use case, an external OSC provides the clock for both the external PHY and the internal controller
13 ENET1_CLK_SEL	ENET1 reference clock mode select. 0 ENET1 TX reference clock driven by ref_enetpll. This clock is also output to pins via the IOMUX. ENET_REF_CLK1 function. 1 Gets ENET1 TX reference clk from the ENET1_TX_CLK pin. In this use case, an external OSC provides the clock for both the external PHY and the internal controller
12 GINT	Global interrupt "0" bit (connected to ARM A7 IRQ#0 and GPC) 0 Global interrupt request is not asserted 1 Global interrupt request is asserted

Table continues on the next page...

IOMUXC_GPR_GPR1 field descriptions (continued)

Field	Description
11–10 ADDRS3[10]	<p>Active Chip Select and Address Space.</p> <p>Each of the ACT_CSx represents one of the four chip selects of the EIM. When ACT_CSx=1'b1, the corresponding chip select is active and has a valid address space according to its address space configuration determined by ADDRSx[10] bits</p> <p>ADDRSx[10] is setting the space for each chip select which is active. The address space of the first active chip select must be the biggest one, the following active chip select address spaces may be equal or lower.</p> <p>Total address space size is 128 MByte.</p> <p>The supported configurations are:</p> <p>CS0(128M), CS1 (0M), CS2 (0M), CS3(0M) [default configuration]</p> <p>CS0(64M), CS1(64M), CS2(0M), CS3(0M)</p> <p>CS0(64M), CS1(32M), CS2(32M), CS3(0M)</p> <p>CS0(32M), CS1(32M), CS2(32M), CS3(32M)</p> <p>Address Space Configuration options (ADDRSx[10]):</p> <p>00 32 MByte 01 64 MByte 10 128 MByte 11 Reserved</p>
9 ACT_CS3	See description for ADDRS3[10]
8–7 ADDRS2[10]	See description for ADDRS3[10]
6 ACT_CS2	See description for ADDRS3[10]
5–4 ADDRS1[10]	See description for ADDRS3[10]
3 ACT_CS1	See description for ADDRS3[10]
2–1 ADDRS0[10]	See description for ADDRS3[10]
0 ACT_CS0	See description for ADDRS3[10]

32.4.3 GPR2 General Purpose Register (IOMUXC_GPR_GPR2)

GPR Register

Address: 20E_4000h base + 8h offset = 20E_4008h

Bit	31	30	29	28	27	26	25	24	23	22	21	20	19	18	17	16
R									MQS_CLK_DIV							
W	DRAM_CKE_BYPASS	DRAM_CKE1	DRAM_CKE0	DRAM_RESET	DRAM_RESET_BYPASS	MQS_OVERSAMPLE	MQS_EN	MQS_SW_RST								
Reset	0	0	0	0	0	0	0	0	0	0	0	0	0	0	0	0
Bit	15	14	13	12	11	10	9	8	7	6	5	4	3	2	1	0
R	L2_MEM_LIGHTSLEEP	L2_MEM_DEEPSLEEP	L2_MEM_SHUTDOWN	L2_MEM_EN_POWERSAVING	LCDIF2_MEM_LIGHTSLEEP	LCDIF2_MEM_DEEPSLEEP	LCDIF2_MEM_SHUTDOWN	LCDIF2_MEM_EN_POWERSAVING	LCDIF1_MEM_LIGHTSLEEP	LCDIF1_MEM_DEEPSLEEP	LCDIF1_MEM_SHUTDOWN	LCDIF1_MEM_EN_POWERSAVING	PXP_MEM_LIGHTSLEEP	PXP_MEM_DEEPSLEEP	PXP_MEM_SHUTDOWN	PXP_MEM_EN_POWERSAVING
W																
Reset	0	0	0	0	0	0	0	0	0	0	0	0	0	0	0	0

IOMUXC_GPR_GPR2 field descriptions

Field	Description
31 DRAM_CKE_BYPASS	DRAM CKE Bypass Select 0 DRAM CKE1, CKE0 driven by MMDC PHY Controller 1 DRAM CKE1, CKE0 driven by GPR2 register bits [30:29]
30 DRAM_CKE1	CKE1 Bypass Value 0 Drive CKE1 with 0 1 Drive CKE1 with 1
29 DRAM_CKE0	CKE0 Bypass Value 0 Drive CKE0 with 0 1 Drive CKE0 with 1
28 DRAM_RESET	DRAM Reset Value 0 Drive DRAM reset with 0 1 Drive DRAM reset with 1
27 DRAM_RESET_BYPASS	DRAM Reset Bypass Select

Table continues on the next page...

IOMUXC_GPR_GPR2 field descriptions (continued)

Field	Description
	0 DRAM reset driven by MMDc PHY Controller 1 DRAM reset driven by GPR2 register bit [28]
26 MQS_ OVERSAMPLE	Used to control the PWM oversampling rate compared with mclk. 0 32 1 64
25 MQS_EN	MQS enable. 0 Disable MQS 1 Enable MQS
24 MQS_SW_RST	MQS software reset. 0 Exit software reset for MQS 1 Enable software reset for MQS
23–16 MQS_CLK_DIV	Divider ratio control for mclk from hmclk. $mclk \text{ frequency} = 1/(n+1) * hmclk \text{ frequency}$. 00000000 mclk frequency = hmclk frequency 00000001 mclk frequency = 1/2 * hmclk frequency 00000010 mclk frequency = 1/3 * hmclk frequency 11111111 mclk frequency = 1/256 * hmclk frequency
15 L2_MEM_ LIGHTSLEEP	set to bring memory to light sleep state (Low leakage mode, maintain memory contents, no change to memory output)
14 L2_MEM_ DEEPSLEEP	control how memory enter Deep Sleep mode (shutdown periphery power, but maintain memory contents, outputs of memory are pulled low) 0 no force sleep control supported, memory deep sleep mode only entered when whole system in stop mode 1 force memory into deep sleep mode
13 L2_MEM_ SHUTDOWN	set to bring memory to shutdown state (most power saving state, Shut Down periphery and core, no memory retention)
12 L2_MEM_EN_ POWERSAVING	enable power saving features on L2 memory 0 none memory power saving features enabled, SHUTDOWN/DEEPSLEEP/LIGHTSLEEP will have no effect 1 memory power saving features enabled, set SHUTDOWN/DEEPSLEEP/LIGHTSLEEP(priority high to low) to enable power saving levels
11 LCDIF2_MEM_ LIGHTSLEEP	set to bring memory to light sleep state (Low leakage mode, maintain memory contents, no change to memory output)
10 LCDIF2_MEM_ DEEPSLEEP	control how memory enter Deep Sleep mode (shutdown periphery power, but maintain memory contents, outputs of memory are pulled low) 0 no force sleep control supported, memory deep sleep mode only entered when whole system in stop mode 1 force memory into deep sleep mode
9 LCDIF2_MEM_ SHUTDOWN	set to bring memory to shutdown state (most power saving state, Shut Down periphery and core, no memory retention)

Table continues on the next page...

IOMUXC_GPR_GPR2 field descriptions (continued)

Field	Description
8 LCDIF2_MEM_EN_POWERSAVING	enable power saving features on LCDIF memory 0 none memory power saving features enabled, SHUTDOWN/DEEPSLEEP/LIGHTSLEEP will have no effect 1 memory power saving features enabled, set SHUTDOWN/DEEPSLEEP/LIGHTSLEEP(priority high to low) to enable power saving levels
7 LCDIF1_MEM_LIGHTSLEEP	set to bring memory to light sleep state (Low leakage mode, maintain memory contents, no change to memory output)
6 LCDIF1_MEM_DEEPSLEEP	control how memory enter Deep Sleep mode (shutdown periphery power, but maintain memory contents, outputs of memory are pulled low) 0 no force sleep control supported, memory deep sleep mode only entered when whole system in stop mode 1 force memory into deep sleep mode
5 LCDIF1_MEM_SHUTDOWN	set to bring memory to shutdown state (most power saving state, Shut Down periphery and core, no memory retention)
4 LCDIF1_MEM_EN_POWERSAVING	enable power saving features on LCDIF memory 0 none memory power saving features enabled, SHUTDOWN/DEEPSLEEP/LIGHTSLEEP will have no effect 1 memory power saving features enabled, set SHUTDOWN/DEEPSLEEP/LIGHTSLEEP(priority high to low) to enable power saving levels
3 PXP_MEM_LIGHTSLEEP	set to bring memory to light sleep state (Low leakage mode, maintain memory contents, no change to memory output)
2 PXP_MEM_DEEPSLEEP	control how memory enter Deep Sleep mode (shutdown periphery power, but maintain memory contents, outputs of memory are pulled low) 0 no force sleep control supported, memory deep sleep mode only entered when whole system in stop mode 1 force memory into deep sleep mode
1 PXP_MEM_SHUTDOWN	set to bring memory to shutdown state (most power saving state, Shut Down periphery and core, no memory retention)
0 PXP_MEM_EN_POWERSAVING	enable power saving features on PXP memory 0 none memory power saving features enabled, SHUTDOWN/DEEPSLEEP/LIGHTSLEEP will have no effect 1 memory power saving features enabled, set SHUTDOWN/DEEPSLEEP/LIGHTSLEEP(priority high to low) to enable power saving levels

32.4.4 GPR3 General Purpose Register (IOMUXC_GPR_GPR3)

GPR Register

Address: 20E_4000h base + Ch offset = 20E_400Ch

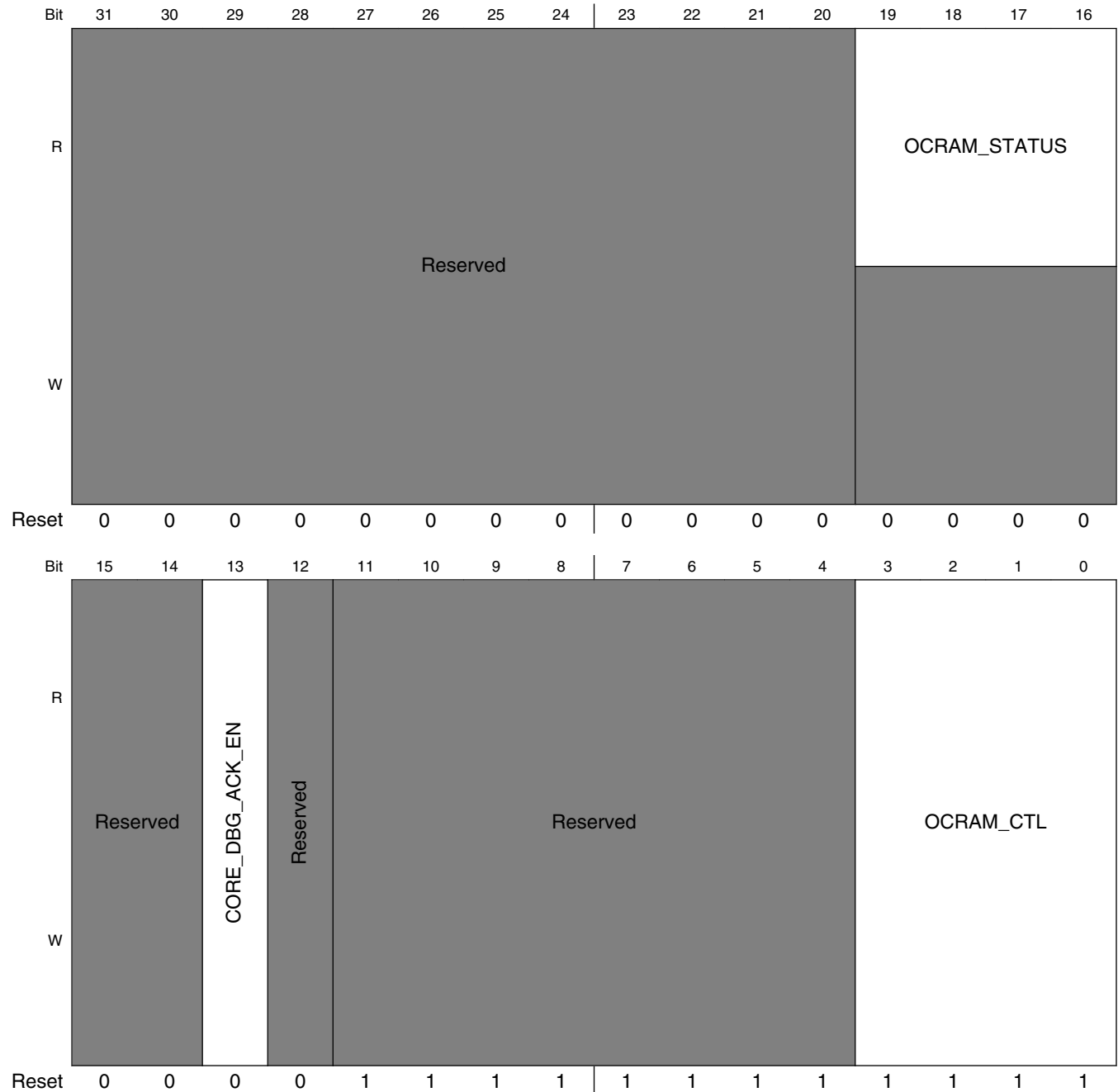

IOMUXC_GPR_GPR3 field descriptions

Field	Description
31–20 -	This field is reserved. Reserved
19–16 OCRAM_ STATUS	<p>This field shows the OCRAM pipeline settings status, controlled by OCRAM_CTL[24:21] bits respectively. When the control bit is changed, the corresponding status bit goes high and keeps high until this new configuration is applied the internal logic. This provides a way for software to detect that the configuration has become valid. The suggested flow for changing the configuration in software is:</p> <ul style="list-style-type: none"> • set/clear the control bit • poll the status bit until it goes to 0 <p>OCRAM_STATUS[19] shows the write address pipeline status. This bit value reflects the propagation of the respective control bit to OCRAM memory.</p> <p>OCRAM_STATUS[18] shows the write data pipeline status. This bit value reflects the propagation of the respective control bit to OCRAM memory.</p> <p>OCRAM_STATUS[17] shows the read address pipeline status. This bit value reflects the propagation of the respective control bit to OCRAM memory.</p> <p>OCRAM_STATUS[16] shows the read data pipeline status. This bit value reflects the propagation of the respective control bit to OCRAM memory.</p> <p>0 read data pipeline configuration valid 1 read data pipeline control bit changed</p>
15–14 -	This field is reserved. Reserved
13 CORE_DBG_ ACK_EN	<p>Mask control of Core debug acknowledge to global debug acknowledge</p> <p>0 Core debug acknowledge is part of global acknowledge. 1 Core debug acknowledge is masked by this bit, and it is not part of global acknowledge.</p>
12 -	This field is reserved. Reserved
11–4 -	This field is reserved. Reserved
OCRAM_CTL	<p>OCRAM_CTL[3] write address pipeline control bit.</p> <p>When this feature is enabled, the write address from the AXI master would be delayed 1 cycle before it can be accepted by the on-chip RAM. This can avoid setup time issue for the write access on the memory cell at high frequency. Enable this feature would cost at most 1 more clock cycle for each AXI write transaction, i.e., at most 1 more clock cycle for each write burst with multiple beats of data. When this feature is disabled, the write address from the AXI master can be accepted by the on-chip RAM without delay, and data can be written to memory at this cycle (if no other access and write data is also ready at this cycle).</p> <p>0 write address pipeline is disabled 1 write address pipeline is enabled</p> <p>OCRAM_CTL[2] - write data pipeline control bit</p> <p>When this feature is enabled, the write data from the AXI master would be delayed 1 cycle before it can be accepted by the on-chip RAM. This can avoid setup time issue for the write access on the memory cell at high frequency. Enabling this feature would cost at most 1 more clock cycle for each AXI write transaction, i.e., at most 1 more clock cycle for each write burst with multiple beats of data.</p>

Table continues on the next page...

IOMUXC_GPR_GPR3 field descriptions (continued)

Field	Description
	<p>When this feature is disabled, the write data from the AXI master can be accepted by the on-chip RAM without delay, and data can be written to memory at this cycle (if no other access and write address is also ready at this cycle).</p> <p>0 write data pipeline is disabled 1 write data pipeline is enabled</p> <p>OGRAM_CTL[1] read address pipeline control bit.</p> <p>When this feature is enabled, the read address from the AXI master would be delayed 1 cycle before it can be accepted by the on-chip RAM. This can avoid setup time issue for the read access on the memory cell at high frequency. Enable this feature would cost at most 1 more clock cycle for each AXI read transaction, i.e., at most 1 more clock cycle for each read burst with multiple beats of data. When this feature is disabled, the read address from the AXI master can be accepted by the on-chip RAM without delay, and data can become ready for master at next clock cycle (if no other access and no read data wait).</p> <p>0 read address pipeline is disabled 1 read address pipeline is enabled</p> <p>OGRAM_CTL[0] - read data wait state control bit</p> <p>When thread data wait state is enabled, it will cost 2 cycles for each read access, (each beat of a read burst). This can avoid the potential timing problem caused by the relatively longer memory access time at higher frequency. When this feature is disabled, it only costs 1 clock cycle to finish a read transaction, i.e., get read data back in the next cycle of read request becomes valid on the bus.</p> <p>0 read data pipeline is disabled 1 read data pipeline is enabled</p>

32.4.5 GPR4 General Purpose Register (IOMUXC_GPR_GPR4)

GPR Register

Address: 20E_4000h base + 10h offset = 20E_4010h

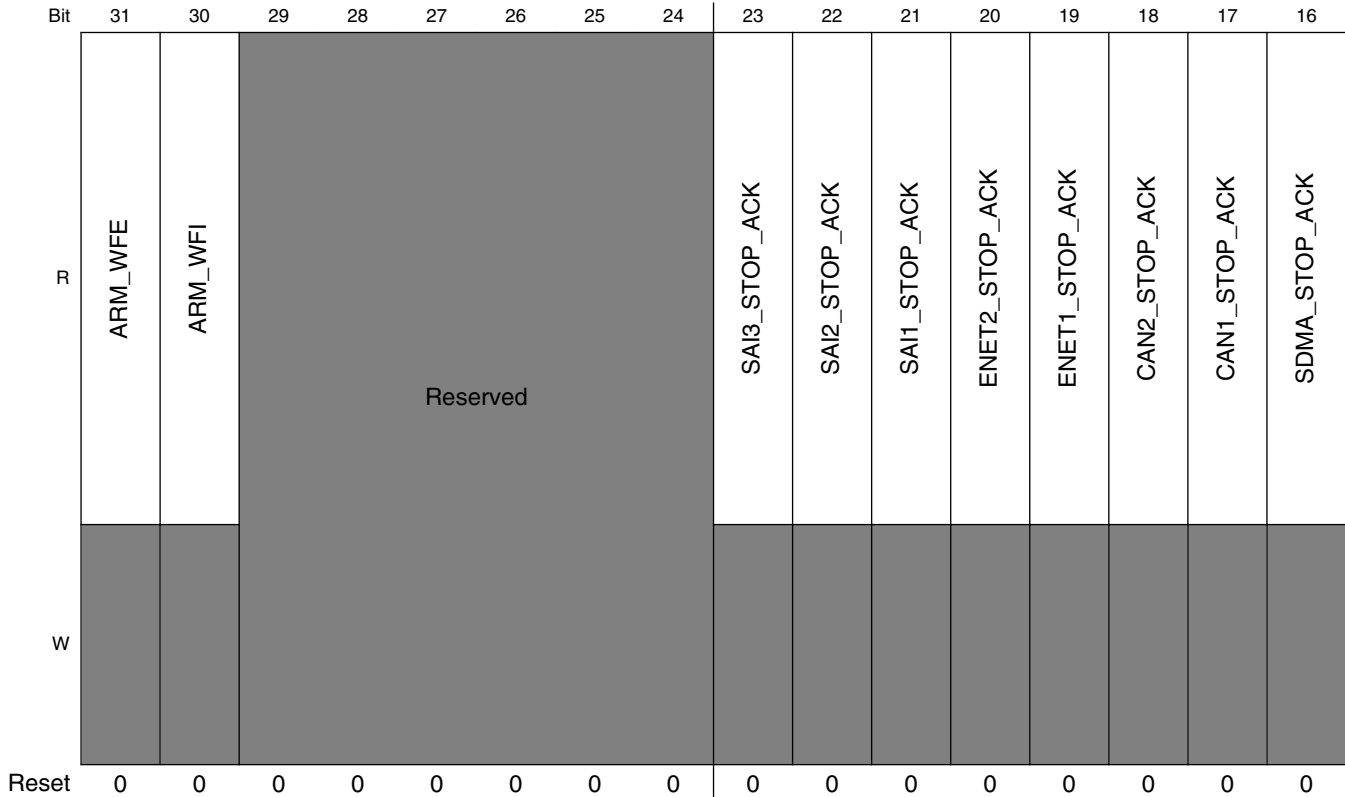

IOMUXC GPR Memory Map/Register Definition

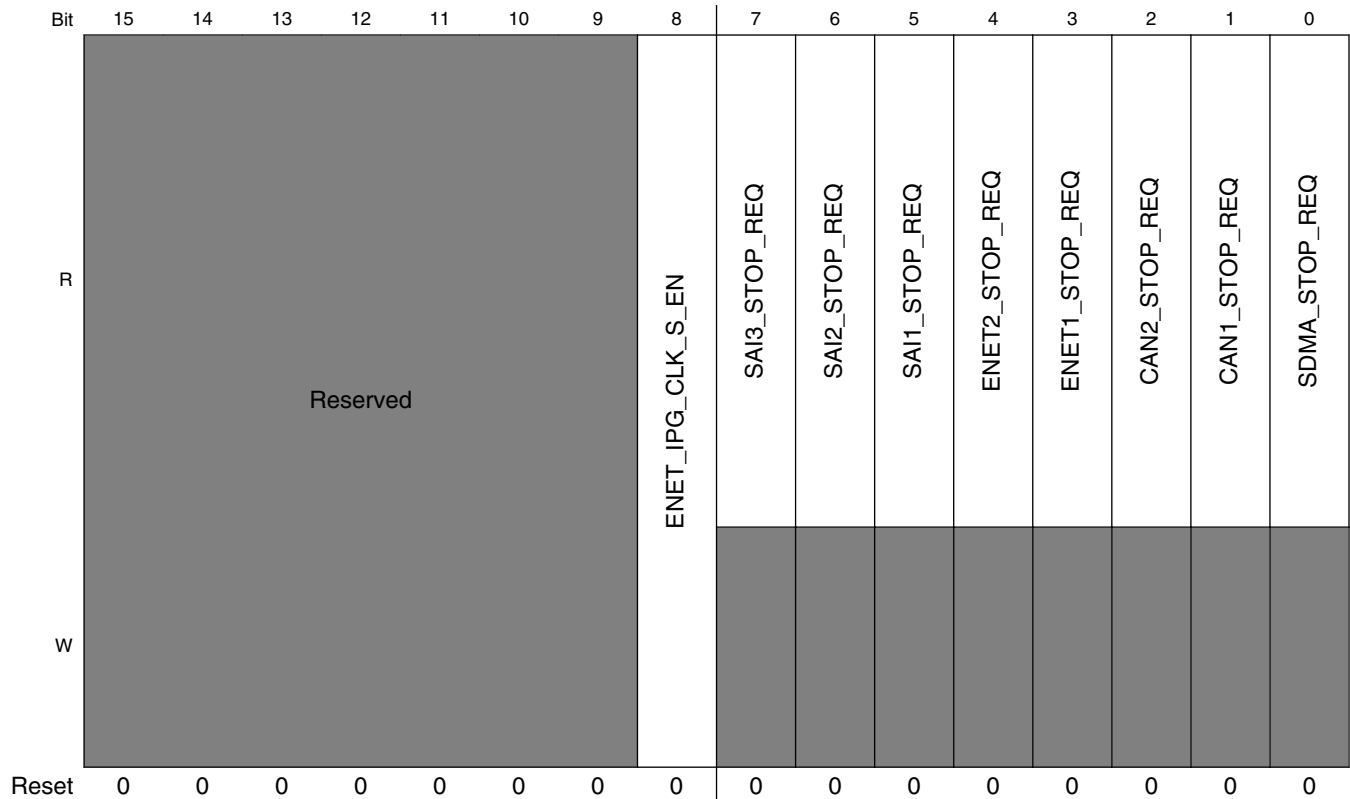

IOMUXC_GPR_GPR4 field descriptions

Field	Description
31 ARM_WFE	ARM A7 WFE event out indication on WFE state of the cores (these are status, read only bits) 0 ARM Core[GPR5-index - 4] is not in WFE mode 1 ARM Core[GPR5-index - 4] is in WFE mode
30 ARM_WFI	ARM A7 WFI event out indicating on WFI state of the cores (these are status, read only bits) 0 ARM Core[GPR5-index] is not in WFI mode 1 ARM Core[GPR5-index] is in WFI mode
29–24 -	This field is reserved. Reserved
23 SAI3_STOP_ACK	SAI3 stop acknowledge. This is a status (read-only) bit 0 SAI3 stop acknowledge is not asserted 1 SAI3 stop acknowledge is asserted, SDMA is in STOP mode
22 SAI2_STOP_ACK	SAI2 stop acknowledge. This is a status (read-only) bit 0 SAI2 stop acknowledge is not asserted 1 SAI2 stop acknowledge is asserted, SDMA is in STOP mode
21 SAI1_STOP_ACK	SAI1 stop acknowledge. This is a status (read-only) bit 0 SAI1 stop acknowledge is not asserted 1 SAI1 stop acknowledge is asserted, SDMA is in STOP mode

Table continues on the next page...

IOMUXC_GPR_GPR4 field descriptions (continued)

Field	Description
20 ENET2_STOP_ACK	ENET2 stop acknowledge. This is a status (read-only) bit 0 ENET2 stop acknowledge is not asserted 1 ENET2 stop acknowledge is asserted, SDMA is in STOP mode
19 ENET1_STOP_ACK	ENET1 stop acknowledge. This is a status (read-only) bit 0 ENET1 stop acknowledge is not asserted 1 ENET1 stop acknowledge is asserted, SDMA is in STOP mode
18 CAN2_STOP_ACK	CAN2 stop acknowledge. This is a status (read-only) bit 0 CAN2 stop acknowledge is not asserted 1 CAN2 stop acknowledge is asserted, SDMA is in STOP mode
17 CAN1_STOP_ACK	CAN1 stop acknowledge. This is a status (read-only) bit 0 CAN1 stop acknowledge is not asserted 1 CAN1 stop acknowledge is asserted, SDMA is in STOP mode
16 SDMA_STOP_ACK	SDMA stop acknowledge. This is a status (read-only) bit 0 SDMA stop acknowledge is not asserted 1 SDMA stop acknowledge is asserted, SDMA is in STOP mode
15–9 -	This field is reserved. Reserved
8 ENET_IPG_CLK_S_EN	ENET ipg_clk_s clock gating enable 0 ipg_clk_s is gated when there's no IPS access 1 ipg_clk_s is always on
7 SAI3_STOP_REQ	SAI3 stop request. 0 stop request off 1 stop request on
6 SAI2_STOP_REQ	SAI2 stop request. 0 stop request off 1 stop request on
5 SAI1_STOP_REQ	SAI1 stop request. 0 stop request off 1 stop request on
4 ENET2_STOP_REQ	ENET2 stop request. 0 stop request off 1 stop request on
3 ENET1_STOP_REQ	ENET1 stop request. 0 stop request off 1 stop request on
2 CAN2_STOP_REQ	CAN2 stop request.

Table continues on the next page...

IOMUXC_GPR_GPR4 field descriptions (continued)

Field	Description
	0 stop request off 1 stop request on
1 CAN1_STOP_REQ	CAN1 stop request. 0 stop request off 1 stop request on
0 SDMA_STOP_REQ	SDMA stop request. 0 stop request off 1 stop request on

32.4.6 GPR5 General Purpose Register (IOMUXC_GPR_GPR5)

GPR Register

Address: 20E_4000h base + 14h offset = 20E_4014h

Bit	31	30	29	28	27	26	25	24	23	22	21	20	19	18	17	16
R	REF_1M_CLK_EPIT2	REF_1M_CLK_EPIT1	VREF_1M_CLK_GPT2	VREF_1M_CLK_GPT1	Reserved	ENET2_EVENT3IN_SEL	ENET1_EVENT3IN_SEL	GPT2_CAPIN2_SEL	GPT2_CAPIN1_SEL	Reserved	Reserved	WDOG3_MASK	Reserved	Reserved	LCDIF_HANDSHAKE_PXP	
W																
Reset	0	0	0	0	0	0	0	0	0	0	0	0	0	0	0	0
Bit	15	14	13	12	11	10	9	8	7	6	5	4	3	2	1	0
R	Reserved	Reserved	LCDIF_HANDSHAKE_LCDIF	Reserved	Reserved	LCDIF_HANDSHAKE_CSI	Reserved	Reserved	WDOG2_MASK	WDOG1_MASK	Reserved	Reserved	Reserved	Reserved	Reserved	Reserved
W																
Reset	0	0	0	0	0	0	0	0	0	0	0	0	0	0	0	0

IOMUXC_GPR_GPR5 field descriptions

Field	Description
31 REF_1M_CLK_EPIT2	EPIT2 1 MHz clock source select

Table continues on the next page...

IOMUXC_GPR_GPR5 field descriptions (continued)

Field	Description
	0 EPIT2 ipg_clk_highfreq driven by IPG_PERCLK 1 EPIT2 ipg_clk_highfreq driven by anatop 1 MHz clock
30 REF_1M_CLK_ EPIT1	EPIT1 1 MHz clock source select 0 EPIT1 ipg_clk_highfreq driven by IPG_PERCLK 1 EPIT1 ipg_clk_highfreq driven by anatop 1 MHz clock
29 VREF_1M_CLK_ GPT2	GPT2 1 MHz clock source select 0 GPT2 ipg_clk_highfreq driven by IPG_PERCLK 1 GPT2 ipg_clk_highfreq driven by anatop 1 MHz clock
28 VREF_1M_CLK_ GPT1	GPT1 1 MHz clock source select 0 GPT1 ipg_clk_highfreq driven by IPG_PERCLK 1 GPT1 ipg_clk_highfreq driven by anatop 1 MHz clock
27 -	This field is reserved. Reserved
26 ENET2_ EVENT3IN_SEL	ENET2 input timer event3 source select 0 event3 source input from pad 1 event3 source input from gpt2.ipp_do_cmpout2
25 ENET1_ EVENT3IN_SEL	ENET1 input timer event3 source select 0 event3 source input from pad 1 event3 source input from gpt2.ipp_do_cmpout1
24 GPT2_CAPIN2_ SEL	GPT2 input capture channel 2 source select 0 source from pad 1 source from enet2.ipp_do_mac0_timer[3]
23 GPT2_CAPIN1_ SEL	GPT2 input capture channel 1 source select 0 source from pad 1 source from enet1.ipp_do_mac0_timer[3]
22–21 -	This field is reserved. Reserved
20 WDOG3_MASK	WDOG3 Timeout Mask 0 WDOG3 Timeout behaves normally 1 WDOG3 Timeout is masked
19–18 -	This field is reserved. Reserved
17–16 LCDIF_ HANDSHAKE_ PXP	PXP Input Handshake Select 00 LCDIF done input to PXP comes from LCDIF 01 LCDIF done input to PXP tied to GND 10 LCDIF done input to PXP tied to GND 11 LCDIF done input to PXP tied to GND
15–14 -	This field is reserved. Reserved

Table continues on the next page...

IOMUXC_GPR_GPR5 field descriptions (continued)

Field	Description
13–12 LCDIF_ HANDSHAKE_ LCDIF	LCDIF Input Handshake Select 00 LCDIF input handshake signals come from CSI 01 LCDIF input handshake signals tied to GND 10 LCDIF input handshake signals come from PXP 11 LCDIF input handshake signals tied to GND
11–10 -	This field is reserved. Reserved
9–8 LCDIF_ HANDSHAKE_ CSI	CSI Input Handshake Select 00 LCDIF done input to CSI comes from LCDIF 01 LCDIF done input to CSI tied to GND 10 LCDIF done input to CSI tied to GND 11 LCDIF done input to CSI tied to GND
7 WDOG2_MASK	WDOG2 Timeout Mask 0 WDOG2 Timeout behaves normally 1 WDOG2 Timeout is masked
6 WDOG1_MASK	WDOG1 Timeout Mask 0 WDOG1 Timeout behaves normally 1 WDOG1 Timeout is masked
-	This field is reserved. Reserved

32.4.7 GPR9 General Purpose Register (IOMUXC_GPR_GPR9)

GPR Register

Address: 20E_4000h base + 24h offset = 20E_4024h

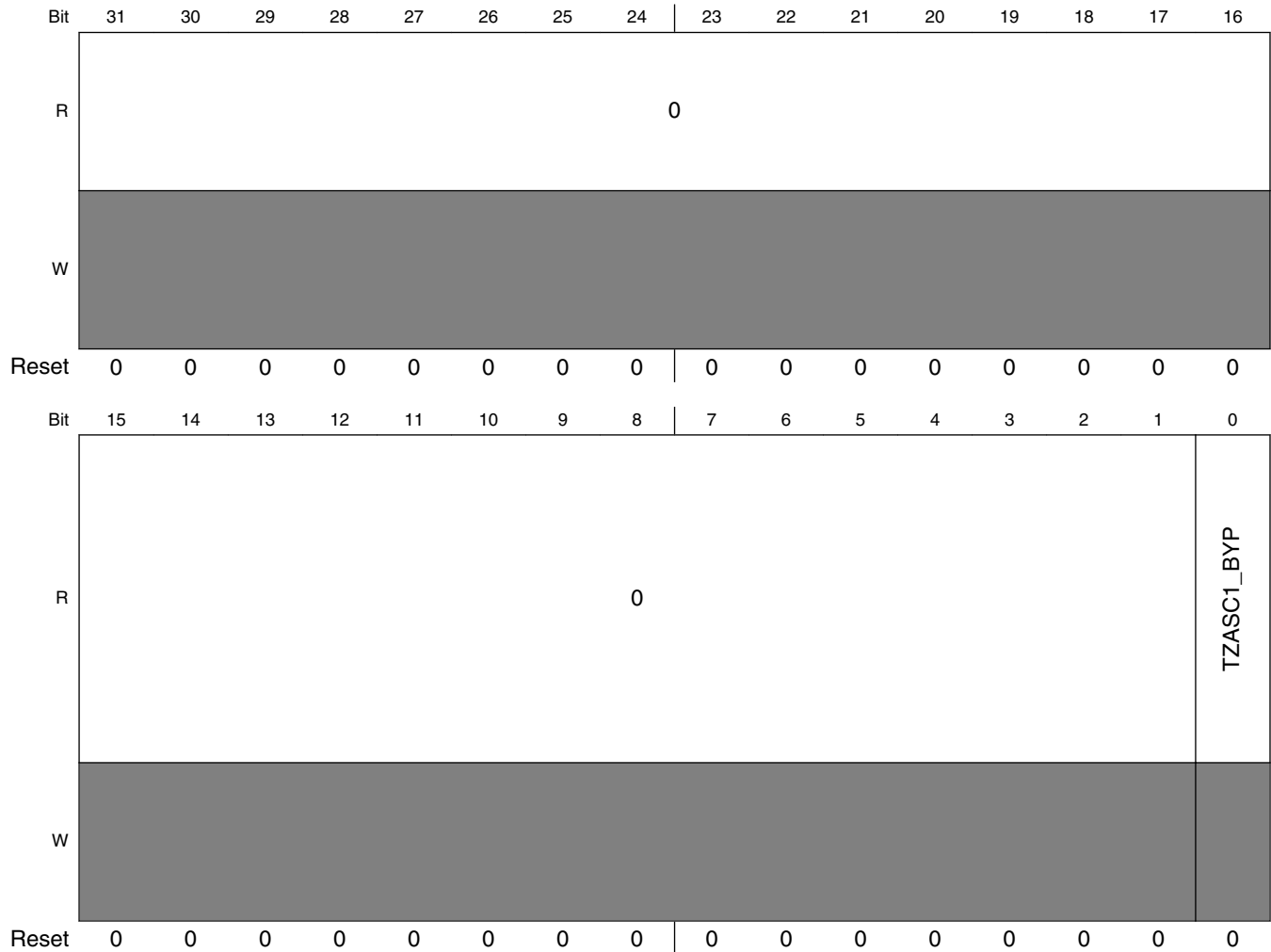

IOMUXC_GPR_GPR9 field descriptions

Field	Description
31–1 Reserved	This read-only field is reserved and always has the value 0.
0 TZASC1_BYP	TZASC-1 BYPASS MUX control 0 The TZASC-1 is bypassed and the transactions to DDR are not being checked. 1 The TZASC-1 is not bypassed and the transactions to DDR are being monitored / checked.

32.4.8 GPR10 General Purpose Register (IOMUXC_GPR_GPR10)

GPR Register

Address: 20E_4000h base + 28h offset = 20E_4028h

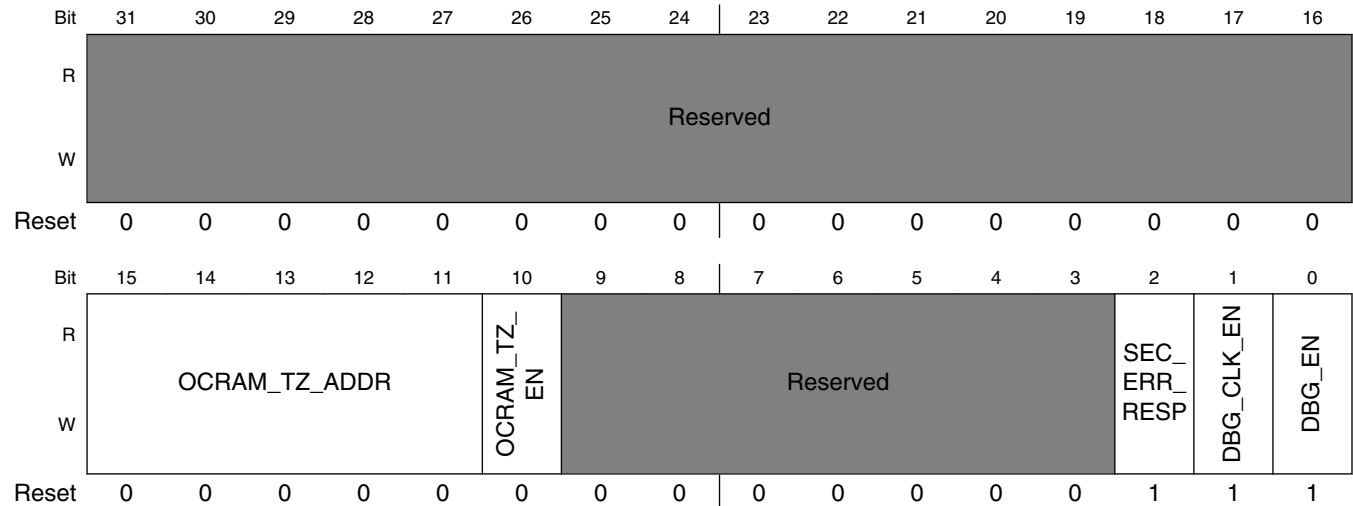

IOMUXC_GPR_GPR10 field descriptions

Field	Description
31–16 -	This field is reserved. Reserved
15–11 OCRAM_TZ_ADDR	OCRAM TrustZone (TZ) start address. This is the start address of the secure memory region within the OCRAM memory space is 4KB granularity. The start address affects the OCRAM transactions only if OCRAM_TZ_EN bit is set. The OCRAM TZ ENDADDR is not configurable and is set to the end of OCRAM memory space.
10 OCRAM_TZ_EN	OCRAM TrustZone (TZ) enable. 0 The TrustZone feature is disabled. Entire OCRAM space is available for all access types (secure/non-secure/user/supervisor). 1 The TrustZone feature is enabled. Access to address in the range specified by [ENDADDR:STARTADDR] follows the execution mode access policy described in CSU chapter.
9–3 -	This field is reserved. Reserved
2 SEC_ERR_RESP	Security error response enable for all security gaskets (on both AHB and AXI busses) 0 OKEY response 1 SLVError (default)
1 DBG_CLK_EN	ARM Debug clock enable 0 Debug turned off. 1 Debug enabled (default).
0 DBG_EN	ARM non secure (non-invasive) debug enable 0 Debug turned off. 1 Debug enabled (default).

32.4.9 GPR14 General Purpose Register (IOMUXC_GPR_GPR14)

GPR Register

Address: 20E_4000h base + 38h offset = 20E_4038h

Bit	31	30	29	28	27	26	25	24	23	22	21	20	19	18	17	16
R	GPR															
W	GPR															
Reset	0	0	0	0	0	0	0	0	0	0	0	0	0	0	0	0
Bit	15	14	13	12	11	10	9	8	7	6	5	4	3	2	1	0
R	GPR															Reserved
W	GPR															Reserved
Reset	0	0	0	0	0	0	0	0	0	0	0	0	0	0	0	0

IOMUXC_GPR_GPR14 field descriptions

Field	Description
31–2 GPR	General purpose bits General purpose bits to be used by SoC integration. Bit Type: DEFAULT
-	This field is reserved. Reserved

32.5 IOMUXC SNVS Memory Map/Register Definition

IOMUXC_SNVS memory map

Absolute address (hex)	Register name	Width (in bits)	Access	Reset value	Section/page
229_0000	SW_MUX_CTL_PAD_BOOT_MODE0 SW MUX Control Register (IOMUXC_SNVS_SW_MUX_CTL_PAD_BOOT_MODE0)	32	R/W	0000_0000h	32.5.1/1497
229_0004	SW_MUX_CTL_PAD_BOOT_MODE1 SW MUX Control Register (IOMUXC_SNVS_SW_MUX_CTL_PAD_BOOT_MODE1)	32	R/W	0000_0000h	32.5.2/1498
229_0008	SW_MUX_CTL_PAD_SNVS_TAMPER0 SW MUX Control Register (IOMUXC_SNVS_SW_MUX_CTL_PAD_SNVS_TAMPER0)	32	R/W	0000_0000h	32.5.3/1499
229_000C	SW_MUX_CTL_PAD_SNVS_TAMPER1 SW MUX Control Register (IOMUXC_SNVS_SW_MUX_CTL_PAD_SNVS_TAMPER1)	32	R/W	0000_0000h	32.5.4/1500
229_0010	SW_MUX_CTL_PAD_SNVS_TAMPER2 SW MUX Control Register (IOMUXC_SNVS_SW_MUX_CTL_PAD_SNVS_TAMPER2)	32	R/W	0000_0000h	32.5.5/1501

Table continues on the next page...

IOMUXC_SNVS memory map (continued)

Absolute address (hex)	Register name	Width (in bits)	Access	Reset value	Section/page
229_0014	SW_MUX_CTL_PAD_SNVS_TAMPER3 SW MUX Control Register (IOMUXC_SNVS_SW_MUX_CTL_PAD_SNVS_TAMPER3)	32	R/W	0000_0000h	32.5.6/1502
229_0018	SW_MUX_CTL_PAD_SNVS_TAMPER4 SW MUX Control Register (IOMUXC_SNVS_SW_MUX_CTL_PAD_SNVS_TAMPER4)	32	R/W	0000_0000h	32.5.7/1503
229_001C	SW_MUX_CTL_PAD_SNVS_TAMPER5 SW MUX Control Register (IOMUXC_SNVS_SW_MUX_CTL_PAD_SNVS_TAMPER5)	32	R/W	0000_0000h	32.5.8/1504
229_0020	SW_MUX_CTL_PAD_SNVS_TAMPER6 SW MUX Control Register (IOMUXC_SNVS_SW_MUX_CTL_PAD_SNVS_TAMPER6)	32	R/W	0000_0000h	32.5.9/1505
229_0024	SW_MUX_CTL_PAD_SNVS_TAMPER7 SW MUX Control Register (IOMUXC_SNVS_SW_MUX_CTL_PAD_SNVS_TAMPER7)	32	R/W	0000_0000h	32.5.10/1506
229_0028	SW_MUX_CTL_PAD_SNVS_TAMPER8 SW MUX Control Register (IOMUXC_SNVS_SW_MUX_CTL_PAD_SNVS_TAMPER8)	32	R/W	0000_0000h	32.5.11/1507
229_002C	SW_MUX_CTL_PAD_SNVS_TAMPER9 SW MUX Control Register (IOMUXC_SNVS_SW_MUX_CTL_PAD_SNVS_TAMPER9)	32	R/W	0000_0000h	32.5.12/1508
229_0030	SW_PAD_CTL_PAD_TEST_MODE SW PAD Control Register (IOMUXC_SNVS_SW_PAD_CTL_PAD_TEST_MODE)	32	R/W	0000_30A0h	32.5.13/1509
229_0034	SW_PAD_CTL_PAD_POR_B SW PAD Control Register (IOMUXC_SNVS_SW_PAD_CTL_PAD_POR_B)	32	R/W	0001_B0A0h	32.5.14/1511
229_0038	SW_PAD_CTL_PAD_ONOFF SW PAD Control Register (IOMUXC_SNVS_SW_PAD_CTL_PAD_ONOFF)	32	R/W	0001_B0A0h	32.5.15/1513
229_003C	SW_PAD_CTL_PAD_SNVS_PMIC_ON_REQ SW PAD Control Register (IOMUXC_SNVS_SW_PAD_CTL_PAD_SNVS_PMIC_ON_REQ)	32	R/W	0000_B8A0h	32.5.16/1515
229_0040	SW_PAD_CTL_PAD_CCM_PMIC_STBY_REQ SW PAD Control Register (IOMUXC_SNVS_SW_PAD_CTL_PAD_CCM_PMIC_STBY_REQ)	32	R/W	0000_20A0h	32.5.17/1517
229_0044	SW_PAD_CTL_PAD_BOOT_MODE0 SW PAD Control Register (IOMUXC_SNVS_SW_PAD_CTL_PAD_BOOT_MODE0)	32	R/W	0001_30A0h	32.5.18/1519
229_0048	SW_PAD_CTL_PAD_BOOT_MODE1 SW PAD Control Register (IOMUXC_SNVS_SW_PAD_CTL_PAD_BOOT_MODE1)	32	R/W	0001_30A0h	32.5.19/1521
229_004C	SW_PAD_CTL_PAD_SNVS_TAMPER0 SW PAD Control Register (IOMUXC_SNVS_SW_PAD_CTL_PAD_SNVS_TAMPER0)	32	R/W	0001_10A0h	32.5.20/1523

Table continues on the next page...

IOMUXC_SNVS memory map (continued)

Absolute address (hex)	Register name	Width (in bits)	Access	Reset value	Section/page
229_0050	SW_PAD_CTL_PAD_SNVS_TAMPER1 SW PAD Control Register (IOMUXC_SNVS_SW_PAD_CTL_PAD_SNVS_TAMPER1)	32	R/W	0001_10A0h	32.5.21/1525
229_0054	SW_PAD_CTL_PAD_SNVS_TAMPER2 SW PAD Control Register (IOMUXC_SNVS_SW_PAD_CTL_PAD_SNVS_TAMPER2)	32	R/W	0001_10A0h	32.5.22/1527
229_0058	SW_PAD_CTL_PAD_SNVS_TAMPER3 SW PAD Control Register (IOMUXC_SNVS_SW_PAD_CTL_PAD_SNVS_TAMPER3)	32	R/W	0001_10A0h	32.5.23/1529
229_005C	SW_PAD_CTL_PAD_SNVS_TAMPER4 SW PAD Control Register (IOMUXC_SNVS_SW_PAD_CTL_PAD_SNVS_TAMPER4)	32	R/W	0001_10A0h	32.5.24/1531
229_0060	SW_PAD_CTL_PAD_SNVS_TAMPER5 SW PAD Control Register (IOMUXC_SNVS_SW_PAD_CTL_PAD_SNVS_TAMPER5)	32	R/W	0001_10A0h	32.5.25/1533
229_0064	SW_PAD_CTL_PAD_SNVS_TAMPER6 SW PAD Control Register (IOMUXC_SNVS_SW_PAD_CTL_PAD_SNVS_TAMPER6)	32	R/W	0001_10A0h	32.5.26/1535
229_0068	SW_PAD_CTL_PAD_SNVS_TAMPER7 SW PAD Control Register (IOMUXC_SNVS_SW_PAD_CTL_PAD_SNVS_TAMPER7)	32	R/W	0001_10A0h	32.5.27/1537
229_006C	SW_PAD_CTL_PAD_SNVS_TAMPER8 SW PAD Control Register (IOMUXC_SNVS_SW_PAD_CTL_PAD_SNVS_TAMPER8)	32	R/W	0001_10A0h	32.5.28/1539
229_0070	SW_PAD_CTL_PAD_SNVS_TAMPER9 SW PAD Control Register (IOMUXC_SNVS_SW_PAD_CTL_PAD_SNVS_TAMPER9)	32	R/W	0001_10A0h	32.5.29/1541

32.5.1 SW_MUX_CTL_PAD_BOOT_MODE0 SW MUX Control Register (IOMUXC_SNVS_SW_MUX_CTL_PAD_BOOT_MODE0)

SW_MUX_CTL Register

Address: 229_0000h base + 0h offset = 229_0000h

Bit	31	30	29	28	27	26	25	24	23	22	21	20	19	18	17	16
R	Reserved															
W	Reserved															
Reset	0	0	0	0	0	0	0	0	0	0	0	0	0	0	0	0
Bit	15	14	13	12	11	10	9	8	7	6	5	4	3	2	1	0
R	Reserved											SION	MUX_MODE			
W	Reserved											SION	MUX_MODE			
Reset	0	0	0	0	0	0	0	0	0	0	0	0	0	0	0	0

IOMUXC_SNVS_SW_MUX_CTL_PAD_BOOT_MODE0 field descriptions

Field	Description
31–5 -	This field is reserved. Reserved
4 SION	Software Input On Field. Force the selected mux mode Input path no matter of MUX_MODE functionality. 1 ENABLED — Force input path of pad BOOT_MODE0 0 DISABLED — Input Path is determined by functionality
MUX_MODE	MUX Mode Select Field NOTE: ALT5 mode is only valid when BOOT MODE PIN is used as GPIO. 101 ALT5 — Select mux mode: ALT5 mux port, GPIO5_IO10 of instance - gpio5 Other Reserved

32.5.2 SW_MUX_CTL_PAD_BOOT_MODE1 SW MUX Control Register (IOMUXC_SNVS_SW_MUX_CTL_PAD_BOOT_MODE1)

SW_MUX_CTL Register

Address: 229_0000h base + 4h offset = 229_0004h

Bit	31	30	29	28	27	26	25	24	23	22	21	20	19	18	17	16
R	Reserved															
W	Reserved															
Reset	0	0	0	0	0	0	0	0	0	0	0	0	0	0	0	0
Bit	15	14	13	12	11	10	9	8	7	6	5	4	3	2	1	0
R	Reserved											SION		MUX_MODE		
W	Reserved											SION		MUX_MODE		
Reset	0	0	0	0	0	0	0	0	0	0	0	0	0	0	0	0

IOMUXC_SNVS_SW_MUX_CTL_PAD_BOOT_MODE1 field descriptions

Field	Description
31–5 -	This field is reserved. Reserved
4 SION	Software Input On Field. Force the selected mux mode Input path no matter of MUX_MODE functionality. 1 ENABLED — Force input path of pad BOOT_MODE1 0 DISABLED — Input Path is determined by functionality
MUX_MODE	MUX Mode Select Field NOTE: ALT5 mode is only valid when BOOT MODE PIN is used as GPIO.

Table continues on the next page...

IOMUXC_SNVS_SW_MUX_CTL_PAD_BOOT_MODE1 field descriptions (continued)

Field	Description
101	ALT5 — Select mux mode: ALT5 mux port, GPIO5_IO11 of instance - gpio5
Other	Reserved

32.5.3 SW_MUX_CTL_PAD_SNVS_TAMPER0 SW MUX Control Register (IOMUXC_SNVS_SW_MUX_CTL_PAD_SNVS_TAMPER0)

SW_MUX_CTL Register

Address: 229_0000h base + 8h offset = 229_0008h

Bit	31	30	29	28	27	26	25	24	23	22	21	20	19	18	17	16	
R	Reserved																
W	Reserved																
Reset	0	0	0	0	0	0	0	0	0	0	0	0	0	0	0	0	
Bit	15	14	13	12	11	10	9	8	7	6	5	4	3	2	1	0	
R	Reserved											SION		MUX_MODE			
W	Reserved											SION		MUX_MODE			
Reset	0	0	0	0	0	0	0	0	0	0	0	0	0	0	0	0	

IOMUXC_SNVS_SW_MUX_CTL_PAD_SNVS_TAMPER0 field descriptions

Field	Description
31–5 -	This field is reserved. Reserved
4 SION	Software Input On Field. Force the selected mux mode Input path no matter of MUX_MODE functionality. 1 ENABLED — Force input path of pad SNVS_TAMPER0 0 DISABLED — Input Path is determined by functionality
MUX_MODE	MUX Mode Select Field NOTE: ALT5 mode is only valid when TAMPER PIN is used as GPIO. This depends on FUSE setting "TAMPER_PIN_DISABLE[1:0]". Following is the mux information when TAMPER PIN is used as GPIO: SNVS_TAMPER0 ==> GPIO5_00 101 ALT5 — Select mux mode: ALT5 mux port, GPIO5_IO00 of instance - gpio5 Other Reserved

32.5.4 SW_MUX_CTL_PAD_SNVS_TAMPER1 SW MUX Control Register (IOMUXC_SNVS_SW_MUX_CTL_PAD_SNVS_TAMPER1)

SW_MUX_CTL Register

Address: 229_0000h base + Ch offset = 229_000Ch

Bit	31	30	29	28	27	26	25	24		23	22	21	20	19	18	17	16
R	Reserved																
W	Reserved																
Reset	0	0	0	0	0	0	0	0		0	0	0	0	0	0	0	0
Bit	15	14	13	12	11	10	9	8		7	6	5	4	3	2	1	0
R	Reserved												SION	MUX_MODE			
W	Reserved												SION	MUX_MODE			
Reset	0	0	0	0	0	0	0	0		0	0	0	0	0	0	0	0

IOMUXC_SNVS_SW_MUX_CTL_PAD_SNVS_TAMPER1 field descriptions

Field	Description
31-5 -	This field is reserved. Reserved
4 SION	Software Input On Field. Force the selected mux mode Input path no matter of MUX_MODE functionality. 1 ENABLED — Force input path of pad SNVS_TAMPER1 0 DISABLED — Input Path is determined by functionality
MUX_MODE	NOTE: ALT5 mode is only valid when TAMPER PIN is used as GPIO. This depends on FUSE setting "TAMPER_PIN_DISABLE[1:0]". Following is the mux information when TAMPER PIN is used as GPIO: SNVS_TAMPER1 ==> GPIO5_01 101 ALT5 — Select mux mode: ALT5 mux port, GPIO5_IO01 of instance - gpio5 Other Reserved

32.5.5 SW_MUX_CTL_PAD_SNVS_TAMPER2 SW MUX Control Register (IOMUXC_SNVS_SW_MUX_CTL_PAD_SNVS_TAMPER2)

SW_MUX_CTL Register

Address: 229_0000h base + 10h offset = 229_0010h

Bit	31	30	29	28	27	26	25	24	23	22	21	20	19	18	17	16
R	Reserved															
W	Reserved															
Reset	0	0	0	0	0	0	0	0	0	0	0	0	0	0	0	0
Bit	15	14	13	12	11	10	9	8	7	6	5	4	3	2	1	0
R	Reserved												SION		MUX_MODE	
W	Reserved												SION		MUX_MODE	
Reset	0	0	0	0	0	0	0	0	0	0	0	0	0	0	0	0

IOMUXC_SNVS_SW_MUX_CTL_PAD_SNVS_TAMPER2 field descriptions

Field	Description
31–5 -	This field is reserved. Reserved
4 SION	Software Input On Field. Force the selected mux mode Input path no matter of MUX_MODE functionality. 1 ENABLED — Force input path of pad SNVS_TAMPER2 0 DISABLED — Input Path is determined by functionality
MUX_MODE	NOTE: ALT5 mode is only valid when TAMPER PIN is used as GPIO. This depends on FUSE setting "TAMPER_PIN_DISABLE[1:0]". Following is the mux information when TAMPER PIN is used as GPIO: SNVS_TAMPER2 ==> GPIO5_02 101 ALT5 — Slect mux mode: ALT5 mux port, GPIO5_IO02 of instance - gpio5 Other Reserved

32.5.6 SW_MUX_CTL_PAD_SNVS_TAMPER3 SW MUX Control Register (IOMUXC_SNVS_SW_MUX_CTL_PAD_SNVS_TAMPER3)

SW_MUX_CTL Register

Address: 229_0000h base + 14h offset = 229_0014h

Bit	31	30	29	28	27	26	25	24		23	22	21	20	19	18	17	16
R	Reserved																
W	Reserved																
Reset	0	0	0	0	0	0	0	0		0	0	0	0	0	0	0	0
Bit	15	14	13	12	11	10	9	8		7	6	5	4	3	2	1	0
R	Reserved												SION	MUX_MODE			
W	Reserved												SION	MUX_MODE			
Reset	0	0	0	0	0	0	0	0		0	0	0	0	0	0	0	0

IOMUXC_SNVS_SW_MUX_CTL_PAD_SNVS_TAMPER3 field descriptions

Field	Description
31–5 -	This field is reserved. Reserved
4 SION	Software Input On Field. Force the selected mux mode Input path no matter of MUX_MODE functionality. 1 ENABLED — Force input path of pad SNVS_TAMPER3 0 DISABLED — Input Path is determined by functionality
MUX_MODE	Mux Mode Select Field NOTE: ALT5 mode is only valid when TAMPER PIN is used as GPIO. This depends on FUSE setting "TAMPER_PIN_DISABLE[1:0]". Following is the mux information when TAMPER PIN is used as GPIO: SNVS_TAMPER3 ==> GPIO5_03 101 ALT5 — Select mux mode: ALT5 mux port, GPIO5_IO03 of instance - gpio Other Reserved

32.5.7 SW_MUX_CTL_PAD_SNVS_TAMPER4 SW MUX Control Register (IOMUXC_SNVS_SW_MUX_CTL_PAD_SNVS_TAMPER4)

SW_MUX_CTL Register

Address: 229_0000h base + 18h offset = 229_0018h

Bit	31	30	29	28	27	26	25	24	23	22	21	20	19	18	17	16
R	Reserved															
W	Reserved															
Reset	0	0	0	0	0	0	0	0	0	0	0	0	0	0	0	0
Bit	15	14	13	12	11	10	9	8	7	6	5	4	3	2	1	0
R	Reserved												SION		MUX_MODE	
W	Reserved												SION		MUX_MODE	
Reset	0	0	0	0	0	0	0	0	0	0	0	0	0	0	0	0

IOMUXC_SNVS_SW_MUX_CTL_PAD_SNVS_TAMPER4 field descriptions

Field	Description
31–5 -	This field is reserved. Reserved
4 SION	Software Input On Field. Force the selected mux mode Input path no matter of MUX_MODE functionality. 1 ENABLED — Force input path of pad SNVS_TAMPER4 0 DISABLED — Input Path is determined by functionality
MUX_MODE	NOTE: ALT5 mode is only valid when TAMPER PIN is used as GPIO. This depends on FUSE setting "TAMPER_PIN_DISABLE[1:0]". Following is the mux information when TAMPER PIN is used as GPIO: SNVS_TAMPER4 ==> GPIO5_04 101 ALT5 — Select mux mode: ALT5 mux port, GPIO5_IO04 of instance - gpio5 Other Reserved

32.5.8 SW_MUX_CTL_PAD_SNVS_TAMPER5 SW MUX Control Register (IOMUXC_SNVS_SW_MUX_CTL_PAD_SNVS_TAMPER5)

SW_MUX_CTL Register

Address: 229_0000h base + 1Ch offset = 229_001Ch

Bit	31	30	29	28	27	26	25	24		23	22	21	20	19	18	17	16
R	Reserved																
W	Reserved																
Reset	0	0	0	0	0	0	0	0		0	0	0	0	0	0	0	0
Bit	15	14	13	12	11	10	9	8		7	6	5	4	3	2	1	0
R	Reserved												SION	MUX_MODE			
W	Reserved												SION	MUX_MODE			
Reset	0	0	0	0	0	0	0	0		0	0	0	0	0	0	0	0

IOMUXC_SNVS_SW_MUX_CTL_PAD_SNVS_TAMPER5 field descriptions

Field	Description
31–5 -	This field is reserved. Reserved
4 SION	Software Input On Field. Force the selected mux mode Input path no matter of MUX_MODE functionality. 1 ENABLED — Force input path of pad SNVS_TAMPER5 0 DISABLED — Input Path is determined by functionality
MUX_MODE	MUX Mode Select Field NOTE: ALT5 mode is only valid when TAMPER PIN is used as GPIO. This depends on FUSE setting "TAMPER_PIN_DISABLE[1:0]". Following is the mux information when TAMPER PIN is used as GPIO: SNVS_TAMPER5 ==> GPIO5_05 101 ALT5 — Select mux mode: ALT5 mux port, GPIO5_IO05 of instance - gpio5 Other Reserved

32.5.9 SW_MUX_CTL_PAD_SNVS_TAMPER6 SW MUX Control Register (IOMUXC_SNVS_SW_MUX_CTL_PAD_SNVS_TAMPER6)

SW_MUX_CTL Register

Address: 229_0000h base + 20h offset = 229_0020h

Bit	31	30	29	28	27	26	25	24	23	22	21	20	19	18	17	16
R	Reserved															
W	Reserved															
Reset	0	0	0	0	0	0	0	0	0	0	0	0	0	0	0	0
Bit	15	14	13	12	11	10	9	8	7	6	5	4	3	2	1	0
R	Reserved												SION		MUX_MODE	
W	Reserved												SION		MUX_MODE	
Reset	0	0	0	0	0	0	0	0	0	0	0	0	0	0	0	0

IOMUXC_SNVS_SW_MUX_CTL_PAD_SNVS_TAMPER6 field descriptions

Field	Description
31–5 -	This field is reserved. Reserved
4 SION	Software Input On Field. Force the selected mux mode Input path no matter of MUX_MODE functionality. 1 ENABLED — Force input path of pad SNVS_TAMPER6 0 DISABLED — Input Path is determined by functionality
MUX_MODE	NOTE: ALT5 mode is only valid when TAMPER PIN is used as GPIO. This depends on FUSE setting "TAMPER_PIN_DISABLE[1:0]". Following is the mux information when TAMPER PIN is used as GPIO: SNVS_TAMPER6 ==> GPIO5_06 101 ALT5 — Select mux mode: ALT5 mux port, GPIO5_IO06 of instance - gpio5 Other Reserved

32.5.10 SW_MUX_CTL_PAD_SNVS_TAMPER7 SW MUX Control Register (IOMUXC_SNVS_SW_MUX_CTL_PAD_SNVS_TAMPER7)

SW_MUX_CTL Register

Address: 229_0000h base + 24h offset = 229_0024h

Bit	31	30	29	28	27	26	25	24		23	22	21	20	19	18	17	16
R	Reserved																
W	Reserved																
Reset	0	0	0	0	0	0	0	0		0	0	0	0	0	0	0	0
Bit	15	14	13	12	11	10	9	8		7	6	5	4	3	2	1	0
R	Reserved												SION	MUX_MODE			
W	Reserved												SION	MUX_MODE			
Reset	0	0	0	0	0	0	0	0		0	0	0	0	0	0	0	0

IOMUXC_SNVS_SW_MUX_CTL_PAD_SNVS_TAMPER7 field descriptions

Field	Description
31-5 -	This field is reserved. Reserved
4 SION	Software Input On Field. Force the selected mux mode Input path no matter of MUX_MODE functionality. 1 ENABLED — Force input path of pad SNVS_TAMPER7 0 DISABLED — Input Path is determined by functionality
MUX_MODE	NOTE: ALT5 mode is only valid when TAMPER PIN is used as GPIO. This depends on FUSE setting "TAMPER_PIN_DISABLE[1:0]". Following is the mux information when TAMPER PIN is used as GPIO: SNVS_TAMPER7 ==> GPIO5_07 101 ALT5 — Select mux mode: ALT5 mux port, GPIO5_IO07 of instance - gpio5 Other Reserved

32.5.11 SW_MUX_CTL_PAD_SNVS_TAMPER8 SW MUX Control Register (IOMUXC_SNVS_SW_MUX_CTL_PAD_SNVS_TAMPER8)

SW_MUX_CTL Register

Address: 229_0000h base + 28h offset = 229_0028h

Bit	31	30	29	28	27	26	25	24	23	22	21	20	19	18	17	16
R	Reserved															
W	Reserved															
Reset	0	0	0	0	0	0	0	0	0	0	0	0	0	0	0	0
Bit	15	14	13	12	11	10	9	8	7	6	5	4	3	2	1	0
R	Reserved												SION		MUX_MODE	
W	Reserved												SION		MUX_MODE	
Reset	0	0	0	0	0	0	0	0	0	0	0	0	0	0	0	0

IOMUXC_SNVS_SW_MUX_CTL_PAD_SNVS_TAMPER8 field descriptions

Field	Description
31–5 -	This field is reserved. Reserved
4 SION	Software Input On Field. Force the selected mux mode Input path no matter of MUX_MODE functionality. 1 ENABLED — Force input path of pad SNVS_TAMPER8 0 DISABLED — Input Path is determined by functionality
MUX_MODE	NOTE: ALT5 mode is only valid when TAMPER PIN is used as GPIO. This depends on FUSE setting "TAMPER_PIN_DISABLE[1:0]". Following is the mux information when TAMPER PIN is used as GPIO: SNVS_TAMPER8 ==> GPIO5_08 101 ALT5 — Select mux moe: ALT5 mux port, GPIO05_IO08 of instance - gpio5 Other Reserved

32.5.12 SW_MUX_CTL_PAD_SNVS_TAMPER9 SW MUX Control Register (IOMUXC_SNVS_SW_MUX_CTL_PAD_SNVS_TAMPER9)

SW_MUX_CTL Register

Address: 229_0000h base + 2Ch offset = 229_002Ch

Bit	31	30	29	28	27	26	25	24		23	22	21	20	19	18	17	16
R	Reserved																
W	Reserved																
Reset	0	0	0	0	0	0	0	0		0	0	0	0	0	0	0	0
Bit	15	14	13	12	11	10	9	8		7	6	5	4	3	2	1	0
R	Reserved												SION	MUX_MODE			
W	Reserved												SION	MUX_MODE			
Reset	0	0	0	0	0	0	0	0		0	0	0	0	0	0	0	0

IOMUXC_SNVS_SW_MUX_CTL_PAD_SNVS_TAMPER9 field descriptions

Field	Description
31–5 -	This field is reserved. Reserved
4 SION	Software Input On Field. Force the selected mux mode Input path no matter of MUX_MODE functionality. 1 ENABLED — Force input path of pad SNVS_TAMPER9 0 DISABLED — Input Path is determined by functionality
MUX_MODE	NOTE: ALT5 mode is only valid when TAMPER PIN is used as GPIO. This depends on FUSE setting "TAMPER_PIN_DISABLE[1:0]". Following is the mux information when TAMPER PIN is used as GPIO: SNVS_TAMPER9 ==> GPIO5_09 101 ALT5 — Select mux mode: ALT5 mux port, GPIO5_IO09 of instance - gpio9 Other Reserved

32.5.13 SW_PAD_CTL_PAD_TEST_MODE SW PAD Control Register (IOMUXC_SNVS_SW_PAD_CTL_PAD_TEST_MODE)

SW_PAD_CTL Register

Address: 229_0000h base + 30h offset = 229_0030h

Bit	31	30	29	28	27	26	25	24	23	22	21	20	19	18	17	16
R	Reserved															HYS
W																
Reset	0	0	0	0	0	0	0	0	0	0	0	0	0	0	0	0
Bit	15	14	13	12	11	10	9	8	7	6	5	4	3	2	1	0
R						Reserved			SPEED			DSE		Reserved		SRE
W	PUS		PUE	PKE	ODE											
Reset	0	0	1	1	0	0	0	0	1	0	1	0	0	0	0	0

IOMUXC_SNVS_SW_PAD_CTL_PAD_TEST_MODE field descriptions

Field	Description
31–17 -	This field is reserved. Reserved
16 HYS	Hyst. Enable Field Select one out of next values for pad: TEST_MODE 0 HYS_0_Hysteresis_Disabled — Hysteresis Disabled 1 HYS_1_Hysteresis_Enabled — Hysteresis Enabled
15–14 PUS	Pull Up / Down Config. Field Select one out of next values for pad: TEST_MODE 00 PUS_0_100K_Ohm_Pull_Down — 100K Ohm Pull Down 01 PUS_1_47K_Ohm_Pull_Up — 47K Ohm Pull Up 10 PUS_2_100K_Ohm_Pull_Up — 100K Ohm Pull Up 11 PUS_3_22K_Ohm_Pull_Up — 22K Ohm Pull Up
13 PUE	Pull / Keep Select Field Select one out of next values for pad: TEST_MODE 0 PUE_0_Keeper — Keeper 1 PUE_1_Pull — Pull
12 PKE	Pull / Keep Enable Field Select one out of next values for pad: TEST_MODE 0 PKE_0_Pull_Keeper_Disabled — Pull/Keeper Disabled 1 PKE_1_Pull_Keeper_Enabled — Pull/Keeper Enabled

Table continues on the next page...

IOMUXC_SNVS_SW_PAD_CTL_PAD_TEST_MODE field descriptions (continued)

Field	Description
11 ODE	Open Drain Enable Field Select one out of next values for pad: TEST_MODE 0 ODE_0_Open_Drain_Disabled — Open Drain Disabled 1 ODE_1_Open_Drain_Enabled — Open Drain Enabled
10–8 -	This field is reserved. Reserved
7–6 SPEED	Speed Field Read Only Field 10 SPEED — medium(100MHz)
5–3 DSE	Drive Strength Field Select one out of next values for pad: TEST_MODE 000 DSE_0_output_driver_disabled_ — output driver disabled; 001 DSE_1_R0_260_Ohm_3_3V_150_Ohm_1_8V_240_Ohm_for_DDR_ — R0(260 Ohm @ 3.3V, 150 Ohm@1.8V, 240 Ohm for DDR) 010 DSE_2_R0_2 — R0/2 011 DSE_3_R0_3 — R0/3 100 DSE_4_R0_4 — R0/4 101 DSE_5_R0_5 — R0/5 110 DSE_6_R0_6 — R0/6 111 DSE_7_R0_7 — R0/7
2–1 -	This field is reserved. Reserved
0 SRE	Slew Rate Field Select one out of next values for pad: TEST_MODE 0 SRE_0_Slow_Slew_Rate — Slow Slew Rate 1 SRE_1_Fast_Slew_Rate — Fast Slew Rate

32.5.14 SW_PAD_CTL_PAD_POR_B SW PAD Control Register (IOMUXC_SNVS_SW_PAD_CTL_PAD_POR_B)

SW_PAD_CTL Register

Address: 229_0000h base + 34h offset = 229_0034h

Bit	31	30	29	28	27	26	25	24	23	22	21	20	19	18	17	16
R	Reserved															HYS
W																
Reset	0	0	0	0	0	0	0	0	0	0	0	0	0	0	0	1
Bit	15	14	13	12	11	10	9	8	7	6	5	4	3	2	1	0
R	PUS	PUE	PKE	ODE	Reserved			SPEED		DSE			Reserved		SRE	
W																
Reset	1	0	1	1	0	0	0	0	1	0	1	0	0	0	0	0

IOMUXC_SNVS_SW_PAD_CTL_PAD_POR_B field descriptions

Field	Description
31–17 -	This field is reserved. Reserved
16 HYS	Hyst. Enable Field Select one out of next values for pad: POR_B 0 HYS_0_Hysteresis_Disabled — Hysteresis Disabled 1 HYS_1_Hysteresis_Enabled — Hysteresis Enabled
15–14 PUS	Pull Up / Down Config. Field Select one out of next values for pad: POR_B 00 PUS_0_100K_Ohm_Pull_Down — 100K Ohm Pull Down 01 PUS_1_47K_Ohm_Pull_Up — 47K Ohm Pull Up 10 PUS_2_100K_Ohm_Pull_Up — 100K Ohm Pull Up 11 PUS_3_22K_Ohm_Pull_Up — 22K Ohm Pull Up
13 PUE	Pull / Keep Select Field Select one out of next values for pad: POR_B 0 PUE_0_Keeper — Keeper 1 PUE_1_Pull — Pull
12 PKE	Pull / Keep Enable Field Select one out of next values for pad: POR_B 0 PKE_0_Pull_Keeper_Disabled — Pull/Keeper Disabled 1 PKE_1_Pull_Keeper_Enabled — Pull/Keeper Enabled

Table continues on the next page...

IOMUXC_SNVS_SW_PAD_CTL_PAD_POR_B field descriptions (continued)

Field	Description
11 ODE	Open Drain Enable Field Select one out of next values for pad: POR_B 0 ODE_0_Open_Drain_Disabled — Open Drain Disabled 1 ODE_1_Open_Drain_Enabled — Open Drain Enabled
10–8 -	This field is reserved. Reserved
7–6 SPEED	Speed Field Read Only Field 10 SPEED — medium(100MHz)
5–3 DSE	Drive Strength Field Select one out of next values for pad: POR_B 000 DSE_0_output_driver_disabled_ — output driver disabled; 001 DSE_1_R0_260_Ohm_3_3V_150_Ohm_1_8V_240_Ohm_for_DDR_ — R0(260 Ohm @ 3.3V, 150 Ohm@1.8V, 240 Ohm for DDR) 010 DSE_2_R0_2 — R0/2 011 DSE_3_R0_3 — R0/3 100 DSE_4_R0_4 — R0/4 101 DSE_5_R0_5 — R0/5 110 DSE_6_R0_6 — R0/6 111 DSE_7_R0_7 — R0/7
2–1 -	This field is reserved. Reserved
0 SRE	Slew Rate Field Select one out of next values for pad: POR_B 0 SRE_0_Slow_Slew_Rate — Slow Slew Rate 1 SRE_1_Fast_Slew_Rate — Fast Slew Rate

32.5.15 SW_PAD_CTL_PAD_ONOFF SW PAD Control Register (IOMUXC_SNVS_SW_PAD_CTL_PAD_ONOFF)

SW_PAD_CTL Register

Address: 229_0000h base + 38h offset = 229_0038h

Bit	31	30	29	28	27	26	25	24	23	22	21	20	19	18	17	16
R	Reserved															HYS
W																
Reset	0	0	0	0	0	0	0	0	0	0	0	0	0	0	0	1
Bit	15	14	13	12	11	10	9	8	7	6	5	4	3	2	1	0
R	PUS	PUE	PKE	ODE	Reserved			SPEED		DSE			Reserved		SRE	
W																
Reset	1	0	1	1	0	0	0	0	1	0	1	0	0	0	0	0

IOMUXC_SNVS_SW_PAD_CTL_PAD_ONOFF field descriptions

Field	Description
31–17 -	This field is reserved. Reserved
16 HYS	Hyst. Enable Field Select one out of next values for pad: ONOFF 0 HYS_0_Hysteresis_Disabled — Hysteresis Disabled 1 HYS_1_Hysteresis_Enabled — Hysteresis Enabled
15–14 PUS	Pull Up / Down Config. Field Select one out of next values for pad: ONOFF 00 PUS_0_100K_Ohm_Pull_Down — 100K Ohm Pull Down 01 PUS_1_47K_Ohm_Pull_Up — 47K Ohm Pull Up 10 PUS_2_100K_Ohm_Pull_Up — 100K Ohm Pull Up 11 PUS_3_22K_Ohm_Pull_Up — 22K Ohm Pull Up
13 PUE	Pull / Keep Select Field Select one out of next values for pad: ONOFF 0 PUE_0_Keeper — Keeper 1 PUE_1_Pull — Pull
12 PKE	Pull / Keep Enable Field Select one out of next values for pad: ONOFF 0 PKE_0_Pull_Keeper_Disabled — Pull/Keeper Disabled 1 PKE_1_Pull_Keeper_Enabled — Pull/Keeper Enabled

Table continues on the next page...

IOMUXC_SNVS_SW_PAD_CTL_PAD_ONOFF field descriptions (continued)

Field	Description
11 ODE	Open Drain Enable Field Select one out of next values for pad: ONOFF 0 ODE_0_Open_Drain_Disabled — Open Drain Disabled 1 ODE_1_Open_Drain_Enabled — Open Drain Enabled
10–8 -	This field is reserved. Reserved
7–6 SPEED	Speed Field Read Only Field 10 SPEED — medium(100MHz)
5–3 DSE	Drive Strength Field Select one out of next values for pad: ONOFF 000 DSE_0_output_driver_disabled_ — output driver disabled; 001 DSE_1_R0_260_Ohm_3_3V_150_Ohm_1_8V_240_Ohm_for_DDR_ — R0(260 Ohm @ 3.3V, 150 Ohm@1.8V, 240 Ohm for DDR) 010 DSE_2_R0_2 — R0/2 011 DSE_3_R0_3 — R0/3 100 DSE_4_R0_4 — R0/4 101 DSE_5_R0_5 — R0/5 110 DSE_6_R0_6 — R0/6 111 DSE_7_R0_7 — R0/7
2–1 -	This field is reserved. Reserved
0 SRE	Slew Rate Field Select one out of next values for pad: ONOFF 0 SRE_0_Slow_Slew_Rate — Slow Slew Rate 1 SRE_1_Fast_Slew_Rate — Fast Slew Rate

32.5.16 SW_PAD_CTL_PAD_SNVS_PMIC_ON_REQ SW PAD Control Register (IOMUXC_SNVS_SW_PAD_CTL_PAD_SNVS_PMIC_ON_REQ)

SW_PAD_CTL Register

Address: 229_0000h base + 3Ch offset = 229_003Ch

Bit	31	30	29	28	27	26	25	24	23	22	21	20	19	18	17	16
R	Reserved															HYS
W	Reserved															HYS
Reset	0	0	0	0	0	0	0	0	0	0	0	0	0	0	0	0
Bit	15	14	13	12	11	10	9	8	7	6	5	4	3	2	1	0
R	PUS	PUE	PKE	ODE	Reserved			SPEED		DSE			Reserved		SRE	
W	PUS	PUE	PKE	ODE	Reserved			SPEED		DSE			Reserved		SRE	
Reset	1	0	1	1	1	0	0	0	1	0	1	0	0	0	0	0

IOMUXC_SNVS_SW_PAD_CTL_PAD_SNVS_PMIC_ON_REQ field descriptions

Field	Description
31–17 -	This field is reserved. Reserved
16 HYS	Hyst. Enable Field Select one out of next values for pad: SNVS_PMIC_ON_REQ 0 HYS_0_Hysteresis_Disabled — Hysteresis Disabled 1 HYS_1_Hysteresis_Enabled — Hysteresis Enabled
15–14 PUS	Pull Up / Down Config. Field Select one out of next values for pad: SNVS_PMIC_ON_REQ 00 PUS_0_100K_Ohm_Pull_Down — 100K Ohm Pull Down 01 PUS_1_47K_Ohm_Pull_Up — 47K Ohm Pull Up 10 PUS_2_100K_Ohm_Pull_Up — 100K Ohm Pull Up 11 PUS_3_22K_Ohm_Pull_Up — 22K Ohm Pull Up
13 PUE	Pull / Keep Select Field Select one out of next values for pad: SNVS_PMIC_ON_REQ 0 PUE_0_Keeper — Keeper 1 PUE_1_Pull — Pull
12 PKE	Pull / Keep Enable Field Select one out of next values for pad: SNVS_PMIC_ON_REQ 0 PKE_0_Pull_Keeper_Disabled — Pull/Keeper Disabled 1 PKE_1_Pull_Keeper_Enabled — Pull/Keeper Enabled

Table continues on the next page...

IOMUXC_SNVS_SW_PAD_CTL_PAD_SNVS_PMIC_ON_REQ field descriptions (continued)

Field	Description
11 ODE	Open Drain Enable Field Select one out of next values for pad: SNVS_PMIC_ON_REQ 0 ODE_0_Open_Drain_Disabled — Open Drain Disabled 1 ODE_1_Open_Drain_Enabled — Open Drain Enabled
10–8 -	This field is reserved. Reserved
7–6 SPEED	Speed Field Read Only Field 10 SPEED — medium(100MHz)
5–3 DSE	Drive Strength Field Select one out of next values for pad: SNVS_PMIC_ON_REQ 000 DSE_0_output_driver_disabled_ — output driver disabled; 001 DSE_1_R0_260_Ohm__3_3V_150_Ohm_1_8V_240_Ohm_for_DDR_ — R0(260 Ohm @ 3.3V, 150 Ohm@1.8V, 240 Ohm for DDR) 010 DSE_2_R0_2 — R0/2 011 DSE_3_R0_3 — R0/3 100 DSE_4_R0_4 — R0/4 101 DSE_5_R0_5 — R0/5 110 DSE_6_R0_6 — R0/6 111 DSE_7_R0_7 — R0/7
2–1 -	This field is reserved. Reserved
0 SRE	Slew Rate Field Select one out of next values for pad: SNVS_PMIC_ON_REQ 0 SRE_0_Slow_Slew_Rate — Slow Slew Rate 1 SRE_1_Fast_Slew_Rate — Fast Slew Rate

32.5.17 SW_PAD_CTL_PAD_CCM_PMIC_STBY_REQ SW PAD Control Register (IOMUXC_SNVS_SW_PAD_CTL_PAD_CCM_PMIC_STBY_REQ)

SW_PAD_CTL Register

Address: 229_0000h base + 40h offset = 229_0040h

Bit	31	30	29	28	27	26	25	24	23	22	21	20	19	18	17	16
R	Reserved															HYS
W	Reserved															
Reset	0	0	0	0	0	0	0	0	0	0	0	0	0	0	0	0
Bit	15	14	13	12	11	10	9	8	7	6	5	4	3	2	1	0
R	PUS	PUE	PKE	ODE	Reserved			SPEED		DSE			Reserved		SRE	
W	PUS	PUE	PKE	ODE	Reserved			SPEED		DSE			Reserved		SRE	
Reset	0	0	1	0	0	0	0	0	1	0	1	0	0	0	0	0

IOMUXC_SNVS_SW_PAD_CTL_PAD_CCM_PMIC_STBY_REQ field descriptions

Field	Description
31–17 -	This field is reserved. Reserved
16 HYS	Hyst. Enable Field Select one out of next values for pad: CCM_PMIC_STBY_REQ 0 HYS_0_Hysteresis_Disabled — Hysteresis Disabled 1 HYS_1_Hysteresis_Enabled — Hysteresis Enabled
15–14 PUS	Pull Up / Down Config. Field Select one out of next values for pad: CCM_PMIC_STBY_REQ 00 PUS_0_100K_Ohm_Pull_Down — 100K Ohm Pull Down 01 PUS_1_47K_Ohm_Pull_Up — 47K Ohm Pull Up 10 PUS_2_100K_Ohm_Pull_Up — 100K Ohm Pull Up 11 PUS_3_22K_Ohm_Pull_Up — 22K Ohm Pull Up
13 PUE	Pull / Keep Select Field Select one out of next values for pad: CCM_PMIC_STBY_REQ 0 PUE_0_Keeper — Keeper 1 PUE_1_Pull — Pull
12 PKE	Pull / Keep Enable Field Select one out of next values for pad: CCM_PMIC_STBY_REQ 0 PKE_0_Pull_Keeper_Disabled — Pull/Keeper Disabled 1 PKE_1_Pull_Keeper_Enabled — Pull/Keeper Enabled

Table continues on the next page...

IOMUXC_SNVS_SW_PAD_CTL_PAD_CCM_PMIC_STBY_REQ field descriptions (continued)

Field	Description
11 ODE	Open Drain Enable Field Select one out of next values for pad: CCM_PMIC_STBY_REQ 0 ODE_0_Open_Drain_Disabled — Open Drain Disabled 1 ODE_1_Open_Drain_Enabled — Open Drain Enabled
10–8 -	This field is reserved. Reserved
7–6 SPEED	Speed Field Read Only Field 10 SPEED — medium(100MHz)
5–3 DSE	Drive Strength Field Select one out of next values for pad: CCM_PMIC_STBY_REQ 000 DSE_0_output_driver_disabled_ — output driver disabled; 001 DSE_1_R0_260_Ohm__3_3V_150_Ohm_1_8V_240_Ohm_for_DDR_ — R0(260 Ohm @ 3.3V, 150 Ohm@1.8V, 240 Ohm for DDR) 010 DSE_2_R0_2 — R0/2 011 DSE_3_R0_3 — R0/3 100 DSE_4_R0_4 — R0/4 101 DSE_5_R0_5 — R0/5 110 DSE_6_R0_6 — R0/6 111 DSE_7_R0_7 — R0/7
2–1 -	This field is reserved. Reserved
0 SRE	Slew Rate Field Select one out of next values for pad: CCM_PMIC_STBY_REQ 0 SRE_0_Slow_Slew_Rate — Slow Slew Rate 1 SRE_1_Fast_Slew_Rate — Fast Slew Rate

32.5.18 SW_PAD_CTL_PAD_BOOT_MODE0 SW PAD Control Register (IOMUXC_SNVS_SW_PAD_CTL_PAD_BOOT_MODE0)

SW_PAD_CTL Register

Address: 229_0000h base + 44h offset = 229_0044h

Bit	31	30	29	28	27	26	25	24	23	22	21	20	19	18	17	16	
R	Reserved															HYS	
W	Reserved																
Reset	0	0	0	0	0	0	0	0	0	0	0	0	0	0	0	0	1
Bit	15	14	13	12	11	10	9	8	7	6	5	4	3	2	1	0	
R	PUS	PUE	PKE	ODE	Reserved			SPEED		DSE			Reserved		SRE		
W	PUS	PUE	PKE	ODE	Reserved			SPEED		DSE			Reserved		SRE		
Reset	0	0	1	1	0	0	0	0	1	0	1	0	0	0	0	0	

IOMUXC_SNVS_SW_PAD_CTL_PAD_BOOT_MODE0 field descriptions

Field	Description
31–17 -	This field is reserved. Reserved
16 HYS	Hyst. Enable Field Select one out of next values for pad: BOOT_MODE0 0 HYS_0_Hysteresis_Disabled — Hysteresis Disabled 1 HYS_1_Hysteresis_Enabled — Hysteresis Enabled
15–14 PUS	Pull Up / Down Config. Field Select one out of next values for pad: BOOT_MODE0 00 PUS_0_100K_Ohm_Pull_Down — 100K Ohm Pull Down 01 PUS_1_47K_Ohm_Pull_Up — 47K Ohm Pull Up 10 PUS_2_100K_Ohm_Pull_Up — 100K Ohm Pull Up 11 PUS_3_22K_Ohm_Pull_Up — 22K Ohm Pull Up
13 PUE	Pull / Keep Select Field Select one out of next values for pad: BOOT_MODE0 0 PUE_0_Keeper — Keeper 1 PUE_1_Pull — Pull
12 PKE	Pull / Keep Enable Field Select one out of next values for pad: BOOT_MODE0 0 PKE_0_Pull_Keeper_Disabled — Pull/Keeper Disabled 1 PKE_1_Pull_Keeper_Enabled — Pull/Keeper Enabled

Table continues on the next page...

IOMUXC_SNVS_SW_PAD_CTL_PAD_BOOT_MODE0 field descriptions (continued)

Field	Description
11 ODE	Open Drain Enable Field Select one out of next values for pad: BOOT_MODE0 0 ODE_0_Open_Drain_Disabled — Open Drain Disabled 1 ODE_1_Open_Drain_Enabled — Open Drain Enabled
10–8 -	This field is reserved. Reserved
7–6 SPEED	Speed Field Read Only Field 10 SPEED — medium(100MHz)
5–3 DSE	Drive Strength Field Select one out of next values for pad: BOOT_MODE0 000 DSE_0_output_driver_disabled_ — output driver disabled; 001 DSE_1_R0_260_Ohm_3_3V_150_Ohm_1_8V_240_Ohm_for_DDR_ — R0(260 Ohm @ 3.3V, 150 Ohm@1.8V, 240 Ohm for DDR) 010 DSE_2_R0_2 — R0/2 011 DSE_3_R0_3 — R0/3 100 DSE_4_R0_4 — R0/4 101 DSE_5_R0_5 — R0/5 110 DSE_6_R0_6 — R0/6 111 DSE_7_R0_7 — R0/7
2–1 -	This field is reserved. Reserved
0 SRE	Slew Rate Field Select one out of next values for pad: BOOT_MODE0 0 SRE_0_Slow_Slew_Rate — Slow Slew Rate 1 SRE_1_Fast_Slew_Rate — Fast Slew Rate

32.5.19 SW_PAD_CTL_PAD_BOOT_MODE1 SW PAD Control Register (IOMUXC_SNVS_SW_PAD_CTL_PAD_BOOT_MODE1)

SW_PAD_CTL Register

Address: 229_0000h base + 48h offset = 229_0048h

Bit	31	30	29	28	27	26	25	24	23	22	21	20	19	18	17	16	
R	Reserved															HYS	
W	Reserved																
Reset	0	0	0	0	0	0	0	0	0	0	0	0	0	0	0	0	1
Bit	15	14	13	12	11	10	9	8	7	6	5	4	3	2	1	0	
R	PUS	PUE	PKE	ODE	Reserved			SPEED		DSE			Reserved		SRE		
W	PUS	PUE	PKE	ODE	Reserved			SPEED		DSE			Reserved		SRE		
Reset	0	0	1	1	0	0	0	0	1	0	1	0	0	0	0	0	

IOMUXC_SNVS_SW_PAD_CTL_PAD_BOOT_MODE1 field descriptions

Field	Description
31–17 -	This field is reserved. Reserved
16 HYS	Hyst. Enable Field Select one out of next values for pad: BOOT_MODE1 0 HYS_0_Hysteresis_Disabled — Hysteresis Disabled 1 HYS_1_Hysteresis_Enabled — Hysteresis Enabled
15–14 PUS	Pull Up / Down Config. Field Select one out of next values for pad: BOOT_MODE1 00 PUS_0_100K_Ohm_Pull_Down — 100K Ohm Pull Down 01 PUS_1_47K_Ohm_Pull_Up — 47K Ohm Pull Up 10 PUS_2_100K_Ohm_Pull_Up — 100K Ohm Pull Up 11 PUS_3_22K_Ohm_Pull_Up — 22K Ohm Pull Up
13 PUE	Pull / Keep Select Field Select one out of next values for pad: BOOT_MODE1 0 PUE_0_Keeper — Keeper 1 PUE_1_Pull — Pull
12 PKE	Pull / Keep Enable Field Select one out of next values for pad: BOOT_MODE1 0 PKE_0_Pull_Keeper_Disabled — Pull/Keeper Disabled 1 PKE_1_Pull_Keeper_Enabled — Pull/Keeper Enabled

Table continues on the next page...

IOMUXC_SNVS_SW_PAD_CTL_PAD_BOOT_MODE1 field descriptions (continued)

Field	Description
11 ODE	Open Drain Enable Field Select one out of next values for pad: BOOT_MODE1 0 ODE_0_Open_Drain_Disabled — Open Drain Disabled 1 ODE_1_Open_Drain_Enabled — Open Drain Enabled
10–8 -	This field is reserved. Reserved
7–6 SPEED	Speed Field Read Only Field 10 SPEED — medium(100MHz)
5–3 DSE	Drive Strength Field Select one out of next values for pad: BOOT_MODE1 000 DSE_0_output_driver_disabled_ — output driver disabled; 001 DSE_1_R0_260_Ohm_3_3V_150_Ohm_1_8V_240_Ohm_for_DDR_ — R0(260 Ohm @ 3.3V, 150 Ohm@1.8V, 240 Ohm for DDR) 010 DSE_2_R0_2 — R0/2 011 DSE_3_R0_3 — R0/3 100 DSE_4_R0_4 — R0/4 101 DSE_5_R0_5 — R0/5 110 DSE_6_R0_6 — R0/6 111 DSE_7_R0_7 — R0/7
2–1 -	This field is reserved. Reserved
0 SRE	Slew Rate Field Select one out of next values for pad: BOOT_MODE1 0 SRE_0_Slow_Slew_Rate — Slow Slew Rate 1 SRE_1_Fast_Slew_Rate — Fast Slew Rate

32.5.20 SW_PAD_CTL_PAD_SNVS_TAMPER0 SW PAD Control Register (IOMUXC_SNVS_SW_PAD_CTL_PAD_SNVS_TAMPER0)

SW_PAD_CTL Register

Address: 229_0000h base + 4Ch offset = 229_004Ch

Bit	31	30	29	28	27	26	25	24	23	22	21	20	19	18	17	16	
R	Reserved															HYS	
W	Reserved															HYS	
Reset	0	0	0	0	0	0	0	0	0	0	0	0	0	0	0	0	1
Bit	15	14	13	12	11	10	9	8	7	6	5	4	3	2	1	0	
R	PUS	PUE	PKE	ODE	Reserved			SPEED		DSE			Reserved		SRE		
W	PUS	PUE	PKE	ODE	Reserved			SPEED		DSE			Reserved		SRE		
Reset	0	0	0	1	0	0	0	0	1	0	1	0	0	0	0	0	

IOMUXC_SNVS_SW_PAD_CTL_PAD_SNVS_TAMPER0 field descriptions

Field	Description
31–17 -	This field is reserved. Reserved
16 HYS	Hyst. Enable Field Select one out of next values for pad: SNVS_TAMPER0 0 HYS_0_Hysteresis_Disabled — Hysteresis Disabled 1 HYS_1_Hysteresis_Enabled — Hysteresis Enabled
15–14 PUS	Pull Up / Down Config. Field Select one out of next values for pad: SNVS_TAMPER0 00 PUS_0_100K_Ohm_Pull_Down — 100K Ohm Pull Down 01 PUS_1_47K_Ohm_Pull_Up — 47K Ohm Pull Up 10 PUS_2_100K_Ohm_Pull_Up — 100K Ohm Pull Up 11 PUS_3_22K_Ohm_Pull_Up — 22K Ohm Pull Up
13 PUE	Pull / Keep Select Field Select one out of next values for pad: SNVS_TAMPER0 0 PUE_0_Keeper — Keeper 1 PUE_1_Pull — Pull
12 PKE	Pull / Keep Enable Field Select one out of next values for pad: SNVS_TAMPER0 0 PKE_0_Pull_Keeper_Disabled — Pull/Keeper Disabled 1 PKE_1_Pull_Keeper_Enabled — Pull/Keeper Enabled

Table continues on the next page...

IOMUXC_SNVS_SW_PAD_CTL_PAD_SNVS_TAMPER0 field descriptions (continued)

Field	Description
11 ODE	Open Drain Enable Field Select one out of next values for pad: SNVS_TAMPER0 0 ODE_0_Open_Drain_Disabled — Open Drain Disabled 1 ODE_1_Open_Drain_Enabled — Open Drain Enabled
10–8 -	This field is reserved. Reserved
7–6 SPEED	Speed Field Read Only Field 10 SPEED — medium(100MHz)
5–3 DSE	Drive Strength Field Select one out of next values for pad: SNVS_TAMPER0 000 DSE_0_output_driver_disabled_ — output driver disabled; 001 DSE_1_R0_260_Ohm__3_3V_150_Ohm_1_8V_240_Ohm_for_DDR_ — R0(260 Ohm @ 3.3V, 150 Ohm@1.8V, 240 Ohm for DDR) 010 DSE_2_R0_2 — R0/2 011 DSE_3_R0_3 — R0/3 100 DSE_4_R0_4 — R0/4 101 DSE_5_R0_5 — R0/5 110 DSE_6_R0_6 — R0/6 111 DSE_7_R0_7 — R0/7
2–1 -	This field is reserved. Reserved
0 SRE	Slew Rate Field Select one out of next values for pad: SNVS_TAMPER0 0 SRE_0_Slow_Slew_Rate — Slow Slew Rate 1 SRE_1_Fast_Slew_Rate — Fast Slew Rate

32.5.21 SW_PAD_CTL_PAD_SNVS_TAMPER1 SW PAD Control Register (IOMUXC_SNVS_SW_PAD_CTL_PAD_SNVS_TAMPER1)

SW_PAD_CTL Register

Address: 229_0000h base + 50h offset = 229_0050h

Bit	31	30	29	28	27	26	25	24	23	22	21	20	19	18	17	16
R	Reserved															HYS
W	Reserved															HYS
Reset	0	0	0	0	0	0	0	0	0	0	0	0	0	0	0	1
Bit	15	14	13	12	11	10	9	8	7	6	5	4	3	2	1	0
R	PUS	PUE	PKE	ODE	Reserved			SPEED		DSE			Reserved		SRE	
W	PUS	PUE	PKE	ODE	Reserved			SPEED		DSE			Reserved		SRE	
Reset	0	0	0	1	0	0	0	0	1	0	1	0	0	0	0	0

IOMUXC_SNVS_SW_PAD_CTL_PAD_SNVS_TAMPER1 field descriptions

Field	Description
31–17 -	This field is reserved. Reserved
16 HYS	Hyst. Enable Field Select one out of next values for pad: SNVS_TAMPER1 0 HYS_0_Hysteresis_Disabled — Hysteresis Disabled 1 HYS_1_Hysteresis_Enabled — Hysteresis Enabled
15–14 PUS	Pull Up / Down Config. Field Select one out of next values for pad: SNVS_TAMPER1 00 PUS_0_100K_Ohm_Pull_Down — 100K Ohm Pull Down 01 PUS_1_47K_Ohm_Pull_Up — 47K Ohm Pull Up 10 PUS_2_100K_Ohm_Pull_Up — 100K Ohm Pull Up 11 PUS_3_22K_Ohm_Pull_Up — 22K Ohm Pull Up
13 PUE	Pull / Keep Select Field Select one out of next values for pad: SNVS_TAMPER1 0 PUE_0_Keeper — Keeper 1 PUE_1_Pull — Pull
12 PKE	Pull / Keep Enable Field Select one out of next values for pad: SNVS_TAMPER1 0 PKE_0_Pull_Keeper_Disabled — Pull/Keeper Disabled 1 PKE_1_Pull_Keeper_Enabled — Pull/Keeper Enabled

Table continues on the next page...

IOMUXC_SNVS_SW_PAD_CTL_PAD_SNVS_TAMPER1 field descriptions (continued)

Field	Description
11 ODE	Open Drain Enable Field Select one out of next values for pad: SNVS_TAMPER1 0 ODE_0_Open_Drain_Disabled — Open Drain Disabled 1 ODE_1_Open_Drain_Enabled — Open Drain Enabled
10–8 -	This field is reserved. Reserved
7–6 SPEED	Speed Field Read Only Field 10 SPEED — medium(100MHz)
5–3 DSE	Drive Strength Field Select one out of next values for pad: SNVS_TAMPER1 000 DSE_0_output_driver_disabled_ — output driver disabled; 001 DSE_1_R0_260_Ohm_3_3V_150_Ohm_1_8V_240_Ohm_for_DDR_ — R0(260 Ohm @ 3.3V, 150 Ohm@1.8V, 240 Ohm for DDR) 010 DSE_2_R0_2 — R0/2 011 DSE_3_R0_3 — R0/3 100 DSE_4_R0_4 — R0/4 101 DSE_5_R0_5 — R0/5 110 DSE_6_R0_6 — R0/6 111 DSE_7_R0_7 — R0/7
2–1 -	This field is reserved. Reserved
0 SRE	Slew Rate Field Select one out of next values for pad: SNVS_TAMPER1 0 SRE_0_Slow_Slew_Rate — Slow Slew Rate 1 SRE_1_Fast_Slew_Rate — Fast Slew Rate

32.5.22 SW_PAD_CTL_PAD_SNVS_TAMPER2 SW PAD Control Register (IOMUXC_SNVS_SW_PAD_CTL_PAD_SNVS_TAMPER2)

SW_PAD_CTL Register

Address: 229_0000h base + 54h offset = 229_0054h

Bit	31	30	29	28	27	26	25	24	23	22	21	20	19	18	17	16
R	Reserved															HYS
W																
Reset	0	0	0	0	0	0	0	0	0	0	0	0	0	0	0	1
Bit	15	14	13	12	11	10	9	8	7	6	5	4	3	2	1	0
R						Reserved			SPEED					Reserved		SRE
W	PUS	PUE	PKE	ODE	Reserved				SPEED		DSE			Reserved		SRE
Reset	0	0	0	1	0	0	0	0	1	0	1	0	0	0	0	0

IOMUXC_SNVS_SW_PAD_CTL_PAD_SNVS_TAMPER2 field descriptions

Field	Description
31–17 -	This field is reserved. Reserved
16 HYS	Hyst. Enable Field Select one out of next values for pad: SNVS_TAMPER2 0 HYS_0_Hysteresis_Disabled — Hysteresis Disabled 1 HYS_1_Hysteresis_Enabled — Hysteresis Enabled
15–14 PUS	Pull Up / Down Config. Field Select one out of next values for pad: SNVS_TAMPER2 00 PUS_0_100K_Ohm_Pull_Down — 100K Ohm Pull Down 01 PUS_1_47K_Ohm_Pull_Up — 47K Ohm Pull Up 10 PUS_2_100K_Ohm_Pull_Up — 100K Ohm Pull Up 11 PUS_3_22K_Ohm_Pull_Up — 22K Ohm Pull Up
13 PUE	Pull / Keep Select Field Select one out of next values for pad: SNVS_TAMPER2 0 PUE_0_Keeper — Keeper 1 PUE_1_Pull — Pull
12 PKE	Pull / Keep Enable Field Select one out of next values for pad: SNVS_TAMPER2 0 PKE_0_Pull_Keeper_Disabled — Pull/Keeper Disabled 1 PKE_1_Pull_Keeper_Enabled — Pull/Keeper Enabled

Table continues on the next page...

IOMUXC_SNVS_SW_PAD_CTL_PAD_SNVS_TAMPER2 field descriptions (continued)

Field	Description
11 ODE	Open Drain Enable Field Select one out of next values for pad: SNVS_TAMPER2 0 ODE_0_Open_Drain_Disabled — Open Drain Disabled 1 ODE_1_Open_Drain_Enabled — Open Drain Enabled
10–8 -	This field is reserved. Reserved
7–6 SPEED	Speed Field Read Only Field 10 SPEED — medium(100MHz)
5–3 DSE	Drive Strength Field Select one out of next values for pad: SNVS_TAMPER2 000 DSE_0_output_driver_disabled_ — output driver disabled; 001 DSE_1_R0_260_Ohm__3_3V_150_Ohm_1_8V_240_Ohm_for_DDR_ — R0(260 Ohm @ 3.3V, 150 Ohm@1.8V, 240 Ohm for DDR) 010 DSE_2_R0_2 — R0/2 011 DSE_3_R0_3 — R0/3 100 DSE_4_R0_4 — R0/4 101 DSE_5_R0_5 — R0/5 110 DSE_6_R0_6 — R0/6 111 DSE_7_R0_7 — R0/7
2–1 -	This field is reserved. Reserved
0 SRE	Slew Rate Field Select one out of next values for pad: SNVS_TAMPER2 0 SRE_0_Slow_Slew_Rate — Slow Slew Rate 1 SRE_1_Fast_Slew_Rate — Fast Slew Rate

32.5.23 SW_PAD_CTL_PAD_SNVS_TAMPER3 SW PAD Control Register (IOMUXC_SNVS_SW_PAD_CTL_PAD_SNVS_TAMPER3)

SW_PAD_CTL Register

Address: 229_0000h base + 58h offset = 229_0058h

Bit	31	30	29	28	27	26	25	24	23	22	21	20	19	18	17	16
R	Reserved															HYS
W																
Reset	0	0	0	0	0	0	0	0	0	0	0	0	0	0	0	1
Bit	15	14	13	12	11	10	9	8	7	6	5	4	3	2	1	0
R	PUS		PUE	PKE	ODE	Reserved			SPEED		DSE			Reserved		SRE
W																
Reset	0	0	0	1	0	0	0	0	1	0	1	0	0	0	0	0

IOMUXC_SNVS_SW_PAD_CTL_PAD_SNVS_TAMPER3 field descriptions

Field	Description
31–17 -	This field is reserved. Reserved
16 HYS	Hyst. Enable Field Select one out of next values for pad: SNVS_TAMPER3 0 HYS_0_Hysteresis_Disabled — Hysteresis Disabled 1 HYS_1_Hysteresis_Enabled — Hysteresis Enabled
15–14 PUS	Pull Up / Down Config. Field Select one out of next values for pad: SNVS_TAMPER3 00 PUS_0_100K_Ohm_Pull_Down — 100K Ohm Pull Down 01 PUS_1_47K_Ohm_Pull_Up — 47K Ohm Pull Up 10 PUS_2_100K_Ohm_Pull_Up — 100K Ohm Pull Up 11 PUS_3_22K_Ohm_Pull_Up — 22K Ohm Pull Up
13 PUE	Pull / Keep Select Field Select one out of next values for pad: SNVS_TAMPER3 0 PUE_0_Keeper — Keeper 1 PUE_1_Pull — Pull
12 PKE	Pull / Keep Enable Field Select one out of next values for pad: SNVS_TAMPER3 0 PKE_0_Pull_Keeper_Disabled — Pull/Keeper Disabled 1 PKE_1_Pull_Keeper_Enabled — Pull/Keeper Enabled

Table continues on the next page...

IOMUXC_SNVS_SW_PAD_CTL_PAD_SNVS_TAMPER3 field descriptions (continued)

Field	Description
11 ODE	Open Drain Enable Field Select one out of next values for pad: SNVS_TAMPER3 0 ODE_0_Open_Drain_Disabled — Open Drain Disabled 1 ODE_1_Open_Drain_Enabled — Open Drain Enabled
10–8 -	This field is reserved. Reserved
7–6 SPEED	Speed Field Read Only Field 10 SPEED — medium(100MHz)
5–3 DSE	Drive Strength Field Select one out of next values for pad: SNVS_TAMPER3 000 DSE_0_output_driver_disabled_ — output driver disabled; 001 DSE_1_R0_260_Ohm__3_3V_150_Ohm_1_8V_240_Ohm_for_DDR_ — R0(260 Ohm @ 3.3V, 150 Ohm@1.8V, 240 Ohm for DDR) 010 DSE_2_R0_2 — R0/2 011 DSE_3_R0_3 — R0/3 100 DSE_4_R0_4 — R0/4 101 DSE_5_R0_5 — R0/5 110 DSE_6_R0_6 — R0/6 111 DSE_7_R0_7 — R0/7
2–1 -	This field is reserved. Reserved
0 SRE	Slew Rate Field Select one out of next values for pad: SNVS_TAMPER3 0 SRE_0_Slow_Slew_Rate — Slow Slew Rate 1 SRE_1_Fast_Slew_Rate — Fast Slew Rate

32.5.24 SW_PAD_CTL_PAD_SNVS_TAMPER4 SW PAD Control Register (IOMUXC_SNVS_SW_PAD_CTL_PAD_SNVS_TAMPER4)

SW_PAD_CTL Register

Address: 229_0000h base + 5Ch offset = 229_005Ch

Bit	31	30	29	28	27	26	25	24	23	22	21	20	19	18	17	16	
R	Reserved															HYS	
W	Reserved															HYS	
Reset	0	0	0	0	0	0	0	0	0	0	0	0	0	0	0	0	1
Bit	15	14	13	12	11	10	9	8	7	6	5	4	3	2	1	0	
R	PUS	PUE	PKE	ODE	Reserved			SPEED		DSE			Reserved		SRE		
W	PUS	PUE	PKE	ODE	Reserved			SPEED		DSE			Reserved		SRE		
Reset	0	0	0	1	0	0	0	0	1	0	1	0	0	0	0	0	

IOMUXC_SNVS_SW_PAD_CTL_PAD_SNVS_TAMPER4 field descriptions

Field	Description
31–17 -	This field is reserved. Reserved
16 HYS	Hyst. Enable Field Select one out of next values for pad: SNVS_TAMPER4 0 HYS_0_Hysteresis_Disabled — Hysteresis Disabled 1 HYS_1_Hysteresis_Enabled — Hysteresis Enabled
15–14 PUS	Pull Up / Down Config. Field Select one out of next values for pad: SNVS_TAMPER4 00 PUS_0_100K_Ohm_Pull_Down — 100K Ohm Pull Down 01 PUS_1_47K_Ohm_Pull_Up — 47K Ohm Pull Up 10 PUS_2_100K_Ohm_Pull_Up — 100K Ohm Pull Up 11 PUS_3_22K_Ohm_Pull_Up — 22K Ohm Pull Up
13 PUE	Pull / Keep Select Field Select one out of next values for pad: SNVS_TAMPER4 0 PUE_0_Keeper — Keeper 1 PUE_1_Pull — Pull
12 PKE	Pull / Keep Enable Field Select one out of next values for pad: SNVS_TAMPER4 0 PKE_0_Pull_Keeper_Disabled — Pull/Keeper Disabled 1 PKE_1_Pull_Keeper_Enabled — Pull/Keeper Enabled

Table continues on the next page...

IOMUXC_SNVS_SW_PAD_CTL_PAD_SNVS_TAMPER4 field descriptions (continued)

Field	Description
11 ODE	Open Drain Enable Field Select one out of next values for pad: SNVS_TAMPER4 0 ODE_0_Open_Drain_Disabled — Open Drain Disabled 1 ODE_1_Open_Drain_Enabled — Open Drain Enabled
10–8 -	This field is reserved. Reserved
7–6 SPEED	Speed Field Read Only Field 10 SPEED — medium(100MHz)
5–3 DSE	Drive Strength Field Select one out of next values for pad: SNVS_TAMPER4 000 DSE_0_output_driver_disabled_ — output driver disabled; 001 DSE_1_R0_260_Ohm__3_3V_150_Ohm_1_8V_240_Ohm_for_DDR_ — R0(260 Ohm @ 3.3V, 150 Ohm@1.8V, 240 Ohm for DDR) 010 DSE_2_R0_2 — R0/2 011 DSE_3_R0_3 — R0/3 100 DSE_4_R0_4 — R0/4 101 DSE_5_R0_5 — R0/5 110 DSE_6_R0_6 — R0/6 111 DSE_7_R0_7 — R0/7
2–1 -	This field is reserved. Reserved
0 SRE	Slew Rate Field Select one out of next values for pad: SNVS_TAMPER4 0 SRE_0_Slow_Slew_Rate — Slow Slew Rate 1 SRE_1_Fast_Slew_Rate — Fast Slew Rate

32.5.25 SW_PAD_CTL_PAD_SNVS_TAMPER5 SW PAD Control Register (IOMUXC_SNVS_SW_PAD_CTL_PAD_SNVS_TAMPER5)

SW_PAD_CTL Register

Address: 229_0000h base + 60h offset = 229_0060h

Bit	31	30	29	28	27	26	25	24	23	22	21	20	19	18	17	16
R	Reserved															HYS
W	Reserved															HYS
Reset	0	0	0	0	0	0	0	0	0	0	0	0	0	0	0	1
Bit	15	14	13	12	11	10	9	8	7	6	5	4	3	2	1	0
R	PUS	PUE	PKE	ODE	Reserved			SPEED		DSE			Reserved		SRE	
W	PUS	PUE	PKE	ODE	Reserved			SPEED		DSE			Reserved		SRE	
Reset	0	0	0	1	0	0	0	0	1	0	1	0	0	0	0	0

IOMUXC_SNVS_SW_PAD_CTL_PAD_SNVS_TAMPER5 field descriptions

Field	Description
31–17 -	This field is reserved. Reserved
16 HYS	Hyst. Enable Field Select one out of next values for pad: SNVS_TAMPER5 0 HYS_0_Hysteresis_Disabled — Hysteresis Disabled 1 HYS_1_Hysteresis_Enabled — Hysteresis Enabled
15–14 PUS	Pull Up / Down Config. Field Select one out of next values for pad: SNVS_TAMPER5 00 PUS_0_100K_Ohm_Pull_Down — 100K Ohm Pull Down 01 PUS_1_47K_Ohm_Pull_Up — 47K Ohm Pull Up 10 PUS_2_100K_Ohm_Pull_Up — 100K Ohm Pull Up 11 PUS_3_22K_Ohm_Pull_Up — 22K Ohm Pull Up
13 PUE	Pull / Keep Select Field Select one out of next values for pad: SNVS_TAMPER5 0 PUE_0_Keeper — Keeper 1 PUE_1_Pull — Pull
12 PKE	Pull / Keep Enable Field Select one out of next values for pad: SNVS_TAMPER5 0 PKE_0_Pull_Keeper_Disabled — Pull/Keeper Disabled 1 PKE_1_Pull_Keeper_Enabled — Pull/Keeper Enabled

Table continues on the next page...

IOMUXC_SNVS_SW_PAD_CTL_PAD_SNVS_TAMPER5 field descriptions (continued)

Field	Description
11 ODE	Open Drain Enable Field Select one out of next values for pad: SNVS_TAMPER5 0 ODE_0_Open_Drain_Disabled — Open Drain Disabled 1 ODE_1_Open_Drain_Enabled — Open Drain Enabled
10–8 -	This field is reserved. Reserved
7–6 SPEED	Speed Field Read Only Field 10 SPEED — medium(100MHz)
5–3 DSE	Drive Strength Field Select one out of next values for pad: SNVS_TAMPER5 000 DSE_0_output_driver_disabled_ — output driver disabled; 001 DSE_1_R0_260_Ohm__3_3V_150_Ohm_1_8V_240_Ohm_for_DDR_ — R0(260 Ohm @ 3.3V, 150 Ohm@1.8V, 240 Ohm for DDR) 010 DSE_2_R0_2 — R0/2 011 DSE_3_R0_3 — R0/3 100 DSE_4_R0_4 — R0/4 101 DSE_5_R0_5 — R0/5 110 DSE_6_R0_6 — R0/6 111 DSE_7_R0_7 — R0/7
2–1 -	This field is reserved. Reserved
0 SRE	Slew Rate Field Select one out of next values for pad: SNVS_TAMPER5 0 SRE_0_Slow_Slew_Rate — Slow Slew Rate 1 SRE_1_Fast_Slew_Rate — Fast Slew Rate

32.5.26 SW_PAD_CTL_PAD_SNVS_TAMPER6 SW PAD Control Register (IOMUXC_SNVS_SW_PAD_CTL_PAD_SNVS_TAMPER6)

SW_PAD_CTL Register

Address: 229_0000h base + 64h offset = 229_0064h

Bit	31	30	29	28	27	26	25	24	23	22	21	20	19	18	17	16
R	Reserved															HYS
W																
Reset	0	0	0	0	0	0	0	0	0	0	0	0	0	0	0	1
Bit	15	14	13	12	11	10	9	8	7	6	5	4	3	2	1	0
R	PUS		PUE	PKE	ODE	Reserved			SPEED		DSE			Reserved		SRE
W																
Reset	0	0	0	1	0	0	0	0	1	0	1	0	0	0	0	0

IOMUXC_SNVS_SW_PAD_CTL_PAD_SNVS_TAMPER6 field descriptions

Field	Description
31–17 -	This field is reserved. Reserved
16 HYS	Hyst. Enable Field Select one out of next values for pad: SNVS_TAMPER6 0 HYS_0_Hysteresis_Disabled — Hysteresis Disabled 1 HYS_1_Hysteresis_Enabled — Hysteresis Enabled
15–14 PUS	Pull Up / Down Config. Field Select one out of next values for pad: SNVS_TAMPER6 00 PUS_0_100K_Ohm_Pull_Down — 100K Ohm Pull Down 01 PUS_1_47K_Ohm_Pull_Up — 47K Ohm Pull Up 10 PUS_2_100K_Ohm_Pull_Up — 100K Ohm Pull Up 11 PUS_3_22K_Ohm_Pull_Up — 22K Ohm Pull Up
13 PUE	Pull / Keep Select Field Select one out of next values for pad: SNVS_TAMPER6 0 PUE_0_Keeper — Keeper 1 PUE_1_Pull — Pull
12 PKE	Pull / Keep Enable Field Select one out of next values for pad: SNVS_TAMPER6 0 PKE_0_Pull_Keeper_Disabled — Pull/Keeper Disabled 1 PKE_1_Pull_Keeper_Enabled — Pull/Keeper Enabled

Table continues on the next page...

IOMUXC_SNVS_SW_PAD_CTL_PAD_SNVS_TAMPER6 field descriptions (continued)

Field	Description
11 ODE	Open Drain Enable Field Select one out of next values for pad: SNVS_TAMPER6 0 ODE_0_Open_Drain_Disabled — Open Drain Disabled 1 ODE_1_Open_Drain_Enabled — Open Drain Enabled
10–8 -	This field is reserved. Reserved
7–6 SPEED	Speed Field Read Only Field 10 SPEED — medium(100MHz)
5–3 DSE	Drive Strength Field Select one out of next values for pad: SNVS_TAMPER6 000 DSE_0_output_driver_disabled_ — output driver disabled; 001 DSE_1_R0_260_Ohm__3_3V_150_Ohm_1_8V_240_Ohm_for_DDR_ — R0(260 Ohm @ 3.3V, 150 Ohm@1.8V, 240 Ohm for DDR) 010 DSE_2_R0_2 — R0/2 011 DSE_3_R0_3 — R0/3 100 DSE_4_R0_4 — R0/4 101 DSE_5_R0_5 — R0/5 110 DSE_6_R0_6 — R0/6 111 DSE_7_R0_7 — R0/7
2–1 -	This field is reserved. Reserved
0 SRE	Slew Rate Field Select one out of next values for pad: SNVS_TAMPER6 0 SRE_0_Slow_Slew_Rate — Slow Slew Rate 1 SRE_1_Fast_Slew_Rate — Fast Slew Rate

32.5.27 SW_PAD_CTL_PAD_SNVS_TAMPER7 SW PAD Control Register (IOMUXC_SNVS_SW_PAD_CTL_PAD_SNVS_TAMPER7)

SW_PAD_CTL Register

Address: 229_0000h base + 68h offset = 229_0068h

Bit	31	30	29	28	27	26	25	24	23	22	21	20	19	18	17	16
R	Reserved															HYS
W																
Reset	0	0	0	0	0	0	0	0	0	0	0	0	0	0	0	1
Bit	15	14	13	12	11	10	9	8	7	6	5	4	3	2	1	0
R	PUS		PUE	PKE	ODE	Reserved			SPEED		DSE			Reserved		SRE
W																
Reset	0	0	0	1	0	0	0	0	1	0	1	0	0	0	0	0

IOMUXC_SNVS_SW_PAD_CTL_PAD_SNVS_TAMPER7 field descriptions

Field	Description
31–17 -	This field is reserved. Reserved
16 HYS	Hyst. Enable Field Select one out of next values for pad: SNVS_TAMPER7 0 HYS_0_Hysteresis_Disabled — Hysteresis Disabled 1 HYS_1_Hysteresis_Enabled — Hysteresis Enabled
15–14 PUS	Pull Up / Down Config. Field Select one out of next values for pad: SNVS_TAMPER7 00 PUS_0_100K_Ohm_Pull_Down — 100K Ohm Pull Down 01 PUS_1_47K_Ohm_Pull_Up — 47K Ohm Pull Up 10 PUS_2_100K_Ohm_Pull_Up — 100K Ohm Pull Up 11 PUS_3_22K_Ohm_Pull_Up — 22K Ohm Pull Up
13 PUE	Pull / Keep Select Field Select one out of next values for pad: SNVS_TAMPER7 0 PUE_0_Keeper — Keeper 1 PUE_1_Pull — Pull
12 PKE	Pull / Keep Enable Field Select one out of next values for pad: SNVS_TAMPER7 0 PKE_0_Pull_Keeper_Disabled — Pull/Keeper Disabled 1 PKE_1_Pull_Keeper_Enabled — Pull/Keeper Enabled

Table continues on the next page...

IOMUXC_SNVS_SW_PAD_CTL_PAD_SNVS_TAMPER7 field descriptions (continued)

Field	Description
11 ODE	Open Drain Enable Field Select one out of next values for pad: SNVS_TAMPER7 0 ODE_0_Open_Drain_Disabled — Open Drain Disabled 1 ODE_1_Open_Drain_Enabled — Open Drain Enabled
10–8 -	This field is reserved. Reserved
7–6 SPEED	Speed Field Read Only Field 10 SPEED — medium(100MHz)
5–3 DSE	Drive Strength Field Select one out of next values for pad: SNVS_TAMPER7 000 DSE_0_output_driver_disabled_ — output driver disabled; 001 DSE_1_R0_260_Ohm__3_3V_150_Ohm_1_8V_240_Ohm_for_DDR_ — R0(260 Ohm @ 3.3V, 150 Ohm@1.8V, 240 Ohm for DDR) 010 DSE_2_R0_2 — R0/2 011 DSE_3_R0_3 — R0/3 100 DSE_4_R0_4 — R0/4 101 DSE_5_R0_5 — R0/5 110 DSE_6_R0_6 — R0/6 111 DSE_7_R0_7 — R0/7
2–1 -	This field is reserved. Reserved
0 SRE	Slew Rate Field Select one out of next values for pad: SNVS_TAMPER7 0 SRE_0_Slow_Slew_Rate — Slow Slew Rate 1 SRE_1_Fast_Slew_Rate — Fast Slew Rate

32.5.28 SW_PAD_CTL_PAD_SNVS_TAMPER8 SW PAD Control Register (IOMUXC_SNVS_SW_PAD_CTL_PAD_SNVS_TAMPER8)

SW_PAD_CTL Register

Address: 229_0000h base + 6Ch offset = 229_006Ch

Bit	31	30	29	28	27	26	25	24	23	22	21	20	19	18	17	16	
R	Reserved															HYS	
W	Reserved																
Reset	0	0	0	0	0	0	0	0	0	0	0	0	0	0	0	0	1
Bit	15	14	13	12	11	10	9	8	7	6	5	4	3	2	1	0	
R	PUS		PUE	PKE	ODE	Reserved			SPEED		DSE			Reserved		SRE	
W	PUS		PUE	PKE	ODE	Reserved			SPEED		DSE			Reserved		SRE	
Reset	0	0	0	1	0	0	0	0	1	0	1	0	0	0	0	0	

IOMUXC_SNVS_SW_PAD_CTL_PAD_SNVS_TAMPER8 field descriptions

Field	Description
31–17 -	This field is reserved. Reserved
16 HYS	Hyst. Enable Field Select one out of next values for pad: SNVS_TAMPER8 0 HYS_0_Hysteresis_Disabled — Hysteresis Disabled 1 HYS_1_Hysteresis_Enabled — Hysteresis Enabled
15–14 PUS	Pull Up / Down Config. Field Select one out of next values for pad: SNVS_TAMPER8 00 PUS_0_100K_Ohm_Pull_Down — 100K Ohm Pull Down 01 PUS_1_47K_Ohm_Pull_Up — 47K Ohm Pull Up 10 PUS_2_100K_Ohm_Pull_Up — 100K Ohm Pull Up 11 PUS_3_22K_Ohm_Pull_Up — 22K Ohm Pull Up
13 PUE	Pull / Keep Select Field Select one out of next values for pad: SNVS_TAMPER8 0 PUE_0_Keeper — Keeper 1 PUE_1_Pull — Pull
12 PKE	Pull / Keep Enable Field Select one out of next values for pad: SNVS_TAMPER8 0 PKE_0_Pull_Keeper_Disabled — Pull/Keeper Disabled 1 PKE_1_Pull_Keeper_Enabled — Pull/Keeper Enabled

Table continues on the next page...

IOMUXC_SNVS_SW_PAD_CTL_PAD_SNVS_TAMPER8 field descriptions (continued)

Field	Description
11 ODE	Open Drain Enable Field Select one out of next values for pad: SNVS_TAMPER8 0 ODE_0_Open_Drain_Disabled — Open Drain Disabled 1 ODE_1_Open_Drain_Enabled — Open Drain Enabled
10–8 -	This field is reserved. Reserved
7–6 SPEED	Speed Field Read Only Field 10 SPEED — medium(100MHz)
5–3 DSE	Drive Strength Field Select one out of next values for pad: SNVS_TAMPER8 000 DSE_0_output_driver_disabled_ — output driver disabled; 001 DSE_1_R0_260_Ohm__3_3V_150_Ohm_1_8V_240_Ohm_for_DDR_ — R0(260 Ohm @ 3.3V, 150 Ohm@1.8V, 240 Ohm for DDR) 010 DSE_2_R0_2 — R0/2 011 DSE_3_R0_3 — R0/3 100 DSE_4_R0_4 — R0/4 101 DSE_5_R0_5 — R0/5 110 DSE_6_R0_6 — R0/6 111 DSE_7_R0_7 — R0/7
2–1 -	This field is reserved. Reserved
0 SRE	Slew Rate Field Select one out of next values for pad: SNVS_TAMPER8 0 SRE_0_Slow_Slew_Rate — Slow Slew Rate 1 SRE_1_Fast_Slew_Rate — Fast Slew Rate

32.5.29 SW_PAD_CTL_PAD_SNVS_TAMPER9 SW PAD Control Register (IOMUXC_SNVS_SW_PAD_CTL_PAD_SNVS_TAMPER9)

SW_PAD_CTL Register

Address: 229_0000h base + 70h offset = 229_0070h

Bit	31	30	29	28	27	26	25	24	23	22	21	20	19	18	17	16
R	Reserved															HYS
W																
Reset	0	0	0	0	0	0	0	0	0	0	0	0	0	0	0	1
Bit	15	14	13	12	11	10	9	8	7	6	5	4	3	2	1	0
R	PUS		PUE	PKE	ODE	Reserved			SPEED		DSE			Reserved		SRE
W																
Reset	0	0	0	1	0	0	0	0	1	0	1	0	0	0	0	0

IOMUXC_SNVS_SW_PAD_CTL_PAD_SNVS_TAMPER9 field descriptions

Field	Description
31–17 -	This field is reserved. Reserved
16 HYS	Hyst. Enable Field Select one out of next values for pad: SNVS_TAMPER9 0 HYS_0_Hysteresis_Disabled — Hysteresis Disabled 1 HYS_1_Hysteresis_Enabled — Hysteresis Enabled
15–14 PUS	Pull Up / Down Config. Field Select one out of next values for pad: SNVS_TAMPER9 00 PUS_0_100K_Ohm_Pull_Down — 100K Ohm Pull Down 01 PUS_1_47K_Ohm_Pull_Up — 47K Ohm Pull Up 10 PUS_2_100K_Ohm_Pull_Up — 100K Ohm Pull Up 11 PUS_3_22K_Ohm_Pull_Up — 22K Ohm Pull Up
13 PUE	Pull / Keep Select Field Select one out of next values for pad: SNVS_TAMPER9 0 PUE_0_Keeper — Keeper 1 PUE_1_Pull — Pull
12 PKE	Pull / Keep Enable Field Select one out of next values for pad: SNVS_TAMPER9 0 PKE_0_Pull_Keeper_Disabled — Pull/Keeper Disabled 1 PKE_1_Pull_Keeper_Enabled — Pull/Keeper Enabled

Table continues on the next page...

IOMUXC_SNVS_SW_PAD_CTL_PAD_SNVS_TAMPER9 field descriptions (continued)

Field	Description
11 ODE	Open Drain Enable Field Select one out of next values for pad: SNVS_TAMPER9 0 ODE_0_Open_Drain_Disabled — Open Drain Disabled 1 ODE_1_Open_Drain_Enabled — Open Drain Enabled
10–8 -	This field is reserved. Reserved
7–6 SPEED	Speed Field Read Only Field 10 SPEED — medium(100MHz)
5–3 DSE	Drive Strength Field Select one out of next values for pad: SNVS_TAMPER9 000 DSE_0_output_driver_disabled_ — output driver disabled; 001 DSE_1_R0_260_Ohm_3_3V_150_Ohm_1_8V_240_Ohm_for_DDR_ — R0(260 Ohm @ 3.3V, 150 Ohm@1.8V, 240 Ohm for DDR) 010 DSE_2_R0_2 — R0/2 011 DSE_3_R0_3 — R0/3 100 DSE_4_R0_4 — R0/4 101 DSE_5_R0_5 — R0/5 110 DSE_6_R0_6 — R0/6 111 DSE_7_R0_7 — R0/7
2–1 -	This field is reserved. Reserved
0 SRE	Slew Rate Field Select one out of next values for pad: SNVS_TAMPER9 0 SRE_0_Slow_Slew_Rate — Slow Slew Rate 1 SRE_1_Fast_Slew_Rate — Fast Slew Rate

32.6 IOMUXC Memory Map/Register Definition

IOMUXC memory map

Absolute address (hex)	Register name	Width (in bits)	Access	Reset value	Section/page
20E_0044	SW_MUX_CTL_PAD_JTAG_MOD SW MUX Control Register (IOMUXC_SW_MUX_CTL_PAD_JTAG_MOD)	32	R/W	0000_0000h	32.6.1/1562
20E_0048	SW_MUX_CTL_PAD_JTAG_TMS SW MUX Control Register (IOMUXC_SW_MUX_CTL_PAD_JTAG_TMS)	32	R/W	0000_0000h	32.6.2/1563

Table continues on the next page...

IOMUXC memory map (continued)

Absolute address (hex)	Register name	Width (in bits)	Access	Reset value	Section/page
20E_004C	SW_MUX_CTL_PAD_JTAG_TDO SW MUX Control Register (IOMUXC_SW_MUX_CTL_PAD_JTAG_TDO)	32	R/W	0000_0000h	32.6.3/1564
20E_0050	SW_MUX_CTL_PAD_JTAG_TDI SW MUX Control Register (IOMUXC_SW_MUX_CTL_PAD_JTAG_TDI)	32	R/W	0000_0000h	32.6.4/1565
20E_0054	SW_MUX_CTL_PAD_JTAG_TCK SW MUX Control Register (IOMUXC_SW_MUX_CTL_PAD_JTAG_TCK)	32	R/W	0000_0000h	32.6.5/1566
20E_0058	SW_MUX_CTL_PAD_JTAG_TRST_B SW MUX Control Register (IOMUXC_SW_MUX_CTL_PAD_JTAG_TRST_B)	32	R/W	0000_0000h	32.6.6/1567
20E_005C	SW_MUX_CTL_PAD_GPIO1_IO00 SW MUX Control Register (IOMUXC_SW_MUX_CTL_PAD_GPIO1_IO00)	32	R/W	0000_0005h	32.6.7/1568
20E_0060	SW_MUX_CTL_PAD_GPIO1_IO01 SW MUX Control Register (IOMUXC_SW_MUX_CTL_PAD_GPIO1_IO01)	32	R/W	0000_0005h	32.6.8/1569
20E_0064	SW_MUX_CTL_PAD_GPIO1_IO02 SW MUX Control Register (IOMUXC_SW_MUX_CTL_PAD_GPIO1_IO02)	32	R/W	0000_0005h	32.6.9/1570
20E_0068	SW_MUX_CTL_PAD_GPIO1_IO03 SW MUX Control Register (IOMUXC_SW_MUX_CTL_PAD_GPIO1_IO03)	32	R/W	0000_0005h	32.6.10/1571
20E_006C	SW_MUX_CTL_PAD_GPIO1_IO04 SW MUX Control Register (IOMUXC_SW_MUX_CTL_PAD_GPIO1_IO04)	32	R/W	0000_0005h	32.6.11/1572
20E_0070	SW_MUX_CTL_PAD_GPIO1_IO05 SW MUX Control Register (IOMUXC_SW_MUX_CTL_PAD_GPIO1_IO05)	32	R/W	0000_0005h	32.6.12/1573
20E_0074	SW_MUX_CTL_PAD_GPIO1_IO06 SW MUX Control Register (IOMUXC_SW_MUX_CTL_PAD_GPIO1_IO06)	32	R/W	0000_0005h	32.6.13/1574
20E_0078	SW_MUX_CTL_PAD_GPIO1_IO07 SW MUX Control Register (IOMUXC_SW_MUX_CTL_PAD_GPIO1_IO07)	32	R/W	0000_0005h	32.6.14/1575
20E_007C	SW_MUX_CTL_PAD_GPIO1_IO08 SW MUX Control Register (IOMUXC_SW_MUX_CTL_PAD_GPIO1_IO08)	32	R/W	0000_0005h	32.6.15/1576
20E_0080	SW_MUX_CTL_PAD_GPIO1_IO09 SW MUX Control Register (IOMUXC_SW_MUX_CTL_PAD_GPIO1_IO09)	32	R/W	0000_0005h	32.6.16/1577
20E_0084	SW_MUX_CTL_PAD_UART1_TX_DATA SW MUX Control Register (IOMUXC_SW_MUX_CTL_PAD_UART1_TX_DATA)	32	R/W	0000_0005h	32.6.17/1578
20E_0088	SW_MUX_CTL_PAD_UART1_RX_DATA SW MUX Control Register (IOMUXC_SW_MUX_CTL_PAD_UART1_RX_DATA)	32	R/W	0000_0005h	32.6.18/1579
20E_008C	SW_MUX_CTL_PAD_UART1_CTS_B SW MUX Control Register (IOMUXC_SW_MUX_CTL_PAD_UART1_CTS_B)	32	R/W	0000_0005h	32.6.19/1580
20E_0090	SW_MUX_CTL_PAD_UART1_RTS_B SW MUX Control Register (IOMUXC_SW_MUX_CTL_PAD_UART1_RTS_B)	32	R/W	0000_0005h	32.6.20/1581
20E_0094	SW_MUX_CTL_PAD_UART2_TX_DATA SW MUX Control Register (IOMUXC_SW_MUX_CTL_PAD_UART2_TX_DATA)	32	R/W	0000_0005h	32.6.21/1582
20E_0098	SW_MUX_CTL_PAD_UART2_RX_DATA SW MUX Control Register (IOMUXC_SW_MUX_CTL_PAD_UART2_RX_DATA)	32	R/W	0000_0005h	32.6.22/1583

Table continues on the next page...

IOMUXC memory map (continued)

Absolute address (hex)	Register name	Width (in bits)	Access	Reset value	Section/page
20E_009C	SW_MUX_CTL_PAD_UART2_CTS_B SW MUX Control Register (IOMUXC_SW_MUX_CTL_PAD_UART2_CTS_B)	32	R/W	0000_0005h	32.6.23/1584
20E_00A0	SW_MUX_CTL_PAD_UART2_RTS_B SW MUX Control Register (IOMUXC_SW_MUX_CTL_PAD_UART2_RTS_B)	32	R/W	0000_0005h	32.6.24/1585
20E_00A4	SW_MUX_CTL_PAD_UART3_TX_DATA SW MUX Control Register (IOMUXC_SW_MUX_CTL_PAD_UART3_TX_DATA)	32	R/W	0000_0005h	32.6.25/1586
20E_00A8	SW_MUX_CTL_PAD_UART3_RX_DATA SW MUX Control Register (IOMUXC_SW_MUX_CTL_PAD_UART3_RX_DATA)	32	R/W	0000_0005h	32.6.26/1587
20E_00AC	SW_MUX_CTL_PAD_UART3_CTS_B SW MUX Control Register (IOMUXC_SW_MUX_CTL_PAD_UART3_CTS_B)	32	R/W	0000_0005h	32.6.27/1588
20E_00B0	SW_MUX_CTL_PAD_UART3_RTS_B SW MUX Control Register (IOMUXC_SW_MUX_CTL_PAD_UART3_RTS_B)	32	R/W	0000_0005h	32.6.28/1589
20E_00B4	SW_MUX_CTL_PAD_UART4_TX_DATA SW MUX Control Register (IOMUXC_SW_MUX_CTL_PAD_UART4_TX_DATA)	32	R/W	0000_0005h	32.6.29/1590
20E_00B8	SW_MUX_CTL_PAD_UART4_RX_DATA SW MUX Control Register (IOMUXC_SW_MUX_CTL_PAD_UART4_RX_DATA)	32	R/W	0000_0005h	32.6.30/1591
20E_00BC	SW_MUX_CTL_PAD_UART5_TX_DATA SW MUX Control Register (IOMUXC_SW_MUX_CTL_PAD_UART5_TX_DATA)	32	R/W	0000_0005h	32.6.31/1592
20E_00C0	SW_MUX_CTL_PAD_UART5_RX_DATA SW MUX Control Register (IOMUXC_SW_MUX_CTL_PAD_UART5_RX_DATA)	32	R/W	0000_0005h	32.6.32/1593
20E_00C4	SW_MUX_CTL_PAD_ENET1_RX_DATA0 SW MUX Control Register (IOMUXC_SW_MUX_CTL_PAD_ENET1_RX_DATA0)	32	R/W	0000_0005h	32.6.33/1594
20E_00C8	SW_MUX_CTL_PAD_ENET1_RX_DATA1 SW MUX Control Register (IOMUXC_SW_MUX_CTL_PAD_ENET1_RX_DATA1)	32	R/W	0000_0005h	32.6.34/1595
20E_00CC	SW_MUX_CTL_PAD_ENET1_RX_EN SW MUX Control Register (IOMUXC_SW_MUX_CTL_PAD_ENET1_RX_EN)	32	R/W	0000_0005h	32.6.35/1596
20E_00D0	SW_MUX_CTL_PAD_ENET1_TX_DATA0 SW MUX Control Register (IOMUXC_SW_MUX_CTL_PAD_ENET1_TX_DATA0)	32	R/W	0000_0005h	32.6.36/1597
20E_00D4	SW_MUX_CTL_PAD_ENET1_TX_DATA1 SW MUX Control Register (IOMUXC_SW_MUX_CTL_PAD_ENET1_TX_DATA1)	32	R/W	0000_0005h	32.6.37/1598
20E_00D8	SW_MUX_CTL_PAD_ENET1_TX_EN SW MUX Control Register (IOMUXC_SW_MUX_CTL_PAD_ENET1_TX_EN)	32	R/W	0000_0005h	32.6.38/1599
20E_00DC	SW_MUX_CTL_PAD_ENET1_TX_CLK SW MUX Control Register (IOMUXC_SW_MUX_CTL_PAD_ENET1_TX_CLK)	32	R/W	0000_0005h	32.6.39/1600
20E_00E0	SW_MUX_CTL_PAD_ENET1_RX_ER SW MUX Control Register (IOMUXC_SW_MUX_CTL_PAD_ENET1_RX_ER)	32	R/W	0000_0005h	32.6.40/1601

Table continues on the next page...

IOMUXC memory map (continued)

Absolute address (hex)	Register name	Width (in bits)	Access	Reset value	Section/page
20E_00E4	SW_MUX_CTL_PAD_ENET2_RX_DATA0 SW MUX Control Register (IOMUXC_SW_MUX_CTL_PAD_ENET2_RX_DATA0)	32	R/W	0000_0005h	32.6.41/ 1602
20E_00E8	SW_MUX_CTL_PAD_ENET2_RX_DATA1 SW MUX Control Register (IOMUXC_SW_MUX_CTL_PAD_ENET2_RX_DATA1)	32	R/W	0000_0005h	32.6.42/ 1603
20E_00EC	SW_MUX_CTL_PAD_ENET2_RX_EN SW MUX Control Register (IOMUXC_SW_MUX_CTL_PAD_ENET2_RX_EN)	32	R/W	0000_0005h	32.6.43/ 1604
20E_00F0	SW_MUX_CTL_PAD_ENET2_TX_DATA0 SW MUX Control Register (IOMUXC_SW_MUX_CTL_PAD_ENET2_TX_DATA0)	32	R/W	0000_0005h	32.6.44/ 1605
20E_00F4	SW_MUX_CTL_PAD_ENET2_TX_DATA1 SW MUX Control Register (IOMUXC_SW_MUX_CTL_PAD_ENET2_TX_DATA1)	32	R/W	0000_0005h	32.6.45/ 1606
20E_00F8	SW_MUX_CTL_PAD_ENET2_TX_EN SW MUX Control Register (IOMUXC_SW_MUX_CTL_PAD_ENET2_TX_EN)	32	R/W	0000_0005h	32.6.46/ 1607
20E_00FC	SW_MUX_CTL_PAD_ENET2_TX_CLK SW MUX Control Register (IOMUXC_SW_MUX_CTL_PAD_ENET2_TX_CLK)	32	R/W	0000_0005h	32.6.47/ 1608
20E_0100	SW_MUX_CTL_PAD_ENET2_RX_ER SW MUX Control Register (IOMUXC_SW_MUX_CTL_PAD_ENET2_RX_ER)	32	R/W	0000_0005h	32.6.48/ 1609
20E_0104	SW_MUX_CTL_PAD_LCD_CLK SW MUX Control Register (IOMUXC_SW_MUX_CTL_PAD_LCD_CLK)	32	R/W	0000_0005h	32.6.49/ 1610
20E_0108	SW_MUX_CTL_PAD_LCD_ENABLE SW MUX Control Register (IOMUXC_SW_MUX_CTL_PAD_LCD_ENABLE)	32	R/W	0000_0005h	32.6.50/ 1611
20E_010C	SW_MUX_CTL_PAD_LCD_HSYNC SW MUX Control Register (IOMUXC_SW_MUX_CTL_PAD_LCD_HSYNC)	32	R/W	0000_0005h	32.6.51/ 1612
20E_0110	SW_MUX_CTL_PAD_LCD_VSYNC SW MUX Control Register (IOMUXC_SW_MUX_CTL_PAD_LCD_VSYNC)	32	R/W	0000_0005h	32.6.52/ 1613
20E_0114	SW_MUX_CTL_PAD_LCD_RESET SW MUX Control Register (IOMUXC_SW_MUX_CTL_PAD_LCD_RESET)	32	R/W	0000_0005h	32.6.53/ 1614
20E_0118	SW_MUX_CTL_PAD_LCD_DATA00 SW MUX Control Register (IOMUXC_SW_MUX_CTL_PAD_LCD_DATA00)	32	R/W	0000_0005h	32.6.54/ 1615
20E_011C	SW_MUX_CTL_PAD_LCD_DATA01 SW MUX Control Register (IOMUXC_SW_MUX_CTL_PAD_LCD_DATA01)	32	R/W	0000_0005h	32.6.55/ 1616
20E_0120	SW_MUX_CTL_PAD_LCD_DATA02 SW MUX Control Register (IOMUXC_SW_MUX_CTL_PAD_LCD_DATA02)	32	R/W	0000_0005h	32.6.56/ 1617
20E_0124	SW_MUX_CTL_PAD_LCD_DATA03 SW MUX Control Register (IOMUXC_SW_MUX_CTL_PAD_LCD_DATA03)	32	R/W	0000_0005h	32.6.57/ 1618
20E_0128	SW_MUX_CTL_PAD_LCD_DATA04 SW MUX Control Register (IOMUXC_SW_MUX_CTL_PAD_LCD_DATA04)	32	R/W	0000_0005h	32.6.58/ 1619
20E_012C	SW_MUX_CTL_PAD_LCD_DATA05 SW MUX Control Register (IOMUXC_SW_MUX_CTL_PAD_LCD_DATA05)	32	R/W	0000_0005h	32.6.59/ 1620
20E_0130	SW_MUX_CTL_PAD_LCD_DATA06 SW MUX Control Register (IOMUXC_SW_MUX_CTL_PAD_LCD_DATA06)	32	R/W	0000_0005h	32.6.60/ 1621

Table continues on the next page...

IOMUXC memory map (continued)

Absolute address (hex)	Register name	Width (in bits)	Access	Reset value	Section/page
20E_0134	SW_MUX_CTL_PAD_LCD_DATA07 SW MUX Control Register (IOMUXC_SW_MUX_CTL_PAD_LCD_DATA07)	32	R/W	0000_0005h	32.6.61/ 1622
20E_0138	SW_MUX_CTL_PAD_LCD_DATA08 SW MUX Control Register (IOMUXC_SW_MUX_CTL_PAD_LCD_DATA08)	32	R/W	0000_0005h	32.6.62/ 1623
20E_013C	SW_MUX_CTL_PAD_LCD_DATA09 SW MUX Control Register (IOMUXC_SW_MUX_CTL_PAD_LCD_DATA09)	32	R/W	0000_0005h	32.6.63/ 1624
20E_0140	SW_MUX_CTL_PAD_LCD_DATA10 SW MUX Control Register (IOMUXC_SW_MUX_CTL_PAD_LCD_DATA10)	32	R/W	0000_0005h	32.6.64/ 1625
20E_0144	SW_MUX_CTL_PAD_LCD_DATA11 SW MUX Control Register (IOMUXC_SW_MUX_CTL_PAD_LCD_DATA11)	32	R/W	0000_0005h	32.6.65/ 1626
20E_0148	SW_MUX_CTL_PAD_LCD_DATA12 SW MUX Control Register (IOMUXC_SW_MUX_CTL_PAD_LCD_DATA12)	32	R/W	0000_0005h	32.6.66/ 1627
20E_014C	SW_MUX_CTL_PAD_LCD_DATA13 SW MUX Control Register (IOMUXC_SW_MUX_CTL_PAD_LCD_DATA13)	32	R/W	0000_0005h	32.6.67/ 1628
20E_0150	SW_MUX_CTL_PAD_LCD_DATA14 SW MUX Control Register (IOMUXC_SW_MUX_CTL_PAD_LCD_DATA14)	32	R/W	0000_0005h	32.6.68/ 1629
20E_0154	SW_MUX_CTL_PAD_LCD_DATA15 SW MUX Control Register (IOMUXC_SW_MUX_CTL_PAD_LCD_DATA15)	32	R/W	0000_0005h	32.6.69/ 1630
20E_0158	SW_MUX_CTL_PAD_LCD_DATA16 SW MUX Control Register (IOMUXC_SW_MUX_CTL_PAD_LCD_DATA16)	32	R/W	0000_0005h	32.6.70/ 1631
20E_015C	SW_MUX_CTL_PAD_LCD_DATA17 SW MUX Control Register (IOMUXC_SW_MUX_CTL_PAD_LCD_DATA17)	32	R/W	0000_0005h	32.6.71/ 1632
20E_0160	SW_MUX_CTL_PAD_LCD_DATA18 SW MUX Control Register (IOMUXC_SW_MUX_CTL_PAD_LCD_DATA18)	32	R/W	0000_0005h	32.6.72/ 1633
20E_0164	SW_MUX_CTL_PAD_LCD_DATA19 SW MUX Control Register (IOMUXC_SW_MUX_CTL_PAD_LCD_DATA19)	32	R/W	0000_0005h	32.6.73/ 1634
20E_0168	SW_MUX_CTL_PAD_LCD_DATA20 SW MUX Control Register (IOMUXC_SW_MUX_CTL_PAD_LCD_DATA20)	32	R/W	0000_0005h	32.6.74/ 1635
20E_016C	SW_MUX_CTL_PAD_LCD_DATA21 SW MUX Control Register (IOMUXC_SW_MUX_CTL_PAD_LCD_DATA21)	32	R/W	0000_0005h	32.6.75/ 1636
20E_0170	SW_MUX_CTL_PAD_LCD_DATA22 SW MUX Control Register (IOMUXC_SW_MUX_CTL_PAD_LCD_DATA22)	32	R/W	0000_0005h	32.6.76/ 1637
20E_0174	SW_MUX_CTL_PAD_LCD_DATA23 SW MUX Control Register (IOMUXC_SW_MUX_CTL_PAD_LCD_DATA23)	32	R/W	0000_0005h	32.6.77/ 1638
20E_0178	SW_MUX_CTL_PAD_NAND_RE_B SW MUX Control Register (IOMUXC_SW_MUX_CTL_PAD_NAND_RE_B)	32	R/W	0000_0005h	32.6.78/ 1639
20E_017C	SW_MUX_CTL_PAD_NAND_WE_B SW MUX Control Register (IOMUXC_SW_MUX_CTL_PAD_NAND_WE_B)	32	R/W	0000_0005h	32.6.79/ 1640
20E_0180	SW_MUX_CTL_PAD_NAND_DATA00 SW MUX Control Register (IOMUXC_SW_MUX_CTL_PAD_NAND_DATA00)	32	R/W	0000_0005h	32.6.80/ 1641
20E_0184	SW_MUX_CTL_PAD_NAND_DATA01 SW MUX Control Register (IOMUXC_SW_MUX_CTL_PAD_NAND_DATA01)	32	R/W	0000_0005h	32.6.81/ 1642
20E_0188	SW_MUX_CTL_PAD_NAND_DATA02 SW MUX Control Register (IOMUXC_SW_MUX_CTL_PAD_NAND_DATA02)	32	R/W	0000_0005h	32.6.82/ 1643

Table continues on the next page...

IOMUXC memory map (continued)

Absolute address (hex)	Register name	Width (in bits)	Access	Reset value	Section/page
20E_018C	SW_MUX_CTL_PAD_NAND_DATA03 SW MUX Control Register (IOMUXC_SW_MUX_CTL_PAD_NAND_DATA03)	32	R/W	0000_0005h	32.6.83/ 1644
20E_0190	SW_MUX_CTL_PAD_NAND_DATA04 SW MUX Control Register (IOMUXC_SW_MUX_CTL_PAD_NAND_DATA04)	32	R/W	0000_0005h	32.6.84/ 1645
20E_0194	SW_MUX_CTL_PAD_NAND_DATA05 SW MUX Control Register (IOMUXC_SW_MUX_CTL_PAD_NAND_DATA05)	32	R/W	0000_0005h	32.6.85/ 1646
20E_0198	SW_MUX_CTL_PAD_NAND_DATA06 SW MUX Control Register (IOMUXC_SW_MUX_CTL_PAD_NAND_DATA06)	32	R/W	0000_0005h	32.6.86/ 1647
20E_019C	SW_MUX_CTL_PAD_NAND_DATA07 SW MUX Control Register (IOMUXC_SW_MUX_CTL_PAD_NAND_DATA07)	32	R/W	0000_0005h	32.6.87/ 1648
20E_01A0	SW_MUX_CTL_PAD_NAND_ALE SW MUX Control Register (IOMUXC_SW_MUX_CTL_PAD_NAND_ALE)	32	R/W	0000_0005h	32.6.88/ 1649
20E_01A4	SW_MUX_CTL_PAD_NAND_WP_B SW MUX Control Register (IOMUXC_SW_MUX_CTL_PAD_NAND_WP_B)	32	R/W	0000_0005h	32.6.89/ 1650
20E_01A8	SW_MUX_CTL_PAD_NAND_READY_B SW MUX Control Register (IOMUXC_SW_MUX_CTL_PAD_NAND_READY_B)	32	R/W	0000_0005h	32.6.90/ 1651
20E_01AC	SW_MUX_CTL_PAD_NAND_CE0_B SW MUX Control Register (IOMUXC_SW_MUX_CTL_PAD_NAND_CE0_B)	32	R/W	0000_0005h	32.6.91/ 1652
20E_01B0	SW_MUX_CTL_PAD_NAND_CE1_B SW MUX Control Register (IOMUXC_SW_MUX_CTL_PAD_NAND_CE1_B)	32	R/W	0000_0005h	32.6.92/ 1653
20E_01B4	SW_MUX_CTL_PAD_NAND_CLE SW MUX Control Register (IOMUXC_SW_MUX_CTL_PAD_NAND_CLE)	32	R/W	0000_0005h	32.6.93/ 1654
20E_01B8	SW_MUX_CTL_PAD_NAND_DQS SW MUX Control Register (IOMUXC_SW_MUX_CTL_PAD_NAND_DQS)	32	R/W	0000_0005h	32.6.94/ 1655
20E_01BC	SW_MUX_CTL_PAD_SD1_CMD SW MUX Control Register (IOMUXC_SW_MUX_CTL_PAD_SD1_CMD)	32	R/W	0000_0005h	32.6.95/ 1656
20E_01C0	SW_MUX_CTL_PAD_SD1_CLK SW MUX Control Register (IOMUXC_SW_MUX_CTL_PAD_SD1_CLK)	32	R/W	0000_0005h	32.6.96/ 1657
20E_01C4	SW_MUX_CTL_PAD_SD1_DATA0 SW MUX Control Register (IOMUXC_SW_MUX_CTL_PAD_SD1_DATA0)	32	R/W	0000_0005h	32.6.97/ 1658
20E_01C8	SW_MUX_CTL_PAD_SD1_DATA1 SW MUX Control Register (IOMUXC_SW_MUX_CTL_PAD_SD1_DATA1)	32	R/W	0000_0005h	32.6.98/ 1659
20E_01CC	SW_MUX_CTL_PAD_SD1_DATA2 SW MUX Control Register (IOMUXC_SW_MUX_CTL_PAD_SD1_DATA2)	32	R/W	0000_0005h	32.6.99/ 1660
20E_01D0	SW_MUX_CTL_PAD_SD1_DATA3 SW MUX Control Register (IOMUXC_SW_MUX_CTL_PAD_SD1_DATA3)	32	R/W	0000_0005h	32.6.100/ 1661
20E_01D4	SW_MUX_CTL_PAD_CSI_MCLK SW MUX Control Register (IOMUXC_SW_MUX_CTL_PAD_CSI_MCLK)	32	R/W	0000_0005h	32.6.101/ 1662
20E_01D8	SW_MUX_CTL_PAD_CSI_PIXCLK SW MUX Control Register (IOMUXC_SW_MUX_CTL_PAD_CSI_PIXCLK)	32	R/W	0000_0005h	32.6.102/ 1663
20E_01DC	SW_MUX_CTL_PAD_CSI_VSYNC SW MUX Control Register (IOMUXC_SW_MUX_CTL_PAD_CSI_VSYNC)	32	R/W	0000_0005h	32.6.103/ 1664
20E_01E0	SW_MUX_CTL_PAD_CSI_HSYNC SW MUX Control Register (IOMUXC_SW_MUX_CTL_PAD_CSI_HSYNC)	32	R/W	0000_0005h	32.6.104/ 1665

Table continues on the next page...

IOMUXC memory map (continued)

Absolute address (hex)	Register name	Width (in bits)	Access	Reset value	Section/page
20E_01E4	SW_MUX_CTL_PAD_CSI_DATA00 SW MUX Control Register (IOMUXC_SW_MUX_CTL_PAD_CSI_DATA00)	32	R/W	0000_0005h	32.6.105/1666
20E_01E8	SW_MUX_CTL_PAD_CSI_DATA01 SW MUX Control Register (IOMUXC_SW_MUX_CTL_PAD_CSI_DATA01)	32	R/W	0000_0005h	32.6.106/1667
20E_01EC	SW_MUX_CTL_PAD_CSI_DATA02 SW MUX Control Register (IOMUXC_SW_MUX_CTL_PAD_CSI_DATA02)	32	R/W	0000_0005h	32.6.107/1668
20E_01F0	SW_MUX_CTL_PAD_CSI_DATA03 SW MUX Control Register (IOMUXC_SW_MUX_CTL_PAD_CSI_DATA03)	32	R/W	0000_0005h	32.6.108/1669
20E_01F4	SW_MUX_CTL_PAD_CSI_DATA04 SW MUX Control Register (IOMUXC_SW_MUX_CTL_PAD_CSI_DATA04)	32	R/W	0000_0005h	32.6.109/1670
20E_01F8	SW_MUX_CTL_PAD_CSI_DATA05 SW MUX Control Register (IOMUXC_SW_MUX_CTL_PAD_CSI_DATA05)	32	R/W	0000_0005h	32.6.110/1671
20E_01FC	SW_MUX_CTL_PAD_CSI_DATA06 SW MUX Control Register (IOMUXC_SW_MUX_CTL_PAD_CSI_DATA06)	32	R/W	0000_0005h	32.6.111/1672
20E_0200	SW_MUX_CTL_PAD_CSI_DATA07 SW MUX Control Register (IOMUXC_SW_MUX_CTL_PAD_CSI_DATA07)	32	R/W	0000_0005h	32.6.112/1673
20E_0204	SW_PAD_CTL_PAD_DRAM_ADDR00 SW PAD Control Register (IOMUXC_SW_PAD_CTL_PAD_DRAM_ADDR00)	32	R/W	0000_8000h	32.6.113/1674
20E_0208	SW_PAD_CTL_PAD_DRAM_ADDR01 SW PAD Control Register (IOMUXC_SW_PAD_CTL_PAD_DRAM_ADDR01)	32	R/W	0000_8000h	32.6.114/1677
20E_020C	SW_PAD_CTL_PAD_DRAM_ADDR02 SW PAD Control Register (IOMUXC_SW_PAD_CTL_PAD_DRAM_ADDR02)	32	R/W	0000_8000h	32.6.115/1680
20E_0210	SW_PAD_CTL_PAD_DRAM_ADDR03 SW PAD Control Register (IOMUXC_SW_PAD_CTL_PAD_DRAM_ADDR03)	32	R/W	0000_8000h	32.6.116/1683
20E_0214	SW_PAD_CTL_PAD_DRAM_ADDR04 SW PAD Control Register (IOMUXC_SW_PAD_CTL_PAD_DRAM_ADDR04)	32	R/W	0000_8000h	32.6.117/1686
20E_0218	SW_PAD_CTL_PAD_DRAM_ADDR05 SW PAD Control Register (IOMUXC_SW_PAD_CTL_PAD_DRAM_ADDR05)	32	R/W	0000_8000h	32.6.118/1689
20E_021C	SW_PAD_CTL_PAD_DRAM_ADDR06 SW PAD Control Register (IOMUXC_SW_PAD_CTL_PAD_DRAM_ADDR06)	32	R/W	0000_8000h	32.6.119/1692
20E_0220	SW_PAD_CTL_PAD_DRAM_ADDR07 SW PAD Control Register (IOMUXC_SW_PAD_CTL_PAD_DRAM_ADDR07)	32	R/W	0000_8000h	32.6.120/1695
20E_0224	SW_PAD_CTL_PAD_DRAM_ADDR08 SW PAD Control Register (IOMUXC_SW_PAD_CTL_PAD_DRAM_ADDR08)	32	R/W	0000_8000h	32.6.121/1698
20E_0228	SW_PAD_CTL_PAD_DRAM_ADDR09 SW PAD Control Register (IOMUXC_SW_PAD_CTL_PAD_DRAM_ADDR09)	32	R/W	0000_8000h	32.6.122/1701
20E_022C	SW_PAD_CTL_PAD_DRAM_ADDR10 SW PAD Control Register (IOMUXC_SW_PAD_CTL_PAD_DRAM_ADDR10)	32	R/W	0000_8000h	32.6.123/1704
20E_0230	SW_PAD_CTL_PAD_DRAM_ADDR11 SW PAD Control Register (IOMUXC_SW_PAD_CTL_PAD_DRAM_ADDR11)	32	R/W	0000_8000h	32.6.124/1707
20E_0234	SW_PAD_CTL_PAD_DRAM_ADDR12 SW PAD Control Register (IOMUXC_SW_PAD_CTL_PAD_DRAM_ADDR12)	32	R/W	0000_8000h	32.6.125/1710
20E_0238	SW_PAD_CTL_PAD_DRAM_ADDR13 SW PAD Control Register (IOMUXC_SW_PAD_CTL_PAD_DRAM_ADDR13)	32	R/W	0000_8000h	32.6.126/1713

Table continues on the next page...

IOMUXC memory map (continued)

Absolute address (hex)	Register name	Width (in bits)	Access	Reset value	Section/page
20E_023C	SW_PAD_CTL_PAD_DRAM_ADDR14 SW PAD Control Register (IOMUXC_SW_PAD_CTL_PAD_DRAM_ADDR14)	32	R/W	0000_8000h	32.6.127/1716
20E_0240	SW_PAD_CTL_PAD_DRAM_ADDR15 SW PAD Control Register (IOMUXC_SW_PAD_CTL_PAD_DRAM_ADDR15)	32	R/W	0000_8000h	32.6.128/1719
20E_0244	SW_PAD_CTL_PAD_DRAM_DQM0 SW PAD Control Register (IOMUXC_SW_PAD_CTL_PAD_DRAM_DQM0)	32	R/W	0000_8030h	32.6.129/1722
20E_0248	SW_PAD_CTL_PAD_DRAM_DQM1 SW PAD Control Register (IOMUXC_SW_PAD_CTL_PAD_DRAM_DQM1)	32	R/W	0000_8030h	32.6.130/1725
20E_024C	SW_PAD_CTL_PAD_DRAM_RAS_B SW PAD Control Register (IOMUXC_SW_PAD_CTL_PAD_DRAM_RAS_B)	32	R/W	0000_8030h	32.6.131/1728
20E_0250	SW_PAD_CTL_PAD_DRAM_CAS_B SW PAD Control Register (IOMUXC_SW_PAD_CTL_PAD_DRAM_CAS_B)	32	R/W	0000_8030h	32.6.132/1731
20E_0254	SW_PAD_CTL_PAD_DRAM_CS0_B SW PAD Control Register (IOMUXC_SW_PAD_CTL_PAD_DRAM_CS0_B)	32	R/W	0000_8000h	32.6.133/1734
20E_0258	SW_PAD_CTL_PAD_DRAM_CS1_B SW PAD Control Register (IOMUXC_SW_PAD_CTL_PAD_DRAM_CS1_B)	32	R/W	0000_8000h	32.6.134/1737
20E_025C	SW_PAD_CTL_PAD_DRAM_SDWE_B SW PAD Control Register (IOMUXC_SW_PAD_CTL_PAD_DRAM_SDWE_B)	32	R/W	0000_8000h	32.6.135/1740
20E_0260	SW_PAD_CTL_PAD_DRAM_ODT0 SW PAD Control Register (IOMUXC_SW_PAD_CTL_PAD_DRAM_ODT0)	32	R/W	0000_3030h	32.6.136/1743
20E_0264	SW_PAD_CTL_PAD_DRAM_ODT1 SW PAD Control Register (IOMUXC_SW_PAD_CTL_PAD_DRAM_ODT1)	32	R/W	0000_3030h	32.6.137/1746
20E_0268	SW_PAD_CTL_PAD_DRAM_SDBA0 SW PAD Control Register (IOMUXC_SW_PAD_CTL_PAD_DRAM_SDBA0)	32	R/W	0000_8000h	32.6.138/1749
20E_026C	SW_PAD_CTL_PAD_DRAM_SDBA1 SW PAD Control Register (IOMUXC_SW_PAD_CTL_PAD_DRAM_SDBA1)	32	R/W	0000_8000h	32.6.139/1752
20E_0270	SW_PAD_CTL_PAD_DRAM_SDBA2 SW PAD Control Register (IOMUXC_SW_PAD_CTL_PAD_DRAM_SDBA2)	32	R/W	0000_B000h	32.6.140/1755
20E_0274	SW_PAD_CTL_PAD_DRAM_SDCKE0 SW PAD Control Register (IOMUXC_SW_PAD_CTL_PAD_DRAM_SDCKE0)	32	R/W	0000_3000h	32.6.141/1758
20E_0278	SW_PAD_CTL_PAD_DRAM_SDCKE1 SW PAD Control Register (IOMUXC_SW_PAD_CTL_PAD_DRAM_SDCKE1)	32	R/W	0000_3000h	32.6.142/1761
20E_027C	SW_PAD_CTL_PAD_DRAM_SDCLK0_P SW PAD Control Register (IOMUXC_SW_PAD_CTL_PAD_DRAM_SDCLK0_P)	32	R/W	0000_8030h	32.6.143/1764
20E_0280	SW_PAD_CTL_PAD_DRAM_SDQS0_P SW PAD Control Register (IOMUXC_SW_PAD_CTL_PAD_DRAM_SDQS0_P)	32	R/W	0000_2030h	32.6.144/1767
20E_0284	SW_PAD_CTL_PAD_DRAM_SDQS1_P SW PAD Control Register (IOMUXC_SW_PAD_CTL_PAD_DRAM_SDQS1_P)	32	R/W	0000_2030h	32.6.145/1770
20E_0288	SW_PAD_CTL_PAD_DRAM_RESET SW PAD Control Register (IOMUXC_SW_PAD_CTL_PAD_DRAM_RESET)	32	R/W	0008_3030h	32.6.146/1773
20E_02D0	SW_PAD_CTL_PAD_JTAG_MOD SW PAD Control Register (IOMUXC_SW_PAD_CTL_PAD_JTAG_MOD)	32	R/W	0000_B0A0h	32.6.147/1775

Table continues on the next page...

IOMUXC memory map (continued)

Absolute address (hex)	Register name	Width (in bits)	Access	Reset value	Section/page
20E_02D4	SW_PAD_CTL_PAD_JTAG_TMS SW PAD Control Register (IOMUXC_SW_PAD_CTL_PAD_JTAG_TMS)	32	R/W	0000_70A0h	32.6.148/1777
20E_02D8	SW_PAD_CTL_PAD_JTAG_TDO SW PAD Control Register (IOMUXC_SW_PAD_CTL_PAD_JTAG_TDO)	32	R/W	0000_90B1h	32.6.149/1779
20E_02DC	SW_PAD_CTL_PAD_JTAG_TDI SW PAD Control Register (IOMUXC_SW_PAD_CTL_PAD_JTAG_TDI)	32	R/W	0000_70A0h	32.6.150/1781
20E_02E0	SW_PAD_CTL_PAD_JTAG_TCK SW PAD Control Register (IOMUXC_SW_PAD_CTL_PAD_JTAG_TCK)	32	R/W	0000_70A0h	32.6.151/1783
20E_02E4	SW_PAD_CTL_PAD_JTAG_TRST_B SW PAD Control Register (IOMUXC_SW_PAD_CTL_PAD_JTAG_TRST_B)	32	R/W	0000_70A0h	32.6.152/1785
20E_02E8	SW_PAD_CTL_PAD_GPIO1_IO00 SW PAD Control Register (IOMUXC_SW_PAD_CTL_PAD_GPIO1_IO00)	32	R/W	0000_10B0h	32.6.153/1787
20E_02EC	SW_PAD_CTL_PAD_GPIO1_IO01 SW PAD Control Register (IOMUXC_SW_PAD_CTL_PAD_GPIO1_IO01)	32	R/W	0000_10B0h	32.6.154/1789
20E_02F0	SW_PAD_CTL_PAD_GPIO1_IO02 SW PAD Control Register (IOMUXC_SW_PAD_CTL_PAD_GPIO1_IO02)	32	R/W	0000_10B0h	32.6.155/1791
20E_02F4	SW_PAD_CTL_PAD_GPIO1_IO03 SW PAD Control Register (IOMUXC_SW_PAD_CTL_PAD_GPIO1_IO03)	32	R/W	0000_10B0h	32.6.156/1793
20E_02F8	SW_PAD_CTL_PAD_GPIO1_IO04 SW PAD Control Register (IOMUXC_SW_PAD_CTL_PAD_GPIO1_IO04)	32	R/W	0000_10B0h	32.6.157/1795
20E_02FC	SW_PAD_CTL_PAD_GPIO1_IO05 SW PAD Control Register (IOMUXC_SW_PAD_CTL_PAD_GPIO1_IO05)	32	R/W	0000_10B0h	32.6.158/1797
20E_0300	SW_PAD_CTL_PAD_GPIO1_IO06 SW PAD Control Register (IOMUXC_SW_PAD_CTL_PAD_GPIO1_IO06)	32	R/W	0000_10B0h	32.6.159/1799
20E_0304	SW_PAD_CTL_PAD_GPIO1_IO07 SW PAD Control Register (IOMUXC_SW_PAD_CTL_PAD_GPIO1_IO07)	32	R/W	0000_10B0h	32.6.160/1801
20E_0308	SW_PAD_CTL_PAD_GPIO1_IO08 SW PAD Control Register (IOMUXC_SW_PAD_CTL_PAD_GPIO1_IO08)	32	R/W	0000_10B0h	32.6.161/1803
20E_030C	SW_PAD_CTL_PAD_GPIO1_IO09 SW PAD Control Register (IOMUXC_SW_PAD_CTL_PAD_GPIO1_IO09)	32	R/W	0000_10B0h	32.6.162/1805
20E_0310	SW_PAD_CTL_PAD_UART1_TX_DATA SW PAD Control Register (IOMUXC_SW_PAD_CTL_PAD_UART1_TX_DATA)	32	R/W	0000_10B0h	32.6.163/1807
20E_0314	SW_PAD_CTL_PAD_UART1_RX_DATA SW PAD Control Register (IOMUXC_SW_PAD_CTL_PAD_UART1_RX_DATA)	32	R/W	0000_10B0h	32.6.164/1809
20E_0318	SW_PAD_CTL_PAD_UART1_CTS_B SW PAD Control Register (IOMUXC_SW_PAD_CTL_PAD_UART1_CTS_B)	32	R/W	0000_10B0h	32.6.165/1811
20E_031C	SW_PAD_CTL_PAD_UART1_RTS_B SW PAD Control Register (IOMUXC_SW_PAD_CTL_PAD_UART1_RTS_B)	32	R/W	0000_10B0h	32.6.166/1813
20E_0320	SW_PAD_CTL_PAD_UART2_TX_DATA SW PAD Control Register (IOMUXC_SW_PAD_CTL_PAD_UART2_TX_DATA)	32	R/W	0000_10B0h	32.6.167/1815

Table continues on the next page...

IOMUXC memory map (continued)

Absolute address (hex)	Register name	Width (in bits)	Access	Reset value	Section/page
20E_0324	SW_PAD_CTL_PAD_UART2_RX_DATA SW PAD Control Register (IOMUXC_SW_PAD_CTL_PAD_UART2_RX_DATA)	32	R/W	0000_10B0h	32.6.168/1817
20E_0328	SW_PAD_CTL_PAD_UART2_CTS_B SW PAD Control Register (IOMUXC_SW_PAD_CTL_PAD_UART2_CTS_B)	32	R/W	0000_10B0h	32.6.169/1819
20E_032C	SW_PAD_CTL_PAD_UART2_RTS_B SW PAD Control Register (IOMUXC_SW_PAD_CTL_PAD_UART2_RTS_B)	32	R/W	0000_10B0h	32.6.170/1821
20E_0330	SW_PAD_CTL_PAD_UART3_TX_DATA SW PAD Control Register (IOMUXC_SW_PAD_CTL_PAD_UART3_TX_DATA)	32	R/W	0000_10B0h	32.6.171/1823
20E_0334	SW_PAD_CTL_PAD_UART3_RX_DATA SW PAD Control Register (IOMUXC_SW_PAD_CTL_PAD_UART3_RX_DATA)	32	R/W	0000_10B0h	32.6.172/1825
20E_0338	SW_PAD_CTL_PAD_UART3_CTS_B SW PAD Control Register (IOMUXC_SW_PAD_CTL_PAD_UART3_CTS_B)	32	R/W	0000_10B0h	32.6.173/1827
20E_033C	SW_PAD_CTL_PAD_UART3_RTS_B SW PAD Control Register (IOMUXC_SW_PAD_CTL_PAD_UART3_RTS_B)	32	R/W	0000_10B0h	32.6.174/1829
20E_0340	SW_PAD_CTL_PAD_UART4_TX_DATA SW PAD Control Register (IOMUXC_SW_PAD_CTL_PAD_UART4_TX_DATA)	32	R/W	0000_10B0h	32.6.175/1831
20E_0344	SW_PAD_CTL_PAD_UART4_RX_DATA SW PAD Control Register (IOMUXC_SW_PAD_CTL_PAD_UART4_RX_DATA)	32	R/W	0000_10B0h	32.6.176/1833
20E_0348	SW_PAD_CTL_PAD_UART5_TX_DATA SW PAD Control Register (IOMUXC_SW_PAD_CTL_PAD_UART5_TX_DATA)	32	R/W	0000_10B0h	32.6.177/1835
20E_034C	SW_PAD_CTL_PAD_UART5_RX_DATA SW PAD Control Register (IOMUXC_SW_PAD_CTL_PAD_UART5_RX_DATA)	32	R/W	0000_10B0h	32.6.178/1837
20E_0350	SW_PAD_CTL_PAD_ENET1_RX_DATA0 SW PAD Control Register (IOMUXC_SW_PAD_CTL_PAD_ENET1_RX_DATA0)	32	R/W	0000_10B0h	32.6.179/1839
20E_0354	SW_PAD_CTL_PAD_ENET1_RX_DATA1 SW PAD Control Register (IOMUXC_SW_PAD_CTL_PAD_ENET1_RX_DATA1)	32	R/W	0000_10B0h	32.6.180/1841
20E_0358	SW_PAD_CTL_PAD_ENET1_RX_EN SW PAD Control Register (IOMUXC_SW_PAD_CTL_PAD_ENET1_RX_EN)	32	R/W	0000_10B0h	32.6.181/1843
20E_035C	SW_PAD_CTL_PAD_ENET1_TX_DATA0 SW PAD Control Register (IOMUXC_SW_PAD_CTL_PAD_ENET1_TX_DATA0)	32	R/W	0000_10B0h	32.6.182/1845
20E_0360	SW_PAD_CTL_PAD_ENET1_TX_DATA1 SW PAD Control Register (IOMUXC_SW_PAD_CTL_PAD_ENET1_TX_DATA1)	32	R/W	0000_10B0h	32.6.183/1847
20E_0364	SW_PAD_CTL_PAD_ENET1_TX_EN SW PAD Control Register (IOMUXC_SW_PAD_CTL_PAD_ENET1_TX_EN)	32	R/W	0000_10B0h	32.6.184/1849

Table continues on the next page...

IOMUXC memory map (continued)

Absolute address (hex)	Register name	Width (in bits)	Access	Reset value	Section/page
20E_0368	SW_PAD_CTL_PAD_ENET1_TX_CLK SW PAD Control Register (IOMUXC_SW_PAD_CTL_PAD_ENET1_TX_CLK)	32	R/W	0000_10B0h	32.6.185/1851
20E_036C	SW_PAD_CTL_PAD_ENET1_RX_ER SW PAD Control Register (IOMUXC_SW_PAD_CTL_PAD_ENET1_RX_ER)	32	R/W	0000_10B0h	32.6.186/1853
20E_0370	SW_PAD_CTL_PAD_ENET2_RX_DATA0 SW PAD Control Register (IOMUXC_SW_PAD_CTL_PAD_ENET2_RX_DATA0)	32	R/W	0000_10B0h	32.6.187/1855
20E_0374	SW_PAD_CTL_PAD_ENET2_RX_DATA1 SW PAD Control Register (IOMUXC_SW_PAD_CTL_PAD_ENET2_RX_DATA1)	32	R/W	0000_10B0h	32.6.188/1857
20E_0378	SW_PAD_CTL_PAD_ENET2_RX_EN SW PAD Control Register (IOMUXC_SW_PAD_CTL_PAD_ENET2_RX_EN)	32	R/W	0000_10B0h	32.6.189/1859
20E_037C	SW_PAD_CTL_PAD_ENET2_TX_DATA0 SW PAD Control Register (IOMUXC_SW_PAD_CTL_PAD_ENET2_TX_DATA0)	32	R/W	0000_10B0h	32.6.190/1861
20E_0380	SW_PAD_CTL_PAD_ENET2_TX_DATA1 SW PAD Control Register (IOMUXC_SW_PAD_CTL_PAD_ENET2_TX_DATA1)	32	R/W	0000_10B0h	32.6.191/1863
20E_0384	SW_PAD_CTL_PAD_ENET2_TX_EN SW PAD Control Register (IOMUXC_SW_PAD_CTL_PAD_ENET2_TX_EN)	32	R/W	0000_10B0h	32.6.192/1865
20E_0388	SW_PAD_CTL_PAD_ENET2_TX_CLK SW PAD Control Register (IOMUXC_SW_PAD_CTL_PAD_ENET2_TX_CLK)	32	R/W	0000_10B0h	32.6.193/1867
20E_038C	SW_PAD_CTL_PAD_ENET2_RX_ER SW PAD Control Register (IOMUXC_SW_PAD_CTL_PAD_ENET2_RX_ER)	32	R/W	0000_10B0h	32.6.194/1869
20E_0390	SW_PAD_CTL_PAD_LCD_CLK SW PAD Control Register (IOMUXC_SW_PAD_CTL_PAD_LCD_CLK)	32	R/W	0000_10B0h	32.6.195/1871
20E_0394	SW_PAD_CTL_PAD_LCD_ENABLE SW PAD Control Register (IOMUXC_SW_PAD_CTL_PAD_LCD_ENABLE)	32	R/W	0000_10B0h	32.6.196/1873
20E_0398	SW_PAD_CTL_PAD_LCD_HSYNC SW PAD Control Register (IOMUXC_SW_PAD_CTL_PAD_LCD_HSYNC)	32	R/W	0000_10B0h	32.6.197/1875
20E_039C	SW_PAD_CTL_PAD_LCD_VSYNC SW PAD Control Register (IOMUXC_SW_PAD_CTL_PAD_LCD_VSYNC)	32	R/W	0000_10B0h	32.6.198/1877
20E_03A0	SW_PAD_CTL_PAD_LCD_RESET SW PAD Control Register (IOMUXC_SW_PAD_CTL_PAD_LCD_RESET)	32	R/W	0000_10B0h	32.6.199/1879
20E_03A4	SW_PAD_CTL_PAD_LCD_DATA00 SW PAD Control Register (IOMUXC_SW_PAD_CTL_PAD_LCD_DATA00)	32	R/W	0000_10B0h	32.6.200/1881
20E_03A8	SW_PAD_CTL_PAD_LCD_DATA01 SW PAD Control Register (IOMUXC_SW_PAD_CTL_PAD_LCD_DATA01)	32	R/W	0000_10B0h	32.6.201/1883
20E_03AC	SW_PAD_CTL_PAD_LCD_DATA02 SW PAD Control Register (IOMUXC_SW_PAD_CTL_PAD_LCD_DATA02)	32	R/W	0000_10B0h	32.6.202/1885
20E_03B0	SW_PAD_CTL_PAD_LCD_DATA03 SW PAD Control Register (IOMUXC_SW_PAD_CTL_PAD_LCD_DATA03)	32	R/W	0000_10B0h	32.6.203/1887
20E_03B4	SW_PAD_CTL_PAD_LCD_DATA04 SW PAD Control Register (IOMUXC_SW_PAD_CTL_PAD_LCD_DATA04)	32	R/W	0000_10B0h	32.6.204/1889

Table continues on the next page...

IOMUXC memory map (continued)

Absolute address (hex)	Register name	Width (in bits)	Access	Reset value	Section/page
20E_03B8	SW_PAD_CTL_PAD_LCD_DATA05 SW PAD Control Register (IOMUXC_SW_PAD_CTL_PAD_LCD_DATA05)	32	R/W	0000_10B0h	32.6.205/1891
20E_03BC	SW_PAD_CTL_PAD_LCD_DATA06 SW PAD Control Register (IOMUXC_SW_PAD_CTL_PAD_LCD_DATA06)	32	R/W	0000_10B0h	32.6.206/1893
20E_03C0	SW_PAD_CTL_PAD_LCD_DATA07 SW PAD Control Register (IOMUXC_SW_PAD_CTL_PAD_LCD_DATA07)	32	R/W	0000_10B0h	32.6.207/1895
20E_03C4	SW_PAD_CTL_PAD_LCD_DATA08 SW PAD Control Register (IOMUXC_SW_PAD_CTL_PAD_LCD_DATA08)	32	R/W	0000_10B0h	32.6.208/1897
20E_03C8	SW_PAD_CTL_PAD_LCD_DATA09 SW PAD Control Register (IOMUXC_SW_PAD_CTL_PAD_LCD_DATA09)	32	R/W	0000_10B0h	32.6.209/1899
20E_03CC	SW_PAD_CTL_PAD_LCD_DATA10 SW PAD Control Register (IOMUXC_SW_PAD_CTL_PAD_LCD_DATA10)	32	R/W	0000_10B0h	32.6.210/1901
20E_03D0	SW_PAD_CTL_PAD_LCD_DATA11 SW PAD Control Register (IOMUXC_SW_PAD_CTL_PAD_LCD_DATA11)	32	R/W	0000_10B0h	32.6.211/1903
20E_03D4	SW_PAD_CTL_PAD_LCD_DATA12 SW PAD Control Register (IOMUXC_SW_PAD_CTL_PAD_LCD_DATA12)	32	R/W	0000_10B0h	32.6.212/1905
20E_03D8	SW_PAD_CTL_PAD_LCD_DATA13 SW PAD Control Register (IOMUXC_SW_PAD_CTL_PAD_LCD_DATA13)	32	R/W	0000_10B0h	32.6.213/1907
20E_03DC	SW_PAD_CTL_PAD_LCD_DATA14 SW PAD Control Register (IOMUXC_SW_PAD_CTL_PAD_LCD_DATA14)	32	R/W	0000_10B0h	32.6.214/1909
20E_03E0	SW_PAD_CTL_PAD_LCD_DATA15 SW PAD Control Register (IOMUXC_SW_PAD_CTL_PAD_LCD_DATA15)	32	R/W	0000_10B0h	32.6.215/1911
20E_03E4	SW_PAD_CTL_PAD_LCD_DATA16 SW PAD Control Register (IOMUXC_SW_PAD_CTL_PAD_LCD_DATA16)	32	R/W	0000_10B0h	32.6.216/1913
20E_03E8	SW_PAD_CTL_PAD_LCD_DATA17 SW PAD Control Register (IOMUXC_SW_PAD_CTL_PAD_LCD_DATA17)	32	R/W	0000_10B0h	32.6.217/1915
20E_03EC	SW_PAD_CTL_PAD_LCD_DATA18 SW PAD Control Register (IOMUXC_SW_PAD_CTL_PAD_LCD_DATA18)	32	R/W	0000_10B0h	32.6.218/1917
20E_03F0	SW_PAD_CTL_PAD_LCD_DATA19 SW PAD Control Register (IOMUXC_SW_PAD_CTL_PAD_LCD_DATA19)	32	R/W	0000_10B0h	32.6.219/1919
20E_03F4	SW_PAD_CTL_PAD_LCD_DATA20 SW PAD Control Register (IOMUXC_SW_PAD_CTL_PAD_LCD_DATA20)	32	R/W	0000_10B0h	32.6.220/1921
20E_03F8	SW_PAD_CTL_PAD_LCD_DATA21 SW PAD Control Register (IOMUXC_SW_PAD_CTL_PAD_LCD_DATA21)	32	R/W	0000_10B0h	32.6.221/1923
20E_03FC	SW_PAD_CTL_PAD_LCD_DATA22 SW PAD Control Register (IOMUXC_SW_PAD_CTL_PAD_LCD_DATA22)	32	R/W	0000_10B0h	32.6.222/1925
20E_0400	SW_PAD_CTL_PAD_LCD_DATA23 SW PAD Control Register (IOMUXC_SW_PAD_CTL_PAD_LCD_DATA23)	32	R/W	0000_10B0h	32.6.223/1927
20E_0404	SW_PAD_CTL_PAD_NAND_RE_B SW PAD Control Register (IOMUXC_SW_PAD_CTL_PAD_NAND_RE_B)	32	R/W	0000_10B0h	32.6.224/1929
20E_0408	SW_PAD_CTL_PAD_NAND_WE_B SW PAD Control Register (IOMUXC_SW_PAD_CTL_PAD_NAND_WE_B)	32	R/W	0000_10B0h	32.6.225/1931
20E_040C	SW_PAD_CTL_PAD_NAND_DATA00 SW PAD Control Register (IOMUXC_SW_PAD_CTL_PAD_NAND_DATA00)	32	R/W	0000_10B0h	32.6.226/1933

Table continues on the next page...

IOMUXC memory map (continued)

Absolute address (hex)	Register name	Width (in bits)	Access	Reset value	Section/page
20E_0410	SW_PAD_CTL_PAD_NAND_DATA01 SW PAD Control Register (IOMUXC_SW_PAD_CTL_PAD_NAND_DATA01)	32	R/W	0000_10B0h	32.6.227/1935
20E_0414	SW_PAD_CTL_PAD_NAND_DATA02 SW PAD Control Register (IOMUXC_SW_PAD_CTL_PAD_NAND_DATA02)	32	R/W	0000_10B0h	32.6.228/1937
20E_0418	SW_PAD_CTL_PAD_NAND_DATA03 SW PAD Control Register (IOMUXC_SW_PAD_CTL_PAD_NAND_DATA03)	32	R/W	0000_10B0h	32.6.229/1939
20E_041C	SW_PAD_CTL_PAD_NAND_DATA04 SW PAD Control Register (IOMUXC_SW_PAD_CTL_PAD_NAND_DATA04)	32	R/W	0000_10B0h	32.6.230/1941
20E_0420	SW_PAD_CTL_PAD_NAND_DATA05 SW PAD Control Register (IOMUXC_SW_PAD_CTL_PAD_NAND_DATA05)	32	R/W	0000_10B0h	32.6.231/1943
20E_0424	SW_PAD_CTL_PAD_NAND_DATA06 SW PAD Control Register (IOMUXC_SW_PAD_CTL_PAD_NAND_DATA06)	32	R/W	0000_10B0h	32.6.232/1945
20E_0428	SW_PAD_CTL_PAD_NAND_DATA07 SW PAD Control Register (IOMUXC_SW_PAD_CTL_PAD_NAND_DATA07)	32	R/W	0000_10B0h	32.6.233/1947
20E_042C	SW_PAD_CTL_PAD_NAND_ALE SW PAD Control Register (IOMUXC_SW_PAD_CTL_PAD_NAND_ALE)	32	R/W	0000_10B0h	32.6.234/1949
20E_0430	SW_PAD_CTL_PAD_NAND_WP_B SW PAD Control Register (IOMUXC_SW_PAD_CTL_PAD_NAND_WP_B)	32	R/W	0000_10B0h	32.6.235/1951
20E_0434	SW_PAD_CTL_PAD_NAND_READY_B SW PAD Control Register (IOMUXC_SW_PAD_CTL_PAD_NAND_READY_B)	32	R/W	0000_10B0h	32.6.236/1953
20E_0438	SW_PAD_CTL_PAD_NAND_CE0_B SW PAD Control Register (IOMUXC_SW_PAD_CTL_PAD_NAND_CE0_B)	32	R/W	0000_10B0h	32.6.237/1955
20E_043C	SW_PAD_CTL_PAD_NAND_CE1_B SW PAD Control Register (IOMUXC_SW_PAD_CTL_PAD_NAND_CE1_B)	32	R/W	0000_10B0h	32.6.238/1957
20E_0440	SW_PAD_CTL_PAD_NAND_CLE SW PAD Control Register (IOMUXC_SW_PAD_CTL_PAD_NAND_CLE)	32	R/W	0000_10B0h	32.6.239/1959
20E_0444	SW_PAD_CTL_PAD_NAND_DQS SW PAD Control Register (IOMUXC_SW_PAD_CTL_PAD_NAND_DQS)	32	R/W	0000_10B0h	32.6.240/1961
20E_0448	SW_PAD_CTL_PAD_SD1_CMD SW PAD Control Register (IOMUXC_SW_PAD_CTL_PAD_SD1_CMD)	32	R/W	0000_10B0h	32.6.241/1963
20E_044C	SW_PAD_CTL_PAD_SD1_CLK SW PAD Control Register (IOMUXC_SW_PAD_CTL_PAD_SD1_CLK)	32	R/W	0000_10B0h	32.6.242/1965
20E_0450	SW_PAD_CTL_PAD_SD1_DATA0 SW PAD Control Register (IOMUXC_SW_PAD_CTL_PAD_SD1_DATA0)	32	R/W	0000_10B0h	32.6.243/1967
20E_0454	SW_PAD_CTL_PAD_SD1_DATA1 SW PAD Control Register (IOMUXC_SW_PAD_CTL_PAD_SD1_DATA1)	32	R/W	0000_10B0h	32.6.244/1969
20E_0458	SW_PAD_CTL_PAD_SD1_DATA2 SW PAD Control Register (IOMUXC_SW_PAD_CTL_PAD_SD1_DATA2)	32	R/W	0000_10B0h	32.6.245/1971
20E_045C	SW_PAD_CTL_PAD_SD1_DATA3 SW PAD Control Register (IOMUXC_SW_PAD_CTL_PAD_SD1_DATA3)	32	R/W	0000_10B0h	32.6.246/1973
20E_0460	SW_PAD_CTL_PAD_CSI_MCLK SW PAD Control Register (IOMUXC_SW_PAD_CTL_PAD_CSI_MCLK)	32	R/W	0000_10B0h	32.6.247/1975
20E_0464	SW_PAD_CTL_PAD_CSI_PIXCLK SW PAD Control Register (IOMUXC_SW_PAD_CTL_PAD_CSI_PIXCLK)	32	R/W	0000_10B0h	32.6.248/1977

Table continues on the next page...

IOMUXC memory map (continued)

Absolute address (hex)	Register name	Width (in bits)	Access	Reset value	Section/page
20E_0468	SW_PAD_CTL_PAD_CSI_VSYNC SW PAD Control Register (IOMUXC_SW_PAD_CTL_PAD_CSI_VSYNC)	32	R/W	0000_10B0h	32.6.249/1979
20E_046C	SW_PAD_CTL_PAD_CSI_HSYNC SW PAD Control Register (IOMUXC_SW_PAD_CTL_PAD_CSI_HSYNC)	32	R/W	0000_10B0h	32.6.250/1981
20E_0470	SW_PAD_CTL_PAD_CSI_DATA00 SW PAD Control Register (IOMUXC_SW_PAD_CTL_PAD_CSI_DATA00)	32	R/W	0000_10B0h	32.6.251/1983
20E_0474	SW_PAD_CTL_PAD_CSI_DATA01 SW PAD Control Register (IOMUXC_SW_PAD_CTL_PAD_CSI_DATA01)	32	R/W	0000_10B0h	32.6.252/1985
20E_0478	SW_PAD_CTL_PAD_CSI_DATA02 SW PAD Control Register (IOMUXC_SW_PAD_CTL_PAD_CSI_DATA02)	32	R/W	0000_10B0h	32.6.253/1987
20E_047C	SW_PAD_CTL_PAD_CSI_DATA03 SW PAD Control Register (IOMUXC_SW_PAD_CTL_PAD_CSI_DATA03)	32	R/W	0000_10B0h	32.6.254/1989
20E_0480	SW_PAD_CTL_PAD_CSI_DATA04 SW PAD Control Register (IOMUXC_SW_PAD_CTL_PAD_CSI_DATA04)	32	R/W	0000_10B0h	32.6.255/1991
20E_0484	SW_PAD_CTL_PAD_CSI_DATA05 SW PAD Control Register (IOMUXC_SW_PAD_CTL_PAD_CSI_DATA05)	32	R/W	0000_10B0h	32.6.256/1993
20E_0488	SW_PAD_CTL_PAD_CSI_DATA06 SW PAD Control Register (IOMUXC_SW_PAD_CTL_PAD_CSI_DATA06)	32	R/W	0000_10B0h	32.6.257/1995
20E_048C	SW_PAD_CTL_PAD_CSI_DATA07 SW PAD Control Register (IOMUXC_SW_PAD_CTL_PAD_CSI_DATA07)	32	R/W	0000_10B0h	32.6.258/1997
20E_0490	SW_PAD_CTL_GRP_ADDDS SW GRP Register (IOMUXC_SW_PAD_CTL_GRP_ADDDS)	32	R/W	0000_0030h	32.6.259/1998
20E_0494	SW_PAD_CTL_GRP_DDRMODE_CTL SW GRP Register (IOMUXC_SW_PAD_CTL_GRP_DDRMODE_CTL)	32	R/W	0000_0000h	32.6.260/1999
20E_0498	SW_PAD_CTL_GRP_B0DS SW GRP Register (IOMUXC_SW_PAD_CTL_GRP_B0DS)	32	R/W	0000_0030h	32.6.261/2000
20E_049C	SW_PAD_CTL_GRP_DDRPK SW GRP Register (IOMUXC_SW_PAD_CTL_GRP_DDRPK)	32	R/W	0000_2000h	32.6.262/2001
20E_04A0	SW_PAD_CTL_GRP_CTLDS SW GRP Register (IOMUXC_SW_PAD_CTL_GRP_CTLDS)	32	R/W	0000_0030h	32.6.263/2001
20E_04A4	SW_PAD_CTL_GRP_B1DS SW GRP Register (IOMUXC_SW_PAD_CTL_GRP_B1DS)	32	R/W	0000_0030h	32.6.264/2002
20E_04A8	SW_PAD_CTL_GRP_DDRHYS SW GRP Register (IOMUXC_SW_PAD_CTL_GRP_DDRHYS)	32	R/W	0000_0000h	32.6.265/2003
20E_04AC	SW_PAD_CTL_GRP_DDRPKE SW GRP Register (IOMUXC_SW_PAD_CTL_GRP_DDRPKE)	32	R/W	0000_1000h	32.6.266/2004
20E_04B0	SW_PAD_CTL_GRP_DDRMODE SW GRP Register (IOMUXC_SW_PAD_CTL_GRP_DDRMODE)	32	R/W	0000_0000h	32.6.267/2005
20E_04B4	SW_PAD_CTL_GRP_DDR_TYPE SW GRP Register (IOMUXC_SW_PAD_CTL_GRP_DDR_TYPE)	32	R/W	0008_0000h	32.6.268/2006
20E_04B8	USB_OTG1_ID_SELECT_INPUT DAISY Register (IOMUXC_ANATOP_USB_OTG_ID_SELECT_INPUT)	32	R/W	0000_0000h	32.6.269/2007
20E_04BC	USB_OTG2_ID_SELECT_INPUT DAISY Register (IOMUXC_USB_OTG2_ID_SELECT_INPUT)	32	R/W	0000_0000h	32.6.270/2007

Table continues on the next page...

IOMUXC memory map (continued)

Absolute address (hex)	Register name	Width (in bits)	Access	Reset value	Section/page
20E_04C0	CCM_PMIC_READY_SELECT_INPUT DAISY Register (IOMUXC_CCM_PMIC_READY_SELECT_INPUT)	32	R/W	0000_0000h	32.6.271/2008
20E_04C4	CSI_DATA02_SELECT_INPUT DAISY Register (IOMUXC_CSI_DATA02_SELECT_INPUT)	32	R/W	0000_0000h	32.6.272/2009
20E_04C8	CSI_DATA03_SELECT_INPUT DAISY Register (IOMUXC_CSI_DATA03_SELECT_INPUT)	32	R/W	0000_0000h	32.6.273/2010
20E_04CC	CSI_DATA05_SELECT_INPUT DAISY Register (IOMUXC_CSI_DATA05_SELECT_INPUT)	32	R/W	0000_0000h	32.6.274/2011
20E_04D0	CSI_DATA00_SELECT_INPUT DAISY Register (IOMUXC_CSI_DATA00_SELECT_INPUT)	32	R/W	0000_0000h	32.6.275/2012
20E_04D4	CSI_DATA01_SELECT_INPUT DAISY Register (IOMUXC_CSI_DATA01_SELECT_INPUT)	32	R/W	0000_0000h	32.6.276/2013
20E_04D8	CSI_DATA04_SELECT_INPUT DAISY Register (IOMUXC_CSI_DATA04_SELECT_INPUT)	32	R/W	0000_0000h	32.6.277/2014
20E_04DC	CSI_DATA06_SELECT_INPUT DAISY Register (IOMUXC_CSI_DATA06_SELECT_INPUT)	32	R/W	0000_0000h	32.6.278/2015
20E_04E0	CSI_DATA07_SELECT_INPUT DAISY Register (IOMUXC_CSI_DATA07_SELECT_INPUT)	32	R/W	0000_0000h	32.6.279/2016
20E_04E4	CSI_DATA08_SELECT_INPUT DAISY Register (IOMUXC_CSI_DATA08_SELECT_INPUT)	32	R/W	0000_0000h	32.6.280/2017
20E_04E8	CSI_DATA09_SELECT_INPUT DAISY Register (IOMUXC_CSI_DATA09_SELECT_INPUT)	32	R/W	0000_0000h	32.6.281/2018
20E_04EC	CSI_DATA10_SELECT_INPUT DAISY Register (IOMUXC_CSI_DATA10_SELECT_INPUT)	32	R/W	0000_0000h	32.6.282/2019
20E_04F0	CSI_DATA11_SELECT_INPUT DAISY Register (IOMUXC_CSI_DATA11_SELECT_INPUT)	32	R/W	0000_0000h	32.6.283/2020
20E_04F4	CSI_DATA12_SELECT_INPUT DAISY Register (IOMUXC_CSI_DATA12_SELECT_INPUT)	32	R/W	0000_0000h	32.6.284/2021
20E_04F8	CSI_DATA13_SELECT_INPUT DAISY Register (IOMUXC_CSI_DATA13_SELECT_INPUT)	32	R/W	0000_0000h	32.6.285/2022
20E_04FC	CSI_DATA14_SELECT_INPUT DAISY Register (IOMUXC_CSI_DATA14_SELECT_INPUT)	32	R/W	0000_0000h	32.6.286/2023
20E_0500	CSI_DATA15_SELECT_INPUT DAISY Register (IOMUXC_CSI_DATA15_SELECT_INPUT)	32	R/W	0000_0000h	32.6.287/2024
20E_0504	CSI_DATA16_SELECT_INPUT DAISY Register (IOMUXC_CSI_DATA16_SELECT_INPUT)	32	R/W	0000_0000h	32.6.288/2025
20E_0508	CSI_DATA17_SELECT_INPUT DAISY Register (IOMUXC_CSI_DATA17_SELECT_INPUT)	32	R/W	0000_0000h	32.6.289/2026
20E_050C	CSI_DATA18_SELECT_INPUT DAISY Register (IOMUXC_CSI_DATA18_SELECT_INPUT)	32	R/W	0000_0000h	32.6.290/2027
20E_0510	CSI_DATA19_SELECT_INPUT DAISY Register (IOMUXC_CSI_DATA19_SELECT_INPUT)	32	R/W	0000_0000h	32.6.291/2028
20E_0514	CSI_DATA20_SELECT_INPUT DAISY Register (IOMUXC_CSI_DATA20_SELECT_INPUT)	32	R/W	0000_0000h	32.6.292/2029

Table continues on the next page...

IOMUXC memory map (continued)

Absolute address (hex)	Register name	Width (in bits)	Access	Reset value	Section/page
20E_0518	CSI_DATA21_SELECT_INPUT DAISY Register (IOMUXC_CSI_DATA21_SELECT_INPUT)	32	R/W	0000_0000h	32.6.293/2030
20E_051C	CSI_DATA22_SELECT_INPUT DAISY Register (IOMUXC_CSI_DATA22_SELECT_INPUT)	32	R/W	0000_0000h	32.6.294/2031
20E_0520	CSI_DATA23_SELECT_INPUT DAISY Register (IOMUXC_CSI_DATA23_SELECT_INPUT)	32	R/W	0000_0000h	32.6.295/2032
20E_0524	CSI_HSYNC_SELECT_INPUT DAISY Register (IOMUXC_CSI_HSYNC_SELECT_INPUT)	32	R/W	0000_0000h	32.6.296/2033
20E_0528	CSI_PIXCLK_SELECT_INPUT DAISY Register (IOMUXC_CSI_PIXCLK_SELECT_INPUT)	32	R/W	0000_0000h	32.6.297/2034
20E_052C	CSI_VSYNC_SELECT_INPUT DAISY Register (IOMUXC_CSI_VSYNC_SELECT_INPUT)	32	R/W	0000_0000h	32.6.298/2035
20E_0530	CSI_FIELD_SELECT_INPUT DAISY Register (IOMUXC_CSI_FIELD_SELECT_INPUT)	32	R/W	0000_0000h	32.6.299/2036
20E_0534	ECSPI1_SCLK_SELECT_INPUT DAISY Register (IOMUXC_ECSP11_SCLK_SELECT_INPUT)	32	R/W	0000_0000h	32.6.300/2037
20E_0538	ECSPI1_MISO_SELECT_INPUT DAISY Register (IOMUXC_ECSP11_MISO_SELECT_INPUT)	32	R/W	0000_0000h	32.6.301/2038
20E_053C	ECSPI1_MOSI_SELECT_INPUT DAISY Register (IOMUXC_ECSP11_MOSI_SELECT_INPUT)	32	R/W	0000_0000h	32.6.302/2039
20E_0540	ECSPI1_SS0_B_SELECT_INPUT DAISY Register (IOMUXC_ECSP11_SS0_B_SELECT_INPUT)	32	R/W	0000_0000h	32.6.303/2040
20E_0544	ECSPI2_SCLK_SELECT_INPUT DAISY Register (IOMUXC_ECSP12_SCLK_SELECT_INPUT)	32	R/W	0000_0000h	32.6.304/2041
20E_0548	ECSPI2_MISO_SELECT_INPUT DAISY Register (IOMUXC_ECSP12_MISO_SELECT_INPUT)	32	R/W	0000_0000h	32.6.305/2042
20E_054C	ECSPI2_MOSI_SELECT_INPUT DAISY Register (IOMUXC_ECSP12_MOSI_SELECT_INPUT)	32	R/W	0000_0000h	32.6.306/2043
20E_0550	ECSPI2_SS0_B_SELECT_INPUT DAISY Register (IOMUXC_ECSP12_SS0_B_SELECT_INPUT)	32	R/W	0000_0000h	32.6.307/2044
20E_0554	ECSPI3_SCLK_SELECT_INPUT DAISY Register (IOMUXC_ECSP13_SCLK_SELECT_INPUT)	32	R/W	0000_0000h	32.6.308/2045
20E_0558	ECSPI3_MISO_SELECT_INPUT DAISY Register (IOMUXC_ECSP13_MISO_SELECT_INPUT)	32	R/W	0000_0000h	32.6.309/2046
20E_055C	ECSPI3_MOSI_SELECT_INPUT DAISY Register (IOMUXC_ECSP13_MOSI_SELECT_INPUT)	32	R/W	0000_0000h	32.6.310/2047
20E_0560	ECSPI3_SS0_B_SELECT_INPUT DAISY Register (IOMUXC_ECSP13_SS0_B_SELECT_INPUT)	32	R/W	0000_0000h	32.6.311/2048
20E_0564	ECSPI4_SCLK_SELECT_INPUT DAISY Register (IOMUXC_ECSP14_SCLK_SELECT_INPUT)	32	R/W	0000_0000h	32.6.312/2049
20E_0568	ECSPI4_MISO_SELECT_INPUT DAISY Register (IOMUXC_ECSP14_MISO_SELECT_INPUT)	32	R/W	0000_0000h	32.6.313/2050
20E_056C	ECSPI4_MOSI_SELECT_INPUT DAISY Register (IOMUXC_ECSP14_MOSI_SELECT_INPUT)	32	R/W	0000_0000h	32.6.314/2051

Table continues on the next page...

IOMUXC memory map (continued)

Absolute address (hex)	Register name	Width (in bits)	Access	Reset value	Section/page
20E_0570	ECSPI4_SS0_B_SELECT_INPUT DAISY Register (IOMUXC_ECSPi4_SS0_B_SELECT_INPUT)	32	R/W	0000_0000h	32.6.315/2052
20E_0574	ENET1_REF_CLK1_SELECT_INPUT DAISY Register (IOMUXC_ENET1_REF_CLK1_SELECT_INPUT)	32	R/W	0000_0000h	32.6.316/2052
20E_0578	ENET1_MAC0_MDIO_SELECT_INPUT DAISY Register (IOMUXC_ENET1_MAC0_MDIO_SELECT_INPUT)	32	R/W	0000_0000h	32.6.317/2053
20E_057C	ENET2_REF_CLK2_SELECT_INPUT DAISY Register (IOMUXC_ENET2_REF_CLK2_SELECT_INPUT)	32	R/W	0000_0000h	32.6.318/2054
20E_0580	ENET2_MAC0_MDIO_SELECT_INPUT DAISY Register (IOMUXC_ENET2_MAC0_MDIO_SELECT_INPUT)	32	R/W	0000_0000h	32.6.319/2055
20E_0584	FLEXCAN1_RX_SELECT_INPUT DAISY Register (IOMUXC_FLEXCAN1_RX_SELECT_INPUT)	32	R/W	0000_0000h	32.6.320/2055
20E_0588	FLEXCAN2_RX_SELECT_INPUT DAISY Register (IOMUXC_FLEXCAN2_RX_SELECT_INPUT)	32	R/W	0000_0000h	32.6.321/2056
20E_058C	GPT1_CAPTURE1_SELECT_INPUT DAISY Register (IOMUXC_GPT1_CAPTURE1_SELECT_INPUT)	32	R/W	0000_0000h	32.6.322/2057
20E_0590	GPT1_CAPTURE2_SELECT_INPUT DAISY Register (IOMUXC_GPT1_CAPTURE2_SELECT_INPUT)	32	R/W	0000_0000h	32.6.323/2058
20E_0594	GPT1_CLK_SELECT_INPUT DAISY Register (IOMUXC_GPT1_CLK_SELECT_INPUT)	32	R/W	0000_0000h	32.6.324/2059
20E_0598	GPT2_CAPTURE1_SELECT_INPUT DAISY Register (IOMUXC_GPT2_CAPTURE1_SELECT_INPUT)	32	R/W	0000_0000h	32.6.325/2060
20E_059C	GPT2_CAPTURE2_SELECT_INPUT DAISY Register (IOMUXC_GPT2_CAPTURE2_SELECT_INPUT)	32	R/W	0000_0000h	32.6.326/2061
20E_05A0	GPT2_CLK_SELECT_INPUT DAISY Register (IOMUXC_GPT2_CLK_SELECT_INPUT)	32	R/W	0000_0000h	32.6.327/2062
20E_05A4	I2C1_SCL_SELECT_INPUT DAISY Register (IOMUXC_I2C1_SCL_SELECT_INPUT)	32	R/W	0000_0000h	32.6.328/2062
20E_05A8	I2C1_SDA_SELECT_INPUT DAISY Register (IOMUXC_I2C1_SDA_SELECT_INPUT)	32	R/W	0000_0000h	32.6.329/2063
20E_05AC	I2C2_SCL_SELECT_INPUT DAISY Register (IOMUXC_I2C2_SCL_SELECT_INPUT)	32	R/W	0000_0000h	32.6.330/2064
20E_05B0	I2C2_SDA_SELECT_INPUT DAISY Register (IOMUXC_I2C2_SDA_SELECT_INPUT)	32	R/W	0000_0000h	32.6.331/2064
20E_05B4	I2C3_SCL_SELECT_INPUT DAISY Register (IOMUXC_I2C3_SCL_SELECT_INPUT)	32	R/W	0000_0000h	32.6.332/2065
20E_05B8	I2C3_SDA_SELECT_INPUT DAISY Register (IOMUXC_I2C3_SDA_SELECT_INPUT)	32	R/W	0000_0000h	32.6.333/2066
20E_05BC	I2C4_SCL_SELECT_INPUT DAISY Register (IOMUXC_I2C4_SCL_SELECT_INPUT)	32	R/W	0000_0000h	32.6.334/2066
20E_05C0	I2C4_SDA_SELECT_INPUT DAISY Register (IOMUXC_I2C4_SDA_SELECT_INPUT)	32	R/W	0000_0000h	32.6.335/2067
20E_05C4	KPP_COLO_SELECT_INPUT DAISY Register (IOMUXC_KPP_COLO_SELECT_INPUT)	32	R/W	0000_0000h	32.6.336/2068

Table continues on the next page...

IOMUXC memory map (continued)

Absolute address (hex)	Register name	Width (in bits)	Access	Reset value	Section/page
20E_05C8	KPP_COL1_SELECT_INPUT DAISY Register (IOMUXC_KPP_COL1_SELECT_INPUT)	32	R/W	0000_0000h	32.6.337/2069
20E_05CC	KPP_COL2_SELECT_INPUT DAISY Register (IOMUXC_KPP_COL2_SELECT_INPUT)	32	R/W	0000_0000h	32.6.338/2070
20E_05D0	KPP_ROW0_SELECT_INPUT DAISY Register (IOMUXC_KPP_ROW0_SELECT_INPUT)	32	R/W	0000_0000h	32.6.339/2071
20E_05D4	KPP_ROW1_SELECT_INPUT DAISY Register (IOMUXC_KPP_ROW1_SELECT_INPUT)	32	R/W	0000_0000h	32.6.340/2072
20E_05D8	KPP_ROW2_SELECT_INPUT DAISY Register (IOMUXC_KPP_ROW2_SELECT_INPUT)	32	R/W	0000_0000h	32.6.341/2073
20E_05DC	LCD_BUSY_SELECT_INPUT DAISY Register (IOMUXC_LCD_BUSY_SELECT_INPUT)	32	R/W	0000_0000h	32.6.342/2074
20E_05E0	SAI1_MCLK_SELECT_INPUT DAISY Register (IOMUXC_SAI1_MCLK_SELECT_INPUT)	32	R/W	0000_0000h	32.6.343/2075
20E_05E4	SAI1_RX_DATA_SELECT_INPUT DAISY Register (IOMUXC_SAI1_RX_DATA_SELECT_INPUT)	32	R/W	0000_0000h	32.6.344/2076
20E_05E8	SAI1_TX_BCLK_SELECT_INPUT DAISY Register (IOMUXC_SAI1_TX_BCLK_SELECT_INPUT)	32	R/W	0000_0000h	32.6.345/2077
20E_05EC	SAI1_TX_SYNC_SELECT_INPUT DAISY Register (IOMUXC_SAI1_TX_SYNC_SELECT_INPUT)	32	R/W	0000_0000h	32.6.346/2078
20E_05F0	SAI2_MCLK_SELECT_INPUT DAISY Register (IOMUXC_SAI2_MCLK_SELECT_INPUT)	32	R/W	0000_0000h	32.6.347/2079
20E_05F4	SAI2_RX_DATA_SELECT_INPUT DAISY Register (IOMUXC_SAI2_RX_DATA_SELECT_INPUT)	32	R/W	0000_0000h	32.6.348/2080
20E_05F8	SAI2_TX_BCLK_SELECT_INPUT DAISY Register (IOMUXC_SAI2_TX_BCLK_SELECT_INPUT)	32	R/W	0000_0000h	32.6.349/2081
20E_05FC	SAI2_TX_SYNC_SELECT_INPUT DAISY Register (IOMUXC_SAI2_TX_SYNC_SELECT_INPUT)	32	R/W	0000_0000h	32.6.350/2082
20E_0600	SAI3_MCLK_SELECT_INPUT DAISY Register (IOMUXC_SAI3_MCLK_SELECT_INPUT)	32	R/W	0000_0000h	32.6.351/2083
20E_0604	SAI3_RX_DATA_SELECT_INPUT DAISY Register (IOMUXC_SAI3_RX_DATA_SELECT_INPUT)	32	R/W	0000_0000h	32.6.352/2084
20E_0608	SAI3_TX_BCLK_SELECT_INPUT DAISY Register (IOMUXC_SAI3_TX_BCLK_SELECT_INPUT)	32	R/W	0000_0000h	32.6.353/2085
20E_060C	SAI3_TX_SYNC_SELECT_INPUT DAISY Register (IOMUXC_SAI3_TX_SYNC_SELECT_INPUT)	32	R/W	0000_0000h	32.6.354/2086
20E_0610	SDMA_EVENTS0_SELECT_INPUT DAISY Register (IOMUXC_SDMA_EVENTS0_SELECT_INPUT)	32	R/W	0000_0000h	32.6.355/2086
20E_0614	SDMA_EVENTS1_SELECT_INPUT DAISY Register (IOMUXC_SDMA_EVENTS1_SELECT_INPUT)	32	R/W	0000_0000h	32.6.356/2087
20E_0618	SPDIF_IN_SELECT_INPUT DAISY Register (IOMUXC_SPDIF_IN_SELECT_INPUT)	32	R/W	0000_0000h	32.6.357/2088
20E_061C	SPDIF_EXT_CLK_SELECT_INPUT DAISY Register (IOMUXC_SPDIF_EXT_CLK_SELECT_INPUT)	32	R/W	0000_0000h	32.6.358/2089

Table continues on the next page...

IOMUXC memory map (continued)

Absolute address (hex)	Register name	Width (in bits)	Access	Reset value	Section/page
20E_0620	UART1_RTS_B_SELECT_INPUT DAISY Register (IOMUXC_UART1_RTS_B_SELECT_INPUT)	32	R/W	0000_0000h	32.6.359/2089
20E_0624	UART1_RX_DATA_SELECT_INPUT DAISY Register (IOMUXC_UART1_RX_DATA_SELECT_INPUT)	32	R/W	0000_0000h	32.6.360/2090
20E_0628	UART2_RTS_B_SELECT_INPUT DAISY Register (IOMUXC_UART2_RTS_B_SELECT_INPUT)	32	R/W	0000_0000h	32.6.361/2091
20E_062C	UART2_RX_DATA_SELECT_INPUT DAISY Register (IOMUXC_UART2_RX_DATA_SELECT_INPUT)	32	R/W	0000_0000h	32.6.362/2091
20E_0630	UART3_RTS_B_SELECT_INPUT DAISY Register (IOMUXC_UART3_RTS_B_SELECT_INPUT)	32	R/W	0000_0000h	32.6.363/2092
20E_0634	UART3_RX_DATA_SELECT_INPUT DAISY Register (IOMUXC_UART3_RX_DATA_SELECT_INPUT)	32	R/W	0000_0000h	32.6.364/2093
20E_0638	UART4_RTS_B_SELECT_INPUT DAISY Register (IOMUXC_UART4_RTS_B_SELECT_INPUT)	32	R/W	0000_0000h	32.6.365/2093
20E_063C	UART4_RX_DATA_SELECT_INPUT DAISY Register (IOMUXC_UART4_RX_DATA_SELECT_INPUT)	32	R/W	0000_0000h	32.6.366/2094
20E_0640	UART5_RTS_B_SELECT_INPUT DAISY Register (IOMUXC_UART5_RTS_B_SELECT_INPUT)	32	R/W	0000_0000h	32.6.367/2095
20E_0644	UART5_RX_DATA_SELECT_INPUT DAISY Register (IOMUXC_UART5_RX_DATA_SELECT_INPUT)	32	R/W	0000_0000h	32.6.368/2095
20E_0648	UART6_RTS_B_SELECT_INPUT DAISY Register (IOMUXC_UART6_RTS_B_SELECT_INPUT)	32	R/W	0000_0000h	32.6.369/2096
20E_064C	UART6_RX_DATA_SELECT_INPUT DAISY Register (IOMUXC_UART6_RX_DATA_SELECT_INPUT)	32	R/W	0000_0000h	32.6.370/2097
20E_0650	UART7_RTS_B_SELECT_INPUT DAISY Register (IOMUXC_UART7_RTS_B_SELECT_INPUT)	32	R/W	0000_0000h	32.6.371/2097
20E_0654	UART7_RX_DATA_SELECT_INPUT DAISY Register (IOMUXC_UART7_RX_DATA_SELECT_INPUT)	32	R/W	0000_0000h	32.6.372/2098
20E_0658	UART8_RTS_B_SELECT_INPUT DAISY Register (IOMUXC_UART8_RTS_B_SELECT_INPUT)	32	R/W	0000_0000h	32.6.373/2099
20E_065C	UART8_RX_DATA_SELECT_INPUT DAISY Register (IOMUXC_UART8_RX_DATA_SELECT_INPUT)	32	R/W	0000_0000h	32.6.374/2099
20E_0660	USB_OTG2_OC_SELECT_INPUT DAISY Register (IOMUXC_USB_OTG2_OC_SELECT_INPUT)	32	R/W	0000_0000h	32.6.375/2100
20E_0664	USB_OTG_OC_SELECT_INPUT DAISY Register (IOMUXC_USB_OTG_OC_SELECT_INPUT)	32	R/W	0000_0000h	32.6.376/2101
20E_0668	USDHC1_CD_B_SELECT_INPUT DAISY Register (IOMUXC_USDHC1_CD_B_SELECT_INPUT)	32	R/W	0000_0000h	32.6.377/2101
20E_066C	USDHC1_WP_SELECT_INPUT DAISY Register (IOMUXC_USDHC1_WP_SELECT_INPUT)	32	R/W	0000_0000h	32.6.378/2102
20E_0670	USDHC2_CLK_SELECT_INPUT DAISY Register (IOMUXC_USDHC2_CLK_SELECT_INPUT)	32	R/W	0000_0000h	32.6.379/2103
20E_0674	USDHC2_CD_B_SELECT_INPUT DAISY Register (IOMUXC_USDHC2_CD_B_SELECT_INPUT)	32	R/W	0000_0000h	32.6.380/2103

Table continues on the next page...

IOMUXC memory map (continued)

Absolute address (hex)	Register name	Width (in bits)	Access	Reset value	Section/page
20E_0678	USDHC2_CMD_SELECT_INPUT DAISY Register (IOMUXC_USDHC2_CMD_SELECT_INPUT)	32	R/W	0000_0000h	32.6.381/2104
20E_067C	USDHC2_DATA0_SELECT_INPUT DAISY Register (IOMUXC_USDHC2_DATA0_SELECT_INPUT)	32	R/W	0000_0000h	32.6.382/2105
20E_0680	USDHC2_DATA1_SELECT_INPUT DAISY Register (IOMUXC_USDHC2_DATA1_SELECT_INPUT)	32	R/W	0000_0000h	32.6.383/2105
20E_0684	USDHC2_DATA2_SELECT_INPUT DAISY Register (IOMUXC_USDHC2_DATA2_SELECT_INPUT)	32	R/W	0000_0000h	32.6.384/2106
20E_0688	USDHC2_DATA3_SELECT_INPUT DAISY Register (IOMUXC_USDHC2_DATA3_SELECT_INPUT)	32	R/W	0000_0000h	32.6.385/2107
20E_068C	USDHC2_DATA4_SELECT_INPUT DAISY Register (IOMUXC_USDHC2_DATA4_SELECT_INPUT)	32	R/W	0000_0000h	32.6.386/2107
20E_0690	USDHC2_DATA5_SELECT_INPUT DAISY Register (IOMUXC_USDHC2_DATA5_SELECT_INPUT)	32	R/W	0000_0000h	32.6.387/2108
20E_0694	USDHC2_DATA6_SELECT_INPUT DAISY Register (IOMUXC_USDHC2_DATA6_SELECT_INPUT)	32	R/W	0000_0000h	32.6.388/2109
20E_0698	USDHC2_DATA7_SELECT_INPUT DAISY Register (IOMUXC_USDHC2_DATA7_SELECT_INPUT)	32	R/W	0000_0000h	32.6.389/2109
20E_069C	USDHC2_WP_SELECT_INPUT DAISY Register (IOMUXC_USDHC2_WP_SELECT_INPUT)	32	R/W	0000_0000h	32.6.390/2110

32.6.1 SW_MUX_CTL_PAD_JTAG_MOD SW MUX Control Register (IOMUXC_SW_MUX_CTL_PAD_JTAG_MOD)

SW_MUX_CTL Register

Address: 20E_0000h base + 44h offset = 20E_0044h

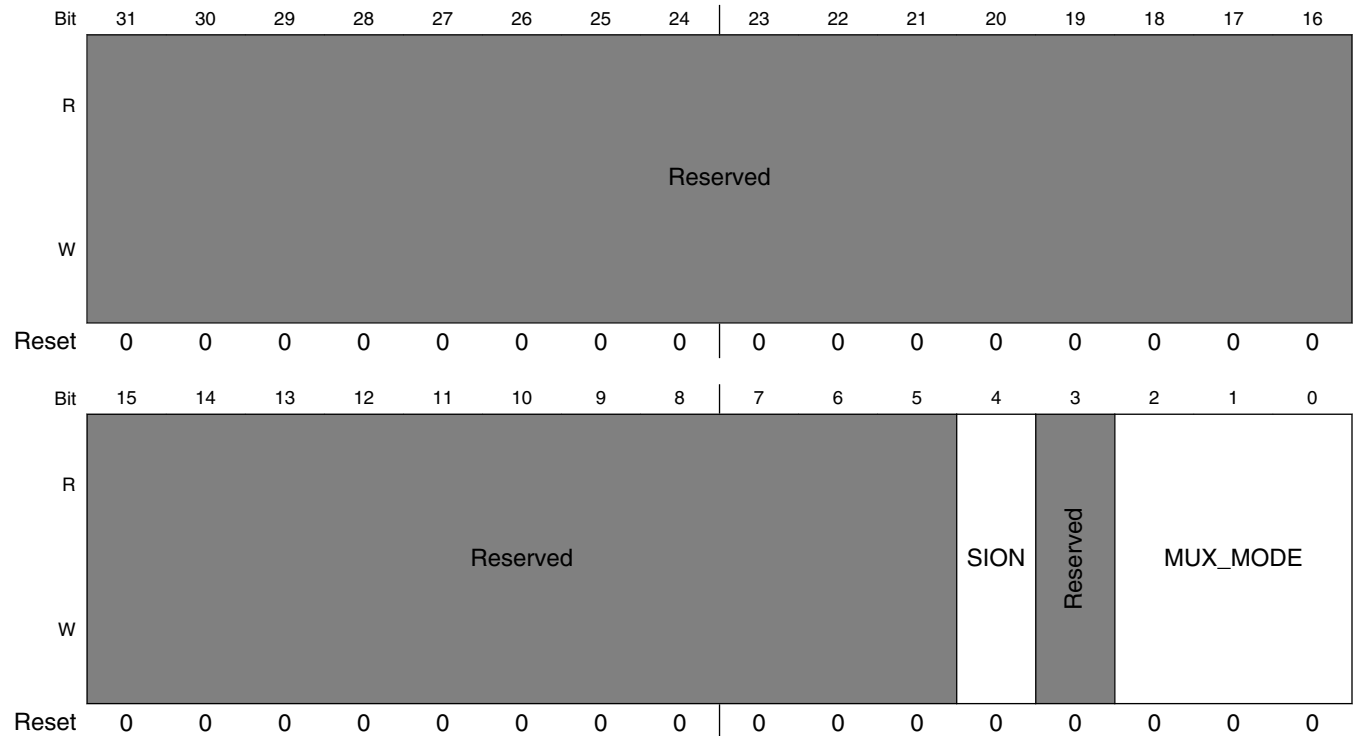

IOMUXC_SW_MUX_CTL_PAD_JTAG_MOD field descriptions

Field	Description
31–5 -	This field is reserved. Reserved
4 SION	Software Input On Field. Force the selected mux mode Input path no matter of MUX_MODE functionality. 1 ENABLED — Force input path of pad JTAG_MOD 0 DISABLED — Input Path is determined by functionality
3 -	This field is reserved. Reserved
MUX_MODE	MUX Mode Select Field. Select 1 of 7 iomux modes to be used for pad: JTAG_MOD. 000 ALT0 — Select mux mode: ALT0 mux port: SJC_MOD of instance: sjc 001 ALT1 — Select mux mode: ALT1 mux port: GPT2_CLK of instance: gpt2 010 ALT2 — Select mux mode: ALT2 mux port: SPDIF_OUT of instance: spdif

Table continues on the next page...

IOMUXC_SW_MUX_CTL_PAD_JTAG_MOD field descriptions (continued)

Field	Description
011	ALT3 — Select mux mode: ALT3 mux port: ENET1_REF_CLK_25M of instance: enet1
100	ALT4 — Select mux mode: ALT4 mux port: CCM_PMIC_RDY of instance: ccm
101	ALT5 — Select mux mode: ALT5 mux port: GPIO1_IO10 of instance: gpio1
110	ALT6 — Select mux mode: ALT6 mux port: SDMA_EXT_EVENT00 of instance: sdma

32.6.2 SW_MUX_CTL_PAD_JTAG_TMS SW MUX Control Register (IOMUXC_SW_MUX_CTL_PAD_JTAG_TMS)

SW_MUX_CTL Register

Address: 20E_0000h base + 48h offset = 20E_0048h

Bit	31	30	29	28	27	26	25	24	23	22	21	20	19	18	17	16
R	Reserved															
W	Reserved															
Reset	0	0	0	0	0	0	0	0	0	0	0	0	0	0	0	0
Bit	15	14	13	12	11	10	9	8	7	6	5	4	3	2	1	0
R	Reserved											SION		MUX_MODE		
W	Reserved											SION		MUX_MODE		
Reset	0	0	0	0	0	0	0	0	0	0	0	0	0	0	0	0

IOMUXC_SW_MUX_CTL_PAD_JTAG_TMS field descriptions

Field	Description
31–5 -	This field is reserved. Reserved
4 SION	Software Input On Field. Force the selected mux mode Input path no matter of MUX_MODE functionality. 1 ENABLED — Force input path of pad JTAG_TMS 0 DISABLED — Input Path is determined by functionality
MUX_MODE	MUX Mode Select Field. Select 1 of 8 iomux modes to be used for pad: JTAG_TMS. 0000 ALT0 — Select mux mode: ALT0 mux port: SJC_TMS of instance: sjc 0001 ALT1 — Select mux mode: ALT1 mux port: GPT2_CAPTURE1 of instance: gpt2 0010 ALT2 — Select mux mode: ALT2 mux port: SAI2_MCLK of instance: sai2 0011 ALT3 — Select mux mode: ALT3 mux port: CCM_CLKO1 of instance: ccm 0100 ALT4 — Select mux mode: ALT4 mux port: CCM_WAIT of instance: ccm 0101 ALT5 — Select mux mode: ALT5 mux port: GPIO1_IO11 of instance: gpio1 0110 ALT6 — Select mux mode: ALT6 mux port: SDMA_EXT_EVENT01 of instance: sdma 1000 ALT8 — Select mux mode: ALT8 mux port: EPIT1_OUT of instance: epit1

32.6.3 SW_MUX_CTL_PAD_JTAG_TDO SW MUX Control Register (IOMUXC_SW_MUX_CTL_PAD_JTAG_TDO)

SW_MUX_CTL Register

Address: 20E_0000h base + 4Ch offset = 20E_004Ch

Bit	31	30	29	28	27	26	25	24	23	22	21	20	19	18	17	16	
R	Reserved																
W	Reserved																
Reset	0	0	0	0	0	0	0	0	0	0	0	0	0	0	0	0	
Bit	15	14	13	12	11	10	9	8	7	6	5	4	3	2	1	0	
R	Reserved											SION		MUX_MODE			
W	Reserved											SION		MUX_MODE			
Reset	0	0	0	0	0	0	0	0	0	0	0	0	0	0	0	0	

IOMUXC_SW_MUX_CTL_PAD_JTAG_TDO field descriptions

Field	Description
31–5 -	This field is reserved. Reserved
4 SION	Software Input On Field. Force the selected mux mode Input path no matter of MUX_MODE functionality. 1 ENABLED — Force input path of pad JTAG_TDO 0 DISABLED — Input Path is determined by functionality
MUX_MODE	MUX Mode Select Field. Select 1 of 8 iomux modes to be used for pad: JTAG_TDO. 0000 ALT0 — Select mux mode: ALT0 mux port: SJC_TDO of instance: sjc 0001 ALT1 — Select mux mode: ALT1 mux port: GPT2_CAPTURE2 of instance: gpt2 0010 ALT2 — Select mux mode: ALT2 mux port: SAI2_TX_SYNC of instance: sai2 0011 ALT3 — Select mux mode: ALT3 mux port: CCM_CLKO2 of instance: ccm 0100 ALT4 — Select mux mode: ALT4 mux port: CCM_STOP of instance: ccm 0101 ALT5 — Select mux mode: ALT5 mux port: GPIO1_IO12 of instance: gpio1 0110 ALT6 — Select mux mode: ALT6 mux port: MQS_RIGHT of instance: mqs 1000 ALT8 — Select mux mode: ALT8 mux port: EPIT2_OUT of instance: epit2

32.6.4 SW_MUX_CTL_PAD_JTAG_TDI SW MUX Control Register (IOMUXC_SW_MUX_CTL_PAD_JTAG_TDI)

SW_MUX_CTL Register

Address: 20E_0000h base + 50h offset = 20E_0050h

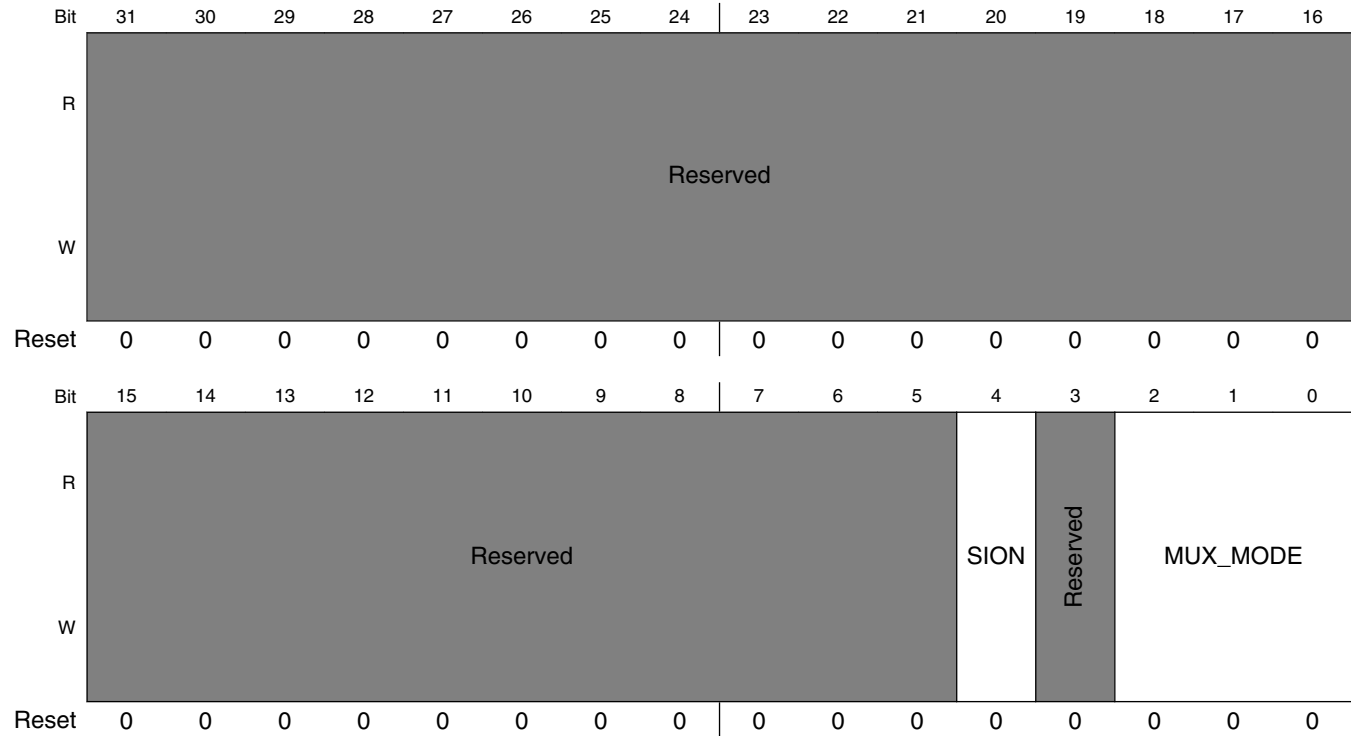

IOMUXC_SW_MUX_CTL_PAD_JTAG_TDI field descriptions

Field	Description
31–5 -	This field is reserved. Reserved
4 SION	Software Input On Field. Force the selected mux mode Input path no matter of MUX_MODE functionality. 1 ENABLED — Force input path of pad JTAG_TDI 0 DISABLED — Input Path is determined by functionality
3 -	This field is reserved. Reserved
MUX_MODE	MUX Mode Select Field. Select 1 of 7 iomux modes to be used for pad: JTAG_TDI. 0000 ALT0 — Select mux mode: ALT0 mux port: SJC_TDI of instance: sjc 0001 ALT1 — Select mux mode: ALT1 mux port: GPT2_COMPARE1 of instance: gpt2 0010 ALT2 — Select mux mode: ALT2 mux port: SAI2_TX_BCLK of instance: sai2

Table continues on the next page...

IOMUXC_SW_MUX_CTL_PAD_JTAG_TDI field descriptions (continued)

Field	Description
0100	ALT4 — Select mux mode: ALT4 mux port: PWM6_OUT of instance: pwm6
0101	ALT5 — Select mux mode: ALT5 mux port: GPIO1_IO13 of instance: gpio1
0110	ALT6 — Select mux mode: ALT6 mux port: MQS_LEFT of instance: mqs
1000	ALT8 — Select mux mode: ALT8 mux port: SIM1_POWER_FAIL of instance: sim1

32.6.5 SW_MUX_CTL_PAD_JTAG_TCK SW MUX Control Register (IOMUXC_SW_MUX_CTL_PAD_JTAG_TCK)

SW_MUX_CTL Register

Address: 20E_0000h base + 54h offset = 20E_0054h

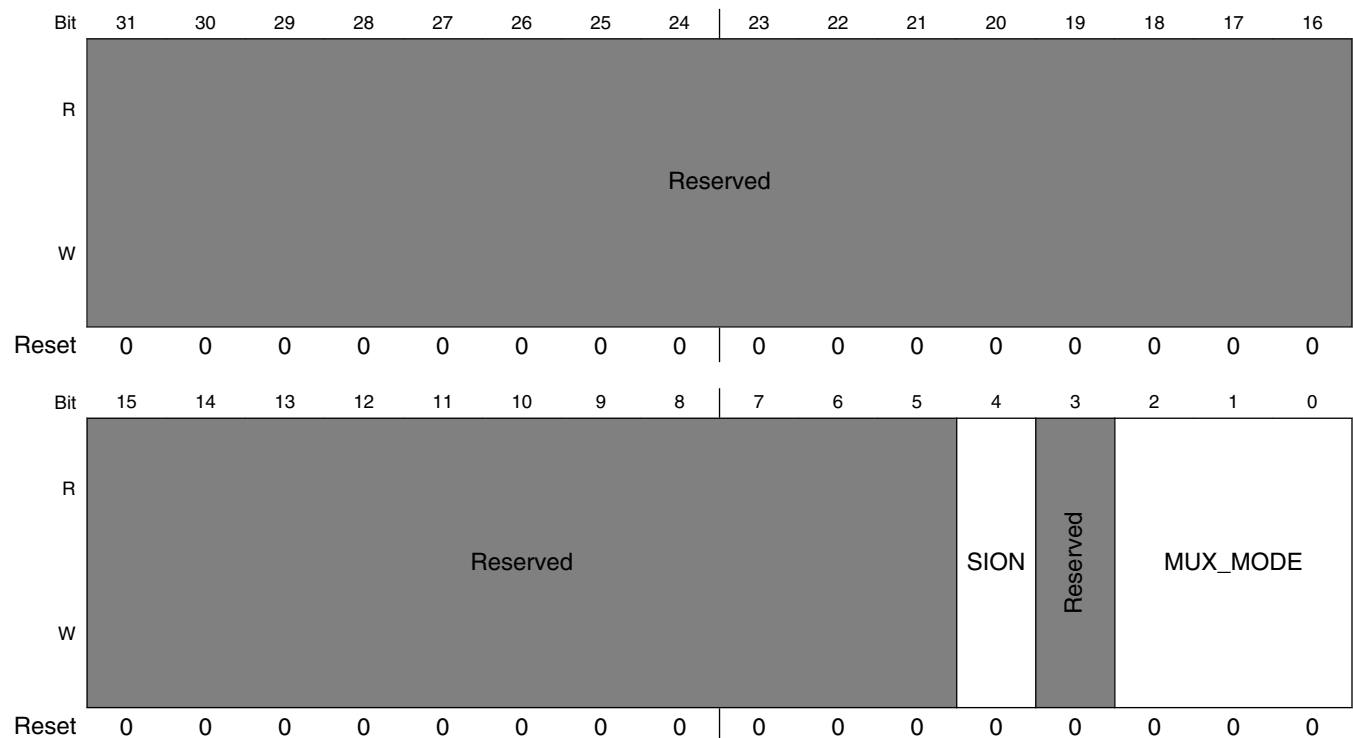

IOMUXC_SW_MUX_CTL_PAD_JTAG_TCK field descriptions

Field	Description
31–5 -	This field is reserved. Reserved
4 SION	Software Input On Field. Force the selected mux mode Input path no matter of MUX_MODE functionality. 1 ENABLED — Force input path of pad JTAG_TCK 0 DISABLED — Input Path is determined by functionality

Table continues on the next page...

IOMUXC_SW_MUX_CTL_PAD_JTAG_TCK field descriptions (continued)

Field	Description
3 -	This field is reserved. Reserved
MUX_MODE	<p>MUX Mode Select Field.</p> <p>Select 1 of 7 iomux modes to be used for pad: JTAG_TCK.</p> <p>0000 ALT0 — Select mux mode: ALT0 mux port: SJC_TCK of instance: sjc 0001 ALT1 — Select mux mode: ALT1 mux port: GPT2_COMPARE2 of instance: gpt2 0010 ALT2 — Select mux mode: ALT2 mux port: SAI2_RX_DATA of instance: sai2 0100 ALT4 — Select mux mode: ALT4 mux port: PWM7_OUT of instance: pwm7 0101 ALT5 — Select mux mode: ALT5 mux port: GPIO1_IO14 of instance: gpio1 1000 ALT8 — Select mux mode: ALT8 mux port: SIM2_POWER_FAIL of instance: sim2</p>

32.6.6 SW_MUX_CTL_PAD_JTAG_TRST_B SW MUX Control Register (IOMUXC_SW_MUX_CTL_PAD_JTAG_TRST_B)

SW_MUX_CTL Register

Address: 20E_0000h base + 58h offset = 20E_0058h

Bit	31	30	29	28	27	26	25	24	23	22	21	20	19	18	17	16	
R	Reserved																
W	Reserved																
Reset	0	0	0	0	0	0	0	0	0	0	0	0	0	0	0	0	
Bit	15	14	13	12	11	10	9	8	7	6	5	4	3	2	1	0	
R	Reserved										SION	Reserved	MUX_MODE				
W	Reserved										SION	Reserved	MUX_MODE				
Reset	0	0	0	0	0	0	0	0	0	0	0	0	0	0	0	0	

IOMUXC_SW_MUX_CTL_PAD_JTAG_TRST_B field descriptions

Field	Description
31–5 -	This field is reserved. Reserved
4 SION	Software Input On Field. Force the selected mux mode Input path no matter of MUX_MODE functionality. 1 ENABLED — Force input path of pad JTAG_TRST_B 0 DISABLED — Input Path is determined by functionality
3 -	This field is reserved. Reserved
MUX_MODE	MUX Mode Select Field. Select 1 of 7 iomux modes to be used for pad: JTAG_TRST_B. 0000 ALT0 — Select mux mode: ALT0 mux port: SJC_TRSTB of instance: sjc 0001 ALT1 — Select mux mode: ALT1 mux port: GPT2_COMPARE3 of instance: gpt2 0010 ALT2 — Select mux mode: ALT2 mux port: SAI2_TX_DATA of instance: sai2 0100 ALT4 — Select mux mode: ALT4 mux port: PWM8_OUT of instance: pwm8 0101 ALT5 — Select mux mode: ALT5 mux port: GPIO1_IO15 of instance: gpio1 1000 ALT8 — Select mux mode: ALT8 mux port: CAAM_RNG_OSC_OBS of instance: caam

32.6.7 SW_MUX_CTL_PAD_GPIO1_IO00 SW MUX Control Register (IOMUXC_SW_MUX_CTL_PAD_GPIO1_IO00)

SW_MUX_CTL Register

Address: 20E_0000h base + 5Ch offset = 20E_005Ch

Bit	31	30	29	28	27	26	25	24	23	22	21	20	19	18	17	16
R	Reserved															
W	Reserved															
Reset	0	0	0	0	0	0	0	0	0	0	0	0	0	0	0	0
Bit	15	14	13	12	11	10	9	8	7	6	5	4	3	2	1	0
R	Reserved												SION	MUX_MODE		
W	Reserved												SION	MUX_MODE		
Reset	0	0	0	0	0	0	0	0	0	0	0	0	0	1	0	1

IOMUXC_SW_MUX_CTL_PAD_GPIO1_IO00 field descriptions

Field	Description
31–5 -	This field is reserved. Reserved
4 SION	Software Input On Field. Force the selected mux mode Input path no matter of MUX_MODE functionality.

Table continues on the next page...

IOMUXC_SW_MUX_CTL_PAD_GPIO1_IO00 field descriptions (continued)

Field	Description
	1 ENABLED — Force input path of pad GPIO1_IO00 0 DISABLED — Input Path is determined by functionality
MUX_MODE	MUX Mode Select Field. Select 1 of 9 iomux modes to be used for pad: GPIO1_IO00. 0000 ALT0 — Select mux mode: ALT0 mux port: I2C2_SCL of instance: i2c2 0001 ALT1 — Select mux mode: ALT1 mux port: GPT1_CAPTURE1 of instance: gpt1 0010 ALT2 — Select mux mode: ALT2 mux port: ANATOP_OTG1_ID of instance: anatop 0011 ALT3 — Select mux mode: ALT3 mux port: ENET1_REF_CLK1 of instance: enet1 0100 ALT4 — Select mux mode: ALT4 mux port: MQS_RIGHT of instance: mqs 0101 ALT5 — Select mux mode: ALT5 mux port: GPIO1_IO00 of instance: gpio1 0110 ALT6 — Select mux mode: ALT6 mux port: ENET1_1588_EVENT0_IN of instance: enet1 0111 ALT7 — Select mux mode: ALT7 mux port: SRC_SYSTEM_RESET of instance: src 1000 ALT8 — Select mux mode: ALT8 mux port: WDOG3_WDOG_B of instance: wdog3

32.6.8 SW_MUX_CTL_PAD_GPIO1_IO01 SW MUX Control Register (IOMUXC_SW_MUX_CTL_PAD_GPIO1_IO01)

SW_MUX_CTL Register

Address: 20E_0000h base + 60h offset = 20E_0060h

Bit	31	30	29	28	27	26	25	24	23	22	21	20	19	18	17	16
R	Reserved															
W	Reserved															
Reset	0	0	0	0	0	0	0	0	0	0	0	0	0	0	0	0
Bit	15	14	13	12	11	10	9	8	7	6	5	4	3	2	1	0
R	Reserved												SION	MUX_MODE		
W	Reserved												SION	MUX_MODE		
Reset	0	0	0	0	0	0	0	0	0	0	0	0	0	1	0	1

IOMUXC_SW_MUX_CTL_PAD_GPIO1_IO01 field descriptions

Field	Description
31–5 -	This field is reserved. Reserved
4 SION	Software Input On Field. Force the selected mux mode Input path no matter of MUX_MODE functionality. 1 ENABLED — Force input path of pad GPIO1_IO01 0 DISABLED — Input Path is determined by functionality
MUX_MODE	MUX Mode Select Field. Select 1 of 9 iomux modes to be used for pad: GPIO1_IO01.

Table continues on the next page...

IOMUXC_SW_MUX_CTL_PAD_GPIO1_IO01 field descriptions (continued)

Field	Description
0000	ALT0 — Select mux mode: ALT0 mux port: I2C2_SDA of instance: i2c2
0001	ALT1 — Select mux mode: ALT1 mux port: GPT1_COMPARE1 of instance: gpt1
0010	ALT2 — Select mux mode: ALT2 mux port: USB_OTG1_OC of instance: usb
0011	ALT3 — Select mux mode: ALT3 mux port: ENET2_REF_CLK2 of instance: enet2
0100	ALT4 — Select mux mode: ALT4 mux port: MQS_LEFT of instance: mqs
0101	ALT5 — Select mux mode: ALT5 mux port: GPIO1_IO01 of instance: gpio1
0110	ALT6 — Select mux mode: ALT6 mux port: ENET1_1588_EVENT0_OUT of instance: enet1
0111	ALT7 — Select mux mode: ALT7 mux port: SRC_EARLY_RESET of instance: src
1000	ALT8 — Select mux mode: ALT8 mux port: WDOG1_WDOG_B of instance: wdog1

32.6.9 SW_MUX_CTL_PAD_GPIO1_IO02 SW MUX Control Register (IOMUXC_SW_MUX_CTL_PAD_GPIO1_IO02)

SW_MUX_CTL Register

Address: 20E_0000h base + 64h offset = 20E_0064h

Bit	31	30	29	28	27	26	25	24	23	22	21	20	19	18	17	16
R	Reserved															
W	Reserved															
Reset	0	0	0	0	0	0	0	0	0	0	0	0	0	0	0	0
Bit	15	14	13	12	11	10	9	8	7	6	5	4	3	2	1	0
R	Reserved											SION	MUX_MODE			
W	Reserved											SION	MUX_MODE			
Reset	0	0	0	0	0	0	0	0	0	0	0	0	0	1	0	1

IOMUXC_SW_MUX_CTL_PAD_GPIO1_IO02 field descriptions

Field	Description
31–5 -	This field is reserved. Reserved
4 SION	Software Input On Field. Force the selected mux mode Input path no matter of MUX_MODE functionality. 1 ENABLED — Force input path of pad GPIO1_IO02 0 DISABLED — Input Path is determined by functionality
MUX_MODE	MUX Mode Select Field. Select 1 of 9 iomux modes to be used for pad: GPIO1_IO02. 0000 ALT0 — Select mux mode: ALT0 mux port: I2C1_SCL of instance: i2c1 0001 ALT1 — Select mux mode: ALT1 mux port: GPT1_COMPARE2 of instance: gpt1 0010 ALT2 — Select mux mode: ALT2 mux port: USB_OTG2_PWR of instance: usb 0011 ALT3 — Select mux mode: ALT3 mux port: ENET1_REF_CLK_25M of instance: enet1 0100 ALT4 — Select mux mode: ALT4 mux port: USDHC1_WP of instance: usdhc1 0101 ALT5 — Select mux mode: ALT5 mux port: GPIO1_IO02 of instance: gpio1

Table continues on the next page...

IOMUXC_SW_MUX_CTL_PAD_GPIO1_IO02 field descriptions (continued)

Field	Description
0110	ALT6 — Select mux mode: ALT6 mux port: SDMA_EXT_EVENT00 of instance: sdma
0111	ALT7 — Select mux mode: ALT7 mux port: SRC_ANY_PU_RESET of instance: src
1000	ALT8 — Select mux mode: ALT8 mux port: UART1_TX of instance: uart1

32.6.10 SW_MUX_CTL_PAD_GPIO1_IO03 SW MUX Control Register (IOMUXC_SW_MUX_CTL_PAD_GPIO1_IO03)

SW_MUX_CTL Register

Address: 20E_0000h base + 68h offset = 20E_0068h

Bit	31	30	29	28	27	26	25	24	23	22	21	20	19	18	17	16
R	Reserved															
W	Reserved															
Reset	0	0	0	0	0	0	0	0	0	0	0	0	0	0	0	0
Bit	15	14	13	12	11	10	9	8	7	6	5	4	3	2	1	0
R	Reserved											SION		MUX_MODE		
W	Reserved											SION		MUX_MODE		
Reset	0	0	0	0	0	0	0	0	0	0	0	0	0	1	0	1

IOMUXC_SW_MUX_CTL_PAD_GPIO1_IO03 field descriptions

Field	Description
31–5 -	This field is reserved. Reserved
4 SION	Software Input On Field. Force the selected mux mode Input path no matter of MUX_MODE functionality. 1 ENABLED — Force input path of pad GPIO1_IO03 0 DISABLED — Input Path is determined by functionality
MUX_MODE	MUX Mode Select Field. Select 1 of 9 iomux modes to be used for pad: GPIO1_IO03. 0000 ALT0 — Select mux mode: ALT0 mux port: I2C1_SDA of instance: i2c1 0001 ALT1 — Select mux mode: ALT1 mux port: GPT1_COMPARE3 of instance: gpt1 0010 ALT2 — Select mux mode: ALT2 mux port: USB_OTG2_OC of instance: usb 0100 ALT4 — Select mux mode: ALT4 mux port: USDHC1_CD_B of instance: usdhc1 0101 ALT5 — Select mux mode: ALT5 mux port: GPIO1_IO03 of instance: gpio1 0110 ALT6 — Select mux mode: ALT6 mux port: CCM_DI0_EXT_CLK of instance: ccm 0111 ALT7 — Select mux mode: ALT7 mux port: SRC_TESTER_ACK of instance: src NOTE: ALT7 mode will be automatically active when system reset. The PAD setting will be 100 K pull down and input enable during reset period. Once system reset is completed, the state of GPIO1_IO03 will be output keeper and input enable. 1000 ALT8 — Select mux mode: ALT8 mux port: UART1_RX of instance: uart1

32.6.11 SW_MUX_CTL_PAD_GPIO1_IO04 SW MUX Control Register (IOMUXC_SW_MUX_CTL_PAD_GPIO1_IO04)

SW_MUX_CTL Register

Address: 20E_0000h base + 6Ch offset = 20E_006Ch

Bit	31	30	29	28	27	26	25	24	23	22	21	20	19	18	17	16
R	Reserved															
W	Reserved															
Reset	0	0	0	0	0	0	0	0	0	0	0	0	0	0	0	0
Bit	15	14	13	12	11	10	9	8	7	6	5	4	3	2	1	0
R	Reserved											SION		MUX_MODE		
W	Reserved											SION		MUX_MODE		
Reset	0	0	0	0	0	0	0	0	0	0	0	0	0	1	0	1

IOMUXC_SW_MUX_CTL_PAD_GPIO1_IO04 field descriptions

Field	Description
31–5 -	This field is reserved. Reserved
4 SION	Software Input On Field. Force the selected mux mode Input path no matter of MUX_MODE functionality. 1 ENABLED — Force input path of pad GPIO1_IO04 0 DISABLED — Input Path is determined by functionality
MUX_MODE	MUX Mode Select Field. Select 1 of 9 iomux modes to be used for pad: GPIO1_IO04. 0000 ALT0 — Select mux mode: ALT0 mux port: ENET1_REF_CLK1 of instance: enet1 0001 ALT1 — Select mux mode: ALT1 mux port: PWM3_OUT of instance: pwm3 0010 ALT2 — Select mux mode: ALT2 mux port: USB_OTG1_PWR of instance: usb 0100 ALT4 — Select mux mode: ALT4 mux port: USDHC1_RESET_B of instance: usdhc1 0101 ALT5 — Select mux mode: ALT5 mux port: GPIO1_IO04 of instance: gpio1 0110 ALT6 — Select mux mode: ALT6 mux port: ENET2_1588_EVENT0_IN of instance: enet2 1000 ALT8 — Select mux mode: ALT8 mux port: UART5_TX of instance: uart5

32.6.12 SW_MUX_CTL_PAD_GPIO1_IO05 SW MUX Control Register (IOMUXC_SW_MUX_CTL_PAD_GPIO1_IO05)

SW_MUX_CTL Register

Address: 20E_0000h base + 70h offset = 20E_0070h

Bit	31	30	29	28	27	26	25	24	23	22	21	20	19	18	17	16
R	Reserved															
W	Reserved															
Reset	0	0	0	0	0	0	0	0	0	0	0	0	0	0	0	0
Bit	15	14	13	12	11	10	9	8	7	6	5	4	3	2	1	0
R	Reserved												SION		MUX_MODE	
W	Reserved												SION		MUX_MODE	
Reset	0	0	0	0	0	0	0	0	0	0	0	0	0	1	0	1

IOMUXC_SW_MUX_CTL_PAD_GPIO1_IO05 field descriptions

Field	Description
31–5 -	This field is reserved. Reserved
4 SION	Software Input On Field. Force the selected mux mode Input path no matter of MUX_MODE functionality. 1 ENABLED — Force input path of pad GPIO1_IO05 0 DISABLED — Input Path is determined by functionality
MUX_MODE	MUX Mode Select Field. Select 1 of 9 iomux modes to be used for pad: GPIO1_IO05. 0000 ALT0 — Select mux mode: ALT0 mux port: ENET2_REF_CLK2 of instance: enet2 0001 ALT1 — Select mux mode: ALT1 mux port: PWM4_OUT of instance: pwm4 0010 ALT2 — Select mux mode: ALT2 mux port: ANATOP_OTG2_ID of instance: anatop 0011 ALT3 — Select mux mode: ALT3 mux port: CSI_FIELD of instance: csi 0100 ALT4 — Select mux mode: ALT4 mux port: USDHC1_VSELECT of instance: usdhc1 0101 ALT5 — Select mux mode: ALT5 mux port: GPIO1_IO05 of instance: gpio1 0110 ALT6 — Select mux mode: ALT6 mux port: ENET2_1588_EVENT0_OUT of instance: enet2 1000 ALT8 — Select mux mode: ALT8 mux port: UART5_RX of instance: uart5

32.6.13 SW_MUX_CTL_PAD_GPIO1_IO06 SW MUX Control Register (IOMUXC_SW_MUX_CTL_PAD_GPIO1_IO06)

SW_MUX_CTL Register

Address: 20E_0000h base + 74h offset = 20E_0074h

Bit	31	30	29	28	27	26	25	24		23	22	21	20	19	18	17	16
R	Reserved																
W	Reserved																
Reset	0	0	0	0	0	0	0	0		0	0	0	0	0	0	0	0
Bit	15	14	13	12	11	10	9	8		7	6	5	4	3	2	1	0
R	Reserved											SION		MUX_MODE			
W	Reserved											SION		MUX_MODE			
Reset	0	0	0	0	0	0	0	0		0	0	0	0	0	1	0	1

IOMUXC_SW_MUX_CTL_PAD_GPIO1_IO06 field descriptions

Field	Description
31–5 -	This field is reserved. Reserved
4 SION	Software Input On Field. Force the selected mux mode Input path no matter of MUX_MODE functionality. 1 ENABLED — Force input path of pad GPIO1_IO06 0 DISABLED — Input Path is determined by functionality
MUX_MODE	MUX Mode Select Field. Select 1 of 9 iomux modes to be used for pad: GPIO1_IO06. 0000 ALT0 — Select mux mode: ALT0 mux port: ENET1_MDIO of instance: enet1 0001 ALT1 — Select mux mode: ALT1 mux port: ENET2_MDIO of instance: enet2 0010 ALT2 — Select mux mode: ALT2 mux port: USB_OTG_PWR_WAKE of instance: usb 0011 ALT3 — Select mux mode: ALT3 mux port: CSI_MCLK of instance: csi 0100 ALT4 — Select mux mode: ALT4 mux port: USDHC2_WP of instance: usdhc2 0101 ALT5 — Select mux mode: ALT5 mux port: GPIO1_IO06 of instance: gpio1 0110 ALT6 — Select mux mode: ALT6 mux port: CCM_WAIT of instance: ccm 0111 ALT7 — Select mux mode: ALT7 mux port: CCM_REF_EN_B of instance: ccm 1000 ALT8 — Select mux mode: ALT8 mux port: UART1_CTS_B of instance: uart1

32.6.14 SW_MUX_CTL_PAD_GPIO1_IO07 SW MUX Control Register (IOMUXC_SW_MUX_CTL_PAD_GPIO1_IO07)

SW_MUX_CTL Register

Address: 20E_0000h base + 78h offset = 20E_0078h

Bit	31	30	29	28	27	26	25	24	23	22	21	20	19	18	17	16
R	Reserved															
W	Reserved															
Reset	0	0	0	0	0	0	0	0	0	0	0	0	0	0	0	0
Bit	15	14	13	12	11	10	9	8	7	6	5	4	3	2	1	0
R	Reserved												SION		MUX_MODE	
W	Reserved												SION		MUX_MODE	
Reset	0	0	0	0	0	0	0	0	0	0	0	0	0	1	0	1

IOMUXC_SW_MUX_CTL_PAD_GPIO1_IO07 field descriptions

Field	Description
31–5 -	This field is reserved. Reserved
4 SION	Software Input On Field. Force the selected mux mode Input path no matter of MUX_MODE functionality. 1 ENABLED — Force input path of pad GPIO1_IO07 0 DISABLED — Input Path is determined by functionality
MUX_MODE	MUX Mode Select Field. Select 1 of 9 iomux modes to be used for pad: GPIO1_IO07. 0000 ALT0 — Select mux mode: ALT0 mux port: ENET1_MDC of instance: enet1 0001 ALT1 — Select mux mode: ALT1 mux port: ENET2_MDC of instance: enet2 0010 ALT2 — Select mux mode: ALT2 mux port: USB_OTG_HOST_MODE of instance: usb 0011 ALT3 — Select mux mode: ALT3 mux port: CSI_PIXCLK of instance: csi 0100 ALT4 — Select mux mode: ALT4 mux port: USDHC2_CD_B of instance: usdhc2 0101 ALT5 — Select mux mode: ALT5 mux port: GPIO1_IO07 of instance: gpio1 0110 ALT6 — Select mux mode: ALT6 mux port: CCM_STOP of instance: ccm 1000 ALT8 — Select mux mode: ALT8 mux port: UART1_RTS_B of instance: uart1

32.6.15 SW_MUX_CTL_PAD_GPIO1_IO08 SW MUX Control Register (IOMUXC_SW_MUX_CTL_PAD_GPIO1_IO08)

SW_MUX_CTL Register

Address: 20E_0000h base + 7Ch offset = 20E_007Ch

Bit	31	30	29	28	27	26	25	24	23	22	21	20	19	18	17	16
R	Reserved															
W	Reserved															
Reset	0	0	0	0	0	0	0	0	0	0	0	0	0	0	0	0
Bit	15	14	13	12	11	10	9	8	7	6	5	4	3	2	1	0
R	Reserved											SION		MUX_MODE		
W	Reserved											SION		MUX_MODE		
Reset	0	0	0	0	0	0	0	0	0	0	0	0	0	1	0	1

IOMUXC_SW_MUX_CTL_PAD_GPIO1_IO08 field descriptions

Field	Description
31–5 -	This field is reserved. Reserved
4 SION	Software Input On Field. Force the selected mux mode Input path no matter of MUX_MODE functionality. 1 ENABLED — Force input path of pad GPIO1_IO08 0 DISABLED — Input Path is determined by functionality
MUX_MODE	MUX Mode Select Field. Select 1 of 9 iomux modes to be used for pad: GPIO1_IO08. 0000 ALT0 — Select mux mode: ALT0 mux port: PWM1_OUT of instance: pwm1 0001 ALT1 — Select mux mode: ALT1 mux port: WDOG1_WDOG_B of instance: wdog1 0010 ALT2 — Select mux mode: ALT2 mux port: SPDIF_OUT of instance: spdif 0011 ALT3 — Select mux mode: ALT3 mux port: CSI_VSYNC of instance: csi 0100 ALT4 — Select mux mode: ALT4 mux port: USDHC2_VSELECT of instance: usdhc2 0101 ALT5 — Select mux mode: ALT5 mux port: GPIO1_IO08 of instance: gpio1 0110 ALT6 — Select mux mode: ALT6 mux port: CCM_PMIC_RDY of instance: ccm 1000 ALT8 — Select mux mode: ALT8 mux port: UART5_RTS_B of instance: uart5

32.6.16 SW_MUX_CTL_PAD_GPIO1_IO09 SW MUX Control Register (IOMUXC_SW_MUX_CTL_PAD_GPIO1_IO09)

SW_MUX_CTL Register

Address: 20E_0000h base + 80h offset = 20E_0080h

Bit	31	30	29	28	27	26	25	24	23	22	21	20	19	18	17	16
R	Reserved															
W	Reserved															
Reset	0	0	0	0	0	0	0	0	0	0	0	0	0	0	0	0
Bit	15	14	13	12	11	10	9	8	7	6	5	4	3	2	1	0
R	Reserved												SION		MUX_MODE	
W	Reserved												SION		MUX_MODE	
Reset	0	0	0	0	0	0	0	0	0	0	0	0	0	1	0	1

IOMUXC_SW_MUX_CTL_PAD_GPIO1_IO09 field descriptions

Field	Description
31–5 -	This field is reserved. Reserved
4 SION	Software Input On Field. Force the selected mux mode Input path no matter of MUX_MODE functionality. 1 ENABLED — Force input path of pad GPIO1_IO09 0 DISABLED — Input Path is determined by functionality
MUX_MODE	MUX Mode Select Field. Select 1 of 9 iomux modes to be used for pad: GPIO1_IO09. 0000 ALT0 — Select mux mode: ALT0 mux port: PWM2_OUT of instance: pwm2 0001 ALT1 — Select mux mode: ALT1 mux port: WDOG1_WDOG_ANY of instance: wdog1 0010 ALT2 — Select mux mode: ALT2 mux port: SPDIF_IN of instance: spdif 0011 ALT3 — Select mux mode: ALT3 mux port: CSI_HSYNC of instance: csi 0100 ALT4 — Select mux mode: ALT4 mux port: USDHC2_RESET_B of instance: usdhc2 0101 ALT5 — Select mux mode: ALT5 mux port: GPIO1_IO09 of instance: gpio1 0110 ALT6 — Select mux mode: ALT6 mux port: USDHC1_RESET_B of instance: usdhc1 1000 ALT8 — Select mux mode: ALT8 mux port: UART5_CTS_B of instance: uart5

32.6.17 SW_MUX_CTL_PAD_UART1_TX_DATA SW MUX Control Register (IOMUXC_SW_MUX_CTL_PAD_UART1_TX_DATA)

SW_MUX_CTL Register

Address: 20E_0000h base + 84h offset = 20E_0084h

Bit	31	30	29	28	27	26	25	24	23	22	21	20	19	18	17	16
R	Reserved															
W	Reserved															
Reset	0	0	0	0	0	0	0	0	0	0	0	0	0	0	0	0
Bit	15	14	13	12	11	10	9	8	7	6	5	4	3	2	1	0
R	Reserved											SION	MUX_MODE			
W	Reserved											SION	MUX_MODE			
Reset	0	0	0	0	0	0	0	0	0	0	0	0	0	1	0	1

IOMUXC_SW_MUX_CTL_PAD_UART1_TX_DATA field descriptions

Field	Description
31–5 -	This field is reserved. Reserved
4 SION	Software Input On Field. Force the selected mux mode Input path no matter of MUX_MODE functionality. 1 ENABLED — Force input path of pad UART1_TX_DATA 0 DISABLED — Input Path is determined by functionality
MUX_MODE	MUX Mode Select Field. Select 1 of 10 iomux modes to be used for pad: UART1_TX_DATA. 0000 ALT0 — Select mux mode: ALT0 mux port: UART1_TX of instance: uart1 0001 ALT1 — Select mux mode: ALT1 mux port: ENET1_RDATA02 of instance: enet1 0010 ALT2 — Select mux mode: ALT2 mux port: I2C3_SCL of instance: i2c3 0011 ALT3 — Select mux mode: ALT3 mux port: CSI_DATA02 of instance: csi 0100 ALT4 — Select mux mode: ALT4 mux port: GPT1_COMPARE1 of instance: gpt1 0101 ALT5 — Select mux mode: ALT5 mux port: GPIO1_IO16 of instance: gpio1 1000 ALT8 — Select mux mode: ALT8 mux port: SPDIF_OUT of instance: spdif 1001 ALT9 — Select mux mode: ALT9 mux port: UART5_TX of instance: uart5

32.6.18 SW_MUX_CTL_PAD_UART1_RX_DATA SW MUX Control Register (IOMUXC_SW_MUX_CTL_PAD_UART1_RX_DATA)

SW_MUX_CTL Register

Address: 20E_0000h base + 88h offset = 20E_0088h

Bit	31	30	29	28	27	26	25	24	23	22	21	20	19	18	17	16
R	Reserved															
W	Reserved															
Reset	0	0	0	0	0	0	0	0	0	0	0	0	0	0	0	0
Bit	15	14	13	12	11	10	9	8	7	6	5	4	3	2	1	0
R	Reserved												SION		MUX_MODE	
W	Reserved												SION		MUX_MODE	
Reset	0	0	0	0	0	0	0	0	0	0	0	0	0	1	0	1

IOMUXC_SW_MUX_CTL_PAD_UART1_RX_DATA field descriptions

Field	Description
31–5 -	This field is reserved. Reserved
4 SION	Software Input On Field. Force the selected mux mode Input path no matter of MUX_MODE functionality. 1 ENABLED — Force input path of pad UART1_RX_DATA 0 DISABLED — Input Path is determined by functionality
MUX_MODE	MUX Mode Select Field. Select 1 of 10 iomux modes to be used for pad: UART1_RX_DATA. 0000 ALT0 — Select mux mode: ALT0 mux port: UART1_RX of instance: uart1 0001 ALT1 — Select mux mode: ALT1 mux port: ENET1_RDATA03 of instance: enet1 0010 ALT2 — Select mux mode: ALT2 mux port: I2C3_SDA of instance: i2c3 0011 ALT3 — Select mux mode: ALT3 mux port: CSI_DATA03 of instance: csi 0100 ALT4 — Select mux mode: ALT4 mux port: GPT1_CLK of instance: gpt1 0101 ALT5 — Select mux mode: ALT5 mux port: GPIO1_IO17 of instance: gpio1 1000 ALT8 — Select mux mode: ALT8 mux port: SPDIF_IN of instance: spdif 1001 ALT9 — Select mux mode: ALT9 mux port: UART5_RX of instance: uart5

32.6.19 SW_MUX_CTL_PAD_UART1_CTS_B SW MUX Control Register (IOMUXC_SW_MUX_CTL_PAD_UART1_CTS_B)

SW_MUX_CTL Register

Address: 20E_0000h base + 8Ch offset = 20E_008Ch

Bit	31	30	29	28	27	26	25	24		23	22	21	20	19	18	17	16
R	Reserved																
W	Reserved																
Reset	0	0	0	0	0	0	0	0		0	0	0	0	0	0	0	0
Bit	15	14	13	12	11	10	9	8		7	6	5	4	3	2	1	0
R	Reserved											SION		MUX_MODE			
W	Reserved											SION		MUX_MODE			
Reset	0	0	0	0	0	0	0	0		0	0	0	0	0	1	0	1

IOMUXC_SW_MUX_CTL_PAD_UART1_CTS_B field descriptions

Field	Description
31–5 -	This field is reserved. Reserved
4 SION	Software Input On Field. Force the selected mux mode Input path no matter of MUX_MODE functionality. 1 ENABLED — Force input path of pad UART1_CTS_B 0 DISABLED — Input Path is determined by functionality
MUX_MODE	MUX Mode Select Field. Select 1 of 10 iomux modes to be used for pad: UART1_CTS_B. 0000 ALT0 — Select mux mode: ALT0 mux port: UART1_CTS_B of instance: uart1 0001 ALT1 — Select mux mode: ALT1 mux port: ENET1_RX_CLK of instance: enet1 0010 ALT2 — Select mux mode: ALT2 mux port: USDHC1_WP of instance: usdhc1 0011 ALT3 — Select mux mode: ALT3 mux port: CSI_DATA04 of instance: csi 0100 ALT4 — Select mux mode: ALT4 mux port: ENET2_1588_EVENT1_IN of instance: enet2 0101 ALT5 — Select mux mode: ALT5 mux port: GPIO1_IO18 of instance: gpio1 1000 ALT8 — Select mux mode: ALT8 mux port: USDHC2_WP of instance: usdhc2 1001 ALT9 — Select mux mode: ALT9 mux port: UART5_CTS_B of instance: uart5

32.6.20 SW_MUX_CTL_PAD_UART1_RTS_B SW MUX Control Register (IOMUXC_SW_MUX_CTL_PAD_UART1_RTS_B)

SW_MUX_CTL Register

Address: 20E_0000h base + 90h offset = 20E_0090h

Bit	31	30	29	28	27	26	25	24	23	22	21	20	19	18	17	16
R	Reserved															
W	Reserved															
Reset	0	0	0	0	0	0	0	0	0	0	0	0	0	0	0	0
Bit	15	14	13	12	11	10	9	8	7	6	5	4	3	2	1	0
R	Reserved												SION		MUX_MODE	
W	Reserved												SION		MUX_MODE	
Reset	0	0	0	0	0	0	0	0	0	0	0	0	0	1	0	1

IOMUXC_SW_MUX_CTL_PAD_UART1_RTS_B field descriptions

Field	Description
31–5 -	This field is reserved. Reserved
4 SION	Software Input On Field. Force the selected mux mode Input path no matter of MUX_MODE functionality. 1 ENABLED — Force input path of pad UART1_RTS_B 0 DISABLED — Input Path is determined by functionality
MUX_MODE	MUX Mode Select Field. Select 1 of 10 iomux modes to be used for pad: UART1_RTS_B. 0000 ALT0 — Select mux mode: ALT0 mux port: UART1_RTS_B of instance: uart1 0001 ALT1 — Select mux mode: ALT1 mux port: ENET1_TX_ER of instance: enet1 0010 ALT2 — Select mux mode: ALT2 mux port: USDHC1_CD_B of instance: usdhc1 0011 ALT3 — Select mux mode: ALT3 mux port: CSI_DATA05 of instance: csi 0100 ALT4 — Select mux mode: ALT4 mux port: ENET2_1588_EVENT1_OUT of instance: enet2 0101 ALT5 — Select mux mode: ALT5 mux port: GPIO1_IO19 of instance: gpio1 1000 ALT8 — Select mux mode: ALT8 mux port: USDHC2_CD_B of instance: usdhc2 1001 ALT9 — Select mux mode: ALT9 mux port: UART5_RTS_B of instance: uart5

32.6.21 SW_MUX_CTL_PAD_UART2_TX_DATA SW MUX Control Register (IOMUXC_SW_MUX_CTL_PAD_UART2_TX_DATA)

SW_MUX_CTL Register

Address: 20E_0000h base + 94h offset = 20E_0094h

Bit	31	30	29	28	27	26	25	24	23	22	21	20	19	18	17	16
R	Reserved															
W	Reserved															
Reset	0	0	0	0	0	0	0	0	0	0	0	0	0	0	0	0
Bit	15	14	13	12	11	10	9	8	7	6	5	4	3	2	1	0
R	Reserved											SION	MUX_MODE			
W	Reserved											SION	MUX_MODE			
Reset	0	0	0	0	0	0	0	0	0	0	0	0	0	1	0	1

IOMUXC_SW_MUX_CTL_PAD_UART2_TX_DATA field descriptions

Field	Description
31–5 -	This field is reserved. Reserved
4 SION	Software Input On Field. Force the selected mux mode Input path no matter of MUX_MODE functionality. 1 ENABLED — Force input path of pad UART2_TX_DATA 0 DISABLED — Input Path is determined by functionality
MUX_MODE	MUX Mode Select Field. Select 1 of 9 iomux modes to be used for pad: UART2_TX_DATA. 0000 ALT0 — Select mux mode: ALT0 mux port: UART2_TX of instance: uart2 0001 ALT1 — Select mux mode: ALT1 mux port: ENET1_TDATA02 of instance: enet1 0010 ALT2 — Select mux mode: ALT2 mux port: I2C4_SCL of instance: i2c4 0011 ALT3 — Select mux mode: ALT3 mux port: CSI_DATA06 of instance: csi 0100 ALT4 — Select mux mode: ALT4 mux port: GPT1_CAPTURE1 of instance: gpt1 0101 ALT5 — Select mux mode: ALT5 mux port: GPIO1_IO20 of instance: gpio1 1000 ALT8 — Select mux mode: ALT8 mux port: ECSPi3_SS0 of instance: ecspi3

32.6.22 SW_MUX_CTL_PAD_UART2_RX_DATA SW MUX Control Register (IOMUXC_SW_MUX_CTL_PAD_UART2_RX_DATA)

SW_MUX_CTL Register

Address: 20E_0000h base + 98h offset = 20E_0098h

Bit	31	30	29	28	27	26	25	24	23	22	21	20	19	18	17	16
R	Reserved															
W	Reserved															
Reset	0	0	0	0	0	0	0	0	0	0	0	0	0	0	0	0
Bit	15	14	13	12	11	10	9	8	7	6	5	4	3	2	1	0
R	Reserved												SION		MUX_MODE	
W	Reserved												SION		MUX_MODE	
Reset	0	0	0	0	0	0	0	0	0	0	0	0	0	1	0	1

IOMUXC_SW_MUX_CTL_PAD_UART2_RX_DATA field descriptions

Field	Description
31–5 -	This field is reserved. Reserved
4 SION	Software Input On Field. Force the selected mux mode Input path no matter of MUX_MODE functionality. 1 ENABLED — Force input path of pad UART2_RX_DATA 0 DISABLED — Input Path is determined by functionality
MUX_MODE	MUX Mode Select Field. Select 1 of 9 iomux modes to be used for pad: UART2_RX_DATA. 0000 ALT0 — Select mux mode: ALT0 mux port: UART2_RX of instance: uart2 0001 ALT1 — Select mux mode: ALT1 mux port: ENET1_TDATA03 of instance: enet1 0010 ALT2 — Select mux mode: ALT2 mux port: I2C4_SDA of instance: i2c4 0011 ALT3 — Select mux mode: ALT3 mux port: CSI_DATA07 of instance: csi 0100 ALT4 — Select mux mode: ALT4 mux port: GPT1_CAPTURE2 of instance: gpt1 0101 ALT5 — Select mux mode: ALT5 mux port: GPIO1_IO21 of instance: gpio1 0111 ALT7 — Select mux mode: ALT7 mux port: SJC_DONE of instance: sjc 1000 ALT8 — Select mux mode: ALT8 mux port: ECSPI3_SCLK of instance: ecspi3

32.6.23 SW_MUX_CTL_PAD_UART2_CTS_B SW MUX Control Register (IOMUXC_SW_MUX_CTL_PAD_UART2_CTS_B)

SW_MUX_CTL Register

Address: 20E_0000h base + 9Ch offset = 20E_009Ch

Bit	31	30	29	28	27	26	25	24		23	22	21	20	19	18	17	16
R	Reserved																
W	Reserved																
Reset	0	0	0	0	0	0	0	0		0	0	0	0	0	0	0	0
Bit	15	14	13	12	11	10	9	8		7	6	5	4	3	2	1	0
R	Reserved											SION		MUX_MODE			
W	Reserved											SION		MUX_MODE			
Reset	0	0	0	0	0	0	0	0		0	0	0	0	0	1	0	1

IOMUXC_SW_MUX_CTL_PAD_UART2_CTS_B field descriptions

Field	Description
31–5 -	This field is reserved. Reserved
4 SION	Software Input On Field. Force the selected mux mode Input path no matter of MUX_MODE functionality. 1 ENABLED — Force input path of pad UART2_CTS_B 0 DISABLED — Input Path is determined by functionality
MUX_MODE	MUX Mode Select Field. Select 1 of 9 iomux modes to be used for pad: UART2_CTS_B. 0000 ALT0 — Select mux mode: ALT0 mux port: UART2_CTS_B of instance: uart2 0001 ALT1 — Select mux mode: ALT1 mux port: ENET1_CRS of instance: enet1 0010 ALT2 — Select mux mode: ALT2 mux port: FLEXCAN2_TX of instance: flexcan2 0011 ALT3 — Select mux mode: ALT3 mux port: CSI_DATA08 of instance: csi 0100 ALT4 — Select mux mode: ALT4 mux port: GPT1_COMPARE2 of instance: gpt1 0101 ALT5 — Select mux mode: ALT5 mux port: GPIO1_IO22 of instance: gpio1 0111 ALT7 — Select mux mode: ALT7 mux port: SJC_DE_B of instance: sjc 1000 ALT8 — Select mux mode: ALT8 mux port: ECSPI3_MOSI of instance: ecspi3

32.6.24 SW_MUX_CTL_PAD_UART2_RTS_B SW MUX Control Register (IOMUXC_SW_MUX_CTL_PAD_UART2_RTS_B)

SW_MUX_CTL Register

Address: 20E_0000h base + A0h offset = 20E_00A0h

Bit	31	30	29	28	27	26	25	24	23	22	21	20	19	18	17	16
R	Reserved															
W	Reserved															
Reset	0	0	0	0	0	0	0	0	0	0	0	0	0	0	0	0
Bit	15	14	13	12	11	10	9	8	7	6	5	4	3	2	1	0
R	Reserved												SION		MUX_MODE	
W	Reserved												SION		MUX_MODE	
Reset	0	0	0	0	0	0	0	0	0	0	0	0	0	1	0	1

IOMUXC_SW_MUX_CTL_PAD_UART2_RTS_B field descriptions

Field	Description
31–5 -	This field is reserved. Reserved
4 SION	Software Input On Field. Force the selected mux mode Input path no matter of MUX_MODE functionality. 1 ENABLED — Force input path of pad UART2_RTS_B 0 DISABLED — Input Path is determined by functionality
MUX_MODE	MUX Mode Select Field. Select 1 of 9 iomux modes to be used for pad: UART2_RTS_B. 0000 ALT0 — Select mux mode: ALT0 mux port: UART2_RTS_B of instance: uart2 0001 ALT1 — Select mux mode: ALT1 mux port: ENET1_COL of instance: enet1 0010 ALT2 — Select mux mode: ALT2 mux port: FLEXCAN2_RX of instance: flexcan2 0011 ALT3 — Select mux mode: ALT3 mux port: CSI_DATA09 of instance: csi 0100 ALT4 — Select mux mode: ALT4 mux port: GPT1_COMPARE3 of instance: gpt1 0101 ALT5 — Select mux mode: ALT5 mux port: GPIO1_IO23 of instance: gpio1 0111 ALT7 — Select mux mode: ALT7 mux port: SJC_FAIL of instance: sjc 1000 ALT8 — Select mux mode: ALT8 mux port: ECSPI3_MISO of instance: ecspi3

32.6.25 SW_MUX_CTL_PAD_UART3_TX_DATA SW MUX Control Register (IOMUXC_SW_MUX_CTL_PAD_UART3_TX_DATA)

SW_MUX_CTL Register

Address: 20E_0000h base + A4h offset = 20E_00A4h

Bit	31	30	29	28	27	26	25	24	23	22	21	20	19	18	17	16	
R	Reserved																
W	Reserved																
Reset	0	0	0	0	0	0	0	0	0	0	0	0	0	0	0	0	
Bit	15	14	13	12	11	10	9	8	7	6	5	4	3	2	1	0	
R	Reserved											SION		MUX_MODE			
W	Reserved											SION		MUX_MODE			
Reset	0	0	0	0	0	0	0	0	0	0	0	0	0	0	1	0	1

IOMUXC_SW_MUX_CTL_PAD_UART3_TX_DATA field descriptions

Field	Description
31–5 -	This field is reserved. Reserved
4 SION	Software Input On Field. Force the selected mux mode Input path no matter of MUX_MODE functionality. 1 ENABLED — Force input path of pad UART3_TX_DATA 0 DISABLED — Input Path is determined by functionality
MUX_MODE	MUX Mode Select Field. Select 1 of 8 iomux modes to be used for pad: UART3_TX_DATA. 0000 ALT0 — Select mux mode: ALT0 mux port: UART3_TX of instance: uart3 0001 ALT1 — Select mux mode: ALT1 mux port: ENET2_RDATA02 of instance: enet2 0010 ALT2 — Reserved 0011 ALT3 — Select mux mode: ALT3 mux port: CSI_DATA01 of instance: csi 0100 ALT4 — Select mux mode: ALT4 mux port: UART2_CTS_B of instance: uart2 0101 ALT5 — Select mux mode: ALT5 mux port: GPIO1_IO24 of instance: gpio1 0111 ALT7 — Select mux mode: ALT7 mux port: SJC_JTAG_ACT of instance: sjc NOTE: ALT7 mode will be automatically active (output SJC.SJC_JTAG_ACT) when system reset. Once system reset is completed, the state of UART3_TX_DATA will be output keeper and input enenable. 1000 ALT8 — Select mux mode: ALT8 mux port: ANATOP_OTG1_ID of instance: anatop

32.6.26 SW_MUX_CTL_PAD_UART3_RX_DATA SW MUX Control Register (IOMUXC_SW_MUX_CTL_PAD_UART3_RX_DATA)

SW_MUX_CTL Register

Address: 20E_0000h base + A8h offset = 20E_00A8h

Bit	31	30	29	28	27	26	25	24	23	22	21	20	19	18	17	16
R	Reserved															
W	Reserved															
Reset	0	0	0	0	0	0	0	0	0	0	0	0	0	0	0	0
Bit	15	14	13	12	11	10	9	8	7	6	5	4	3	2	1	0
R	Reserved												SION		MUX_MODE	
W	Reserved												SION		MUX_MODE	
Reset	0	0	0	0	0	0	0	0	0	0	0	0	0	1	0	1

IOMUXC_SW_MUX_CTL_PAD_UART3_RX_DATA field descriptions

Field	Description
31–5 -	This field is reserved. Reserved
4 SION	Software Input On Field. Force the selected mux mode Input path no matter of MUX_MODE functionality. 1 ENABLED — Force input path of pad UART3_RX_DATA 0 DISABLED — Input Path is determined by functionality
MUX_MODE	MUX Mode Select Field. Select 1 of 8 iomux modes to be used for pad: UART3_RX_DATA. 0000 ALT0 — Select mux mode: ALT0 mux port: UART3_RX of instance: uart3 0001 ALT1 — Select mux mode: ALT1 mux port: ENET2_RDATA03 of instance: enet2 0010 ALT2 — Reserved 0011 ALT3 — Select mux mode: ALT3 mux port: CSI_DATA00 of instance: csi 0100 ALT4 — Select mux mode: ALT4 mux port: UART2_RTS_B of instance: uart2 0101 ALT5 — Select mux mode: ALT5 mux port: GPIO1_IO25 of instance: gpio1 1000 ALT8 — Select mux mode: ALT8 mux port: EPIT1_OUT of instance: epit1

32.6.27 SW_MUX_CTL_PAD_UART3_CTS_B SW MUX Control Register (IOMUXC_SW_MUX_CTL_PAD_UART3_CTS_B)

SW_MUX_CTL Register

Address: 20E_0000h base + ACh offset = 20E_00ACh

Bit	31	30	29	28	27	26	25	24		23	22	21	20	19	18	17	16
R	Reserved																
W	Reserved																
Reset	0	0	0	0	0	0	0	0		0	0	0	0	0	0	0	0
Bit	15	14	13	12	11	10	9	8		7	6	5	4	3	2	1	0
R	Reserved											SION		MUX_MODE			
W	Reserved											SION		MUX_MODE			
Reset	0	0	0	0	0	0	0	0		0	0	0	0	0	1	0	1

IOMUXC_SW_MUX_CTL_PAD_UART3_CTS_B field descriptions

Field	Description
31–5 -	This field is reserved. Reserved
4 SION	Software Input On Field. Force the selected mux mode Input path no matter of MUX_MODE functionality. 1 ENABLED — Force input path of pad UART3_CTS_B 0 DISABLED — Input Path is determined by functionality
MUX_MODE	MUX Mode Select Field. Select 1 of 9 iomux modes to be used for pad: UART3_CTS_B. 0000 ALT0 — Select mux mode: ALT0 mux port: UART3_CTS_B of instance: uart3 0001 ALT1 — Select mux mode: ALT1 mux port: ENET2_RX_CLK of instance: enet2 0010 ALT2 — Select mux mode: ALT2 mux port: FLEXCAN1_TX of instance: flexcan1 0011 ALT3 — Select mux mode: ALT3 mux port: CSI_DATA10 of instance: csi 0100 ALT4 — Select mux mode: ALT4 mux port: ENET1_1588_EVENT1_IN of instance: enet1 0101 ALT5 — Select mux mode: ALT5 mux port: GPIO1_IO26 of instance: gpio1 1000 ALT8 — Select mux mode: ALT8 mux port: EPIT2_OUT of instance: epit2

32.6.28 SW_MUX_CTL_PAD_UART3_RTS_B SW MUX Control Register (IOMUXC_SW_MUX_CTL_PAD_UART3_RTS_B)

SW_MUX_CTL Register

Address: 20E_0000h base + B0h offset = 20E_00B0h

Bit	31	30	29	28	27	26	25	24	23	22	21	20	19	18	17	16
R	Reserved															
W	Reserved															
Reset	0	0	0	0	0	0	0	0	0	0	0	0	0	0	0	0
Bit	15	14	13	12	11	10	9	8	7	6	5	4	3	2	1	0
R	Reserved												SION		MUX_MODE	
W	Reserved												SION		MUX_MODE	
Reset	0	0	0	0	0	0	0	0	0	0	0	0	0	1	0	1

IOMUXC_SW_MUX_CTL_PAD_UART3_RTS_B field descriptions

Field	Description
31–5 -	This field is reserved. Reserved
4 SION	Software Input On Field. Force the selected mux mode Input path no matter of MUX_MODE functionality. 1 ENABLED — Force input path of pad UART3_RTS_B 0 DISABLED — Input Path is determined by functionality
MUX_MODE	MUX Mode Select Field. Select 1 of 9 iomux modes to be used for pad: UART3_RTS_B. 0000 ALT0 — Select mux mode: ALT0 mux port: UART3_RTS_B of instance: uart3 0001 ALT1 — Select mux mode: ALT1 mux port: ENET2_TX_ER of instance: enet2 0010 ALT2 — Select mux mode: ALT2 mux port: FLEXCAN1_RX of instance: flexcan1 0011 ALT3 — Select mux mode: ALT3 mux port: CSI_DATA11 of instance: csi 0100 ALT4 — Select mux mode: ALT4 mux port: ENET1_1588_EVENT1_OUT of instance: enet1 0101 ALT5 — Select mux mode: ALT5 mux port: GPIO1_IO27 of instance: gpio1 1000 ALT8 — Select mux mode: ALT8 mux port: WDOG1_WDOG_B of instance: wdog1

32.6.29 SW_MUX_CTL_PAD_UART4_TX_DATA SW MUX Control Register (IOMUXC_SW_MUX_CTL_PAD_UART4_TX_DATA)

SW_MUX_CTL Register

Address: 20E_0000h base + B4h offset = 20E_00B4h

Bit	31	30	29	28	27	26	25	24		23	22	21	20	19	18	17	16
R	Reserved																
W	Reserved																
Reset	0	0	0	0	0	0	0	0		0	0	0	0	0	0	0	0
Bit	15	14	13	12	11	10	9	8		7	6	5	4	3	2	1	0
R	Reserved												SION	MUX_MODE			
W	Reserved												SION	MUX_MODE			
Reset	0	0	0	0	0	0	0	0		0	0	0	0	0	1	0	1

IOMUXC_SW_MUX_CTL_PAD_UART4_TX_DATA field descriptions

Field	Description
31–5 -	This field is reserved. Reserved
4 SION	Software Input On Field. Force the selected mux mode Input path no matter of MUX_MODE functionality. 1 ENABLED — Force input path of pad UART4_TX_DATA 0 DISABLED — Input Path is determined by functionality
MUX_MODE	MUX Mode Select Field. Select 1 of 9 iomux modes to be used for pad: UART4_TX_DATA. 0000 ALT0 — Select mux mode: ALT0 mux port: UART4_TX of instance: uart4 0001 ALT1 — Select mux mode: ALT1 mux port: ENET2_TDATA02 of instance: enet2 0010 ALT2 — Select mux mode: ALT2 mux port: I2C1_SCL of instance: i2c1 0011 ALT3 — Select mux mode: ALT3 mux port: CSI_DATA12 of instance: csi 0100 ALT4 — Select mux mode: ALT4 mux port: CSU_CSU_ALARM_AUT02 of instance: csu 0101 ALT5 — Select mux mode: ALT5 mux port: GPIO1_IO28 of instance: gpio1 1000 ALT8 — Select mux mode: ALT8 mux port: ECSPI2_SCLK of instance: ecspi2

32.6.30 SW_MUX_CTL_PAD_UART4_RX_DATA SW MUX Control Register (IOMUXC_SW_MUX_CTL_PAD_UART4_RX_DATA)

SW_MUX_CTL Register

Address: 20E_0000h base + B8h offset = 20E_00B8h

Bit	31	30	29	28	27	26	25	24	23	22	21	20	19	18	17	16
R	Reserved															
W	Reserved															
Reset	0	0	0	0	0	0	0	0	0	0	0	0	0	0	0	0
Bit	15	14	13	12	11	10	9	8	7	6	5	4	3	2	1	0
R	Reserved												SION		MUX_MODE	
W	Reserved												SION		MUX_MODE	
Reset	0	0	0	0	0	0	0	0	0	0	0	0	0	1	0	1

IOMUXC_SW_MUX_CTL_PAD_UART4_RX_DATA field descriptions

Field	Description
31–5 -	This field is reserved. Reserved
4 SION	Software Input On Field. Force the selected mux mode Input path no matter of MUX_MODE functionality. 1 ENABLED — Force input path of pad UART4_RX_DATA 0 DISABLED — Input Path is determined by functionality
MUX_MODE	MUX Mode Select Field. Select 1 of 10 iomux modes to be used for pad: UART4_RX_DATA. 0000 ALT0 — Select mux mode: ALT0 mux port: UART4_RX of instance: uart4 0001 ALT1 — Select mux mode: ALT1 mux port: ENET2_TDATA03 of instance: enet2 0010 ALT2 — Select mux mode: ALT2 mux port: I2C1_SDA of instance: i2c1 0011 ALT3 — Select mux mode: ALT3 mux port: CSI_DATA13 of instance: csi 0100 ALT4 — Select mux mode: ALT4 mux port: CSU_CSU_ALARM_AUT01 of instance: csu 0101 ALT5 — Select mux mode: ALT5 mux port: GPIO1_IO29 of instance: gpio1 1000 ALT8 — Select mux mode: ALT8 mux port: ECSPI2_SS0 of instance: ecspi2 1001 ALT9 — Select mux mode: ALT9 mux port: EPDC_PWRCTRL01 of instance: epdc

32.6.31 SW_MUX_CTL_PAD_UART5_TX_DATA SW MUX Control Register (IOMUXC_SW_MUX_CTL_PAD_UART5_TX_DATA)

SW_MUX_CTL Register

Address: 20E_0000h base + BCh offset = 20E_00BCh

Bit	31	30	29	28	27	26	25	24	23	22	21	20	19	18	17	16
R	Reserved															
W	Reserved															
Reset	0	0	0	0	0	0	0	0	0	0	0	0	0	0	0	0
Bit	15	14	13	12	11	10	9	8	7	6	5	4	3	2	1	0
R	Reserved											SION	MUX_MODE			
W	Reserved											SION	MUX_MODE			
Reset	0	0	0	0	0	0	0	0	0	0	0	0	0	1	0	1

IOMUXC_SW_MUX_CTL_PAD_UART5_TX_DATA field descriptions

Field	Description
31–5 -	This field is reserved. Reserved
4 SION	Software Input On Field. Force the selected mux mode Input path no matter of MUX_MODE functionality. 1 ENABLED — Force input path of pad UART5_TX_DATA 0 DISABLED — Input Path is determined by functionality
MUX_MODE	MUX Mode Select Field. Select 1 of 10 iomux modes to be used for pad: UART5_TX_DATA. 0101 ALT5 — Select mux mode: ALT5 mux port: GPIO1_IO30 of instance: gpio1 1000 ALT8 — Select mux mode: ALT8 mux port: ECSPi2_MOSI of instance: ecspi2 1001 ALT9 — Select mux mode: ALT9 mux port: EPDC_PWRCTRL02 of instance: epdc 0000 ALT0 — Select mux mode: ALT0 mux port: UART5_TX of instance: uart5 0001 ALT1 — Select mux mode: ALT1 mux port: ENET2_CRs of instance: enet2 0010 ALT2 — Select mux mode: ALT2 mux port: I2C2_SCL of instance: i2c2 0011 ALT3 — Select mux mode: ALT3 mux port: CSI_DATA14 of instance: csi 0100 ALT4 — Select mux mode: ALT4 mux port: CSU_CSU_ALARM_AUT00 of instance: csu

32.6.32 SW_MUX_CTL_PAD_UART5_RX_DATA SW MUX Control Register (IOMUXC_SW_MUX_CTL_PAD_UART5_RX_DATA)

SW_MUX_CTL Register

Address: 20E_0000h base + C0h offset = 20E_00C0h

Bit	31	30	29	28	27	26	25	24	23	22	21	20	19	18	17	16	
R	Reserved																
W	Reserved																
Reset	0	0	0	0	0	0	0	0	0	0	0	0	0	0	0	0	
Bit	15	14	13	12	11	10	9	8	7	6	5	4	3	2	1	0	
R	Reserved												SION		MUX_MODE		
W	Reserved												SION		MUX_MODE		
Reset	0	0	0	0	0	0	0	0	0	0	0	0	0	0	1	0	1

IOMUXC_SW_MUX_CTL_PAD_UART5_RX_DATA field descriptions

Field	Description
31–5 -	This field is reserved. Reserved
4 SION	Software Input On Field. Force the selected mux mode Input path no matter of MUX_MODE functionality. 1 ENABLED — Force input path of pad UART5_RX_DATA 0 DISABLED — Input Path is determined by functionality
MUX_MODE	MUX Mode Select Field. Select 1 of 10 iomux modes to be used for pad: UART5_RX_DATA. 0000 ALT0 — Select mux mode: ALT0 mux port: UART5_RX of instance: uart5 0001 ALT1 — Select mux mode: ALT1 mux port: ENET2_COL of instance: enet2 0010 ALT2 — Select mux mode: ALT2 mux port: I2C2_SDA of instance: i2c2 0011 ALT3 — Select mux mode: ALT3 mux port: CSI_DATA15 of instance: csi 0100 ALT4 — Select mux mode: ALT4 mux port: CSU_CSU_INT_DEB of instance: csu 0101 ALT5 — Select mux mode: ALT5 mux port: GPIO1_IO31 of instance: gpio1 1000 ALT8 — Select mux mode: ALT8 mux port: ECSPi2_MISO of instance: ecspi2 1001 ALT9 — Select mux mode: ALT9 mux port: EPDC_PWRCTRL03 of instance: epdc

32.6.33 SW_MUX_CTL_PAD_ENET1_RX_DATA0 SW MUX Control Register (IOMUXC_SW_MUX_CTL_PAD_ENET1_RX_DATA0)

SW_MUX_CTL Register

Address: 20E_0000h base + C4h offset = 20E_00C4h

Bit	31	30	29	28	27	26	25	24	23	22	21	20	19	18	17	16
R	Reserved															
W	Reserved															
Reset	0	0	0	0	0	0	0	0	0	0	0	0	0	0	0	0
Bit	15	14	13	12	11	10	9	8	7	6	5	4	3	2	1	0
R	Reserved											SION	MUX_MODE			
W	Reserved											SION	MUX_MODE			
Reset	0	0	0	0	0	0	0	0	0	0	0	0	0	1	0	1

IOMUXC_SW_MUX_CTL_PAD_ENET1_RX_DATA0 field descriptions

Field	Description
31–5 -	This field is reserved. Reserved
4 SION	Software Input On Field. Force the selected mux mode Input path no matter of MUX_MODE functionality. 1 ENABLED — Force input path of pad ENET1_RX_DATA0 0 DISABLED — Input Path is determined by functionality
MUX_MODE	MUX Mode Select Field. Select 1 of 10 iomux modes to be used for pad: ENET1_RX_DATA0. 0000 ALT0 — Select mux mode: ALT0 mux port: ENET1_RDATA00 of instance: enet1 0001 ALT1 — Select mux mode: ALT1 mux port: UART4_RTS_B of instance: uart4 0010 ALT2 — Select mux mode: ALT2 mux port: PWM1_OUT of instance: pwm1 0011 ALT3 — Select mux mode: ALT3 mux port: CSI_DATA16 of instance: csi 0100 ALT4 — Select mux mode: ALT4 mux port: FLEXCAN1_TX of instance: flexcan1 0101 ALT5 — Select mux mode: ALT5 mux port: GPIO2_IO00 of instance: gpio2 0110 ALT6 — Select mux mode: ALT6 mux port: KPP_ROW00 of instance: kpp 1000 ALT8 — Select mux mode: ALT8 mux port: USDHC1_LCTL of instance: usdhc1 1001 ALT9 — Select mux mode: ALT9 mux port: EPDC_SDCE04 of instance: epdc

32.6.34 SW_MUX_CTL_PAD_ENET1_RX_DATA1 SW MUX Control Register (IOMUXC_SW_MUX_CTL_PAD_ENET1_RX_DATA1)

SW_MUX_CTL Register

Address: 20E_0000h base + C8h offset = 20E_00C8h

Bit	31	30	29	28	27	26	25	24	23	22	21	20	19	18	17	16	
R	Reserved																
W	Reserved																
Reset	0	0	0	0	0	0	0	0	0	0	0	0	0	0	0	0	
Bit	15	14	13	12	11	10	9	8	7	6	5	4	3	2	1	0	
R	Reserved												SION		MUX_MODE		
W	Reserved												SION		MUX_MODE		
Reset	0	0	0	0	0	0	0	0	0	0	0	0	0	0	1	0	1

IOMUXC_SW_MUX_CTL_PAD_ENET1_RX_DATA1 field descriptions

Field	Description
31–5 -	This field is reserved. Reserved
4 SION	Software Input On Field. Force the selected mux mode Input path no matter of MUX_MODE functionality. 1 ENABLED — Force input path of pad ENET1_RX_DATA1 0 DISABLED — Input Path is determined by functionality
MUX_MODE	MUX Mode Select Field. Select 1 of 10 iomux modes to be used for pad: ENET1_RX_DATA1. 0000 ALT0 — Select mux mode: ALT0 mux port: ENET1_RDATA01 of instance: enet1 0001 ALT1 — Select mux mode: ALT1 mux port: UART4_CTS_B of instance: uart4 0010 ALT2 — Select mux mode: ALT2 mux port: PWM2_OUT of instance: pwm2 0011 ALT3 — Select mux mode: ALT3 mux port: CSI_DATA17 of instance: csi 0100 ALT4 — Select mux mode: ALT4 mux port: FLEXCAN1_RX of instance: flexcan1 0101 ALT5 — Select mux mode: ALT5 mux port: GPIO2_IO01 of instance: gpio2 0110 ALT6 — Select mux mode: ALT6 mux port: KPP_COL00 of instance: kpp 1000 ALT8 — Select mux mode: ALT8 mux port: USDHC2_LCTL of instance: usdhc2 1001 ALT9 — Select mux mode: ALT9 mux port: EPDC_SDCE05 of instance: epdc

32.6.35 SW_MUX_CTL_PAD_ENET1_RX_EN SW MUX Control Register (IOMUXC_SW_MUX_CTL_PAD_ENET1_RX_EN)

SW_MUX_CTL Register

Address: 20E_0000h base + CCh offset = 20E_00CCh

Bit	31	30	29	28	27	26	25	24		23	22	21	20	19	18	17	16
R	Reserved																
W	Reserved																
Reset	0	0	0	0	0	0	0	0		0	0	0	0	0	0	0	0
Bit	15	14	13	12	11	10	9	8		7	6	5	4	3	2	1	0
R	Reserved												SION		MUX_MODE		
W	Reserved												SION		MUX_MODE		
Reset	0	0	0	0	0	0	0	0		0	0	0	0	0	1	0	1

IOMUXC_SW_MUX_CTL_PAD_ENET1_RX_EN field descriptions

Field	Description
31–5 -	This field is reserved. Reserved
4 SION	Software Input On Field. Force the selected mux mode Input path no matter of MUX_MODE functionality. 1 ENABLED — Force input path of pad ENET1_RX_EN 0 DISABLED — Input Path is determined by functionality
MUX_MODE	MUX Mode Select Field. Select 1 of 10 iomux modes to be used for pad: ENET1_RX_EN. 0000 ALT0 — Select mux mode: ALT0 mux port: ENET1_RX_EN of instance: enet1 0001 ALT1 — Select mux mode: ALT1 mux port: UART5_RTS_B of instance: uart5 0011 ALT3 — Select mux mode: ALT3 mux port: CSI_DATA18 of instance: csi 0100 ALT4 — Select mux mode: ALT4 mux port: FLEXCAN2_TX of instance: flexcan2 0101 ALT5 — Select mux mode: ALT5 mux port: GPIO2_IO02 of instance: gpio2 0110 ALT6 — Select mux mode: ALT6 mux port: KPP_ROW01 of instance: kpp 1000 ALT8 — Select mux mode: ALT8 mux port: USDHC1_VSELECT of instance: usdhc1 1001 ALT9 — Select mux mode: ALT9 mux port: EPDC_SDCE06 of instance: epdc

32.6.36 SW_MUX_CTL_PAD_ENET1_TX_DATA0 SW MUX Control Register (IOMUXC_SW_MUX_CTL_PAD_ENET1_TX_DATA0)

SW_MUX_CTL Register

Address: 20E_0000h base + D0h offset = 20E_00D0h

Bit	31	30	29	28	27	26	25	24	23	22	21	20	19	18	17	16	
R	Reserved																
W	Reserved																
Reset	0	0	0	0	0	0	0	0	0	0	0	0	0	0	0	0	
Bit	15	14	13	12	11	10	9	8	7	6	5	4	3	2	1	0	
R	Reserved												SION		MUX_MODE		
W	Reserved												SION		MUX_MODE		
Reset	0	0	0	0	0	0	0	0	0	0	0	0	0	0	1	0	1

IOMUXC_SW_MUX_CTL_PAD_ENET1_TX_DATA0 field descriptions

Field	Description
31–5 -	This field is reserved. Reserved
4 SION	Software Input On Field. Force the selected mux mode Input path no matter of MUX_MODE functionality. 1 ENABLED — Force input path of pad ENET1_TX_DATA0 0 DISABLED — Input Path is determined by functionality
MUX_MODE	MUX Mode Select Field. Select 1 of 10 iomux modes to be used for pad: ENET1_TX_DATA0. 0000 ALT0 — Select mux mode: ALT0 mux port: ENET1_TDATA00 of instance: enet1 0001 ALT1 — Select mux mode: ALT1 mux port: UART5_CTS_B of instance: uart5 0011 ALT3 — Select mux mode: ALT3 mux port: CSI_DATA19 of instance: csi 0100 ALT4 — Select mux mode: ALT4 mux port: FLEXCAN2_RX of instance: flexcan2 0101 ALT5 — Select mux mode: ALT5 mux port: GPIO2_IO03 of instance: gpio2 0110 ALT6 — Select mux mode: ALT6 mux port: KPP_COL01 of instance: kpp 1000 ALT8 — Select mux mode: ALT8 mux port: USDHC2_VSELECT of instance: usdhc2 1001 ALT9 — Select mux mode: ALT9 mux port: EPDC_SDCE07 of instance: epdc

32.6.37 SW_MUX_CTL_PAD_ENET1_TX_DATA1 SW MUX Control Register (IOMUXC_SW_MUX_CTL_PAD_ENET1_TX_DATA1)

SW_MUX_CTL Register

Address: 20E_0000h base + D4h offset = 20E_00D4h

Bit	31	30	29	28	27	26	25	24	23	22	21	20	19	18	17	16
R	Reserved															
W	Reserved															
Reset	0	0	0	0	0	0	0	0	0	0	0	0	0	0	0	0
Bit	15	14	13	12	11	10	9	8	7	6	5	4	3	2	1	0
R	Reserved											SION	MUX_MODE			
W	Reserved											SION	MUX_MODE			
Reset	0	0	0	0	0	0	0	0	0	0	0	0	0	1	0	1

IOMUXC_SW_MUX_CTL_PAD_ENET1_TX_DATA1 field descriptions

Field	Description
31–5 -	This field is reserved. Reserved
4 SION	Software Input On Field. Force the selected mux mode Input path no matter of MUX_MODE functionality. 1 ENABLED — Force input path of pad ENET1_TX_DATA1 0 DISABLED — Input Path is determined by functionality
MUX_MODE	MUX Mode Select Field. Select 1 of 10 iomux modes to be used for pad: ENET1_TX_DATA1. 0000 ALT0 — Select mux mode: ALT0 mux port: ENET1_TDATA01 of instance: enet1 0001 ALT1 — Select mux mode: ALT1 mux port: UART6_CTS_B of instance: uart6 0010 ALT2 — Select mux mode: ALT2 mux port: PWM5_OUT of instance: pwm5 0011 ALT3 — Select mux mode: ALT3 mux port: CSI_DATA20 of instance: csi 0100 ALT4 — Select mux mode: ALT4 mux port: ENET2_MDIO of instance: enet2 0101 ALT5 — Select mux mode: ALT5 mux port: GPIO2_IO04 of instance: gpio2 0110 ALT6 — Select mux mode: ALT6 mux port: KPP_ROW02 of instance: kpp 1000 ALT8 — Select mux mode: ALT8 mux port: WDOG1_WDOG_RST_B_DEB of instance: wdog1 1001 ALT9 — Select mux mode: ALT9 mux port: EPDC_SDCE08 of instance: epdc

32.6.38 SW_MUX_CTL_PAD_ENET1_TX_EN SW MUX Control Register (IOMUXC_SW_MUX_CTL_PAD_ENET1_TX_EN)

SW_MUX_CTL Register

Address: 20E_0000h base + D8h offset = 20E_00D8h

Bit	31	30	29	28	27	26	25	24	23	22	21	20	19	18	17	16
R	Reserved															
W	Reserved															
Reset	0	0	0	0	0	0	0	0	0	0	0	0	0	0	0	0
Bit	15	14	13	12	11	10	9	8	7	6	5	4	3	2	1	0
R	Reserved												SION		MUX_MODE	
W	Reserved												SION		MUX_MODE	
Reset	0	0	0	0	0	0	0	0	0	0	0	0	0	1	0	1

IOMUXC_SW_MUX_CTL_PAD_ENET1_TX_EN field descriptions

Field	Description
31–5 -	This field is reserved. Reserved
4 SION	Software Input On Field. Force the selected mux mode Input path no matter of MUX_MODE functionality. 1 ENABLED — Force input path of pad ENET1_TX_EN 0 DISABLED — Input Path is determined by functionality
MUX_MODE	MUX Mode Select Field. Select 1 of 10 iomux modes to be used for pad: ENET1_TX_EN. 0000 ALT0 — Select mux mode: ALT0 mux port: ENET1_TX_EN of instance: enet1 0001 ALT1 — Select mux mode: ALT1 mux port: UART6_RTS_B of instance: uart6 0010 ALT2 — Select mux mode: ALT2 mux port: PWM6_OUT of instance: pwm6 0011 ALT3 — Select mux mode: ALT3 mux port: CSI_DATA21 of instance: csi 0100 ALT4 — Select mux mode: ALT4 mux port: ENET2_MDC of instance: enet2 0101 ALT5 — Select mux mode: ALT5 mux port: GPIO2_IO05 of instance: gpio2 0110 ALT6 — Select mux mode: ALT6 mux port: KPP_COL02 of instance: kpp 1000 ALT8 — Select mux mode: ALT8 mux port: WDOG2_WDOG_RST_B_DEB of instance: wdog2 1001 ALT9 — Select mux mode: ALT9 mux port: EPDC_SDCE09 of instance: epdc

32.6.39 SW_MUX_CTL_PAD_ENET1_TX_CLK SW MUX Control Register (IOMUXC_SW_MUX_CTL_PAD_ENET1_TX_CLK)

SW_MUX_CTL Register

Address: 20E_0000h base + DCh offset = 20E_00DCh

Bit	31	30	29	28	27	26	25	24		23	22	21	20	19	18	17	16
R	Reserved																
W	Reserved																
Reset	0	0	0	0	0	0	0	0		0	0	0	0	0	0	0	0
Bit	15	14	13	12	11	10	9	8		7	6	5	4	3	2	1	0
R	Reserved											SION	MUX_MODE				
W	Reserved											SION	MUX_MODE				
Reset	0	0	0	0	0	0	0	0		0	0	0	0	0	1	0	1

IOMUXC_SW_MUX_CTL_PAD_ENET1_TX_CLK field descriptions

Field	Description
31–5 -	This field is reserved. Reserved
4 SION	Software Input On Field. Force the selected mux mode Input path no matter of MUX_MODE functionality. 1 ENABLED — Force input path of pad ENET1_TX_CLK 0 DISABLED — Input Path is determined by functionality
MUX_MODE	MUX Mode Select Field. Select 1 of 10 iomux modes to be used for pad: ENET1_TX_CLK. 0000 ALT0 — Select mux mode: ALT0 mux port: ENET1_TX_CLK of instance: enet1 0001 ALT1 — Select mux mode: ALT1 mux port: UART7_CTS_B of instance: uart7 0010 ALT2 — Select mux mode: ALT2 mux port: PWM7_OUT of instance: pwm7 0011 ALT3 — Select mux mode: ALT3 mux port: CSI_DATA22 of instance: csi 0100 ALT4 — Select mux mode: ALT4 mux port: ENET1_REF_CLK1 of instance: enet1 0101 ALT5 — Select mux mode: ALT5 mux port: GPIO2_IO06 of instance: gpio2 0110 ALT6 — Select mux mode: ALT6 mux port: KPP_ROW03 of instance: kpp 1000 ALT8 — Select mux mode: ALT8 mux port: GPT1_CLK of instance: gpt1 1001 ALT9 — Select mux mode: ALT9 mux port: EPDC_SDOED of instance: epdc

32.6.40 SW_MUX_CTL_PAD_ENET1_RX_ER SW MUX Control Register (IOMUXC_SW_MUX_CTL_PAD_ENET1_RX_ER)

SW_MUX_CTL Register

Address: 20E_0000h base + E0h offset = 20E_00E0h

Bit	31	30	29	28	27	26	25	24	23	22	21	20	19	18	17	16
R	Reserved															
W	Reserved															
Reset	0	0	0	0	0	0	0	0	0	0	0	0	0	0	0	0
Bit	15	14	13	12	11	10	9	8	7	6	5	4	3	2	1	0
R	Reserved												SION		MUX_MODE	
W	Reserved												SION		MUX_MODE	
Reset	0	0	0	0	0	0	0	0	0	0	0	0	0	1	0	1

IOMUXC_SW_MUX_CTL_PAD_ENET1_RX_ER field descriptions

Field	Description
31–5 -	This field is reserved. Reserved
4 SION	Software Input On Field. Force the selected mux mode Input path no matter of MUX_MODE functionality. 1 ENABLED — Force input path of pad ENET1_RX_ER 0 DISABLED — Input Path is determined by functionality
MUX_MODE	MUX Mode Select Field. Select 1 of 10 iomux modes to be used for pad: ENET1_RX_ER. 0000 ALT0 — Select mux mode: ALT0 mux port: ENET1_RX_ER of instance: enet1 0001 ALT1 — Select mux mode: ALT1 mux port: UART7_RTS_B of instance: uart7 0010 ALT2 — Select mux mode: ALT2 mux port: PWM8_OUT of instance: pwm8 0011 ALT3 — Select mux mode: ALT3 mux port: CSI_DATA23 of instance: csi 0100 ALT4 — Select mux mode: ALT4 mux port: EIM_CRE of instance: eim 0101 ALT5 — Select mux mode: ALT5 mux port: GPIO2_IO07 of instance: gpio2 0110 ALT6 — Select mux mode: ALT6 mux port: KPP_COL03 of instance: kpp 1000 ALT8 — Select mux mode: ALT8 mux port: GPT1_CAPTURE2 of instance: gpt1 1001 ALT9 — Select mux mode: ALT9 mux port: EPDC_SDOEZ of instance: epdc

32.6.41 SW_MUX_CTL_PAD_ENET2_RX_DATA0 SW MUX Control Register (IOMUXC_SW_MUX_CTL_PAD_ENET2_RX_DATA0)

SW_MUX_CTL Register

Address: 20E_0000h base + E4h offset = 20E_00E4h

Bit	31	30	29	28	27	26	25	24		23	22	21	20	19	18	17	16
R	Reserved																
W	Reserved																
Reset	0	0	0	0	0	0	0	0		0	0	0	0	0	0	0	0
Bit	15	14	13	12	11	10	9	8		7	6	5	4	3	2	1	0
R	Reserved												SION		MUX_MODE		
W	Reserved												SION		MUX_MODE		
Reset	0	0	0	0	0	0	0	0		0	0	0	0	0	1	0	1

IOMUXC_SW_MUX_CTL_PAD_ENET2_RX_DATA0 field descriptions

Field	Description
31–5 -	This field is reserved. Reserved
4 SION	Software Input On Field. Force the selected mux mode Input path no matter of MUX_MODE functionality. 1 ENABLED — Force input path of pad ENET2_RX_DATA0 0 DISABLED — Input Path is determined by functionality
MUX_MODE	MUX Mode Select Field. Select 1 of 9 iomux modes to be used for pad: ENET2_RX_DATA0. 0000 ALT0 — Select mux mode: ALT0 mux port: ENET2_RDATA00 of instance: enet2 0001 ALT1 — Select mux mode: ALT1 mux port: UART6_TX of instance: uart6 0010 ALT2 — Reserved 0011 ALT3 — Select mux mode: ALT3 mux port: I2C3_SCL of instance: i2c3 0100 ALT4 — Select mux mode: ALT4 mux port: ENET1_MDIO of instance: enet1 0101 ALT5 — Select mux mode: ALT5 mux port: GPIO2_IO08 of instance: gpio2 0110 ALT6 — Select mux mode: ALT6 mux port: KPP_ROW04 of instance: kpp 1000 ALT8 — Select mux mode: ALT8 mux port: USB_OTG1_PWR of instance: usb 1001 ALT9 — Select mux mode: ALT9 mux port: EPDC_SDDO08 of instance: epdc

32.6.42 SW_MUX_CTL_PAD_ENET2_RX_DATA1 SW MUX Control Register (IOMUXC_SW_MUX_CTL_PAD_ENET2_RX_DATA1)

SW_MUX_CTL Register

Address: 20E_0000h base + E8h offset = 20E_00E8h

Bit	31	30	29	28	27	26	25	24	23	22	21	20	19	18	17	16
R	Reserved															
W	Reserved															
Reset	0	0	0	0	0	0	0	0	0	0	0	0	0	0	0	0
Bit	15	14	13	12	11	10	9	8	7	6	5	4	3	2	1	0
R	Reserved											SION		MUX_MODE		
W	Reserved											SION		MUX_MODE		
Reset	0	0	0	0	0	0	0	0	0	0	0	0	0	1	0	1

IOMUXC_SW_MUX_CTL_PAD_ENET2_RX_DATA1 field descriptions

Field	Description
31–5 -	This field is reserved. Reserved
4 SION	Software Input On Field. Force the selected mux mode Input path no matter of MUX_MODE functionality. 1 ENABLED — Force input path of pad ENET2_RX_DATA1 0 DISABLED — Input Path is determined by functionality
MUX_MODE	MUX Mode Select Field. Select 1 of 9 iomux modes to be used for pad: ENET2_RX_DATA1. 0000 ALT0 — Select mux mode: ALT0 mux port: ENET2_RDATA01 of instance: enet2 0001 ALT1 — Select mux mode: ALT1 mux port: UART6_RX of instance: uart6 0010 ALT2 — Reserved 0011 ALT3 — Select mux mode: ALT3 mux port: I2C3_SDA of instance: i2c3 0100 ALT4 — Select mux mode: ALT4 mux port: ENET1_MDC of instance: enet1 0101 ALT5 — Select mux mode: ALT5 mux port: GPIO2_IO09 of instance: gpio2 0110 ALT6 — Select mux mode: ALT6 mux port: KPP_COL04 of instance: kpp 1000 ALT8 — Select mux mode: ALT8 mux port: USB_OTG1_OC of instance: usb 1001 ALT9 — Select mux mode: ALT9 mux port: EPDC_SDDO09 of instance: epdc

32.6.43 SW_MUX_CTL_PAD_ENET2_RX_EN SW MUX Control Register (IOMUXC_SW_MUX_CTL_PAD_ENET2_RX_EN)

SW_MUX_CTL Register

Address: 20E_0000h base + ECh offset = 20E_00ECh

Bit	31	30	29	28	27	26	25	24		23	22	21	20	19	18	17	16		
R	Reserved																		
W	Reserved																		
Reset	0	0	0	0	0	0	0	0		0	0	0	0	0	0	0	0		
Bit	15	14	13	12	11	10	9	8		7	6	5	4	3	2	1	0		
R	Reserved												SION		MUX_MODE				
W	Reserved												SION		MUX_MODE				
Reset	0	0	0	0	0	0	0	0		0	0	0	0	0	0	1	0	0	1

IOMUXC_SW_MUX_CTL_PAD_ENET2_RX_EN field descriptions

Field	Description
31–5 -	This field is reserved. Reserved
4 SION	Software Input On Field. Force the selected mux mode Input path no matter of MUX_MODE functionality. 1 ENABLED — Force input path of pad ENET2_RX_EN 0 DISABLED — Input Path is determined by functionality
MUX_MODE	MUX Mode Select Field. Select 1 of 9 iomux modes to be used for pad: ENET2_RX_EN. 0000 ALT0 — Select mux mode: ALT0 mux port: ENET2_RX_EN of instance: enet2 0001 ALT1 — Select mux mode: ALT1 mux port: UART7_TX of instance: uart7 0010 ALT2 — Reserved 0011 ALT3 — Select mux mode: ALT3 mux port: I2C4_SCL of instance: i2c4 0100 ALT4 — Select mux mode: ALT4 mux port: EIM_ADDR26 of instance: eim 0101 ALT5 — Select mux mode: ALT5 mux port: GPIO2_IO10 of instance: gpio2 0110 ALT6 — Select mux mode: ALT6 mux port: KPP_ROW05 of instance: kpp 1000 ALT8 — Select mux mode: ALT8 mux port: ENET1_REF_CLK_25M of instance: enet1 1001 ALT9 — Select mux mode: ALT9 mux port: EPDC_SDDO10 of instance: epdc

32.6.44 SW_MUX_CTL_PAD_ENET2_TX_DATA0 SW MUX Control Register (IOMUXC_SW_MUX_CTL_PAD_ENET2_TX_DATA0)

SW_MUX_CTL Register

Address: 20E_0000h base + F0h offset = 20E_00F0h

Bit	31	30	29	28	27	26	25	24	23	22	21	20	19	18	17	16
R	Reserved															
W	Reserved															
Reset	0	0	0	0	0	0	0	0	0	0	0	0	0	0	0	0
Bit	15	14	13	12	11	10	9	8	7	6	5	4	3	2	1	0
R	Reserved											SION		MUX_MODE		
W	Reserved											SION		MUX_MODE		
Reset	0	0	0	0	0	0	0	0	0	0	0	0	0	1	0	1

IOMUXC_SW_MUX_CTL_PAD_ENET2_TX_DATA0 field descriptions

Field	Description
31–5 -	This field is reserved. Reserved
4 SION	Software Input On Field. Force the selected mux mode Input path no matter of MUX_MODE functionality. 1 ENABLED — Force input path of pad ENET2_TX_DATA0 0 DISABLED — Input Path is determined by functionality
MUX_MODE	MUX Mode Select Field. Select 1 of 9 iomux modes to be used for pad: ENET2_TX_DATA0. 0000 ALT0 — Select mux mode: ALT0 mux port: ENET2_TDATA00 of instance: enet2 0001 ALT1 — Select mux mode: ALT1 mux port: UART7_RX of instance: uart7 0010 ALT2 — Reserved 0011 ALT3 — Select mux mode: ALT3 mux port: I2C4_SDA of instance: i2c4 0100 ALT4 — Select mux mode: ALT4 mux port: EIM_EB_B02 of instance: eim 0101 ALT5 — Select mux mode: ALT5 mux port: GPIO2_IO11 of instance: gpio2 0110 ALT6 — Select mux mode: ALT6 mux port: KPP_COL05 of instance: kpp 1001 ALT9 — Select mux mode: ALT9 mux port: EPDC_SDDO11 of instance: epdc

32.6.45 SW_MUX_CTL_PAD_ENET2_TX_DATA1 SW MUX Control Register (IOMUXC_SW_MUX_CTL_PAD_ENET2_TX_DATA1)

SW_MUX_CTL Register

Address: 20E_0000h base + F4h offset = 20E_00F4h

Bit	31	30	29	28	27	26	25	24		23	22	21	20	19	18	17	16
R	Reserved																
W	Reserved																
Reset	0	0	0	0	0	0	0	0		0	0	0	0	0	0	0	0
Bit	15	14	13	12	11	10	9	8		7	6	5	4	3	2	1	0
R	Reserved												SION	MUX_MODE			
W	Reserved												SION	MUX_MODE			
Reset	0	0	0	0	0	0	0	0		0	0	0	0	0	1	0	1

IOMUXC_SW_MUX_CTL_PAD_ENET2_TX_DATA1 field descriptions

Field	Description
31–5 -	This field is reserved. Reserved
4 SION	Software Input On Field. Force the selected mux mode Input path no matter of MUX_MODE functionality. 1 ENABLED — Force input path of pad ENET2_TX_DATA1 0 DISABLED — Input Path is determined by functionality
MUX_MODE	MUX Mode Select Field. Select 1 of 9 iomux modes to be used for pad: ENET2_TX_DATA1. 0000 ALT0 — Select mux mode: ALT0 mux port: ENET2_TDATA01 of instance: enet2 0001 ALT1 — Select mux mode: ALT1 mux port: UART8_TX of instance: uart8 0010 ALT2 — Reserved 0011 ALT3 — Select mux mode: ALT3 mux port: ECSPi4_SCLK of instance: ecspi4 0100 ALT4 — Select mux mode: ALT4 mux port: EIM_EB_B03 of instance: eim 0101 ALT5 — Select mux mode: ALT5 mux port: GPIO2_IO12 of instance: gpio2 0110 ALT6 — Select mux mode: ALT6 mux port: KPP_ROW06 of instance: kpp 1000 ALT8 — Select mux mode: ALT8 mux port: USB_OTG2_PWR of instance: usb 1001 ALT9 — Select mux mode: ALT9 mux port: EPDC_SDDO12 of instance: epdc

32.6.46 SW_MUX_CTL_PAD_ENET2_TX_EN SW MUX Control Register (IOMUXC_SW_MUX_CTL_PAD_ENET2_TX_EN)

SW_MUX_CTL Register

Address: 20E_0000h base + F8h offset = 20E_00F8h

Bit	31	30	29	28	27	26	25	24	23	22	21	20	19	18	17	16
R	Reserved															
W	Reserved															
Reset	0	0	0	0	0	0	0	0	0	0	0	0	0	0	0	0
Bit	15	14	13	12	11	10	9	8	7	6	5	4	3	2	1	0
R	Reserved												SION		MUX_MODE	
W	Reserved												SION		MUX_MODE	
Reset	0	0	0	0	0	0	0	0	0	0	0	0	0	1	0	1

IOMUXC_SW_MUX_CTL_PAD_ENET2_TX_EN field descriptions

Field	Description
31–5 -	This field is reserved. Reserved
4 SION	Software Input On Field. Force the selected mux mode Input path no matter of MUX_MODE functionality. 1 ENABLED — Force input path of pad ENET2_TX_EN 0 DISABLED — Input Path is determined by functionality
MUX_MODE	MUX Mode Select Field. Select 1 of 9 iomux modes to be used for pad: ENET2_TX_EN. 0000 ALT0 — Select mux mode: ALT0 mux port: ENET2_TX_EN of instance: enet2 0001 ALT1 — Select mux mode: ALT1 mux port: UART8_RX of instance: uart8 0010 ALT2 — Reserved 0011 ALT3 — Select mux mode: ALT3 mux port: ECSPI4_MOSI of instance: ecspi4 0100 ALT4 — Select mux mode: ALT4 mux port: EIM_ACLK_FREERUN of instance: eim 0101 ALT5 — Select mux mode: ALT5 mux port: GPIO2_IO13 of instance: gpio2 0110 ALT6 — Select mux mode: ALT6 mux port: KPP_COL06 of instance: kpp 1000 ALT8 — Select mux mode: ALT8 mux port: USB_OTG2_OC of instance: usb 1001 ALT9 — Select mux mode: ALT9 mux port: EPDC_SDDO13 of instance: epdc

32.6.47 SW_MUX_CTL_PAD_ENET2_TX_CLK SW MUX Control Register (IOMUXC_SW_MUX_CTL_PAD_ENET2_TX_CLK)

SW_MUX_CTL Register

Address: 20E_0000h base + FCh offset = 20E_00FCh

Bit	31	30	29	28	27	26	25	24		23	22	21	20	19	18	17	16
R	Reserved																
W	Reserved																
Reset	0	0	0	0	0	0	0	0		0	0	0	0	0	0	0	0
Bit	15	14	13	12	11	10	9	8		7	6	5	4	3	2	1	0
R	Reserved												SION	MUX_MODE			
W	Reserved												SION	MUX_MODE			
Reset	0	0	0	0	0	0	0	0		0	0	0	0	0	1	0	1

IOMUXC_SW_MUX_CTL_PAD_ENET2_TX_CLK field descriptions

Field	Description
31–5 -	This field is reserved. Reserved
4 SION	Software Input On Field. Force the selected mux mode Input path no matter of MUX_MODE functionality. 1 ENABLED — Force input path of pad ENET2_TX_CLK 0 DISABLED — Input Path is determined by functionality
MUX_MODE	MUX Mode Select Field. Select 1 of 9 iomux modes to be used for pad: ENET2_TX_CLK. 0000 ALT0 — Select mux mode: ALT0 mux port: ENET2_TX_CLK of instance: enet2 0001 ALT1 — Select mux mode: ALT1 mux port: UART8_CTS_B of instance: uart8 0010 ALT2 — Reserved 0011 ALT3 — Select mux mode: ALT3 mux port: ECSPI4_MISO of instance: ecspi4 0100 ALT4 — Select mux mode: ALT4 mux port: ENET2_REF_CLK2 of instance: enet2 0101 ALT5 — Select mux mode: ALT5 mux port: GPIO2_IO14 of instance: gpio2 0110 ALT6 — Select mux mode: ALT6 mux port: KPP_ROW07 of instance: kpp 1000 ALT8 — Select mux mode: ALT8 mux port: ANATOP_OTG2_ID of instance: anatop 1001 ALT9 — Select mux mode: ALT9 mux port: EPDC_SDDO14 of instance: epdc

32.6.48 SW_MUX_CTL_PAD_ENET2_RX_ER SW MUX Control Register (IOMUXC_SW_MUX_CTL_PAD_ENET2_RX_ER)

SW_MUX_CTL Register

Address: 20E_0000h base + 100h offset = 20E_0100h

Bit	31	30	29	28	27	26	25	24	23	22	21	20	19	18	17	16
R	Reserved															
W	Reserved															
Reset	0	0	0	0	0	0	0	0	0	0	0	0	0	0	0	0
Bit	15	14	13	12	11	10	9	8	7	6	5	4	3	2	1	0
R	Reserved												SION		MUX_MODE	
W	Reserved												SION		MUX_MODE	
Reset	0	0	0	0	0	0	0	0	0	0	0	0	0	1	0	1

IOMUXC_SW_MUX_CTL_PAD_ENET2_RX_ER field descriptions

Field	Description
31–5 -	This field is reserved. Reserved
4 SION	Software Input On Field. Force the selected mux mode Input path no matter of MUX_MODE functionality. 1 ENABLED — Force input path of pad ENET2_RX_ER 0 DISABLED — Input Path is determined by functionality
MUX_MODE	MUX Mode Select Field. Select 1 of 9 iomux modes to be used for pad: ENET2_RX_ER. 0000 ALT0 — Select mux mode: ALT0 mux port: ENET2_RX_ER of instance: enet2 0001 ALT1 — Select mux mode: ALT1 mux port: UART8_RTS_B of instance: uart8 0010 ALT2 — Reserved 0011 ALT3 — Select mux mode: ALT3 mux port: ECSPi4_SS0 of instance: ecspi4 0100 ALT4 — Select mux mode: ALT4 mux port: EIM_ADDR25 of instance: eim 0101 ALT5 — Select mux mode: ALT5 mux port: GPIO2_IO15 of instance: gpio2 0110 ALT6 — Select mux mode: ALT6 mux port: KPP_COL07 of instance: kpp 1000 ALT8 — Select mux mode: ALT8 mux port: WDOG1_WDOG_ANY of instance: wdog1 1001 ALT9 — Select mux mode: ALT9 mux port: EPDC_SDDO15 of instance: epdc

32.6.49 SW_MUX_CTL_PAD_LCD_CLK SW MUX Control Register (IOMUXC_SW_MUX_CTL_PAD_LCD_CLK)

SW_MUX_CTL Register

Address: 20E_0000h base + 104h offset = 20E_0104h

Bit	31	30	29	28	27	26	25	24		23	22	21	20	19	18	17	16
R	Reserved																
W	Reserved																
Reset	0	0	0	0	0	0	0	0		0	0	0	0	0	0	0	0
Bit	15	14	13	12	11	10	9	8		7	6	5	4	3	2	1	0
R	Reserved											SION		MUX_MODE			
W	Reserved											SION		MUX_MODE			
Reset	0	0	0	0	0	0	0	0		0	0	0	0	0	1	0	1

IOMUXC_SW_MUX_CTL_PAD_LCD_CLK field descriptions

Field	Description
31–5 -	This field is reserved. Reserved
4 SION	Software Input On Field. Force the selected mux mode Input path no matter of MUX_MODE functionality. 1 ENABLED — Force input path of pad LCD_CLK 0 DISABLED — Input Path is determined by functionality
MUX_MODE	MUX Mode Select Field. Select 1 of 10 iomux modes to be used for pad: LCD_CLK. 0000 ALT0 — Select mux mode: ALT0 mux port: LCDIF_CLK of instance: lcdif 0001 ALT1 — Select mux mode: ALT1 mux port: LCDIF_WR_RWN of instance: lcdif 0010 ALT2 — Select mux mode: ALT2 mux port: UART4_TX of instance: uart4 0011 ALT3 — Select mux mode: ALT3 mux port: SAI3_MCLK of instance: sai3 0100 ALT4 — Select mux mode: ALT4 mux port: EIM_CS2_B of instance: eim 0101 ALT5 — Select mux mode: ALT5 mux port: GPIO3_IO00 of instance: gpio3 1000 ALT8 — Select mux mode: ALT8 mux port: WDOG1_WDOG_RST_B_DEB of instance: wdog1 1001 ALT9 — Select mux mode: ALT9 mux port: EPDC_SDCLK of instance: epdc

32.6.50 SW_MUX_CTL_PAD_LCD_ENABLE SW MUX Control Register (IOMUXC_SW_MUX_CTL_PAD_LCD_ENABLE)

SW_MUX_CTL Register

Address: 20E_0000h base + 108h offset = 20E_0108h

Bit	31	30	29	28	27	26	25	24	23	22	21	20	19	18	17	16
R	Reserved															
W	Reserved															
Reset	0	0	0	0	0	0	0	0	0	0	0	0	0	0	0	0
Bit	15	14	13	12	11	10	9	8	7	6	5	4	3	2	1	0
R	Reserved												SION		MUX_MODE	
W	Reserved												SION		MUX_MODE	
Reset	0	0	0	0	0	0	0	0	0	0	0	0	0	1	0	1

IOMUXC_SW_MUX_CTL_PAD_LCD_ENABLE field descriptions

Field	Description
31–5 -	This field is reserved. Reserved
4 SION	Software Input On Field. Force the selected mux mode Input path no matter of MUX_MODE functionality. 1 ENABLED — Force input path of pad LCD_ENABLE 0 DISABLED — Input Path is determined by functionality
MUX_MODE	MUX Mode Select Field. Select 1 of 10 iomux modes to be used for pad: LCD_ENABLE. 0000 ALT0 — Select mux mode: ALT0 mux port: LCDIF_ENABLE of instance: lcdif 0001 ALT1 — Select mux mode: ALT1 mux port: LCDIF_RD_E of instance: lcdif 0010 ALT2 — Select mux mode: ALT2 mux port: UART4_RX of instance: uart4 0011 ALT3 — Select mux mode: ALT3 mux port: SAI3_TX_SYNC of instance: sai3 0100 ALT4 — Select mux mode: ALT4 mux port: EIM_CS3_B of instance: eim 0101 ALT5 — Select mux mode: ALT5 mux port: GPIO3_IO01 of instance: gpio3 1000 ALT8 — Select mux mode: ALT8 mux port: ECSPI2_RDY of instance: ecspi2 1001 ALT9 — Select mux mode: ALT9 mux port: EPDC_SDLE of instance: epdc

32.6.51 SW_MUX_CTL_PAD_LCD_HSYNC SW MUX Control Register (IOMUXC_SW_MUX_CTL_PAD_LCD_HSYNC)

SW_MUX_CTL Register

Address: 20E_0000h base + 10Ch offset = 20E_010Ch

Bit	31	30	29	28	27	26	25	24		23	22	21	20	19	18	17	16
R	Reserved																
W	Reserved																
Reset	0	0	0	0	0	0	0	0		0	0	0	0	0	0	0	0
Bit	15	14	13	12	11	10	9	8		7	6	5	4	3	2	1	0
R	Reserved											SION		MUX_MODE			
W	Reserved											SION		MUX_MODE			
Reset	0	0	0	0	0	0	0	0		0	0	0	0	0	1	0	1

IOMUXC_SW_MUX_CTL_PAD_LCD_HSYNC field descriptions

Field	Description
31–5 -	This field is reserved. Reserved
4 SION	Software Input On Field. Force the selected mux mode Input path no matter of MUX_MODE functionality. 1 ENABLED — Force input path of pad LCD_HSYNC 0 DISABLED — Input Path is determined by functionality
MUX_MODE	MUX Mode Select Field. Select 1 of 10 iomux modes to be used for pad: LCD_HSYNC. 0000 ALT0 — Select mux mode: ALT0 mux port: LCDIF_HSYNC of instance: lcdif 0001 ALT1 — Select mux mode: ALT1 mux port: LCDIF_RS of instance: lcdif 0010 ALT2 — Select mux mode: ALT2 mux port: UART4_CTS_B of instance: uart4 0011 ALT3 — Select mux mode: ALT3 mux port: SAI3_TX_BCLK of instance: sai3 0100 ALT4 — Select mux mode: ALT4 mux port: WDOG3_WDOG_RST_B_DEB of instance: wdog3 0101 ALT5 — Select mux mode: ALT5 mux port: GPIO3_IO02 of instance: gpio3 1000 ALT8 — Select mux mode: ALT8 mux port: ECSPi2_SS1 of instance: ecspi2 1001 ALT9 — Select mux mode: ALT9 mux port: EPDC_SDOE of instance: epdc

32.6.52 SW_MUX_CTL_PAD_LCD_VSYNC SW MUX Control Register (IOMUXC_SW_MUX_CTL_PAD_LCD_VSYNC)

SW_MUX_CTL Register

Address: 20E_0000h base + 110h offset = 20E_0110h

Bit	31	30	29	28	27	26	25	24	23	22	21	20	19	18	17	16
R	Reserved															
W	Reserved															
Reset	0	0	0	0	0	0	0	0	0	0	0	0	0	0	0	0
Bit	15	14	13	12	11	10	9	8	7	6	5	4	3	2	1	0
R	Reserved												SION		MUX_MODE	
W	Reserved												SION		MUX_MODE	
Reset	0	0	0	0	0	0	0	0	0	0	0	0	0	1	0	1

IOMUXC_SW_MUX_CTL_PAD_LCD_VSYNC field descriptions

Field	Description
31–5 -	This field is reserved. Reserved
4 SION	Software Input On Field. Force the selected mux mode Input path no matter of MUX_MODE functionality. 1 ENABLED — Force input path of pad LCD_VSYNC 0 DISABLED — Input Path is determined by functionality
MUX_MODE	MUX Mode Select Field. Select 1 of 10 iomux modes to be used for pad: LCD_VSYNC. 0000 ALT0 — Select mux mode: ALT0 mux port: LCDIF_VSYNC of instance: lcdif 0001 ALT1 — Select mux mode: ALT1 mux port: LCDIF_BUSY of instance: lcdif 0010 ALT2 — Select mux mode: ALT2 mux port: UART4_RTS_B of instance: uart4 0011 ALT3 — Select mux mode: ALT3 mux port: SAI3_RX_DATA of instance: sai3 0100 ALT4 — Select mux mode: ALT4 mux port: WDOG2_WDOG_B of instance: wdog2 0101 ALT5 — Select mux mode: ALT5 mux port: GPIO3_IO03 of instance: gpio3 1000 ALT8 — Select mux mode: ALT8 mux port: ECSPi2_SS2 of instance: ecspi2 1001 ALT9 — Select mux mode: ALT9 mux port: EPDC_SDCE00 of instance: epdc

32.6.53 SW_MUX_CTL_PAD_LCD_RESET SW MUX Control Register (IOMUXC_SW_MUX_CTL_PAD_LCD_RESET)

SW_MUX_CTL Register

Address: 20E_0000h base + 114h offset = 20E_0114h

Bit	31	30	29	28	27	26	25	24	23	22	21	20	19	18	17	16
R	Reserved															
W	Reserved															
Reset	0	0	0	0	0	0	0	0	0	0	0	0	0	0	0	0
Bit	15	14	13	12	11	10	9	8	7	6	5	4	3	2	1	0
R	Reserved											SION		MUX_MODE		
W	Reserved											SION		MUX_MODE		
Reset	0	0	0	0	0	0	0	0	0	0	0	0	0	1	0	1

IOMUXC_SW_MUX_CTL_PAD_LCD_RESET field descriptions

Field	Description
31–5 -	This field is reserved. Reserved
4 SION	Software Input On Field. Force the selected mux mode Input path no matter of MUX_MODE functionality. 1 ENABLED — Force input path of pad LCD_RESET 0 DISABLED — Input Path is determined by functionality
MUX_MODE	MUX Mode Select Field. Select 1 of 10 iomux modes to be used for pad: LCD_RESET. 0000 ALT0 — Select mux mode: ALT0 mux port: LCDIF_RESET of instance: lcdif 0001 ALT1 — Select mux mode: ALT1 mux port: LCDIF_CS of instance: lcdif 0010 ALT2 — Select mux mode: ALT2 mux port: CA7_MX6ULL_EVENT1 of instance: ca7_mx6ull 0011 ALT3 — Select mux mode: ALT3 mux port: SAI3_TX_DATA of instance: sai3 0100 ALT4 — Select mux mode: ALT4 mux port: WDOG1_WDOG_ANY of instance: wdog1 0101 ALT5 — Select mux mode: ALT5 mux port: GPIO3_IO04 of instance: gpio3 1000 ALT8 — Select mux mode: ALT8 mux port: ECSPi2_SS3 of instance: ecspi2 1001 ALT9 — Select mux mode: ALT9 mux port: EPDC_GDOE of instance: epdc

32.6.54 SW_MUX_CTL_PAD_LCD_DATA00 SW MUX Control Register (IOMUXC_SW_MUX_CTL_PAD_LCD_DATA00)

SW_MUX_CTL Register

Address: 20E_0000h base + 118h offset = 20E_0118h

Bit	31	30	29	28	27	26	25	24	23	22	21	20	19	18	17	16
R	Reserved															
W	Reserved															
Reset	0	0	0	0	0	0	0	0	0	0	0	0	0	0	0	0
Bit	15	14	13	12	11	10	9	8	7	6	5	4	3	2	1	0
R	Reserved												SION		MUX_MODE	
W	Reserved												SION		MUX_MODE	
Reset	0	0	0	0	0	0	0	0	0	0	0	0	0	1	0	1

IOMUXC_SW_MUX_CTL_PAD_LCD_DATA00 field descriptions

Field	Description
31–5 -	This field is reserved. Reserved
4 SION	Software Input On Field. Force the selected mux mode Input path no matter of MUX_MODE functionality. 1 ENABLED — Force input path of pad LCD_DATA00 0 DISABLED — Input Path is determined by functionality
MUX_MODE	MUX Mode Select Field. Select 1 of 10 iomux modes to be used for pad: LCD_DATA00. 0000 ALT0 — Select mux mode: ALT0 mux port: LCDIF_DATA00 of instance: lcdif 0001 ALT1 — Select mux mode: ALT1 mux port: PWM1_OUT of instance: pwm1 0011 ALT3 — Select mux mode: ALT3 mux port: ENET1_1588_EVENT2_IN of instance: enet1 0100 ALT4 — Select mux mode: ALT4 mux port: I2C3_SDA of instance: i2c3 0101 ALT5 — Select mux mode: ALT5 mux port: GPIO3_IO05 of instance: gpio3 0110 ALT6 — Select mux mode: ALT6 mux port: SRC_BT_CFG00 of instance: src 1000 ALT8 — Select mux mode: ALT8 mux port: SAI1_MCLK of instance: sai1 1001 ALT9 — Select mux mode: ALT9 mux port: EPDC_SDDO00 of instance: epdc

32.6.55 SW_MUX_CTL_PAD_LCD_DATA01 SW MUX Control Register (IOMUXC_SW_MUX_CTL_PAD_LCD_DATA01)

SW_MUX_CTL Register

Address: 20E_0000h base + 11Ch offset = 20E_011Ch

Bit	31	30	29	28	27	26	25	24		23	22	21	20	19	18	17	16	
R	Reserved																	
W	Reserved																	
Reset	0	0	0	0	0	0	0	0		0	0	0	0	0	0	0	0	
Bit	15	14	13	12	11	10	9	8		7	6	5	4	3	2	1	0	
R	Reserved												SION		MUX_MODE			
W	Reserved												SION		MUX_MODE			
Reset	0	0	0	0	0	0	0	0		0	0	0	0	0	0	1	0	1

IOMUXC_SW_MUX_CTL_PAD_LCD_DATA01 field descriptions

Field	Description
31–5 -	This field is reserved. Reserved
4 SION	Software Input On Field. Force the selected mux mode Input path no matter of MUX_MODE functionality. 1 ENABLED — Force input path of pad LCD_DATA01 0 DISABLED — Input Path is determined by functionality
MUX_MODE	MUX Mode Select Field. Select 1 of 10 iomux modes to be used for pad: LCD_DATA01. 0000 ALT0 — Select mux mode: ALT0 mux port: LCDIF_DATA01 of instance: lcdif 0001 ALT1 — Select mux mode: ALT1 mux port: PWM2_OUT of instance: pwm2 0011 ALT3 — Select mux mode: ALT3 mux port: ENET1_1588_EVENT2_OUT of instance: enet1 0100 ALT4 — Select mux mode: ALT4 mux port: I2C3_SCL of instance: i2c3 0101 ALT5 — Select mux mode: ALT5 mux port: GPIO3_IO06 of instance: gpio3 0110 ALT6 — Select mux mode: ALT6 mux port: SRC_BT_CFG01 of instance: src 1000 ALT8 — Select mux mode: ALT8 mux port: SAI1_TX_SYNC of instance: sai1 1001 ALT9 — Select mux mode: ALT9 mux port: EPDC_SDDO01 of instance: epdc

32.6.56 SW_MUX_CTL_PAD_LCD_DATA02 SW MUX Control Register (IOMUXC_SW_MUX_CTL_PAD_LCD_DATA02)

SW_MUX_CTL Register

Address: 20E_0000h base + 120h offset = 20E_0120h

Bit	31	30	29	28	27	26	25	24	23	22	21	20	19	18	17	16
R	Reserved															
W	Reserved															
Reset	0	0	0	0	0	0	0	0	0	0	0	0	0	0	0	0
Bit	15	14	13	12	11	10	9	8	7	6	5	4	3	2	1	0
R	Reserved												SION		MUX_MODE	
W	Reserved												SION		MUX_MODE	
Reset	0	0	0	0	0	0	0	0	0	0	0	0	0	1	0	1

IOMUXC_SW_MUX_CTL_PAD_LCD_DATA02 field descriptions

Field	Description
31–5 -	This field is reserved. Reserved
4 SION	Software Input On Field. Force the selected mux mode Input path no matter of MUX_MODE functionality. 1 ENABLED — Force input path of pad LCD_DATA02 0 DISABLED — Input Path is determined by functionality
MUX_MODE	MUX Mode Select Field. Select 1 of 10 iomux modes to be used for pad: LCD_DATA02. 0000 ALT0 — Select mux mode: ALT0 mux port: LCDIF_DATA02 of instance: lcdif 0001 ALT1 — Select mux mode: ALT1 mux port: PWM3_OUT of instance: pwm3 0011 ALT3 — Select mux mode: ALT3 mux port: ENET1_1588_EVENT3_IN of instance: enet1 0100 ALT4 — Select mux mode: ALT4 mux port: I2C4_SDA of instance: i2c4 0101 ALT5 — Select mux mode: ALT5 mux port: GPIO3_IO07 of instance: gpio3 0110 ALT6 — Select mux mode: ALT6 mux port: SRC_BT_CFG02 of instance: src 1000 ALT8 — Select mux mode: ALT8 mux port: SAI1_TX_BCLK of instance: sai1 1001 ALT9 — Select mux mode: ALT9 mux port: EPDC_SDDO02 of instance: epdc

32.6.57 SW_MUX_CTL_PAD_LCD_DATA03 SW MUX Control Register (IOMUXC_SW_MUX_CTL_PAD_LCD_DATA03)

SW_MUX_CTL Register

Address: 20E_0000h base + 124h offset = 20E_0124h

Bit	31	30	29	28	27	26	25	24	23	22	21	20	19	18	17	16
R	Reserved															
W	Reserved															
Reset	0	0	0	0	0	0	0	0	0	0	0	0	0	0	0	0
Bit	15	14	13	12	11	10	9	8	7	6	5	4	3	2	1	0
R	Reserved												SION		MUX_MODE	
W	Reserved												SION		MUX_MODE	
Reset	0	0	0	0	0	0	0	0	0	0	0	0	0	1	0	1

IOMUXC_SW_MUX_CTL_PAD_LCD_DATA03 field descriptions

Field	Description
31–5 -	This field is reserved. Reserved
4 SION	Software Input On Field. Force the selected mux mode Input path no matter of MUX_MODE functionality. 1 ENABLED — Force input path of pad LCD_DATA03 0 DISABLED — Input Path is determined by functionality
MUX_MODE	MUX Mode Select Field. Select 1 of 10 iomux modes to be used for pad: LCD_DATA03. 0000 ALT0 — Select mux mode: ALT0 mux port: LCDIF_DATA03 of instance: lcdif 0001 ALT1 — Select mux mode: ALT1 mux port: PWM4_OUT of instance: pwm4 0011 ALT3 — Select mux mode: ALT3 mux port: ENET1_1588_EVENT3_OUT of instance: enet1 0100 ALT4 — Select mux mode: ALT4 mux port: I2C4_SCL of instance: i2c4 0101 ALT5 — Select mux mode: ALT5 mux port: GPIO3_IO08 of instance: gpio3 0110 ALT6 — Select mux mode: ALT6 mux port: SRC_BT_CFG03 of instance: src 1000 ALT8 — Select mux mode: ALT8 mux port: SAI1_RX_DATA of instance: sai1 1001 ALT9 — Select mux mode: ALT9 mux port: EPDC_SDDO03 of instance: epdc

32.6.58 SW_MUX_CTL_PAD_LCD_DATA04 SW MUX Control Register (IOMUXC_SW_MUX_CTL_PAD_LCD_DATA04)

SW_MUX_CTL Register

Address: 20E_0000h base + 128h offset = 20E_0128h

Bit	31	30	29	28	27	26	25	24	23	22	21	20	19	18	17	16
R	Reserved															
W	Reserved															
Reset	0	0	0	0	0	0	0	0	0	0	0	0	0	0	0	0
Bit	15	14	13	12	11	10	9	8	7	6	5	4	3	2	1	0
R	Reserved												SION		MUX_MODE	
W	Reserved												SION		MUX_MODE	
Reset	0	0	0	0	0	0	0	0	0	0	0	0	0	1	0	1

IOMUXC_SW_MUX_CTL_PAD_LCD_DATA04 field descriptions

Field	Description
31–5 -	This field is reserved. Reserved
4 SION	Software Input On Field. Force the selected mux mode Input path no matter of MUX_MODE functionality. 1 ENABLED — Force input path of pad LCD_DATA04 0 DISABLED — Input Path is determined by functionality
MUX_MODE	MUX Mode Select Field. Select 1 of 10 iomux modes to be used for pad: LCD_DATA04. 0000 ALT0 — Select mux mode: ALT0 mux port: LCDIF_DATA04 of instance: lcdif 0001 ALT1 — Select mux mode: ALT1 mux port: UART8_CTS_B of instance: uart8 0011 ALT3 — Select mux mode: ALT3 mux port: ENET2_1588_EVENT2_IN of instance: enet2 0100 ALT4 — Select mux mode: ALT4 mux port: SPDIF_SR_CLK of instance: spdif 0101 ALT5 — Select mux mode: ALT5 mux port: GPIO3_IO09 of instance: gpio3 0110 ALT6 — Select mux mode: ALT6 mux port: SRC_BT_CFG04 of instance: src 1000 ALT8 — Select mux mode: ALT8 mux port: SAI1_TX_DATA of instance: sai1 1001 ALT9 — Select mux mode: ALT9 mux port: EPDC_SDDO04 of instance: epdc

32.6.59 SW_MUX_CTL_PAD_LCD_DATA05 SW MUX Control Register (IOMUXC_SW_MUX_CTL_PAD_LCD_DATA05)

SW_MUX_CTL Register

Address: 20E_0000h base + 12Ch offset = 20E_012Ch

Bit	31	30	29	28	27	26	25	24		23	22	21	20	19	18	17	16
R	Reserved																
W	Reserved																
Reset	0	0	0	0	0	0	0	0		0	0	0	0	0	0	0	0
Bit	15	14	13	12	11	10	9	8		7	6	5	4	3	2	1	0
R	Reserved												SION		MUX_MODE		
W	Reserved												SION		MUX_MODE		
Reset	0	0	0	0	0	0	0	0		0	0	0	0	0	1	0	1

IOMUXC_SW_MUX_CTL_PAD_LCD_DATA05 field descriptions

Field	Description
31–5 -	This field is reserved. Reserved
4 SION	Software Input On Field. Force the selected mux mode Input path no matter of MUX_MODE functionality. 1 ENABLED — Force input path of pad LCD_DATA05 0 DISABLED — Input Path is determined by functionality
MUX_MODE	MUX Mode Select Field. Select 1 of 10 iomux modes to be used for pad: LCD_DATA05. 0000 ALT0 — Select mux mode: ALT0 mux port: LCDIF_DATA05 of instance: lcdif 0001 ALT1 — Select mux mode: ALT1 mux port: UART8_RTS_B of instance: uart8 0011 ALT3 — Select mux mode: ALT3 mux port: ENET2_1588_EVENT2_OUT of instance: enet2 0100 ALT4 — Select mux mode: ALT4 mux port: SPDIF_OUT of instance: spdif 0101 ALT5 — Select mux mode: ALT5 mux port: GPIO3_IO10 of instance: gpio3 0110 ALT6 — Select mux mode: ALT6 mux port: SRC_BT_CFG05 of instance: src 1000 ALT8 — Select mux mode: ALT8 mux port: ECSP11_SS1 of instance: ecspi1 1001 ALT9 — Select mux mode: ALT9 mux port: EPDC_SDDO05 of instance: epdc

32.6.60 SW_MUX_CTL_PAD_LCD_DATA06 SW MUX Control Register (IOMUXC_SW_MUX_CTL_PAD_LCD_DATA06)

SW_MUX_CTL Register

Address: 20E_0000h base + 130h offset = 20E_0130h

Bit	31	30	29	28	27	26	25	24	23	22	21	20	19	18	17	16
R	Reserved															
W	Reserved															
Reset	0	0	0	0	0	0	0	0	0	0	0	0	0	0	0	0
Bit	15	14	13	12	11	10	9	8	7	6	5	4	3	2	1	0
R	Reserved												SION		MUX_MODE	
W	Reserved												SION		MUX_MODE	
Reset	0	0	0	0	0	0	0	0	0	0	0	0	0	1	0	1

IOMUXC_SW_MUX_CTL_PAD_LCD_DATA06 field descriptions

Field	Description
31–5 -	This field is reserved. Reserved
4 SION	Software Input On Field. Force the selected mux mode Input path no matter of MUX_MODE functionality. 1 ENABLED — Force input path of pad LCD_DATA06 0 DISABLED — Input Path is determined by functionality
MUX_MODE	MUX Mode Select Field. Select 1 of 10 iomux modes to be used for pad: LCD_DATA06. 0000 ALT0 — Select mux mode: ALT0 mux port: LCDIF_DATA06 of instance: lcdif 0001 ALT1 — Select mux mode: ALT1 mux port: UART7_CTS_B of instance: uart7 0011 ALT3 — Select mux mode: ALT3 mux port: ENET2_1588_EVENT3_IN of instance: enet2 0100 ALT4 — Select mux mode: ALT4 mux port: SPDIF_LOCK of instance: spdif 0101 ALT5 — Select mux mode: ALT5 mux port: GPIO3_IO11 of instance: gpio3 0110 ALT6 — Select mux mode: ALT6 mux port: SRC_BT_CFG06 of instance: src 1000 ALT8 — Select mux mode: ALT8 mux port: ECSP11_SS2 of instance: ecspi1 1001 ALT9 — Select mux mode: ALT9 mux port: EPDC_SDDO06 of instance: epdc

32.6.61 SW_MUX_CTL_PAD_LCD_DATA07 SW MUX Control Register (IOMUXC_SW_MUX_CTL_PAD_LCD_DATA07)

SW_MUX_CTL Register

Address: 20E_0000h base + 134h offset = 20E_0134h

Bit	31	30	29	28	27	26	25	24	23	22	21	20	19	18	17	16
R	Reserved															
W	Reserved															
Reset	0	0	0	0	0	0	0	0	0	0	0	0	0	0	0	0
Bit	15	14	13	12	11	10	9	8	7	6	5	4	3	2	1	0
R	Reserved											SION		MUX_MODE		
W	Reserved											SION		MUX_MODE		
Reset	0	0	0	0	0	0	0	0	0	0	0	0	0	1	0	1

IOMUXC_SW_MUX_CTL_PAD_LCD_DATA07 field descriptions

Field	Description
31–5 -	This field is reserved. Reserved
4 SION	Software Input On Field. Force the selected mux mode Input path no matter of MUX_MODE functionality. 1 ENABLED — Force input path of pad LCD_DATA07 0 DISABLED — Input Path is determined by functionality
MUX_MODE	MUX Mode Select Field. Select 1 of 10 iomux modes to be used for pad: LCD_DATA07. 0000 ALT0 — Select mux mode: ALT0 mux port: LCDIF_DATA07 of instance: lcdif 0001 ALT1 — Select mux mode: ALT1 mux port: UART7_RTS_B of instance: uart7 0011 ALT3 — Select mux mode: ALT3 mux port: ENET2_1588_EVENT3_OUT of instance: enet2 0100 ALT4 — Select mux mode: ALT4 mux port: SPDIF_EXT_CLK of instance: spdif 0101 ALT5 — Select mux mode: ALT5 mux port: GPIO3_IO12 of instance: gpio3 0110 ALT6 — Select mux mode: ALT6 mux port: SRC_BT_CFG07 of instance: src 1000 ALT8 — Select mux mode: ALT8 mux port: ECSP11_SS3 of instance: ecspi1 1001 ALT9 — Select mux mode: ALT9 mux port: EPDC_SDDO07 of instance: epdc

32.6.62 SW_MUX_CTL_PAD_LCD_DATA08 SW MUX Control Register (IOMUXC_SW_MUX_CTL_PAD_LCD_DATA08)

SW_MUX_CTL Register

Address: 20E_0000h base + 138h offset = 20E_0138h

Bit	31	30	29	28	27	26	25	24	23	22	21	20	19	18	17	16
R	Reserved															
W	Reserved															
Reset	0	0	0	0	0	0	0	0	0	0	0	0	0	0	0	0
Bit	15	14	13	12	11	10	9	8	7	6	5	4	3	2	1	0
R	Reserved												SION		MUX_MODE	
W	Reserved												SION		MUX_MODE	
Reset	0	0	0	0	0	0	0	0	0	0	0	0	0	1	0	1

IOMUXC_SW_MUX_CTL_PAD_LCD_DATA08 field descriptions

Field	Description
31–5 -	This field is reserved. Reserved
4 SION	Software Input On Field. Force the selected mux mode Input path no matter of MUX_MODE functionality. 1 ENABLED — Force input path of pad LCD_DATA08 0 DISABLED — Input Path is determined by functionality
MUX_MODE	MUX Mode Select Field. Select 1 of 10 iomux modes to be used for pad: LCD_DATA08. 0000 ALT0 — Select mux mode: ALT0 mux port: LCDIF_DATA08 of instance: lcdif 0001 ALT1 — Select mux mode: ALT1 mux port: SPDIF_IN of instance: spdif 0011 ALT3 — Select mux mode: ALT3 mux port: CSI_DATA16 of instance: csi 0100 ALT4 — Select mux mode: ALT4 mux port: EIM_DATA00 of instance: eim 0101 ALT5 — Select mux mode: ALT5 mux port: GPIO3_IO13 of instance: gpio3 0110 ALT6 — Select mux mode: ALT6 mux port: SRC_BT_CFG08 of instance: src 1000 ALT8 — Select mux mode: ALT8 mux port: FLEXCAN1_TX of instance: flexcan1 1001 ALT9 — Select mux mode: ALT9 mux port: EPDC_PWRIRQ of instance: epdc

32.6.63 SW_MUX_CTL_PAD_LCD_DATA09 SW MUX Control Register (IOMUXC_SW_MUX_CTL_PAD_LCD_DATA09)

SW_MUX_CTL Register

Address: 20E_0000h base + 13Ch offset = 20E_013Ch

Bit	31	30	29	28	27	26	25	24	23	22	21	20	19	18	17	16
R	Reserved															
W	Reserved															
Reset	0	0	0	0	0	0	0	0	0	0	0	0	0	0	0	0
Bit	15	14	13	12	11	10	9	8	7	6	5	4	3	2	1	0
R	Reserved											SION		MUX_MODE		
W	Reserved											SION		MUX_MODE		
Reset	0	0	0	0	0	0	0	0	0	0	0	0	0	1	0	1

IOMUXC_SW_MUX_CTL_PAD_LCD_DATA09 field descriptions

Field	Description
31–5 -	This field is reserved. Reserved
4 SION	Software Input On Field. Force the selected mux mode Input path no matter of MUX_MODE functionality. 1 ENABLED — Force input path of pad LCD_DATA09 0 DISABLED — Input Path is determined by functionality
MUX_MODE	MUX Mode Select Field. Select 1 of 10 iomux modes to be used for pad: LCD_DATA09. 0000 ALT0 — Select mux mode: ALT0 mux port: LCDIF_DATA09 of instance: lcdif 0001 ALT1 — Select mux mode: ALT1 mux port: SAI3_MCLK of instance: sai3 0011 ALT3 — Select mux mode: ALT3 mux port: CSI_DATA17 of instance: csi 0100 ALT4 — Select mux mode: ALT4 mux port: EIM_DATA01 of instance: eim 0101 ALT5 — Select mux mode: ALT5 mux port: GPIO3_IO14 of instance: gpio3 0110 ALT6 — Select mux mode: ALT6 mux port: SRC_BT_CFG09 of instance: src 1000 ALT8 — Select mux mode: ALT8 mux port: FLEXCAN1_RX of instance: flexcan1 1001 ALT9 — Select mux mode: ALT9 mux port: EPDC_PWRWAKE of instance: epdc

32.6.64 SW_MUX_CTL_PAD_LCD_DATA10 SW MUX Control Register (IOMUXC_SW_MUX_CTL_PAD_LCD_DATA10)

SW_MUX_CTL Register

Address: 20E_0000h base + 140h offset = 20E_0140h

Bit	31	30	29	28	27	26	25	24	23	22	21	20	19	18	17	16
R	Reserved															
W	Reserved															
Reset	0	0	0	0	0	0	0	0	0	0	0	0	0	0	0	0
Bit	15	14	13	12	11	10	9	8	7	6	5	4	3	2	1	0
R	Reserved												SION		MUX_MODE	
W	Reserved												SION		MUX_MODE	
Reset	0	0	0	0	0	0	0	0	0	0	0	0	0	1	0	1

IOMUXC_SW_MUX_CTL_PAD_LCD_DATA10 field descriptions

Field	Description
31–5 -	This field is reserved. Reserved
4 SION	Software Input On Field. Force the selected mux mode Input path no matter of MUX_MODE functionality. 1 ENABLED — Force input path of pad LCD_DATA10 0 DISABLED — Input Path is determined by functionality
MUX_MODE	MUX Mode Select Field. Select 1 of 10 iomux modes to be used for pad: LCD_DATA10. 0000 ALT0 — Select mux mode: ALT0 mux port: LCDIF_DATA10 of instance: lcdif 0001 ALT1 — Select mux mode: ALT1 mux port: SAI3_RX_SYNC of instance: sai3 0011 ALT3 — Select mux mode: ALT3 mux port: CSI_DATA18 of instance: csi 0100 ALT4 — Select mux mode: ALT4 mux port: EIM_DATA02 of instance: eim 0101 ALT5 — Select mux mode: ALT5 mux port: GPIO3_IO15 of instance: gpio3 0110 ALT6 — Select mux mode: ALT6 mux port: SRC_BT_CFG10 of instance: src 1000 ALT8 — Select mux mode: ALT8 mux port: FLEXCAN2_TX of instance: flexcan2 1001 ALT9 — Select mux mode: ALT9 mux port: EPDC_PWRCOM of instance: epdc

32.6.65 SW_MUX_CTL_PAD_LCD_DATA11 SW MUX Control Register (IOMUXC_SW_MUX_CTL_PAD_LCD_DATA11)

SW_MUX_CTL Register

Address: 20E_0000h base + 144h offset = 20E_0144h

Bit	31	30	29	28	27	26	25	24	23	22	21	20	19	18	17	16
R	Reserved															
W	Reserved															
Reset	0	0	0	0	0	0	0	0	0	0	0	0	0	0	0	0
Bit	15	14	13	12	11	10	9	8	7	6	5	4	3	2	1	0
R	Reserved											SION		MUX_MODE		
W	Reserved											SION		MUX_MODE		
Reset	0	0	0	0	0	0	0	0	0	0	0	0	0	1	0	1

IOMUXC_SW_MUX_CTL_PAD_LCD_DATA11 field descriptions

Field	Description
31–5 -	This field is reserved. Reserved
4 SION	Software Input On Field. Force the selected mux mode Input path no matter of MUX_MODE functionality. 1 ENABLED — Force input path of pad LCD_DATA11 0 DISABLED — Input Path is determined by functionality
MUX_MODE	MUX Mode Select Field. Select 1 of 10 iomux modes to be used for pad: LCD_DATA11. 0000 ALT0 — Select mux mode: ALT0 mux port: LCDIF_DATA11 of instance: lcdif 0001 ALT1 — Select mux mode: ALT1 mux port: SAI3_RX_BCLK of instance: sai3 0011 ALT3 — Select mux mode: ALT3 mux port: CSI_DATA19 of instance: csi 0100 ALT4 — Select mux mode: ALT4 mux port: EIM_DATA03 of instance: eim 0101 ALT5 — Select mux mode: ALT5 mux port: GPIO3_IO16 of instance: gpio3 0110 ALT6 — Select mux mode: ALT6 mux port: SRC_BT_CFG11 of instance: src 1000 ALT8 — Select mux mode: ALT8 mux port: FLEXCAN2_RX of instance: flexcan2 1001 ALT9 — Select mux mode: ALT9 mux port: EPDC_PWRSTAT of instance: epdc

32.6.66 SW_MUX_CTL_PAD_LCD_DATA12 SW MUX Control Register (IOMUXC_SW_MUX_CTL_PAD_LCD_DATA12)

SW_MUX_CTL Register

Address: 20E_0000h base + 148h offset = 20E_0148h

Bit	31	30	29	28	27	26	25	24	23	22	21	20	19	18	17	16
R	Reserved															
W	Reserved															
Reset	0	0	0	0	0	0	0	0	0	0	0	0	0	0	0	0
Bit	15	14	13	12	11	10	9	8	7	6	5	4	3	2	1	0
R	Reserved												SION		MUX_MODE	
W	Reserved												SION		MUX_MODE	
Reset	0	0	0	0	0	0	0	0	0	0	0	0	0	1	0	1

IOMUXC_SW_MUX_CTL_PAD_LCD_DATA12 field descriptions

Field	Description
31–5 -	This field is reserved. Reserved
4 SION	Software Input On Field. Force the selected mux mode Input path no matter of MUX_MODE functionality. 1 ENABLED — Force input path of pad LCD_DATA12 0 DISABLED — Input Path is determined by functionality
MUX_MODE	MUX Mode Select Field. Select 1 of 10 iomux modes to be used for pad: LCD_DATA12. 0000 ALT0 — Select mux mode: ALT0 mux port: LCDIF_DATA12 of instance: lcdif 0001 ALT1 — Select mux mode: ALT1 mux port: SAI3_TX_SYNC of instance: sai3 0011 ALT3 — Select mux mode: ALT3 mux port: CSI_DATA20 of instance: csi 0100 ALT4 — Select mux mode: ALT4 mux port: EIM_DATA04 of instance: eim 0101 ALT5 — Select mux mode: ALT5 mux port: GPIO3_IO17 of instance: gpio3 0110 ALT6 — Select mux mode: ALT6 mux port: SRC_BT_CFG12 of instance: src 1000 ALT8 — Select mux mode: ALT8 mux port: ECSP11_RDY of instance: ecspi1 1001 ALT9 — Select mux mode: ALT9 mux port: EPDC_PWRCTRL00 of instance: epdc

32.6.67 SW_MUX_CTL_PAD_LCD_DATA13 SW MUX Control Register (IOMUXC_SW_MUX_CTL_PAD_LCD_DATA13)

SW_MUX_CTL Register

Address: 20E_0000h base + 14Ch offset = 20E_014Ch

Bit	31	30	29	28	27	26	25	24	23	22	21	20	19	18	17	16
R	Reserved															
W	Reserved															
Reset	0	0	0	0	0	0	0	0	0	0	0	0	0	0	0	0
Bit	15	14	13	12	11	10	9	8	7	6	5	4	3	2	1	0
R	Reserved											SION		MUX_MODE		
W	Reserved											SION		MUX_MODE		
Reset	0	0	0	0	0	0	0	0	0	0	0	0	0	1	0	1

IOMUXC_SW_MUX_CTL_PAD_LCD_DATA13 field descriptions

Field	Description
31–5 -	This field is reserved. Reserved
4 SION	Software Input On Field. Force the selected mux mode Input path no matter of MUX_MODE functionality. 1 ENABLED — Force input path of pad LCD_DATA13 0 DISABLED — Input Path is determined by functionality
MUX_MODE	MUX Mode Select Field. Select 1 of 10 iomux modes to be used for pad: LCD_DATA13. 0000 ALT0 — Select mux mode: ALT0 mux port: LCDIF_DATA13 of instance: lcdif 0001 ALT1 — Select mux mode: ALT1 mux port: SAI3_TX_BCLK of instance: sai3 0011 ALT3 — Select mux mode: ALT3 mux port: CSI_DATA21 of instance: csi 0100 ALT4 — Select mux mode: ALT4 mux port: EIM_DATA05 of instance: eim 0101 ALT5 — Select mux mode: ALT5 mux port: GPIO3_IO18 of instance: gpio3 0110 ALT6 — Select mux mode: ALT6 mux port: SRC_BT_CFG13 of instance: src 1000 ALT8 — Select mux mode: ALT8 mux port: USDHC2_RESET_B of instance: usdhc2 1001 ALT9 — Select mux mode: ALT9 mux port: EPDC_BDR00 of instance: epdc

32.6.68 SW_MUX_CTL_PAD_LCD_DATA14 SW MUX Control Register (IOMUXC_SW_MUX_CTL_PAD_LCD_DATA14)

SW_MUX_CTL Register

Address: 20E_0000h base + 150h offset = 20E_0150h

Bit	31	30	29	28	27	26	25	24	23	22	21	20	19	18	17	16
R	Reserved															
W	Reserved															
Reset	0	0	0	0	0	0	0	0	0	0	0	0	0	0	0	0
Bit	15	14	13	12	11	10	9	8	7	6	5	4	3	2	1	0
R	Reserved												SION		MUX_MODE	
W	Reserved												SION		MUX_MODE	
Reset	0	0	0	0	0	0	0	0	0	0	0	0	0	1	0	1

IOMUXC_SW_MUX_CTL_PAD_LCD_DATA14 field descriptions

Field	Description
31–5 -	This field is reserved. Reserved
4 SION	Software Input On Field. Force the selected mux mode Input path no matter of MUX_MODE functionality. 1 ENABLED — Force input path of pad LCD_DATA14 0 DISABLED — Input Path is determined by functionality
MUX_MODE	MUX Mode Select Field. Select 1 of 10 iomux modes to be used for pad: LCD_DATA14. 0000 ALT0 — Select mux mode: ALT0 mux port: LCDIF_DATA14 of instance: lcdif 0001 ALT1 — Select mux mode: ALT1 mux port: SAI3_RX_DATA of instance: sai3 0011 ALT3 — Select mux mode: ALT3 mux port: CSI_DATA22 of instance: csi 0100 ALT4 — Select mux mode: ALT4 mux port: EIM_DATA06 of instance: eim 0101 ALT5 — Select mux mode: ALT5 mux port: GPIO3_IO19 of instance: gpio3 0110 ALT6 — Select mux mode: ALT6 mux port: SRC_BT_CFG14 of instance: src 1000 ALT8 — Select mux mode: ALT8 mux port: USDHC2_DATA4 of instance: usdhc2 1001 ALT9 — Select mux mode: ALT9 mux port: EPDC_SDSHR of instance: epdc

32.6.69 SW_MUX_CTL_PAD_LCD_DATA15 SW MUX Control Register (IOMUXC_SW_MUX_CTL_PAD_LCD_DATA15)

SW_MUX_CTL Register

Address: 20E_0000h base + 154h offset = 20E_0154h

Bit	31	30	29	28	27	26	25	24	23	22	21	20	19	18	17	16
R	Reserved															
W	Reserved															
Reset	0	0	0	0	0	0	0	0	0	0	0	0	0	0	0	0
Bit	15	14	13	12	11	10	9	8	7	6	5	4	3	2	1	0
R	Reserved											SION		MUX_MODE		
W	Reserved											SION		MUX_MODE		
Reset	0	0	0	0	0	0	0	0	0	0	0	0	0	1	0	1

IOMUXC_SW_MUX_CTL_PAD_LCD_DATA15 field descriptions

Field	Description
31–5 -	This field is reserved. Reserved
4 SION	Software Input On Field. Force the selected mux mode Input path no matter of MUX_MODE functionality. 1 ENABLED — Force input path of pad LCD_DATA15 0 DISABLED — Input Path is determined by functionality
MUX_MODE	MUX Mode Select Field. Select 1 of 10 iomux modes to be used for pad: LCD_DATA15. 0000 ALT0 — Select mux mode: ALT0 mux port: LCDIF_DATA15 of instance: lcdif 0001 ALT1 — Select mux mode: ALT1 mux port: SAI3_TX_DATA of instance: sai3 0011 ALT3 — Select mux mode: ALT3 mux port: CSI_DATA23 of instance: csi 0100 ALT4 — Select mux mode: ALT4 mux port: EIM_DATA07 of instance: eim 0101 ALT5 — Select mux mode: ALT5 mux port: GPIO3_IO20 of instance: gpio3 0110 ALT6 — Select mux mode: ALT6 mux port: SRC_BT_CFG15 of instance: src 1000 ALT8 — Select mux mode: ALT8 mux port: USDHC2_DATA5 of instance: usdhc2 1001 ALT9 — Select mux mode: ALT9 mux port: EPDC_GDRL of instance: epdc

32.6.70 SW_MUX_CTL_PAD_LCD_DATA16 SW MUX Control Register (IOMUXC_SW_MUX_CTL_PAD_LCD_DATA16)

SW_MUX_CTL Register

Address: 20E_0000h base + 158h offset = 20E_0158h

Bit	31	30	29	28	27	26	25	24	23	22	21	20	19	18	17	16
R	Reserved															
W	Reserved															
Reset	0	0	0	0	0	0	0	0	0	0	0	0	0	0	0	0
Bit	15	14	13	12	11	10	9	8	7	6	5	4	3	2	1	0
R	Reserved												SION		MUX_MODE	
W	Reserved												SION		MUX_MODE	
Reset	0	0	0	0	0	0	0	0	0	0	0	0	0	1	0	1

IOMUXC_SW_MUX_CTL_PAD_LCD_DATA16 field descriptions

Field	Description
31–5 -	This field is reserved. Reserved
4 SION	Software Input On Field. Force the selected mux mode Input path no matter of MUX_MODE functionality. 1 ENABLED — Force input path of pad LCD_DATA16 0 DISABLED — Input Path is determined by functionality
MUX_MODE	MUX Mode Select Field. Select 1 of 10 iomux modes to be used for pad: LCD_DATA16. 0000 ALT0 — Select mux mode: ALT0 mux port: LCDIF_DATA16 of instance: lcdif 0001 ALT1 — Select mux mode: ALT1 mux port: UART7_TX of instance: uart7 0011 ALT3 — Select mux mode: ALT3 mux port: CSI_DATA01 of instance: csi 0100 ALT4 — Select mux mode: ALT4 mux port: EIM_DATA08 of instance: eim 0101 ALT5 — Select mux mode: ALT5 mux port: GPIO3_IO21 of instance: gpio3 0110 ALT6 — Select mux mode: ALT6 mux port: SRC_BT_CFG24 of instance: src 1000 ALT8 — Select mux mode: ALT8 mux port: USDHC2_DATA6 of instance: usdhc2 1001 ALT9 — Select mux mode: ALT9 mux port: EPDC_GDCLK of instance: epdc

32.6.71 SW_MUX_CTL_PAD_LCD_DATA17 SW MUX Control Register (IOMUXC_SW_MUX_CTL_PAD_LCD_DATA17)

SW_MUX_CTL Register

Address: 20E_0000h base + 15Ch offset = 20E_015Ch

Bit	31	30	29	28	27	26	25	24		23	22	21	20	19	18	17	16
R	Reserved																
W	Reserved																
Reset	0	0	0	0	0	0	0	0		0	0	0	0	0	0	0	0
Bit	15	14	13	12	11	10	9	8		7	6	5	4	3	2	1	0
R	Reserved												SION		MUX_MODE		
W	Reserved												SION		MUX_MODE		
Reset	0	0	0	0	0	0	0	0		0	0	0	0	0	1	0	1

IOMUXC_SW_MUX_CTL_PAD_LCD_DATA17 field descriptions

Field	Description
31–5 -	This field is reserved. Reserved
4 SION	Software Input On Field. Force the selected mux mode Input path no matter of MUX_MODE functionality. 1 ENABLED — Force input path of pad LCD_DATA17 0 DISABLED — Input Path is determined by functionality
MUX_MODE	MUX Mode Select Field. Select 1 of 10 iomux modes to be used for pad: LCD_DATA17. 0000 ALT0 — Select mux mode: ALT0 mux port: LCDIF_DATA17 of instance: lcdif 0001 ALT1 — Select mux mode: ALT1 mux port: UART7_RX of instance: uart7 0011 ALT3 — Select mux mode: ALT3 mux port: CSI_DATA00 of instance: csi 0100 ALT4 — Select mux mode: ALT4 mux port: EIM_DATA09 of instance: eim 0101 ALT5 — Select mux mode: ALT5 mux port: GPIO3_IO22 of instance: gpio3 0110 ALT6 — Select mux mode: ALT6 mux port: SRC_BT_CFG25 of instance: src 1000 ALT8 — Select mux mode: ALT8 mux port: USDHC2_DATA7 of instance: usdhc2 1001 ALT9 — Select mux mode: ALT9 mux port: EPDC_GDSP of instance: epdc

32.6.72 SW_MUX_CTL_PAD_LCD_DATA18 SW MUX Control Register (IOMUXC_SW_MUX_CTL_PAD_LCD_DATA18)

SW_MUX_CTL Register

Address: 20E_0000h base + 160h offset = 20E_0160h

Bit	31	30	29	28	27	26	25	24	23	22	21	20	19	18	17	16
R	Reserved															
W	Reserved															
Reset	0	0	0	0	0	0	0	0	0	0	0	0	0	0	0	0
Bit	15	14	13	12	11	10	9	8	7	6	5	4	3	2	1	0
R	Reserved												SION		MUX_MODE	
W	Reserved												SION		MUX_MODE	
Reset	0	0	0	0	0	0	0	0	0	0	0	0	0	1	0	1

IOMUXC_SW_MUX_CTL_PAD_LCD_DATA18 field descriptions

Field	Description
31–5 -	This field is reserved. Reserved
4 SION	Software Input On Field. Force the selected mux mode Input path no matter of MUX_MODE functionality. 1 ENABLED — Force input path of pad LCD_DATA18 0 DISABLED — Input Path is determined by functionality
MUX_MODE	MUX Mode Select Field. Select 1 of 10 iomux modes to be used for pad: LCD_DATA18. 0000 ALT0 — Select mux mode: ALT0 mux port: LCDIF_DATA18 of instance: lcdif 0001 ALT1 — Select mux mode: ALT1 mux port: PWM5_OUT of instance: pwm5 0010 ALT2 — Select mux mode: ALT2 mux port: CA7_MX6ULL_EVENTO of instance: ca7_mx6ull 0011 ALT3 — Select mux mode: ALT3 mux port: CSI_DATA10 of instance: csi 0100 ALT4 — Select mux mode: ALT4 mux port: EIM_DATA10 of instance: eim 0101 ALT5 — Select mux mode: ALT5 mux port: GPIO3_IO23 of instance: gpio3 0110 ALT6 — Select mux mode: ALT6 mux port: SRC_BT_CFG26 of instance: src 1000 ALT8 — Select mux mode: ALT8 mux port: USDHC2_CMD of instance: usdhc2 1001 ALT9 — Select mux mode: ALT9 mux port: EPDC_BDR01 of instance: epdc

32.6.73 SW_MUX_CTL_PAD_LCD_DATA19 SW MUX Control Register (IOMUXC_SW_MUX_CTL_PAD_LCD_DATA19)

SW_MUX_CTL Register

Address: 20E_0000h base + 164h offset = 20E_0164h

Bit	31	30	29	28	27	26	25	24		23	22	21	20	19	18	17	16
R	Reserved																
W	Reserved																
Reset	0	0	0	0	0	0	0	0		0	0	0	0	0	0	0	0
Bit	15	14	13	12	11	10	9	8		7	6	5	4	3	2	1	0
R	Reserved												SION		MUX_MODE		
W	Reserved												SION		MUX_MODE		
Reset	0	0	0	0	0	0	0	0		0	0	0	0	0	1	0	1

IOMUXC_SW_MUX_CTL_PAD_LCD_DATA19 field descriptions

Field	Description
31–5 -	This field is reserved. Reserved
4 SION	Software Input On Field. Force the selected mux mode Input path no matter of MUX_MODE functionality. 1 ENABLED — Force input path of pad LCD_DATA19 0 DISABLED — Input Path is determined by functionality
MUX_MODE	MUX Mode Select Field. Select 1 of 10 iomux modes to be used for pad: LCD_DATA19. 0100 ALT4 — Select mux mode: ALT4 mux port: EIM_DATA11 of instance: eim 0101 ALT5 — Select mux mode: ALT5 mux port: GPIO3_IO24 of instance: gpio3 0110 ALT6 — Select mux mode: ALT6 mux port: SRC_BT_CFG27 of instance: src 1000 ALT8 — Select mux mode: ALT8 mux port: USDHC2_CLK of instance: usdhc2 1001 ALT9 — Select mux mode: ALT9 mux port: EPDC_VCOM00 of instance: epdc 0000 ALT0 — Select mux mode: ALT0 mux port: LCDIF_DATA19 of instance: lcdif 0001 ALT1 — Select mux mode: ALT1 mux port: PWM6_OUT of instance: pwm6 0010 ALT2 — Select mux mode: ALT2 mux port: WDOG1_WDOG_ANY of instance: wdog1 0011 ALT3 — Select mux mode: ALT3 mux port: CSI_DATA11 of instance: csi

32.6.74 SW_MUX_CTL_PAD_LCD_DATA20 SW MUX Control Register (IOMUXC_SW_MUX_CTL_PAD_LCD_DATA20)

SW_MUX_CTL Register

Address: 20E_0000h base + 168h offset = 20E_0168h

Bit	31	30	29	28	27	26	25	24	23	22	21	20	19	18	17	16
R	Reserved															
W	Reserved															
Reset	0	0	0	0	0	0	0	0	0	0	0	0	0	0	0	0
Bit	15	14	13	12	11	10	9	8	7	6	5	4	3	2	1	0
R	Reserved												SION		MUX_MODE	
W	Reserved												SION		MUX_MODE	
Reset	0	0	0	0	0	0	0	0	0	0	0	0	0	1	0	1

IOMUXC_SW_MUX_CTL_PAD_LCD_DATA20 field descriptions

Field	Description
31–5 -	This field is reserved. Reserved
4 SION	Software Input On Field. Force the selected mux mode Input path no matter of MUX_MODE functionality. 1 ENABLED — Force input path of pad LCD_DATA20 0 DISABLED — Input Path is determined by functionality
MUX_MODE	MUX Mode Select Field. Select 1 of 10 iomux modes to be used for pad: LCD_DATA20. 0100 ALT4 — Select mux mode: ALT4 mux port: EIM_DATA12 of instance: eim 0101 ALT5 — Select mux mode: ALT5 mux port: GPIO3_IO25 of instance: gpio3 0110 ALT6 — Select mux mode: ALT6 mux port: SRC_BT_CFG28 of instance: src 1000 ALT8 — Select mux mode: ALT8 mux port: USDHC2_DATA0 of instance: usdhc2 1001 ALT9 — Select mux mode: ALT9 mux port: EPDC_VCOM01 of instance: epdc 0000 ALT0 — Select mux mode: ALT0 mux port: LCDIF_DATA20 of instance: lcdif 0001 ALT1 — Select mux mode: ALT1 mux port: UART8_TX of instance: uart8 0010 ALT2 — Select mux mode: ALT2 mux port: ECSP11_SCLK of instance: ecspi1 0011 ALT3 — Select mux mode: ALT3 mux port: CSI_DATA12 of instance: csi

32.6.75 SW_MUX_CTL_PAD_LCD_DATA21 SW MUX Control Register (IOMUXC_SW_MUX_CTL_PAD_LCD_DATA21)

SW_MUX_CTL Register

Address: 20E_0000h base + 16Ch offset = 20E_016Ch

Bit	31	30	29	28	27	26	25	24		23	22	21	20	19	18	17	16
R	Reserved																
W	Reserved																
Reset	0	0	0	0	0	0	0	0		0	0	0	0	0	0	0	0
Bit	15	14	13	12	11	10	9	8		7	6	5	4	3	2	1	0
R	Reserved												SION		MUX_MODE		
W	Reserved												SION		MUX_MODE		
Reset	0	0	0	0	0	0	0	0		0	0	0	0	0	1	0	1

IOMUXC_SW_MUX_CTL_PAD_LCD_DATA21 field descriptions

Field	Description
31–5 -	This field is reserved. Reserved
4 SION	Software Input On Field. Force the selected mux mode Input path no matter of MUX_MODE functionality. 1 ENABLED — Force input path of pad LCD_DATA21 0 DISABLED — Input Path is determined by functionality
MUX_MODE	MUX Mode Select Field. Select 1 of 10 iomux modes to be used for pad: LCD_DATA21. 0000 ALT0 — Select mux mode: ALT0 mux port: LCDIF_DATA21 of instance: lcdif 0001 ALT1 — Select mux mode: ALT1 mux port: UART8_RX of instance: uart8 0010 ALT2 — Select mux mode: ALT2 mux port: ECSP11_SS0 of instance: ecspi1 0011 ALT3 — Select mux mode: ALT3 mux port: CSI_DATA13 of instance: csi 0100 ALT4 — Select mux mode: ALT4 mux port: EIM_DATA13 of instance: eim 0101 ALT5 — Select mux mode: ALT5 mux port: GPIO3_IO26 of instance: gpio3 0110 ALT6 — Select mux mode: ALT6 mux port: SRC_BT_CFG29 of instance: src 1000 ALT8 — Select mux mode: ALT8 mux port: USDHC2_DATA1 of instance: usdhc2 1001 ALT9 — Select mux mode: ALT9 mux port: EPDC_SDCE01 of instance: epdc

32.6.76 SW_MUX_CTL_PAD_LCD_DATA22 SW MUX Control Register (IOMUXC_SW_MUX_CTL_PAD_LCD_DATA22)

SW_MUX_CTL Register

Address: 20E_0000h base + 170h offset = 20E_0170h

Bit	31	30	29	28	27	26	25	24	23	22	21	20	19	18	17	16
R	Reserved															
W	Reserved															
Reset	0	0	0	0	0	0	0	0	0	0	0	0	0	0	0	0
Bit	15	14	13	12	11	10	9	8	7	6	5	4	3	2	1	0
R	Reserved												SION		MUX_MODE	
W	Reserved												SION		MUX_MODE	
Reset	0	0	0	0	0	0	0	0	0	0	0	0	0	1	0	1

IOMUXC_SW_MUX_CTL_PAD_LCD_DATA22 field descriptions

Field	Description
31–5 -	This field is reserved. Reserved
4 SION	Software Input On Field. Force the selected mux mode Input path no matter of MUX_MODE functionality. 1 ENABLED — Force input path of pad LCD_DATA22 0 DISABLED — Input Path is determined by functionality
MUX_MODE	MUX Mode Select Field. Select 1 of 10 iomux modes to be used for pad: LCD_DATA22. 0000 ALT0 — Select mux mode: ALT0 mux port: LCDIF_DATA22 of instance: lcdif 0001 ALT1 — Select mux mode: ALT1 mux port: MQS_RIGHT of instance: mqs 0010 ALT2 — Select mux mode: ALT2 mux port: ECSPI1_MOSI of instance: ecspi1 0011 ALT3 — Select mux mode: ALT3 mux port: CSI_DATA14 of instance: csi 0100 ALT4 — Select mux mode: ALT4 mux port: EIM_DATA14 of instance: eim 0101 ALT5 — Select mux mode: ALT5 mux port: GPIO3_IO27 of instance: gpio3 0110 ALT6 — Select mux mode: ALT6 mux port: SRC_BT_CFG30 of instance: src 1000 ALT8 — Select mux mode: ALT8 mux port: USDHC2_DATA2 of instance: usdhc2 1001 ALT9 — Select mux mode: ALT9 mux port: EPDC_SDCE02 of instance: epdc

32.6.77 SW_MUX_CTL_PAD_LCD_DATA23 SW MUX Control Register (IOMUXC_SW_MUX_CTL_PAD_LCD_DATA23)

SW_MUX_CTL Register

Address: 20E_0000h base + 174h offset = 20E_0174h

Bit	31	30	29	28	27	26	25	24		23	22	21	20	19	18	17	16
R	Reserved																
W	Reserved																
Reset	0	0	0	0	0	0	0	0		0	0	0	0	0	0	0	0
Bit	15	14	13	12	11	10	9	8		7	6	5	4	3	2	1	0
R	Reserved												SION		MUX_MODE		
W	Reserved												SION		MUX_MODE		
Reset	0	0	0	0	0	0	0	0		0	0	0	0	0	1	0	1

IOMUXC_SW_MUX_CTL_PAD_LCD_DATA23 field descriptions

Field	Description
31–5 -	This field is reserved. Reserved
4 SION	Software Input On Field. Force the selected mux mode Input path no matter of MUX_MODE functionality. 1 ENABLED — Force input path of pad LCD_DATA23 0 DISABLED — Input Path is determined by functionality
MUX_MODE	MUX Mode Select Field. Select 1 of 10 iomux modes to be used for pad: LCD_DATA23. 1001 ALT9 — Select mux mode: ALT9 mux port: EPDC_SDCE03 of instance: epdc 0000 ALT0 — Select mux mode: ALT0 mux port: LCDIF_DATA23 of instance: lcdif 0001 ALT1 — Select mux mode: ALT1 mux port: MQS_LEFT of instance: mqs 0010 ALT2 — Select mux mode: ALT2 mux port: ECSP11_MISO of instance: ecspi1 0011 ALT3 — Select mux mode: ALT3 mux port: CSI_DATA15 of instance: csi 0100 ALT4 — Select mux mode: ALT4 mux port: EIM_DATA15 of instance: eim 0101 ALT5 — Select mux mode: ALT5 mux port: GPIO3_IO28 of instance: gpio3 0110 ALT6 — Select mux mode: ALT6 mux port: SRC_BT_CFG31 of instance: src 1000 ALT8 — Select mux mode: ALT8 mux port: USDHC2_DATA3 of instance: usdhc2

32.6.78 SW_MUX_CTL_PAD_NAND_RE_B SW MUX Control Register (IOMUXC_SW_MUX_CTL_PAD_NAND_RE_B)

SW_MUX_CTL Register

Address: 20E_0000h base + 178h offset = 20E_0178h

Bit	31	30	29	28	27	26	25	24	23	22	21	20	19	18	17	16
R	Reserved															
W	Reserved															
Reset	0	0	0	0	0	0	0	0	0	0	0	0	0	0	0	0
Bit	15	14	13	12	11	10	9	8	7	6	5	4	3	2	1	0
R	Reserved												SION		MUX_MODE	
W	Reserved												SION		MUX_MODE	
Reset	0	0	0	0	0	0	0	0	0	0	0	0	0	1	0	1

IOMUXC_SW_MUX_CTL_PAD_NAND_RE_B field descriptions

Field	Description
31–5 -	This field is reserved. Reserved
4 SION	Software Input On Field. Force the selected mux mode Input path no matter of MUX_MODE functionality. 1 ENABLED — Force input path of pad NAND_RE_B 0 DISABLED — Input Path is determined by functionality
MUX_MODE	MUX Mode Select Field. Select 1 of 9 iomux modes to be used for pad: NAND_RE_B. 0000 ALT0 — Select mux mode: ALT0 mux port: RAWNAND_RE_B of instance: rawnand 0001 ALT1 — Select mux mode: ALT1 mux port: USDHC2_CLK of instance: usdhc2 0010 ALT2 — Select mux mode: ALT2 mux port: QSPI_B_SCLK of instance: qspi 0011 ALT3 — Select mux mode: ALT3 mux port: KPP_ROW00 of instance: kpp 0100 ALT4 — Select mux mode: ALT4 mux port: EIM_EB_B00 of instance: eim 0101 ALT5 — Select mux mode: ALT5 mux port: GPIO4_IO00 of instance: gpio4 1000 ALT8 — Select mux mode: ALT8 mux port: ECSPi3_SS2 of instance: ecspi3

32.6.79 SW_MUX_CTL_PAD_NAND_WE_B SW MUX Control Register (IOMUXC_SW_MUX_CTL_PAD_NAND_WE_B)

SW_MUX_CTL Register

Address: 20E_0000h base + 17Ch offset = 20E_017Ch

Bit	31	30	29	28	27	26	25	24		23	22	21	20	19	18	17	16
R	Reserved																
W	Reserved																
Reset	0	0	0	0	0	0	0	0		0	0	0	0	0	0	0	0
Bit	15	14	13	12	11	10	9	8		7	6	5	4	3	2	1	0
R	Reserved											SION		MUX_MODE			
W	Reserved											SION		MUX_MODE			
Reset	0	0	0	0	0	0	0	0		0	0	0	0	0	1	0	1

IOMUXC_SW_MUX_CTL_PAD_NAND_WE_B field descriptions

Field	Description
31–5 -	This field is reserved. Reserved
4 SION	Software Input On Field. Force the selected mux mode Input path no matter of MUX_MODE functionality. 1 ENABLED — Force input path of pad NAND_WE_B 0 DISABLED — Input Path is determined by functionality
MUX_MODE	MUX Mode Select Field. Select 1 of 9 iomux modes to be used for pad: NAND_WE_B. 0000 ALT0 — Select mux mode: ALT0 mux port: RAWNAND_WE_B of instance: rawnand 0001 ALT1 — Select mux mode: ALT1 mux port: USDHC2_CMD of instance: usdhc2 0010 ALT2 — Select mux mode: ALT2 mux port: QSPI_B_SS0_B of instance: qspi 0011 ALT3 — Select mux mode: ALT3 mux port: KPP_COL00 of instance: kpp 0100 ALT4 — Select mux mode: ALT4 mux port: EIM_EB_B01 of instance: eim 0101 ALT5 — Select mux mode: ALT5 mux port: GPIO4_IO01 of instance: gpio4 1000 ALT8 — Select mux mode: ALT8 mux port: ECSPi3_SS3 of instance: ecspi3

32.6.80 SW_MUX_CTL_PAD_NAND_DATA00 SW MUX Control Register (IOMUXC_SW_MUX_CTL_PAD_NAND_DATA00)

SW_MUX_CTL Register

Address: 20E_0000h base + 180h offset = 20E_0180h

Bit	31	30	29	28	27	26	25	24	23	22	21	20	19	18	17	16
R	Reserved															
W	Reserved															
Reset	0	0	0	0	0	0	0	0	0	0	0	0	0	0	0	0
Bit	15	14	13	12	11	10	9	8	7	6	5	4	3	2	1	0
R	Reserved												SION		MUX_MODE	
W	Reserved												SION		MUX_MODE	
Reset	0	0	0	0	0	0	0	0	0	0	0	0	0	1	0	1

IOMUXC_SW_MUX_CTL_PAD_NAND_DATA00 field descriptions

Field	Description
31–5 -	This field is reserved. Reserved
4 SION	Software Input On Field. Force the selected mux mode Input path no matter of MUX_MODE functionality. 1 ENABLED — Force input path of pad NAND_DATA00 0 DISABLED — Input Path is determined by functionality
MUX_MODE	MUX Mode Select Field. Select 1 of 9 iomux modes to be used for pad: NAND_DATA00. 0000 ALT0 — Select mux mode: ALT0 mux port: RAWNAND_DATA00 of instance: rawnand 0001 ALT1 — Select mux mode: ALT1 mux port: USDHC2_DATA0 of instance: usdhc2 0010 ALT2 — Select mux mode: ALT2 mux port: QSPI_B_SS1_B of instance: qspi 0011 ALT3 — Select mux mode: ALT3 mux port: KPP_ROW01 of instance: kpp 0100 ALT4 — Select mux mode: ALT4 mux port: EIM_AD08 of instance: eim 0101 ALT5 — Select mux mode: ALT5 mux port: GPIO4_IO02 of instance: gpio4 1000 ALT8 — Select mux mode: ALT8 mux port: ECSPI4_RDY of instance: ecspi4

32.6.81 SW_MUX_CTL_PAD_NAND_DATA01 SW MUX Control Register (IOMUXC_SW_MUX_CTL_PAD_NAND_DATA01)

SW_MUX_CTL Register

Address: 20E_0000h base + 184h offset = 20E_0184h

Bit	31	30	29	28	27	26	25	24	23	22	21	20	19	18	17	16
R	Reserved															
W	Reserved															
Reset	0	0	0	0	0	0	0	0	0	0	0	0	0	0	0	0
Bit	15	14	13	12	11	10	9	8	7	6	5	4	3	2	1	0
R	Reserved											SION		MUX_MODE		
W	Reserved											SION		MUX_MODE		
Reset	0	0	0	0	0	0	0	0	0	0	0	0	0	1	0	1

IOMUXC_SW_MUX_CTL_PAD_NAND_DATA01 field descriptions

Field	Description
31–5 -	This field is reserved. Reserved
4 SION	Software Input On Field. Force the selected mux mode Input path no matter of MUX_MODE functionality. 1 ENABLED — Force input path of pad NAND_DATA01 0 DISABLED — Input Path is determined by functionality
MUX_MODE	MUX Mode Select Field. Select 1 of 9 iomux modes to be used for pad: NAND_DATA01. 0000 ALT0 — Select mux mode: ALT0 mux port: RAWNAND_DATA01 of instance: rawnand 0001 ALT1 — Select mux mode: ALT1 mux port: USDHC2_DATA1 of instance: usdhc2 0010 ALT2 — Select mux mode: ALT2 mux port: QSPI_B_DQS of instance: qspi 0011 ALT3 — Select mux mode: ALT3 mux port: KPP_COL01 of instance: kpp 0100 ALT4 — Select mux mode: ALT4 mux port: EIM_AD09 of instance: eim 0101 ALT5 — Select mux mode: ALT5 mux port: GPIO4_IO03 of instance: gpio4 1000 ALT8 — Select mux mode: ALT8 mux port: ECSPi4_SS1 of instance: ecspi4

32.6.82 SW_MUX_CTL_PAD_NAND_DATA02 SW MUX Control Register (IOMUXC_SW_MUX_CTL_PAD_NAND_DATA02)

SW_MUX_CTL Register

Address: 20E_0000h base + 188h offset = 20E_0188h

Bit	31	30	29	28	27	26	25	24	23	22	21	20	19	18	17	16
R	Reserved															
W	Reserved															
Reset	0	0	0	0	0	0	0	0	0	0	0	0	0	0	0	0
Bit	15	14	13	12	11	10	9	8	7	6	5	4	3	2	1	0
R	Reserved												SION		MUX_MODE	
W	Reserved												SION		MUX_MODE	
Reset	0	0	0	0	0	0	0	0	0	0	0	0	0	1	0	1

IOMUXC_SW_MUX_CTL_PAD_NAND_DATA02 field descriptions

Field	Description
31–5 -	This field is reserved. Reserved
4 SION	Software Input On Field. Force the selected mux mode Input path no matter of MUX_MODE functionality. 1 ENABLED — Force input path of pad NAND_DATA02 0 DISABLED — Input Path is determined by functionality
MUX_MODE	MUX Mode Select Field. Select 1 of 9 iomux modes to be used for pad: NAND_DATA02. 0000 ALT0 — Select mux mode: ALT0 mux port: RAWNAND_DATA02 of instance: rawnand 0001 ALT1 — Select mux mode: ALT1 mux port: USDHC2_DATA2 of instance: usdhc2 0010 ALT2 — Select mux mode: ALT2 mux port: QSPI_B_DATA00 of instance: qspi 0011 ALT3 — Select mux mode: ALT3 mux port: KPP_ROW02 of instance: kpp 0100 ALT4 — Select mux mode: ALT4 mux port: EIM_AD10 of instance: eim 0101 ALT5 — Select mux mode: ALT5 mux port: GPIO4_IO04 of instance: gpio4 1000 ALT8 — Select mux mode: ALT8 mux port: ECSPi4_SS2 of instance: ecspi4

32.6.83 SW_MUX_CTL_PAD_NAND_DATA03 SW MUX Control Register (IOMUXC_SW_MUX_CTL_PAD_NAND_DATA03)

SW_MUX_CTL Register

Address: 20E_0000h base + 18Ch offset = 20E_018Ch

Bit	31	30	29	28	27	26	25	24	23	22	21	20	19	18	17	16
R	Reserved															
W	Reserved															
Reset	0	0	0	0	0	0	0	0	0	0	0	0	0	0	0	0
Bit	15	14	13	12	11	10	9	8	7	6	5	4	3	2	1	0
R	Reserved											SION		MUX_MODE		
W	Reserved											SION		MUX_MODE		
Reset	0	0	0	0	0	0	0	0	0	0	0	0	0	1	0	1

IOMUXC_SW_MUX_CTL_PAD_NAND_DATA03 field descriptions

Field	Description
31–5 -	This field is reserved. Reserved
4 SION	Software Input On Field. Force the selected mux mode Input path no matter of MUX_MODE functionality. 1 ENABLED — Force input path of pad NAND_DATA03 0 DISABLED — Input Path is determined by functionality
MUX_MODE	MUX Mode Select Field. Select 1 of 9 iomux modes to be used for pad: NAND_DATA03. 0000 ALT0 — Select mux mode: ALT0 mux port: RAWNAND_DATA03 of instance: rawnand 0001 ALT1 — Select mux mode: ALT1 mux port: USDHC2_DATA3 of instance: usdhc2 0010 ALT2 — Select mux mode: ALT2 mux port: QSPI_B_DATA01 of instance: qspi 0011 ALT3 — Select mux mode: ALT3 mux port: KPP_COL02 of instance: kpp 0100 ALT4 — Select mux mode: ALT4 mux port: EIM_AD11 of instance: eim 0101 ALT5 — Select mux mode: ALT5 mux port: GPIO4_IO05 of instance: gpio4 1000 ALT8 — Select mux mode: ALT8 mux port: ECSPi4_SS3 of instance: ecspi4

32.6.84 SW_MUX_CTL_PAD_NAND_DATA04 SW MUX Control Register (IOMUXC_SW_MUX_CTL_PAD_NAND_DATA04)

SW_MUX_CTL Register

Address: 20E_0000h base + 190h offset = 20E_0190h

Bit	31	30	29	28	27	26	25	24	23	22	21	20	19	18	17	16
R	Reserved															
W	Reserved															
Reset	0	0	0	0	0	0	0	0	0	0	0	0	0	0	0	0
Bit	15	14	13	12	11	10	9	8	7	6	5	4	3	2	1	0
R	Reserved												SION		MUX_MODE	
W	Reserved												SION		MUX_MODE	
Reset	0	0	0	0	0	0	0	0	0	0	0	0	0	1	0	1

IOMUXC_SW_MUX_CTL_PAD_NAND_DATA04 field descriptions

Field	Description
31–5 -	This field is reserved. Reserved
4 SION	Software Input On Field. Force the selected mux mode Input path no matter of MUX_MODE functionality. 1 ENABLED — Force input path of pad NAND_DATA04 0 DISABLED — Input Path is determined by functionality
MUX_MODE	MUX Mode Select Field. Select 1 of 9 iomux modes to be used for pad: NAND_DATA04. 0000 ALT0 — Select mux mode: ALT0 mux port: RAWNAND_DATA04 of instance: rawnand 0001 ALT1 — Select mux mode: ALT1 mux port: USDHC2_DATA4 of instance: usdhc2 0010 ALT2 — Select mux mode: ALT2 mux port: QSPI_B_DATA02 of instance: qspi 0011 ALT3 — Select mux mode: ALT3 mux port: ECSPi4_SCLK of instance: ecspi4 0100 ALT4 — Select mux mode: ALT4 mux port: EIM_AD12 of instance: eim 0101 ALT5 — Select mux mode: ALT5 mux port: GPIO4_IO06 of instance: gpio4 1000 ALT8 — Select mux mode: ALT8 mux port: UART2_TX of instance: uart2

32.6.85 SW_MUX_CTL_PAD_NAND_DATA05 SW MUX Control Register (IOMUXC_SW_MUX_CTL_PAD_NAND_DATA05)

SW_MUX_CTL Register

Address: 20E_0000h base + 194h offset = 20E_0194h

Bit	31	30	29	28	27	26	25	24	23	22	21	20	19	18	17	16
R	Reserved															
W	Reserved															
Reset	0	0	0	0	0	0	0	0	0	0	0	0	0	0	0	0
Bit	15	14	13	12	11	10	9	8	7	6	5	4	3	2	1	0
R	Reserved											SION		MUX_MODE		
W	Reserved											SION		MUX_MODE		
Reset	0	0	0	0	0	0	0	0	0	0	0	0	0	1	0	1

IOMUXC_SW_MUX_CTL_PAD_NAND_DATA05 field descriptions

Field	Description
31–5 -	This field is reserved. Reserved
4 SION	Software Input On Field. Force the selected mux mode Input path no matter of MUX_MODE functionality. 1 ENABLED — Force input path of pad NAND_DATA05 0 DISABLED — Input Path is determined by functionality
MUX_MODE	MUX Mode Select Field. Select 1 of 9 iomux modes to be used for pad: NAND_DATA05. 0000 ALT0 — Select mux mode: ALT0 mux port: RAWNAND_DATA05 of instance: rawnand 0001 ALT1 — Select mux mode: ALT1 mux port: USDHC2_DATA5 of instance: usdhc2 0010 ALT2 — Select mux mode: ALT2 mux port: QSPI_B_DATA03 of instance: qspi 0011 ALT3 — Select mux mode: ALT3 mux port: ECSPi4_MOSI of instance: ecspi4 0100 ALT4 — Select mux mode: ALT4 mux port: EIM_AD13 of instance: eim 0101 ALT5 — Select mux mode: ALT5 mux port: GPIO4_IO07 of instance: gpio4 1000 ALT8 — Select mux mode: ALT8 mux port: UART2_RX of instance: uart2

32.6.86 SW_MUX_CTL_PAD_NAND_DATA06 SW MUX Control Register (IOMUXC_SW_MUX_CTL_PAD_NAND_DATA06)

SW_MUX_CTL Register

Address: 20E_0000h base + 198h offset = 20E_0198h

Bit	31	30	29	28	27	26	25	24	23	22	21	20	19	18	17	16
R	Reserved															
W	Reserved															
Reset	0	0	0	0	0	0	0	0	0	0	0	0	0	0	0	0
Bit	15	14	13	12	11	10	9	8	7	6	5	4	3	2	1	0
R	Reserved												SION		MUX_MODE	
W	Reserved												SION		MUX_MODE	
Reset	0	0	0	0	0	0	0	0	0	0	0	0	0	1	0	1

IOMUXC_SW_MUX_CTL_PAD_NAND_DATA06 field descriptions

Field	Description
31–5 -	This field is reserved. Reserved
4 SION	Software Input On Field. Force the selected mux mode Input path no matter of MUX_MODE functionality. 1 ENABLED — Force input path of pad NAND_DATA06 0 DISABLED — Input Path is determined by functionality
MUX_MODE	MUX Mode Select Field. Select 1 of 9 iomux modes to be used for pad: NAND_DATA06. 0000 ALT0 — Select mux mode: ALT0 mux port: RAWNAND_DATA06 of instance: rawnand 0001 ALT1 — Select mux mode: ALT1 mux port: USDHC2_DATA6 of instance: usdhc2 0010 ALT2 — Select mux mode: ALT2 mux port: SAI2_RX_BCLK of instance: sai2 0011 ALT3 — Select mux mode: ALT3 mux port: ECSPi4_MISO of instance: ecspi4 0100 ALT4 — Select mux mode: ALT4 mux port: EIM_AD14 of instance: eim 0101 ALT5 — Select mux mode: ALT5 mux port: GPIO4_IO08 of instance: gpio4 1000 ALT8 — Select mux mode: ALT8 mux port: UART2_CTS_B of instance: uart2

32.6.87 SW_MUX_CTL_PAD_NAND_DATA07 SW MUX Control Register (IOMUXC_SW_MUX_CTL_PAD_NAND_DATA07)

SW_MUX_CTL Register

Address: 20E_0000h base + 19Ch offset = 20E_019Ch

Bit	31	30	29	28	27	26	25	24	23	22	21	20	19	18	17	16
R	Reserved															
W	Reserved															
Reset	0	0	0	0	0	0	0	0	0	0	0	0	0	0	0	0
Bit	15	14	13	12	11	10	9	8	7	6	5	4	3	2	1	0
R	Reserved											SION		MUX_MODE		
W	Reserved											SION		MUX_MODE		
Reset	0	0	0	0	0	0	0	0	0	0	0	0	0	1	0	1

IOMUXC_SW_MUX_CTL_PAD_NAND_DATA07 field descriptions

Field	Description
31–5 -	This field is reserved. Reserved
4 SION	Software Input On Field. Force the selected mux mode Input path no matter of MUX_MODE functionality. 1 ENABLED — Force input path of pad NAND_DATA07 0 DISABLED — Input Path is determined by functionality
MUX_MODE	MUX Mode Select Field. Select 1 of 9 iomux modes to be used for pad: NAND_DATA07. 0000 ALT0 — Select mux mode: ALT0 mux port: RAWNAND_DATA07 of instance: rawnand 0001 ALT1 — Select mux mode: ALT1 mux port: USDHC2_DATA7 of instance: usdhc2 0010 ALT2 — Select mux mode: ALT2 mux port: QSPI_A_SS1_B of instance: qspi 0011 ALT3 — Select mux mode: ALT3 mux port: ECSPi4_SS0 of instance: ecspi4 0100 ALT4 — Select mux mode: ALT4 mux port: EIM_AD15 of instance: eim 0101 ALT5 — Select mux mode: ALT5 mux port: GPIO4_IO09 of instance: gpio4 1000 ALT8 — Select mux mode: ALT8 mux port: UART2_RTS_B of instance: uart2

32.6.88 SW_MUX_CTL_PAD_NAND_ALE SW MUX Control Register (IOMUXC_SW_MUX_CTL_PAD_NAND_ALE)

SW_MUX_CTL Register

Address: 20E_0000h base + 1A0h offset = 20E_01A0h

Bit	31	30	29	28	27	26	25	24	23	22	21	20	19	18	17	16
R	Reserved															
W	Reserved															
Reset	0	0	0	0	0	0	0	0	0	0	0	0	0	0	0	0
Bit	15	14	13	12	11	10	9	8	7	6	5	4	3	2	1	0
R	Reserved												SION		MUX_MODE	
W	Reserved												SION		MUX_MODE	
Reset	0	0	0	0	0	0	0	0	0	0	0	0	0	1	0	1

IOMUXC_SW_MUX_CTL_PAD_NAND_ALE field descriptions

Field	Description
31–5 -	This field is reserved. Reserved
4 SION	Software Input On Field. Force the selected mux mode Input path no matter of MUX_MODE functionality. 1 ENABLED — Force input path of pad NAND_ALE 0 DISABLED — Input Path is determined by functionality
MUX_MODE	MUX Mode Select Field. Select 1 of 9 iomux modes to be used for pad: NAND_ALE. 0000 ALT0 — Select mux mode: ALT0 mux port: RAWNAND_ALE of instance: rawnand 0001 ALT1 — Select mux mode: ALT1 mux port: USDHC2_RESET_B of instance: usdhc2 0010 ALT2 — Select mux mode: ALT2 mux port: QSPI_A_DQS of instance: qspi 0011 ALT3 — Select mux mode: ALT3 mux port: PWM3_OUT of instance: pwm3 0100 ALT4 — Select mux mode: ALT4 mux port: EIM_ADDR17 of instance: eim 0101 ALT5 — Select mux mode: ALT5 mux port: GPIO4_IO10 of instance: gpio4 1000 ALT8 — Select mux mode: ALT8 mux port: ECSPI3_SS1 of instance: ecspi3

32.6.89 SW_MUX_CTL_PAD_NAND_WP_B SW MUX Control Register (IOMUXC_SW_MUX_CTL_PAD_NAND_WP_B)

SW_MUX_CTL Register

Address: 20E_0000h base + 1A4h offset = 20E_01A4h

Bit	31	30	29	28	27	26	25	24	23	22	21	20	19	18	17	16
R	Reserved															
W	Reserved															
Reset	0	0	0	0	0	0	0	0	0	0	0	0	0	0	0	0
Bit	15	14	13	12	11	10	9	8	7	6	5	4	3	2	1	0
R	Reserved												SION		MUX_MODE	
W	Reserved												SION		MUX_MODE	
Reset	0	0	0	0	0	0	0	0	0	0	0	0	0	1	0	1

IOMUXC_SW_MUX_CTL_PAD_NAND_WP_B field descriptions

Field	Description
31–5 -	This field is reserved. Reserved
4 SION	Software Input On Field. Force the selected mux mode Input path no matter of MUX_MODE functionality. 1 ENABLED — Force input path of pad NAND_WP_B 0 DISABLED — Input Path is determined by functionality
MUX_MODE	MUX Mode Select Field. Select 1 of 9 iomux modes to be used for pad: NAND_WP_B. 0000 ALT0 — Select mux mode: ALT0 mux port: RAWNAND_WP_B of instance: rawnand 0001 ALT1 — Select mux mode: ALT1 mux port: USDHC1_RESET_B of instance: usdhc1 0010 ALT2 — Select mux mode: ALT2 mux port: QSPI_A_SCLK of instance: qspi 0011 ALT3 — Select mux mode: ALT3 mux port: PWM4_OUT of instance: pwm4 0100 ALT4 — Select mux mode: ALT4 mux port: EIM_BCLK of instance: eim 0101 ALT5 — Select mux mode: ALT5 mux port: GPIO4_IO11 of instance: gpio4 1000 ALT8 — Select mux mode: ALT8 mux port: ECSPI3_RDY of instance: ecspi3

32.6.90 SW_MUX_CTL_PAD_NAND_READY_B SW MUX Control Register (IOMUXC_SW_MUX_CTL_PAD_NAND_READY_B)

SW_MUX_CTL Register

Address: 20E_0000h base + 1A8h offset = 20E_01A8h

Bit	31	30	29	28	27	26	25	24	23	22	21	20	19	18	17	16
R	Reserved															
W	Reserved															
Reset	0	0	0	0	0	0	0	0	0	0	0	0	0	0	0	0
Bit	15	14	13	12	11	10	9	8	7	6	5	4	3	2	1	0
R	Reserved												SION		MUX_MODE	
W	Reserved												SION		MUX_MODE	
Reset	0	0	0	0	0	0	0	0	0	0	0	0	0	1	0	1

IOMUXC_SW_MUX_CTL_PAD_NAND_READY_B field descriptions

Field	Description
31–5 -	This field is reserved. Reserved
4 SION	Software Input On Field. Force the selected mux mode Input path no matter of MUX_MODE functionality. 1 ENABLED — Force input path of pad NAND_READY_B 0 DISABLED — Input Path is determined by functionality
MUX_MODE	MUX Mode Select Field. Select 1 of 9 iomux modes to be used for pad: NAND_READY_B. 0000 ALT0 — Select mux mode: ALT0 mux port: RAWNAND_READY_B of instance: rawnand 0001 ALT1 — Select mux mode: ALT1 mux port: USDHC1_DATA4 of instance: usdhc1 0010 ALT2 — Select mux mode: ALT2 mux port: QSPI_A_DATA00 of instance: qspi 0011 ALT3 — Select mux mode: ALT3 mux port: ECSPI3_SS0 of instance: ecspi3 0100 ALT4 — Select mux mode: ALT4 mux port: EIM_CS1_B of instance: eim 0101 ALT5 — Select mux mode: ALT5 mux port: GPIO4_IO12 of instance: gpio4 1000 ALT8 — Select mux mode: ALT8 mux port: UART3_TX of instance: uart3

32.6.91 SW_MUX_CTL_PAD_NAND_CE0_B SW MUX Control Register (IOMUXC_SW_MUX_CTL_PAD_NAND_CE0_B)

SW_MUX_CTL Register

Address: 20E_0000h base + 1ACh offset = 20E_01ACh

Bit	31	30	29	28	27	26	25	24	23	22	21	20	19	18	17	16
R	Reserved															
W	Reserved															
Reset	0	0	0	0	0	0	0	0	0	0	0	0	0	0	0	0
Bit	15	14	13	12	11	10	9	8	7	6	5	4	3	2	1	0
R	Reserved											SION		MUX_MODE		
W	Reserved											SION		MUX_MODE		
Reset	0	0	0	0	0	0	0	0	0	0	0	0	0	1	0	1

IOMUXC_SW_MUX_CTL_PAD_NAND_CE0_B field descriptions

Field	Description
31–5 -	This field is reserved. Reserved
4 SION	Software Input On Field. Force the selected mux mode Input path no matter of MUX_MODE functionality. 1 ENABLED — Force input path of pad NAND_CE0_B 0 DISABLED — Input Path is determined by functionality
MUX_MODE	MUX Mode Select Field. Select 1 of 9 iomux modes to be used for pad: NAND_CE0_B. 0000 ALT0 — Select mux mode: ALT0 mux port: RAWNAND_CE0_B of instance: rawnand 0001 ALT1 — Select mux mode: ALT1 mux port: USDHC1_DATA5 of instance: usdhc1 0010 ALT2 — Select mux mode: ALT2 mux port: QSPI_A_DATA01 of instance: qspi 0011 ALT3 — Select mux mode: ALT3 mux port: ECSPi3_SCLK of instance: ecspi3 0100 ALT4 — Select mux mode: ALT4 mux port: EIM_DTACK_B of instance: eim 0101 ALT5 — Select mux mode: ALT5 mux port: GPIO4_IO13 of instance: gpio4 1000 ALT8 — Select mux mode: ALT8 mux port: UART3_RX of instance: uart3

32.6.92 SW_MUX_CTL_PAD_NAND_CE1_B SW MUX Control Register (IOMUXC_SW_MUX_CTL_PAD_NAND_CE1_B)

SW_MUX_CTL Register

Address: 20E_0000h base + 1B0h offset = 20E_01B0h

Bit	31	30	29	28	27	26	25	24	23	22	21	20	19	18	17	16
R	Reserved															
W	Reserved															
Reset	0	0	0	0	0	0	0	0	0	0	0	0	0	0	0	0
Bit	15	14	13	12	11	10	9	8	7	6	5	4	3	2	1	0
R	Reserved												SION		MUX_MODE	
W	Reserved												SION		MUX_MODE	
Reset	0	0	0	0	0	0	0	0	0	0	0	0	0	1	0	1

IOMUXC_SW_MUX_CTL_PAD_NAND_CE1_B field descriptions

Field	Description
31–5 -	This field is reserved. Reserved
4 SION	Software Input On Field. Force the selected mux mode Input path no matter of MUX_MODE functionality. 1 ENABLED — Force input path of pad NAND_CE1_B 0 DISABLED — Input Path is determined by functionality
MUX_MODE	MUX Mode Select Field. Select 1 of 9 iomux modes to be used for pad: NAND_CE1_B. 0000 ALT0 — Select mux mode: ALT0 mux port: RAWNAND_CE1_B of instance: rawnand 0001 ALT1 — Select mux mode: ALT1 mux port: USDHC1_DATA6 of instance: usdhc1 0010 ALT2 — Select mux mode: ALT2 mux port: QSPI_A_DATA02 of instance: qspi 0011 ALT3 — Select mux mode: ALT3 mux port: ECSPi3_MOSI of instance: ecspi3 0100 ALT4 — Select mux mode: ALT4 mux port: EIM_ADDR18 of instance: eim 0101 ALT5 — Select mux mode: ALT5 mux port: GPIO4_IO14 of instance: gpio4 1000 ALT8 — Select mux mode: ALT8 mux port: UART3_CTS_B of instance: uart3

32.6.93 SW_MUX_CTL_PAD_NAND_CLE SW MUX Control Register (IOMUXC_SW_MUX_CTL_PAD_NAND_CLE)

SW_MUX_CTL Register

Address: 20E_0000h base + 1B4h offset = 20E_01B4h

Bit	31	30	29	28	27	26	25	24		23	22	21	20	19	18	17	16
R	Reserved																
W	Reserved																
Reset	0	0	0	0	0	0	0	0		0	0	0	0	0	0	0	0
Bit	15	14	13	12	11	10	9	8		7	6	5	4	3	2	1	0
R	Reserved											SION		MUX_MODE			
W	Reserved											SION		MUX_MODE			
Reset	0	0	0	0	0	0	0	0		0	0	0	0	0	1	0	1

IOMUXC_SW_MUX_CTL_PAD_NAND_CLE field descriptions

Field	Description
31–5 -	This field is reserved. Reserved
4 SION	Software Input On Field. Force the selected mux mode Input path no matter of MUX_MODE functionality. 1 ENABLED — Force input path of pad NAND_CLE 0 DISABLED — Input Path is determined by functionality
MUX_MODE	MUX Mode Select Field. Select 1 of 9 iomux modes to be used for pad: NAND_CLE. 0000 ALT0 — Select mux mode: ALT0 mux port: RAWNAND_CLE of instance: rawnand 0001 ALT1 — Select mux mode: ALT1 mux port: USDHC1_DATA7 of instance: usdhc1 0010 ALT2 — Select mux mode: ALT2 mux port: QSPI_A_DATA03 of instance: qspi 0011 ALT3 — Select mux mode: ALT3 mux port: ECSPI3_MISO of instance: ecspi3 0100 ALT4 — Select mux mode: ALT4 mux port: EIM_ADDR16 of instance: eim 0101 ALT5 — Select mux mode: ALT5 mux port: GPIO4_IO15 of instance: gpio4 1000 ALT8 — Select mux mode: ALT8 mux port: UART3_RTS_B of instance: uart3

32.6.94 SW_MUX_CTL_PAD_NAND_DQS SW MUX Control Register (IOMUXC_SW_MUX_CTL_PAD_NAND_DQS)

SW_MUX_CTL Register

Address: 20E_0000h base + 1B8h offset = 20E_01B8h

Bit	31	30	29	28	27	26	25	24	23	22	21	20	19	18	17	16
R	Reserved															
W	Reserved															
Reset	0	0	0	0	0	0	0	0	0	0	0	0	0	0	0	0
Bit	15	14	13	12	11	10	9	8	7	6	5	4	3	2	1	0
R	Reserved												SION		MUX_MODE	
W	Reserved												SION		MUX_MODE	
Reset	0	0	0	0	0	0	0	0	0	0	0	0	0	1	0	1

IOMUXC_SW_MUX_CTL_PAD_NAND_DQS field descriptions

Field	Description
31–5 -	This field is reserved. Reserved
4 SION	Software Input On Field. Force the selected mux mode Input path no matter of MUX_MODE functionality. 1 ENABLED — Force input path of pad NAND_DQS 0 DISABLED — Input Path is determined by functionality
MUX_MODE	MUX Mode Select Field. Select 1 of 9 iomux modes to be used for pad: NAND_DQS. 0000 ALT0 — Select mux mode: ALT0 mux port: RAWNAND_DQS of instance: rawnand 0001 ALT1 — Select mux mode: ALT1 mux port: CSI_FIELD of instance: csi 0010 ALT2 — Select mux mode: ALT2 mux port: QSPI_A_SS0_B of instance: qspi 0011 ALT3 — Select mux mode: ALT3 mux port: PWM5_OUT of instance: pwm5 0100 ALT4 — Select mux mode: ALT4 mux port: EIM_WAIT of instance: eim 0101 ALT5 — Select mux mode: ALT5 mux port: GPIO4_IO16 of instance: gpio4 0110 ALT6 — Select mux mode: ALT6 mux port: SDMA_EXT_EVENT01 of instance: sdma 1000 ALT8 — Select mux mode: ALT8 mux port: SPDIF_EXT_CLK of instance: spdif

32.6.95 SW_MUX_CTL_PAD_SD1_CMD SW MUX Control Register (IOMUXC_SW_MUX_CTL_PAD_SD1_CMD)

SW_MUX_CTL Register

Address: 20E_0000h base + 1BCh offset = 20E_01BCh

Bit	31	30	29	28	27	26	25	24		23	22	21	20	19	18	17	16
R	Reserved																
W	Reserved																
Reset	0	0	0	0	0	0	0	0		0	0	0	0	0	0	0	0
Bit	15	14	13	12	11	10	9	8		7	6	5	4	3	2	1	0
R	Reserved											SION		MUX_MODE			
W	Reserved											SION		MUX_MODE			
Reset	0	0	0	0	0	0	0	0		0	0	0	0	0	1	0	1

IOMUXC_SW_MUX_CTL_PAD_SD1_CMD field descriptions

Field	Description
31–5 -	This field is reserved. Reserved
4 SION	Software Input On Field. Force the selected mux mode Input path no matter of MUX_MODE functionality. 1 ENABLED — Force input path of pad SD1_CMD 0 DISABLED — Input Path is determined by functionality
MUX_MODE	MUX Mode Select Field. Select 1 of 9 iomux modes to be used for pad: SD1_CMD. 0000 ALT0 — Select mux mode: ALT0 mux port: USDHC1_CMD of instance: usdhc1 0001 ALT1 — Select mux mode: ALT1 mux port: GPT2_COMPARE1 of instance: gpt2 0010 ALT2 — Select mux mode: ALT2 mux port: SAI2_RX_SYNC of instance: sai2 0011 ALT3 — Select mux mode: ALT3 mux port: SPDIF_OUT of instance: spdif 0100 ALT4 — Select mux mode: ALT4 mux port: EIM_ADDR19 of instance: eim 0101 ALT5 — Select mux mode: ALT5 mux port: GPIO2_IO16 of instance: gpio2 0110 ALT6 — Select mux mode: ALT6 mux port: SDMA_EXT_EVENT00 of instance: sdma 1000 ALT8 — Select mux mode: ALT8 mux port: USB_OTG1_PWR of instance: usb

32.6.96 SW_MUX_CTL_PAD_SD1_CLK SW MUX Control Register (IOMUXC_SW_MUX_CTL_PAD_SD1_CLK)

SW_MUX_CTL Register

Address: 20E_0000h base + 1C0h offset = 20E_01C0h

Bit	31	30	29	28	27	26	25	24	23	22	21	20	19	18	17	16
R	Reserved															
W	Reserved															
Reset	0	0	0	0	0	0	0	0	0	0	0	0	0	0	0	0
Bit	15	14	13	12	11	10	9	8	7	6	5	4	3	2	1	0
R	Reserved												SION		MUX_MODE	
W	Reserved												SION		MUX_MODE	
Reset	0	0	0	0	0	0	0	0	0	0	0	0	0	1	0	1

IOMUXC_SW_MUX_CTL_PAD_SD1_CLK field descriptions

Field	Description
31–5 -	This field is reserved. Reserved
4 SION	Software Input On Field. Force the selected mux mode Input path no matter of MUX_MODE functionality. 1 ENABLED — Force input path of pad SD1_CLK 0 DISABLED — Input Path is determined by functionality
MUX_MODE	MUX Mode Select Field. Select 1 of 9 iomux modes to be used for pad: SD1_CLK. 0000 ALT0 — Select mux mode: ALT0 mux port: USDHC1_CLK of instance: usdhc1 0001 ALT1 — Select mux mode: ALT1 mux port: GPT2_COMPARE2 of instance: gpt2 0010 ALT2 — Select mux mode: ALT2 mux port: SAI2_MCLK of instance: sai2 0011 ALT3 — Select mux mode: ALT3 mux port: SPDIF_IN of instance: spdif 0100 ALT4 — Select mux mode: ALT4 mux port: EIM_ADDR20 of instance: eim 0101 ALT5 — Select mux mode: ALT5 mux port: GPIO2_IO17 of instance: gpio2 1000 ALT8 — Select mux mode: ALT8 mux port: USB_OTG1_OC of instance: usb

32.6.97 SW_MUX_CTL_PAD_SD1_DATA0 SW MUX Control Register (IOMUXC_SW_MUX_CTL_PAD_SD1_DATA0)

SW_MUX_CTL Register

Address: 20E_0000h base + 1C4h offset = 20E_01C4h

Bit	31	30	29	28	27	26	25	24		23	22	21	20	19	18	17	16
R	Reserved																
W	Reserved																
Reset	0	0	0	0	0	0	0	0		0	0	0	0	0	0	0	0
Bit	15	14	13	12	11	10	9	8		7	6	5	4	3	2	1	0
R	Reserved											SION		MUX_MODE			
W	Reserved											SION		MUX_MODE			
Reset	0	0	0	0	0	0	0	0		0	0	0	0	0	1	0	1

IOMUXC_SW_MUX_CTL_PAD_SD1_DATA0 field descriptions

Field	Description
31–5 -	This field is reserved. Reserved
4 SION	Software Input On Field. Force the selected mux mode Input path no matter of MUX_MODE functionality. 1 ENABLED — Force input path of pad SD1_DATA0 0 DISABLED — Input Path is determined by functionality
MUX_MODE	MUX Mode Select Field. Select 1 of 9 iomux modes to be used for pad: SD1_DATA0. 0000 ALT0 — Select mux mode: ALT0 mux port: USDHC1_DATA0 of instance: usdhc1 0001 ALT1 — Select mux mode: ALT1 mux port: GPT2_COMPARE3 of instance: gpt2 0010 ALT2 — Select mux mode: ALT2 mux port: SAI2_TX_SYNC of instance: sai2 0011 ALT3 — Select mux mode: ALT3 mux port: FLEXCAN1_TX of instance: flexcan1 0100 ALT4 — Select mux mode: ALT4 mux port: EIM_ADDR21 of instance: eim 0101 ALT5 — Select mux mode: ALT5 mux port: GPIO2_IO18 of instance: gpio2 1000 ALT8 — Select mux mode: ALT8 mux port: ANATOP_OTG1_ID of instance: anatop

32.6.98 SW_MUX_CTL_PAD_SD1_DATA1 SW MUX Control Register (IOMUXC_SW_MUX_CTL_PAD_SD1_DATA1)

SW_MUX_CTL Register

Address: 20E_0000h base + 1C8h offset = 20E_01C8h

Bit	31	30	29	28	27	26	25	24	23	22	21	20	19	18	17	16
R	Reserved															
W	Reserved															
Reset	0	0	0	0	0	0	0	0	0	0	0	0	0	0	0	0
Bit	15	14	13	12	11	10	9	8	7	6	5	4	3	2	1	0
R	Reserved												SION		MUX_MODE	
W	Reserved												SION		MUX_MODE	
Reset	0	0	0	0	0	0	0	0	0	0	0	0	0	1	0	1

IOMUXC_SW_MUX_CTL_PAD_SD1_DATA1 field descriptions

Field	Description
31–5 -	This field is reserved. Reserved
4 SION	Software Input On Field. Force the selected mux mode Input path no matter of MUX_MODE functionality. 1 ENABLED — Force input path of pad SD1_DATA1 0 DISABLED — Input Path is determined by functionality
MUX_MODE	MUX Mode Select Field. Select 1 of 9 iomux modes to be used for pad: SD1_DATA1. 0000 ALT0 — Select mux mode: ALT0 mux port: USDHC1_DATA1 of instance: usdhc1 0001 ALT1 — Select mux mode: ALT1 mux port: GPT2_CLK of instance: gpt2 0010 ALT2 — Select mux mode: ALT2 mux port: SAI2_TX_BCLK of instance: sai2 0011 ALT3 — Select mux mode: ALT3 mux port: FLEXCAN1_RX of instance: flexcan1 0100 ALT4 — Select mux mode: ALT4 mux port: EIM_ADDR22 of instance: eim 0101 ALT5 — Select mux mode: ALT5 mux port: GPIO2_IO19 of instance: gpio2 1000 ALT8 — Select mux mode: ALT8 mux port: USB_OTG2_PWR of instance: usb

32.6.99 SW_MUX_CTL_PAD_SD1_DATA2 SW MUX Control Register (IOMUXC_SW_MUX_CTL_PAD_SD1_DATA2)

SW_MUX_CTL Register

Address: 20E_0000h base + 1CCh offset = 20E_01CCh

Bit	31	30	29	28	27	26	25	24		23	22	21	20	19	18	17	16
R	Reserved																
W	Reserved																
Reset	0	0	0	0	0	0	0	0		0	0	0	0	0	0	0	0
Bit	15	14	13	12	11	10	9	8		7	6	5	4	3	2	1	0
R	Reserved											SION		MUX_MODE			
W	Reserved											SION		MUX_MODE			
Reset	0	0	0	0	0	0	0	0		0	0	0	0	0	1	0	1

IOMUXC_SW_MUX_CTL_PAD_SD1_DATA2 field descriptions

Field	Description
31–5 -	This field is reserved. Reserved
4 SION	Software Input On Field. Force the selected mux mode Input path no matter of MUX_MODE functionality. 1 ENABLED — Force input path of pad SD1_DATA2 0 DISABLED — Input Path is determined by functionality
MUX_MODE	MUX Mode Select Field. Select 1 of 9 iomux modes to be used for pad: SD1_DATA2. 0000 ALT0 — Select mux mode: ALT0 mux port: USDHC1_DATA2 of instance: usdhc1 0001 ALT1 — Select mux mode: ALT1 mux port: GPT2_CAPTURE1 of instance: gpt2 0010 ALT2 — Select mux mode: ALT2 mux port: SAI2_RX_DATA of instance: sai2 0011 ALT3 — Select mux mode: ALT3 mux port: FLEXCAN2_TX of instance: flexcan2 0100 ALT4 — Select mux mode: ALT4 mux port: EIM_ADDR23 of instance: eim 0101 ALT5 — Select mux mode: ALT5 mux port: GPIO2_IO20 of instance: gpio2 0110 ALT6 — Select mux mode: ALT6 mux port: CCM_CLKO1 of instance: ccm 1000 ALT8 — Select mux mode: ALT8 mux port: USB_OTG2_OC of instance: usb

32.6.100 SW_MUX_CTL_PAD_SD1_DATA3 SW MUX Control Register (IOMUXC_SW_MUX_CTL_PAD_SD1_DATA3)

SW_MUX_CTL Register

Address: 20E_0000h base + 1D0h offset = 20E_01D0h

Bit	31	30	29	28	27	26	25	24	23	22	21	20	19	18	17	16
R	Reserved															
W	Reserved															
Reset	0	0	0	0	0	0	0	0	0	0	0	0	0	0	0	0
Bit	15	14	13	12	11	10	9	8	7	6	5	4	3	2	1	0
R	Reserved												SION		MUX_MODE	
W	Reserved												SION		MUX_MODE	
Reset	0	0	0	0	0	0	0	0	0	0	0	0	0	1	0	1

IOMUXC_SW_MUX_CTL_PAD_SD1_DATA3 field descriptions

Field	Description
31–5 -	This field is reserved. Reserved
4 SION	Software Input On Field. Force the selected mux mode Input path no matter of MUX_MODE functionality. 1 ENABLED — Force input path of pad SD1_DATA3 0 DISABLED — Input Path is determined by functionality
MUX_MODE	MUX Mode Select Field. Select 1 of 9 iomux modes to be used for pad: SD1_DATA3. 0000 ALT0 — Select mux mode: ALT0 mux port: USDHC1_DATA3 of instance: usdhc1 0001 ALT1 — Select mux mode: ALT1 mux port: GPT2_CAPTURE2 of instance: gpt2 0010 ALT2 — Select mux mode: ALT2 mux port: SAI2_TX_DATA of instance: sai2 0011 ALT3 — Select mux mode: ALT3 mux port: FLEXCAN2_RX of instance: flexcan2 0100 ALT4 — Select mux mode: ALT4 mux port: EIM_ADDR24 of instance: eim 0101 ALT5 — Select mux mode: ALT5 mux port: GPIO2_IO21 of instance: gpio2 0110 ALT6 — Select mux mode: ALT6 mux port: CCM_CLKO2 of instance: ccm 1000 ALT8 — Select mux mode: ALT8 mux port: ANATOP_OTG2_ID of instance: anatop

32.6.101 SW_MUX_CTL_PAD_CSI_MCLK SW MUX Control Register (IOMUXC_SW_MUX_CTL_PAD_CSI_MCLK)

SW_MUX_CTL Register

Address: 20E_0000h base + 1D4h offset = 20E_01D4h

Bit	31	30	29	28	27	26	25	24		23	22	21	20	19	18	17	16
R	Reserved																
W	Reserved																
Reset	0	0	0	0	0	0	0	0		0	0	0	0	0	0	0	0
Bit	15	14	13	12	11	10	9	8		7	6	5	4	3	2	1	0
R	Reserved											SION		MUX_MODE			
W	Reserved											SION		MUX_MODE			
Reset	0	0	0	0	0	0	0	0		0	0	0	0	0	1	0	1

IOMUXC_SW_MUX_CTL_PAD_CSI_MCLK field descriptions

Field	Description
31–5 -	This field is reserved. Reserved
4 SION	Software Input On Field. Force the selected mux mode Input path no matter of MUX_MODE functionality. 1 ENABLED — Force input path of pad CSI_MCLK 0 DISABLED — Input Path is determined by functionality
MUX_MODE	MUX Mode Select Field. Select 1 of 10 iomux modes to be used for pad: CSI_MCLK. 0000 ALT0 — Select mux mode: ALT0 mux port: CSI_MCLK of instance: csi 0001 ALT1 — Select mux mode: ALT1 mux port: USDHC2_CD_B of instance: usdhc2 0010 ALT2 — Select mux mode: ALT2 mux port: RAWNAND_CE2_B of instance: rawnand 0011 ALT3 — Select mux mode: ALT3 mux port: I2C1_SDA of instance: i2c1 0100 ALT4 — Select mux mode: ALT4 mux port: EIM_CS0_B of instance: eim 0101 ALT5 — Select mux mode: ALT5 mux port: GPIO4_IO17 of instance: gpio4 0110 ALT6 — Select mux mode: ALT6 mux port: SNVS_HP_VIO_5_CTL of instance: snvs_hp 1000 ALT8 — Select mux mode: ALT8 mux port: UART6_TX of instance: uart6 1001 ALT9 — Select mux mode: ALT9 mux port: ESAI_TX3_RX2 of instance: esai

32.6.102 SW_MUX_CTL_PAD_CSI_PIXCLK SW MUX Control Register (IOMUXC_SW_MUX_CTL_PAD_CSI_PIXCLK)

SW_MUX_CTL Register

Address: 20E_0000h base + 1D8h offset = 20E_01D8h

Bit	31	30	29	28	27	26	25	24	23	22	21	20	19	18	17	16
R	Reserved															
W	Reserved															
Reset	0	0	0	0	0	0	0	0	0	0	0	0	0	0	0	0
Bit	15	14	13	12	11	10	9	8	7	6	5	4	3	2	1	0
R	Reserved												SION		MUX_MODE	
W	Reserved												SION		MUX_MODE	
Reset	0	0	0	0	0	0	0	0	0	0	0	0	0	1	0	1

IOMUXC_SW_MUX_CTL_PAD_CSI_PIXCLK field descriptions

Field	Description
31–5 -	This field is reserved. Reserved
4 SION	Software Input On Field. Force the selected mux mode Input path no matter of MUX_MODE functionality. 1 ENABLED — Force input path of pad CSI_PIXCLK 0 DISABLED — Input Path is determined by functionality
MUX_MODE	MUX Mode Select Field. Select 1 of 10 iomux modes to be used for pad: CSI_PIXCLK. 0000 ALT0 — Select mux mode: ALT0 mux port: CSI_PIXCLK of instance: csi 0001 ALT1 — Select mux mode: ALT1 mux port: USDHC2_WP of instance: usdhc2 0010 ALT2 — Select mux mode: ALT2 mux port: RAWNAND_CE3_B of instance: rawnand 0011 ALT3 — Select mux mode: ALT3 mux port: I2C1_SCL of instance: i2c1 0100 ALT4 — Select mux mode: ALT4 mux port: EIM_OE of instance: eim 0101 ALT5 — Select mux mode: ALT5 mux port: GPIO4_IO18 of instance: gpio4 0110 ALT6 — Select mux mode: ALT6 mux port: SNVS_HP_VIO_5 of instance: snvs_hp 1000 ALT8 — Select mux mode: ALT8 mux port: UART6_RX of instance: uart6 1001 ALT9 — Select mux mode: ALT9 mux port: ESAI_TX2_RX3 of instance: esai

32.6.103 SW_MUX_CTL_PAD_CSI_VSYNC SW MUX Control Register (IOMUXC_SW_MUX_CTL_PAD_CSI_VSYNC)

SW_MUX_CTL Register

Address: 20E_0000h base + 1DCh offset = 20E_01DCh

Bit	31	30	29	28	27	26	25	24	23	22	21	20	19	18	17	16
R	Reserved															
W	Reserved															
Reset	0	0	0	0	0	0	0	0	0	0	0	0	0	0	0	0
Bit	15	14	13	12	11	10	9	8	7	6	5	4	3	2	1	0
R	Reserved											SION		MUX_MODE		
W	Reserved											SION		MUX_MODE		
Reset	0	0	0	0	0	0	0	0	0	0	0	0	0	1	0	1

IOMUXC_SW_MUX_CTL_PAD_CSI_VSYNC field descriptions

Field	Description
31–5 -	This field is reserved. Reserved
4 SION	Software Input On Field. Force the selected mux mode Input path no matter of MUX_MODE functionality. 1 ENABLED — Force input path of pad CSI_VSYNC 0 DISABLED — Input Path is determined by functionality
MUX_MODE	MUX Mode Select Field. Select 1 of 9 iomux modes to be used for pad: CSI_VSYNC. 0000 ALT0 — Select mux mode: ALT0 mux port: CSI_VSYNC of instance: csi 0001 ALT1 — Select mux mode: ALT1 mux port: USDHC2_CLK of instance: usdhc2 0010 ALT2 — Reserved 0011 ALT3 — Select mux mode: ALT3 mux port: I2C2_SDA of instance: i2c2 0100 ALT4 — Select mux mode: ALT4 mux port: EIM_RW of instance: eim 0101 ALT5 — Select mux mode: ALT5 mux port: GPIO4_IO19 of instance: gpio4 0110 ALT6 — Select mux mode: ALT6 mux port: PWM7_OUT of instance: pwm7 1000 ALT8 — Select mux mode: ALT8 mux port: UART6_RTS_B of instance: uart6 1001 ALT9 — Select mux mode: ALT9 mux port: ESAI_TX4_RX1 of instance: esai

32.6.104 SW_MUX_CTL_PAD_CSI_HSYNC SW MUX Control Register (IOMUXC_SW_MUX_CTL_PAD_CSI_HSYNC)

SW_MUX_CTL Register

Address: 20E_0000h base + 1E0h offset = 20E_01E0h

Bit	31	30	29	28	27	26	25	24	23	22	21	20	19	18	17	16
R	Reserved															
W	Reserved															
Reset	0	0	0	0	0	0	0	0	0	0	0	0	0	0	0	0
Bit	15	14	13	12	11	10	9	8	7	6	5	4	3	2	1	0
R	Reserved												SION		MUX_MODE	
W	Reserved												SION		MUX_MODE	
Reset	0	0	0	0	0	0	0	0	0	0	0	0	0	1	0	1

IOMUXC_SW_MUX_CTL_PAD_CSI_HSYNC field descriptions

Field	Description
31–5 -	This field is reserved. Reserved
4 SION	Software Input On Field. Force the selected mux mode Input path no matter of MUX_MODE functionality. 1 ENABLED — Force input path of pad CSI_HSYNC 0 DISABLED — Input Path is determined by functionality
MUX_MODE	MUX Mode Select Field. Select 1 of 9 iomux modes to be used for pad: CSI_HSYNC. 0000 ALT0 — Select mux mode: ALT0 mux port: CSI_HSYNC of instance: csi 0001 ALT1 — Select mux mode: ALT1 mux port: USDHC2_CMD of instance: usdhc2 0010 ALT2 — Reserved 0011 ALT3 — Select mux mode: ALT3 mux port: I2C2_SCL of instance: i2c2 0100 ALT4 — Select mux mode: ALT4 mux port: EIM_LBA_B of instance: eim 0101 ALT5 — Select mux mode: ALT5 mux port: GPIO4_IO20 of instance: gpio4 0110 ALT6 — Select mux mode: ALT6 mux port: PWM8_OUT of instance: pwm8 1000 ALT8 — Select mux mode: ALT8 mux port: UART6_CTS_B of instance: uart6 1001 ALT9 — Select mux mode: ALT9 mux port: ESAI_TX1 of instance: esai

32.6.105 SW_MUX_CTL_PAD_CSI_DATA00 SW MUX Control Register (IOMUXC_SW_MUX_CTL_PAD_CSI_DATA00)

SW_MUX_CTL Register

Address: 20E_0000h base + 1E4h offset = 20E_01E4h

Bit	31	30	29	28	27	26	25	24	23	22	21	20	19	18	17	16
R	Reserved															
W	Reserved															
Reset	0	0	0	0	0	0	0	0	0	0	0	0	0	0	0	0
Bit	15	14	13	12	11	10	9	8	7	6	5	4	3	2	1	0
R	Reserved												SION		MUX_MODE	
W	Reserved												SION		MUX_MODE	
Reset	0	0	0	0	0	0	0	0	0	0	0	0	0	1	0	1

IOMUXC_SW_MUX_CTL_PAD_CSI_DATA00 field descriptions

Field	Description
31–5 -	This field is reserved. Reserved
4 SION	Software Input On Field. Force the selected mux mode Input path no matter of MUX_MODE functionality. 1 ENABLED — Force input path of pad CSI_DATA00 0 DISABLED — Input Path is determined by functionality
MUX_MODE	MUX Mode Select Field. Select 1 of 9 iomux modes to be used for pad: CSI_DATA00. 0000 ALT0 — Select mux mode: ALT0 mux port: CSI_DATA02 of instance: csi 0001 ALT1 — Select mux mode: ALT1 mux port: USDHC2_DATA0 of instance: usdhc2 0010 ALT2 — Reserved 0011 ALT3 — Select mux mode: ALT3 mux port: ECSPi2_SCLK of instance: ecspi2 0100 ALT4 — Select mux mode: ALT4 mux port: EIM_AD00 of instance: eim 0101 ALT5 — Select mux mode: ALT5 mux port: GPIO4_IO21 of instance: gpio4 0110 ALT6 — Select mux mode: ALT6 mux port: SRC_INT_BOOT of instance: src 1000 ALT8 — Select mux mode: ALT8 mux port: UART5_TX of instance: uart5 1001 ALT9 — Select mux mode: ALT9 mux port: ESAI_TX_HF_CLK of instance: esai

32.6.106 SW_MUX_CTL_PAD_CSI_DATA01 SW MUX Control Register (IOMUXC_SW_MUX_CTL_PAD_CSI_DATA01)

SW_MUX_CTL Register

Address: 20E_0000h base + 1E8h offset = 20E_01E8h

Bit	31	30	29	28	27	26	25	24	23	22	21	20	19	18	17	16
R	Reserved															
W	Reserved															
Reset	0	0	0	0	0	0	0	0	0	0	0	0	0	0	0	0
Bit	15	14	13	12	11	10	9	8	7	6	5	4	3	2	1	0
R	Reserved												SION		MUX_MODE	
W	Reserved												SION		MUX_MODE	
Reset	0	0	0	0	0	0	0	0	0	0	0	0	0	1	0	1

IOMUXC_SW_MUX_CTL_PAD_CSI_DATA01 field descriptions

Field	Description
31–5 -	This field is reserved. Reserved
4 SION	Software Input On Field. Force the selected mux mode Input path no matter of MUX_MODE functionality. 1 ENABLED — Force input path of pad CSI_DATA01 0 DISABLED — Input Path is determined by functionality
MUX_MODE	MUX Mode Select Field. Select 1 of 9 iomux modes to be used for pad: CSI_DATA01. 0000 ALT0 — Select mux mode: ALT0 mux port: CSI_DATA03 of instance: csi 0001 ALT1 — Select mux mode: ALT1 mux port: USDHC2_DATA1 of instance: usdhc2 0010 ALT2 — Reserved 0011 ALT3 — Select mux mode: ALT3 mux port: ECSPi2_SS0 of instance: ecspi2 0100 ALT4 — Select mux mode: ALT4 mux port: EIM_AD01 of instance: eim 0101 ALT5 — Select mux mode: ALT5 mux port: GPIO4_IO22 of instance: gpio4 0110 ALT6 — Select mux mode: ALT6 mux port: SAI1_MCLK of instance: sai1 1000 ALT8 — Select mux mode: ALT8 mux port: UART5_RX of instance: uart5 1001 ALT9 — Select mux mode: ALT9 mux port: ESAI_RX_HF_CLK of instance: esai

32.6.107 SW_MUX_CTL_PAD_CSI_DATA02 SW MUX Control Register (IOMUXC_SW_MUX_CTL_PAD_CSI_DATA02)

SW_MUX_CTL Register

Address: 20E_0000h base + 1ECh offset = 20E_01ECh

Bit	31	30	29	28	27	26	25	24		23	22	21	20	19	18	17	16
R	Reserved																
W	Reserved																
Reset	0	0	0	0	0	0	0	0		0	0	0	0	0	0	0	0
Bit	15	14	13	12	11	10	9	8		7	6	5	4	3	2	1	0
R	Reserved											SION		MUX_MODE			
W	Reserved											SION		MUX_MODE			
Reset	0	0	0	0	0	0	0	0		0	0	0	0	0	1	0	1

IOMUXC_SW_MUX_CTL_PAD_CSI_DATA02 field descriptions

Field	Description
31–5 -	This field is reserved. Reserved
4 SION	Software Input On Field. Force the selected mux mode Input path no matter of MUX_MODE functionality. 1 ENABLED — Force input path of pad CSI_DATA02 0 DISABLED — Input Path is determined by functionality
MUX_MODE	MUX Mode Select Field. Select 1 of 9 iomux modes to be used for pad: CSI_DATA02. 0000 ALT0 — Select mux mode: ALT0 mux port: CSI_DATA04 of instance: csi 0001 ALT1 — Select mux mode: ALT1 mux port: USDHC2_DATA2 of instance: usdhc2 0010 ALT2 — Reserved 0011 ALT3 — Select mux mode: ALT3 mux port: ECSPi2_MOSI of instance: ecspi2 0100 ALT4 — Select mux mode: ALT4 mux port: EIM_AD02 of instance: eim 0101 ALT5 — Select mux mode: ALT5 mux port: GPIO4_IO23 of instance: gpio4 0110 ALT6 — Select mux mode: ALT6 mux port: SAI1_RX_SYNC of instance: sai1 1000 ALT8 — Select mux mode: ALT8 mux port: UART5_RTS_B of instance: uart5 1001 ALT9 — Select mux mode: ALT9 mux port: ESAI_RX_FS of instance: esai

32.6.108 SW_MUX_CTL_PAD_CSI_DATA03 SW MUX Control Register (IOMUXC_SW_MUX_CTL_PAD_CSI_DATA03)

SW_MUX_CTL Register

Address: 20E_0000h base + 1F0h offset = 20E_01F0h

Bit	31	30	29	28	27	26	25	24	23	22	21	20	19	18	17	16
R	Reserved															
W	Reserved															
Reset	0	0	0	0	0	0	0	0	0	0	0	0	0	0	0	0
Bit	15	14	13	12	11	10	9	8	7	6	5	4	3	2	1	0
R	Reserved												SION		MUX_MODE	
W	Reserved												SION		MUX_MODE	
Reset	0	0	0	0	0	0	0	0	0	0	0	0	0	1	0	1

IOMUXC_SW_MUX_CTL_PAD_CSI_DATA03 field descriptions

Field	Description
31–5 -	This field is reserved. Reserved
4 SION	Software Input On Field. Force the selected mux mode Input path no matter of MUX_MODE functionality. 1 ENABLED — Force input path of pad CSI_DATA03 0 DISABLED — Input Path is determined by functionality
MUX_MODE	MUX Mode Select Field. Select 1 of 9 iomux modes to be used for pad: CSI_DATA03. 0000 ALT0 — Select mux mode: ALT0 mux port: CSI_DATA05 of instance: csi 0001 ALT1 — Select mux mode: ALT1 mux port: USDHC2_DATA3 of instance: usdhc2 0010 ALT2 — Reserved 0011 ALT3 — Select mux mode: ALT3 mux port: ECSPI2_MISO of instance: ecspi2 0100 ALT4 — Select mux mode: ALT4 mux port: EIM_AD03 of instance: eim 0101 ALT5 — Select mux mode: ALT5 mux port: GPIO4_IO24 of instance: gpio4 0110 ALT6 — Select mux mode: ALT6 mux port: SAI1_RX_BCLK of instance: sai1 1000 ALT8 — Select mux mode: ALT8 mux port: UART5_CTS_B of instance: uart5 1001 ALT9 — Select mux mode: ALT9 mux port: ESAI_RX_CLK of instance: esai

32.6.109 SW_MUX_CTL_PAD_CSI_DATA04 SW MUX Control Register (IOMUXC_SW_MUX_CTL_PAD_CSI_DATA04)

SW_MUX_CTL Register

Address: 20E_0000h base + 1F4h offset = 20E_01F4h

Bit	31	30	29	28	27	26	25	24		23	22	21	20	19	18	17	16
R	Reserved																
W	Reserved																
Reset	0	0	0	0	0	0	0	0		0	0	0	0	0	0	0	0
Bit	15	14	13	12	11	10	9	8		7	6	5	4	3	2	1	0
R	Reserved											SION		MUX_MODE			
W	Reserved											SION		MUX_MODE			
Reset	0	0	0	0	0	0	0	0		0	0	0	0	0	1	0	1

IOMUXC_SW_MUX_CTL_PAD_CSI_DATA04 field descriptions

Field	Description
31–5 -	This field is reserved. Reserved
4 SION	Software Input On Field. Force the selected mux mode Input path no matter of MUX_MODE functionality. 1 ENABLED — Force input path of pad CSI_DATA04 0 DISABLED — Input Path is determined by functionality
MUX_MODE	MUX Mode Select Field. Select 1 of 9 iomux modes to be used for pad: CSI_DATA04. 0000 ALT0 — Select mux mode: ALT0 mux port: CSI_DATA06 of instance: csi 0001 ALT1 — Select mux mode: ALT1 mux port: USDHC2_DATA4 of instance: usdhc2 0010 ALT2 — Reserved 0011 ALT3 — Select mux mode: ALT3 mux port: ECSP11_SCLK of instance: ecspi1 0100 ALT4 — Select mux mode: ALT4 mux port: EIM_AD04 of instance: eim 0101 ALT5 — Select mux mode: ALT5 mux port: GPIO4_IO25 of instance: gpio4 0110 ALT6 — Select mux mode: ALT6 mux port: SAI1_TX_SYNC of instance: sai1 1000 ALT8 — Select mux mode: ALT8 mux port: USDHC1_WP of instance: usdhc1 1001 ALT9 — Select mux mode: ALT9 mux port: ESAI_TX_FS of instance: esai

32.6.110 SW_MUX_CTL_PAD_CSI_DATA05 SW MUX Control Register (IOMUXC_SW_MUX_CTL_PAD_CSI_DATA05)

SW_MUX_CTL Register

Address: 20E_0000h base + 1F8h offset = 20E_01F8h

Bit	31	30	29	28	27	26	25	24	23	22	21	20	19	18	17	16
R	Reserved															
W	Reserved															
Reset	0	0	0	0	0	0	0	0	0	0	0	0	0	0	0	0
Bit	15	14	13	12	11	10	9	8	7	6	5	4	3	2	1	0
R	Reserved												SION		MUX_MODE	
W	Reserved												SION		MUX_MODE	
Reset	0	0	0	0	0	0	0	0	0	0	0	0	0	1	0	1

IOMUXC_SW_MUX_CTL_PAD_CSI_DATA05 field descriptions

Field	Description
31–5 -	This field is reserved. Reserved
4 SION	Software Input On Field. Force the selected mux mode Input path no matter of MUX_MODE functionality. 1 ENABLED — Force input path of pad CSI_DATA05 0 DISABLED — Input Path is determined by functionality
MUX_MODE	MUX Mode Select Field. Select 1 of 9 iomux modes to be used for pad: CSI_DATA05. 0000 ALT0 — Select mux mode: ALT0 mux port: CSI_DATA07 of instance: csi 0001 ALT1 — Select mux mode: ALT1 mux port: USDHC2_DATA5 of instance: usdhc2 0010 ALT2 — Reserved 0011 ALT3 — Select mux mode: ALT3 mux port: ECSP11_SS0 of instance: ecspi1 0100 ALT4 — Select mux mode: ALT4 mux port: EIM_AD05 of instance: eim 0101 ALT5 — Select mux mode: ALT5 mux port: GPIO4_IO26 of instance: gpio4 0110 ALT6 — Select mux mode: ALT6 mux port: SAI1_TX_BCLK of instance: sai1 1000 ALT8 — Select mux mode: ALT8 mux port: USDHC1_CD_B of instance: usdhc1 1001 ALT9 — Select mux mode: ALT9 mux port: ESAI_TX_CLK of instance: esai

32.6.111 SW_MUX_CTL_PAD_CSI_DATA06 SW MUX Control Register (IOMUXC_SW_MUX_CTL_PAD_CSI_DATA06)

SW_MUX_CTL Register

Address: 20E_0000h base + 1FCh offset = 20E_01FCh

Bit	31	30	29	28	27	26	25	24	23	22	21	20	19	18	17	16
R	Reserved															
W	Reserved															
Reset	0	0	0	0	0	0	0	0	0	0	0	0	0	0	0	0
Bit	15	14	13	12	11	10	9	8	7	6	5	4	3	2	1	0
R	Reserved											SION		MUX_MODE		
W	Reserved											SION		MUX_MODE		
Reset	0	0	0	0	0	0	0	0	0	0	0	0	0	1	0	1

IOMUXC_SW_MUX_CTL_PAD_CSI_DATA06 field descriptions

Field	Description
31–5 -	This field is reserved. Reserved
4 SION	Software Input On Field. Force the selected mux mode Input path no matter of MUX_MODE functionality. 1 ENABLED — Force input path of pad CSI_DATA06 0 DISABLED — Input Path is determined by functionality
MUX_MODE	MUX Mode Select Field. Select 1 of 9 iomux modes to be used for pad: CSI_DATA06. 0000 ALT0 — Select mux mode: ALT0 mux port: CSI_DATA08 of instance: csi 0001 ALT1 — Select mux mode: ALT1 mux port: USDHC2_DATA6 of instance: usdhc2 0010 ALT2 — Reserved 0011 ALT3 — Select mux mode: ALT3 mux port: ECSP11_MOSI of instance: ecspi1 0100 ALT4 — Select mux mode: ALT4 mux port: EIM_AD06 of instance: eim 0101 ALT5 — Select mux mode: ALT5 mux port: GPIO4_IO27 of instance: gpio4 0110 ALT6 — Select mux mode: ALT6 mux port: SAI1_RX_DATA of instance: sai1 1000 ALT8 — Select mux mode: ALT8 mux port: USDHC1_RESET_B of instance: usdhc1 1001 ALT9 — Select mux mode: ALT9 mux port: ESAI_TX5_RX0 of instance: esai

32.6.112 SW_MUX_CTL_PAD_CSI_DATA07 SW MUX Control Register (IOMUXC_SW_MUX_CTL_PAD_CSI_DATA07)

SW_MUX_CTL Register

Address: 20E_0000h base + 200h offset = 20E_0200h

Bit	31	30	29	28	27	26	25	24	23	22	21	20	19	18	17	16
R	Reserved															
W	Reserved															
Reset	0	0	0	0	0	0	0	0	0	0	0	0	0	0	0	0
Bit	15	14	13	12	11	10	9	8	7	6	5	4	3	2	1	0
R	Reserved												SION		MUX_MODE	
W	Reserved												SION		MUX_MODE	
Reset	0	0	0	0	0	0	0	0	0	0	0	0	0	1	0	1

IOMUXC_SW_MUX_CTL_PAD_CSI_DATA07 field descriptions

Field	Description
31–5 -	This field is reserved. Reserved
4 SION	Software Input On Field. Force the selected mux mode Input path no matter of MUX_MODE functionality. 1 ENABLED — Force input path of pad CSI_DATA07 0 DISABLED — Input Path is determined by functionality
MUX_MODE	MUX Mode Select Field. Select 1 of 9 iomux modes to be used for pad: CSI_DATA07. 0000 ALT0 — Select mux mode: ALT0 mux port: CSI_DATA09 of instance: csi 0001 ALT1 — Select mux mode: ALT1 mux port: USDHC2_DATA7 of instance: usdhc2 0010 ALT2 — Reserved 0011 ALT3 — Select mux mode: ALT3 mux port: ECSP11_MISO of instance: ecspi1 0100 ALT4 — Select mux mode: ALT4 mux port: EIM_AD07 of instance: eim 0101 ALT5 — Select mux mode: ALT5 mux port: GPIO4_IO28 of instance: gpio4 0110 ALT6 — Select mux mode: ALT6 mux port: SAI1_TX_DATA of instance: sai1 1000 ALT8 — Select mux mode: ALT8 mux port: USDHC1_VSELECT of instance: usdhc1 1001 ALT9 — Select mux mode: ALT9 mux port: ESAI_TX0 of instance: esai

32.6.113 SW_PAD_CTL_PAD_DRAM_ADDR0 SW PAD Control Register (IOMUXC_SW_PAD_CTL_PAD_DRAM_ADDR0)

SW_PAD_CTL Register

Address: 20E_0000h base + 204h offset = 20E_0204h

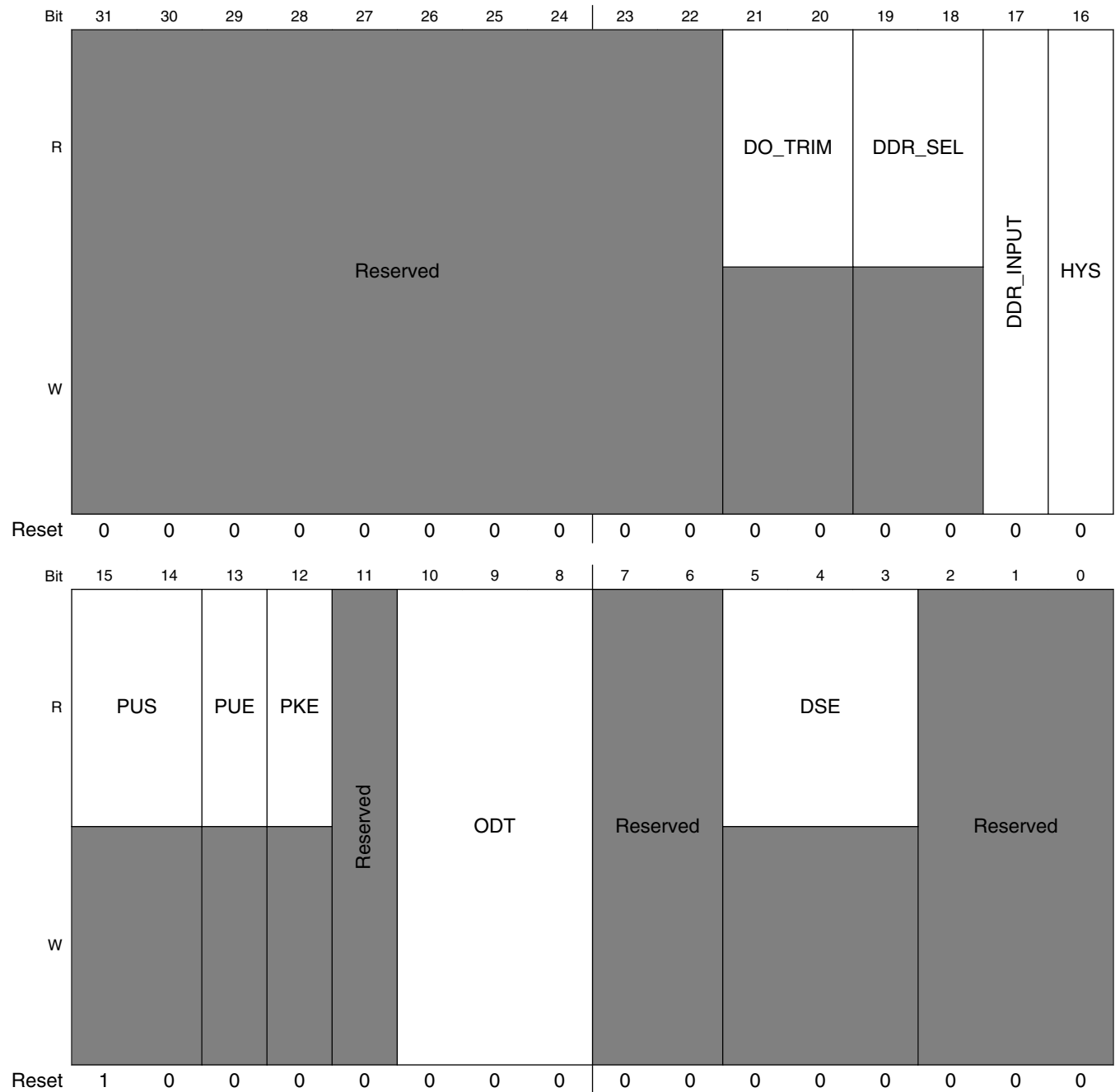

IOMUXC_SW_PAD_CTL_PAD_DRAM_ADDR0 field descriptions

Field	Description
31–22 -	This field is reserved. Reserved
21–20 DO_TRIM	do_trim Field Read Only Field 0 DO_TRIM — min delay
19–18 DDR_SEL	ddr_sel Field Read Only Field 0 DDR_SEL — RESERVED
17 DDR_INPUT	DDR / CMOS Input Mode Field Select one out of next values for pad: DRAM_ADDR0 0 DDR_INPUT_0_CMOS_input_type — CMOS input type 1 DDR_INPUT_1_Differential_input_mode — Differential input mode
16 HYS	Hyst. Enable Field Select one out of next values for pad: DRAM_ADDR0 0 HYS_0_Hysteresis_Disabled — Hysteresis Disabled 1 HYS_1_Hysteresis_Enabled — Hysteresis Enabled
15–14 PUS	Pull Up / Down Config. Field Read Only Field 10 PUS — 100K Ohm Pull Up
13 PUE	Pull / Keep Select Field Read Only Field 0 PUE — Keeper
12 PKE	Pull / Keep Enable Field Read Only Field 0 PKE — Pull/Keeper Disabled
11 -	This field is reserved. Reserved
10–8 ODT	On Die Termination Field Select one out of next values for pad: DRAM_ADDR0 000 ODT_0_off — off 001 ODT_1_120_Ohm_ODT — 120 Ohm ODT 010 ODT_2_60_Ohm_ODT — 60 Ohm ODT 011 ODT_3_40_Ohm_ODT — 40 Ohm ODT 100 ODT_4_30_Ohm_ODT — 30 Ohm ODT 101 ODT_5_24_Ohm_ODT — 24 Ohm ODT

Table continues on the next page...

IOMUXC_SW_PAD_CTL_PAD_DRAM_ADDR0 field descriptions (continued)

Field	Description
	110 ODT_6_20_Ohm_ODT — 20 Ohm ODT 111 ODT_7_17_Ohm_ODT — 17 Ohm ODT
7-6 -	This field is reserved. Reserved
5-3 DSE	Drive Strength Field Read Only Field 0 DSE — output driver disabled;
-	This field is reserved. Reserved

32.6.114 SW_PAD_CTL_PAD_DRAM_ADDR01 SW PAD Control Register (IOMUXC_SW_PAD_CTL_PAD_DRAM_ADDR01)

SW_PAD_CTL Register

Address: 20E_0000h base + 208h offset = 20E_0208h

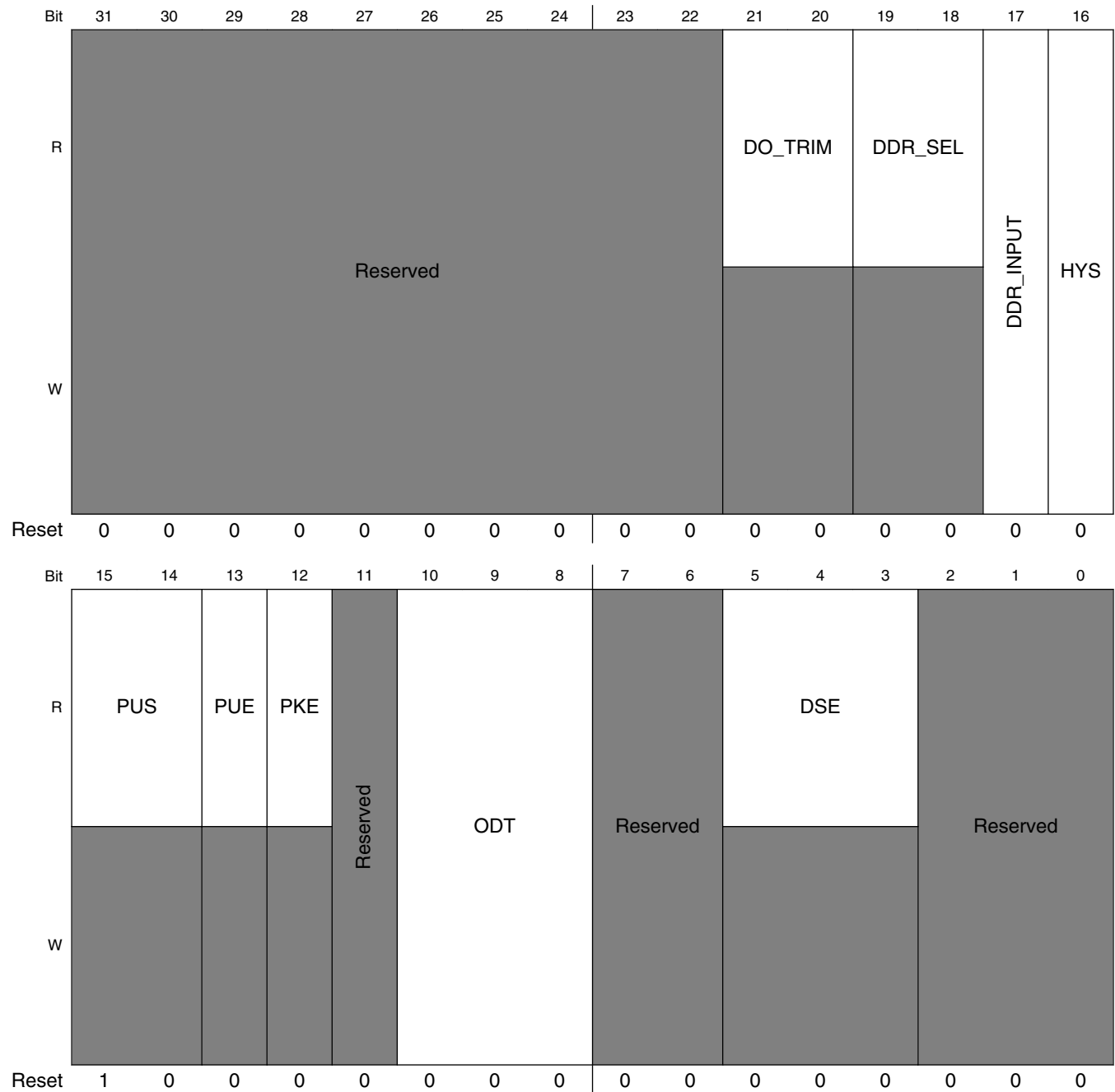

IOMUXC_SW_PAD_CTL_PAD_DRAM_ADDR01 field descriptions

Field	Description
31–22 -	This field is reserved. Reserved
21–20 DO_TRIM	do_trim Field Read Only Field 0 DO_TRIM — min delay
19–18 DDR_SEL	ddr_sel Field Read Only Field 0 DDR_SEL — RESERVED
17 DDR_INPUT	DDR / CMOS Input Mode Field Select one out of next values for pad: DRAM_ADDR01 0 DDR_INPUT_0_CMOS_input_type — CMOS input type 1 DDR_INPUT_1_Differential_input_mode — Differential input mode
16 HYS	Hyst. Enable Field Select one out of next values for pad: DRAM_ADDR01 0 HYS_0_Hysteresis_Disabled — Hysteresis Disabled 1 HYS_1_Hysteresis_Enabled — Hysteresis Enabled
15–14 PUS	Pull Up / Down Config. Field Read Only Field 10 PUS — 100K Ohm Pull Up
13 PUE	Pull / Keep Select Field Read Only Field 0 PUE — Keeper
12 PKE	Pull / Keep Enable Field Read Only Field 0 PKE — Pull/Keeper Disabled
11 -	This field is reserved. Reserved
10–8 ODT	On Die Termination Field Select one out of next values for pad: DRAM_ADDR01 000 ODT_0_off — off 001 ODT_1_120_Ohm_ODT — 120 Ohm ODT 010 ODT_2_60_Ohm_ODT — 60 Ohm ODT 011 ODT_3_40_Ohm_ODT — 40 Ohm ODT 100 ODT_4_30_Ohm_ODT — 30 Ohm ODT 101 ODT_5_24_Ohm_ODT — 24 Ohm ODT

Table continues on the next page...

IOMUXC_SW_PAD_CTL_PAD_DRAM_ADDR01 field descriptions (continued)

Field	Description
	110 ODT_6_20_Ohm_ODT — 20 Ohm ODT 111 ODT_7_17_Ohm_ODT — 17 Ohm ODT
7–6 -	This field is reserved. Reserved
5–3 DSE	Drive Strength Field Read Only Field 0 DSE — output driver disabled;
-	This field is reserved. Reserved

32.6.115 SW_PAD_CTL_PAD_DRAM_ADDR02 SW PAD Control Register (IOMUXC_SW_PAD_CTL_PAD_DRAM_ADDR02)

SW_PAD_CTL Register

Address: 20E_0000h base + 20Ch offset = 20E_020Ch

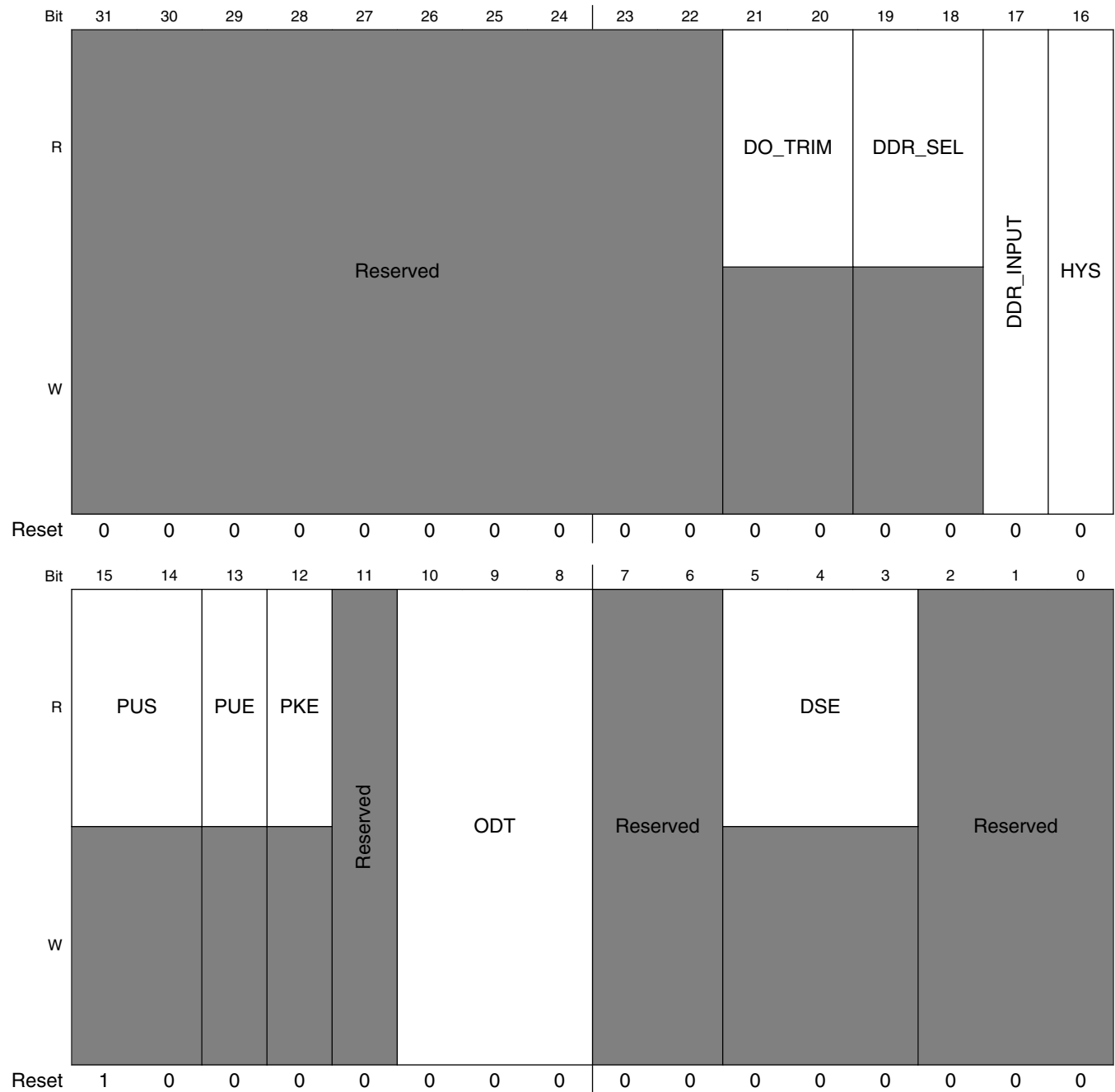

IOMUXC_SW_PAD_CTL_PAD_DRAM_ADDR02 field descriptions

Field	Description
31–22 -	This field is reserved. Reserved
21–20 DO_TRIM	do_trim Field Read Only Field 0 DO_TRIM — min delay
19–18 DDR_SEL	ddr_sel Field Read Only Field 0 DDR_SEL — RESERVED
17 DDR_INPUT	DDR / CMOS Input Mode Field Select one out of next values for pad: DRAM_ADDR02 0 DDR_INPUT_0_CMOS_input_type — CMOS input type 1 DDR_INPUT_1_Differential_input_mode — Differential input mode
16 HYS	Hyst. Enable Field Select one out of next values for pad: DRAM_ADDR02 0 HYS_0_Hysteresis_Disabled — Hysteresis Disabled 1 HYS_1_Hysteresis_Enabled — Hysteresis Enabled
15–14 PUS	Pull Up / Down Config. Field Read Only Field 10 PUS — 100K Ohm Pull Up
13 PUE	Pull / Keep Select Field Read Only Field 0 PUE — Keeper
12 PKE	Pull / Keep Enable Field Read Only Field 0 PKE — Pull/Keeper Disabled
11 -	This field is reserved. Reserved
10–8 ODT	On Die Termination Field Select one out of next values for pad: DRAM_ADDR02 000 ODT_0_off — off 001 ODT_1_120_Ohm_ODT — 120 Ohm ODT 010 ODT_2_60_Ohm_ODT — 60 Ohm ODT 011 ODT_3_40_Ohm_ODT — 40 Ohm ODT 100 ODT_4_30_Ohm_ODT — 30 Ohm ODT 101 ODT_5_24_Ohm_ODT — 24 Ohm ODT

Table continues on the next page...

IOMUXC_SW_PAD_CTL_PAD_DRAM_ADDR02 field descriptions (continued)

Field	Description
	110 ODT_6_20_Ohm_ODT — 20 Ohm ODT 111 ODT_7_17_Ohm_ODT — 17 Ohm ODT
7–6 -	This field is reserved. Reserved
5–3 DSE	Drive Strength Field Read Only Field 0 DSE — output driver disabled;
-	This field is reserved. Reserved

32.6.116 SW_PAD_CTL_PAD_DRAM_ADDR03 SW PAD Control Register (IOMUXC_SW_PAD_CTL_PAD_DRAM_ADDR03)

SW_PAD_CTL Register

Address: 20E_0000h base + 210h offset = 20E_0210h

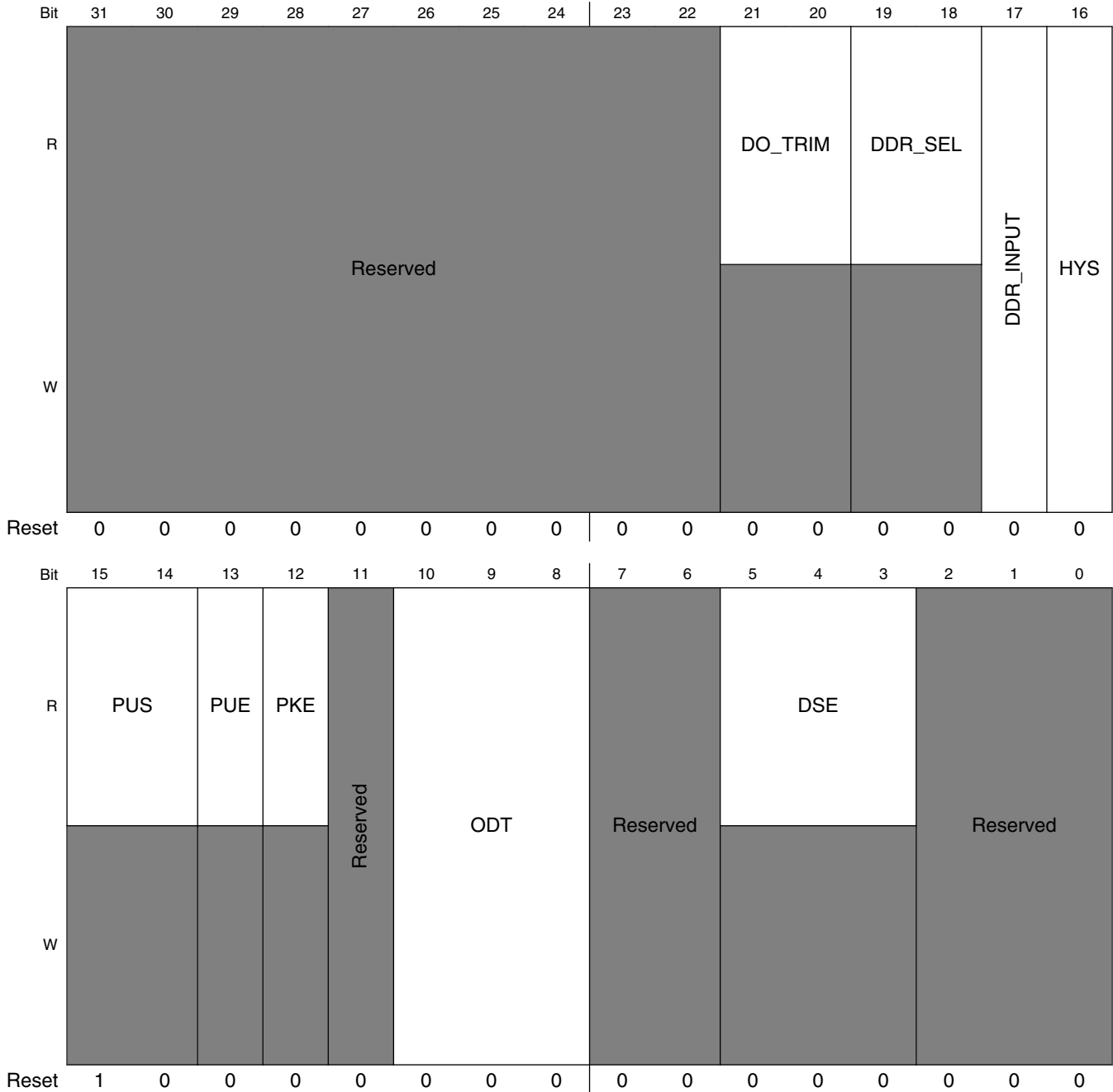

IOMUXC_SW_PAD_CTL_PAD_DRAM_ADDR03 field descriptions

Field	Description
31–22 -	This field is reserved. Reserved
21–20 DO_TRIM	do_trim Field Read Only Field 0 DO_TRIM — min delay
19–18 DDR_SEL	ddr_sel Field Read Only Field 0 DDR_SEL — RESERVED
17 DDR_INPUT	DDR / CMOS Input Mode Field Select one out of next values for pad: DRAM_ADDR03 0 DDR_INPUT_0_CMOS_input_type — CMOS input type 1 DDR_INPUT_1_Differential_input_mode — Differential input mode
16 HYS	Hyst. Enable Field Select one out of next values for pad: DRAM_ADDR03 0 HYS_0_Hysteresis_Disabled — Hysteresis Disabled 1 HYS_1_Hysteresis_Enabled — Hysteresis Enabled
15–14 PUS	Pull Up / Down Config. Field Read Only Field 10 PUS — 100K Ohm Pull Up
13 PUE	Pull / Keep Select Field Read Only Field 0 PUE — Keeper
12 PKE	Pull / Keep Enable Field Read Only Field 0 PKE — Pull/Keeper Disabled
11 -	This field is reserved. Reserved
10–8 ODT	On Die Termination Field Select one out of next values for pad: DRAM_ADDR03 000 ODT_0_off — off 001 ODT_1_120_Ohm_ODT — 120 Ohm ODT 010 ODT_2_60_Ohm_ODT — 60 Ohm ODT 011 ODT_3_40_Ohm_ODT — 40 Ohm ODT 100 ODT_4_30_Ohm_ODT — 30 Ohm ODT 101 ODT_5_24_Ohm_ODT — 24 Ohm ODT

Table continues on the next page...

IOMUXC_SW_PAD_CTL_PAD_DRAM_ADDR03 field descriptions (continued)

Field	Description
	110 ODT_6_20_Ohm_ODT — 20 Ohm ODT 111 ODT_7_17_Ohm_ODT — 17 Ohm ODT
7–6 -	This field is reserved. Reserved
5–3 DSE	Drive Strength Field Read Only Field 0 DSE — output driver disabled;
-	This field is reserved. Reserved

32.6.117 SW_PAD_CTL_PAD_DRAM_ADDR04 SW PAD Control Register (IOMUXC_SW_PAD_CTL_PAD_DRAM_ADDR04)

SW_PAD_CTL Register

Address: 20E_0000h base + 214h offset = 20E_0214h

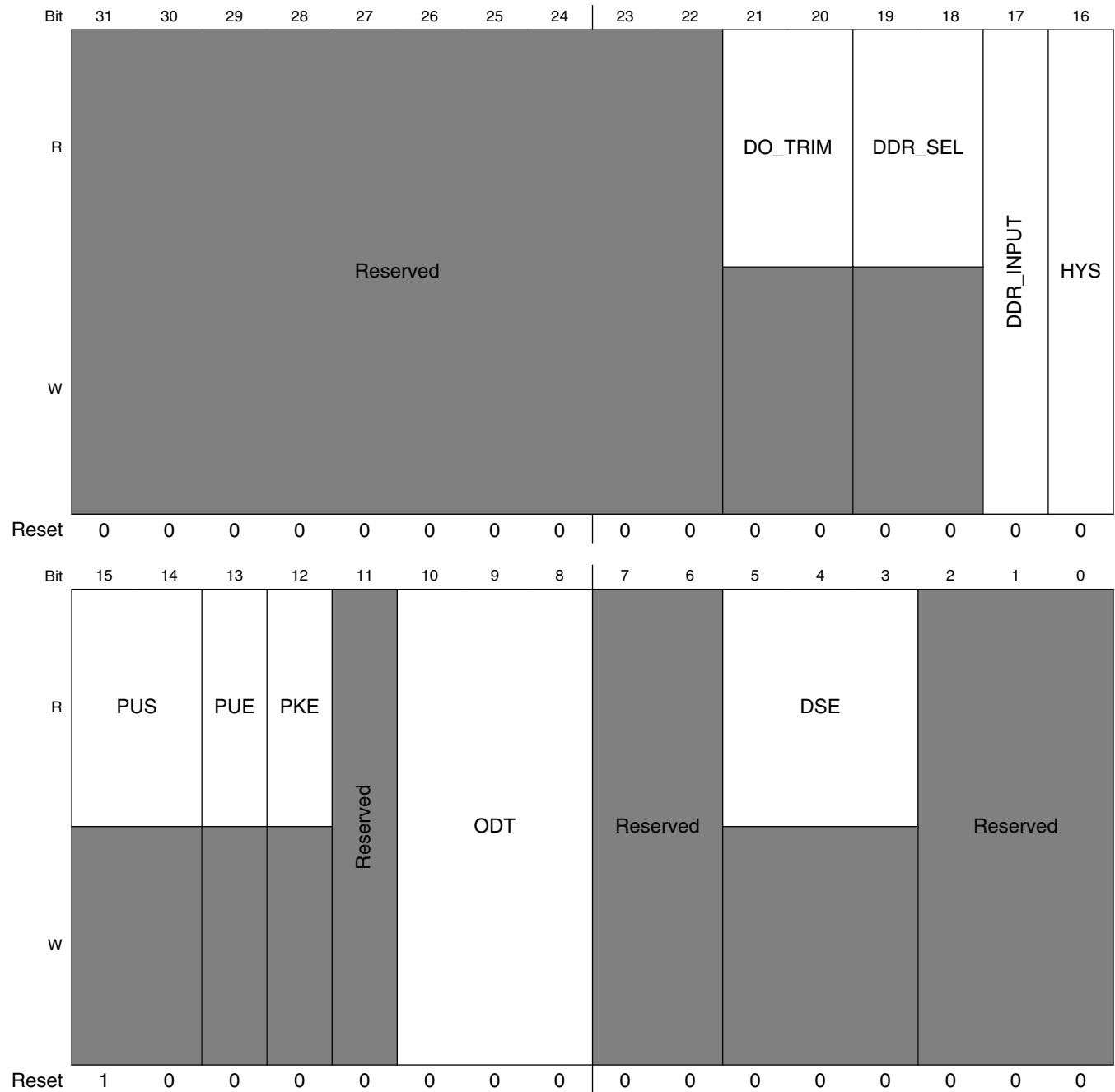

IOMUXC_SW_PAD_CTL_PAD_DRAM_ADDR04 field descriptions

Field	Description
31–22 -	This field is reserved. Reserved
21–20 DO_TRIM	do_trim Field Read Only Field 0 DO_TRIM — min delay
19–18 DDR_SEL	ddr_sel Field Read Only Field 0 DDR_SEL — RESERVED
17 DDR_INPUT	DDR / CMOS Input Mode Field Select one out of next values for pad: DRAM_ADDR04 0 DDR_INPUT_0_CMOS_input_type — CMOS input type 1 DDR_INPUT_1_Differential_input_mode — Differential input mode
16 HYS	Hyst. Enable Field Select one out of next values for pad: DRAM_ADDR04 0 HYS_0_Hysteresis_Disabled — Hysteresis Disabled 1 HYS_1_Hysteresis_Enabled — Hysteresis Enabled
15–14 PUS	Pull Up / Down Config. Field Read Only Field 10 PUS — 100K Ohm Pull Up
13 PUE	Pull / Keep Select Field Read Only Field 0 PUE — Keeper
12 PKE	Pull / Keep Enable Field Read Only Field 0 PKE — Pull/Keeper Disabled
11 -	This field is reserved. Reserved
10–8 ODT	On Die Termination Field Select one out of next values for pad: DRAM_ADDR04 000 ODT_0_off — off 001 ODT_1_120_Ohm_ODT — 120 Ohm ODT 010 ODT_2_60_Ohm_ODT — 60 Ohm ODT 011 ODT_3_40_Ohm_ODT — 40 Ohm ODT 100 ODT_4_30_Ohm_ODT — 30 Ohm ODT 101 ODT_5_24_Ohm_ODT — 24 Ohm ODT

Table continues on the next page...

IOMUXC_SW_PAD_CTL_PAD_DRAM_ADDR04 field descriptions (continued)

Field	Description
	110 ODT_6_20_Ohm_ODT — 20 Ohm ODT 111 ODT_7_17_Ohm_ODT — 17 Ohm ODT
7–6 -	This field is reserved. Reserved
5–3 DSE	Drive Strength Field Read Only Field 0 DSE — output driver disabled;
-	This field is reserved. Reserved

32.6.118 SW_PAD_CTL_PAD_DRAM_ADDR05 SW PAD Control Register (IOMUXC_SW_PAD_CTL_PAD_DRAM_ADDR05)

SW_PAD_CTL Register

Address: 20E_0000h base + 218h offset = 20E_0218h

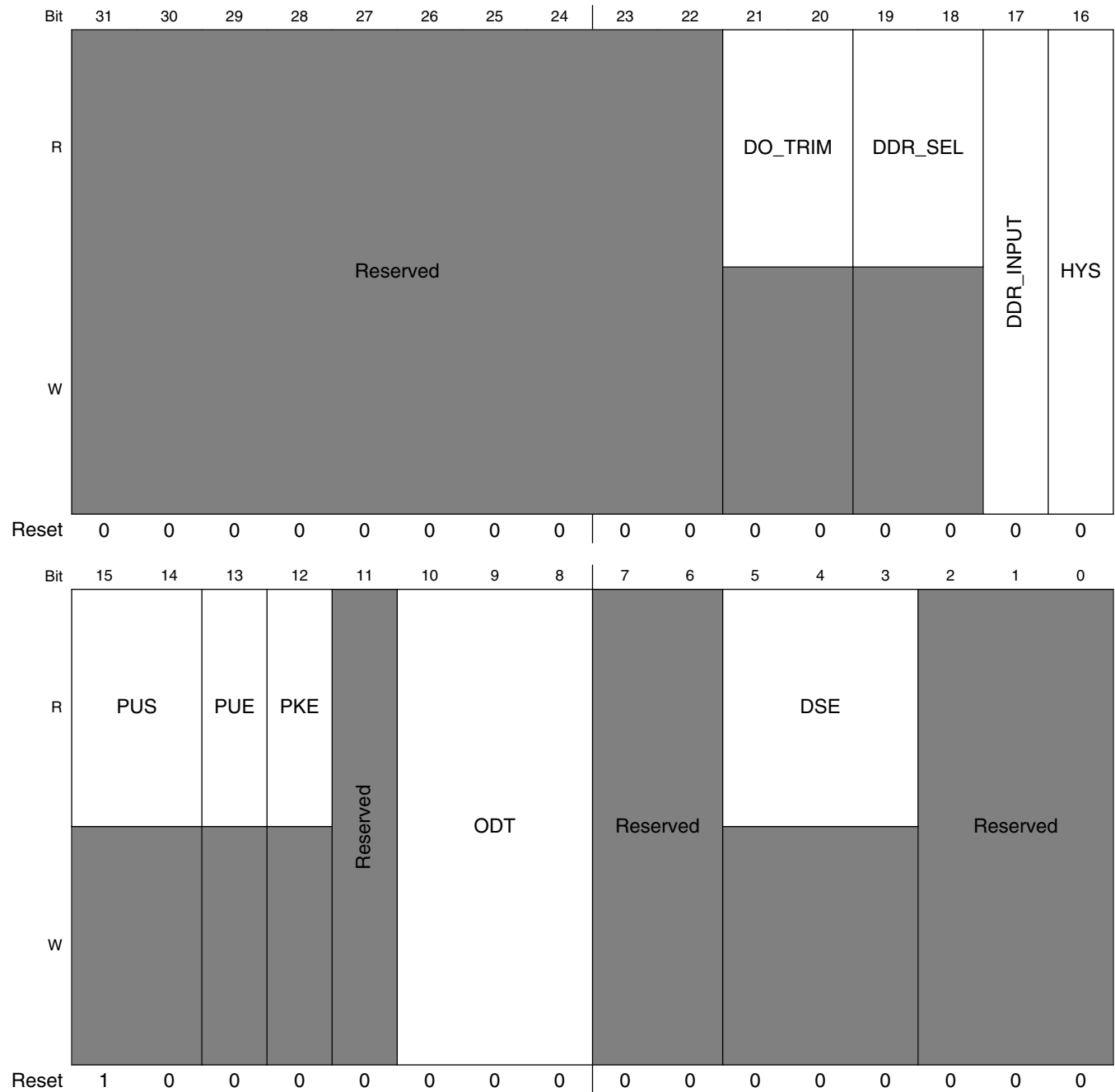

IOMUXC_SW_PAD_CTL_PAD_DRAM_ADDR05 field descriptions

Field	Description
31–22 -	This field is reserved. Reserved
21–20 DO_TRIM	do_trim Field Read Only Field 0 DO_TRIM — min delay
19–18 DDR_SEL	ddr_sel Field Read Only Field 0 DDR_SEL — RESERVED
17 DDR_INPUT	DDR / CMOS Input Mode Field Select one out of next values for pad: DRAM_ADDR05 0 DDR_INPUT_0_CMOS_input_type — CMOS input type 1 DDR_INPUT_1_Differential_input_mode — Differential input mode
16 HYS	Hyst. Enable Field Select one out of next values for pad: DRAM_ADDR05 0 HYS_0_Hysteresis_Disabled — Hysteresis Disabled 1 HYS_1_Hysteresis_Enabled — Hysteresis Enabled
15–14 PUS	Pull Up / Down Config. Field Read Only Field 10 PUS — 100K Ohm Pull Up
13 PUE	Pull / Keep Select Field Read Only Field 0 PUE — Keeper
12 PKE	Pull / Keep Enable Field Read Only Field 0 PKE — Pull/Keeper Disabled
11 -	This field is reserved. Reserved
10–8 ODT	On Die Termination Field Select one out of next values for pad: DRAM_ADDR05 000 ODT_0_off — off 001 ODT_1_120_Ohm_ODT — 120 Ohm ODT 010 ODT_2_60_Ohm_ODT — 60 Ohm ODT 011 ODT_3_40_Ohm_ODT — 40 Ohm ODT 100 ODT_4_30_Ohm_ODT — 30 Ohm ODT 101 ODT_5_24_Ohm_ODT — 24 Ohm ODT

Table continues on the next page...

IOMUXC_SW_PAD_CTL_PAD_DRAM_ADDR05 field descriptions (continued)

Field	Description
	110 ODT_6_20_Ohm_ODT — 20 Ohm ODT 111 ODT_7_17_Ohm_ODT — 17 Ohm ODT
7–6 -	This field is reserved. Reserved
5–3 DSE	Drive Strength Field Read Only Field 0 DSE — output driver disabled;
-	This field is reserved. Reserved

32.6.119 SW_PAD_CTL_PAD_DRAM_ADDR06 SW PAD Control Register (IOMUXC_SW_PAD_CTL_PAD_DRAM_ADDR06)

SW_PAD_CTL Register

Address: 20E_0000h base + 21Ch offset = 20E_021Ch

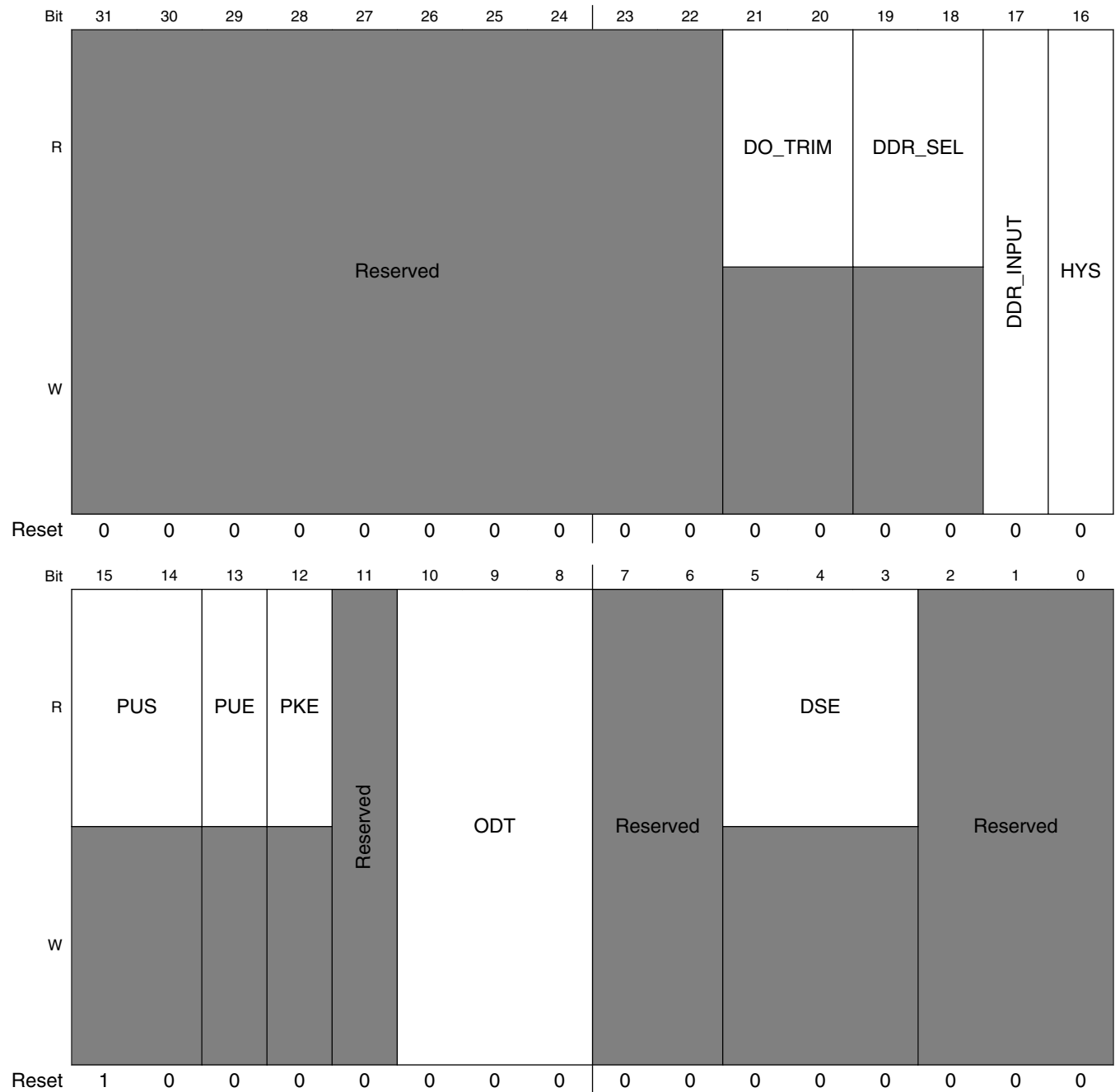

IOMUXC_SW_PAD_CTL_PAD_DRAM_ADDR06 field descriptions

Field	Description
31–22 -	This field is reserved. Reserved
21–20 DO_TRIM	do_trim Field Read Only Field 0 DO_TRIM — min delay
19–18 DDR_SEL	ddr_sel Field Read Only Field 0 DDR_SEL — RESERVED
17 DDR_INPUT	DDR / CMOS Input Mode Field Select one out of next values for pad: DRAM_ADDR06 0 DDR_INPUT_0_CMOS_input_type — CMOS input type 1 DDR_INPUT_1_Differential_input_mode — Differential input mode
16 HYS	Hyst. Enable Field Select one out of next values for pad: DRAM_ADDR06 0 HYS_0_Hysteresis_Disabled — Hysteresis Disabled 1 HYS_1_Hysteresis_Enabled — Hysteresis Enabled
15–14 PUS	Pull Up / Down Config. Field Read Only Field 10 PUS — 100K Ohm Pull Up
13 PUE	Pull / Keep Select Field Read Only Field 0 PUE — Keeper
12 PKE	Pull / Keep Enable Field Read Only Field 0 PKE — Pull/Keeper Disabled
11 -	This field is reserved. Reserved
10–8 ODT	On Die Termination Field Select one out of next values for pad: DRAM_ADDR06 000 ODT_0_off — off 001 ODT_1_120_Ohm_ODT — 120 Ohm ODT 010 ODT_2_60_Ohm_ODT — 60 Ohm ODT 011 ODT_3_40_Ohm_ODT — 40 Ohm ODT 100 ODT_4_30_Ohm_ODT — 30 Ohm ODT 101 ODT_5_24_Ohm_ODT — 24 Ohm ODT

Table continues on the next page...

IOMUXC_SW_PAD_CTL_PAD_DRAM_ADDR06 field descriptions (continued)

Field	Description
	110 ODT_6_20_Ohm_ODT — 20 Ohm ODT 111 ODT_7_17_Ohm_ODT — 17 Ohm ODT
7–6 -	This field is reserved. Reserved
5–3 DSE	Drive Strength Field Read Only Field 0 DSE — output driver disabled;
-	This field is reserved. Reserved

32.6.120 SW_PAD_CTL_PAD_DRAM_ADDR07 SW PAD Control Register (IOMUXC_SW_PAD_CTL_PAD_DRAM_ADDR07)

SW_PAD_CTL Register

Address: 20E_0000h base + 220h offset = 20E_0220h

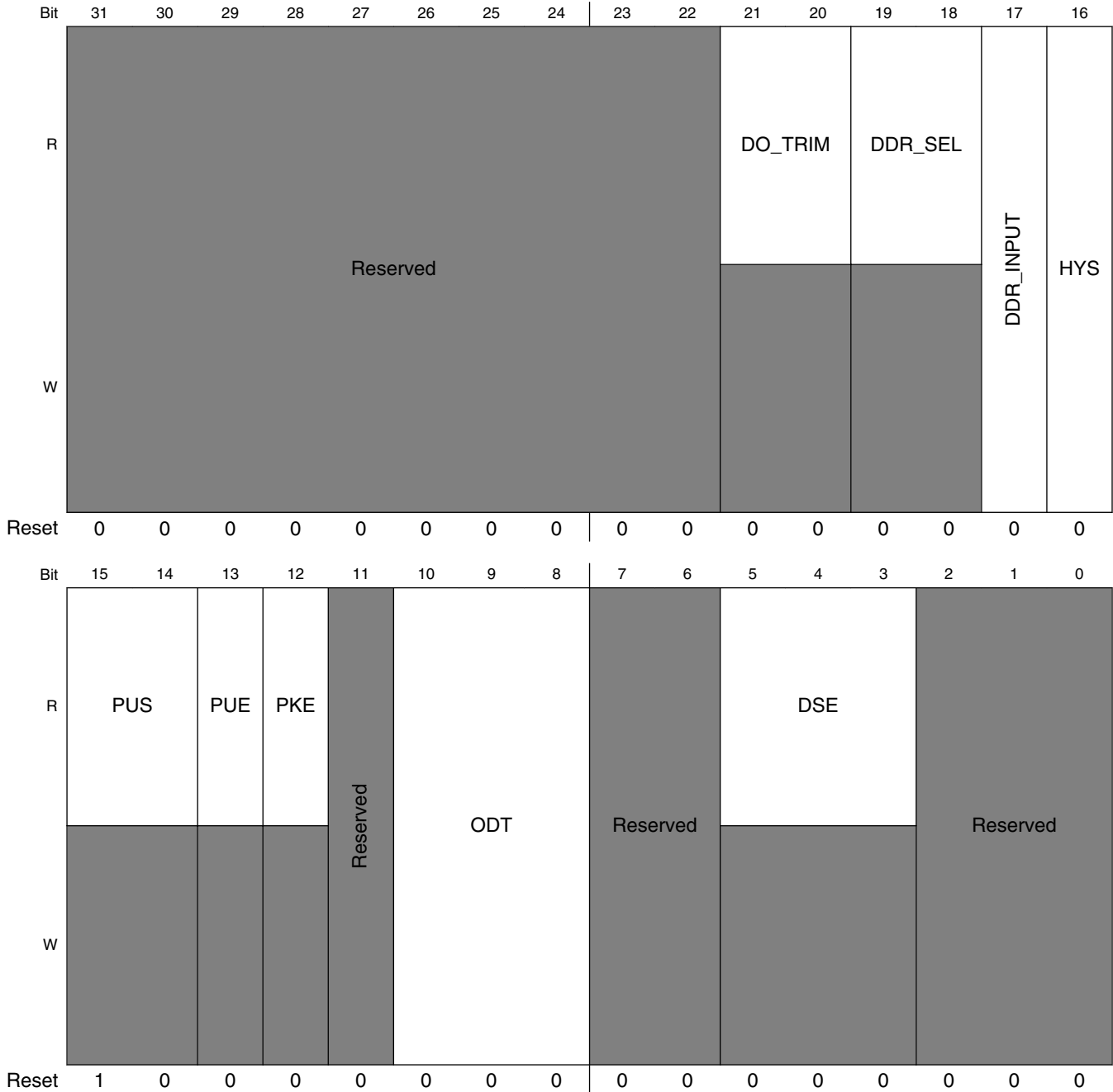

IOMUXC_SW_PAD_CTL_PAD_DRAM_ADDR07 field descriptions

Field	Description
31–22 -	This field is reserved. Reserved
21–20 DO_TRIM	do_trim Field Read Only Field 0 DO_TRIM — min delay
19–18 DDR_SEL	ddr_sel Field Read Only Field 0 DDR_SEL — RESERVED
17 DDR_INPUT	DDR / CMOS Input Mode Field Select one out of next values for pad: DRAM_ADDR07 0 DDR_INPUT_0_CMOS_input_type — CMOS input type 1 DDR_INPUT_1_Differential_input_mode — Differential input mode
16 HYS	Hyst. Enable Field Select one out of next values for pad: DRAM_ADDR07 0 HYS_0_Hysteresis_Disabled — Hysteresis Disabled 1 HYS_1_Hysteresis_Enabled — Hysteresis Enabled
15–14 PUS	Pull Up / Down Config. Field Read Only Field 10 PUS — 100K Ohm Pull Up
13 PUE	Pull / Keep Select Field Read Only Field 0 PUE — Keeper
12 PKE	Pull / Keep Enable Field Read Only Field 0 PKE — Pull/Keeper Disabled
11 -	This field is reserved. Reserved
10–8 ODT	On Die Termination Field Select one out of next values for pad: DRAM_ADDR07 000 ODT_0_off — off 001 ODT_1_120_Ohm_ODT — 120 Ohm ODT 010 ODT_2_60_Ohm_ODT — 60 Ohm ODT 011 ODT_3_40_Ohm_ODT — 40 Ohm ODT 100 ODT_4_30_Ohm_ODT — 30 Ohm ODT 101 ODT_5_24_Ohm_ODT — 24 Ohm ODT

Table continues on the next page...

IOMUXC_SW_PAD_CTL_PAD_DRAM_ADDR07 field descriptions (continued)

Field	Description
	110 ODT_6_20_Ohm_ODT — 20 Ohm ODT 111 ODT_7_17_Ohm_ODT — 17 Ohm ODT
7–6 -	This field is reserved. Reserved
5–3 DSE	Drive Strength Field Read Only Field 0 DSE — output driver disabled;
-	This field is reserved. Reserved

32.6.121 SW_PAD_CTL_PAD_DRAM_ADDR08 SW PAD Control Register (IOMUXC_SW_PAD_CTL_PAD_DRAM_ADDR08)

SW_PAD_CTL Register

Address: 20E_0000h base + 224h offset = 20E_0224h

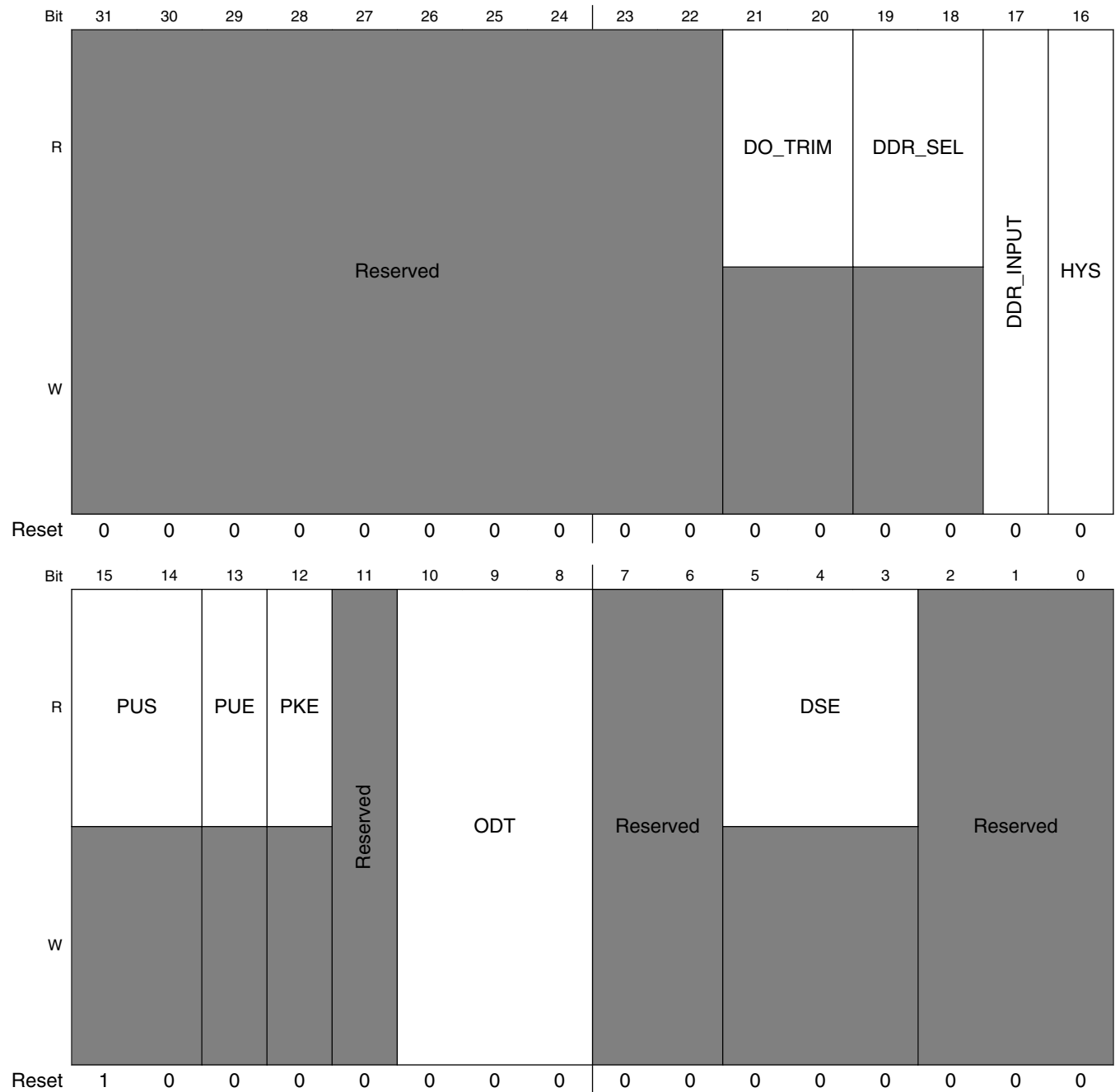

IOMUXC_SW_PAD_CTL_PAD_DRAM_ADDR08 field descriptions

Field	Description
31–22 -	This field is reserved. Reserved
21–20 DO_TRIM	do_trim Field Read Only Field 0 DO_TRIM — min delay
19–18 DDR_SEL	ddr_sel Field Read Only Field 0 DDR_SEL — RESERVED
17 DDR_INPUT	DDR / CMOS Input Mode Field Select one out of next values for pad: DRAM_ADDR08 0 DDR_INPUT_0_CMOS_input_type — CMOS input type 1 DDR_INPUT_1_Differential_input_mode — Differential input mode
16 HYS	Hyst. Enable Field Select one out of next values for pad: DRAM_ADDR08 0 HYS_0_Hysteresis_Disabled — Hysteresis Disabled 1 HYS_1_Hysteresis_Enabled — Hysteresis Enabled
15–14 PUS	Pull Up / Down Config. Field Read Only Field 10 PUS — 100K Ohm Pull Up
13 PUE	Pull / Keep Select Field Read Only Field 0 PUE — Keeper
12 PKE	Pull / Keep Enable Field Read Only Field 0 PKE — Pull/Keeper Disabled
11 -	This field is reserved. Reserved
10–8 ODT	On Die Termination Field Select one out of next values for pad: DRAM_ADDR08 000 ODT_0_off — off 001 ODT_1_120_Ohm_ODT — 120 Ohm ODT 010 ODT_2_60_Ohm_ODT — 60 Ohm ODT 011 ODT_3_40_Ohm_ODT — 40 Ohm ODT 100 ODT_4_30_Ohm_ODT — 30 Ohm ODT 101 ODT_5_24_Ohm_ODT — 24 Ohm ODT

Table continues on the next page...

IOMUXC_SW_PAD_CTL_PAD_DRAM_ADDR08 field descriptions (continued)

Field	Description
	110 ODT_6_20_Ohm_ODT — 20 Ohm ODT 111 ODT_7_17_Ohm_ODT — 17 Ohm ODT
7-6 -	This field is reserved. Reserved
5-3 DSE	Drive Strength Field Read Only Field 0 DSE — output driver disabled;
-	This field is reserved. Reserved

32.6.122 SW_PAD_CTL_PAD_DRAM_ADDR09 SW PAD Control Register (IOMUXC_SW_PAD_CTL_PAD_DRAM_ADDR09)

SW_PAD_CTL Register

Address: 20E_0000h base + 228h offset = 20E_0228h

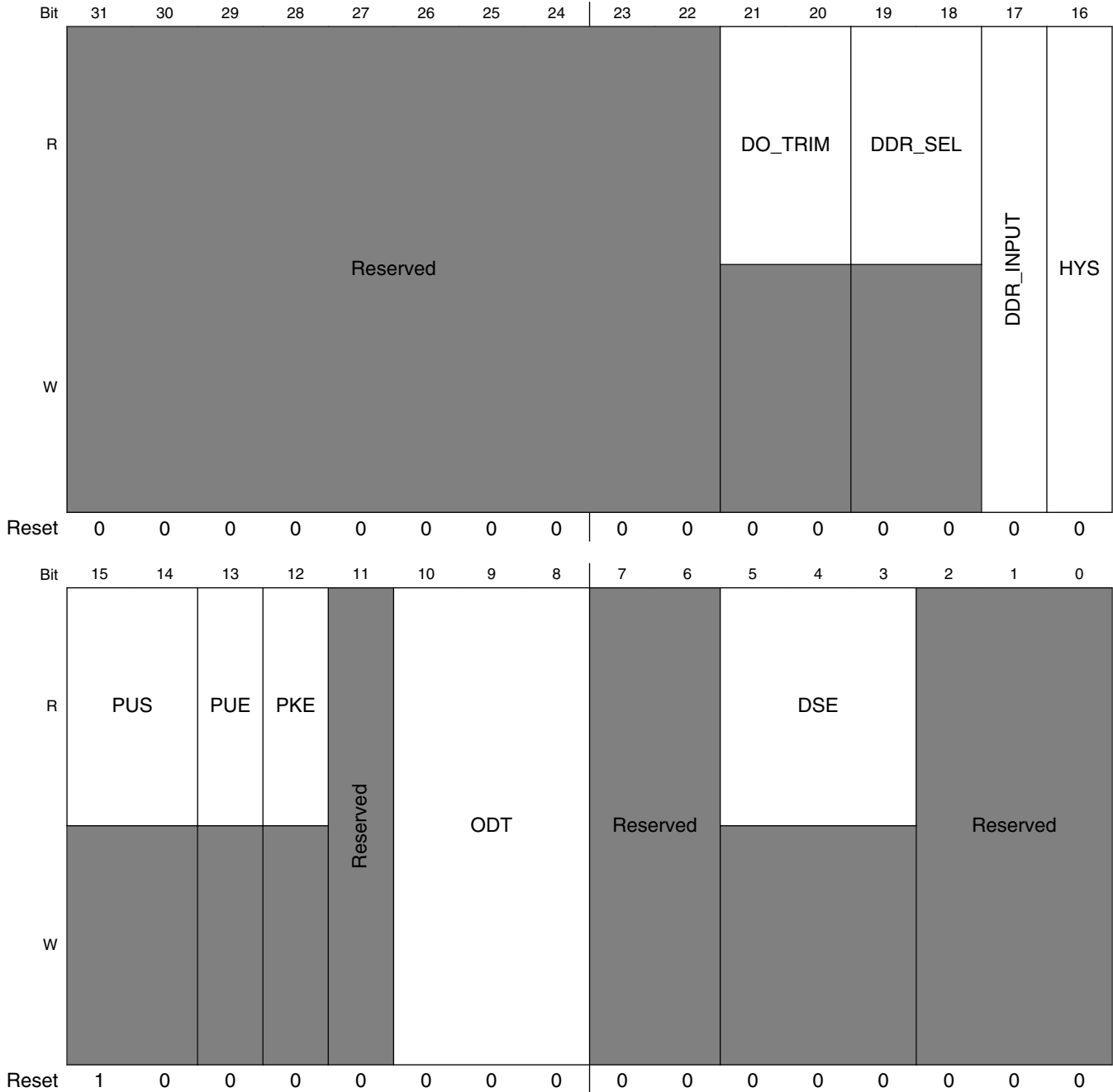

IOMUXC_SW_PAD_CTL_PAD_DRAM_ADDR09 field descriptions

Field	Description
31–22 -	This field is reserved. Reserved
21–20 DO_TRIM	do_trim Field Read Only Field 0 DO_TRIM — min delay
19–18 DDR_SEL	ddr_sel Field Read Only Field 0 DDR_SEL — RESERVED
17 DDR_INPUT	DDR / CMOS Input Mode Field Select one out of next values for pad: DRAM_ADDR09 0 DDR_INPUT_0_CMOS_input_type — CMOS input type 1 DDR_INPUT_1_Differential_input_mode — Differential input mode
16 HYS	Hyst. Enable Field Select one out of next values for pad: DRAM_ADDR09 0 HYS_0_Hysteresis_Disabled — Hysteresis Disabled 1 HYS_1_Hysteresis_Enabled — Hysteresis Enabled
15–14 PUS	Pull Up / Down Config. Field Read Only Field 10 PUS — 100K Ohm Pull Up
13 PUE	Pull / Keep Select Field Read Only Field 0 PUE — Keeper
12 PKE	Pull / Keep Enable Field Read Only Field 0 PKE — Pull/Keeper Disabled
11 -	This field is reserved. Reserved
10–8 ODT	On Die Termination Field Select one out of next values for pad: DRAM_ADDR09 000 ODT_0_off — off 001 ODT_1_120_Ohm_ODT — 120 Ohm ODT 010 ODT_2_60_Ohm_ODT — 60 Ohm ODT 011 ODT_3_40_Ohm_ODT — 40 Ohm ODT 100 ODT_4_30_Ohm_ODT — 30 Ohm ODT 101 ODT_5_24_Ohm_ODT — 24 Ohm ODT

Table continues on the next page...

IOMUXC_SW_PAD_CTL_PAD_DRAM_ADDR09 field descriptions (continued)

Field	Description
	110 ODT_6_20_Ohm_ODT — 20 Ohm ODT 111 ODT_7_17_Ohm_ODT — 17 Ohm ODT
7–6 -	This field is reserved. Reserved
5–3 DSE	Drive Strength Field Read Only Field 0 DSE — output driver disabled;
-	This field is reserved. Reserved

32.6.123 SW_PAD_CTL_PAD_DRAM_ADDR10 SW PAD Control Register (IOMUXC_SW_PAD_CTL_PAD_DRAM_ADDR10)

SW_PAD_CTL Register

Address: 20E_0000h base + 22Ch offset = 20E_022Ch

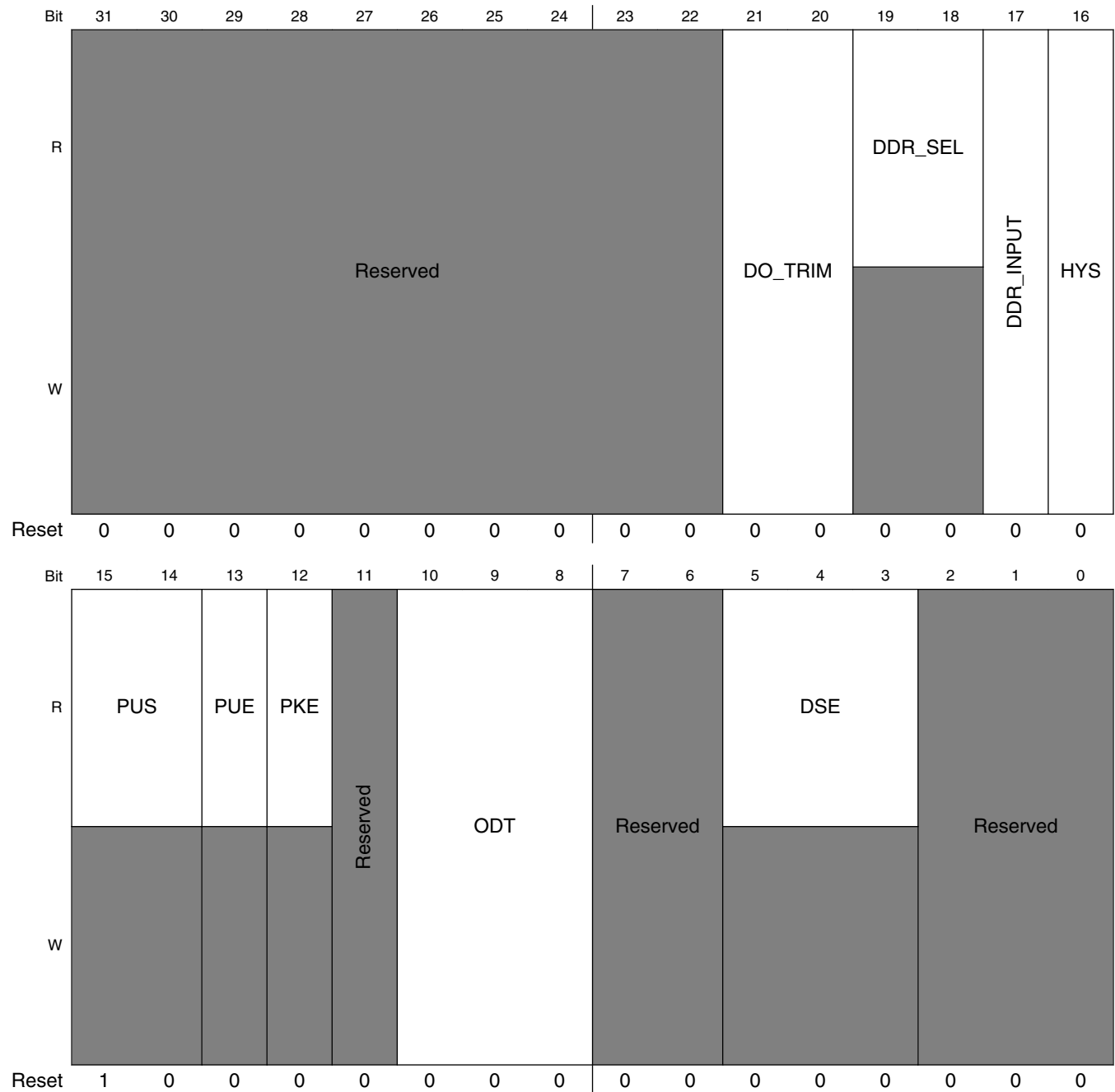

IOMUXC_SW_PAD_CTL_PAD_DRAM_ADDR10 field descriptions

Field	Description
31–22 -	This field is reserved. Reserved
21–20 DO_TRIM	do_trim Field Select one out of next values for pad: DRAM_ADDR10 00 DO_TRIM_0_min_delay — min delay 01 DO_TRIM_1_50ps_ipp_do_pad_delay — + ~50ps ipp_do -> pad delay 10 DO_TRIM_2_100ps_ipp_do_pad_delay — + ~100ps ipp_do -> pad delay 11 DO_TRIM_3_150ps_ipp_do_pad_delay — + ~150ps ipp_do -> pad delay
19–18 DDR_SEL	ddr_sel Field Read Only Field 0 DDR_SEL — RESERVED
17 DDR_INPUT	DDR / CMOS Input Mode Field Select one out of next values for pad: DRAM_ADDR10 0 DDR_INPUT_0_CMOS_input_type — CMOS input type 1 DDR_INPUT_1_Differential_input_mode — Differential input mode
16 HYS	Hyst. Enable Field Select one out of next values for pad: DRAM_ADDR10 0 HYS_0_Hysteresis_Disabled — Hysteresis Disabled 1 HYS_1_Hysteresis_Enabled — Hysteresis Enabled
15–14 PUS	Pull Up / Down Config. Field Read Only Field 10 PUS — 100K Ohm Pull Up
13 PUE	Pull / Keep Select Field Read Only Field 0 PUE — Keeper
12 PKE	Pull / Keep Enable Field Read Only Field 0 PKE — Pull/Keeper Disabled
11 -	This field is reserved. Reserved
10–8 ODT	On Die Termination Field Select one out of next values for pad: DRAM_ADDR10 000 ODT_0_off — off 001 ODT_1_120_Ohm_ODT — 120 Ohm ODT 010 ODT_2_60_Ohm_ODT — 60 Ohm ODT

Table continues on the next page...

IOMUXC_SW_PAD_CTL_PAD_DRAM_ADDR10 field descriptions (continued)

Field	Description
	011 ODT_3_40_Ohm_ODT — 40 Ohm ODT 100 ODT_4_30_Ohm_ODT — 30 Ohm ODT 101 ODT_5_24_Ohm_ODT — 24 Ohm ODT 110 ODT_6_20_Ohm_ODT — 20 Ohm ODT 111 ODT_7_17_Ohm_ODT — 17 Ohm ODT
7–6 -	This field is reserved. Reserved
5–3 DSE	Drive Strength Field Read Only Field 0 DSE — output driver disabled;
-	This field is reserved. Reserved

32.6.124 SW_PAD_CTL_PAD_DRAM_ADDR11 SW PAD Control Register (IOMUXC_SW_PAD_CTL_PAD_DRAM_ADDR11)

SW_PAD_CTL Register

Address: 20E_0000h base + 230h offset = 20E_0230h

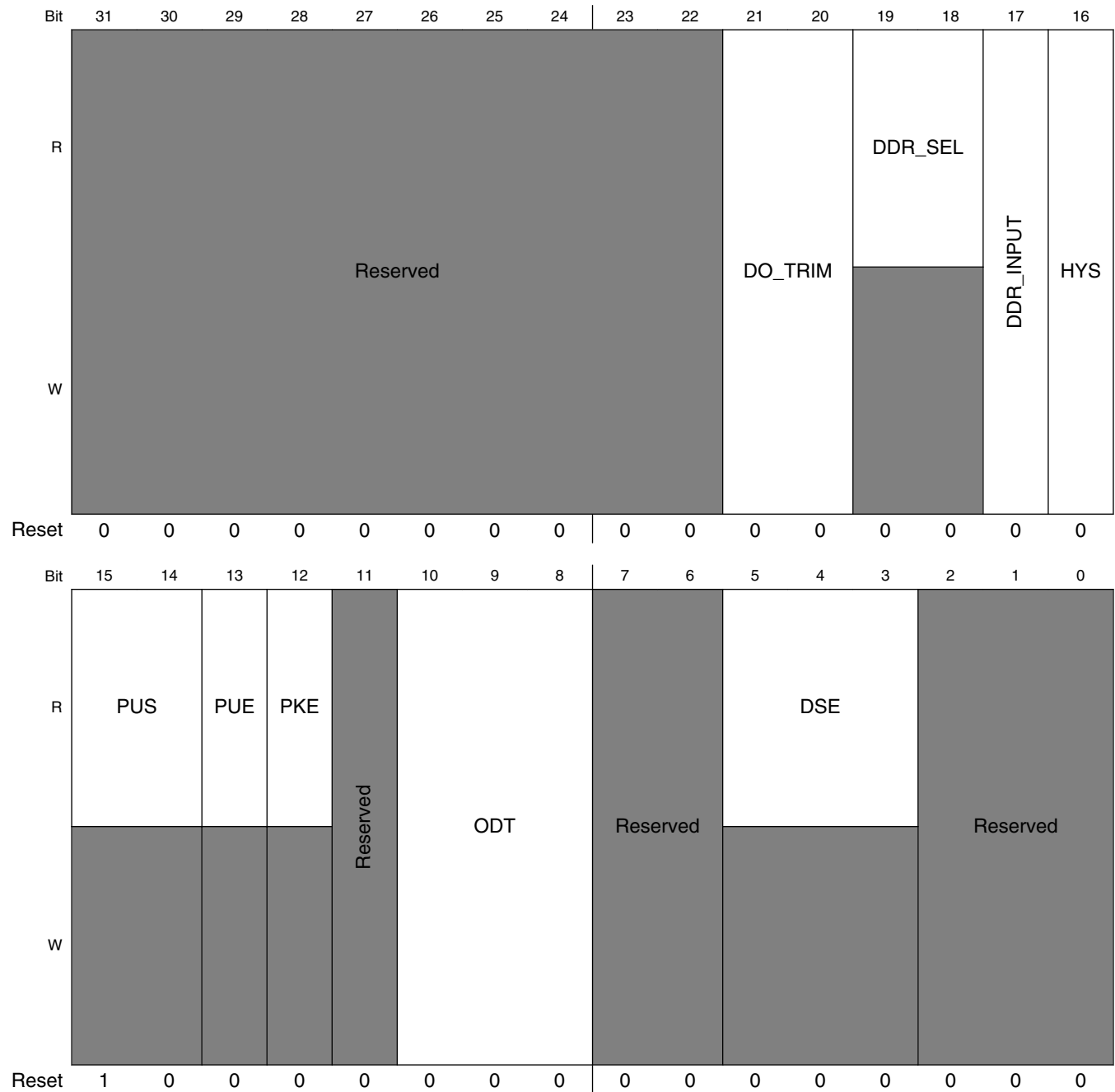

IOMUXC_SW_PAD_CTL_PAD_DRAM_ADDR11 field descriptions

Field	Description
31–22 -	This field is reserved. Reserved
21–20 DO_TRIM	do_trim Field Select one out of next values for pad: DRAM_ADDR11 00 DO_TRIM_0_min_delay — min delay 01 DO_TRIM_1_50ps_ipp_do_pad_delay — + ~50ps ipp_do -> pad delay 10 DO_TRIM_2_100ps_ipp_do_pad_delay — + ~100ps ipp_do -> pad delay 11 DO_TRIM_3_150ps_ipp_do_pad_delay — + ~150ps ipp_do -> pad delay
19–18 DDR_SEL	ddr_sel Field Read Only Field 0 DDR_SEL — RESERVED
17 DDR_INPUT	DDR / CMOS Input Mode Field Select one out of next values for pad: DRAM_ADDR11 0 DDR_INPUT_0_CMOS_input_type — CMOS input type 1 DDR_INPUT_1_Differential_input_mode — Differential input mode
16 HYS	Hyst. Enable Field Select one out of next values for pad: DRAM_ADDR11 0 HYS_0_Hysteresis_Disabled — Hysteresis Disabled 1 HYS_1_Hysteresis_Enabled — Hysteresis Enabled
15–14 PUS	Pull Up / Down Config. Field Read Only Field 10 PUS — 100K Ohm Pull Up
13 PUE	Pull / Keep Select Field Read Only Field 0 PUE — Keeper
12 PKE	Pull / Keep Enable Field Read Only Field 0 PKE — Pull/Keeper Disabled
11 -	This field is reserved. Reserved
10–8 ODT	On Die Termination Field Select one out of next values for pad: DRAM_ADDR11 000 ODT_0_off — off 001 ODT_1_120_Ohm_ODT — 120 Ohm ODT 010 ODT_2_60_Ohm_ODT — 60 Ohm ODT

Table continues on the next page...

IOMUXC_SW_PAD_CTL_PAD_DRAM_ADDR11 field descriptions (continued)

Field	Description
	011 ODT_3_40_Ohm_ODT — 40 Ohm ODT 100 ODT_4_30_Ohm_ODT — 30 Ohm ODT 101 ODT_5_24_Ohm_ODT — 24 Ohm ODT 110 ODT_6_20_Ohm_ODT — 20 Ohm ODT 111 ODT_7_17_Ohm_ODT — 17 Ohm ODT
7–6 -	This field is reserved. Reserved
5–3 DSE	Drive Strength Field Read Only Field 0 DSE — output driver disabled;
-	This field is reserved. Reserved

32.6.125 SW_PAD_CTL_PAD_DRAM_ADDR12 SW PAD Control Register (IOMUXC_SW_PAD_CTL_PAD_DRAM_ADDR12)

SW_PAD_CTL Register

Address: 20E_0000h base + 234h offset = 20E_0234h

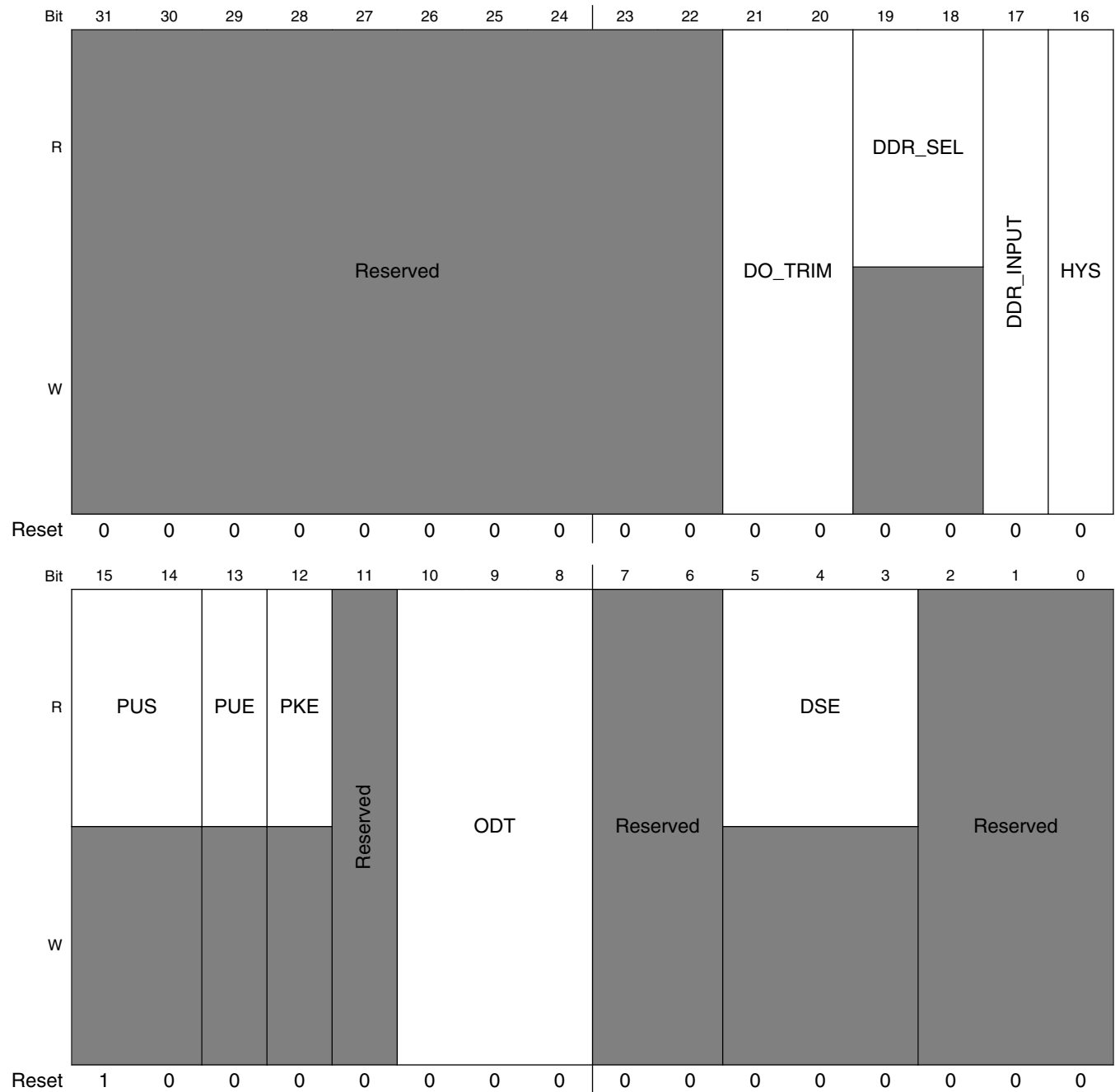

IOMUXC_SW_PAD_CTL_PAD_DRAM_ADDR12 field descriptions

Field	Description
31–22 -	This field is reserved. Reserved
21–20 DO_TRIM	do_trim Field Select one out of next values for pad: DRAM_ADDR12 00 DO_TRIM_0_min_delay — min delay 01 DO_TRIM_1_50ps_ipp_do_pad_delay — + ~50ps ipp_do -> pad delay 10 DO_TRIM_2_100ps_ipp_do_pad_delay — + ~100ps ipp_do -> pad delay 11 DO_TRIM_3_150ps_ipp_do_pad_delay — + ~150ps ipp_do -> pad delay
19–18 DDR_SEL	ddr_sel Field Read Only Field 0 DDR_SEL — RESERVED
17 DDR_INPUT	DDR / CMOS Input Mode Field Select one out of next values for pad: DRAM_ADDR12 0 DDR_INPUT_0_CMOS_input_type — CMOS input type 1 DDR_INPUT_1_Differential_input_mode — Differential input mode
16 HYS	Hyst. Enable Field Select one out of next values for pad: DRAM_ADDR12 0 HYS_0_Hysteresis_Disabled — Hysteresis Disabled 1 HYS_1_Hysteresis_Enabled — Hysteresis Enabled
15–14 PUS	Pull Up / Down Config. Field Read Only Field 10 PUS — 100K Ohm Pull Up
13 PUE	Pull / Keep Select Field Read Only Field 0 PUE — Keeper
12 PKE	Pull / Keep Enable Field Read Only Field 0 PKE — Pull/Keeper Disabled
11 -	This field is reserved. Reserved
10–8 ODT	On Die Termination Field Select one out of next values for pad: DRAM_ADDR12 000 ODT_0_off — off 001 ODT_1_120_Ohm_ODT — 120 Ohm ODT 010 ODT_2_60_Ohm_ODT — 60 Ohm ODT

Table continues on the next page...

IOMUXC_SW_PAD_CTL_PAD_DRAM_ADDR12 field descriptions (continued)

Field	Description
	011 ODT_3_40_Ohm_ODT — 40 Ohm ODT 100 ODT_4_30_Ohm_ODT — 30 Ohm ODT 101 ODT_5_24_Ohm_ODT — 24 Ohm ODT 110 ODT_6_20_Ohm_ODT — 20 Ohm ODT 111 ODT_7_17_Ohm_ODT — 17 Ohm ODT
7–6 -	This field is reserved. Reserved
5–3 DSE	Drive Strength Field Read Only Field 0 DSE — output driver disabled;
-	This field is reserved. Reserved

32.6.126 SW_PAD_CTL_PAD_DRAM_ADDR13 SW PAD Control Register (IOMUXC_SW_PAD_CTL_PAD_DRAM_ADDR13)

SW_PAD_CTL Register

Address: 20E_0000h base + 238h offset = 20E_0238h

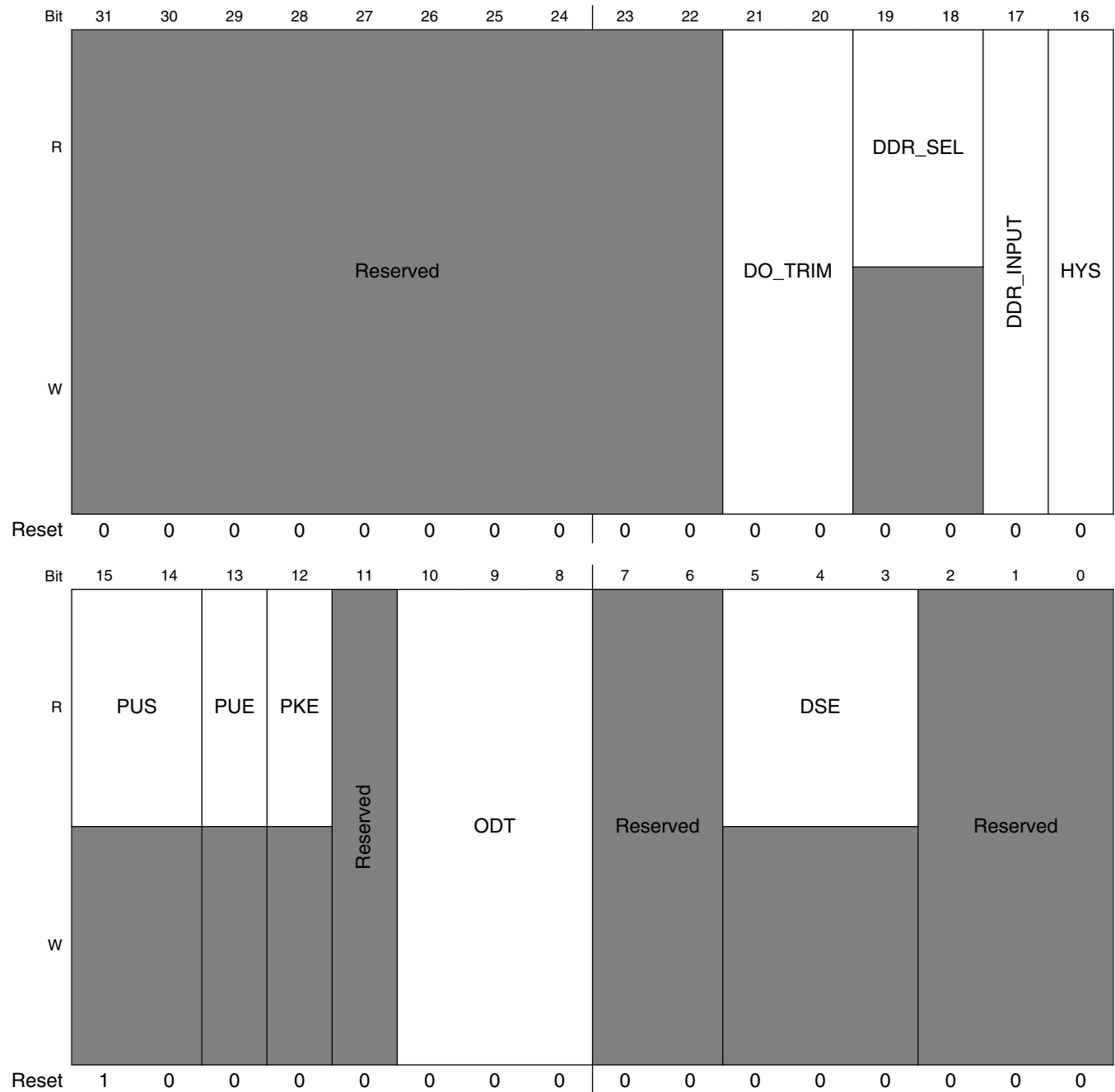

IOMUXC_SW_PAD_CTL_PAD_DRAM_ADDR13 field descriptions

Field	Description
31–22 -	This field is reserved. Reserved
21–20 DO_TRIM	do_trim Field Select one out of next values for pad: DRAM_ADDR13 00 DO_TRIM_0_min_delay — min delay 01 DO_TRIM_1_50ps_ipp_do_pad_delay — + ~50ps ipp_do -> pad delay 10 DO_TRIM_2_100ps_ipp_do_pad_delay — + ~100ps ipp_do -> pad delay 11 DO_TRIM_3_150ps_ipp_do_pad_delay — + ~150ps ipp_do -> pad delay
19–18 DDR_SEL	ddr_sel Field Read Only Field 0 DDR_SEL — RESERVED
17 DDR_INPUT	DDR / CMOS Input Mode Field Select one out of next values for pad: DRAM_ADDR13 0 DDR_INPUT_0_CMOS_input_type — CMOS input type 1 DDR_INPUT_1_Differential_input_mode — Differential input mode
16 HYS	Hyst. Enable Field Select one out of next values for pad: DRAM_ADDR13 0 HYS_0_Hysteresis_Disabled — Hysteresis Disabled 1 HYS_1_Hysteresis_Enabled — Hysteresis Enabled
15–14 PUS	Pull Up / Down Config. Field Read Only Field 10 PUS — 100K Ohm Pull Up
13 PUE	Pull / Keep Select Field Read Only Field 0 PUE — Keeper
12 PKE	Pull / Keep Enable Field Read Only Field 0 PKE — Pull/Keeper Disabled
11 -	This field is reserved. Reserved
10–8 ODT	On Die Termination Field Select one out of next values for pad: DRAM_ADDR13 000 ODT_0_off — off 001 ODT_1_120_Ohm_ODT — 120 Ohm ODT 010 ODT_2_60_Ohm_ODT — 60 Ohm ODT

Table continues on the next page...

IOMUXC_SW_PAD_CTL_PAD_DRAM_ADDR13 field descriptions (continued)

Field	Description
	011 ODT_3_40_Ohm_ODT — 40 Ohm ODT 100 ODT_4_30_Ohm_ODT — 30 Ohm ODT 101 ODT_5_24_Ohm_ODT — 24 Ohm ODT 110 ODT_6_20_Ohm_ODT — 20 Ohm ODT 111 ODT_7_17_Ohm_ODT — 17 Ohm ODT
7–6 -	This field is reserved. Reserved
5–3 DSE	Drive Strength Field Read Only Field 0 DSE — output driver disabled;
-	This field is reserved. Reserved

32.6.127 SW_PAD_CTL_PAD_DRAM_ADDR14 SW PAD Control Register (IOMUXC_SW_PAD_CTL_PAD_DRAM_ADDR14)

SW_PAD_CTL Register

Address: 20E_0000h base + 23Ch offset = 20E_023Ch

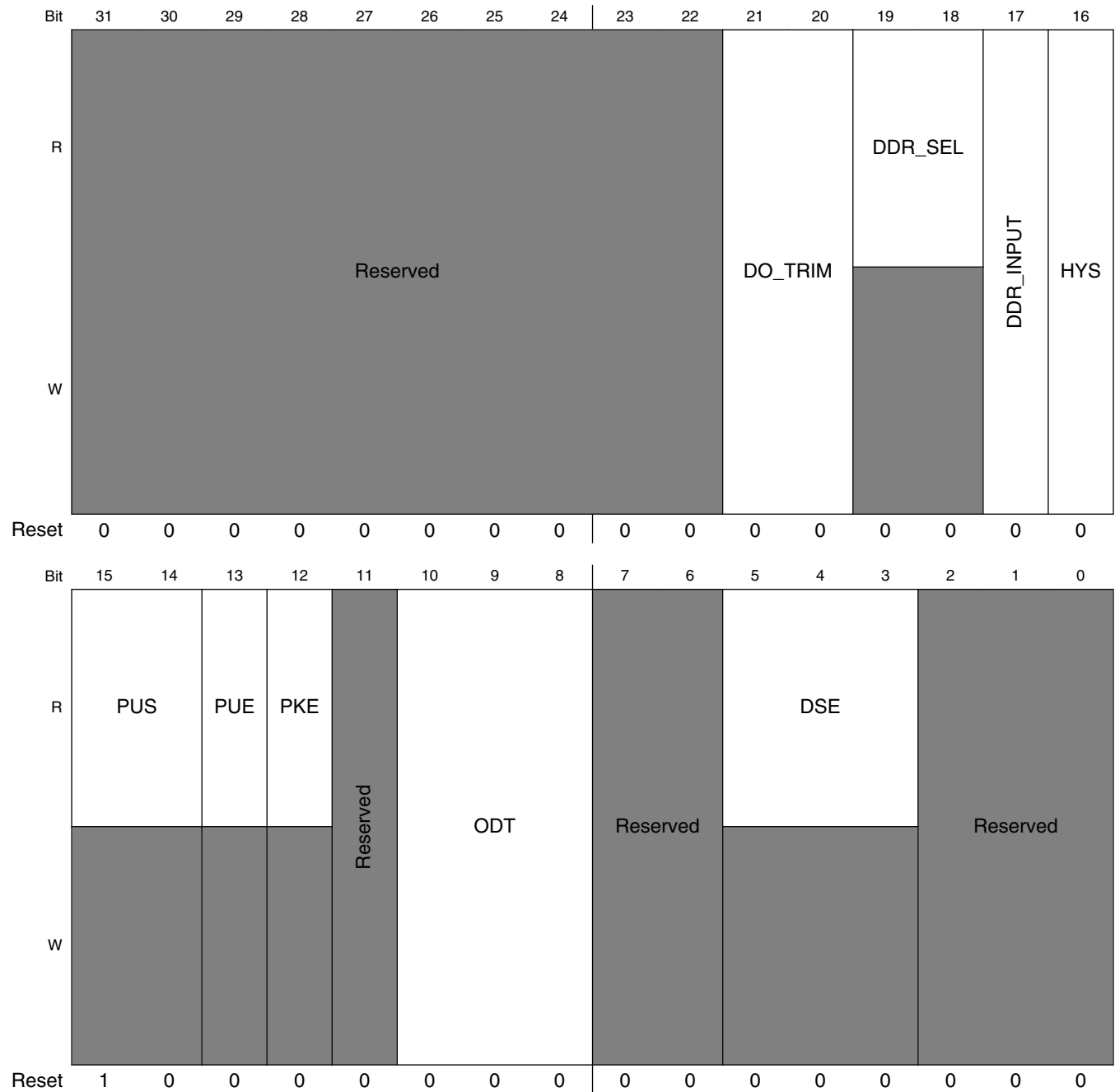

IOMUXC_SW_PAD_CTL_PAD_DRAM_ADDR14 field descriptions

Field	Description
31–22 -	This field is reserved. Reserved
21–20 DO_TRIM	do_trim Field Select one out of next values for pad: DRAM_ADDR14 00 DO_TRIM_0_min_delay — min delay 01 DO_TRIM_1_50ps_ipp_do_pad_delay — + ~50ps ipp_do -> pad delay 10 DO_TRIM_2_100ps_ipp_do_pad_delay — + ~100ps ipp_do -> pad delay 11 DO_TRIM_3_150ps_ipp_do_pad_delay — + ~150ps ipp_do -> pad delay
19–18 DDR_SEL	ddr_sel Field Read Only Field 0 DDR_SEL — RESERVED
17 DDR_INPUT	DDR / CMOS Input Mode Field Select one out of next values for pad: DRAM_ADDR14 0 DDR_INPUT_0_CMOS_input_type — CMOS input type 1 DDR_INPUT_1_Differential_input_mode — Differential input mode
16 HYS	Hyst. Enable Field Select one out of next values for pad: DRAM_ADDR14 0 HYS_0_Hysteresis_Disabled — Hysteresis Disabled 1 HYS_1_Hysteresis_Enabled — Hysteresis Enabled
15–14 PUS	Pull Up / Down Config. Field Read Only Field 10 PUS — 100K Ohm Pull Up
13 PUE	Pull / Keep Select Field Read Only Field 0 PUE — Keeper
12 PKE	Pull / Keep Enable Field Read Only Field 0 PKE — Pull/Keeper Disabled
11 -	This field is reserved. Reserved
10–8 ODT	On Die Termination Field Select one out of next values for pad: DRAM_ADDR14 000 ODT_0_off — off 001 ODT_1_120_Ohm_ODT — 120 Ohm ODT 010 ODT_2_60_Ohm_ODT — 60 Ohm ODT

Table continues on the next page...

IOMUXC_SW_PAD_CTL_PAD_DRAM_ADDR14 field descriptions (continued)

Field	Description
	011 ODT_3_40_Ohm_ODT — 40 Ohm ODT 100 ODT_4_30_Ohm_ODT — 30 Ohm ODT 101 ODT_5_24_Ohm_ODT — 24 Ohm ODT 110 ODT_6_20_Ohm_ODT — 20 Ohm ODT 111 ODT_7_17_Ohm_ODT — 17 Ohm ODT
7–6 -	This field is reserved. Reserved
5–3 DSE	Drive Strength Field Read Only Field 0 DSE — output driver disabled;
-	This field is reserved. Reserved

32.6.128 SW_PAD_CTL_PAD_DRAM_ADDR15 SW PAD Control Register (IOMUXC_SW_PAD_CTL_PAD_DRAM_ADDR15)

SW_PAD_CTL Register

Address: 20E_0000h base + 240h offset = 20E_0240h

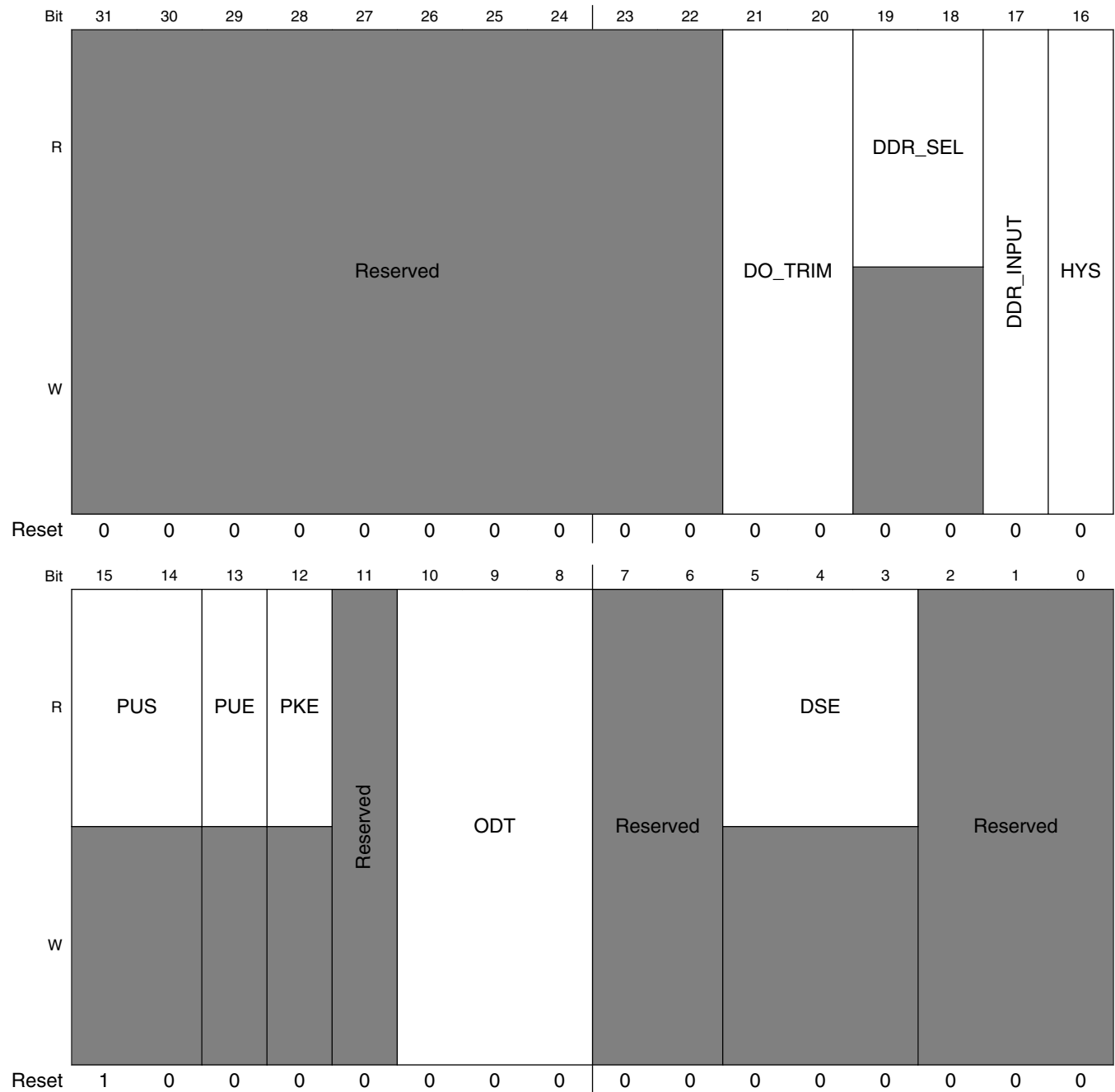

IOMUXC_SW_PAD_CTL_PAD_DRAM_ADDR15 field descriptions

Field	Description
31–22 -	This field is reserved. Reserved
21–20 DO_TRIM	do_trim Field Select one out of next values for pad: DRAM_ADDR15 00 DO_TRIM_0_min_delay — min delay 01 DO_TRIM_1_50ps_ipp_do_pad_delay — + ~50ps ipp_do -> pad delay 10 DO_TRIM_2_100ps_ipp_do_pad_delay — + ~100ps ipp_do -> pad delay 11 DO_TRIM_3_150ps_ipp_do_pad_delay — + ~150ps ipp_do -> pad delay
19–18 DDR_SEL	ddr_sel Field Read Only Field 0 DDR_SEL — RESERVED
17 DDR_INPUT	DDR / CMOS Input Mode Field Select one out of next values for pad: DRAM_ADDR15 0 DDR_INPUT_0_CMOS_input_type — CMOS input type 1 DDR_INPUT_1_Differential_input_mode — Differential input mode
16 HYS	Hyst. Enable Field Select one out of next values for pad: DRAM_ADDR15 0 HYS_0_Hysteresis_Disabled — Hysteresis Disabled 1 HYS_1_Hysteresis_Enabled — Hysteresis Enabled
15–14 PUS	Pull Up / Down Config. Field Read Only Field 10 PUS — 100K Ohm Pull Up
13 PUE	Pull / Keep Select Field Read Only Field 0 PUE — Keeper
12 PKE	Pull / Keep Enable Field Read Only Field 0 PKE — Pull/Keeper Disabled
11 -	This field is reserved. Reserved
10–8 ODT	On Die Termination Field Select one out of next values for pad: DRAM_ADDR15 000 ODT_0_off — off 001 ODT_1_120_Ohm_ODT — 120 Ohm ODT 010 ODT_2_60_Ohm_ODT — 60 Ohm ODT

Table continues on the next page...

IOMUXC_SW_PAD_CTL_PAD_DRAM_ADDR15 field descriptions (continued)

Field	Description
	011 ODT_3_40_Ohm_ODT — 40 Ohm ODT 100 ODT_4_30_Ohm_ODT — 30 Ohm ODT 101 ODT_5_24_Ohm_ODT — 24 Ohm ODT 110 ODT_6_20_Ohm_ODT — 20 Ohm ODT 111 ODT_7_17_Ohm_ODT — 17 Ohm ODT
7–6 -	This field is reserved. Reserved
5–3 DSE	Drive Strength Field Read Only Field 0 DSE — output driver disabled;
-	This field is reserved. Reserved

32.6.129 SW_PAD_CTL_PAD_DRAM_DQM0 SW PAD Control Register (IOMUXC_SW_PAD_CTL_PAD_DRAM_DQM0)

SW_PAD_CTL Register

Address: 20E_0000h base + 244h offset = 20E_0244h

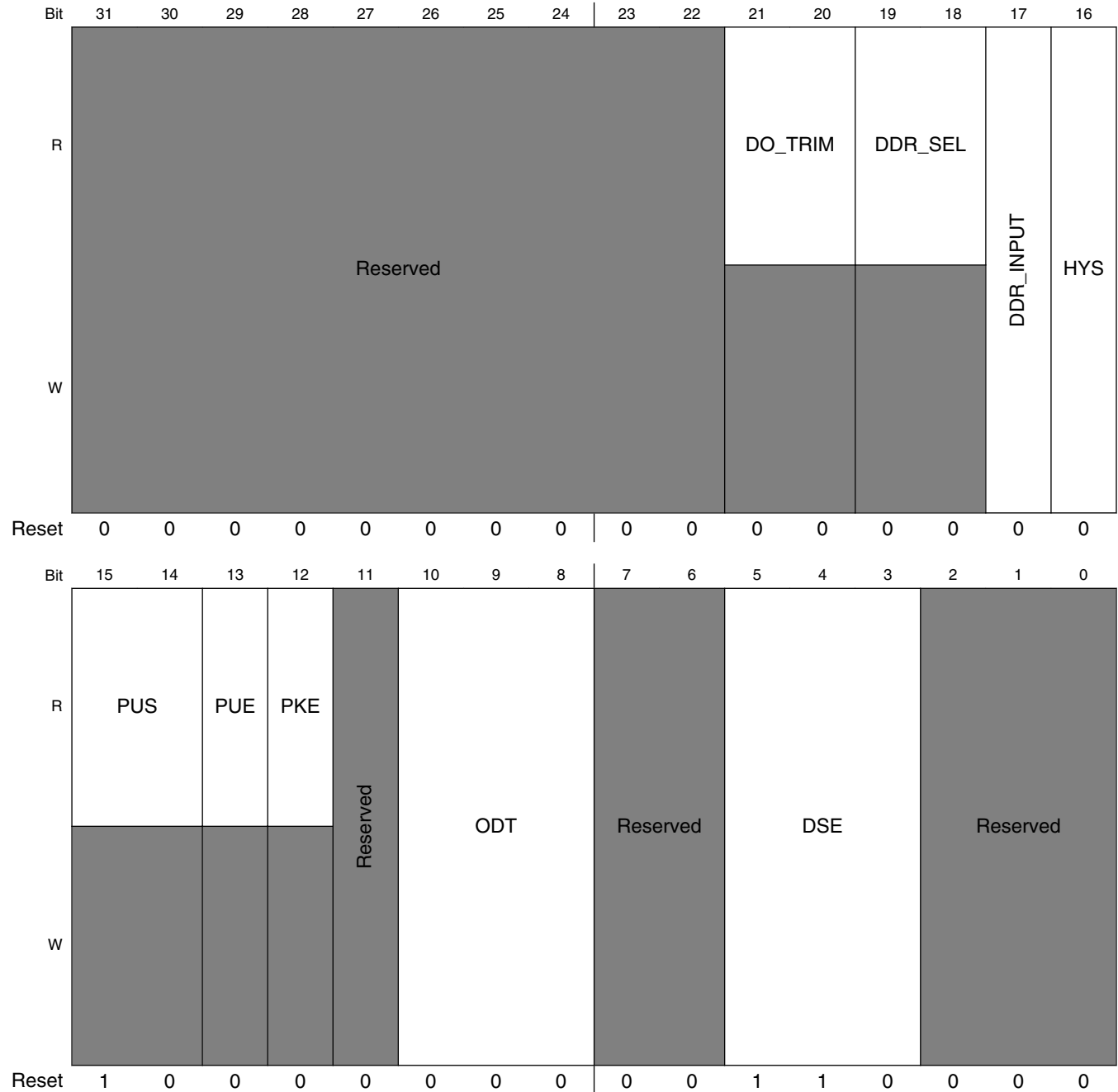

IOMUXC_SW_PAD_CTL_PAD_DRAM_DQM0 field descriptions

Field	Description
31–22 -	This field is reserved. Reserved
21–20 DO_TRIM	do_trim Field Read Only Field 0 DO_TRIM — min delay
19–18 DDR_SEL	ddr_sel Field Read Only Field 0 DDR_SEL — RESERVED
17 DDR_INPUT	DDR / CMOS Input Mode Field Select one out of next values for pad: DRAM_DQM0 0 DDR_INPUT_0_CMOS_input_type — CMOS input type 1 DDR_INPUT_1_Differential_input_mode — Differential input mode
16 HYS	Hyst. Enable Field Select one out of next values for pad: DRAM_DQM0 0 HYS_0_Hysteresis_Disabled — Hysteresis Disabled 1 HYS_1_Hysteresis_Enabled — Hysteresis Enabled
15–14 PUS	Pull Up / Down Config. Field Read Only Field 10 PUS — 100K Ohm Pull Up
13 PUE	Pull / Keep Select Field Read Only Field 0 PUE — Keeper
12 PKE	Pull / Keep Enable Field Read Only Field 0 PKE — Pull/Keeper Disabled
11 -	This field is reserved. Reserved
10–8 ODT	On Die Termination Field Select one out of next values for pad: DRAM_DQM0 000 ODT_0_off — off 001 ODT_1_120_Ohm_ODT — 120 Ohm ODT 010 ODT_2_60_Ohm_ODT — 60 Ohm ODT 011 ODT_3_40_Ohm_ODT — 40 Ohm ODT 100 ODT_4_30_Ohm_ODT — 30 Ohm ODT 101 ODT_5_24_Ohm_ODT — 24 Ohm ODT

Table continues on the next page...

IOMUXC_SW_PAD_CTL_PAD_DRAM_DQM0 field descriptions (continued)

Field	Description
	110 ODT_6_20_Ohm_ODT — 20 Ohm ODT 111 ODT_7_17_Ohm_ODT — 17 Ohm ODT
7–6 -	This field is reserved. Reserved
5–3 DSE	Drive Strength Field Select one out of next values for pad: DRAM_DQM0 000 DSE_0_output_driver_disabled_ — output driver disabled; 001 DSE_1_R0_260_Ohm__3_3V__150_Ohm_1_8V__240_Ohm_for_DDR_ — R0(260 Ohm @ 3.3V, 150 Ohm@1.8V, 240 Ohm for DDR) 010 DSE_2_R0_2 — R0/2 011 DSE_3_R0_3 — R0/3 100 DSE_4_R0_4 — R0/4 101 DSE_5_R0_5 — R0/5 110 DSE_6_R0_6 — R0/6 111 DSE_7_R0_7 — R0/7
-	This field is reserved. Reserved

32.6.130 SW_PAD_CTL_PAD_DRAM_DQM1 SW PAD Control Register (IOMUXC_SW_PAD_CTL_PAD_DRAM_DQM1)

SW_PAD_CTL Register

Address: 20E_0000h base + 248h offset = 20E_0248h

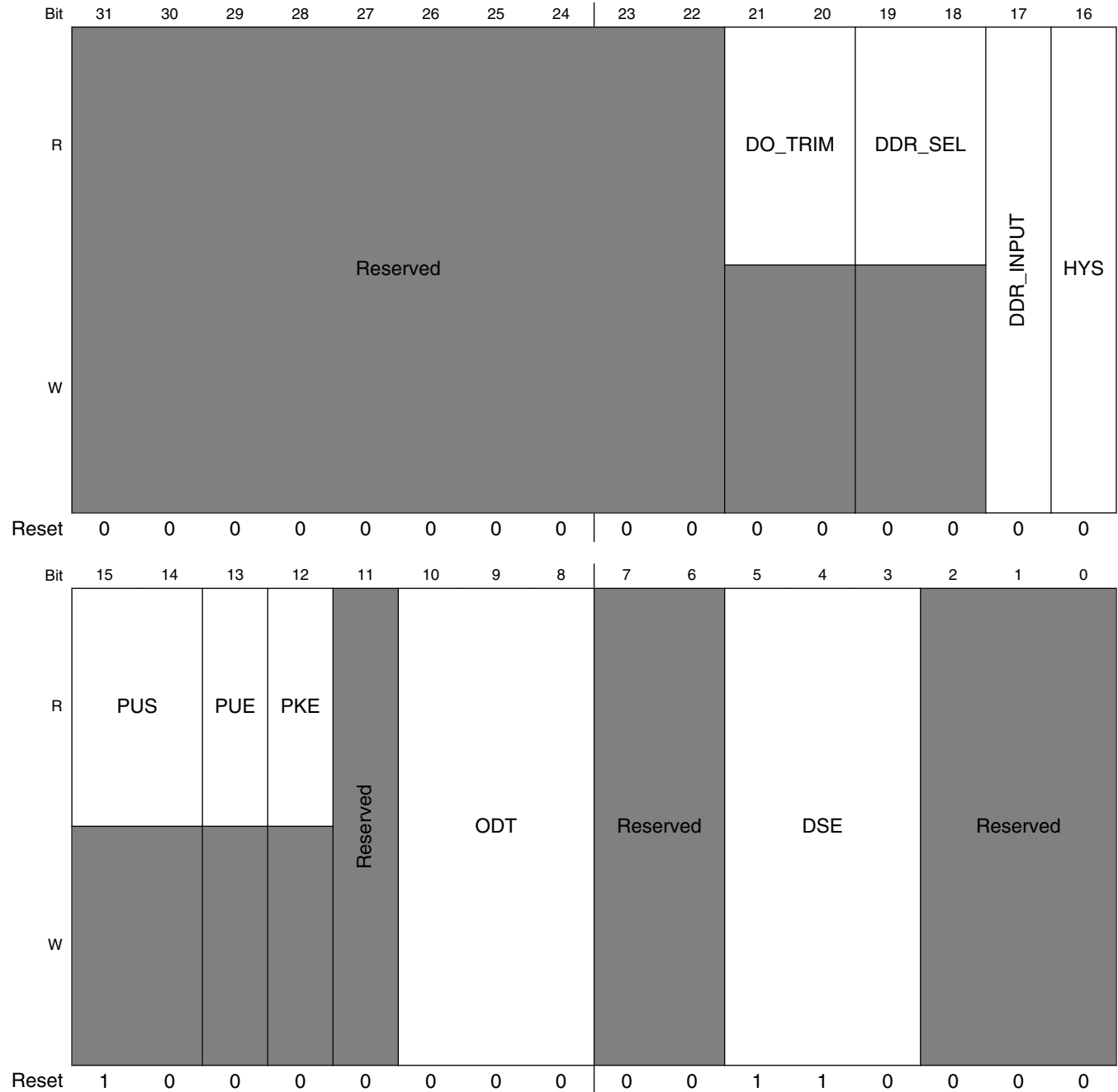

IOMUXC_SW_PAD_CTL_PAD_DRAM_DQM1 field descriptions

Field	Description
31–22 -	This field is reserved. Reserved
21–20 DO_TRIM	do_trim Field Read Only Field 0 DO_TRIM — min delay
19–18 DDR_SEL	ddr_sel Field Read Only Field 0 DDR_SEL — RESERVED
17 DDR_INPUT	DDR / CMOS Input Mode Field Select one out of next values for pad: DRAM_DQM1 0 DDR_INPUT_0_CMOS_input_type — CMOS input type 1 DDR_INPUT_1_Differential_input_mode — Differential input mode
16 HYS	Hyst. Enable Field Select one out of next values for pad: DRAM_DQM1 0 HYS_0_Hysteresis_Disabled — Hysteresis Disabled 1 HYS_1_Hysteresis_Enabled — Hysteresis Enabled
15–14 PUS	Pull Up / Down Config. Field Read Only Field 10 PUS — 100K Ohm Pull Up
13 PUE	Pull / Keep Select Field Read Only Field 0 PUE — Keeper
12 PKE	Pull / Keep Enable Field Read Only Field 0 PKE — Pull/Keeper Disabled
11 -	This field is reserved. Reserved
10–8 ODT	On Die Termination Field Select one out of next values for pad: DRAM_DQM1 000 ODT_0_off — off 001 ODT_1_120_Ohm_ODT — 120 Ohm ODT 010 ODT_2_60_Ohm_ODT — 60 Ohm ODT 011 ODT_3_40_Ohm_ODT — 40 Ohm ODT 100 ODT_4_30_Ohm_ODT — 30 Ohm ODT 101 ODT_5_24_Ohm_ODT — 24 Ohm ODT

Table continues on the next page...

IOMUXC_SW_PAD_CTL_PAD_DRAM_DQM1 field descriptions (continued)

Field	Description
	110 ODT_6_20_Ohm_ODT — 20 Ohm ODT 111 ODT_7_17_Ohm_ODT — 17 Ohm ODT
7–6 -	This field is reserved. Reserved
5–3 DSE	Drive Strength Field Select one out of next values for pad: DRAM_DQM1 000 DSE_0_output_driver_disabled_ — output driver disabled; 001 DSE_1_R0_260_Ohm__3_3V__150_Ohm_1_8V__240_Ohm_for_DDR_ — R0(260 Ohm @ 3.3V, 150 Ohm@1.8V, 240 Ohm for DDR) 010 DSE_2_R0_2 — R0/2 011 DSE_3_R0_3 — R0/3 100 DSE_4_R0_4 — R0/4 101 DSE_5_R0_5 — R0/5 110 DSE_6_R0_6 — R0/6 111 DSE_7_R0_7 — R0/7
-	This field is reserved. Reserved

32.6.131 SW_PAD_CTL_PAD_DRAM_RAS_B SW PAD Control Register (IOMUXC_SW_PAD_CTL_PAD_DRAM_RAS_B)

SW_PAD_CTL Register

Address: 20E_0000h base + 24Ch offset = 20E_024Ch

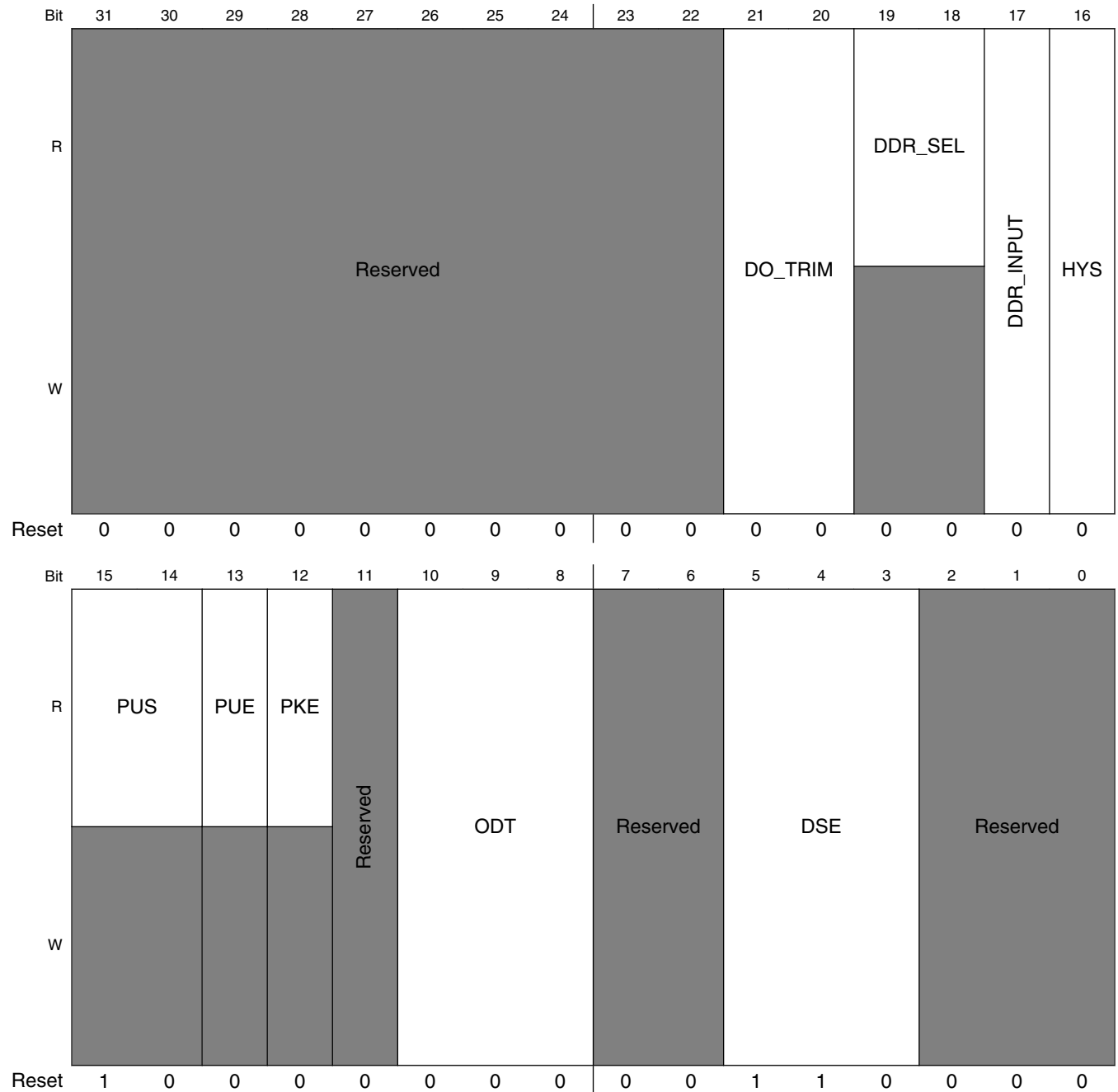

IOMUXC_SW_PAD_CTL_PAD_DRAM_RAS_B field descriptions

Field	Description
31–22 -	This field is reserved. Reserved
21–20 DO_TRIM	do_trim Field Select one out of next values for pad: DRAM_RAS_B 00 DO_TRIM_0_min_delay — min delay 01 DO_TRIM_1_50ps_ipp_do_pad_delay — + ~50ps ipp_do -> pad delay 10 DO_TRIM_2_100ps_ipp_do_pad_delay — + ~100ps ipp_do -> pad delay 11 DO_TRIM_3_150ps_ipp_do_pad_delay — + ~150ps ipp_do -> pad delay
19–18 DDR_SEL	ddr_sel Field Read Only Field 0 DDR_SEL — RESERVED
17 DDR_INPUT	DDR / CMOS Input Mode Field Select one out of next values for pad: DRAM_RAS_B 0 DDR_INPUT_0_CMOS_input_type — CMOS input type 1 DDR_INPUT_1_Differential_input_mode — Differential input mode
16 HYS	Hyst. Enable Field Select one out of next values for pad: DRAM_RAS_B 0 HYS_0_Hysteresis_Disabled — Hysteresis Disabled 1 HYS_1_Hysteresis_Enabled — Hysteresis Enabled
15–14 PUS	Pull Up / Down Config. Field Read Only Field 10 PUS — 100K Ohm Pull Up
13 PUE	Pull / Keep Select Field Read Only Field 0 PUE — Keeper
12 PKE	Pull / Keep Enable Field Read Only Field 0 PKE — Pull/Keeper Disabled
11 -	This field is reserved. Reserved
10–8 ODT	On Die Termination Field Select one out of next values for pad: DRAM_RAS_B 000 ODT_0_off — off 001 ODT_1_120_Ohm_ODT — 120 Ohm ODT 010 ODT_2_60_Ohm_ODT — 60 Ohm ODT

Table continues on the next page...

IOMUXC_SW_PAD_CTL_PAD_DRAM_RAS_B field descriptions (continued)

Field	Description
	011 ODT_3_40_Ohm_ODT — 40 Ohm ODT 100 ODT_4_30_Ohm_ODT — 30 Ohm ODT 101 ODT_5_24_Ohm_ODT — 24 Ohm ODT 110 ODT_6_20_Ohm_ODT — 20 Ohm ODT 111 ODT_7_17_Ohm_ODT — 17 Ohm ODT
7–6 -	This field is reserved. Reserved
5–3 DSE	Drive Strength Field Select one out of next values for pad: DRAM_RAS_B 000 DSE_0_output_driver_disabled_ — output driver disabled; 001 DSE_1_R0_260_Ohm_3_3V_150_Ohm_1_8V_240_Ohm_for_DDR_ — R0(260 Ohm @ 3.3V, 150 Ohm@1.8V, 240 Ohm for DDR) 010 DSE_2_R0_2 — R0/2 011 DSE_3_R0_3 — R0/3 100 DSE_4_R0_4 — R0/4 101 DSE_5_R0_5 — R0/5 110 DSE_6_R0_6 — R0/6 111 DSE_7_R0_7 — R0/7
-	This field is reserved. Reserved

32.6.132 SW_PAD_CTL_PAD_DRAM_CAS_B SW PAD Control Register (IOMUXC_SW_PAD_CTL_PAD_DRAM_CAS_B)

SW_PAD_CTL Register

Address: 20E_0000h base + 250h offset = 20E_0250h

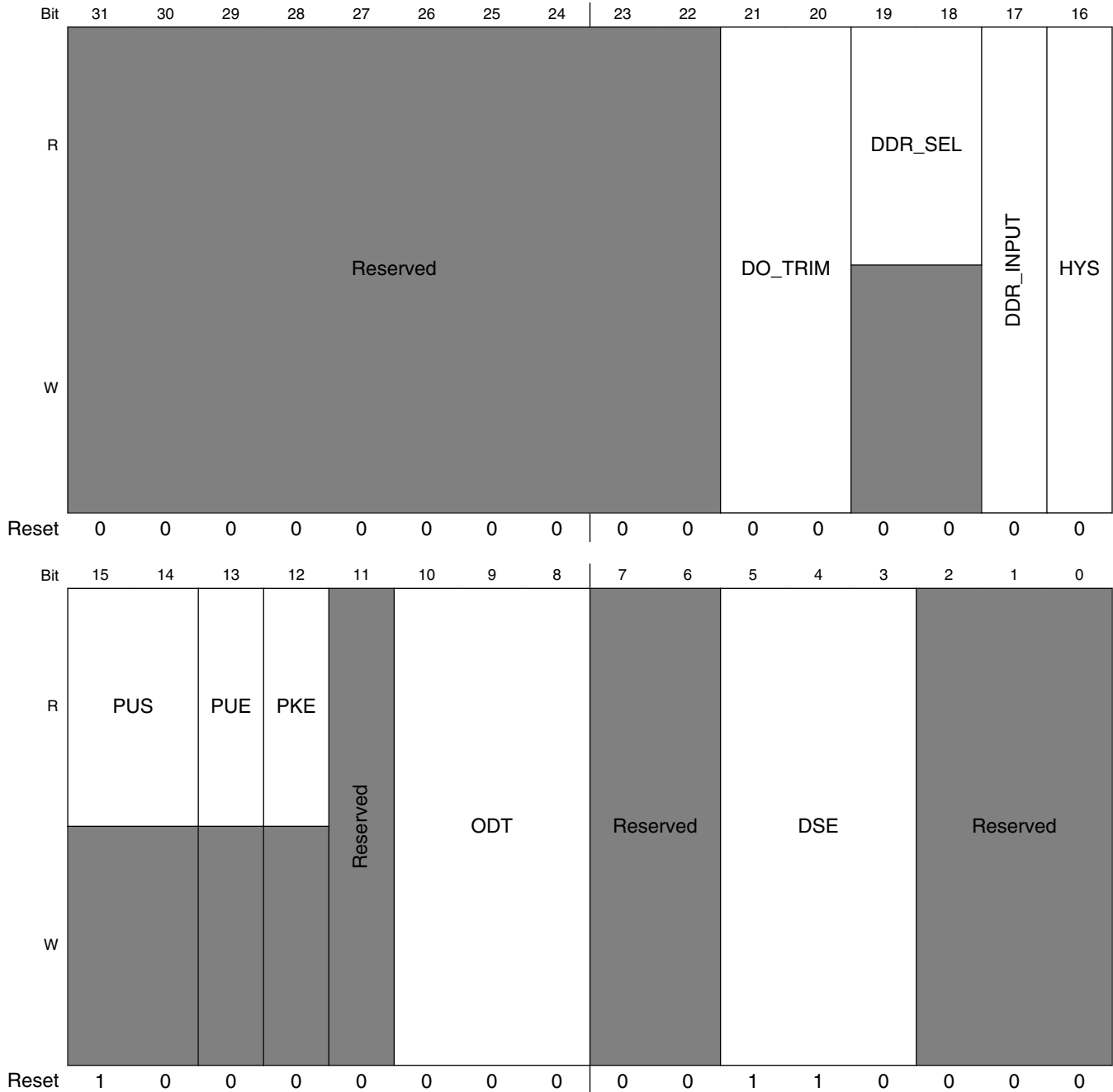

IOMUXC_SW_PAD_CTL_PAD_DRAM_CAS_B field descriptions

Field	Description
31–22 -	This field is reserved. Reserved
21–20 DO_TRIM	do_trim Field Select one out of next values for pad: DRAM_CAS_B 00 DO_TRIM_0_min_delay — min delay 01 DO_TRIM_1_50ps_ipp_do_pad_delay — + ~50ps ipp_do -> pad delay 10 DO_TRIM_2_100ps_ipp_do_pad_delay — + ~100ps ipp_do -> pad delay 11 DO_TRIM_3_150ps_ipp_do_pad_delay — + ~150ps ipp_do -> pad delay
19–18 DDR_SEL	ddr_sel Field Read Only Field 0 DDR_SEL — RESERVED
17 DDR_INPUT	DDR / CMOS Input Mode Field Select one out of next values for pad: DRAM_CAS_B 0 DDR_INPUT_0_CMOS_input_type — CMOS input type 1 DDR_INPUT_1_Differential_input_mode — Differential input mode
16 HYS	Hyst. Enable Field Select one out of next values for pad: DRAM_CAS_B 0 HYS_0_Hysteresis_Disabled — Hysteresis Disabled 1 HYS_1_Hysteresis_Enabled — Hysteresis Enabled
15–14 PUS	Pull Up / Down Config. Field Read Only Field 10 PUS — 100K Ohm Pull Up
13 PUE	Pull / Keep Select Field Read Only Field 0 PUE — Keeper
12 PKE	Pull / Keep Enable Field Read Only Field 0 PKE — Pull/Keeper Disabled
11 -	This field is reserved. Reserved
10–8 ODT	On Die Termination Field Select one out of next values for pad: DRAM_CAS_B 000 ODT_0_off — off 001 ODT_1_120_Ohm_ODT — 120 Ohm ODT 010 ODT_2_60_Ohm_ODT — 60 Ohm ODT

Table continues on the next page...

IOMUXC_SW_PAD_CTL_PAD_DRAM_CAS_B field descriptions (continued)

Field	Description
	011 ODT_3_40_Ohm_ODT — 40 Ohm ODT 100 ODT_4_30_Ohm_ODT — 30 Ohm ODT 101 ODT_5_24_Ohm_ODT — 24 Ohm ODT 110 ODT_6_20_Ohm_ODT — 20 Ohm ODT 111 ODT_7_17_Ohm_ODT — 17 Ohm ODT
7–6 -	This field is reserved. Reserved
5–3 DSE	Drive Strength Field Select one out of next values for pad: DRAM_CAS_B 000 DSE_0_output_driver_disabled_ — output driver disabled; 001 DSE_1_R0_260_Ohm_3_3V_150_Ohm_1_8V_240_Ohm_for_DDR_ — R0(260 Ohm @ 3.3V, 150 Ohm@1.8V, 240 Ohm for DDR) 010 DSE_2_R0_2 — R0/2 011 DSE_3_R0_3 — R0/3 100 DSE_4_R0_4 — R0/4 101 DSE_5_R0_5 — R0/5 110 DSE_6_R0_6 — R0/6 111 DSE_7_R0_7 — R0/7
-	This field is reserved. Reserved

32.6.133 SW_PAD_CTL_PAD_DRAM_CS0_B SW PAD Control Register (IOMUXC_SW_PAD_CTL_PAD_DRAM_CS0_B)

SW_PAD_CTL Register

Address: 20E_0000h base + 254h offset = 20E_0254h

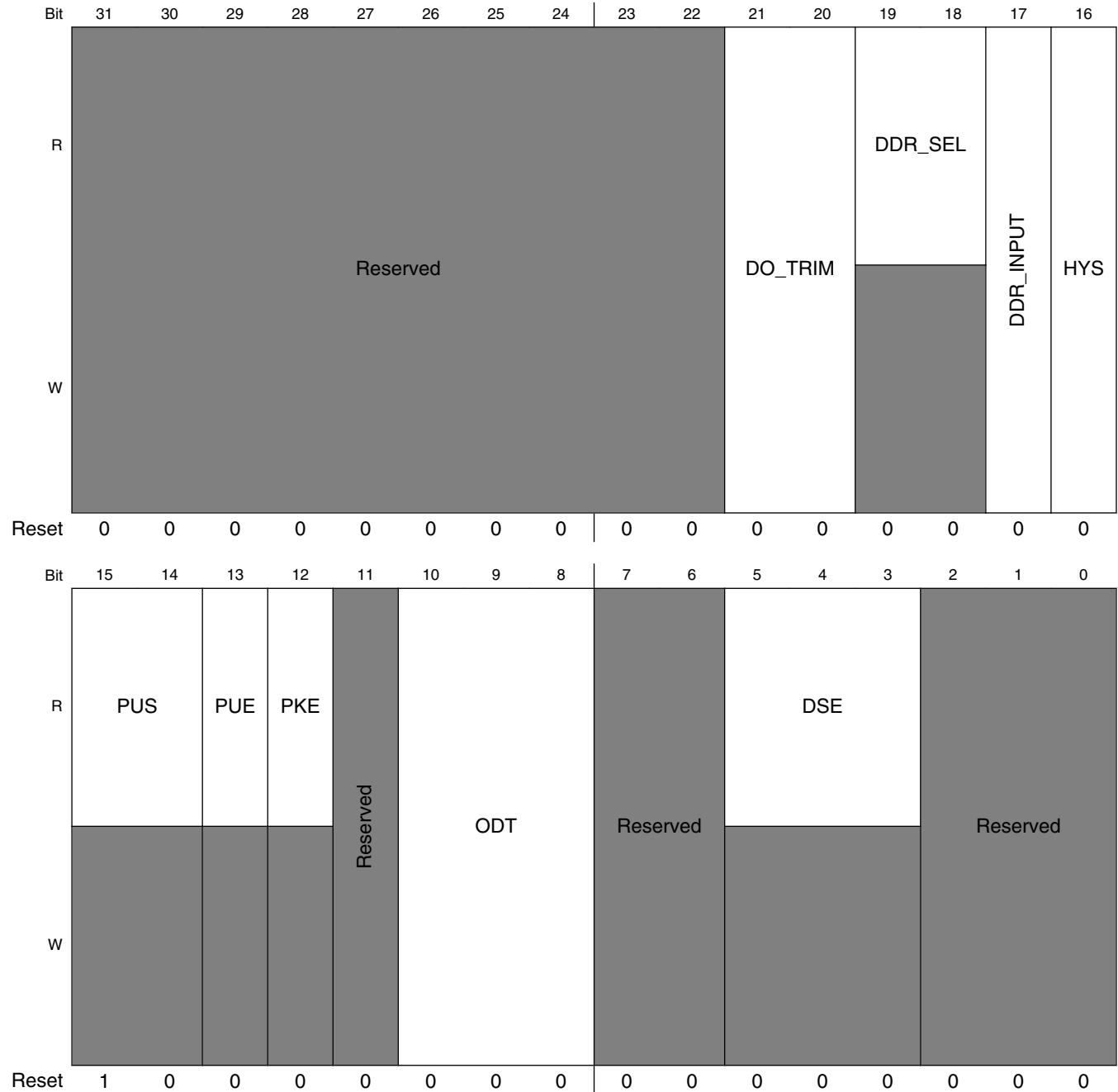

IOMUXC_SW_PAD_CTL_PAD_DRAM_CS0_B field descriptions

Field	Description
31–22 -	This field is reserved. Reserved
21–20 DO_TRIM	do_trim Field Select one out of next values for pad: DRAM_CS0_B 00 DO_TRIM_0_min_delay — min delay 01 DO_TRIM_1_50ps_ipp_do_pad_delay — + ~50ps ipp_do -> pad delay 10 DO_TRIM_2_100ps_ipp_do_pad_delay — + ~100ps ipp_do -> pad delay 11 DO_TRIM_3_150ps_ipp_do_pad_delay — + ~150ps ipp_do -> pad delay
19–18 DDR_SEL	ddr_sel Field Read Only Field 0 DDR_SEL — RESERVED
17 DDR_INPUT	DDR / CMOS Input Mode Field Select one out of next values for pad: DRAM_CS0_B 0 DDR_INPUT_0_CMOS_input_type — CMOS input type 1 DDR_INPUT_1_Differential_input_mode — Differential input mode
16 HYS	Hyst. Enable Field Select one out of next values for pad: DRAM_CS0_B 0 HYS_0_Hysteresis_Disabled — Hysteresis Disabled 1 HYS_1_Hysteresis_Enabled — Hysteresis Enabled
15–14 PUS	Pull Up / Down Config. Field Read Only Field 10 PUS — 100K Ohm Pull Up
13 PUE	Pull / Keep Select Field Read Only Field 0 PUE — Keeper
12 PKE	Pull / Keep Enable Field Read Only Field 0 PKE — Pull/Keeper Disabled
11 -	This field is reserved. Reserved
10–8 ODT	On Die Termination Field Select one out of next values for pad: DRAM_CS0_B 000 ODT_0_off — off 001 ODT_1_120_Ohm_ODT — 120 Ohm ODT 010 ODT_2_60_Ohm_ODT — 60 Ohm ODT

Table continues on the next page...

IOMUXC_SW_PAD_CTL_PAD_DRAM_CS0_B field descriptions (continued)

Field	Description
	011 ODT_3_40_Ohm_ODT — 40 Ohm ODT 100 ODT_4_30_Ohm_ODT — 30 Ohm ODT 101 ODT_5_24_Ohm_ODT — 24 Ohm ODT 110 ODT_6_20_Ohm_ODT — 20 Ohm ODT 111 ODT_7_17_Ohm_ODT — 17 Ohm ODT
7–6 -	This field is reserved. Reserved
5–3 DSE	Drive Strength Field Read Only Field 0 DSE — output driver disabled;
-	This field is reserved. Reserved

32.6.134 SW_PAD_CTL_PAD_DRAM_CS1_B SW PAD Control Register (IOMUXC_SW_PAD_CTL_PAD_DRAM_CS1_B)

SW_PAD_CTL Register

Address: 20E_0000h base + 258h offset = 20E_0258h

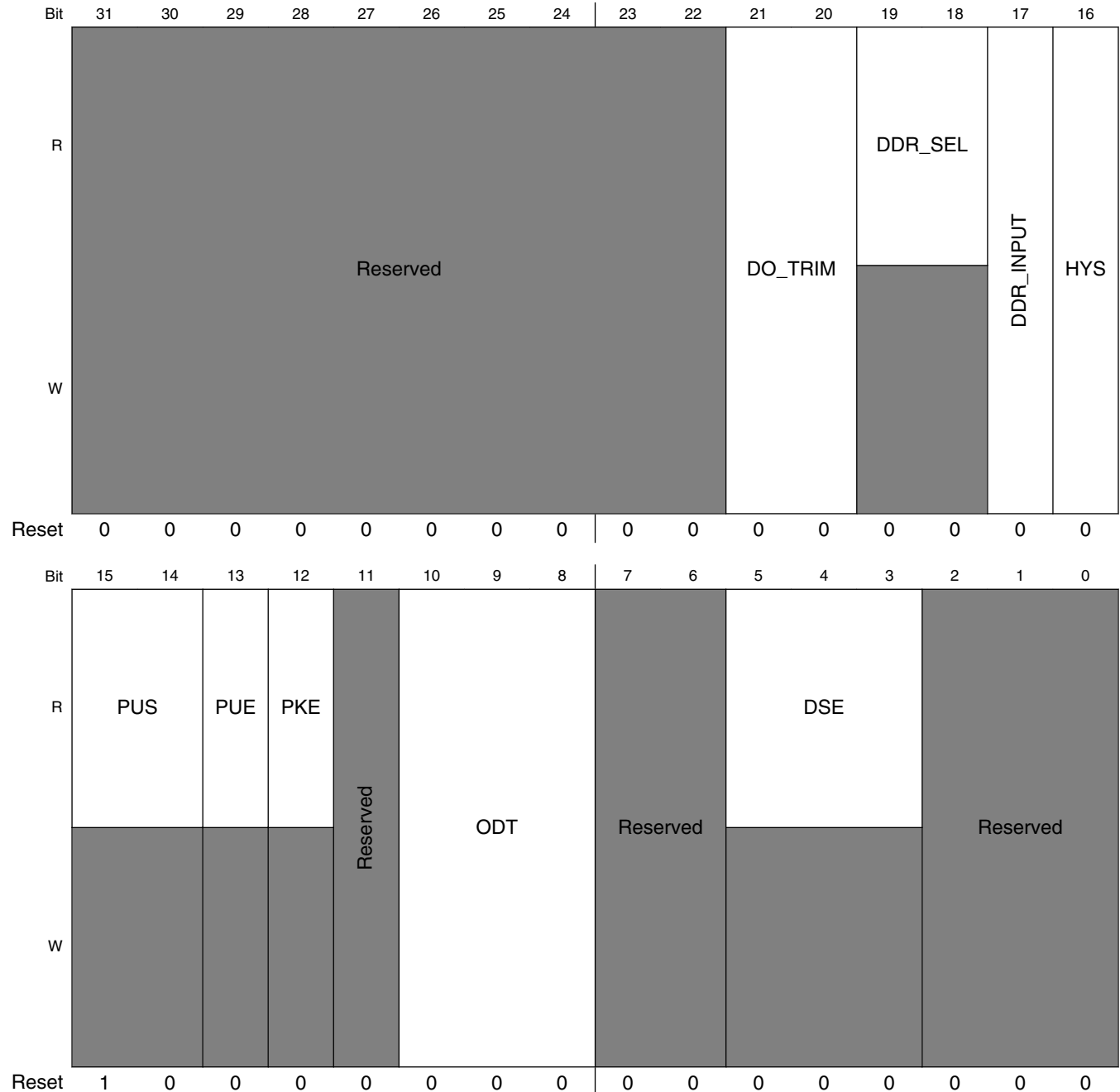

IOMUXC_SW_PAD_CTL_PAD_DRAM_CS1_B field descriptions

Field	Description
31–22 -	This field is reserved. Reserved
21–20 DO_TRIM	do_trim Field Select one out of next values for pad: DRAM_CS1_B 00 DO_TRIM_0_min_delay — min delay 01 DO_TRIM_1_50ps_ipp_do_pad_delay — + ~50ps ipp_do -> pad delay 10 DO_TRIM_2_100ps_ipp_do_pad_delay — + ~100ps ipp_do -> pad delay 11 DO_TRIM_3_150ps_ipp_do_pad_delay — + ~150ps ipp_do -> pad delay
19–18 DDR_SEL	ddr_sel Field Read Only Field 0 DDR_SEL — RESERVED
17 DDR_INPUT	DDR / CMOS Input Mode Field Select one out of next values for pad: DRAM_CS1_B 0 DDR_INPUT_0_CMOS_input_type — CMOS input type 1 DDR_INPUT_1_Differential_input_mode — Differential input mode
16 HYS	Hyst. Enable Field Select one out of next values for pad: DRAM_CS1_B 0 HYS_0_Hysteresis_Disabled — Hysteresis Disabled 1 HYS_1_Hysteresis_Enabled — Hysteresis Enabled
15–14 PUS	Pull Up / Down Config. Field Read Only Field 10 PUS — 100K Ohm Pull Up
13 PUE	Pull / Keep Select Field Read Only Field 0 PUE — Keeper
12 PKE	Pull / Keep Enable Field Read Only Field 0 PKE — Pull/Keeper Disabled
11 -	This field is reserved. Reserved
10–8 ODT	On Die Termination Field Select one out of next values for pad: DRAM_CS1_B 000 ODT_0_off — off 001 ODT_1_120_Ohm_ODT — 120 Ohm ODT 010 ODT_2_60_Ohm_ODT — 60 Ohm ODT

Table continues on the next page...

IOMUXC_SW_PAD_CTL_PAD_DRAM_CS1_B field descriptions (continued)

Field	Description
	011 ODT_3_40_Ohm_ODT — 40 Ohm ODT 100 ODT_4_30_Ohm_ODT — 30 Ohm ODT 101 ODT_5_24_Ohm_ODT — 24 Ohm ODT 110 ODT_6_20_Ohm_ODT — 20 Ohm ODT 111 ODT_7_17_Ohm_ODT — 17 Ohm ODT
7–6 -	This field is reserved. Reserved
5–3 DSE	Drive Strength Field Read Only Field 0 DSE — output driver disabled;
-	This field is reserved. Reserved

32.6.135 SW_PAD_CTL_PAD_DRAM_SDWE_B SW PAD Control Register (IOMUXC_SW_PAD_CTL_PAD_DRAM_SDWE_B)

SW_PAD_CTL Register

Address: 20E_0000h base + 25Ch offset = 20E_025Ch

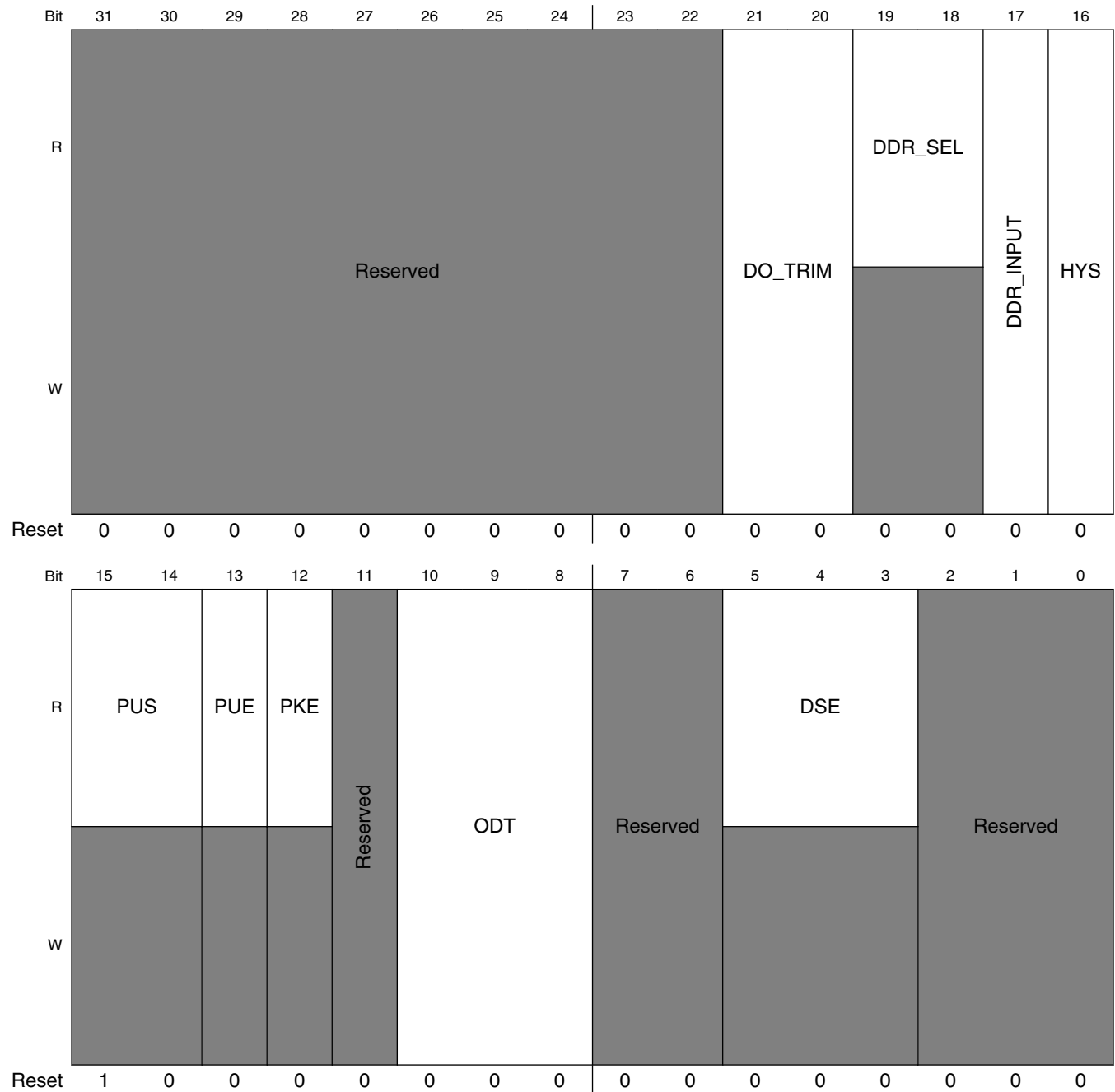

IOMUXC_SW_PAD_CTL_PAD_DRAM_SDWE_B field descriptions

Field	Description
31–22 -	This field is reserved. Reserved
21–20 DO_TRIM	do_trim Field Select one out of next values for pad: DRAM_SDWE_B 00 DO_TRIM_0_min_delay — min delay 01 DO_TRIM_1_50ps_ipp_do_pad_delay — + ~50ps ipp_do -> pad delay 10 DO_TRIM_2_100ps_ipp_do_pad_delay — + ~100ps ipp_do -> pad delay 11 DO_TRIM_3_150ps_ipp_do_pad_delay — + ~150ps ipp_do -> pad delay
19–18 DDR_SEL	ddr_sel Field Read Only Field 0 DDR_SEL — RESERVED
17 DDR_INPUT	DDR / CMOS Input Mode Field Select one out of next values for pad: DRAM_SDWE_B 0 DDR_INPUT_0_CMOS_input_type — CMOS input type 1 DDR_INPUT_1_Differential_input_mode — Differential input mode
16 HYS	Hyst. Enable Field Select one out of next values for pad: DRAM_SDWE_B 0 HYS_0_Hysteresis_Disabled — Hysteresis Disabled 1 HYS_1_Hysteresis_Enabled — Hysteresis Enabled
15–14 PUS	Pull Up / Down Config. Field Read Only Field 10 PUS — 100K Ohm Pull Up
13 PUE	Pull / Keep Select Field Read Only Field 0 PUE — Keeper
12 PKE	Pull / Keep Enable Field Read Only Field 0 PKE — Pull/Keeper Disabled
11 -	This field is reserved. Reserved
10–8 ODT	On Die Termination Field Select one out of next values for pad: DRAM_SDWE_B 000 ODT_0_off — off 001 ODT_1_120_Ohm_ODT — 120 Ohm ODT 010 ODT_2_60_Ohm_ODT — 60 Ohm ODT

Table continues on the next page...

IOMUXC_SW_PAD_CTL_PAD_DRAM_SDWE_B field descriptions (continued)

Field	Description
	011 ODT_3_40_Ohm_ODT — 40 Ohm ODT 100 ODT_4_30_Ohm_ODT — 30 Ohm ODT 101 ODT_5_24_Ohm_ODT — 24 Ohm ODT 110 ODT_6_20_Ohm_ODT — 20 Ohm ODT 111 ODT_7_17_Ohm_ODT — 17 Ohm ODT
7–6 -	This field is reserved. Reserved
5–3 DSE	Drive Strength Field Read Only Field 0 DSE — output driver disabled;
-	This field is reserved. Reserved

32.6.136 SW_PAD_CTL_PAD_DRAM_ODT0 SW PAD Control Register (IOMUXC_SW_PAD_CTL_PAD_DRAM_ODT0)

SW_PAD_CTL Register

Address: 20E_0000h base + 260h offset = 20E_0260h

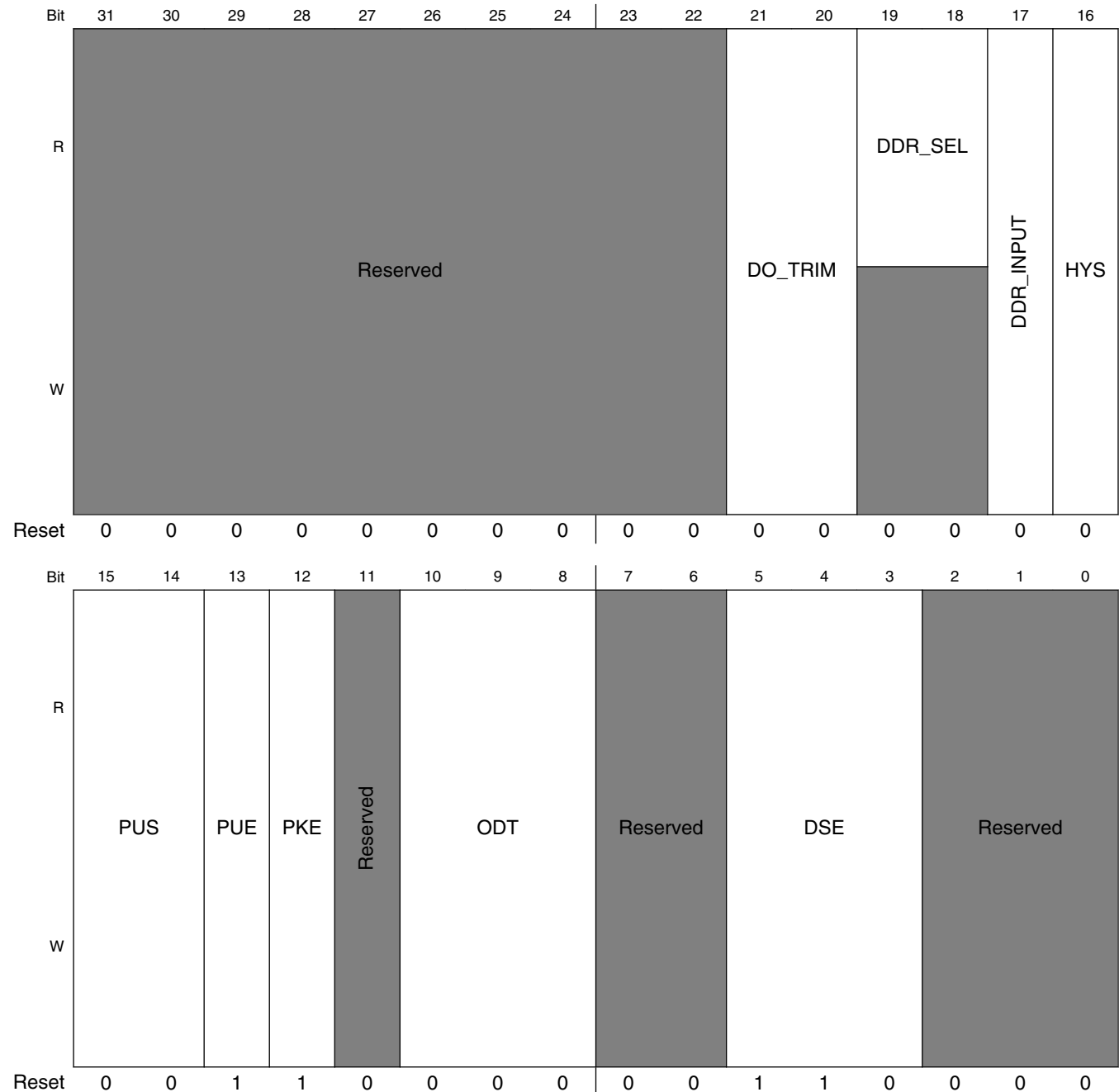

IOMUXC_SW_PAD_CTL_PAD_DRAM_ODT0 field descriptions

Field	Description
31–22 -	This field is reserved. Reserved
21–20 DO_TRIM	do_trim Field Select one out of next values for pad: DRAM_ODT0 00 DO_TRIM_0_min_delay — min delay 01 DO_TRIM_1_50ps_ipp_do_pad_delay — + ~50ps ipp_do -> pad delay 10 DO_TRIM_2_100ps_ipp_do_pad_delay — + ~100ps ipp_do -> pad delay 11 DO_TRIM_3_150ps_ipp_do_pad_delay — + ~150ps ipp_do -> pad delay
19–18 DDR_SEL	ddr_sel Field Read Only Field 0 DDR_SEL — RESERVED
17 DDR_INPUT	DDR / CMOS Input Mode Field Select one out of next values for pad: DRAM_ODT0 0 DDR_INPUT_0_CMOS_input_type — CMOS input type 1 DDR_INPUT_1_Differential_input_mode — Differential input mode
16 HYS	Hyst. Enable Field Select one out of next values for pad: DRAM_ODT0 0 HYS_0_Hysteresis_Disabled — Hysteresis Disabled 1 HYS_1_Hysteresis_Enabled — Hysteresis Enabled
15–14 PUS	Pull Up / Down Config. Field Select one out of next values for pad: DRAM_ODT0 00 PUS_0_100K_Ohm_Pull_Down — 100K Ohm Pull Down 01 PUS_1_47K_Ohm_Pull_Up — 47K Ohm Pull Up 10 PUS_2_100K_Ohm_Pull_Up — 100K Ohm Pull Up 11 PUS_3_22K_Ohm_Pull_Up — 22K Ohm Pull Up
13 PUE	Pull / Keep Select Field Select one out of next values for pad: DRAM_ODT0 0 PUE_0_Keeper — Keeper 1 PUE_1_Pull — Pull
12 PKE	Pull / Keep Enable Field Select one out of next values for pad: DRAM_ODT0 0 PKE_0_Pull_Keeper_Disabled — Pull/Keeper Disabled 1 PKE_1_Pull_Keeper_Enabled — Pull/Keeper Enabled
11 -	This field is reserved. Reserved
10–8 ODT	On Die Termination Field

Table continues on the next page...

IOMUXC_SW_PAD_CTL_PAD_DRAM_ODT0 field descriptions (continued)

Field	Description
	Select one out of next values for pad: DRAM_ODT0 000 ODT_0_off — off 001 ODT_1_120_Ohm_ODT — 120 Ohm ODT 010 ODT_2_60_Ohm_ODT — 60 Ohm ODT 011 ODT_3_40_Ohm_ODT — 40 Ohm ODT 100 ODT_4_30_Ohm_ODT — 30 Ohm ODT 101 ODT_5_24_Ohm_ODT — 24 Ohm ODT 110 ODT_6_20_Ohm_ODT — 20 Ohm ODT 111 ODT_7_17_Ohm_ODT — 17 Ohm ODT
7–6 -	This field is reserved. Reserved
5–3 DSE	Drive Strength Field Select one out of next values for pad: DRAM_ODT0 000 DSE_0_output_driver_disabled_ — output driver disabled; 001 DSE_1_R0_260_Ohm_3_3V_150_Ohm_1_8V_240_Ohm_for_DDR_ — R0(260 Ohm @ 3.3V, 150 Ohm@1.8V, 240 Ohm for DDR) 010 DSE_2_R0_2 — R0/2 011 DSE_3_R0_3 — R0/3 100 DSE_4_R0_4 — R0/4 101 DSE_5_R0_5 — R0/5 110 DSE_6_R0_6 — R0/6 111 DSE_7_R0_7 — R0/7
-	This field is reserved. Reserved

32.6.137 SW_PAD_CTL_PAD_DRAM_ODT1 SW PAD Control Register (IOMUXC_SW_PAD_CTL_PAD_DRAM_ODT1)

SW_PAD_CTL Register

Address: 20E_0000h base + 264h offset = 20E_0264h

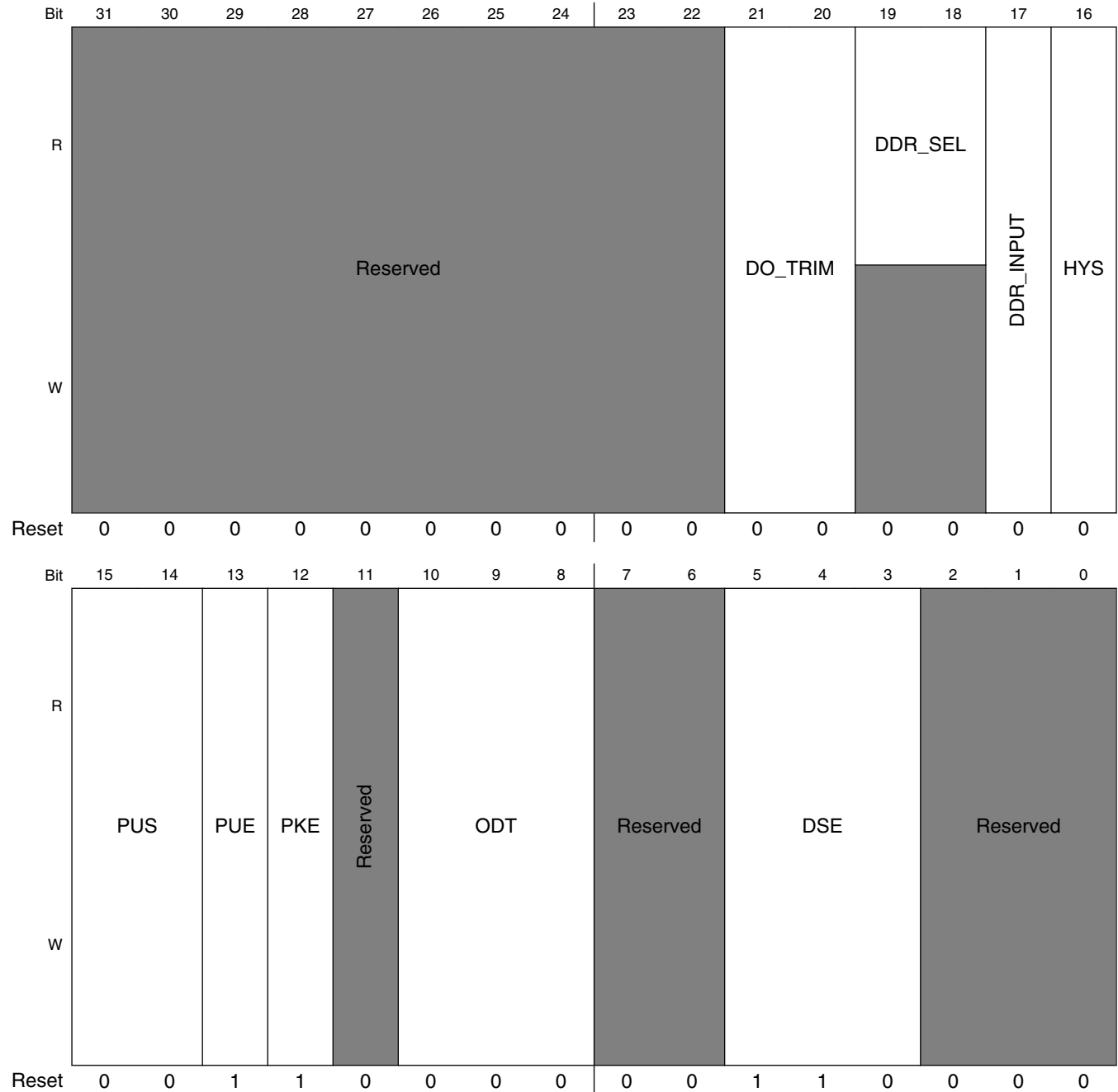

IOMUXC_SW_PAD_CTL_PAD_DRAM_ODT1 field descriptions

Field	Description
31–22 -	This field is reserved. Reserved
21–20 DO_TRIM	do_trim Field Select one out of next values for pad: DRAM_ODT1 00 DO_TRIM_0_min_delay — min delay 01 DO_TRIM_1_50ps_ipp_do_pad_delay — + ~50ps ipp_do -> pad delay 10 DO_TRIM_2_100ps_ipp_do_pad_delay — + ~100ps ipp_do -> pad delay 11 DO_TRIM_3_150ps_ipp_do_pad_delay — + ~150ps ipp_do -> pad delay
19–18 DDR_SEL	ddr_sel Field Read Only Field 0 DDR_SEL — RESERVED
17 DDR_INPUT	DDR / CMOS Input Mode Field Select one out of next values for pad: DRAM_ODT1 0 DDR_INPUT_0_CMOS_input_type — CMOS input type 1 DDR_INPUT_1_Differential_input_mode — Differential input mode
16 HYS	Hyst. Enable Field Select one out of next values for pad: DRAM_ODT1 0 HYS_0_Hysteresis_Disabled — Hysteresis Disabled 1 HYS_1_Hysteresis_Enabled — Hysteresis Enabled
15–14 PUS	Pull Up / Down Config. Field Select one out of next values for pad: DRAM_ODT1 00 PUS_0_100K_Ohm_Pull_Down — 100K Ohm Pull Down 01 PUS_1_47K_Ohm_Pull_Up — 47K Ohm Pull Up 10 PUS_2_100K_Ohm_Pull_Up — 100K Ohm Pull Up 11 PUS_3_22K_Ohm_Pull_Up — 22K Ohm Pull Up
13 PUE	Pull / Keep Select Field Select one out of next values for pad: DRAM_ODT1 0 PUE_0_Keeper — Keeper 1 PUE_1_Pull — Pull
12 PKE	Pull / Keep Enable Field Select one out of next values for pad: DRAM_ODT1 0 PKE_0_Pull_Keeper_Disabled — Pull/Keeper Disabled 1 PKE_1_Pull_Keeper_Enabled — Pull/Keeper Enabled
11 -	This field is reserved. Reserved
10–8 ODT	On Die Termination Field

Table continues on the next page...

IOMUXC_SW_PAD_CTL_PAD_DRAM_ODT1 field descriptions (continued)

Field	Description
	Select one out of next values for pad: DRAM_ODT1 000 ODT_0_off — off 001 ODT_1_120_Ohm_ODT — 120 Ohm ODT 010 ODT_2_60_Ohm_ODT — 60 Ohm ODT 011 ODT_3_40_Ohm_ODT — 40 Ohm ODT 100 ODT_4_30_Ohm_ODT — 30 Ohm ODT 101 ODT_5_24_Ohm_ODT — 24 Ohm ODT 110 ODT_6_20_Ohm_ODT — 20 Ohm ODT 111 ODT_7_17_Ohm_ODT — 17 Ohm ODT
7–6 -	This field is reserved. Reserved
5–3 DSE	Drive Strength Field Select one out of next values for pad: DRAM_ODT1 000 DSE_0_output_driver_disabled_ — output driver disabled; 001 DSE_1_R0_260_Ohm_3_3V_150_Ohm_1_8V_240_Ohm_for_DDR_ — R0(260 Ohm @ 3.3V, 150 Ohm@1.8V, 240 Ohm for DDR) 010 DSE_2_R0_2 — R0/2 011 DSE_3_R0_3 — R0/3 100 DSE_4_R0_4 — R0/4 101 DSE_5_R0_5 — R0/5 110 DSE_6_R0_6 — R0/6 111 DSE_7_R0_7 — R0/7
-	This field is reserved. Reserved

32.6.138 SW_PAD_CTL_PAD_DRAM_SDBA0 SW PAD Control Register (IOMUXC_SW_PAD_CTL_PAD_DRAM_SDBA0)

SW_PAD_CTL Register

Address: 20E_0000h base + 268h offset = 20E_0268h

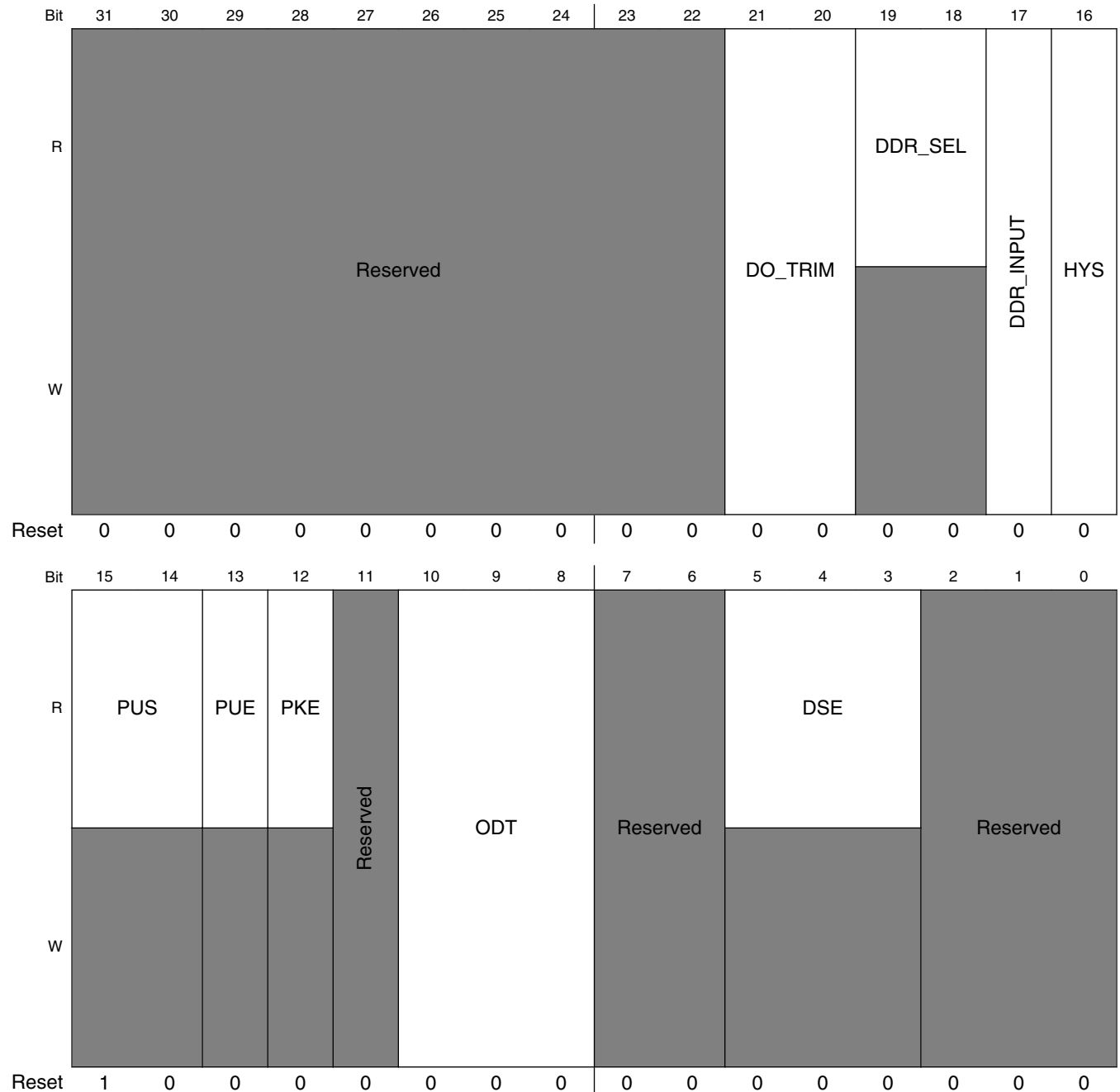

IOMUXC_SW_PAD_CTL_PAD_DRAM_SDBA0 field descriptions

Field	Description
31–22 -	This field is reserved. Reserved
21–20 DO_TRIM	do_trim Field Select one out of next values for pad: DRAM_SDBA0 00 DO_TRIM_0_min_delay — min delay 01 DO_TRIM_1_50ps_ipp_do_pad_delay — + ~50ps ipp_do -> pad delay 10 DO_TRIM_2_100ps_ipp_do_pad_delay — + ~100ps ipp_do -> pad delay 11 DO_TRIM_3_150ps_ipp_do_pad_delay — + ~150ps ipp_do -> pad delay
19–18 DDR_SEL	ddr_sel Field Read Only Field 0 DDR_SEL — RESERVED
17 DDR_INPUT	DDR / CMOS Input Mode Field Select one out of next values for pad: DRAM_SDBA0 0 DDR_INPUT_0_CMOS_input_type — CMOS input type 1 DDR_INPUT_1_Differential_input_mode — Differential input mode
16 HYS	Hyst. Enable Field Select one out of next values for pad: DRAM_SDBA0 0 HYS_0_Hysteresis_Disabled — Hysteresis Disabled 1 HYS_1_Hysteresis_Enabled — Hysteresis Enabled
15–14 PUS	Pull Up / Down Config. Field Read Only Field 10 PUS — 100K Ohm Pull Up
13 PUE	Pull / Keep Select Field Read Only Field 0 PUE — Keeper
12 PKE	Pull / Keep Enable Field Read Only Field 0 PKE — Pull/Keeper Disabled
11 -	This field is reserved. Reserved
10–8 ODT	On Die Termination Field Select one out of next values for pad: DRAM_SDBA0 000 ODT_0_off — off 001 ODT_1_120_Ohm_ODT — 120 Ohm ODT 010 ODT_2_60_Ohm_ODT — 60 Ohm ODT

Table continues on the next page...

IOMUXC_SW_PAD_CTL_PAD_DRAM_SDBA0 field descriptions (continued)

Field	Description
	011 ODT_3_40_Ohm_ODT — 40 Ohm ODT 100 ODT_4_30_Ohm_ODT — 30 Ohm ODT 101 ODT_5_24_Ohm_ODT — 24 Ohm ODT 110 ODT_6_20_Ohm_ODT — 20 Ohm ODT 111 ODT_7_17_Ohm_ODT — 17 Ohm ODT
7–6 -	This field is reserved. Reserved
5–3 DSE	Drive Strength Field Read Only Field 0 DSE — output driver disabled;
-	This field is reserved. Reserved

32.6.139 SW_PAD_CTL_PAD_DRAM_SDBA1 SW PAD Control Register (IOMUXC_SW_PAD_CTL_PAD_DRAM_SDBA1)

SW_PAD_CTL Register

Address: 20E_0000h base + 26Ch offset = 20E_026Ch

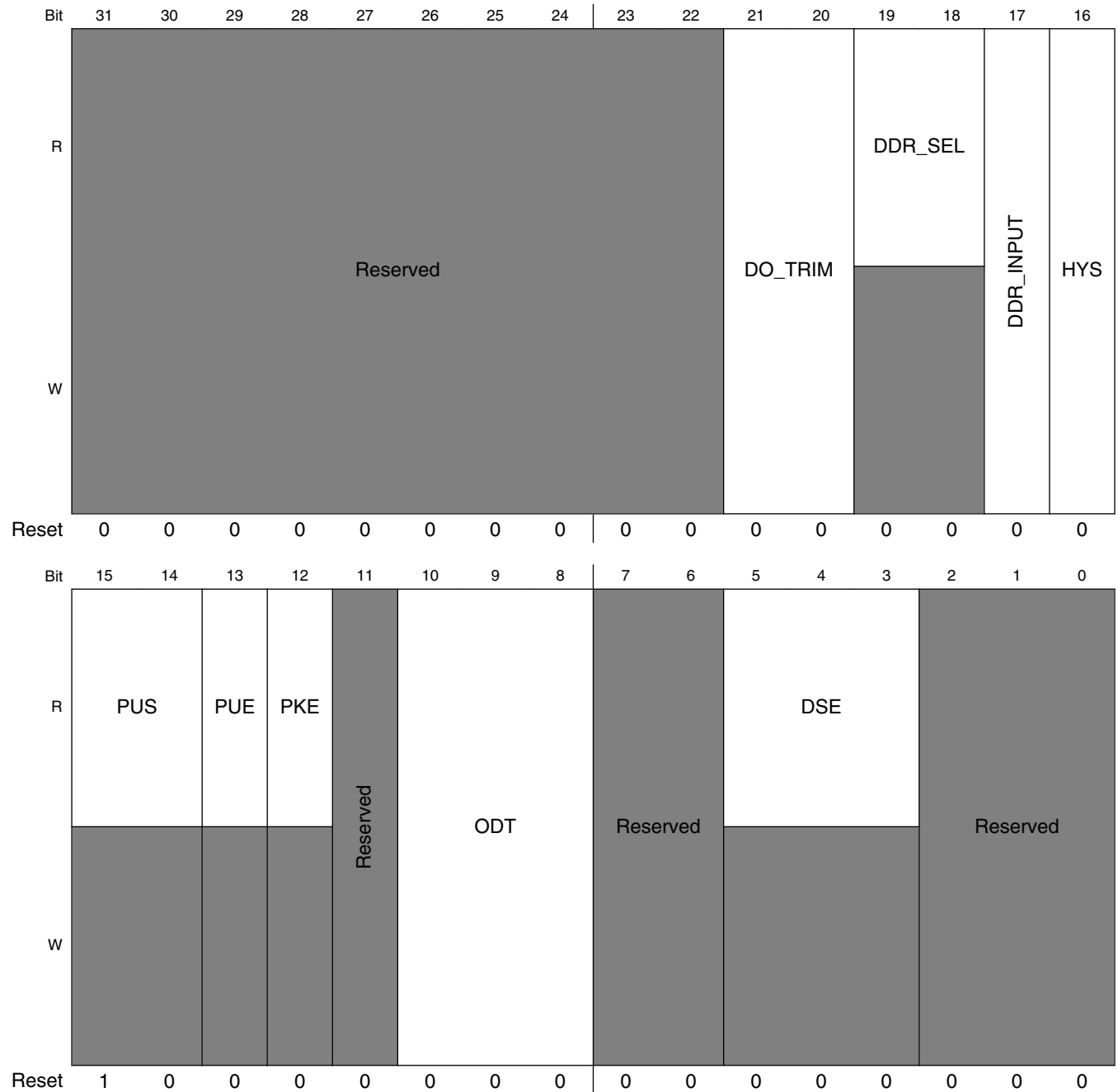

IOMUXC_SW_PAD_CTL_PAD_DRAM_SDBA1 field descriptions

Field	Description
31–22 -	This field is reserved. Reserved
21–20 DO_TRIM	do_trim Field Select one out of next values for pad: DRAM_SDBA1 00 DO_TRIM_0_min_delay — min delay 01 DO_TRIM_1_50ps_ipp_do_pad_delay — + ~50ps ipp_do -> pad delay 10 DO_TRIM_2_100ps_ipp_do_pad_delay — + ~100ps ipp_do -> pad delay 11 DO_TRIM_3_150ps_ipp_do_pad_delay — + ~150ps ipp_do -> pad delay
19–18 DDR_SEL	ddr_sel Field Read Only Field 0 DDR_SEL — RESERVED
17 DDR_INPUT	DDR / CMOS Input Mode Field Select one out of next values for pad: DRAM_SDBA1 0 DDR_INPUT_0_CMOS_input_type — CMOS input type 1 DDR_INPUT_1_Differential_input_mode — Differential input mode
16 HYS	Hyst. Enable Field Select one out of next values for pad: DRAM_SDBA1 0 HYS_0_Hysteresis_Disabled — Hysteresis Disabled 1 HYS_1_Hysteresis_Enabled — Hysteresis Enabled
15–14 PUS	Pull Up / Down Config. Field Read Only Field 10 PUS — 100K Ohm Pull Up
13 PUE	Pull / Keep Select Field Read Only Field 0 PUE — Keeper
12 PKE	Pull / Keep Enable Field Read Only Field 0 PKE — Pull/Keeper Disabled
11 -	This field is reserved. Reserved
10–8 ODT	On Die Termination Field Select one out of next values for pad: DRAM_SDBA1 000 ODT_0_off — off 001 ODT_1_120_Ohm_ODT — 120 Ohm ODT 010 ODT_2_60_Ohm_ODT — 60 Ohm ODT

Table continues on the next page...

IOMUXC_SW_PAD_CTL_PAD_DRAM_SDBA1 field descriptions (continued)

Field	Description
	011 ODT_3_40_Ohm_ODT — 40 Ohm ODT 100 ODT_4_30_Ohm_ODT — 30 Ohm ODT 101 ODT_5_24_Ohm_ODT — 24 Ohm ODT 110 ODT_6_20_Ohm_ODT — 20 Ohm ODT 111 ODT_7_17_Ohm_ODT — 17 Ohm ODT
7–6 -	This field is reserved. Reserved
5–3 DSE	Drive Strength Field Read Only Field 0 DSE — output driver disabled;
-	This field is reserved. Reserved

32.6.140 SW_PAD_CTL_PAD_DRAM_SDBA2 SW PAD Control Register (IOMUXC_SW_PAD_CTL_PAD_DRAM_SDBA2)

SW_PAD_CTL Register

Address: 20E_0000h base + 270h offset = 20E_0270h

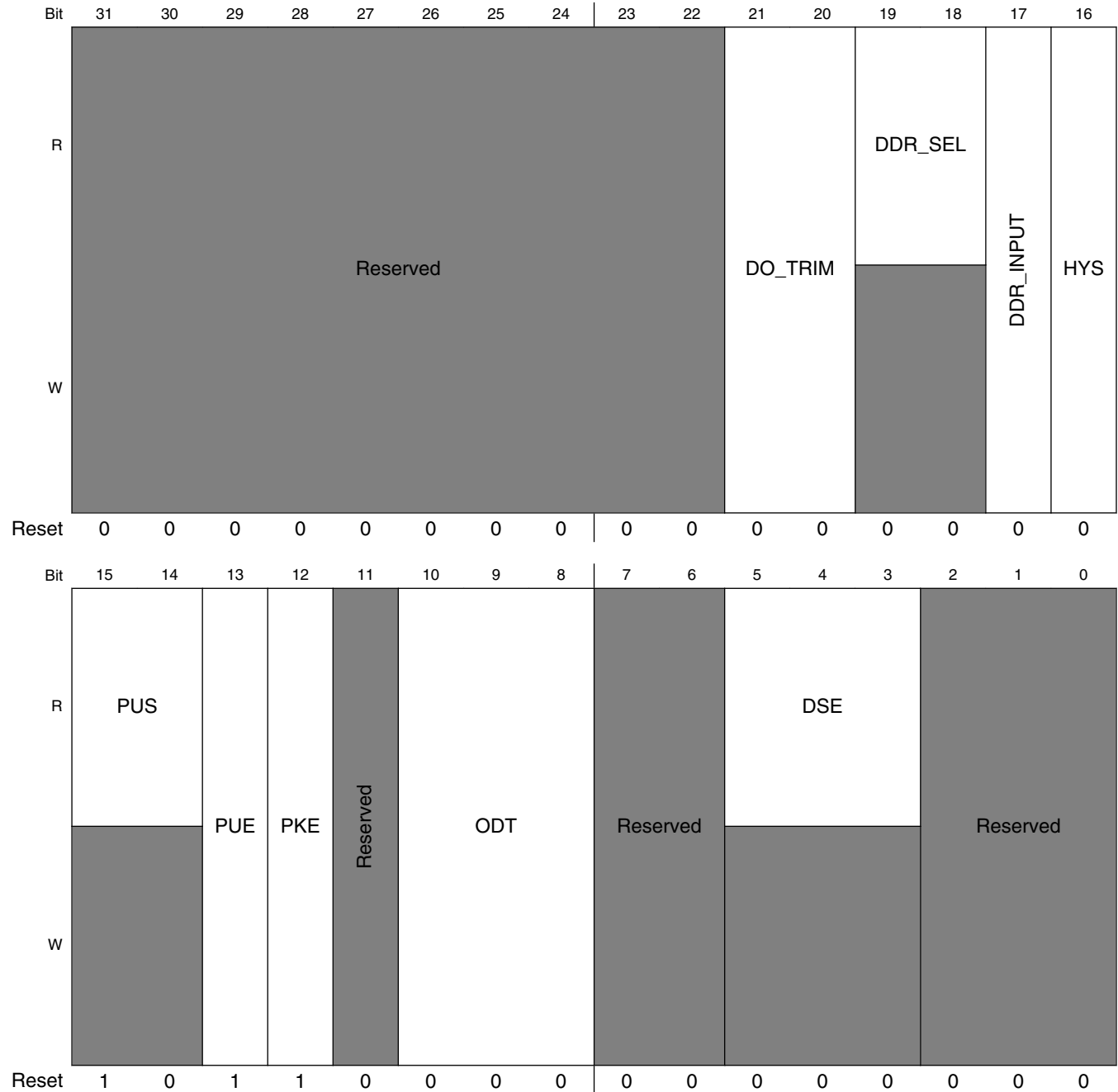

IOMUXC_SW_PAD_CTL_PAD_DRAM_SDBA2 field descriptions

Field	Description
31–22 -	This field is reserved. Reserved
21–20 DO_TRIM	do_trim Field Select one out of next values for pad: DRAM_SDBA2 00 DO_TRIM_0_min_delay — min delay 01 DO_TRIM_1_50ps_ipp_do_pad_delay — + ~50ps ipp_do -> pad delay 10 DO_TRIM_2_100ps_ipp_do_pad_delay — + ~100ps ipp_do -> pad delay 11 DO_TRIM_3_150ps_ipp_do_pad_delay — + ~150ps ipp_do -> pad delay
19–18 DDR_SEL	ddr_sel Field Read Only Field 0 DDR_SEL — RESERVED
17 DDR_INPUT	DDR / CMOS Input Mode Field Select one out of next values for pad: DRAM_SDBA2 0 DDR_INPUT_0_CMOS_input_type — CMOS input type 1 DDR_INPUT_1_Differential_input_mode — Differential input mode
16 HYS	Hyst. Enable Field Select one out of next values for pad: DRAM_SDBA2 0 HYS_0_Hysteresis_Disabled — Hysteresis Disabled 1 HYS_1_Hysteresis_Enabled — Hysteresis Enabled
15–14 PUS	Pull Up / Down Config. Field Read Only Field 10 PUS — 100K Ohm Pull Up
13 PUE	Pull / Keep Select Field Select one out of next values for pad: DRAM_SDBA2 0 PUE_0_Keeper — Keeper 1 PUE_1_Pull — Pull
12 PKE	Pull / Keep Enable Field Select one out of next values for pad: DRAM_SDBA2 0 PKE_0_Pull_Keeper_Disabled — Pull/Keeper Disabled 1 PKE_1_Pull_Keeper_Enabled — Pull/Keeper Enabled
11 -	This field is reserved. Reserved
10–8 ODT	On Die Termination Field Select one out of next values for pad: DRAM_SDBA2 000 ODT_0_off — off

Table continues on the next page...

IOMUXC_SW_PAD_CTL_PAD_DRAM_SDBA2 field descriptions (continued)

Field	Description
	001 ODT_1_120_Ohm_ODT — 120 Ohm ODT 010 ODT_2_60_Ohm_ODT — 60 Ohm ODT 011 ODT_3_40_Ohm_ODT — 40 Ohm ODT 100 ODT_4_30_Ohm_ODT — 30 Ohm ODT 101 ODT_5_24_Ohm_ODT — 24 Ohm ODT 110 ODT_6_20_Ohm_ODT — 20 Ohm ODT 111 ODT_7_17_Ohm_ODT — 17 Ohm ODT
7–6 -	This field is reserved. Reserved
5–3 DSE	Drive Strength Field Read Only Field 0 DSE — output driver disabled;
-	This field is reserved. Reserved

32.6.141 SW_PAD_CTL_PAD_DRAM_SDCKE0 SW PAD Control Register (IOMUXC_SW_PAD_CTL_PAD_DRAM_SDCKE0)

SW_PAD_CTL Register

Address: 20E_0000h base + 274h offset = 20E_0274h

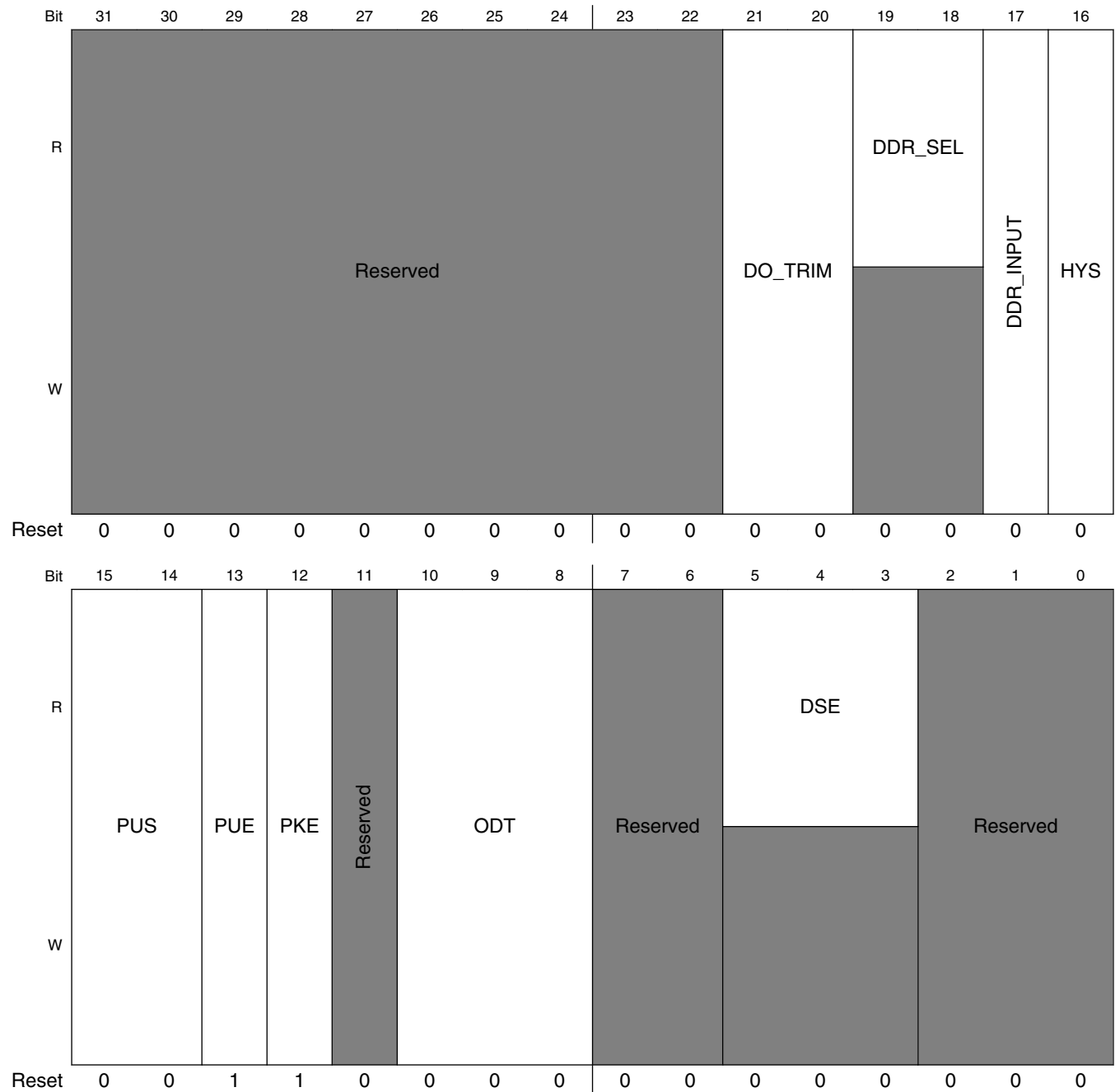

IOMUXC_SW_PAD_CTL_PAD_DRAM_SDCKE0 field descriptions

Field	Description
31–22 -	This field is reserved. Reserved
21–20 DO_TRIM	do_trim Field Select one out of next values for pad: DRAM_SDCKE0 00 DO_TRIM_0_min_delay — min delay 01 DO_TRIM_1_50ps_ipp_do_pad_delay — + ~50ps ipp_do -> pad delay 10 DO_TRIM_2_100ps_ipp_do_pad_delay — + ~100ps ipp_do -> pad delay 11 DO_TRIM_3_150ps_ipp_do_pad_delay — + ~150ps ipp_do -> pad delay
19–18 DDR_SEL	ddr_sel Field Read Only Field 0 DDR_SEL — RESERVED
17 DDR_INPUT	DDR / CMOS Input Mode Field Select one out of next values for pad: DRAM_SDCKE0 0 DDR_INPUT_0_CMOS_input_type — CMOS input type 1 DDR_INPUT_1_Differential_input_mode — Differential input mode
16 HYS	Hyst. Enable Field Select one out of next values for pad: DRAM_SDCKE0 0 HYS_0_Hysteresis_Disabled — Hysteresis Disabled 1 HYS_1_Hysteresis_Enabled — Hysteresis Enabled
15–14 PUS	Pull Up / Down Config. Field Select one out of next values for pad: DRAM_SDCKE0 00 PUS_0_100K_Ohm_Pull_Down — 100K Ohm Pull Down 01 PUS_1_47K_Ohm_Pull_Up — 47K Ohm Pull Up 10 PUS_2_100K_Ohm_Pull_Up — 100K Ohm Pull Up 11 PUS_3_22K_Ohm_Pull_Up — 22K Ohm Pull Up
13 PUE	Pull / Keep Select Field Select one out of next values for pad: DRAM_SDCKE0 0 PUE_0_Keeper — Keeper 1 PUE_1_Pull — Pull
12 PKE	Pull / Keep Enable Field Select one out of next values for pad: DRAM_SDCKE0 0 PKE_0_Pull_Keeper_Disabled — Pull/Keeper Disabled 1 PKE_1_Pull_Keeper_Enabled — Pull/Keeper Enabled
11 -	This field is reserved. Reserved
10–8 ODT	On Die Termination Field

Table continues on the next page...

IOMUXC_SW_PAD_CTL_PAD_DRAM_SDCKE0 field descriptions (continued)

Field	Description
	Select one out of next values for pad: DRAM_SDCKE0 000 ODT_0_off — off 001 ODT_1_120_Ohm_ODT — 120 Ohm ODT 010 ODT_2_60_Ohm_ODT — 60 Ohm ODT 011 ODT_3_40_Ohm_ODT — 40 Ohm ODT 100 ODT_4_30_Ohm_ODT — 30 Ohm ODT 101 ODT_5_24_Ohm_ODT — 24 Ohm ODT 110 ODT_6_20_Ohm_ODT — 20 Ohm ODT 111 ODT_7_17_Ohm_ODT — 17 Ohm ODT
7–6 -	This field is reserved. Reserved
5–3 DSE	Drive Strength Field Read Only Field 0 DSE — output driver disabled;
-	This field is reserved. Reserved

32.6.142 SW_PAD_CTL_PAD_DRAM_SDCKE1 SW PAD Control Register (IOMUXC_SW_PAD_CTL_PAD_DRAM_SDCKE1)

SW_PAD_CTL Register

Address: 20E_0000h base + 278h offset = 20E_0278h

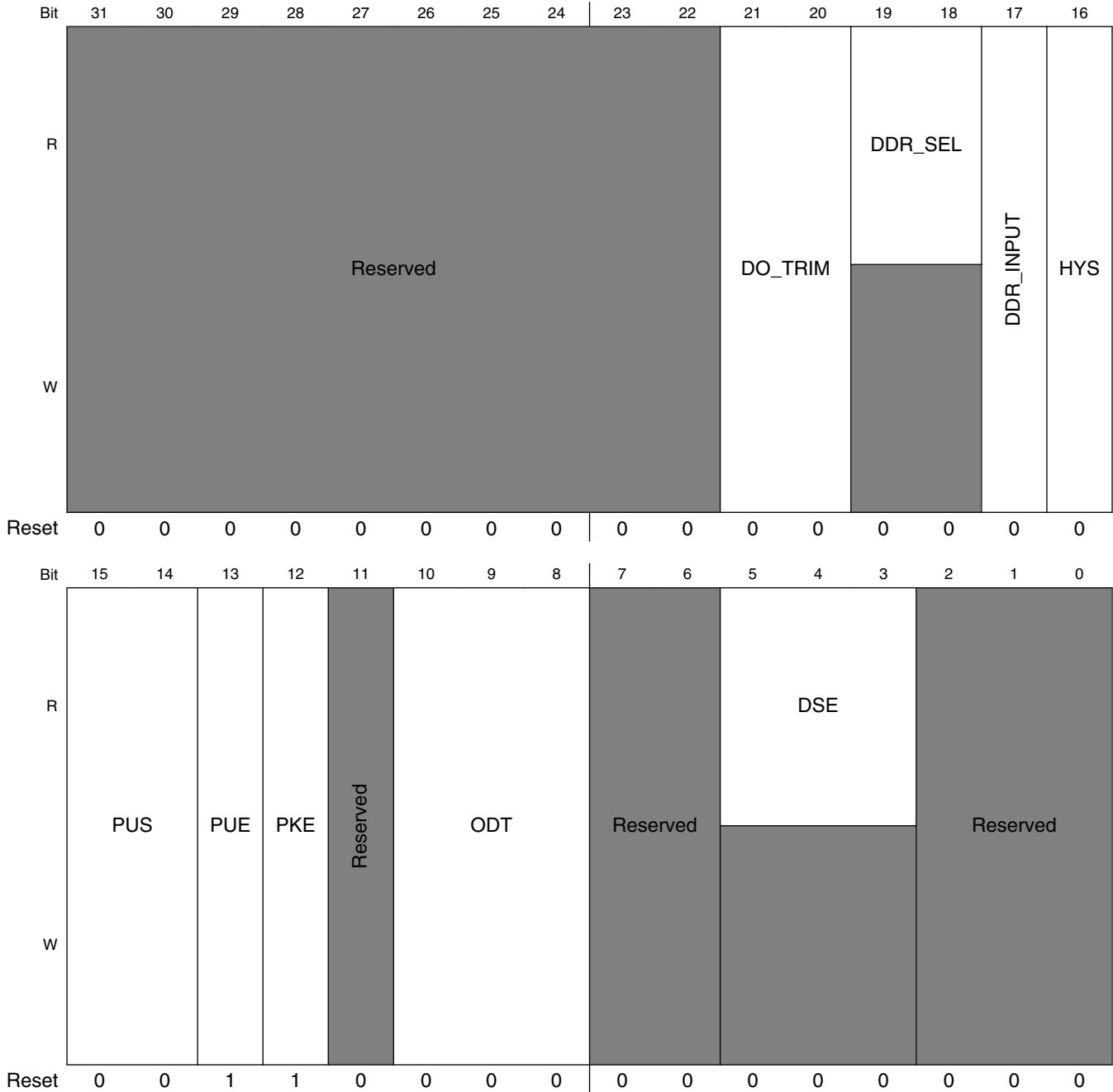

IOMUXC_SW_PAD_CTL_PAD_DRAM_SDCKE1 field descriptions

Field	Description
31–22 -	This field is reserved. Reserved
21–20 DO_TRIM	do_trim Field Select one out of next values for pad: DRAM_SDCKE1 00 DO_TRIM_0_min_delay — min delay 01 DO_TRIM_1_50ps_ipp_do_pad_delay — + ~50ps ipp_do -> pad delay 10 DO_TRIM_2_100ps_ipp_do_pad_delay — + ~100ps ipp_do -> pad delay 11 DO_TRIM_3_150ps_ipp_do_pad_delay — + ~150ps ipp_do -> pad delay
19–18 DDR_SEL	ddr_sel Field Read Only Field 0 DDR_SEL — RESERVED
17 DDR_INPUT	DDR / CMOS Input Mode Field Select one out of next values for pad: DRAM_SDCKE1 0 DDR_INPUT_0_CMOS_input_type — CMOS input type 1 DDR_INPUT_1_Differential_input_mode — Differential input mode
16 HYS	Hyst. Enable Field Select one out of next values for pad: DRAM_SDCKE1 0 HYS_0_Hysteresis_Disabled — Hysteresis Disabled 1 HYS_1_Hysteresis_Enabled — Hysteresis Enabled
15–14 PUS	Pull Up / Down Config. Field Select one out of next values for pad: DRAM_SDCKE1 00 PUS_0_100K_Ohm_Pull_Down — 100K Ohm Pull Down 01 PUS_1_47K_Ohm_Pull_Up — 47K Ohm Pull Up 10 PUS_2_100K_Ohm_Pull_Up — 100K Ohm Pull Up 11 PUS_3_22K_Ohm_Pull_Up — 22K Ohm Pull Up
13 PUE	Pull / Keep Select Field Select one out of next values for pad: DRAM_SDCKE1 0 PUE_0_Keeper — Keeper 1 PUE_1_Pull — Pull
12 PKE	Pull / Keep Enable Field Select one out of next values for pad: DRAM_SDCKE1 0 PKE_0_Pull_Keeper_Disabled — Pull/Keeper Disabled 1 PKE_1_Pull_Keeper_Enabled — Pull/Keeper Enabled
11 -	This field is reserved. Reserved
10–8 ODT	On Die Termination Field

Table continues on the next page...

IOMUXC_SW_PAD_CTL_PAD_DRAM_SDCKE1 field descriptions (continued)

Field	Description
	Select one out of next values for pad: DRAM_SDCKE1 000 ODT_0_off — off 001 ODT_1_120_Ohm_ODT — 120 Ohm ODT 010 ODT_2_60_Ohm_ODT — 60 Ohm ODT 011 ODT_3_40_Ohm_ODT — 40 Ohm ODT 100 ODT_4_30_Ohm_ODT — 30 Ohm ODT 101 ODT_5_24_Ohm_ODT — 24 Ohm ODT 110 ODT_6_20_Ohm_ODT — 20 Ohm ODT 111 ODT_7_17_Ohm_ODT — 17 Ohm ODT
7–6 -	This field is reserved. Reserved
5–3 DSE	Drive Strength Field Read Only Field 0 DSE — output driver disabled;
-	This field is reserved. Reserved

32.6.143 SW_PAD_CTL_PAD_DRAM_SDCLK0_P SW PAD Control Register (IOMUXC_SW_PAD_CTL_PAD_DRAM_SDCLK0_P)

SW_PAD_CTL Register

Address: 20E_0000h base + 27Ch offset = 20E_027Ch

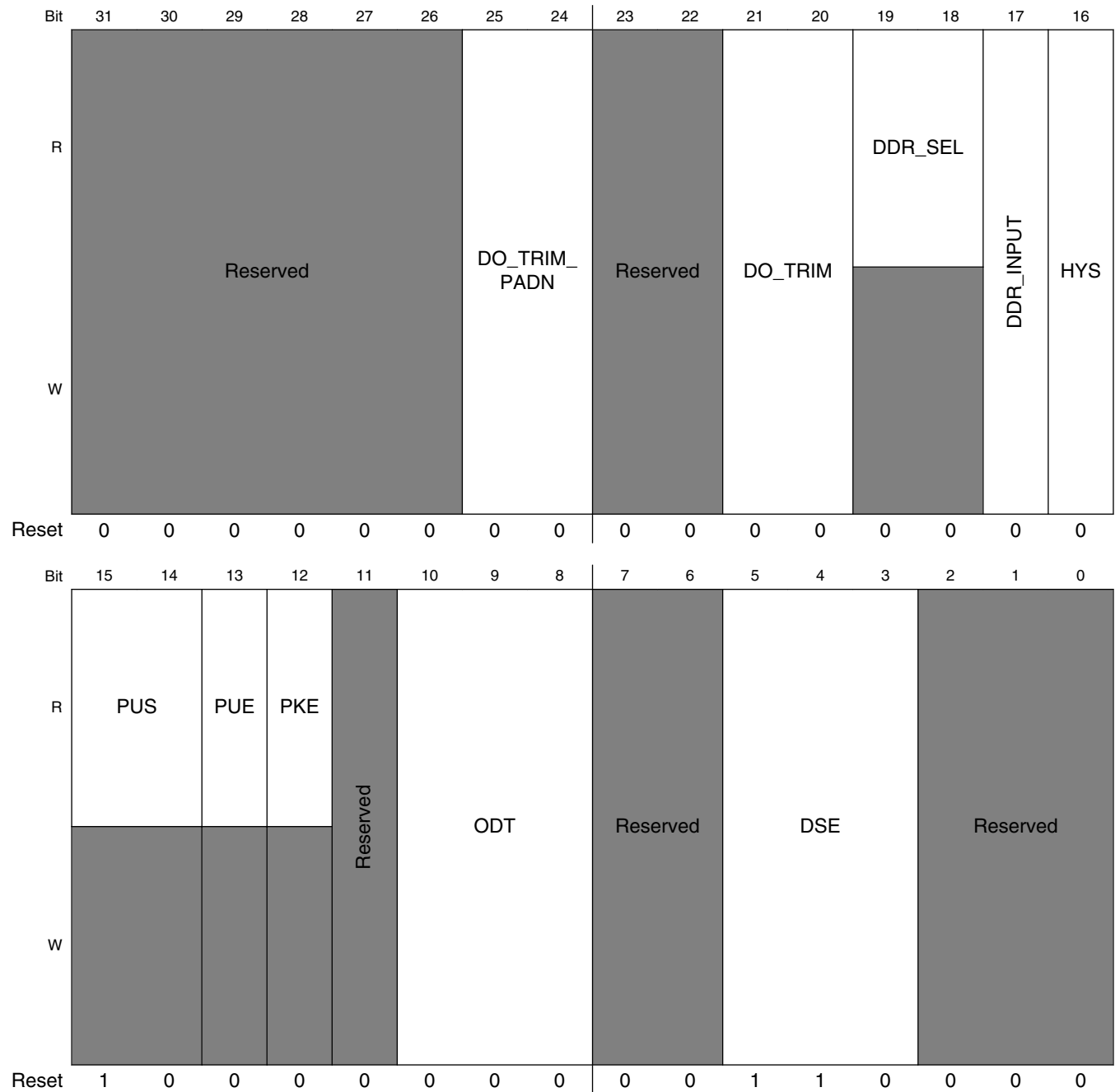

IOMUXC_SW_PAD_CTL_PAD_DRAM_SDCLK0_P field descriptions

Field	Description
31–26 -	This field is reserved. Reserved
25–24 DO_TRIM_PADN	do_trim_padn Field Select one out of next values for pad: DRAM_SDCLK0_P 00 DO_TRIM_PADN_0_min_delay — min delay 01 DO_TRIM_PADN_1_50ps_ipp_do_pad_delay — + ~50ps ipp_do -> pad delay 10 DO_TRIM_PADN_2_100ps_ipp_do_pad_delay — + ~100ps ipp_do -> pad delay 11 DO_TRIM_PADN_3_150ps_ipp_do_pad_delay — + ~150ps ipp_do -> pad delay
23–22 -	This field is reserved. Reserved
21–20 DO_TRIM	do_trim Field Select one out of next values for pad: DRAM_SDCLK0_P 00 DO_TRIM_0_min_delay — min delay 01 DO_TRIM_1_50ps_ipp_do_pad_delay — + ~50ps ipp_do -> pad delay 10 DO_TRIM_2_100ps_ipp_do_pad_delay — + ~100ps ipp_do -> pad delay 11 DO_TRIM_3_150ps_ipp_do_pad_delay — + ~150ps ipp_do -> pad delay
19–18 DDR_SEL	ddr_sel Field Read Only Field 0 DDR_SEL — RESERVED
17 DDR_INPUT	DDR / CMOS Input Mode Field Select one out of next values for pad: DRAM_SDCLK0_P 0 DDR_INPUT_0_CMOS_input_type — CMOS input type 1 DDR_INPUT_1_Differential_input_mode — Differential input mode
16 HYS	Hyst. Enable Field Select one out of next values for pad: DRAM_SDCLK0_P 0 HYS_0_Hysteresis_Disabled — Hysteresis Disabled 1 HYS_1_Hysteresis_Enabled — Hysteresis Enabled
15–14 PUS	Pull Up / Down Config. Field Read Only Field 10 PUS — 100K Ohm Pull Up
13 PUE	Pull / Keep Select Field Read Only Field 0 PUE — Keeper
12 PKE	Pull / Keep Enable Field Read Only Field

Table continues on the next page...

IOMUXC_SW_PAD_CTL_PAD_DRAM_SDCLK0_P field descriptions (continued)

Field	Description
	0 PKE — Pull/Keeper Disabled
11 -	This field is reserved. Reserved
10–8 ODT	On Die Termination Field Select one out of next values for pad: DRAM_SDCLK0_P 000 ODT_0_off — off 001 ODT_1_120_Ohm_ODT — 120 Ohm ODT 010 ODT_2_60_Ohm_ODT — 60 Ohm ODT 011 ODT_3_40_Ohm_ODT — 40 Ohm ODT 100 ODT_4_30_Ohm_ODT — 30 Ohm ODT 101 ODT_5_24_Ohm_ODT — 24 Ohm ODT 110 ODT_6_20_Ohm_ODT — 20 Ohm ODT 111 ODT_7_17_Ohm_ODT — 17 Ohm ODT
7–6 -	This field is reserved. Reserved
5–3 DSE	Drive Strength Field Select one out of next values for pad: DRAM_SDCLK0_P 000 DSE_0_output_driver_disabled_ — output driver disabled; 001 DSE_1_R0_260_Ohm_3_3V_150_Ohm_1_8V_240_Ohm_for_DDR_ — R0(260 Ohm @ 3.3V, 150 Ohm@1.8V, 240 Ohm for DDR) 010 DSE_2_R0_2 — R0/2 011 DSE_3_R0_3 — R0/3 100 DSE_4_R0_4 — R0/4 101 DSE_5_R0_5 — R0/5 110 DSE_6_R0_6 — R0/6 111 DSE_7_R0_7 — R0/7
-	This field is reserved. Reserved

32.6.144 SW_PAD_CTL_PAD_DRAM_SDQS0_P SW PAD Control Register (IOMUXC_SW_PAD_CTL_PAD_DRAM_SDQS0_P)

SW_PAD_CTL Register

Address: 20E_0000h base + 280h offset = 20E_0280h

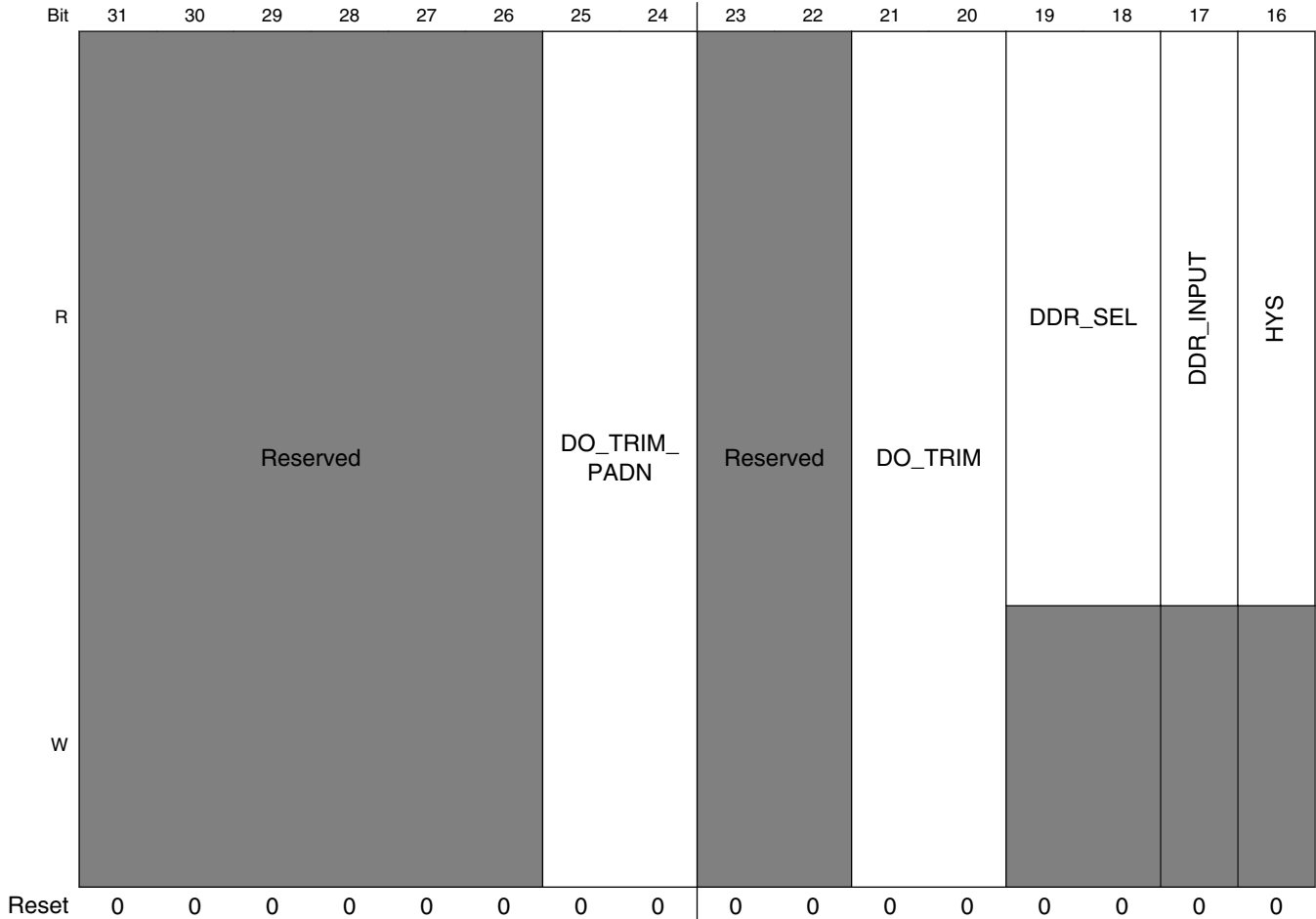

IOMUXC Memory Map/Register Definition

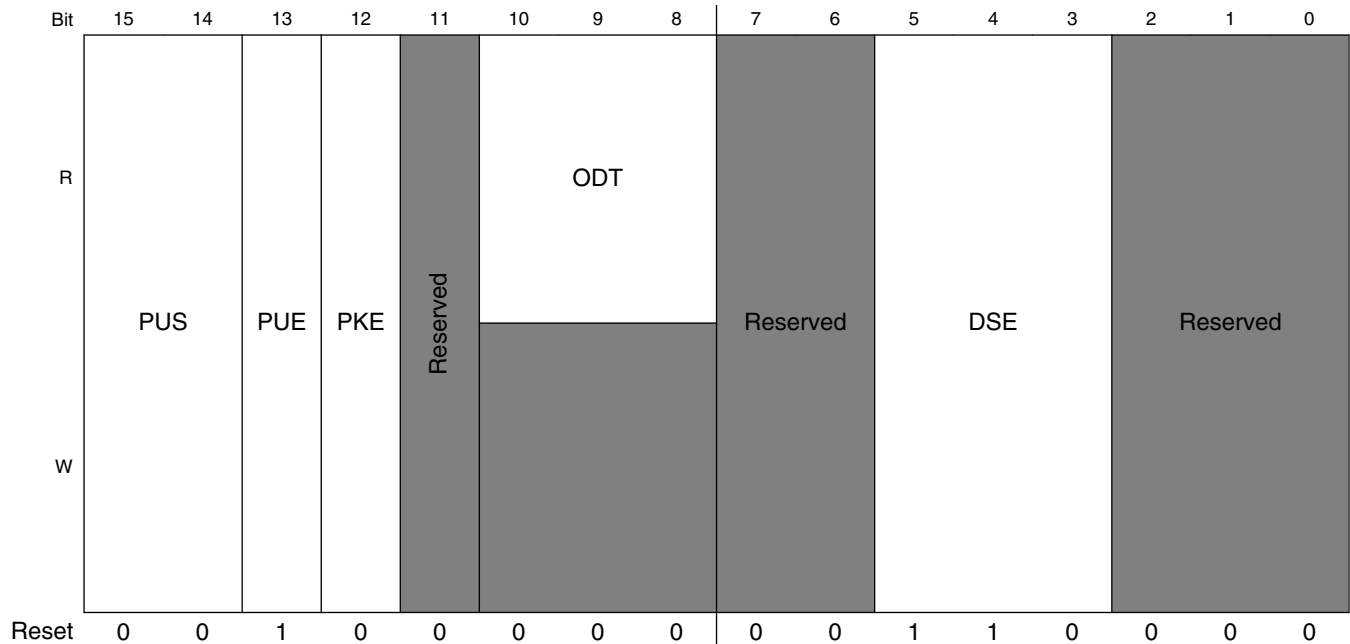

IOMUXC_SW_PAD_CTL_PAD_DRAM_SDQS0_P field descriptions

Field	Description
31–26 -	This field is reserved. Reserved
25–24 DO_TRIM_PADN	do_trim_padn Field Select one out of next values for pad: DRAM_SDQS0_P 00 DO_TRIM_PADN_0_min_delay — min delay 01 DO_TRIM_PADN_1_50ps_ipp_do_pad_delay — + ~50ps ipp_do -> pad delay 10 DO_TRIM_PADN_2_100ps_ipp_do_pad_delay — + ~100ps ipp_do -> pad delay 11 DO_TRIM_PADN_3_150ps_ipp_do_pad_delay — + ~150ps ipp_do -> pad delay
23–22 -	This field is reserved. Reserved
21–20 DO_TRIM	do_trim Field Select one out of next values for pad: DRAM_SDQS0_P 00 DO_TRIM_0_min_delay — min delay 01 DO_TRIM_1_50ps_ipp_do_pad_delay — + ~50ps ipp_do -> pad delay 10 DO_TRIM_2_100ps_ipp_do_pad_delay — + ~100ps ipp_do -> pad delay 11 DO_TRIM_3_150ps_ipp_do_pad_delay — + ~150ps ipp_do -> pad delay
19–18 DDR_SEL	ddr_sel Field Read Only Field 0 DDR_SEL — RESERVED
17 DDR_INPUT	DDR / CMOS Input Mode Field Read Only Field

Table continues on the next page...

IOMUXC_SW_PAD_CTL_PAD_DRAM_SDQS0_P field descriptions (continued)

Field	Description
	0 DDR_INPUT — CMOS input type
16 HYS	Hyst. Enable Field Read Only Field 0 HYS — Hysteresis Disabled
15–14 PUS	Pull Up / Down Config. Field Select one out of next values for pad: DRAM_SDQS0_P 00 PUS_0_100K_Ohm_Pull_Down — 100K Ohm Pull Down 01 PUS_1_47K_Ohm_Pull_Up — 47K Ohm Pull Up 10 PUS_2_100K_Ohm_Pull_Up — 100K Ohm Pull Up 11 PUS_3_22K_Ohm_Pull_Up — 22K Ohm Pull Up
13 PUE	Pull / Keep Select Field Select one out of next values for pad: DRAM_SDQS0_P 0 PUE_0_Keeper — Keeper 1 PUE_1_Pull — Pull
12 PKE	Pull / Keep Enable Field Select one out of next values for pad: DRAM_SDQS0_P 0 PKE_0_Pull_Keeper_Disabled — Pull/Keeper Disabled 1 PKE_1_Pull_Keeper_Enabled — Pull/Keeper Enabled
11 -	This field is reserved. Reserved
10–8 ODT	On Die Termination Field Read Only Field 0 ODT — off
7–6 -	This field is reserved. Reserved
5–3 DSE	Drive Strength Field Select one out of next values for pad: DRAM_SDQS0_P 000 DSE_0_output_driver_disabled_ — output driver disabled; 001 DSE_1_R0_260_Ohm__3_3V_150_Ohm_1_8V_240_Ohm_for_DDR_ — R0(260 Ohm @ 3.3V, 150 Ohm@1.8V, 240 Ohm for DDR) 010 DSE_2_R0_2 — R0/2 011 DSE_3_R0_3 — R0/3 100 DSE_4_R0_4 — R0/4 101 DSE_5_R0_5 — R0/5 110 DSE_6_R0_6 — R0/6 111 DSE_7_R0_7 — R0/7
-	This field is reserved. Reserved

32.6.145 SW_PAD_CTL_PAD_DRAM_SDQS1_P SW PAD Control Register (IOMUXC_SW_PAD_CTL_PAD_DRAM_SDQS1_P)

SW_PAD_CTL Register

Address: 20E_0000h base + 284h offset = 20E_0284h

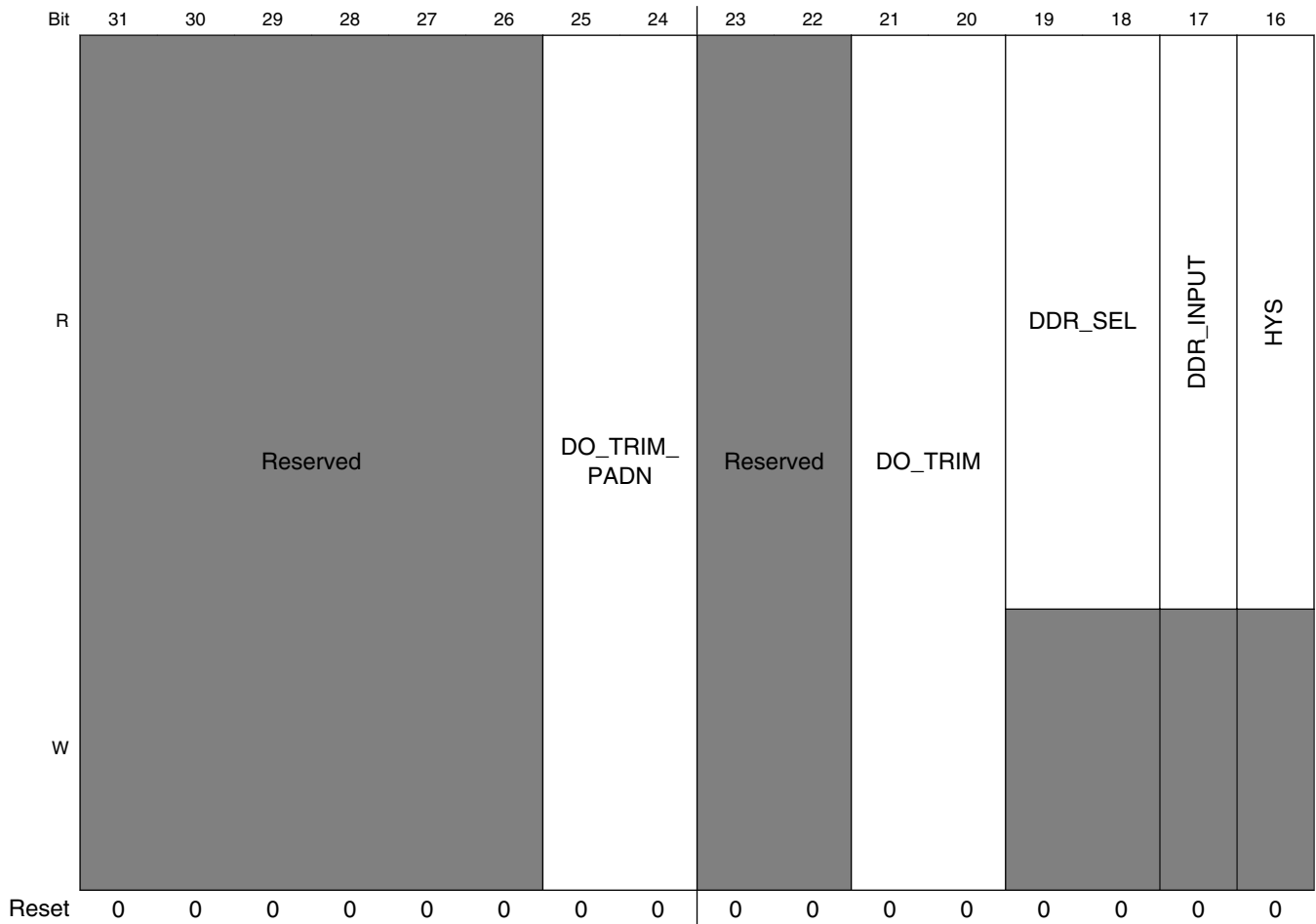

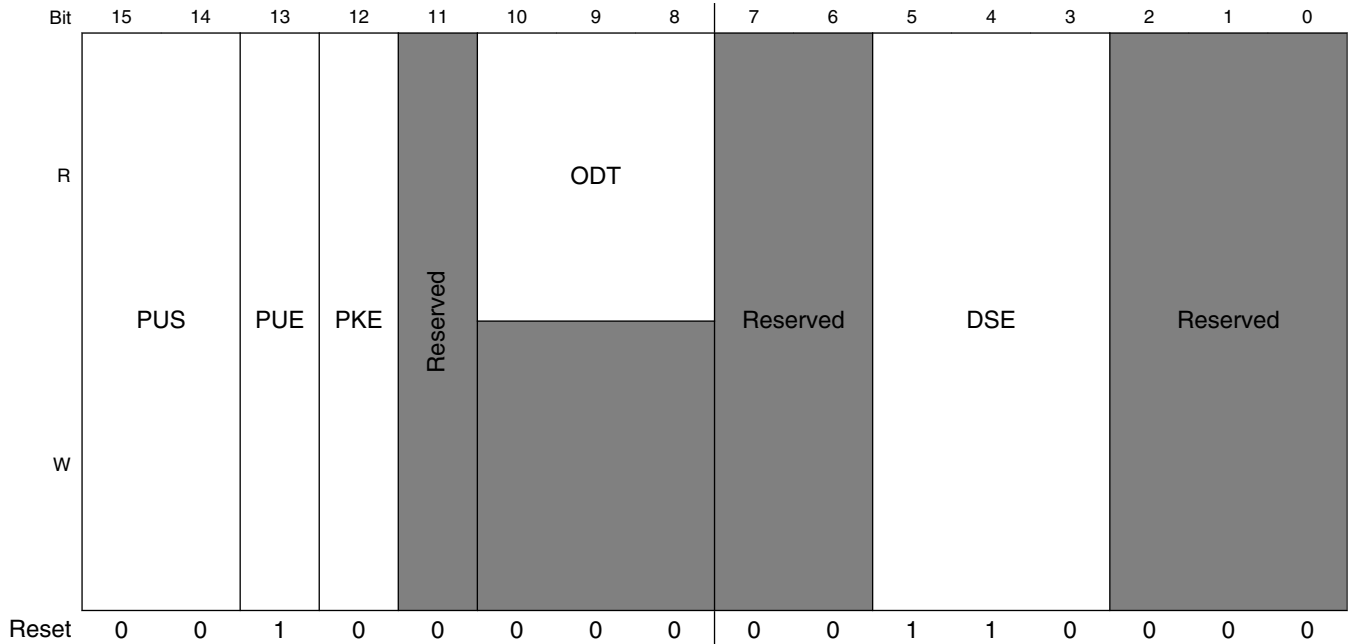

IOMUXC_SW_PAD_CTL_PAD_DRAM_SDQS1_P field descriptions

Field	Description
31–26 -	This field is reserved. Reserved
25–24 DO_TRIM_PADN	do_trim_padn Field Select one out of next values for pad: DRAM_SDQS1_P 00 DO_TRIM_PADN_0_min_delay — min delay 01 DO_TRIM_PADN_1_50ps_ipp_do_pad_delay — + ~50ps ipp_do -> pad delay 10 DO_TRIM_PADN_2_100ps_ipp_do_pad_delay — + ~100ps ipp_do -> pad delay 11 DO_TRIM_PADN_3_150ps_ipp_do_pad_delay — + ~150ps ipp_do -> pad delay
23–22 -	This field is reserved. Reserved
21–20 DO_TRIM	do_trim Field Select one out of next values for pad: DRAM_SDQS1_P 00 DO_TRIM_0_min_delay — min delay 01 DO_TRIM_1_50ps_ipp_do_pad_delay — + ~50ps ipp_do -> pad delay 10 DO_TRIM_2_100ps_ipp_do_pad_delay — + ~100ps ipp_do -> pad delay 11 DO_TRIM_3_150ps_ipp_do_pad_delay — + ~150ps ipp_do -> pad delay
19–18 DDR_SEL	ddr_sel Field Read Only Field 0 DDR_SEL — RESERVED
17 DDR_INPUT	DDR / CMOS Input Mode Field Read Only Field

Table continues on the next page...

IOMUXC_SW_PAD_CTL_PAD_DRAM_SDQS1_P field descriptions (continued)

Field	Description
	0 DDR_INPUT — CMOS input type
16 HYS	Hyst. Enable Field Read Only Field 0 HYS — Hysteresis Disabled
15–14 PUS	Pull Up / Down Config. Field Select one out of next values for pad: DRAM_SDQS1_P 00 PUS_0_100K_Ohm_Pull_Down — 100K Ohm Pull Down 01 PUS_1_47K_Ohm_Pull_Up — 47K Ohm Pull Up 10 PUS_2_100K_Ohm_Pull_Up — 100K Ohm Pull Up 11 PUS_3_22K_Ohm_Pull_Up — 22K Ohm Pull Up
13 PUE	Pull / Keep Select Field Select one out of next values for pad: DRAM_SDQS1_P 0 PUE_0_Keeper — Keeper 1 PUE_1_Pull — Pull
12 PKE	Pull / Keep Enable Field Select one out of next values for pad: DRAM_SDQS1_P 0 PKE_0_Pull_Keeper_Disabled — Pull/Keeper Disabled 1 PKE_1_Pull_Keeper_Enabled — Pull/Keeper Enabled
11 -	This field is reserved. Reserved
10–8 ODT	On Die Termination Field Read Only Field 0 ODT — off
7–6 -	This field is reserved. Reserved
5–3 DSE	Drive Strength Field Select one out of next values for pad: DRAM_SDQS1_P 000 DSE_0_output_driver_disabled_ — output driver disabled; 001 DSE_1_R0_260_Ohm__3_3V__150_Ohm_1_8V__240_Ohm_for_DDR_ — R0(260 Ohm @ 3.3V, 150 Ohm@1.8V, 240 Ohm for DDR) 010 DSE_2_R0_2 — R0/2 011 DSE_3_R0_3 — R0/3 100 DSE_4_R0_4 — R0/4 101 DSE_5_R0_5 — R0/5 110 DSE_6_R0_6 — R0/6 111 DSE_7_R0_7 — R0/7
-	This field is reserved. Reserved

32.6.146 SW_PAD_CTL_PAD_DRAM_RESET SW PAD Control Register (IOMUXC_SW_PAD_CTL_PAD_DRAM_RESET)

SW_PAD_CTL Register

Address: 20E_0000h base + 288h offset = 20E_0288h

Bit	31	30	29	28	27	26	25	24	23	22	21	20	19	18	17	16
R	Reserved								DO_TRIM		DDR_SEL		DDR_INPUT	HYS		
W	Reserved								DO_TRIM		DDR_SEL		DDR_INPUT	HYS		
Reset	0	0	0	0	0	0	0	0	0	0	0	0	1	0	0	0
Bit	15	14	13	12	11	10	9	8	7	6	5	4	3	2	1	0
R	PUS		PUE	PKE	Reserved	ODT			Reserved		DSE		Reserved			
W	PUS		PUE	PKE	Reserved	ODT			Reserved		DSE		Reserved			
Reset	0	0	1	1	0	0	0	0	0	0	1	1	0	0	0	0

IOMUXC_SW_PAD_CTL_PAD_DRAM_RESET field descriptions

Field	Description
31-22 -	This field is reserved. Reserved
21-20 DO_TRIM	do_trim Field Select one out of next values for pad: DRAM_RESET 00 DO_TRIM_0_min_delay — min delay 01 DO_TRIM_1_50ps_ipp_do_pad_delay — + ~50ps ipp_do -> pad delay 10 DO_TRIM_2_100ps_ipp_do_pad_delay — + ~100ps ipp_do -> pad delay 11 DO_TRIM_3_150ps_ipp_do_pad_delay — + ~150ps ipp_do -> pad delay
19-18 DDR_SEL	ddr_sel Field Select one out of next values for pad: DRAM_RESET 00 DDR_SEL_0_RESERVED — RESERVED 01 DDR_SEL_1_RESERVED — RESERVED

Table continues on the next page...

IOMUXC_SW_PAD_CTL_PAD_DRAM_RESET field descriptions (continued)

Field	Description
	10 DDR_SEL_2_LPDDR2_mode — LPDDR2 mode 11 DDR_SEL_3_DDR3_mode — DDR3 mode
17 DDR_INPUT	DDR / CMOS Input Mode Field Select one out of next values for pad: DRAM_RESET 0 DDR_INPUT_0_CMOS_input_type — CMOS input type 1 DDR_INPUT_1_Differential_input_mode — Differential input mode
16 HYS	Hyst. Enable Field Select one out of next values for pad: DRAM_RESET 0 HYS_0_Hysteresis_Disabled — Hysteresis Disabled 1 HYS_1_Hysteresis_Enabled — Hysteresis Enabled
15–14 PUS	Pull Up / Down Config. Field Select one out of next values for pad: DRAM_RESET 00 PUS_0_100K_Ohm_Pull_Down — 100K Ohm Pull Down 01 PUS_1_47K_Ohm_Pull_Up — 47K Ohm Pull Up 10 PUS_2_100K_Ohm_Pull_Up — 100K Ohm Pull Up 11 PUS_3_22K_Ohm_Pull_Up — 22K Ohm Pull Up
13 PUE	Pull / Keep Select Field Select one out of next values for pad: DRAM_RESET 0 PUE_0_Keeper — Keeper 1 PUE_1_Pull — Pull
12 PKE	Pull / Keep Enable Field Select one out of next values for pad: DRAM_RESET 0 PKE_0_Pull_Keeper_Disabled — Pull/Keeper Disabled 1 PKE_1_Pull_Keeper_Enabled — Pull/Keeper Enabled
11 -	This field is reserved. Reserved
10–8 ODT	On Die Termination Field Select one out of next values for pad: DRAM_RESET 000 ODT_0_off — off 001 ODT_1_120_Ohm_ODT — 120 Ohm ODT 010 ODT_2_60_Ohm_ODT — 60 Ohm ODT 011 ODT_3_40_Ohm_ODT — 40 Ohm ODT 100 ODT_4_30_Ohm_ODT — 30 Ohm ODT 101 ODT_5_24_Ohm_ODT — 24 Ohm ODT 110 ODT_6_20_Ohm_ODT — 20 Ohm ODT 111 ODT_7_17_Ohm_ODT — 17 Ohm ODT
7–6 -	This field is reserved. Reserved

Table continues on the next page...

IOMUXC_SW_PAD_CTL_PAD_DRAM_RESET field descriptions (continued)

Field	Description
5–3 DSE	Drive Strength Field Select one out of next values for pad: DRAM_RESET 000 DSE_0_output_driver_disabled_ — output driver disabled; 001 DSE_1_R0_260_Ohm__3_3V__150_Ohm_1_8V__240_Ohm_for_DDR_ — R0(260 Ohm @ 3.3V, 150 Ohm@1.8V, 240 Ohm for DDR) 010 DSE_2_R0_2 — R0/2 011 DSE_3_R0_3 — R0/3 100 DSE_4_R0_4 — R0/4 101 DSE_5_R0_5 — R0/5 110 DSE_6_R0_6 — R0/6 111 DSE_7_R0_7 — R0/7
-	This field is reserved. Reserved

32.6.147 SW_PAD_CTL_PAD_JTAG_MOD SW PAD Control Register (IOMUXC_SW_PAD_CTL_PAD_JTAG_MOD)

SW_PAD_CTL Register

Address: 20E_0000h base + 2D0h offset = 20E_02D0h

Bit	31	30	29	28	27	26	25	24	23	22	21	20	19	18	17	16	
R	Reserved															HYS	
W	Reserved																
Reset	0	0	0	0	0	0	0	0	0	0	0	0	0	0	0	0	0
Bit	15	14	13	12	11	10	9	8	7	6	5	4	3	2	1	0	
R	PUS	PUE	PKE	ODE	Reserved				SPEED		DSE			Reserved		SRE	
W					Reserved				Reserved		Reserved			Reserved			
Reset	1	0	1	1	0	0	0	0	1	0	1	0	0	0	0	0	0

IOMUXC_SW_PAD_CTL_PAD_JTAG_MOD field descriptions

Field	Description
31–17 -	This field is reserved. Reserved
16 HYS	Hyst. Enable Field Select one out of next values for pad: JTAG_MOD 0 HYS_0_Hysteresis_Disabled — Hysteresis Disabled 1 HYS_1_Hysteresis_Enabled — Hysteresis Enabled

Table continues on the next page...

IOMUXC_SW_PAD_CTL_PAD_JTAG_MOD field descriptions (continued)

Field	Description
15–14 PUS	<p>Pull Up / Down Config. Field</p> <p>Select one out of next values for pad: JTAG_MOD</p> <p>00 PUS_0_100K_Ohm_Pull_Down — 100K Ohm Pull Down</p> <p>01 PUS_1_47K_Ohm_Pull_Up — 47K Ohm Pull Up</p> <p>10 PUS_2_100K_Ohm_Pull_Up — 100K Ohm Pull Up</p> <p>11 PUS_3_22K_Ohm_Pull_Up — 22K Ohm Pull Up</p>
13 PUE	<p>Pull / Keep Select Field</p> <p>Select one out of next values for pad: JTAG_MOD</p> <p>0 PUE_0_Keeper — Keeper</p> <p>1 PUE_1_Pull — Pull</p>
12 PKE	<p>Pull / Keep Enable Field</p> <p>Select one out of next values for pad: JTAG_MOD</p> <p>0 PKE_0_Pull_Keeper_Disabled — Pull/Keeper Disabled</p> <p>1 PKE_1_Pull_Keeper_Enabled — Pull/Keeper Enabled</p>
11 ODE	<p>Open Drain Enable Field</p> <p>Select one out of next values for pad: JTAG_MOD</p> <p>0 ODE_0_Open_Drain_Disabled — Open Drain Disabled</p> <p>1 ODE_1_Open_Drain_Enabled — Open Drain Enabled</p>
10–8 -	<p>This field is reserved.</p> <p>Reserved</p>
7–6 SPEED	<p>Speed Field</p> <p>Read Only Field</p> <p>10 SPEED — medium(100MHz)</p>
5–3 DSE	<p>Drive Strength Field</p> <p>Select one out of next values for pad: JTAG_MOD</p> <p>000 DSE_0_output_driver_disabled — output driver disabled;</p> <p>001 DSE_1_R0_260_Ohm__3_3V_150_Ohm_1_8V_240_Ohm_for_DDR_ — R0(260 Ohm @ 3.3V, 150 Ohm@1.8V, 240 Ohm for DDR)</p> <p>010 DSE_2_R0_2 — R0/2</p> <p>011 DSE_3_R0_3 — R0/3</p> <p>100 DSE_4_R0_4 — R0/4</p> <p>101 DSE_5_R0_5 — R0/5</p> <p>110 DSE_6_R0_6 — R0/6</p> <p>111 DSE_7_R0_7 — R0/7</p>
2–1 -	<p>This field is reserved.</p> <p>Reserved</p>
0 SRE	<p>Slew Rate Field</p> <p>Select one out of next values for pad: JTAG_MOD</p>

Table continues on the next page...

IOMUXC_SW_PAD_CTL_PAD_JTAG_MOD field descriptions (continued)

Field	Description
0	SRE_0_Slow_Slew_Rate — Slow Slew Rate
1	SRE_1_Fast_Slew_Rate — Fast Slew Rate

32.6.148 SW_PAD_CTL_PAD_JTAG_TMS SW PAD Control Register (IOMUXC_SW_PAD_CTL_PAD_JTAG_TMS)

SW_PAD_CTL Register

Address: 20E_0000h base + 2D4h offset = 20E_02D4h

Bit	31	30	29	28	27	26	25	24	23	22	21	20	19	18	17	16													
R	Reserved															HYS													
W																													
Reset	0	0	0	0	0	0	0	0	0	0	0	0	0	0	0	0													
Bit	15	14	13	12	11	10	9	8	7	6	5	4	3	2	1	0													
R	PUS				PUE				PKE				ODE				Reserved				SPEED		DSE				Reserved		SRE
W																													
Reset	0	1	1	1	0	0	0	0	1	0	1	0	0	0	0	0													

IOMUXC_SW_PAD_CTL_PAD_JTAG_TMS field descriptions

Field	Description
31–17 -	This field is reserved. Reserved
16 HYS	Hyst. Enable Field Select one out of next values for pad: JTAG_TMS 0 HYS_0_Hysteresis_Disabled — Hysteresis Disabled 1 HYS_1_Hysteresis_Enabled — Hysteresis Enabled
15–14 PUS	Pull Up / Down Config. Field Select one out of next values for pad: JTAG_TMS 00 PUS_0_100K_Ohm_Pull_Down — 100K Ohm Pull Down 01 PUS_1_47K_Ohm_Pull_Up — 47K Ohm Pull Up 10 PUS_2_100K_Ohm_Pull_Up — 100K Ohm Pull Up 11 PUS_3_22K_Ohm_Pull_Up — 22K Ohm Pull Up
13 PUE	Pull / Keep Select Field Select one out of next values for pad: JTAG_TMS 0 PUE_0_Keeper — Keeper 1 PUE_1_Pull — Pull

Table continues on the next page...

IOMUXC_SW_PAD_CTL_PAD_JTAG_TMS field descriptions (continued)

Field	Description
12 PKE	<p>Pull / Keep Enable Field</p> <p>Select one out of next values for pad: JTAG_TMS</p> <p>0 PKE_0_Pull_Keeper_Disabled — Pull/Keeper Disabled</p> <p>1 PKE_1_Pull_Keeper_Enabled — Pull/Keeper Enabled</p>
11 ODE	<p>Open Drain Enable Field</p> <p>Select one out of next values for pad: JTAG_TMS</p> <p>0 ODE_0_Open_Drain_Disabled — Open Drain Disabled</p> <p>1 ODE_1_Open_Drain_Enabled — Open Drain Enabled</p>
10–8 -	<p>This field is reserved.</p> <p>Reserved</p>
7–6 SPEED	<p>Speed Field</p> <p>Read Only Field</p> <p>10 SPEED — medium(100MHz)</p>
5–3 DSE	<p>Drive Strength Field</p> <p>Select one out of next values for pad: JTAG_TMS</p> <p>000 DSE_0_output_driver_disabled_ — output driver disabled;</p> <p>001 DSE_1_R0_260_Ohm__3_3V__150_Ohm_1_8V__240_Ohm_for_DDR_ — R0(260 Ohm @ 3.3V, 150 Ohm@1.8V, 240 Ohm for DDR)</p> <p>010 DSE_2_R0_2 — R0/2</p> <p>011 DSE_3_R0_3 — R0/3</p> <p>100 DSE_4_R0_4 — R0/4</p> <p>101 DSE_5_R0_5 — R0/5</p> <p>110 DSE_6_R0_6 — R0/6</p> <p>111 DSE_7_R0_7 — R0/7</p>
2–1 -	<p>This field is reserved.</p> <p>Reserved</p>
0 SRE	<p>Slew Rate Field</p> <p>Select one out of next values for pad: JTAG_TMS</p> <p>0 SRE_0_Slow_Slew_Rate — Slow Slew Rate</p> <p>1 SRE_1_Fast_Slew_Rate — Fast Slew Rate</p>

32.6.149 SW_PAD_CTL_PAD_JTAG_TDO SW PAD Control Register (IOMUXC_SW_PAD_CTL_PAD_JTAG_TDO)

SW_PAD_CTL Register

Address: 20E_0000h base + 2D8h offset = 20E_02D8h

Bit	31	30	29	28	27	26	25	24	23	22	21	20	19	18	17	16
R	Reserved															HYS
W																
Reset	0	0	0	0	0	0	0	0	0	0	0	0	0	0	0	0
Bit	15	14	13	12	11	10	9	8	7	6	5	4	3	2	1	0
R	PUS	PUE	PKE	ODE	Reserved				SPEED		DSE			Reserved		SRE
W																
Reset	1	0	0	1	0	0	0	0	1	0	1	1	0	0	0	1

IOMUXC_SW_PAD_CTL_PAD_JTAG_TDO field descriptions

Field	Description
31–17 -	This field is reserved. Reserved
16 HYS	Hyst. Enable Field Select one out of next values for pad: JTAG_TDO 0 HYS_0_Hysteresis_Disabled — Hysteresis Disabled 1 HYS_1_Hysteresis_Enabled — Hysteresis Enabled
15–14 PUS	Pull Up / Down Config. Field Select one out of next values for pad: JTAG_TDO 00 PUS_0_100K_Ohm_Pull_Down — 100K Ohm Pull Down 01 PUS_1_47K_Ohm_Pull_Up — 47K Ohm Pull Up 10 PUS_2_100K_Ohm_Pull_Up — 100K Ohm Pull Up 11 PUS_3_22K_Ohm_Pull_Up — 22K Ohm Pull Up
13 PUE	Pull / Keep Select Field Select one out of next values for pad: JTAG_TDO 0 PUE_0_Keeper — Keeper 1 PUE_1_Pull — Pull
12 PKE	Pull / Keep Enable Field Select one out of next values for pad: JTAG_TDO 0 PKE_0_Pull_Keeper_Disabled — Pull/Keeper Disabled 1 PKE_1_Pull_Keeper_Enabled — Pull/Keeper Enabled

Table continues on the next page...

IOMUXC_SW_PAD_CTL_PAD_JTAG_TDO field descriptions (continued)

Field	Description
11 ODE	Open Drain Enable Field Select one out of next values for pad: JTAG_TDO 0 ODE_0_Open_Drain_Disabled — Open Drain Disabled 1 ODE_1_Open_Drain_Enabled — Open Drain Enabled
10–8 -	This field is reserved. Reserved
7–6 SPEED	Speed Field Read Only Field 10 SPEED — medium(100MHz)
5–3 DSE	Drive Strength Field Select one out of next values for pad: JTAG_TDO 000 DSE_0_output_driver_disabled_ — output driver disabled; 001 DSE_1_R0_260_Ohm_3_3V_150_Ohm_1_8V_240_Ohm_for_DDR_ — R0(260 Ohm @ 3.3V, 150 Ohm@1.8V, 240 Ohm for DDR) 010 DSE_2_R0_2 — R0/2 011 DSE_3_R0_3 — R0/3 100 DSE_4_R0_4 — R0/4 101 DSE_5_R0_5 — R0/5 110 DSE_6_R0_6 — R0/6 111 DSE_7_R0_7 — R0/7
2–1 -	This field is reserved. Reserved
0 SRE	Slew Rate Field Select one out of next values for pad: JTAG_TDO 0 SRE_0_Slow_Slew_Rate — Slow Slew Rate 1 SRE_1_Fast_Slew_Rate — Fast Slew Rate

32.6.150 SW_PAD_CTL_PAD_JTAG_TDI SW PAD Control Register (IOMUXC_SW_PAD_CTL_PAD_JTAG_TDI)

SW_PAD_CTL Register

Address: 20E_0000h base + 2DCh offset = 20E_02DCh

Bit	31	30	29	28	27	26	25	24	23	22	21	20	19	18	17	16
R	Reserved															HYS
W																
Reset	0	0	0	0	0	0	0	0	0	0	0	0	0	0	0	0
Bit	15	14	13	12	11	10	9	8	7	6	5	4	3	2	1	0
R	PUS	PUE	PKE	ODE	Reserved			SPEED		DSE			Reserved		SRE	
W																
Reset	0	1	1	1	0	0	0	0	1	0	1	0	0	0	0	0

IOMUXC_SW_PAD_CTL_PAD_JTAG_TDI field descriptions

Field	Description
31–17 -	This field is reserved. Reserved
16 HYS	Hyst. Enable Field Select one out of next values for pad: JTAG_TDI 0 HYS_0_Hysteresis_Disabled — Hysteresis Disabled 1 HYS_1_Hysteresis_Enabled — Hysteresis Enabled
15–14 PUS	Pull Up / Down Config. Field Select one out of next values for pad: JTAG_TDI 00 PUS_0_100K_Ohm_Pull_Down — 100K Ohm Pull Down 01 PUS_1_47K_Ohm_Pull_Up — 47K Ohm Pull Up 10 PUS_2_100K_Ohm_Pull_Up — 100K Ohm Pull Up 11 PUS_3_22K_Ohm_Pull_Up — 22K Ohm Pull Up
13 PUE	Pull / Keep Select Field Select one out of next values for pad: JTAG_TDI 0 PUE_0_Keeper — Keeper 1 PUE_1_Pull — Pull
12 PKE	Pull / Keep Enable Field Select one out of next values for pad: JTAG_TDI 0 PKE_0_Pull_Keeper_Disabled — Pull/Keeper Disabled 1 PKE_1_Pull_Keeper_Enabled — Pull/Keeper Enabled

Table continues on the next page...

IOMUXC_SW_PAD_CTL_PAD_JTAG_TDI field descriptions (continued)

Field	Description
11 ODE	Open Drain Enable Field Select one out of next values for pad: JTAG_TDI 0 ODE_0_Open_Drain_Disabled — Open Drain Disabled 1 ODE_1_Open_Drain_Enabled — Open Drain Enabled
10–8 -	This field is reserved. Reserved
7–6 SPEED	Speed Field Read Only Field 10 SPEED — medium(100MHz)
5–3 DSE	Drive Strength Field Select one out of next values for pad: JTAG_TDI 000 DSE_0_output_driver_disabled_ — output driver disabled; 001 DSE_1_R0_260_Ohm_3_3V_150_Ohm_1_8V_240_Ohm_for_DDR_ — R0(260 Ohm @ 3.3V, 150 Ohm@1.8V, 240 Ohm for DDR) 010 DSE_2_R0_2 — R0/2 011 DSE_3_R0_3 — R0/3 100 DSE_4_R0_4 — R0/4 101 DSE_5_R0_5 — R0/5 110 DSE_6_R0_6 — R0/6 111 DSE_7_R0_7 — R0/7
2–1 -	This field is reserved. Reserved
0 SRE	Slew Rate Field Select one out of next values for pad: JTAG_TDI 0 SRE_0_Slow_Slew_Rate — Slow Slew Rate 1 SRE_1_Fast_Slew_Rate — Fast Slew Rate

32.6.151 SW_PAD_CTL_PAD_JTAG_TCK SW PAD Control Register (IOMUXC_SW_PAD_CTL_PAD_JTAG_TCK)

SW_PAD_CTL Register

Address: 20E_0000h base + 2E0h offset = 20E_02E0h

Bit	31	30	29	28	27	26	25	24	23	22	21	20	19	18	17	16
R	Reserved															HYS
W																
Reset	0	0	0	0	0	0	0	0	0	0	0	0	0	0	0	0
Bit	15	14	13	12	11	10	9	8	7	6	5	4	3	2	1	0
R	PUS	PUE	PKE	ODE	Reserved			SPEED		DSE			Reserved		SRE	
W																
Reset	0	1	1	1	0	0	0	0	1	0	1	0	0	0	0	0

IOMUXC_SW_PAD_CTL_PAD_JTAG_TCK field descriptions

Field	Description
31–17 -	This field is reserved. Reserved
16 HYS	Hyst. Enable Field Select one out of next values for pad: JTAG_TCK 0 HYS_0_Hysteresis_Disabled — Hysteresis Disabled 1 HYS_1_Hysteresis_Enabled — Hysteresis Enabled
15–14 PUS	Pull Up / Down Config. Field Select one out of next values for pad: JTAG_TCK 00 PUS_0_100K_Ohm_Pull_Down — 100K Ohm Pull Down 01 PUS_1_47K_Ohm_Pull_Up — 47K Ohm Pull Up 10 PUS_2_100K_Ohm_Pull_Up — 100K Ohm Pull Up 11 PUS_3_22K_Ohm_Pull_Up — 22K Ohm Pull Up
13 PUE	Pull / Keep Select Field Select one out of next values for pad: JTAG_TCK 0 PUE_0_Keeper — Keeper 1 PUE_1_Pull — Pull
12 PKE	Pull / Keep Enable Field Select one out of next values for pad: JTAG_TCK 0 PKE_0_Pull_Keeper_Disabled — Pull/Keeper Disabled 1 PKE_1_Pull_Keeper_Enabled — Pull/Keeper Enabled

Table continues on the next page...

IOMUXC_SW_PAD_CTL_PAD_JTAG_TCK field descriptions (continued)

Field	Description
11 ODE	Open Drain Enable Field Select one out of next values for pad: JTAG_TCK 0 ODE_0_Open_Drain_Disabled — Open Drain Disabled 1 ODE_1_Open_Drain_Enabled — Open Drain Enabled
10–8 -	This field is reserved. Reserved
7–6 SPEED	Speed Field Read Only Field 10 SPEED — medium(100MHz)
5–3 DSE	Drive Strength Field Select one out of next values for pad: JTAG_TCK 000 DSE_0_output_driver_disabled_ — output driver disabled; 001 DSE_1_R0_260_Ohm__3_3V__150_Ohm_1_8V__240_Ohm_for_DDR_ — R0(260 Ohm @ 3.3V, 150 Ohm@1.8V, 240 Ohm for DDR) 010 DSE_2_R0_2 — R0/2 011 DSE_3_R0_3 — R0/3 100 DSE_4_R0_4 — R0/4 101 DSE_5_R0_5 — R0/5 110 DSE_6_R0_6 — R0/6 111 DSE_7_R0_7 — R0/7
2–1 -	This field is reserved. Reserved
0 SRE	Slew Rate Field Select one out of next values for pad: JTAG_TCK 0 SRE_0_Slow_Slew_Rate — Slow Slew Rate 1 SRE_1_Fast_Slew_Rate — Fast Slew Rate

32.6.152 SW_PAD_CTL_PAD_JTAG_TRST_B SW PAD Control Register (IOMUXC_SW_PAD_CTL_PAD_JTAG_TRST_B)

SW_PAD_CTL Register

Address: 20E_0000h base + 2E4h offset = 20E_02E4h

Bit	31	30	29	28	27	26	25	24	23	22	21	20	19	18	17	16
R	Reserved															HYS
W																
Reset	0	0	0	0	0	0	0	0	0	0	0	0	0	0	0	0
Bit	15	14	13	12	11	10	9	8	7	6	5	4	3	2	1	0
R	PUS	PUE	PKE	ODE	Reserved			SPEED		DSE			Reserved		SRE	
W																
Reset	0	1	1	1	0	0	0	0	1	0	1	0	0	0	0	0

IOMUXC_SW_PAD_CTL_PAD_JTAG_TRST_B field descriptions

Field	Description
31–17 -	This field is reserved. Reserved
16 HYS	Hyst. Enable Field Select one out of next values for pad: JTAG_TRST_B 0 HYS_0_Hysteresis_Disabled — Hysteresis Disabled 1 HYS_1_Hysteresis_Enabled — Hysteresis Enabled
15–14 PUS	Pull Up / Down Config. Field Select one out of next values for pad: JTAG_TRST_B 00 PUS_0_100K_Ohm_Pull_Down — 100K Ohm Pull Down 01 PUS_1_47K_Ohm_Pull_Up — 47K Ohm Pull Up 10 PUS_2_100K_Ohm_Pull_Up — 100K Ohm Pull Up 11 PUS_3_22K_Ohm_Pull_Up — 22K Ohm Pull Up
13 PUE	Pull / Keep Select Field Select one out of next values for pad: JTAG_TRST_B 0 PUE_0_Keeper — Keeper 1 PUE_1_Pull — Pull
12 PKE	Pull / Keep Enable Field Select one out of next values for pad: JTAG_TRST_B 0 PKE_0_Pull_Keeper_Disabled — Pull/Keeper Disabled 1 PKE_1_Pull_Keeper_Enabled — Pull/Keeper Enabled

Table continues on the next page...

IOMUXC_SW_PAD_CTL_PAD_JTAG_TRST_B field descriptions (continued)

Field	Description
11 ODE	Open Drain Enable Field Select one out of next values for pad: JTAG_TRST_B 0 ODE_0_Open_Drain_Disabled — Open Drain Disabled 1 ODE_1_Open_Drain_Enabled — Open Drain Enabled
10–8 -	This field is reserved. Reserved
7–6 SPEED	Speed Field Read Only Field 10 SPEED — medium(100MHz)
5–3 DSE	Drive Strength Field Select one out of next values for pad: JTAG_TRST_B 000 DSE_0_output_driver_disabled_ — output driver disabled; 001 DSE_1_R0_260_Ohm_3_3V_150_Ohm_1_8V_240_Ohm_for_DDR_ — R0(260 Ohm @ 3.3V, 150 Ohm@1.8V, 240 Ohm for DDR) 010 DSE_2_R0_2 — R0/2 011 DSE_3_R0_3 — R0/3 100 DSE_4_R0_4 — R0/4 101 DSE_5_R0_5 — R0/5 110 DSE_6_R0_6 — R0/6 111 DSE_7_R0_7 — R0/7
2–1 -	This field is reserved. Reserved
0 SRE	Slew Rate Field Select one out of next values for pad: JTAG_TRST_B 0 SRE_0_Slow_Slew_Rate — Slow Slew Rate 1 SRE_1_Fast_Slew_Rate — Fast Slew Rate

32.6.153 SW_PAD_CTL_PAD_GPIO1_IO00 SW PAD Control Register (IOMUXC_SW_PAD_CTL_PAD_GPIO1_IO00)

SW_PAD_CTL Register

Address: 20E_0000h base + 2E8h offset = 20E_02E8h

Bit	31	30	29	28	27	26	25	24	23	22	21	20	19	18	17	16
R	Reserved															HYS
W																
Reset	0	0	0	0	0	0	0	0	0	0	0	0	0	0	0	0
Bit	15	14	13	12	11	10	9	8	7	6	5	4	3	2	1	0
R	PUS	PUE	PKE	ODE	Reserved			SPEED	DSE			Reserved		SRE		
W																
Reset	0	0	0	1	0	0	0	0	1	0	1	1	0	0	0	0

IOMUXC_SW_PAD_CTL_PAD_GPIO1_IO00 field descriptions

Field	Description
31–17 -	This field is reserved. Reserved
16 HYS	Hyst. Enable Field Select one out of next values for pad: GPIO1_IO00 0 HYS_0_Hysteresis_Disabled — Hysteresis Disabled 1 HYS_1_Hysteresis_Enabled — Hysteresis Enabled
15–14 PUS	Pull Up / Down Config. Field Select one out of next values for pad: GPIO1_IO00 00 PUS_0_100K_Ohm_Pull_Down — 100K Ohm Pull Down 01 PUS_1_47K_Ohm_Pull_Up — 47K Ohm Pull Up 10 PUS_2_100K_Ohm_Pull_Up — 100K Ohm Pull Up 11 PUS_3_22K_Ohm_Pull_Up — 22K Ohm Pull Up
13 PUE	Pull / Keep Select Field Select one out of next values for pad: GPIO1_IO00 0 PUE_0_Keeper — Keeper 1 PUE_1_Pull — Pull
12 PKE	Pull / Keep Enable Field Select one out of next values for pad: GPIO1_IO00 0 PKE_0_Pull_Keeper_Disabled — Pull/Keeper Disabled 1 PKE_1_Pull_Keeper_Enabled — Pull/Keeper Enabled
11 ODE	Open Drain Enable Field Select one out of next values for pad: GPIO1_IO00

Table continues on the next page...

IOMUXC_SW_PAD_CTL_PAD_GPIO1_IO00 field descriptions (continued)

Field	Description
	0 ODE_0_Open_Drain_Disabled — Open Drain Disabled 1 ODE_1_Open_Drain_Enabled — Open Drain Enabled
10–8 -	This field is reserved. Reserved
7–6 SPEED	Speed Field Select one out of next values for pad: GPIO1_IO00 00 SPEED_0_low_50MHz_ — low(50MHz) 01 SPEED_1_medium_100MHz_ — medium(100MHz) 10 SPEED_2_medium_100MHz_ — medium(100MHz) 11 SPEED_3_max_200MHz_ — max(200MHz)
5–3 DSE	Drive Strength Field Select one out of next values for pad: GPIO1_IO00 000 DSE_0_output_driver_disabled_ — output driver disabled; 001 DSE_1_R0_260_Ohm__3_3V_150_Ohm_1_8V_240_Ohm_for_DDR_ — R0(260 Ohm @ 3.3V, 150 Ohm@1.8V, 240 Ohm for DDR) 010 DSE_2_R0_2 — R0/2 011 DSE_3_R0_3 — R0/3 100 DSE_4_R0_4 — R0/4 101 DSE_5_R0_5 — R0/5 110 DSE_6_R0_6 — R0/6 111 DSE_7_R0_7 — R0/7
2–1 -	This field is reserved. Reserved
0 SRE	Slew Rate Field Select one out of next values for pad: GPIO1_IO00 0 SRE_0_Slow_Slew_Rate — Slow Slew Rate 1 SRE_1_Fast_Slew_Rate — Fast Slew Rate

32.6.154 SW_PAD_CTL_PAD_GPIO1_IO01 SW PAD Control Register (IOMUXC_SW_PAD_CTL_PAD_GPIO1_IO01)

SW_PAD_CTL Register

Address: 20E_0000h base + 2ECh offset = 20E_02ECh

Bit	31	30	29	28	27	26	25	24	23	22	21	20	19	18	17	16
R	Reserved															HYS
W																
Reset	0	0	0	0	0	0	0	0	0	0	0	0	0	0	0	0
Bit	15	14	13	12	11	10	9	8	7	6	5	4	3	2	1	0
R	PUS	PUE	PKE	ODE	Reserved			SPEED	DSE			Reserved		SRE		
W																
Reset	0	0	0	1	0	0	0	0	1	0	1	1	0	0	0	0

IOMUXC_SW_PAD_CTL_PAD_GPIO1_IO01 field descriptions

Field	Description
31–17 -	This field is reserved. Reserved
16 HYS	Hyst. Enable Field Select one out of next values for pad: GPIO1_IO01 0 HYS_0_Hysteresis_Disabled — Hysteresis Disabled 1 HYS_1_Hysteresis_Enabled — Hysteresis Enabled
15–14 PUS	Pull Up / Down Config. Field Select one out of next values for pad: GPIO1_IO01 00 PUS_0_100K_Ohm_Pull_Down — 100K Ohm Pull Down 01 PUS_1_47K_Ohm_Pull_Up — 47K Ohm Pull Up 10 PUS_2_100K_Ohm_Pull_Up — 100K Ohm Pull Up 11 PUS_3_22K_Ohm_Pull_Up — 22K Ohm Pull Up
13 PUE	Pull / Keep Select Field Select one out of next values for pad: GPIO1_IO01 0 PUE_0_Keeper — Keeper 1 PUE_1_Pull — Pull
12 PKE	Pull / Keep Enable Field Select one out of next values for pad: GPIO1_IO01 0 PKE_0_Pull_Keeper_Disabled — Pull/Keeper Disabled 1 PKE_1_Pull_Keeper_Enabled — Pull/Keeper Enabled
11 ODE	Open Drain Enable Field Select one out of next values for pad: GPIO1_IO01

Table continues on the next page...

IOMUXC_SW_PAD_CTL_PAD_GPIO1_IO01 field descriptions (continued)

Field	Description
	0 ODE_0_Open_Drain_Disabled — Open Drain Disabled 1 ODE_1_Open_Drain_Enabled — Open Drain Enabled
10–8 -	This field is reserved. Reserved
7–6 SPEED	Speed Field Select one out of next values for pad: GPIO1_IO01 00 SPEED_0_low_50MHz_ — low(50MHz) 01 SPEED_1_medium_100MHz_ — medium(100MHz) 10 SPEED_2_medium_100MHz_ — medium(100MHz) 11 SPEED_3_max_200MHz_ — max(200MHz)
5–3 DSE	Drive Strength Field Select one out of next values for pad: GPIO1_IO01 000 DSE_0_output_driver_disabled_ — output driver disabled; 001 DSE_1_R0_260_Ohm_3_3V_150_Ohm_1_8V_240_Ohm_for_DDR_ — R0(260 Ohm @ 3.3V, 150 Ohm@1.8V, 240 Ohm for DDR) 010 DSE_2_R0_2 — R0/2 011 DSE_3_R0_3 — R0/3 100 DSE_4_R0_4 — R0/4 101 DSE_5_R0_5 — R0/5 110 DSE_6_R0_6 — R0/6 111 DSE_7_R0_7 — R0/7
2–1 -	This field is reserved. Reserved
0 SRE	Slew Rate Field Select one out of next values for pad: GPIO1_IO01 0 SRE_0_Slow_Slew_Rate — Slow Slew Rate 1 SRE_1_Fast_Slew_Rate — Fast Slew Rate

32.6.155 SW_PAD_CTL_PAD_GPIO1_IO02 SW PAD Control Register (IOMUXC_SW_PAD_CTL_PAD_GPIO1_IO02)

SW_PAD_CTL Register

Address: 20E_0000h base + 2F0h offset = 20E_02F0h

Bit	31	30	29	28	27	26	25	24	23	22	21	20	19	18	17	16
R	Reserved															HYS
W																
Reset	0	0	0	0	0	0	0	0	0	0	0	0	0	0	0	0
Bit	15	14	13	12	11	10	9	8	7	6	5	4	3	2	1	0
R	PUS	PUE	PKE	ODE	Reserved			SPEED	DSE			Reserved		SRE		
W																
Reset	0	0	0	1	0	0	0	0	1	0	1	1	0	0	0	0

IOMUXC_SW_PAD_CTL_PAD_GPIO1_IO02 field descriptions

Field	Description
31–17 -	This field is reserved. Reserved
16 HYS	Hyst. Enable Field Select one out of next values for pad: GPIO1_IO02 0 HYS_0_Hysteresis_Disabled — Hysteresis Disabled 1 HYS_1_Hysteresis_Enabled — Hysteresis Enabled
15–14 PUS	Pull Up / Down Config. Field Select one out of next values for pad: GPIO1_IO02 00 PUS_0_100K_Ohm_Pull_Down — 100K Ohm Pull Down 01 PUS_1_47K_Ohm_Pull_Up — 47K Ohm Pull Up 10 PUS_2_100K_Ohm_Pull_Up — 100K Ohm Pull Up 11 PUS_3_22K_Ohm_Pull_Up — 22K Ohm Pull Up
13 PUE	Pull / Keep Select Field Select one out of next values for pad: GPIO1_IO02 0 PUE_0_Keeper — Keeper 1 PUE_1_Pull — Pull
12 PKE	Pull / Keep Enable Field Select one out of next values for pad: GPIO1_IO02 0 PKE_0_Pull_Keeper_Disabled — Pull/Keeper Disabled 1 PKE_1_Pull_Keeper_Enabled — Pull/Keeper Enabled
11 ODE	Open Drain Enable Field Select one out of next values for pad: GPIO1_IO02

Table continues on the next page...

IOMUXC_SW_PAD_CTL_PAD_GPIO1_IO02 field descriptions (continued)

Field	Description
	0 ODE_0_Open_Drain_Disabled — Open Drain Disabled 1 ODE_1_Open_Drain_Enabled — Open Drain Enabled
10–8 -	This field is reserved. Reserved
7–6 SPEED	Speed Field Select one out of next values for pad: GPIO1_IO02 00 SPEED_0_low_50MHz_ — low(50MHz) 01 SPEED_1_medium_100MHz_ — medium(100MHz) 10 SPEED_2_medium_100MHz_ — medium(100MHz) 11 SPEED_3_max_200MHz_ — max(200MHz)
5–3 DSE	Drive Strength Field Select one out of next values for pad: GPIO1_IO02 000 DSE_0_output_driver_disabled_ — output driver disabled; 001 DSE_1_R0_260_Ohm__3_3V_150_Ohm_1_8V_240_Ohm_for_DDR_ — R0(260 Ohm @ 3.3V, 150 Ohm@1.8V, 240 Ohm for DDR) 010 DSE_2_R0_2 — R0/2 011 DSE_3_R0_3 — R0/3 100 DSE_4_R0_4 — R0/4 101 DSE_5_R0_5 — R0/5 110 DSE_6_R0_6 — R0/6 111 DSE_7_R0_7 — R0/7
2–1 -	This field is reserved. Reserved
0 SRE	Slew Rate Field Select one out of next values for pad: GPIO1_IO02 0 SRE_0_Slow_Slew_Rate — Slow Slew Rate 1 SRE_1_Fast_Slew_Rate — Fast Slew Rate

32.6.156 SW_PAD_CTL_PAD_GPIO1_IO03 SW PAD Control Register (IOMUXC_SW_PAD_CTL_PAD_GPIO1_IO03)

SW_PAD_CTL Register

Address: 20E_0000h base + 2F4h offset = 20E_02F4h

Bit	31	30	29	28	27	26	25	24	23	22	21	20	19	18	17	16
R	Reserved															HYS
W																
Reset	0	0	0	0	0	0	0	0	0	0	0	0	0	0	0	0
Bit	15	14	13	12	11	10	9	8	7	6	5	4	3	2	1	0
R	PUS	PUE	PKE	ODE	Reserved			SPEED	DSE			Reserved		SRE		
W																
Reset	0	0	0	1	0	0	0	0	1	0	1	1	0	0	0	0

IOMUXC_SW_PAD_CTL_PAD_GPIO1_IO03 field descriptions

Field	Description
31–17 -	This field is reserved. Reserved
16 HYS	Hyst. Enable Field Select one out of next values for pad: GPIO1_IO03 0 HYS_0_Hysteresis_Disabled — Hysteresis Disabled 1 HYS_1_Hysteresis_Enabled — Hysteresis Enabled
15–14 PUS	Pull Up / Down Config. Field Select one out of next values for pad: GPIO1_IO03 00 PUS_0_100K_Ohm_Pull_Down — 100K Ohm Pull Down 01 PUS_1_47K_Ohm_Pull_Up — 47K Ohm Pull Up 10 PUS_2_100K_Ohm_Pull_Up — 100K Ohm Pull Up 11 PUS_3_22K_Ohm_Pull_Up — 22K Ohm Pull Up
13 PUE	Pull / Keep Select Field Select one out of next values for pad: GPIO1_IO03 0 PUE_0_Keeper — Keeper 1 PUE_1_Pull — Pull
12 PKE	Pull / Keep Enable Field Select one out of next values for pad: GPIO1_IO03 0 PKE_0_Pull_Keeper_Disabled — Pull/Keeper Disabled 1 PKE_1_Pull_Keeper_Enabled — Pull/Keeper Enabled
11 ODE	Open Drain Enable Field Select one out of next values for pad: GPIO1_IO03

Table continues on the next page...

IOMUXC_SW_PAD_CTL_PAD_GPIO1_IO03 field descriptions (continued)

Field	Description
	0 ODE_0_Open_Drain_Disabled — Open Drain Disabled 1 ODE_1_Open_Drain_Enabled — Open Drain Enabled
10–8 -	This field is reserved. Reserved
7–6 SPEED	Speed Field Select one out of next values for pad: GPIO1_IO03 00 SPEED_0_low_50MHz_ — low(50MHz) 01 SPEED_1_medium_100MHz_ — medium(100MHz) 10 SPEED_2_medium_100MHz_ — medium(100MHz) 11 SPEED_3_max_200MHz_ — max(200MHz)
5–3 DSE	Drive Strength Field Select one out of next values for pad: GPIO1_IO03 000 DSE_0_output_driver_disabled_ — output driver disabled; 001 DSE_1_R0_260_Ohm__3_3V_150_Ohm_1_8V_240_Ohm_for_DDR_ — R0(260 Ohm @ 3.3V, 150 Ohm@1.8V, 240 Ohm for DDR) 010 DSE_2_R0_2 — R0/2 011 DSE_3_R0_3 — R0/3 100 DSE_4_R0_4 — R0/4 101 DSE_5_R0_5 — R0/5 110 DSE_6_R0_6 — R0/6 111 DSE_7_R0_7 — R0/7
2–1 -	This field is reserved. Reserved
0 SRE	Slew Rate Field Select one out of next values for pad: GPIO1_IO03 0 SRE_0_Slow_Slew_Rate — Slow Slew Rate 1 SRE_1_Fast_Slew_Rate — Fast Slew Rate

32.6.157 SW_PAD_CTL_PAD_GPIO1_IO04 SW PAD Control Register (IOMUXC_SW_PAD_CTL_PAD_GPIO1_IO04)

SW_PAD_CTL Register

Address: 20E_0000h base + 2F8h offset = 20E_02F8h

Bit	31	30	29	28	27	26	25	24	23	22	21	20	19	18	17	16
R	Reserved															HYS
W																
Reset	0	0	0	0	0	0	0	0	0	0	0	0	0	0	0	0
Bit	15	14	13	12	11	10	9	8	7	6	5	4	3	2	1	0
R	PUS	PUE	PKE	ODE	Reserved			SPEED	DSE			Reserved		SRE		
W																
Reset	0	0	0	1	0	0	0	0	1	0	1	1	0	0	0	0

IOMUXC_SW_PAD_CTL_PAD_GPIO1_IO04 field descriptions

Field	Description
31–17 -	This field is reserved. Reserved
16 HYS	Hyst. Enable Field Select one out of next values for pad: GPIO1_IO04 0 HYS_0_Hysteresis_Disabled — Hysteresis Disabled 1 HYS_1_Hysteresis_Enabled — Hysteresis Enabled
15–14 PUS	Pull Up / Down Config. Field Select one out of next values for pad: GPIO1_IO04 00 PUS_0_100K_Ohm_Pull_Down — 100K Ohm Pull Down 01 PUS_1_47K_Ohm_Pull_Up — 47K Ohm Pull Up 10 PUS_2_100K_Ohm_Pull_Up — 100K Ohm Pull Up 11 PUS_3_22K_Ohm_Pull_Up — 22K Ohm Pull Up
13 PUE	Pull / Keep Select Field Select one out of next values for pad: GPIO1_IO04 0 PUE_0_Keeper — Keeper 1 PUE_1_Pull — Pull
12 PKE	Pull / Keep Enable Field Select one out of next values for pad: GPIO1_IO04 0 PKE_0_Pull_Keeper_Disabled — Pull/Keeper Disabled 1 PKE_1_Pull_Keeper_Enabled — Pull/Keeper Enabled
11 ODE	Open Drain Enable Field Select one out of next values for pad: GPIO1_IO04

Table continues on the next page...

IOMUXC_SW_PAD_CTL_PAD_GPIO1_IO04 field descriptions (continued)

Field	Description
	0 ODE_0_Open_Drain_Disabled — Open Drain Disabled 1 ODE_1_Open_Drain_Enabled — Open Drain Enabled
10–8 -	This field is reserved. Reserved
7–6 SPEED	Speed Field Select one out of next values for pad: GPIO1_IO04 00 SPEED_0_low_50MHz_ — low(50MHz) 01 SPEED_1_medium_100MHz_ — medium(100MHz) 10 SPEED_2_medium_100MHz_ — medium(100MHz) 11 SPEED_3_max_200MHz_ — max(200MHz)
5–3 DSE	Drive Strength Field Select one out of next values for pad: GPIO1_IO04 000 DSE_0_output_driver_disabled_ — output driver disabled; 001 DSE_1_R0_260_Ohm__3_3V_150_Ohm_1_8V_240_Ohm_for_DDR_ — R0(260 Ohm @ 3.3V, 150 Ohm@1.8V, 240 Ohm for DDR) 010 DSE_2_R0_2 — R0/2 011 DSE_3_R0_3 — R0/3 100 DSE_4_R0_4 — R0/4 101 DSE_5_R0_5 — R0/5 110 DSE_6_R0_6 — R0/6 111 DSE_7_R0_7 — R0/7
2–1 -	This field is reserved. Reserved
0 SRE	Slew Rate Field Select one out of next values for pad: GPIO1_IO04 0 SRE_0_Slow_Slew_Rate — Slow Slew Rate 1 SRE_1_Fast_Slew_Rate — Fast Slew Rate

32.6.158 SW_PAD_CTL_PAD_GPIO1_IO05 SW PAD Control Register (IOMUXC_SW_PAD_CTL_PAD_GPIO1_IO05)

SW_PAD_CTL Register

Address: 20E_0000h base + 2FCCh offset = 20E_02FCh

Bit	31	30	29	28	27	26	25	24	23	22	21	20	19	18	17	16
R	Reserved															HYS
W																
Reset	0	0	0	0	0	0	0	0	0	0	0	0	0	0	0	0
Bit	15	14	13	12	11	10	9	8	7	6	5	4	3	2	1	0
R	PUS	PUE	PKE	ODE	Reserved			SPEED	DSE			Reserved		SRE		
W																
Reset	0	0	0	1	0	0	0	0	1	0	1	1	0	0	0	0

IOMUXC_SW_PAD_CTL_PAD_GPIO1_IO05 field descriptions

Field	Description
31–17 -	This field is reserved. Reserved
16 HYS	Hyst. Enable Field Select one out of next values for pad: GPIO1_IO05 0 HYS_0_Hysteresis_Disabled — Hysteresis Disabled 1 HYS_1_Hysteresis_Enabled — Hysteresis Enabled
15–14 PUS	Pull Up / Down Config. Field Select one out of next values for pad: GPIO1_IO05 00 PUS_0_100K_Ohm_Pull_Down — 100K Ohm Pull Down 01 PUS_1_47K_Ohm_Pull_Up — 47K Ohm Pull Up 10 PUS_2_100K_Ohm_Pull_Up — 100K Ohm Pull Up 11 PUS_3_22K_Ohm_Pull_Up — 22K Ohm Pull Up
13 PUE	Pull / Keep Select Field Select one out of next values for pad: GPIO1_IO05 0 PUE_0_Keeper — Keeper 1 PUE_1_Pull — Pull
12 PKE	Pull / Keep Enable Field Select one out of next values for pad: GPIO1_IO05 0 PKE_0_Pull_Keeper_Disabled — Pull/Keeper Disabled 1 PKE_1_Pull_Keeper_Enabled — Pull/Keeper Enabled
11 ODE	Open Drain Enable Field Select one out of next values for pad: GPIO1_IO05

Table continues on the next page...

IOMUXC_SW_PAD_CTL_PAD_GPIO1_IO05 field descriptions (continued)

Field	Description
	0 ODE_0_Open_Drain_Disabled — Open Drain Disabled 1 ODE_1_Open_Drain_Enabled — Open Drain Enabled
10–8 -	This field is reserved. Reserved
7–6 SPEED	Speed Field Select one out of next values for pad: GPIO1_IO05 00 SPEED_0_low_50MHz_ — low(50MHz) 01 SPEED_1_medium_100MHz_ — medium(100MHz) 10 SPEED_2_medium_100MHz_ — medium(100MHz) 11 SPEED_3_max_200MHz_ — max(200MHz)
5–3 DSE	Drive Strength Field Select one out of next values for pad: GPIO1_IO05 000 DSE_0_output_driver_disabled_ — output driver disabled; 001 DSE_1_R0_260_Ohm__3_3V_150_Ohm_1_8V_240_Ohm_for_DDR_ — R0(260 Ohm @ 3.3V, 150 Ohm@1.8V, 240 Ohm for DDR) 010 DSE_2_R0_2 — R0/2 011 DSE_3_R0_3 — R0/3 100 DSE_4_R0_4 — R0/4 101 DSE_5_R0_5 — R0/5 110 DSE_6_R0_6 — R0/6 111 DSE_7_R0_7 — R0/7
2–1 -	This field is reserved. Reserved
0 SRE	Slew Rate Field Select one out of next values for pad: GPIO1_IO05 0 SRE_0_Slow_Slew_Rate — Slow Slew Rate 1 SRE_1_Fast_Slew_Rate — Fast Slew Rate

32.6.159 SW_PAD_CTL_PAD_GPIO1_IO06 SW PAD Control Register (IOMUXC_SW_PAD_CTL_PAD_GPIO1_IO06)

SW_PAD_CTL Register

Address: 20E_0000h base + 300h offset = 20E_0300h

Bit	31	30	29	28	27	26	25	24	23	22	21	20	19	18	17	16
R	Reserved															HYS
W																
Reset	0	0	0	0	0	0	0	0	0	0	0	0	0	0	0	0
Bit	15	14	13	12	11	10	9	8	7	6	5	4	3	2	1	0
R	PUS	PUE	PKE	ODE	Reserved			SPEED	DSE			Reserved		SRE		
W																
Reset	0	0	0	1	0	0	0	0	1	0	1	1	0	0	0	0

IOMUXC_SW_PAD_CTL_PAD_GPIO1_IO06 field descriptions

Field	Description
31–17 -	This field is reserved. Reserved
16 HYS	Hyst. Enable Field Select one out of next values for pad: GPIO1_IO06 0 HYS_0_Hysteresis_Disabled — Hysteresis Disabled 1 HYS_1_Hysteresis_Enabled — Hysteresis Enabled
15–14 PUS	Pull Up / Down Config. Field Select one out of next values for pad: GPIO1_IO06 00 PUS_0_100K_Ohm_Pull_Down — 100K Ohm Pull Down 01 PUS_1_47K_Ohm_Pull_Up — 47K Ohm Pull Up 10 PUS_2_100K_Ohm_Pull_Up — 100K Ohm Pull Up 11 PUS_3_22K_Ohm_Pull_Up — 22K Ohm Pull Up
13 PUE	Pull / Keep Select Field Select one out of next values for pad: GPIO1_IO06 0 PUE_0_Keeper — Keeper 1 PUE_1_Pull — Pull
12 PKE	Pull / Keep Enable Field Select one out of next values for pad: GPIO1_IO06 0 PKE_0_Pull_Keeper_Disabled — Pull/Keeper Disabled 1 PKE_1_Pull_Keeper_Enabled — Pull/Keeper Enabled
11 ODE	Open Drain Enable Field Select one out of next values for pad: GPIO1_IO06

Table continues on the next page...

IOMUXC_SW_PAD_CTL_PAD_GPIO1_IO06 field descriptions (continued)

Field	Description
	0 ODE_0_Open_Drain_Disabled — Open Drain Disabled 1 ODE_1_Open_Drain_Enabled — Open Drain Enabled
10–8 -	This field is reserved. Reserved
7–6 SPEED	Speed Field Select one out of next values for pad: GPIO1_IO06 00 SPEED_0_low_50MHz_ — low(50MHz) 01 SPEED_1_medium_100MHz_ — medium(100MHz) 10 SPEED_2_medium_100MHz_ — medium(100MHz) 11 SPEED_3_max_200MHz_ — max(200MHz)
5–3 DSE	Drive Strength Field Select one out of next values for pad: GPIO1_IO06 000 DSE_0_output_driver_disabled_ — output driver disabled; 001 DSE_1_R0_260_Ohm__3_3V_150_Ohm_1_8V_240_Ohm_for_DDR_ — R0(260 Ohm @ 3.3V, 150 Ohm@1.8V, 240 Ohm for DDR) 010 DSE_2_R0_2 — R0/2 011 DSE_3_R0_3 — R0/3 100 DSE_4_R0_4 — R0/4 101 DSE_5_R0_5 — R0/5 110 DSE_6_R0_6 — R0/6 111 DSE_7_R0_7 — R0/7
2–1 -	This field is reserved. Reserved
0 SRE	Slew Rate Field Select one out of next values for pad: GPIO1_IO06 0 SRE_0_Slow_Slew_Rate — Slow Slew Rate 1 SRE_1_Fast_Slew_Rate — Fast Slew Rate

32.6.160 SW_PAD_CTL_PAD_GPIO1_IO07 SW PAD Control Register (IOMUXC_SW_PAD_CTL_PAD_GPIO1_IO07)

SW_PAD_CTL Register

Address: 20E_0000h base + 304h offset = 20E_0304h

Bit	31	30	29	28	27	26	25	24	23	22	21	20	19	18	17	16
R	Reserved															HYS
W																
Reset	0	0	0	0	0	0	0	0	0	0	0	0	0	0	0	0
Bit	15	14	13	12	11	10	9	8	7	6	5	4	3	2	1	0
R	PUS	PUE	PKE	ODE	Reserved			SPEED	DSE			Reserved		SRE		
W																
Reset	0	0	0	1	0	0	0	0	1	0	1	1	0	0	0	0

IOMUXC_SW_PAD_CTL_PAD_GPIO1_IO07 field descriptions

Field	Description
31–17 -	This field is reserved. Reserved
16 HYS	Hyst. Enable Field Select one out of next values for pad: GPIO1_IO07 0 HYS_0_Hysteresis_Disabled — Hysteresis Disabled 1 HYS_1_Hysteresis_Enabled — Hysteresis Enabled
15–14 PUS	Pull Up / Down Config. Field Select one out of next values for pad: GPIO1_IO07 00 PUS_0_100K_Ohm_Pull_Down — 100K Ohm Pull Down 01 PUS_1_47K_Ohm_Pull_Up — 47K Ohm Pull Up 10 PUS_2_100K_Ohm_Pull_Up — 100K Ohm Pull Up 11 PUS_3_22K_Ohm_Pull_Up — 22K Ohm Pull Up
13 PUE	Pull / Keep Select Field Select one out of next values for pad: GPIO1_IO07 0 PUE_0_Keeper — Keeper 1 PUE_1_Pull — Pull
12 PKE	Pull / Keep Enable Field Select one out of next values for pad: GPIO1_IO07 0 PKE_0_Pull_Keeper_Disabled — Pull/Keeper Disabled 1 PKE_1_Pull_Keeper_Enabled — Pull/Keeper Enabled
11 ODE	Open Drain Enable Field Select one out of next values for pad: GPIO1_IO07

Table continues on the next page...

IOMUXC_SW_PAD_CTL_PAD_GPIO1_IO07 field descriptions (continued)

Field	Description
	0 ODE_0_Open_Drain_Disabled — Open Drain Disabled 1 ODE_1_Open_Drain_Enabled — Open Drain Enabled
10–8 -	This field is reserved. Reserved
7–6 SPEED	Speed Field Select one out of next values for pad: GPIO1_IO07 00 SPEED_0_low_50MHz_ — low(50MHz) 01 SPEED_1_medium_100MHz_ — medium(100MHz) 10 SPEED_2_medium_100MHz_ — medium(100MHz) 11 SPEED_3_max_200MHz_ — max(200MHz)
5–3 DSE	Drive Strength Field Select one out of next values for pad: GPIO1_IO07 000 DSE_0_output_driver_disabled_ — output driver disabled; 001 DSE_1_R0_260_Ohm__3_3V_150_Ohm_1_8V_240_Ohm_for_DDR_ — R0(260 Ohm @ 3.3V, 150 Ohm@1.8V, 240 Ohm for DDR) 010 DSE_2_R0_2 — R0/2 011 DSE_3_R0_3 — R0/3 100 DSE_4_R0_4 — R0/4 101 DSE_5_R0_5 — R0/5 110 DSE_6_R0_6 — R0/6 111 DSE_7_R0_7 — R0/7
2–1 -	This field is reserved. Reserved
0 SRE	Slew Rate Field Select one out of next values for pad: GPIO1_IO07 0 SRE_0_Slow_Slew_Rate — Slow Slew Rate 1 SRE_1_Fast_Slew_Rate — Fast Slew Rate

32.6.161 SW_PAD_CTL_PAD_GPIO1_IO08 SW PAD Control Register (IOMUXC_SW_PAD_CTL_PAD_GPIO1_IO08)

SW_PAD_CTL Register

Address: 20E_0000h base + 308h offset = 20E_0308h

Bit	31	30	29	28	27	26	25	24	23	22	21	20	19	18	17	16
R	Reserved															HYS
W																
Reset	0	0	0	0	0	0	0	0	0	0	0	0	0	0	0	0
Bit	15	14	13	12	11	10	9	8	7	6	5	4	3	2	1	0
R	PUS	PUE	PKE	ODE	Reserved			SPEED	DSE			Reserved		SRE		
W																
Reset	0	0	0	1	0	0	0	0	1	0	1	1	0	0	0	0

IOMUXC_SW_PAD_CTL_PAD_GPIO1_IO08 field descriptions

Field	Description
31–17 -	This field is reserved. Reserved
16 HYS	Hyst. Enable Field Select one out of next values for pad: GPIO1_IO08 0 HYS_0_Hysteresis_Disabled — Hysteresis Disabled 1 HYS_1_Hysteresis_Enabled — Hysteresis Enabled
15–14 PUS	Pull Up / Down Config. Field Select one out of next values for pad: GPIO1_IO08 00 PUS_0_100K_Ohm_Pull_Down — 100K Ohm Pull Down 01 PUS_1_47K_Ohm_Pull_Up — 47K Ohm Pull Up 10 PUS_2_100K_Ohm_Pull_Up — 100K Ohm Pull Up 11 PUS_3_22K_Ohm_Pull_Up — 22K Ohm Pull Up
13 PUE	Pull / Keep Select Field Select one out of next values for pad: GPIO1_IO08 0 PUE_0_Keeper — Keeper 1 PUE_1_Pull — Pull
12 PKE	Pull / Keep Enable Field Select one out of next values for pad: GPIO1_IO08 0 PKE_0_Pull_Keeper_Disabled — Pull/Keeper Disabled 1 PKE_1_Pull_Keeper_Enabled — Pull/Keeper Enabled
11 ODE	Open Drain Enable Field Select one out of next values for pad: GPIO1_IO08

Table continues on the next page...

IOMUXC_SW_PAD_CTL_PAD_GPIO1_IO08 field descriptions (continued)

Field	Description
	0 ODE_0_Open_Drain_Disabled — Open Drain Disabled 1 ODE_1_Open_Drain_Enabled — Open Drain Enabled
10–8 -	This field is reserved. Reserved
7–6 SPEED	Speed Field Select one out of next values for pad: GPIO1_IO08 00 SPEED_0_low_50MHz_ — low(50MHz) 01 SPEED_1_medium_100MHz_ — medium(100MHz) 10 SPEED_2_medium_100MHz_ — medium(100MHz) 11 SPEED_3_max_200MHz_ — max(200MHz)
5–3 DSE	Drive Strength Field Select one out of next values for pad: GPIO1_IO08 000 DSE_0_output_driver_disabled_ — output driver disabled; 001 DSE_1_R0_260_Ohm__3_3V_150_Ohm_1_8V_240_Ohm_for_DDR_ — R0(260 Ohm @ 3.3V, 150 Ohm@1.8V, 240 Ohm for DDR) 010 DSE_2_R0_2 — R0/2 011 DSE_3_R0_3 — R0/3 100 DSE_4_R0_4 — R0/4 101 DSE_5_R0_5 — R0/5 110 DSE_6_R0_6 — R0/6 111 DSE_7_R0_7 — R0/7
2–1 -	This field is reserved. Reserved
0 SRE	Slew Rate Field Select one out of next values for pad: GPIO1_IO08 0 SRE_0_Slow_Slew_Rate — Slow Slew Rate 1 SRE_1_Fast_Slew_Rate — Fast Slew Rate

32.6.162 SW_PAD_CTL_PAD_GPIO1_IO09 SW PAD Control Register (IOMUXC_SW_PAD_CTL_PAD_GPIO1_IO09)

SW_PAD_CTL Register

Address: 20E_0000h base + 30Ch offset = 20E_030Ch

Bit	31	30	29	28	27	26	25	24	23	22	21	20	19	18	17	16
R	Reserved															HYS
W																
Reset	0	0	0	0	0	0	0	0	0	0	0	0	0	0	0	0
Bit	15	14	13	12	11	10	9	8	7	6	5	4	3	2	1	0
R	PUS	PUE	PKE	ODE	Reserved			SPEED	DSE			Reserved		SRE		
W																
Reset	0	0	0	1	0	0	0	0	1	0	1	1	0	0	0	0

IOMUXC_SW_PAD_CTL_PAD_GPIO1_IO09 field descriptions

Field	Description
31–17 -	This field is reserved. Reserved
16 HYS	Hyst. Enable Field Select one out of next values for pad: GPIO1_IO09 0 HYS_0_Hysteresis_Disabled — Hysteresis Disabled 1 HYS_1_Hysteresis_Enabled — Hysteresis Enabled
15–14 PUS	Pull Up / Down Config. Field Select one out of next values for pad: GPIO1_IO09 00 PUS_0_100K_Ohm_Pull_Down — 100K Ohm Pull Down 01 PUS_1_47K_Ohm_Pull_Up — 47K Ohm Pull Up 10 PUS_2_100K_Ohm_Pull_Up — 100K Ohm Pull Up 11 PUS_3_22K_Ohm_Pull_Up — 22K Ohm Pull Up
13 PUE	Pull / Keep Select Field Select one out of next values for pad: GPIO1_IO09 0 PUE_0_Keeper — Keeper 1 PUE_1_Pull — Pull
12 PKE	Pull / Keep Enable Field Select one out of next values for pad: GPIO1_IO09 0 PKE_0_Pull_Keeper_Disabled — Pull/Keeper Disabled 1 PKE_1_Pull_Keeper_Enabled — Pull/Keeper Enabled
11 ODE	Open Drain Enable Field Select one out of next values for pad: GPIO1_IO09

Table continues on the next page...

IOMUXC_SW_PAD_CTL_PAD_GPIO1_IO09 field descriptions (continued)

Field	Description
	0 ODE_0_Open_Drain_Disabled — Open Drain Disabled 1 ODE_1_Open_Drain_Enabled — Open Drain Enabled
10–8 -	This field is reserved. Reserved
7–6 SPEED	Speed Field Select one out of next values for pad: GPIO1_IO09 00 SPEED_0_low_50MHz_ — low(50MHz) 01 SPEED_1_medium_100MHz_ — medium(100MHz) 10 SPEED_2_medium_100MHz_ — medium(100MHz) 11 SPEED_3_max_200MHz_ — max(200MHz)
5–3 DSE	Drive Strength Field Select one out of next values for pad: GPIO1_IO09 000 DSE_0_output_driver_disabled_ — output driver disabled; 001 DSE_1_R0_260_Ohm__3_3V_150_Ohm_1_8V_240_Ohm_for_DDR_ — R0(260 Ohm @ 3.3V, 150 Ohm@1.8V, 240 Ohm for DDR) 010 DSE_2_R0_2 — R0/2 011 DSE_3_R0_3 — R0/3 100 DSE_4_R0_4 — R0/4 101 DSE_5_R0_5 — R0/5 110 DSE_6_R0_6 — R0/6 111 DSE_7_R0_7 — R0/7
2–1 -	This field is reserved. Reserved
0 SRE	Slew Rate Field Select one out of next values for pad: GPIO1_IO09 0 SRE_0_Slow_Slew_Rate — Slow Slew Rate 1 SRE_1_Fast_Slew_Rate — Fast Slew Rate

32.6.163 SW_PAD_CTL_PAD_UART1_TX_DATA SW PAD Control Register (IOMUXC_SW_PAD_CTL_PAD_UART1_TX_DATA)

SW_PAD_CTL Register

Address: 20E_0000h base + 310h offset = 20E_0310h

Bit	31	30	29	28	27	26	25	24	23	22	21	20	19	18	17	16
R	Reserved															HYS
W																
Reset	0	0	0	0	0	0	0	0	0	0	0	0	0	0	0	0
Bit	15	14	13	12	11	10	9	8	7	6	5	4	3	2	1	0
R	PUS	PUE	PKE	ODE	Reserved			SPEED	DSE			Reserved		SRE		
W																
Reset	0	0	0	1	0	0	0	0	1	0	1	1	0	0	0	0

IOMUXC_SW_PAD_CTL_PAD_UART1_TX_DATA field descriptions

Field	Description
31–17 -	This field is reserved. Reserved
16 HYS	Hyst. Enable Field Select one out of next values for pad: UART1_TX_DATA 0 HYS_0_Hysteresis_Disabled — Hysteresis Disabled 1 HYS_1_Hysteresis_Enabled — Hysteresis Enabled
15–14 PUS	Pull Up / Down Config. Field Select one out of next values for pad: UART1_TX_DATA 00 PUS_0_100K_Ohm_Pull_Down — 100K Ohm Pull Down 01 PUS_1_47K_Ohm_Pull_Up — 47K Ohm Pull Up 10 PUS_2_100K_Ohm_Pull_Up — 100K Ohm Pull Up 11 PUS_3_22K_Ohm_Pull_Up — 22K Ohm Pull Up
13 PUE	Pull / Keep Select Field Select one out of next values for pad: UART1_TX_DATA 0 PUE_0_Keeper — Keeper 1 PUE_1_Pull — Pull
12 PKE	Pull / Keep Enable Field Select one out of next values for pad: UART1_TX_DATA 0 PKE_0_Pull_Keeper_Disabled — Pull/Keeper Disabled 1 PKE_1_Pull_Keeper_Enabled — Pull/Keeper Enabled
11 ODE	Open Drain Enable Field Select one out of next values for pad: UART1_TX_DATA

Table continues on the next page...

IOMUXC_SW_PAD_CTL_PAD_UART1_TX_DATA field descriptions (continued)

Field	Description
	0 ODE_0_Open_Drain_Disabled — Open Drain Disabled 1 ODE_1_Open_Drain_Enabled — Open Drain Enabled
10–8 -	This field is reserved. Reserved
7–6 SPEED	Speed Field Select one out of next values for pad: UART1_TX_DATA 00 SPEED_0_low_50MHz_ — low(50MHz) 01 SPEED_1_medium_100MHz_ — medium(100MHz) 10 SPEED_2_medium_100MHz_ — medium(100MHz) 11 SPEED_3_max_200MHz_ — max(200MHz)
5–3 DSE	Drive Strength Field Select one out of next values for pad: UART1_TX_DATA 000 DSE_0_output_driver_disabled_ — output driver disabled; 001 DSE_1_R0_260_Ohm__3_3V_150_Ohm_1_8V_240_Ohm_for_DDR_ — R0(260 Ohm @ 3.3V, 150 Ohm@1.8V, 240 Ohm for DDR) 010 DSE_2_R0_2 — R0/2 011 DSE_3_R0_3 — R0/3 100 DSE_4_R0_4 — R0/4 101 DSE_5_R0_5 — R0/5 110 DSE_6_R0_6 — R0/6 111 DSE_7_R0_7 — R0/7
2–1 -	This field is reserved. Reserved
0 SRE	Slew Rate Field Select one out of next values for pad: UART1_TX_DATA 0 SRE_0_Slow_Slew_Rate — Slow Slew Rate 1 SRE_1_Fast_Slew_Rate — Fast Slew Rate

32.6.164 SW_PAD_CTL_PAD_UART1_RX_DATA SW PAD Control Register (IOMUXC_SW_PAD_CTL_PAD_UART1_RX_DATA)

SW_PAD_CTL Register

Address: 20E_0000h base + 314h offset = 20E_0314h

Bit	31	30	29	28	27	26	25	24	23	22	21	20	19	18	17	16
R	Reserved															HYS
W																
Reset	0	0	0	0	0	0	0	0	0	0	0	0	0	0	0	0
Bit	15	14	13	12	11	10	9	8	7	6	5	4	3	2	1	0
R	PUS	PUE	PKE	ODE	Reserved			SPEED	DSE			Reserved		SRE		
W																
Reset	0	0	0	1	0	0	0	0	1	0	1	1	0	0	0	0

IOMUXC_SW_PAD_CTL_PAD_UART1_RX_DATA field descriptions

Field	Description
31–17 -	This field is reserved. Reserved
16 HYS	Hyst. Enable Field Select one out of next values for pad: UART1_RX_DATA 0 HYS_0_Hysteresis_Disabled — Hysteresis Disabled 1 HYS_1_Hysteresis_Enabled — Hysteresis Enabled
15–14 PUS	Pull Up / Down Config. Field Select one out of next values for pad: UART1_RX_DATA 00 PUS_0_100K_Ohm_Pull_Down — 100K Ohm Pull Down 01 PUS_1_47K_Ohm_Pull_Up — 47K Ohm Pull Up 10 PUS_2_100K_Ohm_Pull_Up — 100K Ohm Pull Up 11 PUS_3_22K_Ohm_Pull_Up — 22K Ohm Pull Up
13 PUE	Pull / Keep Select Field Select one out of next values for pad: UART1_RX_DATA 0 PUE_0_Keeper — Keeper 1 PUE_1_Pull — Pull
12 PKE	Pull / Keep Enable Field Select one out of next values for pad: UART1_RX_DATA 0 PKE_0_Pull_Keeper_Disabled — Pull/Keeper Disabled 1 PKE_1_Pull_Keeper_Enabled — Pull/Keeper Enabled
11 ODE	Open Drain Enable Field Select one out of next values for pad: UART1_RX_DATA

Table continues on the next page...

IOMUXC_SW_PAD_CTL_PAD_UART1_RX_DATA field descriptions (continued)

Field	Description
	0 ODE_0_Open_Drain_Disabled — Open Drain Disabled 1 ODE_1_Open_Drain_Enabled — Open Drain Enabled
10–8 -	This field is reserved. Reserved
7–6 SPEED	Speed Field Select one out of next values for pad: UART1_RX_DATA 00 SPEED_0_low_50MHz_ — low(50MHz) 01 SPEED_1_medium_100MHz_ — medium(100MHz) 10 SPEED_2_medium_100MHz_ — medium(100MHz) 11 SPEED_3_max_200MHz_ — max(200MHz)
5–3 DSE	Drive Strength Field Select one out of next values for pad: UART1_RX_DATA 000 DSE_0_output_driver_disabled_ — output driver disabled; 001 DSE_1_R0_260_Ohm__3_3V_150_Ohm_1_8V_240_Ohm_for_DDR_ — R0(260 Ohm @ 3.3V, 150 Ohm@1.8V, 240 Ohm for DDR) 010 DSE_2_R0_2 — R0/2 011 DSE_3_R0_3 — R0/3 100 DSE_4_R0_4 — R0/4 101 DSE_5_R0_5 — R0/5 110 DSE_6_R0_6 — R0/6 111 DSE_7_R0_7 — R0/7
2–1 -	This field is reserved. Reserved
0 SRE	Slew Rate Field Select one out of next values for pad: UART1_RX_DATA 0 SRE_0_Slow_Slew_Rate — Slow Slew Rate 1 SRE_1_Fast_Slew_Rate — Fast Slew Rate

32.6.165 SW_PAD_CTL_PAD_UART1_CTS_B SW PAD Control Register (IOMUXC_SW_PAD_CTL_PAD_UART1_CTS_B)

SW_PAD_CTL Register

Address: 20E_0000h base + 318h offset = 20E_0318h

Bit	31	30	29	28	27	26	25	24	23	22	21	20	19	18	17	16
R	Reserved															HYS
W																
Reset	0	0	0	0	0	0	0	0	0	0	0	0	0	0	0	0
Bit	15	14	13	12	11	10	9	8	7	6	5	4	3	2	1	0
R	PUS	PUE	PKE	ODE	Reserved			SPEED	DSE			Reserved		SRE		
W																
Reset	0	0	0	1	0	0	0	0	1	0	1	1	0	0	0	0

IOMUXC_SW_PAD_CTL_PAD_UART1_CTS_B field descriptions

Field	Description
31–17 -	This field is reserved. Reserved
16 HYS	Hyst. Enable Field Select one out of next values for pad: UART1_CTS_B 0 HYS_0_Hysteresis_Disabled — Hysteresis Disabled 1 HYS_1_Hysteresis_Enabled — Hysteresis Enabled
15–14 PUS	Pull Up / Down Config. Field Select one out of next values for pad: UART1_CTS_B 00 PUS_0_100K_Ohm_Pull_Down — 100K Ohm Pull Down 01 PUS_1_47K_Ohm_Pull_Up — 47K Ohm Pull Up 10 PUS_2_100K_Ohm_Pull_Up — 100K Ohm Pull Up 11 PUS_3_22K_Ohm_Pull_Up — 22K Ohm Pull Up
13 PUE	Pull / Keep Select Field Select one out of next values for pad: UART1_CTS_B 0 PUE_0_Keeper — Keeper 1 PUE_1_Pull — Pull
12 PKE	Pull / Keep Enable Field Select one out of next values for pad: UART1_CTS_B 0 PKE_0_Pull_Keeper_Disabled — Pull/Keeper Disabled 1 PKE_1_Pull_Keeper_Enabled — Pull/Keeper Enabled
11 ODE	Open Drain Enable Field Select one out of next values for pad: UART1_CTS_B

Table continues on the next page...

IOMUXC_SW_PAD_CTL_PAD_UART1_CTS_B field descriptions (continued)

Field	Description
	0 ODE_0_Open_Drain_Disabled — Open Drain Disabled 1 ODE_1_Open_Drain_Enabled — Open Drain Enabled
10–8 -	This field is reserved. Reserved
7–6 SPEED	Speed Field Select one out of next values for pad: UART1_CTS_B 00 SPEED_0_low_50MHz_ — low(50MHz) 01 SPEED_1_medium_100MHz_ — medium(100MHz) 10 SPEED_2_medium_100MHz_ — medium(100MHz) 11 SPEED_3_max_200MHz_ — max(200MHz)
5–3 DSE	Drive Strength Field Select one out of next values for pad: UART1_CTS_B 000 DSE_0_output_driver_disabled_ — output driver disabled; 001 DSE_1_R0_260_Ohm__3_3V_150_Ohm_1_8V_240_Ohm_for_DDR_ — R0(260 Ohm @ 3.3V, 150 Ohm@1.8V, 240 Ohm for DDR) 010 DSE_2_R0_2 — R0/2 011 DSE_3_R0_3 — R0/3 100 DSE_4_R0_4 — R0/4 101 DSE_5_R0_5 — R0/5 110 DSE_6_R0_6 — R0/6 111 DSE_7_R0_7 — R0/7
2–1 -	This field is reserved. Reserved
0 SRE	Slew Rate Field Select one out of next values for pad: UART1_CTS_B 0 SRE_0_Slow_Slew_Rate — Slow Slew Rate 1 SRE_1_Fast_Slew_Rate — Fast Slew Rate

32.6.166 SW_PAD_CTL_PAD_UART1_RTS_B SW PAD Control Register (IOMUXC_SW_PAD_CTL_PAD_UART1_RTS_B)

SW_PAD_CTL Register

Address: 20E_0000h base + 31Ch offset = 20E_031Ch

Bit	31	30	29	28	27	26	25	24	23	22	21	20	19	18	17	16
R	Reserved															HYS
W																
Reset	0	0	0	0	0	0	0	0	0	0	0	0	0	0	0	0
Bit	15	14	13	12	11	10	9	8	7	6	5	4	3	2	1	0
R	PUS	PUE	PKE	ODE	Reserved			SPEED	DSE			Reserved		SRE		
W																
Reset	0	0	0	1	0	0	0	0	1	0	1	1	0	0	0	0

IOMUXC_SW_PAD_CTL_PAD_UART1_RTS_B field descriptions

Field	Description
31–17 -	This field is reserved. Reserved
16 HYS	Hyst. Enable Field Select one out of next values for pad: UART1_RTS_B 0 HYS_0_Hysteresis_Disabled — Hysteresis Disabled 1 HYS_1_Hysteresis_Enabled — Hysteresis Enabled
15–14 PUS	Pull Up / Down Config. Field Select one out of next values for pad: UART1_RTS_B 00 PUS_0_100K_Ohm_Pull_Down — 100K Ohm Pull Down 01 PUS_1_47K_Ohm_Pull_Up — 47K Ohm Pull Up 10 PUS_2_100K_Ohm_Pull_Up — 100K Ohm Pull Up 11 PUS_3_22K_Ohm_Pull_Up — 22K Ohm Pull Up
13 PUE	Pull / Keep Select Field Select one out of next values for pad: UART1_RTS_B 0 PUE_0_Keeper — Keeper 1 PUE_1_Pull — Pull
12 PKE	Pull / Keep Enable Field Select one out of next values for pad: UART1_RTS_B 0 PKE_0_Pull_Keeper_Disabled — Pull/Keeper Disabled 1 PKE_1_Pull_Keeper_Enabled — Pull/Keeper Enabled
11 ODE	Open Drain Enable Field Select one out of next values for pad: UART1_RTS_B

Table continues on the next page...

IOMUXC_SW_PAD_CTL_PAD_UART1_RTS_B field descriptions (continued)

Field	Description
	0 ODE_0_Open_Drain_Disabled — Open Drain Disabled 1 ODE_1_Open_Drain_Enabled — Open Drain Enabled
10–8 -	This field is reserved. Reserved
7–6 SPEED	Speed Field Select one out of next values for pad: UART1_RTS_B 00 SPEED_0_low_50MHz_ — low(50MHz) 01 SPEED_1_medium_100MHz_ — medium(100MHz) 10 SPEED_2_medium_100MHz_ — medium(100MHz) 11 SPEED_3_max_200MHz_ — max(200MHz)
5–3 DSE	Drive Strength Field Select one out of next values for pad: UART1_RTS_B 000 DSE_0_output_driver_disabled_ — output driver disabled; 001 DSE_1_R0_260_Ohm_3_3V_150_Ohm_1_8V_240_Ohm_for_DDR_ — R0(260 Ohm @ 3.3V, 150 Ohm@1.8V, 240 Ohm for DDR) 010 DSE_2_R0_2 — R0/2 011 DSE_3_R0_3 — R0/3 100 DSE_4_R0_4 — R0/4 101 DSE_5_R0_5 — R0/5 110 DSE_6_R0_6 — R0/6 111 DSE_7_R0_7 — R0/7
2–1 -	This field is reserved. Reserved
0 SRE	Slew Rate Field Select one out of next values for pad: UART1_RTS_B 0 SRE_0_Slow_Slew_Rate — Slow Slew Rate 1 SRE_1_Fast_Slew_Rate — Fast Slew Rate

32.6.167 SW_PAD_CTL_PAD_UART2_TX_DATA SW PAD Control Register (IOMUXC_SW_PAD_CTL_PAD_UART2_TX_DATA)

SW_PAD_CTL Register

Address: 20E_0000h base + 320h offset = 20E_0320h

Bit	31	30	29	28	27	26	25	24	23	22	21	20	19	18	17	16
R	Reserved															HYS
W																
Reset	0	0	0	0	0	0	0	0	0	0	0	0	0	0	0	0
Bit	15	14	13	12	11	10	9	8	7	6	5	4	3	2	1	0
R	PUS	PUE	PKE	ODE	Reserved			SPEED	DSE			Reserved		SRE		
W																
Reset	0	0	0	1	0	0	0	0	1	0	1	1	0	0	0	0

IOMUXC_SW_PAD_CTL_PAD_UART2_TX_DATA field descriptions

Field	Description
31–17 -	This field is reserved. Reserved
16 HYS	Hyst. Enable Field Select one out of next values for pad: UART2_TX_DATA 0 HYS_0_Hysteresis_Disabled — Hysteresis Disabled 1 HYS_1_Hysteresis_Enabled — Hysteresis Enabled
15–14 PUS	Pull Up / Down Config. Field Select one out of next values for pad: UART2_TX_DATA 00 PUS_0_100K_Ohm_Pull_Down — 100K Ohm Pull Down 01 PUS_1_47K_Ohm_Pull_Up — 47K Ohm Pull Up 10 PUS_2_100K_Ohm_Pull_Up — 100K Ohm Pull Up 11 PUS_3_22K_Ohm_Pull_Up — 22K Ohm Pull Up
13 PUE	Pull / Keep Select Field Select one out of next values for pad: UART2_TX_DATA 0 PUE_0_Keeper — Keeper 1 PUE_1_Pull — Pull
12 PKE	Pull / Keep Enable Field Select one out of next values for pad: UART2_TX_DATA 0 PKE_0_Pull_Keeper_Disabled — Pull/Keeper Disabled 1 PKE_1_Pull_Keeper_Enabled — Pull/Keeper Enabled
11 ODE	Open Drain Enable Field Select one out of next values for pad: UART2_TX_DATA

Table continues on the next page...

IOMUXC_SW_PAD_CTL_PAD_UART2_TX_DATA field descriptions (continued)

Field	Description
	0 ODE_0_Open_Drain_Disabled — Open Drain Disabled 1 ODE_1_Open_Drain_Enabled — Open Drain Enabled
10–8 -	This field is reserved. Reserved
7–6 SPEED	Speed Field Select one out of next values for pad: UART2_TX_DATA 00 SPEED_0_low_50MHz_ — low(50MHz) 01 SPEED_1_medium_100MHz_ — medium(100MHz) 10 SPEED_2_medium_100MHz_ — medium(100MHz) 11 SPEED_3_max_200MHz_ — max(200MHz)
5–3 DSE	Drive Strength Field Select one out of next values for pad: UART2_TX_DATA 000 DSE_0_output_driver_disabled_ — output driver disabled; 001 DSE_1_R0_260_Ohm__3_3V_150_Ohm_1_8V_240_Ohm_for_DDR_ — R0(260 Ohm @ 3.3V, 150 Ohm@1.8V, 240 Ohm for DDR) 010 DSE_2_R0_2 — R0/2 011 DSE_3_R0_3 — R0/3 100 DSE_4_R0_4 — R0/4 101 DSE_5_R0_5 — R0/5 110 DSE_6_R0_6 — R0/6 111 DSE_7_R0_7 — R0/7
2–1 -	This field is reserved. Reserved
0 SRE	Slew Rate Field Select one out of next values for pad: UART2_TX_DATA 0 SRE_0_Slow_Slew_Rate — Slow Slew Rate 1 SRE_1_Fast_Slew_Rate — Fast Slew Rate

32.6.168 SW_PAD_CTL_PAD_UART2_RX_DATA SW PAD Control Register (IOMUXC_SW_PAD_CTL_PAD_UART2_RX_DATA)

SW_PAD_CTL Register

Address: 20E_0000h base + 324h offset = 20E_0324h

Bit	31	30	29	28	27	26	25	24	23	22	21	20	19	18	17	16
R	Reserved															HYS
W																
Reset	0	0	0	0	0	0	0	0	0	0	0	0	0	0	0	0
Bit	15	14	13	12	11	10	9	8	7	6	5	4	3	2	1	0
R	PUS	PUE	PKE	ODE	Reserved			SPEED	DSE			Reserved		SRE		
W																
Reset	0	0	0	1	0	0	0	0	1	0	1	1	0	0	0	0

IOMUXC_SW_PAD_CTL_PAD_UART2_RX_DATA field descriptions

Field	Description
31–17 -	This field is reserved. Reserved
16 HYS	Hyst. Enable Field Select one out of next values for pad: UART2_RX_DATA 0 HYS_0_Hysteresis_Disabled — Hysteresis Disabled 1 HYS_1_Hysteresis_Enabled — Hysteresis Enabled
15–14 PUS	Pull Up / Down Config. Field Select one out of next values for pad: UART2_RX_DATA 00 PUS_0_100K_Ohm_Pull_Down — 100K Ohm Pull Down 01 PUS_1_47K_Ohm_Pull_Up — 47K Ohm Pull Up 10 PUS_2_100K_Ohm_Pull_Up — 100K Ohm Pull Up 11 PUS_3_22K_Ohm_Pull_Up — 22K Ohm Pull Up
13 PUE	Pull / Keep Select Field Select one out of next values for pad: UART2_RX_DATA 0 PUE_0_Keeper — Keeper 1 PUE_1_Pull — Pull
12 PKE	Pull / Keep Enable Field Select one out of next values for pad: UART2_RX_DATA 0 PKE_0_Pull_Keeper_Disabled — Pull/Keeper Disabled 1 PKE_1_Pull_Keeper_Enabled — Pull/Keeper Enabled
11 ODE	Open Drain Enable Field Select one out of next values for pad: UART2_RX_DATA

Table continues on the next page...

IOMUXC_SW_PAD_CTL_PAD_UART2_RX_DATA field descriptions (continued)

Field	Description
	0 ODE_0_Open_Drain_Disabled — Open Drain Disabled 1 ODE_1_Open_Drain_Enabled — Open Drain Enabled
10–8 -	This field is reserved. Reserved
7–6 SPEED	Speed Field Select one out of next values for pad: UART2_RX_DATA 00 SPEED_0_low_50MHz_ — low(50MHz) 01 SPEED_1_medium_100MHz_ — medium(100MHz) 10 SPEED_2_medium_100MHz_ — medium(100MHz) 11 SPEED_3_max_200MHz_ — max(200MHz)
5–3 DSE	Drive Strength Field Select one out of next values for pad: UART2_RX_DATA 000 DSE_0_output_driver_disabled_ — output driver disabled; 001 DSE_1_R0_260_Ohm__3_3V_150_Ohm_1_8V_240_Ohm_for_DDR_ — R0(260 Ohm @ 3.3V, 150 Ohm@1.8V, 240 Ohm for DDR) 010 DSE_2_R0_2 — R0/2 011 DSE_3_R0_3 — R0/3 100 DSE_4_R0_4 — R0/4 101 DSE_5_R0_5 — R0/5 110 DSE_6_R0_6 — R0/6 111 DSE_7_R0_7 — R0/7
2–1 -	This field is reserved. Reserved
0 SRE	Slew Rate Field Select one out of next values for pad: UART2_RX_DATA 0 SRE_0_Slow_Slew_Rate — Slow Slew Rate 1 SRE_1_Fast_Slew_Rate — Fast Slew Rate

32.6.169 SW_PAD_CTL_PAD_UART2_CTS_B SW PAD Control Register (IOMUXC_SW_PAD_CTL_PAD_UART2_CTS_B)

SW_PAD_CTL Register

Address: 20E_0000h base + 328h offset = 20E_0328h

Bit	31	30	29	28	27	26	25	24	23	22	21	20	19	18	17	16
R	Reserved															HYS
W	Reserved															
Reset	0	0	0	0	0	0	0	0	0	0	0	0	0	0	0	0
Bit	15	14	13	12	11	10	9	8	7	6	5	4	3	2	1	0
R	PUS	PUE	PKE	ODE	Reserved			SPEED	DSE			Reserved		SRE		
W																
Reset	0	0	0	1	0	0	0	0	1	0	1	1	0	0	0	0

IOMUXC_SW_PAD_CTL_PAD_UART2_CTS_B field descriptions

Field	Description
31–17 -	This field is reserved. Reserved
16 HYS	Hyst. Enable Field Select one out of next values for pad: UART2_CTS_B 0 HYS_0_Hysteresis_Disabled — Hysteresis Disabled 1 HYS_1_Hysteresis_Enabled — Hysteresis Enabled
15–14 PUS	Pull Up / Down Config. Field Select one out of next values for pad: UART2_CTS_B 00 PUS_0_100K_Ohm_Pull_Down — 100K Ohm Pull Down 01 PUS_1_47K_Ohm_Pull_Up — 47K Ohm Pull Up 10 PUS_2_100K_Ohm_Pull_Up — 100K Ohm Pull Up 11 PUS_3_22K_Ohm_Pull_Up — 22K Ohm Pull Up
13 PUE	Pull / Keep Select Field Select one out of next values for pad: UART2_CTS_B 0 PUE_0_Keeper — Keeper 1 PUE_1_Pull — Pull
12 PKE	Pull / Keep Enable Field Select one out of next values for pad: UART2_CTS_B 0 PKE_0_Pull_Keeper_Disabled — Pull/Keeper Disabled 1 PKE_1_Pull_Keeper_Enabled — Pull/Keeper Enabled
11 ODE	Open Drain Enable Field Select one out of next values for pad: UART2_CTS_B

Table continues on the next page...

IOMUXC_SW_PAD_CTL_PAD_UART2_CTS_B field descriptions (continued)

Field	Description
	0 ODE_0_Open_Drain_Disabled — Open Drain Disabled 1 ODE_1_Open_Drain_Enabled — Open Drain Enabled
10–8 -	This field is reserved. Reserved
7–6 SPEED	Speed Field Select one out of next values for pad: UART2_CTS_B 00 SPEED_0_low_50MHz_ — low(50MHz) 01 SPEED_1_medium_100MHz_ — medium(100MHz) 10 SPEED_2_medium_100MHz_ — medium(100MHz) 11 SPEED_3_max_200MHz_ — max(200MHz)
5–3 DSE	Drive Strength Field Select one out of next values for pad: UART2_CTS_B 000 DSE_0_output_driver_disabled_ — output driver disabled; 001 DSE_1_R0_260_Ohm__3_3V_150_Ohm_1_8V_240_Ohm_for_DDR_ — R0(260 Ohm @ 3.3V, 150 Ohm@1.8V, 240 Ohm for DDR) 010 DSE_2_R0_2 — R0/2 011 DSE_3_R0_3 — R0/3 100 DSE_4_R0_4 — R0/4 101 DSE_5_R0_5 — R0/5 110 DSE_6_R0_6 — R0/6 111 DSE_7_R0_7 — R0/7
2–1 -	This field is reserved. Reserved
0 SRE	Slew Rate Field Select one out of next values for pad: UART2_CTS_B 0 SRE_0_Slow_Slew_Rate — Slow Slew Rate 1 SRE_1_Fast_Slew_Rate — Fast Slew Rate

32.6.170 SW_PAD_CTL_PAD_UART2_RTS_B SW PAD Control Register (IOMUXC_SW_PAD_CTL_PAD_UART2_RTS_B)

SW_PAD_CTL Register

Address: 20E_0000h base + 32Ch offset = 20E_032Ch

Bit	31	30	29	28	27	26	25	24	23	22	21	20	19	18	17	16
R	Reserved															HYS
W																
Reset	0	0	0	0	0	0	0	0	0	0	0	0	0	0	0	0
Bit	15	14	13	12	11	10	9	8	7	6	5	4	3	2	1	0
R	PUS	PUE	PKE	ODE	Reserved			SPEED	DSE			Reserved		SRE		
W																
Reset	0	0	0	1	0	0	0	0	1	0	1	1	0	0	0	0

IOMUXC_SW_PAD_CTL_PAD_UART2_RTS_B field descriptions

Field	Description
31–17 -	This field is reserved. Reserved
16 HYS	Hyst. Enable Field Select one out of next values for pad: UART2_RTS_B 0 HYS_0_Hysteresis_Disabled — Hysteresis Disabled 1 HYS_1_Hysteresis_Enabled — Hysteresis Enabled
15–14 PUS	Pull Up / Down Config. Field Select one out of next values for pad: UART2_RTS_B 00 PUS_0_100K_Ohm_Pull_Down — 100K Ohm Pull Down 01 PUS_1_47K_Ohm_Pull_Up — 47K Ohm Pull Up 10 PUS_2_100K_Ohm_Pull_Up — 100K Ohm Pull Up 11 PUS_3_22K_Ohm_Pull_Up — 22K Ohm Pull Up
13 PUE	Pull / Keep Select Field Select one out of next values for pad: UART2_RTS_B 0 PUE_0_Keeper — Keeper 1 PUE_1_Pull — Pull
12 PKE	Pull / Keep Enable Field Select one out of next values for pad: UART2_RTS_B 0 PKE_0_Pull_Keeper_Disabled — Pull/Keeper Disabled 1 PKE_1_Pull_Keeper_Enabled — Pull/Keeper Enabled
11 ODE	Open Drain Enable Field Select one out of next values for pad: UART2_RTS_B

Table continues on the next page...

IOMUXC_SW_PAD_CTL_PAD_UART2_RTS_B field descriptions (continued)

Field	Description
	0 ODE_0_Open_Drain_Disabled — Open Drain Disabled 1 ODE_1_Open_Drain_Enabled — Open Drain Enabled
10–8 -	This field is reserved. Reserved
7–6 SPEED	Speed Field Select one out of next values for pad: UART2_RTS_B 00 SPEED_0_low_50MHz_ — low(50MHz) 01 SPEED_1_medium_100MHz_ — medium(100MHz) 10 SPEED_2_medium_100MHz_ — medium(100MHz) 11 SPEED_3_max_200MHz_ — max(200MHz)
5–3 DSE	Drive Strength Field Select one out of next values for pad: UART2_RTS_B 000 DSE_0_output_driver_disabled_ — output driver disabled; 001 DSE_1_R0_260_Ohm__3_3V_150_Ohm_1_8V_240_Ohm_for_DDR_ — R0(260 Ohm @ 3.3V, 150 Ohm@1.8V, 240 Ohm for DDR) 010 DSE_2_R0_2 — R0/2 011 DSE_3_R0_3 — R0/3 100 DSE_4_R0_4 — R0/4 101 DSE_5_R0_5 — R0/5 110 DSE_6_R0_6 — R0/6 111 DSE_7_R0_7 — R0/7
2–1 -	This field is reserved. Reserved
0 SRE	Slew Rate Field Select one out of next values for pad: UART2_RTS_B 0 SRE_0_Slow_Slew_Rate — Slow Slew Rate 1 SRE_1_Fast_Slew_Rate — Fast Slew Rate

32.6.171 SW_PAD_CTL_PAD_UART3_TX_DATA SW PAD Control Register (IOMUXC_SW_PAD_CTL_PAD_UART3_TX_DATA)

SW_PAD_CTL Register

Address: 20E_0000h base + 330h offset = 20E_0330h

Bit	31	30	29	28	27	26	25	24	23	22	21	20	19	18	17	16
R	Reserved															HYS
W																
Reset	0	0	0	0	0	0	0	0	0	0	0	0	0	0	0	0
Bit	15	14	13	12	11	10	9	8	7	6	5	4	3	2	1	0
R	PUS	PUE	PKE	ODE	Reserved			SPEED	DSE			Reserved		SRE		
W																
Reset	0	0	0	1	0	0	0	0	1	0	1	1	0	0	0	0

IOMUXC_SW_PAD_CTL_PAD_UART3_TX_DATA field descriptions

Field	Description
31–17 -	This field is reserved. Reserved
16 HYS	Hyst. Enable Field Select one out of next values for pad: UART3_TX_DATA 0 HYS_0_Hysteresis_Disabled — Hysteresis Disabled 1 HYS_1_Hysteresis_Enabled — Hysteresis Enabled
15–14 PUS	Pull Up / Down Config. Field Select one out of next values for pad: UART3_TX_DATA 00 PUS_0_100K_Ohm_Pull_Down — 100K Ohm Pull Down 01 PUS_1_47K_Ohm_Pull_Up — 47K Ohm Pull Up 10 PUS_2_100K_Ohm_Pull_Up — 100K Ohm Pull Up 11 PUS_3_22K_Ohm_Pull_Up — 22K Ohm Pull Up
13 PUE	Pull / Keep Select Field Select one out of next values for pad: UART3_TX_DATA 0 PUE_0_Keeper — Keeper 1 PUE_1_Pull — Pull
12 PKE	Pull / Keep Enable Field Select one out of next values for pad: UART3_TX_DATA 0 PKE_0_Pull_Keeper_Disabled — Pull/Keeper Disabled 1 PKE_1_Pull_Keeper_Enabled — Pull/Keeper Enabled
11 ODE	Open Drain Enable Field Select one out of next values for pad: UART3_TX_DATA

Table continues on the next page...

IOMUXC_SW_PAD_CTL_PAD_UART3_TX_DATA field descriptions (continued)

Field	Description
	0 ODE_0_Open_Drain_Disabled — Open Drain Disabled 1 ODE_1_Open_Drain_Enabled — Open Drain Enabled
10–8 -	This field is reserved. Reserved
7–6 SPEED	Speed Field Select one out of next values for pad: UART3_TX_DATA 00 SPEED_0_low_50MHz_ — low(50MHz) 01 SPEED_1_medium_100MHz_ — medium(100MHz) 10 SPEED_2_medium_100MHz_ — medium(100MHz) 11 SPEED_3_max_200MHz_ — max(200MHz)
5–3 DSE	Drive Strength Field Select one out of next values for pad: UART3_TX_DATA 000 DSE_0_output_driver_disabled_ — output driver disabled; 001 DSE_1_R0_260_Ohm_3_3V_150_Ohm_1_8V_240_Ohm_for_DDR_ — R0(260 Ohm @ 3.3V, 150 Ohm@1.8V, 240 Ohm for DDR) 010 DSE_2_R0_2 — R0/2 011 DSE_3_R0_3 — R0/3 100 DSE_4_R0_4 — R0/4 101 DSE_5_R0_5 — R0/5 110 DSE_6_R0_6 — R0/6 111 DSE_7_R0_7 — R0/7
2–1 -	This field is reserved. Reserved
0 SRE	Slew Rate Field Select one out of next values for pad: UART3_TX_DATA 0 SRE_0_Slow_Slew_Rate — Slow Slew Rate 1 SRE_1_Fast_Slew_Rate — Fast Slew Rate

32.6.172 SW_PAD_CTL_PAD_UART3_RX_DATA SW PAD Control Register (IOMUXC_SW_PAD_CTL_PAD_UART3_RX_DATA)

SW_PAD_CTL Register

Address: 20E_0000h base + 334h offset = 20E_0334h

Bit	31	30	29	28	27	26	25	24	23	22	21	20	19	18	17	16
R	Reserved															HYS
W																
Reset	0	0	0	0	0	0	0	0	0	0	0	0	0	0	0	0
Bit	15	14	13	12	11	10	9	8	7	6	5	4	3	2	1	0
R	PUS	PUE	PKE	ODE	Reserved			SPEED	DSE			Reserved		SRE		
W																
Reset	0	0	0	1	0	0	0	0	1	0	1	1	0	0	0	0

IOMUXC_SW_PAD_CTL_PAD_UART3_RX_DATA field descriptions

Field	Description
31–17 -	This field is reserved. Reserved
16 HYS	Hyst. Enable Field Select one out of next values for pad: UART3_RX_DATA 0 HYS_0_Hysteresis_Disabled — Hysteresis Disabled 1 HYS_1_Hysteresis_Enabled — Hysteresis Enabled
15–14 PUS	Pull Up / Down Config. Field Select one out of next values for pad: UART3_RX_DATA 00 PUS_0_100K_Ohm_Pull_Down — 100K Ohm Pull Down 01 PUS_1_47K_Ohm_Pull_Up — 47K Ohm Pull Up 10 PUS_2_100K_Ohm_Pull_Up — 100K Ohm Pull Up 11 PUS_3_22K_Ohm_Pull_Up — 22K Ohm Pull Up
13 PUE	Pull / Keep Select Field Select one out of next values for pad: UART3_RX_DATA 0 PUE_0_Keeper — Keeper 1 PUE_1_Pull — Pull
12 PKE	Pull / Keep Enable Field Select one out of next values for pad: UART3_RX_DATA 0 PKE_0_Pull_Keeper_Disabled — Pull/Keeper Disabled 1 PKE_1_Pull_Keeper_Enabled — Pull/Keeper Enabled
11 ODE	Open Drain Enable Field Select one out of next values for pad: UART3_RX_DATA

Table continues on the next page...

IOMUXC_SW_PAD_CTL_PAD_UART3_RX_DATA field descriptions (continued)

Field	Description
	0 ODE_0_Open_Drain_Disabled — Open Drain Disabled 1 ODE_1_Open_Drain_Enabled — Open Drain Enabled
10–8 -	This field is reserved. Reserved
7–6 SPEED	Speed Field Select one out of next values for pad: UART3_RX_DATA 00 SPEED_0_low_50MHz_ — low(50MHz) 01 SPEED_1_medium_100MHz_ — medium(100MHz) 10 SPEED_2_medium_100MHz_ — medium(100MHz) 11 SPEED_3_max_200MHz_ — max(200MHz)
5–3 DSE	Drive Strength Field Select one out of next values for pad: UART3_RX_DATA 000 DSE_0_output_driver_disabled_ — output driver disabled; 001 DSE_1_R0_260_Ohm__3_3V_150_Ohm_1_8V_240_Ohm_for_DDR_ — R0(260 Ohm @ 3.3V, 150 Ohm@1.8V, 240 Ohm for DDR) 010 DSE_2_R0_2 — R0/2 011 DSE_3_R0_3 — R0/3 100 DSE_4_R0_4 — R0/4 101 DSE_5_R0_5 — R0/5 110 DSE_6_R0_6 — R0/6 111 DSE_7_R0_7 — R0/7
2–1 -	This field is reserved. Reserved
0 SRE	Slew Rate Field Select one out of next values for pad: UART3_RX_DATA 0 SRE_0_Slow_Slew_Rate — Slow Slew Rate 1 SRE_1_Fast_Slew_Rate — Fast Slew Rate

32.6.173 SW_PAD_CTL_PAD_UART3_CTS_B SW PAD Control Register (IOMUXC_SW_PAD_CTL_PAD_UART3_CTS_B)

SW_PAD_CTL Register

Address: 20E_0000h base + 338h offset = 20E_0338h

Bit	31	30	29	28	27	26	25	24	23	22	21	20	19	18	17	16
R	Reserved															HYS
W																
Reset	0	0	0	0	0	0	0	0	0	0	0	0	0	0	0	0
Bit	15	14	13	12	11	10	9	8	7	6	5	4	3	2	1	0
R	PUS	PUE	PKE	ODE	Reserved			SPEED	DSE			Reserved		SRE		
W																
Reset	0	0	0	1	0	0	0	0	1	0	1	1	0	0	0	0

IOMUXC_SW_PAD_CTL_PAD_UART3_CTS_B field descriptions

Field	Description
31–17 -	This field is reserved. Reserved
16 HYS	Hyst. Enable Field Select one out of next values for pad: UART3_CTS_B 0 HYS_0_Hysteresis_Disabled — Hysteresis Disabled 1 HYS_1_Hysteresis_Enabled — Hysteresis Enabled
15–14 PUS	Pull Up / Down Config. Field Select one out of next values for pad: UART3_CTS_B 00 PUS_0_100K_Ohm_Pull_Down — 100K Ohm Pull Down 01 PUS_1_47K_Ohm_Pull_Up — 47K Ohm Pull Up 10 PUS_2_100K_Ohm_Pull_Up — 100K Ohm Pull Up 11 PUS_3_22K_Ohm_Pull_Up — 22K Ohm Pull Up
13 PUE	Pull / Keep Select Field Select one out of next values for pad: UART3_CTS_B 0 PUE_0_Keeper — Keeper 1 PUE_1_Pull — Pull
12 PKE	Pull / Keep Enable Field Select one out of next values for pad: UART3_CTS_B 0 PKE_0_Pull_Keeper_Disabled — Pull/Keeper Disabled 1 PKE_1_Pull_Keeper_Enabled — Pull/Keeper Enabled
11 ODE	Open Drain Enable Field Select one out of next values for pad: UART3_CTS_B

Table continues on the next page...

IOMUXC_SW_PAD_CTL_PAD_UART3_CTS_B field descriptions (continued)

Field	Description
	0 ODE_0_Open_Drain_Disabled — Open Drain Disabled 1 ODE_1_Open_Drain_Enabled — Open Drain Enabled
10–8 -	This field is reserved. Reserved
7–6 SPEED	Speed Field Select one out of next values for pad: UART3_CTS_B 00 SPEED_0_low_50MHz_ — low(50MHz) 01 SPEED_1_medium_100MHz_ — medium(100MHz) 10 SPEED_2_medium_100MHz_ — medium(100MHz) 11 SPEED_3_max_200MHz_ — max(200MHz)
5–3 DSE	Drive Strength Field Select one out of next values for pad: UART3_CTS_B 000 DSE_0_output_driver_disabled_ — output driver disabled; 001 DSE_1_R0_260_Ohm__3_3V_150_Ohm_1_8V_240_Ohm_for_DDR_ — R0(260 Ohm @ 3.3V, 150 Ohm@1.8V, 240 Ohm for DDR) 010 DSE_2_R0_2 — R0/2 011 DSE_3_R0_3 — R0/3 100 DSE_4_R0_4 — R0/4 101 DSE_5_R0_5 — R0/5 110 DSE_6_R0_6 — R0/6 111 DSE_7_R0_7 — R0/7
2–1 -	This field is reserved. Reserved
0 SRE	Slew Rate Field Select one out of next values for pad: UART3_CTS_B 0 SRE_0_Slow_Slew_Rate — Slow Slew Rate 1 SRE_1_Fast_Slew_Rate — Fast Slew Rate

32.6.174 SW_PAD_CTL_PAD_UART3_RTS_B SW PAD Control Register (IOMUXC_SW_PAD_CTL_PAD_UART3_RTS_B)

SW_PAD_CTL Register

Address: 20E_0000h base + 33Ch offset = 20E_033Ch

Bit	31	30	29	28	27	26	25	24	23	22	21	20	19	18	17	16
R	Reserved															HYS
W																
Reset	0	0	0	0	0	0	0	0	0	0	0	0	0	0	0	0
Bit	15	14	13	12	11	10	9	8	7	6	5	4	3	2	1	0
R	PUS	PUE	PKE	ODE	Reserved			SPEED	DSE			Reserved		SRE		
W																
Reset	0	0	0	1	0	0	0	0	1	0	1	1	0	0	0	0

IOMUXC_SW_PAD_CTL_PAD_UART3_RTS_B field descriptions

Field	Description
31–17 -	This field is reserved. Reserved
16 HYS	Hyst. Enable Field Select one out of next values for pad: UART3_RTS_B 0 HYS_0_Hysteresis_Disabled — Hysteresis Disabled 1 HYS_1_Hysteresis_Enabled — Hysteresis Enabled
15–14 PUS	Pull Up / Down Config. Field Select one out of next values for pad: UART3_RTS_B 00 PUS_0_100K_Ohm_Pull_Down — 100K Ohm Pull Down 01 PUS_1_47K_Ohm_Pull_Up — 47K Ohm Pull Up 10 PUS_2_100K_Ohm_Pull_Up — 100K Ohm Pull Up 11 PUS_3_22K_Ohm_Pull_Up — 22K Ohm Pull Up
13 PUE	Pull / Keep Select Field Select one out of next values for pad: UART3_RTS_B 0 PUE_0_Keeper — Keeper 1 PUE_1_Pull — Pull
12 PKE	Pull / Keep Enable Field Select one out of next values for pad: UART3_RTS_B 0 PKE_0_Pull_Keeper_Disabled — Pull/Keeper Disabled 1 PKE_1_Pull_Keeper_Enabled — Pull/Keeper Enabled
11 ODE	Open Drain Enable Field Select one out of next values for pad: UART3_RTS_B

Table continues on the next page...

IOMUXC_SW_PAD_CTL_PAD_UART3_RTS_B field descriptions (continued)

Field	Description
	0 ODE_0_Open_Drain_Disabled — Open Drain Disabled 1 ODE_1_Open_Drain_Enabled — Open Drain Enabled
10–8 -	This field is reserved. Reserved
7–6 SPEED	Speed Field Select one out of next values for pad: UART3_RTS_B 00 SPEED_0_low_50MHz_ — low(50MHz) 01 SPEED_1_medium_100MHz_ — medium(100MHz) 10 SPEED_2_medium_100MHz_ — medium(100MHz) 11 SPEED_3_max_200MHz_ — max(200MHz)
5–3 DSE	Drive Strength Field Select one out of next values for pad: UART3_RTS_B 000 DSE_0_output_driver_disabled_ — output driver disabled; 001 DSE_1_R0_260_Ohm__3_3V_150_Ohm_1_8V_240_Ohm_for_DDR_ — R0(260 Ohm @ 3.3V, 150 Ohm@1.8V, 240 Ohm for DDR) 010 DSE_2_R0_2 — R0/2 011 DSE_3_R0_3 — R0/3 100 DSE_4_R0_4 — R0/4 101 DSE_5_R0_5 — R0/5 110 DSE_6_R0_6 — R0/6 111 DSE_7_R0_7 — R0/7
2–1 -	This field is reserved. Reserved
0 SRE	Slew Rate Field Select one out of next values for pad: UART3_RTS_B 0 SRE_0_Slow_Slew_Rate — Slow Slew Rate 1 SRE_1_Fast_Slew_Rate — Fast Slew Rate

32.6.175 SW_PAD_CTL_PAD_UART4_TX_DATA SW PAD Control Register (IOMUXC_SW_PAD_CTL_PAD_UART4_TX_DATA)

SW_PAD_CTL Register

Address: 20E_0000h base + 340h offset = 20E_0340h

Bit	31	30	29	28	27	26	25	24	23	22	21	20	19	18	17	16
R	Reserved															HYS
W																
Reset	0	0	0	0	0	0	0	0	0	0	0	0	0	0	0	0
Bit	15	14	13	12	11	10	9	8	7	6	5	4	3	2	1	0
R	PUS	PUE	PKE	ODE	Reserved			SPEED	DSE			Reserved		SRE		
W																
Reset	0	0	0	1	0	0	0	0	1	0	1	1	0	0	0	0

IOMUXC_SW_PAD_CTL_PAD_UART4_TX_DATA field descriptions

Field	Description
31–17 -	This field is reserved. Reserved
16 HYS	Hyst. Enable Field Select one out of next values for pad: UART4_TX_DATA 0 HYS_0_Hysteresis_Disabled — Hysteresis Disabled 1 HYS_1_Hysteresis_Enabled — Hysteresis Enabled
15–14 PUS	Pull Up / Down Config. Field Select one out of next values for pad: UART4_TX_DATA 00 PUS_0_100K_Ohm_Pull_Down — 100K Ohm Pull Down 01 PUS_1_47K_Ohm_Pull_Up — 47K Ohm Pull Up 10 PUS_2_100K_Ohm_Pull_Up — 100K Ohm Pull Up 11 PUS_3_22K_Ohm_Pull_Up — 22K Ohm Pull Up
13 PUE	Pull / Keep Select Field Select one out of next values for pad: UART4_TX_DATA 0 PUE_0_Keeper — Keeper 1 PUE_1_Pull — Pull
12 PKE	Pull / Keep Enable Field Select one out of next values for pad: UART4_TX_DATA 0 PKE_0_Pull_Keeper_Disabled — Pull/Keeper Disabled 1 PKE_1_Pull_Keeper_Enabled — Pull/Keeper Enabled
11 ODE	Open Drain Enable Field Select one out of next values for pad: UART4_TX_DATA

Table continues on the next page...

IOMUXC_SW_PAD_CTL_PAD_UART4_TX_DATA field descriptions (continued)

Field	Description
	0 ODE_0_Open_Drain_Disabled — Open Drain Disabled 1 ODE_1_Open_Drain_Enabled — Open Drain Enabled
10–8 -	This field is reserved. Reserved
7–6 SPEED	Speed Field Select one out of next values for pad: UART4_TX_DATA 00 SPEED_0_low_50MHz_ — low(50MHz) 01 SPEED_1_medium_100MHz_ — medium(100MHz) 10 SPEED_2_medium_100MHz_ — medium(100MHz) 11 SPEED_3_max_200MHz_ — max(200MHz)
5–3 DSE	Drive Strength Field Select one out of next values for pad: UART4_TX_DATA 000 DSE_0_output_driver_disabled_ — output driver disabled; 001 DSE_1_R0_260_Ohm__3_3V_150_Ohm_1_8V_240_Ohm_for_DDR_ — R0(260 Ohm @ 3.3V, 150 Ohm@1.8V, 240 Ohm for DDR) 010 DSE_2_R0_2 — R0/2 011 DSE_3_R0_3 — R0/3 100 DSE_4_R0_4 — R0/4 101 DSE_5_R0_5 — R0/5 110 DSE_6_R0_6 — R0/6 111 DSE_7_R0_7 — R0/7
2–1 -	This field is reserved. Reserved
0 SRE	Slew Rate Field Select one out of next values for pad: UART4_TX_DATA 0 SRE_0_Slow_Slew_Rate — Slow Slew Rate 1 SRE_1_Fast_Slew_Rate — Fast Slew Rate

32.6.176 SW_PAD_CTL_PAD_UART4_RX_DATA SW PAD Control Register (IOMUXC_SW_PAD_CTL_PAD_UART4_RX_DATA)

SW_PAD_CTL Register

Address: 20E_0000h base + 344h offset = 20E_0344h

Bit	31	30	29	28	27	26	25	24	23	22	21	20	19	18	17	16
R	Reserved															HYS
W																
Reset	0	0	0	0	0	0	0	0	0	0	0	0	0	0	0	0
Bit	15	14	13	12	11	10	9	8	7	6	5	4	3	2	1	0
R	PUS	PUE	PKE	ODE	Reserved			SPEED	DSE			Reserved		SRE		
W																
Reset	0	0	0	1	0	0	0	0	1	0	1	1	0	0	0	0

IOMUXC_SW_PAD_CTL_PAD_UART4_RX_DATA field descriptions

Field	Description
31–17 -	This field is reserved. Reserved
16 HYS	Hyst. Enable Field Select one out of next values for pad: UART4_RX_DATA 0 HYS_0_Hysteresis_Disabled — Hysteresis Disabled 1 HYS_1_Hysteresis_Enabled — Hysteresis Enabled
15–14 PUS	Pull Up / Down Config. Field Select one out of next values for pad: UART4_RX_DATA 00 PUS_0_100K_Ohm_Pull_Down — 100K Ohm Pull Down 01 PUS_1_47K_Ohm_Pull_Up — 47K Ohm Pull Up 10 PUS_2_100K_Ohm_Pull_Up — 100K Ohm Pull Up 11 PUS_3_22K_Ohm_Pull_Up — 22K Ohm Pull Up
13 PUE	Pull / Keep Select Field Select one out of next values for pad: UART4_RX_DATA 0 PUE_0_Keeper — Keeper 1 PUE_1_Pull — Pull
12 PKE	Pull / Keep Enable Field Select one out of next values for pad: UART4_RX_DATA 0 PKE_0_Pull_Keeper_Disabled — Pull/Keeper Disabled 1 PKE_1_Pull_Keeper_Enabled — Pull/Keeper Enabled
11 ODE	Open Drain Enable Field Select one out of next values for pad: UART4_RX_DATA

Table continues on the next page...

IOMUXC_SW_PAD_CTL_PAD_UART4_RX_DATA field descriptions (continued)

Field	Description
	0 ODE_0_Open_Drain_Disabled — Open Drain Disabled 1 ODE_1_Open_Drain_Enabled — Open Drain Enabled
10–8 -	This field is reserved. Reserved
7–6 SPEED	Speed Field Select one out of next values for pad: UART4_RX_DATA 00 SPEED_0_low_50MHz_ — low(50MHz) 01 SPEED_1_medium_100MHz_ — medium(100MHz) 10 SPEED_2_medium_100MHz_ — medium(100MHz) 11 SPEED_3_max_200MHz_ — max(200MHz)
5–3 DSE	Drive Strength Field Select one out of next values for pad: UART4_RX_DATA 000 DSE_0_output_driver_disabled_ — output driver disabled; 001 DSE_1_R0_260_Ohm__3_3V_150_Ohm_1_8V_240_Ohm_for_DDR_ — R0(260 Ohm @ 3.3V, 150 Ohm@1.8V, 240 Ohm for DDR) 010 DSE_2_R0_2 — R0/2 011 DSE_3_R0_3 — R0/3 100 DSE_4_R0_4 — R0/4 101 DSE_5_R0_5 — R0/5 110 DSE_6_R0_6 — R0/6 111 DSE_7_R0_7 — R0/7
2–1 -	This field is reserved. Reserved
0 SRE	Slew Rate Field Select one out of next values for pad: UART4_RX_DATA 0 SRE_0_Slow_Slew_Rate — Slow Slew Rate 1 SRE_1_Fast_Slew_Rate — Fast Slew Rate

32.6.177 SW_PAD_CTL_PAD_UART5_TX_DATA SW PAD Control Register (IOMUXC_SW_PAD_CTL_PAD_UART5_TX_DATA)

SW_PAD_CTL Register

Address: 20E_0000h base + 348h offset = 20E_0348h

Bit	31	30	29	28	27	26	25	24	23	22	21	20	19	18	17	16
R	Reserved															HYS
W																
Reset	0	0	0	0	0	0	0	0	0	0	0	0	0	0	0	0
Bit	15	14	13	12	11	10	9	8	7	6	5	4	3	2	1	0
R	PUS	PUE	PKE	ODE	Reserved			SPEED	DSE			Reserved		SRE		
W																
Reset	0	0	0	1	0	0	0	0	1	0	1	1	0	0	0	0

IOMUXC_SW_PAD_CTL_PAD_UART5_TX_DATA field descriptions

Field	Description
31–17 -	This field is reserved. Reserved
16 HYS	Hyst. Enable Field Select one out of next values for pad: UART5_TX_DATA 0 HYS_0_Hysteresis_Disabled — Hysteresis Disabled 1 HYS_1_Hysteresis_Enabled — Hysteresis Enabled
15–14 PUS	Pull Up / Down Config. Field Select one out of next values for pad: UART5_TX_DATA 00 PUS_0_100K_Ohm_Pull_Down — 100K Ohm Pull Down 01 PUS_1_47K_Ohm_Pull_Up — 47K Ohm Pull Up 10 PUS_2_100K_Ohm_Pull_Up — 100K Ohm Pull Up 11 PUS_3_22K_Ohm_Pull_Up — 22K Ohm Pull Up
13 PUE	Pull / Keep Select Field Select one out of next values for pad: UART5_TX_DATA 0 PUE_0_Keeper — Keeper 1 PUE_1_Pull — Pull
12 PKE	Pull / Keep Enable Field Select one out of next values for pad: UART5_TX_DATA 0 PKE_0_Pull_Keeper_Disabled — Pull/Keeper Disabled 1 PKE_1_Pull_Keeper_Enabled — Pull/Keeper Enabled
11 ODE	Open Drain Enable Field Select one out of next values for pad: UART5_TX_DATA

Table continues on the next page...

IOMUXC_SW_PAD_CTL_PAD_UART5_TX_DATA field descriptions (continued)

Field	Description
	0 ODE_0_Open_Drain_Disabled — Open Drain Disabled 1 ODE_1_Open_Drain_Enabled — Open Drain Enabled
10–8 -	This field is reserved. Reserved
7–6 SPEED	Speed Field Select one out of next values for pad: UART5_TX_DATA 00 SPEED_0_low_50MHz_ — low(50MHz) 01 SPEED_1_medium_100MHz_ — medium(100MHz) 10 SPEED_2_medium_100MHz_ — medium(100MHz) 11 SPEED_3_max_200MHz_ — max(200MHz)
5–3 DSE	Drive Strength Field Select one out of next values for pad: UART5_TX_DATA 000 DSE_0_output_driver_disabled_ — output driver disabled; 001 DSE_1_R0_260_Ohm__3_3V_150_Ohm_1_8V_240_Ohm_for_DDR_ — R0(260 Ohm @ 3.3V, 150 Ohm@1.8V, 240 Ohm for DDR) 010 DSE_2_R0_2 — R0/2 011 DSE_3_R0_3 — R0/3 100 DSE_4_R0_4 — R0/4 101 DSE_5_R0_5 — R0/5 110 DSE_6_R0_6 — R0/6 111 DSE_7_R0_7 — R0/7
2–1 -	This field is reserved. Reserved
0 SRE	Slew Rate Field Select one out of next values for pad: UART5_TX_DATA 0 SRE_0_Slow_Slew_Rate — Slow Slew Rate 1 SRE_1_Fast_Slew_Rate — Fast Slew Rate

32.6.178 SW_PAD_CTL_PAD_UART5_RX_DATA SW PAD Control Register (IOMUXC_SW_PAD_CTL_PAD_UART5_RX_DATA)

SW_PAD_CTL Register

Address: 20E_0000h base + 34Ch offset = 20E_034Ch

Bit	31	30	29	28	27	26	25	24	23	22	21	20	19	18	17	16
R	Reserved															HYS
W																
Reset	0	0	0	0	0	0	0	0	0	0	0	0	0	0	0	0
Bit	15	14	13	12	11	10	9	8	7	6	5	4	3	2	1	0
R	PUS	PUE	PKE	ODE	Reserved			SPEED	DSE			Reserved		SRE		
W																
Reset	0	0	0	1	0	0	0	0	1	0	1	1	0	0	0	0

IOMUXC_SW_PAD_CTL_PAD_UART5_RX_DATA field descriptions

Field	Description
31–17 -	This field is reserved. Reserved
16 HYS	Hyst. Enable Field Select one out of next values for pad: UART5_RX_DATA 0 HYS_0_Hysteresis_Disabled — Hysteresis Disabled 1 HYS_1_Hysteresis_Enabled — Hysteresis Enabled
15–14 PUS	Pull Up / Down Config. Field Select one out of next values for pad: UART5_RX_DATA 00 PUS_0_100K_Ohm_Pull_Down — 100K Ohm Pull Down 01 PUS_1_47K_Ohm_Pull_Up — 47K Ohm Pull Up 10 PUS_2_100K_Ohm_Pull_Up — 100K Ohm Pull Up 11 PUS_3_22K_Ohm_Pull_Up — 22K Ohm Pull Up
13 PUE	Pull / Keep Select Field Select one out of next values for pad: UART5_RX_DATA 0 PUE_0_Keeper — Keeper 1 PUE_1_Pull — Pull
12 PKE	Pull / Keep Enable Field Select one out of next values for pad: UART5_RX_DATA 0 PKE_0_Pull_Keeper_Disabled — Pull/Keeper Disabled 1 PKE_1_Pull_Keeper_Enabled — Pull/Keeper Enabled
11 ODE	Open Drain Enable Field Select one out of next values for pad: UART5_RX_DATA

Table continues on the next page...

IOMUXC_SW_PAD_CTL_PAD_UART5_RX_DATA field descriptions (continued)

Field	Description
	0 ODE_0_Open_Drain_Disabled — Open Drain Disabled 1 ODE_1_Open_Drain_Enabled — Open Drain Enabled
10–8 -	This field is reserved. Reserved
7–6 SPEED	Speed Field Select one out of next values for pad: UART5_RX_DATA 00 SPEED_0_low_50MHz_ — low(50MHz) 01 SPEED_1_medium_100MHz_ — medium(100MHz) 10 SPEED_2_medium_100MHz_ — medium(100MHz) 11 SPEED_3_max_200MHz_ — max(200MHz)
5–3 DSE	Drive Strength Field Select one out of next values for pad: UART5_RX_DATA 000 DSE_0_output_driver_disabled_ — output driver disabled; 001 DSE_1_R0_260_Ohm__3_3V_150_Ohm_1_8V_240_Ohm_for_DDR_ — R0(260 Ohm @ 3.3V, 150 Ohm@1.8V, 240 Ohm for DDR) 010 DSE_2_R0_2 — R0/2 011 DSE_3_R0_3 — R0/3 100 DSE_4_R0_4 — R0/4 101 DSE_5_R0_5 — R0/5 110 DSE_6_R0_6 — R0/6 111 DSE_7_R0_7 — R0/7
2–1 -	This field is reserved. Reserved
0 SRE	Slew Rate Field Select one out of next values for pad: UART5_RX_DATA 0 SRE_0_Slow_Slew_Rate — Slow Slew Rate 1 SRE_1_Fast_Slew_Rate — Fast Slew Rate

32.6.179 SW_PAD_CTL_PAD_ENET1_RX_DATA0 SW PAD Control Register (IOMUXC_SW_PAD_CTL_PAD_ENET1_RX_DATA0)

SW_PAD_CTL Register

Address: 20E_0000h base + 350h offset = 20E_0350h

Bit	31	30	29	28	27	26	25	24	23	22	21	20	19	18	17	16
R	Reserved															HYS
W																
Reset	0	0	0	0	0	0	0	0	0	0	0	0	0	0	0	0
Bit	15	14	13	12	11	10	9	8	7	6	5	4	3	2	1	0
R	PUS	PUE	PKE	ODE	Reserved			SPEED	DSE			Reserved		SRE		
W																
Reset	0	0	0	1	0	0	0	0	1	0	1	1	0	0	0	0

IOMUXC_SW_PAD_CTL_PAD_ENET1_RX_DATA0 field descriptions

Field	Description
31–17 -	This field is reserved. Reserved
16 HYS	Hyst. Enable Field Select one out of next values for pad: ENET1_RX_DATA0 0 HYS_0_Hysteresis_Disabled — Hysteresis Disabled 1 HYS_1_Hysteresis_Enabled — Hysteresis Enabled
15–14 PUS	Pull Up / Down Config. Field Select one out of next values for pad: ENET1_RX_DATA0 00 PUS_0_100K_Ohm_Pull_Down — 100K Ohm Pull Down 01 PUS_1_47K_Ohm_Pull_Up — 47K Ohm Pull Up 10 PUS_2_100K_Ohm_Pull_Up — 100K Ohm Pull Up 11 PUS_3_22K_Ohm_Pull_Up — 22K Ohm Pull Up
13 PUE	Pull / Keep Select Field Select one out of next values for pad: ENET1_RX_DATA0 0 PUE_0_Keeper — Keeper 1 PUE_1_Pull — Pull
12 PKE	Pull / Keep Enable Field Select one out of next values for pad: ENET1_RX_DATA0 0 PKE_0_Pull_Keeper_Disabled — Pull/Keeper Disabled 1 PKE_1_Pull_Keeper_Enabled — Pull/Keeper Enabled
11 ODE	Open Drain Enable Field Select one out of next values for pad: ENET1_RX_DATA0

Table continues on the next page...

IOMUXC_SW_PAD_CTL_PAD_ENET1_RX_DATA0 field descriptions (continued)

Field	Description
	0 ODE_0_Open_Drain_Disabled — Open Drain Disabled 1 ODE_1_Open_Drain_Enabled — Open Drain Enabled
10–8 -	This field is reserved. Reserved
7–6 SPEED	Speed Field Select one out of next values for pad: ENET1_RX_DATA0 00 SPEED_0_low_50MHz_ — low(50MHz) 01 SPEED_1_medium_100MHz_ — medium(100MHz) 10 SPEED_2_medium_100MHz_ — medium(100MHz) 11 SPEED_3_max_200MHz_ — max(200MHz)
5–3 DSE	Drive Strength Field Select one out of next values for pad: ENET1_RX_DATA0 000 DSE_0_output_driver_disabled_ — output driver disabled; 001 DSE_1_R0_260_Ohm_3_3V_150_Ohm_1_8V_240_Ohm_for_DDR_ — R0(260 Ohm @ 3.3V, 150 Ohm@1.8V, 240 Ohm for DDR) 010 DSE_2_R0_2 — R0/2 011 DSE_3_R0_3 — R0/3 100 DSE_4_R0_4 — R0/4 101 DSE_5_R0_5 — R0/5 110 DSE_6_R0_6 — R0/6 111 DSE_7_R0_7 — R0/7
2–1 -	This field is reserved. Reserved
0 SRE	Slew Rate Field Select one out of next values for pad: ENET1_RX_DATA0 0 SRE_0_Slow_Slew_Rate — Slow Slew Rate 1 SRE_1_Fast_Slew_Rate — Fast Slew Rate

32.6.180 SW_PAD_CTL_PAD_ENET1_RX_DATA1 SW PAD Control Register (IOMUXC_SW_PAD_CTL_PAD_ENET1_RX_DATA1)

SW_PAD_CTL Register

Address: 20E_0000h base + 354h offset = 20E_0354h

Bit	31	30	29	28	27	26	25	24	23	22	21	20	19	18	17	16
R	Reserved															HYS
W																
Reset	0	0	0	0	0	0	0	0	0	0	0	0	0	0	0	0
Bit	15	14	13	12	11	10	9	8	7	6	5	4	3	2	1	0
R	PUS	PUE	PKE	ODE	Reserved			SPEED	DSE			Reserved		SRE		
W																
Reset	0	0	0	1	0	0	0	0	1	0	1	1	0	0	0	0

IOMUXC_SW_PAD_CTL_PAD_ENET1_RX_DATA1 field descriptions

Field	Description
31–17 -	This field is reserved. Reserved
16 HYS	Hyst. Enable Field Select one out of next values for pad: ENET1_RX_DATA1 0 HYS_0_Hysteresis_Disabled — Hysteresis Disabled 1 HYS_1_Hysteresis_Enabled — Hysteresis Enabled
15–14 PUS	Pull Up / Down Config. Field Select one out of next values for pad: ENET1_RX_DATA1 00 PUS_0_100K_Ohm_Pull_Down — 100K Ohm Pull Down 01 PUS_1_47K_Ohm_Pull_Up — 47K Ohm Pull Up 10 PUS_2_100K_Ohm_Pull_Up — 100K Ohm Pull Up 11 PUS_3_22K_Ohm_Pull_Up — 22K Ohm Pull Up
13 PUE	Pull / Keep Select Field Select one out of next values for pad: ENET1_RX_DATA1 0 PUE_0_Keeper — Keeper 1 PUE_1_Pull — Pull
12 PKE	Pull / Keep Enable Field Select one out of next values for pad: ENET1_RX_DATA1 0 PKE_0_Pull_Keeper_Disabled — Pull/Keeper Disabled 1 PKE_1_Pull_Keeper_Enabled — Pull/Keeper Enabled
11 ODE	Open Drain Enable Field Select one out of next values for pad: ENET1_RX_DATA1

Table continues on the next page...

IOMUXC_SW_PAD_CTL_PAD_ENET1_RX_DATA1 field descriptions (continued)

Field	Description
	0 ODE_0_Open_Drain_Disabled — Open Drain Disabled 1 ODE_1_Open_Drain_Enabled — Open Drain Enabled
10–8 -	This field is reserved. Reserved
7–6 SPEED	Speed Field Select one out of next values for pad: ENET1_RX_DATA1 00 SPEED_0_low_50MHz_ — low(50MHz) 01 SPEED_1_medium_100MHz_ — medium(100MHz) 10 SPEED_2_medium_100MHz_ — medium(100MHz) 11 SPEED_3_max_200MHz_ — max(200MHz)
5–3 DSE	Drive Strength Field Select one out of next values for pad: ENET1_RX_DATA1 000 DSE_0_output_driver_disabled_ — output driver disabled; 001 DSE_1_R0_260_Ohm__3_3V_150_Ohm_1_8V_240_Ohm_for_DDR_ — R0(260 Ohm @ 3.3V, 150 Ohm@1.8V, 240 Ohm for DDR) 010 DSE_2_R0_2 — R0/2 011 DSE_3_R0_3 — R0/3 100 DSE_4_R0_4 — R0/4 101 DSE_5_R0_5 — R0/5 110 DSE_6_R0_6 — R0/6 111 DSE_7_R0_7 — R0/7
2–1 -	This field is reserved. Reserved
0 SRE	Slew Rate Field Select one out of next values for pad: ENET1_RX_DATA1 0 SRE_0_Slow_Slew_Rate — Slow Slew Rate 1 SRE_1_Fast_Slew_Rate — Fast Slew Rate

32.6.181 SW_PAD_CTL_PAD_ENET1_RX_EN SW PAD Control Register (IOMUXC_SW_PAD_CTL_PAD_ENET1_RX_EN)

SW_PAD_CTL Register

Address: 20E_0000h base + 358h offset = 20E_0358h

Bit	31	30	29	28	27	26	25	24	23	22	21	20	19	18	17	16
R	Reserved															HYS
W	Reserved															
Reset	0	0	0	0	0	0	0	0	0	0	0	0	0	0	0	0
Bit	15	14	13	12	11	10	9	8	7	6	5	4	3	2	1	0
R	PUS	PUE	PKE	ODE	Reserved			SPEED	DSE			Reserved		SRE		
W					Reserved				DSE			Reserved				
Reset	0	0	0	1	0	0	0	0	1	0	1	1	0	0	0	0

IOMUXC_SW_PAD_CTL_PAD_ENET1_RX_EN field descriptions

Field	Description
31–17 -	This field is reserved. Reserved
16 HYS	Hyst. Enable Field Select one out of next values for pad: ENET1_RX_EN 0 HYS_0_Hysteresis_Disabled — Hysteresis Disabled 1 HYS_1_Hysteresis_Enabled — Hysteresis Enabled
15–14 PUS	Pull Up / Down Config. Field Select one out of next values for pad: ENET1_RX_EN 00 PUS_0_100K_Ohm_Pull_Down — 100K Ohm Pull Down 01 PUS_1_47K_Ohm_Pull_Up — 47K Ohm Pull Up 10 PUS_2_100K_Ohm_Pull_Up — 100K Ohm Pull Up 11 PUS_3_22K_Ohm_Pull_Up — 22K Ohm Pull Up
13 PUE	Pull / Keep Select Field Select one out of next values for pad: ENET1_RX_EN 0 PUE_0_Keeper — Keeper 1 PUE_1_Pull — Pull
12 PKE	Pull / Keep Enable Field Select one out of next values for pad: ENET1_RX_EN 0 PKE_0_Pull_Keeper_Disabled — Pull/Keeper Disabled 1 PKE_1_Pull_Keeper_Enabled — Pull/Keeper Enabled
11 ODE	Open Drain Enable Field Select one out of next values for pad: ENET1_RX_EN

Table continues on the next page...

IOMUXC_SW_PAD_CTL_PAD_ENET1_RX_EN field descriptions (continued)

Field	Description
	0 ODE_0_Open_Drain_Disabled — Open Drain Disabled 1 ODE_1_Open_Drain_Enabled — Open Drain Enabled
10–8 -	This field is reserved. Reserved
7–6 SPEED	Speed Field Select one out of next values for pad: ENET1_RX_EN 00 SPEED_0_low_50MHz_ — low(50MHz) 01 SPEED_1_medium_100MHz_ — medium(100MHz) 10 SPEED_2_medium_100MHz_ — medium(100MHz) 11 SPEED_3_max_200MHz_ — max(200MHz)
5–3 DSE	Drive Strength Field Select one out of next values for pad: ENET1_RX_EN 000 DSE_0_output_driver_disabled_ — output driver disabled; 001 DSE_1_R0_260_Ohm__3_3V_150_Ohm_1_8V_240_Ohm_for_DDR_ — R0(260 Ohm @ 3.3V, 150 Ohm@1.8V, 240 Ohm for DDR) 010 DSE_2_R0_2 — R0/2 011 DSE_3_R0_3 — R0/3 100 DSE_4_R0_4 — R0/4 101 DSE_5_R0_5 — R0/5 110 DSE_6_R0_6 — R0/6 111 DSE_7_R0_7 — R0/7
2–1 -	This field is reserved. Reserved
0 SRE	Slew Rate Field Select one out of next values for pad: ENET1_RX_EN 0 SRE_0_Slow_Slew_Rate — Slow Slew Rate 1 SRE_1_Fast_Slew_Rate — Fast Slew Rate

32.6.182 SW_PAD_CTL_PAD_ENET1_TX_DATA0 SW PAD Control Register (IOMUXC_SW_PAD_CTL_PAD_ENET1_TX_DATA0)

SW_PAD_CTL Register

Address: 20E_0000h base + 35Ch offset = 20E_035Ch

Bit	31	30	29	28	27	26	25	24	23	22	21	20	19	18	17	16
R	Reserved															HYS
W																
Reset	0	0	0	0	0	0	0	0	0	0	0	0	0	0	0	0
Bit	15	14	13	12	11	10	9	8	7	6	5	4	3	2	1	0
R	PUS	PUE	PKE	ODE	Reserved			SPEED	DSE			Reserved		SRE		
W																
Reset	0	0	0	1	0	0	0	0	1	0	1	1	0	0	0	0

IOMUXC_SW_PAD_CTL_PAD_ENET1_TX_DATA0 field descriptions

Field	Description
31–17 -	This field is reserved. Reserved
16 HYS	Hyst. Enable Field Select one out of next values for pad: ENET1_TX_DATA0 0 HYS_0_Hysteresis_Disabled — Hysteresis Disabled 1 HYS_1_Hysteresis_Enabled — Hysteresis Enabled
15–14 PUS	Pull Up / Down Config. Field Select one out of next values for pad: ENET1_TX_DATA0 00 PUS_0_100K_Ohm_Pull_Down — 100K Ohm Pull Down 01 PUS_1_47K_Ohm_Pull_Up — 47K Ohm Pull Up 10 PUS_2_100K_Ohm_Pull_Up — 100K Ohm Pull Up 11 PUS_3_22K_Ohm_Pull_Up — 22K Ohm Pull Up
13 PUE	Pull / Keep Select Field Select one out of next values for pad: ENET1_TX_DATA0 0 PUE_0_Keeper — Keeper 1 PUE_1_Pull — Pull
12 PKE	Pull / Keep Enable Field Select one out of next values for pad: ENET1_TX_DATA0 0 PKE_0_Pull_Keeper_Disabled — Pull/Keeper Disabled 1 PKE_1_Pull_Keeper_Enabled — Pull/Keeper Enabled
11 ODE	Open Drain Enable Field Select one out of next values for pad: ENET1_TX_DATA0

Table continues on the next page...

IOMUXC_SW_PAD_CTL_PAD_ENET1_TX_DATA0 field descriptions (continued)

Field	Description
	0 ODE_0_Open_Drain_Disabled — Open Drain Disabled 1 ODE_1_Open_Drain_Enabled — Open Drain Enabled
10–8 -	This field is reserved. Reserved
7–6 SPEED	Speed Field Select one out of next values for pad: ENET1_TX_DATA0 00 SPEED_0_low_50MHz_ — low(50MHz) 01 SPEED_1_medium_100MHz_ — medium(100MHz) 10 SPEED_2_medium_100MHz_ — medium(100MHz) 11 SPEED_3_max_200MHz_ — max(200MHz)
5–3 DSE	Drive Strength Field Select one out of next values for pad: ENET1_TX_DATA0 000 DSE_0_output_driver_disabled_ — output driver disabled; 001 DSE_1_R0_260_Ohm__3_3V_150_Ohm_1_8V_240_Ohm_for_DDR_ — R0(260 Ohm @ 3.3V, 150 Ohm@1.8V, 240 Ohm for DDR) 010 DSE_2_R0_2 — R0/2 011 DSE_3_R0_3 — R0/3 100 DSE_4_R0_4 — R0/4 101 DSE_5_R0_5 — R0/5 110 DSE_6_R0_6 — R0/6 111 DSE_7_R0_7 — R0/7
2–1 -	This field is reserved. Reserved
0 SRE	Slew Rate Field Select one out of next values for pad: ENET1_TX_DATA0 0 SRE_0_Slow_Slew_Rate — Slow Slew Rate 1 SRE_1_Fast_Slew_Rate — Fast Slew Rate

32.6.183 SW_PAD_CTL_PAD_ENET1_TX_DATA1 SW PAD Control Register (IOMUXC_SW_PAD_CTL_PAD_ENET1_TX_DATA1)

SW_PAD_CTL Register

Address: 20E_0000h base + 360h offset = 20E_0360h

Bit	31	30	29	28	27	26	25	24	23	22	21	20	19	18	17	16
R	Reserved															HYS
W																
Reset	0	0	0	0	0	0	0	0	0	0	0	0	0	0	0	0
Bit	15	14	13	12	11	10	9	8	7	6	5	4	3	2	1	0
R	PUS	PUE	PKE	ODE	Reserved			SPEED	DSE			Reserved		SRE		
W																
Reset	0	0	0	1	0	0	0	0	1	0	1	1	0	0	0	0

IOMUXC_SW_PAD_CTL_PAD_ENET1_TX_DATA1 field descriptions

Field	Description
31–17 -	This field is reserved. Reserved
16 HYS	Hyst. Enable Field Select one out of next values for pad: ENET1_TX_DATA1 0 HYS_0_Hysteresis_Disabled — Hysteresis Disabled 1 HYS_1_Hysteresis_Enabled — Hysteresis Enabled
15–14 PUS	Pull Up / Down Config. Field Select one out of next values for pad: ENET1_TX_DATA1 00 PUS_0_100K_Ohm_Pull_Down — 100K Ohm Pull Down 01 PUS_1_47K_Ohm_Pull_Up — 47K Ohm Pull Up 10 PUS_2_100K_Ohm_Pull_Up — 100K Ohm Pull Up 11 PUS_3_22K_Ohm_Pull_Up — 22K Ohm Pull Up
13 PUE	Pull / Keep Select Field Select one out of next values for pad: ENET1_TX_DATA1 0 PUE_0_Keeper — Keeper 1 PUE_1_Pull — Pull
12 PKE	Pull / Keep Enable Field Select one out of next values for pad: ENET1_TX_DATA1 0 PKE_0_Pull_Keeper_Disabled — Pull/Keeper Disabled 1 PKE_1_Pull_Keeper_Enabled — Pull/Keeper Enabled
11 ODE	Open Drain Enable Field Select one out of next values for pad: ENET1_TX_DATA1

Table continues on the next page...

IOMUXC_SW_PAD_CTL_PAD_ENET1_TX_DATA1 field descriptions (continued)

Field	Description
	0 ODE_0_Open_Drain_Disabled — Open Drain Disabled 1 ODE_1_Open_Drain_Enabled — Open Drain Enabled
10–8 -	This field is reserved. Reserved
7–6 SPEED	Speed Field Select one out of next values for pad: ENET1_TX_DATA1 00 SPEED_0_low_50MHz_ — low(50MHz) 01 SPEED_1_medium_100MHz_ — medium(100MHz) 10 SPEED_2_medium_100MHz_ — medium(100MHz) 11 SPEED_3_max_200MHz_ — max(200MHz)
5–3 DSE	Drive Strength Field Select one out of next values for pad: ENET1_TX_DATA1 000 DSE_0_output_driver_disabled_ — output driver disabled; 001 DSE_1_R0_260_Ohm__3_3V_150_Ohm_1_8V_240_Ohm_for_DDR_ — R0(260 Ohm @ 3.3V, 150 Ohm@1.8V, 240 Ohm for DDR) 010 DSE_2_R0_2 — R0/2 011 DSE_3_R0_3 — R0/3 100 DSE_4_R0_4 — R0/4 101 DSE_5_R0_5 — R0/5 110 DSE_6_R0_6 — R0/6 111 DSE_7_R0_7 — R0/7
2–1 -	This field is reserved. Reserved
0 SRE	Slew Rate Field Select one out of next values for pad: ENET1_TX_DATA1 0 SRE_0_Slow_Slew_Rate — Slow Slew Rate 1 SRE_1_Fast_Slew_Rate — Fast Slew Rate

32.6.184 SW_PAD_CTL_PAD_ENET1_TX_EN SW PAD Control Register (IOMUXC_SW_PAD_CTL_PAD_ENET1_TX_EN)

SW_PAD_CTL Register

Address: 20E_0000h base + 364h offset = 20E_0364h

Bit	31	30	29	28	27	26	25	24	23	22	21	20	19	18	17	16
R	Reserved															HYS
W																
Reset	0	0	0	0	0	0	0	0	0	0	0	0	0	0	0	0
Bit	15	14	13	12	11	10	9	8	7	6	5	4	3	2	1	0
R	PUS	PUE	PKE	ODE	Reserved			SPEED	DSE			Reserved		SRE		
W																
Reset	0	0	0	1	0	0	0	0	1	0	1	1	0	0	0	0

IOMUXC_SW_PAD_CTL_PAD_ENET1_TX_EN field descriptions

Field	Description
31–17 -	This field is reserved. Reserved
16 HYS	Hyst. Enable Field Select one out of next values for pad: ENET1_TX_EN 0 HYS_0_Hysteresis_Disabled — Hysteresis Disabled 1 HYS_1_Hysteresis_Enabled — Hysteresis Enabled
15–14 PUS	Pull Up / Down Config. Field Select one out of next values for pad: ENET1_TX_EN 00 PUS_0_100K_Ohm_Pull_Down — 100K Ohm Pull Down 01 PUS_1_47K_Ohm_Pull_Up — 47K Ohm Pull Up 10 PUS_2_100K_Ohm_Pull_Up — 100K Ohm Pull Up 11 PUS_3_22K_Ohm_Pull_Up — 22K Ohm Pull Up
13 PUE	Pull / Keep Select Field Select one out of next values for pad: ENET1_TX_EN 0 PUE_0_Keeper — Keeper 1 PUE_1_Pull — Pull
12 PKE	Pull / Keep Enable Field Select one out of next values for pad: ENET1_TX_EN 0 PKE_0_Pull_Keeper_Disabled — Pull/Keeper Disabled 1 PKE_1_Pull_Keeper_Enabled — Pull/Keeper Enabled
11 ODE	Open Drain Enable Field Select one out of next values for pad: ENET1_TX_EN

Table continues on the next page...

IOMUXC_SW_PAD_CTL_PAD_ENET1_TX_EN field descriptions (continued)

Field	Description
	0 ODE_0_Open_Drain_Disabled — Open Drain Disabled 1 ODE_1_Open_Drain_Enabled — Open Drain Enabled
10–8 -	This field is reserved. Reserved
7–6 SPEED	Speed Field Select one out of next values for pad: ENET1_TX_EN 00 SPEED_0_low_50MHz_ — low(50MHz) 01 SPEED_1_medium_100MHz_ — medium(100MHz) 10 SPEED_2_medium_100MHz_ — medium(100MHz) 11 SPEED_3_max_200MHz_ — max(200MHz)
5–3 DSE	Drive Strength Field Select one out of next values for pad: ENET1_TX_EN 000 DSE_0_output_driver_disabled_ — output driver disabled; 001 DSE_1_R0_260_Ohm_3_3V_150_Ohm_1_8V_240_Ohm_for_DDR_ — R0(260 Ohm @ 3.3V, 150 Ohm@1.8V, 240 Ohm for DDR) 010 DSE_2_R0_2 — R0/2 011 DSE_3_R0_3 — R0/3 100 DSE_4_R0_4 — R0/4 101 DSE_5_R0_5 — R0/5 110 DSE_6_R0_6 — R0/6 111 DSE_7_R0_7 — R0/7
2–1 -	This field is reserved. Reserved
0 SRE	Slew Rate Field Select one out of next values for pad: ENET1_TX_EN 0 SRE_0_Slow_Slew_Rate — Slow Slew Rate 1 SRE_1_Fast_Slew_Rate — Fast Slew Rate

32.6.185 SW_PAD_CTL_PAD_ENET1_TX_CLK SW PAD Control Register (IOMUXC_SW_PAD_CTL_PAD_ENET1_TX_CLK)

SW_PAD_CTL Register

Address: 20E_0000h base + 368h offset = 20E_0368h

Bit	31	30	29	28	27	26	25	24	23	22	21	20	19	18	17	16
R	Reserved															HYS
W																
Reset	0	0	0	0	0	0	0	0	0	0	0	0	0	0	0	0
Bit	15	14	13	12	11	10	9	8	7	6	5	4	3	2	1	0
R	PUS	PUE	PKE	ODE	Reserved			SPEED	DSE			Reserved		SRE		
W																
Reset	0	0	0	1	0	0	0	0	1	0	1	1	0	0	0	0

IOMUXC_SW_PAD_CTL_PAD_ENET1_TX_CLK field descriptions

Field	Description
31–17 -	This field is reserved. Reserved
16 HYS	Hyst. Enable Field Select one out of next values for pad: ENET1_TX_CLK 0 HYS_0_Hysteresis_Disabled — Hysteresis Disabled 1 HYS_1_Hysteresis_Enabled — Hysteresis Enabled
15–14 PUS	Pull Up / Down Config. Field Select one out of next values for pad: ENET1_TX_CLK 00 PUS_0_100K_Ohm_Pull_Down — 100K Ohm Pull Down 01 PUS_1_47K_Ohm_Pull_Up — 47K Ohm Pull Up 10 PUS_2_100K_Ohm_Pull_Up — 100K Ohm Pull Up 11 PUS_3_22K_Ohm_Pull_Up — 22K Ohm Pull Up
13 PUE	Pull / Keep Select Field Select one out of next values for pad: ENET1_TX_CLK 0 PUE_0_Keeper — Keeper 1 PUE_1_Pull — Pull
12 PKE	Pull / Keep Enable Field Select one out of next values for pad: ENET1_TX_CLK 0 PKE_0_Pull_Keeper_Disabled — Pull/Keeper Disabled 1 PKE_1_Pull_Keeper_Enabled — Pull/Keeper Enabled
11 ODE	Open Drain Enable Field Select one out of next values for pad: ENET1_TX_CLK

Table continues on the next page...

IOMUXC_SW_PAD_CTL_PAD_ENET1_TX_CLK field descriptions (continued)

Field	Description
	0 ODE_0_Open_Drain_Disabled — Open Drain Disabled 1 ODE_1_Open_Drain_Enabled — Open Drain Enabled
10–8 -	This field is reserved. Reserved
7–6 SPEED	Speed Field Select one out of next values for pad: ENET1_TX_CLK 00 SPEED_0_low_50MHz_ — low(50MHz) 01 SPEED_1_medium_100MHz_ — medium(100MHz) 10 SPEED_2_medium_100MHz_ — medium(100MHz) 11 SPEED_3_max_200MHz_ — max(200MHz)
5–3 DSE	Drive Strength Field Select one out of next values for pad: ENET1_TX_CLK 000 DSE_0_output_driver_disabled_ — output driver disabled; 001 DSE_1_R0_260_Ohm_3_3V_150_Ohm_1_8V_240_Ohm_for_DDR_ — R0(260 Ohm @ 3.3V, 150 Ohm@1.8V, 240 Ohm for DDR) 010 DSE_2_R0_2 — R0/2 011 DSE_3_R0_3 — R0/3 100 DSE_4_R0_4 — R0/4 101 DSE_5_R0_5 — R0/5 110 DSE_6_R0_6 — R0/6 111 DSE_7_R0_7 — R0/7
2–1 -	This field is reserved. Reserved
0 SRE	Slew Rate Field Select one out of next values for pad: ENET1_TX_CLK 0 SRE_0_Slow_Slew_Rate — Slow Slew Rate 1 SRE_1_Fast_Slew_Rate — Fast Slew Rate

32.6.186 SW_PAD_CTL_PAD_ENET1_RX_ER SW PAD Control Register (IOMUXC_SW_PAD_CTL_PAD_ENET1_RX_ER)

SW_PAD_CTL Register

Address: 20E_0000h base + 36Ch offset = 20E_036Ch

Bit	31	30	29	28	27	26	25	24	23	22	21	20	19	18	17	16
R	Reserved															HYS
W																
Reset	0	0	0	0	0	0	0	0	0	0	0	0	0	0	0	0
Bit	15	14	13	12	11	10	9	8	7	6	5	4	3	2	1	0
R	PUS	PUE	PKE	ODE	Reserved			SPEED	DSE			Reserved		SRE		
W																
Reset	0	0	0	1	0	0	0	0	1	0	1	1	0	0	0	0

IOMUXC_SW_PAD_CTL_PAD_ENET1_RX_ER field descriptions

Field	Description
31–17 -	This field is reserved. Reserved
16 HYS	Hyst. Enable Field Select one out of next values for pad: ENET1_RX_ER 0 HYS_0_Hysteresis_Disabled — Hysteresis Disabled 1 HYS_1_Hysteresis_Enabled — Hysteresis Enabled
15–14 PUS	Pull Up / Down Config. Field Select one out of next values for pad: ENET1_RX_ER 00 PUS_0_100K_Ohm_Pull_Down — 100K Ohm Pull Down 01 PUS_1_47K_Ohm_Pull_Up — 47K Ohm Pull Up 10 PUS_2_100K_Ohm_Pull_Up — 100K Ohm Pull Up 11 PUS_3_22K_Ohm_Pull_Up — 22K Ohm Pull Up
13 PUE	Pull / Keep Select Field Select one out of next values for pad: ENET1_RX_ER 0 PUE_0_Keeper — Keeper 1 PUE_1_Pull — Pull
12 PKE	Pull / Keep Enable Field Select one out of next values for pad: ENET1_RX_ER 0 PKE_0_Pull_Keeper_Disabled — Pull/Keeper Disabled 1 PKE_1_Pull_Keeper_Enabled — Pull/Keeper Enabled
11 ODE	Open Drain Enable Field Select one out of next values for pad: ENET1_RX_ER

Table continues on the next page...

IOMUXC_SW_PAD_CTL_PAD_ENET1_RX_ER field descriptions (continued)

Field	Description
	0 ODE_0_Open_Drain_Disabled — Open Drain Disabled 1 ODE_1_Open_Drain_Enabled — Open Drain Enabled
10–8 -	This field is reserved. Reserved
7–6 SPEED	Speed Field Select one out of next values for pad: ENET1_RX_ER 00 SPEED_0_low_50MHz_ — low(50MHz) 01 SPEED_1_medium_100MHz_ — medium(100MHz) 10 SPEED_2_medium_100MHz_ — medium(100MHz) 11 SPEED_3_max_200MHz_ — max(200MHz)
5–3 DSE	Drive Strength Field Select one out of next values for pad: ENET1_RX_ER 000 DSE_0_output_driver_disabled_ — output driver disabled; 001 DSE_1_R0_260_Ohm_3_3V_150_Ohm_1_8V_240_Ohm_for_DDR_ — R0(260 Ohm @ 3.3V, 150 Ohm@1.8V, 240 Ohm for DDR) 010 DSE_2_R0_2 — R0/2 011 DSE_3_R0_3 — R0/3 100 DSE_4_R0_4 — R0/4 101 DSE_5_R0_5 — R0/5 110 DSE_6_R0_6 — R0/6 111 DSE_7_R0_7 — R0/7
2–1 -	This field is reserved. Reserved
0 SRE	Slew Rate Field Select one out of next values for pad: ENET1_RX_ER 0 SRE_0_Slow_Slew_Rate — Slow Slew Rate 1 SRE_1_Fast_Slew_Rate — Fast Slew Rate

32.6.187 SW_PAD_CTL_PAD_ENET2_RX_DATA0 SW PAD Control Register (IOMUXC_SW_PAD_CTL_PAD_ENET2_RX_DATA0)

SW_PAD_CTL Register

Address: 20E_0000h base + 370h offset = 20E_0370h

Bit	31	30	29	28	27	26	25	24	23	22	21	20	19	18	17	16
R	Reserved															HYS
W																
Reset	0	0	0	0	0	0	0	0	0	0	0	0	0	0	0	0
Bit	15	14	13	12	11	10	9	8	7	6	5	4	3	2	1	0
R	PUS	PUE	PKE	ODE	Reserved			SPEED	DSE			Reserved		SRE		
W																
Reset	0	0	0	1	0	0	0	0	1	0	1	1	0	0	0	0

IOMUXC_SW_PAD_CTL_PAD_ENET2_RX_DATA0 field descriptions

Field	Description
31–17 -	This field is reserved. Reserved
16 HYS	Hyst. Enable Field Select one out of next values for pad: ENET2_RX_DATA0 0 HYS_0_Hysteresis_Disabled — Hysteresis Disabled 1 HYS_1_Hysteresis_Enabled — Hysteresis Enabled
15–14 PUS	Pull Up / Down Config. Field Select one out of next values for pad: ENET2_RX_DATA0 00 PUS_0_100K_Ohm_Pull_Down — 100K Ohm Pull Down 01 PUS_1_47K_Ohm_Pull_Up — 47K Ohm Pull Up 10 PUS_2_100K_Ohm_Pull_Up — 100K Ohm Pull Up 11 PUS_3_22K_Ohm_Pull_Up — 22K Ohm Pull Up
13 PUE	Pull / Keep Select Field Select one out of next values for pad: ENET2_RX_DATA0 0 PUE_0_Keeper — Keeper 1 PUE_1_Pull — Pull
12 PKE	Pull / Keep Enable Field Select one out of next values for pad: ENET2_RX_DATA0 0 PKE_0_Pull_Keeper_Disabled — Pull/Keeper Disabled 1 PKE_1_Pull_Keeper_Enabled — Pull/Keeper Enabled
11 ODE	Open Drain Enable Field Select one out of next values for pad: ENET2_RX_DATA0

Table continues on the next page...

IOMUXC_SW_PAD_CTL_PAD_ENET2_RX_DATA0 field descriptions (continued)

Field	Description
	0 ODE_0_Open_Drain_Disabled — Open Drain Disabled 1 ODE_1_Open_Drain_Enabled — Open Drain Enabled
10–8 -	This field is reserved. Reserved
7–6 SPEED	Speed Field Select one out of next values for pad: ENET2_RX_DATA0 00 SPEED_0_low_50MHz_ — low(50MHz) 01 SPEED_1_medium_100MHz_ — medium(100MHz) 10 SPEED_2_medium_100MHz_ — medium(100MHz) 11 SPEED_3_max_200MHz_ — max(200MHz)
5–3 DSE	Drive Strength Field Select one out of next values for pad: ENET2_RX_DATA0 000 DSE_0_output_driver_disabled_ — output driver disabled; 001 DSE_1_R0_260_Ohm_3_3V_150_Ohm_1_8V_240_Ohm_for_DDR_ — R0(260 Ohm @ 3.3V, 150 Ohm@1.8V, 240 Ohm for DDR) 010 DSE_2_R0_2 — R0/2 011 DSE_3_R0_3 — R0/3 100 DSE_4_R0_4 — R0/4 101 DSE_5_R0_5 — R0/5 110 DSE_6_R0_6 — R0/6 111 DSE_7_R0_7 — R0/7
2–1 -	This field is reserved. Reserved
0 SRE	Slew Rate Field Select one out of next values for pad: ENET2_RX_DATA0 0 SRE_0_Slow_Slew_Rate — Slow Slew Rate 1 SRE_1_Fast_Slew_Rate — Fast Slew Rate

32.6.188 SW_PAD_CTL_PAD_ENET2_RX_DATA1 SW PAD Control Register (IOMUXC_SW_PAD_CTL_PAD_ENET2_RX_DATA1)

SW_PAD_CTL Register

Address: 20E_0000h base + 374h offset = 20E_0374h

Bit	31	30	29	28	27	26	25	24	23	22	21	20	19	18	17	16
R	Reserved															HYS
W																
Reset	0	0	0	0	0	0	0	0	0	0	0	0	0	0	0	0
Bit	15	14	13	12	11	10	9	8	7	6	5	4	3	2	1	0
R	PUS	PUE	PKE	ODE	Reserved			SPEED	DSE			Reserved		SRE		
W																
Reset	0	0	0	1	0	0	0	0	1	0	1	1	0	0	0	0

IOMUXC_SW_PAD_CTL_PAD_ENET2_RX_DATA1 field descriptions

Field	Description
31–17 -	This field is reserved. Reserved
16 HYS	Hyst. Enable Field Select one out of next values for pad: ENET2_RX_DATA1 0 HYS_0_Hysteresis_Disabled — Hysteresis Disabled 1 HYS_1_Hysteresis_Enabled — Hysteresis Enabled
15–14 PUS	Pull Up / Down Config. Field Select one out of next values for pad: ENET2_RX_DATA1 00 PUS_0_100K_Ohm_Pull_Down — 100K Ohm Pull Down 01 PUS_1_47K_Ohm_Pull_Up — 47K Ohm Pull Up 10 PUS_2_100K_Ohm_Pull_Up — 100K Ohm Pull Up 11 PUS_3_22K_Ohm_Pull_Up — 22K Ohm Pull Up
13 PUE	Pull / Keep Select Field Select one out of next values for pad: ENET2_RX_DATA1 0 PUE_0_Keeper — Keeper 1 PUE_1_Pull — Pull
12 PKE	Pull / Keep Enable Field Select one out of next values for pad: ENET2_RX_DATA1 0 PKE_0_Pull_Keeper_Disabled — Pull/Keeper Disabled 1 PKE_1_Pull_Keeper_Enabled — Pull/Keeper Enabled
11 ODE	Open Drain Enable Field Select one out of next values for pad: ENET2_RX_DATA1

Table continues on the next page...

IOMUXC_SW_PAD_CTL_PAD_ENET2_RX_DATA1 field descriptions (continued)

Field	Description
	0 ODE_0_Open_Drain_Disabled — Open Drain Disabled 1 ODE_1_Open_Drain_Enabled — Open Drain Enabled
10–8 -	This field is reserved. Reserved
7–6 SPEED	Speed Field Select one out of next values for pad: ENET2_RX_DATA1 00 SPEED_0_low_50MHz_ — low(50MHz) 01 SPEED_1_medium_100MHz_ — medium(100MHz) 10 SPEED_2_medium_100MHz_ — medium(100MHz) 11 SPEED_3_max_200MHz_ — max(200MHz)
5–3 DSE	Drive Strength Field Select one out of next values for pad: ENET2_RX_DATA1 000 DSE_0_output_driver_disabled_ — output driver disabled; 001 DSE_1_R0_260_Ohm__3_3V_150_Ohm_1_8V_240_Ohm_for_DDR_ — R0(260 Ohm @ 3.3V, 150 Ohm@1.8V, 240 Ohm for DDR) 010 DSE_2_R0_2 — R0/2 011 DSE_3_R0_3 — R0/3 100 DSE_4_R0_4 — R0/4 101 DSE_5_R0_5 — R0/5 110 DSE_6_R0_6 — R0/6 111 DSE_7_R0_7 — R0/7
2–1 -	This field is reserved. Reserved
0 SRE	Slew Rate Field Select one out of next values for pad: ENET2_RX_DATA1 0 SRE_0_Slow_Slew_Rate — Slow Slew Rate 1 SRE_1_Fast_Slew_Rate — Fast Slew Rate

32.6.189 SW_PAD_CTL_PAD_ENET2_RX_EN SW PAD Control Register (IOMUXC_SW_PAD_CTL_PAD_ENET2_RX_EN)

SW_PAD_CTL Register

Address: 20E_0000h base + 378h offset = 20E_0378h

Bit	31	30	29	28	27	26	25	24	23	22	21	20	19	18	17	16
R	Reserved															HYS
W																
Reset	0	0	0	0	0	0	0	0	0	0	0	0	0	0	0	0
Bit	15	14	13	12	11	10	9	8	7	6	5	4	3	2	1	0
R	PUS	PUE	PKE	ODE	Reserved			SPEED	DSE			Reserved		SRE		
W																
Reset	0	0	0	1	0	0	0	0	1	0	1	1	0	0	0	0

IOMUXC_SW_PAD_CTL_PAD_ENET2_RX_EN field descriptions

Field	Description
31–17 -	This field is reserved. Reserved
16 HYS	Hyst. Enable Field Select one out of next values for pad: ENET2_RX_EN 0 HYS_0_Hysteresis_Disabled — Hysteresis Disabled 1 HYS_1_Hysteresis_Enabled — Hysteresis Enabled
15–14 PUS	Pull Up / Down Config. Field Select one out of next values for pad: ENET2_RX_EN 00 PUS_0_100K_Ohm_Pull_Down — 100K Ohm Pull Down 01 PUS_1_47K_Ohm_Pull_Up — 47K Ohm Pull Up 10 PUS_2_100K_Ohm_Pull_Up — 100K Ohm Pull Up 11 PUS_3_22K_Ohm_Pull_Up — 22K Ohm Pull Up
13 PUE	Pull / Keep Select Field Select one out of next values for pad: ENET2_RX_EN 0 PUE_0_Keeper — Keeper 1 PUE_1_Pull — Pull
12 PKE	Pull / Keep Enable Field Select one out of next values for pad: ENET2_RX_EN 0 PKE_0_Pull_Keeper_Disabled — Pull/Keeper Disabled 1 PKE_1_Pull_Keeper_Enabled — Pull/Keeper Enabled
11 ODE	Open Drain Enable Field Select one out of next values for pad: ENET2_RX_EN

Table continues on the next page...

IOMUXC_SW_PAD_CTL_PAD_ENET2_RX_EN field descriptions (continued)

Field	Description
	0 ODE_0_Open_Drain_Disabled — Open Drain Disabled 1 ODE_1_Open_Drain_Enabled — Open Drain Enabled
10–8 -	This field is reserved. Reserved
7–6 SPEED	Speed Field Select one out of next values for pad: ENET2_RX_EN 00 SPEED_0_low_50MHz_ — low(50MHz) 01 SPEED_1_medium_100MHz_ — medium(100MHz) 10 SPEED_2_medium_100MHz_ — medium(100MHz) 11 SPEED_3_max_200MHz_ — max(200MHz)
5–3 DSE	Drive Strength Field Select one out of next values for pad: ENET2_RX_EN 000 DSE_0_output_driver_disabled_ — output driver disabled; 001 DSE_1_R0_260_Ohm__3_3V_150_Ohm_1_8V_240_Ohm_for_DDR_ — R0(260 Ohm @ 3.3V, 150 Ohm@1.8V, 240 Ohm for DDR) 010 DSE_2_R0_2 — R0/2 011 DSE_3_R0_3 — R0/3 100 DSE_4_R0_4 — R0/4 101 DSE_5_R0_5 — R0/5 110 DSE_6_R0_6 — R0/6 111 DSE_7_R0_7 — R0/7
2–1 -	This field is reserved. Reserved
0 SRE	Slew Rate Field Select one out of next values for pad: ENET2_RX_EN 0 SRE_0_Slow_Slew_Rate — Slow Slew Rate 1 SRE_1_Fast_Slew_Rate — Fast Slew Rate

32.6.190 SW_PAD_CTL_PAD_ENET2_TX_DATA0 SW PAD Control Register (IOMUXC_SW_PAD_CTL_PAD_ENET2_TX_DATA0)

SW_PAD_CTL Register

Address: 20E_0000h base + 37Ch offset = 20E_037Ch

Bit	31	30	29	28	27	26	25	24	23	22	21	20	19	18	17	16
R	Reserved															HYS
W																
Reset	0	0	0	0	0	0	0	0	0	0	0	0	0	0	0	0
Bit	15	14	13	12	11	10	9	8	7	6	5	4	3	2	1	0
R	PUS	PUE	PKE	ODE	Reserved			SPEED	DSE			Reserved		SRE		
W																
Reset	0	0	0	1	0	0	0	0	1	0	1	1	0	0	0	0

IOMUXC_SW_PAD_CTL_PAD_ENET2_TX_DATA0 field descriptions

Field	Description
31–17 -	This field is reserved. Reserved
16 HYS	Hyst. Enable Field Select one out of next values for pad: ENET2_TX_DATA0 0 HYS_0_Hysteresis_Disabled — Hysteresis Disabled 1 HYS_1_Hysteresis_Enabled — Hysteresis Enabled
15–14 PUS	Pull Up / Down Config. Field Select one out of next values for pad: ENET2_TX_DATA0 00 PUS_0_100K_Ohm_Pull_Down — 100K Ohm Pull Down 01 PUS_1_47K_Ohm_Pull_Up — 47K Ohm Pull Up 10 PUS_2_100K_Ohm_Pull_Up — 100K Ohm Pull Up 11 PUS_3_22K_Ohm_Pull_Up — 22K Ohm Pull Up
13 PUE	Pull / Keep Select Field Select one out of next values for pad: ENET2_TX_DATA0 0 PUE_0_Keeper — Keeper 1 PUE_1_Pull — Pull
12 PKE	Pull / Keep Enable Field Select one out of next values for pad: ENET2_TX_DATA0 0 PKE_0_Pull_Keeper_Disabled — Pull/Keeper Disabled 1 PKE_1_Pull_Keeper_Enabled — Pull/Keeper Enabled
11 ODE	Open Drain Enable Field Select one out of next values for pad: ENET2_TX_DATA0

Table continues on the next page...

IOMUXC_SW_PAD_CTL_PAD_ENET2_TX_DATA0 field descriptions (continued)

Field	Description
	0 ODE_0_Open_Drain_Disabled — Open Drain Disabled 1 ODE_1_Open_Drain_Enabled — Open Drain Enabled
10–8 -	This field is reserved. Reserved
7–6 SPEED	Speed Field Select one out of next values for pad: ENET2_TX_DATA0 00 SPEED_0_low_50MHz_ — low(50MHz) 01 SPEED_1_medium_100MHz_ — medium(100MHz) 10 SPEED_2_medium_100MHz_ — medium(100MHz) 11 SPEED_3_max_200MHz_ — max(200MHz)
5–3 DSE	Drive Strength Field Select one out of next values for pad: ENET2_TX_DATA0 000 DSE_0_output_driver_disabled_ — output driver disabled; 001 DSE_1_R0_260_Ohm__3_3V_150_Ohm_1_8V_240_Ohm_for_DDR_ — R0(260 Ohm @ 3.3V, 150 Ohm@1.8V, 240 Ohm for DDR) 010 DSE_2_R0_2 — R0/2 011 DSE_3_R0_3 — R0/3 100 DSE_4_R0_4 — R0/4 101 DSE_5_R0_5 — R0/5 110 DSE_6_R0_6 — R0/6 111 DSE_7_R0_7 — R0/7
2–1 -	This field is reserved. Reserved
0 SRE	Slew Rate Field Select one out of next values for pad: ENET2_TX_DATA0 0 SRE_0_Slow_Slew_Rate — Slow Slew Rate 1 SRE_1_Fast_Slew_Rate — Fast Slew Rate

32.6.191 SW_PAD_CTL_PAD_ENET2_TX_DATA1 SW PAD Control Register (IOMUXC_SW_PAD_CTL_PAD_ENET2_TX_DATA1)

SW_PAD_CTL Register

Address: 20E_0000h base + 380h offset = 20E_0380h

Bit	31	30	29	28	27	26	25	24	23	22	21	20	19	18	17	16
R	Reserved															HYS
W																
Reset	0	0	0	0	0	0	0	0	0	0	0	0	0	0	0	0
Bit	15	14	13	12	11	10	9	8	7	6	5	4	3	2	1	0
R	PUS	PUE	PKE	ODE	Reserved			SPEED	DSE			Reserved		SRE		
W																
Reset	0	0	0	1	0	0	0	0	1	0	1	1	0	0	0	0

IOMUXC_SW_PAD_CTL_PAD_ENET2_TX_DATA1 field descriptions

Field	Description
31–17 -	This field is reserved. Reserved
16 HYS	Hyst. Enable Field Select one out of next values for pad: ENET2_TX_DATA1 0 HYS_0_Hysteresis_Disabled — Hysteresis Disabled 1 HYS_1_Hysteresis_Enabled — Hysteresis Enabled
15–14 PUS	Pull Up / Down Config. Field Select one out of next values for pad: ENET2_TX_DATA1 00 PUS_0_100K_Ohm_Pull_Down — 100K Ohm Pull Down 01 PUS_1_47K_Ohm_Pull_Up — 47K Ohm Pull Up 10 PUS_2_100K_Ohm_Pull_Up — 100K Ohm Pull Up 11 PUS_3_22K_Ohm_Pull_Up — 22K Ohm Pull Up
13 PUE	Pull / Keep Select Field Select one out of next values for pad: ENET2_TX_DATA1 0 PUE_0_Keeper — Keeper 1 PUE_1_Pull — Pull
12 PKE	Pull / Keep Enable Field Select one out of next values for pad: ENET2_TX_DATA1 0 PKE_0_Pull_Keeper_Disabled — Pull/Keeper Disabled 1 PKE_1_Pull_Keeper_Enabled — Pull/Keeper Enabled
11 ODE	Open Drain Enable Field Select one out of next values for pad: ENET2_TX_DATA1

Table continues on the next page...

IOMUXC_SW_PAD_CTL_PAD_ENET2_TX_DATA1 field descriptions (continued)

Field	Description
	0 ODE_0_Open_Drain_Disabled — Open Drain Disabled 1 ODE_1_Open_Drain_Enabled — Open Drain Enabled
10–8 -	This field is reserved. Reserved
7–6 SPEED	Speed Field Select one out of next values for pad: ENET2_TX_DATA1 00 SPEED_0_low_50MHz_ — low(50MHz) 01 SPEED_1_medium_100MHz_ — medium(100MHz) 10 SPEED_2_medium_100MHz_ — medium(100MHz) 11 SPEED_3_max_200MHz_ — max(200MHz)
5–3 DSE	Drive Strength Field Select one out of next values for pad: ENET2_TX_DATA1 000 DSE_0_output_driver_disabled_ — output driver disabled; 001 DSE_1_R0_260_Ohm__3_3V_150_Ohm_1_8V_240_Ohm_for_DDR_ — R0(260 Ohm @ 3.3V, 150 Ohm@1.8V, 240 Ohm for DDR) 010 DSE_2_R0_2 — R0/2 011 DSE_3_R0_3 — R0/3 100 DSE_4_R0_4 — R0/4 101 DSE_5_R0_5 — R0/5 110 DSE_6_R0_6 — R0/6 111 DSE_7_R0_7 — R0/7
2–1 -	This field is reserved. Reserved
0 SRE	Slew Rate Field Select one out of next values for pad: ENET2_TX_DATA1 0 SRE_0_Slow_Slew_Rate — Slow Slew Rate 1 SRE_1_Fast_Slew_Rate — Fast Slew Rate

32.6.192 SW_PAD_CTL_PAD_ENET2_TX_EN SW PAD Control Register (IOMUXC_SW_PAD_CTL_PAD_ENET2_TX_EN)

SW_PAD_CTL Register

Address: 20E_0000h base + 384h offset = 20E_0384h

Bit	31	30	29	28	27	26	25	24	23	22	21	20	19	18	17	16
R	Reserved															HYS
W																
Reset	0	0	0	0	0	0	0	0	0	0	0	0	0	0	0	0
Bit	15	14	13	12	11	10	9	8	7	6	5	4	3	2	1	0
R	PUS	PUE	PKE	ODE	Reserved			SPEED	DSE			Reserved		SRE		
W																
Reset	0	0	0	1	0	0	0	0	1	0	1	1	0	0	0	0

IOMUXC_SW_PAD_CTL_PAD_ENET2_TX_EN field descriptions

Field	Description
31–17 -	This field is reserved. Reserved
16 HYS	Hyst. Enable Field Select one out of next values for pad: ENET2_TX_EN 0 HYS_0_Hysteresis_Disabled — Hysteresis Disabled 1 HYS_1_Hysteresis_Enabled — Hysteresis Enabled
15–14 PUS	Pull Up / Down Config. Field Select one out of next values for pad: ENET2_TX_EN 00 PUS_0_100K_Ohm_Pull_Down — 100K Ohm Pull Down 01 PUS_1_47K_Ohm_Pull_Up — 47K Ohm Pull Up 10 PUS_2_100K_Ohm_Pull_Up — 100K Ohm Pull Up 11 PUS_3_22K_Ohm_Pull_Up — 22K Ohm Pull Up
13 PUE	Pull / Keep Select Field Select one out of next values for pad: ENET2_TX_EN 0 PUE_0_Keeper — Keeper 1 PUE_1_Pull — Pull
12 PKE	Pull / Keep Enable Field Select one out of next values for pad: ENET2_TX_EN 0 PKE_0_Pull_Keeper_Disabled — Pull/Keeper Disabled 1 PKE_1_Pull_Keeper_Enabled — Pull/Keeper Enabled
11 ODE	Open Drain Enable Field Select one out of next values for pad: ENET2_TX_EN

Table continues on the next page...

IOMUXC_SW_PAD_CTL_PAD_ENET2_TX_EN field descriptions (continued)

Field	Description
	0 ODE_0_Open_Drain_Disabled — Open Drain Disabled 1 ODE_1_Open_Drain_Enabled — Open Drain Enabled
10–8 -	This field is reserved. Reserved
7–6 SPEED	Speed Field Select one out of next values for pad: ENET2_TX_EN 00 SPEED_0_low_50MHz_ — low(50MHz) 01 SPEED_1_medium_100MHz_ — medium(100MHz) 10 SPEED_2_medium_100MHz_ — medium(100MHz) 11 SPEED_3_max_200MHz_ — max(200MHz)
5–3 DSE	Drive Strength Field Select one out of next values for pad: ENET2_TX_EN 000 DSE_0_output_driver_disabled_ — output driver disabled; 001 DSE_1_R0_260_Ohm__3_3V_150_Ohm_1_8V_240_Ohm_for_DDR_ — R0(260 Ohm @ 3.3V, 150 Ohm@1.8V, 240 Ohm for DDR) 010 DSE_2_R0_2 — R0/2 011 DSE_3_R0_3 — R0/3 100 DSE_4_R0_4 — R0/4 101 DSE_5_R0_5 — R0/5 110 DSE_6_R0_6 — R0/6 111 DSE_7_R0_7 — R0/7
2–1 -	This field is reserved. Reserved
0 SRE	Slew Rate Field Select one out of next values for pad: ENET2_TX_EN 0 SRE_0_Slow_Slew_Rate — Slow Slew Rate 1 SRE_1_Fast_Slew_Rate — Fast Slew Rate

32.6.193 SW_PAD_CTL_PAD_ENET2_TX_CLK SW PAD Control Register (IOMUXC_SW_PAD_CTL_PAD_ENET2_TX_CLK)

SW_PAD_CTL Register

Address: 20E_0000h base + 388h offset = 20E_0388h

Bit	31	30	29	28	27	26	25	24	23	22	21	20	19	18	17	16
R	Reserved															HYS
W																
Reset	0	0	0	0	0	0	0	0	0	0	0	0	0	0	0	0
Bit	15	14	13	12	11	10	9	8	7	6	5	4	3	2	1	0
R	PUS	PUE	PKE	ODE	Reserved			SPEED	DSE			Reserved		SRE		
W																
Reset	0	0	0	1	0	0	0	0	1	0	1	1	0	0	0	0

IOMUXC_SW_PAD_CTL_PAD_ENET2_TX_CLK field descriptions

Field	Description
31–17 -	This field is reserved. Reserved
16 HYS	Hyst. Enable Field Select one out of next values for pad: ENET2_TX_CLK 0 HYS_0_Hysteresis_Disabled — Hysteresis Disabled 1 HYS_1_Hysteresis_Enabled — Hysteresis Enabled
15–14 PUS	Pull Up / Down Config. Field Select one out of next values for pad: ENET2_TX_CLK 00 PUS_0_100K_Ohm_Pull_Down — 100K Ohm Pull Down 01 PUS_1_47K_Ohm_Pull_Up — 47K Ohm Pull Up 10 PUS_2_100K_Ohm_Pull_Up — 100K Ohm Pull Up 11 PUS_3_22K_Ohm_Pull_Up — 22K Ohm Pull Up
13 PUE	Pull / Keep Select Field Select one out of next values for pad: ENET2_TX_CLK 0 PUE_0_Keeper — Keeper 1 PUE_1_Pull — Pull
12 PKE	Pull / Keep Enable Field Select one out of next values for pad: ENET2_TX_CLK 0 PKE_0_Pull_Keeper_Disabled — Pull/Keeper Disabled 1 PKE_1_Pull_Keeper_Enabled — Pull/Keeper Enabled
11 ODE	Open Drain Enable Field Select one out of next values for pad: ENET2_TX_CLK

Table continues on the next page...

IOMUXC_SW_PAD_CTL_PAD_ENET2_TX_CLK field descriptions (continued)

Field	Description
	0 ODE_0_Open_Drain_Disabled — Open Drain Disabled 1 ODE_1_Open_Drain_Enabled — Open Drain Enabled
10–8 -	This field is reserved. Reserved
7–6 SPEED	Speed Field Select one out of next values for pad: ENET2_TX_CLK 00 SPEED_0_low_50MHz_ — low(50MHz) 01 SPEED_1_medium_100MHz_ — medium(100MHz) 10 SPEED_2_medium_100MHz_ — medium(100MHz) 11 SPEED_3_max_200MHz_ — max(200MHz)
5–3 DSE	Drive Strength Field Select one out of next values for pad: ENET2_TX_CLK 000 DSE_0_output_driver_disabled_ — output driver disabled; 001 DSE_1_R0_260_Ohm__3_3V_150_Ohm_1_8V_240_Ohm_for_DDR_ — R0(260 Ohm @ 3.3V, 150 Ohm@1.8V, 240 Ohm for DDR) 010 DSE_2_R0_2 — R0/2 011 DSE_3_R0_3 — R0/3 100 DSE_4_R0_4 — R0/4 101 DSE_5_R0_5 — R0/5 110 DSE_6_R0_6 — R0/6 111 DSE_7_R0_7 — R0/7
2–1 -	This field is reserved. Reserved
0 SRE	Slew Rate Field Select one out of next values for pad: ENET2_TX_CLK 0 SRE_0_Slow_Slew_Rate — Slow Slew Rate 1 SRE_1_Fast_Slew_Rate — Fast Slew Rate

32.6.194 SW_PAD_CTL_PAD_ENET2_RX_ER SW PAD Control Register (IOMUXC_SW_PAD_CTL_PAD_ENET2_RX_ER)

SW_PAD_CTL Register

Address: 20E_0000h base + 38Ch offset = 20E_038Ch

Bit	31	30	29	28	27	26	25	24	23	22	21	20	19	18	17	16
R	Reserved															HYS
W																
Reset	0	0	0	0	0	0	0	0	0	0	0	0	0	0	0	0
Bit	15	14	13	12	11	10	9	8	7	6	5	4	3	2	1	0
R	PUS	PUE	PKE	ODE	Reserved			SPEED	DSE			Reserved		SRE		
W																
Reset	0	0	0	1	0	0	0	0	1	0	1	1	0	0	0	0

IOMUXC_SW_PAD_CTL_PAD_ENET2_RX_ER field descriptions

Field	Description
31–17 -	This field is reserved. Reserved
16 HYS	Hyst. Enable Field Select one out of next values for pad: ENET2_RX_ER 0 HYS_0_Hysteresis_Disabled — Hysteresis Disabled 1 HYS_1_Hysteresis_Enabled — Hysteresis Enabled
15–14 PUS	Pull Up / Down Config. Field Select one out of next values for pad: ENET2_RX_ER 00 PUS_0_100K_Ohm_Pull_Down — 100K Ohm Pull Down 01 PUS_1_47K_Ohm_Pull_Up — 47K Ohm Pull Up 10 PUS_2_100K_Ohm_Pull_Up — 100K Ohm Pull Up 11 PUS_3_22K_Ohm_Pull_Up — 22K Ohm Pull Up
13 PUE	Pull / Keep Select Field Select one out of next values for pad: ENET2_RX_ER 0 PUE_0_Keeper — Keeper 1 PUE_1_Pull — Pull
12 PKE	Pull / Keep Enable Field Select one out of next values for pad: ENET2_RX_ER 0 PKE_0_Pull_Keeper_Disabled — Pull/Keeper Disabled 1 PKE_1_Pull_Keeper_Enabled — Pull/Keeper Enabled
11 ODE	Open Drain Enable Field Select one out of next values for pad: ENET2_RX_ER

Table continues on the next page...

IOMUXC_SW_PAD_CTL_PAD_ENET2_RX_ER field descriptions (continued)

Field	Description
	0 ODE_0_Open_Drain_Disabled — Open Drain Disabled 1 ODE_1_Open_Drain_Enabled — Open Drain Enabled
10–8 -	This field is reserved. Reserved
7–6 SPEED	Speed Field Select one out of next values for pad: ENET2_RX_ER 00 SPEED_0_low_50MHz_ — low(50MHz) 01 SPEED_1_medium_100MHz_ — medium(100MHz) 10 SPEED_2_medium_100MHz_ — medium(100MHz) 11 SPEED_3_max_200MHz_ — max(200MHz)
5–3 DSE	Drive Strength Field Select one out of next values for pad: ENET2_RX_ER 000 DSE_0_output_driver_disabled_ — output driver disabled; 001 DSE_1_R0_260_Ohm__3_3V_150_Ohm_1_8V_240_Ohm_for_DDR_ — R0(260 Ohm @ 3.3V, 150 Ohm@1.8V, 240 Ohm for DDR) 010 DSE_2_R0_2 — R0/2 011 DSE_3_R0_3 — R0/3 100 DSE_4_R0_4 — R0/4 101 DSE_5_R0_5 — R0/5 110 DSE_6_R0_6 — R0/6 111 DSE_7_R0_7 — R0/7
2–1 -	This field is reserved. Reserved
0 SRE	Slew Rate Field Select one out of next values for pad: ENET2_RX_ER 0 SRE_0_Slow_Slew_Rate — Slow Slew Rate 1 SRE_1_Fast_Slew_Rate — Fast Slew Rate

32.6.195 SW_PAD_CTL_PAD_LCD_CLK SW PAD Control Register (IOMUXC_SW_PAD_CTL_PAD_LCD_CLK)

SW_PAD_CTL Register

Address: 20E_0000h base + 390h offset = 20E_0390h

Bit	31	30	29	28	27	26	25	24	23	22	21	20	19	18	17	16
R	Reserved															HYS
W	Reserved															
Reset	0	0	0	0	0	0	0	0	0	0	0	0	0	0	0	0
Bit	15	14	13	12	11	10	9	8	7	6	5	4	3	2	1	0
R	PUS	PUE	PKE	ODE	Reserved			SPEED	DSE			Reserved		SRE		
W																
Reset	0	0	0	1	0	0	0	0	1	0	1	1	0	0	0	0

IOMUXC_SW_PAD_CTL_PAD_LCD_CLK field descriptions

Field	Description
31–17 -	This field is reserved. Reserved
16 HYS	Hyst. Enable Field Select one out of next values for pad: LCD_CLK 0 HYS_0_Hysteresis_Disabled — Hysteresis Disabled 1 HYS_1_Hysteresis_Enabled — Hysteresis Enabled
15–14 PUS	Pull Up / Down Config. Field Select one out of next values for pad: LCD_CLK 00 PUS_0_100K_Ohm_Pull_Down — 100K Ohm Pull Down 01 PUS_1_47K_Ohm_Pull_Up — 47K Ohm Pull Up 10 PUS_2_100K_Ohm_Pull_Up — 100K Ohm Pull Up 11 PUS_3_22K_Ohm_Pull_Up — 22K Ohm Pull Up
13 PUE	Pull / Keep Select Field Select one out of next values for pad: LCD_CLK 0 PUE_0_Keeper — Keeper 1 PUE_1_Pull — Pull
12 PKE	Pull / Keep Enable Field Select one out of next values for pad: LCD_CLK 0 PKE_0_Pull_Keeper_Disabled — Pull/Keeper Disabled 1 PKE_1_Pull_Keeper_Enabled — Pull/Keeper Enabled
11 ODE	Open Drain Enable Field Select one out of next values for pad: LCD_CLK

Table continues on the next page...

IOMUXC_SW_PAD_CTL_PAD_LCD_CLK field descriptions (continued)

Field	Description
	0 ODE_0_Open_Drain_Disabled — Open Drain Disabled 1 ODE_1_Open_Drain_Enabled — Open Drain Enabled
10–8 -	This field is reserved. Reserved
7–6 SPEED	Speed Field Select one out of next values for pad: LCD_CLK 00 SPEED_0_low_50MHz_ — low(50MHz) 01 SPEED_1_medium_100MHz_ — medium(100MHz) 10 SPEED_2_medium_100MHz_ — medium(100MHz) 11 SPEED_3_max_200MHz_ — max(200MHz)
5–3 DSE	Drive Strength Field Select one out of next values for pad: LCD_CLK 000 DSE_0_output_driver_disabled_ — output driver disabled; 001 DSE_1_R0_260_Ohm__3_3V_150_Ohm_1_8V_240_Ohm_for_DDR_ — R0(260 Ohm @ 3.3V, 150 Ohm@1.8V, 240 Ohm for DDR) 010 DSE_2_R0_2 — R0/2 011 DSE_3_R0_3 — R0/3 100 DSE_4_R0_4 — R0/4 101 DSE_5_R0_5 — R0/5 110 DSE_6_R0_6 — R0/6 111 DSE_7_R0_7 — R0/7
2–1 -	This field is reserved. Reserved
0 SRE	Slew Rate Field Select one out of next values for pad: LCD_CLK 0 SRE_0_Slow_Slew_Rate — Slow Slew Rate 1 SRE_1_Fast_Slew_Rate — Fast Slew Rate

32.6.196 SW_PAD_CTL_PAD_LCD_ENABLE SW PAD Control Register (IOMUXC_SW_PAD_CTL_PAD_LCD_ENABLE)

SW_PAD_CTL Register

Address: 20E_0000h base + 394h offset = 20E_0394h

Bit	31	30	29	28	27	26	25	24	23	22	21	20	19	18	17	16
R	Reserved															HYS
W																
Reset	0	0	0	0	0	0	0	0	0	0	0	0	0	0	0	0
Bit	15	14	13	12	11	10	9	8	7	6	5	4	3	2	1	0
R	PUS	PUE	PKE	ODE	Reserved			SPEED	DSE			Reserved		SRE		
W																
Reset	0	0	0	1	0	0	0	0	1	0	1	1	0	0	0	0

IOMUXC_SW_PAD_CTL_PAD_LCD_ENABLE field descriptions

Field	Description
31–17 -	This field is reserved. Reserved
16 HYS	Hyst. Enable Field Select one out of next values for pad: LCD_ENABLE 0 HYS_0_Hysteresis_Disabled — Hysteresis Disabled 1 HYS_1_Hysteresis_Enabled — Hysteresis Enabled
15–14 PUS	Pull Up / Down Config. Field Select one out of next values for pad: LCD_ENABLE 00 PUS_0_100K_Ohm_Pull_Down — 100K Ohm Pull Down 01 PUS_1_47K_Ohm_Pull_Up — 47K Ohm Pull Up 10 PUS_2_100K_Ohm_Pull_Up — 100K Ohm Pull Up 11 PUS_3_22K_Ohm_Pull_Up — 22K Ohm Pull Up
13 PUE	Pull / Keep Select Field Select one out of next values for pad: LCD_ENABLE 0 PUE_0_Keeper — Keeper 1 PUE_1_Pull — Pull
12 PKE	Pull / Keep Enable Field Select one out of next values for pad: LCD_ENABLE 0 PKE_0_Pull_Keeper_Disabled — Pull/Keeper Disabled 1 PKE_1_Pull_Keeper_Enabled — Pull/Keeper Enabled
11 ODE	Open Drain Enable Field Select one out of next values for pad: LCD_ENABLE

Table continues on the next page...

IOMUXC_SW_PAD_CTL_PAD_LCD_ENABLE field descriptions (continued)

Field	Description
	0 ODE_0_Open_Drain_Disabled — Open Drain Disabled 1 ODE_1_Open_Drain_Enabled — Open Drain Enabled
10–8 -	This field is reserved. Reserved
7–6 SPEED	Speed Field Select one out of next values for pad: LCD_ENABLE 00 SPEED_0_low_50MHz_ — low(50MHz) 01 SPEED_1_medium_100MHz_ — medium(100MHz) 10 SPEED_2_medium_100MHz_ — medium(100MHz) 11 SPEED_3_max_200MHz_ — max(200MHz)
5–3 DSE	Drive Strength Field Select one out of next values for pad: LCD_ENABLE 000 DSE_0_output_driver_disabled_ — output driver disabled; 001 DSE_1_R0_260_Ohm__3_3V_150_Ohm_1_8V_240_Ohm_for_DDR_ — R0(260 Ohm @ 3.3V, 150 Ohm@1.8V, 240 Ohm for DDR) 010 DSE_2_R0_2 — R0/2 011 DSE_3_R0_3 — R0/3 100 DSE_4_R0_4 — R0/4 101 DSE_5_R0_5 — R0/5 110 DSE_6_R0_6 — R0/6 111 DSE_7_R0_7 — R0/7
2–1 -	This field is reserved. Reserved
0 SRE	Slew Rate Field Select one out of next values for pad: LCD_ENABLE 0 SRE_0_Slow_Slew_Rate — Slow Slew Rate 1 SRE_1_Fast_Slew_Rate — Fast Slew Rate

32.6.197 SW_PAD_CTL_PAD_LCD_HSYNC SW PAD Control Register (IOMUXC_SW_PAD_CTL_PAD_LCD_HSYNC)

SW_PAD_CTL Register

Address: 20E_0000h base + 398h offset = 20E_0398h

Bit	31	30	29	28	27	26	25	24	23	22	21	20	19	18	17	16
R	Reserved															HYS
W	Reserved															
Reset	0	0	0	0	0	0	0	0	0	0	0	0	0	0	0	0
Bit	15	14	13	12	11	10	9	8	7	6	5	4	3	2	1	0
R	PUS	PUE	PKE	ODE	Reserved			SPEED	DSE			Reserved		SRE		
W																
Reset	0	0	0	1	0	0	0	0	1	0	1	1	0	0	0	0

IOMUXC_SW_PAD_CTL_PAD_LCD_HSYNC field descriptions

Field	Description
31–17 -	This field is reserved. Reserved
16 HYS	Hyst. Enable Field Select one out of next values for pad: LCD_HSYNC 0 HYS_0_Hysteresis_Disabled — Hysteresis Disabled 1 HYS_1_Hysteresis_Enabled — Hysteresis Enabled
15–14 PUS	Pull Up / Down Config. Field Select one out of next values for pad: LCD_HSYNC 00 PUS_0_100K_Ohm_Pull_Down — 100K Ohm Pull Down 01 PUS_1_47K_Ohm_Pull_Up — 47K Ohm Pull Up 10 PUS_2_100K_Ohm_Pull_Up — 100K Ohm Pull Up 11 PUS_3_22K_Ohm_Pull_Up — 22K Ohm Pull Up
13 PUE	Pull / Keep Select Field Select one out of next values for pad: LCD_HSYNC 0 PUE_0_Keeper — Keeper 1 PUE_1_Pull — Pull
12 PKE	Pull / Keep Enable Field Select one out of next values for pad: LCD_HSYNC 0 PKE_0_Pull_Keeper_Disabled — Pull/Keeper Disabled 1 PKE_1_Pull_Keeper_Enabled — Pull/Keeper Enabled
11 ODE	Open Drain Enable Field Select one out of next values for pad: LCD_HSYNC

Table continues on the next page...

IOMUXC_SW_PAD_CTL_PAD_LCD_HSYNC field descriptions (continued)

Field	Description
	0 ODE_0_Open_Drain_Disabled — Open Drain Disabled 1 ODE_1_Open_Drain_Enabled — Open Drain Enabled
10–8 -	This field is reserved. Reserved
7–6 SPEED	Speed Field Select one out of next values for pad: LCD_HSYNC 00 SPEED_0_low_50MHz_ — low(50MHz) 01 SPEED_1_medium_100MHz_ — medium(100MHz) 10 SPEED_2_medium_100MHz_ — medium(100MHz) 11 SPEED_3_max_200MHz_ — max(200MHz)
5–3 DSE	Drive Strength Field Select one out of next values for pad: LCD_HSYNC 000 DSE_0_output_driver_disabled_ — output driver disabled; 001 DSE_1_R0_260_Ohm_3_3V_150_Ohm_1_8V_240_Ohm_for_DDR_ — R0(260 Ohm @ 3.3V, 150 Ohm@1.8V, 240 Ohm for DDR) 010 DSE_2_R0_2 — R0/2 011 DSE_3_R0_3 — R0/3 100 DSE_4_R0_4 — R0/4 101 DSE_5_R0_5 — R0/5 110 DSE_6_R0_6 — R0/6 111 DSE_7_R0_7 — R0/7
2–1 -	This field is reserved. Reserved
0 SRE	Slew Rate Field Select one out of next values for pad: LCD_HSYNC 0 SRE_0_Slow_Slew_Rate — Slow Slew Rate 1 SRE_1_Fast_Slew_Rate — Fast Slew Rate

32.6.198 SW_PAD_CTL_PAD_LCD_VSYNC SW PAD Control Register (IOMUXC_SW_PAD_CTL_PAD_LCD_VSYNC)

SW_PAD_CTL Register

Address: 20E_0000h base + 39Ch offset = 20E_039Ch

Bit	31	30	29	28	27	26	25	24	23	22	21	20	19	18	17	16
R	Reserved															HYS
W																
Reset	0	0	0	0	0	0	0	0	0	0	0	0	0	0	0	0
Bit	15	14	13	12	11	10	9	8	7	6	5	4	3	2	1	0
R	PUS	PUE	PKE	ODE	Reserved			SPEED	DSE			Reserved		SRE		
W																
Reset	0	0	0	1	0	0	0	0	1	0	1	1	0	0	0	0

IOMUXC_SW_PAD_CTL_PAD_LCD_VSYNC field descriptions

Field	Description
31–17 -	This field is reserved. Reserved
16 HYS	Hyst. Enable Field Select one out of next values for pad: LCD_VSYNC 0 HYS_0_Hysteresis_Disabled — Hysteresis Disabled 1 HYS_1_Hysteresis_Enabled — Hysteresis Enabled
15–14 PUS	Pull Up / Down Config. Field Select one out of next values for pad: LCD_VSYNC 00 PUS_0_100K_Ohm_Pull_Down — 100K Ohm Pull Down 01 PUS_1_47K_Ohm_Pull_Up — 47K Ohm Pull Up 10 PUS_2_100K_Ohm_Pull_Up — 100K Ohm Pull Up 11 PUS_3_22K_Ohm_Pull_Up — 22K Ohm Pull Up
13 PUE	Pull / Keep Select Field Select one out of next values for pad: LCD_VSYNC 0 PUE_0_Keeper — Keeper 1 PUE_1_Pull — Pull
12 PKE	Pull / Keep Enable Field Select one out of next values for pad: LCD_VSYNC 0 PKE_0_Pull_Keeper_Disabled — Pull/Keeper Disabled 1 PKE_1_Pull_Keeper_Enabled — Pull/Keeper Enabled
11 ODE	Open Drain Enable Field Select one out of next values for pad: LCD_VSYNC

Table continues on the next page...

IOMUXC_SW_PAD_CTL_PAD_LCD_VSYNC field descriptions (continued)

Field	Description
	0 ODE_0_Open_Drain_Disabled — Open Drain Disabled 1 ODE_1_Open_Drain_Enabled — Open Drain Enabled
10–8 -	This field is reserved. Reserved
7–6 SPEED	Speed Field Select one out of next values for pad: LCD_VSYNC 00 SPEED_0_low_50MHz_ — low(50MHz) 01 SPEED_1_medium_100MHz_ — medium(100MHz) 10 SPEED_2_medium_100MHz_ — medium(100MHz) 11 SPEED_3_max_200MHz_ — max(200MHz)
5–3 DSE	Drive Strength Field Select one out of next values for pad: LCD_VSYNC 000 DSE_0_output_driver_disabled_ — output driver disabled; 001 DSE_1_R0_260_Ohm__3_3V_150_Ohm_1_8V_240_Ohm_for_DDR_ — R0(260 Ohm @ 3.3V, 150 Ohm@1.8V, 240 Ohm for DDR) 010 DSE_2_R0_2 — R0/2 011 DSE_3_R0_3 — R0/3 100 DSE_4_R0_4 — R0/4 101 DSE_5_R0_5 — R0/5 110 DSE_6_R0_6 — R0/6 111 DSE_7_R0_7 — R0/7
2–1 -	This field is reserved. Reserved
0 SRE	Slew Rate Field Select one out of next values for pad: LCD_VSYNC 0 SRE_0_Slow_Slew_Rate — Slow Slew Rate 1 SRE_1_Fast_Slew_Rate — Fast Slew Rate

32.6.199 SW_PAD_CTL_PAD_LCD_RESET SW PAD Control Register (IOMUXC_SW_PAD_CTL_PAD_LCD_RESET)

SW_PAD_CTL Register

Address: 20E_0000h base + 3A0h offset = 20E_03A0h

Bit	31	30	29	28	27	26	25	24	23	22	21	20	19	18	17	16
R	Reserved															HYS
W																
Reset	0	0	0	0	0	0	0	0	0	0	0	0	0	0	0	0
Bit	15	14	13	12	11	10	9	8	7	6	5	4	3	2	1	0
R	PUS	PUE	PKE	ODE	Reserved			SPEED	DSE			Reserved		SRE		
W																
Reset	0	0	0	1	0	0	0	0	1	0	1	1	0	0	0	0

IOMUXC_SW_PAD_CTL_PAD_LCD_RESET field descriptions

Field	Description
31–17 -	This field is reserved. Reserved
16 HYS	Hyst. Enable Field Select one out of next values for pad: LCD_RESET 0 HYS_0_Hysteresis_Disabled — Hysteresis Disabled 1 HYS_1_Hysteresis_Enabled — Hysteresis Enabled
15–14 PUS	Pull Up / Down Config. Field Select one out of next values for pad: LCD_RESET 00 PUS_0_100K_Ohm_Pull_Down — 100K Ohm Pull Down 01 PUS_1_47K_Ohm_Pull_Up — 47K Ohm Pull Up 10 PUS_2_100K_Ohm_Pull_Up — 100K Ohm Pull Up 11 PUS_3_22K_Ohm_Pull_Up — 22K Ohm Pull Up
13 PUE	Pull / Keep Select Field Select one out of next values for pad: LCD_RESET 0 PUE_0_Keeper — Keeper 1 PUE_1_Pull — Pull
12 PKE	Pull / Keep Enable Field Select one out of next values for pad: LCD_RESET 0 PKE_0_Pull_Keeper_Disabled — Pull/Keeper Disabled 1 PKE_1_Pull_Keeper_Enabled — Pull/Keeper Enabled
11 ODE	Open Drain Enable Field Select one out of next values for pad: LCD_RESET

Table continues on the next page...

IOMUXC_SW_PAD_CTL_PAD_LCD_RESET field descriptions (continued)

Field	Description
	0 ODE_0_Open_Drain_Disabled — Open Drain Disabled 1 ODE_1_Open_Drain_Enabled — Open Drain Enabled
10–8 -	This field is reserved. Reserved
7–6 SPEED	Speed Field Select one out of next values for pad: LCD_RESET 00 SPEED_0_low_50MHz_ — low(50MHz) 01 SPEED_1_medium_100MHz_ — medium(100MHz) 10 SPEED_2_medium_100MHz_ — medium(100MHz) 11 SPEED_3_max_200MHz_ — max(200MHz)
5–3 DSE	Drive Strength Field Select one out of next values for pad: LCD_RESET 000 DSE_0_output_driver_disabled_ — output driver disabled; 001 DSE_1_R0_260_Ohm__3_3V_150_Ohm_1_8V_240_Ohm_for_DDR_ — R0(260 Ohm @ 3.3V, 150 Ohm@1.8V, 240 Ohm for DDR) 010 DSE_2_R0_2 — R0/2 011 DSE_3_R0_3 — R0/3 100 DSE_4_R0_4 — R0/4 101 DSE_5_R0_5 — R0/5 110 DSE_6_R0_6 — R0/6 111 DSE_7_R0_7 — R0/7
2–1 -	This field is reserved. Reserved
0 SRE	Slew Rate Field Select one out of next values for pad: LCD_RESET 0 SRE_0_Slow_Slew_Rate — Slow Slew Rate 1 SRE_1_Fast_Slew_Rate — Fast Slew Rate

32.6.200 SW_PAD_CTL_PAD_LCD_DATA00 SW PAD Control Register (IOMUXC_SW_PAD_CTL_PAD_LCD_DATA00)

SW_PAD_CTL Register

Address: 20E_0000h base + 3A4h offset = 20E_03A4h

Bit	31	30	29	28	27	26	25	24	23	22	21	20	19	18	17	16
R	Reserved															HYS
W																
Reset	0	0	0	0	0	0	0	0	0	0	0	0	0	0	0	0
Bit	15	14	13	12	11	10	9	8	7	6	5	4	3	2	1	0
R	PUS	PUE	PKE	ODE	Reserved			SPEED	DSE			Reserved		SRE		
W																
Reset	0	0	0	1	0	0	0	0	1	0	1	1	0	0	0	0

IOMUXC_SW_PAD_CTL_PAD_LCD_DATA00 field descriptions

Field	Description
31–17 -	This field is reserved. Reserved
16 HYS	Hyst. Enable Field Select one out of next values for pad: LCD_DATA00 0 HYS_0_Hysteresis_Disabled — Hysteresis Disabled 1 HYS_1_Hysteresis_Enabled — Hysteresis Enabled
15–14 PUS	Pull Up / Down Config. Field Select one out of next values for pad: LCD_DATA00 00 PUS_0_100K_Ohm_Pull_Down — 100K Ohm Pull Down 01 PUS_1_47K_Ohm_Pull_Up — 47K Ohm Pull Up 10 PUS_2_100K_Ohm_Pull_Up — 100K Ohm Pull Up 11 PUS_3_22K_Ohm_Pull_Up — 22K Ohm Pull Up
13 PUE	Pull / Keep Select Field Select one out of next values for pad: LCD_DATA00 0 PUE_0_Keeper — Keeper 1 PUE_1_Pull — Pull
12 PKE	Pull / Keep Enable Field Select one out of next values for pad: LCD_DATA00 0 PKE_0_Pull_Keeper_Disabled — Pull/Keeper Disabled 1 PKE_1_Pull_Keeper_Enabled — Pull/Keeper Enabled
11 ODE	Open Drain Enable Field Select one out of next values for pad: LCD_DATA00

Table continues on the next page...

IOMUXC_SW_PAD_CTL_PAD_LCD_DATA00 field descriptions (continued)

Field	Description
	0 ODE_0_Open_Drain_Disabled — Open Drain Disabled 1 ODE_1_Open_Drain_Enabled — Open Drain Enabled
10–8 -	This field is reserved. Reserved
7–6 SPEED	Speed Field Select one out of next values for pad: LCD_DATA00 00 SPEED_0_low_50MHz_ — low(50MHz) 01 SPEED_1_medium_100MHz_ — medium(100MHz) 10 SPEED_2_medium_100MHz_ — medium(100MHz) 11 SPEED_3_max_200MHz_ — max(200MHz)
5–3 DSE	Drive Strength Field Select one out of next values for pad: LCD_DATA00 000 DSE_0_output_driver_disabled_ — output driver disabled; 001 DSE_1_R0_260_Ohm__3_3V_150_Ohm_1_8V_240_Ohm_for_DDR_ — R0(260 Ohm @ 3.3V, 150 Ohm@1.8V, 240 Ohm for DDR) 010 DSE_2_R0_2 — R0/2 011 DSE_3_R0_3 — R0/3 100 DSE_4_R0_4 — R0/4 101 DSE_5_R0_5 — R0/5 110 DSE_6_R0_6 — R0/6 111 DSE_7_R0_7 — R0/7
2–1 -	This field is reserved. Reserved
0 SRE	Slew Rate Field Select one out of next values for pad: LCD_DATA00 0 SRE_0_Slow_Slew_Rate — Slow Slew Rate 1 SRE_1_Fast_Slew_Rate — Fast Slew Rate

32.6.201 SW_PAD_CTL_PAD_LCD_DATA01 SW PAD Control Register (IOMUXC_SW_PAD_CTL_PAD_LCD_DATA01)

SW_PAD_CTL Register

Address: 20E_0000h base + 3A8h offset = 20E_03A8h

Bit	31	30	29	28	27	26	25	24	23	22	21	20	19	18	17	16
R	Reserved															HYS
W																
Reset	0	0	0	0	0	0	0	0	0	0	0	0	0	0	0	0
Bit	15	14	13	12	11	10	9	8	7	6	5	4	3	2	1	0
R	PUS	PUE	PKE	ODE	Reserved			SPEED	DSE			Reserved		SRE		
W																
Reset	0	0	0	1	0	0	0	0	1	0	1	1	0	0	0	0

IOMUXC_SW_PAD_CTL_PAD_LCD_DATA01 field descriptions

Field	Description
31–17 -	This field is reserved. Reserved
16 HYS	Hyst. Enable Field Select one out of next values for pad: LCD_DATA01 0 HYS_0_Hysteresis_Disabled — Hysteresis Disabled 1 HYS_1_Hysteresis_Enabled — Hysteresis Enabled
15–14 PUS	Pull Up / Down Config. Field Select one out of next values for pad: LCD_DATA01 00 PUS_0_100K_Ohm_Pull_Down — 100K Ohm Pull Down 01 PUS_1_47K_Ohm_Pull_Up — 47K Ohm Pull Up 10 PUS_2_100K_Ohm_Pull_Up — 100K Ohm Pull Up 11 PUS_3_22K_Ohm_Pull_Up — 22K Ohm Pull Up
13 PUE	Pull / Keep Select Field Select one out of next values for pad: LCD_DATA01 0 PUE_0_Keeper — Keeper 1 PUE_1_Pull — Pull
12 PKE	Pull / Keep Enable Field Select one out of next values for pad: LCD_DATA01 0 PKE_0_Pull_Keeper_Disabled — Pull/Keeper Disabled 1 PKE_1_Pull_Keeper_Enabled — Pull/Keeper Enabled
11 ODE	Open Drain Enable Field Select one out of next values for pad: LCD_DATA01

Table continues on the next page...

IOMUXC_SW_PAD_CTL_PAD_LCD_DATA01 field descriptions (continued)

Field	Description
	0 ODE_0_Open_Drain_Disabled — Open Drain Disabled 1 ODE_1_Open_Drain_Enabled — Open Drain Enabled
10–8 -	This field is reserved. Reserved
7–6 SPEED	Speed Field Select one out of next values for pad: LCD_DATA01 00 SPEED_0_low_50MHz_ — low(50MHz) 01 SPEED_1_medium_100MHz_ — medium(100MHz) 10 SPEED_2_medium_100MHz_ — medium(100MHz) 11 SPEED_3_max_200MHz_ — max(200MHz)
5–3 DSE	Drive Strength Field Select one out of next values for pad: LCD_DATA01 000 DSE_0_output_driver_disabled_ — output driver disabled; 001 DSE_1_R0_260_Ohm__3_3V_150_Ohm_1_8V_240_Ohm_for_DDR_ — R0(260 Ohm @ 3.3V, 150 Ohm@1.8V, 240 Ohm for DDR) 010 DSE_2_R0_2 — R0/2 011 DSE_3_R0_3 — R0/3 100 DSE_4_R0_4 — R0/4 101 DSE_5_R0_5 — R0/5 110 DSE_6_R0_6 — R0/6 111 DSE_7_R0_7 — R0/7
2–1 -	This field is reserved. Reserved
0 SRE	Slew Rate Field Select one out of next values for pad: LCD_DATA01 0 SRE_0_Slow_Slew_Rate — Slow Slew Rate 1 SRE_1_Fast_Slew_Rate — Fast Slew Rate

32.6.202 SW_PAD_CTL_PAD_LCD_DATA02 SW PAD Control Register (IOMUXC_SW_PAD_CTL_PAD_LCD_DATA02)

SW_PAD_CTL Register

Address: 20E_0000h base + 3ACh offset = 20E_03ACh

Bit	31	30	29	28	27	26	25	24	23	22	21	20	19	18	17	16
R	Reserved															HYS
W																
Reset	0	0	0	0	0	0	0	0	0	0	0	0	0	0	0	0
Bit	15	14	13	12	11	10	9	8	7	6	5	4	3	2	1	0
R	PUS	PUE	PKE	ODE	Reserved			SPEED	DSE			Reserved		SRE		
W																
Reset	0	0	0	1	0	0	0	0	1	0	1	1	0	0	0	0

IOMUXC_SW_PAD_CTL_PAD_LCD_DATA02 field descriptions

Field	Description
31–17 -	This field is reserved. Reserved
16 HYS	Hyst. Enable Field Select one out of next values for pad: LCD_DATA02 0 HYS_0_Hysteresis_Disabled — Hysteresis Disabled 1 HYS_1_Hysteresis_Enabled — Hysteresis Enabled
15–14 PUS	Pull Up / Down Config. Field Select one out of next values for pad: LCD_DATA02 00 PUS_0_100K_Ohm_Pull_Down — 100K Ohm Pull Down 01 PUS_1_47K_Ohm_Pull_Up — 47K Ohm Pull Up 10 PUS_2_100K_Ohm_Pull_Up — 100K Ohm Pull Up 11 PUS_3_22K_Ohm_Pull_Up — 22K Ohm Pull Up
13 PUE	Pull / Keep Select Field Select one out of next values for pad: LCD_DATA02 0 PUE_0_Keeper — Keeper 1 PUE_1_Pull — Pull
12 PKE	Pull / Keep Enable Field Select one out of next values for pad: LCD_DATA02 0 PKE_0_Pull_Keeper_Disabled — Pull/Keeper Disabled 1 PKE_1_Pull_Keeper_Enabled — Pull/Keeper Enabled
11 ODE	Open Drain Enable Field Select one out of next values for pad: LCD_DATA02

Table continues on the next page...

IOMUXC_SW_PAD_CTL_PAD_LCD_DATA02 field descriptions (continued)

Field	Description
	0 ODE_0_Open_Drain_Disabled — Open Drain Disabled 1 ODE_1_Open_Drain_Enabled — Open Drain Enabled
10–8 -	This field is reserved. Reserved
7–6 SPEED	Speed Field Select one out of next values for pad: LCD_DATA02 00 SPEED_0_low_50MHz_ — low(50MHz) 01 SPEED_1_medium_100MHz_ — medium(100MHz) 10 SPEED_2_medium_100MHz_ — medium(100MHz) 11 SPEED_3_max_200MHz_ — max(200MHz)
5–3 DSE	Drive Strength Field Select one out of next values for pad: LCD_DATA02 000 DSE_0_output_driver_disabled_ — output driver disabled; 001 DSE_1_R0_260_Ohm__3_3V_150_Ohm_1_8V_240_Ohm_for_DDR_ — R0(260 Ohm @ 3.3V, 150 Ohm@1.8V, 240 Ohm for DDR) 010 DSE_2_R0_2 — R0/2 011 DSE_3_R0_3 — R0/3 100 DSE_4_R0_4 — R0/4 101 DSE_5_R0_5 — R0/5 110 DSE_6_R0_6 — R0/6 111 DSE_7_R0_7 — R0/7
2–1 -	This field is reserved. Reserved
0 SRE	Slew Rate Field Select one out of next values for pad: LCD_DATA02 0 SRE_0_Slow_Slew_Rate — Slow Slew Rate 1 SRE_1_Fast_Slew_Rate — Fast Slew Rate

32.6.203 SW_PAD_CTL_PAD_LCD_DATA03 SW PAD Control Register (IOMUXC_SW_PAD_CTL_PAD_LCD_DATA03)

SW_PAD_CTL Register

Address: 20E_0000h base + 3B0h offset = 20E_03B0h

Bit	31	30	29	28	27	26	25	24	23	22	21	20	19	18	17	16
R	Reserved															HYS
W																
Reset	0	0	0	0	0	0	0	0	0	0	0	0	0	0	0	0
Bit	15	14	13	12	11	10	9	8	7	6	5	4	3	2	1	0
R	PUS	PUE	PKE	ODE	Reserved			SPEED	DSE			Reserved		SRE		
W																
Reset	0	0	0	1	0	0	0	0	1	0	1	1	0	0	0	0

IOMUXC_SW_PAD_CTL_PAD_LCD_DATA03 field descriptions

Field	Description
31–17 -	This field is reserved. Reserved
16 HYS	Hyst. Enable Field Select one out of next values for pad: LCD_DATA03 0 HYS_0_Hysteresis_Disabled — Hysteresis Disabled 1 HYS_1_Hysteresis_Enabled — Hysteresis Enabled
15–14 PUS	Pull Up / Down Config. Field Select one out of next values for pad: LCD_DATA03 00 PUS_0_100K_Ohm_Pull_Down — 100K Ohm Pull Down 01 PUS_1_47K_Ohm_Pull_Up — 47K Ohm Pull Up 10 PUS_2_100K_Ohm_Pull_Up — 100K Ohm Pull Up 11 PUS_3_22K_Ohm_Pull_Up — 22K Ohm Pull Up
13 PUE	Pull / Keep Select Field Select one out of next values for pad: LCD_DATA03 0 PUE_0_Keeper — Keeper 1 PUE_1_Pull — Pull
12 PKE	Pull / Keep Enable Field Select one out of next values for pad: LCD_DATA03 0 PKE_0_Pull_Keeper_Disabled — Pull/Keeper Disabled 1 PKE_1_Pull_Keeper_Enabled — Pull/Keeper Enabled
11 ODE	Open Drain Enable Field Select one out of next values for pad: LCD_DATA03

Table continues on the next page...

IOMUXC_SW_PAD_CTL_PAD_LCD_DATA03 field descriptions (continued)

Field	Description
	0 ODE_0_Open_Drain_Disabled — Open Drain Disabled 1 ODE_1_Open_Drain_Enabled — Open Drain Enabled
10–8 -	This field is reserved. Reserved
7–6 SPEED	Speed Field Select one out of next values for pad: LCD_DATA03 00 SPEED_0_low_50MHz_ — low(50MHz) 01 SPEED_1_medium_100MHz_ — medium(100MHz) 10 SPEED_2_medium_100MHz_ — medium(100MHz) 11 SPEED_3_max_200MHz_ — max(200MHz)
5–3 DSE	Drive Strength Field Select one out of next values for pad: LCD_DATA03 000 DSE_0_output_driver_disabled_ — output driver disabled; 001 DSE_1_R0_260_Ohm__3_3V_150_Ohm_1_8V_240_Ohm_for_DDR_ — R0(260 Ohm @ 3.3V, 150 Ohm@1.8V, 240 Ohm for DDR) 010 DSE_2_R0_2 — R0/2 011 DSE_3_R0_3 — R0/3 100 DSE_4_R0_4 — R0/4 101 DSE_5_R0_5 — R0/5 110 DSE_6_R0_6 — R0/6 111 DSE_7_R0_7 — R0/7
2–1 -	This field is reserved. Reserved
0 SRE	Slew Rate Field Select one out of next values for pad: LCD_DATA03 0 SRE_0_Slow_Slew_Rate — Slow Slew Rate 1 SRE_1_Fast_Slew_Rate — Fast Slew Rate

32.6.204 SW_PAD_CTL_PAD_LCD_DATA04 SW PAD Control Register (IOMUXC_SW_PAD_CTL_PAD_LCD_DATA04)

SW_PAD_CTL Register

Address: 20E_0000h base + 3B4h offset = 20E_03B4h

Bit	31	30	29	28	27	26	25	24	23	22	21	20	19	18	17	16
R	Reserved															HYS
W																
Reset	0	0	0	0	0	0	0	0	0	0	0	0	0	0	0	0
Bit	15	14	13	12	11	10	9	8	7	6	5	4	3	2	1	0
R	PUS	PUE	PKE	ODE	Reserved			SPEED	DSE			Reserved		SRE		
W																
Reset	0	0	0	1	0	0	0	0	1	0	1	1	0	0	0	0

IOMUXC_SW_PAD_CTL_PAD_LCD_DATA04 field descriptions

Field	Description
31–17 -	This field is reserved. Reserved
16 HYS	Hyst. Enable Field Select one out of next values for pad: LCD_DATA04 0 HYS_0_Hysteresis_Disabled — Hysteresis Disabled 1 HYS_1_Hysteresis_Enabled — Hysteresis Enabled
15–14 PUS	Pull Up / Down Config. Field Select one out of next values for pad: LCD_DATA04 00 PUS_0_100K_Ohm_Pull_Down — 100K Ohm Pull Down 01 PUS_1_47K_Ohm_Pull_Up — 47K Ohm Pull Up 10 PUS_2_100K_Ohm_Pull_Up — 100K Ohm Pull Up 11 PUS_3_22K_Ohm_Pull_Up — 22K Ohm Pull Up
13 PUE	Pull / Keep Select Field Select one out of next values for pad: LCD_DATA04 0 PUE_0_Keeper — Keeper 1 PUE_1_Pull — Pull
12 PKE	Pull / Keep Enable Field Select one out of next values for pad: LCD_DATA04 0 PKE_0_Pull_Keeper_Disabled — Pull/Keeper Disabled 1 PKE_1_Pull_Keeper_Enabled — Pull/Keeper Enabled
11 ODE	Open Drain Enable Field Select one out of next values for pad: LCD_DATA04

Table continues on the next page...

IOMUXC_SW_PAD_CTL_PAD_LCD_DATA04 field descriptions (continued)

Field	Description
	0 ODE_0_Open_Drain_Disabled — Open Drain Disabled 1 ODE_1_Open_Drain_Enabled — Open Drain Enabled
10–8 -	This field is reserved. Reserved
7–6 SPEED	Speed Field Select one out of next values for pad: LCD_DATA04 00 SPEED_0_low_50MHz_ — low(50MHz) 01 SPEED_1_medium_100MHz_ — medium(100MHz) 10 SPEED_2_medium_100MHz_ — medium(100MHz) 11 SPEED_3_max_200MHz_ — max(200MHz)
5–3 DSE	Drive Strength Field Select one out of next values for pad: LCD_DATA04 000 DSE_0_output_driver_disabled_ — output driver disabled; 001 DSE_1_R0_260_Ohm__3_3V_150_Ohm_1_8V_240_Ohm_for_DDR_ — R0(260 Ohm @ 3.3V, 150 Ohm@1.8V, 240 Ohm for DDR) 010 DSE_2_R0_2 — R0/2 011 DSE_3_R0_3 — R0/3 100 DSE_4_R0_4 — R0/4 101 DSE_5_R0_5 — R0/5 110 DSE_6_R0_6 — R0/6 111 DSE_7_R0_7 — R0/7
2–1 -	This field is reserved. Reserved
0 SRE	Slew Rate Field Select one out of next values for pad: LCD_DATA04 0 SRE_0_Slow_Slew_Rate — Slow Slew Rate 1 SRE_1_Fast_Slew_Rate — Fast Slew Rate

32.6.205 SW_PAD_CTL_PAD_LCD_DATA05 SW PAD Control Register (IOMUXC_SW_PAD_CTL_PAD_LCD_DATA05)

SW_PAD_CTL Register

Address: 20E_0000h base + 3B8h offset = 20E_03B8h

Bit	31	30	29	28	27	26	25	24	23	22	21	20	19	18	17	16
R	Reserved															HYS
W	Reserved															
Reset	0	0	0	0	0	0	0	0	0	0	0	0	0	0	0	0
Bit	15	14	13	12	11	10	9	8	7	6	5	4	3	2	1	0
R	PUS	PUE	PKE	ODE	Reserved			SPEED	DSE			Reserved		SRE		
W																
Reset	0	0	0	1	0	0	0	0	1	0	1	1	0	0	0	0

IOMUXC_SW_PAD_CTL_PAD_LCD_DATA05 field descriptions

Field	Description
31–17 -	This field is reserved. Reserved
16 HYS	Hyst. Enable Field Select one out of next values for pad: LCD_DATA05 0 HYS_0_Hysteresis_Disabled — Hysteresis Disabled 1 HYS_1_Hysteresis_Enabled — Hysteresis Enabled
15–14 PUS	Pull Up / Down Config. Field Select one out of next values for pad: LCD_DATA05 00 PUS_0_100K_Ohm_Pull_Down — 100K Ohm Pull Down 01 PUS_1_47K_Ohm_Pull_Up — 47K Ohm Pull Up 10 PUS_2_100K_Ohm_Pull_Up — 100K Ohm Pull Up 11 PUS_3_22K_Ohm_Pull_Up — 22K Ohm Pull Up
13 PUE	Pull / Keep Select Field Select one out of next values for pad: LCD_DATA05 0 PUE_0_Keeper — Keeper 1 PUE_1_Pull — Pull
12 PKE	Pull / Keep Enable Field Select one out of next values for pad: LCD_DATA05 0 PKE_0_Pull_Keeper_Disabled — Pull/Keeper Disabled 1 PKE_1_Pull_Keeper_Enabled — Pull/Keeper Enabled
11 ODE	Open Drain Enable Field Select one out of next values for pad: LCD_DATA05

Table continues on the next page...

IOMUXC_SW_PAD_CTL_PAD_LCD_DATA05 field descriptions (continued)

Field	Description
	0 ODE_0_Open_Drain_Disabled — Open Drain Disabled 1 ODE_1_Open_Drain_Enabled — Open Drain Enabled
10–8 -	This field is reserved. Reserved
7–6 SPEED	Speed Field Select one out of next values for pad: LCD_DATA05 00 SPEED_0_low_50MHz_ — low(50MHz) 01 SPEED_1_medium_100MHz_ — medium(100MHz) 10 SPEED_2_medium_100MHz_ — medium(100MHz) 11 SPEED_3_max_200MHz_ — max(200MHz)
5–3 DSE	Drive Strength Field Select one out of next values for pad: LCD_DATA05 000 DSE_0_output_driver_disabled_ — output driver disabled; 001 DSE_1_R0_260_Ohm__3_3V_150_Ohm_1_8V_240_Ohm_for_DDR_ — R0(260 Ohm @ 3.3V, 150 Ohm@1.8V, 240 Ohm for DDR) 010 DSE_2_R0_2 — R0/2 011 DSE_3_R0_3 — R0/3 100 DSE_4_R0_4 — R0/4 101 DSE_5_R0_5 — R0/5 110 DSE_6_R0_6 — R0/6 111 DSE_7_R0_7 — R0/7
2–1 -	This field is reserved. Reserved
0 SRE	Slew Rate Field Select one out of next values for pad: LCD_DATA05 0 SRE_0_Slow_Slew_Rate — Slow Slew Rate 1 SRE_1_Fast_Slew_Rate — Fast Slew Rate

32.6.206 SW_PAD_CTL_PAD_LCD_DATA06 SW PAD Control Register (IOMUXC_SW_PAD_CTL_PAD_LCD_DATA06)

SW_PAD_CTL Register

Address: 20E_0000h base + 3BCh offset = 20E_03BCh

Bit	31	30	29	28	27	26	25	24	23	22	21	20	19	18	17	16
R	Reserved															HYS
W																
Reset	0	0	0	0	0	0	0	0	0	0	0	0	0	0	0	0
Bit	15	14	13	12	11	10	9	8	7	6	5	4	3	2	1	0
R	PUS	PUE	PKE	ODE	Reserved			SPEED	DSE			Reserved		SRE		
W																
Reset	0	0	0	1	0	0	0	0	1	0	1	1	0	0	0	0

IOMUXC_SW_PAD_CTL_PAD_LCD_DATA06 field descriptions

Field	Description
31–17 -	This field is reserved. Reserved
16 HYS	Hyst. Enable Field Select one out of next values for pad: LCD_DATA06 0 HYS_0_Hysteresis_Disabled — Hysteresis Disabled 1 HYS_1_Hysteresis_Enabled — Hysteresis Enabled
15–14 PUS	Pull Up / Down Config. Field Select one out of next values for pad: LCD_DATA06 00 PUS_0_100K_Ohm_Pull_Down — 100K Ohm Pull Down 01 PUS_1_47K_Ohm_Pull_Up — 47K Ohm Pull Up 10 PUS_2_100K_Ohm_Pull_Up — 100K Ohm Pull Up 11 PUS_3_22K_Ohm_Pull_Up — 22K Ohm Pull Up
13 PUE	Pull / Keep Select Field Select one out of next values for pad: LCD_DATA06 0 PUE_0_Keeper — Keeper 1 PUE_1_Pull — Pull
12 PKE	Pull / Keep Enable Field Select one out of next values for pad: LCD_DATA06 0 PKE_0_Pull_Keeper_Disabled — Pull/Keeper Disabled 1 PKE_1_Pull_Keeper_Enabled — Pull/Keeper Enabled
11 ODE	Open Drain Enable Field Select one out of next values for pad: LCD_DATA06

Table continues on the next page...

IOMUXC_SW_PAD_CTL_PAD_LCD_DATA06 field descriptions (continued)

Field	Description
	0 ODE_0_Open_Drain_Disabled — Open Drain Disabled 1 ODE_1_Open_Drain_Enabled — Open Drain Enabled
10–8 -	This field is reserved. Reserved
7–6 SPEED	Speed Field Select one out of next values for pad: LCD_DATA06 00 SPEED_0_low_50MHz_ — low(50MHz) 01 SPEED_1_medium_100MHz_ — medium(100MHz) 10 SPEED_2_medium_100MHz_ — medium(100MHz) 11 SPEED_3_max_200MHz_ — max(200MHz)
5–3 DSE	Drive Strength Field Select one out of next values for pad: LCD_DATA06 000 DSE_0_output_driver_disabled_ — output driver disabled; 001 DSE_1_R0_260_Ohm__3_3V_150_Ohm_1_8V_240_Ohm_for_DDR_ — R0(260 Ohm @ 3.3V, 150 Ohm@1.8V, 240 Ohm for DDR) 010 DSE_2_R0_2 — R0/2 011 DSE_3_R0_3 — R0/3 100 DSE_4_R0_4 — R0/4 101 DSE_5_R0_5 — R0/5 110 DSE_6_R0_6 — R0/6 111 DSE_7_R0_7 — R0/7
2–1 -	This field is reserved. Reserved
0 SRE	Slew Rate Field Select one out of next values for pad: LCD_DATA06 0 SRE_0_Slow_Slew_Rate — Slow Slew Rate 1 SRE_1_Fast_Slew_Rate — Fast Slew Rate

32.6.207 SW_PAD_CTL_PAD_LCD_DATA07 SW PAD Control Register (IOMUXC_SW_PAD_CTL_PAD_LCD_DATA07)

SW_PAD_CTL Register

Address: 20E_0000h base + 3C0h offset = 20E_03C0h

Bit	31	30	29	28	27	26	25	24	23	22	21	20	19	18	17	16
R	Reserved															HYS
W																
Reset	0	0	0	0	0	0	0	0	0	0	0	0	0	0	0	0
Bit	15	14	13	12	11	10	9	8	7	6	5	4	3	2	1	0
R	PUS	PUE	PKE	ODE	Reserved			SPEED	DSE			Reserved		SRE		
W																
Reset	0	0	0	1	0	0	0	0	1	0	1	1	0	0	0	0

IOMUXC_SW_PAD_CTL_PAD_LCD_DATA07 field descriptions

Field	Description
31–17 -	This field is reserved. Reserved
16 HYS	Hyst. Enable Field Select one out of next values for pad: LCD_DATA07 0 HYS_0_Hysteresis_Disabled — Hysteresis Disabled 1 HYS_1_Hysteresis_Enabled — Hysteresis Enabled
15–14 PUS	Pull Up / Down Config. Field Select one out of next values for pad: LCD_DATA07 00 PUS_0_100K_Ohm_Pull_Down — 100K Ohm Pull Down 01 PUS_1_47K_Ohm_Pull_Up — 47K Ohm Pull Up 10 PUS_2_100K_Ohm_Pull_Up — 100K Ohm Pull Up 11 PUS_3_22K_Ohm_Pull_Up — 22K Ohm Pull Up
13 PUE	Pull / Keep Select Field Select one out of next values for pad: LCD_DATA07 0 PUE_0_Keeper — Keeper 1 PUE_1_Pull — Pull
12 PKE	Pull / Keep Enable Field Select one out of next values for pad: LCD_DATA07 0 PKE_0_Pull_Keeper_Disabled — Pull/Keeper Disabled 1 PKE_1_Pull_Keeper_Enabled — Pull/Keeper Enabled
11 ODE	Open Drain Enable Field Select one out of next values for pad: LCD_DATA07

Table continues on the next page...

IOMUXC_SW_PAD_CTL_PAD_LCD_DATA07 field descriptions (continued)

Field	Description
	0 ODE_0_Open_Drain_Disabled — Open Drain Disabled 1 ODE_1_Open_Drain_Enabled — Open Drain Enabled
10–8 -	This field is reserved. Reserved
7–6 SPEED	Speed Field Select one out of next values for pad: LCD_DATA07 00 SPEED_0_low_50MHz_ — low(50MHz) 01 SPEED_1_medium_100MHz_ — medium(100MHz) 10 SPEED_2_medium_100MHz_ — medium(100MHz) 11 SPEED_3_max_200MHz_ — max(200MHz)
5–3 DSE	Drive Strength Field Select one out of next values for pad: LCD_DATA07 000 DSE_0_output_driver_disabled_ — output driver disabled; 001 DSE_1_R0_260_Ohm__3_3V_150_Ohm_1_8V_240_Ohm_for_DDR_ — R0(260 Ohm @ 3.3V, 150 Ohm@1.8V, 240 Ohm for DDR) 010 DSE_2_R0_2 — R0/2 011 DSE_3_R0_3 — R0/3 100 DSE_4_R0_4 — R0/4 101 DSE_5_R0_5 — R0/5 110 DSE_6_R0_6 — R0/6 111 DSE_7_R0_7 — R0/7
2–1 -	This field is reserved. Reserved
0 SRE	Slew Rate Field Select one out of next values for pad: LCD_DATA07 0 SRE_0_Slow_Slew_Rate — Slow Slew Rate 1 SRE_1_Fast_Slew_Rate — Fast Slew Rate

32.6.208 SW_PAD_CTL_PAD_LCD_DATA08 SW PAD Control Register (IOMUXC_SW_PAD_CTL_PAD_LCD_DATA08)

SW_PAD_CTL Register

Address: 20E_0000h base + 3C4h offset = 20E_03C4h

Bit	31	30	29	28	27	26	25	24	23	22	21	20	19	18	17	16
R	Reserved															HYS
W																
Reset	0	0	0	0	0	0	0	0	0	0	0	0	0	0	0	0
Bit	15	14	13	12	11	10	9	8	7	6	5	4	3	2	1	0
R	PUS	PUE	PKE	ODE	Reserved			SPEED	DSE			Reserved		SRE		
W																
Reset	0	0	0	1	0	0	0	0	1	0	1	1	0	0	0	0

IOMUXC_SW_PAD_CTL_PAD_LCD_DATA08 field descriptions

Field	Description
31–17 -	This field is reserved. Reserved
16 HYS	Hyst. Enable Field Select one out of next values for pad: LCD_DATA08 0 HYS_0_Hysteresis_Disabled — Hysteresis Disabled 1 HYS_1_Hysteresis_Enabled — Hysteresis Enabled
15–14 PUS	Pull Up / Down Config. Field Select one out of next values for pad: LCD_DATA08 00 PUS_0_100K_Ohm_Pull_Down — 100K Ohm Pull Down 01 PUS_1_47K_Ohm_Pull_Up — 47K Ohm Pull Up 10 PUS_2_100K_Ohm_Pull_Up — 100K Ohm Pull Up 11 PUS_3_22K_Ohm_Pull_Up — 22K Ohm Pull Up
13 PUE	Pull / Keep Select Field Select one out of next values for pad: LCD_DATA08 0 PUE_0_Keeper — Keeper 1 PUE_1_Pull — Pull
12 PKE	Pull / Keep Enable Field Select one out of next values for pad: LCD_DATA08 0 PKE_0_Pull_Keeper_Disabled — Pull/Keeper Disabled 1 PKE_1_Pull_Keeper_Enabled — Pull/Keeper Enabled
11 ODE	Open Drain Enable Field Select one out of next values for pad: LCD_DATA08

Table continues on the next page...

IOMUXC_SW_PAD_CTL_PAD_LCD_DATA08 field descriptions (continued)

Field	Description
	0 ODE_0_Open_Drain_Disabled — Open Drain Disabled 1 ODE_1_Open_Drain_Enabled — Open Drain Enabled
10–8 -	This field is reserved. Reserved
7–6 SPEED	Speed Field Select one out of next values for pad: LCD_DATA08 00 SPEED_0_low_50MHz_ — low(50MHz) 01 SPEED_1_medium_100MHz_ — medium(100MHz) 10 SPEED_2_medium_100MHz_ — medium(100MHz) 11 SPEED_3_max_200MHz_ — max(200MHz)
5–3 DSE	Drive Strength Field Select one out of next values for pad: LCD_DATA08 000 DSE_0_output_driver_disabled_ — output driver disabled; 001 DSE_1_R0_260_Ohm__3_3V_150_Ohm_1_8V_240_Ohm_for_DDR_ — R0(260 Ohm @ 3.3V, 150 Ohm@1.8V, 240 Ohm for DDR) 010 DSE_2_R0_2 — R0/2 011 DSE_3_R0_3 — R0/3 100 DSE_4_R0_4 — R0/4 101 DSE_5_R0_5 — R0/5 110 DSE_6_R0_6 — R0/6 111 DSE_7_R0_7 — R0/7
2–1 -	This field is reserved. Reserved
0 SRE	Slew Rate Field Select one out of next values for pad: LCD_DATA08 0 SRE_0_Slow_Slew_Rate — Slow Slew Rate 1 SRE_1_Fast_Slew_Rate — Fast Slew Rate

32.6.209 SW_PAD_CTL_PAD_LCD_DATA09 SW PAD Control Register (IOMUXC_SW_PAD_CTL_PAD_LCD_DATA09)

SW_PAD_CTL Register

Address: 20E_0000h base + 3C8h offset = 20E_03C8h

Bit	31	30	29	28	27	26	25	24	23	22	21	20	19	18	17	16
R	Reserved															HYS
W																
Reset	0	0	0	0	0	0	0	0	0	0	0	0	0	0	0	0
Bit	15	14	13	12	11	10	9	8	7	6	5	4	3	2	1	0
R	PUS	PUE	PKE	ODE	Reserved			SPEED	DSE			Reserved		SRE		
W																
Reset	0	0	0	1	0	0	0	0	1	0	1	1	0	0	0	0

IOMUXC_SW_PAD_CTL_PAD_LCD_DATA09 field descriptions

Field	Description
31–17 -	This field is reserved. Reserved
16 HYS	Hyst. Enable Field Select one out of next values for pad: LCD_DATA09 0 HYS_0_Hysteresis_Disabled — Hysteresis Disabled 1 HYS_1_Hysteresis_Enabled — Hysteresis Enabled
15–14 PUS	Pull Up / Down Config. Field Select one out of next values for pad: LCD_DATA09 00 PUS_0_100K_Ohm_Pull_Down — 100K Ohm Pull Down 01 PUS_1_47K_Ohm_Pull_Up — 47K Ohm Pull Up 10 PUS_2_100K_Ohm_Pull_Up — 100K Ohm Pull Up 11 PUS_3_22K_Ohm_Pull_Up — 22K Ohm Pull Up
13 PUE	Pull / Keep Select Field Select one out of next values for pad: LCD_DATA09 0 PUE_0_Keeper — Keeper 1 PUE_1_Pull — Pull
12 PKE	Pull / Keep Enable Field Select one out of next values for pad: LCD_DATA09 0 PKE_0_Pull_Keeper_Disabled — Pull/Keeper Disabled 1 PKE_1_Pull_Keeper_Enabled — Pull/Keeper Enabled
11 ODE	Open Drain Enable Field Select one out of next values for pad: LCD_DATA09

Table continues on the next page...

IOMUXC_SW_PAD_CTL_PAD_LCD_DATA09 field descriptions (continued)

Field	Description
	0 ODE_0_Open_Drain_Disabled — Open Drain Disabled 1 ODE_1_Open_Drain_Enabled — Open Drain Enabled
10–8 -	This field is reserved. Reserved
7–6 SPEED	Speed Field Select one out of next values for pad: LCD_DATA09 00 SPEED_0_low_50MHz_ — low(50MHz) 01 SPEED_1_medium_100MHz_ — medium(100MHz) 10 SPEED_2_medium_100MHz_ — medium(100MHz) 11 SPEED_3_max_200MHz_ — max(200MHz)
5–3 DSE	Drive Strength Field Select one out of next values for pad: LCD_DATA09 000 DSE_0_output_driver_disabled_ — output driver disabled; 001 DSE_1_R0_260_Ohm__3_3V_150_Ohm_1_8V_240_Ohm_for_DDR_ — R0(260 Ohm @ 3.3V, 150 Ohm@1.8V, 240 Ohm for DDR) 010 DSE_2_R0_2 — R0/2 011 DSE_3_R0_3 — R0/3 100 DSE_4_R0_4 — R0/4 101 DSE_5_R0_5 — R0/5 110 DSE_6_R0_6 — R0/6 111 DSE_7_R0_7 — R0/7
2–1 -	This field is reserved. Reserved
0 SRE	Slew Rate Field Select one out of next values for pad: LCD_DATA09 0 SRE_0_Slow_Slew_Rate — Slow Slew Rate 1 SRE_1_Fast_Slew_Rate — Fast Slew Rate

32.6.210 SW_PAD_CTL_PAD_LCD_DATA10 SW PAD Control Register (IOMUXC_SW_PAD_CTL_PAD_LCD_DATA10)

SW_PAD_CTL Register

Address: 20E_0000h base + 3CCCh offset = 20E_03CCh

Bit	31	30	29	28	27	26	25	24	23	22	21	20	19	18	17	16
R	Reserved															HYS
W																
Reset	0	0	0	0	0	0	0	0	0	0	0	0	0	0	0	0
Bit	15	14	13	12	11	10	9	8	7	6	5	4	3	2	1	0
R	PUS	PUE	PKE	ODE	Reserved			SPEED	DSE			Reserved		SRE		
W																
Reset	0	0	0	1	0	0	0	0	1	0	1	1	0	0	0	0

IOMUXC_SW_PAD_CTL_PAD_LCD_DATA10 field descriptions

Field	Description
31–17 -	This field is reserved. Reserved
16 HYS	Hyst. Enable Field Select one out of next values for pad: LCD_DATA10 0 HYS_0_Hysteresis_Disabled — Hysteresis Disabled 1 HYS_1_Hysteresis_Enabled — Hysteresis Enabled
15–14 PUS	Pull Up / Down Config. Field Select one out of next values for pad: LCD_DATA10 00 PUS_0_100K_Ohm_Pull_Down — 100K Ohm Pull Down 01 PUS_1_47K_Ohm_Pull_Up — 47K Ohm Pull Up 10 PUS_2_100K_Ohm_Pull_Up — 100K Ohm Pull Up 11 PUS_3_22K_Ohm_Pull_Up — 22K Ohm Pull Up
13 PUE	Pull / Keep Select Field Select one out of next values for pad: LCD_DATA10 0 PUE_0_Keeper — Keeper 1 PUE_1_Pull — Pull
12 PKE	Pull / Keep Enable Field Select one out of next values for pad: LCD_DATA10 0 PKE_0_Pull_Keeper_Disabled — Pull/Keeper Disabled 1 PKE_1_Pull_Keeper_Enabled — Pull/Keeper Enabled
11 ODE	Open Drain Enable Field Select one out of next values for pad: LCD_DATA10

Table continues on the next page...

IOMUXC_SW_PAD_CTL_PAD_LCD_DATA10 field descriptions (continued)

Field	Description
	0 ODE_0_Open_Drain_Disabled — Open Drain Disabled 1 ODE_1_Open_Drain_Enabled — Open Drain Enabled
10–8 -	This field is reserved. Reserved
7–6 SPEED	Speed Field Select one out of next values for pad: LCD_DATA10 00 SPEED_0_low_50MHz_ — low(50MHz) 01 SPEED_1_medium_100MHz_ — medium(100MHz) 10 SPEED_2_medium_100MHz_ — medium(100MHz) 11 SPEED_3_max_200MHz_ — max(200MHz)
5–3 DSE	Drive Strength Field Select one out of next values for pad: LCD_DATA10 000 DSE_0_output_driver_disabled_ — output driver disabled; 001 DSE_1_R0_260_Ohm__3_3V_150_Ohm_1_8V_240_Ohm_for_DDR_ — R0(260 Ohm @ 3.3V, 150 Ohm@1.8V, 240 Ohm for DDR) 010 DSE_2_R0_2 — R0/2 011 DSE_3_R0_3 — R0/3 100 DSE_4_R0_4 — R0/4 101 DSE_5_R0_5 — R0/5 110 DSE_6_R0_6 — R0/6 111 DSE_7_R0_7 — R0/7
2–1 -	This field is reserved. Reserved
0 SRE	Slew Rate Field Select one out of next values for pad: LCD_DATA10 0 SRE_0_Slow_Slew_Rate — Slow Slew Rate 1 SRE_1_Fast_Slew_Rate — Fast Slew Rate

32.6.211 SW_PAD_CTL_PAD_LCD_DATA11 SW PAD Control Register (IOMUXC_SW_PAD_CTL_PAD_LCD_DATA11)

SW_PAD_CTL Register

Address: 20E_0000h base + 3D0h offset = 20E_03D0h

Bit	31	30	29	28	27	26	25	24	23	22	21	20	19	18	17	16
R	Reserved															HYS
W																
Reset	0	0	0	0	0	0	0	0	0	0	0	0	0	0	0	0
Bit	15	14	13	12	11	10	9	8	7	6	5	4	3	2	1	0
R	PUS	PUE	PKE	ODE	Reserved			SPEED	DSE			Reserved		SRE		
W																
Reset	0	0	0	1	0	0	0	0	1	0	1	1	0	0	0	0

IOMUXC_SW_PAD_CTL_PAD_LCD_DATA11 field descriptions

Field	Description
31–17 -	This field is reserved. Reserved
16 HYS	Hyst. Enable Field Select one out of next values for pad: LCD_DATA11 0 HYS_0_Hysteresis_Disabled — Hysteresis Disabled 1 HYS_1_Hysteresis_Enabled — Hysteresis Enabled
15–14 PUS	Pull Up / Down Config. Field Select one out of next values for pad: LCD_DATA11 00 PUS_0_100K_Ohm_Pull_Down — 100K Ohm Pull Down 01 PUS_1_47K_Ohm_Pull_Up — 47K Ohm Pull Up 10 PUS_2_100K_Ohm_Pull_Up — 100K Ohm Pull Up 11 PUS_3_22K_Ohm_Pull_Up — 22K Ohm Pull Up
13 PUE	Pull / Keep Select Field Select one out of next values for pad: LCD_DATA11 0 PUE_0_Keeper — Keeper 1 PUE_1_Pull — Pull
12 PKE	Pull / Keep Enable Field Select one out of next values for pad: LCD_DATA11 0 PKE_0_Pull_Keeper_Disabled — Pull/Keeper Disabled 1 PKE_1_Pull_Keeper_Enabled — Pull/Keeper Enabled
11 ODE	Open Drain Enable Field Select one out of next values for pad: LCD_DATA11

Table continues on the next page...

IOMUXC_SW_PAD_CTL_PAD_LCD_DATA11 field descriptions (continued)

Field	Description
	0 ODE_0_Open_Drain_Disabled — Open Drain Disabled 1 ODE_1_Open_Drain_Enabled — Open Drain Enabled
10–8 -	This field is reserved. Reserved
7–6 SPEED	Speed Field Select one out of next values for pad: LCD_DATA11 00 SPEED_0_low_50MHz_ — low(50MHz) 01 SPEED_1_medium_100MHz_ — medium(100MHz) 10 SPEED_2_medium_100MHz_ — medium(100MHz) 11 SPEED_3_max_200MHz_ — max(200MHz)
5–3 DSE	Drive Strength Field Select one out of next values for pad: LCD_DATA11 000 DSE_0_output_driver_disabled_ — output driver disabled; 001 DSE_1_R0_260_Ohm__3_3V_150_Ohm_1_8V_240_Ohm_for_DDR_ — R0(260 Ohm @ 3.3V, 150 Ohm@1.8V, 240 Ohm for DDR) 010 DSE_2_R0_2 — R0/2 011 DSE_3_R0_3 — R0/3 100 DSE_4_R0_4 — R0/4 101 DSE_5_R0_5 — R0/5 110 DSE_6_R0_6 — R0/6 111 DSE_7_R0_7 — R0/7
2–1 -	This field is reserved. Reserved
0 SRE	Slew Rate Field Select one out of next values for pad: LCD_DATA11 0 SRE_0_Slow_Slew_Rate — Slow Slew Rate 1 SRE_1_Fast_Slew_Rate — Fast Slew Rate

32.6.212 SW_PAD_CTL_PAD_LCD_DATA12 SW PAD Control Register (IOMUXC_SW_PAD_CTL_PAD_LCD_DATA12)

SW_PAD_CTL Register

Address: 20E_0000h base + 3D4h offset = 20E_03D4h

Bit	31	30	29	28	27	26	25	24	23	22	21	20	19	18	17	16
R	Reserved															HYS
W																
Reset	0	0	0	0	0	0	0	0	0	0	0	0	0	0	0	0
Bit	15	14	13	12	11	10	9	8	7	6	5	4	3	2	1	0
R	PUS	PUE	PKE	ODE	Reserved			SPEED	DSE			Reserved		SRE		
W																
Reset	0	0	0	1	0	0	0	0	1	0	1	1	0	0	0	0

IOMUXC_SW_PAD_CTL_PAD_LCD_DATA12 field descriptions

Field	Description
31–17 -	This field is reserved. Reserved
16 HYS	Hyst. Enable Field Select one out of next values for pad: LCD_DATA12 0 HYS_0_Hysteresis_Disabled — Hysteresis Disabled 1 HYS_1_Hysteresis_Enabled — Hysteresis Enabled
15–14 PUS	Pull Up / Down Config. Field Select one out of next values for pad: LCD_DATA12 00 PUS_0_100K_Ohm_Pull_Down — 100K Ohm Pull Down 01 PUS_1_47K_Ohm_Pull_Up — 47K Ohm Pull Up 10 PUS_2_100K_Ohm_Pull_Up — 100K Ohm Pull Up 11 PUS_3_22K_Ohm_Pull_Up — 22K Ohm Pull Up
13 PUE	Pull / Keep Select Field Select one out of next values for pad: LCD_DATA12 0 PUE_0_Keeper — Keeper 1 PUE_1_Pull — Pull
12 PKE	Pull / Keep Enable Field Select one out of next values for pad: LCD_DATA12 0 PKE_0_Pull_Keeper_Disabled — Pull/Keeper Disabled 1 PKE_1_Pull_Keeper_Enabled — Pull/Keeper Enabled
11 ODE	Open Drain Enable Field Select one out of next values for pad: LCD_DATA12

Table continues on the next page...

IOMUXC_SW_PAD_CTL_PAD_LCD_DATA12 field descriptions (continued)

Field	Description
	0 ODE_0_Open_Drain_Disabled — Open Drain Disabled 1 ODE_1_Open_Drain_Enabled — Open Drain Enabled
10–8 -	This field is reserved. Reserved
7–6 SPEED	Speed Field Select one out of next values for pad: LCD_DATA12 00 SPEED_0_low_50MHz_ — low(50MHz) 01 SPEED_1_medium_100MHz_ — medium(100MHz) 10 SPEED_2_medium_100MHz_ — medium(100MHz) 11 SPEED_3_max_200MHz_ — max(200MHz)
5–3 DSE	Drive Strength Field Select one out of next values for pad: LCD_DATA12 000 DSE_0_output_driver_disabled_ — output driver disabled; 001 DSE_1_R0_260_Ohm__3_3V_150_Ohm_1_8V_240_Ohm_for_DDR_ — R0(260 Ohm @ 3.3V, 150 Ohm@1.8V, 240 Ohm for DDR) 010 DSE_2_R0_2 — R0/2 011 DSE_3_R0_3 — R0/3 100 DSE_4_R0_4 — R0/4 101 DSE_5_R0_5 — R0/5 110 DSE_6_R0_6 — R0/6 111 DSE_7_R0_7 — R0/7
2–1 -	This field is reserved. Reserved
0 SRE	Slew Rate Field Select one out of next values for pad: LCD_DATA12 0 SRE_0_Slow_Slew_Rate — Slow Slew Rate 1 SRE_1_Fast_Slew_Rate — Fast Slew Rate

32.6.213 SW_PAD_CTL_PAD_LCD_DATA13 SW PAD Control Register (IOMUXC_SW_PAD_CTL_PAD_LCD_DATA13)

SW_PAD_CTL Register

Address: 20E_0000h base + 3D8h offset = 20E_03D8h

Bit	31	30	29	28	27	26	25	24	23	22	21	20	19	18	17	16
R	Reserved															HYS
W																
Reset	0	0	0	0	0	0	0	0	0	0	0	0	0	0	0	0
Bit	15	14	13	12	11	10	9	8	7	6	5	4	3	2	1	0
R	PUS	PUE	PKE	ODE	Reserved			SPEED	DSE			Reserved		SRE		
W																
Reset	0	0	0	1	0	0	0	0	1	0	1	1	0	0	0	0

IOMUXC_SW_PAD_CTL_PAD_LCD_DATA13 field descriptions

Field	Description
31–17 -	This field is reserved. Reserved
16 HYS	Hyst. Enable Field Select one out of next values for pad: LCD_DATA13 0 HYS_0_Hysteresis_Disabled — Hysteresis Disabled 1 HYS_1_Hysteresis_Enabled — Hysteresis Enabled
15–14 PUS	Pull Up / Down Config. Field Select one out of next values for pad: LCD_DATA13 00 PUS_0_100K_Ohm_Pull_Down — 100K Ohm Pull Down 01 PUS_1_47K_Ohm_Pull_Up — 47K Ohm Pull Up 10 PUS_2_100K_Ohm_Pull_Up — 100K Ohm Pull Up 11 PUS_3_22K_Ohm_Pull_Up — 22K Ohm Pull Up
13 PUE	Pull / Keep Select Field Select one out of next values for pad: LCD_DATA13 0 PUE_0_Keeper — Keeper 1 PUE_1_Pull — Pull
12 PKE	Pull / Keep Enable Field Select one out of next values for pad: LCD_DATA13 0 PKE_0_Pull_Keeper_Disabled — Pull/Keeper Disabled 1 PKE_1_Pull_Keeper_Enabled — Pull/Keeper Enabled
11 ODE	Open Drain Enable Field Select one out of next values for pad: LCD_DATA13

Table continues on the next page...

IOMUXC_SW_PAD_CTL_PAD_LCD_DATA13 field descriptions (continued)

Field	Description
	0 ODE_0_Open_Drain_Disabled — Open Drain Disabled 1 ODE_1_Open_Drain_Enabled — Open Drain Enabled
10–8 -	This field is reserved. Reserved
7–6 SPEED	Speed Field Select one out of next values for pad: LCD_DATA13 00 SPEED_0_low_50MHz_ — low(50MHz) 01 SPEED_1_medium_100MHz_ — medium(100MHz) 10 SPEED_2_medium_100MHz_ — medium(100MHz) 11 SPEED_3_max_200MHz_ — max(200MHz)
5–3 DSE	Drive Strength Field Select one out of next values for pad: LCD_DATA13 000 DSE_0_output_driver_disabled_ — output driver disabled; 001 DSE_1_R0_260_Ohm__3_3V_150_Ohm_1_8V_240_Ohm_for_DDR_ — R0(260 Ohm @ 3.3V, 150 Ohm@1.8V, 240 Ohm for DDR) 010 DSE_2_R0_2 — R0/2 011 DSE_3_R0_3 — R0/3 100 DSE_4_R0_4 — R0/4 101 DSE_5_R0_5 — R0/5 110 DSE_6_R0_6 — R0/6 111 DSE_7_R0_7 — R0/7
2–1 -	This field is reserved. Reserved
0 SRE	Slew Rate Field Select one out of next values for pad: LCD_DATA13 0 SRE_0_Slow_Slew_Rate — Slow Slew Rate 1 SRE_1_Fast_Slew_Rate — Fast Slew Rate

32.6.214 SW_PAD_CTL_PAD_LCD_DATA14 SW PAD Control Register (IOMUXC_SW_PAD_CTL_PAD_LCD_DATA14)

SW_PAD_CTL Register

Address: 20E_0000h base + 3DCCh offset = 20E_03DCCh

Bit	31	30	29	28	27	26	25	24	23	22	21	20	19	18	17	16
R	Reserved															HYS
W																
Reset	0	0	0	0	0	0	0	0	0	0	0	0	0	0	0	0
Bit	15	14	13	12	11	10	9	8	7	6	5	4	3	2	1	0
R	PUS	PUE	PKE	ODE	Reserved			SPEED	DSE			Reserved		SRE		
W																
Reset	0	0	0	1	0	0	0	0	1	0	1	1	0	0	0	0

IOMUXC_SW_PAD_CTL_PAD_LCD_DATA14 field descriptions

Field	Description
31–17 -	This field is reserved. Reserved
16 HYS	Hyst. Enable Field Select one out of next values for pad: LCD_DATA14 0 HYS_0_Hysteresis_Disabled — Hysteresis Disabled 1 HYS_1_Hysteresis_Enabled — Hysteresis Enabled
15–14 PUS	Pull Up / Down Config. Field Select one out of next values for pad: LCD_DATA14 00 PUS_0_100K_Ohm_Pull_Down — 100K Ohm Pull Down 01 PUS_1_47K_Ohm_Pull_Up — 47K Ohm Pull Up 10 PUS_2_100K_Ohm_Pull_Up — 100K Ohm Pull Up 11 PUS_3_22K_Ohm_Pull_Up — 22K Ohm Pull Up
13 PUE	Pull / Keep Select Field Select one out of next values for pad: LCD_DATA14 0 PUE_0_Keeper — Keeper 1 PUE_1_Pull — Pull
12 PKE	Pull / Keep Enable Field Select one out of next values for pad: LCD_DATA14 0 PKE_0_Pull_Keeper_Disabled — Pull/Keeper Disabled 1 PKE_1_Pull_Keeper_Enabled — Pull/Keeper Enabled
11 ODE	Open Drain Enable Field Select one out of next values for pad: LCD_DATA14

Table continues on the next page...

IOMUXC_SW_PAD_CTL_PAD_LCD_DATA14 field descriptions (continued)

Field	Description
	0 ODE_0_Open_Drain_Disabled — Open Drain Disabled 1 ODE_1_Open_Drain_Enabled — Open Drain Enabled
10–8 -	This field is reserved. Reserved
7–6 SPEED	Speed Field Select one out of next values for pad: LCD_DATA14 00 SPEED_0_low_50MHz_ — low(50MHz) 01 SPEED_1_medium_100MHz_ — medium(100MHz) 10 SPEED_2_medium_100MHz_ — medium(100MHz) 11 SPEED_3_max_200MHz_ — max(200MHz)
5–3 DSE	Drive Strength Field Select one out of next values for pad: LCD_DATA14 000 DSE_0_output_driver_disabled_ — output driver disabled; 001 DSE_1_R0_260_Ohm__3_3V_150_Ohm_1_8V_240_Ohm_for_DDR_ — R0(260 Ohm @ 3.3V, 150 Ohm@1.8V, 240 Ohm for DDR) 010 DSE_2_R0_2 — R0/2 011 DSE_3_R0_3 — R0/3 100 DSE_4_R0_4 — R0/4 101 DSE_5_R0_5 — R0/5 110 DSE_6_R0_6 — R0/6 111 DSE_7_R0_7 — R0/7
2–1 -	This field is reserved. Reserved
0 SRE	Slew Rate Field Select one out of next values for pad: LCD_DATA14 0 SRE_0_Slow_Slew_Rate — Slow Slew Rate 1 SRE_1_Fast_Slew_Rate — Fast Slew Rate

32.6.215 SW_PAD_CTL_PAD_LCD_DATA15 SW PAD Control Register (IOMUXC_SW_PAD_CTL_PAD_LCD_DATA15)

SW_PAD_CTL Register

Address: 20E_0000h base + 3E0h offset = 20E_03E0h

Bit	31	30	29	28	27	26	25	24	23	22	21	20	19	18	17	16
R	Reserved															HYS
W																
Reset	0	0	0	0	0	0	0	0	0	0	0	0	0	0	0	0
Bit	15	14	13	12	11	10	9	8	7	6	5	4	3	2	1	0
R	PUS	PUE	PKE	ODE	Reserved			SPEED	DSE			Reserved		SRE		
W																
Reset	0	0	0	1	0	0	0	0	1	0	1	1	0	0	0	0

IOMUXC_SW_PAD_CTL_PAD_LCD_DATA15 field descriptions

Field	Description
31–17 -	This field is reserved. Reserved
16 HYS	Hyst. Enable Field Select one out of next values for pad: LCD_DATA15 0 HYS_0_Hysteresis_Disabled — Hysteresis Disabled 1 HYS_1_Hysteresis_Enabled — Hysteresis Enabled
15–14 PUS	Pull Up / Down Config. Field Select one out of next values for pad: LCD_DATA15 00 PUS_0_100K_Ohm_Pull_Down — 100K Ohm Pull Down 01 PUS_1_47K_Ohm_Pull_Up — 47K Ohm Pull Up 10 PUS_2_100K_Ohm_Pull_Up — 100K Ohm Pull Up 11 PUS_3_22K_Ohm_Pull_Up — 22K Ohm Pull Up
13 PUE	Pull / Keep Select Field Select one out of next values for pad: LCD_DATA15 0 PUE_0_Keeper — Keeper 1 PUE_1_Pull — Pull
12 PKE	Pull / Keep Enable Field Select one out of next values for pad: LCD_DATA15 0 PKE_0_Pull_Keeper_Disabled — Pull/Keeper Disabled 1 PKE_1_Pull_Keeper_Enabled — Pull/Keeper Enabled
11 ODE	Open Drain Enable Field Select one out of next values for pad: LCD_DATA15

Table continues on the next page...

IOMUXC_SW_PAD_CTL_PAD_LCD_DATA15 field descriptions (continued)

Field	Description
	0 ODE_0_Open_Drain_Disabled — Open Drain Disabled 1 ODE_1_Open_Drain_Enabled — Open Drain Enabled
10–8 -	This field is reserved. Reserved
7–6 SPEED	Speed Field Select one out of next values for pad: LCD_DATA15 00 SPEED_0_low_50MHz_ — low(50MHz) 01 SPEED_1_medium_100MHz_ — medium(100MHz) 10 SPEED_2_medium_100MHz_ — medium(100MHz) 11 SPEED_3_max_200MHz_ — max(200MHz)
5–3 DSE	Drive Strength Field Select one out of next values for pad: LCD_DATA15 000 DSE_0_output_driver_disabled_ — output driver disabled; 001 DSE_1_R0_260_Ohm__3_3V_150_Ohm_1_8V_240_Ohm_for_DDR_ — R0(260 Ohm @ 3.3V, 150 Ohm@1.8V, 240 Ohm for DDR) 010 DSE_2_R0_2 — R0/2 011 DSE_3_R0_3 — R0/3 100 DSE_4_R0_4 — R0/4 101 DSE_5_R0_5 — R0/5 110 DSE_6_R0_6 — R0/6 111 DSE_7_R0_7 — R0/7
2–1 -	This field is reserved. Reserved
0 SRE	Slew Rate Field Select one out of next values for pad: LCD_DATA15 0 SRE_0_Slow_Slew_Rate — Slow Slew Rate 1 SRE_1_Fast_Slew_Rate — Fast Slew Rate

32.6.216 SW_PAD_CTL_PAD_LCD_DATA16 SW PAD Control Register (IOMUXC_SW_PAD_CTL_PAD_LCD_DATA16)

SW_PAD_CTL Register

Address: 20E_0000h base + 3E4h offset = 20E_03E4h

Bit	31	30	29	28	27	26	25	24	23	22	21	20	19	18	17	16
R	Reserved															HYS
W																
Reset	0	0	0	0	0	0	0	0	0	0	0	0	0	0	0	0
Bit	15	14	13	12	11	10	9	8	7	6	5	4	3	2	1	0
R	PUS	PUE	PKE	ODE	Reserved			SPEED	DSE			Reserved		SRE		
W																
Reset	0	0	0	1	0	0	0	0	1	0	1	1	0	0	0	0

IOMUXC_SW_PAD_CTL_PAD_LCD_DATA16 field descriptions

Field	Description
31–17 -	This field is reserved. Reserved
16 HYS	Hyst. Enable Field Select one out of next values for pad: LCD_DATA16 0 HYS_0_Hysteresis_Disabled — Hysteresis Disabled 1 HYS_1_Hysteresis_Enabled — Hysteresis Enabled
15–14 PUS	Pull Up / Down Config. Field Select one out of next values for pad: LCD_DATA16 00 PUS_0_100K_Ohm_Pull_Down — 100K Ohm Pull Down 01 PUS_1_47K_Ohm_Pull_Up — 47K Ohm Pull Up 10 PUS_2_100K_Ohm_Pull_Up — 100K Ohm Pull Up 11 PUS_3_22K_Ohm_Pull_Up — 22K Ohm Pull Up
13 PUE	Pull / Keep Select Field Select one out of next values for pad: LCD_DATA16 0 PUE_0_Keeper — Keeper 1 PUE_1_Pull — Pull
12 PKE	Pull / Keep Enable Field Select one out of next values for pad: LCD_DATA16 0 PKE_0_Pull_Keeper_Disabled — Pull/Keeper Disabled 1 PKE_1_Pull_Keeper_Enabled — Pull/Keeper Enabled
11 ODE	Open Drain Enable Field Select one out of next values for pad: LCD_DATA16

Table continues on the next page...

IOMUXC_SW_PAD_CTL_PAD_LCD_DATA16 field descriptions (continued)

Field	Description
	0 ODE_0_Open_Drain_Disabled — Open Drain Disabled 1 ODE_1_Open_Drain_Enabled — Open Drain Enabled
10–8 -	This field is reserved. Reserved
7–6 SPEED	Speed Field Select one out of next values for pad: LCD_DATA16 00 SPEED_0_low_50MHz_ — low(50MHz) 01 SPEED_1_medium_100MHz_ — medium(100MHz) 10 SPEED_2_medium_100MHz_ — medium(100MHz) 11 SPEED_3_max_200MHz_ — max(200MHz)
5–3 DSE	Drive Strength Field Select one out of next values for pad: LCD_DATA16 000 DSE_0_output_driver_disabled_ — output driver disabled; 001 DSE_1_R0_260_Ohm__3_3V_150_Ohm_1_8V_240_Ohm_for_DDR_ — R0(260 Ohm @ 3.3V, 150 Ohm@1.8V, 240 Ohm for DDR) 010 DSE_2_R0_2 — R0/2 011 DSE_3_R0_3 — R0/3 100 DSE_4_R0_4 — R0/4 101 DSE_5_R0_5 — R0/5 110 DSE_6_R0_6 — R0/6 111 DSE_7_R0_7 — R0/7
2–1 -	This field is reserved. Reserved
0 SRE	Slew Rate Field Select one out of next values for pad: LCD_DATA16 0 SRE_0_Slow_Slew_Rate — Slow Slew Rate 1 SRE_1_Fast_Slew_Rate — Fast Slew Rate

32.6.217 SW_PAD_CTL_PAD_LCD_DATA17 SW PAD Control Register (IOMUXC_SW_PAD_CTL_PAD_LCD_DATA17)

SW_PAD_CTL Register

Address: 20E_0000h base + 3E8h offset = 20E_03E8h

Bit	31	30	29	28	27	26	25	24	23	22	21	20	19	18	17	16
R	Reserved															HYS
W																
Reset	0	0	0	0	0	0	0	0	0	0	0	0	0	0	0	0
Bit	15	14	13	12	11	10	9	8	7	6	5	4	3	2	1	0
R	PUS	PUE	PKE	ODE	Reserved			SPEED	DSE			Reserved		SRE		
W																
Reset	0	0	0	1	0	0	0	0	1	0	1	1	0	0	0	0

IOMUXC_SW_PAD_CTL_PAD_LCD_DATA17 field descriptions

Field	Description
31–17 -	This field is reserved. Reserved
16 HYS	Hyst. Enable Field Select one out of next values for pad: LCD_DATA17 0 HYS_0_Hysteresis_Disabled — Hysteresis Disabled 1 HYS_1_Hysteresis_Enabled — Hysteresis Enabled
15–14 PUS	Pull Up / Down Config. Field Select one out of next values for pad: LCD_DATA17 00 PUS_0_100K_Ohm_Pull_Down — 100K Ohm Pull Down 01 PUS_1_47K_Ohm_Pull_Up — 47K Ohm Pull Up 10 PUS_2_100K_Ohm_Pull_Up — 100K Ohm Pull Up 11 PUS_3_22K_Ohm_Pull_Up — 22K Ohm Pull Up
13 PUE	Pull / Keep Select Field Select one out of next values for pad: LCD_DATA17 0 PUE_0_Keeper — Keeper 1 PUE_1_Pull — Pull
12 PKE	Pull / Keep Enable Field Select one out of next values for pad: LCD_DATA17 0 PKE_0_Pull_Keeper_Disabled — Pull/Keeper Disabled 1 PKE_1_Pull_Keeper_Enabled — Pull/Keeper Enabled
11 ODE	Open Drain Enable Field Select one out of next values for pad: LCD_DATA17

Table continues on the next page...

IOMUXC_SW_PAD_CTL_PAD_LCD_DATA17 field descriptions (continued)

Field	Description
	0 ODE_0_Open_Drain_Disabled — Open Drain Disabled 1 ODE_1_Open_Drain_Enabled — Open Drain Enabled
10–8 -	This field is reserved. Reserved
7–6 SPEED	Speed Field Select one out of next values for pad: LCD_DATA17 00 SPEED_0_low_50MHz_ — low(50MHz) 01 SPEED_1_medium_100MHz_ — medium(100MHz) 10 SPEED_2_medium_100MHz_ — medium(100MHz) 11 SPEED_3_max_200MHz_ — max(200MHz)
5–3 DSE	Drive Strength Field Select one out of next values for pad: LCD_DATA17 000 DSE_0_output_driver_disabled_ — output driver disabled; 001 DSE_1_R0_260_Ohm__3_3V_150_Ohm_1_8V_240_Ohm_for_DDR_ — R0(260 Ohm @ 3.3V, 150 Ohm@1.8V, 240 Ohm for DDR) 010 DSE_2_R0_2 — R0/2 011 DSE_3_R0_3 — R0/3 100 DSE_4_R0_4 — R0/4 101 DSE_5_R0_5 — R0/5 110 DSE_6_R0_6 — R0/6 111 DSE_7_R0_7 — R0/7
2–1 -	This field is reserved. Reserved
0 SRE	Slew Rate Field Select one out of next values for pad: LCD_DATA17 0 SRE_0_Slow_Slew_Rate — Slow Slew Rate 1 SRE_1_Fast_Slew_Rate — Fast Slew Rate

32.6.218 SW_PAD_CTL_PAD_LCD_DATA18 SW PAD Control Register (IOMUXC_SW_PAD_CTL_PAD_LCD_DATA18)

SW_PAD_CTL Register

Address: 20E_0000h base + 3ECh offset = 20E_03ECh

Bit	31	30	29	28	27	26	25	24	23	22	21	20	19	18	17	16
R	Reserved															HYS
W																
Reset	0	0	0	0	0	0	0	0	0	0	0	0	0	0	0	0
Bit	15	14	13	12	11	10	9	8	7	6	5	4	3	2	1	0
R	PUS	PUE	PKE	ODE	Reserved			SPEED	DSE			Reserved		SRE		
W																
Reset	0	0	0	1	0	0	0	0	1	0	1	1	0	0	0	0

IOMUXC_SW_PAD_CTL_PAD_LCD_DATA18 field descriptions

Field	Description
31–17 -	This field is reserved. Reserved
16 HYS	Hyst. Enable Field Select one out of next values for pad: LCD_DATA18 0 HYS_0_Hysteresis_Disabled — Hysteresis Disabled 1 HYS_1_Hysteresis_Enabled — Hysteresis Enabled
15–14 PUS	Pull Up / Down Config. Field Select one out of next values for pad: LCD_DATA18 00 PUS_0_100K_Ohm_Pull_Down — 100K Ohm Pull Down 01 PUS_1_47K_Ohm_Pull_Up — 47K Ohm Pull Up 10 PUS_2_100K_Ohm_Pull_Up — 100K Ohm Pull Up 11 PUS_3_22K_Ohm_Pull_Up — 22K Ohm Pull Up
13 PUE	Pull / Keep Select Field Select one out of next values for pad: LCD_DATA18 0 PUE_0_Keeper — Keeper 1 PUE_1_Pull — Pull
12 PKE	Pull / Keep Enable Field Select one out of next values for pad: LCD_DATA18 0 PKE_0_Pull_Keeper_Disabled — Pull/Keeper Disabled 1 PKE_1_Pull_Keeper_Enabled — Pull/Keeper Enabled
11 ODE	Open Drain Enable Field Select one out of next values for pad: LCD_DATA18

Table continues on the next page...

IOMUXC_SW_PAD_CTL_PAD_LCD_DATA18 field descriptions (continued)

Field	Description
	0 ODE_0_Open_Drain_Disabled — Open Drain Disabled 1 ODE_1_Open_Drain_Enabled — Open Drain Enabled
10–8 -	This field is reserved. Reserved
7–6 SPEED	Speed Field Select one out of next values for pad: LCD_DATA18 00 SPEED_0_low_50MHz_ — low(50MHz) 01 SPEED_1_medium_100MHz_ — medium(100MHz) 10 SPEED_2_medium_100MHz_ — medium(100MHz) 11 SPEED_3_max_200MHz_ — max(200MHz)
5–3 DSE	Drive Strength Field Select one out of next values for pad: LCD_DATA18 000 DSE_0_output_driver_disabled_ — output driver disabled; 001 DSE_1_R0_260_Ohm__3_3V_150_Ohm_1_8V_240_Ohm_for_DDR_ — R0(260 Ohm @ 3.3V, 150 Ohm@1.8V, 240 Ohm for DDR) 010 DSE_2_R0_2 — R0/2 011 DSE_3_R0_3 — R0/3 100 DSE_4_R0_4 — R0/4 101 DSE_5_R0_5 — R0/5 110 DSE_6_R0_6 — R0/6 111 DSE_7_R0_7 — R0/7
2–1 -	This field is reserved. Reserved
0 SRE	Slew Rate Field Select one out of next values for pad: LCD_DATA18 0 SRE_0_Slow_Slew_Rate — Slow Slew Rate 1 SRE_1_Fast_Slew_Rate — Fast Slew Rate

32.6.219 SW_PAD_CTL_PAD_LCD_DATA19 SW PAD Control Register (IOMUXC_SW_PAD_CTL_PAD_LCD_DATA19)

SW_PAD_CTL Register

Address: 20E_0000h base + 3F0h offset = 20E_03F0h

Bit	31	30	29	28	27	26	25	24	23	22	21	20	19	18	17	16
R	Reserved															HYS
W																
Reset	0	0	0	0	0	0	0	0	0	0	0	0	0	0	0	0
Bit	15	14	13	12	11	10	9	8	7	6	5	4	3	2	1	0
R	PUS	PUE	PKE	ODE	Reserved			SPEED	DSE			Reserved		SRE		
W																
Reset	0	0	0	1	0	0	0	0	1	0	1	1	0	0	0	0

IOMUXC_SW_PAD_CTL_PAD_LCD_DATA19 field descriptions

Field	Description
31–17 -	This field is reserved. Reserved
16 HYS	Hyst. Enable Field Select one out of next values for pad: LCD_DATA19 0 HYS_0_Hysteresis_Disabled — Hysteresis Disabled 1 HYS_1_Hysteresis_Enabled — Hysteresis Enabled
15–14 PUS	Pull Up / Down Config. Field Select one out of next values for pad: LCD_DATA19 00 PUS_0_100K_Ohm_Pull_Down — 100K Ohm Pull Down 01 PUS_1_47K_Ohm_Pull_Up — 47K Ohm Pull Up 10 PUS_2_100K_Ohm_Pull_Up — 100K Ohm Pull Up 11 PUS_3_22K_Ohm_Pull_Up — 22K Ohm Pull Up
13 PUE	Pull / Keep Select Field Select one out of next values for pad: LCD_DATA19 0 PUE_0_Keeper — Keeper 1 PUE_1_Pull — Pull
12 PKE	Pull / Keep Enable Field Select one out of next values for pad: LCD_DATA19 0 PKE_0_Pull_Keeper_Disabled — Pull/Keeper Disabled 1 PKE_1_Pull_Keeper_Enabled — Pull/Keeper Enabled
11 ODE	Open Drain Enable Field Select one out of next values for pad: LCD_DATA19

Table continues on the next page...

IOMUXC_SW_PAD_CTL_PAD_LCD_DATA19 field descriptions (continued)

Field	Description
	0 ODE_0_Open_Drain_Disabled — Open Drain Disabled 1 ODE_1_Open_Drain_Enabled — Open Drain Enabled
10–8 -	This field is reserved. Reserved
7–6 SPEED	Speed Field Select one out of next values for pad: LCD_DATA19 00 SPEED_0_low_50MHz_ — low(50MHz) 01 SPEED_1_medium_100MHz_ — medium(100MHz) 10 SPEED_2_medium_100MHz_ — medium(100MHz) 11 SPEED_3_max_200MHz_ — max(200MHz)
5–3 DSE	Drive Strength Field Select one out of next values for pad: LCD_DATA19 000 DSE_0_output_driver_disabled_ — output driver disabled; 001 DSE_1_R0_260_Ohm__3_3V_150_Ohm_1_8V_240_Ohm_for_DDR_ — R0(260 Ohm @ 3.3V, 150 Ohm@1.8V, 240 Ohm for DDR) 010 DSE_2_R0_2 — R0/2 011 DSE_3_R0_3 — R0/3 100 DSE_4_R0_4 — R0/4 101 DSE_5_R0_5 — R0/5 110 DSE_6_R0_6 — R0/6 111 DSE_7_R0_7 — R0/7
2–1 -	This field is reserved. Reserved
0 SRE	Slew Rate Field Select one out of next values for pad: LCD_DATA19 0 SRE_0_Slow_Slew_Rate — Slow Slew Rate 1 SRE_1_Fast_Slew_Rate — Fast Slew Rate

32.6.220 SW_PAD_CTL_PAD_LCD_DATA20 SW PAD Control Register (IOMUXC_SW_PAD_CTL_PAD_LCD_DATA20)

SW_PAD_CTL Register

Address: 20E_0000h base + 3F4h offset = 20E_03F4h

Bit	31	30	29	28	27	26	25	24	23	22	21	20	19	18	17	16
R	Reserved															HYS
W																
Reset	0	0	0	0	0	0	0	0	0	0	0	0	0	0	0	0
Bit	15	14	13	12	11	10	9	8	7	6	5	4	3	2	1	0
R	PUS	PUE	PKE	ODE	Reserved			SPEED	DSE			Reserved		SRE		
W																
Reset	0	0	0	1	0	0	0	0	1	0	1	1	0	0	0	0

IOMUXC_SW_PAD_CTL_PAD_LCD_DATA20 field descriptions

Field	Description
31–17 -	This field is reserved. Reserved
16 HYS	Hyst. Enable Field Select one out of next values for pad: LCD_DATA20 0 HYS_0_Hysteresis_Disabled — Hysteresis Disabled 1 HYS_1_Hysteresis_Enabled — Hysteresis Enabled
15–14 PUS	Pull Up / Down Config. Field Select one out of next values for pad: LCD_DATA20 00 PUS_0_100K_Ohm_Pull_Down — 100K Ohm Pull Down 01 PUS_1_47K_Ohm_Pull_Up — 47K Ohm Pull Up 10 PUS_2_100K_Ohm_Pull_Up — 100K Ohm Pull Up 11 PUS_3_22K_Ohm_Pull_Up — 22K Ohm Pull Up
13 PUE	Pull / Keep Select Field Select one out of next values for pad: LCD_DATA20 0 PUE_0_Keeper — Keeper 1 PUE_1_Pull — Pull
12 PKE	Pull / Keep Enable Field Select one out of next values for pad: LCD_DATA20 0 PKE_0_Pull_Keeper_Disabled — Pull/Keeper Disabled 1 PKE_1_Pull_Keeper_Enabled — Pull/Keeper Enabled
11 ODE	Open Drain Enable Field Select one out of next values for pad: LCD_DATA20

Table continues on the next page...

IOMUXC_SW_PAD_CTL_PAD_LCD_DATA20 field descriptions (continued)

Field	Description
	0 ODE_0_Open_Drain_Disabled — Open Drain Disabled 1 ODE_1_Open_Drain_Enabled — Open Drain Enabled
10–8 -	This field is reserved. Reserved
7–6 SPEED	Speed Field Select one out of next values for pad: LCD_DATA20 00 SPEED_0_low_50MHz_ — low(50MHz) 01 SPEED_1_medium_100MHz_ — medium(100MHz) 10 SPEED_2_medium_100MHz_ — medium(100MHz) 11 SPEED_3_max_200MHz_ — max(200MHz)
5–3 DSE	Drive Strength Field Select one out of next values for pad: LCD_DATA20 000 DSE_0_output_driver_disabled_ — output driver disabled; 001 DSE_1_R0_260_Ohm__3_3V_150_Ohm_1_8V_240_Ohm_for_DDR_ — R0(260 Ohm @ 3.3V, 150 Ohm@1.8V, 240 Ohm for DDR) 010 DSE_2_R0_2 — R0/2 011 DSE_3_R0_3 — R0/3 100 DSE_4_R0_4 — R0/4 101 DSE_5_R0_5 — R0/5 110 DSE_6_R0_6 — R0/6 111 DSE_7_R0_7 — R0/7
2–1 -	This field is reserved. Reserved
0 SRE	Slew Rate Field Select one out of next values for pad: LCD_DATA20 0 SRE_0_Slow_Slew_Rate — Slow Slew Rate 1 SRE_1_Fast_Slew_Rate — Fast Slew Rate

32.6.221 SW_PAD_CTL_PAD_LCD_DATA21 SW PAD Control Register (IOMUXC_SW_PAD_CTL_PAD_LCD_DATA21)

SW_PAD_CTL Register

Address: 20E_0000h base + 3F8h offset = 20E_03F8h

Bit	31	30	29	28	27	26	25	24	23	22	21	20	19	18	17	16
R	Reserved															HYS
W																
Reset	0	0	0	0	0	0	0	0	0	0	0	0	0	0	0	0
Bit	15	14	13	12	11	10	9	8	7	6	5	4	3	2	1	0
R	PUS	PUE	PKE	ODE	Reserved			SPEED	DSE			Reserved		SRE		
W																
Reset	0	0	0	1	0	0	0	0	1	0	1	1	0	0	0	0

IOMUXC_SW_PAD_CTL_PAD_LCD_DATA21 field descriptions

Field	Description
31–17 -	This field is reserved. Reserved
16 HYS	Hyst. Enable Field Select one out of next values for pad: LCD_DATA21 0 HYS_0_Hysteresis_Disabled — Hysteresis Disabled 1 HYS_1_Hysteresis_Enabled — Hysteresis Enabled
15–14 PUS	Pull Up / Down Config. Field Select one out of next values for pad: LCD_DATA21 00 PUS_0_100K_Ohm_Pull_Down — 100K Ohm Pull Down 01 PUS_1_47K_Ohm_Pull_Up — 47K Ohm Pull Up 10 PUS_2_100K_Ohm_Pull_Up — 100K Ohm Pull Up 11 PUS_3_22K_Ohm_Pull_Up — 22K Ohm Pull Up
13 PUE	Pull / Keep Select Field Select one out of next values for pad: LCD_DATA21 0 PUE_0_Keeper — Keeper 1 PUE_1_Pull — Pull
12 PKE	Pull / Keep Enable Field Select one out of next values for pad: LCD_DATA21 0 PKE_0_Pull_Keeper_Disabled — Pull/Keeper Disabled 1 PKE_1_Pull_Keeper_Enabled — Pull/Keeper Enabled
11 ODE	Open Drain Enable Field Select one out of next values for pad: LCD_DATA21

Table continues on the next page...

IOMUXC_SW_PAD_CTL_PAD_LCD_DATA21 field descriptions (continued)

Field	Description
	0 ODE_0_Open_Drain_Disabled — Open Drain Disabled 1 ODE_1_Open_Drain_Enabled — Open Drain Enabled
10–8 -	This field is reserved. Reserved
7–6 SPEED	Speed Field Select one out of next values for pad: LCD_DATA21 00 SPEED_0_low_50MHz_ — low(50MHz) 01 SPEED_1_medium_100MHz_ — medium(100MHz) 10 SPEED_2_medium_100MHz_ — medium(100MHz) 11 SPEED_3_max_200MHz_ — max(200MHz)
5–3 DSE	Drive Strength Field Select one out of next values for pad: LCD_DATA21 000 DSE_0_output_driver_disabled_ — output driver disabled; 001 DSE_1_R0_260_Ohm__3_3V_150_Ohm_1_8V_240_Ohm_for_DDR_ — R0(260 Ohm @ 3.3V, 150 Ohm@1.8V, 240 Ohm for DDR) 010 DSE_2_R0_2 — R0/2 011 DSE_3_R0_3 — R0/3 100 DSE_4_R0_4 — R0/4 101 DSE_5_R0_5 — R0/5 110 DSE_6_R0_6 — R0/6 111 DSE_7_R0_7 — R0/7
2–1 -	This field is reserved. Reserved
0 SRE	Slew Rate Field Select one out of next values for pad: LCD_DATA21 0 SRE_0_Slow_Slew_Rate — Slow Slew Rate 1 SRE_1_Fast_Slew_Rate — Fast Slew Rate

32.6.222 SW_PAD_CTL_PAD_LCD_DATA22 SW PAD Control Register (IOMUXC_SW_PAD_CTL_PAD_LCD_DATA22)

SW_PAD_CTL Register

Address: 20E_0000h base + 3FCh offset = 20E_03FCh

Bit	31	30	29	28	27	26	25	24	23	22	21	20	19	18	17	16
R	Reserved															HYS
W																
Reset	0	0	0	0	0	0	0	0	0	0	0	0	0	0	0	0
Bit	15	14	13	12	11	10	9	8	7	6	5	4	3	2	1	0
R	PUS	PUE	PKE	ODE	Reserved			SPEED	DSE			Reserved		SRE		
W																
Reset	0	0	0	1	0	0	0	0	1	0	1	1	0	0	0	0

IOMUXC_SW_PAD_CTL_PAD_LCD_DATA22 field descriptions

Field	Description
31–17 -	This field is reserved. Reserved
16 HYS	Hyst. Enable Field Select one out of next values for pad: LCD_DATA22 0 HYS_0_Hysteresis_Disabled — Hysteresis Disabled 1 HYS_1_Hysteresis_Enabled — Hysteresis Enabled
15–14 PUS	Pull Up / Down Config. Field Select one out of next values for pad: LCD_DATA22 00 PUS_0_100K_Ohm_Pull_Down — 100K Ohm Pull Down 01 PUS_1_47K_Ohm_Pull_Up — 47K Ohm Pull Up 10 PUS_2_100K_Ohm_Pull_Up — 100K Ohm Pull Up 11 PUS_3_22K_Ohm_Pull_Up — 22K Ohm Pull Up
13 PUE	Pull / Keep Select Field Select one out of next values for pad: LCD_DATA22 0 PUE_0_Keeper — Keeper 1 PUE_1_Pull — Pull
12 PKE	Pull / Keep Enable Field Select one out of next values for pad: LCD_DATA22 0 PKE_0_Pull_Keeper_Disabled — Pull/Keeper Disabled 1 PKE_1_Pull_Keeper_Enabled — Pull/Keeper Enabled
11 ODE	Open Drain Enable Field Select one out of next values for pad: LCD_DATA22

Table continues on the next page...

IOMUXC_SW_PAD_CTL_PAD_LCD_DATA22 field descriptions (continued)

Field	Description
	0 ODE_0_Open_Drain_Disabled — Open Drain Disabled 1 ODE_1_Open_Drain_Enabled — Open Drain Enabled
10–8 -	This field is reserved. Reserved
7–6 SPEED	Speed Field Select one out of next values for pad: LCD_DATA22 00 SPEED_0_low_50MHz_ — low(50MHz) 01 SPEED_1_medium_100MHz_ — medium(100MHz) 10 SPEED_2_medium_100MHz_ — medium(100MHz) 11 SPEED_3_max_200MHz_ — max(200MHz)
5–3 DSE	Drive Strength Field Select one out of next values for pad: LCD_DATA22 000 DSE_0_output_driver_disabled_ — output driver disabled; 001 DSE_1_R0_260_Ohm__3_3V_150_Ohm_1_8V_240_Ohm_for_DDR_ — R0(260 Ohm @ 3.3V, 150 Ohm@1.8V, 240 Ohm for DDR) 010 DSE_2_R0_2 — R0/2 011 DSE_3_R0_3 — R0/3 100 DSE_4_R0_4 — R0/4 101 DSE_5_R0_5 — R0/5 110 DSE_6_R0_6 — R0/6 111 DSE_7_R0_7 — R0/7
2–1 -	This field is reserved. Reserved
0 SRE	Slew Rate Field Select one out of next values for pad: LCD_DATA22 0 SRE_0_Slow_Slew_Rate — Slow Slew Rate 1 SRE_1_Fast_Slew_Rate — Fast Slew Rate

32.6.223 SW_PAD_CTL_PAD_LCD_DATA23 SW PAD Control Register (IOMUXC_SW_PAD_CTL_PAD_LCD_DATA23)

SW_PAD_CTL Register

Address: 20E_0000h base + 400h offset = 20E_0400h

Bit	31	30	29	28	27	26	25	24	23	22	21	20	19	18	17	16
R	Reserved															HYS
W																
Reset	0	0	0	0	0	0	0	0	0	0	0	0	0	0	0	0
Bit	15	14	13	12	11	10	9	8	7	6	5	4	3	2	1	0
R	PUS	PUE	PKE	ODE	Reserved			SPEED	DSE			Reserved		SRE		
W																
Reset	0	0	0	1	0	0	0	0	1	0	1	1	0	0	0	0

IOMUXC_SW_PAD_CTL_PAD_LCD_DATA23 field descriptions

Field	Description
31–17 -	This field is reserved. Reserved
16 HYS	Hyst. Enable Field Select one out of next values for pad: LCD_DATA23 0 HYS_0_Hysteresis_Disabled — Hysteresis Disabled 1 HYS_1_Hysteresis_Enabled — Hysteresis Enabled
15–14 PUS	Pull Up / Down Config. Field Select one out of next values for pad: LCD_DATA23 00 PUS_0_100K_Ohm_Pull_Down — 100K Ohm Pull Down 01 PUS_1_47K_Ohm_Pull_Up — 47K Ohm Pull Up 10 PUS_2_100K_Ohm_Pull_Up — 100K Ohm Pull Up 11 PUS_3_22K_Ohm_Pull_Up — 22K Ohm Pull Up
13 PUE	Pull / Keep Select Field Select one out of next values for pad: LCD_DATA23 0 PUE_0_Keeper — Keeper 1 PUE_1_Pull — Pull
12 PKE	Pull / Keep Enable Field Select one out of next values for pad: LCD_DATA23 0 PKE_0_Pull_Keeper_Disabled — Pull/Keeper Disabled 1 PKE_1_Pull_Keeper_Enabled — Pull/Keeper Enabled
11 ODE	Open Drain Enable Field Select one out of next values for pad: LCD_DATA23

Table continues on the next page...

IOMUXC_SW_PAD_CTL_PAD_LCD_DATA23 field descriptions (continued)

Field	Description
	0 ODE_0_Open_Drain_Disabled — Open Drain Disabled 1 ODE_1_Open_Drain_Enabled — Open Drain Enabled
10–8 -	This field is reserved. Reserved
7–6 SPEED	Speed Field Select one out of next values for pad: LCD_DATA23 00 SPEED_0_low_50MHz_ — low(50MHz) 01 SPEED_1_medium_100MHz_ — medium(100MHz) 10 SPEED_2_medium_100MHz_ — medium(100MHz) 11 SPEED_3_max_200MHz_ — max(200MHz)
5–3 DSE	Drive Strength Field Select one out of next values for pad: LCD_DATA23 000 DSE_0_output_driver_disabled_ — output driver disabled; 001 DSE_1_R0_260_Ohm__3_3V_150_Ohm_1_8V_240_Ohm_for_DDR_ — R0(260 Ohm @ 3.3V, 150 Ohm@1.8V, 240 Ohm for DDR) 010 DSE_2_R0_2 — R0/2 011 DSE_3_R0_3 — R0/3 100 DSE_4_R0_4 — R0/4 101 DSE_5_R0_5 — R0/5 110 DSE_6_R0_6 — R0/6 111 DSE_7_R0_7 — R0/7
2–1 -	This field is reserved. Reserved
0 SRE	Slew Rate Field Select one out of next values for pad: LCD_DATA23 0 SRE_0_Slow_Slew_Rate — Slow Slew Rate 1 SRE_1_Fast_Slew_Rate — Fast Slew Rate

32.6.224 SW_PAD_CTL_PAD_NAND_RE_B SW PAD Control Register (IOMUXC_SW_PAD_CTL_PAD_NAND_RE_B)

SW_PAD_CTL Register

Address: 20E_0000h base + 404h offset = 20E_0404h

Bit	31	30	29	28	27	26	25	24	23	22	21	20	19	18	17	16
R	Reserved															HYS
W																
Reset	0	0	0	0	0	0	0	0	0	0	0	0	0	0	0	0
Bit	15	14	13	12	11	10	9	8	7	6	5	4	3	2	1	0
R	PUS	PUE	PKE	ODE	Reserved			SPEED	DSE			Reserved		SRE		
W																
Reset	0	0	0	1	0	0	0	0	1	0	1	1	0	0	0	0

IOMUXC_SW_PAD_CTL_PAD_NAND_RE_B field descriptions

Field	Description
31–17 -	This field is reserved. Reserved
16 HYS	Hyst. Enable Field Select one out of next values for pad: NAND_RE_B 0 HYS_0_Hysteresis_Disabled — Hysteresis Disabled 1 HYS_1_Hysteresis_Enabled — Hysteresis Enabled
15–14 PUS	Pull Up / Down Config. Field Select one out of next values for pad: NAND_RE_B 00 PUS_0_100K_Ohm_Pull_Down — 100K Ohm Pull Down 01 PUS_1_47K_Ohm_Pull_Up — 47K Ohm Pull Up 10 PUS_2_100K_Ohm_Pull_Up — 100K Ohm Pull Up 11 PUS_3_22K_Ohm_Pull_Up — 22K Ohm Pull Up
13 PUE	Pull / Keep Select Field Select one out of next values for pad: NAND_RE_B 0 PUE_0_Keeper — Keeper 1 PUE_1_Pull — Pull
12 PKE	Pull / Keep Enable Field Select one out of next values for pad: NAND_RE_B 0 PKE_0_Pull_Keeper_Disabled — Pull/Keeper Disabled 1 PKE_1_Pull_Keeper_Enabled — Pull/Keeper Enabled
11 ODE	Open Drain Enable Field Select one out of next values for pad: NAND_RE_B

Table continues on the next page...

IOMUXC_SW_PAD_CTL_PAD_NAND_RE_B field descriptions (continued)

Field	Description
	0 ODE_0_Open_Drain_Disabled — Open Drain Disabled 1 ODE_1_Open_Drain_Enabled — Open Drain Enabled
10–8 -	This field is reserved. Reserved
7–6 SPEED	Speed Field Select one out of next values for pad: NAND_RE_B 00 SPEED_0_low_50MHz_ — low(50MHz) 01 SPEED_1_medium_100MHz_ — medium(100MHz) 10 SPEED_2_medium_100MHz_ — medium(100MHz) 11 SPEED_3_max_200MHz_ — max(200MHz)
5–3 DSE	Drive Strength Field Select one out of next values for pad: NAND_RE_B 000 DSE_0_output_driver_disabled_ — output driver disabled; 001 DSE_1_R0_260_Ohm__3_3V_150_Ohm_1_8V_240_Ohm_for_DDR_ — R0(260 Ohm @ 3.3V, 150 Ohm@1.8V, 240 Ohm for DDR) 010 DSE_2_R0_2 — R0/2 011 DSE_3_R0_3 — R0/3 100 DSE_4_R0_4 — R0/4 101 DSE_5_R0_5 — R0/5 110 DSE_6_R0_6 — R0/6 111 DSE_7_R0_7 — R0/7
2–1 -	This field is reserved. Reserved
0 SRE	Slew Rate Field Select one out of next values for pad: NAND_RE_B 0 SRE_0_Slow_Slew_Rate — Slow Slew Rate 1 SRE_1_Fast_Slew_Rate — Fast Slew Rate

32.6.225 SW_PAD_CTL_PAD_NAND_WE_B SW PAD Control Register (IOMUXC_SW_PAD_CTL_PAD_NAND_WE_B)

SW_PAD_CTL Register

Address: 20E_0000h base + 408h offset = 20E_0408h

Bit	31	30	29	28	27	26	25	24	23	22	21	20	19	18	17	16
R	Reserved															HYS
W																
Reset	0	0	0	0	0	0	0	0	0	0	0	0	0	0	0	0
Bit	15	14	13	12	11	10	9	8	7	6	5	4	3	2	1	0
R	PUS	PUE	PKE	ODE	Reserved			SPEED	DSE			Reserved		SRE		
W																
Reset	0	0	0	1	0	0	0	0	1	0	1	1	0	0	0	0

IOMUXC_SW_PAD_CTL_PAD_NAND_WE_B field descriptions

Field	Description
31–17 -	This field is reserved. Reserved
16 HYS	Hyst. Enable Field Select one out of next values for pad: NAND_WE_B 0 HYS_0_Hysteresis_Disabled — Hysteresis Disabled 1 HYS_1_Hysteresis_Enabled — Hysteresis Enabled
15–14 PUS	Pull Up / Down Config. Field Select one out of next values for pad: NAND_WE_B 00 PUS_0_100K_Ohm_Pull_Down — 100K Ohm Pull Down 01 PUS_1_47K_Ohm_Pull_Up — 47K Ohm Pull Up 10 PUS_2_100K_Ohm_Pull_Up — 100K Ohm Pull Up 11 PUS_3_22K_Ohm_Pull_Up — 22K Ohm Pull Up
13 PUE	Pull / Keep Select Field Select one out of next values for pad: NAND_WE_B 0 PUE_0_Keeper — Keeper 1 PUE_1_Pull — Pull
12 PKE	Pull / Keep Enable Field Select one out of next values for pad: NAND_WE_B 0 PKE_0_Pull_Keeper_Disabled — Pull/Keeper Disabled 1 PKE_1_Pull_Keeper_Enabled — Pull/Keeper Enabled
11 ODE	Open Drain Enable Field Select one out of next values for pad: NAND_WE_B

Table continues on the next page...

IOMUXC_SW_PAD_CTL_PAD_NAND_WE_B field descriptions (continued)

Field	Description
	0 ODE_0_Open_Drain_Disabled — Open Drain Disabled 1 ODE_1_Open_Drain_Enabled — Open Drain Enabled
10–8 -	This field is reserved. Reserved
7–6 SPEED	Speed Field Select one out of next values for pad: NAND_WE_B 00 SPEED_0_low_50MHz_ — low(50MHz) 01 SPEED_1_medium_100MHz_ — medium(100MHz) 10 SPEED_2_medium_100MHz_ — medium(100MHz) 11 SPEED_3_max_200MHz_ — max(200MHz)
5–3 DSE	Drive Strength Field Select one out of next values for pad: NAND_WE_B 000 DSE_0_output_driver_disabled_ — output driver disabled; 001 DSE_1_R0_260_Ohm__3_3V_150_Ohm_1_8V_240_Ohm_for_DDR_ — R0(260 Ohm @ 3.3V, 150 Ohm@1.8V, 240 Ohm for DDR) 010 DSE_2_R0_2 — R0/2 011 DSE_3_R0_3 — R0/3 100 DSE_4_R0_4 — R0/4 101 DSE_5_R0_5 — R0/5 110 DSE_6_R0_6 — R0/6 111 DSE_7_R0_7 — R0/7
2–1 -	This field is reserved. Reserved
0 SRE	Slew Rate Field Select one out of next values for pad: NAND_WE_B 0 SRE_0_Slow_Slew_Rate — Slow Slew Rate 1 SRE_1_Fast_Slew_Rate — Fast Slew Rate

32.6.226 SW_PAD_CTL_PAD_NAND_DATA00 SW PAD Control Register (IOMUXC_SW_PAD_CTL_PAD_NAND_DATA00)

SW_PAD_CTL Register

Address: 20E_0000h base + 40Ch offset = 20E_040Ch

Bit	31	30	29	28	27	26	25	24	23	22	21	20	19	18	17	16
R	Reserved															HYS
W																
Reset	0	0	0	0	0	0	0	0	0	0	0	0	0	0	0	0
Bit	15	14	13	12	11	10	9	8	7	6	5	4	3	2	1	0
R	PUS	PUE	PKE	ODE	Reserved			SPEED	DSE			Reserved		SRE		
W																
Reset	0	0	0	1	0	0	0	0	1	0	1	1	0	0	0	0

IOMUXC_SW_PAD_CTL_PAD_NAND_DATA00 field descriptions

Field	Description
31–17 -	This field is reserved. Reserved
16 HYS	Hyst. Enable Field Select one out of next values for pad: NAND_DATA00 0 HYS_0_Hysteresis_Disabled — Hysteresis Disabled 1 HYS_1_Hysteresis_Enabled — Hysteresis Enabled
15–14 PUS	Pull Up / Down Config. Field Select one out of next values for pad: NAND_DATA00 00 PUS_0_100K_Ohm_Pull_Down — 100K Ohm Pull Down 01 PUS_1_47K_Ohm_Pull_Up — 47K Ohm Pull Up 10 PUS_2_100K_Ohm_Pull_Up — 100K Ohm Pull Up 11 PUS_3_22K_Ohm_Pull_Up — 22K Ohm Pull Up
13 PUE	Pull / Keep Select Field Select one out of next values for pad: NAND_DATA00 0 PUE_0_Keeper — Keeper 1 PUE_1_Pull — Pull
12 PKE	Pull / Keep Enable Field Select one out of next values for pad: NAND_DATA00 0 PKE_0_Pull_Keeper_Disabled — Pull/Keeper Disabled 1 PKE_1_Pull_Keeper_Enabled — Pull/Keeper Enabled
11 ODE	Open Drain Enable Field Select one out of next values for pad: NAND_DATA00

Table continues on the next page...

IOMUXC_SW_PAD_CTL_PAD_NAND_DATA00 field descriptions (continued)

Field	Description
	0 ODE_0_Open_Drain_Disabled — Open Drain Disabled 1 ODE_1_Open_Drain_Enabled — Open Drain Enabled
10–8 -	This field is reserved. Reserved
7–6 SPEED	Speed Field Select one out of next values for pad: NAND_DATA00 00 SPEED_0_low_50MHz_ — low(50MHz) 01 SPEED_1_medium_100MHz_ — medium(100MHz) 10 SPEED_2_medium_100MHz_ — medium(100MHz) 11 SPEED_3_max_200MHz_ — max(200MHz)
5–3 DSE	Drive Strength Field Select one out of next values for pad: NAND_DATA00 000 DSE_0_output_driver_disabled_ — output driver disabled; 001 DSE_1_R0_260_Ohm__3_3V_150_Ohm_1_8V_240_Ohm_for_DDR_ — R0(260 Ohm @ 3.3V, 150 Ohm@1.8V, 240 Ohm for DDR) 010 DSE_2_R0_2 — R0/2 011 DSE_3_R0_3 — R0/3 100 DSE_4_R0_4 — R0/4 101 DSE_5_R0_5 — R0/5 110 DSE_6_R0_6 — R0/6 111 DSE_7_R0_7 — R0/7
2–1 -	This field is reserved. Reserved
0 SRE	Slew Rate Field Select one out of next values for pad: NAND_DATA00 0 SRE_0_Slow_Slew_Rate — Slow Slew Rate 1 SRE_1_Fast_Slew_Rate — Fast Slew Rate

32.6.227 SW_PAD_CTL_PAD_NAND_DATA01 SW PAD Control Register (IOMUXC_SW_PAD_CTL_PAD_NAND_DATA01)

SW_PAD_CTL Register

Address: 20E_0000h base + 410h offset = 20E_0410h

Bit	31	30	29	28	27	26	25	24	23	22	21	20	19	18	17	16
R	Reserved															HYS
W																
Reset	0	0	0	0	0	0	0	0	0	0	0	0	0	0	0	0
Bit	15	14	13	12	11	10	9	8	7	6	5	4	3	2	1	0
R	PUS	PUE	PKE	ODE	Reserved			SPEED	DSE			Reserved		SRE		
W																
Reset	0	0	0	1	0	0	0	0	1	0	1	1	0	0	0	0

IOMUXC_SW_PAD_CTL_PAD_NAND_DATA01 field descriptions

Field	Description
31–17 -	This field is reserved. Reserved
16 HYS	Hyst. Enable Field Select one out of next values for pad: NAND_DATA01 0 HYS_0_Hysteresis_Disabled — Hysteresis Disabled 1 HYS_1_Hysteresis_Enabled — Hysteresis Enabled
15–14 PUS	Pull Up / Down Config. Field Select one out of next values for pad: NAND_DATA01 00 PUS_0_100K_Ohm_Pull_Down — 100K Ohm Pull Down 01 PUS_1_47K_Ohm_Pull_Up — 47K Ohm Pull Up 10 PUS_2_100K_Ohm_Pull_Up — 100K Ohm Pull Up 11 PUS_3_22K_Ohm_Pull_Up — 22K Ohm Pull Up
13 PUE	Pull / Keep Select Field Select one out of next values for pad: NAND_DATA01 0 PUE_0_Keeper — Keeper 1 PUE_1_Pull — Pull
12 PKE	Pull / Keep Enable Field Select one out of next values for pad: NAND_DATA01 0 PKE_0_Pull_Keeper_Disabled — Pull/Keeper Disabled 1 PKE_1_Pull_Keeper_Enabled — Pull/Keeper Enabled
11 ODE	Open Drain Enable Field Select one out of next values for pad: NAND_DATA01

Table continues on the next page...

IOMUXC_SW_PAD_CTL_PAD_NAND_DATA01 field descriptions (continued)

Field	Description
	0 ODE_0_Open_Drain_Disabled — Open Drain Disabled 1 ODE_1_Open_Drain_Enabled — Open Drain Enabled
10–8 -	This field is reserved. Reserved
7–6 SPEED	Speed Field Select one out of next values for pad: NAND_DATA01 00 SPEED_0_low_50MHz_ — low(50MHz) 01 SPEED_1_medium_100MHz_ — medium(100MHz) 10 SPEED_2_medium_100MHz_ — medium(100MHz) 11 SPEED_3_max_200MHz_ — max(200MHz)
5–3 DSE	Drive Strength Field Select one out of next values for pad: NAND_DATA01 000 DSE_0_output_driver_disabled_ — output driver disabled; 001 DSE_1_R0_260_Ohm__3_3V_150_Ohm_1_8V_240_Ohm_for_DDR_ — R0(260 Ohm @ 3.3V, 150 Ohm@1.8V, 240 Ohm for DDR) 010 DSE_2_R0_2 — R0/2 011 DSE_3_R0_3 — R0/3 100 DSE_4_R0_4 — R0/4 101 DSE_5_R0_5 — R0/5 110 DSE_6_R0_6 — R0/6 111 DSE_7_R0_7 — R0/7
2–1 -	This field is reserved. Reserved
0 SRE	Slew Rate Field Select one out of next values for pad: NAND_DATA01 0 SRE_0_Slow_Slew_Rate — Slow Slew Rate 1 SRE_1_Fast_Slew_Rate — Fast Slew Rate

32.6.228 SW_PAD_CTL_PAD_NAND_DATA02 SW PAD Control Register (IOMUXC_SW_PAD_CTL_PAD_NAND_DATA02)

SW_PAD_CTL Register

Address: 20E_0000h base + 414h offset = 20E_0414h

Bit	31	30	29	28	27	26	25	24	23	22	21	20	19	18	17	16
R	Reserved															HYS
W																
Reset	0	0	0	0	0	0	0	0	0	0	0	0	0	0	0	0
Bit	15	14	13	12	11	10	9	8	7	6	5	4	3	2	1	0
R	PUS	PUE	PKE	ODE	Reserved			SPEED	DSE			Reserved		SRE		
W																
Reset	0	0	0	1	0	0	0	0	1	0	1	1	0	0	0	0

IOMUXC_SW_PAD_CTL_PAD_NAND_DATA02 field descriptions

Field	Description
31–17 -	This field is reserved. Reserved
16 HYS	Hyst. Enable Field Select one out of next values for pad: NAND_DATA02 0 HYS_0_Hysteresis_Disabled — Hysteresis Disabled 1 HYS_1_Hysteresis_Enabled — Hysteresis Enabled
15–14 PUS	Pull Up / Down Config. Field Select one out of next values for pad: NAND_DATA02 00 PUS_0_100K_Ohm_Pull_Down — 100K Ohm Pull Down 01 PUS_1_47K_Ohm_Pull_Up — 47K Ohm Pull Up 10 PUS_2_100K_Ohm_Pull_Up — 100K Ohm Pull Up 11 PUS_3_22K_Ohm_Pull_Up — 22K Ohm Pull Up
13 PUE	Pull / Keep Select Field Select one out of next values for pad: NAND_DATA02 0 PUE_0_Keeper — Keeper 1 PUE_1_Pull — Pull
12 PKE	Pull / Keep Enable Field Select one out of next values for pad: NAND_DATA02 0 PKE_0_Pull_Keeper_Disabled — Pull/Keeper Disabled 1 PKE_1_Pull_Keeper_Enabled — Pull/Keeper Enabled
11 ODE	Open Drain Enable Field Select one out of next values for pad: NAND_DATA02

Table continues on the next page...

IOMUXC_SW_PAD_CTL_PAD_NAND_DATA02 field descriptions (continued)

Field	Description
	0 ODE_0_Open_Drain_Disabled — Open Drain Disabled 1 ODE_1_Open_Drain_Enabled — Open Drain Enabled
10–8 -	This field is reserved. Reserved
7–6 SPEED	Speed Field Select one out of next values for pad: NAND_DATA02 00 SPEED_0_low_50MHz_ — low(50MHz) 01 SPEED_1_medium_100MHz_ — medium(100MHz) 10 SPEED_2_medium_100MHz_ — medium(100MHz) 11 SPEED_3_max_200MHz_ — max(200MHz)
5–3 DSE	Drive Strength Field Select one out of next values for pad: NAND_DATA02 000 DSE_0_output_driver_disabled_ — output driver disabled; 001 DSE_1_R0_260_Ohm__3_3V_150_Ohm_1_8V_240_Ohm_for_DDR_ — R0(260 Ohm @ 3.3V, 150 Ohm@1.8V, 240 Ohm for DDR) 010 DSE_2_R0_2 — R0/2 011 DSE_3_R0_3 — R0/3 100 DSE_4_R0_4 — R0/4 101 DSE_5_R0_5 — R0/5 110 DSE_6_R0_6 — R0/6 111 DSE_7_R0_7 — R0/7
2–1 -	This field is reserved. Reserved
0 SRE	Slew Rate Field Select one out of next values for pad: NAND_DATA02 0 SRE_0_Slow_Slew_Rate — Slow Slew Rate 1 SRE_1_Fast_Slew_Rate — Fast Slew Rate

32.6.229 SW_PAD_CTL_PAD_NAND_DATA03 SW PAD Control Register (IOMUXC_SW_PAD_CTL_PAD_NAND_DATA03)

SW_PAD_CTL Register

Address: 20E_0000h base + 418h offset = 20E_0418h

Bit	31	30	29	28	27	26	25	24	23	22	21	20	19	18	17	16
R	Reserved															HYS
W																
Reset	0	0	0	0	0	0	0	0	0	0	0	0	0	0	0	0
Bit	15	14	13	12	11	10	9	8	7	6	5	4	3	2	1	0
R	PUS	PUE	PKE	ODE	Reserved			SPEED	DSE			Reserved		SRE		
W																
Reset	0	0	0	1	0	0	0	0	1	0	1	1	0	0	0	0

IOMUXC_SW_PAD_CTL_PAD_NAND_DATA03 field descriptions

Field	Description
31–17 -	This field is reserved. Reserved
16 HYS	Hyst. Enable Field Select one out of next values for pad: NAND_DATA03 0 HYS_0_Hysteresis_Disabled — Hysteresis Disabled 1 HYS_1_Hysteresis_Enabled — Hysteresis Enabled
15–14 PUS	Pull Up / Down Config. Field Select one out of next values for pad: NAND_DATA03 00 PUS_0_100K_Ohm_Pull_Down — 100K Ohm Pull Down 01 PUS_1_47K_Ohm_Pull_Up — 47K Ohm Pull Up 10 PUS_2_100K_Ohm_Pull_Up — 100K Ohm Pull Up 11 PUS_3_22K_Ohm_Pull_Up — 22K Ohm Pull Up
13 PUE	Pull / Keep Select Field Select one out of next values for pad: NAND_DATA03 0 PUE_0_Keeper — Keeper 1 PUE_1_Pull — Pull
12 PKE	Pull / Keep Enable Field Select one out of next values for pad: NAND_DATA03 0 PKE_0_Pull_Keeper_Disabled — Pull/Keeper Disabled 1 PKE_1_Pull_Keeper_Enabled — Pull/Keeper Enabled
11 ODE	Open Drain Enable Field Select one out of next values for pad: NAND_DATA03

Table continues on the next page...

IOMUXC_SW_PAD_CTL_PAD_NAND_DATA03 field descriptions (continued)

Field	Description
	0 ODE_0_Open_Drain_Disabled — Open Drain Disabled 1 ODE_1_Open_Drain_Enabled — Open Drain Enabled
10–8 -	This field is reserved. Reserved
7–6 SPEED	Speed Field Select one out of next values for pad: NAND_DATA03 00 SPEED_0_low_50MHz_ — low(50MHz) 01 SPEED_1_medium_100MHz_ — medium(100MHz) 10 SPEED_2_medium_100MHz_ — medium(100MHz) 11 SPEED_3_max_200MHz_ — max(200MHz)
5–3 DSE	Drive Strength Field Select one out of next values for pad: NAND_DATA03 000 DSE_0_output_driver_disabled_ — output driver disabled; 001 DSE_1_R0_260_Ohm__3_3V_150_Ohm_1_8V_240_Ohm_for_DDR_ — R0(260 Ohm @ 3.3V, 150 Ohm@1.8V, 240 Ohm for DDR) 010 DSE_2_R0_2 — R0/2 011 DSE_3_R0_3 — R0/3 100 DSE_4_R0_4 — R0/4 101 DSE_5_R0_5 — R0/5 110 DSE_6_R0_6 — R0/6 111 DSE_7_R0_7 — R0/7
2–1 -	This field is reserved. Reserved
0 SRE	Slew Rate Field Select one out of next values for pad: NAND_DATA03 0 SRE_0_Slow_Slew_Rate — Slow Slew Rate 1 SRE_1_Fast_Slew_Rate — Fast Slew Rate

32.6.230 SW_PAD_CTL_PAD_NAND_DATA04 SW PAD Control Register (IOMUXC_SW_PAD_CTL_PAD_NAND_DATA04)

SW_PAD_CTL Register

Address: 20E_0000h base + 41Ch offset = 20E_041Ch

Bit	31	30	29	28	27	26	25	24	23	22	21	20	19	18	17	16
R	Reserved															HYS
W																
Reset	0	0	0	0	0	0	0	0	0	0	0	0	0	0	0	0
Bit	15	14	13	12	11	10	9	8	7	6	5	4	3	2	1	0
R	PUS	PUE	PKE	ODE	Reserved			SPEED	DSE			Reserved		SRE		
W																
Reset	0	0	0	1	0	0	0	0	1	0	1	1	0	0	0	0

IOMUXC_SW_PAD_CTL_PAD_NAND_DATA04 field descriptions

Field	Description
31–17 -	This field is reserved. Reserved
16 HYS	Hyst. Enable Field Select one out of next values for pad: NAND_DATA04 0 HYS_0_Hysteresis_Disabled — Hysteresis Disabled 1 HYS_1_Hysteresis_Enabled — Hysteresis Enabled
15–14 PUS	Pull Up / Down Config. Field Select one out of next values for pad: NAND_DATA04 00 PUS_0_100K_Ohm_Pull_Down — 100K Ohm Pull Down 01 PUS_1_47K_Ohm_Pull_Up — 47K Ohm Pull Up 10 PUS_2_100K_Ohm_Pull_Up — 100K Ohm Pull Up 11 PUS_3_22K_Ohm_Pull_Up — 22K Ohm Pull Up
13 PUE	Pull / Keep Select Field Select one out of next values for pad: NAND_DATA04 0 PUE_0_Keeper — Keeper 1 PUE_1_Pull — Pull
12 PKE	Pull / Keep Enable Field Select one out of next values for pad: NAND_DATA04 0 PKE_0_Pull_Keeper_Disabled — Pull/Keeper Disabled 1 PKE_1_Pull_Keeper_Enabled — Pull/Keeper Enabled
11 ODE	Open Drain Enable Field Select one out of next values for pad: NAND_DATA04

Table continues on the next page...

IOMUXC_SW_PAD_CTL_PAD_NAND_DATA04 field descriptions (continued)

Field	Description
	0 ODE_0_Open_Drain_Disabled — Open Drain Disabled 1 ODE_1_Open_Drain_Enabled — Open Drain Enabled
10–8 -	This field is reserved. Reserved
7–6 SPEED	Speed Field Select one out of next values for pad: NAND_DATA04 00 SPEED_0_low_50MHz_ — low(50MHz) 01 SPEED_1_medium_100MHz_ — medium(100MHz) 10 SPEED_2_medium_100MHz_ — medium(100MHz) 11 SPEED_3_max_200MHz_ — max(200MHz)
5–3 DSE	Drive Strength Field Select one out of next values for pad: NAND_DATA04 000 DSE_0_output_driver_disabled_ — output driver disabled; 001 DSE_1_R0_260_Ohm__3_3V_150_Ohm_1_8V_240_Ohm_for_DDR_ — R0(260 Ohm @ 3.3V, 150 Ohm@1.8V, 240 Ohm for DDR) 010 DSE_2_R0_2 — R0/2 011 DSE_3_R0_3 — R0/3 100 DSE_4_R0_4 — R0/4 101 DSE_5_R0_5 — R0/5 110 DSE_6_R0_6 — R0/6 111 DSE_7_R0_7 — R0/7
2–1 -	This field is reserved. Reserved
0 SRE	Slew Rate Field Select one out of next values for pad: NAND_DATA04 0 SRE_0_Slow_Slew_Rate — Slow Slew Rate 1 SRE_1_Fast_Slew_Rate — Fast Slew Rate

32.6.231 SW_PAD_CTL_PAD_NAND_DATA05 SW PAD Control Register (IOMUXC_SW_PAD_CTL_PAD_NAND_DATA05)

SW_PAD_CTL Register

Address: 20E_0000h base + 420h offset = 20E_0420h

Bit	31	30	29	28	27	26	25	24	23	22	21	20	19	18	17	16
R	Reserved															HYS
W																
Reset	0	0	0	0	0	0	0	0	0	0	0	0	0	0	0	0
Bit	15	14	13	12	11	10	9	8	7	6	5	4	3	2	1	0
R	PUS	PUE	PKE	ODE	Reserved			SPEED	DSE			Reserved		SRE		
W																
Reset	0	0	0	1	0	0	0	0	1	0	1	1	0	0	0	0

IOMUXC_SW_PAD_CTL_PAD_NAND_DATA05 field descriptions

Field	Description
31–17 -	This field is reserved. Reserved
16 HYS	Hyst. Enable Field Select one out of next values for pad: NAND_DATA05 0 HYS_0_Hysteresis_Disabled — Hysteresis Disabled 1 HYS_1_Hysteresis_Enabled — Hysteresis Enabled
15–14 PUS	Pull Up / Down Config. Field Select one out of next values for pad: NAND_DATA05 00 PUS_0_100K_Ohm_Pull_Down — 100K Ohm Pull Down 01 PUS_1_47K_Ohm_Pull_Up — 47K Ohm Pull Up 10 PUS_2_100K_Ohm_Pull_Up — 100K Ohm Pull Up 11 PUS_3_22K_Ohm_Pull_Up — 22K Ohm Pull Up
13 PUE	Pull / Keep Select Field Select one out of next values for pad: NAND_DATA05 0 PUE_0_Keeper — Keeper 1 PUE_1_Pull — Pull
12 PKE	Pull / Keep Enable Field Select one out of next values for pad: NAND_DATA05 0 PKE_0_Pull_Keeper_Disabled — Pull/Keeper Disabled 1 PKE_1_Pull_Keeper_Enabled — Pull/Keeper Enabled
11 ODE	Open Drain Enable Field Select one out of next values for pad: NAND_DATA05

Table continues on the next page...

IOMUXC_SW_PAD_CTL_PAD_NAND_DATA05 field descriptions (continued)

Field	Description
	0 ODE_0_Open_Drain_Disabled — Open Drain Disabled 1 ODE_1_Open_Drain_Enabled — Open Drain Enabled
10–8 -	This field is reserved. Reserved
7–6 SPEED	Speed Field Select one out of next values for pad: NAND_DATA05 00 SPEED_0_low_50MHz_ — low(50MHz) 01 SPEED_1_medium_100MHz_ — medium(100MHz) 10 SPEED_2_medium_100MHz_ — medium(100MHz) 11 SPEED_3_max_200MHz_ — max(200MHz)
5–3 DSE	Drive Strength Field Select one out of next values for pad: NAND_DATA05 000 DSE_0_output_driver_disabled_ — output driver disabled; 001 DSE_1_R0_260_Ohm_3_3V_150_Ohm_1_8V_240_Ohm_for_DDR_ — R0(260 Ohm @ 3.3V, 150 Ohm@1.8V, 240 Ohm for DDR) 010 DSE_2_R0_2 — R0/2 011 DSE_3_R0_3 — R0/3 100 DSE_4_R0_4 — R0/4 101 DSE_5_R0_5 — R0/5 110 DSE_6_R0_6 — R0/6 111 DSE_7_R0_7 — R0/7
2–1 -	This field is reserved. Reserved
0 SRE	Slew Rate Field Select one out of next values for pad: NAND_DATA05 0 SRE_0_Slow_Slew_Rate — Slow Slew Rate 1 SRE_1_Fast_Slew_Rate — Fast Slew Rate

32.6.232 SW_PAD_CTL_PAD_NAND_DATA06 SW PAD Control Register (IOMUXC_SW_PAD_CTL_PAD_NAND_DATA06)

SW_PAD_CTL Register

Address: 20E_0000h base + 424h offset = 20E_0424h

Bit	31	30	29	28	27	26	25	24	23	22	21	20	19	18	17	16
R	Reserved															HYS
W																
Reset	0	0	0	0	0	0	0	0	0	0	0	0	0	0	0	0
Bit	15	14	13	12	11	10	9	8	7	6	5	4	3	2	1	0
R	PUS	PUE	PKE	ODE	Reserved			SPEED	DSE			Reserved		SRE		
W																
Reset	0	0	0	1	0	0	0	0	1	0	1	1	0	0	0	0

IOMUXC_SW_PAD_CTL_PAD_NAND_DATA06 field descriptions

Field	Description
31–17 -	This field is reserved. Reserved
16 HYS	Hyst. Enable Field Select one out of next values for pad: NAND_DATA06 0 HYS_0_Hysteresis_Disabled — Hysteresis Disabled 1 HYS_1_Hysteresis_Enabled — Hysteresis Enabled
15–14 PUS	Pull Up / Down Config. Field Select one out of next values for pad: NAND_DATA06 00 PUS_0_100K_Ohm_Pull_Down — 100K Ohm Pull Down 01 PUS_1_47K_Ohm_Pull_Up — 47K Ohm Pull Up 10 PUS_2_100K_Ohm_Pull_Up — 100K Ohm Pull Up 11 PUS_3_22K_Ohm_Pull_Up — 22K Ohm Pull Up
13 PUE	Pull / Keep Select Field Select one out of next values for pad: NAND_DATA06 0 PUE_0_Keeper — Keeper 1 PUE_1_Pull — Pull
12 PKE	Pull / Keep Enable Field Select one out of next values for pad: NAND_DATA06 0 PKE_0_Pull_Keeper_Disabled — Pull/Keeper Disabled 1 PKE_1_Pull_Keeper_Enabled — Pull/Keeper Enabled
11 ODE	Open Drain Enable Field Select one out of next values for pad: NAND_DATA06

Table continues on the next page...

IOMUXC_SW_PAD_CTL_PAD_NAND_DATA06 field descriptions (continued)

Field	Description
	0 ODE_0_Open_Drain_Disabled — Open Drain Disabled 1 ODE_1_Open_Drain_Enabled — Open Drain Enabled
10–8 -	This field is reserved. Reserved
7–6 SPEED	Speed Field Select one out of next values for pad: NAND_DATA06 00 SPEED_0_low_50MHz_ — low(50MHz) 01 SPEED_1_medium_100MHz_ — medium(100MHz) 10 SPEED_2_medium_100MHz_ — medium(100MHz) 11 SPEED_3_max_200MHz_ — max(200MHz)
5–3 DSE	Drive Strength Field Select one out of next values for pad: NAND_DATA06 000 DSE_0_output_driver_disabled_ — output driver disabled; 001 DSE_1_R0_260_Ohm_3_3V_150_Ohm_1_8V_240_Ohm_for_DDR_ — R0(260 Ohm @ 3.3V, 150 Ohm@1.8V, 240 Ohm for DDR) 010 DSE_2_R0_2 — R0/2 011 DSE_3_R0_3 — R0/3 100 DSE_4_R0_4 — R0/4 101 DSE_5_R0_5 — R0/5 110 DSE_6_R0_6 — R0/6 111 DSE_7_R0_7 — R0/7
2–1 -	This field is reserved. Reserved
0 SRE	Slew Rate Field Select one out of next values for pad: NAND_DATA06 0 SRE_0_Slow_Slew_Rate — Slow Slew Rate 1 SRE_1_Fast_Slew_Rate — Fast Slew Rate

32.6.233 SW_PAD_CTL_PAD_NAND_DATA07 SW PAD Control Register (IOMUXC_SW_PAD_CTL_PAD_NAND_DATA07)

SW_PAD_CTL Register

Address: 20E_0000h base + 428h offset = 20E_0428h

Bit	31	30	29	28	27	26	25	24	23	22	21	20	19	18	17	16
R	Reserved															HYS
W																
Reset	0	0	0	0	0	0	0	0	0	0	0	0	0	0	0	0
Bit	15	14	13	12	11	10	9	8	7	6	5	4	3	2	1	0
R	PUS	PUE	PKE	ODE	Reserved			SPEED	DSE			Reserved		SRE		
W																
Reset	0	0	0	1	0	0	0	0	1	0	1	1	0	0	0	0

IOMUXC_SW_PAD_CTL_PAD_NAND_DATA07 field descriptions

Field	Description
31–17 -	This field is reserved. Reserved
16 HYS	Hyst. Enable Field Select one out of next values for pad: NAND_DATA07 0 HYS_0_Hysteresis_Disabled — Hysteresis Disabled 1 HYS_1_Hysteresis_Enabled — Hysteresis Enabled
15–14 PUS	Pull Up / Down Config. Field Select one out of next values for pad: NAND_DATA07 00 PUS_0_100K_Ohm_Pull_Down — 100K Ohm Pull Down 01 PUS_1_47K_Ohm_Pull_Up — 47K Ohm Pull Up 10 PUS_2_100K_Ohm_Pull_Up — 100K Ohm Pull Up 11 PUS_3_22K_Ohm_Pull_Up — 22K Ohm Pull Up
13 PUE	Pull / Keep Select Field Select one out of next values for pad: NAND_DATA07 0 PUE_0_Keeper — Keeper 1 PUE_1_Pull — Pull
12 PKE	Pull / Keep Enable Field Select one out of next values for pad: NAND_DATA07 0 PKE_0_Pull_Keeper_Disabled — Pull/Keeper Disabled 1 PKE_1_Pull_Keeper_Enabled — Pull/Keeper Enabled
11 ODE	Open Drain Enable Field Select one out of next values for pad: NAND_DATA07

Table continues on the next page...

IOMUXC_SW_PAD_CTL_PAD_NAND_DATA07 field descriptions (continued)

Field	Description
	0 ODE_0_Open_Drain_Disabled — Open Drain Disabled 1 ODE_1_Open_Drain_Enabled — Open Drain Enabled
10–8 -	This field is reserved. Reserved
7–6 SPEED	Speed Field Select one out of next values for pad: NAND_DATA07 00 SPEED_0_low_50MHz_ — low(50MHz) 01 SPEED_1_medium_100MHz_ — medium(100MHz) 10 SPEED_2_medium_100MHz_ — medium(100MHz) 11 SPEED_3_max_200MHz_ — max(200MHz)
5–3 DSE	Drive Strength Field Select one out of next values for pad: NAND_DATA07 000 DSE_0_output_driver_disabled_ — output driver disabled; 001 DSE_1_R0_260_Ohm__3_3V_150_Ohm_1_8V_240_Ohm_for_DDR_ — R0(260 Ohm @ 3.3V, 150 Ohm@1.8V, 240 Ohm for DDR) 010 DSE_2_R0_2 — R0/2 011 DSE_3_R0_3 — R0/3 100 DSE_4_R0_4 — R0/4 101 DSE_5_R0_5 — R0/5 110 DSE_6_R0_6 — R0/6 111 DSE_7_R0_7 — R0/7
2–1 -	This field is reserved. Reserved
0 SRE	Slew Rate Field Select one out of next values for pad: NAND_DATA07 0 SRE_0_Slow_Slew_Rate — Slow Slew Rate 1 SRE_1_Fast_Slew_Rate — Fast Slew Rate

32.6.234 SW_PAD_CTL_PAD_NAND_ALE SW PAD Control Register (IOMUXC_SW_PAD_CTL_PAD_NAND_ALE)

SW_PAD_CTL Register

Address: 20E_0000h base + 42Ch offset = 20E_042Ch

Bit	31	30	29	28	27	26	25	24	23	22	21	20	19	18	17	16
R	Reserved															HYS
W																
Reset	0	0	0	0	0	0	0	0	0	0	0	0	0	0	0	0
Bit	15	14	13	12	11	10	9	8	7	6	5	4	3	2	1	0
R	PUS	PUE	PKE	ODE	Reserved			SPEED	DSE			Reserved		SRE		
W																
Reset	0	0	0	1	0	0	0	0	1	0	1	1	0	0	0	0

IOMUXC_SW_PAD_CTL_PAD_NAND_ALE field descriptions

Field	Description
31–17 -	This field is reserved. Reserved
16 HYS	Hyst. Enable Field Select one out of next values for pad: NAND_ALE 0 HYS_0_Hysteresis_Disabled — Hysteresis Disabled 1 HYS_1_Hysteresis_Enabled — Hysteresis Enabled
15–14 PUS	Pull Up / Down Config. Field Select one out of next values for pad: NAND_ALE 00 PUS_0_100K_Ohm_Pull_Down — 100K Ohm Pull Down 01 PUS_1_47K_Ohm_Pull_Up — 47K Ohm Pull Up 10 PUS_2_100K_Ohm_Pull_Up — 100K Ohm Pull Up 11 PUS_3_22K_Ohm_Pull_Up — 22K Ohm Pull Up
13 PUE	Pull / Keep Select Field Select one out of next values for pad: NAND_ALE 0 PUE_0_Keeper — Keeper 1 PUE_1_Pull — Pull
12 PKE	Pull / Keep Enable Field Select one out of next values for pad: NAND_ALE 0 PKE_0_Pull_Keeper_Disabled — Pull/Keeper Disabled 1 PKE_1_Pull_Keeper_Enabled — Pull/Keeper Enabled
11 ODE	Open Drain Enable Field Select one out of next values for pad: NAND_ALE

Table continues on the next page...

IOMUXC_SW_PAD_CTL_PAD_NAND_ALE field descriptions (continued)

Field	Description
	0 ODE_0_Open_Drain_Disabled — Open Drain Disabled 1 ODE_1_Open_Drain_Enabled — Open Drain Enabled
10–8 -	This field is reserved. Reserved
7–6 SPEED	Speed Field Select one out of next values for pad: NAND_ALE 00 SPEED_0_low_50MHz_ — low(50MHz) 01 SPEED_1_medium_100MHz_ — medium(100MHz) 10 SPEED_2_medium_100MHz_ — medium(100MHz) 11 SPEED_3_max_200MHz_ — max(200MHz)
5–3 DSE	Drive Strength Field Select one out of next values for pad: NAND_ALE 000 DSE_0_output_driver_disabled_ — output driver disabled; 001 DSE_1_R0_260_Ohm__3_3V_150_Ohm_1_8V_240_Ohm_for_DDR_ — R0(260 Ohm @ 3.3V, 150 Ohm@1.8V, 240 Ohm for DDR) 010 DSE_2_R0_2 — R0/2 011 DSE_3_R0_3 — R0/3 100 DSE_4_R0_4 — R0/4 101 DSE_5_R0_5 — R0/5 110 DSE_6_R0_6 — R0/6 111 DSE_7_R0_7 — R0/7
2–1 -	This field is reserved. Reserved
0 SRE	Slew Rate Field Select one out of next values for pad: NAND_ALE 0 SRE_0_Slow_Slew_Rate — Slow Slew Rate 1 SRE_1_Fast_Slew_Rate — Fast Slew Rate

32.6.235 SW_PAD_CTL_PAD_NAND_WP_B SW PAD Control Register (IOMUXC_SW_PAD_CTL_PAD_NAND_WP_B)

SW_PAD_CTL Register

Address: 20E_0000h base + 430h offset = 20E_0430h

Bit	31	30	29	28	27	26	25	24	23	22	21	20	19	18	17	16
R	Reserved															HYS
W																
Reset	0	0	0	0	0	0	0	0	0	0	0	0	0	0	0	0
Bit	15	14	13	12	11	10	9	8	7	6	5	4	3	2	1	0
R	PUS	PUE	PKE	ODE	Reserved			SPEED	DSE			Reserved		SRE		
W																
Reset	0	0	0	1	0	0	0	0	1	0	1	1	0	0	0	0

IOMUXC_SW_PAD_CTL_PAD_NAND_WP_B field descriptions

Field	Description
31–17 -	This field is reserved. Reserved
16 HYS	Hyst. Enable Field Select one out of next values for pad: NAND_WP_B 0 HYS_0_Hysteresis_Disabled — Hysteresis Disabled 1 HYS_1_Hysteresis_Enabled — Hysteresis Enabled
15–14 PUS	Pull Up / Down Config. Field Select one out of next values for pad: NAND_WP_B 00 PUS_0_100K_Ohm_Pull_Down — 100K Ohm Pull Down 01 PUS_1_47K_Ohm_Pull_Up — 47K Ohm Pull Up 10 PUS_2_100K_Ohm_Pull_Up — 100K Ohm Pull Up 11 PUS_3_22K_Ohm_Pull_Up — 22K Ohm Pull Up
13 PUE	Pull / Keep Select Field Select one out of next values for pad: NAND_WP_B 0 PUE_0_Keeper — Keeper 1 PUE_1_Pull — Pull
12 PKE	Pull / Keep Enable Field Select one out of next values for pad: NAND_WP_B 0 PKE_0_Pull_Keeper_Disabled — Pull/Keeper Disabled 1 PKE_1_Pull_Keeper_Enabled — Pull/Keeper Enabled
11 ODE	Open Drain Enable Field Select one out of next values for pad: NAND_WP_B

Table continues on the next page...

IOMUXC_SW_PAD_CTL_PAD_NAND_WP_B field descriptions (continued)

Field	Description
	0 ODE_0_Open_Drain_Disabled — Open Drain Disabled 1 ODE_1_Open_Drain_Enabled — Open Drain Enabled
10–8 -	This field is reserved. Reserved
7–6 SPEED	Speed Field Select one out of next values for pad: NAND_WP_B 00 SPEED_0_low_50MHz_ — low(50MHz) 01 SPEED_1_medium_100MHz_ — medium(100MHz) 10 SPEED_2_medium_100MHz_ — medium(100MHz) 11 SPEED_3_max_200MHz_ — max(200MHz)
5–3 DSE	Drive Strength Field Select one out of next values for pad: NAND_WP_B 000 DSE_0_output_driver_disabled_ — output driver disabled; 001 DSE_1_R0_260_Ohm__3_3V_150_Ohm_1_8V_240_Ohm_for_DDR_ — R0(260 Ohm @ 3.3V, 150 Ohm@1.8V, 240 Ohm for DDR) 010 DSE_2_R0_2 — R0/2 011 DSE_3_R0_3 — R0/3 100 DSE_4_R0_4 — R0/4 101 DSE_5_R0_5 — R0/5 110 DSE_6_R0_6 — R0/6 111 DSE_7_R0_7 — R0/7
2–1 -	This field is reserved. Reserved
0 SRE	Slew Rate Field Select one out of next values for pad: NAND_WP_B 0 SRE_0_Slow_Slew_Rate — Slow Slew Rate 1 SRE_1_Fast_Slew_Rate — Fast Slew Rate

32.6.236 SW_PAD_CTL_PAD_NAND_READY_B SW PAD Control Register (IOMUXC_SW_PAD_CTL_PAD_NAND_READY_B)

SW_PAD_CTL Register

Address: 20E_0000h base + 434h offset = 20E_0434h

Bit	31	30	29	28	27	26	25	24	23	22	21	20	19	18	17	16
R	Reserved															HYS
W																
Reset	0	0	0	0	0	0	0	0	0	0	0	0	0	0	0	0
Bit	15	14	13	12	11	10	9	8	7	6	5	4	3	2	1	0
R	PUS	PUE	PKE	ODE	Reserved			SPEED	DSE			Reserved		SRE		
W																
Reset	0	0	0	1	0	0	0	0	1	0	1	1	0	0	0	0

IOMUXC_SW_PAD_CTL_PAD_NAND_READY_B field descriptions

Field	Description
31–17 -	This field is reserved. Reserved
16 HYS	Hyst. Enable Field Select one out of next values for pad: NAND_READY_B 0 HYS_0_Hysteresis_Disabled — Hysteresis Disabled 1 HYS_1_Hysteresis_Enabled — Hysteresis Enabled
15–14 PUS	Pull Up / Down Config. Field Select one out of next values for pad: NAND_READY_B 00 PUS_0_100K_Ohm_Pull_Down — 100K Ohm Pull Down 01 PUS_1_47K_Ohm_Pull_Up — 47K Ohm Pull Up 10 PUS_2_100K_Ohm_Pull_Up — 100K Ohm Pull Up 11 PUS_3_22K_Ohm_Pull_Up — 22K Ohm Pull Up
13 PUE	Pull / Keep Select Field Select one out of next values for pad: NAND_READY_B 0 PUE_0_Keeper — Keeper 1 PUE_1_Pull — Pull
12 PKE	Pull / Keep Enable Field Select one out of next values for pad: NAND_READY_B 0 PKE_0_Pull_Keeper_Disabled — Pull/Keeper Disabled 1 PKE_1_Pull_Keeper_Enabled — Pull/Keeper Enabled
11 ODE	Open Drain Enable Field Select one out of next values for pad: NAND_READY_B

Table continues on the next page...

IOMUXC_SW_PAD_CTL_PAD_NAND_READY_B field descriptions (continued)

Field	Description
	0 ODE_0_Open_Drain_Disabled — Open Drain Disabled 1 ODE_1_Open_Drain_Enabled — Open Drain Enabled
10–8 -	This field is reserved. Reserved
7–6 SPEED	Speed Field Select one out of next values for pad: NAND_READY_B 00 SPEED_0_low_50MHz_ — low(50MHz) 01 SPEED_1_medium_100MHz_ — medium(100MHz) 10 SPEED_2_medium_100MHz_ — medium(100MHz) 11 SPEED_3_max_200MHz_ — max(200MHz)
5–3 DSE	Drive Strength Field Select one out of next values for pad: NAND_READY_B 000 DSE_0_output_driver_disabled_ — output driver disabled; 001 DSE_1_R0_260_Ohm__3_3V_150_Ohm_1_8V_240_Ohm_for_DDR_ — R0(260 Ohm @ 3.3V, 150 Ohm@1.8V, 240 Ohm for DDR) 010 DSE_2_R0_2 — R0/2 011 DSE_3_R0_3 — R0/3 100 DSE_4_R0_4 — R0/4 101 DSE_5_R0_5 — R0/5 110 DSE_6_R0_6 — R0/6 111 DSE_7_R0_7 — R0/7
2–1 -	This field is reserved. Reserved
0 SRE	Slew Rate Field Select one out of next values for pad: NAND_READY_B 0 SRE_0_Slow_Slew_Rate — Slow Slew Rate 1 SRE_1_Fast_Slew_Rate — Fast Slew Rate

32.6.237 SW_PAD_CTL_PAD_NAND_CE0_B SW PAD Control Register (IOMUXC_SW_PAD_CTL_PAD_NAND_CE0_B)

SW_PAD_CTL Register

Address: 20E_0000h base + 438h offset = 20E_0438h

Bit	31	30	29	28	27	26	25	24	23	22	21	20	19	18	17	16
R	Reserved															HYS
W																
Reset	0	0	0	0	0	0	0	0	0	0	0	0	0	0	0	0
Bit	15	14	13	12	11	10	9	8	7	6	5	4	3	2	1	0
R	PUS	PUE	PKE	ODE	Reserved			SPEED	DSE			Reserved		SRE		
W																
Reset	0	0	0	1	0	0	0	0	1	0	1	1	0	0	0	0

IOMUXC_SW_PAD_CTL_PAD_NAND_CE0_B field descriptions

Field	Description
31–17 -	This field is reserved. Reserved
16 HYS	Hyst. Enable Field Select one out of next values for pad: NAND_CE0_B 0 HYS_0_Hysteresis_Disabled — Hysteresis Disabled 1 HYS_1_Hysteresis_Enabled — Hysteresis Enabled
15–14 PUS	Pull Up / Down Config. Field Select one out of next values for pad: NAND_CE0_B 00 PUS_0_100K_Ohm_Pull_Down — 100K Ohm Pull Down 01 PUS_1_47K_Ohm_Pull_Up — 47K Ohm Pull Up 10 PUS_2_100K_Ohm_Pull_Up — 100K Ohm Pull Up 11 PUS_3_22K_Ohm_Pull_Up — 22K Ohm Pull Up
13 PUE	Pull / Keep Select Field Select one out of next values for pad: NAND_CE0_B 0 PUE_0_Keeper — Keeper 1 PUE_1_Pull — Pull
12 PKE	Pull / Keep Enable Field Select one out of next values for pad: NAND_CE0_B 0 PKE_0_Pull_Keeper_Disabled — Pull/Keeper Disabled 1 PKE_1_Pull_Keeper_Enabled — Pull/Keeper Enabled
11 ODE	Open Drain Enable Field Select one out of next values for pad: NAND_CE0_B

Table continues on the next page...

IOMUXC_SW_PAD_CTL_PAD_NAND_CE0_B field descriptions (continued)

Field	Description
	0 ODE_0_Open_Drain_Disabled — Open Drain Disabled 1 ODE_1_Open_Drain_Enabled — Open Drain Enabled
10–8 -	This field is reserved. Reserved
7–6 SPEED	Speed Field Select one out of next values for pad: NAND_CE0_B 00 SPEED_0_low_50MHz_ — low(50MHz) 01 SPEED_1_medium_100MHz_ — medium(100MHz) 10 SPEED_2_medium_100MHz_ — medium(100MHz) 11 SPEED_3_max_200MHz_ — max(200MHz)
5–3 DSE	Drive Strength Field Select one out of next values for pad: NAND_CE0_B 000 DSE_0_output_driver_disabled_ — output driver disabled; 001 DSE_1_R0_260_Ohm__3_3V_150_Ohm_1_8V_240_Ohm_for_DDR_ — R0(260 Ohm @ 3.3V, 150 Ohm@1.8V, 240 Ohm for DDR) 010 DSE_2_R0_2 — R0/2 011 DSE_3_R0_3 — R0/3 100 DSE_4_R0_4 — R0/4 101 DSE_5_R0_5 — R0/5 110 DSE_6_R0_6 — R0/6 111 DSE_7_R0_7 — R0/7
2–1 -	This field is reserved. Reserved
0 SRE	Slew Rate Field Select one out of next values for pad: NAND_CE0_B 0 SRE_0_Slow_Slew_Rate — Slow Slew Rate 1 SRE_1_Fast_Slew_Rate — Fast Slew Rate

32.6.238 SW_PAD_CTL_PAD_NAND_CE1_B SW PAD Control Register (IOMUXC_SW_PAD_CTL_PAD_NAND_CE1_B)

SW_PAD_CTL Register

Address: 20E_0000h base + 43Ch offset = 20E_043Ch

Bit	31	30	29	28	27	26	25	24	23	22	21	20	19	18	17	16
R	Reserved															HYS
W																
Reset	0	0	0	0	0	0	0	0	0	0	0	0	0	0	0	0
Bit	15	14	13	12	11	10	9	8	7	6	5	4	3	2	1	0
R	PUS	PUE	PKE	ODE	Reserved			SPEED	DSE			Reserved		SRE		
W																
Reset	0	0	0	1	0	0	0	0	1	0	1	1	0	0	0	0

IOMUXC_SW_PAD_CTL_PAD_NAND_CE1_B field descriptions

Field	Description
31–17 -	This field is reserved. Reserved
16 HYS	Hyst. Enable Field Select one out of next values for pad: NAND_CE1_B 0 HYS_0_Hysteresis_Disabled — Hysteresis Disabled 1 HYS_1_Hysteresis_Enabled — Hysteresis Enabled
15–14 PUS	Pull Up / Down Config. Field Select one out of next values for pad: NAND_CE1_B 00 PUS_0_100K_Ohm_Pull_Down — 100K Ohm Pull Down 01 PUS_1_47K_Ohm_Pull_Up — 47K Ohm Pull Up 10 PUS_2_100K_Ohm_Pull_Up — 100K Ohm Pull Up 11 PUS_3_22K_Ohm_Pull_Up — 22K Ohm Pull Up
13 PUE	Pull / Keep Select Field Select one out of next values for pad: NAND_CE1_B 0 PUE_0_Keeper — Keeper 1 PUE_1_Pull — Pull
12 PKE	Pull / Keep Enable Field Select one out of next values for pad: NAND_CE1_B 0 PKE_0_Pull_Keeper_Disabled — Pull/Keeper Disabled 1 PKE_1_Pull_Keeper_Enabled — Pull/Keeper Enabled
11 ODE	Open Drain Enable Field Select one out of next values for pad: NAND_CE1_B

Table continues on the next page...

IOMUXC_SW_PAD_CTL_PAD_NAND_CE1_B field descriptions (continued)

Field	Description
	0 ODE_0_Open_Drain_Disabled — Open Drain Disabled 1 ODE_1_Open_Drain_Enabled — Open Drain Enabled
10–8 -	This field is reserved. Reserved
7–6 SPEED	Speed Field Select one out of next values for pad: NAND_CE1_B 00 SPEED_0_low_50MHz_ — low(50MHz) 01 SPEED_1_medium_100MHz_ — medium(100MHz) 10 SPEED_2_medium_100MHz_ — medium(100MHz) 11 SPEED_3_max_200MHz_ — max(200MHz)
5–3 DSE	Drive Strength Field Select one out of next values for pad: NAND_CE1_B 000 DSE_0_output_driver_disabled_ — output driver disabled; 001 DSE_1_R0_260_Ohm__3_3V_150_Ohm_1_8V_240_Ohm_for_DDR_ — R0(260 Ohm @ 3.3V, 150 Ohm@1.8V, 240 Ohm for DDR) 010 DSE_2_R0_2 — R0/2 011 DSE_3_R0_3 — R0/3 100 DSE_4_R0_4 — R0/4 101 DSE_5_R0_5 — R0/5 110 DSE_6_R0_6 — R0/6 111 DSE_7_R0_7 — R0/7
2–1 -	This field is reserved. Reserved
0 SRE	Slew Rate Field Select one out of next values for pad: NAND_CE1_B 0 SRE_0_Slow_Slew_Rate — Slow Slew Rate 1 SRE_1_Fast_Slew_Rate — Fast Slew Rate

32.6.239 SW_PAD_CTL_PAD_NAND_CLE SW PAD Control Register (IOMUXC_SW_PAD_CTL_PAD_NAND_CLE)

SW_PAD_CTL Register

Address: 20E_0000h base + 440h offset = 20E_0440h

Bit	31	30	29	28	27	26	25	24	23	22	21	20	19	18	17	16
R	Reserved															HYS
W																
Reset	0	0	0	0	0	0	0	0	0	0	0	0	0	0	0	0
Bit	15	14	13	12	11	10	9	8	7	6	5	4	3	2	1	0
R	PUS	PUE	PKE	ODE	Reserved			SPEED	DSE			Reserved		SRE		
W																
Reset	0	0	0	1	0	0	0	0	1	0	1	1	0	0	0	0

IOMUXC_SW_PAD_CTL_PAD_NAND_CLE field descriptions

Field	Description
31–17 -	This field is reserved. Reserved
16 HYS	Hyst. Enable Field Select one out of next values for pad: NAND_CLE 0 HYS_0_Hysteresis_Disabled — Hysteresis Disabled 1 HYS_1_Hysteresis_Enabled — Hysteresis Enabled
15–14 PUS	Pull Up / Down Config. Field Select one out of next values for pad: NAND_CLE 00 PUS_0_100K_Ohm_Pull_Down — 100K Ohm Pull Down 01 PUS_1_47K_Ohm_Pull_Up — 47K Ohm Pull Up 10 PUS_2_100K_Ohm_Pull_Up — 100K Ohm Pull Up 11 PUS_3_22K_Ohm_Pull_Up — 22K Ohm Pull Up
13 PUE	Pull / Keep Select Field Select one out of next values for pad: NAND_CLE 0 PUE_0_Keeper — Keeper 1 PUE_1_Pull — Pull
12 PKE	Pull / Keep Enable Field Select one out of next values for pad: NAND_CLE 0 PKE_0_Pull_Keeper_Disabled — Pull/Keeper Disabled 1 PKE_1_Pull_Keeper_Enabled — Pull/Keeper Enabled
11 ODE	Open Drain Enable Field Select one out of next values for pad: NAND_CLE

Table continues on the next page...

IOMUXC_SW_PAD_CTL_PAD_NAND_CLE field descriptions (continued)

Field	Description
	0 ODE_0_Open_Drain_Disabled — Open Drain Disabled 1 ODE_1_Open_Drain_Enabled — Open Drain Enabled
10–8 -	This field is reserved. Reserved
7–6 SPEED	Speed Field Select one out of next values for pad: NAND_CLE 00 SPEED_0_low_50MHz_ — low(50MHz) 01 SPEED_1_medium_100MHz_ — medium(100MHz) 10 SPEED_2_medium_100MHz_ — medium(100MHz) 11 SPEED_3_max_200MHz_ — max(200MHz)
5–3 DSE	Drive Strength Field Select one out of next values for pad: NAND_CLE 000 DSE_0_output_driver_disabled_ — output driver disabled; 001 DSE_1_R0_260_Ohm__3_3V_150_Ohm_1_8V_240_Ohm_for_DDR_ — R0(260 Ohm @ 3.3V, 150 Ohm@1.8V, 240 Ohm for DDR) 010 DSE_2_R0_2 — R0/2 011 DSE_3_R0_3 — R0/3 100 DSE_4_R0_4 — R0/4 101 DSE_5_R0_5 — R0/5 110 DSE_6_R0_6 — R0/6 111 DSE_7_R0_7 — R0/7
2–1 -	This field is reserved. Reserved
0 SRE	Slew Rate Field Select one out of next values for pad: NAND_CLE 0 SRE_0_Slow_Slew_Rate — Slow Slew Rate 1 SRE_1_Fast_Slew_Rate — Fast Slew Rate

32.6.240 SW_PAD_CTL_PAD_NAND_DQS SW PAD Control Register (IOMUXC_SW_PAD_CTL_PAD_NAND_DQS)

SW_PAD_CTL Register

Address: 20E_0000h base + 444h offset = 20E_0444h

Bit	31	30	29	28	27	26	25	24	23	22	21	20	19	18	17	16
R	Reserved															HYS
W																
Reset	0	0	0	0	0	0	0	0	0	0	0	0	0	0	0	0
Bit	15	14	13	12	11	10	9	8	7	6	5	4	3	2	1	0
R	PUS	PUE	PKE	ODE	Reserved			SPEED	DSE			Reserved		SRE		
W																
Reset	0	0	0	1	0	0	0	0	1	0	1	1	0	0	0	0

IOMUXC_SW_PAD_CTL_PAD_NAND_DQS field descriptions

Field	Description
31–17 -	This field is reserved. Reserved
16 HYS	Hyst. Enable Field Select one out of next values for pad: NAND_DQS 0 HYS_0_Hysteresis_Disabled — Hysteresis Disabled 1 HYS_1_Hysteresis_Enabled — Hysteresis Enabled
15–14 PUS	Pull Up / Down Config. Field Select one out of next values for pad: NAND_DQS 00 PUS_0_100K_Ohm_Pull_Down — 100K Ohm Pull Down 01 PUS_1_47K_Ohm_Pull_Up — 47K Ohm Pull Up 10 PUS_2_100K_Ohm_Pull_Up — 100K Ohm Pull Up 11 PUS_3_22K_Ohm_Pull_Up — 22K Ohm Pull Up
13 PUE	Pull / Keep Select Field Select one out of next values for pad: NAND_DQS 0 PUE_0_Keeper — Keeper 1 PUE_1_Pull — Pull
12 PKE	Pull / Keep Enable Field Select one out of next values for pad: NAND_DQS 0 PKE_0_Pull_Keeper_Disabled — Pull/Keeper Disabled 1 PKE_1_Pull_Keeper_Enabled — Pull/Keeper Enabled
11 ODE	Open Drain Enable Field Select one out of next values for pad: NAND_DQS

Table continues on the next page...

IOMUXC_SW_PAD_CTL_PAD_NAND_DQS field descriptions (continued)

Field	Description
	0 ODE_0_Open_Drain_Disabled — Open Drain Disabled 1 ODE_1_Open_Drain_Enabled — Open Drain Enabled
10–8 -	This field is reserved. Reserved
7–6 SPEED	Speed Field Select one out of next values for pad: NAND_DQS 00 SPEED_0_low_50MHz_ — low(50MHz) 01 SPEED_1_medium_100MHz_ — medium(100MHz) 10 SPEED_2_medium_100MHz_ — medium(100MHz) 11 SPEED_3_max_200MHz_ — max(200MHz)
5–3 DSE	Drive Strength Field Select one out of next values for pad: NAND_DQS 000 DSE_0_output_driver_disabled_ — output driver disabled; 001 DSE_1_R0_260_Ohm__3_3V_150_Ohm_1_8V_240_Ohm_for_DDR_ — R0(260 Ohm @ 3.3V, 150 Ohm@1.8V, 240 Ohm for DDR) 010 DSE_2_R0_2 — R0/2 011 DSE_3_R0_3 — R0/3 100 DSE_4_R0_4 — R0/4 101 DSE_5_R0_5 — R0/5 110 DSE_6_R0_6 — R0/6 111 DSE_7_R0_7 — R0/7
2–1 -	This field is reserved. Reserved
0 SRE	Slew Rate Field Select one out of next values for pad: NAND_DQS 0 SRE_0_Slow_Slew_Rate — Slow Slew Rate 1 SRE_1_Fast_Slew_Rate — Fast Slew Rate

32.6.241 SW_PAD_CTL_PAD_SD1_CMD SW PAD Control Register (IOMUXC_SW_PAD_CTL_PAD_SD1_CMD)

SW_PAD_CTL Register

Address: 20E_0000h base + 448h offset = 20E_0448h

Bit	31	30	29	28	27	26	25	24	23	22	21	20	19	18	17	16
R	Reserved															HYS
W																
Reset	0	0	0	0	0	0	0	0	0	0	0	0	0	0	0	0
Bit	15	14	13	12	11	10	9	8	7	6	5	4	3	2	1	0
R	PUS	PUE	PKE	ODE	Reserved			SPEED	DSE			Reserved		SRE		
W																
Reset	0	0	0	1	0	0	0	0	1	0	1	1	0	0	0	0

IOMUXC_SW_PAD_CTL_PAD_SD1_CMD field descriptions

Field	Description
31–17 -	This field is reserved. Reserved
16 HYS	Hyst. Enable Field Select one out of next values for pad: SD1_CMD 0 HYS_0_Hysteresis_Disabled — Hysteresis Disabled 1 HYS_1_Hysteresis_Enabled — Hysteresis Enabled
15–14 PUS	Pull Up / Down Config. Field Select one out of next values for pad: SD1_CMD 00 PUS_0_100K_Ohm_Pull_Down — 100K Ohm Pull Down 01 PUS_1_47K_Ohm_Pull_Up — 47K Ohm Pull Up 10 PUS_2_100K_Ohm_Pull_Up — 100K Ohm Pull Up 11 PUS_3_22K_Ohm_Pull_Up — 22K Ohm Pull Up
13 PUE	Pull / Keep Select Field Select one out of next values for pad: SD1_CMD 0 PUE_0_Keeper — Keeper 1 PUE_1_Pull — Pull
12 PKE	Pull / Keep Enable Field Select one out of next values for pad: SD1_CMD 0 PKE_0_Pull_Keeper_Disabled — Pull/Keeper Disabled 1 PKE_1_Pull_Keeper_Enabled — Pull/Keeper Enabled
11 ODE	Open Drain Enable Field Select one out of next values for pad: SD1_CMD

Table continues on the next page...

IOMUXC_SW_PAD_CTL_PAD_SD1_CMD field descriptions (continued)

Field	Description
	0 ODE_0_Open_Drain_Disabled — Open Drain Disabled 1 ODE_1_Open_Drain_Enabled — Open Drain Enabled
10–8 -	This field is reserved. Reserved
7–6 SPEED	Speed Field Select one out of next values for pad: SD1_CMD 00 SPEED_0_low_50MHz_ — low(50MHz) 01 SPEED_1_medium_100MHz_ — medium(100MHz) 10 SPEED_2_medium_100MHz_ — medium(100MHz) 11 SPEED_3_max_200MHz_ — max(200MHz)
5–3 DSE	Drive Strength Field Select one out of next values for pad: SD1_CMD 000 DSE_0_output_driver_disabled_ — output driver disabled; 001 DSE_1_R0_260_Ohm__3_3V_150_Ohm_1_8V_240_Ohm_for_DDR_ — R0(260 Ohm @ 3.3V, 150 Ohm@1.8V, 240 Ohm for DDR) 010 DSE_2_R0_2 — R0/2 011 DSE_3_R0_3 — R0/3 100 DSE_4_R0_4 — R0/4 101 DSE_5_R0_5 — R0/5 110 DSE_6_R0_6 — R0/6 111 DSE_7_R0_7 — R0/7
2–1 -	This field is reserved. Reserved
0 SRE	Slew Rate Field Select one out of next values for pad: SD1_CMD 0 SRE_0_Slow_Slew_Rate — Slow Slew Rate 1 SRE_1_Fast_Slew_Rate — Fast Slew Rate

32.6.242 SW_PAD_CTL_PAD_SD1_CLK SW PAD Control Register (IOMUXC_SW_PAD_CTL_PAD_SD1_CLK)

SW_PAD_CTL Register

Address: 20E_0000h base + 44Ch offset = 20E_044Ch

Bit	31	30	29	28	27	26	25	24	23	22	21	20	19	18	17	16
R	Reserved															HYS
W	Reserved															
Reset	0	0	0	0	0	0	0	0	0	0	0	0	0	0	0	0
Bit	15	14	13	12	11	10	9	8	7	6	5	4	3	2	1	0
R	PUS	PUE	PKE	ODE	Reserved			SPEED	DSE			Reserved		SRE		
W																
Reset	0	0	0	1	0	0	0	0	1	0	1	1	0	0	0	0

IOMUXC_SW_PAD_CTL_PAD_SD1_CLK field descriptions

Field	Description
31–17 -	This field is reserved. Reserved
16 HYS	Hyst. Enable Field Select one out of next values for pad: SD1_CLK 0 HYS_0_Hysteresis_Disabled — Hysteresis Disabled 1 HYS_1_Hysteresis_Enabled — Hysteresis Enabled
15–14 PUS	Pull Up / Down Config. Field Select one out of next values for pad: SD1_CLK 00 PUS_0_100K_Ohm_Pull_Down — 100K Ohm Pull Down 01 PUS_1_47K_Ohm_Pull_Up — 47K Ohm Pull Up 10 PUS_2_100K_Ohm_Pull_Up — 100K Ohm Pull Up 11 PUS_3_22K_Ohm_Pull_Up — 22K Ohm Pull Up
13 PUE	Pull / Keep Select Field Select one out of next values for pad: SD1_CLK 0 PUE_0_Keeper — Keeper 1 PUE_1_Pull — Pull
12 PKE	Pull / Keep Enable Field Select one out of next values for pad: SD1_CLK 0 PKE_0_Pull_Keeper_Disabled — Pull/Keeper Disabled 1 PKE_1_Pull_Keeper_Enabled — Pull/Keeper Enabled
11 ODE	Open Drain Enable Field Select one out of next values for pad: SD1_CLK

Table continues on the next page...

IOMUXC_SW_PAD_CTL_PAD_SD1_CLK field descriptions (continued)

Field	Description
	0 ODE_0_Open_Drain_Disabled — Open Drain Disabled 1 ODE_1_Open_Drain_Enabled — Open Drain Enabled
10–8 -	This field is reserved. Reserved
7–6 SPEED	Speed Field Select one out of next values for pad: SD1_CLK 00 SPEED_0_low_50MHz_ — low(50MHz) 01 SPEED_1_medium_100MHz_ — medium(100MHz) 10 SPEED_2_medium_100MHz_ — medium(100MHz) 11 SPEED_3_max_200MHz_ — max(200MHz)
5–3 DSE	Drive Strength Field Select one out of next values for pad: SD1_CLK 000 DSE_0_output_driver_disabled_ — output driver disabled; 001 DSE_1_R0_260_Ohm__3_3V_150_Ohm_1_8V_240_Ohm_for_DDR_ — R0(260 Ohm @ 3.3V, 150 Ohm@1.8V, 240 Ohm for DDR) 010 DSE_2_R0_2 — R0/2 011 DSE_3_R0_3 — R0/3 100 DSE_4_R0_4 — R0/4 101 DSE_5_R0_5 — R0/5 110 DSE_6_R0_6 — R0/6 111 DSE_7_R0_7 — R0/7
2–1 -	This field is reserved. Reserved
0 SRE	Slew Rate Field Select one out of next values for pad: SD1_CLK 0 SRE_0_Slow_Slew_Rate — Slow Slew Rate 1 SRE_1_Fast_Slew_Rate — Fast Slew Rate

32.6.243 SW_PAD_CTL_PAD_SD1_DATA0 SW PAD Control Register (IOMUXC_SW_PAD_CTL_PAD_SD1_DATA0)

SW_PAD_CTL Register

Address: 20E_0000h base + 450h offset = 20E_0450h

Bit	31	30	29	28	27	26	25	24	23	22	21	20	19	18	17	16
R	Reserved															HYS
W	Reserved															HYS
Reset	0	0	0	0	0	0	0	0	0	0	0	0	0	0	0	0
Bit	15	14	13	12	11	10	9	8	7	6	5	4	3	2	1	0
R	PUS	PUE	PKE	ODE	Reserved			SPEED	DSE			Reserved		SRE		
W	PUS	PUE	PKE	ODE	Reserved			SPEED	DSE			Reserved		SRE		
Reset	0	0	0	1	0	0	0	0	1	0	1	1	0	0	0	0

IOMUXC_SW_PAD_CTL_PAD_SD1_DATA0 field descriptions

Field	Description
31–17 -	This field is reserved. Reserved
16 HYS	Hyst. Enable Field Select one out of next values for pad: SD1_DATA0 0 HYS_0_Hysteresis_Disabled — Hysteresis Disabled 1 HYS_1_Hysteresis_Enabled — Hysteresis Enabled
15–14 PUS	Pull Up / Down Config. Field Select one out of next values for pad: SD1_DATA0 00 PUS_0_100K_Ohm_Pull_Down — 100K Ohm Pull Down 01 PUS_1_47K_Ohm_Pull_Up — 47K Ohm Pull Up 10 PUS_2_100K_Ohm_Pull_Up — 100K Ohm Pull Up 11 PUS_3_22K_Ohm_Pull_Up — 22K Ohm Pull Up
13 PUE	Pull / Keep Select Field Select one out of next values for pad: SD1_DATA0 0 PUE_0_Keeper — Keeper 1 PUE_1_Pull — Pull
12 PKE	Pull / Keep Enable Field Select one out of next values for pad: SD1_DATA0 0 PKE_0_Pull_Keeper_Disabled — Pull/Keeper Disabled 1 PKE_1_Pull_Keeper_Enabled — Pull/Keeper Enabled
11 ODE	Open Drain Enable Field Select one out of next values for pad: SD1_DATA0

Table continues on the next page...

IOMUXC_SW_PAD_CTL_PAD_SD1_DATA0 field descriptions (continued)

Field	Description
	0 ODE_0_Open_Drain_Disabled — Open Drain Disabled 1 ODE_1_Open_Drain_Enabled — Open Drain Enabled
10–8 -	This field is reserved. Reserved
7–6 SPEED	Speed Field Select one out of next values for pad: SD1_DATA0 00 SPEED_0_low_50MHz_ — low(50MHz) 01 SPEED_1_medium_100MHz_ — medium(100MHz) 10 SPEED_2_medium_100MHz_ — medium(100MHz) 11 SPEED_3_max_200MHz_ — max(200MHz)
5–3 DSE	Drive Strength Field Select one out of next values for pad: SD1_DATA0 000 DSE_0_output_driver_disabled_ — output driver disabled; 001 DSE_1_R0_260_Ohm__3_3V_150_Ohm_1_8V_240_Ohm_for_DDR_ — R0(260 Ohm @ 3.3V, 150 Ohm@1.8V, 240 Ohm for DDR) 010 DSE_2_R0_2 — R0/2 011 DSE_3_R0_3 — R0/3 100 DSE_4_R0_4 — R0/4 101 DSE_5_R0_5 — R0/5 110 DSE_6_R0_6 — R0/6 111 DSE_7_R0_7 — R0/7
2–1 -	This field is reserved. Reserved
0 SRE	Slew Rate Field Select one out of next values for pad: SD1_DATA0 0 SRE_0_Slow_Slew_Rate — Slow Slew Rate 1 SRE_1_Fast_Slew_Rate — Fast Slew Rate

32.6.244 SW_PAD_CTL_PAD_SD1_DATA1 SW PAD Control Register (IOMUXC_SW_PAD_CTL_PAD_SD1_DATA1)

SW_PAD_CTL Register

Address: 20E_0000h base + 454h offset = 20E_0454h

Bit	31	30	29	28	27	26	25	24	23	22	21	20	19	18	17	16
R	Reserved															HYS
W																
Reset	0	0	0	0	0	0	0	0	0	0	0	0	0	0	0	0
Bit	15	14	13	12	11	10	9	8	7	6	5	4	3	2	1	0
R	PUS	PUE	PKE	ODE	Reserved			SPEED	DSE			Reserved		SRE		
W																
Reset	0	0	0	1	0	0	0	0	1	0	1	1	0	0	0	0

IOMUXC_SW_PAD_CTL_PAD_SD1_DATA1 field descriptions

Field	Description
31–17 -	This field is reserved. Reserved
16 HYS	Hyst. Enable Field Select one out of next values for pad: SD1_DATA1 0 HYS_0_Hysteresis_Disabled — Hysteresis Disabled 1 HYS_1_Hysteresis_Enabled — Hysteresis Enabled
15–14 PUS	Pull Up / Down Config. Field Select one out of next values for pad: SD1_DATA1 00 PUS_0_100K_Ohm_Pull_Down — 100K Ohm Pull Down 01 PUS_1_47K_Ohm_Pull_Up — 47K Ohm Pull Up 10 PUS_2_100K_Ohm_Pull_Up — 100K Ohm Pull Up 11 PUS_3_22K_Ohm_Pull_Up — 22K Ohm Pull Up
13 PUE	Pull / Keep Select Field Select one out of next values for pad: SD1_DATA1 0 PUE_0_Keeper — Keeper 1 PUE_1_Pull — Pull
12 PKE	Pull / Keep Enable Field Select one out of next values for pad: SD1_DATA1 0 PKE_0_Pull_Keeper_Disabled — Pull/Keeper Disabled 1 PKE_1_Pull_Keeper_Enabled — Pull/Keeper Enabled
11 ODE	Open Drain Enable Field Select one out of next values for pad: SD1_DATA1

Table continues on the next page...

IOMUXC_SW_PAD_CTL_PAD_SD1_DATA1 field descriptions (continued)

Field	Description
	0 ODE_0_Open_Drain_Disabled — Open Drain Disabled 1 ODE_1_Open_Drain_Enabled — Open Drain Enabled
10–8 -	This field is reserved. Reserved
7–6 SPEED	Speed Field Select one out of next values for pad: SD1_DATA1 00 SPEED_0_low_50MHz_ — low(50MHz) 01 SPEED_1_medium_100MHz_ — medium(100MHz) 10 SPEED_2_medium_100MHz_ — medium(100MHz) 11 SPEED_3_max_200MHz_ — max(200MHz)
5–3 DSE	Drive Strength Field Select one out of next values for pad: SD1_DATA1 000 DSE_0_output_driver_disabled_ — output driver disabled; 001 DSE_1_R0_260_Ohm__3_3V_150_Ohm_1_8V_240_Ohm_for_DDR_ — R0(260 Ohm @ 3.3V, 150 Ohm@1.8V, 240 Ohm for DDR) 010 DSE_2_R0_2 — R0/2 011 DSE_3_R0_3 — R0/3 100 DSE_4_R0_4 — R0/4 101 DSE_5_R0_5 — R0/5 110 DSE_6_R0_6 — R0/6 111 DSE_7_R0_7 — R0/7
2–1 -	This field is reserved. Reserved
0 SRE	Slew Rate Field Select one out of next values for pad: SD1_DATA1 0 SRE_0_Slow_Slew_Rate — Slow Slew Rate 1 SRE_1_Fast_Slew_Rate — Fast Slew Rate

32.6.245 SW_PAD_CTL_PAD_SD1_DATA2 SW PAD Control Register (IOMUXC_SW_PAD_CTL_PAD_SD1_DATA2)

SW_PAD_CTL Register

Address: 20E_0000h base + 458h offset = 20E_0458h

Bit	31	30	29	28	27	26	25	24	23	22	21	20	19	18	17	16
R	Reserved															HYS
W																
Reset	0	0	0	0	0	0	0	0	0	0	0	0	0	0	0	0
Bit	15	14	13	12	11	10	9	8	7	6	5	4	3	2	1	0
R	PUS	PUE	PKE	ODE	Reserved			SPEED	DSE			Reserved		SRE		
W																
Reset	0	0	0	1	0	0	0	0	1	0	1	1	0	0	0	0

IOMUXC_SW_PAD_CTL_PAD_SD1_DATA2 field descriptions

Field	Description
31–17 -	This field is reserved. Reserved
16 HYS	Hyst. Enable Field Select one out of next values for pad: SD1_DATA2 0 HYS_0_Hysteresis_Disabled — Hysteresis Disabled 1 HYS_1_Hysteresis_Enabled — Hysteresis Enabled
15–14 PUS	Pull Up / Down Config. Field Select one out of next values for pad: SD1_DATA2 00 PUS_0_100K_Ohm_Pull_Down — 100K Ohm Pull Down 01 PUS_1_47K_Ohm_Pull_Up — 47K Ohm Pull Up 10 PUS_2_100K_Ohm_Pull_Up — 100K Ohm Pull Up 11 PUS_3_22K_Ohm_Pull_Up — 22K Ohm Pull Up
13 PUE	Pull / Keep Select Field Select one out of next values for pad: SD1_DATA2 0 PUE_0_Keeper — Keeper 1 PUE_1_Pull — Pull
12 PKE	Pull / Keep Enable Field Select one out of next values for pad: SD1_DATA2 0 PKE_0_Pull_Keeper_Disabled — Pull/Keeper Disabled 1 PKE_1_Pull_Keeper_Enabled — Pull/Keeper Enabled
11 ODE	Open Drain Enable Field Select one out of next values for pad: SD1_DATA2

Table continues on the next page...

IOMUXC_SW_PAD_CTL_PAD_SD1_DATA2 field descriptions (continued)

Field	Description
	0 ODE_0_Open_Drain_Disabled — Open Drain Disabled 1 ODE_1_Open_Drain_Enabled — Open Drain Enabled
10–8 -	This field is reserved. Reserved
7–6 SPEED	Speed Field Select one out of next values for pad: SD1_DATA2 00 SPEED_0_low_50MHz_ — low(50MHz) 01 SPEED_1_medium_100MHz_ — medium(100MHz) 10 SPEED_2_medium_100MHz_ — medium(100MHz) 11 SPEED_3_max_200MHz_ — max(200MHz)
5–3 DSE	Drive Strength Field Select one out of next values for pad: SD1_DATA2 000 DSE_0_output_driver_disabled_ — output driver disabled; 001 DSE_1_R0_260_Ohm__3_3V_150_Ohm_1_8V_240_Ohm_for_DDR_ — R0(260 Ohm @ 3.3V, 150 Ohm@1.8V, 240 Ohm for DDR) 010 DSE_2_R0_2 — R0/2 011 DSE_3_R0_3 — R0/3 100 DSE_4_R0_4 — R0/4 101 DSE_5_R0_5 — R0/5 110 DSE_6_R0_6 — R0/6 111 DSE_7_R0_7 — R0/7
2–1 -	This field is reserved. Reserved
0 SRE	Slew Rate Field Select one out of next values for pad: SD1_DATA2 0 SRE_0_Slow_Slew_Rate — Slow Slew Rate 1 SRE_1_Fast_Slew_Rate — Fast Slew Rate

32.6.246 SW_PAD_CTL_PAD_SD1_DATA3 SW PAD Control Register (IOMUXC_SW_PAD_CTL_PAD_SD1_DATA3)

SW_PAD_CTL Register

Address: 20E_0000h base + 45Ch offset = 20E_045Ch

Bit	31	30	29	28	27	26	25	24	23	22	21	20	19	18	17	16
R	Reserved															HYS
W																
Reset	0	0	0	0	0	0	0	0	0	0	0	0	0	0	0	0
Bit	15	14	13	12	11	10	9	8	7	6	5	4	3	2	1	0
R	PUS	PUE	PKE	ODE	Reserved			SPEED	DSE			Reserved		SRE		
W																
Reset	0	0	0	1	0	0	0	0	1	0	1	1	0	0	0	0

IOMUXC_SW_PAD_CTL_PAD_SD1_DATA3 field descriptions

Field	Description
31–17 -	This field is reserved. Reserved
16 HYS	Hyst. Enable Field Select one out of next values for pad: SD1_DATA3 0 HYS_0_Hysteresis_Disabled — Hysteresis Disabled 1 HYS_1_Hysteresis_Enabled — Hysteresis Enabled
15–14 PUS	Pull Up / Down Config. Field Select one out of next values for pad: SD1_DATA3 00 PUS_0_100K_Ohm_Pull_Down — 100K Ohm Pull Down 01 PUS_1_47K_Ohm_Pull_Up — 47K Ohm Pull Up 10 PUS_2_100K_Ohm_Pull_Up — 100K Ohm Pull Up 11 PUS_3_22K_Ohm_Pull_Up — 22K Ohm Pull Up
13 PUE	Pull / Keep Select Field Select one out of next values for pad: SD1_DATA3 0 PUE_0_Keeper — Keeper 1 PUE_1_Pull — Pull
12 PKE	Pull / Keep Enable Field Select one out of next values for pad: SD1_DATA3 0 PKE_0_Pull_Keeper_Disabled — Pull/Keeper Disabled 1 PKE_1_Pull_Keeper_Enabled — Pull/Keeper Enabled
11 ODE	Open Drain Enable Field Select one out of next values for pad: SD1_DATA3

Table continues on the next page...

IOMUXC_SW_PAD_CTL_PAD_SD1_DATA3 field descriptions (continued)

Field	Description
	0 ODE_0_Open_Drain_Disabled — Open Drain Disabled 1 ODE_1_Open_Drain_Enabled — Open Drain Enabled
10–8 -	This field is reserved. Reserved
7–6 SPEED	Speed Field Select one out of next values for pad: SD1_DATA3 00 SPEED_0_low_50MHz_ — low(50MHz) 01 SPEED_1_medium_100MHz_ — medium(100MHz) 10 SPEED_2_medium_100MHz_ — medium(100MHz) 11 SPEED_3_max_200MHz_ — max(200MHz)
5–3 DSE	Drive Strength Field Select one out of next values for pad: SD1_DATA3 000 DSE_0_output_driver_disabled_ — output driver disabled; 001 DSE_1_R0_260_Ohm__3_3V_150_Ohm_1_8V_240_Ohm_for_DDR_ — R0(260 Ohm @ 3.3V, 150 Ohm@1.8V, 240 Ohm for DDR) 010 DSE_2_R0_2 — R0/2 011 DSE_3_R0_3 — R0/3 100 DSE_4_R0_4 — R0/4 101 DSE_5_R0_5 — R0/5 110 DSE_6_R0_6 — R0/6 111 DSE_7_R0_7 — R0/7
2–1 -	This field is reserved. Reserved
0 SRE	Slew Rate Field Select one out of next values for pad: SD1_DATA3 0 SRE_0_Slow_Slew_Rate — Slow Slew Rate 1 SRE_1_Fast_Slew_Rate — Fast Slew Rate

32.6.247 SW_PAD_CTL_PAD_CSI_MCLK SW PAD Control Register (IOMUXC_SW_PAD_CTL_PAD_CSI_MCLK)

SW_PAD_CTL Register

Address: 20E_0000h base + 460h offset = 20E_0460h

Bit	31	30	29	28	27	26	25	24	23	22	21	20	19	18	17	16
R	Reserved															HYS
W	Reserved															
Reset	0	0	0	0	0	0	0	0	0	0	0	0	0	0	0	0
Bit	15	14	13	12	11	10	9	8	7	6	5	4	3	2	1	0
R	PUS	PUE	PKE	ODE	Reserved			SPEED	DSE			Reserved		SRE		
W																
Reset	0	0	0	1	0	0	0	0	1	0	1	1	0	0	0	0

IOMUXC_SW_PAD_CTL_PAD_CSI_MCLK field descriptions

Field	Description
31–17 -	This field is reserved. Reserved
16 HYS	Hyst. Enable Field Select one out of next values for pad: CSI_MCLK 0 HYS_0_Hysteresis_Disabled — Hysteresis Disabled 1 HYS_1_Hysteresis_Enabled — Hysteresis Enabled
15–14 PUS	Pull Up / Down Config. Field Select one out of next values for pad: CSI_MCLK 00 PUS_0_100K_Ohm_Pull_Down — 100K Ohm Pull Down 01 PUS_1_47K_Ohm_Pull_Up — 47K Ohm Pull Up 10 PUS_2_100K_Ohm_Pull_Up — 100K Ohm Pull Up 11 PUS_3_22K_Ohm_Pull_Up — 22K Ohm Pull Up
13 PUE	Pull / Keep Select Field Select one out of next values for pad: CSI_MCLK 0 PUE_0_Keeper — Keeper 1 PUE_1_Pull — Pull
12 PKE	Pull / Keep Enable Field Select one out of next values for pad: CSI_MCLK 0 PKE_0_Pull_Keeper_Disabled — Pull/Keeper Disabled 1 PKE_1_Pull_Keeper_Enabled — Pull/Keeper Enabled
11 ODE	Open Drain Enable Field Select one out of next values for pad: CSI_MCLK

Table continues on the next page...

IOMUXC_SW_PAD_CTL_PAD_CSI_MCLK field descriptions (continued)

Field	Description
	0 ODE_0_Open_Drain_Disabled — Open Drain Disabled 1 ODE_1_Open_Drain_Enabled — Open Drain Enabled
10–8 -	This field is reserved. Reserved
7–6 SPEED	Speed Field Select one out of next values for pad: CSI_MCLK 00 SPEED_0_low_50MHz_ — low(50MHz) 01 SPEED_1_medium_100MHz_ — medium(100MHz) 10 SPEED_2_medium_100MHz_ — medium(100MHz) 11 SPEED_3_max_200MHz_ — max(200MHz)
5–3 DSE	Drive Strength Field Select one out of next values for pad: CSI_MCLK 000 DSE_0_output_driver_disabled_ — output driver disabled; 001 DSE_1_R0_260_Ohm_3_3V_150_Ohm_1_8V_240_Ohm_for_DDR_ — R0(260 Ohm @ 3.3V, 150 Ohm@1.8V, 240 Ohm for DDR) 010 DSE_2_R0_2 — R0/2 011 DSE_3_R0_3 — R0/3 100 DSE_4_R0_4 — R0/4 101 DSE_5_R0_5 — R0/5 110 DSE_6_R0_6 — R0/6 111 DSE_7_R0_7 — R0/7
2–1 -	This field is reserved. Reserved
0 SRE	Slew Rate Field Select one out of next values for pad: CSI_MCLK 0 SRE_0_Slow_Slew_Rate — Slow Slew Rate 1 SRE_1_Fast_Slew_Rate — Fast Slew Rate

32.6.248 SW_PAD_CTL_PAD_CSI_PIXCLK SW PAD Control Register (IOMUXC_SW_PAD_CTL_PAD_CSI_PIXCLK)

SW_PAD_CTL Register

Address: 20E_0000h base + 464h offset = 20E_0464h

Bit	31	30	29	28	27	26	25	24	23	22	21	20	19	18	17	16
R	Reserved															HYS
W																
Reset	0	0	0	0	0	0	0	0	0	0	0	0	0	0	0	0
Bit	15	14	13	12	11	10	9	8	7	6	5	4	3	2	1	0
R	PUS	PUE	PKE	ODE	Reserved			SPEED	DSE			Reserved		SRE		
W																
Reset	0	0	0	1	0	0	0	0	1	0	1	1	0	0	0	0

IOMUXC_SW_PAD_CTL_PAD_CSI_PIXCLK field descriptions

Field	Description
31–17 -	This field is reserved. Reserved
16 HYS	Hyst. Enable Field Select one out of next values for pad: CSI_PIXCLK 0 HYS_0_Hysteresis_Disabled — Hysteresis Disabled 1 HYS_1_Hysteresis_Enabled — Hysteresis Enabled
15–14 PUS	Pull Up / Down Config. Field Select one out of next values for pad: CSI_PIXCLK 00 PUS_0_100K_Ohm_Pull_Down — 100K Ohm Pull Down 01 PUS_1_47K_Ohm_Pull_Up — 47K Ohm Pull Up 10 PUS_2_100K_Ohm_Pull_Up — 100K Ohm Pull Up 11 PUS_3_22K_Ohm_Pull_Up — 22K Ohm Pull Up
13 PUE	Pull / Keep Select Field Select one out of next values for pad: CSI_PIXCLK 0 PUE_0_Keeper — Keeper 1 PUE_1_Pull — Pull
12 PKE	Pull / Keep Enable Field Select one out of next values for pad: CSI_PIXCLK 0 PKE_0_Pull_Keeper_Disabled — Pull/Keeper Disabled 1 PKE_1_Pull_Keeper_Enabled — Pull/Keeper Enabled
11 ODE	Open Drain Enable Field Select one out of next values for pad: CSI_PIXCLK

Table continues on the next page...

IOMUXC_SW_PAD_CTL_PAD_CSI_PIXCLK field descriptions (continued)

Field	Description
	0 ODE_0_Open_Drain_Disabled — Open Drain Disabled 1 ODE_1_Open_Drain_Enabled — Open Drain Enabled
10–8 -	This field is reserved. Reserved
7–6 SPEED	Speed Field Select one out of next values for pad: CSI_PIXCLK 00 SPEED_0_low_50MHz_ — low(50MHz) 01 SPEED_1_medium_100MHz_ — medium(100MHz) 10 SPEED_2_medium_100MHz_ — medium(100MHz) 11 SPEED_3_max_200MHz_ — max(200MHz)
5–3 DSE	Drive Strength Field Select one out of next values for pad: CSI_PIXCLK 000 DSE_0_output_driver_disabled_ — output driver disabled; 001 DSE_1_R0_260_Ohm_3_3V_150_Ohm_1_8V_240_Ohm_for_DDR_ — R0(260 Ohm @ 3.3V, 150 Ohm@1.8V, 240 Ohm for DDR) 010 DSE_2_R0_2 — R0/2 011 DSE_3_R0_3 — R0/3 100 DSE_4_R0_4 — R0/4 101 DSE_5_R0_5 — R0/5 110 DSE_6_R0_6 — R0/6 111 DSE_7_R0_7 — R0/7
2–1 -	This field is reserved. Reserved
0 SRE	Slew Rate Field Select one out of next values for pad: CSI_PIXCLK 0 SRE_0_Slow_Slew_Rate — Slow Slew Rate 1 SRE_1_Fast_Slew_Rate — Fast Slew Rate

32.6.249 SW_PAD_CTL_PAD_CSI_VSYNC SW PAD Control Register (IOMUXC_SW_PAD_CTL_PAD_CSI_VSYNC)

SW_PAD_CTL Register

Address: 20E_0000h base + 468h offset = 20E_0468h

Bit	31	30	29	28	27	26	25	24	23	22	21	20	19	18	17	16
R	Reserved															HYS
W																
Reset	0	0	0	0	0	0	0	0	0	0	0	0	0	0	0	0
Bit	15	14	13	12	11	10	9	8	7	6	5	4	3	2	1	0
R	PUS	PUE	PKE	ODE	Reserved			SPEED	DSE			Reserved		SRE		
W																
Reset	0	0	0	1	0	0	0	0	1	0	1	1	0	0	0	0

IOMUXC_SW_PAD_CTL_PAD_CSI_VSYNC field descriptions

Field	Description
31–17 -	This field is reserved. Reserved
16 HYS	Hyst. Enable Field Select one out of next values for pad: CSI_VSYNC 0 HYS_0_Hysteresis_Disabled — Hysteresis Disabled 1 HYS_1_Hysteresis_Enabled — Hysteresis Enabled
15–14 PUS	Pull Up / Down Config. Field Select one out of next values for pad: CSI_VSYNC 00 PUS_0_100K_Ohm_Pull_Down — 100K Ohm Pull Down 01 PUS_1_47K_Ohm_Pull_Up — 47K Ohm Pull Up 10 PUS_2_100K_Ohm_Pull_Up — 100K Ohm Pull Up 11 PUS_3_22K_Ohm_Pull_Up — 22K Ohm Pull Up
13 PUE	Pull / Keep Select Field Select one out of next values for pad: CSI_VSYNC 0 PUE_0_Keeper — Keeper 1 PUE_1_Pull — Pull
12 PKE	Pull / Keep Enable Field Select one out of next values for pad: CSI_VSYNC 0 PKE_0_Pull_Keeper_Disabled — Pull/Keeper Disabled 1 PKE_1_Pull_Keeper_Enabled — Pull/Keeper Enabled
11 ODE	Open Drain Enable Field Select one out of next values for pad: CSI_VSYNC

Table continues on the next page...

IOMUXC_SW_PAD_CTL_PAD_CSI_VSYNC field descriptions (continued)

Field	Description
	0 ODE_0_Open_Drain_Disabled — Open Drain Disabled 1 ODE_1_Open_Drain_Enabled — Open Drain Enabled
10–8 -	This field is reserved. Reserved
7–6 SPEED	Speed Field Select one out of next values for pad: CSI_VSYNC 00 SPEED_0_low_50MHz_ — low(50MHz) 01 SPEED_1_medium_100MHz_ — medium(100MHz) 10 SPEED_2_medium_100MHz_ — medium(100MHz) 11 SPEED_3_max_200MHz_ — max(200MHz)
5–3 DSE	Drive Strength Field Select one out of next values for pad: CSI_VSYNC 000 DSE_0_output_driver_disabled_ — output driver disabled; 001 DSE_1_R0_260_Ohm__3_3V_150_Ohm_1_8V_240_Ohm_for_DDR_ — R0(260 Ohm @ 3.3V, 150 Ohm@1.8V, 240 Ohm for DDR) 010 DSE_2_R0_2 — R0/2 011 DSE_3_R0_3 — R0/3 100 DSE_4_R0_4 — R0/4 101 DSE_5_R0_5 — R0/5 110 DSE_6_R0_6 — R0/6 111 DSE_7_R0_7 — R0/7
2–1 -	This field is reserved. Reserved
0 SRE	Slew Rate Field Select one out of next values for pad: CSI_VSYNC 0 SRE_0_Slow_Slew_Rate — Slow Slew Rate 1 SRE_1_Fast_Slew_Rate — Fast Slew Rate

32.6.250 SW_PAD_CTL_PAD_CSI_HSYNC SW PAD Control Register (IOMUXC_SW_PAD_CTL_PAD_CSI_HSYNC)

SW_PAD_CTL Register

Address: 20E_0000h base + 46Ch offset = 20E_046Ch

Bit	31	30	29	28	27	26	25	24	23	22	21	20	19	18	17	16
R	Reserved															HYS
W																
Reset	0	0	0	0	0	0	0	0	0	0	0	0	0	0	0	0
Bit	15	14	13	12	11	10	9	8	7	6	5	4	3	2	1	0
R	PUS	PUE	PKE	ODE	Reserved			SPEED	DSE			Reserved		SRE		
W																
Reset	0	0	0	1	0	0	0	0	1	0	1	1	0	0	0	0

IOMUXC_SW_PAD_CTL_PAD_CSI_HSYNC field descriptions

Field	Description
31–17 -	This field is reserved. Reserved
16 HYS	Hyst. Enable Field Select one out of next values for pad: CSI_HSYNC 0 HYS_0_Hysteresis_Disabled — Hysteresis Disabled 1 HYS_1_Hysteresis_Enabled — Hysteresis Enabled
15–14 PUS	Pull Up / Down Config. Field Select one out of next values for pad: CSI_HSYNC 00 PUS_0_100K_Ohm_Pull_Down — 100K Ohm Pull Down 01 PUS_1_47K_Ohm_Pull_Up — 47K Ohm Pull Up 10 PUS_2_100K_Ohm_Pull_Up — 100K Ohm Pull Up 11 PUS_3_22K_Ohm_Pull_Up — 22K Ohm Pull Up
13 PUE	Pull / Keep Select Field Select one out of next values for pad: CSI_HSYNC 0 PUE_0_Keeper — Keeper 1 PUE_1_Pull — Pull
12 PKE	Pull / Keep Enable Field Select one out of next values for pad: CSI_HSYNC 0 PKE_0_Pull_Keeper_Disabled — Pull/Keeper Disabled 1 PKE_1_Pull_Keeper_Enabled — Pull/Keeper Enabled
11 ODE	Open Drain Enable Field Select one out of next values for pad: CSI_HSYNC

Table continues on the next page...

IOMUXC_SW_PAD_CTL_PAD_CSI_HSYNC field descriptions (continued)

Field	Description
	0 ODE_0_Open_Drain_Disabled — Open Drain Disabled 1 ODE_1_Open_Drain_Enabled — Open Drain Enabled
10–8 -	This field is reserved. Reserved
7–6 SPEED	Speed Field Select one out of next values for pad: CSI_HSYNC 00 SPEED_0_low_50MHz_ — low(50MHz) 01 SPEED_1_medium_100MHz_ — medium(100MHz) 10 SPEED_2_medium_100MHz_ — medium(100MHz) 11 SPEED_3_max_200MHz_ — max(200MHz)
5–3 DSE	Drive Strength Field Select one out of next values for pad: CSI_HSYNC 000 DSE_0_output_driver_disabled_ — output driver disabled; 001 DSE_1_R0_260_Ohm_3_3V_150_Ohm_1_8V_240_Ohm_for_DDR_ — R0(260 Ohm @ 3.3V, 150 Ohm@1.8V, 240 Ohm for DDR) 010 DSE_2_R0_2 — R0/2 011 DSE_3_R0_3 — R0/3 100 DSE_4_R0_4 — R0/4 101 DSE_5_R0_5 — R0/5 110 DSE_6_R0_6 — R0/6 111 DSE_7_R0_7 — R0/7
2–1 -	This field is reserved. Reserved
0 SRE	Slew Rate Field Select one out of next values for pad: CSI_HSYNC 0 SRE_0_Slow_Slew_Rate — Slow Slew Rate 1 SRE_1_Fast_Slew_Rate — Fast Slew Rate

32.6.251 SW_PAD_CTL_PAD_CSI_DATA00 SW PAD Control Register (IOMUXC_SW_PAD_CTL_PAD_CSI_DATA00)

SW_PAD_CTL Register

Address: 20E_0000h base + 470h offset = 20E_0470h

Bit	31	30	29	28	27	26	25	24	23	22	21	20	19	18	17	16
R	Reserved															HYS
W																
Reset	0	0	0	0	0	0	0	0	0	0	0	0	0	0	0	0
Bit	15	14	13	12	11	10	9	8	7	6	5	4	3	2	1	0
R	PUS	PUE	PKE	ODE	Reserved			SPEED	DSE			Reserved		SRE		
W																
Reset	0	0	0	1	0	0	0	0	1	0	1	1	0	0	0	0

IOMUXC_SW_PAD_CTL_PAD_CSI_DATA00 field descriptions

Field	Description
31–17 -	This field is reserved. Reserved
16 HYS	Hyst. Enable Field Select one out of next values for pad: CSI_DATA00 0 HYS_0_Hysteresis_Disabled — Hysteresis Disabled 1 HYS_1_Hysteresis_Enabled — Hysteresis Enabled
15–14 PUS	Pull Up / Down Config. Field Select one out of next values for pad: CSI_DATA00 00 PUS_0_100K_Ohm_Pull_Down — 100K Ohm Pull Down 01 PUS_1_47K_Ohm_Pull_Up — 47K Ohm Pull Up 10 PUS_2_100K_Ohm_Pull_Up — 100K Ohm Pull Up 11 PUS_3_22K_Ohm_Pull_Up — 22K Ohm Pull Up
13 PUE	Pull / Keep Select Field Select one out of next values for pad: CSI_DATA00 0 PUE_0_Keeper — Keeper 1 PUE_1_Pull — Pull
12 PKE	Pull / Keep Enable Field Select one out of next values for pad: CSI_DATA00 0 PKE_0_Pull_Keeper_Disabled — Pull/Keeper Disabled 1 PKE_1_Pull_Keeper_Enabled — Pull/Keeper Enabled
11 ODE	Open Drain Enable Field Select one out of next values for pad: CSI_DATA00

Table continues on the next page...

IOMUXC_SW_PAD_CTL_PAD_CSI_DATA00 field descriptions (continued)

Field	Description
	0 ODE_0_Open_Drain_Disabled — Open Drain Disabled 1 ODE_1_Open_Drain_Enabled — Open Drain Enabled
10–8 -	This field is reserved. Reserved
7–6 SPEED	Speed Field Select one out of next values for pad: CSI_DATA00 00 SPEED_0_low_50MHz_ — low(50MHz) 01 SPEED_1_medium_100MHz_ — medium(100MHz) 10 SPEED_2_medium_100MHz_ — medium(100MHz) 11 SPEED_3_max_200MHz_ — max(200MHz)
5–3 DSE	Drive Strength Field Select one out of next values for pad: CSI_DATA00 000 DSE_0_output_driver_disabled_ — output driver disabled; 001 DSE_1_R0_260_Ohm__3_3V_150_Ohm_1_8V_240_Ohm_for_DDR_ — R0(260 Ohm @ 3.3V, 150 Ohm@1.8V, 240 Ohm for DDR) 010 DSE_2_R0_2 — R0/2 011 DSE_3_R0_3 — R0/3 100 DSE_4_R0_4 — R0/4 101 DSE_5_R0_5 — R0/5 110 DSE_6_R0_6 — R0/6 111 DSE_7_R0_7 — R0/7
2–1 -	This field is reserved. Reserved
0 SRE	Slew Rate Field Select one out of next values for pad: CSI_DATA00 0 SRE_0_Slow_Slew_Rate — Slow Slew Rate 1 SRE_1_Fast_Slew_Rate — Fast Slew Rate

32.6.252 SW_PAD_CTL_PAD_CSI_DATA01 SW PAD Control Register (IOMUXC_SW_PAD_CTL_PAD_CSI_DATA01)

SW_PAD_CTL Register

Address: 20E_0000h base + 474h offset = 20E_0474h

Bit	31	30	29	28	27	26	25	24	23	22	21	20	19	18	17	16
R	Reserved															HYS
W																
Reset	0	0	0	0	0	0	0	0	0	0	0	0	0	0	0	0
Bit	15	14	13	12	11	10	9	8	7	6	5	4	3	2	1	0
R	PUS	PUE	PKE	ODE	Reserved			SPEED	DSE			Reserved		SRE		
W																
Reset	0	0	0	1	0	0	0	0	1	0	1	1	0	0	0	0

IOMUXC_SW_PAD_CTL_PAD_CSI_DATA01 field descriptions

Field	Description
31–17 -	This field is reserved. Reserved
16 HYS	Hyst. Enable Field Select one out of next values for pad: CSI_DATA01 0 HYS_0_Hysteresis_Disabled — Hysteresis Disabled 1 HYS_1_Hysteresis_Enabled — Hysteresis Enabled
15–14 PUS	Pull Up / Down Config. Field Select one out of next values for pad: CSI_DATA01 00 PUS_0_100K_Ohm_Pull_Down — 100K Ohm Pull Down 01 PUS_1_47K_Ohm_Pull_Up — 47K Ohm Pull Up 10 PUS_2_100K_Ohm_Pull_Up — 100K Ohm Pull Up 11 PUS_3_22K_Ohm_Pull_Up — 22K Ohm Pull Up
13 PUE	Pull / Keep Select Field Select one out of next values for pad: CSI_DATA01 0 PUE_0_Keeper — Keeper 1 PUE_1_Pull — Pull
12 PKE	Pull / Keep Enable Field Select one out of next values for pad: CSI_DATA01 0 PKE_0_Pull_Keeper_Disabled — Pull/Keeper Disabled 1 PKE_1_Pull_Keeper_Enabled — Pull/Keeper Enabled
11 ODE	Open Drain Enable Field Select one out of next values for pad: CSI_DATA01

Table continues on the next page...

IOMUXC_SW_PAD_CTL_PAD_CSI_DATA01 field descriptions (continued)

Field	Description
	0 ODE_0_Open_Drain_Disabled — Open Drain Disabled 1 ODE_1_Open_Drain_Enabled — Open Drain Enabled
10–8 -	This field is reserved. Reserved
7–6 SPEED	Speed Field Select one out of next values for pad: CSI_DATA01 00 SPEED_0_low_50MHz_ — low(50MHz) 01 SPEED_1_medium_100MHz_ — medium(100MHz) 10 SPEED_2_medium_100MHz_ — medium(100MHz) 11 SPEED_3_max_200MHz_ — max(200MHz)
5–3 DSE	Drive Strength Field Select one out of next values for pad: CSI_DATA01 000 DSE_0_output_driver_disabled_ — output driver disabled; 001 DSE_1_R0_260_Ohm__3_3V_150_Ohm_1_8V_240_Ohm_for_DDR_ — R0(260 Ohm @ 3.3V, 150 Ohm@1.8V, 240 Ohm for DDR) 010 DSE_2_R0_2 — R0/2 011 DSE_3_R0_3 — R0/3 100 DSE_4_R0_4 — R0/4 101 DSE_5_R0_5 — R0/5 110 DSE_6_R0_6 — R0/6 111 DSE_7_R0_7 — R0/7
2–1 -	This field is reserved. Reserved
0 SRE	Slew Rate Field Select one out of next values for pad: CSI_DATA01 0 SRE_0_Slow_Slew_Rate — Slow Slew Rate 1 SRE_1_Fast_Slew_Rate — Fast Slew Rate

32.6.253 SW_PAD_CTL_PAD_CSI_DATA02 SW PAD Control Register (IOMUXC_SW_PAD_CTL_PAD_CSI_DATA02)

SW_PAD_CTL Register

Address: 20E_0000h base + 478h offset = 20E_0478h

Bit	31	30	29	28	27	26	25	24	23	22	21	20	19	18	17	16
R	Reserved															HYS
W																
Reset	0	0	0	0	0	0	0	0	0	0	0	0	0	0	0	0
Bit	15	14	13	12	11	10	9	8	7	6	5	4	3	2	1	0
R	PUS	PUE	PKE	ODE	Reserved			SPEED	DSE			Reserved		SRE		
W																
Reset	0	0	0	1	0	0	0	0	1	0	1	1	0	0	0	0

IOMUXC_SW_PAD_CTL_PAD_CSI_DATA02 field descriptions

Field	Description
31–17 -	This field is reserved. Reserved
16 HYS	Hyst. Enable Field Select one out of next values for pad: CSI_DATA02 0 HYS_0_Hysteresis_Disabled — Hysteresis Disabled 1 HYS_1_Hysteresis_Enabled — Hysteresis Enabled
15–14 PUS	Pull Up / Down Config. Field Select one out of next values for pad: CSI_DATA02 00 PUS_0_100K_Ohm_Pull_Down — 100K Ohm Pull Down 01 PUS_1_47K_Ohm_Pull_Up — 47K Ohm Pull Up 10 PUS_2_100K_Ohm_Pull_Up — 100K Ohm Pull Up 11 PUS_3_22K_Ohm_Pull_Up — 22K Ohm Pull Up
13 PUE	Pull / Keep Select Field Select one out of next values for pad: CSI_DATA02 0 PUE_0_Keeper — Keeper 1 PUE_1_Pull — Pull
12 PKE	Pull / Keep Enable Field Select one out of next values for pad: CSI_DATA02 0 PKE_0_Pull_Keeper_Disabled — Pull/Keeper Disabled 1 PKE_1_Pull_Keeper_Enabled — Pull/Keeper Enabled
11 ODE	Open Drain Enable Field Select one out of next values for pad: CSI_DATA02

Table continues on the next page...

IOMUXC_SW_PAD_CTL_PAD_CSI_DATA02 field descriptions (continued)

Field	Description
	0 ODE_0_Open_Drain_Disabled — Open Drain Disabled 1 ODE_1_Open_Drain_Enabled — Open Drain Enabled
10–8 -	This field is reserved. Reserved
7–6 SPEED	Speed Field Select one out of next values for pad: CSI_DATA02 00 SPEED_0_low_50MHz_ — low(50MHz) 01 SPEED_1_medium_100MHz_ — medium(100MHz) 10 SPEED_2_medium_100MHz_ — medium(100MHz) 11 SPEED_3_max_200MHz_ — max(200MHz)
5–3 DSE	Drive Strength Field Select one out of next values for pad: CSI_DATA02 000 DSE_0_output_driver_disabled_ — output driver disabled; 001 DSE_1_R0_260_Ohm__3_3V_150_Ohm_1_8V_240_Ohm_for_DDR_ — R0(260 Ohm @ 3.3V, 150 Ohm@1.8V, 240 Ohm for DDR) 010 DSE_2_R0_2 — R0/2 011 DSE_3_R0_3 — R0/3 100 DSE_4_R0_4 — R0/4 101 DSE_5_R0_5 — R0/5 110 DSE_6_R0_6 — R0/6 111 DSE_7_R0_7 — R0/7
2–1 -	This field is reserved. Reserved
0 SRE	Slew Rate Field Select one out of next values for pad: CSI_DATA02 0 SRE_0_Slow_Slew_Rate — Slow Slew Rate 1 SRE_1_Fast_Slew_Rate — Fast Slew Rate

32.6.254 SW_PAD_CTL_PAD_CSI_DATA03 SW PAD Control Register (IOMUXC_SW_PAD_CTL_PAD_CSI_DATA03)

SW_PAD_CTL Register

Address: 20E_0000h base + 47Ch offset = 20E_047Ch

Bit	31	30	29	28	27	26	25	24	23	22	21	20	19	18	17	16
R	Reserved															HYS
W																
Reset	0	0	0	0	0	0	0	0	0	0	0	0	0	0	0	0
Bit	15	14	13	12	11	10	9	8	7	6	5	4	3	2	1	0
R	PUS	PUE	PKE	ODE	Reserved			SPEED	DSE			Reserved		SRE		
W																
Reset	0	0	0	1	0	0	0	0	1	0	1	1	0	0	0	0

IOMUXC_SW_PAD_CTL_PAD_CSI_DATA03 field descriptions

Field	Description
31–17 -	This field is reserved. Reserved
16 HYS	Hyst. Enable Field Select one out of next values for pad: CSI_DATA03 0 HYS_0_Hysteresis_Disabled — Hysteresis Disabled 1 HYS_1_Hysteresis_Enabled — Hysteresis Enabled
15–14 PUS	Pull Up / Down Config. Field Select one out of next values for pad: CSI_DATA03 00 PUS_0_100K_Ohm_Pull_Down — 100K Ohm Pull Down 01 PUS_1_47K_Ohm_Pull_Up — 47K Ohm Pull Up 10 PUS_2_100K_Ohm_Pull_Up — 100K Ohm Pull Up 11 PUS_3_22K_Ohm_Pull_Up — 22K Ohm Pull Up
13 PUE	Pull / Keep Select Field Select one out of next values for pad: CSI_DATA03 0 PUE_0_Keeper — Keeper 1 PUE_1_Pull — Pull
12 PKE	Pull / Keep Enable Field Select one out of next values for pad: CSI_DATA03 0 PKE_0_Pull_Keeper_Disabled — Pull/Keeper Disabled 1 PKE_1_Pull_Keeper_Enabled — Pull/Keeper Enabled
11 ODE	Open Drain Enable Field Select one out of next values for pad: CSI_DATA03

Table continues on the next page...

IOMUXC_SW_PAD_CTL_PAD_CSI_DATA03 field descriptions (continued)

Field	Description
	0 ODE_0_Open_Drain_Disabled — Open Drain Disabled 1 ODE_1_Open_Drain_Enabled — Open Drain Enabled
10–8 -	This field is reserved. Reserved
7–6 SPEED	Speed Field Select one out of next values for pad: CSI_DATA03 00 SPEED_0_low_50MHz_ — low(50MHz) 01 SPEED_1_medium_100MHz_ — medium(100MHz) 10 SPEED_2_medium_100MHz_ — medium(100MHz) 11 SPEED_3_max_200MHz_ — max(200MHz)
5–3 DSE	Drive Strength Field Select one out of next values for pad: CSI_DATA03 000 DSE_0_output_driver_disabled_ — output driver disabled; 001 DSE_1_R0_260_Ohm__3_3V_150_Ohm_1_8V_240_Ohm_for_DDR_ — R0(260 Ohm @ 3.3V, 150 Ohm@1.8V, 240 Ohm for DDR) 010 DSE_2_R0_2 — R0/2 011 DSE_3_R0_3 — R0/3 100 DSE_4_R0_4 — R0/4 101 DSE_5_R0_5 — R0/5 110 DSE_6_R0_6 — R0/6 111 DSE_7_R0_7 — R0/7
2–1 -	This field is reserved. Reserved
0 SRE	Slew Rate Field Select one out of next values for pad: CSI_DATA03 0 SRE_0_Slow_Slew_Rate — Slow Slew Rate 1 SRE_1_Fast_Slew_Rate — Fast Slew Rate

32.6.255 SW_PAD_CTL_PAD_CSI_DATA04 SW PAD Control Register (IOMUXC_SW_PAD_CTL_PAD_CSI_DATA04)

SW_PAD_CTL Register

Address: 20E_0000h base + 480h offset = 20E_0480h

Bit	31	30	29	28	27	26	25	24	23	22	21	20	19	18	17	16
R	Reserved															HYS
W																
Reset	0	0	0	0	0	0	0	0	0	0	0	0	0	0	0	0
Bit	15	14	13	12	11	10	9	8	7	6	5	4	3	2	1	0
R	PUS	PUE	PKE	ODE	Reserved			SPEED	DSE			Reserved		SRE		
W																
Reset	0	0	0	1	0	0	0	0	1	0	1	1	0	0	0	0

IOMUXC_SW_PAD_CTL_PAD_CSI_DATA04 field descriptions

Field	Description
31–17 -	This field is reserved. Reserved
16 HYS	Hyst. Enable Field Select one out of next values for pad: CSI_DATA04 0 HYS_0_Hysteresis_Disabled — Hysteresis Disabled 1 HYS_1_Hysteresis_Enabled — Hysteresis Enabled
15–14 PUS	Pull Up / Down Config. Field Select one out of next values for pad: CSI_DATA04 00 PUS_0_100K_Ohm_Pull_Down — 100K Ohm Pull Down 01 PUS_1_47K_Ohm_Pull_Up — 47K Ohm Pull Up 10 PUS_2_100K_Ohm_Pull_Up — 100K Ohm Pull Up 11 PUS_3_22K_Ohm_Pull_Up — 22K Ohm Pull Up
13 PUE	Pull / Keep Select Field Select one out of next values for pad: CSI_DATA04 0 PUE_0_Keeper — Keeper 1 PUE_1_Pull — Pull
12 PKE	Pull / Keep Enable Field Select one out of next values for pad: CSI_DATA04 0 PKE_0_Pull_Keeper_Disabled — Pull/Keeper Disabled 1 PKE_1_Pull_Keeper_Enabled — Pull/Keeper Enabled
11 ODE	Open Drain Enable Field Select one out of next values for pad: CSI_DATA04

Table continues on the next page...

IOMUXC_SW_PAD_CTL_PAD_CSI_DATA04 field descriptions (continued)

Field	Description
	0 ODE_0_Open_Drain_Disabled — Open Drain Disabled 1 ODE_1_Open_Drain_Enabled — Open Drain Enabled
10–8 -	This field is reserved. Reserved
7–6 SPEED	Speed Field Select one out of next values for pad: CSI_DATA04 00 SPEED_0_low_50MHz_ — low(50MHz) 01 SPEED_1_medium_100MHz_ — medium(100MHz) 10 SPEED_2_medium_100MHz_ — medium(100MHz) 11 SPEED_3_max_200MHz_ — max(200MHz)
5–3 DSE	Drive Strength Field Select one out of next values for pad: CSI_DATA04 000 DSE_0_output_driver_disabled_ — output driver disabled; 001 DSE_1_R0_260_Ohm__3_3V_150_Ohm_1_8V_240_Ohm_for_DDR_ — R0(260 Ohm @ 3.3V, 150 Ohm@1.8V, 240 Ohm for DDR) 010 DSE_2_R0_2 — R0/2 011 DSE_3_R0_3 — R0/3 100 DSE_4_R0_4 — R0/4 101 DSE_5_R0_5 — R0/5 110 DSE_6_R0_6 — R0/6 111 DSE_7_R0_7 — R0/7
2–1 -	This field is reserved. Reserved
0 SRE	Slew Rate Field Select one out of next values for pad: CSI_DATA04 0 SRE_0_Slow_Slew_Rate — Slow Slew Rate 1 SRE_1_Fast_Slew_Rate — Fast Slew Rate

32.6.256 SW_PAD_CTL_PAD_CSI_DATA05 SW PAD Control Register (IOMUXC_SW_PAD_CTL_PAD_CSI_DATA05)

SW_PAD_CTL Register

Address: 20E_0000h base + 484h offset = 20E_0484h

Bit	31	30	29	28	27	26	25	24	23	22	21	20	19	18	17	16
R	Reserved															HYS
W																
Reset	0	0	0	0	0	0	0	0	0	0	0	0	0	0	0	0
Bit	15	14	13	12	11	10	9	8	7	6	5	4	3	2	1	0
R	PUS	PUE	PKE	ODE	Reserved			SPEED	DSE			Reserved		SRE		
W																
Reset	0	0	0	1	0	0	0	0	1	0	1	1	0	0	0	0

IOMUXC_SW_PAD_CTL_PAD_CSI_DATA05 field descriptions

Field	Description
31–17 -	This field is reserved. Reserved
16 HYS	Hyst. Enable Field Select one out of next values for pad: CSI_DATA05 0 HYS_0_Hysteresis_Disabled — Hysteresis Disabled 1 HYS_1_Hysteresis_Enabled — Hysteresis Enabled
15–14 PUS	Pull Up / Down Config. Field Select one out of next values for pad: CSI_DATA05 00 PUS_0_100K_Ohm_Pull_Down — 100K Ohm Pull Down 01 PUS_1_47K_Ohm_Pull_Up — 47K Ohm Pull Up 10 PUS_2_100K_Ohm_Pull_Up — 100K Ohm Pull Up 11 PUS_3_22K_Ohm_Pull_Up — 22K Ohm Pull Up
13 PUE	Pull / Keep Select Field Select one out of next values for pad: CSI_DATA05 0 PUE_0_Keeper — Keeper 1 PUE_1_Pull — Pull
12 PKE	Pull / Keep Enable Field Select one out of next values for pad: CSI_DATA05 0 PKE_0_Pull_Keeper_Disabled — Pull/Keeper Disabled 1 PKE_1_Pull_Keeper_Enabled — Pull/Keeper Enabled
11 ODE	Open Drain Enable Field Select one out of next values for pad: CSI_DATA05

Table continues on the next page...

IOMUXC_SW_PAD_CTL_PAD_CSI_DATA05 field descriptions (continued)

Field	Description
	0 ODE_0_Open_Drain_Disabled — Open Drain Disabled 1 ODE_1_Open_Drain_Enabled — Open Drain Enabled
10–8 -	This field is reserved. Reserved
7–6 SPEED	Speed Field Select one out of next values for pad: CSI_DATA05 00 SPEED_0_low_50MHz_ — low(50MHz) 01 SPEED_1_medium_100MHz_ — medium(100MHz) 10 SPEED_2_medium_100MHz_ — medium(100MHz) 11 SPEED_3_max_200MHz_ — max(200MHz)
5–3 DSE	Drive Strength Field Select one out of next values for pad: CSI_DATA05 000 DSE_0_output_driver_disabled_ — output driver disabled; 001 DSE_1_R0_260_Ohm__3_3V_150_Ohm_1_8V_240_Ohm_for_DDR_ — R0(260 Ohm @ 3.3V, 150 Ohm@1.8V, 240 Ohm for DDR) 010 DSE_2_R0_2 — R0/2 011 DSE_3_R0_3 — R0/3 100 DSE_4_R0_4 — R0/4 101 DSE_5_R0_5 — R0/5 110 DSE_6_R0_6 — R0/6 111 DSE_7_R0_7 — R0/7
2–1 -	This field is reserved. Reserved
0 SRE	Slew Rate Field Select one out of next values for pad: CSI_DATA05 0 SRE_0_Slow_Slew_Rate — Slow Slew Rate 1 SRE_1_Fast_Slew_Rate — Fast Slew Rate

32.6.257 SW_PAD_CTL_PAD_CSI_DATA06 SW PAD Control Register (IOMUXC_SW_PAD_CTL_PAD_CSI_DATA06)

SW_PAD_CTL Register

Address: 20E_0000h base + 488h offset = 20E_0488h

Bit	31	30	29	28	27	26	25	24	23	22	21	20	19	18	17	16
R	Reserved															HYS
W																
Reset	0	0	0	0	0	0	0	0	0	0	0	0	0	0	0	0
Bit	15	14	13	12	11	10	9	8	7	6	5	4	3	2	1	0
R	PUS	PUE	PKE	ODE	Reserved			SPEED	DSE			Reserved		SRE		
W																
Reset	0	0	0	1	0	0	0	0	1	0	1	1	0	0	0	0

IOMUXC_SW_PAD_CTL_PAD_CSI_DATA06 field descriptions

Field	Description
31–17 -	This field is reserved. Reserved
16 HYS	Hyst. Enable Field Select one out of next values for pad: CSI_DATA06 0 HYS_0_Hysteresis_Disabled — Hysteresis Disabled 1 HYS_1_Hysteresis_Enabled — Hysteresis Enabled
15–14 PUS	Pull Up / Down Config. Field Select one out of next values for pad: CSI_DATA06 00 PUS_0_100K_Ohm_Pull_Down — 100K Ohm Pull Down 01 PUS_1_47K_Ohm_Pull_Up — 47K Ohm Pull Up 10 PUS_2_100K_Ohm_Pull_Up — 100K Ohm Pull Up 11 PUS_3_22K_Ohm_Pull_Up — 22K Ohm Pull Up
13 PUE	Pull / Keep Select Field Select one out of next values for pad: CSI_DATA06 0 PUE_0_Keeper — Keeper 1 PUE_1_Pull — Pull
12 PKE	Pull / Keep Enable Field Select one out of next values for pad: CSI_DATA06 0 PKE_0_Pull_Keeper_Disabled — Pull/Keeper Disabled 1 PKE_1_Pull_Keeper_Enabled — Pull/Keeper Enabled
11 ODE	Open Drain Enable Field Select one out of next values for pad: CSI_DATA06

Table continues on the next page...

IOMUXC_SW_PAD_CTL_PAD_CSI_DATA06 field descriptions (continued)

Field	Description
	0 ODE_0_Open_Drain_Disabled — Open Drain Disabled 1 ODE_1_Open_Drain_Enabled — Open Drain Enabled
10–8 -	This field is reserved. Reserved
7–6 SPEED	Speed Field Select one out of next values for pad: CSI_DATA06 00 SPEED_0_low_50MHz_ — low(50MHz) 01 SPEED_1_medium_100MHz_ — medium(100MHz) 10 SPEED_2_medium_100MHz_ — medium(100MHz) 11 SPEED_3_max_200MHz_ — max(200MHz)
5–3 DSE	Drive Strength Field Select one out of next values for pad: CSI_DATA06 000 DSE_0_output_driver_disabled_ — output driver disabled; 001 DSE_1_R0_260_Ohm__3_3V_150_Ohm_1_8V_240_Ohm_for_DDR_ — R0(260 Ohm @ 3.3V, 150 Ohm@1.8V, 240 Ohm for DDR) 010 DSE_2_R0_2 — R0/2 011 DSE_3_R0_3 — R0/3 100 DSE_4_R0_4 — R0/4 101 DSE_5_R0_5 — R0/5 110 DSE_6_R0_6 — R0/6 111 DSE_7_R0_7 — R0/7
2–1 -	This field is reserved. Reserved
0 SRE	Slew Rate Field Select one out of next values for pad: CSI_DATA06 0 SRE_0_Slow_Slew_Rate — Slow Slew Rate 1 SRE_1_Fast_Slew_Rate — Fast Slew Rate

32.6.258 SW_PAD_CTL_PAD_CSI_DATA07 SW PAD Control Register (IOMUXC_SW_PAD_CTL_PAD_CSI_DATA07)

SW_PAD_CTL Register

Address: 20E_0000h base + 48Ch offset = 20E_048Ch

Bit	31	30	29	28	27	26	25	24	23	22	21	20	19	18	17	16
R	Reserved															HYS
W																
Reset	0	0	0	0	0	0	0	0	0	0	0	0	0	0	0	0
Bit	15	14	13	12	11	10	9	8	7	6	5	4	3	2	1	0
R	PUS	PUE	PKE	ODE	Reserved			SPEED	DSE			Reserved		SRE		
W																
Reset	0	0	0	1	0	0	0	0	1	0	1	1	0	0	0	0

IOMUXC_SW_PAD_CTL_PAD_CSI_DATA07 field descriptions

Field	Description
31–17 -	This field is reserved. Reserved
16 HYS	Hyst. Enable Field Select one out of next values for pad: CSI_DATA07 0 HYS_0_Hysteresis_Disabled — Hysteresis Disabled 1 HYS_1_Hysteresis_Enabled — Hysteresis Enabled
15–14 PUS	Pull Up / Down Config. Field Select one out of next values for pad: CSI_DATA07 00 PUS_0_100K_Ohm_Pull_Down — 100K Ohm Pull Down 01 PUS_1_47K_Ohm_Pull_Up — 47K Ohm Pull Up 10 PUS_2_100K_Ohm_Pull_Up — 100K Ohm Pull Up 11 PUS_3_22K_Ohm_Pull_Up — 22K Ohm Pull Up
13 PUE	Pull / Keep Select Field Select one out of next values for pad: CSI_DATA07 0 PUE_0_Keeper — Keeper 1 PUE_1_Pull — Pull
12 PKE	Pull / Keep Enable Field Select one out of next values for pad: CSI_DATA07 0 PKE_0_Pull_Keeper_Disabled — Pull/Keeper Disabled 1 PKE_1_Pull_Keeper_Enabled — Pull/Keeper Enabled
11 ODE	Open Drain Enable Field Select one out of next values for pad: CSI_DATA07

Table continues on the next page...

IOMUXC_SW_PAD_CTL_PAD_CSI_DATA07 field descriptions (continued)

Field	Description
	0 ODE_0_Open_Drain_Disabled — Open Drain Disabled 1 ODE_1_Open_Drain_Enabled — Open Drain Enabled
10–8 -	This field is reserved. Reserved
7–6 SPEED	Speed Field Select one out of next values for pad: CSI_DATA07 00 SPEED_0_low_50MHz_ — low(50MHz) 01 SPEED_1_medium_100MHz_ — medium(100MHz) 10 SPEED_2_medium_100MHz_ — medium(100MHz) 11 SPEED_3_max_200MHz_ — max(200MHz)
5–3 DSE	Drive Strength Field Select one out of next values for pad: CSI_DATA07 000 DSE_0_output_driver_disabled_ — output driver disabled; 001 DSE_1_R0_260_Ohm__3_3V_150_Ohm_1_8V_240_Ohm_for_DDR_ — R0(260 Ohm @ 3.3V, 150 Ohm@1.8V, 240 Ohm for DDR) 010 DSE_2_R0_2 — R0/2 011 DSE_3_R0_3 — R0/3 100 DSE_4_R0_4 — R0/4 101 DSE_5_R0_5 — R0/5 110 DSE_6_R0_6 — R0/6 111 DSE_7_R0_7 — R0/7
2–1 -	This field is reserved. Reserved
0 SRE	Slew Rate Field Select one out of next values for pad: CSI_DATA07 0 SRE_0_Slow_Slew_Rate — Slow Slew Rate 1 SRE_1_Fast_Slew_Rate — Fast Slew Rate

32.6.259 SW_PAD_CTL_GRP_ADDDS SW GRP Register (IOMUXC_SW_PAD_CTL_GRP_ADDDS)

SW_GRP Register

Address: 20E_0000h base + 490h offset = 20E_0490h

Bit	31	30	29	28	27	26	25	24	23	22	21	20	19	18	17	16	15	14	13	12	11	10	9	8	7	6	5	4	3	2	1	0
R	Reserved																DSE			Reserved												
W	Reserved																DSE			Reserved												
Reset	0	0	0	0	0	0	0	0	0	0	0	0	0	0	0	0	0	0	0	0	0	0	0	0	0	0	1	1	0	0	0	0

IOMUXC_SW_PAD_CTL_GRP_ADDDS field descriptions

Field	Description
31–6 -	This field is reserved. Reserved
5–3 DSE	<p>Drive Strength Field</p> <p>Select one out of next values for group: ADDDS (Pads: DRAM_ADDR00 DRAM_ADDR01 DRAM_ADDR02 DRAM_ADDR03 DRAM_ADDR04 DRAM_ADDR05 DRAM_ADDR06 DRAM_ADDR07 DRAM_ADDR08 DRAM_ADDR09 DRAM_ADDR10 DRAM_ADDR11 DRAM_ADDR12 DRAM_ADDR13 DRAM_ADDR14 DRAM_ADDR15 DRAM_SDBA0 DRAM_SDBA1)</p> <p>000 DSE_0_output_driver_disabled_ — output driver disabled; 001 DSE_1_R0_260_Ohm_3_3V_150_Ohm_1_8V_240_Ohm_for_DDR_ — R0(260 Ohm @ 3.3V, 150 Ohm@1.8V, 240 Ohm for DDR) 010 DSE_2_R0_2 — R0/2 011 DSE_3_R0_3 — R0/3 100 DSE_4_R0_4 — R0/4 101 DSE_5_R0_5 — R0/5 110 DSE_6_R0_6 — R0/6 111 DSE_7_R0_7 — R0/7</p>
-	This field is reserved. Reserved

32.6.260 SW_PAD_CTL_GRP_DDRMODE_CTL SW GRP Register (IOMUXC_SW_PAD_CTL_GRP_DDRMODE_CTL)

SW_GRP Register

Address: 20E_0000h base + 494h offset = 20E_0494h

Bit	31	30	29	28	27	26	25	24	23	22	21	20	19	18	17	16
R	Reserved														DDR_INPUT	Reserved
W	Reserved														DDR_INPUT	Reserved
Reset	0	0	0	0	0	0	0	0	0	0	0	0	0	0	0	0
Bit	15	14	13	12	11	10	9	8	7	6	5	4	3	2	1	0
R	Reserved															
W	Reserved															
Reset	0	0	0	0	0	0	0	0	0	0	0	0	0	0	0	0

IOMUXC_SW_PAD_CTL_GRP_DDRMODE_CTL field descriptions

Field	Description
31–18 -	This field is reserved. Reserved
17 DDR_INPUT	DDR / CMOS Input Mode Field Select one out of next values for group: DDRMODE_CTL (Pads: DRAM_SDQS0_P DRAM_SDQS1_P) 0 DDR_INPUT_0_CMOS_input_type — CMOS input type 1 DDR_INPUT_1_Differential_input_mode — Differential input mode
-	This field is reserved. Reserved

32.6.261 SW_PAD_CTL_GRP_B0DS SW GRP Register (IOMUXC_SW_PAD_CTL_GRP_B0DS)

SW_GRP Register

Address: 20E_0000h base + 498h offset = 20E_0498h

Bit	31	30	29	28	27	26	25	24	23	22	21	20	19	18	17	16	15	14	13	12	11	10	9	8	7	6	5	4	3	2	1	0
R	Reserved																DSE			Reserved												
W	0																1			0												
Reset	0	0	0	0	0	0	0	0	0	0	0	0	0	0	0	0	0	0	0	0	0	0	0	0	0	0	1	1	0	0	0	0

IOMUXC_SW_PAD_CTL_GRP_B0DS field descriptions

Field	Description
31–6 -	This field is reserved. Reserved
5–3 DSE	Drive Strength Field Select one out of next values for group: B0DS (Pads: DRAM_DATA00 DRAM_DATA01 DRAM_DATA02 DRAM_DATA03 DRAM_DATA04 DRAM_DATA05 DRAM_DATA06 DRAM_DATA07) 000 DSE_0_output_driver_disabled_ — output driver disabled; 001 DSE_1_R0_260_Ohm__3_3V__150_Ohm_1_8V__240_Ohm_for_DDR_ — R0(260 Ohm @ 3.3V, 150 Ohm@1.8V, 240 Ohm for DDR) 010 DSE_2_R0_2 — R0/2 011 DSE_3_R0_3 — R0/3 100 DSE_4_R0_4 — R0/4 101 DSE_5_R0_5 — R0/5 110 DSE_6_R0_6 — R0/6 111 DSE_7_R0_7 — R0/7
-	This field is reserved. Reserved

32.6.262 SW_PAD_CTL_GRP_DDRPK SW GRP Register (IOMUXC_SW_PAD_CTL_GRP_DDRPK)

SW_GRP Register

Address: 20E_0000h base + 49Ch offset = 20E_049Ch

Bit	31	30	29	28	27	26	25	24	23	22	21	20	19	18	17	16
R	Reserved															
W	Reserved															
Reset	0	0	0	0	0	0	0	0	0	0	0	0	0	0	0	0
Bit	15	14	13	12	11	10	9	8	7	6	5	4	3	2	1	0
R	Reserved		PUE	Reserved												
W	Reserved		PUE	Reserved												
Reset	0	0	1	0	0	0	0	0	0	0	0	0	0	0	0	0

IOMUXC_SW_PAD_CTL_GRP_DDRPK field descriptions

Field	Description
31–14 -	This field is reserved. Reserved
13 PUE	Pull / Keep Select Field Select one out of next values for group: DDRPK (Pads: DRAM_ADDR00 DRAM_ADDR01 DRAM_ADDR02 DRAM_ADDR03 DRAM_ADDR04 DRAM_ADDR05 DRAM_ADDR06 DRAM_ADDR07 DRAM_ADDR08 DRAM_ADDR09 DRAM_ADDR10 DRAM_ADDR11 DRAM_ADDR12 DRAM_ADDR13 DRAM_ADDR14 DRAM_ADDR15 DRAM_CAS_B DRAM_CS0_B DRAM_CS1_B DRAM_DATA00 DRAM_DATA01 DRAM_DATA02 DRAM_DATA03 DRAM_DATA04 DRAM_DATA05 DRAM_DATA06 DRAM_DATA07 DRAM_DATA08 DRAM_DATA09 DRAM_DATA10 DRAM_DATA11 DRAM_DATA12 DRAM_DATA13 DRAM_DATA14 DRAM_DATA15 DRAM_DQM0 DRAM_DQM1 DRAM_RAS_B DRAM_SDBA0 DRAM_SDBA1 DRAM_SDCLK0_P DRAM_SDWE_B) 0 PUE_0_Keeper — Keeper 1 PUE_1_Pull — Pull
-	This field is reserved. Reserved

32.6.263 SW_PAD_CTL_GRP_CTLDS SW GRP Register (IOMUXC_SW_PAD_CTL_GRP_CTLDS)

SW_GRP Register

Address: 20E_0000h base + 4A0h offset = 20E_04A0h

Bit	31	30	29	28	27	26	25	24	23	22	21	20	19	18	17	16	15	14	13	12	11	10	9	8	7	6	5	4	3	2	1	0
R	Reserved																DSE			Reserved												
W	Reserved																DSE			Reserved												
Reset	0	0	0	0	0	0	0	0	0	0	0	0	0	0	0	0	0	0	0	0	0	0	0	0	0	0	1	1	0	0	0	0

IOMUXC_SW_PAD_CTL_GRP_CTLDS field descriptions

Field	Description
31–6 -	This field is reserved. Reserved
5–3 DSE	<p>Drive Strength Field</p> <p>Select one out of next values for group: CTLDS (Pads: DRAM_CS0_B DRAM_CS1_B DRAM_SDBA2 DRAM_SDCKE0 DRAM_SDCKE1 DRAM_SDWE_B)</p> <p>000 DSE_0_output_driver_disabled_ — output driver disabled;</p> <p>001 DSE_1_R0_260_Ohm__3_3V_150_Ohm_1_8V__240_Ohm_for_DDR_ — R0(260 Ohm @ 3.3V, 150 Ohm@1.8V, 240 Ohm for DDR)</p> <p>010 DSE_2_R0_2 — R0/2</p> <p>011 DSE_3_R0_3 — R0/3</p> <p>100 DSE_4_R0_4 — R0/4</p> <p>101 DSE_5_R0_5 — R0/5</p> <p>110 DSE_6_R0_6 — R0/6</p> <p>111 DSE_7_R0_7 — R0/7</p>
-	This field is reserved. Reserved

32.6.264 SW_PAD_CTL_GRP_B1DS SW GRP Register (IOMUXC_SW_PAD_CTL_GRP_B1DS)

SW_GRP Register

Address: 20E_0000h base + 4A4h offset = 20E_04A4h

Bit	31	30	29	28	27	26	25	24	23	22	21	20	19	18	17	16	15	14	13	12	11	10	9	8	7	6	5	4	3	2	1	0
R	Reserved																DSE			Reserved												
W	Reserved																DSE			Reserved												
Reset	0	0	0	0	0	0	0	0	0	0	0	0	0	0	0	0	0	0	0	0	0	0	0	0	0	0	1	1	0	0	0	0

IOMUXC_SW_PAD_CTL_GRP_B1DS field descriptions

Field	Description
31–6 -	This field is reserved. Reserved
5–3 DSE	<p>Drive Strength Field</p> <p>Select one out of next values for group: B1DS (Pads: DRAM_DATA08 DRAM_DATA09 DRAM_DATA10 DRAM_DATA11 DRAM_DATA12 DRAM_DATA13 DRAM_DATA14 DRAM_DATA15)</p> <p>000 DSE_0_output_driver_disabled_ — output driver disabled;</p> <p>001 DSE_1_R0_260_Ohm__3_3V_150_Ohm_1_8V__240_Ohm_for_DDR_ — R0(260 Ohm @ 3.3V, 150 Ohm@1.8V, 240 Ohm for DDR)</p> <p>010 DSE_2_R0_2 — R0/2</p> <p>011 DSE_3_R0_3 — R0/3</p> <p>100 DSE_4_R0_4 — R0/4</p>

Table continues on the next page...

IOMUXC_SW_PAD_CTL_GRP_B1DS field descriptions (continued)

Field	Description
101	DSE_5_R0_5 — R0/5
110	DSE_6_R0_6 — R0/6
111	DSE_7_R0_7 — R0/7
-	This field is reserved. Reserved

32.6.265 SW_PAD_CTL_GRP_DDRHYS SW GRP Register (IOMUXC_SW_PAD_CTL_GRP_DDRHYS)

SW_GRP Register

Address: 20E_0000h base + 4A8h offset = 20E_04A8h

Bit	31	30	29	28	27	26	25	24	23	22	21	20	19	18	17	16
R	Reserved															HYS
W	Reserved															
Reset	0	0	0	0	0	0	0	0	0	0	0	0	0	0	0	0
Bit	15	14	13	12	11	10	9	8	7	6	5	4	3	2	1	0
R	Reserved															
W	Reserved															
Reset	0	0	0	0	0	0	0	0	0	0	0	0	0	0	0	0

IOMUXC_SW_PAD_CTL_GRP_DDRHYS field descriptions

Field	Description
31–17 -	This field is reserved. Reserved
16 HYS	Hyst. Enable Field Select one out of next values for group: DDRHYS (Pads: DRAM_DATA00 DRAM_DATA01 DRAM_DATA02 DRAM_DATA03 DRAM_DATA04 DRAM_DATA05 DRAM_DATA06 DRAM_DATA07 DRAM_DATA08 DRAM_DATA09 DRAM_DATA10 DRAM_DATA11 DRAM_DATA12 DRAM_DATA13 DRAM_DATA14 DRAM_DATA15 DRAM_SDQS0_P DRAM_SDQS1_P) 0 HYS_0_Hysteresis_Disabled — Hysteresis Disabled 1 HYS_1_Hysteresis_Enabled — Hysteresis Enabled
-	This field is reserved. Reserved

32.6.266 SW_PAD_CTL_GRP_DDRPKE SW GRP Register (IOMUXC_SW_PAD_CTL_GRP_DDRPKE)

SW_GRP Register

Address: 20E_0000h base + 4ACh offset = 20E_04ACh

Bit	31	30	29	28	27	26	25	24		23	22	21	20	19	18	17	16
R	Reserved																
W	Reserved																
Reset	0	0	0	0	0	0	0	0		0	0	0	0	0	0	0	0
Bit	15	14	13	12	11	10	9	8		7	6	5	4	3	2	1	0
R	Reserved			PKE	Reserved												
W	Reserved																
Reset	0	0	0	1	0	0	0	0		0	0	0	0	0	0	0	0

IOMUXC_SW_PAD_CTL_GRP_DDRPKE field descriptions

Field	Description
31–13 -	This field is reserved. Reserved
12 PKE	<p>Pull / Keep Enable Field</p> <p>Select one out of next values for group: DDRPKE (Pads: DRAM_ADDR00 DRAM_ADDR01 DRAM_ADDR02 DRAM_ADDR03 DRAM_ADDR04 DRAM_ADDR05 DRAM_ADDR06 DRAM_ADDR07 DRAM_ADDR08 DRAM_ADDR09 DRAM_ADDR10 DRAM_ADDR11 DRAM_ADDR12 DRAM_ADDR13 DRAM_ADDR14 DRAM_ADDR15 DRAM_CAS_B DRAM_CS0_B DRAM_CS1_B DRAM_DATA00 DRAM_DATA01 DRAM_DATA02 DRAM_DATA03 DRAM_DATA04 DRAM_DATA05 DRAM_DATA06 DRAM_DATA07 DRAM_DATA08 DRAM_DATA09 DRAM_DATA10 DRAM_DATA11 DRAM_DATA12 DRAM_DATA13 DRAM_DATA14 DRAM_DATA15 DRAM_DQM0 DRAM_DQM1 DRAM_RAS_B DRAM_SDBA0 DRAM_SDBA1 DRAM_SDCLK0_P DRAM_SDWE_B)</p> <p>0 PKE_0_Pull_Keeper_Disabled — Pull/Keeper Disabled 1 PKE_1_Pull_Keeper_Enabled — Pull/Keeper Enabled</p>
-	This field is reserved. Reserved

32.6.267 SW_PAD_CTL_GRP_DDRMODE SW GRP Register (IOMUXC_SW_PAD_CTL_GRP_DDRMODE)

SW_GRP Register

Address: 20E_0000h base + 4B0h offset = 20E_04B0h

Bit	31	30	29	28	27	26	25	24	23	22	21	20	19	18	17	16
R	Reserved														DDR_INPUT	Reserved
W	Reserved															
Reset	0	0	0	0	0	0	0	0	0	0	0	0	0	0	0	0
Bit	15	14	13	12	11	10	9	8	7	6	5	4	3	2	1	0
R	Reserved															
W	Reserved															
Reset	0	0	0	0	0	0	0	0	0	0	0	0	0	0	0	0

IOMUXC_SW_PAD_CTL_GRP_DDRMODE field descriptions

Field	Description
31–18 -	This field is reserved. Reserved
17 DDR_INPUT	DDR / CMOS Input Mode Field Select one out of next values for group: DDRMODE (Pads: DRAM_DATA00 DRAM_DATA01 DRAM_DATA02 DRAM_DATA03 DRAM_DATA04 DRAM_DATA05 DRAM_DATA06 DRAM_DATA07 DRAM_DATA08 DRAM_DATA09 DRAM_DATA10 DRAM_DATA11 DRAM_DATA12 DRAM_DATA13 DRAM_DATA14 DRAM_DATA15) 0 DDR_INPUT_0_CMOS_input_type — CMOS input type 1 DDR_INPUT_1_Differential_input_mode — Differential input mode
-	This field is reserved. Reserved

32.6.268 SW_PAD_CTL_GRP_DDR_TYPE SW GRP Register (IOMUXC_SW_PAD_CTL_GRP_DDR_TYPE)

SW_GRP Register

Address: 20E_0000h base + 4B4h offset = 20E_04B4h

Bit	31	30	29	28	27	26	25	24	23	22	21	20	19	18	17	16
R	Reserved												DDR_SEL	Reserved		
W	Reserved												DDR_SEL	Reserved		
Reset	0	0	0	0	0	0	0	0	0	0	0	0	1	0	0	0
Bit	15	14	13	12	11	10	9	8	7	6	5	4	3	2	1	0
R	Reserved															
W	Reserved															
Reset	0	0	0	0	0	0	0	0	0	0	0	0	0	0	0	0

IOMUXC_SW_PAD_CTL_GRP_DDR_TYPE field descriptions

Field	Description
31–20 -	This field is reserved. Reserved
19–18 DDR_SEL	<p>ddr_sel Field</p> <p>Select one out of next values for group: DDR_TYPE (Pads: DRAM_ADDR00 DRAM_ADDR01 DRAM_ADDR02 DRAM_ADDR03 DRAM_ADDR04 DRAM_ADDR05 DRAM_ADDR06 DRAM_ADDR07 DRAM_ADDR08 DRAM_ADDR09 DRAM_ADDR10 DRAM_ADDR11 DRAM_ADDR12 DRAM_ADDR13 DRAM_ADDR14 DRAM_ADDR15 DRAM_CAS_B DRAM_CS0_B DRAM_CS1_B DRAM_DATA00 DRAM_DATA01 DRAM_DATA02 DRAM_DATA03 DRAM_DATA04 DRAM_DATA05 DRAM_DATA06 DRAM_DATA07 DRAM_DATA08 DRAM_DATA09 DRAM_DATA10 DRAM_DATA11 DRAM_DATA12 DRAM_DATA13 DRAM_DATA14 DRAM_DATA15 DRAM_DQM0 DRAM_DQM1 DRAM_ODT0 DRAM_ODT1 DRAM_RAS_B DRAM_SDBA0 DRAM_SDBA1 DRAM_SDBA2 DRAM_SDCKE0 DRAM_SDCKE1 DRAM_SDCLK0_P DRAM_SDQS0_P DRAM_SDQS1_P DRAM_SDWE_B)</p> <p>00 DDR_SEL_0_RESERVED — RESERVED 01 DDR_SEL_1_RESERVED — RESERVED 10 DDR_SEL_2_LPDDR2_mode — LPDDR2 mode 11 DDR_SEL_3_DDR3_mode — DDR3 mode</p>
-	This field is reserved. Reserved

32.6.269 USB_OTG1_ID_SELECT_INPUT DAISY Register (IOMUXC_ANATOP_USB_OTG_ID_SELECT_INPUT)

DAISY Register

Address: 20E_0000h base + 4B8h offset = 20E_04B8h

Bit	31	30	29	28	27	26	25	24	23	22	21	20	19	18	17	16
R	Reserved															
W	Reserved															
Reset	0	0	0	0	0	0	0	0	0	0	0	0	0	0	0	0
Bit	15	14	13	12	11	10	9	8	7	6	5	4	3	2	1	0
R	Reserved															DAISY
W	Reserved															DAISY
Reset	0	0	0	0	0	0	0	0	0	0	0	0	0	0	0	0

IOMUXC_ANATOP_USB_OTG_ID_SELECT_INPUT field descriptions

Field	Description
31–2 -	This field is reserved. Reserved
DAISY	Selecting Pads Involved in Daisy Chain. Instance: anatop, In Pin: usb_otg_id 00 GPIO1_IO00_ALT2 — Selecting Pad: GPIO1_IO00 for Mode: ALT2 01 UART3_TX_DATA_ALT8 — Selecting Pad: UART3_TX_DATA for Mode: ALT8 10 SD1_DATA0_ALT8 — Selecting Pad: SD1_DATA0 for Mode: ALT8

32.6.270 USB_OTG2_ID_SELECT_INPUT DAISY Register (IOMUXC_USB_OTG2_ID_SELECT_INPUT)

DAISY Register

Address: 20E_0000h base + 4BCh offset = 20E_04BCh

Bit	31	30	29	28	27	26	25	24	23	22	21	20	19	18	17	16
R	Reserved															
W	Reserved															
Reset	0	0	0	0	0	0	0	0	0	0	0	0	0	0	0	0
Bit	15	14	13	12	11	10	9	8	7	6	5	4	3	2	1	0
R	Reserved															DAISY
W	Reserved															DAISY
Reset	0	0	0	0	0	0	0	0	0	0	0	0	0	0	0	0

IOMUXC_USB_OTG2_ID_SELECT_INPUT field descriptions

Field	Description
31–2 -	This field is reserved. Reserved
DAISY	Selecting Pads Involved in Daisy Chain. Instance: anatop, In Pin: usb_uh1_id 00 GPIO1_IO05_ALT2 — Selecting Pad: GPIO1_IO05 for Mode: ALT2 01 ENET2_TX_CLK_ALT8 — Selecting Pad: ENET2_TX_CLK for Mode: ALT8 10 SD1_DATA3_ALT8 — Selecting Pad: SD1_DATA3 for Mode: ALT8

32.6.271 CCM_PMIC_READY_SELECT_INPUT DAISY Register (IOMUXC_CCM_PMIC_READY_SELECT_INPUT)

DAISY Register

Address: 20E_0000h base + 4C0h offset = 20E_04C0h

Bit	31	30	29	28	27	26	25	24		23	22	21	20	19	18	17	16
R	Reserved																
W																	
Reset	0	0	0	0	0	0	0	0		0	0	0	0	0	0	0	0
Bit	15	14	13	12	11	10	9	8		7	6	5	4	3	2	1	0
R	Reserved															DAISY	
W																	
Reset	0	0	0	0	0	0	0	0		0	0	0	0	0	0	0	0

IOMUXC_CCM_PMIC_READY_SELECT_INPUT field descriptions

Field	Description
31–1 -	This field is reserved. Reserved
0 DAISY	Selecting Pads Involved in Daisy Chain. Instance: ccm, In Pin: pmic_ready 0 JTAG_MOD_ALT4 — Selecting Pad: JTAG_MOD for Mode: ALT4 1 GPIO1_IO08_ALT6 — Selecting Pad: GPIO1_IO08 for Mode: ALT6

32.6.272 CSI_DATA02_SELECT_INPUT DAISY Register (IOMUXC_CSI_DATA02_SELECT_INPUT)

DAISY Register

Address: 20E_0000h base + 4C4h offset = 20E_04C4h

Bit	31	30	29	28	27	26	25	24		23	22	21	20	19	18	17	16
R	Reserved																
W	Reserved																
Reset	0	0	0	0	0	0	0	0		0	0	0	0	0	0	0	0
Bit	15	14	13	12	11	10	9	8		7	6	5	4	3	2	1	0
R	Reserved															DAISY	
W	Reserved															DAISY	
Reset	0	0	0	0	0	0	0	0		0	0	0	0	0	0	0	0

IOMUXC_CSI_DATA02_SELECT_INPUT field descriptions

Field	Description
31–1 -	This field is reserved. Reserved
0 DAISY	Selecting Pads Involved in Daisy Chain. Instance: csi, In Pin: csi_d2 0 CSI_DATA00_ALT0 — Selecting Pad: CSI_DATA00 for Mode: ALT0 1 UART1_TX_DATA_ALT3 — Selecting Pad: UART1_TX_DATA for Mode: ALT3

32.6.273 CSI_DATA03_SELECT_INPUT DAISY Register (IOMUXC_CSI_DATA03_SELECT_INPUT)

DAISY Register

Address: 20E_0000h base + 4C8h offset = 20E_04C8h

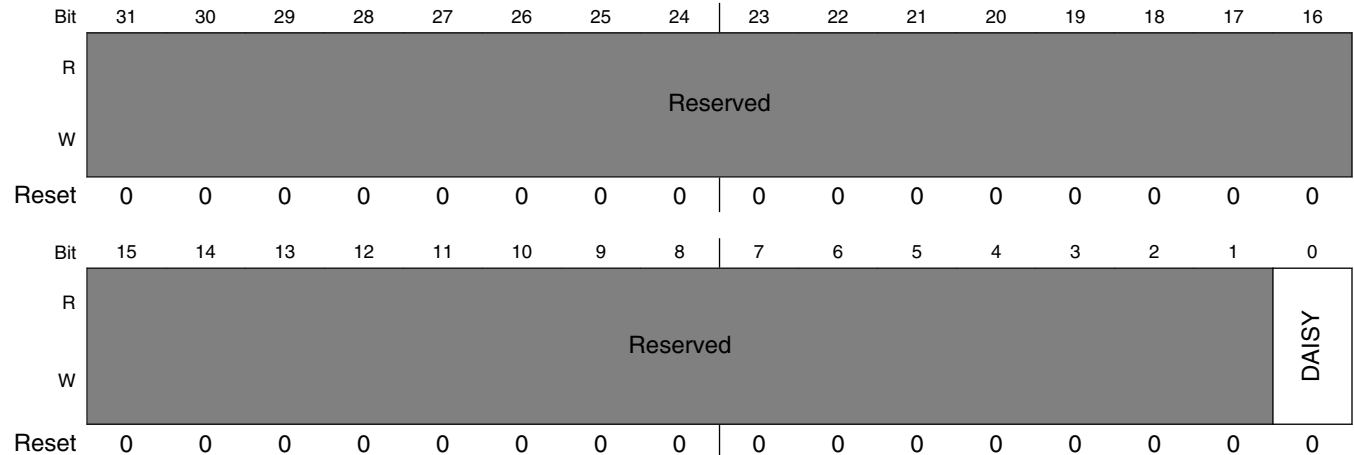

IOMUXC_CSI_DATA03_SELECT_INPUT field descriptions

Field	Description
31–1 -	This field is reserved. Reserved
0 DAISY	Selecting Pads Involved in Daisy Chain. Instance: csi, In Pin: csi_d3 0 CSI_DATA01_ALT0 — Selecting Pad: CSI_DATA01 for Mode: ALT0 1 UART1_RX_DATA_ALT3 — Selecting Pad: UART1_RX_DATA for Mode: ALT3

32.6.274 CSI_DATA05_SELECT_INPUT DAISY Register (IOMUXC_CSI_DATA05_SELECT_INPUT)

DAISY Register

Address: 20E_0000h base + 4CCh offset = 20E_04CCh

Bit	31	30	29	28	27	26	25	24		23	22	21	20	19	18	17	16
R	Reserved																
W	Reserved																
Reset	0	0	0	0	0	0	0	0		0	0	0	0	0	0	0	0
Bit	15	14	13	12	11	10	9	8		7	6	5	4	3	2	1	0
R	Reserved															DAISY	
W	Reserved															DAISY	
Reset	0	0	0	0	0	0	0	0		0	0	0	0	0	0	0	0

IOMUXC_CSI_DATA05_SELECT_INPUT field descriptions

Field	Description
31–1 -	This field is reserved. Reserved
0 DAISY	Selecting Pads Involved in Daisy Chain. Instance: csi, In Pin: csi_d5 0 CSI_DATA03_ALTO — Selecting Pad: CSI_DATA03 for Mode: ALTO 1 UART1_RTS_B_ALT3 — Selecting Pad: UART1_RTS_B for Mode: ALT3

32.6.275 CSI_DATA00_SELECT_INPUT DAISY Register (IOMUXC_CSI_DATA00_SELECT_INPUT)

DAISY Register

Address: 20E_0000h base + 4D0h offset = 20E_04D0h

Bit	31	30	29	28	27	26	25	24		23	22	21	20	19	18	17	16
R	Reserved																
W																	
Reset	0	0	0	0	0	0	0	0		0	0	0	0	0	0	0	0
Bit	15	14	13	12	11	10	9	8		7	6	5	4	3	2	1	0
R	Reserved															DAISY	
W																	
Reset	0	0	0	0	0	0	0	0		0	0	0	0	0	0	0	0

IOMUXC_CSI_DATA00_SELECT_INPUT field descriptions

Field	Description
31–1 -	This field is reserved. Reserved
0 DAISY	Selecting Pads Involved in Daisy Chain. Instance: csi, In Pin: csi_d0 0 UART3_RX_DATA_ALT3 — Selecting Pad: UART3_RX_DATA for Mode: ALT3 1 LCD_DATA17_ALT3 — Selecting Pad: LCD_DATA17 for Mode: ALT3

32.6.276 CSI_DATA01_SELECT_INPUT DAISY Register (IOMUXC_CSI_DATA01_SELECT_INPUT)

DAISY Register

Address: 20E_0000h base + 4D4h offset = 20E_04D4h

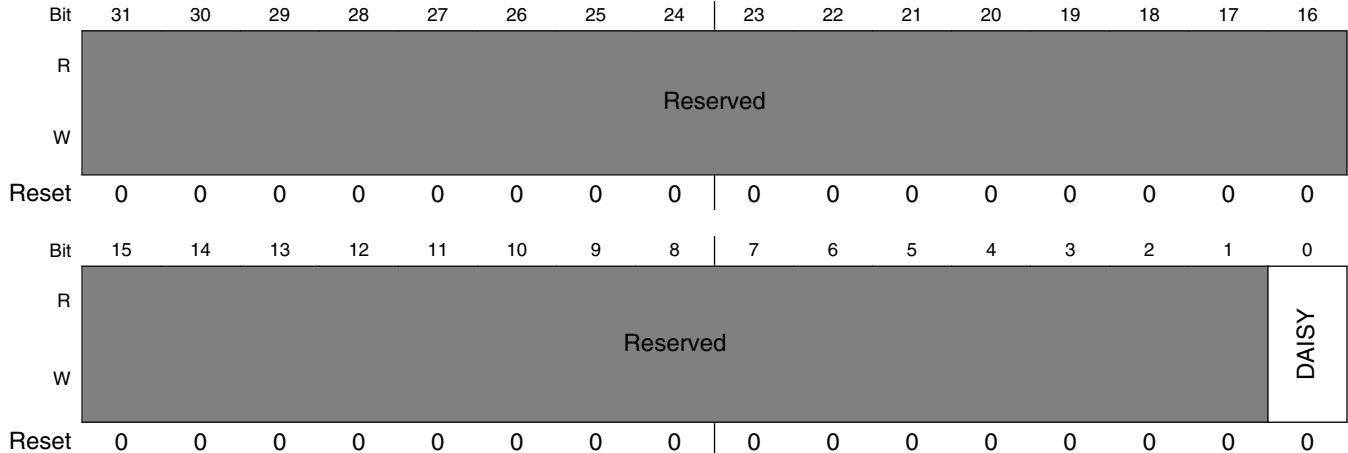

IOMUXC_CSI_DATA01_SELECT_INPUT field descriptions

Field	Description
31-1 -	This field is reserved. Reserved
0 DAISY	Selecting Pads Involved in Daisy Chain. Instance: csi, In Pin: csi_d1 0 UART3_TX_DATA_ALT3 — Selecting Pad: UART3_TX_DATA for Mode: ALT3 1 LCD_DATA16_ALT3 — Selecting Pad: LCD_DATA16 for Mode: ALT3

32.6.277 CSI_DATA04_SELECT_INPUT DAISY Register (IOMUXC_CSI_DATA04_SELECT_INPUT)

DAISY Register

Address: 20E_0000h base + 4D8h offset = 20E_04D8h

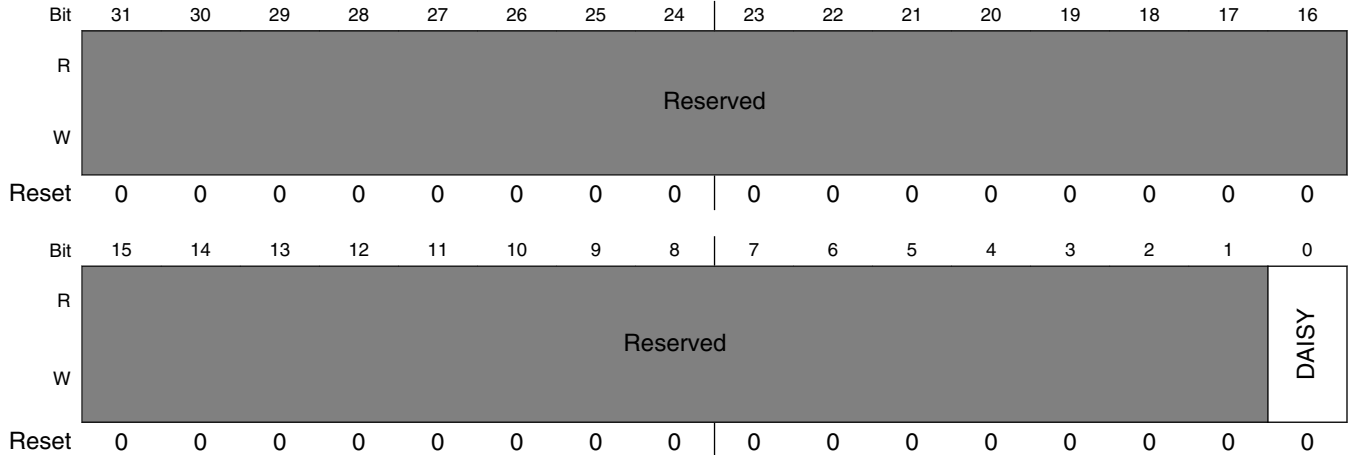

IOMUXC_CSI_DATA04_SELECT_INPUT field descriptions

Field	Description
31–1 -	This field is reserved. Reserved
0 DAISY	Selecting Pads Involved in Daisy Chain. Instance: csi, In Pin: csi_d4 0 UART1_CTS_B_ALT3 — Selecting Pad: UART1_CTS_B for Mode: ALT3 1 CSI_DATA02_ALT0 — Selecting Pad: CSI_DATA02 for Mode: ALT0

32.6.278 CSI_DATA06_SELECT_INPUT DAISY Register (IOMUXC_CSI_DATA06_SELECT_INPUT)

DAISY Register

Address: 20E_0000h base + 4DCh offset = 20E_04DCh

Bit	31	30	29	28	27	26	25	24		23	22	21	20	19	18	17	16
R	Reserved																
W	Reserved																
Reset	0	0	0	0	0	0	0	0		0	0	0	0	0	0	0	0
Bit	15	14	13	12	11	10	9	8		7	6	5	4	3	2	1	0
R	Reserved															DAISY	
W	Reserved															DAISY	
Reset	0	0	0	0	0	0	0	0		0	0	0	0	0	0	0	0

IOMUXC_CSI_DATA06_SELECT_INPUT field descriptions

Field	Description
31–1 -	This field is reserved. Reserved
0 DAISY	Selecting Pads Involved in Daisy Chain. Instance: csi, In Pin: csi_d6 0 UART2_TX_DATA_ALT3 — Selecting Pad: UART2_TX_DATA for Mode: ALT3 1 CSI_DATA04_ALT0 — Selecting Pad: CSI_DATA04 for Mode: ALT0

32.6.279 CSI_DATA07_SELECT_INPUT DAISY Register (IOMUXC_CSI_DATA07_SELECT_INPUT)

DAISY Register

Address: 20E_0000h base + 4E0h offset = 20E_04E0h

Bit	31	30	29	28	27	26	25	24		23	22	21	20	19	18	17	16
R	Reserved																
W																	
Reset	0	0	0	0	0	0	0	0		0	0	0	0	0	0	0	0
Bit	15	14	13	12	11	10	9	8		7	6	5	4	3	2	1	0
R	Reserved															DAISY	
W																	
Reset	0	0	0	0	0	0	0	0		0	0	0	0	0	0	0	0

IOMUXC_CSI_DATA07_SELECT_INPUT field descriptions

Field	Description
31–1 -	This field is reserved. Reserved
0 DAISY	Selecting Pads Involved in Daisy Chain. Instance: csi, In Pin: csi_d7 0 UART2_RX_DATA_ALT3 — Selecting Pad: UART2_RX_DATA for Mode: ALT3 1 CSI_DATA05_ALT0 — Selecting Pad: CSI_DATA05 for Mode: ALT0

32.6.280 CSI_DATA08_SELECT_INPUT DAISY Register (IOMUXC_CSI_DATA08_SELECT_INPUT)

DAISY Register

Address: 20E_0000h base + 4E4h offset = 20E_04E4h

Bit	31	30	29	28	27	26	25	24		23	22	21	20	19	18	17	16
R	Reserved																
W	Reserved																
Reset	0	0	0	0	0	0	0	0		0	0	0	0	0	0	0	0
Bit	15	14	13	12	11	10	9	8		7	6	5	4	3	2	1	0
R	Reserved															DAISY	
W	Reserved															DAISY	
Reset	0	0	0	0	0	0	0	0		0	0	0	0	0	0	0	0

IOMUXC_CSI_DATA08_SELECT_INPUT field descriptions

Field	Description
31–1 -	This field is reserved. Reserved
0 DAISY	Selecting Pads Involved in Daisy Chain. Instance: csi, In Pin: csi_d8 0 UART2_CTS_B_ALT3 — Selecting Pad: UART2_CTS_B for Mode: ALT3 1 CSI_DATA06_ALT0 — Selecting Pad: CSI_DATA06 for Mode: ALT0

32.6.281 CSI_DATA09_SELECT_INPUT DAISY Register (IOMUXC_CSI_DATA09_SELECT_INPUT)

DAISY Register

Address: 20E_0000h base + 4E8h offset = 20E_04E8h

Bit	31	30	29	28	27	26	25	24		23	22	21	20	19	18	17	16
R	Reserved																
W																	
Reset	0	0	0	0	0	0	0	0		0	0	0	0	0	0	0	0
Bit	15	14	13	12	11	10	9	8		7	6	5	4	3	2	1	0
R	Reserved															DAISY	
W																	
Reset	0	0	0	0	0	0	0	0		0	0	0	0	0	0	0	0

IOMUXC_CSI_DATA09_SELECT_INPUT field descriptions

Field	Description
31–1 -	This field is reserved. Reserved
0 DAISY	Selecting Pads Involved in Daisy Chain. Instance: csi, In Pin: csi_d9 0 UART2_RTS_B_ALT3 — Selecting Pad: UART2_RTS_B for Mode: ALT3 1 CSI_DATA07_ALTO — Selecting Pad: CSI_DATA07 for Mode: ALTO

32.6.282 CSI_DATA10_SELECT_INPUT DAISY Register (IOMUXC_CSI_DATA10_SELECT_INPUT)

DAISY Register

Address: 20E_0000h base + 4ECh offset = 20E_04ECh

Bit	31	30	29	28	27	26	25	24		23	22	21	20	19	18	17	16
R	Reserved																
W	Reserved																
Reset	0	0	0	0	0	0	0	0		0	0	0	0	0	0	0	0
Bit	15	14	13	12	11	10	9	8		7	6	5	4	3	2	1	0
R	Reserved															DAISY	
W	Reserved															DAISY	
Reset	0	0	0	0	0	0	0	0		0	0	0	0	0	0	0	0

IOMUXC_CSI_DATA10_SELECT_INPUT field descriptions

Field	Description
31–1 -	This field is reserved. Reserved
0 DAISY	Selecting Pads Involved in Daisy Chain. Instance: csi, In Pin: csi_d10 0 UART3_CTS_B_ALT3 — Selecting Pad: UART3_CTS_B for Mode: ALT3 1 LCD_DATA18_ALT3 — Selecting Pad: LCD_DATA18 for Mode: ALT3

32.6.283 CSI_DATA11_SELECT_INPUT DAISY Register (IOMUXC_CSI_DATA11_SELECT_INPUT)

DAISY Register

Address: 20E_0000h base + 4F0h offset = 20E_04F0h

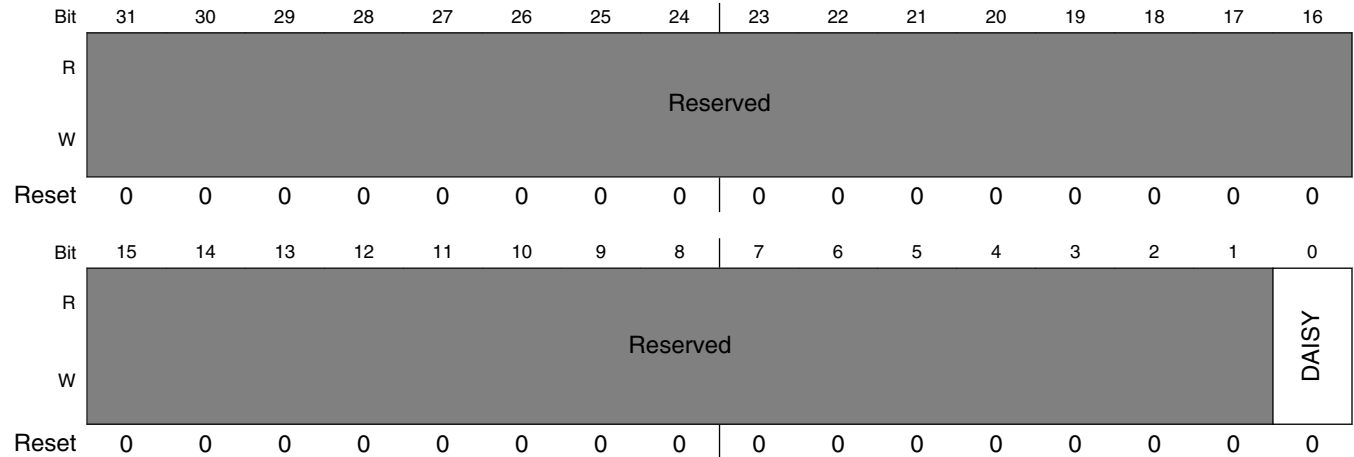

IOMUXC_CSI_DATA11_SELECT_INPUT field descriptions

Field	Description
31–1 -	This field is reserved. Reserved
0 DAISY	Selecting Pads Involved in Daisy Chain. Instance: csi, In Pin: csi_d11 0 UART3_RTS_B_ALT3 — Selecting Pad: UART3_RTS_B for Mode: ALT3 1 LCD_DATA19_ALT3 — Selecting Pad: LCD_DATA19 for Mode: ALT3

32.6.284 CSI_DATA12_SELECT_INPUT DAISY Register (IOMUXC_CSI_DATA12_SELECT_INPUT)

DAISY Register

Address: 20E_0000h base + 4F4h offset = 20E_04F4h

Bit	31	30	29	28	27	26	25	24		23	22	21	20	19	18	17	16
R	Reserved																
W	Reserved																
Reset	0	0	0	0	0	0	0	0		0	0	0	0	0	0	0	0
Bit	15	14	13	12	11	10	9	8		7	6	5	4	3	2	1	0
R	Reserved															DAISY	
W	Reserved															DAISY	
Reset	0	0	0	0	0	0	0	0		0	0	0	0	0	0	0	0

IOMUXC_CSI_DATA12_SELECT_INPUT field descriptions

Field	Description
31–1 -	This field is reserved. Reserved
0 DAISY	Selecting Pads Involved in Daisy Chain. Instance: csi, In Pin: csi_d12 0 UART4_TX_DATA_ALT3 — Selecting Pad: UART4_TX_DATA for Mode: ALT3 1 LCD_DATA20_ALT3 — Selecting Pad: LCD_DATA20 for Mode: ALT3

32.6.285 CSI_DATA13_SELECT_INPUT DAISY Register (IOMUXC_CSI_DATA13_SELECT_INPUT)

DAISY Register

Address: 20E_0000h base + 4F8h offset = 20E_04F8h

Bit	31	30	29	28	27	26	25	24		23	22	21	20	19	18	17	16
R	Reserved																
W																	
Reset	0	0	0	0	0	0	0	0		0	0	0	0	0	0	0	0
Bit	15	14	13	12	11	10	9	8		7	6	5	4	3	2	1	0
R	Reserved															DAISY	
W																	
Reset	0	0	0	0	0	0	0	0		0	0	0	0	0	0	0	0

IOMUXC_CSI_DATA13_SELECT_INPUT field descriptions

Field	Description
31–1 -	This field is reserved. Reserved
0 DAISY	Selecting Pads Involved in Daisy Chain. Instance: csi, In Pin: csi_d13 0 UART4_RX_DATA_ALT3 — Selecting Pad: UART4_RX_DATA for Mode: ALT3 1 LCD_DATA21_ALT3 — Selecting Pad: LCD_DATA21 for Mode: ALT3

32.6.286 CSI_DATA14_SELECT_INPUT DAISY Register (IOMUXC_CSI_DATA14_SELECT_INPUT)

DAISY Register

Address: 20E_0000h base + 4FCh offset = 20E_04FCh

Bit	31	30	29	28	27	26	25	24		23	22	21	20	19	18	17	16
R	Reserved																
W	Reserved																
Reset	0	0	0	0	0	0	0	0		0	0	0	0	0	0	0	0
Bit	15	14	13	12	11	10	9	8		7	6	5	4	3	2	1	0
R	Reserved															DAISY	
W	Reserved															DAISY	
Reset	0	0	0	0	0	0	0	0		0	0	0	0	0	0	0	0

IOMUXC_CSI_DATA14_SELECT_INPUT field descriptions

Field	Description
31–1 -	This field is reserved. Reserved
0 DAISY	Selecting Pads Involved in Daisy Chain. Instance: csi, In Pin: csi_d14 0 UART5_TX_DATA_ALT3 — Selecting Pad: UART5_TX_DATA for Mode: ALT3 1 LCD_DATA22_ALT3 — Selecting Pad: LCD_DATA22 for Mode: ALT3

32.6.287 CSI_DATA15_SELECT_INPUT DAISY Register (IOMUXC_CSI_DATA15_SELECT_INPUT)

DAISY Register

Address: 20E_0000h base + 500h offset = 20E_0500h

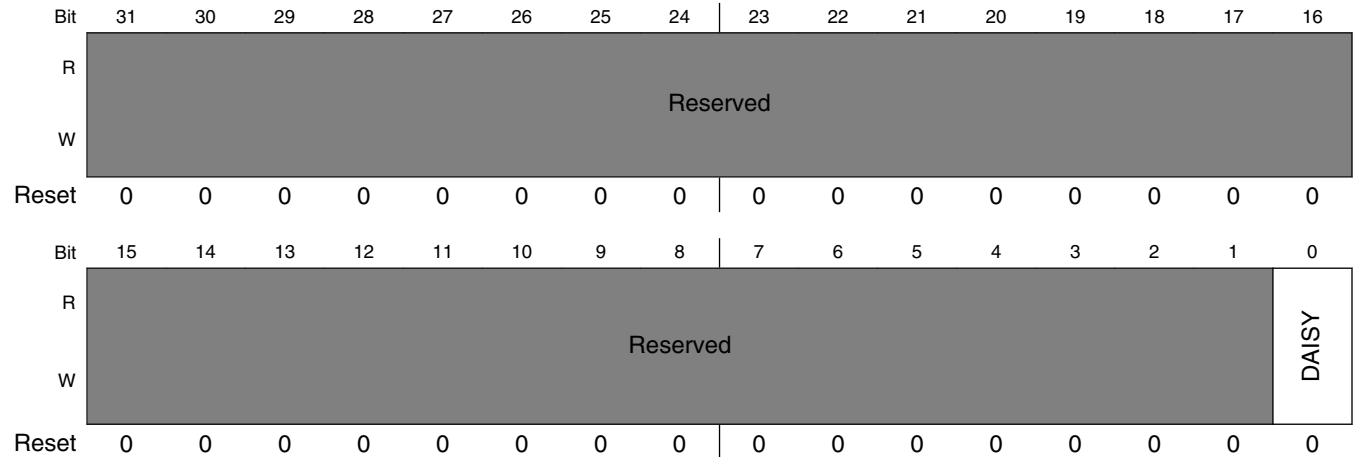

IOMUXC_CSI_DATA15_SELECT_INPUT field descriptions

Field	Description
31–1 -	This field is reserved. Reserved
0 DAISY	Selecting Pads Involved in Daisy Chain. Instance: csi, In Pin: csi_d15 0 UART5_RX_DATA_ALT3 — Selecting Pad: UART5_RX_DATA for Mode: ALT3 1 LCD_DATA23_ALT3 — Selecting Pad: LCD_DATA23 for Mode: ALT3

32.6.288 CSI_DATA16_SELECT_INPUT DAISY Register (IOMUXC_CSI_DATA16_SELECT_INPUT)

DAISY Register

Address: 20E_0000h base + 504h offset = 20E_0504h

Bit	31	30	29	28	27	26	25	24		23	22	21	20	19	18	17	16
R	Reserved																
W	Reserved																
Reset	0	0	0	0	0	0	0	0		0	0	0	0	0	0	0	0
Bit	15	14	13	12	11	10	9	8		7	6	5	4	3	2	1	0
R	Reserved															DAISY	
W	Reserved															DAISY	
Reset	0	0	0	0	0	0	0	0		0	0	0	0	0	0	0	0

IOMUXC_CSI_DATA16_SELECT_INPUT field descriptions

Field	Description
31–1 -	This field is reserved. Reserved
0 DAISY	Selecting Pads Involved in Daisy Chain. Instance: csi, In Pin: csi_d16 0 ENET1_RX_DATA0_ALT3 — Selecting Pad: ENET1_RX_DATA0 for Mode: ALT3 1 LCD_DATA08_ALT3 — Selecting Pad: LCD_DATA08 for Mode: ALT3

32.6.289 CSI_DATA17_SELECT_INPUT DAISY Register (IOMUXC_CSI_DATA17_SELECT_INPUT)

DAISY Register

Address: 20E_0000h base + 508h offset = 20E_0508h

Bit	31	30	29	28	27	26	25	24		23	22	21	20	19	18	17	16
R	Reserved																
W																	
Reset	0	0	0	0	0	0	0	0		0	0	0	0	0	0	0	0
Bit	15	14	13	12	11	10	9	8		7	6	5	4	3	2	1	0
R	Reserved															DAISY	
W																	
Reset	0	0	0	0	0	0	0	0		0	0	0	0	0	0	0	0

IOMUXC_CSI_DATA17_SELECT_INPUT field descriptions

Field	Description
31-1 -	This field is reserved. Reserved
0 DAISY	Selecting Pads Involved in Daisy Chain. Instance: csi, In Pin: csi_d17 0 ENET1_RX_DATA1_ALT3 — Selecting Pad: ENET1_RX_DATA1 for Mode: ALT3 1 LCD_DATA09_ALT3 — Selecting Pad: LCD_DATA09 for Mode: ALT3

32.6.290 CSI_DATA18_SELECT_INPUT DAISY Register (IOMUXC_CSI_DATA18_SELECT_INPUT)

DAISY Register

Address: 20E_0000h base + 50Ch offset = 20E_050Ch

Bit	31	30	29	28	27	26	25	24		23	22	21	20	19	18	17	16
R	Reserved																
W	Reserved																
Reset	0	0	0	0	0	0	0	0		0	0	0	0	0	0	0	0
Bit	15	14	13	12	11	10	9	8		7	6	5	4	3	2	1	0
R	Reserved															DAISY	
W	Reserved															DAISY	
Reset	0	0	0	0	0	0	0	0		0	0	0	0	0	0	0	0

IOMUXC_CSI_DATA18_SELECT_INPUT field descriptions

Field	Description
31–1 -	This field is reserved. Reserved
0 DAISY	Selecting Pads Involved in Daisy Chain. Instance: csi, In Pin: csi_d18 0 ENET1_RX_EN_ALT3 — Selecting Pad: ENET1_RX_EN for Mode: ALT3 1 LCD_DATA10_ALT3 — Selecting Pad: LCD_DATA10 for Mode: ALT3

32.6.291 CSI_DATA19_SELECT_INPUT DAISY Register (IOMUXC_CSI_DATA19_SELECT_INPUT)

DAISY Register

Address: 20E_0000h base + 510h offset = 20E_0510h

Bit	31	30	29	28	27	26	25	24		23	22	21	20	19	18	17	16
R	Reserved																
W																	
Reset	0	0	0	0	0	0	0	0		0	0	0	0	0	0	0	0
Bit	15	14	13	12	11	10	9	8		7	6	5	4	3	2	1	0
R	Reserved															DAISY	
W																	
Reset	0	0	0	0	0	0	0	0		0	0	0	0	0	0	0	0

IOMUXC_CSI_DATA19_SELECT_INPUT field descriptions

Field	Description
31–1 -	This field is reserved. Reserved
0 DAISY	Selecting Pads Involved in Daisy Chain. Instance: csi, In Pin: csi_d19 0 ENET1_TX_DATA0_ALT3 — Selecting Pad: ENET1_TX_DATA0 for Mode: ALT3 1 LCD_DATA11_ALT3 — Selecting Pad: LCD_DATA11 for Mode: ALT3

32.6.292 CSI_DATA20_SELECT_INPUT DAISY Register (IOMUXC_CSI_DATA20_SELECT_INPUT)

DAISY Register

Address: 20E_0000h base + 514h offset = 20E_0514h

Bit	31	30	29	28	27	26	25	24		23	22	21	20	19	18	17	16
R	Reserved																
W	Reserved																
Reset	0	0	0	0	0	0	0	0		0	0	0	0	0	0	0	0
Bit	15	14	13	12	11	10	9	8		7	6	5	4	3	2	1	0
R	Reserved															DAISY	
W	Reserved															DAISY	
Reset	0	0	0	0	0	0	0	0		0	0	0	0	0	0	0	0

IOMUXC_CSI_DATA20_SELECT_INPUT field descriptions

Field	Description
31–1 -	This field is reserved. Reserved
0 DAISY	Selecting Pads Involved in Daisy Chain. Instance: csi, In Pin: csi_d20 0 ENET1_TX_DATA1_ALT3 — Selecting Pad: ENET1_TX_DATA1 for Mode: ALT3 1 LCD_DATA12_ALT3 — Selecting Pad: LCD_DATA12 for Mode: ALT3

32.6.293 CSI_DATA21_SELECT_INPUT DAISY Register (IOMUXC_CSI_DATA21_SELECT_INPUT)

DAISY Register

Address: 20E_0000h base + 518h offset = 20E_0518h

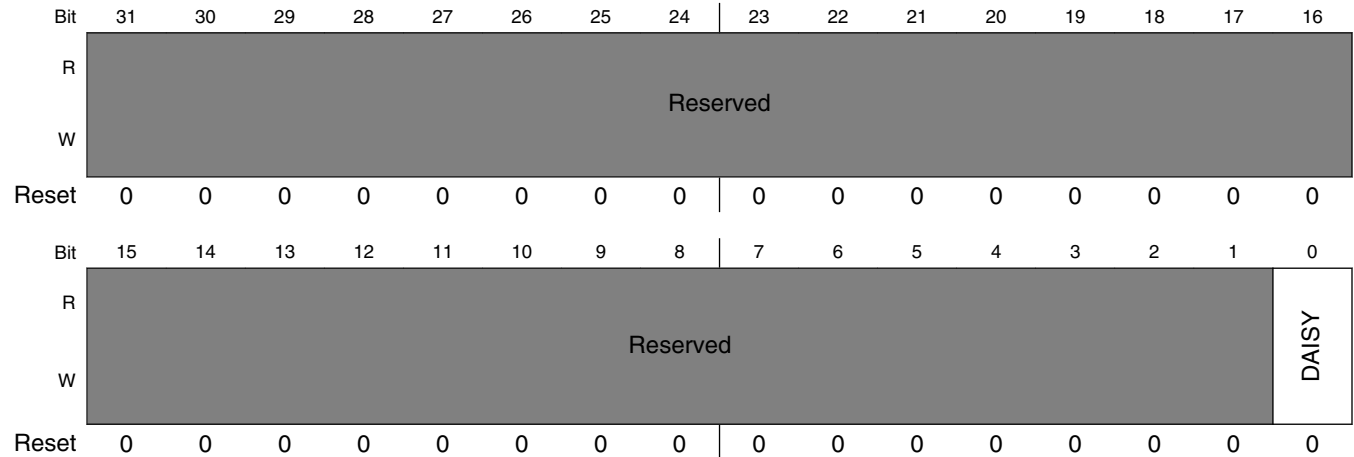

IOMUXC_CSI_DATA21_SELECT_INPUT field descriptions

Field	Description
31–1 -	This field is reserved. Reserved
0 DAISY	Selecting Pads Involved in Daisy Chain. Instance: csi, In Pin: csi_d21 0 ENET1_TX_EN_ALT3 — Selecting Pad: ENET1_TX_EN for Mode: ALT3 1 LCD_DATA13_ALT3 — Selecting Pad: LCD_DATA13 for Mode: ALT3

32.6.294 CSI_DATA22_SELECT_INPUT DAISY Register (IOMUXC_CSI_DATA22_SELECT_INPUT)

DAISY Register

Address: 20E_0000h base + 51Ch offset = 20E_051Ch

Bit	31	30	29	28	27	26	25	24		23	22	21	20	19	18	17	16
R	Reserved																
W	Reserved																
Reset	0	0	0	0	0	0	0	0		0	0	0	0	0	0	0	0
Bit	15	14	13	12	11	10	9	8		7	6	5	4	3	2	1	0
R	Reserved															DAISY	
W	Reserved															DAISY	
Reset	0	0	0	0	0	0	0	0		0	0	0	0	0	0	0	0

IOMUXC_CSI_DATA22_SELECT_INPUT field descriptions

Field	Description
31–1 -	This field is reserved. Reserved
0 DAISY	Selecting Pads Involved in Daisy Chain. Instance: csi, In Pin: csi_d22 0 ENET1_TX_CLK_ALT3 — Selecting Pad: ENET1_TX_CLK for Mode: ALT3 1 LCD_DATA14_ALT3 — Selecting Pad: LCD_DATA14 for Mode: ALT3

32.6.295 CSI_DATA23_SELECT_INPUT DAISY Register (IOMUXC_CSI_DATA23_SELECT_INPUT)

DAISY Register

Address: 20E_0000h base + 520h offset = 20E_0520h

Bit	31	30	29	28	27	26	25	24		23	22	21	20	19	18	17	16
R	Reserved																
W																	
Reset	0	0	0	0	0	0	0	0		0	0	0	0	0	0	0	0
Bit	15	14	13	12	11	10	9	8		7	6	5	4	3	2	1	0
R	Reserved															DAISY	
W																	
Reset	0	0	0	0	0	0	0	0		0	0	0	0	0	0	0	0

IOMUXC_CSI_DATA23_SELECT_INPUT field descriptions

Field	Description
31-1 -	This field is reserved. Reserved
0 DAISY	Selecting Pads Involved in Daisy Chain. Instance: csi, In Pin: csi_d23 0 ENET1_RX_ER_ALT3 — Selecting Pad: ENET1_RX_ER for Mode: ALT3 1 LCD_DATA15_ALT3 — Selecting Pad: LCD_DATA15 for Mode: ALT3

32.6.296 CSI_HSYNC_SELECT_INPUT DAISY Register (IOMUXC_CSI_HSYNC_SELECT_INPUT)

DAISY Register

Address: 20E_0000h base + 524h offset = 20E_0524h

Bit	31	30	29	28	27	26	25	24		23	22	21	20	19	18	17	16
R	Reserved																
W	Reserved																
Reset	0	0	0	0	0	0	0	0		0	0	0	0	0	0	0	0
Bit	15	14	13	12	11	10	9	8		7	6	5	4	3	2	1	0
R	Reserved															DAISY	
W	Reserved															DAISY	
Reset	0	0	0	0	0	0	0	0		0	0	0	0	0	0	0	0

IOMUXC_CSI_HSYNC_SELECT_INPUT field descriptions

Field	Description
31–1 -	This field is reserved. Reserved
0 DAISY	Selecting Pads Involved in Daisy Chain. Instance: csi, In Pin: csi_hsync 0 CSI_HSYNC_ALT0 — Selecting Pad: CSI_HSYNC for Mode: ALT0 1 GPIO1_IO09_ALT3 — Selecting Pad: GPIO1_IO09 for Mode: ALT3

32.6.297 CSI_PIXCLK_SELECT_INPUT DAISY Register (IOMUXC_CSI_PIXCLK_SELECT_INPUT)

DAISY Register

Address: 20E_0000h base + 528h offset = 20E_0528h

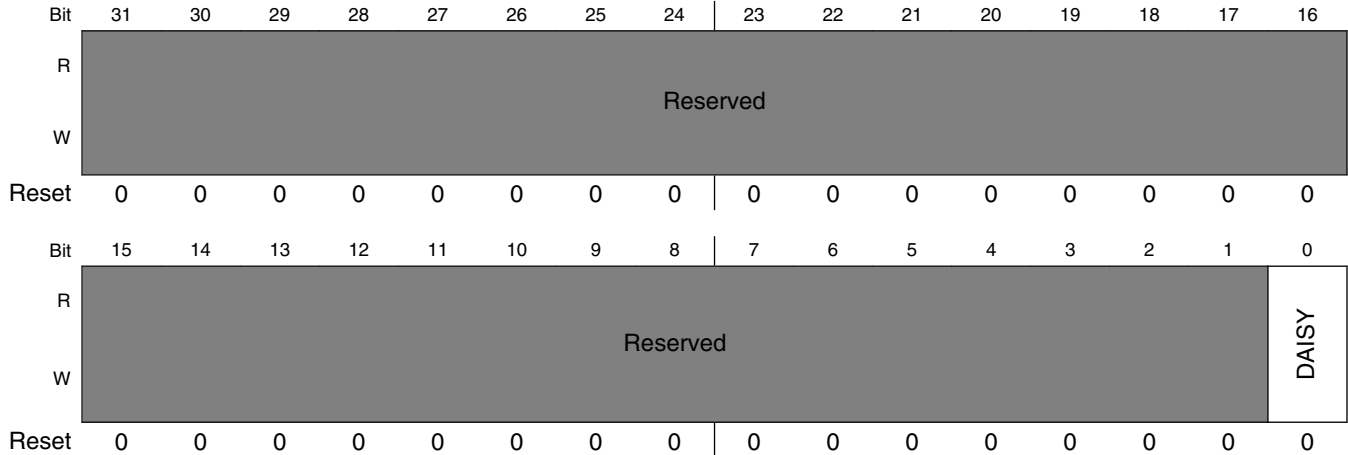

IOMUXC_CSI_PIXCLK_SELECT_INPUT field descriptions

Field	Description
31–1 -	This field is reserved. Reserved
0 DAISY	Selecting Pads Involved in Daisy Chain. Instance: csi, In Pin: csi_pixclk 0 GPIO1_IO07_ALT3 — Selecting Pad: GPIO1_IO07 for Mode: ALT3 1 CSI_PIXCLK_ALT0 — Selecting Pad: CSI_PIXCLK for Mode: ALT0

32.6.298 CSI_VSYNC_SELECT_INPUT DAISY Register (IOMUXC_CSI_VSYNC_SELECT_INPUT)

DAISY Register

Address: 20E_0000h base + 52Ch offset = 20E_052Ch

Bit	31	30	29	28	27	26	25	24		23	22	21	20	19	18	17	16
R	Reserved																
W																	
Reset	0	0	0	0	0	0	0	0		0	0	0	0	0	0	0	0
Bit	15	14	13	12	11	10	9	8		7	6	5	4	3	2	1	0
R	Reserved															DAISY	
W																	
Reset	0	0	0	0	0	0	0	0		0	0	0	0	0	0	0	0

IOMUXC_CSI_VSYNC_SELECT_INPUT field descriptions

Field	Description
31–1 -	This field is reserved. Reserved
0 DAISY	Selecting Pads Involved in Daisy Chain. Instance: csi, In Pin: csi_vsync 0 CSI_VSYNC_ALT0 — Selecting Pad: CSI_VSYNC for Mode: ALT0 1 GPIO1_IO08_ALT3 — Selecting Pad: GPIO1_IO08 for Mode: ALT3

32.6.299 CSI_FIELD_SELECT_INPUT DAISY Register (IOMUXC_CSI_FIELD_SELECT_INPUT)

DAISY Register

Address: 20E_0000h base + 530h offset = 20E_0530h

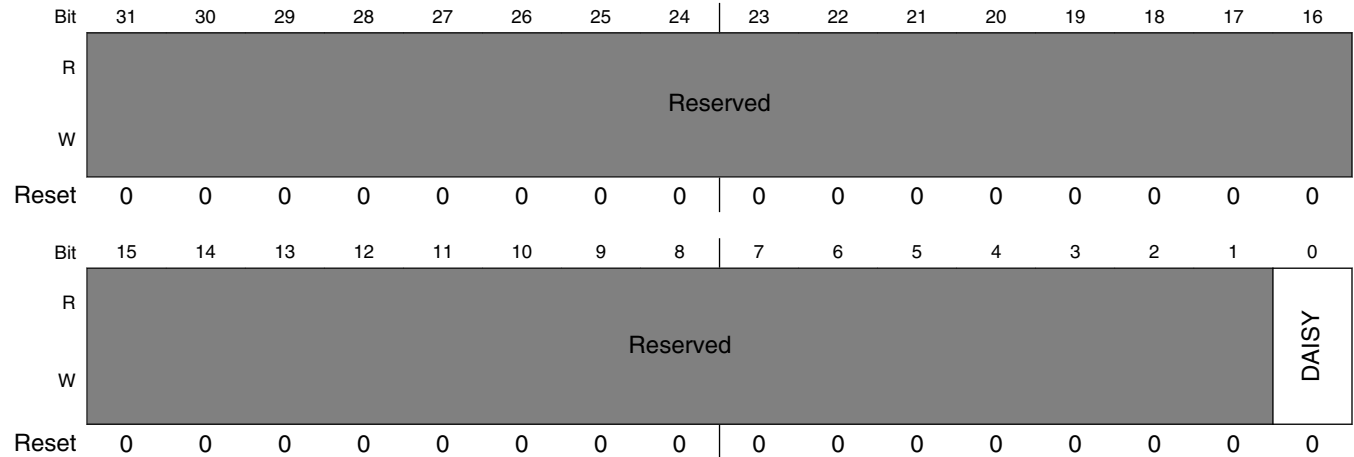

IOMUXC_CSI_FIELD_SELECT_INPUT field descriptions

Field	Description
31-1 -	This field is reserved. Reserved
0 DAISY	Selecting Pads Involved in Daisy Chain. Instance: csi, In Pin: tvdecoder_in_field 0 GPIO1_IO05_ALT3 — Selecting Pad: GPIO1_IO05 for Mode: ALT3 1 NAND_DQS_ALT1 — Selecting Pad: NAND_DQS for Mode: ALT1

32.6.300 ECSPI1_SCLK_SELECT_INPUT DAISY Register (IOMUXC_ECSP11_SCLK_SELECT_INPUT)

DAISY Register

Address: 20E_0000h base + 534h offset = 20E_0534h

Bit	31	30	29	28	27	26	25	24		23	22	21	20	19	18	17	16
R	Reserved																
W																	
Reset	0	0	0	0	0	0	0	0		0	0	0	0	0	0	0	0
Bit	15	14	13	12	11	10	9	8		7	6	5	4	3	2	1	0
R	Reserved															DAISY	
W																	
Reset	0	0	0	0	0	0	0	0		0	0	0	0	0	0	0	0

IOMUXC_ECSP11_SCLK_SELECT_INPUT field descriptions

Field	Description
31–1 -	This field is reserved. Reserved
0 DAISY	Selecting Pads Involved in Daisy Chain. Instance: ecspi1, In Pin: cspi_clk_in 0 LCD_DATA20_ALT2 — Selecting Pad: LCD_DATA20 for Mode: ALT2 1 CSI_DATA04_ALT3 — Selecting Pad: CSI_DATA04 for Mode: ALT3

32.6.301 ECSPI1_MISO_SELECT_INPUT DAISY Register (IOMUXC_ECSP11_MISO_SELECT_INPUT)

DAISY Register

Address: 20E_0000h base + 538h offset = 20E_0538h

Bit	31	30	29	28	27	26	25	24		23	22	21	20	19	18	17	16
R	Reserved																
W																	
Reset	0	0	0	0	0	0	0	0		0	0	0	0	0	0	0	0
Bit	15	14	13	12	11	10	9	8		7	6	5	4	3	2	1	0
R	Reserved															DAISY	
W																	
Reset	0	0	0	0	0	0	0	0		0	0	0	0	0	0	0	0

IOMUXC_ECSP11_MISO_SELECT_INPUT field descriptions

Field	Description
31-1 -	This field is reserved. Reserved
0 DAISY	Selecting Pads Involved in Daisy Chain. Instance: ecspi1, In Pin: miso 0 LCD_DATA23_ALT2 — Selecting Pad: LCD_DATA23 for Mode: ALT2 1 CSI_DATA07_ALT3 — Selecting Pad: CSI_DATA07 for Mode: ALT3

32.6.302 ECSPI1_MOSI_SELECT_INPUT DAISY Register (IOMUXC_ECSP11_MOSI_SELECT_INPUT)

DAISY Register

Address: 20E_0000h base + 53Ch offset = 20E_053Ch

Bit	31	30	29	28	27	26	25	24		23	22	21	20	19	18	17	16
R	Reserved																
W	Reserved																
Reset	0	0	0	0	0	0	0	0		0	0	0	0	0	0	0	0
Bit	15	14	13	12	11	10	9	8		7	6	5	4	3	2	1	0
R	Reserved															DAISY	
W	Reserved															DAISY	
Reset	0	0	0	0	0	0	0	0		0	0	0	0	0	0	0	0

IOMUXC_ECSP11_MOSI_SELECT_INPUT field descriptions

Field	Description
31–1 -	This field is reserved. Reserved
0 DAISY	Selecting Pads Involved in Daisy Chain. Instance: ecspi1, In Pin: mosi 0 LCD_DATA22_ALT2 — Selecting Pad: LCD_DATA22 for Mode: ALT2 1 CSI_DATA06_ALT3 — Selecting Pad: CSI_DATA06 for Mode: ALT3

32.6.303 ECSPi1_SS0_B_SELECT_INPUT DAISY Register (IOMUXC_ECSPi1_SS0_B_SELECT_INPUT)

DAISY Register

Address: 20E_0000h base + 540h offset = 20E_0540h

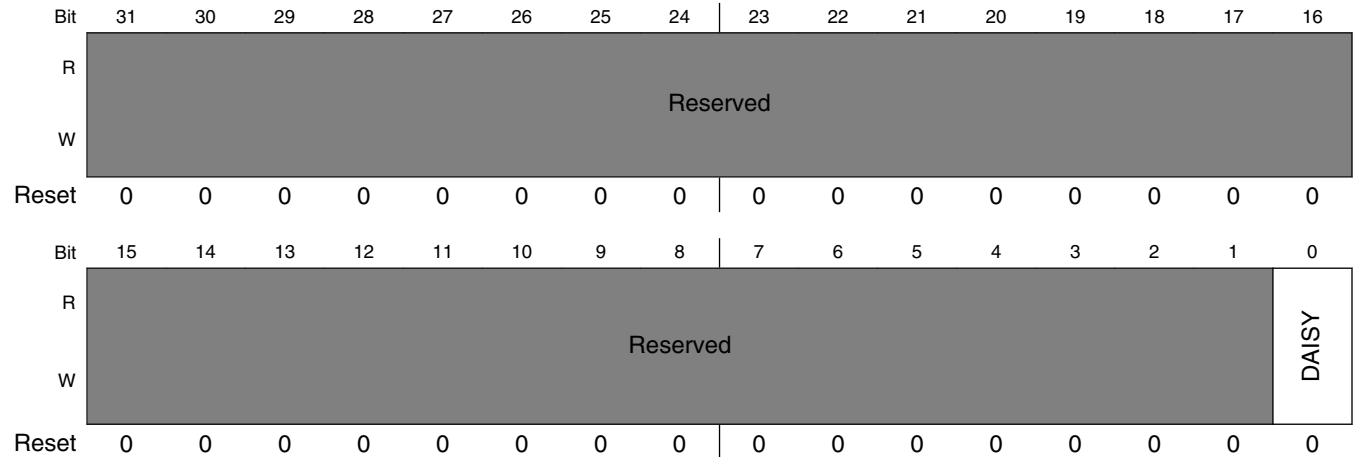

IOMUXC_ECSPi1_SS0_B_SELECT_INPUT field descriptions

Field	Description
31-1 -	This field is reserved. Reserved
0 DAISY	Selecting Pads Involved in Daisy Chain. Instance: ecspi1, In Pin: ss_b0 0 LCD_DATA21_ALT2 — Selecting Pad: LCD_DATA21 for Mode: ALT2 1 CSI_DATA05_ALT3 — Selecting Pad: CSI_DATA05 for Mode: ALT3

32.6.304 ECSPi2_SCLK_SELECT_INPUT DAISY Register (IOMUXC_ECSPi2_SCLK_SELECT_INPUT)

DAISY Register

Address: 20E_0000h base + 544h offset = 20E_0544h

Bit	31	30	29	28	27	26	25	24		23	22	21	20	19	18	17	16
R	Reserved																
W	Reserved																
Reset	0	0	0	0	0	0	0	0		0	0	0	0	0	0	0	0
Bit	15	14	13	12	11	10	9	8		7	6	5	4	3	2	1	0
R	Reserved															DAISY	
W	Reserved															DAISY	
Reset	0	0	0	0	0	0	0	0		0	0	0	0	0	0	0	0

IOMUXC_ECSPi2_SCLK_SELECT_INPUT field descriptions

Field	Description
31–1 -	This field is reserved. Reserved
0 DAISY	Selecting Pads Involved in Daisy Chain. Instance: ecspi2, In Pin: cspi_clk_in 0 CSI_DATA0_ALT3 — Selecting Pad: CSI_DATA0 for Mode: ALT3 1 UART4_TX_DATA_ALT8 — Selecting Pad: UART4_TX_DATA for Mode: ALT8

32.6.305 ECSPi2_MISO_SELECT_INPUT DAISY Register (IOMUXC_ECSPi2_MISO_SELECT_INPUT)

DAISY Register

Address: 20E_0000h base + 548h offset = 20E_0548h

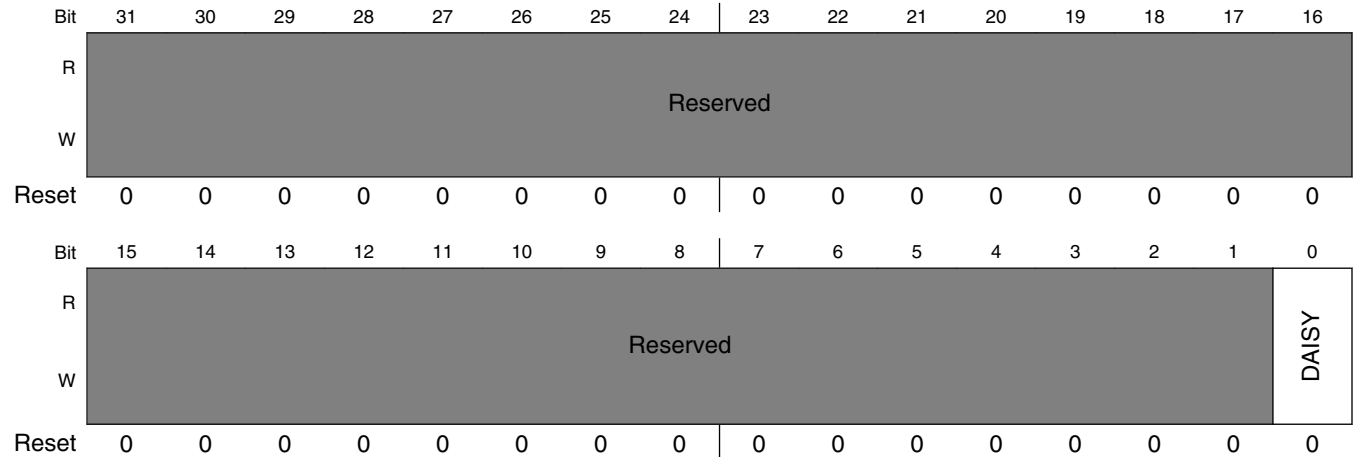

IOMUXC_ECSPi2_MISO_SELECT_INPUT field descriptions

Field	Description
31-1 -	This field is reserved. Reserved
0 DAISY	Selecting Pads Involved in Daisy Chain. Instance: ecspi2, In Pin: miso 0 CSI_DATA03_ALT3 — Selecting Pad: CSI_DATA03 for Mode: ALT3 1 UART5_RX_DATA_ALT8 — Selecting Pad: UART5_RX_DATA for Mode: ALT8

32.6.306 ECSPI2_MOSI_SELECT_INPUT DAISY Register (IOMUXC_ECSPi2_MOSI_SELECT_INPUT)

DAISY Register

Address: 20E_0000h base + 54Ch offset = 20E_054Ch

Bit	31	30	29	28	27	26	25	24		23	22	21	20	19	18	17	16
R	Reserved																
W	Reserved																
Reset	0	0	0	0	0	0	0	0		0	0	0	0	0	0	0	0
Bit	15	14	13	12	11	10	9	8		7	6	5	4	3	2	1	0
R	Reserved															DAISY	
W	Reserved															DAISY	
Reset	0	0	0	0	0	0	0	0		0	0	0	0	0	0	0	0

IOMUXC_ECSPi2_MOSI_SELECT_INPUT field descriptions

Field	Description
31–1 -	This field is reserved. Reserved
0 DAISY	Selecting Pads Involved in Daisy Chain. Instance: ecspi2, In Pin: mosi 0 UART5_TX_DATA_ALT8 — Selecting Pad: UART5_TX_DATA for Mode: ALT8 1 CSI_DATA02_ALT3 — Selecting Pad: CSI_DATA02 for Mode: ALT3

32.6.307 ECSPi2_SS0_B_SELECT_INPUT DAISY Register (IOMUXC_ECSPi2_SS0_B_SELECT_INPUT)

DAISY Register

Address: 20E_0000h base + 550h offset = 20E_0550h

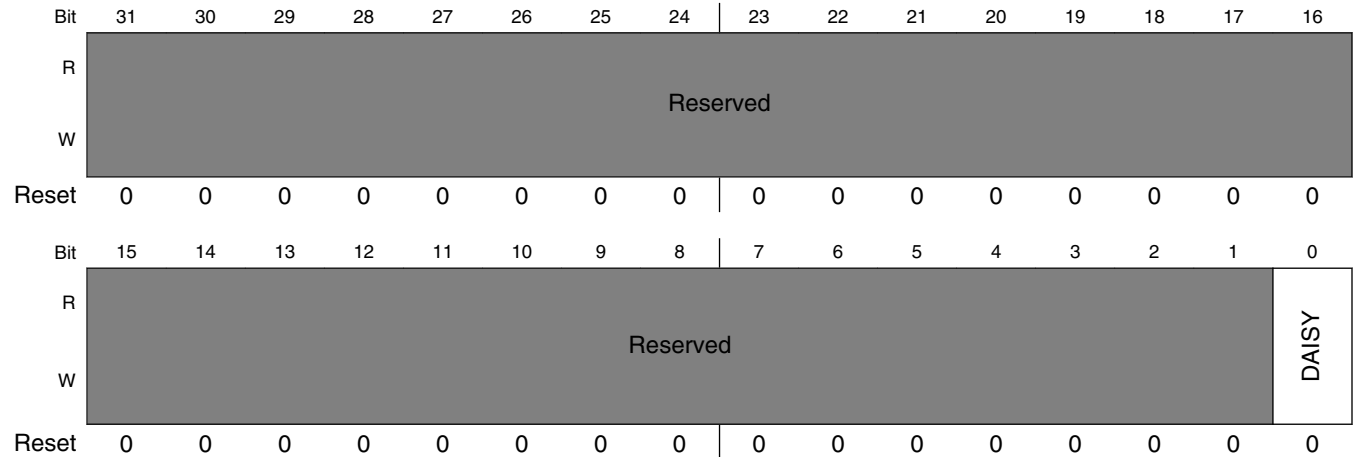

IOMUXC_ECSPi2_SS0_B_SELECT_INPUT field descriptions

Field	Description
31-1 -	This field is reserved. Reserved
0 DAISY	Selecting Pads Involved in Daisy Chain. Instance: ecspi2, In Pin: ss_b0 0 CSI_DATA01_ALT3 — Selecting Pad: CSI_DATA01 for Mode: ALT3 1 UART4_RX_DATA_ALT8 — Selecting Pad: UART4_RX_DATA for Mode: ALT8

32.6.308 ECSPI3_SCLK_SELECT_INPUT DAISY Register (IOMUXC_ECSPi3_SCLK_SELECT_INPUT)

DAISY Register

Address: 20E_0000h base + 554h offset = 20E_0554h

Bit	31	30	29	28	27	26	25	24		23	22	21	20	19	18	17	16
R	Reserved																
W																	
Reset	0	0	0	0	0	0	0	0		0	0	0	0	0	0	0	0
Bit	15	14	13	12	11	10	9	8		7	6	5	4	3	2	1	0
R	Reserved															DAISY	
W																	
Reset	0	0	0	0	0	0	0	0		0	0	0	0	0	0	0	0

IOMUXC_ECSPi3_SCLK_SELECT_INPUT field descriptions

Field	Description
31–1 -	This field is reserved. Reserved
0 DAISY	Selecting Pads Involved in Daisy Chain. Instance: ecspi3, In Pin: cspi_clk_in 0 UART2_RX_DATA_ALT8 — Selecting Pad: UART2_RX_DATA for Mode: ALT8 1 NAND_CE0_B_ALT3 — Selecting Pad: NAND_CE0_B for Mode: ALT3

32.6.309 ECSPI3_MISO_SELECT_INPUT DAISY Register (IOMUXC_ECSPi3_MISO_SELECT_INPUT)

DAISY Register

Address: 20E_0000h base + 558h offset = 20E_0558h

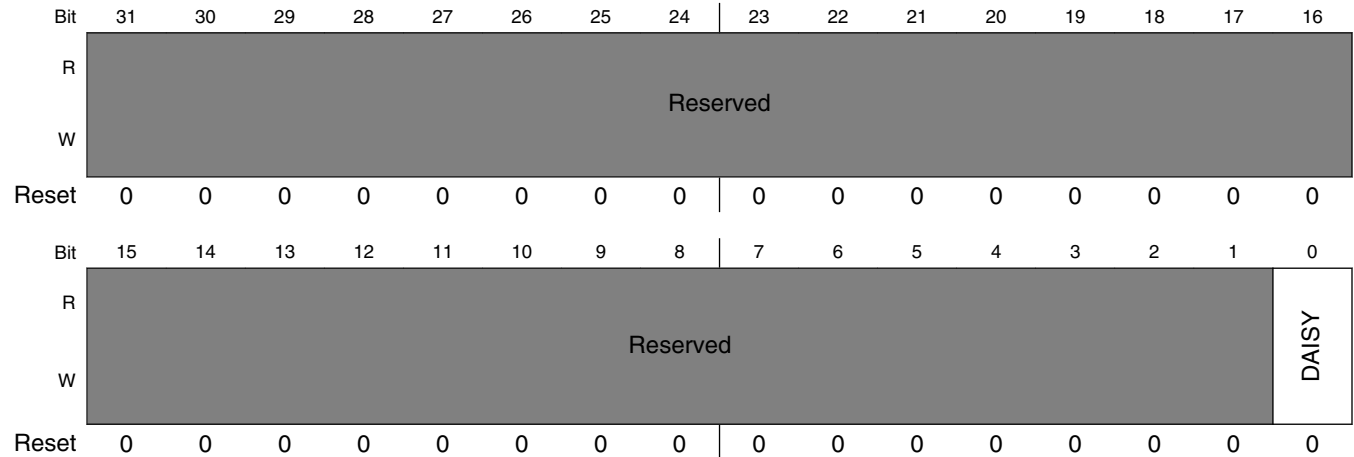

IOMUXC_ECSPi3_MISO_SELECT_INPUT field descriptions

Field	Description
31–1 -	This field is reserved. Reserved
0 DAISY	Selecting Pads Involved in Daisy Chain. Instance: ecspi3, In Pin: miso 0 UART2_RTS_B_ALT8 — Selecting Pad: UART2_RTS_B for Mode: ALT8 1 NAND_CLE_ALT3 — Selecting Pad: NAND_CLE for Mode: ALT3

32.6.310 ECSPI3_MOSI_SELECT_INPUT DAISY Register (IOMUXC_ECSPi3_MOSI_SELECT_INPUT)

DAISY Register

Address: 20E_0000h base + 55Ch offset = 20E_055Ch

Bit	31	30	29	28	27	26	25	24		23	22	21	20	19	18	17	16
R	Reserved																
W	Reserved																
Reset	0	0	0	0	0	0	0	0		0	0	0	0	0	0	0	0
Bit	15	14	13	12	11	10	9	8		7	6	5	4	3	2	1	0
R	Reserved															DAISY	
W	Reserved															DAISY	
Reset	0	0	0	0	0	0	0	0		0	0	0	0	0	0	0	0

IOMUXC_ECSPi3_MOSI_SELECT_INPUT field descriptions

Field	Description
31–1 -	This field is reserved. Reserved
0 DAISY	Selecting Pads Involved in Daisy Chain. Instance: ecspi3, In Pin: mosi 0 UART2_CTS_B_ALT8 — Selecting Pad: UART2_CTS_B for Mode: ALT8 1 NAND_CE1_B_ALT3 — Selecting Pad: NAND_CE1_B for Mode: ALT3

32.6.311 ECSPI3_SS0_B_SELECT_INPUT DAISY Register (IOMUXC_ECSPi3_SS0_B_SELECT_INPUT)

DAISY Register

Address: 20E_0000h base + 560h offset = 20E_0560h

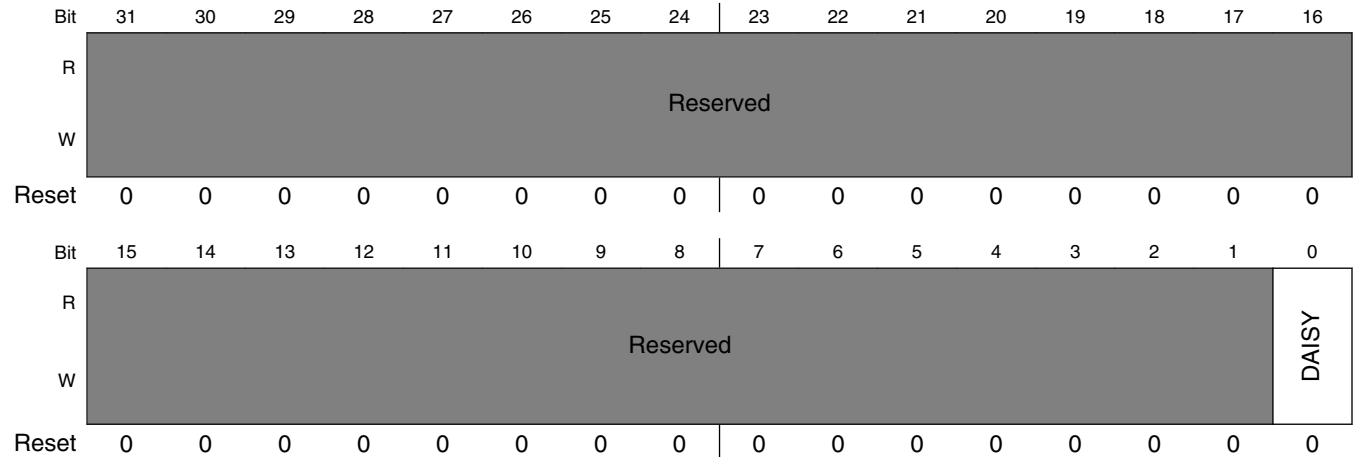

IOMUXC_ECSPi3_SS0_B_SELECT_INPUT field descriptions

Field	Description
31-1 -	This field is reserved. Reserved
0 DAISY	Selecting Pads Involved in Daisy Chain. Instance: ecspi3, In Pin: ss_b0 0 UART2_TX_DATA_ALT8 — Selecting Pad: UART2_TX_DATA for Mode: ALT8 1 NAND_READY_B_ALT3 — Selecting Pad: NAND_READY_B for Mode: ALT3

32.6.312 ECSPi4_SCLK_SELECT_INPUT DAISY Register (IOMUXC_ECSPi4_SCLK_SELECT_INPUT)

DAISY Register

Address: 20E_0000h base + 564h offset = 20E_0564h

Bit	31	30	29	28	27	26	25	24		23	22	21	20	19	18	17	16
R	Reserved																
W																	
Reset	0	0	0	0	0	0	0	0		0	0	0	0	0	0	0	0
Bit	15	14	13	12	11	10	9	8		7	6	5	4	3	2	1	0
R	Reserved															DAISY	
W																	
Reset	0	0	0	0	0	0	0	0		0	0	0	0	0	0	0	0

IOMUXC_ECSPi4_SCLK_SELECT_INPUT field descriptions

Field	Description
31–1 -	This field is reserved. Reserved
0 DAISY	Selecting Pads Involved in Daisy Chain. Instance: ecspi4, In Pin: cspi_clk_in 0 ENET2_TX_DATA1_ALT3 — Selecting Pad: ENET2_TX_DATA1 for Mode: ALT3 1 NAND_DATA04_ALT3 — Selecting Pad: NAND_DATA04 for Mode: ALT3

32.6.313 ECSPi4_MISO_SELECT_INPUT DAISY Register (IOMUXC_ECSPi4_MISO_SELECT_INPUT)

DAISY Register

Address: 20E_0000h base + 568h offset = 20E_0568h

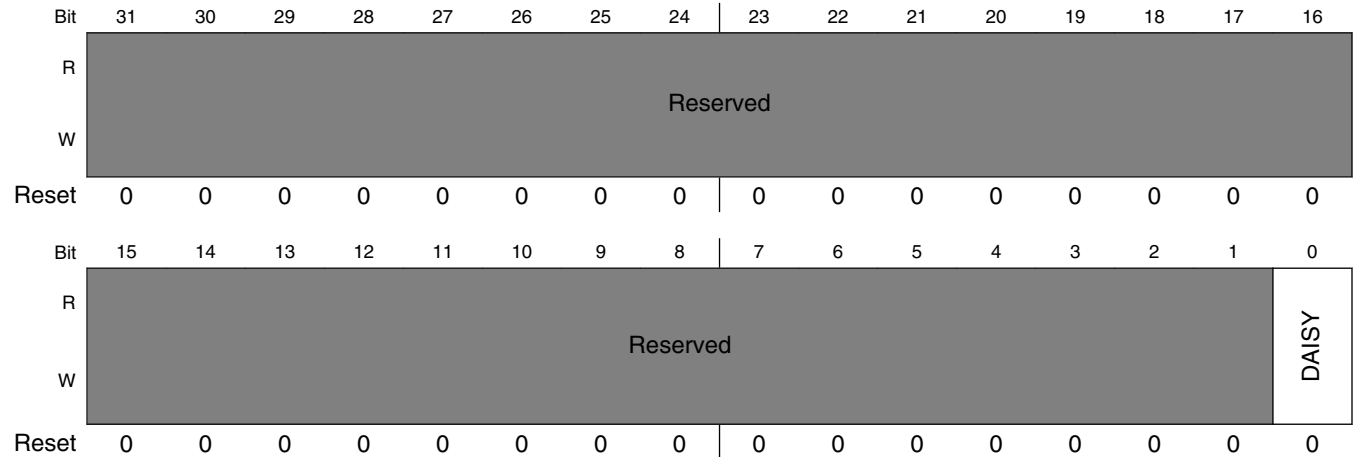

IOMUXC_ECSPi4_MISO_SELECT_INPUT field descriptions

Field	Description
31–1 -	This field is reserved. Reserved
0 DAISY	Selecting Pads Involved in Daisy Chain. Instance: ecspi4, In Pin: miso 0 ENET2_TX_CLK_ALT3 — Selecting Pad: ENET2_TX_CLK for Mode: ALT3 1 NAND_DATA06_ALT3 — Selecting Pad: NAND_DATA06 for Mode: ALT3

32.6.314 ECSPi4_MOSI_SELECT_INPUT DAISY Register (IOMUXC_ECSPi4_MOSI_SELECT_INPUT)

DAISY Register

Address: 20E_0000h base + 56Ch offset = 20E_056Ch

Bit	31	30	29	28	27	26	25	24		23	22	21	20	19	18	17	16
R	Reserved																
W	Reserved																
Reset	0	0	0	0	0	0	0	0		0	0	0	0	0	0	0	0
Bit	15	14	13	12	11	10	9	8		7	6	5	4	3	2	1	0
R	Reserved															DAISY	
W	Reserved															DAISY	
Reset	0	0	0	0	0	0	0	0		0	0	0	0	0	0	0	0

IOMUXC_ECSPi4_MOSI_SELECT_INPUT field descriptions

Field	Description
31–1 -	This field is reserved. Reserved
0 DAISY	Selecting Pads Involved in Daisy Chain. Instance: ecspi4, In Pin: mosi 0 ENET2_TX_EN_ALT3 — Selecting Pad: ENET2_TX_EN for Mode: ALT3 1 NAND_DATA05_ALT3 — Selecting Pad: NAND_DATA05 for Mode: ALT3

32.6.315 ECSPi4_SS0_B_SELECT_INPUT DAISY Register (IOMUXC_ECSPi4_SS0_B_SELECT_INPUT)

DAISY Register

Address: 20E_0000h base + 570h offset = 20E_0570h

Bit	31	30	29	28	27	26	25	24		23	22	21	20	19	18	17	16
R	Reserved																
W	Reserved																
Reset	0	0	0	0	0	0	0	0		0	0	0	0	0	0	0	0
Bit	15	14	13	12	11	10	9	8		7	6	5	4	3	2	1	0
R	Reserved															DAISY	
W	Reserved															DAISY	
Reset	0	0	0	0	0	0	0	0		0	0	0	0	0	0	0	0

IOMUXC_ECSPi4_SS0_B_SELECT_INPUT field descriptions

Field	Description
31-1 -	This field is reserved. Reserved
0 DAISY	Selecting Pads Involved in Daisy Chain. Instance: ecspi4, In Pin: ss_b0 0 ENET2_RX_ER_ALT3 — Selecting Pad: ENET2_RX_ER for Mode: ALT3 1 NAND_DATA07_ALT3 — Selecting Pad: NAND_DATA07 for Mode: ALT3

32.6.316 ENET1_REF_CLK1_SELECT_INPUT DAISY Register (IOMUXC_ENET1_REF_CLK1_SELECT_INPUT)

DAISY Register

Address: 20E_0000h base + 574h offset = 20E_0574h

Bit	31	30	29	28	27	26	25	24		23	22	21	20	19	18	17	16
R	Reserved																
W	Reserved																
Reset	0	0	0	0	0	0	0	0		0	0	0	0	0	0	0	0
Bit	15	14	13	12	11	10	9	8		7	6	5	4	3	2	1	0
R	Reserved															DAISY	
W	Reserved															DAISY	
Reset	0	0	0	0	0	0	0	0		0	0	0	0	0	0	0	0

IOMUXC_ENET1_REF_CLK1_SELECT_INPUT field descriptions

Field	Description
31–2 -	This field is reserved. Reserved
DAISY	Selecting Pads Involved in Daisy Chain. Instance: enet1, In Pin: rmii 00 GPIO1_IO00_ALT3 — Selecting Pad: GPIO1_IO00 for Mode: ALT3 01 GPIO1_IO04_ALT0 — Selecting Pad: GPIO1_IO04 for Mode: ALT0 10 ENET1_TX_CLK_ALT4 — Selecting Pad: ENET1_TX_CLK for Mode: ALT4

32.6.317 ENET1_MAC0_MDIO_SELECT_INPUT DAISY Register (IOMUXC_ENET1_MAC0_MDIO_SELECT_INPUT)

DAISY Register

Address: 20E_0000h base + 578h offset = 20E_0578h

Bit	31	30	29	28	27	26	25	24		23	22	21	20	19	18	17	16
R	Reserved																
W	Reserved																
Reset	0	0	0	0	0	0	0	0		0	0	0	0	0	0	0	0
Bit	15	14	13	12	11	10	9	8		7	6	5	4	3	2	1	0
R	Reserved															DAISY	
W	Reserved															DAISY	
Reset	0	0	0	0	0	0	0	0		0	0	0	0	0	0	0	0

IOMUXC_ENET1_MAC0_MDIO_SELECT_INPUT field descriptions

Field	Description
31–1 -	This field is reserved. Reserved
0 DAISY	Selecting Pads Involved in Daisy Chain. Instance: enet1, In Pin: mac0_mdio 0 GPIO1_IO06_ALT0 — Selecting Pad: GPIO1_IO06 for Mode: ALT0 1 ENET2_RX_DATA0_ALT4 — Selecting Pad: ENET2_RX_DATA0 for Mode: ALT4

32.6.318 ENET2_REF_CLK2_SELECT_INPUT DAISY Register (IOMUXC_ENET2_REF_CLK2_SELECT_INPUT)

DAISY Register

Address: 20E_0000h base + 57Ch offset = 20E_057Ch

Bit	31	30	29	28	27	26	25	24		23	22	21	20	19	18	17	16
R	Reserved																
W	Reserved																
Reset	0	0	0	0	0	0	0	0		0	0	0	0	0	0	0	0
Bit	15	14	13	12	11	10	9	8		7	6	5	4	3	2	1	0
R	Reserved															DAISY	
W	Reserved															DAISY	
Reset	0	0	0	0	0	0	0	0		0	0	0	0	0	0	0	0

IOMUXC_ENET2_REF_CLK2_SELECT_INPUT field descriptions

Field	Description
31–2 -	This field is reserved. Reserved
DAISY	Selecting Pads Involved in Daisy Chain. Instance: enet2, In Pin: rmii 00 GPIO1_IO01_ALT3 — Selecting Pad: GPIO1_IO01 for Mode: ALT3 01 GPIO1_IO05_ALT0 — Selecting Pad: GPIO1_IO05 for Mode: ALT0 10 ENET2_TX_CLK_ALT4 — Selecting Pad: ENET2_TX_CLK for Mode: ALT4

32.6.319 ENET2_MAC0_MDIO_SELECT_INPUT DAISY Register (IOMUXC_ENET2_MAC0_MDIO_SELECT_INPUT)

DAISY Register

Address: 20E_0000h base + 580h offset = 20E_0580h

Bit	31	30	29	28	27	26	25	24	23	22	21	20	19	18	17	16
R	Reserved															
W	Reserved															
Reset	0	0	0	0	0	0	0	0	0	0	0	0	0	0	0	0
Bit	15	14	13	12	11	10	9	8	7	6	5	4	3	2	1	0
R	Reserved															DAISY
W	Reserved															DAISY
Reset	0	0	0	0	0	0	0	0	0	0	0	0	0	0	0	0

IOMUXC_ENET2_MAC0_MDIO_SELECT_INPUT field descriptions

Field	Description
31–1 -	This field is reserved. Reserved
0 DAISY	Selecting Pads Involved in Daisy Chain. Instance: enet2, In Pin: mac0_mdio 0 GPIO1_IO06_ALT1 — Selecting Pad: GPIO1_IO06 for Mode: ALT1 1 ENET1_TX_DATA1_ALT4 — Selecting Pad: ENET1_TX_DATA1 for Mode: ALT4

32.6.320 FLEXCAN1_RX_SELECT_INPUT DAISY Register (IOMUXC_FLEXCAN1_RX_SELECT_INPUT)

DAISY Register

Address: 20E_0000h base + 584h offset = 20E_0584h

Bit	31	30	29	28	27	26	25	24	23	22	21	20	19	18	17	16
R	Reserved															
W	Reserved															
Reset	0	0	0	0	0	0	0	0	0	0	0	0	0	0	0	0
Bit	15	14	13	12	11	10	9	8	7	6	5	4	3	2	1	0
R	Reserved															DAISY
W	Reserved															DAISY
Reset	0	0	0	0	0	0	0	0	0	0	0	0	0	0	0	0

IOMUXC_FLEXCAN1_RX_SELECT_INPUT field descriptions

Field	Description
31–2 -	This field is reserved. Reserved
DAISY	Selecting Pads Involved in Daisy Chain. Instance: flexcan1, In Pin: RX 00 UART3_RTS_B_ALT2 — Selecting Pad: UART3_RTS_B for Mode: ALT2 01 ENET1_RX_DATA1_ALT4 — Selecting Pad: ENET1_RX_DATA1 for Mode: ALT4 10 LCD_DATA09_ALT8 — Selecting Pad: LCD_DATA09 for Mode: ALT8 11 SD1_DATA1_ALT3 — Selecting Pad: SD1_DATA1 for Mode: ALT3

32.6.321 FLEXCAN2_RX_SELECT_INPUT DAISY Register (IOMUXC_FLEXCAN2_RX_SELECT_INPUT)

DAISY Register

Address: 20E_0000h base + 588h offset = 20E_0588h

Bit	31	30	29	28	27	26	25	24		23	22	21	20	19	18	17	16
R	Reserved																
W	Reserved																
Reset	0	0	0	0	0	0	0	0		0	0	0	0	0	0	0	0
Bit	15	14	13	12	11	10	9	8		7	6	5	4	3	2	1	0
R	Reserved															DAISY	
W	Reserved															DAISY	
Reset	0	0	0	0	0	0	0	0		0	0	0	0	0	0	0	0

IOMUXC_FLEXCAN2_RX_SELECT_INPUT field descriptions

Field	Description
31–2 -	This field is reserved. Reserved
DAISY	Selecting Pads Involved in Daisy Chain. Instance: flexcan2, In Pin: RX 00 UART2_RTS_B_ALT2 — Selecting Pad: UART2_RTS_B for Mode: ALT2 01 ENET1_TX_DATA0_ALT4 — Selecting Pad: ENET1_TX_DATA0 for Mode: ALT4 10 LCD_DATA11_ALT8 — Selecting Pad: LCD_DATA11 for Mode: ALT8 11 SD1_DATA3_ALT3 — Selecting Pad: SD1_DATA3 for Mode: ALT3

32.6.322 GPT1_CAPTURE1_SELECT_INPUT DAISY Register (IOMUXC_GPT1_CAPTURE1_SELECT_INPUT)

DAISY Register

Address: 20E_0000h base + 58Ch offset = 20E_058Ch

Bit	31	30	29	28	27	26	25	24		23	22	21	20	19	18	17	16
R	Reserved																
W																	
Reset	0	0	0	0	0	0	0	0		0	0	0	0	0	0	0	0
Bit	15	14	13	12	11	10	9	8		7	6	5	4	3	2	1	0
R	Reserved															DAISY	
W																	
Reset	0	0	0	0	0	0	0	0		0	0	0	0	0	0	0	0

IOMUXC_GPT1_CAPTURE1_SELECT_INPUT field descriptions

Field	Description
31–1 -	This field is reserved. Reserved
0 DAISY	Selecting Pads Involved in Daisy Chain. Instance: gpt1, In Pin: CAPTURE1 0 GPIO1_IO00_ALT1 — Selecting Pad: GPIO1_IO00 for Mode: ALT1 1 UART2_TX_DATA_ALT4 — Selecting Pad: UART2_TX_DATA for Mode: ALT4

32.6.323 GPT1_CAPTURE2_SELECT_INPUT DAISY Register (IOMUXC_GPT1_CAPTURE2_SELECT_INPUT)

DAISY Register

Address: 20E_0000h base + 590h offset = 20E_0590h

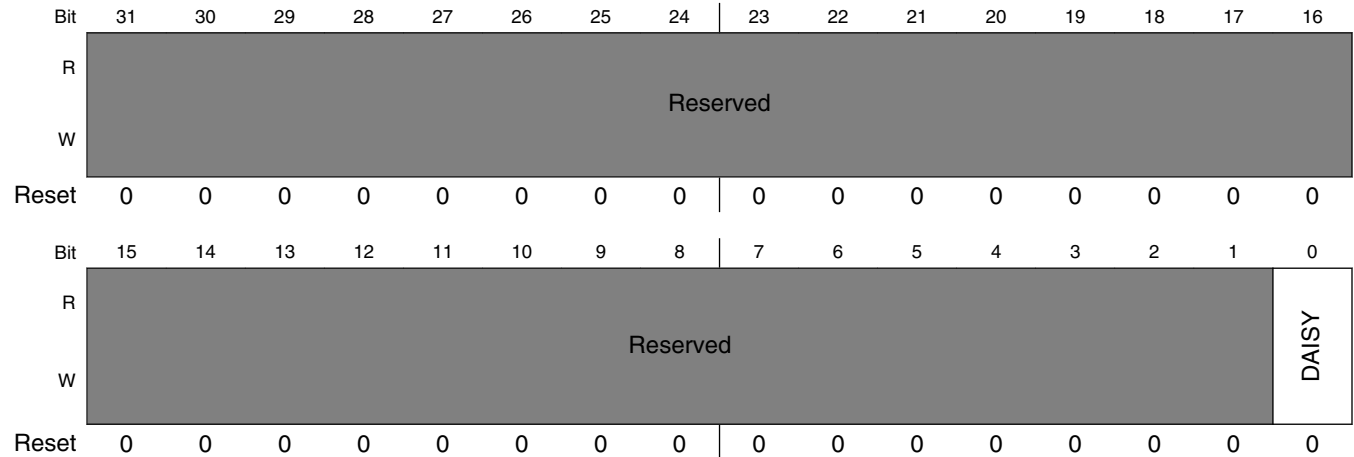

IOMUXC_GPT1_CAPTURE2_SELECT_INPUT field descriptions

Field	Description
31–1 -	This field is reserved. Reserved
0 DAISY	Selecting Pads Involved in Daisy Chain. Instance: gpt1, In Pin: CAPTURE2 0 UART2_RX_DATA_ALT4 — Selecting Pad: UART2_RX_DATA for Mode: ALT4 1 ENET1_RX_ER_ALT8 — Selecting Pad: ENET1_RX_ER for Mode: ALT8

32.6.324 GPT1_CLK_SELECT_INPUT DAISY Register (IOMUXC_GPT1_CLK_SELECT_INPUT)

DAISY Register

Address: 20E_0000h base + 594h offset = 20E_0594h

Bit	31	30	29	28	27	26	25	24		23	22	21	20	19	18	17	16
R	Reserved																
W	Reserved																
Reset	0	0	0	0	0	0	0	0		0	0	0	0	0	0	0	0
Bit	15	14	13	12	11	10	9	8		7	6	5	4	3	2	1	0
R	Reserved															DAISY	
W	Reserved															DAISY	
Reset	0	0	0	0	0	0	0	0		0	0	0	0	0	0	0	0

IOMUXC_GPT1_CLK_SELECT_INPUT field descriptions

Field	Description
31–1 -	This field is reserved. Reserved
0 DAISY	Selecting Pads Involved in Daisy Chain. Instance: gpt1, In Pin: CLK 0 UART1_RX_DATA_ALT4 — Selecting Pad: UART1_RX_DATA for Mode: ALT4 1 ENET1_TX_CLK_ALT8 — Selecting Pad: ENET1_TX_CLK for Mode: ALT8

32.6.325 GPT2_CAPTURE1_SELECT_INPUT DAISY Register (IOMUXC_GPT2_CAPTURE1_SELECT_INPUT)

DAISY Register

Address: 20E_0000h base + 598h offset = 20E_0598h

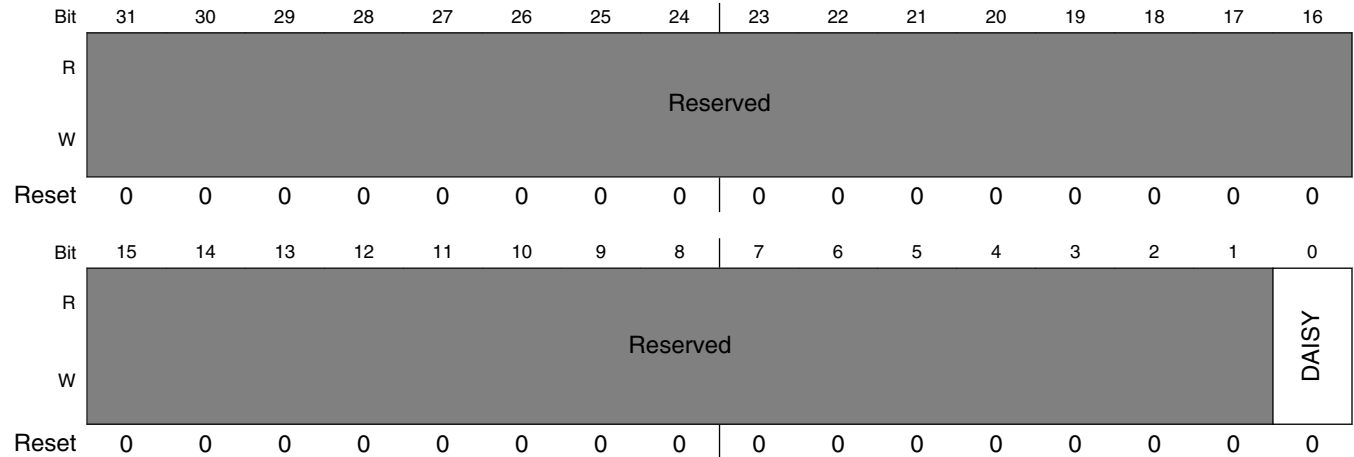

IOMUXC_GPT2_CAPTURE1_SELECT_INPUT field descriptions

Field	Description
31–1 -	This field is reserved. Reserved
0 DAISY	Selecting Pads Involved in Daisy Chain. Instance: gpt2, In Pin: CAPTURE1 0 JTAG_TMS_ALT1 — Selecting Pad: JTAG_TMS for Mode: ALT1 1 SD1_DATA2_ALT1 — Selecting Pad: SD1_DATA2 for Mode: ALT1

32.6.326 GPT2_CAPTURE2_SELECT_INPUT DAISY Register (IOMUXC_GPT2_CAPTURE2_SELECT_INPUT)

DAISY Register

Address: 20E_0000h base + 59Ch offset = 20E_059Ch

Bit	31	30	29	28	27	26	25	24		23	22	21	20	19	18	17	16
R	Reserved																
W																	
Reset	0	0	0	0	0	0	0	0		0	0	0	0	0	0	0	0
Bit	15	14	13	12	11	10	9	8		7	6	5	4	3	2	1	0
R	Reserved															DAISY	
W																	
Reset	0	0	0	0	0	0	0	0		0	0	0	0	0	0	0	0

IOMUXC_GPT2_CAPTURE2_SELECT_INPUT field descriptions

Field	Description
31–1 -	This field is reserved. Reserved
0 DAISY	Selecting Pads Involved in Daisy Chain. Instance: gpt2, In Pin: CAPTURE2 0 JTAG_TDO_ALT1 — Selecting Pad: JTAG_TDO for Mode: ALT1 1 SD1_DATA3_ALT1 — Selecting Pad: SD1_DATA3 for Mode: ALT1

32.6.327 GPT2_CLK_SELECT_INPUT DAISY Register (IOMUXC_GPT2_CLK_SELECT_INPUT)

DAISY Register

Address: 20E_0000h base + 5A0h offset = 20E_05A0h

Bit	31	30	29	28	27	26	25	24		23	22	21	20	19	18	17	16
R	Reserved																
W	Reserved																
Reset	0	0	0	0	0	0	0	0		0	0	0	0	0	0	0	0
Bit	15	14	13	12	11	10	9	8		7	6	5	4	3	2	1	0
R	Reserved															DAISY	
W	Reserved															DAISY	
Reset	0	0	0	0	0	0	0	0		0	0	0	0	0	0	0	0

IOMUXC_GPT2_CLK_SELECT_INPUT field descriptions

Field	Description
31-1 -	This field is reserved. Reserved
0 DAISY	Selecting Pads Involved in Daisy Chain. Instance: gpt2, In Pin: CLK 0 JTAG_MOD_ALT1 — Selecting Pad: JTAG_MOD for Mode: ALT1 1 SD1_DATA1_ALT1 — Selecting Pad: SD1_DATA1 for Mode: ALT1

32.6.328 I2C1_SCL_SELECT_INPUT DAISY Register (IOMUXC_I2C1_SCL_SELECT_INPUT)

DAISY Register

Address: 20E_0000h base + 5A4h offset = 20E_05A4h

Bit	31	30	29	28	27	26	25	24		23	22	21	20	19	18	17	16
R	Reserved																
W	Reserved																
Reset	0	0	0	0	0	0	0	0		0	0	0	0	0	0	0	0
Bit	15	14	13	12	11	10	9	8		7	6	5	4	3	2	1	0
R	Reserved															DAISY	
W	Reserved															DAISY	
Reset	0	0	0	0	0	0	0	0		0	0	0	0	0	0	0	0

IOMUXC_I2C1_SCL_SELECT_INPUT field descriptions

Field	Description
31–2 -	This field is reserved. Reserved
DAISY	Selecting Pads Involved in Daisy Chain. Instance: i2c1, In Pin: scl_in 00 GPIO1_IO02_ALT0 — Selecting Pad: GPIO1_IO02 for Mode: ALT0 01 UART4_TX_DATA_ALT2 — Selecting Pad: UART4_TX_DATA for Mode: ALT2 10 CSI_PIXCLK_ALT3 — Selecting Pad: CSI_PIXCLK for Mode: ALT3

32.6.329 I2C1_SDA_SELECT_INPUT DAISY Register (IOMUXC_I2C1_SDA_SELECT_INPUT)

DAISY Register

Address: 20E_0000h base + 5A8h offset = 20E_05A8h

Bit	31	30	29	28	27	26	25	24	23	22	21	20	19	18	17	16
R	Reserved															
W	Reserved															
Reset	0	0	0	0	0	0	0	0	0	0	0	0	0	0	0	0
Bit	15	14	13	12	11	10	9	8	7	6	5	4	3	2	1	0
R	Reserved															DAISY
W	Reserved															DAISY
Reset	0	0	0	0	0	0	0	0	0	0	0	0	0	0	0	0

IOMUXC_I2C1_SDA_SELECT_INPUT field descriptions

Field	Description
31–2 -	This field is reserved. Reserved
DAISY	Selecting Pads Involved in Daisy Chain. Instance: i2c1, In Pin: sda_in 00 CSI_MCLK_ALT3 — Selecting Pad: CSI_MCLK for Mode: ALT3 01 GPIO1_IO03_ALT0 — Selecting Pad: GPIO1_IO03 for Mode: ALT0 10 UART4_RX_DATA_ALT2 — Selecting Pad: UART4_RX_DATA for Mode: ALT2

32.6.330 I2C2_SCL_SELECT_INPUT DAISY Register (IOMUXC_I2C2_SCL_SELECT_INPUT)

DAISY Register

Address: 20E_0000h base + 5ACh offset = 20E_05ACh

Bit	31	30	29	28	27	26	25	24		23	22	21	20	19	18	17	16
R	Reserved																
W	Reserved																
Reset	0	0	0	0	0	0	0	0		0	0	0	0	0	0	0	0
Bit	15	14	13	12	11	10	9	8		7	6	5	4	3	2	1	0
R	Reserved															DAISY	
W	Reserved															DAISY	
Reset	0	0	0	0	0	0	0	0		0	0	0	0	0	0	0	0

IOMUXC_I2C2_SCL_SELECT_INPUT field descriptions

Field	Description
31–2 -	This field is reserved. Reserved
DAISY	Selecting Pads Involved in Daisy Chain. Instance: i2c2, In Pin: scl_in 00 CSI_HSYNC_ALT3 — Selecting Pad: CSI_HSYNC for Mode: ALT3 01 GPIO1_IO00_ALT0 — Selecting Pad: GPIO1_IO00 for Mode: ALT0 10 UART5_TX_DATA_ALT2 — Selecting Pad: UART5_TX_DATA for Mode: ALT2

32.6.331 I2C2_SDA_SELECT_INPUT DAISY Register (IOMUXC_I2C2_SDA_SELECT_INPUT)

DAISY Register

Address: 20E_0000h base + 5B0h offset = 20E_05B0h

Bit	31	30	29	28	27	26	25	24		23	22	21	20	19	18	17	16
R	Reserved																
W	Reserved																
Reset	0	0	0	0	0	0	0	0		0	0	0	0	0	0	0	0
Bit	15	14	13	12	11	10	9	8		7	6	5	4	3	2	1	0
R	Reserved															DAISY	
W	Reserved															DAISY	
Reset	0	0	0	0	0	0	0	0		0	0	0	0	0	0	0	0

IOMUXC_I2C2_SDA_SELECT_INPUT field descriptions

Field	Description
31–2 -	This field is reserved. Reserved
DAISY	Selecting Pads Involved in Daisy Chain. Instance: i2c2, In Pin: sda_in 00 CSI_VSYNC_ALT3 — Selecting Pad: CSI_VSYNC for Mode: ALT3 01 GPIO1_IO01_ALT0 — Selecting Pad: GPIO1_IO01 for Mode: ALT0 10 UART5_RX_DATA_ALT2 — Selecting Pad: UART5_RX_DATA for Mode: ALT2

32.6.332 I2C3_SCL_SELECT_INPUT DAISY Register (IOMUXC_I2C3_SCL_SELECT_INPUT)

DAISY Register

Address: 20E_0000h base + 5B4h offset = 20E_05B4h

Bit	31	30	29	28	27	26	25	24	23	22	21	20	19	18	17	16
R	Reserved															
W	Reserved															
Reset	0	0	0	0	0	0	0	0	0	0	0	0	0	0	0	0
Bit	15	14	13	12	11	10	9	8	7	6	5	4	3	2	1	0
R	Reserved															DAISY
W	Reserved															DAISY
Reset	0	0	0	0	0	0	0	0	0	0	0	0	0	0	0	0

IOMUXC_I2C3_SCL_SELECT_INPUT field descriptions

Field	Description
31–2 -	This field is reserved. Reserved
DAISY	Selecting Pads Involved in Daisy Chain. Instance: i2c3, In Pin: scl_in 00 UART1_TX_DATA_ALT2 — Selecting Pad: UART1_TX_DATA for Mode: ALT2 01 ENET2_RX_DATA0_ALT3 — Selecting Pad: ENET2_RX_DATA0 for Mode: ALT3 10 LCD_DATA01_ALT4 — Selecting Pad: LCD_DATA01 for Mode: ALT4

32.6.333 I2C3_SDA_SELECT_INPUT DAISY Register (IOMUXC_I2C3_SDA_SELECT_INPUT)

DAISY Register

Address: 20E_0000h base + 5B8h offset = 20E_05B8h

Bit	31	30	29	28	27	26	25	24		23	22	21	20	19	18	17	16
R	Reserved																
W	Reserved																
Reset	0	0	0	0	0	0	0	0		0	0	0	0	0	0	0	0
Bit	15	14	13	12	11	10	9	8		7	6	5	4	3	2	1	0
R	Reserved															DAISY	
W	Reserved															DAISY	
Reset	0	0	0	0	0	0	0	0		0	0	0	0	0	0	0	0

IOMUXC_I2C3_SDA_SELECT_INPUT field descriptions

Field	Description
31–2 -	This field is reserved. Reserved
DAISY	Selecting Pads Involved in Daisy Chain. Instance: i2c3, In Pin: sda_in 00 UART1_RX_DATA_ALT2 — Selecting Pad: UART1_RX_DATA for Mode: ALT2 01 ENET2_RX_DATA1_ALT3 — Selecting Pad: ENET2_RX_DATA1 for Mode: ALT3 10 LCD_DATA00_ALT4 — Selecting Pad: LCD_DATA00 for Mode: ALT4

32.6.334 I2C4_SCL_SELECT_INPUT DAISY Register (IOMUXC_I2C4_SCL_SELECT_INPUT)

DAISY Register

Address: 20E_0000h base + 5BCh offset = 20E_05BCh

Bit	31	30	29	28	27	26	25	24		23	22	21	20	19	18	17	16
R	Reserved																
W	Reserved																
Reset	0	0	0	0	0	0	0	0		0	0	0	0	0	0	0	0
Bit	15	14	13	12	11	10	9	8		7	6	5	4	3	2	1	0
R	Reserved															DAISY	
W	Reserved															DAISY	
Reset	0	0	0	0	0	0	0	0		0	0	0	0	0	0	0	0

IOMUXC_I2C4_SCL_SELECT_INPUT field descriptions

Field	Description
31–2 -	This field is reserved. Reserved
DAISY	Selecting Pads Involved in Daisy Chain. Instance: i2c4, In Pin: scl_in 00 UART2_TX_DATA_ALT2 — Selecting Pad: UART2_TX_DATA for Mode: ALT2 01 ENET2_RX_EN_ALT3 — Selecting Pad: ENET2_RX_EN for Mode: ALT3 10 LCD_DATA03_ALT4 — Selecting Pad: LCD_DATA03 for Mode: ALT4

32.6.335 I2C4_SDA_SELECT_INPUT DAISY Register (IOMUXC_I2C4_SDA_SELECT_INPUT)

DAISY Register

Address: 20E_0000h base + 5C0h offset = 20E_05C0h

Bit	31	30	29	28	27	26	25	24	23	22	21	20	19	18	17	16
R	Reserved															
W	Reserved															
Reset	0	0	0	0	0	0	0	0	0	0	0	0	0	0	0	0
Bit	15	14	13	12	11	10	9	8	7	6	5	4	3	2	1	0
R	Reserved															DAISY
W	Reserved															DAISY
Reset	0	0	0	0	0	0	0	0	0	0	0	0	0	0	0	0

IOMUXC_I2C4_SDA_SELECT_INPUT field descriptions

Field	Description
31–2 -	This field is reserved. Reserved
DAISY	Selecting Pads Involved in Daisy Chain. Instance: i2c4, In Pin: sda_in 00 UART2_RX_DATA_ALT2 — Selecting Pad: UART2_RX_DATA for Mode: ALT2 01 ENET2_TX_DATA0_ALT3 — Selecting Pad: ENET2_TX_DATA0 for Mode: ALT3 10 LCD_DATA02_ALT4 — Selecting Pad: LCD_DATA02 for Mode: ALT4

32.6.336 KPP_COLO_SELECT_INPUT DAISY Register (IOMUXC_KPP_COLO_SELECT_INPUT)

DAISY Register

Address: 20E_0000h base + 5C4h offset = 20E_05C4h

Bit	31	30	29	28	27	26	25	24		23	22	21	20	19	18	17	16
R	Reserved																
W																	
Reset	0	0	0	0	0	0	0	0		0	0	0	0	0	0	0	0
Bit	15	14	13	12	11	10	9	8		7	6	5	4	3	2	1	0
R	Reserved															DAISY	
W																	
Reset	0	0	0	0	0	0	0	0		0	0	0	0	0	0	0	0

IOMUXC_KPP_COLO_SELECT_INPUT field descriptions

Field	Description
31–1 -	This field is reserved. Reserved
0 DAISY	Selecting Pads Involved in Daisy Chain. Instance: kpp, In Pin: col0 0 ENET1_RX_DATA1_ALT6 — Selecting Pad: ENET1_RX_DATA1 for Mode: ALT6 1 NAND_WE_B_ALT3 — Selecting Pad: NAND_WE_B for Mode: ALT3

32.6.337 KPP_COL1_SELECT_INPUT DAISY Register (IOMUXC_KPP_COL1_SELECT_INPUT)

DAISY Register

Address: 20E_0000h base + 5C8h offset = 20E_05C8h

Bit	31	30	29	28	27	26	25	24		23	22	21	20	19	18	17	16
R	Reserved																
W																	
Reset	0	0	0	0	0	0	0	0		0	0	0	0	0	0	0	0
Bit	15	14	13	12	11	10	9	8		7	6	5	4	3	2	1	0
R	Reserved															DAISY	
W																	
Reset	0	0	0	0	0	0	0	0		0	0	0	0	0	0	0	0

IOMUXC_KPP_COL1_SELECT_INPUT field descriptions

Field	Description
31–1 -	This field is reserved. Reserved
0 DAISY	Selecting Pads Involved in Daisy Chain. Instance: kpp, In Pin: col1 0 ENET1_TX_DATA0_ALT6 — Selecting Pad: ENET1_TX_DATA0 for Mode: ALT6 1 NAND_DATA01_ALT3 — Selecting Pad: NAND_DATA01 for Mode: ALT3

32.6.338 KPP_COL2_SELECT_INPUT DAISY Register (IOMUXC_KPP_COL2_SELECT_INPUT)

DAISY Register

Address: 20E_0000h base + 5CCh offset = 20E_05CCh

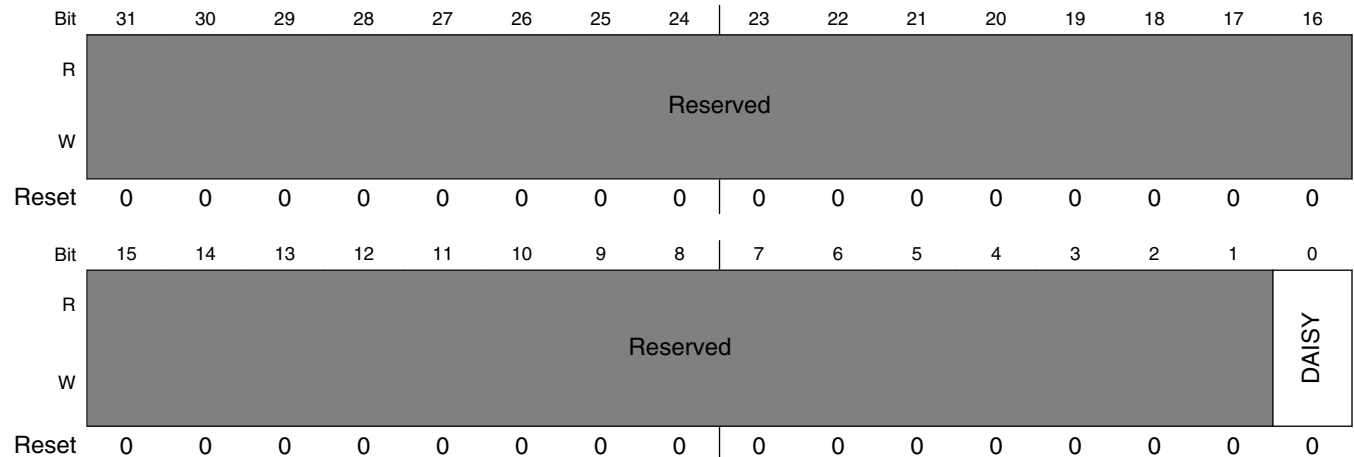

IOMUXC_KPP_COL2_SELECT_INPUT field descriptions

Field	Description
31–1 -	This field is reserved. Reserved
0 DAISY	Selecting Pads Involved in Daisy Chain. Instance: kpp, In Pin: col2 0 ENET1_TX_EN_ALT6 — Selecting Pad: ENET1_TX_EN for Mode: ALT6 1 NAND_DATA03_ALT3 — Selecting Pad: NAND_DATA03 for Mode: ALT3

32.6.339 KPP_ROW0_SELECT_INPUT DAISY Register (IOMUXC_KPP_ROW0_SELECT_INPUT)

DAISY Register

Address: 20E_0000h base + 5D0h offset = 20E_05D0h

Bit	31	30	29	28	27	26	25	24		23	22	21	20	19	18	17	16
R	Reserved																
W	Reserved																
Reset	0	0	0	0	0	0	0	0		0	0	0	0	0	0	0	0
Bit	15	14	13	12	11	10	9	8		7	6	5	4	3	2	1	0
R	Reserved															DAISY	
W	Reserved															DAISY	
Reset	0	0	0	0	0	0	0	0		0	0	0	0	0	0	0	0

IOMUXC_KPP_ROW0_SELECT_INPUT field descriptions

Field	Description
31–1 -	This field is reserved. Reserved
0 DAISY	Selecting Pads Involved in Daisy Chain. Instance: kpp, In Pin: row0 0 ENET1_RX_DATA0_ALT6 — Selecting Pad: ENET1_RX_DATA0 for Mode: ALT6 1 NAND_RE_B_ALT3 — Selecting Pad: NAND_RE_B for Mode: ALT3

32.6.340 KPP_ROW1_SELECT_INPUT DAISY Register (IOMUXC_KPP_ROW1_SELECT_INPUT)

DAISY Register

Address: 20E_0000h base + 5D4h offset = 20E_05D4h

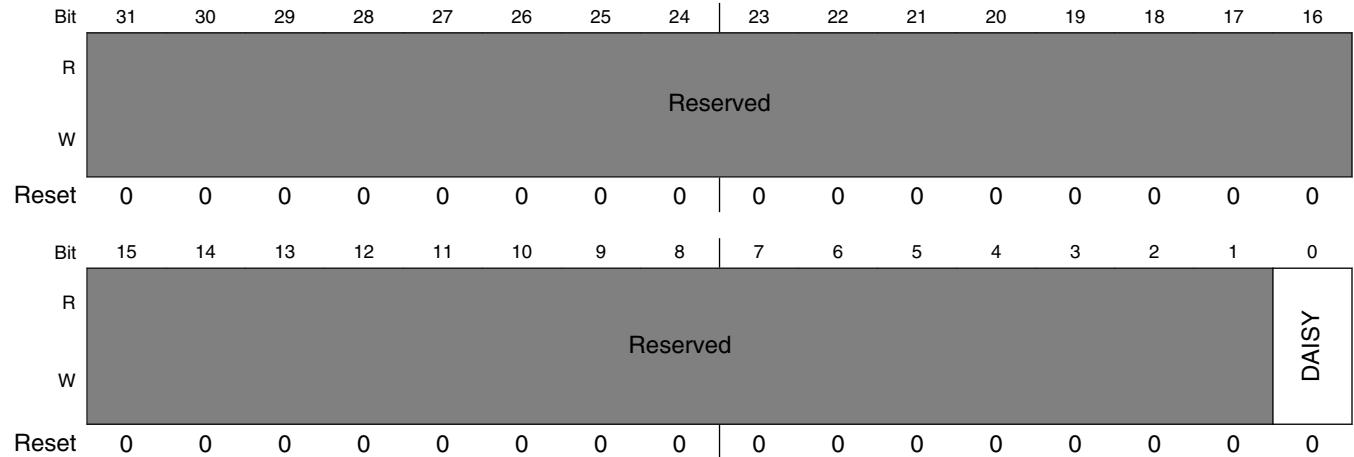

IOMUXC_KPP_ROW1_SELECT_INPUT field descriptions

Field	Description
31–1 -	This field is reserved. Reserved
0 DAISY	Selecting Pads Involved in Daisy Chain. Instance: kpp, In Pin: row1 0 ENET1_RX_EN_ALT6 — Selecting Pad: ENET1_RX_EN for Mode: ALT6 1 NAND_DATA00_ALT3 — Selecting Pad: NAND_DATA00 for Mode: ALT3

32.6.341 KPP_ROW2_SELECT_INPUT DAISY Register (IOMUXC_KPP_ROW2_SELECT_INPUT)

DAISY Register

Address: 20E_0000h base + 5D8h offset = 20E_05D8h

Bit	31	30	29	28	27	26	25	24		23	22	21	20	19	18	17	16
R	Reserved																
W	Reserved																
Reset	0	0	0	0	0	0	0	0		0	0	0	0	0	0	0	0
Bit	15	14	13	12	11	10	9	8		7	6	5	4	3	2	1	0
R	Reserved															DAISY	
W	Reserved															DAISY	
Reset	0	0	0	0	0	0	0	0		0	0	0	0	0	0	0	0

IOMUXC_KPP_ROW2_SELECT_INPUT field descriptions

Field	Description
31–1 -	This field is reserved. Reserved
0 DAISY	Selecting Pads Involved in Daisy Chain. Instance: kpp, In Pin: row2 0 ENET1_TX_DATA1_ALT6 — Selecting Pad: ENET1_TX_DATA1 for Mode: ALT6 1 NAND_DATA02_ALT3 — Selecting Pad: NAND_DATA02 for Mode: ALT3

32.6.342 LCD_BUSY_SELECT_INPUT DAISY Register (IOMUXC_LCD_BUSY_SELECT_INPUT)

DAISY Register

Address: 20E_0000h base + 5DCh offset = 20E_05DCh

Bit	31	30	29	28	27	26	25	24		23	22	21	20	19	18	17	16
R	Reserved																
W																	
Reset	0	0	0	0	0	0	0	0		0	0	0	0	0	0	0	0
Bit	15	14	13	12	11	10	9	8		7	6	5	4	3	2	1	0
R	Reserved															DAISY	
W																	
Reset	0	0	0	0	0	0	0	0		0	0	0	0	0	0	0	0

IOMUXC_LCD_BUSY_SELECT_INPUT field descriptions

Field	Description
31–1 -	This field is reserved. Reserved
0 DAISY	Selecting Pads Involved in Daisy Chain. Instance: lcdif, In Pin: lcdif_busy 0 LCD_HSYNC_ALT0 — Selecting Pad: LCD_HSYNC for Mode: ALT0 1 LCD_VSYNC_ALT1 — Selecting Pad: LCD_VSYNC for Mode: ALT1

32.6.343 SAI1_MCLK_SELECT_INPUT DAISY Register (IOMUXC_SAI1_MCLK_SELECT_INPUT)

DAISY Register

Address: 20E_0000h base + 5E0h offset = 20E_05E0h

Bit	31	30	29	28	27	26	25	24		23	22	21	20	19	18	17	16
R	Reserved																
W	Reserved																
Reset	0	0	0	0	0	0	0	0		0	0	0	0	0	0	0	0
Bit	15	14	13	12	11	10	9	8		7	6	5	4	3	2	1	0
R	Reserved															DAISY	
W	Reserved															DAISY	
Reset	0	0	0	0	0	0	0	0		0	0	0	0	0	0	0	0

IOMUXC_SAI1_MCLK_SELECT_INPUT field descriptions

Field	Description
31–1 -	This field is reserved. Reserved
0 DAISY	Selecting Pads Involved in Daisy Chain. Instance: sai1, In Pin: mclk2 0 CSI_DATA01_ALT6 — Selecting Pad: CSI_DATA01 for Mode: ALT6 1 LCD_DATA00_ALT8 — Selecting Pad: LCD_DATA00 for Mode: ALT8

32.6.344 SAI1_RX_DATA_SELECT_INPUT DAISY Register (IOMUXC_SAI1_RX_DATA_SELECT_INPUT)

DAISY Register

Address: 20E_0000h base + 5E4h offset = 20E_05E4h

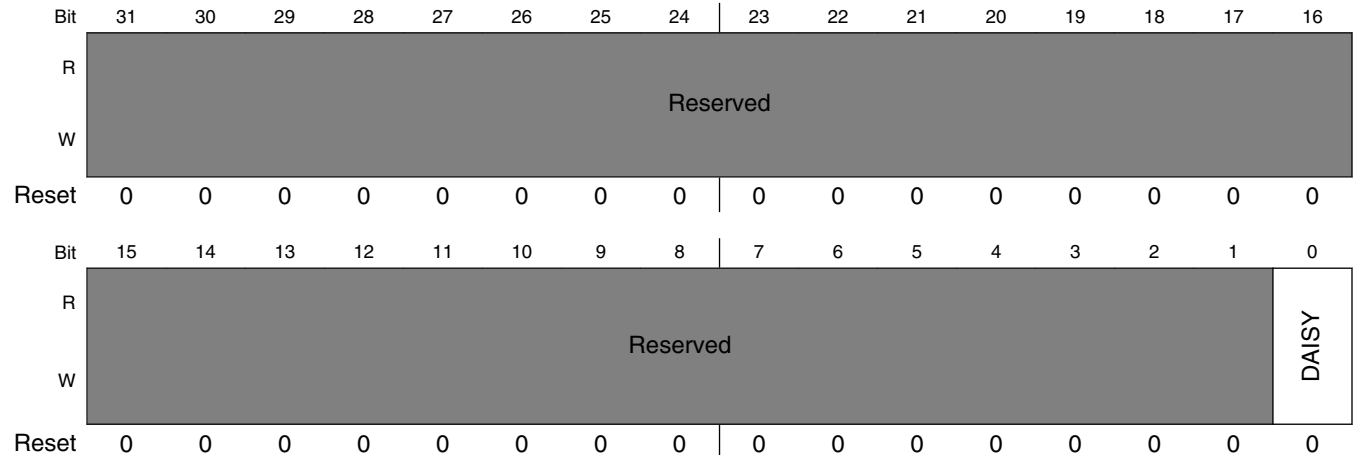

IOMUXC_SAI1_RX_DATA_SELECT_INPUT field descriptions

Field	Description
31-1 -	This field is reserved. Reserved
0 DAISY	Selecting Pads Involved in Daisy Chain. Instance: sai1, In Pin: RX_DATA0 0 LCD_DATA03_ALT8 — Selecting Pad: LCD_DATA03 for Mode: ALT8 1 CSI_DATA06_ALT6 — Selecting Pad: CSI_DATA06 for Mode: ALT6

32.6.345 SAI1_TX_BCLK_SELECT_INPUT DAISY Register (IOMUXC_SAI1_TX_BCLK_SELECT_INPUT)

DAISY Register

Address: 20E_0000h base + 5E8h offset = 20E_05E8h

Bit	31	30	29	28	27	26	25	24		23	22	21	20	19	18	17	16
R	Reserved																
W	Reserved																
Reset	0	0	0	0	0	0	0	0		0	0	0	0	0	0	0	0
Bit	15	14	13	12	11	10	9	8		7	6	5	4	3	2	1	0
R	Reserved															DAISY	
W	Reserved															DAISY	
Reset	0	0	0	0	0	0	0	0		0	0	0	0	0	0	0	0

IOMUXC_SAI1_TX_BCLK_SELECT_INPUT field descriptions

Field	Description
31–1 -	This field is reserved. Reserved
0 DAISY	Selecting Pads Involved in Daisy Chain. Instance: sai1, In Pin: TX_BCLK 0 LCD_DATA02_ALT8 — Selecting Pad: LCD_DATA02 for Mode: ALT8 1 CSI_DATA05_ALT6 — Selecting Pad: CSI_DATA05 for Mode: ALT6

32.6.346 SAI1_TX_SYNC_SELECT_INPUT DAISY Register (IOMUXC_SAI1_TX_SYNC_SELECT_INPUT)

DAISY Register

Address: 20E_0000h base + 5ECh offset = 20E_05ECh

Bit	31	30	29	28	27	26	25	24		23	22	21	20	19	18	17	16
R	Reserved																
W																	
Reset	0	0	0	0	0	0	0	0		0	0	0	0	0	0	0	0
Bit	15	14	13	12	11	10	9	8		7	6	5	4	3	2	1	0
R	Reserved															DAISY	
W																	
Reset	0	0	0	0	0	0	0	0		0	0	0	0	0	0	0	0

IOMUXC_SAI1_TX_SYNC_SELECT_INPUT field descriptions

Field	Description
31-1 -	This field is reserved. Reserved
0 DAISY	Selecting Pads Involved in Daisy Chain. Instance: sai1, In Pin: TX_SYNC 0 LCD_DATA01_ALT8 — Selecting Pad: LCD_DATA01 for Mode: ALT8 1 CSI_DATA04_ALT6 — Selecting Pad: CSI_DATA04 for Mode: ALT6

32.6.347 SAI2_MCLK_SELECT_INPUT DAISY Register (IOMUXC_SAI2_MCLK_SELECT_INPUT)

DAISY Register

Address: 20E_0000h base + 5F0h offset = 20E_05F0h

Bit	31	30	29	28	27	26	25	24		23	22	21	20	19	18	17	16
R	Reserved																
W	Reserved																
Reset	0	0	0	0	0	0	0	0		0	0	0	0	0	0	0	0
Bit	15	14	13	12	11	10	9	8		7	6	5	4	3	2	1	0
R	Reserved															DAISY	
W	Reserved															DAISY	
Reset	0	0	0	0	0	0	0	0		0	0	0	0	0	0	0	0

IOMUXC_SAI2_MCLK_SELECT_INPUT field descriptions

Field	Description
31–1 -	This field is reserved. Reserved
0 DAISY	Selecting Pads Involved in Daisy Chain. Instance: sai2, In Pin: mclk2 0 JTAG_TMS_ALT2 — Selecting Pad: JTAG_TMS for Mode: ALT2 1 SD1_CLK_ALT2 — Selecting Pad: SD1_CLK for Mode: ALT2

32.6.348 SAI2_RX_DATA_SELECT_INPUT DAISY Register (IOMUXC_SAI2_RX_DATA_SELECT_INPUT)

DAISY Register

Address: 20E_0000h base + 5F4h offset = 20E_05F4h

Bit	31	30	29	28	27	26	25	24		23	22	21	20	19	18	17	16
R	Reserved																
W																	
Reset	0	0	0	0	0	0	0	0		0	0	0	0	0	0	0	0
Bit	15	14	13	12	11	10	9	8		7	6	5	4	3	2	1	0
R	Reserved															DAISY	
W																	
Reset	0	0	0	0	0	0	0	0		0	0	0	0	0	0	0	0

IOMUXC_SAI2_RX_DATA_SELECT_INPUT field descriptions

Field	Description
31–1 -	This field is reserved. Reserved
0 DAISY	Selecting Pads Involved in Daisy Chain. Instance: sai2, In Pin: RX_DATA0 0 JTAG_TCK_ALT2 — Selecting Pad: JTAG_TCK for Mode: ALT2 1 SD1_DATA2_ALT2 — Selecting Pad: SD1_DATA2 for Mode: ALT2

32.6.349 SAI2_TX_BCLK_SELECT_INPUT DAISY Register (IOMUXC_SAI2_TX_BCLK_SELECT_INPUT)

DAISY Register

Address: 20E_0000h base + 5F8h offset = 20E_05F8h

Bit	31	30	29	28	27	26	25	24		23	22	21	20	19	18	17	16
R	Reserved																
W	Reserved																
Reset	0	0	0	0	0	0	0	0		0	0	0	0	0	0	0	0
Bit	15	14	13	12	11	10	9	8		7	6	5	4	3	2	1	0
R	Reserved															DAISY	
W	Reserved															DAISY	
Reset	0	0	0	0	0	0	0	0		0	0	0	0	0	0	0	0

IOMUXC_SAI2_TX_BCLK_SELECT_INPUT field descriptions

Field	Description
31–1 -	This field is reserved. Reserved
0 DAISY	Selecting Pads Involved in Daisy Chain. Instance: sai2, In Pin: TX_BCLK 0 JTAG_TDI_ALT2 — Selecting Pad: JTAG_TDI for Mode: ALT2 1 SD1_DATA1_ALT2 — Selecting Pad: SD1_DATA1 for Mode: ALT2

32.6.350 SAI2_TX_SYNC_SELECT_INPUT DAISY Register (IOMUXC_SAI2_TX_SYNC_SELECT_INPUT)

DAISY Register

Address: 20E_0000h base + 5FCh offset = 20E_05FCh

Bit	31	30	29	28	27	26	25	24		23	22	21	20	19	18	17	16
R	Reserved																
W																	
Reset	0	0	0	0	0	0	0	0		0	0	0	0	0	0	0	0
Bit	15	14	13	12	11	10	9	8		7	6	5	4	3	2	1	0
R	Reserved															DAISY	
W																	
Reset	0	0	0	0	0	0	0	0		0	0	0	0	0	0	0	0

IOMUXC_SAI2_TX_SYNC_SELECT_INPUT field descriptions

Field	Description
31–1 -	This field is reserved. Reserved
0 DAISY	Selecting Pads Involved in Daisy Chain. Instance: sai2, In Pin: TX_SYNC 0 JTAG_TDO_ALT2 — Selecting Pad: JTAG_TDO for Mode: ALT2 1 SD1_DATA0_ALT2 — Selecting Pad: SD1_DATA0 for Mode: ALT2

32.6.351 SAI3_MCLK_SELECT_INPUT DAISY Register (IOMUXC_SAI3_MCLK_SELECT_INPUT)

DAISY Register

Address: 20E_0000h base + 600h offset = 20E_0600h

Bit	31	30	29	28	27	26	25	24		23	22	21	20	19	18	17	16
R	Reserved																
W	Reserved																
Reset	0	0	0	0	0	0	0	0		0	0	0	0	0	0	0	0
Bit	15	14	13	12	11	10	9	8		7	6	5	4	3	2	1	0
R	Reserved															DAISY	
W	Reserved															DAISY	
Reset	0	0	0	0	0	0	0	0		0	0	0	0	0	0	0	0

IOMUXC_SAI3_MCLK_SELECT_INPUT field descriptions

Field	Description
31–1 -	This field is reserved. Reserved
0 DAISY	Selecting Pads Involved in Daisy Chain. Instance: sai3, In Pin: mclk2 0 LCD_CLK_ALT3 — Selecting Pad: LCD_CLK for Mode: ALT3 1 LCD_DATA09_ALT1 — Selecting Pad: LCD_DATA09 for Mode: ALT1

32.6.352 SAI3_RX_DATA_SELECT_INPUT DAISY Register (IOMUXC_SAI3_RX_DATA_SELECT_INPUT)

DAISY Register

Address: 20E_0000h base + 604h offset = 20E_0604h

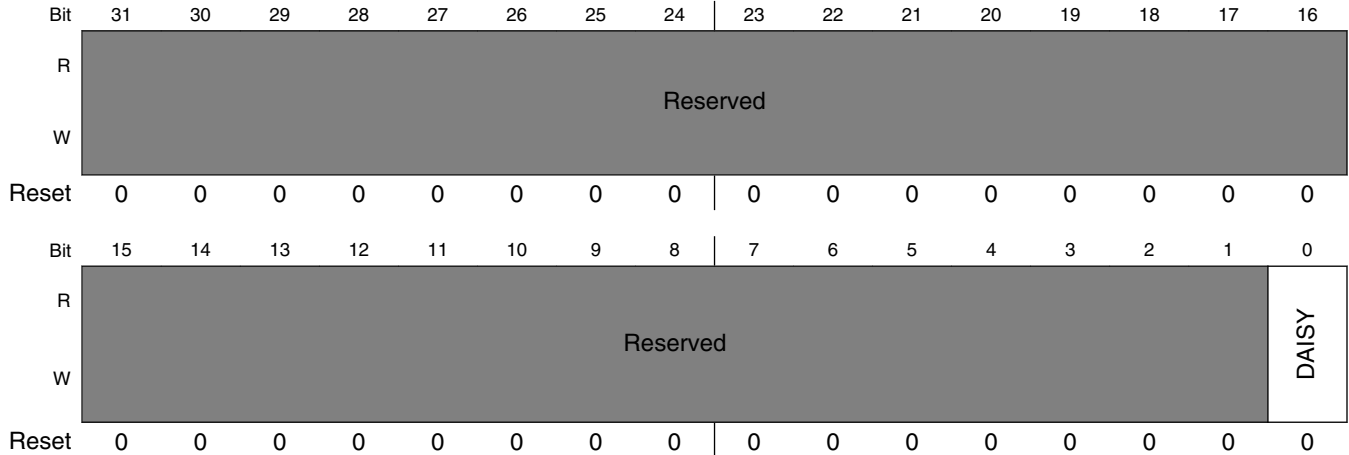

IOMUXC_SAI3_RX_DATA_SELECT_INPUT field descriptions

Field	Description
31–1 -	This field is reserved. Reserved
0 DAISY	Selecting Pads Involved in Daisy Chain. Instance: sai3, In Pin: RX_DATA0 0 LCD_VSYNC_ALT3 — Selecting Pad: LCD_VSYNC for Mode: ALT3 1 LCD_DATA14_ALT1 — Selecting Pad: LCD_DATA14 for Mode: ALT1

32.6.353 SAI3_TX_BCLK_SELECT_INPUT DAISY Register (IOMUXC_SAI3_TX_BCLK_SELECT_INPUT)

DAISY Register

Address: 20E_0000h base + 608h offset = 20E_0608h

Bit	31	30	29	28	27	26	25	24		23	22	21	20	19	18	17	16
R	Reserved																
W	Reserved																
Reset	0	0	0	0	0	0	0	0		0	0	0	0	0	0	0	0
Bit	15	14	13	12	11	10	9	8		7	6	5	4	3	2	1	0
R	Reserved															DAISY	
W	Reserved															DAISY	
Reset	0	0	0	0	0	0	0	0		0	0	0	0	0	0	0	0

IOMUXC_SAI3_TX_BCLK_SELECT_INPUT field descriptions

Field	Description
31–1 -	This field is reserved. Reserved
0 DAISY	Selecting Pads Involved in Daisy Chain. Instance: sai3, In Pin: TX_BCLK 0 LCD_HSYNC_ALT3 — Selecting Pad: LCD_HSYNC for Mode: ALT3 1 LCD_DATA13_ALT1 — Selecting Pad: LCD_DATA13 for Mode: ALT1

32.6.354 SAI3_TX_SYNC_SELECT_INPUT DAISY Register (IOMUXC_SAI3_TX_SYNC_SELECT_INPUT)

DAISY Register

Address: 20E_0000h base + 60Ch offset = 20E_060Ch

Bit	31	30	29	28	27	26	25	24		23	22	21	20	19	18	17	16
R	Reserved																
W	Reserved																
Reset	0	0	0	0	0	0	0	0		0	0	0	0	0	0	0	0
Bit	15	14	13	12	11	10	9	8		7	6	5	4	3	2	1	0
R	Reserved															DAISY	
W	Reserved															DAISY	
Reset	0	0	0	0	0	0	0	0		0	0	0	0	0	0	0	0

IOMUXC_SAI3_TX_SYNC_SELECT_INPUT field descriptions

Field	Description
31-1 -	This field is reserved. Reserved
0 DAISY	Selecting Pads Involved in Daisy Chain. Instance: sai3, In Pin: TX_SYNC 0 LCD_ENABLE_ALT3 — Selecting Pad: LCD_ENABLE for Mode: ALT3 1 LCD_DATA12_ALT1 — Selecting Pad: LCD_DATA12 for Mode: ALT1

32.6.355 SDMA_EVENTS0_SELECT_INPUT DAISY Register (IOMUXC_SDMA_EVENTS0_SELECT_INPUT)

DAISY Register

Address: 20E_0000h base + 610h offset = 20E_0610h

Bit	31	30	29	28	27	26	25	24		23	22	21	20	19	18	17	16
R	Reserved																
W	Reserved																
Reset	0	0	0	0	0	0	0	0		0	0	0	0	0	0	0	0
Bit	15	14	13	12	11	10	9	8		7	6	5	4	3	2	1	0
R	Reserved															DAISY	
W	Reserved															DAISY	
Reset	0	0	0	0	0	0	0	0		0	0	0	0	0	0	0	0

IOMUXC_SDMA_EVENTS0_SELECT_INPUT field descriptions

Field	Description
31–2 -	This field is reserved. Reserved
DAISY	Selecting Pads Involved in Daisy Chain. Instance: sdma, In Pin: events14 00 JTAG_MOD_ALT6 — Selecting Pad: JTAG_MOD for Mode: ALT6 01 GPIO1_IO02_ALT6 — Selecting Pad: GPIO1_IO02 for Mode: ALT6 10 SD1_CMD_ALT6 — Selecting Pad: SD1_CMD for Mode: ALT6

32.6.356 SDMA_EVENTS1_SELECT_INPUT DAISY Register (IOMUXC_SDMA_EVENTS1_SELECT_INPUT)

DAISY Register

Address: 20E_0000h base + 614h offset = 20E_0614h

Bit	31	30	29	28	27	26	25	24	23	22	21	20	19	18	17	16
R	Reserved															
W	Reserved															
Reset	0	0	0	0	0	0	0	0	0	0	0	0	0	0	0	0
Bit	15	14	13	12	11	10	9	8	7	6	5	4	3	2	1	0
R	Reserved															DAISY
W	Reserved															DAISY
Reset	0	0	0	0	0	0	0	0	0	0	0	0	0	0	0	0

IOMUXC_SDMA_EVENTS1_SELECT_INPUT field descriptions

Field	Description
31–1 -	This field is reserved. Reserved
0 DAISY	Selecting Pads Involved in Daisy Chain. Instance: sdma, In Pin: events15 0 JTAG_TMS_ALT6 — Selecting Pad: JTAG_TMS for Mode: ALT6 1 NAND_DQS_ALT6 — Selecting Pad: NAND_DQS for Mode: ALT6

32.6.357 SPDIF_IN_SELECT_INPUT DAISY Register (IOMUXC_SPDIF_IN_SELECT_INPUT)

DAISY Register

Address: 20E_0000h base + 618h offset = 20E_0618h

Bit	31	30	29	28	27	26	25	24		23	22	21	20	19	18	17	16
R	Reserved																
W	Reserved																
Reset	0	0	0	0	0	0	0	0		0	0	0	0	0	0	0	0
Bit	15	14	13	12	11	10	9	8		7	6	5	4	3	2	1	0
R	Reserved															DAISY	
W	Reserved															DAISY	
Reset	0	0	0	0	0	0	0	0		0	0	0	0	0	0	0	0

IOMUXC_SPDIF_IN_SELECT_INPUT field descriptions

Field	Description
31–2 -	This field is reserved. Reserved
DAISY	Selecting Pads Involved in Daisy Chain. Instance: spdif, In Pin: spdif_in1 00 GPIO1_IO09_ALT2 — Selecting Pad: GPIO1_IO09 for Mode: ALT2 01 UART1_RX_DATA_ALT8 — Selecting Pad: UART1_RX_DATA for Mode: ALT8 10 LCD_DATA08_ALT1 — Selecting Pad: LCD_DATA08 for Mode: ALT1 11 SD1_CLK_ALT3 — Selecting Pad: SD1_CLK for Mode: ALT3

32.6.358 SPDIF_EXT_CLK_SELECT_INPUT DAISY Register (IOMUXC_SPDIF_EXT_CLK_SELECT_INPUT)

DAISY Register

Address: 20E_0000h base + 61Ch offset = 20E_061Ch

Bit	31	30	29	28	27	26	25	24	23	22	21	20	19	18	17	16
R	Reserved															
W	Reserved															
Reset	0	0	0	0	0	0	0	0	0	0	0	0	0	0	0	0
Bit	15	14	13	12	11	10	9	8	7	6	5	4	3	2	1	0
R	Reserved															DAISY
W	Reserved															DAISY
Reset	0	0	0	0	0	0	0	0	0	0	0	0	0	0	0	0

IOMUXC_SPDIF_EXT_CLK_SELECT_INPUT field descriptions

Field	Description
31–1 -	This field is reserved. Reserved
0 DAISY	Selecting Pads Involved in Daisy Chain. Instance: spdif, In Pin: tx_clk2 0 LCD_DATA07_ALT4 — Selecting Pad: LCD_DATA07 for Mode: ALT4 1 NAND_DQS_ALT8 — Selecting Pad: NAND_DQS for Mode: ALT8

32.6.359 UART1_RTS_B_SELECT_INPUT DAISY Register (IOMUXC_UART1_RTS_B_SELECT_INPUT)

DAISY Register

Address: 20E_0000h base + 620h offset = 20E_0620h

Bit	31	30	29	28	27	26	25	24	23	22	21	20	19	18	17	16
R	Reserved															
W	Reserved															
Reset	0	0	0	0	0	0	0	0	0	0	0	0	0	0	0	0
Bit	15	14	13	12	11	10	9	8	7	6	5	4	3	2	1	0
R	Reserved															DAISY
W	Reserved															DAISY
Reset	0	0	0	0	0	0	0	0	0	0	0	0	0	0	0	0

IOMUXC_UART1_RTS_B_SELECT_INPUT field descriptions

Field	Description
31–2 -	This field is reserved. Reserved
DAISY	Selecting Pads Involved in Daisy Chain. Instance: uart1, In Pin: uart_rts_b 00 GPIO1_IO06_ALT8 — Selecting Pad: GPIO1_IO06 for Mode: ALT8 01 GPIO1_IO07_ALT8 — Selecting Pad: GPIO1_IO07 for Mode: ALT8 10 UART1_CTS_B_ALT0 — Selecting Pad: UART1_CTS_B for Mode: ALT0 11 UART1_RTS_B_ALT0 — Selecting Pad: UART1_RTS_B for Mode: ALT0

32.6.360 UART1_RX_DATA_SELECT_INPUT DAISY Register (IOMUXC_UART1_RX_DATA_SELECT_INPUT)

DAISY Register

Address: 20E_0000h base + 624h offset = 20E_0624h

Bit	31	30	29	28	27	26	25	24	23	22	21	20	19	18	17	16
R	Reserved															
W	Reserved															
Reset	0	0	0	0	0	0	0	0	0	0	0	0	0	0	0	0
Bit	15	14	13	12	11	10	9	8	7	6	5	4	3	2	1	0
R	Reserved															DAISY
W	Reserved															DAISY
Reset	0	0	0	0	0	0	0	0	0	0	0	0	0	0	0	0

IOMUXC_UART1_RX_DATA_SELECT_INPUT field descriptions

Field	Description
31–2 -	This field is reserved. Reserved
DAISY	Selecting Pads Involved in Daisy Chain. Instance: uart1, In Pin: uart_RX_DATA 00 GPIO1_IO02_ALT8 — Selecting Pad: GPIO1_IO02 for Mode: ALT8 01 GPIO1_IO03_ALT8 — Selecting Pad: GPIO1_IO03 for Mode: ALT8 10 UART1_TX_DATA_ALT0 — Selecting Pad: UART1_TX_DATA for Mode: ALT0 11 UART1_RX_DATA_ALT0 — Selecting Pad: UART1_RX_DATA for Mode: ALT0

32.6.361 UART2_RTS_B_SELECT_INPUT DAISY Register (IOMUXC_UART2_RTS_B_SELECT_INPUT)

DAISY Register

Address: 20E_0000h base + 628h offset = 20E_0628h

Bit	31	30	29	28	27	26	25	24	23	22	21	20	19	18	17	16	15	14	13	12	11	10	9	8	7	6	5	4	3	2	1	0
R	Reserved																DAISY															
W	Reserved																DAISY															
Reset	0	0	0	0	0	0	0	0	0	0	0	0	0	0	0	0	0	0	0	0	0	0	0	0	0	0	0	0	0	0	0	

IOMUXC_UART2_RTS_B_SELECT_INPUT field descriptions

Field	Description
31–3 -	This field is reserved. Reserved
DAISY	<p>Selecting Pads Involved in Daisy Chain.</p> <p>Instance: uart2, In Pin: uart_rts_b</p> <p>000 UART2_CTS_B_ALT0 — Selecting Pad: UART2_CTS_B for Mode: ALT0</p> <p>001 UART2_RTS_B_ALT0 — Selecting Pad: UART2_RTS_B for Mode: ALT0</p> <p>010 UART3_TX_DATA_ALT4 — Selecting Pad: UART3_TX_DATA for Mode: ALT4</p> <p>011 UART3_RX_DATA_ALT4 — Selecting Pad: UART3_RX_DATA for Mode: ALT4</p> <p>100 NAND_DATA06_ALT8 — Selecting Pad: NAND_DATA06 for Mode: ALT8</p> <p>101 NAND_DATA07_ALT8 — Selecting Pad: NAND_DATA07 for Mode: ALT8</p>

32.6.362 UART2_RX_DATA_SELECT_INPUT DAISY Register (IOMUXC_UART2_RX_DATA_SELECT_INPUT)

DAISY Register

Address: 20E_0000h base + 62Ch offset = 20E_062Ch

Bit	31	30	29	28	27	26	25	24	23	22	21	20	19	18	17	16
R	Reserved															
W	Reserved															
Reset	0	0	0	0	0	0	0	0	0	0	0	0	0	0	0	0
Bit	15	14	13	12	11	10	9	8	7	6	5	4	3	2	1	0
R	Reserved															DAISY
W	Reserved															DAISY
Reset	0	0	0	0	0	0	0	0	0	0	0	0	0	0	0	0

IOMUXC_UART2_RX_DATA_SELECT_INPUT field descriptions

Field	Description
31–2 -	This field is reserved. Reserved
DAISY	Selecting Pads Involved in Daisy Chain. Instance: uart2, In Pin: uart_RX_DATA 00 UART2_TX_DATA_ALT0 — Selecting Pad: UART2_TX_DATA for Mode: ALTO 01 UART2_RX_DATA_ALT0 — Selecting Pad: UART2_RX_DATA for Mode: ALTO 10 NAND_DATA04_ALT8 — Selecting Pad: NAND_DATA04 for Mode: ALT8 11 NAND_DATA05_ALT8 — Selecting Pad: NAND_DATA05 for Mode: ALT8

32.6.363 UART3_RTS_B_SELECT_INPUT DAISY Register (IOMUXC_UART3_RTS_B_SELECT_INPUT)

DAISY Register

Address: 20E_0000h base + 630h offset = 20E_0630h

Bit	31	30	29	28	27	26	25	24		23	22	21	20	19	18	17	16
R	Reserved																
W	Reserved																
Reset	0	0	0	0	0	0	0	0		0	0	0	0	0	0	0	0
Bit	15	14	13	12	11	10	9	8		7	6	5	4	3	2	1	0
R	Reserved															DAISY	
W	Reserved															DAISY	
Reset	0	0	0	0	0	0	0	0		0	0	0	0	0	0	0	0

IOMUXC_UART3_RTS_B_SELECT_INPUT field descriptions

Field	Description
31–2 -	This field is reserved. Reserved
DAISY	Selecting Pads Involved in Daisy Chain. Instance: uart3, In Pin: uart_rts_b 00 UART3_CTS_B_ALT0 — Selecting Pad: UART3_CTS_B for Mode: ALTO 01 UART3_RTS_B_ALT0 — Selecting Pad: UART3_RTS_B for Mode: ALTO 10 NAND_CE1_B_ALT8 — Selecting Pad: NAND_CE1_B for Mode: ALT8 11 NAND_CLE_ALT8 — Selecting Pad: NAND_CLE for Mode: ALT8

32.6.364 UART3_RX_DATA_SELECT_INPUT DAISY Register (IOMUXC_UART3_RX_DATA_SELECT_INPUT)

DAISY Register

Address: 20E_0000h base + 634h offset = 20E_0634h

Bit	31	30	29	28	27	26	25	24	23	22	21	20	19	18	17	16
R	Reserved															
W	Reserved															
Reset	0	0	0	0	0	0	0	0	0	0	0	0	0	0	0	0
Bit	15	14	13	12	11	10	9	8	7	6	5	4	3	2	1	0
R	Reserved															DAISY
W	Reserved															DAISY
Reset	0	0	0	0	0	0	0	0	0	0	0	0	0	0	0	0

IOMUXC_UART3_RX_DATA_SELECT_INPUT field descriptions

Field	Description
31–2 -	This field is reserved. Reserved
DAISY	Selecting Pads Involved in Daisy Chain. Instance: uart3, In Pin: uart_RX_DATA 00 UART3_TX_DATA_ALT0 — Selecting Pad: UART3_TX_DATA for Mode: ALT0 01 UART3_RX_DATA_ALT0 — Selecting Pad: UART3_RX_DATA for Mode: ALT0 10 NAND_READY_B_ALT8 — Selecting Pad: NAND_READY_B for Mode: ALT8 11 NAND_CE0_B_ALT8 — Selecting Pad: NAND_CE0_B for Mode: ALT8

32.6.365 UART4_RTS_B_SELECT_INPUT DAISY Register (IOMUXC_UART4_RTS_B_SELECT_INPUT)

DAISY Register

Address: 20E_0000h base + 638h offset = 20E_0638h

Bit	31	30	29	28	27	26	25	24	23	22	21	20	19	18	17	16
R	Reserved															
W	Reserved															
Reset	0	0	0	0	0	0	0	0	0	0	0	0	0	0	0	0
Bit	15	14	13	12	11	10	9	8	7	6	5	4	3	2	1	0
R	Reserved															DAISY
W	Reserved															DAISY
Reset	0	0	0	0	0	0	0	0	0	0	0	0	0	0	0	0

IOMUXC_UART4_RTS_B_SELECT_INPUT field descriptions

Field	Description
31–2 -	This field is reserved. Reserved
DAISY	Selecting Pads Involved in Daisy Chain. Instance: uart4, In Pin: uart_rts_b 00 ENET1_RX_DATA0_ALT1 — Selecting Pad: ENET1_RX_DATA0 for Mode: ALT1 01 ENET1_RX_DATA1_ALT1 — Selecting Pad: ENET1_RX_DATA1 for Mode: ALT1 10 LCD_HSYNC_ALT2 — Selecting Pad: LCD_HSYNC for Mode: ALT2 11 LCD_VSYNC_ALT2 — Selecting Pad: LCD_VSYNC for Mode: ALT2

32.6.366 UART4_RX_DATA_SELECT_INPUT DAISY Register (IOMUXC_UART4_RX_DATA_SELECT_INPUT)

DAISY Register

Address: 20E_0000h base + 63Ch offset = 20E_063Ch

Bit	31	30	29	28	27	26	25	24	23	22	21	20	19	18	17	16
R	Reserved															
W	Reserved															
Reset	0	0	0	0	0	0	0	0	0	0	0	0	0	0	0	0
Bit	15	14	13	12	11	10	9	8	7	6	5	4	3	2	1	0
R	Reserved															DAISY
W	Reserved															DAISY
Reset	0	0	0	0	0	0	0	0	0	0	0	0	0	0	0	0

IOMUXC_UART4_RX_DATA_SELECT_INPUT field descriptions

Field	Description
31–2 -	This field is reserved. Reserved
DAISY	Selecting Pads Involved in Daisy Chain. Instance: uart4, In Pin: uart_RX_DATA 00 UART4_TX_DATA_ALT0 — Selecting Pad: UART4_TX_DATA for Mode: ALTO 01 UART4_RX_DATA_ALT0 — Selecting Pad: UART4_RX_DATA for Mode: ALTO 10 LCD_CLK_ALT2 — Selecting Pad: LCD_CLK for Mode: ALT2 11 LCD_ENABLE_ALT2 — Selecting Pad: LCD_ENABLE for Mode: ALT2

32.6.367 UART5_RTS_B_SELECT_INPUT DAISY Register (IOMUXC_UART5_RTS_B_SELECT_INPUT)

DAISY Register

Address: 20E_0000h base + 640h offset = 20E_0640h

Bit	31	30	29	28	27	26	25	24	23	22	21	20	19	18	17	16	15	14	13	12	11	10	9	8	7	6	5	4	3	2	1	0
R	Reserved																DAISY															
W																																
Reset	0	0	0	0	0	0	0	0	0	0	0	0	0	0	0	0	0	0	0	0	0	0	0	0	0	0	0	0	0	0	0	0

IOMUXC_UART5_RTS_B_SELECT_INPUT field descriptions

Field	Description
31–3 -	This field is reserved. Reserved
DAISY	<p>Selecting Pads Involved in Daisy Chain.</p> <p>Instance: uart5, In Pin: uart_rts_b</p> <p>000 CSI_DATA03_ALT8 — Selecting Pad: CSI_DATA03 for Mode: ALT8</p> <p>001 GPIO1_IO08_ALT8 — Selecting Pad: GPIO1_IO08 for Mode: ALT8</p> <p>010 GPIO1_IO09_ALT8 — Selecting Pad: GPIO1_IO09 for Mode: ALT8</p> <p>011 UART1_CTS_B_ALT9 — Selecting Pad: UART1_CTS_B for Mode: ALT9</p> <p>100 UART1_RTS_B_ALT9 — Selecting Pad: UART1_RTS_B for Mode: ALT9</p> <p>101 ENET1_RX_EN_ALT1 — Selecting Pad: ENET1_RX_EN for Mode: ALT1</p> <p>110 ENET1_TX_DATA0_ALT1 — Selecting Pad: ENET1_TX_DATA0 for Mode: ALT1</p> <p>111 CSI_DATA02_ALT8 — Selecting Pad: CSI_DATA02 for Mode: ALT8</p>

32.6.368 UART5_RX_DATA_SELECT_INPUT DAISY Register (IOMUXC_UART5_RX_DATA_SELECT_INPUT)

DAISY Register

Address: 20E_0000h base + 644h offset = 20E_0644h

Bit	31	30	29	28	27	26	25	24	23	22	21	20	19	18	17	16	15	14	13	12	11	10	9	8	7	6	5	4	3	2	1	0
R	Reserved																DAISY															
W																																
Reset	0	0	0	0	0	0	0	0	0	0	0	0	0	0	0	0	0	0	0	0	0	0	0	0	0	0	0	0	0	0	0	0

IOMUXC_UART5_RX_DATA_SELECT_INPUT field descriptions

Field	Description
31–3 -	This field is reserved. Reserved
DAISY	Selecting Pads Involved in Daisy Chain.

Table continues on the next page...

IOMUXC_UART5_RX_DATA_SELECT_INPUT field descriptions (continued)

Field	Description
	Instance: uart5, In Pin: uart_RX_DATA
000	CSI_DATA00_ALT8 — Selecting Pad: CSI_DATA00 for Mode: ALT8
001	CSI_DATA01_ALT8 — Selecting Pad: CSI_DATA01 for Mode: ALT8
010	GPIO1_IO04_ALT8 — Selecting Pad: GPIO1_IO04 for Mode: ALT8
011	GPIO1_IO05_ALT8 — Selecting Pad: GPIO1_IO05 for Mode: ALT8
100	UART1_TX_DATA_ALT9 — Selecting Pad: UART1_TX_DATA for Mode: ALT9
101	UART1_RX_DATA_ALT9 — Selecting Pad: UART1_RX_DATA for Mode: ALT9
110	UART5_TX_DATA_ALTO — Selecting Pad: UART5_TX_DATA for Mode: ALTO
111	UART5_RX_DATA_ALTO — Selecting Pad: UART5_RX_DATA for Mode: ALTO

32.6.369 UART6_RTS_B_SELECT_INPUT DAISY Register (IOMUXC_UART6_RTS_B_SELECT_INPUT)

DAISY Register

Address: 20E_0000h base + 648h offset = 20E_0648h

Bit	31	30	29	28	27	26	25	24	23	22	21	20	19	18	17	16
R	Reserved															
W	Reserved															
Reset	0	0	0	0	0	0	0	0	0	0	0	0	0	0	0	0
Bit	15	14	13	12	11	10	9	8	7	6	5	4	3	2	1	0
R	Reserved															DAISY
W	Reserved															DAISY
Reset	0	0	0	0	0	0	0	0	0	0	0	0	0	0	0	0

IOMUXC_UART6_RTS_B_SELECT_INPUT field descriptions

Field	Description
31–2 -	This field is reserved. Reserved
DAISY	Selecting Pads Involved in Daisy Chain. Instance: uart6, In Pin: uart_rts_b 00 CSI_VSYNC_ALT8 — Selecting Pad: CSI_VSYNC for Mode: ALT8 01 CSI_HSYNC_ALT8 — Selecting Pad: CSI_HSYNC for Mode: ALT8 10 ENET1_TX_DATA1_ALT1 — Selecting Pad: ENET1_TX_DATA1 for Mode: ALT1 11 ENET1_TX_EN_ALT1 — Selecting Pad: ENET1_TX_EN for Mode: ALT1

32.6.370 UART6_RX_DATA_SELECT_INPUT DAISY Register (IOMUXC_UART6_RX_DATA_SELECT_INPUT)

DAISY Register

Address: 20E_0000h base + 64Ch offset = 20E_064Ch

Bit	31	30	29	28	27	26	25	24	23	22	21	20	19	18	17	16
R	Reserved															
W	Reserved															
Reset	0	0	0	0	0	0	0	0	0	0	0	0	0	0	0	0
Bit	15	14	13	12	11	10	9	8	7	6	5	4	3	2	1	0
R	Reserved															DAISY
W	Reserved															DAISY
Reset	0	0	0	0	0	0	0	0	0	0	0	0	0	0	0	0

IOMUXC_UART6_RX_DATA_SELECT_INPUT field descriptions

Field	Description
31–2 -	This field is reserved. Reserved
DAISY	Selecting Pads Involved in Daisy Chain. Instance: uart6, In Pin: uart_RX_DATA 00 CSI_MCLK_ALT8 — Selecting Pad: CSI_MCLK for Mode: ALT8 01 ENET2_RX_DATA0_ALT1 — Selecting Pad: ENET2_RX_DATA0 for Mode: ALT1 10 ENET2_RX_DATA1_ALT1 — Selecting Pad: ENET2_RX_DATA1 for Mode: ALT1 11 CSI_PIXCLK_ALT8 — Selecting Pad: CSI_PIXCLK for Mode: ALT8

32.6.371 UART7_RTS_B_SELECT_INPUT DAISY Register (IOMUXC_UART7_RTS_B_SELECT_INPUT)

DAISY Register

Address: 20E_0000h base + 650h offset = 20E_0650h

Bit	31	30	29	28	27	26	25	24	23	22	21	20	19	18	17	16
R	Reserved															
W	Reserved															
Reset	0	0	0	0	0	0	0	0	0	0	0	0	0	0	0	0
Bit	15	14	13	12	11	10	9	8	7	6	5	4	3	2	1	0
R	Reserved															DAISY
W	Reserved															DAISY
Reset	0	0	0	0	0	0	0	0	0	0	0	0	0	0	0	0

IOMUXC_UART7_RTS_B_SELECT_INPUT field descriptions

Field	Description
31–2 -	This field is reserved. Reserved
DAISY	Selecting Pads Involved in Daisy Chain. Instance: uart7, In Pin: uart_rts_b 00 ENET1_TX_CLK_ALT1 — Selecting Pad: ENET1_TX_CLK for Mode: ALT1 01 ENET1_RX_ER_ALT1 — Selecting Pad: ENET1_RX_ER for Mode: ALT1 10 LCD_DATA06_ALT1 — Selecting Pad: LCD_DATA06 for Mode: ALT1 11 LCD_DATA07_ALT1 — Selecting Pad: LCD_DATA07 for Mode: ALT1

32.6.372 UART7_RX_DATA_SELECT_INPUT DAISY Register (IOMUXC_UART7_RX_DATA_SELECT_INPUT)

DAISY Register

Address: 20E_0000h base + 654h offset = 20E_0654h

Bit	31	30	29	28	27	26	25	24		23	22	21	20	19	18	17	16
R	Reserved																
W	Reserved																
Reset	0	0	0	0	0	0	0	0		0	0	0	0	0	0	0	0
Bit	15	14	13	12	11	10	9	8		7	6	5	4	3	2	1	0
R	Reserved															DAISY	
W	Reserved															DAISY	
Reset	0	0	0	0	0	0	0	0		0	0	0	0	0	0	0	0

IOMUXC_UART7_RX_DATA_SELECT_INPUT field descriptions

Field	Description
31–2 -	This field is reserved. Reserved
DAISY	Selecting Pads Involved in Daisy Chain. Instance: uart7, In Pin: uart_RX_DATA 00 ENET2_RX_EN_ALT1 — Selecting Pad: ENET2_RX_EN for Mode: ALT1 01 ENET2_TX_DATA0_ALT1 — Selecting Pad: ENET2_TX_DATA0 for Mode: ALT1 10 LCD_DATA16_ALT1 — Selecting Pad: LCD_DATA16 for Mode: ALT1 11 LCD_DATA17_ALT1 — Selecting Pad: LCD_DATA17 for Mode: ALT1

32.6.373 UART8_RTS_B_SELECT_INPUT DAISY Register (IOMUXC_UART8_RTS_B_SELECT_INPUT)

DAISY Register

Address: 20E_0000h base + 658h offset = 20E_0658h

Bit	31	30	29	28	27	26	25	24	23	22	21	20	19	18	17	16
R	Reserved															
W	Reserved															
Reset	0	0	0	0	0	0	0	0	0	0	0	0	0	0	0	0
Bit	15	14	13	12	11	10	9	8	7	6	5	4	3	2	1	0
R	Reserved															DAISY
W	Reserved															DAISY
Reset	0	0	0	0	0	0	0	0	0	0	0	0	0	0	0	0

IOMUXC_UART8_RTS_B_SELECT_INPUT field descriptions

Field	Description
31–2 -	This field is reserved. Reserved
DAISY	Selecting Pads Involved in Daisy Chain. Instance: uart8, In Pin: uart_rts_b 00 ENET2_TX_CLK_ALT1 — Selecting Pad: ENET2_TX_CLK for Mode: ALT1 01 ENET2_RX_ER_ALT1 — Selecting Pad: ENET2_RX_ER for Mode: ALT1 10 LCD_DATA04_ALT1 — Selecting Pad: LCD_DATA04 for Mode: ALT1 11 LCD_DATA05_ALT1 — Selecting Pad: LCD_DATA05 for Mode: ALT1

32.6.374 UART8_RX_DATA_SELECT_INPUT DAISY Register (IOMUXC_UART8_RX_DATA_SELECT_INPUT)

DAISY Register

Address: 20E_0000h base + 65Ch offset = 20E_065Ch

Bit	31	30	29	28	27	26	25	24	23	22	21	20	19	18	17	16
R	Reserved															
W	Reserved															
Reset	0	0	0	0	0	0	0	0	0	0	0	0	0	0	0	0
Bit	15	14	13	12	11	10	9	8	7	6	5	4	3	2	1	0
R	Reserved															DAISY
W	Reserved															DAISY
Reset	0	0	0	0	0	0	0	0	0	0	0	0	0	0	0	0

IOMUXC_UART8_RX_DATA_SELECT_INPUT field descriptions

Field	Description
31–2 -	This field is reserved. Reserved
DAISY	Selecting Pads Involved in Daisy Chain. Instance: uart8, In Pin: uart_RX_DATA 00 ENET2_TX_DATA1_ALT1 — Selecting Pad: ENET2_TX_DATA1 for Mode: ALT1 01 ENET2_TX_EN_ALT1 — Selecting Pad: ENET2_TX_EN for Mode: ALT1 10 LCD_DATA20_ALT1 — Selecting Pad: LCD_DATA20 for Mode: ALT1 11 LCD_DATA21_ALT1 — Selecting Pad: LCD_DATA21 for Mode: ALT1

32.6.375 USB_OTG2_OC_SELECT_INPUT DAISY Register (IOMUXC_USB_OTG2_OC_SELECT_INPUT)

DAISY Register

Address: 20E_0000h base + 660h offset = 20E_0660h

Bit	31	30	29	28	27	26	25	24	23	22	21	20	19	18	17	16
R	Reserved															
W	Reserved															
Reset	0	0	0	0	0	0	0	0	0	0	0	0	0	0	0	0
Bit	15	14	13	12	11	10	9	8	7	6	5	4	3	2	1	0
R	Reserved															DAISY
W	Reserved															DAISY
Reset	0	0	0	0	0	0	0	0	0	0	0	0	0	0	0	0

IOMUXC_USB_OTG2_OC_SELECT_INPUT field descriptions

Field	Description
31–2 -	This field is reserved. Reserved
DAISY	Selecting Pads Involved in Daisy Chain. Instance: usb, In Pin: otg2_oc 00 GPIO1_IO03_ALT2 — Selecting Pad: GPIO1_IO03 for Mode: ALT2 01 ENET2_TX_EN_ALT8 — Selecting Pad: ENET2_TX_EN for Mode: ALT8 10 SD1_DATA2_ALT8 — Selecting Pad: SD1_DATA2 for Mode: ALT8

32.6.376 USB_OTG_OC_SELECT_INPUT DAISY Register (IOMUXC_USB_OTG_OC_SELECT_INPUT)

DAISY Register

Address: 20E_0000h base + 664h offset = 20E_0664h

Bit	31	30	29	28	27	26	25	24	23	22	21	20	19	18	17	16
R	Reserved															
W	Reserved															
Reset	0	0	0	0	0	0	0	0	0	0	0	0	0	0	0	0
Bit	15	14	13	12	11	10	9	8	7	6	5	4	3	2	1	0
R	Reserved															DAISY
W	Reserved															DAISY
Reset	0	0	0	0	0	0	0	0	0	0	0	0	0	0	0	0

IOMUXC_USB_OTG_OC_SELECT_INPUT field descriptions

Field	Description
31–2 -	This field is reserved. Reserved
DAISY	Selecting Pads Involved in Daisy Chain. Instance: usb, In Pin: otg_oc 00 GPIO1_IO01_ALT2 — Selecting Pad: GPIO1_IO01 for Mode: ALT2 01 ENET2_RX_DATA1_ALT8 — Selecting Pad: ENET2_RX_DATA1 for Mode: ALT8 10 SD1_CLK_ALT8 — Selecting Pad: SD1_CLK for Mode: ALT8

32.6.377 USDHC1_CD_B_SELECT_INPUT DAISY Register (IOMUXC_USDHC1_CD_B_SELECT_INPUT)

DAISY Register

Address: 20E_0000h base + 668h offset = 20E_0668h

Bit	31	30	29	28	27	26	25	24	23	22	21	20	19	18	17	16
R	Reserved															
W	Reserved															
Reset	0	0	0	0	0	0	0	0	0	0	0	0	0	0	0	0
Bit	15	14	13	12	11	10	9	8	7	6	5	4	3	2	1	0
R	Reserved															DAISY
W	Reserved															DAISY
Reset	0	0	0	0	0	0	0	0	0	0	0	0	0	0	0	0

IOMUXC_USDHC1_CD_B_SELECT_INPUT field descriptions

Field	Description
31–2 -	This field is reserved. Reserved
DAISY	Selecting Pads Involved in Daisy Chain. Instance: usdhc1, In Pin: card_det 00 GPIO1_IO03_ALT4 — Selecting Pad: GPIO1_IO03 for Mode: ALT4 01 UART1_RTS_B_ALT2 — Selecting Pad: UART1_RTS_B for Mode: ALT2 10 CSI_DATA05_ALT8 — Selecting Pad: CSI_DATA05 for Mode: ALT8

32.6.378 USDHC1_WP_SELECT_INPUT DAISY Register (IOMUXC_USDHC1_WP_SELECT_INPUT)

DAISY Register

Address: 20E_0000h base + 66Ch offset = 20E_066Ch

Bit	31	30	29	28	27	26	25	24		23	22	21	20	19	18	17	16
R	Reserved																
W	Reserved																
Reset	0	0	0	0	0	0	0	0		0	0	0	0	0	0	0	0
Bit	15	14	13	12	11	10	9	8		7	6	5	4	3	2	1	0
R	Reserved															DAISY	
W	Reserved															DAISY	
Reset	0	0	0	0	0	0	0	0		0	0	0	0	0	0	0	0

IOMUXC_USDHC1_WP_SELECT_INPUT field descriptions

Field	Description
31–2 -	This field is reserved. Reserved
DAISY	Selecting Pads Involved in Daisy Chain. Instance: usdhc1, In Pin: wp_on 00 GPIO1_IO02_ALT4 — Selecting Pad: GPIO1_IO02 for Mode: ALT4 01 UART1_CTS_B_ALT2 — Selecting Pad: UART1_CTS_B for Mode: ALT2 10 CSI_DATA04_ALT8 — Selecting Pad: CSI_DATA04 for Mode: ALT8

32.6.379 USDHC2_CLK_SELECT_INPUT DAISY Register (IOMUXC_USDHC2_CLK_SELECT_INPUT)

DAISY Register

Address: 20E_0000h base + 670h offset = 20E_0670h

Bit	31	30	29	28	27	26	25	24	23	22	21	20	19	18	17	16
R	Reserved															
W	Reserved															
Reset	0	0	0	0	0	0	0	0	0	0	0	0	0	0	0	0
Bit	15	14	13	12	11	10	9	8	7	6	5	4	3	2	1	0
R	Reserved															DAISY
W	Reserved															DAISY
Reset	0	0	0	0	0	0	0	0	0	0	0	0	0	0	0	0

IOMUXC_USDHC2_CLK_SELECT_INPUT field descriptions

Field	Description
31–2 -	This field is reserved. Reserved
DAISY	Selecting Pads Involved in Daisy Chain. Instance: usdhc2, In Pin: CLK_in 00 CSI_VSYNC_ALT1 — Selecting Pad: CSI_VSYNC for Mode: ALT1 01 LCD_DATA19_ALT8 — Selecting Pad: LCD_DATA19 for Mode: ALT8 10 NAND_RE_B_ALT1 — Selecting Pad: NAND_RE_B for Mode: ALT1

32.6.380 USDHC2_CD_B_SELECT_INPUT DAISY Register (IOMUXC_USDHC2_CD_B_SELECT_INPUT)

DAISY Register

Address: 20E_0000h base + 674h offset = 20E_0674h

Bit	31	30	29	28	27	26	25	24	23	22	21	20	19	18	17	16
R	Reserved															
W	Reserved															
Reset	0	0	0	0	0	0	0	0	0	0	0	0	0	0	0	0
Bit	15	14	13	12	11	10	9	8	7	6	5	4	3	2	1	0
R	Reserved															DAISY
W	Reserved															DAISY
Reset	0	0	0	0	0	0	0	0	0	0	0	0	0	0	0	0

IOMUXC_USDHC2_CD_B_SELECT_INPUT field descriptions

Field	Description
31–2 -	This field is reserved. Reserved
DAISY	Selecting Pads Involved in Daisy Chain. Instance: usdhc2, In Pin: card_det 00 CSI_MCLK_ALT1 — Selecting Pad: CSI_MCLK for Mode: ALT1 01 GPIO1_IO07_ALT4 — Selecting Pad: GPIO1_IO07 for Mode: ALT4 10 UART1_RTS_B_ALT8 — Selecting Pad: UART1_RTS_B for Mode: ALT8

32.6.381 USDHC2_CMD_SELECT_INPUT DAISY Register (IOMUXC_USDHC2_CMD_SELECT_INPUT)

DAISY Register

Address: 20E_0000h base + 678h offset = 20E_0678h

Bit	31	30	29	28	27	26	25	24	23	22	21	20	19	18	17	16
R	Reserved															
W	Reserved															
Reset	0	0	0	0	0	0	0	0	0	0	0	0	0	0	0	0
Bit	15	14	13	12	11	10	9	8	7	6	5	4	3	2	1	0
R	Reserved															DAISY
W	Reserved															DAISY
Reset	0	0	0	0	0	0	0	0	0	0	0	0	0	0	0	0

IOMUXC_USDHC2_CMD_SELECT_INPUT field descriptions

Field	Description
31–2 -	This field is reserved. Reserved
DAISY	Selecting Pads Involved in Daisy Chain. Instance: usdhc2, In Pin: cmd_in 00 CSI_HSYNC_ALT1 — Selecting Pad: CSI_HSYNC for Mode: ALT1 01 LCD_DATA18_ALT8 — Selecting Pad: LCD_DATA18 for Mode: ALT8 10 NAND_WE_B_ALT1 — Selecting Pad: NAND_WE_B for Mode: ALT1

32.6.382 USDHC2_DATA0_SELECT_INPUT DAISY Register (IOMUXC_USDHC2_DATA0_SELECT_INPUT)

DAISY Register

Address: 20E_0000h base + 67Ch offset = 20E_067Ch

Bit	31	30	29	28	27	26	25	24	23	22	21	20	19	18	17	16
R	Reserved															
W	Reserved															
Reset	0	0	0	0	0	0	0	0	0	0	0	0	0	0	0	0
Bit	15	14	13	12	11	10	9	8	7	6	5	4	3	2	1	0
R	Reserved															DAISY
W	Reserved															DAISY
Reset	0	0	0	0	0	0	0	0	0	0	0	0	0	0	0	0

IOMUXC_USDHC2_DATA0_SELECT_INPUT field descriptions

Field	Description
31–2 -	This field is reserved. Reserved
DAISY	Selecting Pads Involved in Daisy Chain. Instance: usdhc2, In Pin: DATA0_in 00 CSI_DATA00_ALT1 — Selecting Pad: CSI_DATA00 for Mode: ALT1 01 LCD_DATA20_ALT8 — Selecting Pad: LCD_DATA20 for Mode: ALT8 10 NAND_DATA00_ALT1 — Selecting Pad: NAND_DATA00 for Mode: ALT1

32.6.383 USDHC2_DATA1_SELECT_INPUT DAISY Register (IOMUXC_USDHC2_DATA1_SELECT_INPUT)

DAISY Register

Address: 20E_0000h base + 680h offset = 20E_0680h

Bit	31	30	29	28	27	26	25	24	23	22	21	20	19	18	17	16
R	Reserved															
W	Reserved															
Reset	0	0	0	0	0	0	0	0	0	0	0	0	0	0	0	0
Bit	15	14	13	12	11	10	9	8	7	6	5	4	3	2	1	0
R	Reserved															DAISY
W	Reserved															DAISY
Reset	0	0	0	0	0	0	0	0	0	0	0	0	0	0	0	0

IOMUXC_USDHC2_DATA1_SELECT_INPUT field descriptions

Field	Description
31–2 -	This field is reserved. Reserved
DAISY	Selecting Pads Involved in Daisy Chain. Instance: usdhc2, In Pin: DATA1_in 00 CSI_DATA01_ALT1 — Selecting Pad: CSI_DATA01 for Mode: ALT1 01 LCD_DATA21_ALT8 — Selecting Pad: LCD_DATA21 for Mode: ALT8 10 NAND_DATA01_ALT1 — Selecting Pad: NAND_DATA01 for Mode: ALT1

32.6.384 USDHC2_DATA2_SELECT_INPUT DAISY Register (IOMUXC_USDHC2_DATA2_SELECT_INPUT)

DAISY Register

Address: 20E_0000h base + 684h offset = 20E_0684h

Bit	31	30	29	28	27	26	25	24		23	22	21	20	19	18	17	16
R	Reserved																
W	Reserved																
Reset	0	0	0	0	0	0	0	0		0	0	0	0	0	0	0	0
Bit	15	14	13	12	11	10	9	8		7	6	5	4	3	2	1	0
R	Reserved															DAISY	
W	Reserved															DAISY	
Reset	0	0	0	0	0	0	0	0		0	0	0	0	0	0	0	0

IOMUXC_USDHC2_DATA2_SELECT_INPUT field descriptions

Field	Description
31–2 -	This field is reserved. Reserved
DAISY	Selecting Pads Involved in Daisy Chain. Instance: usdhc2, In Pin: DATA2_in 00 LCD_DATA22_ALT8 — Selecting Pad: LCD_DATA22 for Mode: ALT8 01 NAND_DATA02_ALT1 — Selecting Pad: NAND_DATA02 for Mode: ALT1 10 CSI_DATA02_ALT1 — Selecting Pad: CSI_DATA02 for Mode: ALT1

32.6.385 USDHC2_DATA3_SELECT_INPUT DAISY Register (IOMUXC_USDHC2_DATA3_SELECT_INPUT)

DAISY Register

Address: 20E_0000h base + 688h offset = 20E_0688h

Bit	31	30	29	28	27	26	25	24	23	22	21	20	19	18	17	16
R	Reserved															
W	Reserved															
Reset	0	0	0	0	0	0	0	0	0	0	0	0	0	0	0	0
Bit	15	14	13	12	11	10	9	8	7	6	5	4	3	2	1	0
R	Reserved															DAISY
W	Reserved															DAISY
Reset	0	0	0	0	0	0	0	0	0	0	0	0	0	0	0	0

IOMUXC_USDHC2_DATA3_SELECT_INPUT field descriptions

Field	Description
31–2 -	This field is reserved. Reserved
DAISY	Selecting Pads Involved in Daisy Chain. Instance: usdhc2, In Pin: DATA3_in 00 CSI_DATA03_ALT1 — Selecting Pad: CSI_DATA03 for Mode: ALT1 01 LCD_DATA23_ALT8 — Selecting Pad: LCD_DATA23 for Mode: ALT8 10 NAND_DATA03_ALT1 — Selecting Pad: NAND_DATA03 for Mode: ALT1

32.6.386 USDHC2_DATA4_SELECT_INPUT DAISY Register (IOMUXC_USDHC2_DATA4_SELECT_INPUT)

DAISY Register

Address: 20E_0000h base + 68Ch offset = 20E_068Ch

Bit	31	30	29	28	27	26	25	24	23	22	21	20	19	18	17	16
R	Reserved															
W	Reserved															
Reset	0	0	0	0	0	0	0	0	0	0	0	0	0	0	0	0
Bit	15	14	13	12	11	10	9	8	7	6	5	4	3	2	1	0
R	Reserved															DAISY
W	Reserved															DAISY
Reset	0	0	0	0	0	0	0	0	0	0	0	0	0	0	0	0

IOMUXC_USDHC2_DATA4_SELECT_INPUT field descriptions

Field	Description
31–2 -	This field is reserved. Reserved
DAISY	Selecting Pads Involved in Daisy Chain. Instance: usdhc2, In Pin: DATA4_in 00 LCD_DATA14_ALT8 — Selecting Pad: LCD_DATA14 for Mode: ALT8 01 NAND_DATA04_ALT1 — Selecting Pad: NAND_DATA04 for Mode: ALT1 10 CSI_DATA04_ALT1 — Selecting Pad: CSI_DATA04 for Mode: ALT1

32.6.387 USDHC2_DATA5_SELECT_INPUT DAISY Register (IOMUXC_USDHC2_DATA5_SELECT_INPUT)

DAISY Register

Address: 20E_0000h base + 690h offset = 20E_0690h

Bit	31	30	29	28	27	26	25	24	23	22	21	20	19	18	17	16
R	Reserved															
W	Reserved															
Reset	0	0	0	0	0	0	0	0	0	0	0	0	0	0	0	0
Bit	15	14	13	12	11	10	9	8	7	6	5	4	3	2	1	0
R	Reserved															DAISY
W	Reserved															DAISY
Reset	0	0	0	0	0	0	0	0	0	0	0	0	0	0	0	0

IOMUXC_USDHC2_DATA5_SELECT_INPUT field descriptions

Field	Description
31–2 -	This field is reserved. Reserved
DAISY	Selecting Pads Involved in Daisy Chain. Instance: usdhc2, In Pin: DATA5_in 00 LCD_DATA15_ALT8 — Selecting Pad: LCD_DATA15 for Mode: ALT8 01 NAND_DATA05_ALT1 — Selecting Pad: NAND_DATA05 for Mode: ALT1 10 CSI_DATA05_ALT1 — Selecting Pad: CSI_DATA05 for Mode: ALT1

32.6.388 USDHC2_DATA6_SELECT_INPUT DAISY Register (IOMUXC_USDHC2_DATA6_SELECT_INPUT)

DAISY Register

Address: 20E_0000h base + 694h offset = 20E_0694h

Bit	31	30	29	28	27	26	25	24	23	22	21	20	19	18	17	16
R	Reserved															
W	Reserved															
Reset	0	0	0	0	0	0	0	0	0	0	0	0	0	0	0	0
Bit	15	14	13	12	11	10	9	8	7	6	5	4	3	2	1	0
R	Reserved															DAISY
W	Reserved															DAISY
Reset	0	0	0	0	0	0	0	0	0	0	0	0	0	0	0	0

IOMUXC_USDHC2_DATA6_SELECT_INPUT field descriptions

Field	Description
31–2 -	This field is reserved. Reserved
DAISY	Selecting Pads Involved in Daisy Chain. Instance: usdhc2, In Pin: DATA6_in 00 LCD_DATA16_ALT8 — Selecting Pad: LCD_DATA16 for Mode: ALT8 01 NAND_DATA06_ALT1 — Selecting Pad: NAND_DATA06 for Mode: ALT1 10 CSI_DATA06_ALT1 — Selecting Pad: CSI_DATA06 for Mode: ALT1

32.6.389 USDHC2_DATA7_SELECT_INPUT DAISY Register (IOMUXC_USDHC2_DATA7_SELECT_INPUT)

DAISY Register

Address: 20E_0000h base + 698h offset = 20E_0698h

Bit	31	30	29	28	27	26	25	24	23	22	21	20	19	18	17	16
R	Reserved															
W	Reserved															
Reset	0	0	0	0	0	0	0	0	0	0	0	0	0	0	0	0
Bit	15	14	13	12	11	10	9	8	7	6	5	4	3	2	1	0
R	Reserved															DAISY
W	Reserved															DAISY
Reset	0	0	0	0	0	0	0	0	0	0	0	0	0	0	0	0

IOMUXC_USDHC2_DATA7_SELECT_INPUT field descriptions

Field	Description
31–2 -	This field is reserved. Reserved
DAISY	Selecting Pads Involved in Daisy Chain. Instance: usdhc2, In Pin: DATA7_in 00 LCD_DATA17_ALT8 — Selecting Pad: LCD_DATA17 for Mode: ALT8 01 NAND_DATA07_ALT1 — Selecting Pad: NAND_DATA07 for Mode: ALT1 10 CSI_DATA07_ALT1 — Selecting Pad: CSI_DATA07 for Mode: ALT1

32.6.390 USDHC2_WP_SELECT_INPUT DAISY Register (IOMUXC_USDHC2_WP_SELECT_INPUT)

DAISY Register

Address: 20E_0000h base + 69Ch offset = 20E_069Ch

Bit	31	30	29	28	27	26	25	24		23	22	21	20	19	18	17	16
R	Reserved																
W	Reserved																
Reset	0	0	0	0	0	0	0	0		0	0	0	0	0	0	0	0
Bit	15	14	13	12	11	10	9	8		7	6	5	4	3	2	1	0
R	Reserved															DAISY	
W	Reserved															DAISY	
Reset	0	0	0	0	0	0	0	0		0	0	0	0	0	0	0	0

IOMUXC_USDHC2_WP_SELECT_INPUT field descriptions

Field	Description
31–2 -	This field is reserved. Reserved
DAISY	Selecting Pads Involved in Daisy Chain. Instance: usdhc2, In Pin: wp_on 00 GPIO1_IO06_ALT4 — Selecting Pad: GPIO1_IO06 for Mode: ALT4 01 UART1_CTS_B_ALT8 — Selecting Pad: UART1_CTS_B for Mode: ALT8 10 CSI_PIXCLK_ALT1 — Selecting Pad: CSI_PIXCLK for Mode: ALT1



Chapter 33

Keypad Port (KPP)

33.1 Overview

The Keypad Port (KPP) is a 16-bit peripheral that can be used as a keypad matrix interface or as general purpose input/output (I/O).

The figure below shows the KPP block diagram. The KPP provides interface for the keypad matrix with 2-point contact or 3-point contact keys. The KPP is designed to simplify the software task of scanning a keypad matrix. With appropriate software support, the KPP is capable of detecting, debouncing, and decoding one or multiple keys pressed simultaneously on the keypad.

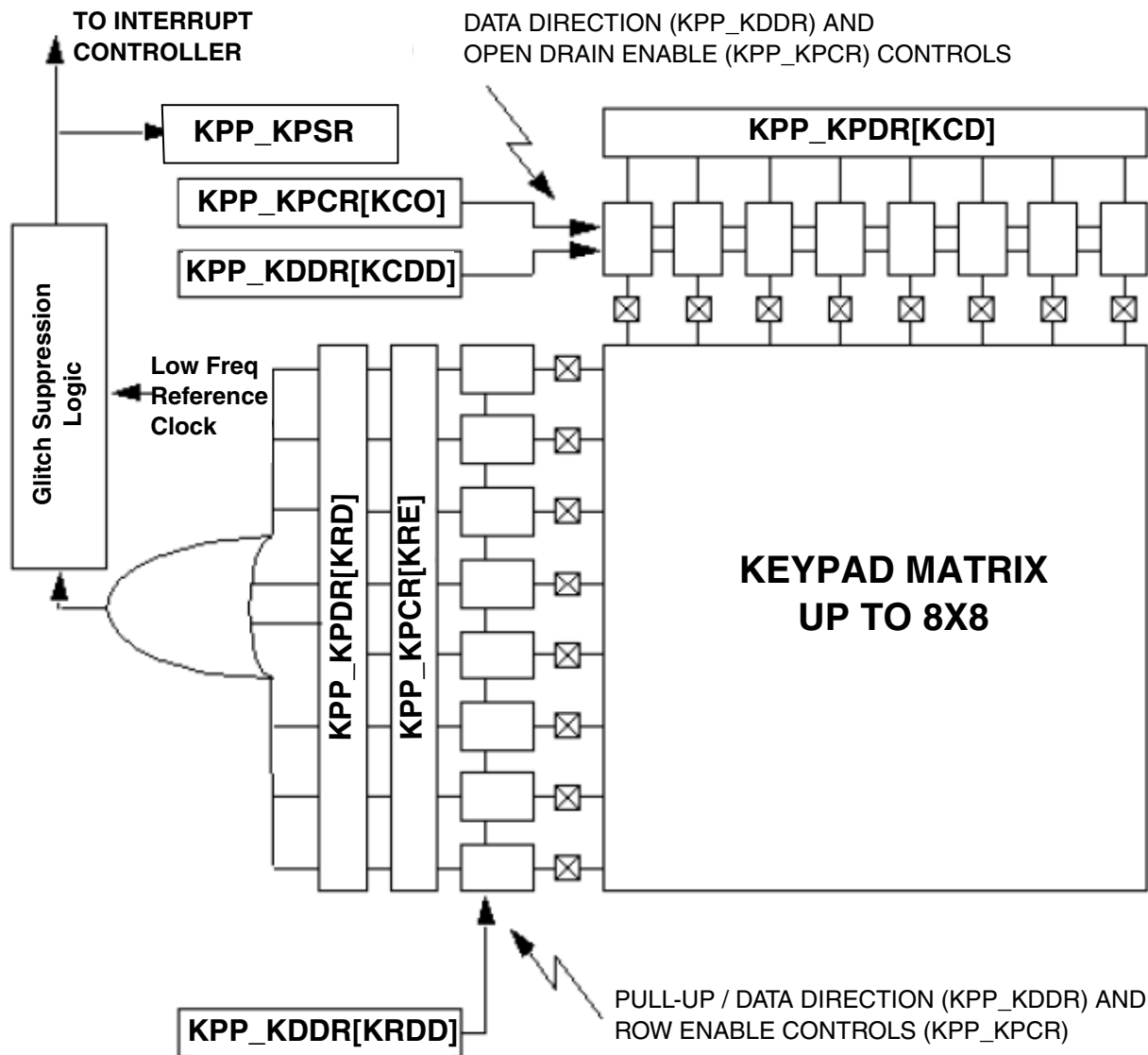

Figure 33-1. KPP Peripheral Block Diagram

33.1.1 Features

The KPP includes these distinctive features:

- Supports up to an 8 x 8 external key pad matrix
- Port pins can be used as general purpose I/O
- Open drain design
- Glitch suppression circuit design
- Multiple-key detection
- Long key-press detection
- Standby key-press detection
- Synchronizer chain clear
- Supports a 2-point and 3-point contact key matrix

33.1.2 Modes and Operations

This block supports the following modes:

- Run Mode-This is the normal functional mode in which the KPP can detect any key press event.
- Low Power Mode-The keypad can detect any key press even in low power modes (when there is no MCU clock).

33.2 Clocks

The table found here describes the clock sources for KPP.

Please see [Clock Controller Module \(CCM\)](#) for clock setting, configuration and gating information.

Table 33-1. KPP Clocks

Clock name	Clock Root	Description
ipg_clk_32k	ckil_sync_clk_root	Low-frequency reference clock (32 kHz)
ipg_clk_s	ipg_clk_root	Peripheral access clock

33.3 External Signals

There are several pins dedicated to the KPP. Keypads of any configuration up to eight rows and eight columns are supported through the software configuration of the peripheral pins. Any pins not used for the keypad are available as general purpose I/O. The registers are configured such that the pins can be treated as an I/O port up to 16 bits wide.

See the table below for the list of external signals.

Table 33-2. KPP External Signals

Signal	Description	Pad	Mode	Direction
KPP_COL0	Column input or output pin, from chip	ENET1_RX_DATA1	ALT6	IO
		NAND_WE_B	ALT3	
KPP_COL1	Column input or output pin, from chip	ENET1_TX_DATA0	ALT6	IO
		NAND_DATA01	ALT3	
KPP_COL2	Column input or output pin, from chip	ENET1_TX_EN	ALT6	IO
		NAND_DATA03	ALT3	
KPP_COL3	Column input or output pin, from chip	ENET1_RX_ER	ALT6	IO
KPP_COL4	Column input or output pin, from chip	ENET2_RX_DATA1	ALT6	IO
KPP_COL5	Column input or output pin, from chip	ENET2_TX_DATA0	ALT6	IO
KPP_COL6	Column input or output pin, from chip	ENET2_TX_EN	ALT6	IO
KPP_COL7	Column input or output pin, from chip	ENET2_RX_ER	ALT6	IO
KPP_ROW0	Row input or output pin, from chip	ENET1_RX_DATA0	ALT6	IO
		NAND_RE_B	ALT3	
KPP_ROW1	Row input or output pin, from chip	ENET1_RX_EN	ALT6	IO
		NAND_DATA00	ALT3	
KPP_ROW2	Row input or output pin, from chip	ENET1_RX_DATA1	ALT6	IO
		NAND_DATA02	ALT3	
KPP_ROW3	Row input or output pin, from chip	ENET1_TX_CLK	ALT6	IO
KPP_ROW4	Row input or output pin, from chip	ENET2_RX_DATA0	ALT6	IO
KPP_ROW5	Row input or output pin, from chip	ENET2_RX_EN	ALT6	IO
KPP_ROW6	Row input or output pin, from chip	ENET2_TX_DATA1	ALT6	IO
KPP_ROW7	Row input or output pin, from chip	ENET2_TX_CLK	ALT6	IO

33.3.1 Input Pins

Any of the 16 pins associated with the KPP can be configured as inputs by writing a "0" to the appropriate bits in the KPP_KDDR. Additionally, the least significant 8 bits (ROW inputs) corresponding to KPP_KDDR[KRDD] have internal pull-ups, which are enabled when the pin is used as an input.

33.3.2 Output Pins

Any of the 16 pins associated with the KPP can be configured as outputs by writing the appropriate bits in the KPP_KDDR to a "1". Additionally, the 8 most significant bits (15-8) can be designated as open drain outputs by writing a "1" to the appropriate bits in the KPP_KPCR. The lower 8 bits (7-0) are always in "totem pole" style, driven when configured as outputs.

See the table below.

Table 33-3. Keypad Port Column Modes

KPP_KDDR (15:8)	KPP_KPCR (15:8)	Pin Function
0	x	Input
1	0	Totem-Pole Output
1	1	Open-Drain Output

NOTE

Totem pole capability should be provided for column pins. Totem pole configuration helps for a faster discharge of keypad capacitance when all columns need to be quickly brought to a "1" during the scan routine. With this configuration, delay between the scanning of two subsequent columns is reduced.

33.3.3 Generation of Transfer Error Signal on Peripheral Bus

If there is an access to an address which is not implemented, then the KPP asserts a transfer error signal on Peripheral Bus.

33.4 Functional Description

The Keypad Port (KPP) is designed to simplify the software task of scanning a keypad matrix. With appropriate software support and matrix organization, the KPP is capable of detecting, debouncing, and decoding one or more keys pressed simultaneously on the keypad.

Logic in the KPP is capable of detecting a key press even while the processor is in one of the low power standby modes provided that a low frequency reference clock (`ipg_clk_32k`) is on. The KPP may generate an Arm platform interrupt any time a key press or key release is detected. This interrupt is capable of forcing the processor out of a low power mode.

33.4.1 Keypad Matrix Construction

The KPP is designed to interface to a keypad matrix, which shorts the intersecting row and column lines together whenever a key is depressed. The interface is not optimized for any other switch configuration.

33.4.2 Keypad Port Configuration

The software must initialize the KPP for the size of the keypad matrix. Pins connected to the keypad columns should be configured as open-drain outputs. Pins connected to the keypad rows should be configured as inputs. On-chip, pull-up resistors should be implemented for active keypad rows.

In addition to enabled row inputs in the Keypad Control register, corresponding interrupt (depress or/and release) must also be enabled to generate an interrupt.

Discrete switches that are not part of the matrix may be connected to any unused row inputs. The second terminal of the discrete switch is connected to ground. The hardware detects closures of these switches without the need for software polling.

33.4.3 Keypad Matrix Scanning

Keypad scanning is performed by a software loop that walks a zero across each of the keypad columns, reading the value on the rows at each step. The process is repeated several times in succession, with the results of each pass optionally compared to those

from the previous pass. When several (3 or 4) consecutive scans yield the same key closures, a valid key press has been detected. Software then can decode exactly which switch was depressed and pass the value up to the next higher software layer.

The basic debouncing period, which must be defined in the software routine, may be controlled with an internal timer. The basic period is the period between the scan of two consecutive columns, so the debouncing time between two consecutive scans of the whole matrix shall be the number of columns multiplied by the basic period.

33.4.4 Keypad Standby

There is no need for the Arm platform to continually scan the keypad. Between key presses, the keypad can be left in a state that requires no software intervention until the next key press is detected. To place the keypad in a standby state, software should write all column outputs low. Row inputs are left enabled. At this point, the Arm platform can attend to other tasks or revert to a low power standby mode. The KPP will interrupt the Arm platform if any key is pressed.

Upon receiving a keypad interrupt, the Arm platform should set all the column strobes high, and begin a normal keypad scanning routine to determine which key was pressed. It is important that open-drain drivers be used when scanning to prevent a possible DC path between power and ground through two or more switches.

33.4.5 Glitch Suppression on Keypad Inputs

A glitch suppression circuit qualifies the keypad inputs to prevent noise from inadvertently interrupting the Arm platform. The circuit is a 4-state synchronizer clocked from a low frequency reference clock (ipg_clk_32k) source. This clock must continue to run in any low power mode where the keypad is a wake-up source, as the Arm platform interrupt is generated from the synchronized input. An interrupt is not generated until all four synchronizer stages have latched a valid key assertion. This guarantees the filtering out of any noise less than three clock periods in duration of a low frequency reference clock. Noise filtering of the duration between three to four clock periods cannot be guaranteed. The interrupt output is latched in an S-R latch and remains asserted until cleared by the software. The Set input of the latch is rising-edge clocked. See the figure below.

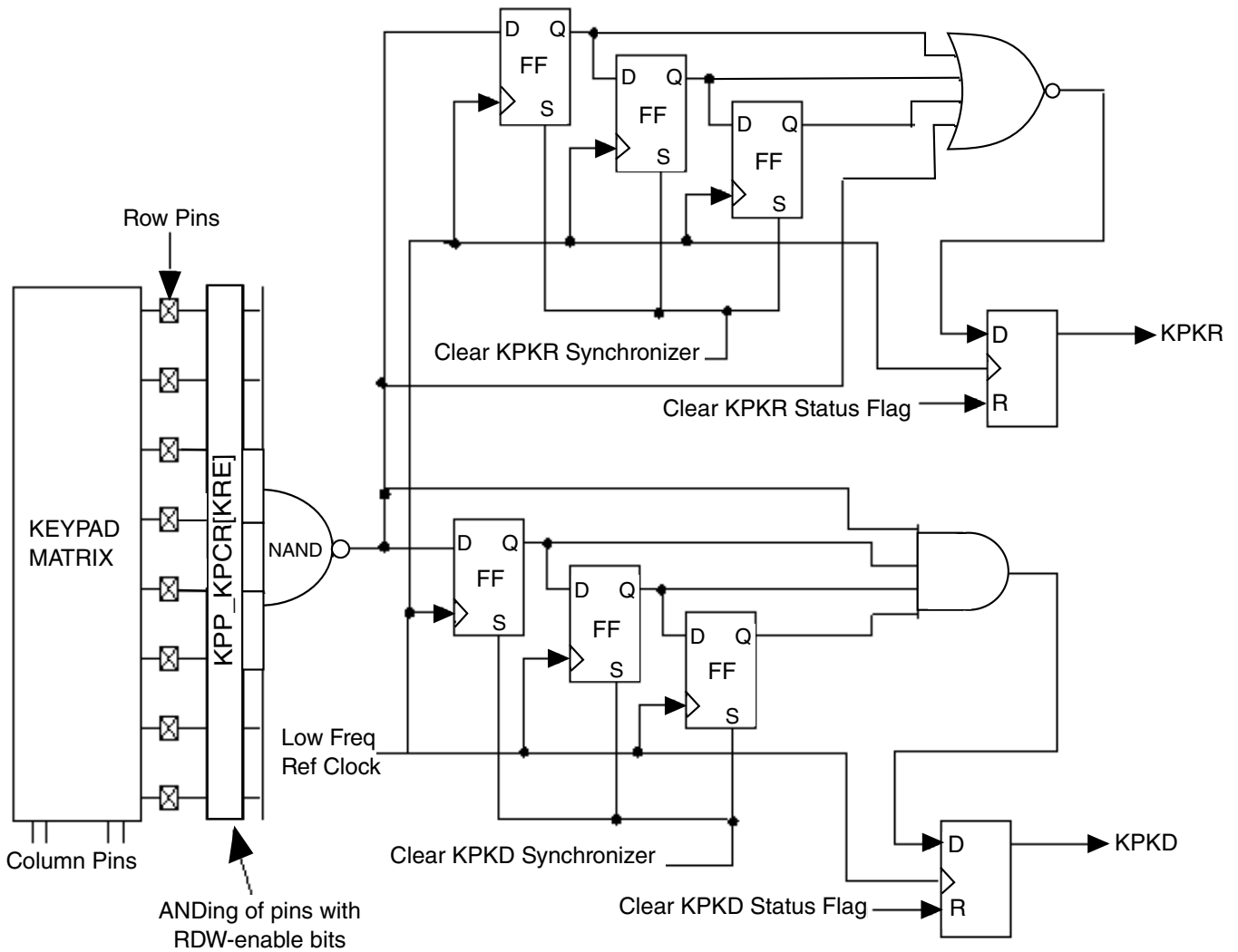

Figure 33-2. Keypad Synchronizer Functional Diagram

33.4.6 Multiple Key Closures

Using the key press and key release interrupts, the software can detect multiple keys or achieve n key rollover. The key scanning routine can be programmed accordingly (See [Initialization/Application Information](#) for more information).

The following figures illustrate the interface of a 2-contact keypad matrix with the KPP controller. With proper enabling of row lines and the performing scan-routine, multiple key presses can be detected. When keys present on the same row are pressed, corresponding row lines (multiple lines) become low when the column is driven low during a scan-routine. By reading the data-register, pressed keys can be detected.

Similarly, when keys present on same row line are pressed, the corresponding row line (only one line) becomes low when logic "0" is driven on the column line during a scan-routine.

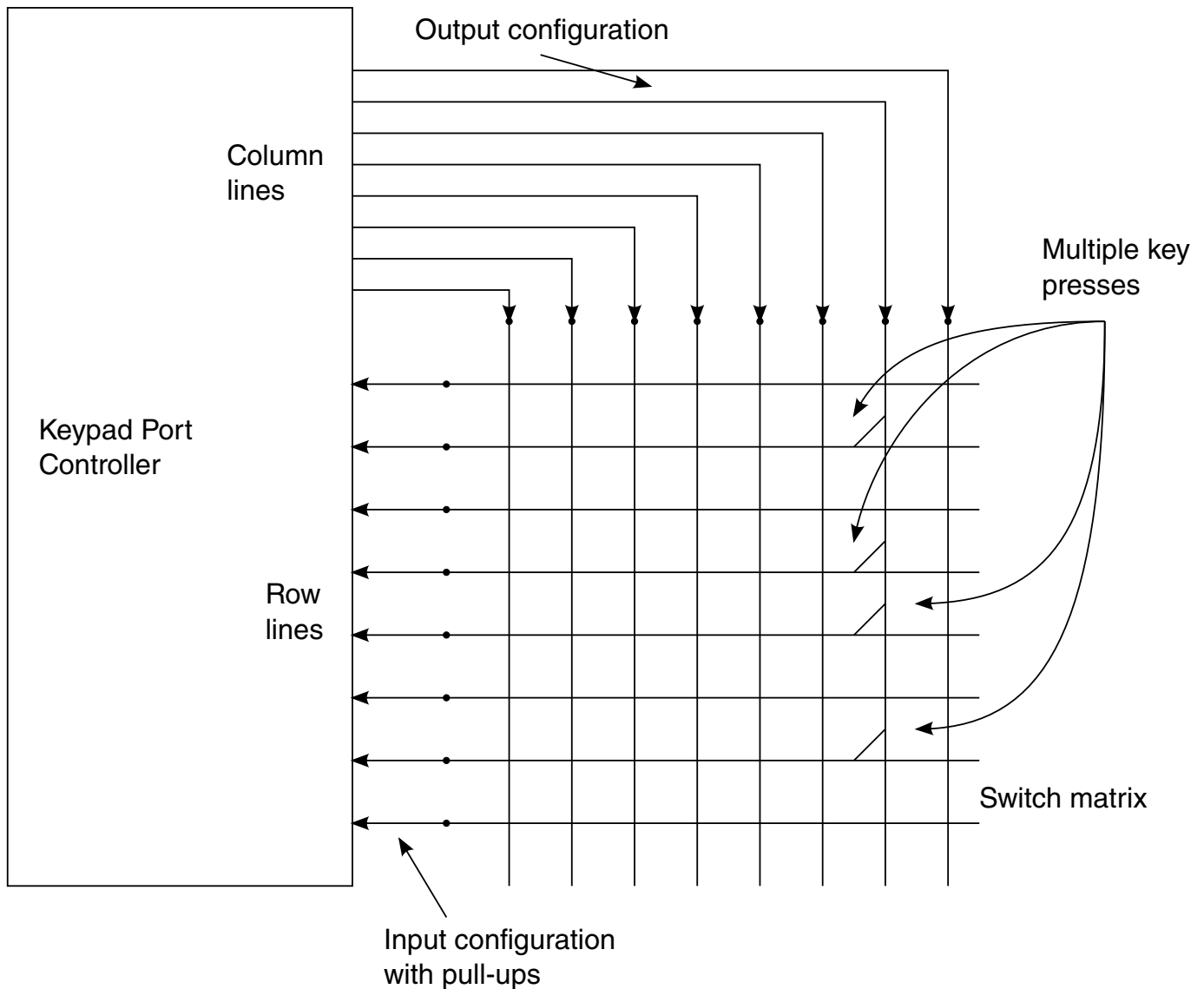

Figure 33-3. Multiple Key Presses on Same Column Line (Simplified View)

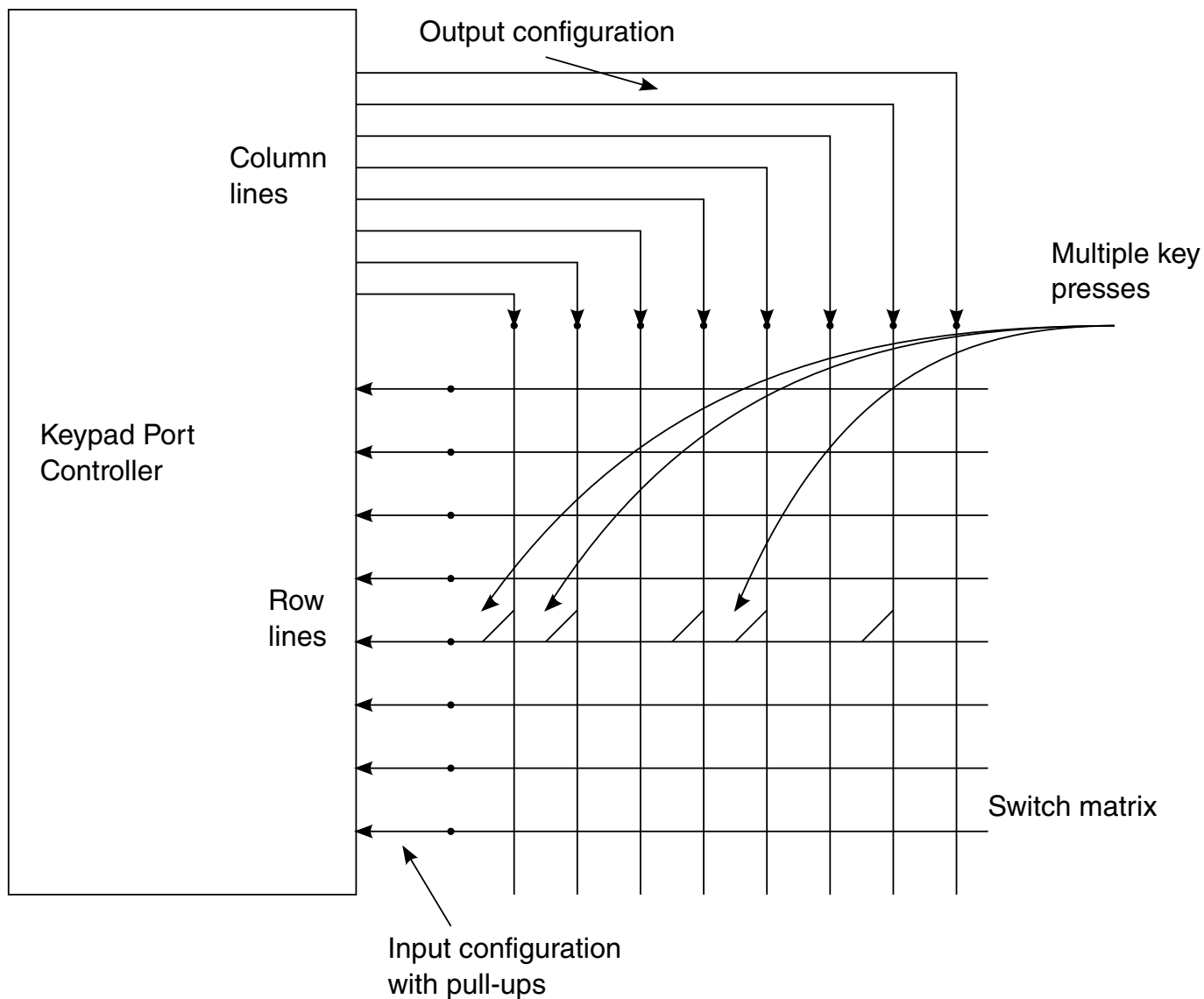

Figure 33-4. Multiple Key Presses on Same Row Line (Simplified View)

NOTE

An n key rollover is a technique with which the system can recognize the order in which keys are pressed.

33.4.6.1 Ghost Key Problem and Correction

The KPP detects if one or multiple keys are pressed or released. In the case where a simple keypad matrix with two-contact switches is used, there is a chance of "ghost" key detection when three or more keys are pressed. This is a limitation imposed by such a keypad matrix.

As seen in [Figure 33-5](#), three keys pressed simultaneously can cause a short between the column currently "scanned" by the software and another column. Depending on the location of the third key pressed, a "ghost" key press may be detected.

However, this can be corrected by using a keypad matrix that provides "ghost" key protection. Such a matrix implements a one-way "diode" at all keypad points between rows and columns. This way, the multiple pressing of three keys will not cause a short at a fourth key (see [Figure 33-6](#)).

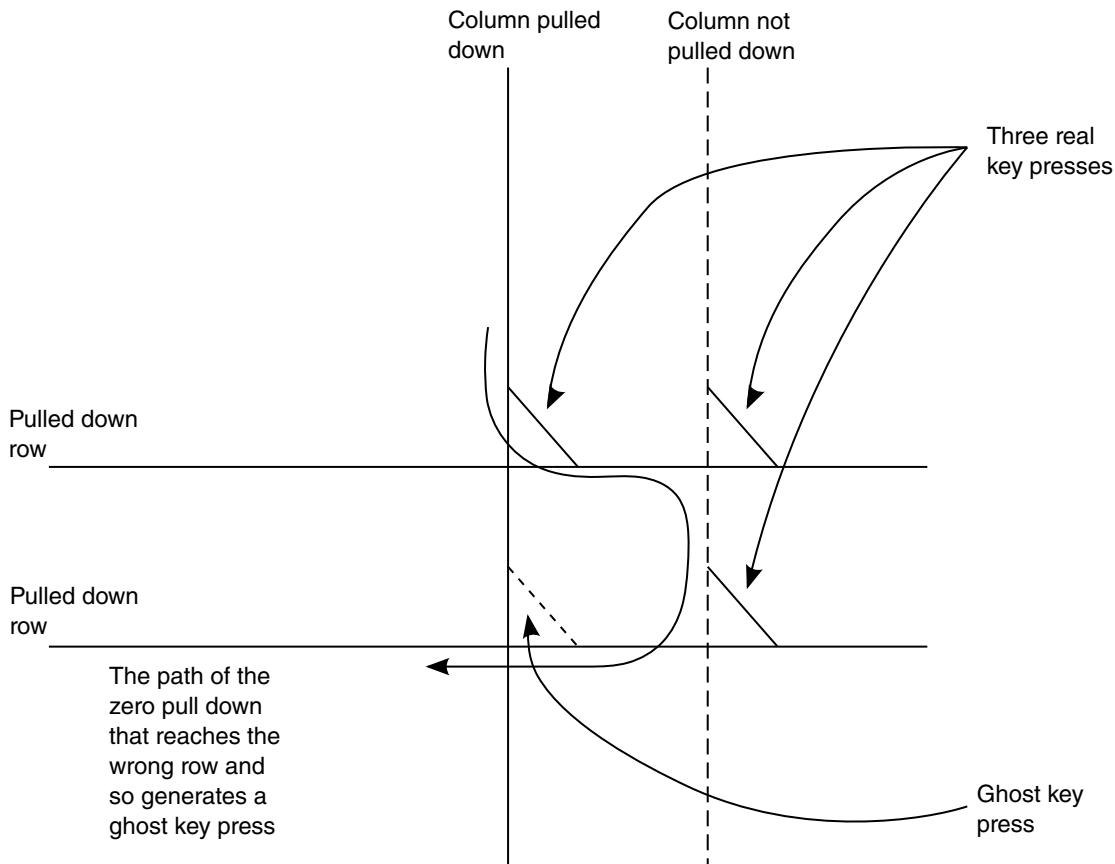

Figure 33-5. Decoding Wrong Three- Key-Presses

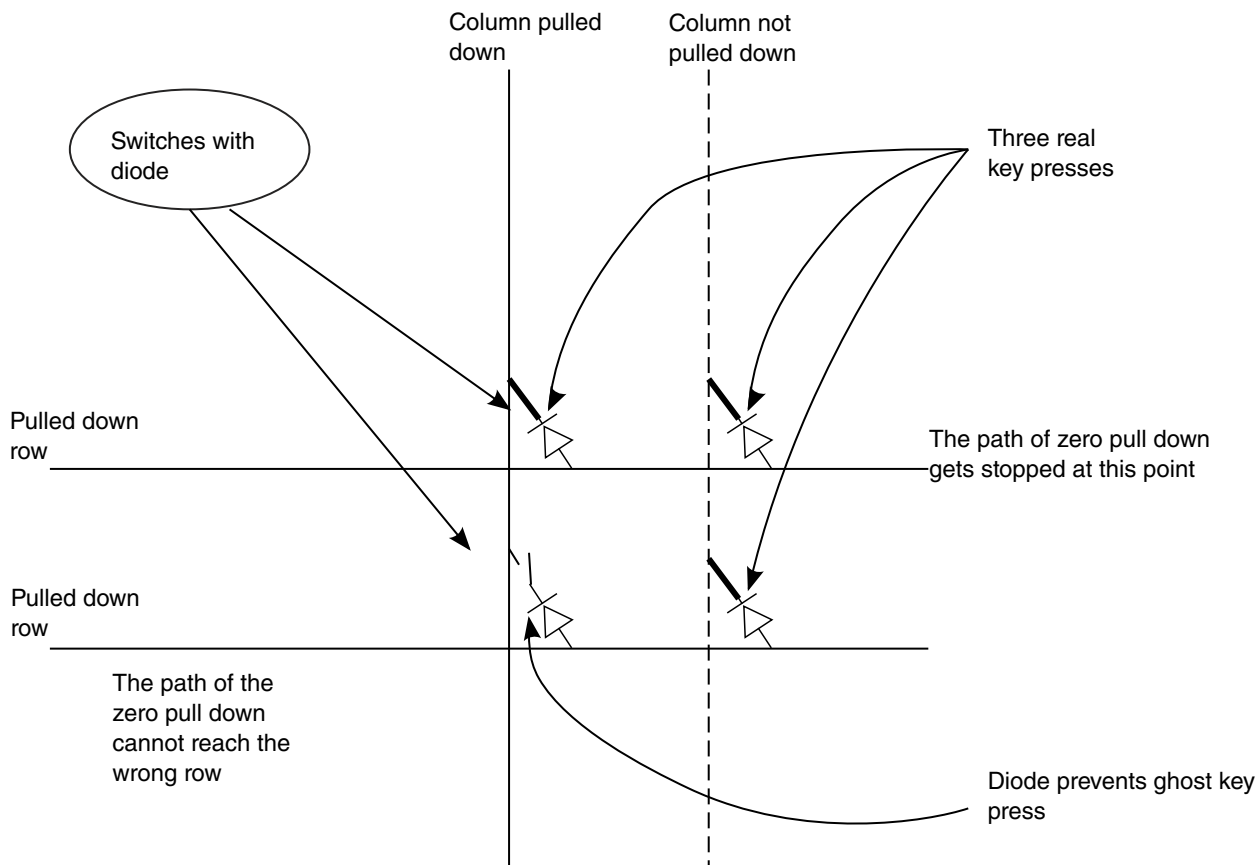

Figure 33-6. Matrix with "Ghost" Key Protections

33.4.7 3-Point Contact Keys Support

The KPP supports interfacing to a matrix consisting of 3-point contact keys. As shown in [Figure 33-7](#), two points of such a key are connected to keypad lines, while a third point is connected to ground (low logic).

The keypad lines should be configured as input and a pull-up should be present on these lines. When such a key is pressed, corresponding keypad lines go low and an interrupt is generated. There is no need to perform a scanning routine for identification of pressed key as it can be done by reading the keypad data-register. A limitation with such a matrix is that for every key at least one keypad row line should be used.

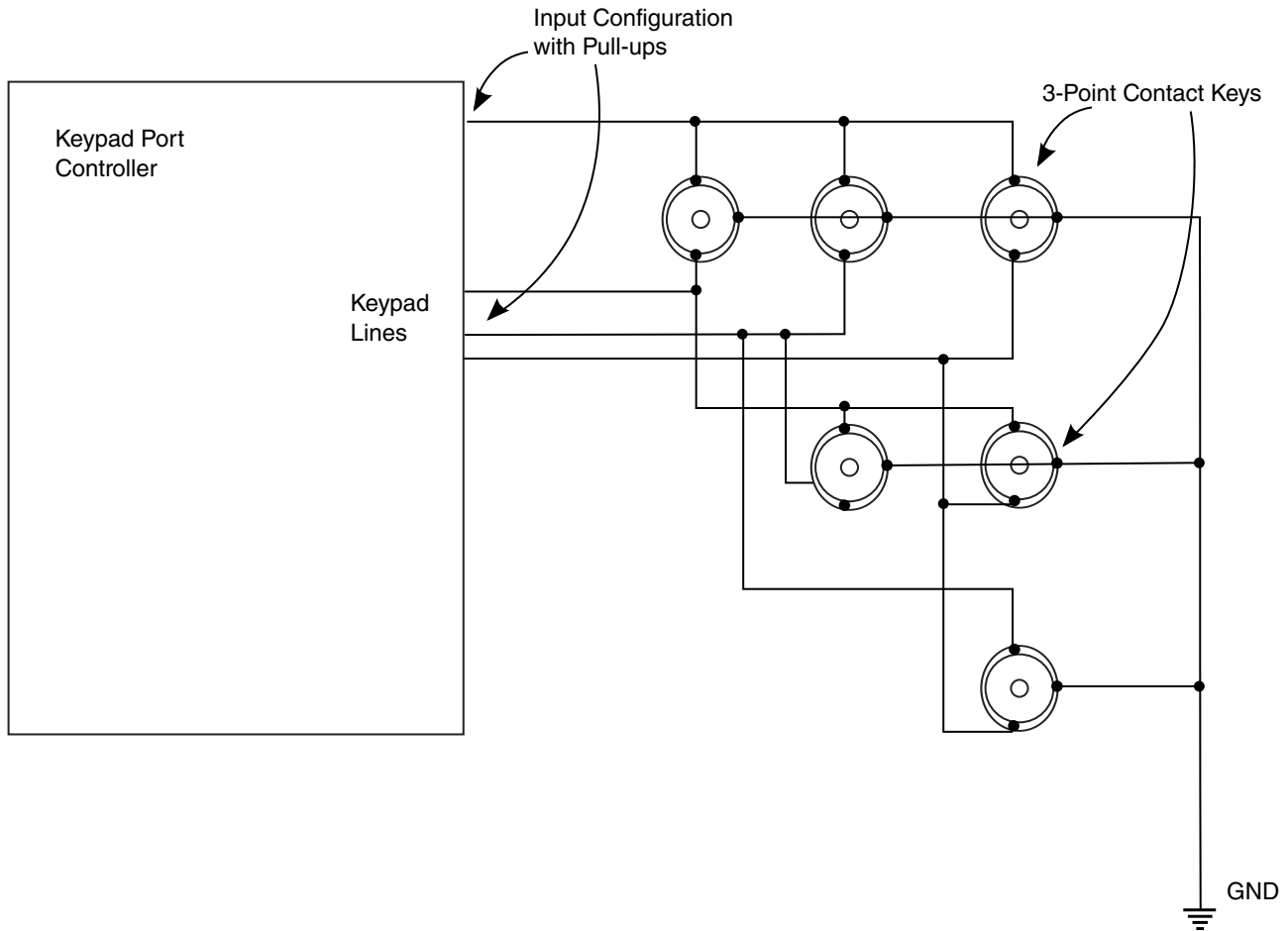

Figure 33-7. KPP Interface with 3-point Contact Key Matrix (Simplified View)

33.5 Initialization/Application Information

33.5.1 Typical Keypad Configuration and Scanning Sequence

Perform the following steps to configure the keypad:

1. Enable the number of rows in the keypad (KPP_KPCR[KRE]).
2. Write 0s to KPP_KPDR[KCD].
3. Configure the keypad columns as open-drain (KPP_KPCR[KCO]).
4. Configure columns as output (KPP_KDDR[KCDD]) and rows as input (KPP_KDDR[KRDD]).
5. Clear the KPKD Status Flag and Synchronizer chain.
6. Set the KDIE control bit, and clear the KRIE control bit (avoid false release events).

7. (The system is now in standby mode, and awaiting a key press.)

33.5.2 Key Press Interrupt Scanning Sequence

Perform the following steps to perform a keypad scanning routine:

1. Disable both (depress and release) keypad interrupts.
2. Write 1s to KPP_KPDR[KCD], setting column data to 1s.
3. Configure columns as totem pole outputs (for quick discharging of keypad capacitance).
4. Configure columns as open-drain.
5. Write a single column to 0, and other columns to 1.
6. Sample row inputs and save data. Multiple key presses can be detected on a single column.
7. Repeat Steps 2-6 for remaining columns.
8. Return all columns to 0 in preparation for standby mode.
9. Clear KPKD and KPKR status bit(s) by writing to a "1"; set the KPKR synchronizer chain by writing a "1" to the KPP_KRSS register; and clear the KPKD synchronizer chain by writing a "1" to the KDSC register.
10. Re-enable the appropriate keypad interrupt(s) so that the KDIE detects a key hold condition, or the KRIE detects a key-release event.

33.5.3 Additional Comments

The order of key press detection can be done in software only. Therefore, the software may need to run the scan routines at very short intervals of time per the application's demands. The reason that such functionality cannot be put in the KPP is that the block is limited by the number of external pins.

For the keys that require a very precise order (such as game keys), individual GPIO pins may be more useful.

33.6 KPP Memory Map/Register Definition

The KPP contains four registers.

KPP memory map

Absolute address (hex)	Register name	Width (in bits)	Access	Reset value	Section/page
20B_8000	Keypad Control Register (KPP_KPCR)	16	R/W	0000h	33.6.1/2125
20B_8002	Keypad Status Register (KPP_KPSR)	16	R/W	0400h	33.6.2/2126
20B_8004	Keypad Data Direction Register (KPP_KDDR)	16	R/W	0000h	33.6.3/2127
20B_8006	Keypad Data Register (KPP_KPDR)	16	R/W	0000h	33.6.4/2128

33.6.1 Keypad Control Register (KPP_KPCR)

The Keypad Control Register determines which of the eight possible column strobes are to be open drain when configured as outputs, and which of the eight row sense lines are considered in generating an interrupt to the core.

It is up to the programmer to ensure that pins being used for functions other than the keypad are properly disabled. The KPP_KPCR register is byte- or half-word-addressable.

Address: 20B_8000h base + 0h offset = 20B_8000h

Bit	15	14	13	12	11	10	9	8	7	6	5	4	3	2	1	0
Read	KCO								KRE							
Write	KCO								KRE							
Reset	0	0	0	0	0	0	0	0	0	0	0	0	0	0	0	0

KPP_KPCR field descriptions

Field	Description
15–8 KCO	Keypad Column Strobe Open-Drain Enable. Setting a column open-drain enable bit (KCO7-KCO0) disables the pull-up driver on that pin. Clearing the bit allows the pin to drive to the high state. This bit has no effect when the pin is configured as an input. NOTE: Configuration of external port control logic (for example, IOMUX) should be done properly so that the KPP controls an open-drain enable of the pin. 0 TOTEM_POLE — Column strobe output is totem pole drive. 1 OPEN_DRAIN — Column strobe output is open drain.
KRE	Keypad Row Enable. Setting a row enable control bit in this register enables the corresponding row line to participate in interrupt generation. Likewise, clearing a bit disables that row from being used to generate an interrupt. This register is cleared by a reset, disabling all rows. The row-enable logic is independent of the programmed direction of the pin. Writing a "0" to the data register of the pins configured as outputs will cause a keypad interrupt to be generated if the row enable associated with that bit is set. 0 Row is not included in the keypad key press detect. 1 Row is included in the keypad key press detect.

33.6.2 Keypad Status Register (KPP_KPSR)

The Keypad Status Register reflects the state of the key press detect circuit. The KPP_KPSR register is byte- or half-word-addressable.

Address: 20B_8000h base + 2h offset = 20B_8002h

Bit	15	14	13	12	11	10	9	8
Read	0						KRIE	KDIE
Write	[Shaded]							
Reset	0	0	0	0	0	1	0	0
Bit	7	6	5	4	3	2	1	0
Read	0				0	0	KPKR	KPKD
Write	[Shaded]				KRSS	KDSC	w1c	w1c
Reset	0	0	0	0	0	0	0	0

KPP_KPSR field descriptions

Field	Description
15–10 Reserved	This read-only field is reserved and always has the value 0.
9 KRIE	Keypad Release Interrupt Enable. The software should ensure that the interrupt for a Key Release event is masked until it has entered the key pressed state, and vice versa, unless this activity is desired (as might be the case when a repeated interrupt is to be generated). The synchronizer chains are capable of being initialized to detect repeated key presses or releases. If they are not initialized when the corresponding event flag is cleared, false interrupts may be generated for depress (or release) events shorter than the length of the corresponding chain. 0 No interrupt request is generated when KPKR is set. 1 An interrupt request is generated when KPKR is set.
8 KDIE	Keypad Key Depress Interrupt Enable. Software should ensure that the interrupt for a Key Release event is masked until it has entered the key pressed state, and vice-versa, unless this activity is desired (as might be the case when a repeated interrupt is to be generated). The synchronizer chains are capable of being initialized to detect repeated key presses or releases. If they are not initialized when the corresponding event flag is cleared, false interrupts may be generated for depress (or release) events shorter than the length of the corresponding chain. 0 No interrupt request is generated when KPKD is set. 1 An interrupt request is generated when KPKD is set.
7–4 Reserved	This read-only field is reserved and always has the value 0.
3 KRSS	Key Release Synchronizer Set. Self-clear bit. The Key release synchronizer is set by writing a logic one into this bit. Reads return a value of "0". 0 No effect 1 Set bits which sets keypad release synchronizer chain

Table continues on the next page...

KPP_KPSR field descriptions (continued)

Field	Description
2 KDSC	<p>Key Depress Synchronizer Clear. Self-clear bit. The Key depress synchronizer is cleared by writing a logic "1" into this bit.</p> <p>Reads return a value of "0".</p> <p>0 No effect 1 Set bits that clear the keypad depress synchronizer chain</p>
1 KPKR	<p>Keypad Key Release. The keypad key release (KPKR) status bit is set when all enabled rows are detected high after synchronization (the KPKR status bit will be set when cleared by a reset). The KPKR bit may be used to generate a maskable key release interrupt. The key release synchronizer may be set high by software after scanning the keypad to ensure a known state. Due to the logic function of the release and depress synchronizer chains, it is possible to see the re-assertion of a status flag (KPKD or KPKR) if it is cleared by software prior to the system exiting the state it represents.</p> <p>Reset value of register is "0" as long as reset is asserted. However when reset is de-asserted, the value of the register depends upon the external row pins and can become "1".</p> <p>0 No key release detected 1 All keys have been released</p>
0 KPKD	<p>Keypad Key Depress. The keypad key depress (KPKD) status bit is set when one or more enabled rows are detected low after synchronization. The KPKD status bit remains set until cleared by the software. The KPKD bit may be used to generate a maskable key depress interrupt. If desired, the software may clear the key press synchronizer chain to allow a repeated interrupt to be generated while a key remains pressed. In this case, a new interrupt will be generated after the synchronizer delay (4 cycles of the low frequency reference clock (ipg_clk_32k) elapses if a key remains pressed. This functionality can be used to detect a long key press. This allows detection of additional key presses of the same key or other keys.</p> <p>Due to the logic function of the release and depress synchronizer chains, it is possible to see the re-assertion of a status flag (KPKD or KPKR) if it is cleared by the software prior to the system exiting the state it represents.</p> <p>0 No key presses detected 1 A key has been depressed</p>

33.6.3 Keypad Data Direction Register (KPP_KDDR)

The bits in the KPP_KDDR control the direction of the keypad port pins. The upper eight bits in the register affect the pins designated as column strobes, while the lower eight bits affect the row sense pins. Setting any bit in this register configures the corresponding pin as an output. Clearing any bit in this register configures the corresponding port pin as an input. For the Keypad Row DDR, an internal pull-up is enabled if the corresponding bit is clear. This register is cleared by a reset, configuring all pins as inputs. The KPP_KDDR register is byte- or half-word addressable.

NOTE

When a pin is used as row pin for keypad purposes, all corresponding pull-ups should be enabled at the upper level (for example, IOMUX) when the bit in KRDD is cleared.

KPP Memory Map/Register Definition

Address: 20B_8000h base + 4h offset = 20B_8004h

Bit	15	14	13	12	11	10	9	8	7	6	5	4	3	2	1	0
Read	KCDD								KRDD							
Write																
Reset	0	0	0	0	0	0	0	0	0	0	0	0	0	0	0	0

KPP_KDDR field descriptions

Field	Description
15–8 KCDD	Keypad Column Data Direction Register. Setting a bit configures the corresponding COL n pin as an output (where $n = 7$ through 0). 0 INPUT — COL n pin is configured as an input. 1 OUTPUT — COL n pin is configured as an output.
KRDD	Keypad Row Data Direction. Setting a bit configures the corresponding ROW n pin as an output (where $n = 7$ through 0). 0 INPUT — ROW n pin configured as an input. 1 OUTPUT — ROW n pin configured as an output.

33.6.4 Keypad Data Register (KPP_KPDR)

This 16-bit register is used to access the column and row data. Data written to this register is stored in an internal latch, and for each pin configured as an output, the stored data is driven onto the pin. A read of this register returns the value on the pin for those bits configured as inputs. Otherwise, the value read is the value stored in the register.

The KPP_KPDR register is byte- or half-word addressable. This register is not initialized by a reset. Valid data should be written to this register before any bits are configured as outputs.

Address: 20B_8000h base + 6h offset = 20B_8006h

Bit	15	14	13	12	11	10	9	8	7	6	5	4	3	2	1	0
Read	KCD								KRD							
Write																
Reset	0	0	0	0	0	0	0	0	0	0	0	0	0	0	0	0

KPP_KPDR field descriptions

Field	Description
15–8 KCD	Keypad Column Data. A read of these bits returns the value on the pin for those bits configured as inputs. Otherwise, the value read is the value stored in the register. 0 Read/Write "0" from/to column ports 1 Read/Write "1" from/to column ports
KRD	Keypad Row Data. A read of these bits returns the value on the pin for those bits configured as inputs. Otherwise, the value read is the value stored in the register. 0 Read/Write "0" from/to row ports 1 Read/Write "1" from/to row ports

KPP_KPDR field descriptions (continued)

Field	Description
-------	-------------

Chapter 34

Enhanced LCD Interface (eLCDIF)

34.1 Overview

The enhanced Liquid Crystal Display Interface (eLCDIF) is a general purpose display controller used to drive a wide range of display devices varying in size and capability.

The eLCDIF block supports the following:

- Displays with an asynchronous parallel MPU interface for command and data transfer to an integrated frame buffer.
- Displays that support moving pictures and require the RGB interface mode (DOTCLK interface).
- VSYNC mode for high-speed data transfers.
- Digital video encoders that accept ITU-R BT.656 format 4:2:2 YCbCr digital component video and convert it to analog TV signals.

The eLCDIF provides fully programmable functionality to supported interfaces:

- Bus master interface to source frame buffer data for display refresh. This interface can also be used to drive data for "Smart" displays.
- PIO interface to manage data transfers between "Smart" displays and SoC.
- 8/16/18/24/32 bit LCD data bus support available depending on I/O mux options.
- Programmable timing and parameters for MPU, VSYNC, and DOTCLK LCD interfaces to support a wide variety of displays.
- ITU-R BT.656 mode (called Digital Video Interface or DVI mode here) including progressive-to-interlace feature and RGB to YCbCr 4:2:2 color space conversion to support 525/60 and 625/50 operation.

34.2 External Signals

The following table describes the external signals of LCD:

Table 34-1. LCD External Signals

Signal	Description	Pad	Mode	Direction
LCD_BUSY	Busy Signal	LCD_VSYNC	ALT1	I
LCD_CLK	Clock signal	LCD_CLK	ALT0	I
LCD_CS	Chip select	LCD_RESET	ALT1	O
LCD_DATA0	Data signals	LCD_DATA00	ALT0	IO
LCD_DATA1		LCD_DATA01	ALT0	
LCD_DATA2		LCD_DATA02	ALT0	
LCD_DATA3		LCD_DATA03	ALT0	
LCD_DATA4		LCD_DATA04	ALT0	
LCD_DATA5		LCD_DATA05	ALT0	
LCD_DATA6		LCD_DATA06	ALT0	
LCD_DATA7		LCD_DATA07	ALT0	
LCD_DATA8		LCD_DATA08	ALT0	
LCD_DATA9		LCD_DATA09	ALT0	
LCD_DATA10		LCD_DATA10	ALT0	
LCD_DATA11		LCD_DATA11	ALT0	
LCD_DATA12		LCD_DATA12	ALT0	
LCD_DATA13		LCD_DATA13	ALT0	
LCD_DATA14		LCD_DATA14	ALT0	
LCD_DATA15		LCD_DATA15	ALT0	
LCD_DATA16		LCD_DATA16	ALT0	
LCD_DATA17		LCD_DATA17	ALT0	
LCD_DATA18		LCD_DATA18	ALT0	
LCD_DATA19		LCD_DATA19	ALT0	
LCD_DATA20		LCD_DATA20	ALT0	
LCD_DATA21		LCD_DATA21	ALT0	
LCD_DATA22		LCD_DATA22	ALT0	
LCD_DATA23		LCD_DATA23	ALT0	
LCD_ENABLE	Enable signal	LCD_ENABLE	ALT0	IO
LCD_HSYNC	HSYNC signal	LCD_HSYNC	ALT0	I
LCD_RD_E	RD_E signal	LCD_ENABLE	ALT1	IO
LCD_RESET	Reset signal	LCD_RESET	ALT0	IO
LCD_RS	RS signal	LCD_HSYNC	ALT1	O
LCD_VSYNC	VSYNC signal	LCD_VSYNC	ALT0	I
LCD_WR_RWN	WR signal	LCD_CLK	ALT1	IO

34.3 Clocks

The following table describes the clock sources for eLCDIF. Please see [Clock Controller Module \(CCM\)](#) for clock setting, configuration and gating information.

Table 34-2. eLCDIF Clocks

Clock name	Clock Root	Description
apb_clk	axi_clk_root	AXI clock
pix_clk	lcdif_pix_clk_root	Pixel clock

34.4 Functional Description

[Bus Interface Mechanisms](#) through [Initializing the eLCDIF](#), describe the internal pipeline for the eLCDIF interfaces. Differences for each mode are then described in separate sections, as follows:

- [MPU Interface](#)
- [VSYNC Interface](#)
- [DOTCLK Interface](#)
- [ITU-R BT.656 Digital Video Interface \(DVI\)](#)

eLCDIF pin usage by interface mode is described in [eLCDIF Pin Usage by Interface Mode](#).

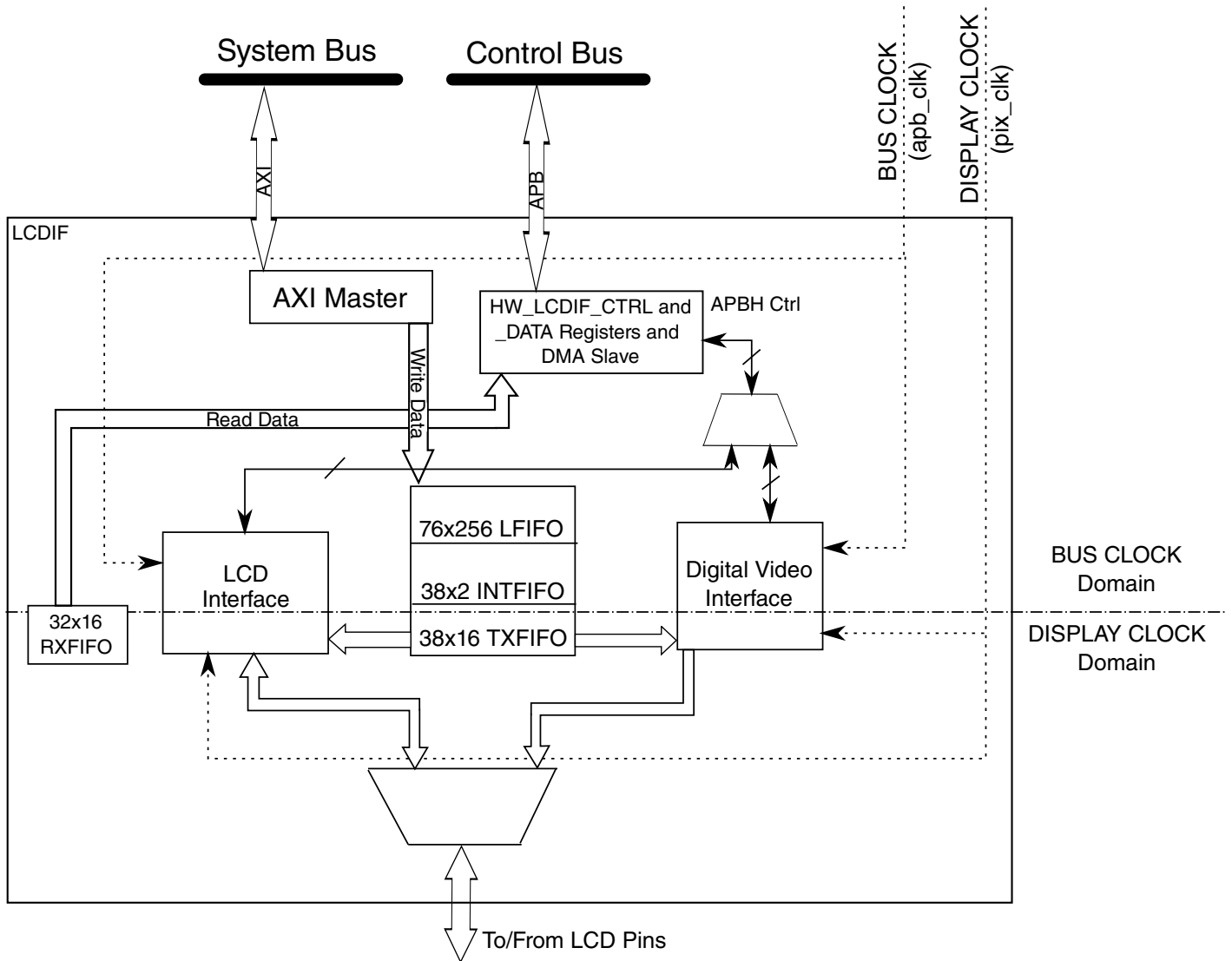

Figure 34-1. Top-Level Block Diagram of eLCDIF subsystem

34.4.1 Bus Interface Mechanisms

The LCDIF module has memory-mapped control, data and status registers. It provides several interfaces to transfer data between the display and SoC.

The bus master interface is used to initiate the requests to transfer data from external memory to the display. It is completely autonomous, or no CPU intervention is required, to manage the cyclical nature of refreshing standard display types. Bus mastering can also be used for MPU mode data writes.

The PIO interface is used to interface to "Smart" displays to transfer frame buffer data and control information to/from the external display. The host CPU executes display drivers to manage the display solution. The following sections describe the system bus interface mechanisms.

34.4.1.1 Bus Master Operation in Write/Display Modes

The eLCDIF block has a bus master interface that initiates requests for data to drive the display. The LCDIF_MASTER bit must be set to 1 to enable the bus master interface. Software should program all control registers required to transfer the frame sequence.

In the MPU and VSYNC mode, single frames are transferred. When a complete frame is transferred, eLCDIF enters idle and clears the RUN bit in the CTRL register. For subsequent frame transmission, the eLCDIF setup sequence should be repeated.

The DOTCLK and DVI mode are used to refresh the display at the desired refresh rate and resolution, and drive displays that don't integrate a display buffer memory. When the display is refreshed, the eLCDIF will automatically update the LCDIF_CUR_BUF_ADDR register with the value in LCDIF_NEXT_BUF_ADDR at the end of current frame and start fetching the next frame from the new address. If the LCDIF_NEXT_BUF_ADDR register was not updated within a frame refresh cycle, eLCDIF will keep transmitting the last frame until a new value is programmed into that register.

eLCDIF also provides the capability of interlacing a progressive frame by fetching odd lines in the first field and then fetching even lines in the second field. This feature can be used in the DVI mode and can be turned on by setting the INTERLACE_FIELDS bit in the LCDIF_CTRL1 register.

34.4.1.2 System Bus Master Performance

The performance of the eLCDIF block can be controlled by changing the burst length and the outstanding cycle issuing capability depending on the memory bandwidth requirements. Two fields in the LCDIF_CTRL2 register will throttle system memory requests. The LCDIF_CTRL2_OUTSTANDING_REQS field will control how many requests the eLCDIF can have in flight on any given clock cycle. This should be programmed based on the expected system bus latency for returned read data. Also, the LCDIF_CTRL2_BURST_LEN_8 bit will set the number of 64 bit words requested for each eLCDIF system bus request to either 8 or 16 QWORDS. Generally, 4 outstanding requests of length 16 will provide enough performance to drive any standard display

resolution. These configuration bits are intended to change the access pattern of the eLCDIF to optimize system bus throughput when other system masters will contend for system memory resources.

The LCDIF_THRES register can also be used to optimize bus throughput and power consumption. The LCDIF_THRES_FASTCLOCK value can be used to change the BUS_CLK frequency when the number of pixels in the LFIFO is below this programmed threshold. The BUS_CLK should be set to a frequency that will exceed the bandwidth requirements of the desired display. In systems supporting the dynamic frequency modulation of the bus clock frequency, the BUS_CLK will be driven at the desired frequency when the number of pixels is below the FASTCLOCK threshold. When the number of pixels is above this threshold, the BUS_CLK will be reduced by a divide factor selected in the centralized clock control module. This will provide an average clock frequency that will exactly meet the pixel bandwidth requirements over time, and minimize power consumption to meet the display bandwidth requirements. During horizontal or vertical blanking intervals, when the LFIFO is full with data for the next active display interval, the clock can be reduced to a slow frequency for extended periods to reduce power consumption.

The LCDIF_THRES_PANIC value can be used to raise the priority of requests initiated by the eLCDIF to alter how the eLCDIF requests are arbitrated by the system bus infrastructure. The panic output control signal is raised when the number of 32bpp pixel equivalents in the LFIFO is less than this programmed value. Since the LFIFO is arranged as a 256x64bit quadword FIFO, it contains two 32bpp pixels per quadword, or 512 32bpp pixels total. To set the panic output when 3/4s of the LFIFO is empty, set the LCDIF_THRES_PANIC value to $3/4 * 512$, or 128. The panic signal output is used to assess higher priority to eLCDIF system requests to avoid eLCDIF under run errors during periods of high system bandwidth utilization.

The features available with the LCDIF_THRES register require support from system clocking and dynamic priority control. Refer to the appropriate block documentation to assess the system support for these features.

34.4.2 Write Data Path

eLCDIF supports raster based frame buffers and there is no support for tiled buffers.

There are several options to accommodate endianness of display buffers in memory before the data is processed for the external display. The LCDIF_CTRL[INPUT_DATA_SWIZZLE] field provides the following options for data word multiplexing:

```

00 (0): No swizzle (little-endian)
01 (1): Swap bytes 0 and 3, swap bytes 1 and 2 (big-endian)
10 (2): Swap half-words
11 (3): Swap bytes within each half-word

```

The LCDIF_CTRL[WORD_LENGTH] field indicates the input data/pixel format. LCDIF_TRANSFER_COUNT register denotes how much data is contained in each frame. The LCDIF_TRANSFER_COUNT[H_COUNT] field indicates the number of pixels per line and LCDIF_TRANSFER_COUNT[V_COUNT] indicates the total number of lines per frame. The LCDIF_CTRL1[BYTE_PACKING_FORMAT] field can be used to specify which bytes within the 32-bit word are going to be valid. For example, if the entire 32-bit word is valid, LCDIF_CTRL1[BYTE_PACKING_FORMAT] should be set to 0xF, if only lower 3 bytes of each word in the frame buffer are valid, then LCDIF_CTRL1[BYTE_PACKING_FORMAT] should be set to 0x7.

The LCDIF_CTRL[LCD_DATABUS_WIDTH] field suggests the width of the bus going to the display controller. There is an option to source all 32 bits of the input word and transfer it to the output I/O display interface. If the LCDIF_CTRL[LCD_DATABUS_WIDTH] is not the same as LCDIF_CTRL[WORD_LENGTH], eLCDIF will perform RGB to RGB color space conversion. For example, if the input frame has fewer bits per pixel than the display, as in a 16 bpp input frame going to 24 bpp LCD, eLCDIF will pad the MSBs of each color to the LSBs of the same color for each pixel. If the input frame has more bits per pixel than the display, for example, 24 bpp input frame going to 16 bpp LCD, eLCDIF will drop the LSBs of each color channel to convert to the lower color depth. eLCDIF also has the capability to support delta pixel displays by swizzling the R, G and B colors of each pixel in the odd and even lines of the frame separately by programming the LCDIF_CTRL2[ODD_LINE_PATTERN] and the LCDIF_CTRL2[EVEN_LINE_PATTERN] bit fields. This operation occurs after the RGB-to-RGB color space conversion operation.

eLCDIF also supports RGB to YCbCr 4:2:2 color space conversion. This is useful in the DVI mode since the TV encoder requires input in YCbCr 4:2:2 format. The LCDIF_CSC* registers have complete programmability over the CSC coefficients and offsets. The values must be written into these registers in the signed two's complement format.

The following list shows how the different input/output combinations can be obtained:

- LCDIF_CTRL[WORD_LENGTH]=1 indicates that the input is 8-bit data. This is most likely going to be used for sending commands in MPU interface, or maybe a gray scale image. Any combination of LCDIF_CTRL1[BYTE_PACKING_FORMAT] is permissible.

Limitation: LCDIF_TRANSFER_COUNT[H_COUNT] must be a multiple of the sum of BYTE_PACKING_FORMAT [3], BYTE_PACKING_FORMAT [2], BYTE_PACKING_FORMAT [1] and BYTE_PACKING_FORMAT [0].

LCDIF_CTRL[LCD_DATABUS_WIDTH] must be 1, indicating an 8-bit data bus.

- LCDIF_CTRL[WORD_LENGTH]=0 implies the input frame buffer is RGB 16 bits per pixel. LCDIF_CTRL[DATA_FORMAT_16_BIT] field determines the pixels are RGB 555 or RGB 565.

Limitation: LCDIF_CTRL1[BYTE_PACKING_FORMAT] should be 0x3 or 0xC if there is only one pixel per word. If there are two pixels per word, it should be 0xF and LCDIF_TRANSFER_COUNT[H_COUNT] will be restricted to be a multiple of 2 pixels.

- LCDIF_CTRL[WORD_LENGTH]=2 indicates that input frame buffer is RGB 18 bits per pixel, that is, RGB 666. The valid RGB values can be left-aligned or right-aligned within a 32-bit word. The alignment of the valid 18 bits within a word is indicated by the LCDIF_CTRL[DATA_FORMAT_18_BIT] bit.

Limitation: LCDIF_CTRL1[BYTE_PACKING_FORMAT] can be 0x7, 0xE or 0xF. Packed pixels are not supported in this case.

LCDIF_TRANSFER_COUNT[H_COUNT] can be any number.

- LCDIF_CTRL[WORD_LENGTH]=3 indicates that the input frame-buffer is RGB 24 bits per pixel (RGB 888). If LCDIF_CTRL1[BYTE_PACKING_FORMAT] is 0x7, it indicates that there is only one pixel per 32-bit word and there is no restriction on LCDIF_TRANSFER_COUNT[H_COUNT]. This is also the option that provides 32 bit output depending on the I/O muxing options available. The fourth byte, or bits [31:24], and connected to the I/Os if this muxing is available in the chip package.

Limitation: If LCDIF_CTRL1[BYTE_PACKING_FORMAT] is 0xF, it indicates that the pixels are packed, that is, there are 4 pixels in 3 words or 12 bytes and LCDIF_TRANSFER_COUNT[H_COUNT] must be a multiple of 4 pixels.

- LCDIF_CTRL1[YCBCR422_INPUT]=1 implies that the input frame is in YCbCr 4:2:2 format. LCDIF_CTRL1[BYTE_PACKING_FORMAT] must be 0xF.

Limitation: LCDIF_CTRL[LCD_DATABUS_WIDTH] must be 8-bit and LCDIF_TRANSFER_COUNT[H_COUNT] must be a multiple of 2 pixels.

LCDIF_CTRL2[ODD_LINE_PATTERN] and LCDIF_CTRL2[EVEN_LINE_PATTERN] must be 0 when any of LCDIF_CTRL[RGB_TO_YCBCR422_CSC] or LCDIF_CTRL1[INTERLACE_FIELDS] or LCDIF_CTRL[YCBCR422_INPUT] bits is 1.

After the RGB to RGB or RGB to YCbCr 4:2:2 color space conversions, there is one more opportunity to swizzle the data before sending it out to the display or the encoder. This can be done with the LCDIF_CTRL[CSC_DATA_SWIZZLE] field, and it provides the same options as the LCDIF_CTRL[INPUT_DATA_SWIZZLE] register.

Finally, there is an option to shift the output data before sending it out to the display. This is done based on the LCDIF_CTRL[SHIFT_DIR] and LCDIF_CTRL[SHIFT_NUM_BITS] fields.

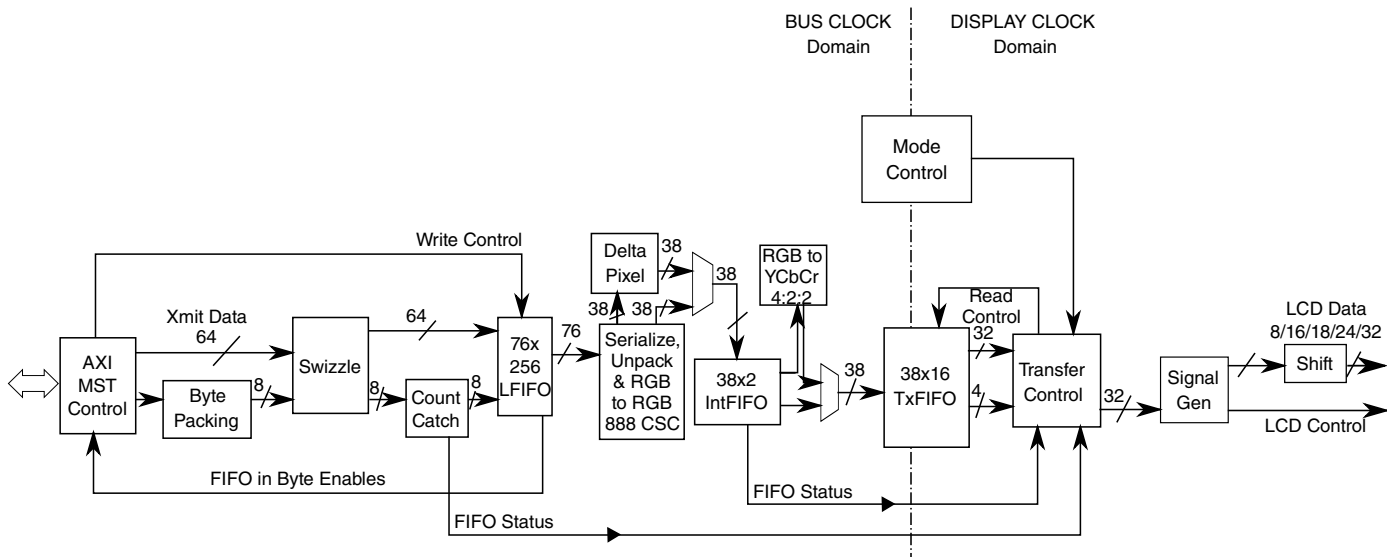

Figure 34-2. General Operations in Write Data Path

The examples in the following figures illustrate some different combinations of register programming for write mode. Assume that the data transferred over the system bus within a 32 bit word is organized as {A7-A0, B7-B0, C7-C0, D7-D0} in 8-bit mode and {A15-A0, B15-B0} in 16-bit mode.

In this example, all 32 bits of the input word are transferred out over an 8 bit display bus. Each byte within the 32 bit word is shifted to the right with zeros appended to bits D[7:6]. The input data bits [7:2] are shifted to the right by 2 bits and presented on the D[5:0].

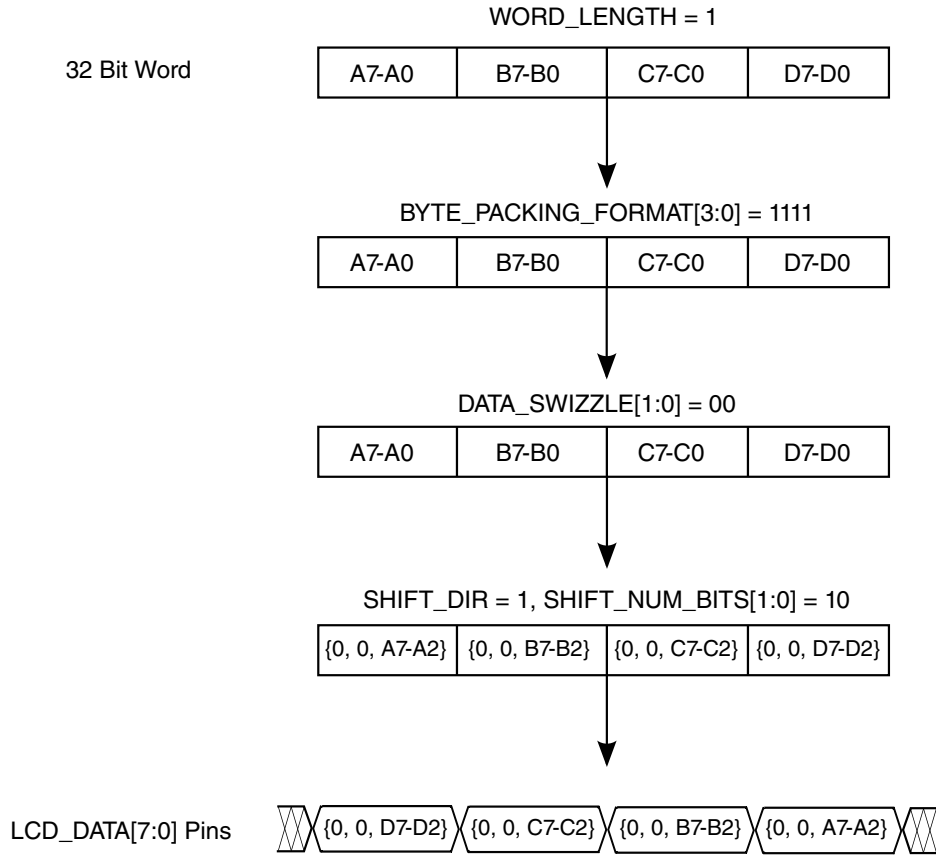

Figure 34-3. Register programming for write mode

In this 8 bit display interface example, one byte of the input word is deleted and not transferred over the external 8 bit display interface. This mode could be used to transfer 24bpp pixels over the 8 bit interface. In this case, the 4th unused byte is not transferred.

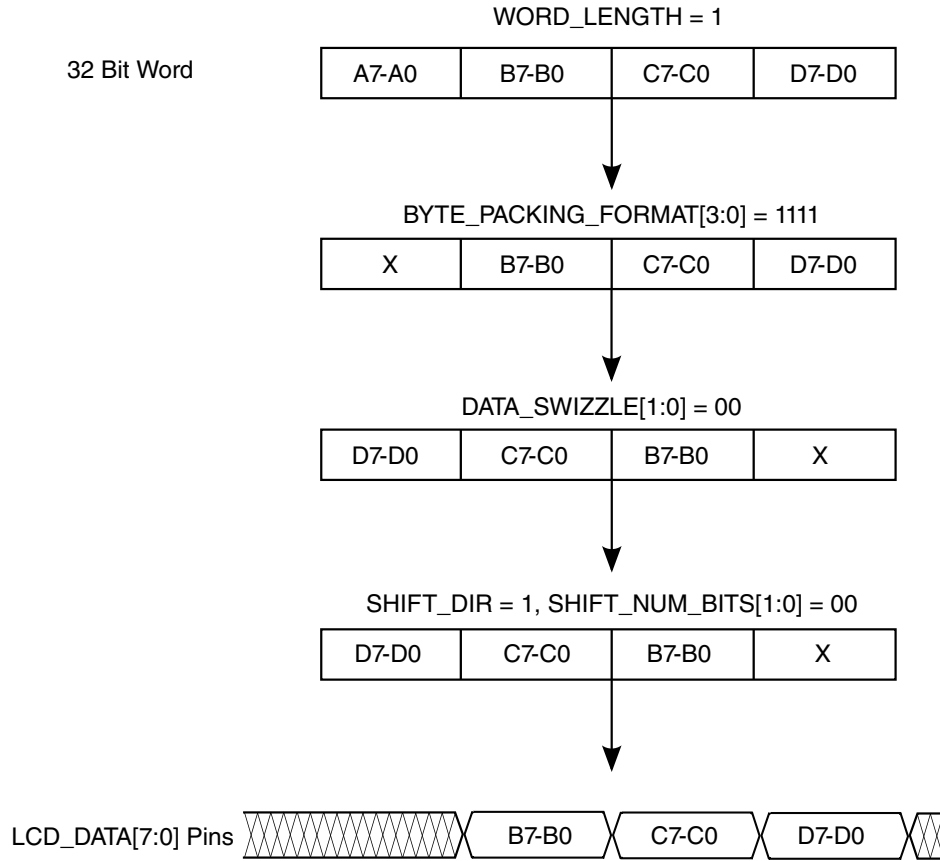

Figure 34-4. Register programming for write mode

The following example uses a 16 bit display interface. Each 16 bit half word is shifted to the right by two bits with zeros appended to the most significant two bits.

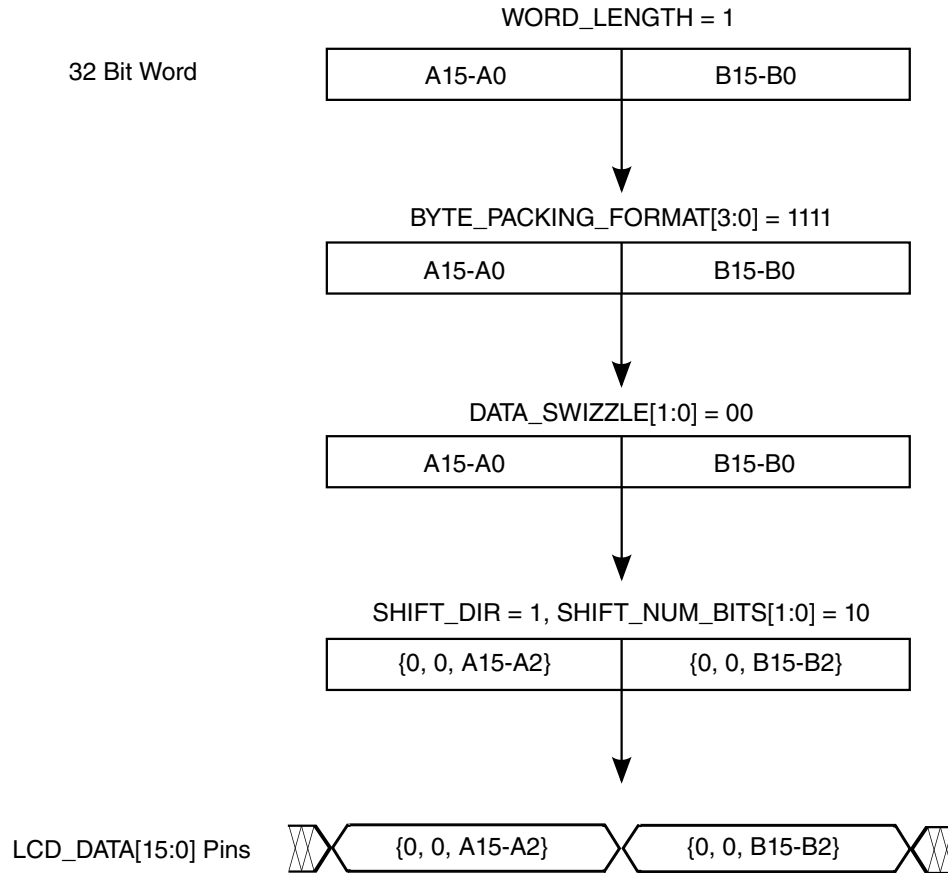

Figure 34-5. Register programming for write mode

This example indicates how an unpacked frame buffer can be sourced for display. Only a single 16 bit half word within the 32 bit word is transferred out via the 16 display bus.

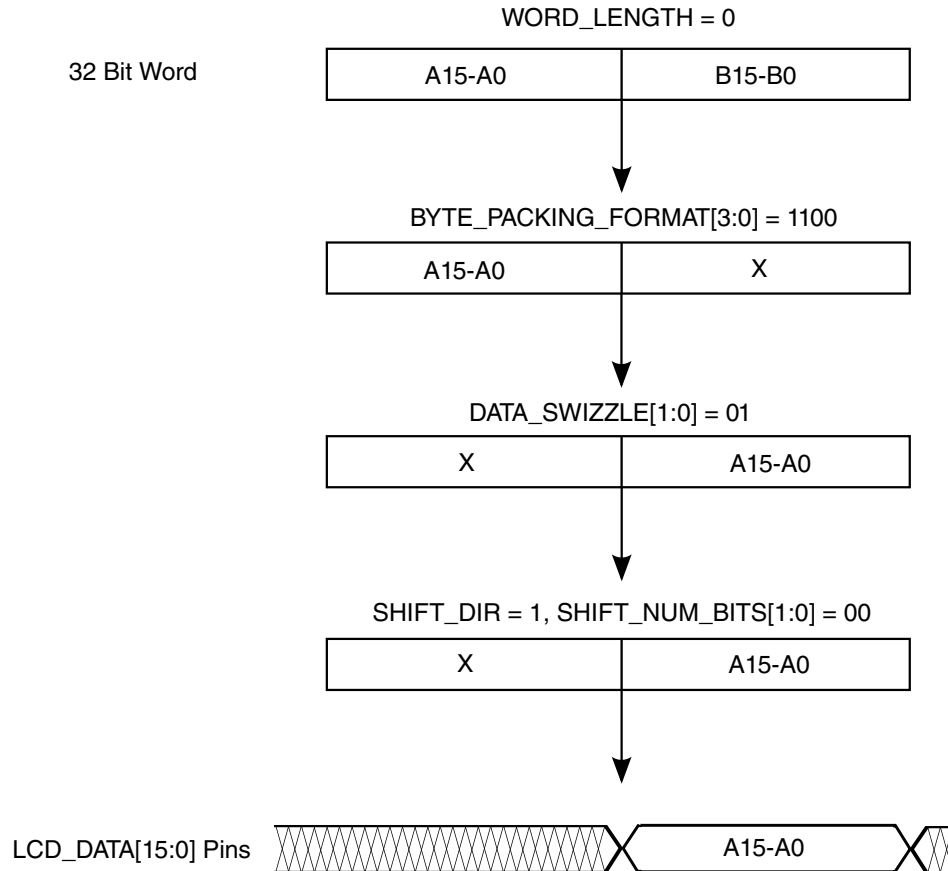

Figure 34-6. Register programming for write mode

34.4.3 Read Data Path

Figure 34-7 shows the MPU read data path in detail.

eLCDIF can read from an external display that follows the 6800/8080 MPU protocol.

The display bus width is determined by the `LCD_DATABUS_WIDTH` bit field. The data sampled at every read strobe is called a subword and the number of subwords that can be packed in a 32-bit word is given by the `READ_MODE_NUM_PACKED_SUBWORDS` bit field. The `INITIAL_DUMMY_READ` bit field directs the eLCDIF to skip the number of programmed subwords before starting to process read data. This feature is useful in the case of an LCD controller that returns the last written data the first time a read is issued, and then sends the correct data thereafter. `SHIFT_DIR` and `SHIFT_NUM_BITS` bit fields indicate whether the data needs to be shifted before getting stored in the internal registers. For example, a value of 2 in `READ_MODE_NUM_PACKED_SUBWORDS` if lcd

Functional Description

data bus width is 8 bits indicates two bytes should be packed in a 32-bit word, while if the lcd databus width is 16 bits, it indicates that two half words (or 4 bytes) should be packed.

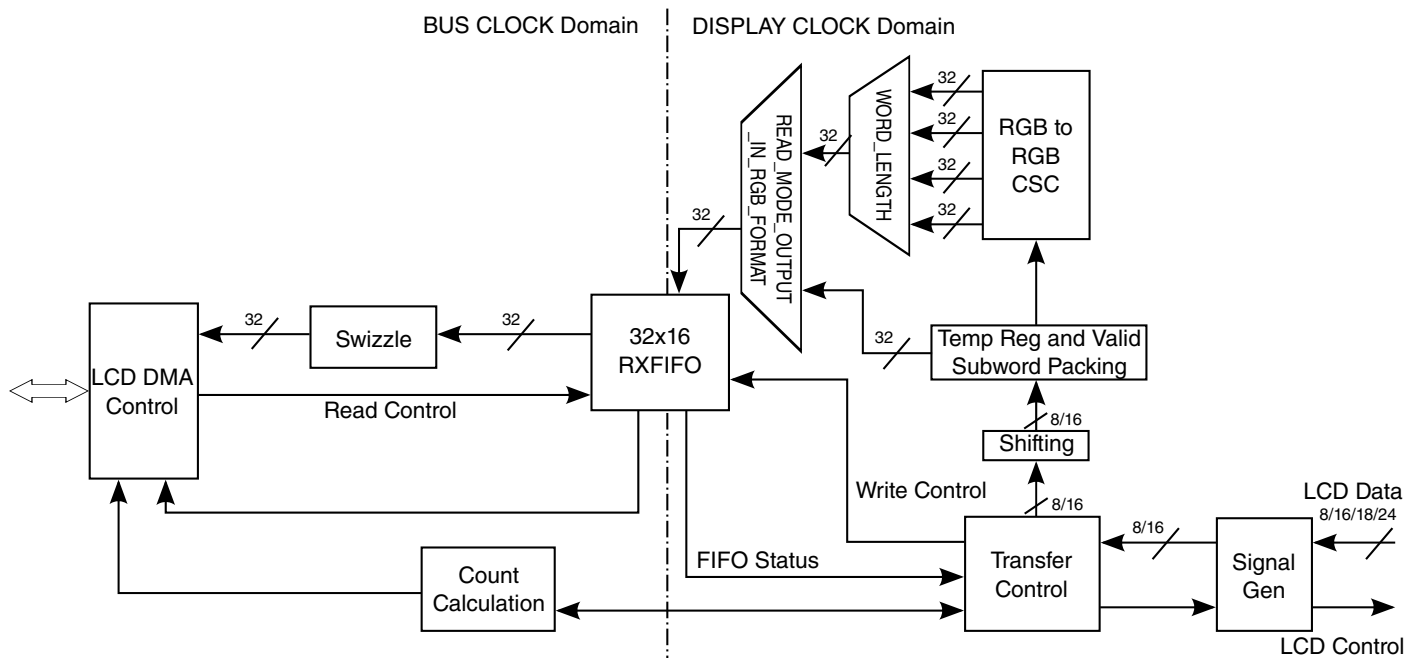

Figure 34-7. MPU Read Data Path

After the last subword within a word is reached, the block looks at the `READ_PACK_DIR` in the `HW_LCDIF_CTRL2` register. If this bit is set, the block will swizzle the data, but only within the valid bytes, unlike in the write mode, where swizzle occurs across all 4 bytes. If the `READ_MODE_OUTPUT_IN_RGB_FORMAT` bit is set, eLCDIF will convert the data obtained from the `READ_PACK_DIR` operation into 24-bit unpacked RGB and then re-convert it into 16/18/24 bpp RGB depending on the `WORD_LENGTH` field. The `DATA_FORMAT_16/18/24_BIT` bit fields are also considered while converting to 24-bit unpacked RGB format. For example, if `DATA_FORMAT_18_BIT` is 1, the RGB666 data will be packed in the upper bits [31:4] of a 32-bit word, and that bit is 0, the data will be packed in the lower bits [17:0]. After all these operations, the data gets written into the RXFIFO.

The following figures show some examples of how data is handled in different MPU read modes.

READ_MODE_NUM_PACKED_SUBWORDS = 2 AND LCD_DATABUS_WIDTH = 8 BITS
 OR
 READ_MODE_NUM_PACKED_SUBWORDS = 1 AND LCD_DATABUS_WIDTH = 16 BITS

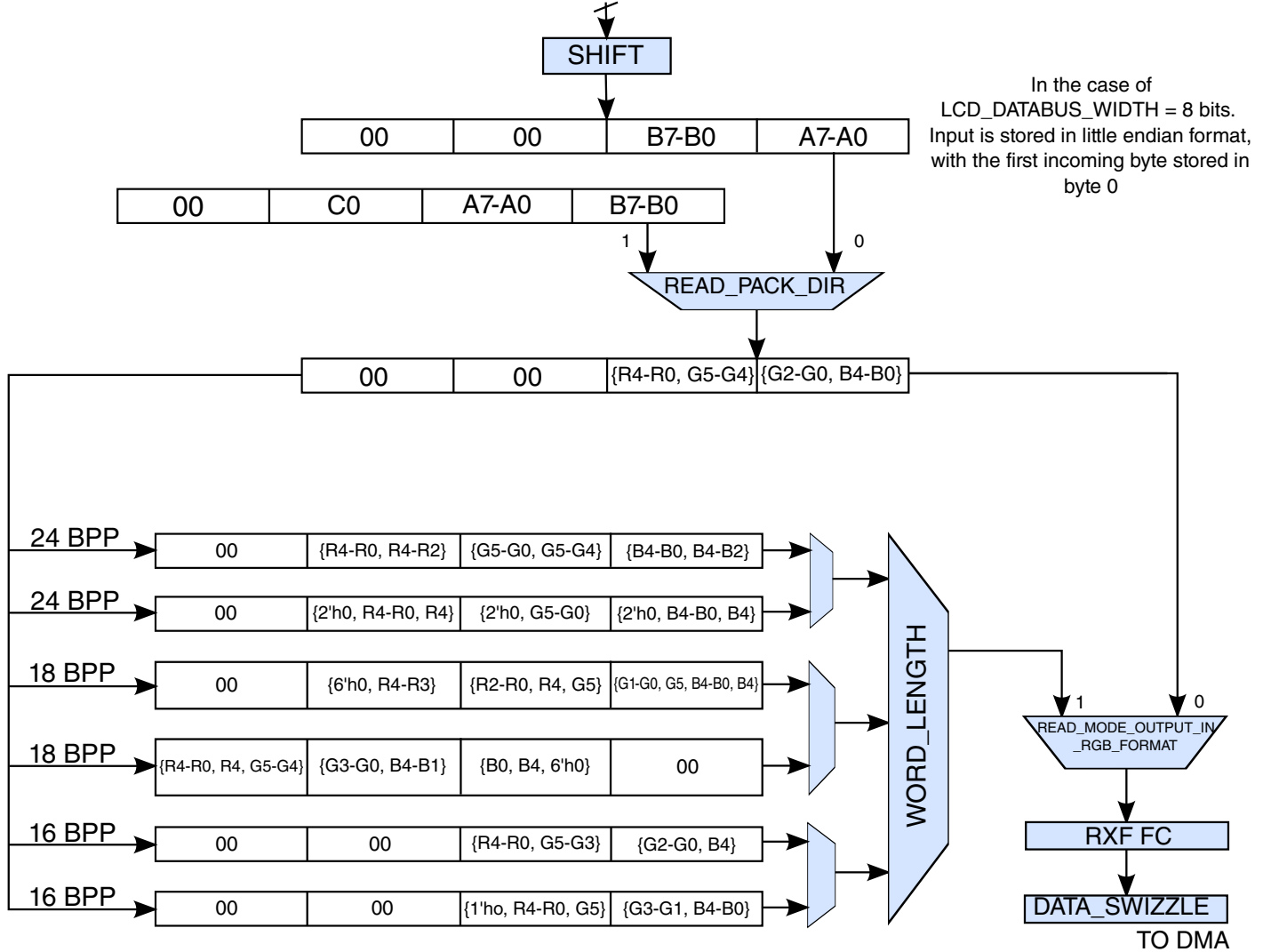

Figure 34-8. Data in MPU read mode

Functional Description

READ_MODE_NUM_PACKED_SUBWORDS = 3 AND LCD_DATABUS_WIDTH = 8 BITS
 OR
 READ_MODE_NUM_PACKED_SUBWORDS = 1 AND LCD_DATABUS_WIDTH = 24 BITS

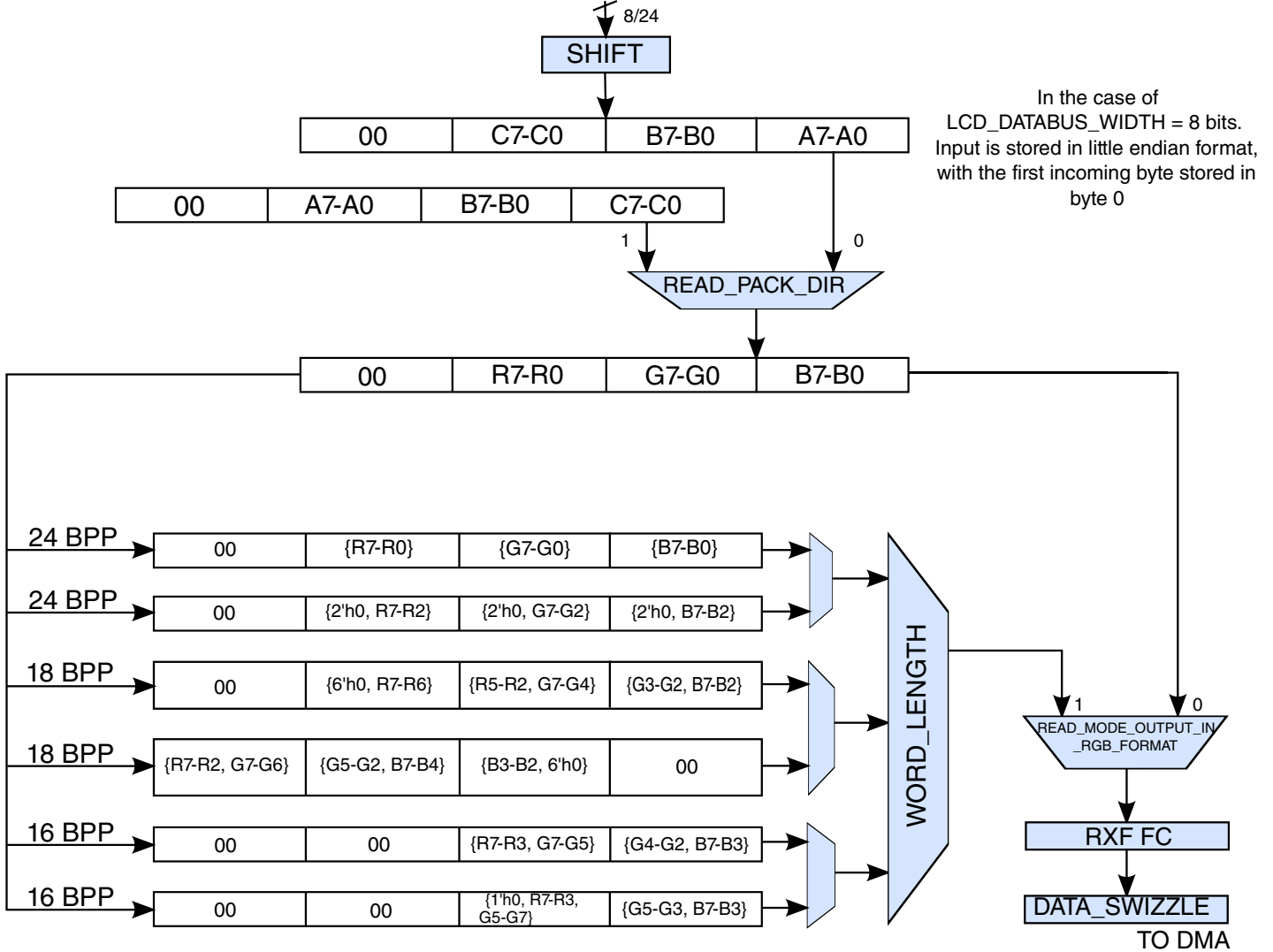

Figure 34-9. Data in MPU read mode

READ_MODE_NUM_PACKED_SUBWORDS = 1 AND LCD_DATABUS_WIDTH = 18 BITS

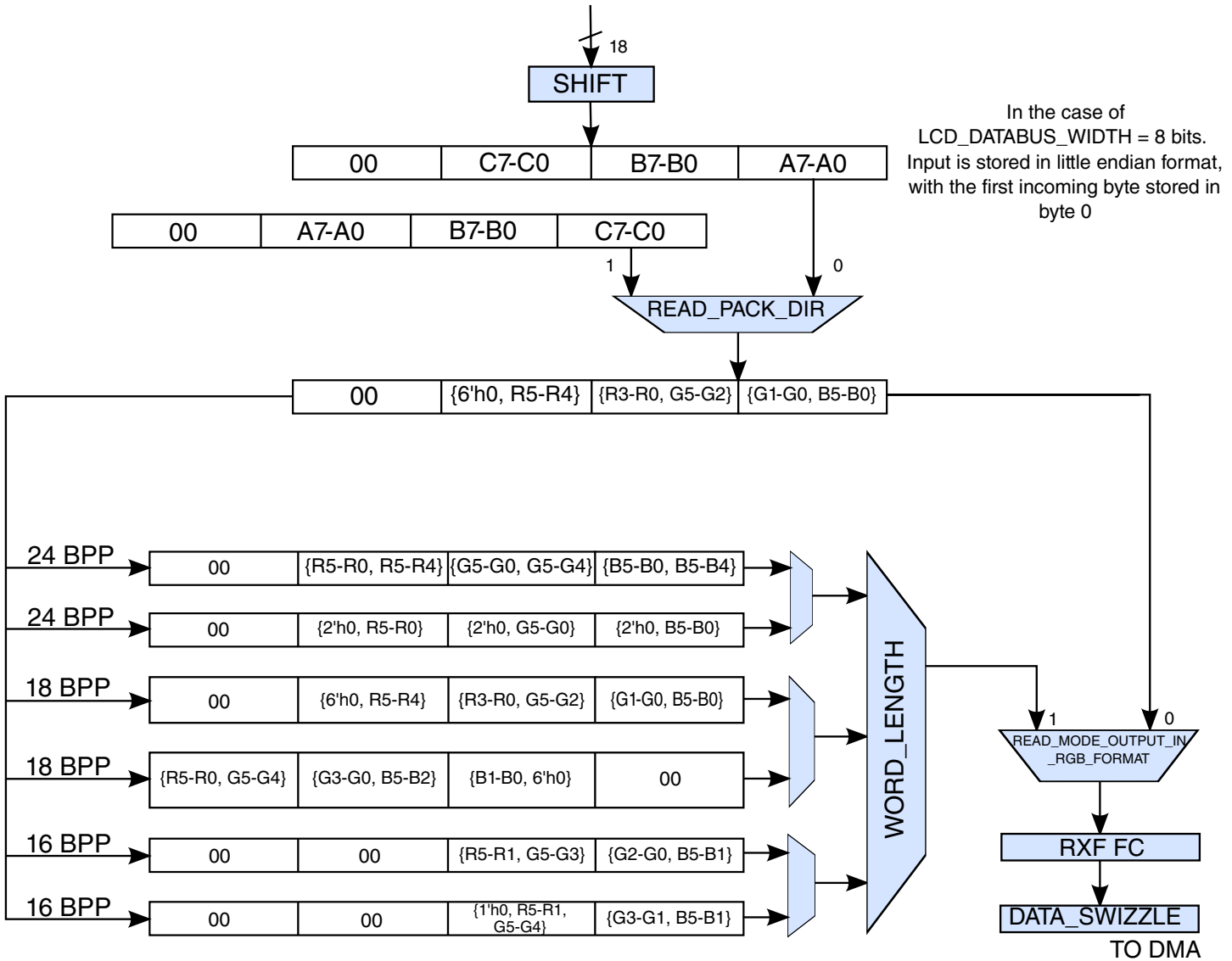

Figure 34-10. Data in MPU read mode

Restrictions:

READ_PACK_DIR should only be used if it is required to swizzle the subwords before doing RGB to RGB CSC, otherwise the DATA_SWIZZLE field should be used to swizzle across bytes.

READ_PACK_DIR must be 0 if LCD_DATABUS_WIDTH is 8 bits and READ_MODE_NUM_PACKED_SUBWORDS = 1

If READ_MODE_OUTPUT_IN_RGB_FORMAT bit is set, the following restrictions should be followed:

- If LCD_DATABUS_WIDTH = 8 bits, then
READ_MODE_NUM_PACKED_SUBWORDS <= 3.
- If LCD_DATABUS_WIDTH = 16/18/24 bits, then
READ_MODE_NUM_PACKED_SUBWORDS = 1.

34.4.4 eLCDIF Interrupts

eLCDIF supports a number of interrupts to aid controlling and status reporting of the block.

All the interrupts have individual mask bits for enabling or disabling each of them. They all get funneled through a single interrupt line connected to the interrupt collector (ICOLL).

The following list describes the different interrupts supported by eLCDIF:

- Underflow interrupt is asserted when the clock domain crossing FIFO (TXFIFO) becomes empty but the block is in active display portion during that time. Software should take corrective action to make sure that this does not happen.
- In the bus master mode, the overflow interrupt will be asserted if the block has requested more data than its FIFOs could hold. In the read mode, it will be asserted if the RxFIFO becomes full and the block reads more data.
- VSYNC edge interrupt will be asserted every time a leading VSYNC edge occurs.
- Cur_frame_done interrupt occurs at the end of every frame in all modes except DVI. In DVI mode, if IRQ_ON_ALTERNATE_FIELDS bit is set, it will occur at the end of every frame, otherwise it will occur at the end of every field.

34.4.5 Initializing the eLCDIF

This section describes write modes and MPU read mode.

34.4.5.1 Write Modes

The following initialization steps are common to all eLCDIF write modes of operation before entering any particular mode.

Initialization steps:

1. Configure the external I/Os to correctly interface the external display, when required.
2. Start the DISPLAY CLOCK (pix_clk) clock and set the appropriate frequency by programming the registers in CCM.

3. Start the BUS CLOCK (apb_clk) and set the appropriate frequency by programming the registers in CCM.
4. Bring the eLCDIF out of soft reset and disable the clock gate bit.
5. Reset the LCD controller by setting LCDIF_CTRL1[RESET] bit appropriately, being careful to observe the reset requirements of the controller. See [Behavior During Reset](#) for more information on Reset requirements.
6. Make sure LCDIF_CTRL[READ_WRITEB] bit is 0.
7. Select the transfer mode of operation. The LCDIF_CTRL[MASTER] bit determines the transfer mode selected. Bus master (LCDIF_CTRL[MASTER] =1), or PIO (LCDIF_CTRL[MASTER] =0) mode are the transfer modes to select.
8. Set the LCDIF_CTRL[INPUT_DATA_SWIZZLE] according to the endianness of the LCD controller. Also, set the LCDIF_CTRL[DATA_SHIFT_DIR] and LCDIF_CTRL[SHIFT_NUM_BITS] if it is required to shift the data left or right before it is output.
9. Set the LCDIF_CTRL[WORD_LENGTH] field appropriately: 0 = 16-bit input, 1 = 8-bit input, 2 = 18-bit input, 3 = 24/32-bit input. Also, select the correct 16/18/24 bit data format with the corresponding fields in LCDIF_CTRL register.
10. Set the LCDIF_CTRL1[BYTE_PACKING_FORMAT] field according to the input frame.
11. Set the LCDIF_CTRL[LCD_DATABUS_WIDTH] appropriately: 0 = 16-bit output, 1 = 8-bit output, 2 = 18-bit output, 3 = 24/32-bit output.
12. Enable the necessary IRQs.

34.4.5.2 MPU Read Mode

The following initialization steps should be done to enter the MPU read mode of operation:

Initialization steps:

1. Configure the external I/Os to correctly interface the external display.
2. Start the DISPLAY CLOCK (pix_clk) and set the appropriate frequency by programming the registers in CCM.
3. Start the BUS CLOCK (apb_clk) and set the appropriate frequency by programming the registers in CCM.
4. Bring the eLCDIF out of soft reset and clock gate.
5. Reset the LCD controller by setting LCDIF_CTRL1_RESET bit appropriately, being careful to observe the reset requirements of the controller.
6. Set the READ_WRITEB bit in LCDIF_CTRL register to 1.
7. Set the LCDIF_MASTER bit in LCDIF_CTRL register to 0. Bus master mode is not supported for reading data from the display.

8. Also, set the `DATA_SHIFT_DIR` and `SHIFT_NUM_BITS` if it is required to shift the data left or right before it is output.
9. Indicate if the read data needs to be color-space-converted and stored in a different RGB format by setting the `READ_MODE_OUTPUT_IN_RGB_FORMAT` field accordingly.
10. Set the `WORD_LENGTH` field appropriately: 0 = 16-bit input, 1 = 8-bit input, 2 = 18-bit input, 3 = 24-bit input if `READ_MODE_OUTPUT_IN_RGB_FORMAT` is required. Also, select the correct 16/18/24 bit data format with the corresponding fields in `LCDIF_CTRL` register.
11. Set the `READ_MODE_NUM_PACKED_SUBWORDS` field in `LCDIF_CTRL2` according to the number of subwords per word required to be packed.
12. Set the `READ_PACK_DIR` to 1 if it is required to store the data in big-endian format.
13. Set the `LCD_DATABUS_WIDTH` appropriately: 0 = 16-bit output, 1 = 8-bit output, 2 = 18-bit output, 3 = 24-bit output.
14. Enable the necessary IRQs.

34.4.6 MPU Interface

The MPU interface is used to transfer data and commands between the SoC via the eLCDIF and the external display at modest data rates.

Bus master or PIO transactions using the `LCDIF_DATA` register can be used for MPU mode write operations. For MPU mode read operations, only PIO can be used. eLCDIF can support the 6800 as well as the 8080 MPU protocol. If `DOTCLK_MODE`, `DVI_MODE` and `VSYNC_MODE` bits in `LCDIF_CTRL` registers are 0, it implies that the block is in MPU interface mode of operation. The LCDIF MPU mode has four basic timing parameters: Setup and Hold for the Command/Data register selection (TCS, TCH) and Setup and Hold for the Data bus (TDS, TDH). These parameters are expressed in DISPLAY CLOCK (pix_clk) cycles. The `LCD_WR` signal is used as the write strobe while `LCD_RS` signal is typically used to switch between command and data modes.

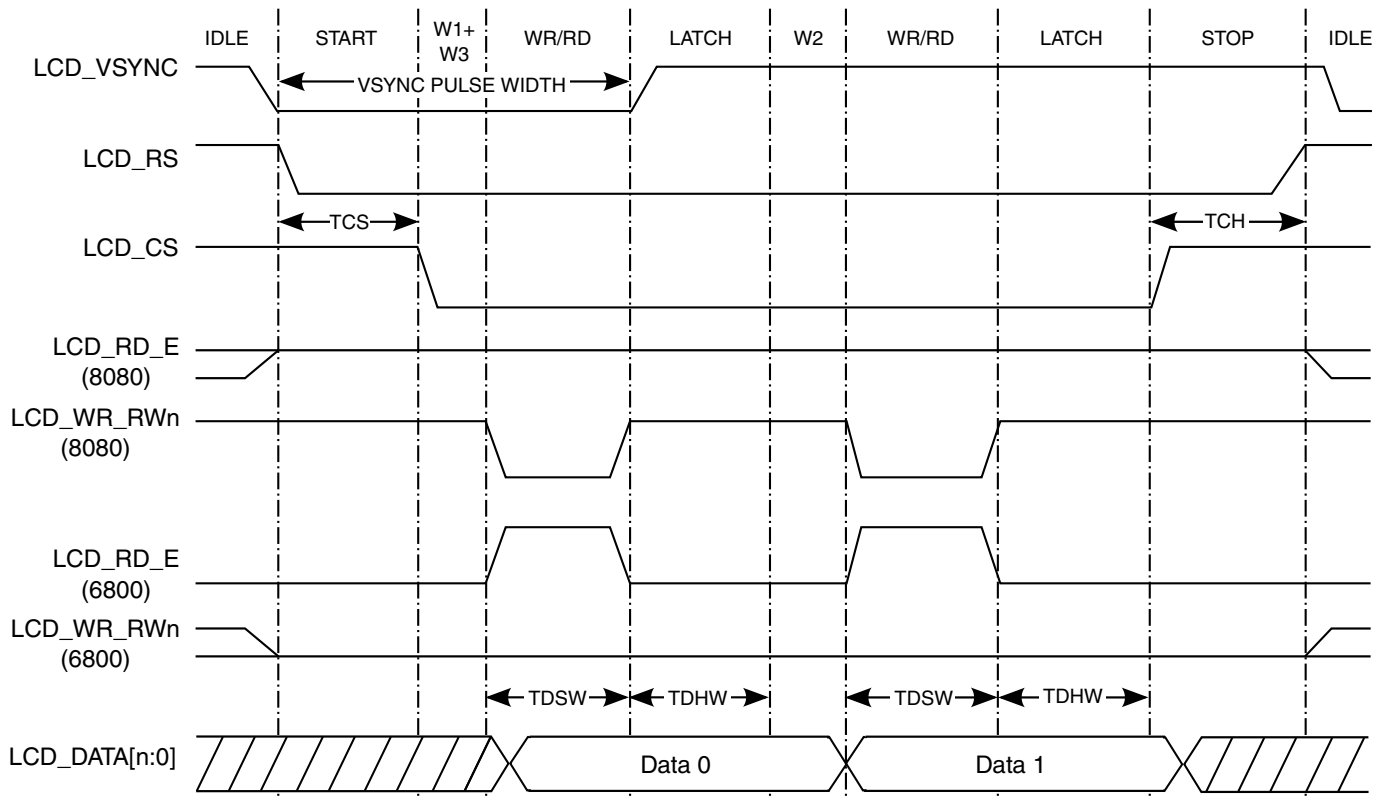

Figure 34-11. Timing in write mode of 6800 and 8080 protocols

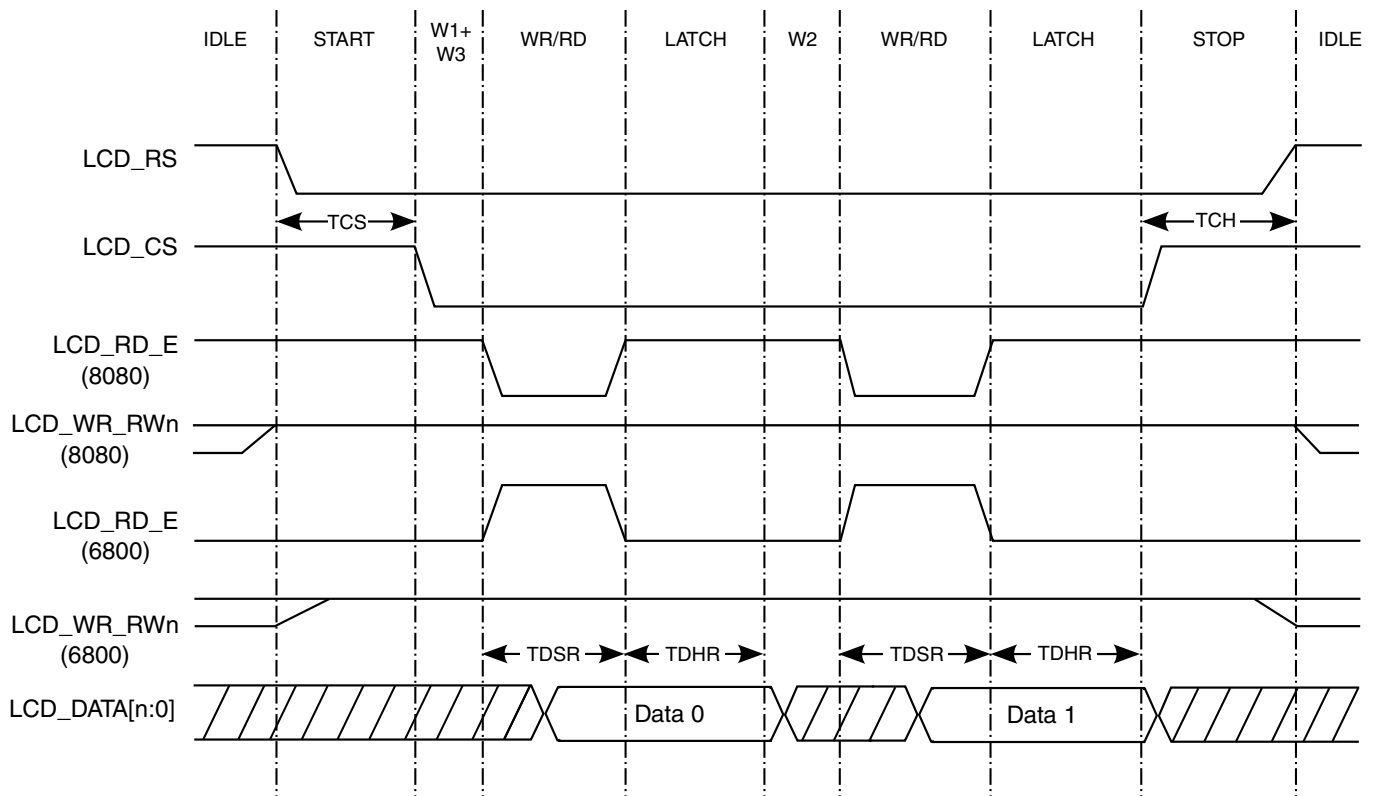

Figure 34-12. Read timing interface in 6800 and 8080 protocols

Functional Description

The eLCDIF has flexible pin and strobe timings which enable it to optimally support a wide range of LCDs. The minimum cycle time is two DISPLAY CLOCK (pix_clk) cycles (TDS=TDH=1). For example, this results in a maximum LCD data rate of 12 MB/s when DISPLAY CLOCK (pix_clk) is 24 MHz. TDS and TDH are 8-bit values, so the minimum eLCDIF period is 510 DISPLAY CLOCK (pix_clk) cycles (47 KHz with a 24 MHz DISPLAY CLOCK (pix_clk)). The timings are not automatically adjusted if the DISPLAY CLOCK (pix_clk) frequency changes, so it may be necessary to adjust the timings if DISPLAY CLOCK (pix_clk) changes.

In the MPU interface mode, the LCDIF_CTRL_BYPASS_COUNT bit must be 0. The RUN bit is cleared automatically once the eLCDIF has received/transmitted all the data as per the LCDIF_TRANSFER_COUNT register and has completed the transfer to the panel. The current transfer can be cancelled/aborted if the RUN bit is manually made 0.

34.4.6.1 Code Example to Initialize the eLCDIF in MPU Write Mode

```
// Note: Common initialization steps in Initializing the eLCDIF must also be
// executed along with the following code
BF_CS1(LCDIF_CTRL, DATA_SELECT, 1); // 0 if sending command, 1 if sending data. Note that the
// idle state for LCD_RS signal is high, regardless of the
// programming of the DATA_SELECT register.
BF_CS1 (LCDIF_CTRL, MODE86, 8080_MODE);
BF_CS1 (LCDIF_CTRL, READ_WRITEB, 0);
BF_CS1 (LCDIF_CTRL, BYPASS_COUNT, 0); //Must be 0 in MPU mode
BF_CS1 (LCDIF_CTRL1, BUSY_ENABLE, 1); //Only if LCD controller implements a busy line
BF_CS4 (LCDIF_TIMING, CMD_HOLD, 2, CMD_SETUP, 2, DATA_HOLD, 2, DATA_SETUP, 2); //Values
based
// on DISPLAY CLOCK (pix_clk) frequency and timing requirements
of controller.
// Note that these register must be non-zero for correct
operation.
BF_CS2 (LCDIF_TRANSFER_COUNT, H_COUNT, 320, V_COUNT, 240); //For a 320 RGB x 240 display
BF_CS1 (LCDIF_CTRL, RUN, 1);
```

The eLCDIF is now ready to receive data via bus master PIO write transactions using the LCDIF_DATA register. Note that when using the PIO write operations to the LCDIF_DATA register, the software will need to poll the FIFO STATUS bits to ensure that it does not overflow the eLCDIF data buffers. When eLCDIF is done transmitting H_COUNT x V_COUNT pixels, it will stop, turn off the RUN bit and assert the cur_frame_done interrupt.

34.4.7 VSYNC Interface

The VSYNC interface uses the same protocol as the MPU interface, with an additional signal VSYNC at the frame rate of the display, as shown in the figure given in MPU Interface section.

It is used in the moving picture display mode where data has to be written to the internal LCD buffer at a speed higher than the display rate and displayed in synchronization with the VSYNC signal. This mode is selected by setting the VSYNC_MODE bit in LCDIF_CTRL register. The VSYNC signal is programmable for period, polarity and direction. Many other programmable parameters are shared with the MPU interface. The VSYNC_OEB bit in LCDIF_VDCTRL0 register indicates whether the display controller will send the VSYNC signal, or whether it should be generated by eLCDIF. The timing of the VSYNC signal is based on the DISPLAY CLOCK (pix_clk) (make sure VSYNC_PULSE_WIDTH_UNIT = VSYNC_PERIOD_UNIT = 0 and VSYNC_ONLY = 1) and it is determined by the VSYNC_PERIOD, VSYNC_PULSE_WIDTH and VSYNC_POL fields in LCDIF_VDCTRL0-4 registers. The SYNC_SIGNALS_ON bit in LCDIF_VDCTRL4 register must be set if the target requires the VSYNC signal to be generated by eLCDIF. If the WAIT_FOR_VSYNC_EDGE bit in LCDIF_CTRL register is set, it indicates that the hardware should wait until it sees the leading VSYNC edge before starting the data transfer. The VERTICAL_WAIT_CNT indicates the number of DISPLAY CLOCK (pix_clk) cycles from the leading VSYNC edge after which data transfer will be started on the interface.

In the VSYNC interface mode, the LCDIF_CTRL_BYPASS_COUNT bit must be 0. The RUN bit is cleared automatically once the eLCDIF has received/transmitted all the data as per the LCDIF_TRANSFER_COUNT register and has completed the transfer to the panel. The current transfer can be cancelled/aborted if the RUN bit is manually made 0.

34.4.7.1 Code Example to Initialize eLCDIF in VSYNC Mode

```
// Note: Common initialization steps in Initializing the eLCDIF must also be
// executed along with the following code
BF_CS1 (LCDIF_CTRL, DATA_SELECT, 1); // 0 if sending command, 1 if sending data. Note that
//the idle state for LCD_RS signal is high, regardless of the programming of the DATA_SELECT
//register.

BF_CS1 (LCDIF_CTRL, MODE86, 8080_MODE);
BF_CS1 (LCDIF_CTRL, BYPASS_COUNT, 0); //Must be 0 in MPU mode
BF_CS1 (LCDIF_CTRL1, BUSY_ENABLE, 0);
BF_CS4 (LCDIF_TIMING, CMD_HOLD, 2, CMD_SETUP, 2, DATA_HOLD, 2, DATA_SETUP, 2); //Values
//based on DISPLAY CLOCK (pix_clk) frequency and timing requirements of controller. Note
that these
//register must be non-zero for the MPU and VSYNC modes.
BF_CS2 (LCDIF_TRANSFER_COUNT, H_COUNT, 320, V_COUNT, 240); //For a 320 RGB x 240 display
//The following section indicates setting up the VSYNC signal timing when VSYNC is an output
BF_CS1 (LCDIF_VDCTRL0, VSYNC_OEB, 0); //Making VSYNC signal an output
BF_CS1 (LCDIF_VDCTRL4, VSYNC_ONLY, 1); //Only need to generate VSYNC signal
BF_CS1 (VDCTRL0, VSYNC_POL, 0); //Setting the polarity of VSYNC signal to be low during
//VSYNC_PULSE_WIDTH time
BF_CS2 (LCDIF_VDCTRL0, VSYNC_PERIOD_UNIT, 0, VSYNC_PULSE_WIDTH_UNIT, 0);
BF_CS2 (LCDIF_VDCTRL1, VSYNC_PERIOD, 400000, VSYNC_PULSE_WIDTH, 100); //Frame display rate in
//terms of number of DISPLAY CLOCKS (pix_clk).
BF_CS2 (LCDIF_VDCTRL2, HSYNC_PULSE_WIDTH, 0, HSYNC_PERIOD, 0);
BF_CS1 (LCDIF_VDCTRL3, VERTICAL_WAIT_CNT, 50);
```

Functional Description

```
BF_CS1 (LCDIF_VDCTRL4, SYNC_SIGNALS_ON, 1);  
BF_CS2 (LCDIF_CTRL, VSYNC_MODE, 1, WAIT_FOR_VSYNC_EDGE, 1); //set WAIT_FOR_VSYNC_EDGE if  
//software wishes to transfer the next frame after the VSYNC edge occurs.  
BF_CS1 (LCDIF_CTRL, RUN, 1);
```

The eLCDIF is now ready to receive data via bus master requests or PIO writes to the LCDIF_DATA register. When eLCDIF is done transmitting H_COUNT x V_COUNT pixels, it will stop, turn off the RUN bit and assert the cur_frame_done interrupt.

34.4.8 DOTCLK Interface

The DOTCLK interface is another mode used in moving picture displays.

It includes the VSYNC, HSYNC, DOTCLK and (optional) ENABLE signals. The interface is popularly called the RGB interface if the ENABLE signal is present.

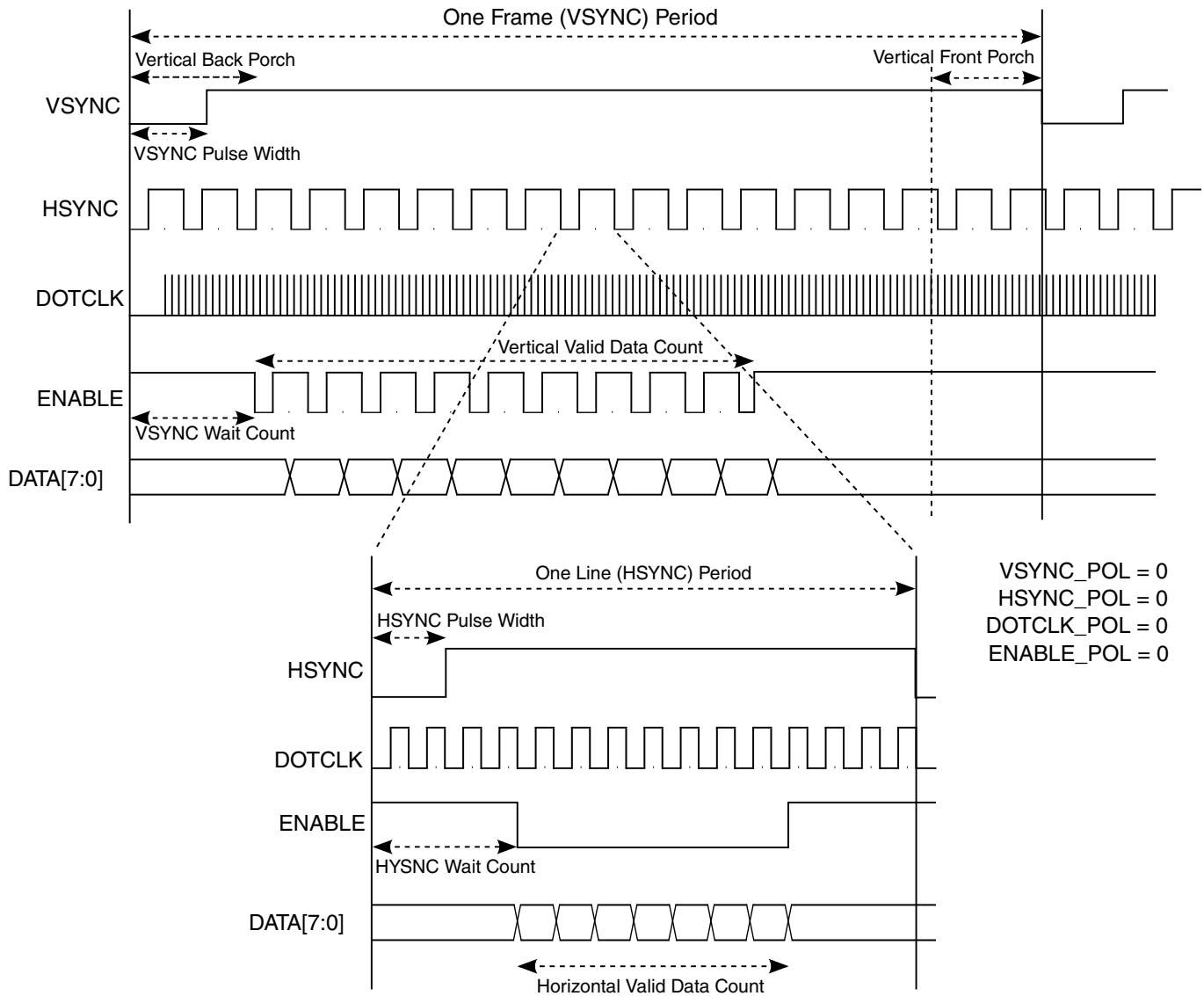

Figure 34-13. DOTCLK protocol with programmable parameters

The DOTCLK mode writes data at high speed to the LCD, and the display operation is synchronized with the VSYNC, HSYNC, ENABLE and DOTCLK signals. The polarities, periods and pulse-widths of the sync signals are programmable using the LCDIF_VDCTRL0-4 registers. The units for the VSYNC signal must be number of horizontal lines and can be selected using the VSYNC_PULSE_WIDTH_UNIT and VSYNC_PERIOD_UNIT bit fields. The VERTICAL_WAIT_CNT is by default given the same unit as the VSYNC_PERIOD. The DISPLAY CLOCK (pix_clk) frequency is managed by the CCM.

In DOTCLK mode, LCDIF_CTRL_BYPASS_COUNT bit must be set to 1. To end the current transfer, the software should make the DOTCLK_MODE bit 0, so that all data that is currently in the LCDIF LFIFO and TXFIFO is transmitted. Once that transfer is complete, the block will automatically clear the RUN bit and issue the cur_frame_done interrupt.

34.4.8.1 Code Example

The following code shows an example for programming a 320x240 display.

NOTE

Setting up the display must be done through the MPU mode or via SPI.

```
// Note: Common initialization steps in Initializing the eLCDIF must also be
// executed along with the following code
BF_CS1 (LCDIF_CTRL, DOTCLK_MODE, 1);
BF_CS1 (LCDIF_CTRL, BYPASS_COUNT, 1); //Always for DOTCLK mode
BF_CS1 (LCDIF_VDCTRL0, VSYNC_OEB, 0); //Vsync is always an output in the DOTCLK mode
BF_CS4 (LCDIF_VDCTRL0, VSYNC_POL, 0, HSYNC_POL, 0, DOTCLK_POL, 0, ENABLE_POL, 0);
BF_CS1 (LCDIF_VDCTRL0, ENABLE_PRESENT, 1);
BF_CS2 (LCDIF_VDCTRL0, VSYNC_PERIOD_UNIT, 1, VSYNC_PULSE_WIDTH_UNIT, 1);
BF_CS1 (LCDIF_VDCTRL0, VSYNC_PULSE_WIDTH, 2);
BF_CS1 (LCDIF_VDCTRL1, VSYNC_PERIOD, 280);
BF_CS2 (LCDIF_VDCTRL2, HSYNC_PULSE_WIDTH, 10, HSYNC_PERIOD, 360); //Assuming
// LCD_DATABUS_WIDTH is 24bit
BF_CS2 (LCDIF_VDCTRL3, VSYNC_ONLY, 0);
BF_CS2 (LCDIF_VDCTRL3, HORIZONTAL_WAIT_CNT, 20, VERTICAL_WAIT_CNT, 20);
BF_CS1 (LCDIF_VDCTRL4, DOTCLK_H_VALID_DATA_CNT, 320); //Note that DOTCLK_V_VALID_DATA_CNT is
//implicitly assumed to be HW_LCDIF_TRANSFER_COUNT_V_COUNT
BF_CS1 (LCDIF_VDCTRL4, SYNC_SIGNALS_ON, 1);
BF_CS1 (LCDIF_CTRL, RUN, 1);
```

To stop the transfer completely, the ideal way is to make DOTCLK_MODE = 0. In that case, the block will transmit the contents in the FIFO and reset the RUN bit.

34.4.9 CSI HANDSHAKE INTERFACE

The LCDIF and CSI support a pipeline mode to use double buffers inside OGRAM for the video pass through from CSI to LCDIF, the pipeline buffer size can be 8 line or 16 line as configurable. The pipeline will be handle by hardware handshake signals between CSI and LCDIF. The LCDIF will have the capability to synchronize display with CSI based on the VSYNC signal from CSI. When LCDIF is enabled to start display, it can optionally wait for the VSYNC edge from CSI before it starts the display for next frame, The delay from VSYNC input to the start of next frame is programmable by LCDIF_SYNC_DELAY register.

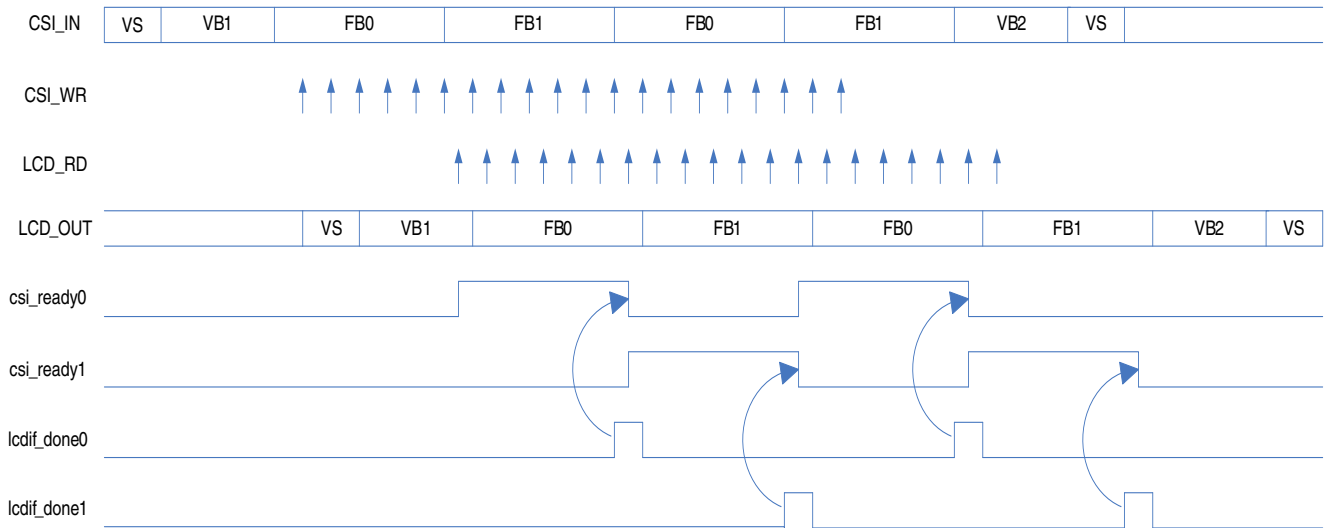

Figure 34-14. CSI HandShake Interface

When this mode is enabled, the hardware handshake protocol will process. At the start of CSI with camera input, the CSI will put the input data to one frame buffer. When the frame buffer is ready for LCDIF display, CSI will assert `csi_ready` signal to indicate LCDIF to read the buffer and LCDIF will display data in this buffer. When one frame buffer reading finished, LCDIF will set the `lcdif_done` signal to indicate CSI this buffer has been displayed and can be written again. With this double buffer handshake mode, the LCDIF can display the video input within very short delay and minimize DRAM bandwidth.

34.4.10 Alpha Blending Interface

The LCDIF has the capability to add an extra overlay on the normal display buffer. LCDIF can fetch data from two buffers and combine them before display, one buffer data can have the alpha value with the RGB pixels. With `LCDIF_AS_CTRL[AS_ENABLE]` is set, the LCDIF will start fetching alpha surface buffer data in bus master mode and combine it with another buffer.

The `LCDIF_AS_CTRL[ALPHA_CTRL]` bits determine how the alpha value is constructed for the alpha surface and alpha blending process is as same as in PXP block, for the alpha blend and color key process refer to the PXP block descriptions.

34.4.11 ITU-R BT.656 Digital Video Interface (DVI)

ITU-R BT.656 Digital Video Interface shown below transmits 4:2:2 YCbCr digital component video to a digital video encoder that can translate it into 525/60 or 625/50 analog TV signal.

Unique timing codes (timing reference signals) are embedded within the video stream to indicate the different timing events that would have been otherwise indicated by VSYNC, HSYNC and BLANK signals. The hardware supports 8-bit data transfers; the pins are shared with the lower 8 bits of LCD data bus. The LCD_RS pin is shared with the clock signal of the interface (called CCIRCLK here for uniqueness). CCIRCLK also can be obtained on the LCD_DOTCLK pin. The mode shares the write FIFO with the LCD interface and the associated pipeline. The programmable parameters in registers LCDIF_DVICTRL0-3 allow setting the total number of horizontal lines per frame, vertical and horizontal blanking interval, odd and even field start and end positions, and so on. In short, these parameters are provided to ensure that the hardware has enough flexibility to generate the right 525/60 or 625/50 data streams. Most of the initialization steps in [Initializing the eLCDIF](#) such as data shifting, swizzle, and so on, are applicable to DVI mode also. The register descriptions in the programmable registers section at the end of this chapter include example code for programming the DVICTRL0-3 registers.

In DVI mode, LCDIF_CTRL_BYPASS_COUNT bit must be set to 1. To end the current transfer, the software should make the DVI_MODE bit the value 0, so that all data that is currently in the LCDIF LFIFO and TXFIFO is transmitted. Once that transfer is complete, the block will automatically clear the RUN bit and assert the cur_frame_done interrupt.

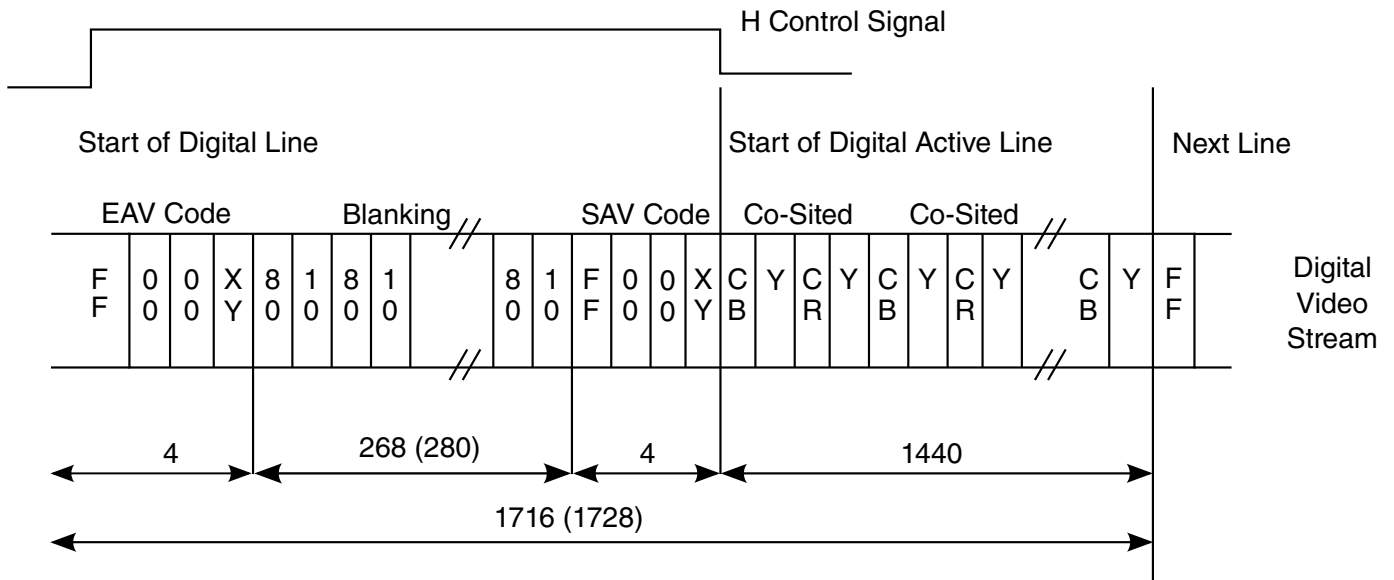

Figure 34-15. Digital Video Interface

34.4.12 eLCDIF Pin Usage by Interface Mode

The following tables detail how the eLCDIF level interface pins are used based on the desired mode of operation. The chip level I/Os should also be configured to be consistent with the desired eLCDIF operating mode.

The VSYNC signal has been mapped onto two pins, LCD_BUSY and LCD_VSYNC. The pin multiplexing can be programmed to select either of those pins to function as VSYN.

NOTE

There is an option to internally mux the HSYNC, DOTCLK and ENABLE signals in the DOTCLK mode by setting the MUX_SYNC_SIGNALS bit in the VDCTRL0 register.

Table 34-3. Pin use in MPU Mode

PIN NAME	8-bit MPU LCD IF	16-bit MPU LCD IF	18-bit MPU LCD IF	24-bit MPU LCD IF
LCD_RS	LCD_RS	LCD_RS	LCD_RS	LCD_RS
LCD_CS	LCD_CS	LCD_CS	LCD_CS	LCD_CS
LCD_WR _RWn	LCD_WR _RWn	LCD_WR _RWn	LCD_WR _RWn	LCD_WR _RWn
LCD_RD_E	LCD_RD_E	LCD_RD_E	LCD_RD_E	LCD_RD_E
LCD_VSYNC* (Two options)	X	X	X	X
LCD_HSYNC	X	X	X	X
LCD_DOTCLK	X	X	X	X
LCD_ENABLE	X	X	X	X
LCD_DATA23 (LCD_D23)	X	X	X	LCD_DATA23
LCD_DATA22 (LCD_D22)	X	X	X	LCD_DATA22
LCD_DATA21 (LCD_D21)	X	X	X	LCD_DATA21
LCD_DATA20 (LCD_D20)	X	X	X	LCD_DATA20
LCD_DATA19 (LCD_D19)	X	X	X	LCD_DATA19
LCD_DATA18 (LCD_D18)	X	X	X	LCD_DATA18
LCD_DATA17 (LCD_D17)	X	X	LCD_DATA17	LCD_DATA17

Table continues on the next page...

Table 34-3. Pin use in MPU Mode (continued)

PIN NAME	8-bit MPU LCD IF	16-bit MPU LCD IF	18-bit MPU LCD IF	24-bit MPU LCD IF
LCD_DATA16 (LCD_D16)	X	X	LCD_DATA16	LCD_DATA16
LCD_DATA15 (LCD_D15) / VSYNC*	X	LCD_DATA15	LCD_DATA15	LCD_DATA15
LCD_DATA14 (LCD_D14) / HSYNC**	X	LCD_DATA14	LCD_DATA14	LCD_DATA14
LCD_DATA13 (LCD_D13) / LCD_DOTCLK**	X	LCD_DATA13	LCD_DATA13	LCD_DATA13
LCD_DATA12 (LCD_D12) / ENABLE**	X	LCD_DATA12	LCD_DATA12	LCD_DATA12
LCD_DATA11 (LCD_D11)	X	LCD_DATA11	LCD_DATA11	LCD_DATA11
LCD_DATA10 (LCD_D10)	X	LCD_DATA10	LCD_DATA10	LCD_DATA10
LCD_DATA09 (LCD_D9)	X	LCD_DATA09	LCD_DATA09	LCD_DATA09
LCD_DATA08 (LCD_D8)	X	LCD_DATA08	LCD_DATA08	LCD_DATA08
LCD_DATA07 (LCD_D7)	LCD_DATA07	LCD_DATA07	LCD_DATA07	LCD_DATA07
LCD_DATA06 (LCD_D6)	LCD_DATA06	LCD_DATA06	LCD_DATA06	LCD_DATA06
LCD_DATA05 (LCD_D5)	LCD_DATA05	LCD_DATA05	LCD_DATA05	LCD_DATA05
LCD_DATA04 (LCD_D4)	LCD_DATA04	LCD_DATA04	LCD_DATA04	LCD_DATA04
LCD_DATA03 (LCD_D3)	LCD_DATA03	LCD_DATA03	LCD_DATA03	LCD_DATA03
LCD_DATA02 (LCD_D2)	LCD_DATA02	LCD_DATA02	LCD_DATA02	LCD_DATA02
LCD_DATA01 (LCD_D1)	LCD_DATA01	LCD_DATA01	LCD_DATA01	LCD_DATA01
LCD_DATA00 (LCD_D0)	LCD_DATA00	LCD_DATA00	LCD_DATA00	LCD_DATA00
LCD_RESET	LCD_RESET	LCD_RESET	LCD_RESET	LCD_RESET
LCD_BUSY / LCD_VSYNC	LCD_BUSY	LCD_BUSY	LCD_BUSY	LCD_BUSY

Table 34-4. Pin use in VSYNC Mode

PIN NAME	8-bit VSYNC LCD IF	16-bit VSYNC LCD IF	18-bit VSYNC LCD IF	24-bit VSYNC LCD IF
LCD_RS	LCD_RS	LCD_RS	LCD_RS	LCD_RS
LCD_CS	LCD_CS	LCD_CS	LCD_CS	LCD_CS

Table continues on the next page...

Table 34-4. Pin use in VSYNC Mode (continued)

PIN NAME	8-bit VSYNC LCD IF	16-bit VSYNC LCD IF	18-bit VSYNC LCD IF	24-bit VSYNC LCD IF
LCD_WR _Rn	LCD_WR _Rn	LCD_WR _Rn	LCD_WR _Rn	LCD_WR _Rn
LCD_RD_E	LCD_RD_E	LCD_RD_E	LCD_RD_E	LCD_RD_E
LCD_VSYNC* (Two options)	LCD_ VSYNC	LCD_ VSYNC	LCD_ VSYNC	LCD_ VSYNC
LCD_HSYNC	X	X	X	X
LCD_DOTCLK	X	X	X	X
LCD_ENABLE	X	X	X	X
LCD_DATA23 (LCD_D23)	X	X	X	LCD_DATA23
LCD_DATA22 (LCD_D22)	X	X	X	LCD_DATA22
LCD_DATA21 (LCD_D21)	X	X	X	LCD_DATA21
LCD_DATA20 (LCD_D20)	X	X	X	LCD_DATA20
LCD_DATA19 (LCD_D19)	X	X	X	LCD_DATA19
LCD_DATA18 (LCD_D18)	X	X	X	LCD_DATA18
LCD_DATA17 (LCD_D17)	X	X	LCD_DATA17	LCD_DATA17
LCD_DATA16 (LCD_D16)	X	X	LCD_DATA16	LCD_DATA16
LCD_DATA15 (LCD_D15) / VSYNC*	VSYNC (optional)	LCD_DATA15	VSYNC (optional)	LCD_DATA15
LCD_DATA14 (LCD_D14) / HSYNC**	X	LCD_DATA14	X	LCD_DATA14
LCD_DATA13 (LCD_D13) / LCD_DOTCLK**	X	LCD_DATA13	X	LCD_DATA13
LCD_DATA12 (LCD_D12) / ENABLE**	X	LCD_DATA12	X	LCD_DATA12
LCD_DATA11 (LCD_D11)	X	LCD_DATA11	X	LCD_DATA11
LCD_DATA10 (LCD_D10)	X	LCD_DATA10	X	LCD_DATA10
LCD_DATA09 (LCD_D9)	X	LCD_DATA09	X	LCD_DATA09

Table continues on the next page...

Table 34-4. Pin use in VSYNC Mode (continued)

PIN NAME	8-bit VSYNC LCD IF	16-bit VSYNC LCD IF	18-bit VSYNC LCD IF	24-bit VSYNC LCD IF
LCD_DATA08 (LCD_D8)	X	LCD_DATA08	X	LCD_DATA08
LCD_DATA07 (LCD_D7)	LCD_DATA07	LCD_DATA07	LCD_DATA07	LCD_DATA07
LCD_DATA06 (LCD_D6)	LCD_DATA06	LCD_DATA06	LCD_DATA06	LCD_DATA06
LCD_DATA05 (LCD_D5)	LCD_DATA05	LCD_DATA05	LCD_DATA05	LCD_DATA05
LCD_DATA04 (LCD_D4)	LCD_DATA04	LCD_DATA04	LCD_DATA04	LCD_DATA04
LCD_DATA03 (LCD_D3)	LCD_DATA03	LCD_DATA03	LCD_DATA03	LCD_DATA03
LCD_DATA02 (LCD_D2)	LCD_DATA02	LCD_DATA02	LCD_DATA02	LCD_DATA02
LCD_DATA01 (LCD_D1)	LCD_DATA01	LCD_DATA01	LCD_DATA01	LCD_DATA01
LCD_DATA00 (LCD_D0)	LCD_DATA00	LCD_DATA00	LCD_DATA00	LCD_DATA00
LCD_RESET	LCD_RESET	LCD_RESET	LCD_RESET	LCD_RESET
LCD_BUSY / LCD_VSYNC	LCD_BUSY (OR optional LCD_VSYNC)	LCD_BUSY (OR optional LCD_VSYNC)	LCD_BUSY (OR optional LCD_VSYNC)	LCD_BUSY (OR optional LCD_VSYNC)

Table 34-5. Pin use in DOTCLK Mode

PIN NAME	8-bit DOTCLK LCD IF	16-bit DOTCLK LCD IF	18-bit DOTCLK LCD IF	24-bit DOTCLK LCD IF
LCD_VSYNC	LCD_VSYNC	LCD_VSYNC	LCD_VSYNC	LCD_VSYNC
LCD_HSYNC	LCD_HSYNC	LCD_HSYNC	LCD_HSYNC	LCD_HSYNC
LCD_DOTCLK	LCD_DOTCLK	LCD_DOTCLK	LCD_DOTCLK	LCD_DOTCLK
LCD_ENABLE	LCD_ENABLE	LCD_ENABLE	LCD_ENABLE	LCD_ENABLE
LCD_DATA23 (LCD_D23)	X	X	X	LCD_DATA23
LCD_DATA22 (LCD_D22)	X	X	X	LCD_DATA22
LCD_DATA21 (LCD_D21)	X	X	X	LCD_DATA21
LCD_DATA20 (LCD_D20)	X	X	X	LCD_DATA20
LCD_DATA19 (LCD_D19)	X	X	X	LCD_DATA19
LCD_DATA18 (LCD_D18)	X	X	X	LCD_DATA18
LCD_DATA17 (LCD_D17)	X	X	LCD_DATA17	LCD_DATA17
LCD_DATA16 (LCD_D16)	X	X	LCD_DATA16	LCD_DATA16
LCD_DATA15 (LCD_D15)	X	LCD_DATA15	LCD_DATA15	LCD_DATA15

Table continues on the next page...

Table 34-5. Pin use in DOTCLK Mode (continued)

PIN NAME	8-bit DOTCLK LCD IF	16-bit DOTCLK LCD IF	18-bit DOTCLK LCD IF	24-bit DOTCLK LCD IF
LCD_DATA14 (LCD_D14)	X	LCD_DATA14	LCD_DATA14	LCD_DATA14
LCD_DATA13 (LCD_D13)	X	LCD_DATA13	LCD_DATA13	LCD_DATA13
LCD_DATA12 (LCD_D12)	X	LCD_DATA12	LCD_DATA12	LCD_DATA12
LCD_DATA11 (LCD_D11)	X	LCD_DATA11	LCD_DATA11	LCD_DATA11
LCD_DATA10 (LCD_D10)	X	LCD_DATA10	LCD_DATA10	LCD_DATA10
LCD_DATA09 (LCD_D9)	X	LCD_DATA09	LCD_DATA09	LCD_DATA09
LCD_DATA08 (LCD_D8)	X	LCD_DATA08	LCD_DATA08	LCD_DATA08
LCD_DATA07 (LCD_D7)	LCD_DATA07	LCD_DATA07	LCD_DATA07	LCD_DATA07
LCD_DATA06 (LCD_D6)	LCD_DATA06	LCD_DATA06	LCD_DATA06	LCD_DATA06
LCD_DATA05 (LCD_D5)	LCD_DATA05	LCD_DATA05	LCD_DATA05	LCD_DATA05
LCD_DATA04 (LCD_D4)	LCD_DATA04	LCD_DATA04	LCD_DATA04	LCD_DATA04
LCD_DATA03 (LCD_D3)	LCD_DATA03	LCD_DATA03	LCD_DATA03	LCD_DATA03
LCD_DATA02 (LCD_D2)	LCD_DATA02	LCD_DATA02	LCD_DATA02	LCD_DATA02
LCD_DATA01 (LCD_D1)	LCD_DATA01	LCD_DATA01	LCD_DATA01	LCD_DATA01
LCD_DATA00 (LCD_D0)	LCD_DATA00	LCD_DATA00	LCD_DATA00	LCD_DATA00
LCD_RESET	LCD_RESET	LCD_RESET	LCD_RESET	LCD_RESET
LCD_BUSY / LCD_VSYNC	LCD_BUSY (OR optional LCD_VSYNC)	LCD_BUSY (OR optional LCD_VSYNC)	LCD_BUSY (OR optional LCD_VSYNC)	LCD_BUSY (OR optional LCD_VSYNC)

Table 34-6. Pin use in DVI Mode

PIN NAME	8-bit DVI LCD IF
LCD_RS	CCIR_CLK
LCD_CS	X
LCD_WR_RWn	X

Table continues on the next page...

Table 34-6. Pin use in DVI Mode (continued)

PIN NAME	8-bit DVI LCD IF
LCD_RD_E	X
LCD_VSYNC* (Two options)	X
LCD_HSYNC	X
LCD_DOTCLK	X
LCD_ENABLE	X
LCD_DATA23 (LCD_D23)	X
LCD_DATA22 (LCD_D22)	X
LCD_DATA21 (LCD_D21)	X
LCD_DATA20 (LCD_D20)	X
LCD_DATA19 (LCD_D19)	X
LCD_DATA18 (LCD_D18)	X
LCD_DATA17 (LCD_D17)	X
LCD_DATA16 (LCD_D16)	X
LCD_DATA15 (LCD_D15) / VSYNC*	X
LCD_DATA14 (LCD_D14) / HSYNC**	X
LCD_DATA13 (LCD_D13) / LCD_DOTCLK**	X
LCD_DATA12 (LCD_D12) / ENABLE**	X
LCD_DATA11 (LCD_D11)	X
LCD_DATA10 (LCD_D10)	X
LCD_DATA09 (LCD_D9)	X
LCD_DATA08 (LCD_D8)	X
LCD_DATA07 (LCD_D7)	LCD_DATA07
LCD_DATA06 (LCD_D6)	LCD_DATA06
LCD_DATA05 (LCD_D5)	LCD_DATA05
LCD_DATA04 (LCD_D4)	LCD_DATA04
LCD_DATA03 (LCD_D3)	LCD_DATA03
LCD_DATA02 (LCD_D2)	LCD_DATA02
LCD_DATA01 (LCD_D1)	LCD_DATA01
LCD_DATA00 (LCD_D0)	LCD_DATA00
LCD_RESET	X
LCD_BUSY / LCD_VSYNC	X

34.5 Behavior During Reset

BUS CLOCK (apb_clk) and DISPLAY CLOCK (pix_clk) must be running before making any changes to SFTRST or CLKGATE bits.

A soft reset (SFTRST) can take multiple clock periods to complete, so do not set CLKGATE when setting SFTRST.

The reset process gates the clocks automatically.

34.6 eLCDIF Memory Map/Register Definition

Some of the LCDIF registers (XXX_SET, XXX_CLR, and XXX_TOG) allow direct bit field masking and access.

- When writing 1 to XXX_SET bit fields, these registers allow setting the masked 1 bit fields, while keeping unchanged all bit fields which remain on 0 logic state.
- When writing 1 to XXX_CLR bit fields, these registers allow clearing the masked 1 bit fields, while keeping unchanged all other bit fields which remained on 0 logic state.
- When writing 1 to XXX_TOG bit fields, these registers allow inverting the logic state of all masked 1 bit fields, while they keep unchanged the remaining bit fields which were kept on 0 logic state.

eLCDIF Hardware Register Format Summary

LCDIF memory map

Absolute address (hex)	Register name	Width (in bits)	Access	Reset value	Section/page
21C_8000	eLCDIF General Control Register (LCDIF_CTRL)	32	R/W	C000_0000h	34.6.1/2168
21C_8004	eLCDIF General Control Register (LCDIF_CTRL_SET)	32	R/W	C000_0000h	34.6.1/2168
21C_8008	eLCDIF General Control Register (LCDIF_CTRL_CLR)	32	R/W	C000_0000h	34.6.1/2168
21C_800C	eLCDIF General Control Register (LCDIF_CTRL_TOG)	32	R/W	C000_0000h	34.6.1/2168
21C_8010	eLCDIF General Control1 Register (LCDIF_CTRL1)	32	R/W	000F_0000h	34.6.2/2171
21C_8014	eLCDIF General Control1 Register (LCDIF_CTRL1_SET)	32	R/W	000F_0000h	34.6.2/2171
21C_8018	eLCDIF General Control1 Register (LCDIF_CTRL1_CLR)	32	R/W	000F_0000h	34.6.2/2171
21C_801C	eLCDIF General Control1 Register (LCDIF_CTRL1_TOG)	32	R/W	000F_0000h	34.6.2/2171

Table continues on the next page...

LCDIF memory map (continued)

Absolute address (hex)	Register name	Width (in bits)	Access	Reset value	Section/page
21C_8020	eLCDIF General Control2 Register (LCDIF_CTRL2)	32	R/W	0020_0000h	34.6.3/2173
21C_8024	eLCDIF General Control2 Register (LCDIF_CTRL2_SET)	32	R/W	0020_0000h	34.6.3/2173
21C_8028	eLCDIF General Control2 Register (LCDIF_CTRL2_CLR)	32	R/W	0020_0000h	34.6.3/2173
21C_802C	eLCDIF General Control2 Register (LCDIF_CTRL2_TOG)	32	R/W	0020_0000h	34.6.3/2173
21C_8030	eLCDIF Horizontal and Vertical Valid Data Count Register (LCDIF_TRANSFER_COUNT)	32	R/W	0001_0000h	34.6.4/2176
21C_8040	LCD Interface Current Buffer Address Register (LCDIF_CUR_BUF)	32	R/W	0000_0000h	34.6.5/2176
21C_8050	LCD Interface Next Buffer Address Register (LCDIF_NEXT_BUF)	32	R/W	0000_0000h	34.6.6/2177
21C_8060	LCD Interface Timing Register (LCDIF_TIMING)	32	R/W	0000_0000h	34.6.7/2177
21C_8070	eLCDIF VSYNC Mode and Dotclk Mode Control Register0 (LCDIF_VDCTRL0)	32	R/W	0000_0000h	34.6.8/2178
21C_8074	eLCDIF VSYNC Mode and Dotclk Mode Control Register0 (LCDIF_VDCTRL0_SET)	32	R/W	0000_0000h	34.6.8/2178
21C_8078	eLCDIF VSYNC Mode and Dotclk Mode Control Register0 (LCDIF_VDCTRL0_CLR)	32	R/W	0000_0000h	34.6.8/2178
21C_807C	eLCDIF VSYNC Mode and Dotclk Mode Control Register0 (LCDIF_VDCTRL0_TOG)	32	R/W	0000_0000h	34.6.8/2178
21C_8080	eLCDIF VSYNC Mode and Dotclk Mode Control Register1 (LCDIF_VDCTRL1)	32	R/W	0000_0000h	34.6.9/2180
21C_8090	LCDIF VSYNC Mode and Dotclk Mode Control Register2 (LCDIF_VDCTRL2)	32	R/W	0000_0000h	34.6.10/2180
21C_80A0	eLCDIF VSYNC Mode and Dotclk Mode Control Register3 (LCDIF_VDCTRL3)	32	R/W	0000_0000h	34.6.11/2181
21C_80B0	eLCDIF VSYNC Mode and Dotclk Mode Control Register4 (LCDIF_VDCTRL4)	32	R/W	0000_0000h	34.6.12/2182
21C_80C0	Digital Video Interface Control0 Register (LCDIF_DVICTRL0)	32	R/W	0000_0000h	34.6.13/2183
21C_80D0	Digital Video Interface Control1 Register (LCDIF_DVICTRL1)	32	R/W	0000_0000h	34.6.14/2183
21C_80E0	Digital Video Interface Control2 Register (LCDIF_DVICTRL2)	32	R/W	0000_0000h	34.6.15/2184
21C_80F0	Digital Video Interface Control3 Register (LCDIF_DVICTRL3)	32	R/W	0000_0000h	34.6.16/2185
21C_8100	Digital Video Interface Control4 Register (LCDIF_DVICTRL4)	32	R/W	0000_0000h	34.6.17/2186
21C_8110	RGB to YCbCr 4:2:2 CSC Coefficient0 Register (LCDIF_CSC_COEFF0)	32	R/W	0000_0000h	34.6.18/2187
21C_8120	RGB to YCbCr 4:2:2 CSC Coefficient1 Register (LCDIF_CSC_COEFF1)	32	R/W	0000_0000h	34.6.19/2188
21C_8130	RGB to YCbCr 4:2:2 CSC Coefficient2 Register (LCDIF_CSC_COEFF2)	32	R/W	0000_0000h	34.6.20/2189

Table continues on the next page...

LCDIF memory map (continued)

Absolute address (hex)	Register name	Width (in bits)	Access	Reset value	Section/page
21C_8140	RGB to YCbCr 4:2:2 CSC Coefficient3 Register (LCDIF_CSC_COEFF3)	32	R/W	0000_0000h	34.6.21/2189
21C_8150	RGB to YCbCr 4:2:2 CSC Coefficient4 Register (LCDIF_CSC_COEFF4)	32	R/W	0000_0000h	34.6.22/2190
21C_8160	RGB to YCbCr 4:2:2 CSC Offset Register (LCDIF_CSC_OFFSET)	32	R/W	0080_0010h	34.6.23/2191
21C_8170	RGB to YCbCr 4:2:2 CSC Limit Register (LCDIF_CSC_LIMIT)	32	R/W	00FF_00FFh	34.6.24/2191
21C_8180	LCD Interface Data Register (LCDIF_DATA)	32	R/W	0000_0000h	34.6.25/2192
21C_8190	Bus Master Error Status Register (LCDIF_BM_ERROR_STAT)	32	R/W	0000_0000h	34.6.26/2193
21C_81A0	CRC Status Register (LCDIF_CRC_STAT)	32	R/W	0000_0000h	34.6.27/2193
21C_81B0	LCD Interface Status Register (LCDIF_STAT)	32	R	9500_0000h	34.6.28/2194
21C_8200	eLCDIF Threshold Register (LCDIF_THRES)	32	R/W	0100_000Fh	34.6.29/2196
21C_8210	eLCDIF AS Buffer Control Register (LCDIF_AS_CTRL)	32	R/W	0000_0000h	34.6.30/2197
21C_8220	Alpha Surface Buffer Pointer (LCDIF_AS_BUF)	32	R/W	0000_0000h	34.6.31/2199
21C_8230	LCDIF_AS_NEXT_BUF	32	R/W	0000_0000h	34.6.32/2200
21C_8240	eLCDIF Overlay Color Key Low (LCDIF_AS_CLRKEYLOW)	32	R/W	00FF_FFFFh	34.6.33/2200
21C_8250	eLCDIF Overlay Color Key High (LCDIF_AS_CLRKEYHIGH)	32	R/W	0000_0000h	34.6.34/2201
21C_8260	LCD working insync mode with CSI for VSYNC delay (LCDIF_SYNC_DELAY)	32	R/W	0000_0000h	34.6.35/2201

34.6.1 eLCDIF General Control Register (LCDIF_CTRLn)

The LCD Interface Control Register provides overall control of the eLCDIF block. The eLCDIF Control Register provides a variety of control functions to the programmer. These functions allow the interface to be very flexible to work with a variety of LCD controllers, and to minimize overhead and increase performance of LCD programming. The register has been organized such that switching between the different LCD modes can be done with minimum PIO writes.

Address: 21C_8000h base + 0h offset + (4d × i), where i=0d to 3d

Bit	31	30	29	28	27	26	25	24	23	22	21	20	19	18	17	16	
R							SHIFT_NUM_BITS										
W	SFTRST	CLKGATE	YBCR422_INPUT	READ_WRITEB	WAIT_FOR_VSYNC_EDGE	DATA_SHIFT_DIR						DVI_MODE	BYPASS_COUNT	VSYNC_MODE	DOTCLK_MODE	DATA_SELECT	
Reset	1	1	0	0	0	0	0	0	0	0	0	0	0	0	0	0	
Bit	15	14	13	12	11	10	9	8	7	6	5	4	3	2	1	0	
R	INPUT_DATA_SWIZZLE		CSC_DATA_SWIZZLE		LCD_DATABUS_WIDTH		WORD_LENGTH		RGB_TO_YBCR422_CSC		ENABLE_PXP_HANDSHAKE	MASTER	Reserved	DATA_FORMAT_16_BIT	DATA_FORMAT_18_BIT	DATA_FORMAT_24_BIT	RUN
W																	
Reset	0	0	0	0	0	0	0	0	0	0	0	0	0	0	0	0	0

LCDIF_CTRLn field descriptions

Field	Description
31 SFTRST	This bit must be set to zero to enable normal operation of the eLCDIF. When set to one, it forces a block level reset.
30 CLKGATE	This bit must be set to zero for normal operation. When set to one it gates off the clocks to the block.
29 YBCR422_INPUT	Zero implies input data is in RGB color space. One implies input data is in YCbCr 4:2:2 format, such that YCbCr are packed in a 32-bit word. It also means that there are 2 pixels in 4 bytes. If this bit is set, software should program the H_COUNT field in the TRANSFER_COUNT register to the total number of pixels that will have to be fetched by the eLCDIF block per line and the BYTE_PACKING_FORMAT should be 0xF. The WORD_LENGTH does not matter in this case.

Table continues on the next page...

LCDIF_CTRLn field descriptions (continued)

Field	Description
28 READ_WRITEB	By default, eLCDIF is in the write mode. Setting this bit to 1 will make the hardware go into 6800/8080 MPU read mode. The LCDIF_MASTER bit must be 0, since bus master mode can only be used for writing the display.
27 WAIT_FOR_VSYNC_EDGE	Setting this bit to 1 will make the hardware wait for the triggering VSYNC edge before starting write transfers to the LCD. Used only in the VSYNC mode of operation.
26 DATA_SHIFT_DIR	Use this bit to determine the direction of shift of transmit data. In the DVI mode, it works only on the active data, not on the timing codes and ancillary data. 0x0 TXDATA_SHIFT_LEFT — Data to be transmitted is shifted LEFT by SHIFT_NUM_BITS bits. 0x1 TXDATA_SHIFT_RIGHT — Data to be transmitted is shifted RIGHT by SHIFT_NUM_BITS bits.
25–21 SHIFT_NUM_BITS	The data to be transmitted is shifted left or right by this number of bits.
20 DVI_MODE	Set this bit to 1 to get into the ITU-R BT.656 digital video interface mode. Toggle this bit from 1 to 0 to make the hardware go out of DVI mode after completing all data transfer and after the RUN bit has been deasserted.
19 BYPASS_COUNT	When this bit is 0, it means that eLCDIF will stop the block operation and turn off the RUN bit after the amount of data indicated by the LCDIF_TRANSFER_COUNT register has been transferred out. When this bit is set to 1, the block will continue normal operation indefinitely until it is told to stop. This bit must be 0 in MPU and VSYNC modes, and must be 1 in DOTCLK and DVI modes of operation.
18 VSYNC_MODE	Setting this bit to 1 will make the eLCDIF hardware go into VSYNC mode. WAIT_FOR_VSYNC_EDGE can be used only if this bit is set. If VSYNC signal is required to be an output from the block, SYNC_SIGNALS_ON bit in LCDIF_VDCTRL4 register must be set.
17 DOTCLK_MODE	Set this bit to 1 to make the hardware go into the DOTCLK mode, i.e. VSYNC/HSYNC/DOTCLK/ENABLE interface mode. ENABLE is optional, selected by the ENABLE_PRESENT bit. Toggle this bit from 1 to 0 to make the hardware go out of DOTCLK mode after completing all data transfer and deasserting the RUN bit.
16 DATA_SELECT	Command Mode polarity bit. This bit should only be changed when RUN is 0. 0x0 CMD_MODE — Command Mode. LCD_RS signal is Low. 0x1 DATA_MODE — Data Mode. LCD_RS signal is High.
15–14 INPUT_DATA_SWIZZLE	This field specifies how to swap the bytes fetched by the bus master interface. The swizzle function is independent of the WORD_LENGTH bit. The supported swizzle configurations are: 0x0 NO_SWAP — No byte swapping.(Little endian) 0x0 LITTLE_ENDIAN — Little Endian byte ordering (same as NO_SWAP). 0x1 BIG_ENDIAN_SWAP — Big Endian swap (swap bytes 0,3 and 1,2). 0x1 SWAP_ALL_BYTES — Swizzle all bytes, swap bytes 0,3 and 1,2 (aka Big Endian). 0x2 HWD_SWAP — Swap half-words. 0x3 HWD_BYTE_SWAP — Swap bytes within each half-word.
13–12 CSC_DATA_SWIZZLE	This field specifies how to swap the bytes after the data has been converted into an internal representation of 24 bits per pixel and before it is transmitted over the LCD interface bus. The data is always transmitted with the least significant byte/hword (half word) first after the swizzle takes place. So, INPUT_DATA_SWIZZLE takes place first on the incoming data, and then CSC_DATA_SWIZZLE is applied. The swizzle function is independent of the WORD_LENGTH or the LCD_DATABUS_WIDTH fields. If RGB_TO_YCRCB422_CSC bit is set, the swizzle occurs on the Y, Cb, Cr values. The supported swizzle configurations are: 0x0 NO_SWAP — No byte swapping.(Little endian)

Table continues on the next page...

LCDIF_CTRLn field descriptions (continued)

Field	Description
	0x0 LITTLE_ENDIAN — Little Endian byte ordering (same as NO_SWAP). 0x1 BIG_ENDIAN_SWAP — Big Endian swap (swap bytes 0,3 and 1,2). 0x1 SWAP_ALL_BYTES — Swizzle all bytes, swap bytes 0,3 and 1,2 (aka Big Endian). 0x2 HWD_SWAP — Swap half-words. 0x3 HWD_BYTE_SWAP — Swap bytes within each half-word.
11–10 LCD_DATABUS_WIDTH	LCD Data bus transfer width. 0x0 16_BIT — 16-bit data bus mode. 0x1 8_BIT — 8-bit data bus mode. 0x2 18_BIT — 18-bit data bus mode. 0x3 24_BIT — 24-bit data bus mode.
9–8 WORD_LENGTH	Input data format. 0x0 16_BIT — Input data is 16 bits per pixel. 0x1 8_BIT — Input data is 8 bits wide. 0x2 18_BIT — Input data is 18 bits per pixel. 0x3 24_BIT — Input data is 24 bits per pixel.
7 RGB_TO_YCBCR422_CSC	Set this bit to 1 to enable conversion from RGB to YCbCr colorspace. See the LCDIF_CSC_ registers for further details.
6 ENABLE_PXP_HANDSHAKE	If this bit is set and LCDIF_MASTER bit is set, the eLCDIF will act as bus master and the handshake mechanism between eLCDIF and PXP will be turned on. If LCDIF_MASTER bit is not set, this bit becomes a don't care.
5 MASTER	Set this bit to make the eLCDIF act as a bus master.
4 RSRVD0	This field is reserved. Reserved bits. Write as 0.
3 DATA_FORMAT_16_BIT	When this bit is 1 and WORD_LENGTH = 0, it implies that the 16-bit data is in ARGB555 format. When this bit is 0 and WORD_LENGTH = 0, it implies that the 16-bit data is in RGB565 format. When WORD_LENGTH is not 0, this bit does not care.
2 DATA_FORMAT_18_BIT	Used only when WORD_LENGTH = 2, i.e. 18-bit. 0x0 LOWER_18_BITS_VALID — Data input to the block is in 18 bpp format, such that lower 18 bits contain RGB 666 and upper 14 bits do not contain any useful data. 0x1 UPPER_18_BITS_VALID — Data input to the block is in 18 bpp format, such that upper 18 bits contain RGB 666 and lower 14 bits do not contain any useful data.
1 DATA_FORMAT_24_BIT	Used only when WORD_LENGTH = 3, i.e. 24-bit. Note that this applies to both packed and unpacked 24-bit data. 0x0 ALL_24_BITS_VALID — Data input to the block is in 24 bpp format, such that all RGB 888 data is contained in 24 bits. 0x1 DROP_UPPER_2_BITS_PER_BYTE — Data input to the block is actually RGB 18 bpp, but there is 1 color per byte, hence the upper 2 bits in each byte do not contain any useful data, and should be dropped.
0 RUN	When this bit is set by software, the eLCDIF will begin transferring data between the SoC and the display. This bit must remain set until the operation is complete.

34.6.2 eLCDIF General Control1 Register (LCDIF_CTRL1n)

The eLCDIF Control Register provides overall control of the eLCDIF block.

The eLCDIF Control1 Register provides additional programming to the eLCDIF. It implements some bits which are unlikely to change often in a particular application. It also carries interrupt-related bits which are common across more than one mode of operation.

Address: 21C_8000h base + 10h offset + (4d × i), where i=0d to 3d

Bit	31	30	29	28	27	26	25	24	23	22	21	20	19	18	17	16	
R	Reserved			Reserved			COMBINE_MPU_WR_STRB	BM_ERROR_IRQ_EN	BM_ERROR_IRQ	RECOVER_ON_UNDERFLOW	INTERLACE_FIELDS	START_INTERLACE_FROM_SECOND_FIELD	FIFO_CLEAR	IRQ_ON_ALTERNATE_FIELDS	BYTE_PACKING_FORMAT		
W	Reserved			Reserved			COMBINE_MPU_WR_STRB	BM_ERROR_IRQ_EN	BM_ERROR_IRQ	RECOVER_ON_UNDERFLOW	INTERLACE_FIELDS	START_INTERLACE_FROM_SECOND_FIELD	FIFO_CLEAR	IRQ_ON_ALTERNATE_FIELDS	BYTE_PACKING_FORMAT		
Reset	0	0	0	0	0	0	0	0	0	0	0	0	1	1	1	1	
Bit	15	14	13	12	11	10	9	8	7	6	5	4	3	2	1	0	
R	OVERFLOW_IRQ_EN	UNDERFLOW_IRQ_EN	CUR_FRAME_DONE_IRQ_EN	VSYNC_EDGE_IRQ_EN	OVERFLOW_IRQ	UNDERFLOW_IRQ	CUR_FRAME_DONE_IRQ	VSYNC_EDGE_IRQ	Reserved					BUSY_ENABLE	MODE86	RESET	
W	OVERFLOW_IRQ_EN	UNDERFLOW_IRQ_EN	CUR_FRAME_DONE_IRQ_EN	VSYNC_EDGE_IRQ_EN	OVERFLOW_IRQ	UNDERFLOW_IRQ	CUR_FRAME_DONE_IRQ	VSYNC_EDGE_IRQ	Reserved					BUSY_ENABLE	MODE86	RESET	
Reset	0	0	0	0	0	0	0	0	0	0	0	0	0	0	0	0	

LCDIF_CTRL1n field descriptions

Field	Description
31 -	This field is reserved. Reserved bits. Write as 0.
30 -	This field is reserved. Reserved bits. Write as 0.
29–28 -	This field is reserved. Reserved bits. Write as 0.
27 COMBINE_MPU_WR_STRB	If this bit is not set, the write strobe will be driven on LCD_WR_RWn pin in the 8080 mode and on the LCD_RD_E pin in the 6800 mode. If it is set, the write strobe of both the 6800 and 8080 modes will be driven only on the LCD_WR_RWn pin. Note that this does not work for read strobe.

Table continues on the next page...

LCDIF_CTRL1n field descriptions (continued)

Field	Description
26 BM_ERROR_ IRQ_EN	This bit is set to enable bus master error interrupt in the eLCDIF master mode.
25 BM_ERROR_ IRQ	This bit is set to indicate that an interrupt is requested by the eLCDIF block. This bit is cleared by software by writing a one to its SCT clear address. This bit will be set when the eLCDIF is in master mode and an error response was returned by the slave. 0x0 NO_REQUEST — No Interrupt Request Pending. 0x1 REQUEST — Interrupt Request Pending.
24 RECOVER_ON_ UNDERFLOW	Set this bit to enable the eLCDIF block to recover in the next field/frame if there was an underflow in the current field/frame.
23 INTERLACE_ FIELDS	Set this bit if it is required that the eLCDIF block fetches odd lines in one field and even lines in the other field. It will work only in LCDIF_MASTER is set to 1.
22 START_ INTERLACE_ FROM_ SECOND_FIELD	The default is to grab the odd lines first and then the even lines. Set this bit if it is required to grab the even lines first and then the odd lines. (Line numbers start from 1, so odd lines are 1,3,5,etc. and even lines are 2,4,6, etc.)
21 FIFO_CLEAR	Set this bit to clear all the data in the latency FIFO (LFIFO), TXFIFO and the RXFIFO.
20 IRQ_ON_ ALTERNATE_ FIELDS	If this bit is set, the eLCDIF block will assert the cur_frame_done interrupt only on alternate fields, otherwise it will issue the interrupt on both odd and even field. This bit is mostly relevant if INTERLACE_FIELDS is set.
19–16 BYTE_ PACKING_ FORMAT	This bitfield is used to show which data bytes in a 32-bit word are valid. Default value 0xf indicates that all bytes are valid. For 8-bit transfers, any combination in this bitfield will mean valid data is present in the corresponding bytes. In the 16-bit mode, a 16-bit half-word is valid only if adjacent bits [1:0] or [3:2] or both are 1. A value of 0x0 will mean that none of the bytes are valid and should not be used. For example, set the bit field value to 0x7 if the display data is arranged in the 24-bit unpacked format (A-R-G-B where A value does not have to be transmitted). When input data is in YCbCr 4:2:2 format (YCBCR422_INPUT is 1), H_COUNT should be the number of pixels that should be fetched by the block and the BYTE_PACKING_FORMAT should be 0xF. (Note - YCBCR422_INPUT = 1 implies 2 pixels per 32 bits).
15 OVERFLOW_ IRQ_EN	This bit is set to enable an overflow interrupt in the TXFIFO in the write mode.
14 UNDERFLOW_ IRQ_EN	This bit is set to enable an underflow interrupt in the TXFIFO in the write mode.
13 CUR_FRAME_ DONE_IRQ_EN	This bit is set to 1 enable an interrupt every time the hardware enters in the vertical blanking state.
12 VSYNC_EDGE_ IRQ_EN	This bit is set to enable an interrupt every time the hardware encounters the leading VSYNC edge in the VSYNC and DOTCLK modes, or the beginning of every field in DVI mode.
11 OVERFLOW_ IRQ	This bit is set to indicate that an interrupt is requested by the eLCDIF block. This bit is cleared by software by writing a one to its SCT clear address. A latency FIFO (LFIFO) overflow in the write mode (MPU/VSYNC/DOTCLK/DVI mode) was detected, data samples have been lost.

Table continues on the next page...

LCDIF_CTRL1n field descriptions (continued)

Field	Description
	0x0 NO_REQUEST — No Interrupt Request Pending. 0x1 REQUEST — Interrupt Request Pending.
10 UNDERFLOW_ IRQ	This bit is set to indicate that an interrupt is requested by the eLCDIF block. This bit is cleared by software by writing a one to its SCT clear address. A TXFIFO underflow in the write mode (MPU/VSYNC/DOTCLK/DVI mode) was detected. Could produce an error in the DOTCLK / DVI modes. 0x0 NO_REQUEST — No Interrupt Request Pending. 0x1 REQUEST — Interrupt Request Pending.
9 CUR_FRAME_ DONE_IRQ	This bit is set to indicate that an interrupt is requested by the eLCDIF block. This bit is cleared by software by writing a one to its SCT clear address. It indicates that the hardware has completed transmitting the current frame and is in the vertical blanking period in the DOTCLK/DVI modes. In the MPU and VSYNC modes, this IRQ is asserted at the end of the data transfer indicated by LCDIF_TRANSFER_COUNT register. 0x0 NO_REQUEST — No Interrupt Request Pending. 0x1 REQUEST — Interrupt Request Pending.
8 VSYNC_EDGE_ IRQ	This bit is set to indicate that an interrupt is requested by the eLCDIF block. This bit is cleared by software by writing a one to its SCT clear address. It is set whenever the leading VSYNC edge is detected in the VSYNC and DOTCLK modes. In the DVI mode, it is asserted every time the block enters a new field. 0x0 NO_REQUEST — No Interrupt Request Pending. 0x1 REQUEST — Interrupt Request Pending.
7–3 RSRVD0	This field is reserved. Reserved bits. Write as 0.
2 BUSY_ENABLE	This bit enables the use of the interface's busy signal input. This should be enabled for LCD controllers that implement a busy line (to stall the eLCDIF from sending more data until ready). Otherwise this bit should be cleared. 0x0 BUSY_DISABLED — The busy signal from the LCD controller will be ignored. 0x1 BUSY_ENABLED — Enable the use of the busy signal from the LCD controller.
1 MODE86	This bit is used to select between the 8080 and 6800 series of microprocessor modes. This bit should only be changed when RUN is 0. 0x0 8080_MODE — Pins LCD_WR_RWn and LCD_RD_E function as active low WR and active low RD signals respectively. 0x1 6800_MODE — Pins LCD_WR_RWn and LCD_RD_E function as Read/Write and active high Enable signals respectively.
0 RESET	Reset bit for the external LCD controller. This bit can be changed at any time. It CANNOT be reset by SFTRST. 0x0 LCDRESET_LOW — LCD_RESET output signal is low. 0x1 LCDRESET_HIGH — LCD_RESET output signal is high.

34.6.3 eLCDIF General Control2 Register (LCDIF_CTRL2n)

The eLCDIF Control Register provides overall control of the eLCDIF block.

The eLCDIF Control2 Register provides additional programming to the eLCDIF. It implements some bits which are unlikely to change often in a particular application.

eLCDIF Memory Map/Register Definition

Address: 21C_8000h base + 20h offset + (4d × i), where i=0d to 3d

Bit	31	30	29	28	27	26	25	24	23	22	21	20	19	18	17	16	
R	Reserved								OUTSTANDING_ REQS			BURST_LEN_8	Reserved	ODD_LINE_ PATTERN			
W																	
Reset	0	0	0	0	0	0	0	0	0	0	1	0	0	0	0	0	
Bit	15	14	13	12	11	10	9	8	7	6	5	4	3	2	1	0	
R	Reserved	EVEN_LINE_ PATTERN				Reserved	READ_PACK_DIR	READ_MODE_OUTPUT_ IN_RGB_FORMAT	READ_MODE_6_BIT_ INPUT	Reserved	READ_MODE_ NUM_PACKED_ SUBWORDS			INITIAL_DUMMY_ READ			Reserved
W																	
Reset	0	0	0	0	0	0	0	0	0	0	0	0	0	0	0	0	

LCDIF_CTRL2n field descriptions

Field	Description
31–24 RSRVD5	This field is reserved. Reserved bits. Write as 0.
23–21 OUTSTANDING_ REQS	This bitfield indicates the maximum number of outstanding transactions that eLCDIF should request when it is acting as a bus master. Default is 2 outstanding transactions. 0x0 REQ_1 — 0x1 REQ_2 — 0x2 REQ_4 — 0x3 REQ_8 — 0x4 REQ_16 —
20 BURST_LEN_8	By default, when the eLCDIF is in the bus master mode, it will issue AXI bursts of length 16 (except when in packed 24 bpp mode, it will issue bursts of length 15). When this bit is set to 1, the block will issue bursts of length 8 (except when in packed 24 bpp mode, it will issue bursts of length 9). Note that this bitfield is only applicable when LCDIF_MASTER is set to 1.
19 RSRVD4	This field is reserved. Reserved bits. Write as 0.
18–16 ODD_LINE_ PATTERN	This field determines the order of the RGB components of each pixel in ODD lines (line numbers 1,3,5,...). This bitfield must be 0 in DVI mode. 0x0 RGB — 0x1 RBG — 0x2 GBR — 0x3 GRB —

Table continues on the next page...

LCDIF_CTRL2n field descriptions (continued)

Field	Description
	0x4 BRG — 0x5 BGR —
15 RSRVD3	This field is reserved. Reserved bits. Write as 0.
14–12 EVEN_LINE_ PATTERN	This field determines the order of the RGB components of each pixel in EVEN lines (line numbers 2,4,6,...). This bitfield must be 0 in DVI mode. 0x0 RGB — 0x1 RBG — 0x2 GBR — 0x3 GRB — 0x4 BRG — 0x5 BGR —
11 RSRVD2	This field is reserved. Reserved bits. Write as 0.
10 READ_PACK_DIR	The default value of 0 indicates data is stored in the little endian format. When LCD_DATABUS_WIDTH is 8-bit, this bit provides the option of rearranging the data byte-wise in the big endian format. For example, if READ_MODE_NUM_PACKED_SUBWORDS = 3 and the order of incoming data is 0x11, 0x22 and 0x33, then setting this bit to 1 will cause the data to be stored as 0x00112233 as opposed to the default 0x00332211. This operation occurs after the shifting operation done by SHIFT_NUM_BITS bitfield.
9 READ_MODE_ OUTPUT_IN_ RGB_FORMAT	Setting this bit will enable the eLCDIF to convert the incoming data to the RGB format given by WORD_LENGTH bitfield. This feature is not available when WORD_LENGTH is set to 8 bits. eLCDIF performs this operation of converting to RGB format after the endianness has been determined by the READ_PACK_DIR bitfield.
8 READ_MODE_6_ BIT_INPUT	Setting this bit to 1 indicates to eLCDIF that even though LCD_DATABUS_WIDTH is set to 8 bits, the input data is actually only 6 bits wide and exists on D5-D0.
7 RSRVD1	This field is reserved. Reserved bits. Write as 0.
6–4 READ_MODE_ NUM_PACKED_ SUBWORDS	Indicates the number of valid 8/16/18/24-bit subwords that will be packed into the 32-bit word in read mode. The subword size (8, 16, 18 or 24 bits) is determined by the LCD_DATABUS_WIDTH field. The swizzle operation is performed after READ_MODE_NUM_PACKED_SUBWORDS number of subwords has been received and stored in little-endian format. For example, if LCD_DATABUS_WIDTH is set to 8-bit and data to be read back has to be stored in memory in 24-bit unpacked RGB format, set READ_MODE_NUM_PACKED_SUBWORDS to 0x3 so that each 32-bit word will contain only 3 valid bytes (RGB). Maximum value of READ_MODE_NUM_PACKED_SUBWORDS is 4 for 8-bit databus, 2 for 16-bit databus and 1 for 18/24-bit databus.
3–1 INITIAL_DUMMY_ READ	The value in this field determines the number of dummy 8/16/18/24-bit subwords that have to be read back from the LCD panel/controller. They will then not be stored in the read FIFO.
0 RSRVD0	This field is reserved. Reserved bits. Write as 0.

34.6.4 eLCDIF Horizontal and Vertical Valid Data Count Register (LCDIF_TRANSFER_COUNT)

This register tells the eLCDIF how much data will be sent for this frame, or transaction. The total number of words is a product of the V_COUNT and H_COUNT fields. The word size is specified by the WORD_LENGTH field.

This register gives the dimensions of the input frame. For normal operation, but V_COUNT and H_COUNT should be non-zero.

Address: 21C_8000h base + 30h offset = 21C_8030h

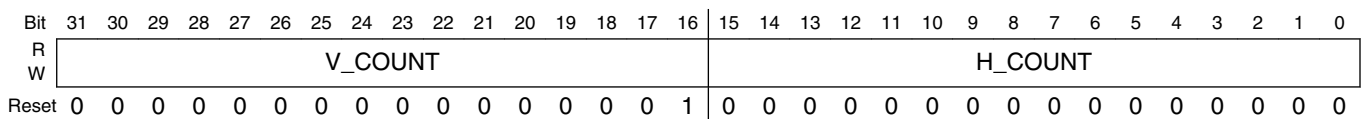

LCDIF_TRANSFER_COUNT field descriptions

Field	Description
31–16 V_COUNT	Number of horizontal lines per frame which contain valid data. In DOTCLK mode, V_COUNT should be the same as the number of active horizontal lines in a progressive frame. In DVI mode, V_COUNT should be the number of active horizontal lines per frame, and not per field.
H_COUNT	Total valid data (pixels) in each horizontal line. The data size is given by the WORD_LENGTH. When input data is in YCbCr 4:2:2 format (YCBCR422_INPUT is 1), H_COUNT should be the number of 32-bit words that should be fetched by the block and the BYTE_PACKING_FORMAT should be 0xF. In 24-bit packed format (WORD_LENGTH=0x3, BYTE_PACKING_FORMAT=0xF), the H_COUNT must be a multiple of 4 pixels. In 16-bit packed format (WORD_LENGTH=0x0, BYTE_PACKING_FORMAT=0xF), the H_COUNT must be a multiple of 2 pixels.

34.6.5 LCD Interface Current Buffer Address Register (LCDIF_CUR_BUF)

This register indicates the address of the current frame being transmitted by eLCDIF.

When the eLCDIF is behaving as a master, this address points to the address of the current frame of data being sent out via the LCDIF. When the current frame is done, the LCDIF block will assert the cur_frame_done interrupt for software to take action. The block will also copy the LCDIF_NEXT_BUF_ADDR into this bitfield so that the software can program the next frame address into the LCDIF_NEXT_BUF_ADDR bitfield. This address must always be double-word aligned.

Address: 21C_8000h base + 40h offset = 21C_8040h

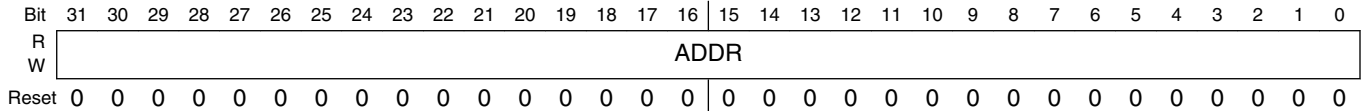

LCDIF_CUR_BUF field descriptions

Field	Description
ADDR	Address of the current frame being transmitted by eLCDIF.

34.6.6 LCD Interface Next Buffer Address Register (LCDIF_NEXT_BUF)

This register indicates the address of next frame that will be transmitted by eLCDIF.

When the eLCDIF is behaving as a master, this address points to the address of the next frame of data that will be sent out via the eLCDIF. It is up to the software to make sure that this register is programmed before the end of the current frame, otherwise it might result in old data going out the eLCDIF. This address must always be double-word aligned.

Address: 21C_8000h base + 50h offset = 21C_8050h

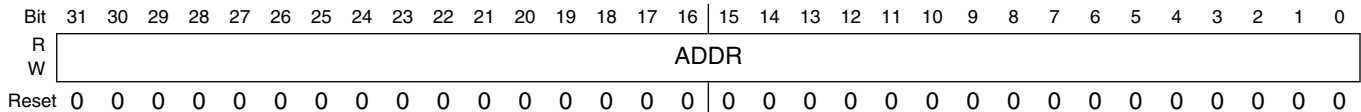

LCDIF_NEXT_BUF field descriptions

Field	Description
ADDR	Address of the next frame that will be transmitted by eLCDIF.

34.6.7 LCD Interface Timing Register (LCDIF_TIMING)

The LCD interface timing register controls the various setup and hold times enforced by the LCD interface in the 6800/8080 MPU and VSYNC modes of operation.

The values used in this register are dependent on the particular LCD controller used, consult the users manual for the particular controller for required timings. Each field of the register must be non-zero, therefore the minimum value is: 0x01010101. NOTE: the timings are not automatically adjusted if the DISPLAY CLOCK (pix_clk) frequency changes—it may be necessary to adjust the timings if DISPLAY CLOCK (pix_clk)

eLCDIF Memory Map/Register Definition

changes. NOTE: Each field in this register must be non-zero for the MPU and VSYNC modes to function. The settings in this register do not affect the DOTCLK and DVI modes.

Address: 21C_8000h base + 60h offset = 21C_8060h

Bit	31	30	29	28	27	26	25	24	23	22	21	20	19	18	17	16	15	14	13	12	11	10	9	8	7	6	5	4	3	2	1	0
R	CMD_HOLD								CMD_SETUP								DATA_HOLD								DATA_SETUP							
W																																
Reset	0	0	0	0	0	0	0	0	0	0	0	0	0	0	0	0	0	0	0	0	0	0	0	0	0	0	0	0	0	0	0	0

LCDIF_TIMING field descriptions

Field	Description
31–24 CMD_HOLD	Number of DISPLAY CLOCK (pix_clk) cycles that the LCD_RS signal is active after LCD_CS is deasserted.
23–16 CMD_SETUP	Number of DISPLAY CLOCK (pix_clk) cycles that the LCD_RS signal is active before LCD_CS is asserted.
15–8 DATA_HOLD	Data bus hold time in DISPLAY CLOCK (pix_clk) cycles. Also the time that the data strobe is deasserted in a cycle
DATA_SETUP	Data bus setup time in DISPLAY CLOCK (pix_clk) cycles. Also the time that the data strobe is asserted in a cycle.

34.6.8 eLCDIF VSYNC Mode and Dotclk Mode Control Register0 (LCDIF_VDCTRL0n)

This register is used to control the VSYNC and DOTCLK modes of the LCDIF so as to work with different types of LCDs like moving picture displays and delta pixel displays.

This register gives general programmability to the VSYNC signal including polarity, direction, pulse width, etc.

Address: 21C_8000h base + 70h offset + (4d × i), where i=0d to 3d

Bit	31	30	29	28	27	26	25	24	23	22	21	20	19	18	17	16
R	Reserved		VSYNC_OEB	ENABLE_PRESENT	VSYNC_POL	HSYNC_POL	DOTCLK_POL	ENABLE_POL	Reserved		VSYNC_PERIOD_UNIT	VSYNC_PULSE_WIDTH_UNIT	HALF_LINE	HALF_LINE_MODE	VSYNC_PULSE_WIDTH	
W																
Reset	0	0	0	0	0	0	0	0	0	0	0	0	0	0	0	0

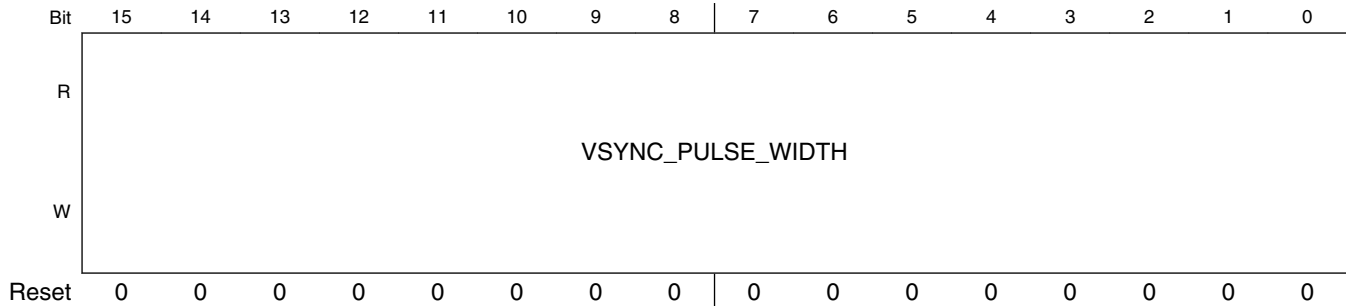

LCDIF_VDCTRL0n field descriptions

Field	Description
31–30 RSRVD2	This field is reserved. Reserved bits. Write as 0.
29 VSYNC_OEB	0 means the VSYNC signal is an output, 1 means it is an input. Should be set to 0 in the DOTCLK mode. 0x0 VSYNC_OUTPUT — The VSYNC pin is in the output mode and the VSYNC signal has to be generated by the eLCDIF block. 0x1 VSYNC_INPUT — The VSYNC pin is in the input mode and the LCD controller sends the VSYNC signal to the block.
28 ENABLE_PRESENT	Setting this bit to 1 will make the hardware generate the ENABLE signal in the DOTCLK mode, thereby making it the true RGB interface along with the remaining three signals VSYNC, HSYNC and DOTCLK.
27 VSYNC_POL	Default 0 active low during VSYNC_PULSE_WIDTH time and will be high during the rest of the VSYNC period. Set it to 1 to invert the polarity.
26 HSYNC_POL	Default 0 active low during HSYNC_PULSE_WIDTH time and will be high during the rest of the HSYNC period. Set it to 1 to invert the polarity.
25 DOTCLK_POL	Default is data launched at negative edge of DOTCLK and captured at positive edge. Set it to 1 to invert the polarity. Set it to 0 in DVI mode.
24 ENABLE_POL	Default 0 active low during valid data transfer on each horizontal line.
23–22 RSRVD1	This field is reserved. Reserved bits. Write as 0.
21 VSYNC_PERIOD_UNIT	Default 0 for counting VSYNC_PERIOD in terms of DISPLAY CLOCK (pix_clk) cycles. Set it to 1 to count in terms of complete horizontal lines. DISPLAY CLOCK (pix_clk) cycles should be used in the VSYNC mode, while horizontal line should be used in the DOTCLK mode.
20 VSYNC_PULSE_WIDTH_UNIT	Default 0 for counting VSYNC_PULSE_WIDTH in terms of DISPLAY CLOCK (pix_clk) cycles. Set it to 1 to count in terms of complete horizontal lines.
19 HALF_LINE	Setting this bit to 1 will make the total VSYNC period equal to the VSYNC_PERIOD field plus half the HORIZONTAL_PERIOD field (i.e. VSYNC_PERIOD field plus half horizontal line), otherwise it is just VSYNC_PERIOD. Should be only used in the DOTCLK mode, not in the VSYNC interface mode.
18 HALF_LINE_MODE	When this bit is 0, the first field (VSYNC period) will end in half a horizontal line and the second field will begin with half a horizontal line. When this bit is 1, all fields will end with half a horizontal line, and none will begin with half a horizontal line.
VSYNC_PULSE_WIDTH	Number of units for which VSYNC signal is active. For the DOTCLK mode, the unit is determined by the VSYNC_PULSE_WIDTH_UNIT. If the VSYNC_PULSE_WIDTH_UNIT is 0 for DOTCLK mode, VSYNC_PULSE_WIDTH must be less than HSYNC_PERIOD. For the VSYNC interface mode, it should be in terms of number of DISPLAY CLOCK (pix_clk) cycles only.

34.6.9 eLCDIF VSYNC Mode and Dotclk Mode Control Register1 (LCDIF_VDCTRL1)

This register is used to control the VSYNC signal in the VSYNC and DOTCLK modes of the block.

This register determines the period and duty cycle of the VSYNC signal when it is generated in the block.

Address: 21C_8000h base + 80h offset = 21C_8080h

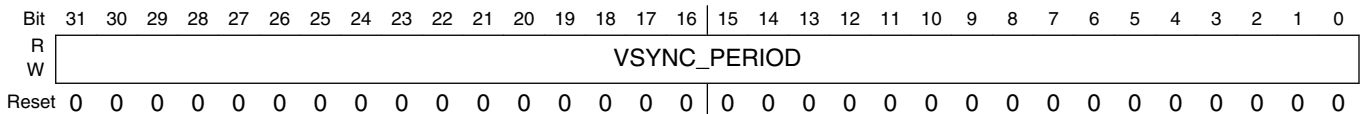

LCDIF_VDCTRL1 field descriptions

Field	Description
VSYNC_PERIOD	Total number of units between two positive or two negative edges of the VSYNC signal. If HALF_LINE is set, it is implicitly calculated to be VSYNC_PERIOD plus half HSYNC_PERIOD.

34.6.10 LCDIF VSYNC Mode and Dotclk Mode Control Register2 (LCDIF_VDCTRL2)

This register is used to control the HSYNC signal in the DOTCLK mode of the block.

This register determines the period and duty cycle of the HSYNC signal when it is generated in the block.

Address: 21C_8000h base + 90h offset = 21C_8090h

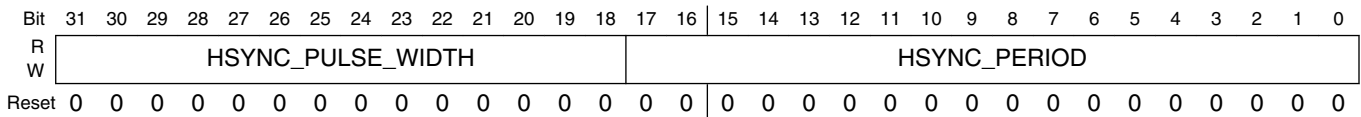

LCDIF_VDCTRL2 field descriptions

Field	Description
31-18 HSYNC_PULSE_WIDTH	Number of DISPLAY CLOCK (pix_clk) cycles for which HSYNC signal is active.
HSYNC_PERIOD	Total number of DISPLAY CLOCK (pix_clk) cycles between two positive or two negative edges of the HSYNC signal.

34.6.11 eLCDIF VSYNC Mode and Dotclk Mode Control Register3 (LCDIF_VDCTRL3)

This register is used to determine the vertical and horizontal wait counts.

This register determines the back porches of HSYNC and VSYNC signals when they are generated by the block.

Address: 21C_8000h base + A0h offset = 21C_80A0h

Bit	31	30	29	28	27	26	25	24	23	22	21	20	19	18	17	16
R	Reserved			MUX_SYNC_SIGNALS	VSYNC_ONLY	HORIZONTAL_WAIT_CNT										
W																
Reset	0	0	0	0	0	0	0	0	0	0	0	0	0	0	0	0
Bit	15	14	13	12	11	10	9	8	7	6	5	4	3	2	1	0
R	VERTICAL_WAIT_CNT															
W																
Reset	0	0	0	0	0	0	0	0	0	0	0	0	0	0	0	0

LCDIF_VDCTRL3 field descriptions

Field	Description
31–30 RSRVD0	This field is reserved. Reserved bits, write as 0.
29 MUX_SYNC_SIGNALS	When this bit is set, the eLCDIF block will internally mux HSYNC with LCD_D14, DOTCLK with LCD_D13 and ENABLE with LCD_D12, otherwise these signals will go out on separate pins. This feature can be used to maintain backward compatible with 37xx.
28 VSYNC_ONLY	This bit must be set to 1 in the VSYNC mode of operation, and 0 in the DOTCLK mode of operation.
27–16 HORIZONTAL_WAIT_CNT	In the DOTCLK mode, wait for this number of clocks from falling edge (or rising if HSYNC_POL is 1) of HSYNC signal to account for horizontal back porch plus the number of DOTCLKs before the moving picture information begins.
VERTICAL_WAIT_CNT	In the VSYNC interface mode, wait for this number of DISPLAY CLOCK (pix_clk) cycles from the falling VSYNC edge (or rising if VSYNC_POL is 1) before starting LCD transactions and is applicable only if WAIT_FOR_VSYNC_EDGE is set. Minimum is CMD_SETUP+5. In the DOTCLK mode, it accounts for the vertical back porch lines plus the number of horizontal lines before the moving picture begins. The unit for this parameter is inherently the same as the VSYNC_PERIOD_UNIT.

34.6.12 eLCDIF VSYNC Mode and Dotclk Mode Control Register4 (LCDIF_VDCTRL4)

This register is used to control the DOTCLK mode of the block.

This register determines the active data in each horizontal line in the DOTCLK mode. Note that the total number of active horizontal lines in the DOTCLK mode is the same as the V_COUNT bitfield in the LCDIF_TRANSFER_COUNT register.

Address: 21C_8000h base + B0h offset = 21C_80B0h

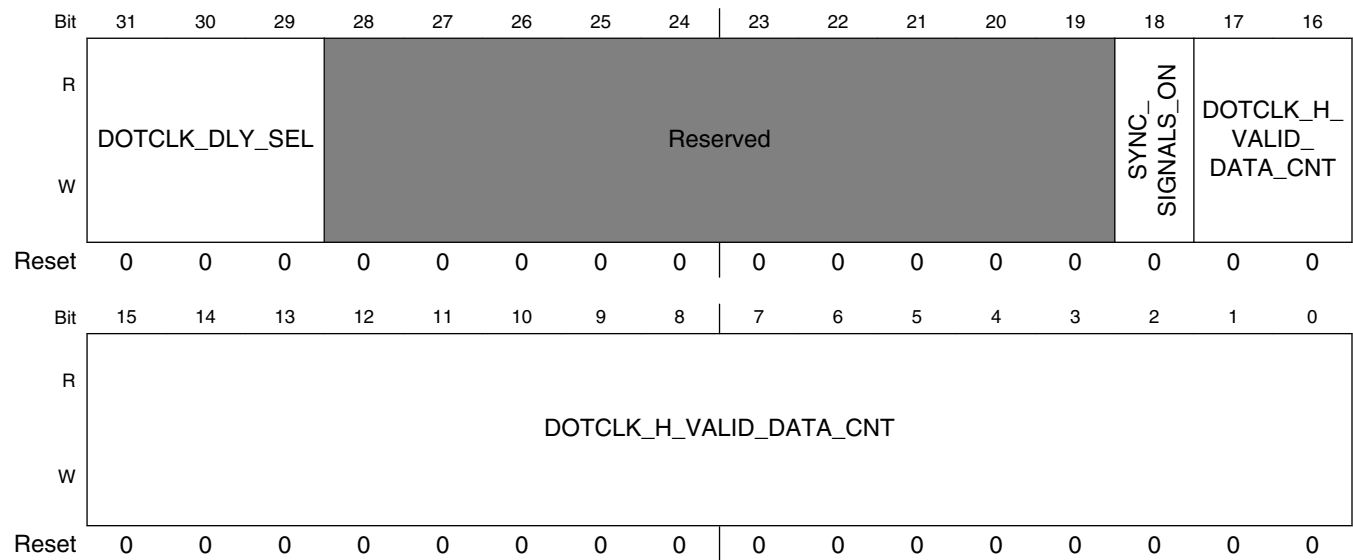

LCDIF_VDCTRL4 field descriptions

Field	Description
31–29 DOTCLK_DLY_SEL	This bitfield selects the amount of time by which the DOTCLK signal should be delayed before coming out of the LCD_DOTCK pin. 0 = 2ns; 1=4ns;2=6ns;3=8ns. Remaining values are reserved.
28–19 RSRVD0	This field is reserved. Reserved bits, write as 0.
18 SYNC_SIGNALS_ON	Set this field to 1 if the LCD controller requires that the VSYNC or VSYNC/HSYNC/DOTCLK control signals should be active at least one frame before the data transfers actually start and remain active at least one frame after the data transfers end. The hardware does not count the number of frames automatically. Rather, the VSYNC edge interrupt can be monitored by software to count the number of frames that have occurred after this bit is set and then the RUN bit can be set to start the data transactions. This bit must always be set in the DOTCLK mode of operation, and it must be set in the VSYNC mode of operation when VSYNC signal is an output.
DOTCLK_H_VALID_DATA_CNT	Total number of DISPLAY CLOCK (pix_clk) cycles on each horizontal line that carry valid data in DOTCLK mode.

34.6.13 Digital Video Interface Control0 Register (LCDIF_DVICTRL0)

The Digital Video interface Control0 register provides the overall control of the Digital Video interface.

This register gives information about the horizontal active, horizontal blanking and total number of lines in the ITU-R BT.656 interface.

EXAMPLE

```
//525/60 video system
HW_LCDIF_DVICTRL0_H_ACTIVE_CNT_WR(0x5A0); //1440
HW_LCDIF_DVICTRL0_H_BLANKING_CNT_WR(0x106); //262
//625/50 video system
HW_LCDIF_DVICTRL0_H_ACTIVE_CNT_WR(0x5A0); //1440
HW_LCDIF_DVICTRL0_H_BLANKING_CNT_WR(0x112); //274
```

Address: 21C_8000h base + C0h offset = 21C_80C0h

Bit	31	30	29	28	27	26	25	24	23	22	21	20	19	18	17	16	15	14	13	12	11	10	9	8	7	6	5	4	3	2	1	0
R																																
W																																
Reset	0	0	0	0	0	0	0	0	0	0	0	0	0	0	0	0	0	0	0	0	0	0	0	0	0	0	0	0	0	0	0	0

LCDIF_DVICTRL0 field descriptions

Field	Description
31–28 RSRVD1	This field is reserved. Reserved bits, write as 0.
27–16 H_ACTIVE_CNT	Number of active video samples to be transmitted. (Mostly will be 1440 for both PAL and NTSC). Must always be a multiple of 4.
15–12 RSRVD0	This field is reserved. Reserved bits, write as 0.
H_BLANKING_CNT	Number of blanking samples to be inserted between EAV and SAV during horizontal blanking interval.

34.6.14 Digital Video Interface Control1 Register (LCDIF_DVICTRL1)

The Digital Video interface Control1 register provides the overall control of the Digital Video interface.

This register contains information about the Field1 start and end, and the Field2 start in the ITU-R BT.656 interface.

EXAMPLE

```
//525/60 video system
HW_LCDIF_DVICTRL1_F1_START_LINE_WR(0x4); //4
HW_LCDIF_DVICTRL1_F1_END_LINE_WR(0x109); //265
HW_LCDIF_DVICTRL1_F2_START_LINE_WR(0x10A); //266
//625/50 video system
HW_LCDIF_DVICTRL1_F1_START_LINE_WR(0x1); //1
HW_LCDIF_DVICTRL1_F1_END_LINE_WR(0x138); //312
HW_LCDIF_DVICTRL1_F2_START_LINE_WR(0x139); //313
```

Address: 21C_8000h base + D0h offset = 21C_80D0h

Bit	31	30	29	28	27	26	25	24	23	22	21	20	19	18	17	16
R	Reserved			F1_START_LINE								F1_END_LINE				
W	Reserved			F1_START_LINE								F1_END_LINE				
Reset	0	0	0	0	0	0	0	0	0	0	0	0	0	0	0	0
Bit	15	14	13	12	11	10	9	8	7	6	5	4	3	2	1	0
R	F1_END_LINE							F2_START_LINE								
W	F1_END_LINE							F2_START_LINE								
Reset	0	0	0	0	0	0	0	0	0	0	0	0	0	0	0	0

LCDIF_DVICTRL1 field descriptions

Field	Description
31–30 RSRVDO	This field is reserved. Reserved bits, write as 0.
29–20 F1_START_LINE	Vertical line number from which Field 1 begins.
19–10 F1_END_LINE	Vertical line number at which Field1 ends.
F2_START_LINE	Vertical line number from which Field 2 begins.

34.6.15 Digital Video Interface Control2 Register (LCDIF_DVICTRL2)

The Digital Video interface Control2 register provides the overall control of the Digital Video interface.

This register contains information about the Field2 end, and the Vertical Blanking1 interval in the ITU-R BT.656 interface.

EXAMPLE

```
//525/60 video system
HW_LCDIF_DVICTRL2_F2_END_LINE_WR(0x3); //3
HW_LCDIF_DVICTRL2_V1_BLANK_START_LINE_WR(0x108); //264
HW_LCDIF_DVICTRL2_V1_BLANK_END_LINE_WR(0x11A); //282
//625/50 video system
HW_LCDIF_DVICTRL2_F2_END_LINE_WR(0x271); //625
HW_LCDIF_DVICTRL2_V1_BLANK_START_LINE_WR(0x137); //311
HW_LCDIF_DVICTRL2_V1_BLANK_END_LINE_WR(0x14F); //335
```

Address: 21C_8000h base + E0h offset = 21C_80E0h

Bit	31	30	29	28	27	26	25	24	23	22	21	20	19	18	17	16
R																
W	Reserved		F2_END_LINE										V1_BLANK_START_LINE			
Reset	0	0	0	0	0	0	0	0	0	0	0	0	0	0	0	0
Bit	15	14	13	12	11	10	9	8	7	6	5	4	3	2	1	0
R	V1_BLANK_START_LINE								V1_BLANK_END_LINE							
W	V1_BLANK_START_LINE								V1_BLANK_END_LINE							
Reset	0	0	0	0	0	0	0	0	0	0	0	0	0	0	0	0

LCDIF_DVICTRL2 field descriptions

Field	Description
31–30 RSRVD0	This field is reserved. Reserved bits, write as 0.
29–20 F2_END_LINE	Vertical line number at which Field 2 ends.
19–10 V1_BLANK_START_LINE	Vertical line number towards the end of Field1 where first Vertical Blanking interval starts.
V1_BLANK_END_LINE	Vertical line number in the beginning part of Field2 where first Vertical Blanking interval ends.

34.6.16 Digital Video Interface Control3 Register (LCDIF_DVICTRL3)

The Digital Video interface Control3 register provides the overall control of the Digital Video interface.

This register contains information about the Vertical Blanking2 interval in the ITU-R BT. 656 interface.

EXAMPLE

```
//525/60 video system
HW_LCDIF_DVICTRL3_V2_BLANK_START_LINE_WR(0x1); //1
HW_LCDIF_DVICTRL3_V2_BLANK_END_LINE_WR(0x13); //19
HW_LCDIF_DVICTRL0_V_LINES_CNT_WR(0x20D); //525
//625/50 video system
HW_LCDIF_DVICTRL3_V2_BLANK_START_LINE_WR(0x270); //624
HW_LCDIF_DVICTRL3_V2_BLANK_END_LINE_WR(0x16); //22
HW_LCDIF_DVICTRL0_V_LINES_CNT_WR(0x271); //625
```

Address: 21C_8000h base + F0h offset = 21C_80F0h

Bit	31	30	29	28	27	26	25	24	23	22	21	20	19	18	17	16
R																
W	Reserved		V2_BLANK_START_LINE										V2_BLANK_END_LINE			
Reset	0	0	0	0	0	0	0	0	0	0	0	0	0	0	0	0

eLCDIF Memory Map/Register Definition

Bit	15	14	13	12	11	10	9	8	7	6	5	4	3	2	1	0
R																
W	V2_BLANK_END_LINE								V_LINES_CNT							
Reset	0	0	0	0	0	0	0	0	0	0	0	0	0	0	0	0

LCDIF_DVICTRL3 field descriptions

Field	Description
31–30 RSRVD0	This field is reserved. Reserved bits, write as 0.
29–20 V2_BLANK_START_LINE	Vertical line number towards the end of Field2 where second Vertical Blanking interval starts.
19–10 V2_BLANK_END_LINE	Vertical line number in the beginning part of Field1 where second Vertical Blanking interval ends.
V_LINES_CNT	Total number of vertical lines per frame (generally 525 or 625)

34.6.17 Digital Video Interface Control4 Register (LCDIF_DVICTRL4)

The Digital Video interface Control4 register provides the overall control of the Digital Video interface.

This register is used to add side borders to the output if the input frame width is less than 720 pixels.

EXAMPLE

```
//If input frame has only 640 pixels per line, but output is supposed to have
720 pixels per line.
HW_LCDIF_DVICTRL4_H_FILL_CNT_WR(0x50); //80
HW_LCDIF_DVICTRL4_Y_FILL_VALUE_WR(0x10); //16
HW_LCDIF_DVICTRL4_CB_FILL_VALUE_WR(0x80); //128
HW_LCDIF_DVICTRL4_CR_FILL_VALUE_WR(0x80); //128
```

Address: 21C_8000h base + 100h offset = 21C_8100h

Bit	31	30	29	28	27	26	25	24	23	22	21	20	19	18	17	16	15	14	13	12	11	10	9	8	7	6	5	4	3	2	1	0
R																																
W	Y_FILL_VALUE								CB_FILL_VALUE								CR_FILL_VALUE								H_FILL_CNT							
Reset	0	0	0	0	0	0	0	0	0	0	0	0	0	0	0	0	0	0	0	0	0	0	0	0	0	0	0	0	0	0	0	0

LCDIF_DVICTRL4 field descriptions

Field	Description
31–24 Y_FILL_VALUE	Value of Y component of filler data

Table continues on the next page...

LCDIF_DVICTRL4 field descriptions (continued)

Field	Description
23–16 CB_FILL_VALUE	Value of CB component of filler data
15–8 CR_FILL_VALUE	Value of CR component of filler data.
H_FILL_CNT	Number of active video samples that have to be filled with the filler data in the front and back portions of the active horizontal interval. Must be a multiple of 4. This field will have to be programmed if the input frame has less than 720 pixels per line.

34.6.18 RGB to YCbCr 4:2:2 CSC Coefficient0 Register (LCDIF_CSC_COEFF0)

LCDIF_CSC_COEFF0 register provides overall control over color space conversion from RGB to 4:2:2 YCbCr. The equations for the conversion are given by: $Y = C0 * R + C1 * G + C2 * B + Y_offset$ $Cb = C3 * R + C4 * G + C5 * B + CbCr_offset$ $Cr = C6 * R + C7 * G + C8 * B + CbCr_offset$

This register carries programming information about RGB to YCbCr 4:2:2 CSC.

EXAMPLE

```
HW_LCDIF_CSC_COEFF0_C0_WR(0x41); //0.257x256=65
HW_LCDIF_CSC_COEFF0_CSC_SUBSAMPLE_FILTER_WR(0x3);
```

Address: 21C_8000h base + 110h offset = 21C_8110h

Bit	31	30	29	28	27	26	25	24	23	22	21	20	19	18	17	16
R	Reserved								C0							
W	Reserved								C0							
Reset	0	0	0	0	0	0	0	0	0	0	0	0	0	0	0	0
Bit	15	14	13	12	11	10	9	8	7	6	5	4	3	2	1	0
R	Reserved														CSC_	
W	Reserved														SUBSAMPL	
															E_FILTER	
Reset	0	0	0	0	0	0	0	0	0	0	0	0	0	0	0	0

LCDIF_CSC_COEFF0 field descriptions

Field	Description
31–26 RSRVD1	This field is reserved. Reserved bits, write as 0.
25–16 C0	Two's complement red multiplier coefficient for Y
15–2 RSRVD0	This field is reserved. Reserved bits, write as 0.

Table continues on the next page...

LCDIF_CSC_COEFF0 field descriptions (continued)

Field	Description
CSC_SUBSAMPLE_FILTER	This register describes the filtering and subsampling scheme to be performed on the chroma components in order to convert from YCbCr 4:4:4 to YCbCr 4:2:2 space. Note that the following descriptions apply individually to Cb and Cr. 0x0 SAMPLE_AND_HOLD — No filtering, simply keep every chroma value for samples numbered 2n and discard chroma values associated with all samples numbered 2n+1. 0x1 RSRVD — Reserved 0x2 INTERSTITIAL — Chroma samples numbered 2n and 2n+1 are averaged (weights 1/2, 1/2) and that chroma value replaces the two chroma values at 2n and 2n+1. This chroma now exists horizontally halfway between the two luma samples. 0x3 COSITED — Chroma samples numbered 2n-1, 2n, and 2n+1 are averaged (weights 1/4, 1/2, 1/4) and that chroma value exists at the same site as the luma sample numbered 2n and the chroma samples at 2n+1 are discarded.

34.6.19 RGB to YCbCr 4:2:2 CSC Coefficient1 Register (LCDIF_CSC_COEFF1)

LCDIF_CSC_COEFF1 register provides overall control over color space conversion from RGB to 4:2:2 YCbCr. The equations for the conversion are given by: $Y = C0 * R + C1 * G + C2 * B + Y_offset$ $Cb = C3 * R + C4 * G + C5 * B + CbCr_offset$ $Cr = C6 * R + C7 * G + C8 * B + CbCr_offset$

This register carries programming information about RGB to YCbCr 4:2:2 CSC.

EXAMPLE

```
HW_LCDIF_CSC_COEFF1_C1_WR(0x81); //0.504x256=129
HW_LCDIF_CSC_COEFF1_C2_WR(0x19); //0.098x256=25
```

Address: 21C_8000h base + 120h offset = 21C_8120h

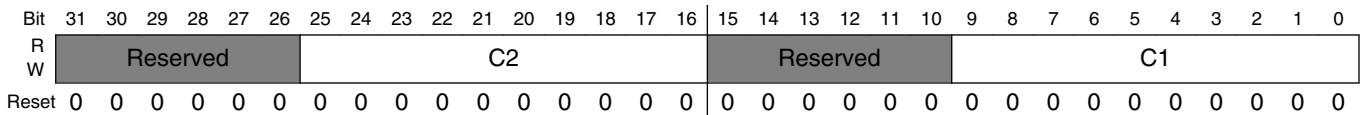

LCDIF_CSC_COEFF1 field descriptions

Field	Description
31–26 RSRVD1	This field is reserved. Reserved bits, write as 0.
25–16 C2	Two's complement blue multiplier coefficient for Y
15–10 RSRVD0	This field is reserved. Reserved bits, write as 0.
C1	Two's complement green multiplier coefficient for Y

34.6.20 RGB to YCbCr 4:2:2 CSC Coefficient2 Register (LCDIF_CSC_COEFF2)

LCDIF_CSC_COEFF2 register provides overall control over color space conversion from RGB to 4:2:2 YCbCr. The equations for the conversion are given by: $Y = C0*R + C1*G + C2*B + Y_offset$ $Cb = C3*R + C4*G + C5*B + CbCr_offset$ $Cr = C6*R + C7*G + C8*B + CbCr_offset$

This register carries programming information about RGB to YCbCr 4:2:2 CSC.

EXAMPLE

```
HW_LCDIF_CSC_COEFF2_C3_WR(0x3DB); //-0.148x256=-37
HW_LCDIF_CSC_COEFF2_C4_WR(0x3B6); //-0.291x256=-74
```

Address: 21C_8000h base + 130h offset = 21C_8130h

Bit	31	30	29	28	27	26	25	24	23	22	21	20	19	18	17	16	15	14	13	12	11	10	9	8	7	6	5	4	3	2	1	0
R																																
W																																
Reset	0	0	0	0	0	0	0	0	0	0	0	0	0	0	0	0	0	0	0	0	0	0	0	0	0	0	0	0	0	0	0	0

LCDIF_CSC_COEFF2 field descriptions

Field	Description
31–26 RSRVD1	This field is reserved. Reserved bits, write as 0.
25–16 C4	Two's complement green multiplier coefficient for Cb
15–10 RSRVD0	This field is reserved. Reserved bits, write as 0.
C3	Two's complement red multiplier coefficient for Cb

34.6.21 RGB to YCbCr 4:2:2 CSC Coefficient3 Register (LCDIF_CSC_COEFF3)

LCDIF_CSC_COEFF3 register provides overall control over color space conversion from RGB to 4:2:2 YCbCr. The equations for the conversion are given by: $Y = C0*R + C1*G + C2*B + Y_offset$ $Cb = C3*R + C4*G + C5*B + CbCr_offset$ $Cr = C6*R + C7*G + C8*B + CbCr_offset$

This register carries programming information about RGB to YCbCr 4:2:2 CSC.

EXAMPLE

eLCDIF Memory Map/Register Definition

```
HW_LCDIF_CSC_COEFF3_C5_WR(0x70) ;//0.439x256=112
HW_LCDIF_CSC_COEFF3_C6_WR(0x70) ;//0.439x256=112
```

Address: 21C_8000h base + 140h offset = 21C_8140h

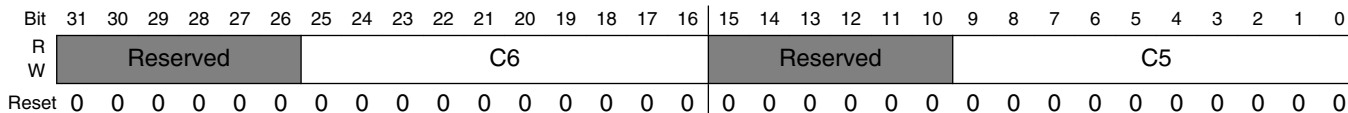

LCDIF_CSC_COEFF3 field descriptions

Field	Description
31–26 RSRVD1	This field is reserved. Reserved bits, write as 0.
25–16 C6	Two's complement red multiplier coefficient for Cr
15–10 RSRVD0	This field is reserved. Reserved bits, write as 0.
C5	Two's complement blue multiplier coefficient for Cb

34.6.22 RGB to YCbCr 4:2:2 CSC Coefficient4 Register (LCDIF_CSC_COEFF4)

LCDIF_CSC_COEFF4 register provides overall control over color space conversion from RGB to 4:2:2 YCbCr. The equations for the conversion are given by: $Y = C0 * R + C1 * G + C2 * B + Y_offset$ $Cb = C3 * R + C4 * G + C5 * B + CbCr_offset$ $Cr = C6 * R + C7 * G + C8 * B + CbCr_offset$

This register carries programming information about RGB to YCbCr 4:2:2 CSC.

EXAMPLE

```
HW_LCDIF_CSC_COEFF4_C7_WR(0x3A2) ;//-0.368x256=-94
HW_LCDIF_CSC_COEFF4_C8_WR(0x3EE) ;//-0.071x256=-18
```

Address: 21C_8000h base + 150h offset = 21C_8150h

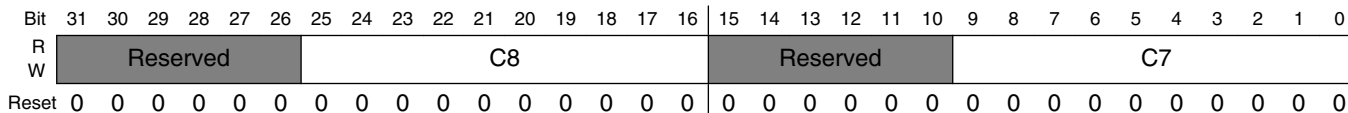

LCDIF_CSC_COEFF4 field descriptions

Field	Description
31–26 RSRVD1	This field is reserved. Reserved bits, write as 0.

Table continues on the next page...

LCDIF_CSC_COEFF4 field descriptions (continued)

Field	Description
25–16 C8	Two's complement blue multiplier coefficient for Cr
15–10 RSRVD0	This field is reserved. Reserved bits, write as 0.
C7	Two's complement green multiplier coefficient for Cr

34.6.23 RGB to YCbCr 4:2:2 CSC Offset Register (LCDIF_CSC_OFFSET)

LCDIF_CSC_ register provides overall control over color space conversion from RGB to 4:2:2 YCbCr. The equations for the conversion are given by: $Y = C0*R + C1*G + C2*B + Y_offset$ $Cb = C3*R + C4*G + C5*B + CbCr_offset$ $Cr = C6*R + C7*G + C8*B + CbCr_offset$

This register carries programming information about RGB to YCbCr 4:2:2 CSC.

Address: 21C_8000h base + 160h offset = 21C_8160h

Bit	31	30	29	28	27	26	25	24	23	22	21	20	19	18	17	16	15	14	13	12	11	10	9	8	7	6	5	4	3	2	1	0	
R	Reserved								CBCR_OFFSET								Reserved								Y_OFFSET								
W	Reserved								CBCR_OFFSET								Reserved								Y_OFFSET								
Reset	0	0	0	0	0	0	0	0	1	0	0	0	0	0	0	0	0	0	0	0	0	0	0	0	0	0	0	0	1	0	0	0	0

LCDIF_CSC_OFFSET field descriptions

Field	Description
31–25 RSRVD1	This field is reserved. Reserved bits, write as 0.
24–16 CBCR_OFFSET	Two's complement offset for the Cb and Cr components
15–9 RSRVD0	This field is reserved. Reserved bits, write as 0.
Y_OFFSET	Two's complement offset for the Y component

34.6.24 RGB to YCbCr 4:2:2 CSC Limit Register (LCDIF_CSC_LIMIT)

LCDIF_CSC_CTRL0 register provides overall control over color space conversion from RGB to 4:2:2 YCbCr. The equations for the conversion are given by: $Y = C0*R + C1*G + C2*B + Y_offset$ $Cb = C3*R + C4*G + C5*B + CbCr_offset$ $Cr = C6*R + C7*G + C8*B + CbCr_offset$

eLCDIF Memory Map/Register Definition

This register carries programming information about RGB to YCbCr 4:2:2 CSC. Note that the values in this register are unsigned.

EXAMPLE

```
HW_LCDIF_CSC_LIMIT_CBCR_MIN_WR(0x10); //16
HW_LCDIF_CSC_LIMIT_CBCR_MAX_WR(0xF0); //240
HW_LCDIF_CSC_LIMIT_Y_MIN_WR(0x10); //16
HW_LCDIF_CSC_LIMIT_Y_MAX_WR(0xEB); //235
```

Address: 21C_8000h base + 170h offset = 21C_8170h

Bit	31	30	29	28	27	26	25	24	23	22	21	20	19	18	17	16	15	14	13	12	11	10	9	8	7	6	5	4	3	2	1	0
R																																
W																																
Reset	0	0	0	0	0	0	0	0	1	1	1	1	1	1	1	1	0	0	0	0	0	0	0	0	1	1	1	1	1	1	1	1

LCDIF_CSC_LIMIT field descriptions

Field	Description
31–24 CBCR_MIN	Lower limit of Cb and Cr after RGB to 4:2:2 YCbCr conversion
23–16 CBCR_MAX	Upper limit of Cb and Cr after RGB to 4:2:2 YCbCr conversion
15–8 Y_MIN	Lower limit of Y after RGB to 4:2:2 YCbCr conversion
Y_MAX	Upper limit of Y after RGB to 4:2:2 YCbCr conversion

34.6.25 LCD Interface Data Register (LCDIF_DATA)

This register is used to transfer data using the PIO interface mode of operation. In MPU mode, data written to this register will be transferred out to the display device. When receiving data from the display, data is read from this register using PIO operations. During write operations, data can be written to this register (from the processor's perspective) as bytes, half-words (16 bits), or words (32 bits) as desired.

This register holds the 32-bit word written by the ARM platform into LCDIF. This data then gets sent out by the block across the interface.

Address: 21C_8000h base + 180h offset = 21C_8180h

Bit	31	30	29	28	27	26	25	24	23	22	21	20	19	18	17	16	15	14	13	12	11	10	9	8	7	6	5	4	3	2	1	0
R																																
W																																
Reset	0	0	0	0	0	0	0	0	0	0	0	0	0	0	0	0	0	0	0	0	0	0	0	0	0	0	0	0	0	0	0	0

LCDIF_DATA field descriptions

Field	Description
31–24 DATA_THREE	Byte 3 (most significant byte) of data written to LCDIF.
23–16 DATA_TWO	Byte 2 of data written to eLCDIF.
15–8 DATA_ONE	Byte 1 of data written to eLCDIF.
DATA_ZERO	Byte 0 (least significant byte) of data written to eLCDIF.

34.6.26 Bus Master Error Status Register (LCDIF_BM_ERROR_STAT)

This register reflects the virtual address at which the AXI master received an error response from the slave.

When the BM_ERROR_IRQ is asserted, the address of the bus error is updated in the register.

Address: 21C_8000h base + 190h offset = 21C_8190h

Bit	31	30	29	28	27	26	25	24	23	22	21	20	19	18	17	16	15	14	13	12	11	10	9	8	7	6	5	4	3	2	1	0		
R																																		
W																																		
	ADDR																																	
Reset	0	0	0	0	0	0	0	0	0	0	0	0	0	0	0	0	0	0	0	0	0	0	0	0	0	0	0	0	0	0	0	0	0	0

LCDIF_BM_ERROR_STAT field descriptions

Field	Description
ADDR	Virtual address at which bus master error occurred.

34.6.27 CRC Status Register (LCDIF_CRC_STAT)

This register reflects the CRC value of each frame sent out by eLCDIF. The CRC is done on the final output bus, so the value will be dependent on the LCD_DATABUS_WIDTH bitfield even if the input data is the same.

This register will be updated when the CUR_FRAME_DONE_IRQ is asserted. In the case of DVI mode, the CRC is calculated for the entire frame, not separately for each field in the frame.

eLCDIF Memory Map/Register Definition

Address: 21C_8000h base + 1A0h offset = 21C_81A0h

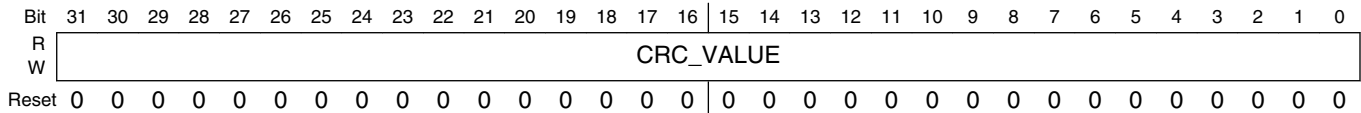

LCDIF_CRC_STAT field descriptions

Field	Description
CRC_VALUE	Calculated CRC value.

34.6.28 LCD Interface Status Register (LCDIF_STAT)

The LCD interface status register can be used to check the current status of the eLCDIF block.

The LCD interface status register that contains read only views of some parameters or current state of the block.

Address: 21C_8000h base + 1B0h offset = 21C_81B0h

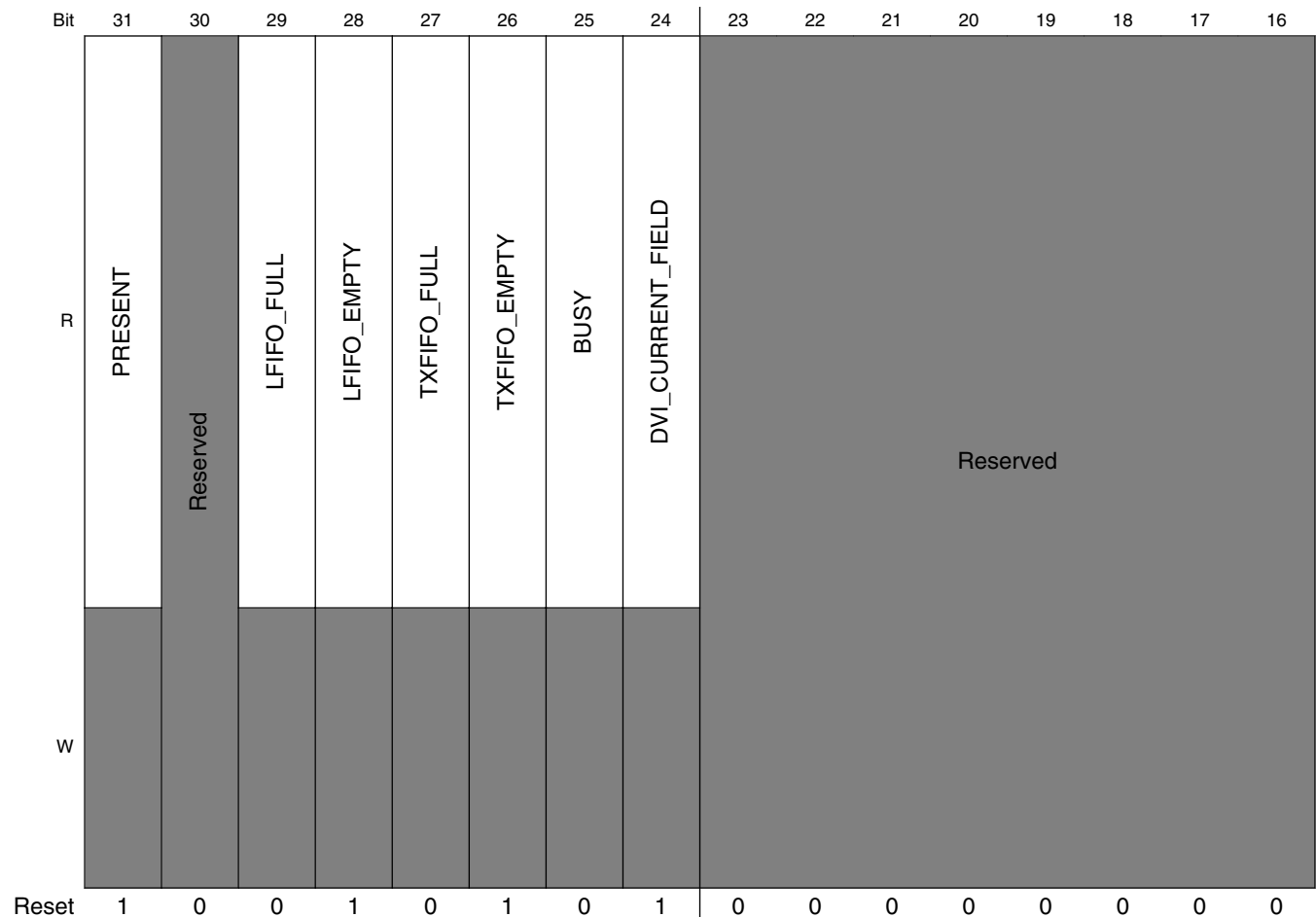

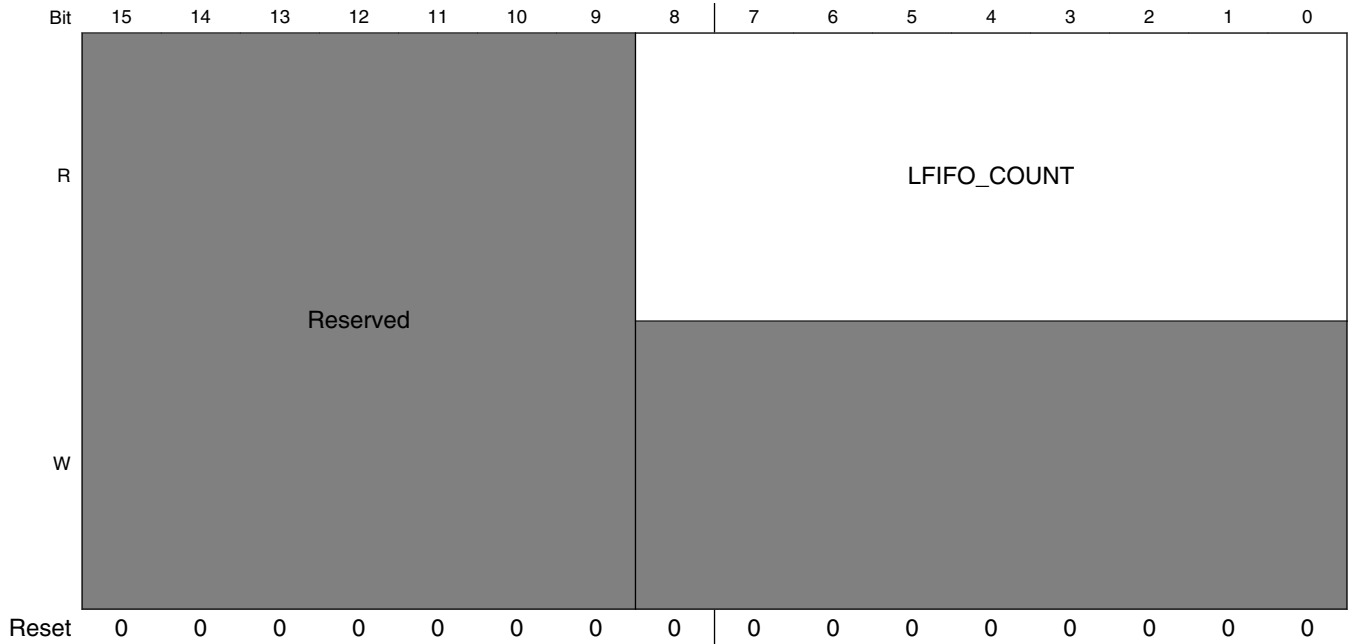

LCDIF_STAT field descriptions

Field	Description
31 PRESENT	0: eLCDIF not present on this product 1: eLCDIF is present.
30 -	This field is reserved. Reserved.
29 LFIFO_FULL	Read only view of the signals that indicates LCD LFIFO is full.
28 LFIFO_EMPTY	Read only view of the signals that indicates LCD LFIFO is empty.
27 TXFIFO_FULL	Read only view of the signals that indicates LCD TXFIFO is full.
26 TXFIFO_EMPTY	Read only view of the signals that indicates LCD TXFIFO is empty.
25 BUSY	Read only view of the input busy signal from the external LCD controller.
24 DVI_CURRENT_FIELD	Read only view of the current field being transmitted. DVI_CURRENT_FIELD = 0 means field 1. DVI_CURRENT_FIELD = 1 means field 2.
23–9 RSRVDO	This field is reserved. Reserved bits. Write as 0.
LFIFO_COUNT	Read only view of the current count in Latency buffer (LFIFO).

34.6.29 eLCDIF Threshold Register (LCDIF_THRES)

This register is used to activate control signals when the number of pixels reaches the programmed threshold. These control signals, in turn, can be used to manipulate access priority or dynamically change the input clock frequency to meet the required pixel throughput.

Memory request priority threshold register.

Address: 21C_8000h base + 200h offset = 21C_8200h

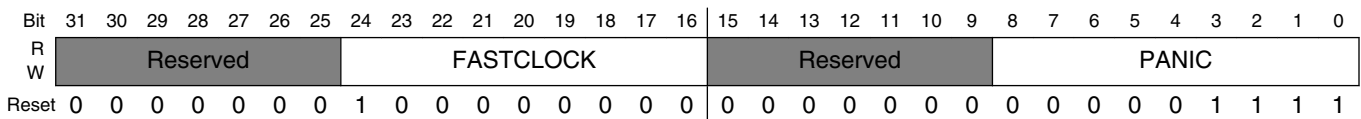

LCDIF_THRES field descriptions

Field	Description
31–25 RSRVD2	This field is reserved. Reserved bits. Write as 0.
24–16 FASTCLOCK	This value should be set to a value of pixels, from 0 to 511. When the number of pixels in the input pixel FIFO is LESS than this value, the fast clock control output will be raised. This signal can be used to reduce the system bus clock frequency to save power during horizontal or vertical blanking intervals. This value should also be programmed to a value that is greater than the "PANIC" threshold value. This will allow a faster clock to recover the number of pixels in the FIFO before a "panic" level is encountered.
15–9 RSRVD1	This field is reserved. Reserved bits. Write as 0.
PANIC	This value should be set to a value of pixels from 0 to 511. When the number of pixels in the input pixel FIFO is less than this value, the internal panic control output will be raised. This signal can be used to raise the access eLCDIF's access priority.

34.6.30 eLCDIF AS Buffer Control Register (LCDIF_AS_CTRL)

The Alpha Surface Parameter register provides additional controls for AS.

Address: 21C_8000h base + 210h offset = 21C_8210h

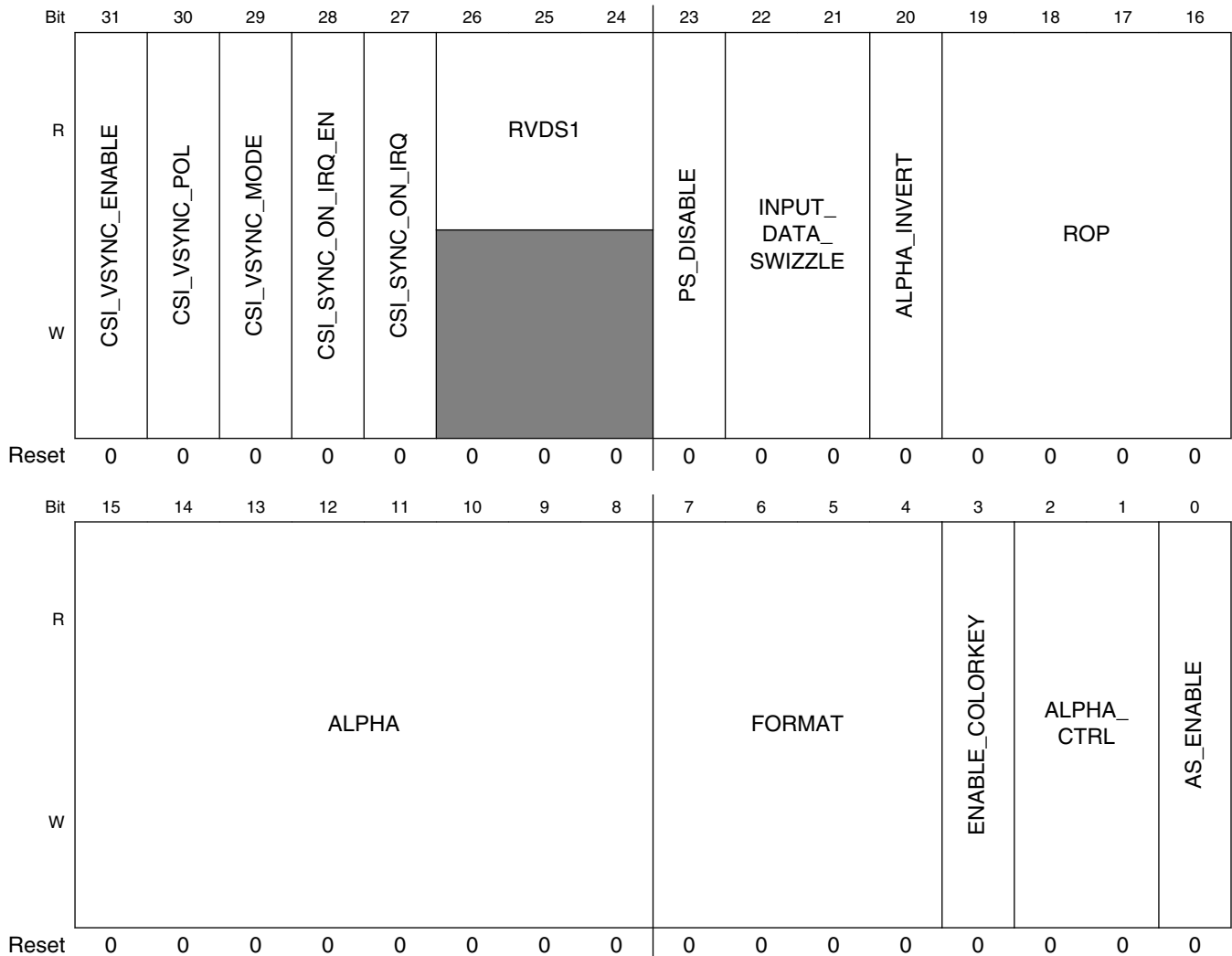

LCDIF_AS_CTRL field descriptions

Field	Description
31 CSI_VSYNC_ENABLE	When this bit is set by software, the LCDIF work as sync mode with CSI input.
30 CSI_VSYNC_POL	Default 0 active low during VSYNC_PULSE_WIDTH time and will be high during the rest of the VSYNC period. Set it to 1 to invert the polarity.

Table continues on the next page...

LCDIF_AS_CTRL field descriptions (continued)

Field	Description
29 CSI_VSYNC_MODE	this bit is set by software to decide which vsync generate mode. LCDIF vsync generate by internal counter when set to 0, LCDIF vsync delayed by each csi_vsync_in when set to 1; INT_SYNC_MODE = 0x0 LCDIF vsync generate by internal counter. EXT_SYNC_MODE = 0x1 LCDIF vsync delayed by each csi_vsync_in.
28 CSI_SYNC_ON_IRQ_EN	This bit is set to enable an interrupt when LCDIF lock with CSI vsync input.
27 CSI_SYNC_ON_IRQ	this bit is set by software to decide which vsync generate mode. LCDIF vsync generate by internal counter when set to 0, LCDIF vsync delayed by each csi_vsync_in when set to 1; INT_SYNC_MODE = 0x0 LCDIF vsync generate by internal counter. EXT_SYNC_MODE = 0x1 LCDIF vsync delayed by each csi_vsync_in.
26–24 RVDS1	Reserved, always set to zero.
23 PS_DISABLE	When this bit is set by software, the LCDIF will disable PS buffer data.
22–21 INPUT_DATA_SWIZZLE	This field specifies how to swap the bytes either in the HW_LCDIF_DATA register or those fetched by the AXI master part of LCDIF. The swizzle function is independent of the WORD_LENGTH bit. See the explanation of the HW_LCDIF_DATA below for names and definitions of data register fields. The supported swizzle configurations are: NO_SWAP = 0x0 No byte swapping.(Little endian) LITTLE_ENDIAN = 0x0 Little Endian byte ordering (same as NO_SWAP). BIG_ENDIAN_SWAP = 0x1 Big Endian swap (swap bytes 0, 3 and 1, 2). SWAP_ALL_BYTES = 0x1 Swizzle all bytes, swap bytes 0, 3 and 1, 2 (aka Big Endian). HWD_SWAP = 0x2 Swap half-words. HWD_BYTE_SWAP = 0x3 Swap bytes within each half-word.
20 ALPHA_INVERT	Setting this bit to logic 0 will not alter the alpha value. A logic 1 will invert the alpha value and apply (1-alpha) for image composition.
19–16 ROP	Indicates a raster operation to perform when enabled. Raster operations are enabled through the ALPHA_CTRL field. MASKAS = 0x0 AS AND PS MASKNOTAS = 0x1 nAS AND PS MASKASNOT = 0x2 AS AND nPS MERGEAS = 0x3 AS OR PS MERGENOTAS = 0x4 nAS OR PS MERGEASNOT = 0x5 AS OR nPS NOTCOPYAS = 0x6 nAS NOT = 0x7 nPS NOTMASKAS = 0x8 AS NAND PS NOTMERGEAS = 0x9 AS NOR PS XORAS = 0xA AS XOR PS NOTXORAS = 0xB AS XNOR PS

Table continues on the next page...

LCDIF_AS_CTRL field descriptions (continued)

Field	Description
15–8 ALPHA	Alpha modifier used when the ALPHA_MULTIPLY or ALPHA_OVERRIDE values are programmed in REG_AS_CTRL[ALPHA_CTRL]. The output alpha value will either be replaced (ALPHA_OVERRIDE) or scaled (ALPHA_MULTIPLY) when selected.
7–4 FORMAT	Indicates the input buffer format for AS. ARGB8888 = 0x0 32-bit pixels with alpha RGB888 = 0x4 32-bit pixels without alpha (unpacked 24-bit format) ARGB1555 = 0x8 16-bit pixels with alpha ARGB4444 = 0x9 16-bit pixels with alpha RGB555 = 0xC 16-bit pixels without alpha RGB444 = 0xD 16-bit pixels without alpha RGB565 = 0xE 16-bit pixels without alpha
3 ENABLE_ COLORKEY	Indicates that colorkey functionality is enabled for this alpha surface. Pixels found in the alpha surface colorkey range will be displayed as transparent (the PS pixel will be used).
2–1 ALPHA_CTRL	Determines how the alpha value is constructed for this alpha surface. Indicates that the value in the ALPHA field should be used instead of the alpha values present in the input pixels. Embedded = 0x0 Indicates that the AS pixel alpha value will be used to blend the AS with PS. The ALPHA field is ignored. Override = 0x1 Indicates that the value in the ALPHA field should be used instead of the alpha values present in the input pixels. Multiply = 0x2 Indicates that the value in the ALPHA field should be used to scale all pixel alpha values. Each pixel alpha is multiplied by the value in the ALPHA field. ROPs = 0x3 Enable ROPs. The ROP field indicates an operation to be performed on the alpha surface and PS pixels.
0 AS_ENABLE	When this bit is set by software, the LCDIF will start fetching AS buffer data in bus master mode and combine it with another buffer.

34.6.31 Alpha Surface Buffer Pointer (LCDIF_AS_BUF)

This register is used to indicate the base address of the AS buffer.

Address: 21C_8000h base + 220h offset = 21C_8220h

Bit	31	30	29	28	27	26	25	24	23	22	21	20	19	18	17	16	15	14	13	12	11	10	9	8	7	6	5	4	3	2	1	0
R																																
W																																
Reset	0	0	0	0	0	0	0	0	0	0	0	0	0	0	0	0	0	0	0	0	0	0	0	0	0	0	0	0	0	0	0	0

LCDIF_AS_BUF field descriptions

Field	Description
ADDR	Address pointer for the alpha surface 0 buffer.

34.6.32 LCDIF_AS_NEXT_BUF

When the LCDIF is behaving as a master, this address points to the address of the next frame of data that will be sent out via the LCDIF. It is upto the software to make sure that this register is programmed before the end of the current frame, otherwise it might result in old data going out the LCDIF. This address must always be double-word aligned.

Address: 21C_8000h base + 230h offset = 21C_8230h

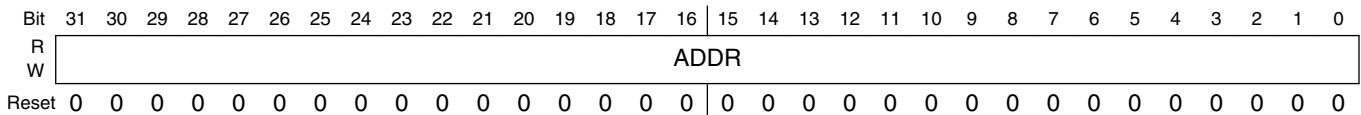

LCDIF_AS_NEXT_BUF field descriptions

Field	Description
ADDR	Address of the next frame that will be transmitted by eLCDIF.

34.6.33 eLCDIF Overlay Color Key Low (LCDIF_AS_CLRKEYLOW)

If a pixel in the current overlay image with a color that falls in the range from the ASCOLORKEYLOW to ASCOLORKEYHIGH range, it will use the PS pixel value for that location. Colorkey operations are higher priority than alpha or ROP operations.

Address: 21C_8000h base + 240h offset = 21C_8240h

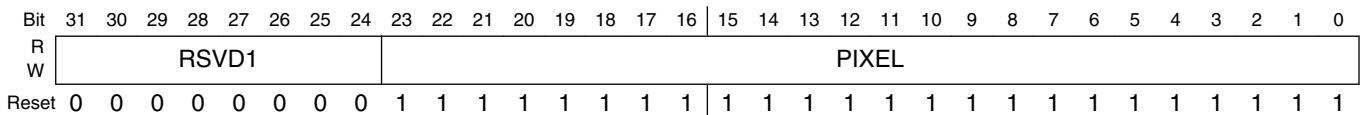

LCDIF_AS_CLRKEYLOW field descriptions

Field	Description
31–24 RSVD1	Reserved, always set to zero.
PIXEL	Low range of RGB color key applied to AS buffer

34.6.34 eLCDIF Overlay Color Key High (LCDIF_AS_CLRKEYHIGH)

If a pixel in the current overlay image with a color that falls in the range from the ASCOLORKEYLOW to ASCOLORKEYHIGH range, it will use the PS pixel value for that location. Colorkey operations are higher priority than alpha or ROP operations.

Address: 21C_8000h base + 250h offset = 21C_8250h

Bit	31	30	29	28	27	26	25	24	23	22	21	20	19	18	17	16	15	14	13	12	11	10	9	8	7	6	5	4	3	2	1	0
R	RSVD1																PIXEL															
W	RSVD1																PIXEL															
Reset	0	0	0	0	0	0	0	0	0	0	0	0	0	0	0	0	0	0	0	0	0	0	0	0	0	0	0	0	0	0	0	0

LCDIF_AS_CLRKEYHIGH field descriptions

Field	Description
31–24 RSVD1	Reserved, always set to zero.
PIXEL	High range of RGB color key applied to AS buffer

34.6.35 LCD working insync mode with CSI for VSYNC delay (LCDIF_SYNC_DELAY)

The LCDIF DOTCLK mode VSYNC will delay from CSI_VSYNC as $(V_COUNT_DELAY * HSYNC_PERIOD + H_COUNT_DELAY)$ PIXCLK cycles

Address: 21C_8000h base + 260h offset = 21C_8260h

Bit	31	30	29	28	27	26	25	24	23	22	21	20	19	18	17	16	15	14	13	12	11	10	9	8	7	6	5	4	3	2	1	0
R	V_COUNT_DELAY																H_COUNT_DELAY															
W	V_COUNT_DELAY																H_COUNT_DELAY															
Reset	0	0	0	0	0	0	0	0	0	0	0	0	0	0	0	0	0	0	0	0	0	0	0	0	0	0	0	0	0	0	0	0

LCDIF_SYNC_DELAY field descriptions

Field	Description
31–16 V_COUNT_DELAY	LCDIF VSYNC delayed counter for CSI_VSYNC.
H_COUNT_DELAY	LCDIF VSYNC delayed counter for CSI_VSYNC.

Chapter 35

Multi Mode DDR Controller (MMDC)

35.1 Overview

MMDC is a multi-mode DDR controller that supports DDR3/DDR3L x16 and LPDDR2x16 memory types. MMDC is configurable, high performance, and optimized.

The following figure shows the MMDC block diagram.

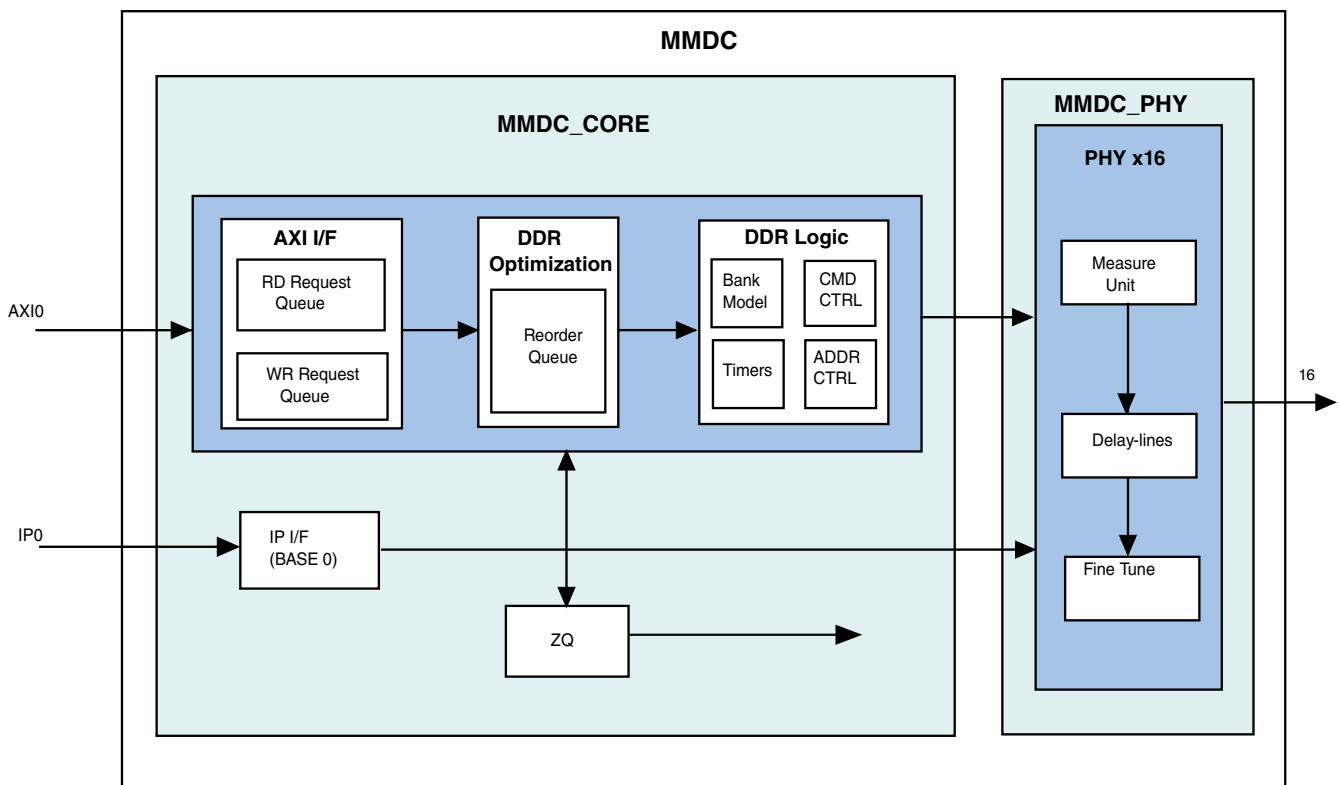

Figure 35-1. MMDC block diagram

MMDC consists of a core (MMDC_CORE) and PHY (MMDC_PHY).

- The core is responsible for communication with the system through an AXI interface, DDR command generation, DDR command optimizations, and a read/write data path.
- The PHY is responsible for the timing adjustment; it uses special calibration mechanisms to ensure data capture margin at a clock rate of up to 400 MHz.

The internal memory map (configuration registers) of the MMDC can be configured through an IP channel (IP0).

35.1.1 MMDC feature summary

The table found here summarizes the MMDC features.

Table 35-1. MMDC feature summary

Feature	Details
DDR standards	<ul style="list-style-type: none"> • DDR3L, DDR3 x16 • LPDDR2 x16 • Does not support LPDDR1MDDR or DDR2
DDR interface	<ul style="list-style-type: none"> • x16 data bus width • Density per DDR device of 256 Mbits–8 Gbits with the following column and row combinations: <ul style="list-style-type: none"> • Column size of 8–12 bits • Row size of 11–16 bits • Two chip selects (one chip select for DDR3/DDR3L, LPDDR2) • Up to 4 Gbytes of address space with configurable partitioning between CS0 and CS1 (for LPDDR2 2ch x32 up to 2 Gbytes per channel) • Supports burst length of 8 (aligned) for DDR3 • Supports burst length of 4 for LPDDR2
DDR performance	<ul style="list-style-type: none"> • MMDC running at up to 400 MHz (800MT/s), see CCM block for actual clock frequencies supported. • Supports Real-Time priority by means of QoS sideband priority signals from the chip to enable various priority levels in the re-ordering mechanism: real-time, latency sensitive, normal priority. • Page hit/page miss optimizations • Consecutive read/write access optimizations • Supports deep read and write request queues to enable bank prediction. • Drives back the critical word in a read transaction as soon as it is received by the DDR device (does not wait until the whole data phase has been completed). • Keeps tracking of open memory pages • Supports bank interleaving • Special optimization in case of non-aligned wrap accesses in DDR3 mode (burst length 8) <p>NOTE: Due to reordering and optimization mechanisms (per different AXI Identifier (ID)), the transactions towards the DDR device may be driven in a different ID order than was received by the AXI master. In a similar fashion, the write response, read response or read data may be driven to the AXI master in a different ID order.</p>
AXI interface	<ul style="list-style-type: none"> • AXI bus compliant • Supports bus transfers of 8, 16, 64 bits (single accesses and bursts) running at 400 MHz.

Table continues on the next page...

Table 35-1. MMDC feature summary (continued)

Feature	Details
	<ul style="list-style-type: none"> • Supports AXI bursts length of up to 16 • Supports burst types of WRAP, INCR and FIXED • Supports 16 bits AXI ID • Write data interleave depth is 1 (no support for Write Data Interleave) • Supports write data before address • Supports buffered/non-buffered accesses (AWCACHE[0] = 0b means a non-bufferable access and AWCACHE[0] = 1b means a bufferable access). The rest of the CACHE options are not supported <ul style="list-style-type: none"> • To keep data access coherency between write and read access of the same master, the response signal is sent as follows: <ul style="list-style-type: none"> • Bufferable write access—BRESP will be sent when last data of the access has entered the MMDC. • Non-bufferable write access—BRESP will be sent when the data was physically written into the external memory device. • Supports four exclusive monitors per configurable ID for only a single access with a size of up to 64 bits • Supports AXI responses as follows: <ul style="list-style-type: none"> • Okay in case the access has been successful or exclusive access failure • Slave error in case of security violation • Exclusive okay in case the read or the write portion of an exclusive access has been successful
DDR calibration and delay-lines.	<ul style="list-style-type: none"> • Supports various calibration processes which can be performed either automatically (hardware) or manually (software) towards either CS0 or CS1. (At the end of the process the delay-lines will work with one set of results.) The following calibration processes are supported: <ul style="list-style-type: none"> • ZQ calibration for external DDR device (in DDR3 through ZQ calibration command and in LPDDR2 through MRW command) <ul style="list-style-type: none"> • Can be handled automatically for ZQ Short (periodically) and ZQ Long (at exit from self-refresh) • Can be handled manually at ZQ INIT • ZQ calibration for DDR I/O pads for calibrating the DDR driving strength <ul style="list-style-type: none"> • The sequence can be handled automatically by hardware • The sequence can be handled step by step manually by software • Read data calibration. Adjustment of read DQS with read data byte. • Read DQS gating calibration for DDR3 only. Adjustment of DQS gate with read preamble window. • Write data calibration. Adjustment of write DQS with write data byte. • Write leveling calibration. Adjustment of write DQS with CK (DDR differential clock). • Read fine tuning. Adjustment of up to 7 delay-line units for each read data bit. • Write fine tuning. Adjustment of up to 3 delay-line units for each read data bit. • Periodic delay-line measurement for keeping its accuracy during refresh interval. • Additional fine tuning delay lines to adjust DDR clock delay, DDR clock duty cycle, DQS duty cycle.
Power saving	<ul style="list-style-type: none"> • Support of dynamic voltage, frequency change and self-refresh mode entry through hardware and software negotiation with the system (request/acknowledge handshake) <ul style="list-style-type: none"> • Upon hardware or software self-refresh request assertion, further AXI requests are blocked (even before the assertion of the acknowledge). • During self-refresh mode the system may deassert the operating clock of the MMDC for power saving. • During self-refresh mode the clock (CK) that is driven to the DDR device will be gated for power saving. • Supports automatic self-refresh and power down entry and exit <ul style="list-style-type: none"> • In automatic self-refresh, the internal operating clock will be gated for power saving.

Table continues on the next page...

Table 35-1. MMDC feature summary (continued)

Feature	Details
	<ul style="list-style-type: none"> • Supports fast and slow precharge power down in DDR3 • Automatic active and precharge power down timer per chip select (one chip select can enter power down while the other is still working) • While CS (chip-select) is inactive (high) the command and address buses are not toggling for power saving.
DDR general	<ul style="list-style-type: none"> • Configurable timing parameters • Configurable refresh scheme • Page boundary crossing support <ul style="list-style-type: none"> • Automatically generates precharge command and activates the next row • Supports various ODT control schemes <ul style="list-style-type: none"> • Assertion or deassertion of ODT control per read or write accesses and for active or passive CS (chip-select) • Supports MRW and MRR commands for LPDDR2 • Software control in LPDDR2 mode for switching to derated timing parameters and/or update the refresh rate according to temperature sensor • Debug and profiling capabilities

35.2 External Signals

The table found here describes the external signals of MMDC.

Table 35-2. MMDC External Signals

Signal	Description	Pad	Mode	Direction
DRAM_ADDR[15:0]	Address Bus Signals	DRAM_A[15:0]	No Muxing	O
DRAM_CAS	Column Address Strobe Signal	DRAM_CAS	No Muxing	O
DRAM_CS[1:0]	Chip Selects	DRAM_CS[1:0]	No Muxing	O
DRAM_DATA[31:0]	Data Bus Signals	DRAM_D[31:0]	No Muxing	I/O
DRAM_DQM[1:0]	Data Mask Signals	DRAM_DQM[1:0]	No Muxing	O
DRAM_ODT[1:0]	On-Die Termination Signals	DRAM_SDOdT[1:0]	No Muxing	O
DRAM_RAS	Row Address Strobe Signal	DRAM_RAS	No Muxing	O
DRAM_RESET	Reset Signal	DRAM_RESET	No Muxing	O
DRAM_SDBA[2:0]	Bank Select Signals	DRAM_SDBA[2:0]	No Muxing	O
DRAM_SDCKE[1:0]	Clock Enable Signals	DRAM_SDCKE[1:0]	No Muxing	O
DRAM_SDCLK0_N	Negative Clock Signals	DRAM_SDCLK_[1:0]	No Muxing	O
DRAM_SDCLK0_P	Positive Clock Signals	DRAM_SDCLK_[1:0]	No Muxing	O
DRAM_SDQS[1:0]_N	Negative DQS Signals	DRAM_SDQS[1:0]_N	No Muxing	I/O
DRAM_SDQS[1:0]_P	Positive DQS Signals	DRAM_SDQS[1:0]_P	No Muxing	I/O
DRAM_SDWE	WE signal	DRAM_SDWE	No Muxing	O
DRAM_ZQPAD	ZQ signal	DRAM_ZQPAD	No Muxing	O

35.3 Clocks

The table found here describes the clock sources for MMDC.

See [Clock Controller Module \(CCM\)](#) for clock setting, configuration and gating information.

NOTE

The terms *clocks* and *cycles* are used interchangeably and refer to the clock period of the main ddr clock (mmdc_axi_clk_root), commonly referred to as the DDR frequency.

Table 35-3. MMDC Clocks

Clock name	Clock Root	Description
aclk_fast_core_p0	mmdc_axi_clk_root	Fast clock (channel 1)
ipg_clk_p0	ipg_clk_root	Peripheral clock (channel 1)
aclk_fast_phy_p0	mmdc_axi_clk_root	Fast clock (channel 1 - PHY)

35.4 Functional Description

This section provides a complete functional description of the block.

35.4.1 Write/Read data flow

35.4.1.1 Write data flow

- Write requests are received into an 8 entry request FIFO. Access is received only when there are at least two available entries. Each entry holds all of the AXI attributes.
 - If the burst length is greater than 8, the access splits into two accesses: one with burst length 8 and the other with the remainder.
 - The access can be performed as soon as the entire data phase of the associated write request is completed (all data beats were received).
- A simple round-robin arbitration between the pending read and write accesses is performed, and the pointer to this stage's winner access is sent to the re-ordering buffer.

3. The reordering mechanism is activated to find the winner access, which is the access that best utilizes the DDR bus, based on its dynamic score. For further information see [Dynamic scoring mode \(Arbitration Winning Conditions\)](#).
4. The winner write access at the previous stage is received and is held for dispatch to the DDR logic.
5. When the DDR command control unit is ready to accept the write request, it issues (if needed) a precharge/active command to the DDR device according to the status of the bank model and the parameters of the timers.
6. The DDR logic drives the associated data to the DDR device through the DDR PHY.

35.4.1.2 Read data flow

1. Read requests are received into a 16 entry request FIFO in MMDC if there are at least two available entries. Each entry holds all of the AXI attributes.

NOTE

If the burst length is greater than 8, the access splits into 2 accesses (one with burst length 8 and the other with the remainder).

2. A simple round-robin arbitration between the pending read and write accesses is performed and the pointer to this phase's winner access is sent to the re-ordering buffer.
3. The reordering mechanism is activated to find the winner access, which is the access that best utilizes the DDR bus, based on its dynamic score. For further information see [Dynamic scoring mode \(Arbitration Winning Conditions\)](#).
4. The winner read access at the previous stage is sampled and is held for dispatch to the DDR logic. This read access will be dispatched when there is at least one free slot in the read data buffer to store the data.
5. When the DDR command control unit is ready to accept the read request, it issues (if needed) a precharge/active command to the DDR device according to the status of the bank model and the parameters of the timers.
6. The MMDC PHY samples the read data, and the DDR logic transfers the data to the associated slot in the read data buffer.
7. MMDC transfers the data back to the master.

35.4.2 MMDC initialization

Because the MMDC is disabled when the chip exits reset, no clock is driven to the DDR device and the whole interface towards the DDR device is inactive. The following steps are required to activate the MMDC properly.

NOTE

To guarantee that the DRAM_RESET and DRAM_SDCKE signals are kept low during the power-up and reset sequences of the chip (as defined by JEDEC), you must connect those signals to pull-down resistors.

1. Set MDSCR[CON_REQ], which sets the configuration request; note that because the MMDC is disabled, there is no need to poll the configuration acknowledge bit at MDSCR[CON_ACK].
2. Configure the desired timing parameters at the MDCFG0, MDCFG1, MDOTC, and MDCFG2 registers.
3. Configure the DDR type and other miscellaneous parameters at the MDMISC register.
4. Configure the required delay while leaving reset, at the MDOR register.
5. Configure the DDR physical parameters (density and burst length) at the MDCTL register.
6. Perform a ZQ calibration of the MMDC module to correctly initialize drive strengths.
7. Enable MMDC with the desired chip select at MDCTL[SDE_0] (for chip select 0) and MDCTL[SDE_1] (for chip select 1). At this point, MMDC starts the reset and initialization sequence related to DRAM_RESET/DRAM_SDCKE as defined by JEDEC.
8. Complete the initialization sequence as defined by JEDEC by issuing MRS/MRW commands for (ZQ, ODT, PRE, and so on). To issue those commands, configure the appropriate command and address at the MDSCR register.
9. Program the DDR mode registers by configuring the appropriate command and address at the MDSCR register.
10. Configure the power down and self-refresh entry and exit parameters at the MDPDC and MAPSR registers.
11. Configure the ZQ scheme at the MPZQHWCTRL and MPZQLP2CTL registers.
12. Configure and activate the periodic refresh scheme at the MDREF register.
13. Deassert the configuration request by clearing MDSCR[CON_REQ].

NOTE

Steps 1 through 6 are non-blocking and can be done in any order.

Upon completion of these steps, MMDC is ready for work and to process AXI accesses.

NOTE

To achieve better timing and better precision, it is recommended that users configure the MMDC PHY delay parameters by operating either the automatic or manual

calibration process. Before starting any calibration process, you must disable the periodic refresh scheme (MDREF[REF_SEL] = 11) and then issue a manual refresh command by configuring MDSCR[CMD] to 2h. For further information, see [Calibration Process](#).

35.4.3 Configuring the MMDC registers

To safely modify MMDC's internal configuration registers, MMDC must be placed into configuration mode.

Use the following steps to enter configuration mode.

1. Issue a configuration request by setting MDSCR[CON_REQ].
2. Poll on configuration acknowledge until it is set at MDSCR[CON_ACK].

At this point, MMDC enters configuration mode and accessing the MMDC registers is permitted.

NOTE

During configuration mode, MMDC prevents further AXI accesses from being acknowledged.

Upon deassertion of MDSCR[CON_REQ], MMDC leaves configuration mode and AXI accesses are processed.

35.4.4 MMDC Address Space

35.4.4.1 Address decoding

MMDC supports up to two consecutive chip selects, each with the same density.

It is optional to configure the partition between the chip selects through MDASP[CS0_END].

The incoming AXI address bus is 32 bits. MMDC decodes each access as follows:

1. chip select
2. bank number
3. row number
4. column number

The following registers in the MMDC define the DDR address space:

- MDMISC[DDR_4_BANK]—Defines either 4 or 8 banks in the DDR device
- MDCTL[DSIZ]—Defines the DDR data bus width of x16
- MDMISC[BI]—Defines whether bank interleaving is on or off
- MDCTL[COL]—Defines the column size of the DDR device
- MDCTL[ROW]—Defines the row size of the DDR device

The following tables show address decoding examples for x16 bit DDR devices when bank interleaving is both on and off. It is assumed that the configuration is as follows: 8 banks (3 bits), 15 bit assignment for the row, and 10 bit assignment for the column. The total density is 256 MWords (512 Mbytes for x16).

NOTE

Chip selection is done by comparing the 7 most significant address bits (ARADDR[31:25]/AWADDR[31:25]) with MDASP[CS0_END].

Table 35-4. Address decoding—bank interleaving off

AXI ADDRESS	x16 DDR	x32 DDR
A29	—	BANK[2]
A28	BANK[2]	BANK[1]
A27	BANK[1]	BANK[0]
A26	BANK[0]	ROW[14]
A25	ROW[14]	ROW[13]
A24	ROW[13]	ROW[12]
A23	ROW[12]	ROW[11]
A22	ROW[11]	ROW[10]
A21	ROW[10]	ROW[9]
A20	ROW[9]	ROW[8]
A19	ROW[8]	ROW[7]
A18	ROW[7]	ROW[6]
A17	ROW[6]	ROW[5]
A16	ROW[5]	ROW[4]
A15	ROW[4]	ROW[3]
A14	ROW[3]	ROW[2]
A13	ROW[2]	ROW[1]
A12	ROW[1]	ROW[0]
A11	ROW[0]	COL[9]
A10	COL[9]	COL[8]
A9	COL[8]	COL[7]
A8	COL[7]	COL[6]
A7	COL[6]	COL[5]
A6	COL[5]	COL[4]

Table continues on the next page...

Table 35-4. Address decoding—bank interleaving off (continued)

AXI ADDRESS	x16 DDR	x32 DDR
A5	COL[4]	COL[3]
A4	COL[3]	COL[2]
A3	COL[2]	COL[1]
A2	COL[1]	COL[0]
A1	COL[0]	—
A0	—	—

Table 35-5. Address decoding—bank interleaving on

AXI ADDRESS	x16 DDR	x32 DDR
A29	—	ROW[14]
A28	ROW[14]	ROW[13]
A27	ROW[13]	ROW[12]
A26	ROW[12]	ROW[11]
A25	ROW[11]	ROW[10]
A24	ROW[10]	ROW[9]
A23	ROW[9]	ROW[8]
A22	ROW[8]	ROW[7]
A21	ROW[7]	ROW[6]
A20	ROW[6]	ROW[5]
A19	ROW[5]	ROW[4]
A18	ROW[4]	ROW[3]
A17	ROW[3]	ROW[2]
A16	ROW[2]	ROW[1]
A15	ROW[1]	ROW[0]
A14	ROW[0]	BANK[2]
A13	BANK[2]	BANK[1]
A12	BANK[1]	BANK[0]
A11	BANK[0]	COL[9]
A10	COL[9]	COL[8]
A9	COL[8]	COL[7]
A8	COL[7]	COL[6]
A7	COL[6]	COL[5]
A6	COL[5]	COL[4]
A5	COL[4]	COL[3]
A4	COL[3]	COL[2]
A3	COL[2]	COL[1]
A2	COL[1]	COL[0]
A1	COL[0]	—
A0	—	—

NOTE

In cases where this is an access to a non-initialized or disconnected chip select, behavior may be unexpected.

35.4.4.2 Chip select settings

MMDC drives the incoming access to either CS0 or CS1 by comparing the 7 most significant address bits (ARADDR[31:25]/AWADDR[31:25]) with MDASP[CS0_END].

Generally, the total density per chip-select must be a power of two and the total density must be the same for each chip-select.

[Creating 4 Gbyte address space with 2 Gbyte CS density](#) and [Creating 2 Gbyte address spaces with 1 Gbyte CS density](#) show how to create a continuous address space and configure the MMDC accordingly.

35.4.4.2.1 Creating 4 Gbyte address space with 2 Gbyte CS density

If the DDR memory space allocation is 4 Gbytes, only one configuration of chip select partition is allowed. The register MDASP[CS0_END] should be set to 2 Gbytes partition (16Gb).

The figure below shows the associated memory space.

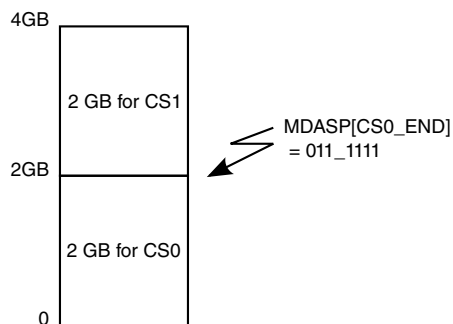

Figure 35-2. Chip select partition—2 Gbytes per chip select

35.4.4.2.2 Creating 2 Gbyte address spaces with 1 Gbyte CS density

If the DDR memory space allocation is 2 Gbytes, there are three options for configuring the chip select partition: MDASP[CS0_END] to 001_1111 (1 Gbyte), MDASP[CS0_END] to 011_1111 (2 Gbytes), and MDASP[CS0_END] to 101_1111 (3 Gbytes).

If DDR memory space allocation is 2 Gbytes, there are three options for configuring the chip select partition:

- MDASP[CS0_END] to 001_1111 (1 Gbyte)
- MDASP[CS0_END] to 011_1111 (2 Gbytes)
- MDASP[CS0_END] to 101_1111 (3 Gbytes)

The figure below shows the associated memory space:

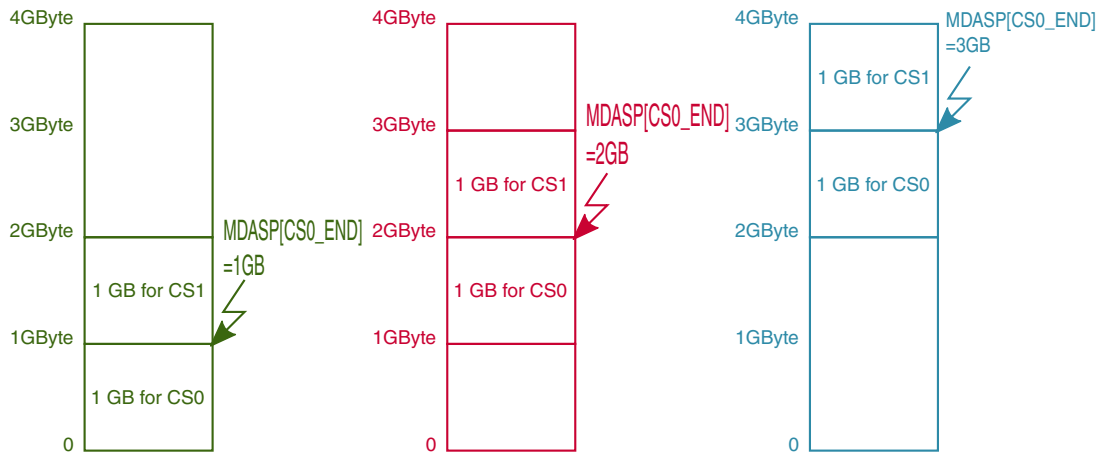

Figure 35-3. Chip select partition—1 Gbyte per chip select

35.4.4.3 Translation of AXI accesses to DDR accesses

35.4.4.3.1 Example 1

Assume the AXI read access has the following attributes:

- Wrap (arburst[1:0] = 10b)
- AXI size of 128 bits (arsize[2:0] = 100b)
- AXI length of 8 (arlen[3:0] = 0111b)
- AXI address with suffix B0h (non-aligned to AXI wrap boundary which is $16B \times 8 = 128B = 0x80$)

Toward DDR3(MDMISC[DDR_TYPE] = 00b) with the following attributes:

- x32 (MDCTL[DSIZ] = 01b)
- burst length of 8 (MDCTL[BL] = 1b)

In this case, the AXI wrap boundary is every $16B \times 8 = 128B$ (0x80) and the DDR wrap boundary is every $4B \times 8 = 32B$ (0x20).

The master expects to fetch the data that is associated with the following addresses: 0xB0, 0xC0, 0xD0, 0xE0, 0xF0, 0x80, 0x90, 0xA0.

The first aligned AXI address that is associated with suffix 0xB0 is with suffix 0x80, and the last wrap AXI address is with suffix 0xFF. Because the AXI master expects to get the first data from AXI address with suffix 0xB0, the MMDC issues the following accesses toward the DDR:

- Read access toward logic address with suffix 0xA0 (DDR boundary is 0x20 and 0xA0 is the closest to 0xB0)

NOTE

Logic address is the address of the column normalized to 1 byte.

- Read access toward logic address with suffix 0xC0
- Read access toward logic address with suffix 0xE0
- Read access toward logic address with suffix 0x80

The MMDC breaks the AXI access into four DDR accesses and returns the read data associated with address 0xB0 to the master first. The read data fetched from address 0xA0 is stored in the internal buffers and is driven back to the master at the end.

35.4.4.3.2 Example 2

Assume the AXI write access has the following attributes:

- Increment (awburst[1:0]=2'b01)
- AXI size of 64bits (awsize[2:0]=3'b011)
- AXI length of 8 (awlen[3:0]=4'b0111)
- AXI address with suffix 0xB0 (aligned as the size of the increment is 8B)

Toward DDR3(MDMISC[DDR_TYPE]=2'b00) with the following attributes:

- x64 (MDCTL[DSIZ]=2'b10)
- burst length of 8 (MDCTL[BL]=1'b1)

In this case, the AXI alignment is every 8B and the DDR boundary is every 8Bx8=64B(0x40).

The master expects to write the data to the following addresses: 0xB0, 0xB8, 0xC0, 0xC8, 0xD0, 0xD8, 0xE0, 0xE8.

The MMDC will issue the following accesses toward the DDR:

Functional Description

- Write access toward logic address with suffix 0x80 (DDR boundary is 0x40 and 0x80 is the closest to 0xB0) while address 0x80 to 0xAF are masked by DM (data masking signal).

NOTE

Logic address is the address of the column normalized to 1 byte.

- Write access toward logic address with suffix 0xC0 while addresses 0xF0 through 0xFF are masked by DM (data masking signal)

The MMDC will break the AXI access into two DDR accesses.

35.4.4.3.3 Example 3

Assume the AXI write access has the following attributes:

- Wrap (awburst[1:0]=2'b10)
- AXI size of 128bits (awsize[2:0]=3'b100)
- AXI length of 4 (awlen[3:0]=4'b0011)
- AXI address with suffix 0x80 (aligned)

Toward DDR3(MDMISC[DDR_TYPE]=2'b00) with the following attributes:

- x64 (MDCTL[DSIZ]=2'b10)
- burst length of 8 (MDCTL[BL]=1'b1)

In this case, the AXI wrap boundary is every $16B \times 4 = 64B$ (0x40) and the DDR wrap boundary is every $8 \times 8 = 64B$ (0x40).

The master expects to write the data to the following addresses: 0x80, 0x90, 0xA0, 0xB0.

Because the AXI wrap boundary and DDR wrap boundary are similar and the starting AXI address is aligned, the MMDC will issue only one access toward the DDR as follows:

- Write access towards logic address with suffix 0x80

NOTE

Logic address is the address of the column normalized to 1 byte.

35.4.4.3.4 Example 4

Assume the AXI write access has the following attributes:

- Increment (awburst[1:0]=2'b01)

- AXI size of 64bits (awsize[2:0]=3'b011)
- AXI length of 2 (awlen[3:0]=4'b0001)
- AXI address with suffix 0x5 (non aligned)

Toward DDR3(MDMISC[DDR_TYPE]=2'b00) with the following attributes:

- x32 (MDCTL[DSIZ]=2'b10)
- burst length of 8 (MDCTL[BL]=1'b1)

In this case the AXI alignment is every 8B (0x8) and the DDR boundary is every 4Bx8=32B(0x20).

The master expects to write the data to the following addresses: 0x5 (with WSTRB=0xE0), 0x8 (till 0xF).

The MMDC will issue one access toward the DDR as follows:

Write access toward logic address with suffix 0x0 (DDR boundary is 0x20 and 0x0 is the closest to 0x0) while address 0x0 till 0x4 are masked by DM (data masking signal) and address 0x10 till 0x1F are also masked by DM.

35.4.4.3.5 Example 5

Assume AXI write access has the following attributes:

- Increment (awburst[1:0]=2'b01)
- AXI size of 64bits (awsize[2:0]=3'b011)
- AXI length of 7 (awlen[3:0]=4'b0001)
- AXI address with suffix 0x10 (aligned)

Toward DDR3 (MDMISC[DDR_TYPE]=2'b00) with the following attributes:

- x64 (MDCTL[DSIZ]=2'b10)
- burst length of 8 (MDCTL[BL]=1'b1)

In this case the AXI alignment is every 8B (0x8) and the DDR boundary is every 8Bx8=64B(0x40).

The master expects to write the data to the following addresses: 0x10, 0x18, 0x20, 0x28, 0x30, 0x38, 0x40, 0x48.

Because the AXI access is not aligned to DDR boundary, which is every 0x40, the MMDC will issue two accesses toward the DDR as follows:

- Write access toward logic address with suffix 0x0 while address 0x0 till 0xF are masked by DM (data masking signal).

NOTE

Logic address is the address of the column normalized to 1 byte.

- Write access towards logic address with suffix 0x40 while addresses 0x50 till 0x7F are masked by DM (data masking signal).

35.4.4.4 Address mirroring

When enabling this feature, address bits DRAM_A3, DRAM_A4, DRAM_A5, DRAM_A6, DRAM_A7, DRAM_A8, DRAM_SDBA0, and DRAM_SDBA1 behave differently according to the associated chip select.

This feature facilitates PCB board routing for devices on chip select 1, which are typically populated on the opposite side of the PCB from the devices on chip select 0.

NOTE

This feature will not be supported for DDR3 since only a single chip select is supported for DDR3

The following table specifies the address mirroring options:

Table 35-6. Address mirroring options

MMDC pin	Chip select 0 pin	Chip select 1 pin
DRAM_A3	DRAM_A3	DRAM_A4
DRAM_A4	DRAM_A4	DRAM_A3
DRAM_A5	DRAM_A5	DRAM_A6
DRAM_A6	DRAM_A6	DRAM_A5
DRAM_A7	DRAM_A7	DRAM_A8
DRAM_A8	DRAM_A8	DRAM_A7
DRAM_SDBA0	DRAM_SDBA0	DRAM_SDBA1
DRAM_SDBA1	DRAM_SDBA1	DRAM_SDBA0

35.4.5 LPDDR2 and DDR3 pin mux mapping

The following table shows the pin mux mapping between LPDDR2 and DDR3. The i.MX DDR I/O pads corresponds with the DDR3 standard.

- In DDR3, all DRAM_DATA, DRAM_SDQS, and DRAM_DQM data lines work with channel 0.
- In LPDDR2, DRAM_DDQS[3:0], DRAM_DATA[31:0] and DRAM_DQM[3:0] work with channel 0. DRAM_SDQS[7:4], DRAM_DATA[63:32], and DRAM_DQM[7:4] work with channel 1.

Table 35-7. LPDDR2 and DRAM pin mux mapping

DRAM I/O pad	LPDDR2 I/O pad
DRAM_ADDR00	LPDDR2_CA0
DRAM_ADDR01	LPDDR2_CA1
DRAM_ADDR02	LPDDR2_CA2
DRAM_ADDR03	LPDDR2_CA3
DRAM_ADDR04	LPDDR2_CA4
DRAM_ADDR05	LPDDR2_CA5
DRAM_ADDR06	LPDDR2_CA6
DRAM_ADDR07	LPDDR2_CA7
DRAM_ADDR08	LPDDR2_CA8
DRAM_ADDR09	LPDDR2_CA9
DRAM_ADDR10	—
DRAM_ADDR11	—
DRAM_ADDR12	—
DRAM_ADDR13	—
DRAM_ADDR14	—
DRAM_ADDR15	—
DRAM_CAS_B	—
DRAM_RAS_B	—
DRAM_WE_B	—
DRAM_SDCKE0	LPDDR2_CKE0
DRAM_SDCKE1	LPDDR2_CKE1
DRAM_CS_B0	LPDDR2_CS_B0
DRAM_CS_B1	LPDDR2_CS_B1
DRAM_ODT0	LPDDR2_ODT0
DRAM_ODT1	LPDDR2_ODT1
DRAM_SDCLK0_P	LPDDR2_CK0
DRAM_SDCLK1	LPDDR2_CK1
DRAM_BA0	—
DRAM_BA1	—
DRAM_BA2	—

35.4.6 Power Saving and Clock Frequency Change modes

35.4.6.1 Power saving general

MMDC supports multiple DDR power saving modes.

NOTE

At default, the power saving modes are disabled. These modes may dramatically decrease the power consumption of DDR memories.

1. Self-refresh entry to the entire DDR device (for both chip select 0 and 1) can be activated through two mechanisms:
 - LPMD (Low Power Mode)
 - Hardware handshaking (LPMD/LPACK) with the clock module in the system
 - Software handshaking by setting the field MAPSR[LPMD] and polling MAPSR[LPACK]
 - Automatic entry by configuring the amount of idle cycle for triggering self-refresh entry through MAPSR[PST] and by clearing MAPSR[PSD]
 - DVFS (Dynamic Voltage and Frequency Change)
 - Hardware handshaking (DVFS/DVACK) with the clock module in the system
 - Software handshaking by setting the field MAPSR[DVFS] and polling MAPSR[DVACK]

NOTE

If hardware or software requests for self-refresh entry were detected by the MMDC (even before the assertion of the LPACK), no write or read accesses will be acknowledged until the deassertion of those requests.

2. Automatic active/precharge power down entry to a specific chip select can be activated by configuring the ESDPDC register:
 - PWDT_0/PWDT_1 - define the number of idle cycles before entering power down, can be different value per chip select.
 - SLOW_PD - In case of DDR3 memory is configured to use slow precharge power down then this bit should be set as well.
 - BOTH_CS_PS - The MMDC can either set each chip select independently to power down, according to its idle state, or set both chip selects to power down only if both in idle state for the configured period.
 - Few parameters must be configured in addition:

- Timing parameters at MDCFG0[tXP and tXPDLL].
- ODT timing at MDOTC[tAOFPD, tAONPD, tANPD and tAXPD]

NOTE

It is possible to enter certain chip selects to low power consumption while the second chip select is activated.

3. Automatic precharge of all DDR banks to a specific chip select. Can be activated by configuring ESDPDC fields: PRCT_0 and PRCT_1. Each field determines a value loaded to a different chip select.

35.4.6.2 Self refresh and Frequency change entry/exit

As described in [Power saving general](#), the MMDC supports two mechanisms that will cause the DDR device to enter self-refresh mode:

- LPMD (Low Power Mode) - For power saving purposes
- DVFS (Dynamic Voltage and Frequency Change) - For clock frequency changes

While the DDR device is in self-refresh mode, there is no need to provide periodic refresh commands.

The MMDC treats hardware/software handshaking of LPMD/DVFS in the same manner:

- Upon the assertion of LPMD/DVFS request, the following is done:
 - The MMDC blocks any further AXI accesses even before the acknowledge is asserted
 - Completes all opened AXI accesses
 - Closes (precharge) all banks in the appropriate timing
 - Drives self-refresh command by deasserting clock enable signal (DRAM_SDCKE is driven to "0") together with a refresh command. This occurs after satisfying tRP/tRPA from the precharge all command.
 - Deasserts the clock (CK) that is driven to the DDR device
 - Asserts LPMD/DVFS acknowledge (LPACK/DVACK)
 - Allows deassertion of the operating clock of the MMDC (AXI clock)
- Upon the deassertion of LPMD/DVFS request, the following is done:
 - Operating clock of the MMDC must be turned on before LPMD/DVFS is deasserted
 - Starts driving the clock (CK) to the DDR device
 - After satisfying tCKSRX from clock renewal the clock enable signal (DRAM_SDCKE) is asserted
 - LPMD/DVFS acknowledge (LPACK/DVACK) is deasserted

Functional Description

- After satisfying t_{XS} from the assertion of `DRAM_SDCKE`, a refresh command is driven to the DDR device.
- If ZQ calibration is enabled then t_{RFC} is satisfied from the refresh command and a long ZQ command is driven.
- t_{ZQoper} idle cycles are counted after the ZQ command.
- After satisfying t_{DLLK} from the assertion `DRAM_SDCKE`, the MMDC returns to normal operation.

The figure below shows the timing diagram of the hardware/software handshaking of LPMD/DVFS:

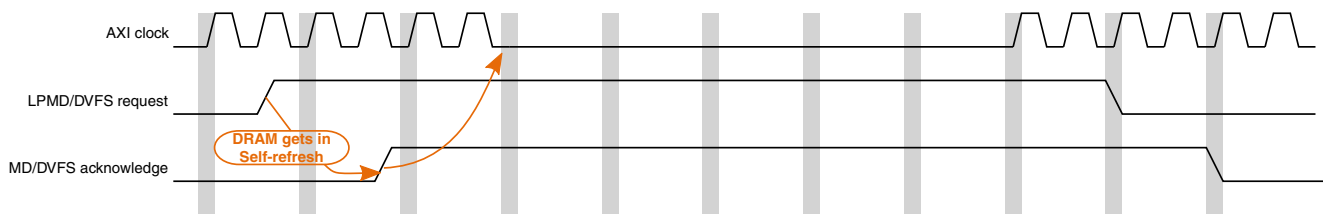

Figure 35-4. LPMD/DVFS Hardware/Software Handshaking

Note for self-refresh:

- As soon as LPMD or DVFS requests are detected by either hardware or software handshaking, the MMDC will deassert the `AXI ARREADY/AWREADY` signals immediately to block further requests from the system.
- In case of automatic self-refresh, the internal operating clock will be negated to save power.

35.4.7 Reset

35.4.7.1 Hard reset

When hard reset is asserted (`aresetn` is driven to "0") while warm reset is deasserted (`warm_reset` is driven to "0"), the entire MMDC will be initialized, including configuration/status registers and state machines.

In order to access the DDR device, the MMDC will then have to be reconfigured.

35.4.7.2 Warm reset

The MMDC supports warm reset signal. The warm reset signal must envelop the hard reset signal and then the MMDC will reset all the internal registers. The only registers that are not reset are those that are essential for returning it to normal operation without repeating the initialization sequence and without losing data stored in the memory (configuration/status registers won't be initialized).

For the successful operation of warm reset, the following steps must be performed:

- The MMDC must enter self-refresh mode. This can be achieved by either LPMD or DFVS requests
- Wait for LPMD or DVFS acknowledge
- Assert warm reset signal (i.e. drive warm_reset to "1")
- Assert hard reset signal (i.e. drive aresetn to "0")
- Deassert hard reset signal
- Deassert warm reset
- Get out of the LPMD/DVFS mode

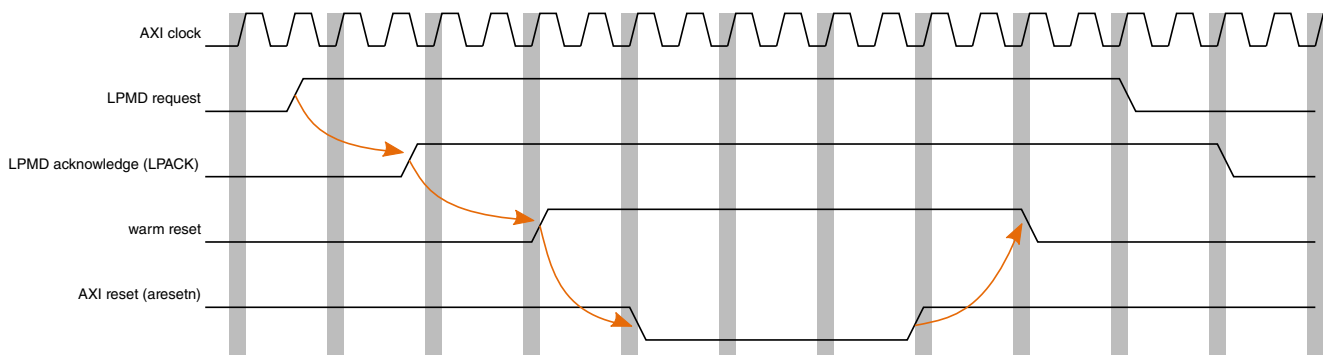

Figure 35-5. Warm Reset Diagram

35.4.7.3 Software reset

The MMDC supports software reset. When software reset is configured then the MMDC will reset all the internal registers except those that are essential for returning to normal operation without repeating the initialization sequence or without losing data stored in the memory (configuration/status registers won't be initialized).

The following steps should be performed for successful operation of software reset:

- The MMDC should enter self-refresh mode. This can be achieved by either LPMD or DFVS request.
- Wait for LPMD or DVFS acknowledge

Functional Description

- Assert software reset, by setting MDMISC[RST]
- Get out of the LPMD/DVFS mode

Normal operation can be resumed.

35.4.8 Refresh Scheme

The MMDC supports various automatic refresh options which can be configured via the MDREF register.

The periodic auto refresh can be triggered by the following clocks:

- 32 kHz clock
- 64 kHz clock
- MMDC operating clock

The refresh scheme of the MMDC is flexible and allows the system to configure the desired AXI accesses delay/latency in each refresh cycle.

The table below shows an example of four configurations of the refresh cycles that will be handled by the MMDC. Each configuration meets a refresh rate of $3.9\mu\text{s}$ (t_{REFI} , refresh command every $3.9\mu\text{s}$).

Table 35-8. MMDC Refresh Scheme

Option number	Description	REFR	REF_SEL	REF_CNT	DDR hang time
1	Issue 8 refresh commands every 31,250 ns	0x7 (8 refreshes)	0x0 (64 kHz)	not needed	$t_{\text{RFC}} \times 8$
2	Issue 4 refresh commands every 15,625ns	0x3 (4 refreshes)	0x1(32 kHz)	not needed	$t_{\text{RFC}} \times 4$
3	Issue 2 refresh commands every 7800ns	0x1(2 refreshes)	0x2 (REF_CNT)	$7800/2.5 = 3120$ (0xC30)	$t_{\text{RFC}} \times 2$
4	Issue 1 refresh command every 3900 ns	0x0 (1 refresh)	0x2 (REF_CNT)	$3900/2.5 = 1560$ (0x618)	t_{RFC}

35.4.9 Burst Length options towards DDR

The MMDC supports burst lengths which can be configured through MD+CTL[BL] as follows:

- In DDR3 mode, only burst length 8 can be used.
- In LPDDR2 mode, only burst length 4 can be used.

In DDR3 mode read/write accesses to the DDR are always 8 words (x16) and aligned in according to JEDEC standards.

In case of AXI INCREMENT, accesses that are not aligned the irrelevant data is masked in write accesses and ignored in read accesses. In case of AXI WRAP accesses, even if the access is not aligned, then the MMDC provides an internal optimization mechanism for better efficiency of the DDR data bus.

35.4.10 Exclusive accesses handling

The MMDC contains four exclusive monitors, each for dedicated ID as configured in MAEXIDR0 and MAEXIDR1.

- If legal read exclusive is received by the MMDC, the associated monitor is turned on.
- While the monitor is turned on upon legal write exclusive, the monitor will be turned off and the write will be completed successfully with EXOKAY.
- The following rules must be met for successful exclusive access:
 - Aligned access (the AXI address is aligned to the AXI size)
 - AXI single access (AXI burst length isn't greater than 1)
 - AXI size of up to 64 bits
 - AXI non-cachable access (i.e. ARCACHE[1]/AWCACHE[1] is equal "0" or ARCACHE[1]/AWCACHE[1] is equal "1" while ARCACHE[3:2]/AWCACHE[3:2] are equal "00")
 - AXI ID that matches one of the four exclusive IDs

Exclusive read behavior (first bullet also correct for non-exclusive accesses):

- In case of security violation, the read is blocked and is not sent to DDR. There are two options for response:
 - If ARCR_SEC_ERR_EN (MAARCR[30]) is high, SLV error is issued towards the Master, otherwise OKAY response is sent to the Master.
- If AXI exclusive rules violation occurs (as described above), the read access is not blocked and is sent to DDR. The data will be fetched and be driven to the master, but the type of response may be unpredicted.
- If none of the above occurs, the read is sent to the DDR. The exclusive monitor will be turned on and the response is EXOKAY
- If additional legal AXI read exclusive is received with the same ID before the AXI exclusive write, the monitor will be updated with the latest attributes.

Exclusive write behavior (first bullet also correct for non-exclusive accesses):

- In case of security violation, the write is blocked and is not sent to DDR, but the monitor will be kept on. There are two options for response:
 - If ARCR_SEC_ERR_EN (MAARCR[30]) is high then SLV error is issued towards the Master, otherwise OKAY response is sent to the Master.
- In case of AXI exclusive rules violation (as described above), the write is blocked and is not sent to DDR. In that case the type of response may be unpredictable.
- In case the exclusive write access has different AXI attributes, but the same ID as the read exclusive access, the write is blocked and is not sent to DDR and the monitor will be turned off. There are two options for response:
 - If ARCR_EXC_ERR_EN (MAARCR[28]) is high then SLV error is issued towards the Master, otherwise OKAY response is sent to the Master.
- In case of regular (non exclusive) write access is received to the same address or overlapping addresses then the write will be sent to the DDR and the monitor will be turned off.
- In case of legal write exclusive access is received with the same attributes as the read exclusive access while the monitor is on (no write accesses occurred to the same address between the read exclusive and write exclusive), then the write is sent to DDR and the response is EXOKAY. But, if the legal write exclusive is received while the monitor is off, the write is blocked and there are two options for response.
 - If ARCR_EXC_ERR_EN (MAARCR[28]) is high then SLV error is issued towards the Master, otherwise OKAY response is sent to the Master.

35.4.11 AXI Error Handling

The MMDC supports the AXI responses listed here.

- In case of AXI exclusive violation there are two options for response:
 - If MAARCR[28] is high then SLV Error is issued towards the Master, Otherwise OKAY response is sent to the Master

NOTE

In case of read error MMDC drives zeros on the read data bus

35.5 Performance

35.5.1 Arbitration and reordering mechanism

35.5.1.1 Arbitration General

The following specifies arbitration and reordering flow in MMDC towards the DDR.

- AXI read and write accesses are sampled in the associated queue.
- Read/write arbitration is handled to select the winning access.
- Winning access is sampled in the reordering queue
- Reordering mechanism is handled between valid requests that reside in the reordering queue to select the access that will be dispatched to the DDR.
 - The reordering is held in order to optimize the accesses and to maximize the utilization of the DDR bus
 - As soon as the reordered access is completed (indicated by end of response or data phase) then it is erased from the associated queue and the MMDC is ready to receive the next available access from the master

In general, the reordering/arbitration mechanism is based on dynamic priority mechanism, which compares dynamic priorities between valid entries in the reordering queue and issues the entry with highest dynamic priority towards the DDR Logic.

The selection of the winning access is based on two modes, which can be activated together, as following:

- Real time channel mode:
 - Accesses with QoS='f' (i.e. awqos[3:0]/arqos[3:0] = "f") will bypass all other requests towards the DDR
- Dynamic scoring mode:
 - The arbitration mechanism is based on dynamic priority. Relevant for the accesses with QoS smaller than 'f' or when real time channel mode is disabled.

NOTE

Due to re-ordering and optimization mechanism (per different AXI ID), the transactions towards the DDR may be driven in a different ID order they were received by the AXI master. In similar way, the write response, read response or read data may be driven to the AXI master in a different ID order.

35.5.1.2 Real time channel mode

When real time mode is enabled (i.e. MAARCR[ARCR_RCH_EN] = "1") , all requests with QoS='f' (i.e. awqos[3:0]/aqos[3:0] = "f") will bypass all other pending accesses towards the DDR. This mode is enabled by default.

35.5.1.3 Dynamic scoring mode (Arbitration Winning Conditions)

The arbitration between pending accesses in the MMDC is handled according to a dynamic priority of each access.

The dynamic priority (may be also called score) is calculated according to a sum of some factors (final_score[3:0]), where part of them may be updated dynamically. The following will specify each scoring factor:

- MAARCR[ARCR_PAG_HIT] (Page hit score) - A static score which is taken into account in case the pending access has a page hit
- MAARCR[ARCR_ACC_HIT] (Access hit score) - A static score, which is taken into account in case the current access type (read/write) is the same as the access that has been dispatched to the DDR previously
- MAARCR[ARCR_DYN_JMP] (Dynamic jump score) - A dynamic score which is given to any pending access in case it was not chosen in the arbitration. The dynamic jump counter is limited by maximum value which is set in MAARCR[ARCR_DYN_MAX].
- QoS score which is indicated through a sideband 4bits AXI signals (awqos[3:0]/ aqqos[3:0]) and is driven by the AXI master per access

NOTE

In order to prevent an overflow in the total sum of scores, a clipping is held and selects the maximum score value of 'f' once a total scores sum is greater than 'f'.

The figure below shows the dynamic score calculations

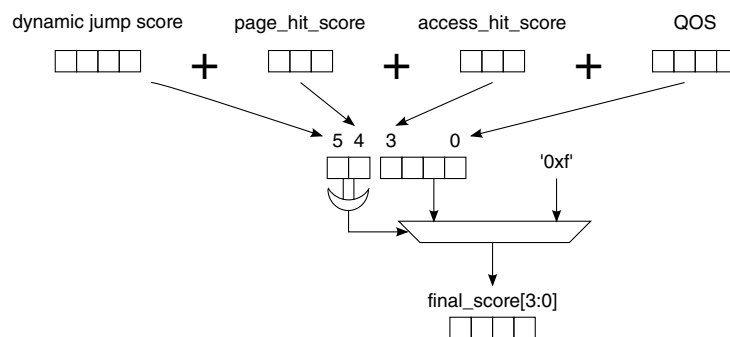

Figure 35-6. Dynamic score/priority calculation

35.5.1.4 Guarding (aging) mechanism

The guarding mechanism (may be also called aging) is used to prevent a starvation of accesses.

As soon as the dynamic jump score reaches its maximum value (MAARCR[ARCR_DYN_MAX]) then each time a pending request was not chosen in the arbitration, the "guarding" counter is incremented by 1. When the "guarding" counter reaches its predefined value, set in MAARCR[ARCR_GUARD], the associated request gets the highest priority and will be chosen in the next arbitration cycle towards the DDR unless a real time channel (i.e access with QoS ="f") is arrived.

Note: In case real time channel has arrived then the dynamic score of the non real time channels won't increment in order to prevent a case where the "guarding" counter of more than one access has reached its limit.

35.5.2 Prediction mechanism

When prediction mechanism is enabled (i.e by configuring MDMISC[MIF3_MODE]) then the MMDC predicts the chip-select, bank address and row address that is going to be issued towards the DDR before the access is physically dispatched towards DDR device.

That mechanism enables to prepare the DDR device with future accesses and improves the overall DDR performance.

This prediction mechanism operates in parallel to the reordering mechanism and may yield a prediction based on 3 levels of pending accesses:

1. Access in first stage of pipeline.
2. Valid access on AXI bus either read channel or write channel.
3. Valid access on special bus from arbitration - this access is chosen by the arbitration as the next miss access in its buffers

35.5.3 Special Optimization for accesses towards DDR3

In case an AXI read/write wrap non-aligned access is acknowledged in DDR3 mode with the same wrap boundary as the DDR wrap boundary then the MMDC will make an optimization and issue only one access towards the DDR, although all the accesses towards the DDR3 must be aligned.

For example: AXI write access with size of 128bits (awsiz[2:0]=3'b100), length of 4 (awlen[3:0]=4'b0011) towards DDR3 x64 (burst length 8). In that case the AXI wrap boundary is 16Bx4=64B (0x40) and the DDR3 wrap boundary is 8Bx8=64B (0x40). If, for example, the AXI access is towards AXI address with suffix of 0x10 (non-aligned to 64B boundary) then the MMDC will get from the AXI master the data that is associated with addresses 0x10, 0x20, 0x30, 0x0. The MMDC will rearrange internally the data so it

will match DDR3 alignment as following: 0x0, 0x10, 0x20, 0x30 and drive it in one access towards the DDR to address 0x0. The alternative was to issue two accesses towards the DDR with address 0x0 with different data masking

NOTE

In read wrap access the same optimization is handled, while as soon as the critical AXI word is fetched from the DDR then it is driven immediately to the AXI master without buffering. Based on the example above, the master expects to fetch first the data that is associated with address 0x10. Therefore the MMDC will issue read access from address 0x0 of the DDR and as soon as the data that is associated with address 0x10 is received then it will be driven back immediately to the master even before fetching the data of the further addresses.

35.6 MMDC Debug

35.6.1 Hardware debug monitor

The MMDC has a hardware debugging mechanism that monitors each access that is driven to the MMDC. Every time this mechanism is enabled (setting of MADPCR0[DBG_EN] to "1") then each access that will be dispatched to the DDR will be also observed in the I/O pads (i.e. over ipp_do_ddr_debug[50:0]). The content of this bus is described in the table below.

Table 35-9. Hardware monitor debugging

Signal Name	Number of Bits	Description
acc_addr	[31:0]	AXI ADDRESS of the selected access
acc_type	1	access type of the selected access. "0" indicates write. "1" indicates read.
acc_id	[15:0]	AXI transaction ID of the selected access
valid_strobe	1	indication for a valid request. This signal will be asserted for 1 clock cycle

The fields above are organized as following:

MMDC_DEBUG[50:0] = { 1'b0,valid_strobe,acc_id,access_type,addr }

These signals are sent to IOMUX, in IOMUX user can configure it to be output from the chip for debug usage.

35.6.2 Step By Step (SBS) software monitor

The MMDC has a Step By Step (SBS) software debugging mechanism that monitors each access that is driven to the MMDC. Every time this mechanism is triggered then one AXI access will be dispatched to the DDR and in parallel its attributes will be observed in a status register.

Once the "step by step" is enabled (i.e. MADPCR0[SBS_EN] is "1") then all accesses to the DDR device will be halted. This SBS feature is used during DDR SDCLK frequency scaling to prevent any accesses to the DDR device during the transition. Setting MADPCR0[SBS] to "1" will dispatch the access that is pending in the head of the MMDC queue (read or write). Upon every setting of MADPCR0[SBS]:

- The AXI attributes of the access will be sampled in the associated MASBS0 and MASBS1 fields
- MADPCR0[SBS] will be cleared automatically.

Setting again MADPCR0[SBS] to "1" will dispatch the next pending access in the MMDC queue.

NOTE

Setting the ARCR_ARB_REO_DIS bit in the MMDC0_MAARCR Register disables the SBS function

35.7 MMDC Profiling

The profiling mechanism provides the ability to calculate the DDR utilization together with read and write accesses statistics towards DDR per given period of time.

MMDC supports the following profiling counters:

- MADPSR0 (Total cycles count) - Indicates the total amount of cycles of the profiling period (up to 2^{32} cycles)
- MADPSR1 (Busy cycles count) - Indicates the total busy cycles during the profiling period. Busy cycles are any MMDC clock cycles where the internal state machine is not idle. If any read or write requests are pending in the FIFOs, the MMDC is not idle.
- MADPSR2 (Total read accesses count) - Indicates the total read accesses towards MMDC during the profiling period
- MADPSR3 (Total write accesses count) - Indicates the total write accesses towards MMDC during the profiling period

- MADPSR4 (Total read bytes count) - Indicates total bytes that were read from MMDC during the profiling period
- MADPSR5 (Total write bytes count) - Indicates total bytes that were written to MMDC during the profiling period

All profiling items described above are disabled by default. The following describes how to control the profiling mechanism:

- MADPCR0[DBG_EN] enables profiling.
- MADPCR0[PRF_FRZ] stops/freezes the profiling for example in case user wishes to perform DDR profiling per specific task. In order to resume profiling then MADPCR0[PRF_FRZ] should be cleared.
- MADPCR0[DBG_RST] clears all profiling counters
- MADPCR0[CYC_OVF] indicates whether an overflow occurred in the total cycles counter (i.e. total amount of cycles are greater than 2^{32}). This field can only be cleared by writing '0'.

Read/Write statistics can be collected per specific AXI ID (16bits). The following fields in MADPCR1 register determine which AXI-ID or AXI-ID's to monitor:

- PRF_AXI_ID defines which AXI IDs are taken for profiling. Default value is 16'h0.
- PRF_AXI_ID_MASK defines which bits from PRF_AXI_ID will be compared with AXI ID of read/write access. "1" means to monitor the associated bit and "0" means don't care. Default value is 16'h0000, meaning all IDs are not monitored

So the AXI-IDs to be monitored are calculated according to the following equation:

$$(AXI-ID \& PRF_AXI_ID_MASK) \text{ Xnor } (PRF_AXI_ID \& PRF_AXI_ID_MASK)$$

For example if AXI ID's between A100 till A1FF are wished to be monitored then the following should be configured:

- PRF_AXI_ID = A100
- PRF_AXI_ID_MASK = FF00

35.8 LPDDR2 Refresh Rate Update and Timing Derating

LPDDR2 devices may have a temperature sensor that is used to determine an appropriate refresh rate and whether AC timing derating is required. The status of the temperature sensor can be read through MRR command from LPDDR2 MR4 register.

The MMDC supports refresh update and timing derating mechanism on the fly. The following steps specify how to use that mechanism:

- Perform periodic polling on MR4 LPDDR2 register using MRR command

- Read MDMRR register and analyze the MR4 indication
- In case refresh rate update and/or AC timing derating is required then it is needed to update MDREF and/or MDMR4[tRCD_DE, tRC_DE, tRAS_DE, tRP_DE, tRRD_DE] parameters

NOTE

MDMR4[tRCD_DE, tRC_DE, tRAS_DE, tRP_DE, tRRD_DE] are referred to the associated values configured at MDCFG3LP[tRC_LP, tRP_LP, tRCD_LP], MDCFG1[tRAS], MDCFG2[tRRD]

- Assert MDMR4[UPDATE_DE_REQ]
- When the MMDC switch to the new values then an acknowledge will be indicated at MDMR4[UPDATE_DE_ACK]

The enabled power saving features may be interfering with the MR4 reads. When these features are enabled the MMDC will automatically enter self-refresh and hence prevent the MR4 reads. Hence the Power Saving and refresh functionality should be disabled when SW performs the MR4 reads.

To disable the “Power Down” mode, set bit 0 of MAPSR (0x021B0404) to 1'b.

To disable the “Self-Refresh Power Down Timer” mode, set bits [15:8] of MDPDC (0x021B0004) to 0x00.

Overall Sequence to Perform MR4 reads

1. Set MAPSR to 0x00010107
2. Set MDPDC to 0x00020076
3. MRR command to read MR4
4. Write MDPDC to 0x00025576 to re-enable this feature
5. Write MAPSR to 0x00010106 to re-enable this feature

35.9 DLL Switching

35.9.1 DLL Off mode

DLL Off mode is supported only in DDR3 and allows operation of the DDR in low frequency (i.e. below 125 MHz as defined in JEDEC standard).

For further details refer to DLL-off Mode chapter in the standard.

The following steps should be executed in order to switch from DLL on to DLL off mode:

- Assert CON_REQ signal and wait to CON_ACK assertion.
- Disable power down timers that can conflict with this sequence, such as: MAPSR[PSD], MDPDC[PWDT_1], MDPDC[PWDT_0], MDPDC[PRCT_0], MDPDC[PRCT_1].
- Execute precharge all banks command (via MDSCR).
- Execute MRW command to MR1 and disable RTT Nom (A9,A6,A2 =0) and DLL ON (A0 =1).
- Execute MRW command to MR2 in order to update CWL to 6.
- Execute MRW command to MR0 in order to update CL to 6.
- De-assert CON_REQ signal.
- Enter self refresh mode. For further information refer to [Self refresh and Frequency change entry/exit](#).
- At self refresh entry acknowledge , change to the desired frequency.
- Exit self refresh mode.
- Assert CON_REQ and wait to CON_ACK assertion.
- Enable Pull Down resistors on DQS (through the I/O-MUX).
- Configure the MMDC register as following:
- Update tCWL =6 and tCL =6 to meet the values configured in the DDR device. (MDCFG0, MDCFG1)
- Disable ODT resistor (i.e. set MPODTCTRL to "0").
- Disable DQS gating (i.e. set MPDGCTRL0[DG_DIS] to "1").
- Enable required power down timers that were disabled, such as: MAPSR[PSD], MDPDC[PWDT_1], MDPDC[PWDT_0], MDPDC[PRCT_0], MDPDC[PRCT_1].
- De-assert CON_REQ and wait for de-assertion of CON_ACK.

The following steps should be executed in order to switch from DLL off to DLL on:

- Execute precharge all banks command (via MDSCR).
- Enter self refresh mode. For further information refer to [Self refresh and Frequency change entry/exit](#).
- At self refresh entry acknowledge, change to the desired frequency.
- Exit self refresh mode
- Assert CON_REQ and wait to CON_ACK assertion.
- Disable power down timers that can conflict with this sequence, such as: MAPSR[PSD], MDPDC[PWDT_1], MDPDC[PWDT_0], MDPDC[PRCT_0], MDPDC[PRCT_1].
- Execute MRW command to MR1 and enable RTT Nom (A9,A6,A2) and DLL ON (A0 =0).
- Execute MRW command to MR0 to reset the DLL (A8) and update CL value
- Execute MRW command to MR2 in order to update CWL value.
- Execute ZQ commnad.
- Reconfigure MMDC BLOCK

- Update tCWL and tCL to meet the values configured to the memory. (MDCGFG0, MDCFG1)
- Enable ODT resistor (i.e. MPODTCTRL register)
- Enable DQS gating (i.e. set MPDGCTRL0[DG_DIS] to "0").
- Disable Pull Down resistors on DQS (through the I/O-MUX).
- Enable required power down timers that were disabled, such as: MAPSR[PSD], MDPDC[PWDT_1], MDPDC[PWDT_0], MDPDC[PRCT_0], MDPDC[PRCT_1].
- De-assert CON_REQ and wait for de-assertion of CON_ACK.

35.10 ODT Configuration

The MMDC supports one DRAM_ODT signal (DRAM_ODT for each DRAM_CS) in DDR3 mode to allow the DDR device to turn on/off its termination resistors. The MMDC suggests various configurations for the assertion of the ODT signal as well as several timing related configurations.

MDOTC register controls the timing for the DRAM_ODT signals assertion.

NOTE

tODTLon determines the delay between DRAM_ODT signal and the associated RTT, where according to JEDEC standard it equals WL(write latency) - 2. Therefore, the value configured to MDOTC[tODTLon] field should correspond with the value configured to MDCGFG1[tCWL].

In precharge power down mode, when all banks are closed, the assertion of ODT corresponds with tAOFPD and tAONPD which are configured in MDOTC register.

The figure below shows timing diagram of DRAM_ODT and RTT signals while MPODTCTRL[0] is set to "1" (i.e. assertion of DRAM_ODT to the non active DRAM_CS in write access command) and MDOTC[tODTLon] is set to 4.

Calibration Process

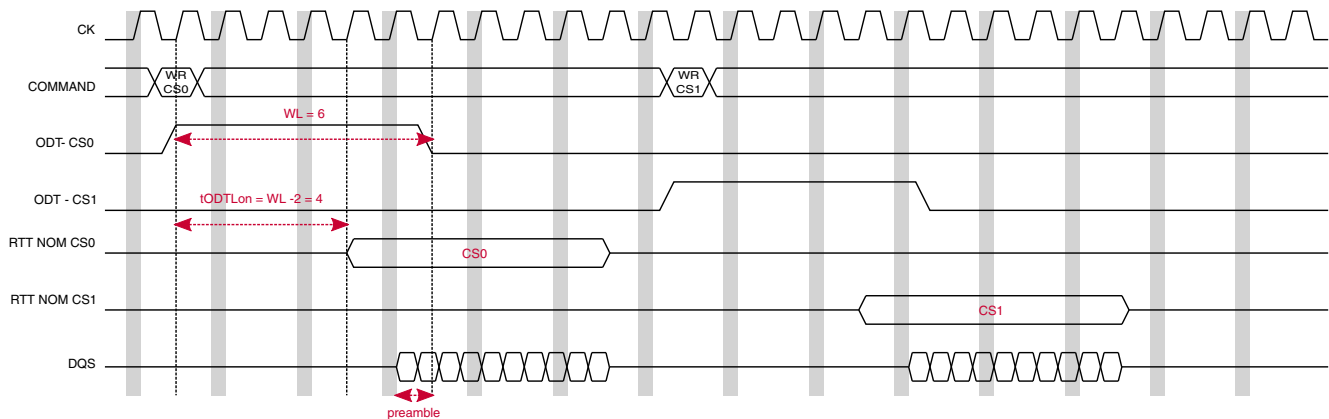

Figure 35-7. ODT - Timing Diagram DDR3 WL=6, BL=8

35.11 Calibration Process

The MMDC offers various calibration processes that are used to obtain better timing accuracy, board skew compensation and I/O pad driving strength adjustment. Each calibration process can be performed either automatically (hardware) or manually (software), though the manual method is typically reserved for debugging purposes. The following calibration processes are supported:

NOTE

Power saving features should be disabled before the calibration process begin. (Such as: MDPDC[PWDTn], MDPDC[PRCTn], MAPSR[PSD])

- ZQ calibration for external DDR device (in DDR3 through ZQ calibration command and in LPDDR2/LPDDR3 through MRW command)
 - Can be handled automatically for ZQ Short (periodically) and ZQ Long (at exit from self-refresh)
 - Can be handled manually at ZQ INIT
- ZQ calibration for i.MX DDR I/O pads for calibrating the DDR driving strength
 - The sequence can be handled automatically by hardware
 - The sequence can be handled step by step manually by software
- Read DQS gating calibration for DDR3 only. Adjustment of DQS gate with read preamble window. For further information refer to [Read DQS Gating Calibration](#)
- Read DQS gating calibration not supported for LPDDR2/LPDDR3
- Read data calibration. Adjustment of read DQS with read data byte. For further information refer to [Read Calibration](#)
- Write data calibration. Adjustment of write DQS with write data byte. For further information refer to [Write Calibration](#)

- Write leveling calibration. Adjustment of write DQS with CK (DDR differential clock). For further information refer to [Write leveling Calibration](#)
- Read fine tuning. Adjustment of up to 7 delay-line units for each read data bit.
- Write fine tuning. Adjustment of up to 3 delay-line units for each read data bit.

NOTE

Before starting any calibration process that involves the DDR3 device MPR mode or write leveling calibration, the following should be done:

- Disable the periodic refresh scheme (i.e. setting MDREF[REF_SEL] = "11") and then issue manual refresh command burst by configuring MDSCR[CMD]= 0x2. At the end of the calibration it is needed to enable the periodic refresh scheme.
- Disable the automatic power saving mode (i.e set MAPSR[PSD] = "1").

35.11.1 Delay-line

Each of the calibration processes controls several delay-lines for aligning data and strobcs.

By default the delay-line is configured to generate 1/4 clock cycle of delay.

Moreover, when the operating clock is at the maximum allowed frequency, as appeared in the features list, then the delay-line is capable to issue a configurable delay of up to 1/2 clock cycle.

NOTE

At the beginning of the calibration process the initial value of the delay-line must be a valid value (i.e. the strobcs must be somewhere among the associated data window) though it might not be the optimal value. The delay-line calibration should be done after Read DQS gating and write-leveling calibrations.

In order to generate an adequate delay during normal operation of the MMDC the delay-line is going through an automatic measurement process during the refresh period of the DDR device

35.11.2 ZQ calibration

The MMDC supports ZQ calibration process to calibrate the driving strength of the DDR I/O pads as well as driving ZQ commands to calibrate the external DDR device driving strength.

The first ZQ calibration (after booting the processor) is performed prior to turning on the MMDC. Subsequent ZQ calibrations may be executed in parallel to the DDR ZQ calibration. The MMDC supports 2 types of ZQ calibration commands: short and long.

The ZQ long calibration is executed during power up sequence, when exiting self-refresh mode or when exiting slow precharge power down (DLL lock can be done in parallel). The ZQ short calibration is executed periodically according to a configurable timer defined by `MPZQHWCTRL[ZQ_HW_PER]`.

The field `MPZQHWCTRL[ZQ_MODE]` determines whether the MMDC will execute ZQ calibration to DDR I/O pads and/or issue ZQ short/long command to the DDR device.

The MMDC supports both automatic (hardware) and manual (software) ZQ calibration process for the DDR I/O pads.

It is possible to perform automatic (hardware) ZQ calibration only once (i.e. non-periodical) by asserting `MPZQHWCTRL[ZQ_HW_FOR]`.

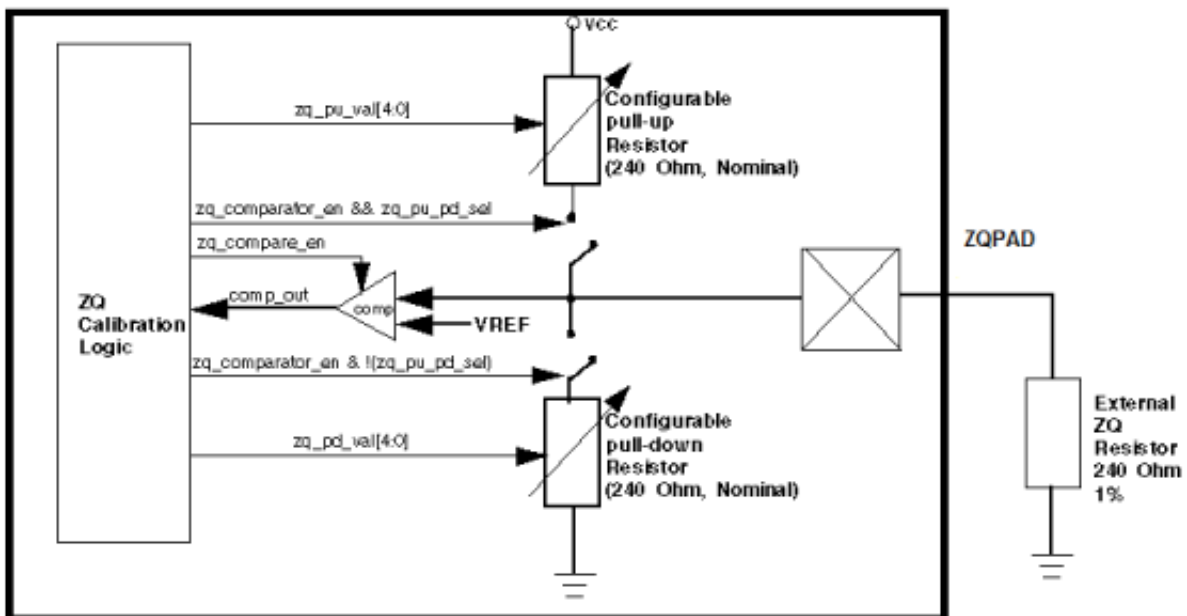

Figure 35-8. MMDC ZQ IF with PAD

35.11.2.1 ZQ automatic (hardware) calibration process

The ZQ automatic calibration occurs over multiple steps isolated by pull-up resistor calibration and by pull-down resistor calibration as follows.

35.11.2.1.1 ZQ automatic Pull-up calibration

The MMDC automatically performs a handshaking mechanism with the ZQ calibration pad as follows:

1. The MMDC drives `zq_comparator_en` to "1"
2. The MMDC waits few cycles according to `MPZQHWCTRL[ZQ_EARLY_COMPARATOR_EN_TIMER]`
3. The MMDC drives `zq_pu_pd_sel` to "1" for indication of pull-up calibration and drives `zq_pu_val[4:0] = 5'b00000`
4. MMDC drives `zq_pu_val[4]` to "1"
5. MMDC asserts `zq_compare_en`
6. MMDC waits few cycles according to `MPZQSWCTRL[ZQ_CMP_OUT_SMP]` before sampling the comparator output (i.e `zq_comp_out`). If `zq_comp_out` is "1" then it means that the output voltage is greater than $V_{dd}/2$ (i.e. internal resistor is less than 240 ohm) and drives bit `zq_pu_val[4]` to "1" else it drives `zq_pu_val[4]` to "0"
7. MMDC deasserts `zq_compare_en`
8. MMDC repeats steps 4-7 for `zq_pu_val` bits 3 to 0
9. MMDC drives ZQ calibration result to `MPZQHWCTRL[ZQ_HW_PU_RES]`
10. MMDC advances to pull-down calibration

35.11.2.1.2 ZQ automatic Pull-down calibration

1. The MMDC drives `zq_pu_pd_sel` to "0" for indication of pull-down calibration and drives `zq_pd_val[4:0] = 5'b00000`
2. MMDC drives `zq_pd_val[4]` to "1"
3. MMDC asserts `zq_compare_en`
4. MMDC waits few cycles according to `MPZQSWCTRL[ZQ_CMP_OUT_SMP]` before sampling the comparator output (i.e `zq_comp_out`). If `zq_comp_out` is "1" then it means that the output voltage is greater than $V_{dd}/2$ (i.e. internal resistor is less than 240 ohm) and drives bit `zq_pd_val[4]` to "0" else it drives `zq_pd_val[4]` to "1"
5. MMDC deasserts `zq_compare_en`
6. MMDC repeats steps 2-5 for `zq_pd_val` bits 3 to 0
7. MMDC drives ZQ calibration result to `MPZQHWCTRL[ZQ_HW_PD_RES]`
8. MMDC deassert `zq_comparator_en` to indicate the completion of the ZQ calibration

35.11.2.2 ZQ software calibration process

The ZQ calibration can be done also in software. However since software ZQ calibration is much slower than hardware calibration it should be used mainly for debugging.

Software should configure the ZQ calibration parameters (Pull-up or Pull-down and their value) then assert the MPZQSWCTRL[ZQ_SW_FOR] bit. Then software should wait till ZQ_SW_FOR is de-asserted and use ZQ_SW_RES status bit in order to calculate the next ZQ calibration parameters.

35.11.2.3 ZQ calibration commands

Before the MMDC can issue a ZQCL/ZQCS command to the memory it should precharge all memory banks and wait tRP period. A single ZQ command can be issued to all devices as long as the devices don't share the same ZQ resistor.

When the MMDC issues the ZQ command it should also drive A10 (long or short command) and CS (0, 1 or both).

The MMDC must keep the memory lines quiet (except for CK) for the ZQ calibration time as defined in the Jedec (512 cycles for ZQCL after reset, 256 for other ZQCL and 64 for ZQCS).

35.11.3 Read DQS Gating Calibration

The read DQS gating calibration is used to adjust the read DQS gating with the middle of the read DQS preamble. The DQS gating includes a delay of up to 7 cycles (The delay is chosen according to two fields MPDGCTRLn[DG_HC_DELn] and MPDGCTRLn[DG_DL_ABS_OFFSETn]

Each DQS has its own delay-line. The DQS gating process can be done for all DQS in parallel.

NOTE

In LPDDR2/LPDDR3 mode hardware Read DQS gating should be disabled and Pull-up/pull-down resistors on DQS/DQSn should be enabled while ODT resistors must be disconnected.

NOTE

In DDR3_x64 mode activation of the calibration is done by setting MPDGCTRL0[HW_DG_EN]

35.11.3.1 Hardware DQS Gating Calibration

- There are two modes of operations:
 - Calibration with the MPR (Multi Purpose Register)
 - Calibration with MMDC pre-defined values

35.11.3.1.1 Hardware DQS Calibration with MPR

The following steps should be executed:

1. Precharge all active banks (Can be done through MDSCR) as required by the standard.
2. Enter the DDR device into MPR mode through MRS commands
3. Configure the MMDC to work with MPR mode by asserting `MPPDCMPR2[MPR_CMP]`
4. Make sure that the initial value that is configured in the read delay line absolute offset of each byte (i.e. `MPRDDLCTL[RD_DL_ABS_OFFSETn]`) will place the read DQS somewhere inside the read DQ window
5. Start the calibration process by asserting `MPDGCTRL0[HW_DG_EN]`

35.11.3.1.2 Hardware DQS Calibration with pre-defined value

In case pre-defined mode is used, (i.e. `MPPDCMPR2[MPR_CMP]`) is cleared, then the following steps should be executed:

1. Precharge all active banks (Can be done through MDSCR) as required by the standard.
2. Configure the pre-defined value, which reflects the value that will be written and compared through the read calibration, to `MPPDCMPR1[PDV1, PDV2]`
3. Issue write access to the external DDR device by setting `MPSWDAR0[SW_DUMMY_WR] = 1` (MMDC will generate internally write access without intervention of the system towards bank 0, row 0, column 0)
4. Make sure that the initial value that is configured in the read delay line absolute offset of each byte (i.e. `MPRDDLCTL[RD_DL_ABS_OFFSETn]`) will place the read DQS somewhere inside the read DQ window
5. Start the calibration process by asserting `MPDGCTRL0[HW_DG_EN]`

The following steps will be executed automatically by the MMDC for both modes (MPR and Pre-defined value):

6. MMDC waits till the read DQS delay-line is updated with the absolute delay value for all bytes at `MPDGCTRLn[DG_HC_DELn]` and `MPDGCTRLn[DG_DL_ABS_OFFSETn]` and also satisfying the $T_{mod} + 4$ requirement

7. MMDC drives read command to the external DDR devices and waits 16 or 32 cycles (according to MPDGCTRL0[DG_CMP_CYC] assuming that the data has arrived from the DDR device).
8. MMDC compares the read data byte to the associated byte in the pre-defined/MPR value for all the bytes in the DDR burst (burst length 4 or 8). If the comparison fails then it indicates that the read DQS gating is asserted in illegal time point. If the comparison passes then MMDC advances to step 14
9. MMDC resets the read FIFO (to the inverted pre-defined/MPR value) and it's pointers by setting MPDGCTRL[RST_RD_FIFO] = 1
10. MMDC increments the read DQS gating delay of each byte by half cycle (i.e. MPDGCTRLn[DG_HC_DELn] + 1)
11. MMDC drives read command to the external DDR devices and waits 16 or 32 cycles (according to MPDGCTRL0[DG_CMP_CYC] assuming that the data has arrived from the DDR device).
12. MMDC compares the read data byte to the associated byte in the pre-defined/MPR value for all the bytes in the DDR burst (burst length 4 or 8).
13. If the comparison fails then it indicates that the read DQS gating is asserted in illegal time point and it is needed to repeat steps 9-12. If the comparison passes then MMDC stores the value of the temporary low boundary and advances to next step
14. MMDC increments the read DQS gating delay-line of each byte by half cycle (i.e. MPDGCTRLn[DG_HC_DELn] + 1) and issue measurement process of the read DQS gating delay-line to update itself with the new value
15. MMDC drives read command to the external DDR devices and waits 16 or 32 cycles (according to MPDGCTRL0[DG_CMP_CYC] assuming that the data has arrived from the DDR device).
16. MMDC compares the read data byte to the associated byte in the pre-defined/MPR value for all the bytes in the DDR burst (burst length 4 or 8)
17. If the comparison passes then it indicates that the read DQS gating is asserted inside the read preamble window and it is needed to repeat steps 14-16. If the comparison fails then MMDC stores the value of the temporary upper boundary and starts searching the adequate low and high boundaries
18. MMDC returns to the temporary low boundary minus half cycle and issue measurement process of the read DQS gating delay-line to update itself with the new value
19. MMDC drives read command to the external DDR devices and waits 16 or 32 cycles (according to MPDGCTRL0[DG_CMP_CYC] assuming that the data has arrived from the DDR device).
20. MMDC compares the read data byte to the associated byte in the pre-defined/MPR value for all the bytes in the DDR burst (burst length 4 or 8)

21. If the comparison fails then it indicates that the read DQS gating is asserted in illegal time point and it is needed to repeat steps 22-23. If the comparison passes then MMDC stores the value of the adequate low boundary and advances to step 24
22. MMDC resets the read FIFO (to the inverted pre-defined/MPR value) and it's pointers by setting `MPDGCTRL[RST_RD_FIFO] = 1`
23. MMDC increments the read DQS gating delay of each byte by 1 (i.e. `MPDGCTRLn[DG_DL_ABS_OFFSETn] + 1`) and issue measurement process of the read DQS gating delay-line to update itself with the new value and advances to step 19
24. MMDC returns to the temporary upper boundary minus half cycle and issue measurement process of the read DQS gating delay-line to update itself with the new value
25. MMDC drives read command to the external DDR devices and waits 16 or 32 cycles (according to `MPDGCTRL0[DG_CMP_CYC]` assuming that the data has arrived from the DDR device.
26. MMDC compares the read data byte to the associated byte in the pre-defined/MPR value for all the bytes in the DDR burst (burst length 4 or 8)
27. If the comparison passes then it indicates that the read DQS gating is asserted inside the read preamble window and it is needed to repeat steps 28-29. If the comparison fails then MMDC stores the value minus 1 of the adequate upper boundary and advances to step 30
28. MMDC resets the read FIFO (to the inverted pre-defined/MPR value) and it's pointers by setting `MPDGCTRL[RST_RD_FIFO] = 1`
29. MMDC increments the read DQS gating delay of each byte by 1 (i.e. `MPDGCTRLn[DG_DL_ABS_OFFSETn] + 1`) and issue measurement process of the read DQS gating delay-line to update itself with the new value and advances to step 25
30. After the MMDC finds the window boundary (lower and upper) of each read data byte then it stores the average between lower and upper boundaries at the associated `MPDGCTRLn[DG_DL_ABS_OFFSETn]` and issue measurement process of the read DQS delay-line to update itself with the new value.
31. MMDC indicates that the read DQS gating calibration had finished by setting `MPDGCTRL0[HW_DG_EN] = 0`
32. Exit the DDR device from MPR mode through MRS command
33. Read the upper boundary that was found: `MPDGHWSTn[HW_DG_UPn]`. This field is 11 bits, 7 LSB bits correspond to `MPDGCTRLn[DG_DL_ABS_OFFSETn]` upper limit value and 4 MSB bits correspond to `MPDGCTRLn[DG_HC_DELn]` upper limit value.
34. Set `MPDGHWSTn[HW_DG_UPn][6:0]` to `MPDGCTRLn[DG_DL_ABS_OFFSETn]`.

35. Set (MPDGHWSTn[HW_DG_UPn][10:7] - 1) to MPDGCTRLn[DG_HC_DELn].
(We set the DQS gating value to be the upper limit value minus 1 half cycle)

35.11.3.2 SW read DQS gating Calibration

There are two modes of operations:

- Calibration with the MPR (Multi Purpose Register)
- Calibration with MMDC pre-defined values

35.11.3.2.1 SW read Calibration with MPR

Execute the following steps:

1. Precharge all active banks (Can be done through MDSCR) as required.
2. Enter the DDR device into MPR mode through MRS commands
3. Configure the MMDC to work with MPR mode by asserting MPPDCMPR2[MPR_CMP]
4. Ensure that the initial value that is configured in the read delay line absolute offset of each byte (i.e. MPRDDLCTL[RD_DL_ABS_OFFSET#]) will place the read DQS somewhere inside the read DQ window

35.11.3.2.2 SW read Calibration with pre-defined value

In case pre-defined mode is used, (i.e. MPPDCMPR2[MPR_CMP]) is cleared, then the following steps should be executed:

1. Precharge all active banks (Can be done through MDSCR) as required by the standard.
2. Configure the pre-defined value, which reflects the value that will be written and compared through the read calibration, to MPPDCMPR1[PDV1, PDV2]
3. Issue write access (with any legal DDR address) to external DDR device
4. Ensure that the initial value that is configured in the read delay line absolute offset of each byte (i.e. MPRDDLCTL[RD_DL_ABS_OFFSETn]) will place the read DQS somewhere inside the read DQ window

The following steps should be executed automatically by the MMDC for both modes (MPR and Pre-defined value):

1. Configure the read DQS delay-line to issue zero delay by setting MPDGCTRLn[DG_DL_ABS_OFFSETn] = 0 and MPDGCTRLn[DG_HC_DELn] = 0
2. Force the delay line to measure itself and to issue the requested read delay by configuring MPMUR[FRC_MSR] = 1

3. Wait 16 DDR cycles till the read DQS delay-line is updated with the absolute delay value for all bytes
4. Issue read command (with the legal DDR address chosen in step 3) from the external DDR device
5. Waits 16 or 32 cycles (according to MPDGCTRL0[DG_CMP_CYC]) assuming that the data has arrived from the DDR device.
6. Compare the read data byte to the associated byte in the pre-defined/MPR value for all the bytes in the DDR burst (burst length 4 or 8). If the comparison fails then it indicates that the read DQS gating is asserted in illegal time point. If the comparison passes then advance to step 11.
7. MMDC resets the read FIFO (to the inverted pre-defined/MPR value) and it's pointers by setting MPDGCTRL[RST_RD_FIFO] = 1
8. Increment the read DQS gating delay of each byte by half cycle (i.e. MPDGCTRLn[DG_HC_DELn] + 1)
9. MMDC drives read command to the external DDR devices and waits 16 or 32 cycles (according to MPDGCTRL0[DG_CMP_CYC]) assuming that the data has arrived from the DDR device.
10. Compare the read data byte to the associated byte in the pre-defined/MPR value for all the bytes in the DDR burst (burst length 4 or 8). If the comparison fails then it indicates that the read DQS gating is asserted in illegal time point and it is needed to repeat steps 7-10. If the comparison passes then advance to step 11.
11. Store the temporary lower boundary and start searching the temporary upper boundary
12. MMDC resets the read FIFO (to the inverted pre-defined/MPR value) and it's pointers by setting MPDGCTRL[RST_RD_FIFO] = 1
13. Increment the read DQS gating delay of each byte by half cycle (i.e. MPDGCTRLn[DG_HC_DELn] + 1)
14. MMDC drives read command to the external DDR devices and waits 16 or 32 cycles (according to MPDGCTRL0[DG_CMP_CYC] assuming that the data has arrived from the DDR device.
15. Compare the read data byte to the associated byte in the pre-defined/MPR value for all the bytes in the DDR burst (burst length 4 or 8).
16. If the comparison passes then it indicates that the read DQS gating is asserted inside the read preamble window and it is needed to repeat steps 12-15. If the comparison fails then it is needed to store the value of the temporary upper boundary and starts searching the adequate low and high boundaries
17. Load the temporary low boundary minus half cycle into the associated MPDGCTRLn[DG_HC_DELn]
18. Reset the read FIFO (to the inverted pre-defined/MPR value) and its pointers by setting MPDGCTRL[RST_RD_FIFO] = 1

19. Increment the read DQS gating delay of each byte by 1 (i.e. $\text{MPDGCTRLn}[\text{DG_DL_ABS_OFFSETn}] + 1$) and force the delay line to measure itself and to issue the requested read DQS delay by configuring $\text{MPMUR0}[\text{FRC_MSR}] = 1$
20. Issue read command to the external DDR devices and waits 16 or 32 cycles (according to $\text{MPDGCTRL0}[\text{DG_CMP_CYC}]$) assuming that the data has arrived from the DDR device.
21. Compare the read data byte to the associated byte in the pre-defined/MPR value for all the bytes in the DDR burst (burst length 4 or 8)
22. If the comparison fails then it indicates that the read DQS gating is asserted in illegal time point and it is needed to repeat steps 18-22. If the comparisons passes then advance to the next step.
23. Store the adequate lower boundary
24. Load the temporary upper boundary minus half cycle into the associated $\text{MPDGCTRLn}[\text{DG_HC_DELn}]$
25. Reset the read FIFO (to the inverted pre-defined/MPR value) and it's pointers by setting $\text{MPDGCTRL}[\text{RST_RD_FIFO}] = 1$
26. Increment the read DQS gating delay of each byte by 1 (i.e. $\text{MPDGCTRLn}[\text{DG_DL_ABS_OFFSETn}] + 1$) and force the delay line to measure itself and to issue the requested read DQS delay by configuring $\text{MPMUR}[\text{FRC_MSR}] = 1$
27. Issue read command to the external DDR devices and waits 16 or 32 cycles (according to $\text{MPDGCTRL0}[\text{DG_CMP_CYC}]$ assuming that the data has arrived from the DDR device.
28. Compare the read data byte to the associated byte in the pre-defined/MPR value for all the bytes in the DDR burst (burst length 4 or 8)
29. If the comparison passes then it is needed to repeat steps 25-28. If the comparisons fails then advance to the next step.
30. Reset the read FIFO (to the inverted pre-defined/MPR value) and it's pointers by setting $\text{MPDGCTRL}[\text{RST_RD_FIFO}] = 1$
31. Store the adequate upper boundary.
32. Keep the $\text{MPDGCTRLn}[\text{DG_DL_ABS_OFFSETn}]$ value of the upper limit.
33. Set $\text{MPDGCTRLn}[\text{DG_HC_DELn}] = (\text{MPDGCTRLn}[\text{DG_HC_DELn}] - 1)$. (We set the DQS gating value to be the upper limit value minus 1 half cycle)
34. Issue the requested read DQS delay by configuring $\text{MPMUR}[\text{FRC_MSR}] = 1$
35. Exit the DDR device from MPR mode through MRS command

35.11.4 Read Calibration

The read calibration is used to adjust the read DQS with read data byte. It is assumed that the read DQS gating calibration process is completed prior to the read calibration.

NOTE

In DDR3 mode, the activation of the calibration is done by setting MPRDDLHWCTL[HW_RD_DL_EN].

NOTE

In LP2_x16 the activation of the calibration is done by setting MPRDDLHWCTL[HW_RD_DL_EN].

35.11.4.1 Hardware (automatic) Read Calibration

There are two modes of operations:

- Calibration with the MPR (Multi Purpose Register)/DQ calibration(LPDDR2)
- Calibration with MMDC pre-defined values

35.11.4.1.1 Hardware (automatic) Calibration with MPR/DQ Calibration

Execute the following steps:

1. Precharge all active banks (can be done through MDSCR) as required.
2. Enter the DDR device into MPR/DQ calibration mode through MRS/MRW commands.
3. Configure the MMDC to work with MPR/DQ calibration mode by asserting MPPDCMPR2[MPR_CMP].
4. Make sure that the initial value that is configured in the read delay line absolute offset of each byte (MPRDDLCTL[RD_DL_ABS_OFFSET#]) will place the read DQS somewhere inside the read DQ window.
5. Start the calibration process by asserting MPRDDLHWCTL[HW_RD_DL_EN].

35.11.4.1.2 Hardware (automatic) Calibration with pre-defined value

In case pre-defined mode is used, i.e. MPPDCMPR2[MPR_CMP] is cleared, then the following steps should be executed:

1. Precharge all active banks (Can be done through MDSCR) as required.
2. Configure the pre-defined value, which reflects the value that will be written and compared through the read calibration, to MPPDCMPR1[PDV1, PDV2]
3. Issue write access to the external DDR device by setting MPSWDAR0[SW_DUMMY_WR] = 1 (MMDC will generate internally write access without intervention of the system towards bank 0, row 0, column 0)
4. Make sure that the initial value that is configured in the read delay line absolute offset of each byte (i.e. MPRDDLCTL[RD_DL_ABS_OFFSETn]) will place the read DQS somewhere inside the read DQ window

5. Start the calibration process by asserting MPRDDLHWCTL[HW_RD_DL_EN]

The following steps will be executed automatically by the MMDC for both modes (MPR and Pre-defined value):

1. MMDC waits till the read delay-line is updated with the absolute delay value for all bytes at MPRDDLCTL[RD_DL_ABS_OFFSETn] and also satisfying the Tmod + 4 requirement
2. MMDC drives read command to the external DDR devices and waits 16 or 32 cycles (according to MPRDDLHWCTL[HW_RD_DL_CMP_CYC]) assuming that the data has arrived from the DDR device.
3. MMDC compares the read data byte to the associated byte in the pre-defined/MPR value for all the bytes in the DDR burst (burst length 4 or 8). If the comparison fails then it indicates that the initial read DQS isn't inside the read DQ window and the MMDC generates an error for the associated byte at MPRDDLHWCTL[HW_RD_DL_ERRn] . If the comparison passes then MMDC advances to next step.
4. MMDC resets the rd fifo (to the inverted pre-defined/MPR value) and it's pointers by setting MPDGCTRL[RST_RD_FIFO] = 1
5. MMDC decrements the read delay line absolute offset of each byte by 1 (i.e. MPRDDLCTL[RD_DL_ABS_OFFSETn]) and issue measurement process of the read delay-line to update itself with the new value.
6. MMDC drives read command to the DDR external devices and waits 16 or 32 cycles (according to MPRDDLHWCTL[HW_RD_DL_CMP_CYC]) assuming that the data has arrived from the DDR device
7. MMDC compares the read data byte to the associated byte in the pre-defined/MPR value for all the bytes in the DDR burst (burst length 4 or 8). If the comparison fails then it stores the low read boundary of the associated byte for each byte at MPRDDLHWST0/1[HW_RD_DL_LOWn] . If the comparison passes then MMDC repeats steps 4-6. If all read data comparisons fail then the MMDC advances to the next step
8. The MMDC start seeking the upper boundary and sets the read delay line absolute offset of each byte to the initial value + 1 as determined at step 4 and issue measurement process of the read delay-line to update itself with the new value
9. MMDC resets the rd fifo (to the inverted pre-defined value) and it's pointers by setting MPDGCTRL[RST_RD_FIFO] = 1
10. MMDC drives read command to the DDR external devices and waits 16 or 32 cycles (according to MPRDDLHWCTL[HW_RD_DL_CMP_CYC]) assuming that the data has arrived from the DDR device
11. MMDC compares the read data byte to the associated byte in the pre-defined/MPR value for all the bytes in the DDR burst (burst length 4 or 8). If the comparison fails then it stores the upper read boundary of the associated byte for each byte at MPRDDLHWST0/1[HW_RD_DL_UPn] . If the comparison passes then MMDC

increments the read delay line absolute offset of each byte by 1 (i.e. `MPRDDLCTL[RD_DL_ABS_OFFSETn]`) and issue measurement process of the read delay-line to update itself with the new value.

12. If all read data comparisons fail then the MMDC advances to the next step. otherwise, MMDC repeats steps 9-11.
13. After the MMDC finds the window boundary (lower and upper) of each read data byte then it stores the average between lower and upper boundaries at the associated `MPRDDLCTL[RD_DL_ABS_OFFSETn]` and issue measurement process of the read delay-line to update itself with the new value.
14. MMDC indicates that the read data calibration had finished by setting `MPRDDLHWCTL[HW_RD_DL_EN] = 0`
15. Exit the DDR device from MPR/DQ calibration mode through MRS/MRW commands

35.11.4.2 SW Read Calibration

There are two modes of operations:

- Calibration with the MPR (Multi Purpose Register)/DQ calibration (LPDDR2)
- Calibration with MMDC pre-defined values

35.11.4.2.1 Calibration with MPR/DQ calibration

Execute the following steps:

1. Precharge all active banks (Can be done through MDSCR) as required.
2. Enter the DDR device into MPR/DQ calibration mode through MRS/MRW commands
3. Configure the MMDC to work with MPR/DQ calibration mode by asserting `MPPDCMPR2[MPR_CMP]`
4. Make sure that the initial value that is configured in the read delay line absolute offset of each byte (i.e. `MPRDDLCTL[RD_DL_ABS_OFFSETn]`) will place the read DQS somewhere inside the read DQ window

35.11.4.2.2 Calibration with pre-defined value

In case pre-defined mode is used, i.e. `MPPDCMPR2[MPR_CMP]` is cleared, then the following steps should be executed:

1. Precharge all active banks (Can be done through MDSCR) as required by the standard.
2. Configure the pre-defined value, which reflects the value that will be written and compared through the read calibration, to `MPPDCMPR1[PDV1, PDV2]`

3. Issue write access (with any legal DDR address) to external DDR device.
4. Make sure that the initial value that is configured in the read delay line absolute offset of each byte (i.e. `MPRDDLCTL[RD_DL_ABS_OFFSETn]`) will place the read DQS somewhere inside the read DQ window

The following steps will be executed manually by SW for both modes (MPR/DQ calibration and Pre-defined value):

1. Force the delay line to measure itself and to issue the requested read delay by configuring `MPMUR[FRC_MSR] = 1`
2. Wait 16 DDR cycles till the read delay-line is updated with the absolute delay value for all bytes
3. Issue read command (with any legal DDR address) from the external DDR device
4. Compare the read data byte to the associated byte in the pre-defined/MPR value for all the bytes in the DDR burst (burst length 4 or 8). If the comparison fails then it indicates that the initial read DQS isn't inside the read DQ window. If the comparison passes then advance to next step.
5. Reset the rd fifo (to the inverted pre-defined/MPR value) and it's pointers by setting `MPDGCTRL[RST_RD_FIFO] = 1`
6. Decrement the read delay line absolute offset of each byte by 1 (i.e. `MPRDDLCTL[RD_DL_ABS_OFFSETn]`)
7. Force the delay line to measure itself and to issue the requested read delay by configuring `MPMUR[FRC_MSR] = 1`
8. Issue read command (with the legal DDR address chosen in step 7) from the external DDR device and waits 16 or 32 cycles (according to `MPRDDLHWCTL[HW_RD_DL_CMP_CYC]`) assuming that the data has arrived from the DDR device
9. Compare the read data byte to the associated byte in the pre-defined/MPR value for all the bytes in the DDR burst (burst length 4 or 8). If the comparison fails then it is needed to store the low read boundary of the associated byte at of each byte . If the comparison passes then repeat steps 5-8. If all read data comparisons fail then advance to the next step.
10. Start seeking the upper boundary and set the read delay line absolute offset of each byte to the initial value + 1 as determined at step 4
11. Force the delay line to measure itself and to issue the requested read delay by configuring `MPMUR[FRC_MSR] = 1`
12. Resets the rd fifo (to the inverted pre-defined/MPR value) and it's pointers by setting `MPDGCTRL[RST_RD_FIFO] = 1`
13. Issue read command (with the legal DDR address chosen in step 7) from the external DDR device

14. Compare the read data byte to the associated byte in the pre-defined/MPR value for all the bytes in the DDR burst (burst length 4 or 8). If the comparison fails then it is needed to store the upper read boundary of the associated byte at of each byte. If the comparison passes then increment the read delay line absolute offset of each byte by 1 (i.e. MPRDDLCTL[RD_DL_ABS_OFFSETn])
15. Force the delay line to measure itself and to issue the requested read delay by configuring MPMUR[FRC_MSR] = 1
16. If all read data comparisons fail then advance to the next step, else repeat steps 12-15.
17. After finding the window boundary (lower and upper) of each read data byte then calculate the average between lower and upper boundaries and store the associated average at MPRDDLCTL[RD_DL_ABS_OFFSETn]
18. Force the delay line to measure itself and to issue the requested read delay by configuring MPMUR[FRC_MSR] = 1
19. Exit the DDR device from MPR/DQ calibration mode through MRS/MRW commands.

35.11.5 Write Calibration

The write calibration is used to adjust the write DQS with write data byte. It is assumed that the read calibration process is completed prior to the write calibration.

NOTE

In DDR3_x64 and LP2_1ch_x64 modes, the activation of the calibration is done by setting MPWRDLHWCTL0[HW_WR_DL_EN]

NOTE

In LP2_x16, LP2_x32 the activation of the calibration of each channel is done by setting MPWRDLHWCTL0[HW_WR_DL_EN].

35.11.5.1 HW (automatic) Write Calibration

The following steps should be executed:

1. Make sure that the initial value that is configured in the write delay line absolute offset of each byte (i.e. MPWRDLCTL[WR_DL_ABS_OFFSET#]) will place the write DQS somewhere inside the write DQ window
2. Configure the pre-defined value, which reflects the value that will be written and compared through the write calibration, to MPPDCMPR1[PDV1, PDV2]

3. Assert MPWRDLHWCTL0[HW_WR_DL_EN]

The following steps will be executed automatically:

4. MMDC waits till the write delay-line is updated with the absolute delay value for all bytes at MPWRDCTL[WR_DL_ABS_OFFSET#]
5. MMDC drives write command to the external DDR devices (to bank 0 address 0) and waits 16 or 32 cycles (according to MPWRDLHWCTL[HW_WR_DL_CMP_CYC]) assuming that the data has arrived to the DDR device.
6. MMDC drives read command to the same address from the external DDR
7. MMDC compares the read data byte to the associated byte in the pre-defined value for all the bytes in the DDR burst (burst length 4 or 8). If the comparison fails then it indicates that the initial write DQS isn't inside the write DQ window and the MMDC generates an error for the associated byte at MPWRDLHWCTL[HW_WR_DL_ERR#] . If the comparison passes then MMDC advances to next step.
8. MMDC resets the rd fifo (to the inverted pre-defined value) and it's pointers by setting MPDGCTRL[RST_RD_FIFO] = 1
9. MMDC decrements the write delay line absolute offset of each byte by 1 (i.e. MPWRDLCTL[WR_DL_ABS_OFFSET#]) and issue measurement process of the write delay-line to update itself with the new value.
10. MMDC drives write command to the external DDR devices (to bank 0 address 0) and waits 16 or 32 cycles (according to MPWRDLHWCTL[HW_WR_DL_CMP_CYC]) assuming that the data has arrived to the DDR device
11. MMDC drives read command to the same address from the external DDR
12. MMDC compares the read data byte to the associated byte in the pre-defined value for all the bytes in the DDR burst (burst length 4 or 8). If the comparison fails then it stores the low write boundary of the associated byte of each byte at MPWRDLHWST0/1[HW_WR_DL_LOW#] . If the comparison passes then MMDC repeats steps 8-11. If all data comparisons fail then the MMDC advances to the next step
13. The MMDC start seeking the upper boundary and sets the write delay line absolute offset of each byte to the initial value + 1 as determined at step 4 and issue measurement process of the write delay-line to update itself with the new value
14. MMDC resets the rd fifo (to the inverted pre-defined value) and its pointers by setting MPDGCTRL[RST_RD_FIFO] = 1
15. MMDC drives write command to the external DDR devices (to bank 0 address 0) and waits 16 or 32 cycles (according to MPWRDLHWCTL[HW_WR_DL_CMP_CYC]) assuming that the data has arrived to the DDR device.
16. MMDC drives read command to the same address from the external DDR
17. MMDC compares the read data byte to the associated byte in the pre-defined value for all the bytes in the DDR burst (burst length 4 or 8). If the comparison fails then it

stores the upper write boundary of the associated byte of each byte at MPWRDLHWST0/1[HW_WR_DL_UP#] . If the comparison passes then MMDC increments the write delay line absolute offset of each byte by 1 (i.e. MPWRDLCTL[WR_DL_ABS_OFFSET#]) and issue measurement process of the write delay-line to update itself with the new value.

18. MMDC repeats steps 14-17. If all data comparisons fail then the MMDC advances to the next step
19. .After the MMDC finds the window boundary (lower and upper) of each write data byte then it stores the average between lower and upper boundaries at the associated MPWRDLCTL[WR_DL_ABS_OFFSET#] and issue measurement process of the write delay-line to update itself with the new value.
20. MMDC indicates that the write data calibration had finished by setting MPWRDLHWCTL[HW_WR_DL_EN] = 0

35.11.5.2 SW Write Calibration

The following steps should be executed:

NOTE

It is recommended to perform the write calibration using the HW method. The SW method is provided for debug purposes only.

1. Make sure that the initial value that is configured in the write delay line absolute offset of each byte (i.e. MPWRDLCTL[WR_DL_ABS_OFFSETn]) will place the write DQS somewhere inside the write DQ window
2. Configure the pre-defined value, which reflects the value that will be written and compared through the write calibration, to MPPDCMPR1[PDV1, PDV2]
3. Force the delay line to measure itself and to issue the requested write delay by configuring MPMUR0[FRC_MSR] = 1
4. Wait 16 DDR cycles till the write delay-line is updated with the absolute delay value for all bytes
5. Issue write command to any legal DDR address of the external DDR device
6. Issue read command, to the address written previously, from the external DDR device
7. Compare the read data byte to the associated byte in the pre-defined value for all bytes in the DDR burst (burst length 4 or 8). If the comparison fails then it indicates that the initial write DQS isn't inside the write DQ window. If the comparison passes then advance to next step.
8. MMDC resets the rd fifo (to the inverted pre-defined value) and it's pointers by setting MPDGCTRL[RST_RD_FIFO] = 1

9. Decrement the write delay line absolute offset of each byte by 1 (i.e. `MPWRDLCTL[WR_DL_ABS_OFFSETn]`)
10. Force the delay line to measure itself and to issue the requested write delay by configuring `MPMUR0[FRC_MSR] = 1`
11. Issue write command to any legal DDR address of the external DDR device
12. Issue read command, to the address written previously, from the external DDR device
13. Compare the read data byte to the associated byte in the pre-defined value for all the bytes in the DDR burst (burst length 4 or 8). If the comparison fails then it is needed to store the low write boundary of the associated byte of each byte at `MPWRDLHWST0/1[HW_WR_DL_LOWn]` . If the comparison passes then repeat steps 8-12. If all data comparisons fail then advance to the next step.
14. Start seeking the upper boundary and set the write delay line absolute offset of each byte to the initial value + 1
15. Force the delay line to measure itself and to issue the requested write delay by configuring `MPMUR0[FRC_MSR] = 1`
16. Reset the rd fifo (to the inverted pre-defined value) and it's pointers by setting `MPDGCTRL[RST_RD_FIFO] = 1`
17. Issue write command to any legal DDR address of the external DDR device
18. Issue read command, to the address written previously, from the external DDR device
19. Compare the read data byte to the associated byte in the pre-defined value for all the bytes in the DDR burst (burst length 4 or 8). If the comparison fails then it is needed to store the upper write boundary of the associated byte of each byte at `MPWRDLHWST0/1[HW_WR_DL_UPn]`. If the comparison passes then increment the write delay line absolute offset of each byte by 1.
20. Force the delay line to measure itself and to issue the requested write delay by configuring `MPMUR0[FRC_MSR] = 1`
21. If all read data comparisons fail then advance to the next step else repeat steps 16-20.
22. .After finding the window boundary (lower and upper) of each write data byte then calculate the average between lower and upper boundaries and store the associated average at `MPWRDLCTL[WR_DL_ABS_OFFSETn]`
23. Force the delay line to measure itself and to issue the requested write delay by configuring `MPMUR0[FRC_MSR] = 1`

35.11.6 Write leveling Calibration

The write leveling calibration can generate a delay between the clock and the associate DQS of up to 3 cycles as following: $(WL_DL_ABS_OFFSET/256 * cycle) + (WL_HC_DEL * half\ cycle) + (WL_CYC_DEL * cycle)$. Write leveling calibration can be executed automatically (HW) or manually (SW).

The automatic calibration process can only detect the optimal DQS to clock delay to within 1 cycle. In extreme cases in which the DDR3 memory is placed far from the microcontroller (long address/command/clock trace lengths), the skew between the DQS and clock may exceed 1 cycle. If this is the case, it is the user's responsibility to both understand that their design causes the DQS to clock skew to exceed 1 cycle and to indicate this manually in the MPWLDECTRL0/1[WL_CYC_DEL#]. It is highly recommended to keep the DDR3 memory as close to the microcontroller as possible, especially in embedded system designs. When using fly-by topology, the user should calculate the PCB flight time of the clock signal to the furthest placed DDR3 memory to ensure less than 1 cycle skew between DQS and clock.

NOTE

In LPDDR2 mode Write-leveling calibration should be disabled.

35.11.6.1 Hardware Write Leveling Calibration

The following steps should be executed:

1. Configure the external DDR device to enter write leveling mode through MRS command
2. Activate the DQS output enable by setting MDSCR[WL_EN]
3. Active automatic calibration by setting MPWLGCR[HW_WL_EN]

The following steps will be executed automatically by the MMDC:

4. MMDC enters write leveling mode, counts 25 + 15 cycles and drives the DQS pads as output while the DQ pads will remain inputs. In parallel the MMDC configures the write leveling delay line to "0" (i.e. $MPWLDECTRL0[WL_DL_ABS_OFFSET\#] = 0$) and issue measurement process of the writ-leveling delay-line to update itself with the new value
5. MMDC drives one DQS pulse to the DDR external device
6. MMDC waits 16 cycles (to guarantee that the DQ prime data is stable) and samples the associated prime DQ bit (for example for DQS1 the MMDC samples DQ[8])
7. MMDC increments the write leveling delay line by 1/8 cycle and perform measurement process in order to load the updated value to the associated delay-line

8. MMDC repeats steps 5-7 till the write leveling delay is 1 cycle
9. MMDC checks the 8 bit prime DQ results for each DQS and finds the first transition from 0 to 1. If no transition is found then the MMDC indicates an error at MPWLGCR[HW_WL_ERR#]
10. MMDC stores the value that issues the last "0" on the prime DQ before the transition and loads it to the write leveling delay-line. The MMDC initiates a fine-tune process by incrementing the delay-line values by 1 step (which is 1/256 part of a cycle) till detecting the most accurate transition from 0 to 1
11. Upon completion of this process the MMDC de-asserts the MPWLGCR[HW_WL_EN] and update the most accurate value of the delay-line at the associated MPWLDECTRL#[WL_DL_ABS_OFFSET#]
12. MMDC perform measurement process in order to load the most accurate value to the associated delay-line
13. User should issue MRS command to exit write leveling mode
14. The user should read the results of the associated delay-line at MPWLDECTRL#[WL_DL_ABS_OFFSET#] and in case the user estimates that the reasonable delay may be above 1 cycle then the user should indicate it at MPWLDECTRL#[WL_CYC_DEL#]. Moreover the user should indicate it in MDMISC[WALAT] field. For example, if the result of the write leveling calibration is 100/256 parts of a cycle, but the user estimates that the delay is above 2 cycles then MPWLDECTRL#[WL_CYC_DEL#] should be configured to 2, so the total delay will be 2 and 100/256 parts of a cycle
15. Return the DQS output enable to functional mode by deasserting MDSCR[WL_EN]

35.11.6.2 SW Write Leveling Calibration

The following steps should be executed:

NOTE

It is recommended to perform the write calibration using the HW method. The SW method is provided for debug purposes only.

1. Configure the external DDR device to enter write leveling mode through MRS command
2. Activate the DQS output enable by setting MDSCR[WL_EN]
3. Set the write-leveling delay-line offset to "0" by configuring MPWLDECTRL0[WL_DL_ABS_OFFSET#] = 0
4. Force the delay line to measure itself and to issue the requested write-leveling delay by configuring MPMUR[FRC_MSR] = 1

5. Activate SW write-leveling calibration and issue one DQS pulse by setting MPWLGCR[SW_WL_EN] = 1 together with MPWLGCR[SW_WL_CNT_EN] = 1
6. Issue an IP read command from MPWLGCR. If MPWLGCR[SW_WL_EN] = 0 then the SW write-leveling result is valid at MPWLGCR[WL_SW_RES#].
7. Increment the write leveling delay line by 1/8 cycle—that is, add 0x20 to {MPWLDECTRL0[WL_HC_DEL#],MPWLDECTRL0[WL_DL_ABS_OFFSET#]}
8. Force the delay line to measure itself and to issue the requested write-leveling delay by configuring MPMUR[FRC_MSR] = 1
9. Activate SW write-leveling calibration and issue one DQS pulse by setting MPWLGCR[SW_WL_EN] = 1
10. Repeat steps 6-9 till the edge of CK was detected (i.e the write-leveling result switched from "0" to "1")
11. Store the value that issues the last "0" on the prime DQ before the transition and load it to the write leveling delay-line and start fine tuning process to detect the exact switch from "0" to "1"
12. Force the delay line to measure itself and to issue the requested write-leveling delay by configuring MPMUR[FRC_MSR] = 1
13. Activate SW write-leveling calibration and issue one DQS pulse by setting MPWLGCR[SW_WL_EN] = 1
14. Issue a IP read command from MPWLGCR. If MPWLGCR[SW_WL_EN] = 0 then the SW write-leveling result is valid at MPWLGCR[WL_SW_RES#].
15. Increment the write leveling delay line by 1 step (i.e add 0x01 to MPWLDECTRL0[WL_DL_ABS_OFFSET#])
16. Force the delay line to measure itself and to issue the requested write-leveling delay by configuring MPMUR[FRC_MSR] = 1
17. Issue an IP read command from MPWLGCR. If MPWLGCR[SW_WL_EN] = 0 then the SW write-leveling result is valid at MPWLGCR[WL_SW_RES#].
18. Activate SW write-leveling calibration and issue one DQS pulse by setting MPWLGCR[SW_WL_EN] = 1
19. Repeat step 15-18 till the exact edge of CK was detected (i.e the write-leveling result switched from "0" to "1")
20. Issue MRS command to exit write leveling mode
21. Return the DQS output enable to functional mode by deasserting MDSCR[WL_EN]

35.11.7 Write fine tuning

Write fine tuning is an additional circuit that provides the ability to fine tune the timing of each of the DQ/DM bits (relative to DQS) by up to 100 ps. To use the write fine tuning, select the number of delay units in each DQ/DM I/O (maximum 3 delay units of around 30-35 ps each). The delay can be configured independently for each DQ/DM. This configuration is controlled by the MPWRDQBYnDL registers.

35.11.8 Read fine tuning

Read fine tuning is an additional circuit that provides the ability to fine tune the timing of each coming dq bits (relative to coming dqs) by up to +/-100 ps.

This is done by reducing the delay between the incoming rd_dqs by 100 ps and adding a configurable delay of up to 200 ps (6 delay units of around 30-35 ps each) for each DQ input. The delay can be configured independently for each DQ. The calibration of this mechanism can be done only by writing and reading data from the memory. Controlled by register MPRDDQBY#DL.

35.11.9 ZQ Fine Tuning

An offset can be added to the PU /PD values determined by the ZQ calibration process. The offset range is programmable from -7 to +7, controlled by the MMDC_MPPDCMPR2[ZQ_PU_OFFSET] and MMDC_MPPDCMPR2[ZQ_PD_OFFSET] fields. The offset is enabled/disabled by MMDC_MPPDCMPR2[ZQ_OFFSET_EN]. See MMDC_MPPDCMPR2 register for more information.

35.11.10 Duty cycle adjustment

Duty cycle adjustments can be made to the SDCLKx and SDQSx signals, see the MMDCx_MPDCCR register for more information.

35.12 MMDC Memory Map/Register Definition

The Memory Map is shown below.

NOTE

The terms *clocks* and *cycles* are used interchangeably and refer to the clock period of the main ddr clock (mmdc_axi_clk_root), commonly referred to as the DDR frequency.

MMDC memory map

Absolute address (hex)	Register name	Width (in bits)	Access	Reset value	Section/page
21B_0000	MMDC Core Control Register (MMDC_MDCTL)	32	R/W	0311_0000h	35.12.1/2263
21B_0004	MMDC Core Power Down Control Register (MMDC_MDPDC)	32	R/W	0003_0012h	35.12.2/2264
21B_0008	MMDC Core ODT Timing Control Register (MMDC_MDOTC)	32	R/W	1227_2000h	35.12.3/2267
21B_000C	MMDC Core Timing Configuration Register 0 (MMDC_MDCFG0)	32	R/W	3236_22D3h	35.12.4/2269
21B_0010	MMDC Core Timing Configuration Register 1 (MMDC_MDCFG1)	32	R/W	B6B1_8A23h	35.12.5/2270
21B_0014	MMDC Core Timing Configuration Register 2 (MMDC_MDCFG2)	32	R/W	00C7_0092h	35.12.6/2273
21B_0018	MMDC Core Miscellaneous Register (MMDC_MDMISC)	32	R/W	0000_1600h	35.12.7/2275
21B_001C	MMDC Core Special Command Register (MMDC_MDSCR)	32	R/W	0000_0000h	35.12.8/2278
21B_0020	MMDC Core Refresh Control Register (MMDC_MDREF)	32	R/W	0000_C000h	35.12.9/2281
21B_002C	MMDC Core Read/Write Command Delay Register (MMDC_MDRWD)	32	R/W	0F9F_26D2h	35.12.10/2283
21B_0030	MMDC Core Out of Reset Delays Register (MMDC_MDOR)	32	R/W	009F_0E0Eh	35.12.11/2285
21B_0034	MMDC Core MRR Data Register (MMDC_MDMRR)	32	R	0000_0000h	35.12.12/2286
21B_0038	MMDC Core Timing Configuration Register 3 (MMDC_MDCFG3LP)	32	R/W	0000_0000h	35.12.13/2287
21B_003C	MMDC Core MR4 Derating Register (MMDC_MDMR4)	32	R/W	0000_0000h	35.12.14/2289
21B_0040	MMDC Core Address Space Partition Register (MMDC_MDASP)	32	R/W	0000_003Fh	35.12.15/2291

Table continues on the next page...

MMDC memory map (continued)

Absolute address (hex)	Register name	Width (in bits)	Access	Reset value	Section/page
21B_0400	MMDC Core AXI Reordering Control Register (MMDC_MAARCR)	32	R/W	5142_01F0h	35.12.16/2292
21B_0404	MMDC Core Power Saving Control and Status Register (MMDC_MAPSR)	32	R/W	0000_1007h	35.12.17/2294
21B_0408	MMDC Core Exclusive ID Monitor Register0 (MMDC_MAEXIDR0)	32	R/W	0020_0000h	35.12.18/2296
21B_040C	MMDC Core Exclusive ID Monitor Register1 (MMDC_MAEXIDR1)	32	R/W	0060_0040h	35.12.19/2297
21B_0410	MMDC Core Debug and Profiling Control Register 0 (MMDC_MADPCR0)	32	R/W	0000_0000h	35.12.20/2298
21B_0414	MMDC Core Debug and Profiling Control Register 1 (MMDC_MADPCR1)	32	R/W	0000_0000h	35.12.21/2299
21B_0418	MMDC Core Debug and Profiling Status Register 0 (MMDC_MADPSR0)	32	R	0000_0000h	35.12.22/2300
21B_041C	MMDC Core Debug and Profiling Status Register 1 (MMDC_MADPSR1)	32	R	0000_0000h	35.12.23/2300
21B_0420	MMDC Core Debug and Profiling Status Register 2 (MMDC_MADPSR2)	32	R	0000_0000h	35.12.24/2301
21B_0424	MMDC Core Debug and Profiling Status Register 3 (MMDC_MADPSR3)	32	R	0000_0000h	35.12.25/2301
21B_0428	MMDC Core Debug and Profiling Status Register 4 (MMDC_MADPSR4)	32	R	0000_0000h	35.12.26/2302
21B_042C	MMDC Core Debug and Profiling Status Register 5 (MMDC_MADPSR5)	32	R	0000_0000h	35.12.27/2302
21B_0430	MMDC Core Step By Step Address Register (MMDC_MASBS0)	32	R	0000_0000h	35.12.28/2303
21B_0434	MMDC Core Step By Step Address Attributes Register (MMDC_MASBS1)	32	R	0000_0000h	35.12.29/2303
21B_0440	MMDC Core General Purpose Register (MMDC_MAGENP)	32	R/W	0000_0000h	35.12.30/2304
21B_0800	MMDC PHY ZQ HW control register (MMDC_MPZQHWCTRL)	32	R/W	A138_0000h	35.12.31/2305
21B_0804	MMDC PHY ZQ SW control register (MMDC_MPZQSWCTRL)	32	R/W	0000_0000h	35.12.32/2308
21B_0808	MMDC PHY Write Leveling Configuration and Error Status Register (MMDC_MPWLGCR)	32	R/W	0000_0000h	35.12.33/2310
21B_080C	MMDC PHY Write Leveling Delay Control Register 0 (MMDC_MPWLDECTRL0)	32	R/W	0000_0000h	35.12.34/2313
21B_0810	MMDC PHY Write Leveling Delay Control Register 1 (MMDC_MPWLDECTRL1)	32	R/W	0000_0000h	35.12.35/2315
21B_0814	MMDC PHY Write Leveling delay-line Status Register (MMDC_MPWLDLST)	32	R	0000_0000h	35.12.36/2318
21B_0818	MMDC PHY ODT control register (MMDC_MPODTCTRL)	32	R/W	0000_0000h	35.12.37/2319

Table continues on the next page...

MMDC memory map (continued)

Absolute address (hex)	Register name	Width (in bits)	Access	Reset value	Section/page
21B_081C	MMDC PHY Read DQ Byte0 Delay Register (MMDC_MPRDDQBY0DL)	32	R/W	0000_0000h	35.12.38/2321
21B_0820	MMDC PHY Read DQ Byte1 Delay Register (MMDC_MPRDDQBY1DL)	32	R/W	0000_0000h	35.12.39/2324
21B_082C	MMDC PHY Write DQ Byte0 Delay Register (MMDC_MPWRDQBY0DL)	32	R/W	0000_0000h	35.12.40/2327
21B_0830	MMDC PHY Write DQ Byte1 Delay Register (MMDC_MPWRDQBY1DL)	32	R/W	0000_0000h	35.12.41/2329
21B_0834	MMDC PHY Write DQ Byte2 Delay Register (MMDC_MPWRDQBY2DL)	32	R/W	0000_0000h	35.12.42/2331
21B_0838	MMDC PHY Write DQ Byte3 Delay Register (MMDC_MPWRDQBY3DL)	32	R/W	0000_0000h	35.12.43/2333
21B_083C	MMDC PHY Read DQS Gating Control Register 0 (MMDC_MPDGCTRL0)	32	R/W	0000_0000h	35.12.44/2336
21B_0840	MMDC PHY Read DQS Gating Control Register 1 (MMDC_MPDGCTRL1)	32	R/W	0000_0000h	35.12.45/2338
21B_0844	MMDC PHY Read DQS Gating delay-line Status Register (MMDC_MPDGDLST0)	32	R	0000_0000h	35.12.46/2340
21B_0848	MMDC PHY Read delay-lines Configuration Register (MMDC_MPRDDLCTL)	32	R/W	4040_4040h	35.12.47/2342
21B_084C	MMDC PHY Read delay-lines Status Register (MMDC_MPRDDLST)	32	R	0000_0000h	35.12.48/2344
21B_0850	MMDC PHY Write delay-lines Configuration Register (MMDC_MPWRDLCTL)	32	R/W	4040_4040h	35.12.49/2346
21B_0854	MMDC PHY Write delay-lines Status Register (MMDC_MPWRDLST)	32	R	0000_0000h	35.12.50/2348
21B_0858	MMDC PHY CK Control Register (MMDC_MPSCCTRL)	32	R/W	0000_0000h	35.12.51/2349
21B_085C	MMDC ZQ LPDDR2 HW Control Register (MMDC_MPZQLP2CTL)	32	R/W	1B5F_0109h	35.12.52/2350
21B_0860	MMDC PHY Read Delay HW Calibration Control Register (MMDC_MPRDDLHWCTL)	32	R/W	0000_0000h	35.12.53/2352
21B_0864	MMDC PHY Write Delay HW Calibration Control Register (MMDC_MPWRDLHWCTL)	32	R/W	0000_0000h	35.12.54/2355
21B_0868	MMDC PHY Read Delay HW Calibration Status Register 0 (MMDC_MPRDDLHWST0)	32	R	0000_0000h	35.12.55/2357
21B_0870	MMDC PHY Write Delay HW Calibration Status Register 0 (MMDC_MPWRDLHWST0)	32	R	0000_0000h	35.12.56/2358
21B_0878	MMDC PHY Write Leveling HW Error Register (MMDC_MPWLHWERR)	32	R/W	0000_0000h	35.12.57/2359
21B_087C	MMDC PHY Read DQS Gating HW Status Register 0 (MMDC_MPDGHWST0)	32	R	0000_0000h	35.12.58/2359
21B_0880	MMDC PHY Read DQS Gating HW Status Register 1 (MMDC_MPDGHWST1)	32	R	0000_0000h	35.12.59/2360

Table continues on the next page...

MMDC memory map (continued)

Absolute address (hex)	Register name	Width (in bits)	Access	Reset value	Section/page
21B_0884	MMDC PHY Read DQS Gating HW Status Register 2 (MMDC_MPDGHWST2)	32	R	0000_0000h	35.12.60/2360
21B_0888	MMDC PHY Read DQS Gating HW Status Register 3 (MMDC_MPDGHWST3)	32	R	0000_0000h	35.12.61/2361
21B_088C	MMDC PHY Pre-defined Compare Register 1 (MMDC_MPPDCMPR1)	32	R/W	0000_0000h	35.12.62/2361
21B_0890	MMDC PHY Pre-defined Compare and CA delay-line Configuration Register (MMDC_MPPDCMPR2)	32	R/W	0040_0000h	35.12.63/2363
21B_0894	MMDC PHY SW Dummy Access Register (MMDC_MPSWDAR0)	32	R/W	0000_0000h	35.12.64/2366
21B_0898	MMDC PHY SW Dummy Read Data Register 0 (MMDC_MPSWDRDR0)	32	R	FFFF_FFFFh	35.12.65/2368
21B_089C	MMDC PHY SW Dummy Read Data Register 1 (MMDC_MPSWDRDR1)	32	R	FFFF_FFFFh	35.12.66/2368
21B_08A0	MMDC PHY SW Dummy Read Data Register 2 (MMDC_MPSWDRDR2)	32	R	FFFF_FFFFh	35.12.67/2369
21B_08A4	MMDC PHY SW Dummy Read Data Register 3 (MMDC_MPSWDRDR3)	32	R	FFFF_FFFFh	35.12.68/2369
21B_08A8	MMDC PHY SW Dummy Read Data Register 4 (MMDC_MPSWDRDR4)	32	R	FFFF_FFFFh	35.12.69/2369
21B_08AC	MMDC PHY SW Dummy Read Data Register 5 (MMDC_MPSWDRDR5)	32	R	FFFF_FFFFh	35.12.70/2370
21B_08B0	MMDC PHY SW Dummy Read Data Register 6 (MMDC_MPSWDRDR6)	32	R	FFFF_FFFFh	35.12.71/2370
21B_08B4	MMDC PHY SW Dummy Read Data Register 7 (MMDC_MPSWDRDR7)	32	R	FFFF_FFFFh	35.12.72/2371
21B_08B8	MMDC PHY Measure Unit Register (MMDC_MPMUR0)	32	R/W	0000_0000h	35.12.73/2371
21B_08BC	MMDC Write CA delay-line controller (MMDC_MPWRCADL)	32	R/W	0000_0000h	35.12.74/2372
21B_08C0	MMDC Duty Cycle Control Register (MMDC_MPDCCR)	32	R/W	2492_2492h	35.12.75/2374

35.12.1 MMDC Core Control Register (MMDC_MDCTL)

Address: 21B_0000h base + 0h offset = 21B_0000h

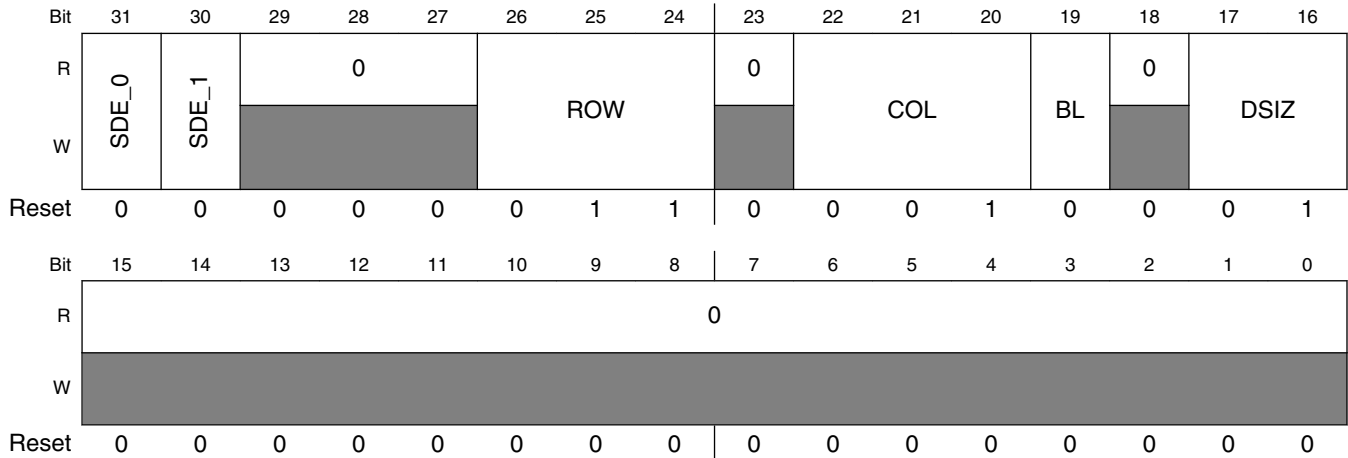

MMDC_MDCTL field descriptions

Field	Description
31 SDE_0	MMDC Enable CS0. This bit enables/disables accesses from the MMDC toward Chip Select 0. The reset value of this bit is "0" (i.e. No clocks and clock enable will be driven to the memory). At the enabling point the MMDC will perform an initialization process (including a delay on RESET and/or CKE) for both chip selects. The initialization length depends on the configured memory type. 0 Disabled 1 Enabled
30 SDE_1	MMDC Enable CS1. This bit enables/disables accesses from the MMDC toward Chip Select 1. The reset value of this bit is "0" (i.e. No clocks and clock enable will be driven to the memory). At the enabling point the MMDC will perform an initialization process (including a delay on RESET and/or CKE) for both chip selects. The initialization length depends on the configured memory type. 0 Disabled 1 Enabled
29–27 Reserved	This read-only field is reserved and always has the value 0.
26–24 ROW	Row Address Width. This field specifies the number of row addresses used by the memory array. It will affect the way an incoming address will be decoded. Settings 110-111 are reserved 000 11 bits Row 001 12 bits Row 010 13 bits Row 011 14 bits Row 100 15 bits Row 101 16 bits Row

Table continues on the next page...

MMDC_MDCTL field descriptions (continued)

Field	Description
23 Reserved	This read-only field is reserved and always has the value 0.
22–20 COL	Column Address Width. This field specifies the number of column addresses used by the memory array. It will determine how an incoming address will be decoded. 0x0 9 bits column 0x1 10 bits column 0x2 11 bits column 0x3 8 bits column 0x4 12 bits column 0x5-0xF Reserved
19 BL	Burst Length. This field determines the burst length of the DDR device. In LPDDR2 mode the MMDC supports burst length 4. In DDR3 mode the MMDC supports burst length 8. 0 Burst Length 4 is used 1 Burst Length 8 is used
18 Reserved	This read-only field is reserved and always has the value 0.
17–16 DSIZ	DDR data bus size. This field determines the size of the data bus of the DDR memory 0 16-bit data bus — 1 Reserved — — 2-3 Reserved
Reserved	This read-only field is reserved and always has the value 0.

35.12.2 MMDC Core Power Down Control Register (MMDC_MDPDC)

Table 35-10. PRCT field encoding

PRCT[2:0]	Precharge Timer
000	Disabled (Bit field reset value)
001	2 clocks
010	4 clocks
011	8 clocks
100	16 clocks
101	32 clocks
110	64 clocks
111	128 clocks

Table 35-11. PWDT field encoding

PWDT[3:0]	Power Down Time-out
0000	Disabled (bit field reset value)
0001	16 cycles
0010	32 cycles
0011	64 cycles
0100	128 cycles
0101	256 cycles
0110	512 cycles
0111	1024 cycles
1000	2048 cycles
1001	4096 cycles
1010	8196 cycles
1011	16384 cycles
1100	32768 cycles
1101-1111	Reserved

Address: 21B_0000h base + 4h offset = 21B_0004h

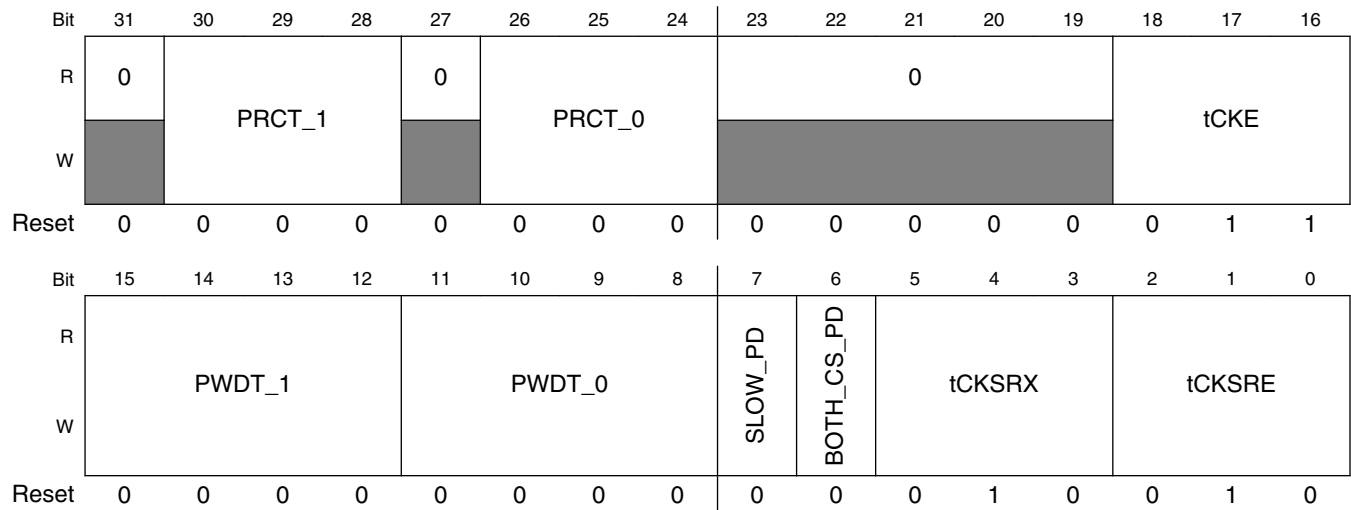

MMDC_MDPDC field descriptions

Field	Description
31 Reserved	This read-only field is reserved and always has the value 0.
30–28 PRCT_1	Precharge Timer - Chip Select 1. This field determines the amount of idle cycle for which chip select 1 will be automatically precharged. The amount of cycles are determined according to the PRCT Field Encoding table above.
27 Reserved	This read-only field is reserved and always has the value 0.

Table continues on the next page...

MMDC_MDPDC field descriptions (continued)

Field	Description
26–24 PRCT_0	Precharge Timer - Chip Select 0. This field determines the amount of idle cycle for which chip select 0 will be automatically precharged. The amount of cycles are determined according to the table below.
23–19 Reserved	This read-only field is reserved and always has the value 0.
18–16 tCKE	CKE minimum pulse width. This field determines the minimum pulse width of CKE. 0x0 1 cycle 0x1 2 cycles 0x6 7 cycles 0x7 8 cycles
15–12 PWDT_1	Power Down Timer - Chip Select 1. This field determines the amount of idle cycle for which chip select 1 will be automatically get into precharge/active power down. The amount of cycles are determined according to the PWDT Field Encoding table above.
11–8 PWDT_0	Power Down Timer - Chip Select 0. This field determines the amount of idle cycle for which chip select 0 will be automatically get into precharge/active power down. The amount of cycles are determined according to the PWDT Field Encoding table above.
7 SLOW_PD	Slow/fast power down. In DDR3 mode this field is referred to slow precharge power-down. LPDDR2 mode: This field is not relevant and should remain in its default reset value. NOTE: Memory should be configured the same. 0 Fast mode. 1 Slow mode.
6 BOTH_CS_PD	Parallel power down entry to both chip selects. When power down timer is used for both chip-selects (i.e. PWDT_0 and PWDT1 don't equal "0") , then if this bit is enabled, the MMDC will enter power down only if the amount of idle cycles of both chip selects was obtained. 0 Each chip select can enter power down independently according to its configuration. 1 Chip selects can enter power down only if the amount of idle cycles of both chip selects was obtained.
5–3 tCKSRX	Valid clock cycles before self-refresh exit. This field determines the amount of clock cycles before self-refresh exit. 0x0 0 cycle 0x1 1 cycles 0x6 6 cycles 0x7 7 cycles
tCKSRE	Valid clock cycles after self-refresh entry. This field determines the amount of clock cycles after self-refresh entry. 0x0 0 cycle 0x1 1 cycles

Table continues on the next page...

MMDC_MDPDC field descriptions (continued)

Field	Description
0x6	6 cycles
0x7	7 cycles

35.12.3 MMDC Core ODT Timing Control Register (MMDC_MDOTC)

For further information see [ODT Configuration](#).

Address: 21B_0000h base + 8h offset = 21B_0008h

Bit	31	30	29	28	27	26	25	24	23	22	21	20	19	18	17	16
R	0		tAOFPD				tAONPD			tANPD			tAXPD			
W	0		0				0			0			0			
Reset	0	0	0	1	0	0	1	0	0	0	1	0	0	1	1	1
Bit	15	14	13	12	11	10	9	8	7	6	5	4	3	2	1	0
R	0	tODTLon				0			tODT_idle_off				0			
W	0	0				0			0				0			
Reset	0	0	1	0	0	0	0	0	0	0	0	0	0	0	0	0

MMDC_MDOTC field descriptions

Field	Description
31–30 Reserved	This read-only field is reserved and always has the value 0.
29–27 tAOFPD	Asynchronous RTT turn-off delay (power down with DLL frozen). This field determines the time between termination circuit starts to turn off the ODT resistance till termination has reached high impedance. LPDDR2 mode: This field is not relevant and should remain in its default reset value. 0x0 1 cycle 0x1 2 cycles 0x6 7 cycles 0x7 8 cycles
26–24 tAONPD	Asynchronous RTT turn-on delay (power down with DLL frozen). This field determines the time between termination circuit gets out of high impedance and begins to turn on till ODT resistance are fully on. LPDDR2 mode: This field is not relevant and should remain in its default reset value. 0x0 1 cycle 0x1 2 cycles 0x6 7 cycles 0x7 8 cycles
23–20 tANPD	Asynchronous ODT to power down entry delay. In DDR3 should be set to tCWL-1 LPDDR2 mode: This field is not relevant and should remain in its default reset value.

Table continues on the next page...

MMDC_MDOTC field descriptions (continued)

Field	Description
	0x0 1 clock 0x1 2 clocks 0x2 3 clocks 0xE 15 clocks 0xF 16 clocks
19–16 tAXPD	Asynchronous ODT to power down exit delay. In DDR3 should be set to tCWL-1 LPDDR2 mode: This field is not relevant and should remain in its default reset value. 0x0 1 clock 0x1 2 clocks 0x2 3 clocks 0xE 15 clocks 0xF 16 clocks
15 Reserved	This read-only field is reserved and always has the value 0.
14–12 tODTLon	ODT turn on latency. This field determines the delay between ODT signal and the associated RTT, where according to JEDEC standard it equals WL(write latency) - 2. Therefore, the value that is configured to tODTLon field should correspond the value that is configured to MDCGFG1[tCWL] LPDDR2 mode: This field is not relevant and should remain in its default reset value. 0x0 - 0x1 Reserved 0x2 2 cycles 0x3 3 cycles 0x4 4 cycles 0x5 5 cycles 0x6 6 cycles 0x7 Reserved
11–9 Reserved	This read-only field is reserved and always has the value 0.
8–4 tODT_idle_off	ODT turn off latency. This field determines the Idle period before turning memory ODT off. NOTE: LPDDR2 mode: This field is not relevant and should remain in its default reset value. 0x0 0 cycle (turned off at the earliest possible time) 0x1 1 cycle 0x2 2 cycles 0x1E 30 cycles 0x1F 31 cycles
Reserved	This read-only field is reserved and always has the value 0.

35.12.4 MMDC Core Timing Configuration Register 0 (MMDC_MDCFG0)

Address: 21B_0000h base + Ch offset = 21B_000Ch

Bit	31	30	29	28	27	26	25	24	23	22	21	20	19	18	17	16	15	14	13	12	11	10	9	8	7	6	5	4	3	2	1	0
R																																
W																																
Reset	0	0	1	1	0	0	1	0	0	0	1	1	0	1	1	0	0	0	1	0	0	0	1	0	1	1	0	1	0	0	1	1

MMDC_MDCFG0 field descriptions

Field	Description
31–24 tRFC	<p>Refresh command to Active or Refresh command time.</p> <p>See DDR3 SDRAM Specification JESD79-3E (July 2010) and LPDDR2 SDRAM Specification JESD209-2B (February 2010) for a detailed description of this parameter.</p> <p>0x0 1 clock 0x1 2 clocks 0x2 3 clocks 0xFE 255 clocks 0xFF 256 clocks</p>
23–16 tXS	<p>Exit self refresh to non READ command. In LPDDR2 it is called tXSR, self-refresh exit to next valid command delay.</p> <p>See DDR3 SDRAM Specification JESD79-3E (July 2010) , LPDDR2 SDRAM Specification JESD209-2B (February 2010) for a detailed description of this parameter.</p> <p>0x0 - 0x15 reserved 0x16 23 clocks 0x17 24 clocks 0xFE 255 clocks 0xFF 256 clocks</p>
15–13 tXP	<p>Exit power down with DLL-on to any valid command. Exit power down with DLL-frozen to commands not requiring a locked DLL</p> <p>In LPDDR2/LPDDR3 mode this field is referred to Exit power-down to next valid command delay.</p> <p>See DDR3 SDRAM Specification JESD79-3E (July 2010) , LPDDR2 SDRAM Specification JESD209-2B (February 2010) for a detailed description of this parameter.</p> <p>0x0 1 cycle 0x1 2 cycles 0x6 7 cycles 0x7 8 cycles</p>
12–9 tXPDLL	<p>Exit precharge power down with DLL frozen to commands requiring DLL.</p> <p>LPDDR2 mode: This field is not relevant and should remain in its default reset value.</p> <p>See DDR3 SDRAM Specification JESD79-3E (July 2010) , LPDDR2 SDRAM Specification JESD209-2B (February 2010) for a detailed description of this parameter.</p> <p>0x0 1 clock</p>

Table continues on the next page...

MMDC_MDCFG0 field descriptions (continued)

Field	Description
	0x1 2 clocks 0x2 3 clocks 0xE 15 clocks 0xF 16 clocks
8–4 tFAW	Four Active Window (all banks). See DDR3 SDRAM Specification JESD79-3E (July 2010) , LPDDR2 SDRAM Specification JESD209-2B (February 2010) for a detailed description of this parameter. 0x0 1 clock 0x1 2 clocks 0x2 3 clocks 0x1E 31 clocks 0x1F 32 clocks
tCL	CAS Read Latency. In DDR3 mode this field is referred to CL. In LPDDR2 mode this field is referred to RL. NOTE: In LPDDR2/LPDDR3 mode only the RL/WL pairs are allowed as specified in MR2 register. See DDR3 SDRAM Specification JESD79-3E (July 2010) , LPDDR2 SDRAM Specification JESD209-2B (February 2010) for a detailed description of this parameter. 0x0 3 cycles 0x1 4 cycles 0x2 5 cycles 0x3 6 cycles 0x4 7 cycles 0x5 8 cycles 0x6 9 cycles 0x7 10 cycles 0x8 11 cycles 0x9 - 0xF Reserved

35.12.5 MMDC Core Timing Configuration Register 1 (MMDC_MDCFG1)

Address: 21B_0000h base + 10h offset = 21B_0010h

Bit	31	30	29	28	27	26	25	24	23	22	21	20	19	18	17	16
R																
W																
Reset	1	0	1	1	0	1	1	0	1	0	1	1	0	0	0	1
Bit	15	14	13	12	11	10	9	8	7	6	5	4	3	2	1	0
R																
W																
Reset	1	0	0	0	1	0	1	0	0	0	1	0	0	0	1	1

MMDC_MDCFG1 field descriptions

Field	Description
31–29 tRCD	<p>Active command to internal read or write delay time (same bank).</p> <p>This field is valid only for DDR2/DDR3 memories</p> <p>In LPDDR2/LPDDR3 mode, this parameter should be configured at tRCD_LP.</p> <p>See DDR3 SDRAM Specification JESD79-3E (July 2010) , LPDDR2 SDRAM Specification JESD209-2B (February 2010) for a detailed description of this parameter.</p> <p>0x0 1 clock 0x1 2 clocks 0x2 3 clocks 0x3 4 clocks 0x4 5 clocks 0x5 6 clocks 0x6 7 clocks 0x7 8 clocks</p>
28–26 tRP	<p>Precharge command period (same bank).</p> <p>This field is valid only for DDR2/DDR3 memories</p> <p>In LPDDR2 mode this parameter should be configured at tRPpb_LP.</p> <p>See DDR3 SDRAM Specification JESD79-3E (July 2010) , LPDDR2 SDRAM Specification JESD209-2B (February 2010) for a detailed description of this parameter.</p> <p>0x0 1 clock 0x1 2 clocks 0x2 3 clocks 0x3 4 clocks 0x4 5 clocks 0x5 6 clocks 0x6 7 clocks 0x7 8 clocks</p>
25–21 tRC	<p>Active to Active or Refresh command period (same bank).</p> <p>This field is valid only for DDR2/DDR3 memories</p> <p>In LPDDR2/LPDDR3 mode, this parameter should be configured at tRC_LP.</p> <p>See DDR3 SDRAM Specification JESD79-3E (July 2010) , LPDDR2 SDRAM Specification JESD209-2B (February 2010) for a detailed description of this parameter.</p> <p>0x0 1 clock 0x1 2 clocks 0x2 3 clocks 0x1E 31 clocks 0x1F 32 clocks</p>
20–16 tRAS	<p>Active to Precharge command period (same bank).</p> <p>See DDR3 SDRAM Specification JESD79-3E (July 2010) , LPDDR2 SDRAM Specification JESD209-2B (February 2010) for a detailed description of this parameter.</p> <p>0x0 1 clock 0x1 2 clocks 0x2 3 clocks</p>

Table continues on the next page...

MMDC_MDCFG1 field descriptions (continued)

Field	Description
	0x1E 31 clocks 0x1F Reserved
15 tRPA	Precharge-all command period. This field is valid only for DDR2/DDR3 memories In LPDDR2/LPDDR3 mode, this parameter should be configured at tRPab_LP. See DDR3 SDRAM Specification JESD79-3E (July 2010) , LPDDR2 SDRAM Specification JESD209-2B (February 2010) for a detailed description of this parameter. 0 Will be equal to: tRP. 1 Will be equal to: tRP+1.
14–12 Reserved	This read-only field is reserved and always has the value 0.
11–9 tWR	WRITE recovery time (same bank). See DDR3 SDRAM Specification JESD79-3E (July 2010) , LPDDR2 SDRAM Specification JESD209-2B (February 2010) for a detailed description of this parameter. 0x0 1cycle 0x1 2cycles 0x2 3cycles 0x3 4cycles 0x4 5cycles 0x5 6cycles 0x6 7cycles 0x7 8 cycles
8–5 tMRD	Mode Register Set command cycle (all banks). In DDR3 mode this field must be set to max (tMRD,tMOD). In LPDDR2/LPDDR3 mode this field should be set to max(tMRR,tMRW). See DDR3 SDRAM Specification JESD79-3E (July 2010) , LPDDR2 SDRAM Specification JESD209-2B (February 2010) for a detailed description of this parameter. 0x0 1 clock 0x1 2 clocks 0x2 3 clocks 0xE 15 clocks 0xF 16 clocks
4–3 Reserved	This read-only field is reserved and always has the value 0.
tCWL	CAS Write Latency. In DDR3 mode this field is referred to CWL. In LPDDR2/LPDDR3 mode this field is referred to WL. 0x0 2 cycles (DDR2/DDR3) ,1 cycles (LPDDR2/LPDDR3) 0x1 3 cycles (DDR2/DDR3) ,2 cycles (LPDDR2/LPDDR3) 0x2 4 cycles (DDR2/DDR3) ,3 cycles (LPDDR2/LPDDR3) 0x3 5 cycles (DDR2/DDR3) ,4 cycles (LPDDR2/LPDDR3) 0x4 6 cycles (DDR2/DDR3) ,5 cycles (LPDDR2/LPDDR3)

Table continues on the next page...

MMDC_MDCFG1 field descriptions (continued)

Field	Description
0x5	7 cycles (DDR2/DDR3) ,6 cycles (LPDDR2/LPDDR3)
0x6	8 cycles (DDR2/DDR3) ,7 cycles (LPDDR2/LPDDR3)
0x7	Reserved

35.12.6 MMDC Core Timing Configuration Register 2 (MMDC_MDCFG2)

Address: 21B_0000h base + 14h offset = 21B_0014h

Bit	31	30	29	28	27	26	25	24	23	22	21	20	19	18	17	16	15	14	13	12	11	10	9	8	7	6	5	4	3	2	1	0		
R	0								tDLLK								0				tRTP		tWTR		tRRD									
W	0								0								0				0		0		0									
Reset	0	0	0	0	0	0	0	0	0	1	1	0	0	0	1	1	1	0	0	0	0	0	0	0	0	0	1	0	0	1	0	0	1	0

MMDC_MDCFG2 field descriptions

Field	Description
31–25 Reserved	This read-only field is reserved and always has the value 0.
24–16 tDLLK	DLL locking time. LPDDR2 mode: This field is not relevant and should remain in its default reset value. See DDR3 SDRAM Specification JESD79-3E (July 2010) , LPDDR2 SDRAM Specification JESD209-2B (February 2010) for a detailed description of this parameter. 0x0 1 cycle. 0x1 2 cycles. 0x2 3 cycles. 0xC7 200 cycles 0x1FE 511 cycles. 0x1FF 512 cycles (JEDEC value for DDR3).
15–9 Reserved	This read-only field is reserved and always has the value 0.
8–6 tRTP	Internal READ command to Precharge command delay (same bank). See DDR3 SDRAM Specification JESD79-3E (July 2010) , LPDDR2 SDRAM Specification JESD209-2B (February 2010) for a detailed description of this parameter. 0x0 1cycle 0x1 2cycles 0x2 3cycles 0x3 4cycles 0x4 5cycles 0x5 6cycles 0x6 7cycles 0x7 8 cycles

Table continues on the next page...

MMDC_MDCFG2 field descriptions (continued)

Field	Description
5-3 tWTR	<p>Internal WRITE to READ command delay (same bank).</p> <p>See DDR3 SDRAM Specification JESD79-3E (July 2010) , LPDDR2 SDRAM Specification JESD209-2B (February 2010) for a detailed description of this parameter.</p> <p>0x0 1cycle 0x1 2cycles 0x2 3cycles 0x3 4cycles 0x4 5cycles 0x5 6cycles 0x6 7cycles 0x7 8 cycles</p>
tRRD	<p>Active to Active command period (all banks).</p> <p>See DDR3 SDRAM Specification JESD79-3E (July 2010) , LPDDR2 SDRAM Specification JESD209-2B (February 2010) for a detailed description of this parameter.</p> <p>0x0 1cycle 0x1 2cycles 0x2 3cycles 0x3 4cycles 0x4 5cycles 0x5 6cycles 0x6 7cycles 0x7 Reserved</p>

35.12.7 MMDC Core Miscellaneous Register (MMDC_MDMISC)

Address: 21B_0000h base + 18h offset = 21B_0018h

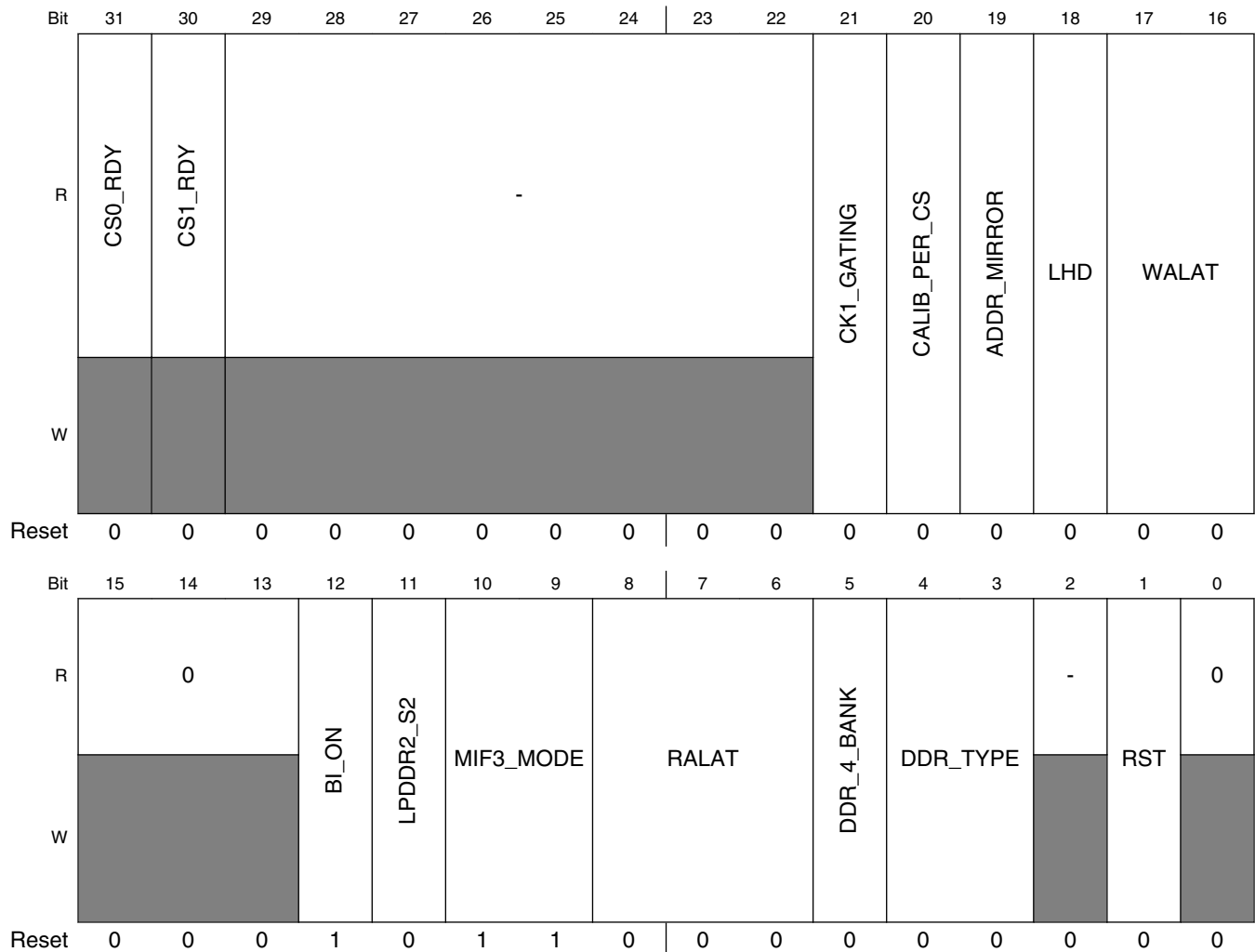

MMDC_MDMISC field descriptions

Field	Description
31 CS0_RDY	External status device on CS0. This is a read-only status bit, that indicates whether the external memory is in wake-up period. 0 Device in wake-up period. 1 Device is ready for initialization.
30 CS1_RDY	External status device on CS1. This is a read-only status bit, that indicates whether the external memory is in wake-up period. 0 Device in wake-up period. 1 Device is ready for initialization.

Table continues on the next page...

MMDC_MDMISC field descriptions (continued)

Field	Description
29–22 -	Reserved
21 CK1_GATING	Gating the secondary DDR clock. When this bit is asserted then the MMDC will disable the secondary DDR clock 0 MMDC drives two clocks toward the DDR memory 1 MMDC drives only one clock toward the DDR memory (CK0)
20 CALIB_PER_CS	Number of chip-select for calibration process. This bit determines the chip-select index that the associated calibration is targeted to. Relevant for read, write, write leveling and read DQS gating calibrations 0 Calibration is targeted to CS0 1 Calibration is targeted to CS1
19 ADDR_MIRROR	Address mirroring. NOTE: This feature is not supported for LPDDR2/LPDDR3 memories. But only for DDR2/DDR3 memories. For further information see Address mirroring . 0 Address mirroring disabled. 1 Address mirroring enabled.
18 LHD	Latency hiding disable. This is a debug feature. When set to "1" the MMDC will handle one read/write access at a time. Meaning that the MMDC pipe-line will be limited to 1 open access (next AXI address phase will be acknowledged if the current AXI data phase had finished) 0 Latency hiding on. 1 Latency hiding disable.
17–16 WALAT	Write Additional latency. In case the write-leveling calibration process indicates a delay of greater than one-eighth a clock cycle (between CK and any of the DQS strobe lines), then this field must be configured accordingly. This field will add delay on the strobe I/O control, which will compensate on the additional write leveling delay on DQS and prevent the DQS from being cropped. NOTE: The purpose of WALAT is to add time delay at the end of a burst write operation to ensure that the JEDEC time specification for Write Post Ambly Delay (tWPST) is met (DQS strobe is held low at the end of a write burst for > 30% a clock cycle before it is released). If the value of any of the WL_DL_ABS_OFFSETn register fields are greater than '1F', WALAT should be set to '1' (cycle additional delay). WALAT should be further increased for any full cycle delays added by the WL_CYC_DELn register fields. 0x0 No additional latency required. 0x1 1 cycle additional delay 0x2 2 cycles additional delay 0x3 3 cycles additional delay
15–13 Reserved	This read-only field is reserved and always has the value 0.
12 BI_ON	Bank Interleaving On. This bit controls the organization of the bank, row and column address bits. For further information see Address decoding .

Table continues on the next page...

MMDC_MDMISC field descriptions (continued)

Field	Description
	0 Banks are not interleaved, and address will be decoded as bank-row-column 1 Banks are interleaved, and address will be decoded as row-bank-column
11 LPDDR2_S2	LPDDR2 S2 device type indication. In case LPDDR2 device is used (DDR_TYPE = 0x1), this bit will indicate whether S2 or S4 device is used. This bit should be cleared in DDR3 mode 0x0 LPDDR2-S4 device is used. 0x1 LPDDR2-S2 device is used.
10–9 MIF3_MODE	Command prediction working mode. This field determines the level of command prediction that will be used by the MMDC 00 Disable prediction. 01 Enable prediction based on : Valid access on first pipe line stage. 10 Enable prediction based on: Valid access on first pipe line stage, Valid access on axi bus. 11 Enable prediction based on: Valid access on first pipe line stage, Valid access on axi bus, Next miss access from access queue.
8–6 RALAT	Read Additional Latency. This field determines the additional read latency which is added to CAS latency and internal delays for which the MMDC will retrieve the read data from the internal FIFO. This field is used to compensate on board/chip delays. NOTE: In LPDDR2 mode 2 extra cycles will be added internally in order to compensate tDQSCK delay. 0x0 no additional latency. 0x1 1 cycle additional latency. 0x2 2 cycles additional latency. 0x3 3 cycles additional latency. 0x4 4 cycles additional latency. 0x5 5 cycles additional latency. 0x6 6 cycles additional latency. 0x7 7 cycles additional latency.
5 DDR_4_BANK	Number of banks per DDR device. When this bit is set to "1" then the MMDC will work with DDR device of 4 banks. 0 8 banks device is being used. (Default) 1 4 banks device is being used
4–3 DDR_TYPE	DDR TYPE. This field determines the type of the external DDR device. 0x0 DDR3 device is used. 0x1 LPDDR2 device is used. 0x2 Reserved 0x3 Reserved
2 -	Reserved
1 RST	Software Reset. When this bit is asserted then the internal FSMs and registers of the MMDC will be initialized. NOTE: This bit once asserted gets deasserted automatically.

Table continues on the next page...

MMDC_MDMISC field descriptions (continued)

Field	Description
	0 Do nothing. 1 Assert reset to the MMDC.
0 Reserved	This read-only field is reserved and always has the value 0.

35.12.8 MMDC Core Special Command Register (MMDC_MDSCR)

This register is used to issue special commands manually toward the external DDR device (such as load mode register, manual self refresh, manual precharge and so on). Every write to this register will be interpreted as a command, and a read from this register will show the last command that was executed.

Every write to this register will result in one special command, and the IP bus will assert `ips_xfr_wait` as long as the special command is being carried out.

Address: 21B_0000h base + 1Ch offset = 21B_001Ch

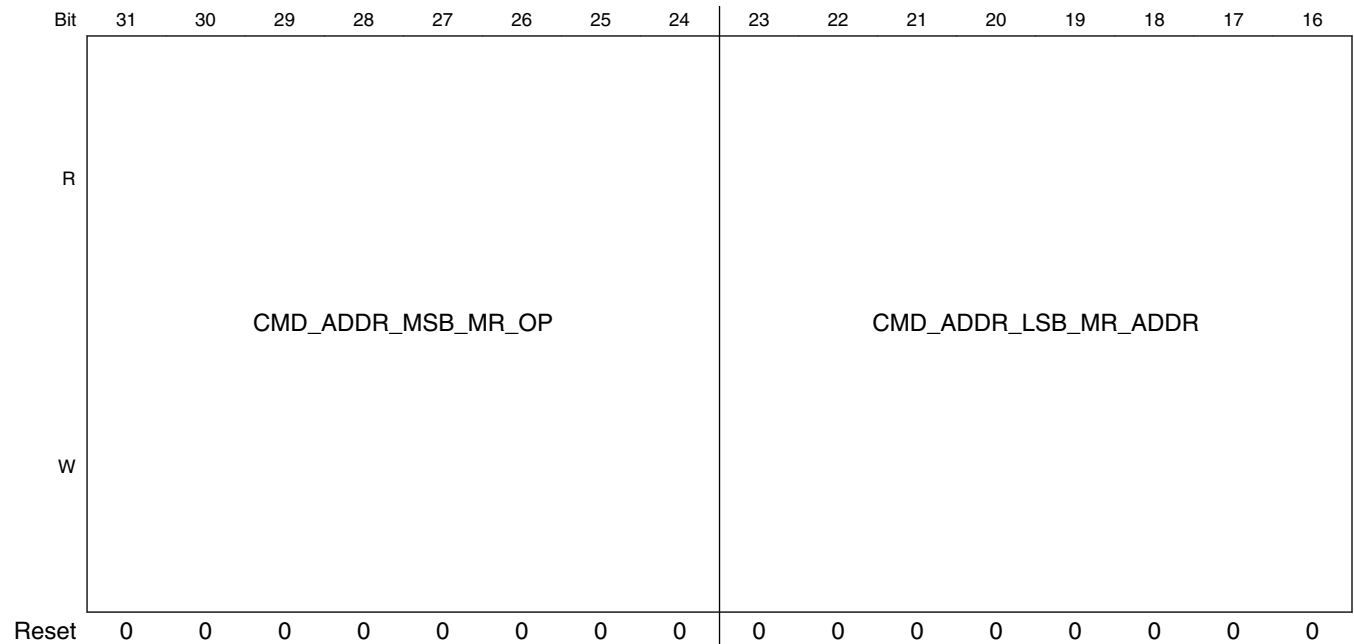

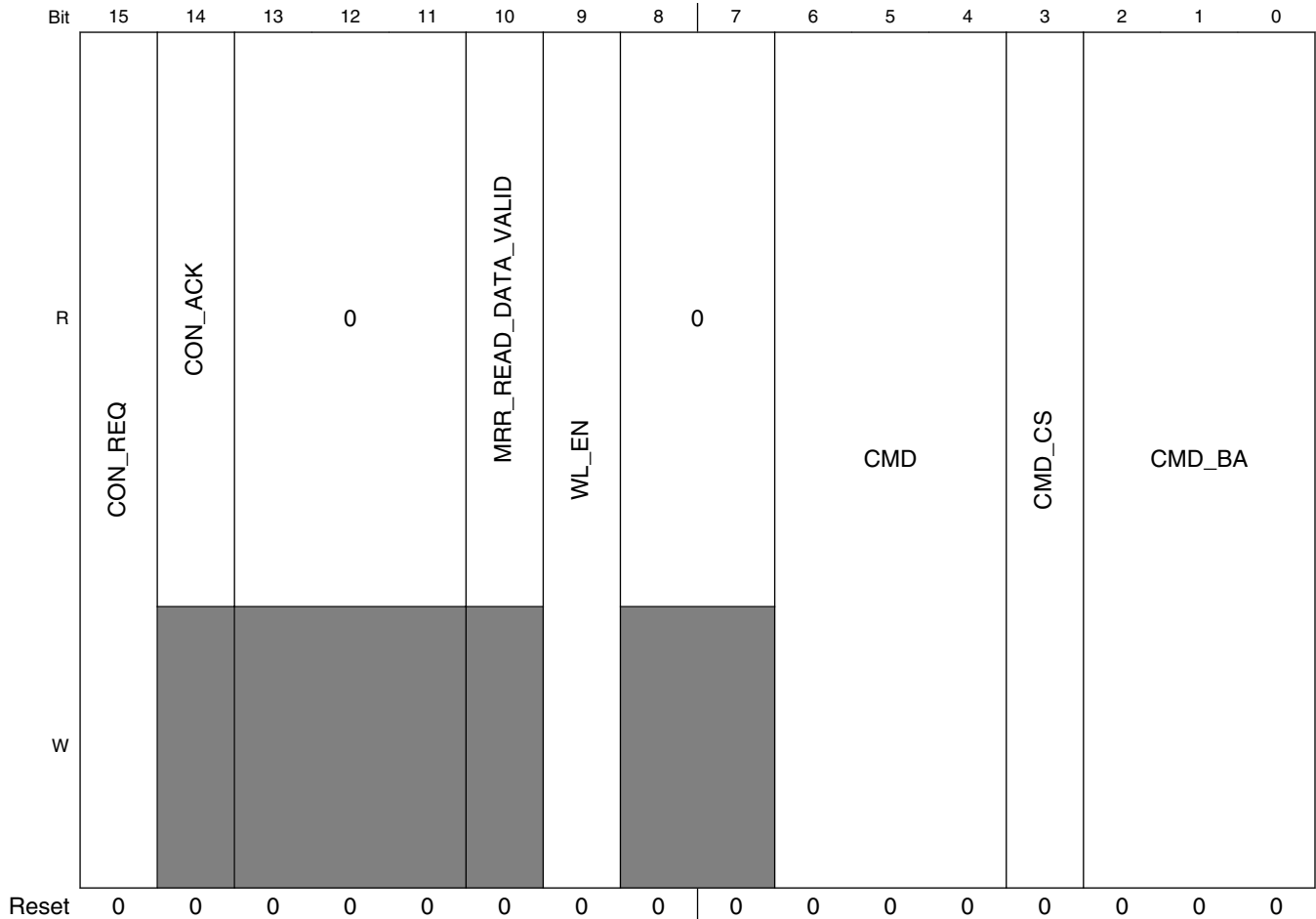

MMDC_MDSCR field descriptions

Field	Description
31–24 CMD_ADDR_MSB_MR_OP	Command/Address MSB. This field indicates the MSB of the command/Address. In LPDDR2/LPDDR3 this field indicates the MRW operand
23–16 CMD_ADDR_LSB_MR_ADDR	Command/Address LSB. This field indicates the LSB of the command/Address In LPDDR2/LPDDR3 this field indicates the MRR/MRW address
15 CON_REQ	Configuration request. When this bit is set then the MMDC will clean the pending AXI accesses and will prevent from further AXI accesses to be acknowledged. This field guarantee safe configuration (or change configuration) of the MMDC while no access is in process and prevents an unexpected behaviour. After setting this bit, it is needed to poll on CON_ACK until it is set to "1". When CON_ACK is asserted then configuration is permitted. After configuration is completed then this bit must be deasserted in order to process further AXI accesses. NOTE: This bit is asserted at the end of the reset sequence, meaning that the MMDC is waiting to configure and initialize the external memory before accepting any AXI accesses. Configuration request/acknowledge mechanism should be used for the following procedures: changing of timing parameters , during calibration process or driving commands via MDSCR[CMD]

Table continues on the next page...

MMDC_MDSCR field descriptions (continued)

Field	Description
	0 No request to configure MMDC. 1 A request to configure MMDC is valid
14 CON_ACK	Configuration acknowledge. Whenever this bit is set, it is permitted to configure MMDC IP registers. 0 Configuration of MMDC registers is forbidden. 1 Configuration of MMDC registers is permitted.
13–11 Reserved	This read-only field is reserved and always has the value 0.
10 MRR_READ_DATA_VALID	MRR read data valid. This field indicates that read data is valid at MDMRR register NOTE: This field is relevant only for LPDDR2/LPDDR3 mode 0 Cleared upon the assertion of MRR command 1 Set after MRR data is valid and stored at MDMRR register.
9 WL_EN	DQS pads direction. This bit controls the DQS pads direction during write-leveling calibration process. Before starting the write-leveling calibration process this bit should be set to "1". It should be set to "0" when sending write leveling exit command. For further information see Write leveling Calibration . 0 Exit write leveling mode or stay in normal mode. 1 Write leveling entry command was sent.
8–7 Reserved	This read-only field is reserved and always has the value 0.
6–4 CMD	Command. This field contains the command to be executed. This field will be automatically cleared after the command will be send to the DDR memory. NOTE: Only the 0x5 Precharge all command should be used, memory operation is unpredictable when using the 0x1 command 0x0 Normal operation 0x1 Precharge all, command is sent independently of bank status (set correct CMD_CS). Will be issued even if banks are closed. Primarily used for initialization sequence purposes. Not to be used during run-time operation. 0x2 Auto-Refresh Command (set correct CMD_CS). 0x3 Load Mode Register Command DDR2/DDR3, set correct CMD_CS, CMD_BA, CMD_ADDR_LSB, CMD_ADDR_MSB), MRW Command (LPDDR2/LPDDR3, set correct CMD_CS, MR_OP, MR_ADDR) 0x4 ZQ calibration (DDR2/DDR3, set correct CMD_CS, {CMD_ADDR_MSB,CMD_ADDR_LSB} = 0x400 or 0x0) 0x5 Precharge all, only if banks open (set correct CMD_CS). 0x6 MRR command (LPDDR2/LPDDR3, set correct CMD_CS, MR_ADDR) 0x7 Reserved
3 CMD_CS	Chip Select. This field determines which chip select the command is targeted to 0 to Chip-select 0 1 to Chip-select 1
CMD_BA	Bank Address. This field determines the address of the bank within the selected chip-select to where the command is targeted.

Table continues on the next page...

MMDC_MDSCR field descriptions (continued)

Field	Description
0x0	bank address 0
0x1	bank address 1
0x2	bank address 2
0x7	bank address 7

35.12.9 MMDC Core Refresh Control Register (MMDC_MDREF)

This register determines the refresh scheme that will be executed toward the DDR device. It specifies how often a refresh cycle occurs and how many refresh commands will be executed every refresh cycle.

For further information see [Refresh Scheme](#).

The following tables show examples of possible refresh schemes.

Table 35-12. Refresh rate example for REF_SEL = 0

REFR[2:0]	Number of refresh commands every 64KHz	Average periodic refresh rate (tREFI)	System Refresh period
0x0	1	15.6 μ s	tRFC
0x1	2	7.8 μ s	2*tRFC
0x3	4	3.9 μ s	4*tRFC
0x7	8	1.95 μ s	8*tRFC

Table 35-13. Refresh rate example for REF_SEL = 1

REFR[2:0]	Number of refresh commands every 32KHz	Average periodic refresh rate (tREFI)	System Refresh period
0x1	2	15.6 μ s	2*tRFC
0x3	4	7.8 μ s	4*tRFC
0x7	8	3.9 μ s	8*tRFC

Table 35-14. Refresh rate example for REF_SEL = 2 @ 400MHz

REFR[2:0]	Number of refresh commands every refresh cycle	REF_CNT	Average periodic refresh rate (tREFI)	System Refresh period
0x0	1	0x618	3.9 μ s	tRFC
0x1	2	0xC30	3.9 μ s	2*tRFC

Table continues on the next page...

Table 35-14. Refresh rate example for REF_SEL = 2@ 400MHz (continued)

REFR[2:0]	Number of refresh commands every refresh cycle	REF_CNT	Average periodic refresh rate (tREFI)	System Refresh period
0x2	3	0x1248	3.9µs	3*tRFC
0x3	4	0x1860	3.9 µs	4*tRFC

Other refresh configurations are also allowed; the configuration values in the tables above are only examples for obtaining the desired average periodic refresh rate.

If the required average periodic refresh rate (tREFI) is kept, all of the rows will be refreshed in every refresh window. Because the memory device issues additional refresh commands for every refresh it receives, the tREFI remains the same across the device, regardless of its number of rows. This is particularly relevant in the tRFC parameter, which becomes bigger as the density increases.

Address: 21B_0000h base + 20h offset = 21B_0020h

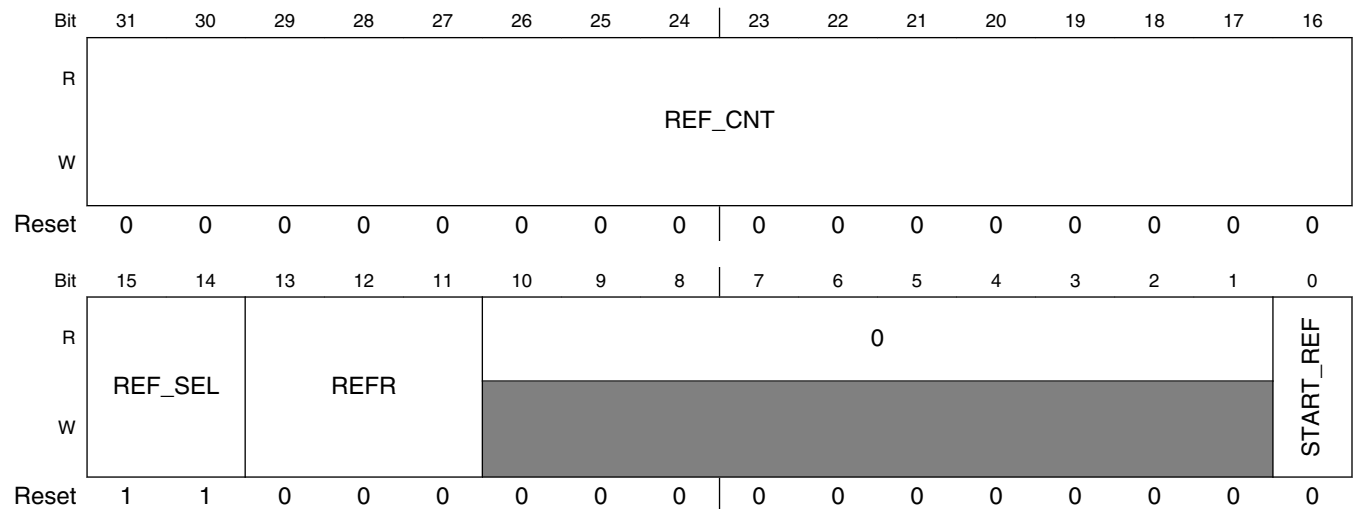

MMDC_MDREF field descriptions

Field	Description
31–16 REF_CNT	Refresh Counter at DDR clock period If REF_SEL equals '2' a refresh cycle will begin every amount of DDR cycles configured in this field. 0x0 Reserved. 0x1 1 cycle. 0xFFFFE 65534 cycles. 0xFFFFF 65535 cycles.
15–14 REF_SEL	Refresh Selector. This bit selects the source of the clock that will trigger each refresh cycle:

Table continues on the next page...

MMDC_MDREF field descriptions (continued)

Field	Description
	0 Periodic refresh cycles will be triggered in frequency of 64KHz. 1 Periodic refresh cycles will be triggered in frequency of 32KHz. 2 Periodic refresh cycles will be triggered every amount of cycles that are configured in REF_CNT field. 3 No refresh cycles will be triggered.
13–11 REFR	Refresh Rate. This field determines how many refresh commands will be issued every refresh cycle. After every refresh command the MMDC won't drive any command to the DDR device until satisfying tRFC period 0x0 1 refresh 0x1 2 refreshes 0x2 3 refreshes 0x3 4 refreshes 0x4 5 refreshes 0x5 6 refreshes 0x6 7 refreshes 0x7 8 refreshes
10–1 Reserved	This read-only field is reserved and always has the value 0.
0 START_REF	Manual start of refresh cycle. When this field is set to '1' the MMDC will start a refresh cycle immediately according to number of refresh commands that are configured in 'REFR' field. This bit returns to zero automatically. 0 Do nothing. 1 Start a refresh cycle.

35.12.10 MMDC Core Read/Write Command Delay Register (MMDC_MDRWD)

This register determines the delay between back to back read and write accesses. The register reset values are set to the minimum required value.

NOTE

As the default values are set to achieve optimal results, changing them is discouraged.

Address: 21B_0000h base + 2Ch offset = 21B_002Ch

Bit	31	30	29	28	27	26	25	24	23	22	21	20	19	18	17	16
R	0															
W				tDAI												
Reset	0	0	0	0	1	1	1	1	1	1	0	0	1	1	1	1

MMDC Memory Map/Register Definition

Bit	15	14	13	12	11	10	9	8	7	6	5	4	3	2	1	0
R	0	RTW_SAME			WTR_DIFF			WTW_DIFF			RTW_DIFF			RTR_DIFF		
W	0															
Reset	0	0	1	0	0	1	1	0	1	1	0	1	0	0	1	0

MMDC_MDRWD field descriptions

Field	Description
31–29 Reserved	This read-only field is reserved and always has the value 0.
28–16 tDAI	Device auto initialization period.(maximum) NOTE: This field is relevant only to LPDDR2 mode 0x0 1 cycle 0xF9F 4000 cycles (Default, JEDEC value for LPDDR2, gives 10us at 400MHz clock). 0x1FFF 8192 cycles
15 Reserved	This read-only field is reserved and always has the value 0.
14–12 RTW_SAME	Read to write delay for the same chip-select. This field controls the delay between read to write commands toward the same chip select. The total delay is calculated according to: $BL/2 + RTW_SAME + (tCL-tCWL) + RALAT$ 0x0 0 cycle 0x1 1 cycle 0x2 2 cycles (Default) 0x3 3 cycles 0x4 4 cycles 0x5 5 cycles 0x6 6 cycles 0x7 7 cycles
11–9 WTR_DIFF	Write to read delay for different chip-select. This field controls the delay between write to read commands toward different chip select. The total delay is calculated according to: $BL/2 + WTR_DIFF + (tCL-tCWL) + RALAT$ 0x0 0 cycle 0x1 1 cycle 0x2 2 cycles 0x3 3 cycles (Default) 0x4 4 cycles 0x5 5 cycles 0x6 6 cycles 0x7 7 cycles
8–6 WTW_DIFF	Write to write delay for different chip-select. This field controls the delay between write to write commands toward different chip select. The total delay is calculated according to: $BL/2 + WTW_DIFF$ 0x0 0 cycle 0x1 1 cycle 0x2 2 cycles 0x3 3 cycles (Default)

Table continues on the next page...

MMDC_MDRWD field descriptions (continued)

Field	Description
	0x4 4 cycles 0x5 5 cycles 0x6 6 cycles 0x7 7 cycles
5-3 RTW_DIFF	Read to write delay for different chip-select. This field controls the delay between read to write commands toward different chip select. The total delay is calculated according to: $BL/2 + RTW_DIFF + (tCL - tCWL) + RALAT$ 0x0 0 cycle 0x1 1 cycle 0x2 2 cycles (Default) 0x3 3 cycles 0x4 4 cycles 0x5 5 cycles 0x6 6 cycles 0x7 7 cycles
RTR_DIFF	Read to read delay for different chip-select. This field controls the delay between read to read commands toward different chip select. The total delay is calculated according to: $BL/2 + RTR_DIFF$ 0x0 0 cycle 0x1 1 cycle 0x2 2 cycles (Default) 0x3 3 cycles 0x4 4 cycles 0x5 5 cycles 0x6 6 cycles 0x7 7 cycles

35.12.11 MMDC Core Out of Reset Delays Register (MMDC_MDOR)

This register defines delays that must be kept when MMDC exits reset.

Address: 21B_0000h base + 30h offset = 21B_0030h

Bit	31	30	29	28	27	26	25	24	23	22	21	20	19	18	17	16	15	14	13	12	11	10	9	8	7	6	5	4	3	2	1	0	
R	0								tXPR								0	SDE_to_RST				0	RST_to_CKE										
W	0								1								0	0				0	0										
Reset	0	0	0	0	0	0	0	0	1	0	0	1	1	1	1	1	1	0	0	0	0	1	1	1	0	0	0	0	0	1	1	1	0

MMDC_MDOR field descriptions

Field	Description
31–24 Reserved	This read-only field is reserved and always has the value 0.
23–16 tXPR	LPDDR2: Not relevant to this mode and should remain in default reset value. DDR3: As defined in timing parameter table. 0x0 Reserved 0x1 2 cycles 0x2 3 cycles 0xFE 255 cycles 0xFF 256 cycles
15–14 Reserved	This read-only field is reserved and always has the value 0.
13–8 SDE_to_RST	DDR3 mode: Time from SDE enable until DDR reset# is high. LPDDR2 mode: This field is not relevant and should remain in its default reset value. NOTE: Each cycle in this field is 15.258 us. 0x0 Reserved 0x1 Reserved 0x2 Reserved 0x3 1 cycles 0x4 2 cycles 0x10 14 cycles (JEDEC value for DDR3) - total of 200 us 0x3E 60 cycles 0x3F 61 cycles
7–6 Reserved	This read-only field is reserved and always has the value 0.
RST_to_CKE	DDR3: Time from SDE enable to CKE rise. In case that DDR reset# is low, will wait until it's high and then wait this period until rising CKE. (JEDEC value is 500 us) LPDDR2: Idle time after first CKE assertion (JEDEC value is 200 us). NOTE: Each cycle in this field is 15.258 us. 0x0 Reserved 0x1 Reserved 0x2 Reserved 0x3 1 cycles 0x10 14 cycles (JEDEC value for LPDDR2) - total of 200 us 0x23 33 cycles (JEDEC value for DDR3) - total of 500 us 0x3E 60 cycles 0x3F 61 cycles

35.12.12 MMDC Core MRR Data Register (MMDC_MDMRR)

This register contains data that was collected after issuing MRR command. The data in this register is valid only when MDSCR[MRR_READ_DATA_VALID] is set to "1".

This register is relevant only in LPDDR2 mode. For further information see [LPDDR2 Refresh Rate Update and Timing Derating](#).

Address: 21B_0000h base + 34h offset = 21B_0034h

Bit	31	30	29	28	27	26	25	24	23	22	21	20	19	18	17	16	15	14	13	12	11	10	9	8	7	6	5	4	3	2	1	0
R	Reserved								Reserved								MRR_READ_DATA1				MRR_READ_DATA0											
W	Reserved								Reserved								Reserved				Reserved											
Reset	0	0	0	0	0	0	0	0	0	0	0	0	0	0	0	0	0	0	0	0	0	0	0	0	0	0	0	0	0	0	0	0

MMDC_MDMRR field descriptions

Field	Description
31–24 -	This field is reserved. Reserved
23–16 -	This field is reserved. Reserved
15–8 MRR_READ_DATA1	MRR DATA that arrived on DQ[15:8]
MRR_READ_DATA0	MRR DATA that arrived on DQ[7:0]

35.12.13 MMDC Core Timing Configuration Register 3 (MMDC_MDCFG3LP)

This register is relevant only for LPDDR2 mode.

Address: 21B_0000h base + 38h offset = 21B_0038h

Bit	31	30	29	28	27	26	25	24	23	22	21	20	19	18	17	16	15	14	13	12	11	10	9	8	7	6	5	4	3	2	1	0
R	0								RC_LP				0				tRCD_LP		tRPpb_LP		tRPab_LP											
W	Reserved								Reserved				Reserved				Reserved		Reserved		Reserved											
Reset	0	0	0	0	0	0	0	0	0	0	0	0	0	0	0	0	0	0	0	0	0	0	0	0	0	0	0	0	0	0	0	0

MMDC_MDCFG3LP field descriptions

Field	Description
31–22 Reserved	This read-only field is reserved and always has the value 0.
21–16 RC_LP	Active to Active or Refresh command period (same bank). This field is valid only for LPDDR2 memories 0x0 1 clock 0x1 2 clocks 0x2 3 clocks

Table continues on the next page...

MMDC_MDCFG3LP field descriptions (continued)

Field	Description
	0x3E 63 clocks 0x3F Reserved
15–12 Reserved	This read-only field is reserved and always has the value 0.
11–8 tRCD_LP	Active command to internal read or write delay time (same bank). This field is valid only for LPDDR2 memories 0x0 1 clock 0x1 2 clocks 0x2 3 clocks 0xE 15 clocks 0xF Reserved
7–4 tRPpb_LP	Precharge (per bank) command period (same bank). This field is valid only for LPDDR2 memories 0x0 1 clock 0x1 2 clocks 0x2 3 clocks 0xE 15 clocks 0xF Reserved
tRPab_LP	Precharge (all banks) command period. This field is valid only for LPDDR2 memories 0x0 1 clock 0x1 2 clocks 0x2 3 clocks 0xE 15 clocks 0xF Reserved

35.12.14 MMDC Core MR4 Derating Register (MMDC_MDMR4)

This register is relevant only for LPDDR2 mode. It is used to dynamically change certain values depending on MR4 read result, which is based on memory temperature sensor result.

Address: 21B_0000h base + 3Ch offset = 21B_003Ch

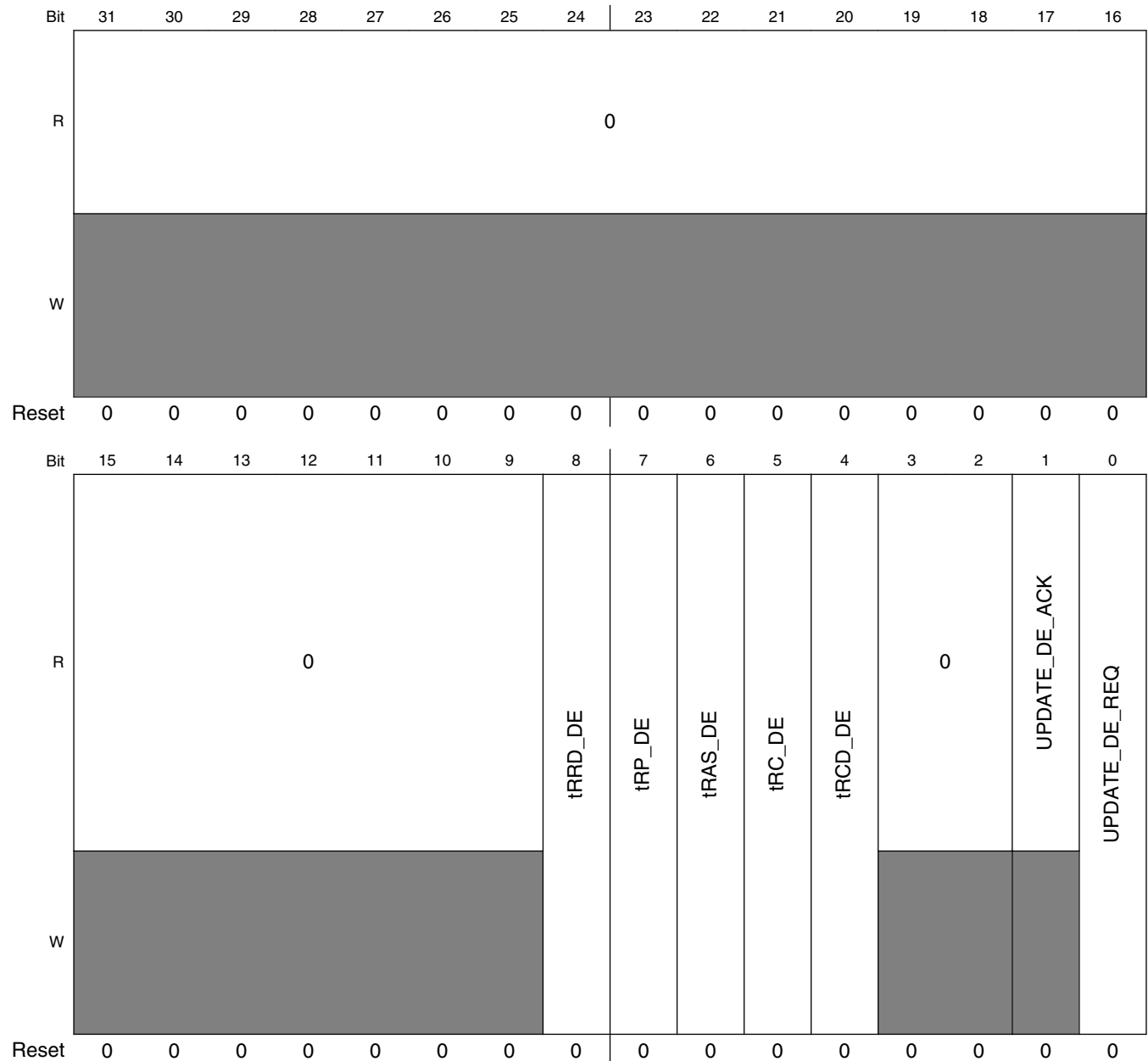

MMDC_MDMR4 field descriptions

Field	Description
31–9 Reserved	This read-only field is reserved and always has the value 0.
8 tRRD_DE	tRRD derating value. 0 Original tRRD is used. 1 tRRD is derated in 1 cycle.
7 tRP_DE	tRP derating value. 0 Original tRP is used. 1 tRP is derated in 1 cycle.
6 tRAS_DE	tRAS derating value. 0 Original tRAS is used. 1 tRAS is derated in 1 cycle.
5 tRC_DE	tRC derating value. 0 Original tRC is used. 1 tRC is derated in 1 cycle.
4 tRCD_DE	tRCD derating value. 0 Original tRCD is used. 1 tRCD is derated in 1 cycle.
3–2 Reserved	This read-only field is reserved and always has the value 0.
1 UPDATE_DE_ACK	Update Derated Values Acknowledge. This read only bit will be cleared upon UPDATE_DE_REQ assertion and will be set after the new values are taken.
0 UPDATE_DE_REQ	Update Derated Values Request. This read modify write field is automatically cleared after the request is issued. 0 Do nothing. 1 Request to update the following values: tRRD, tRCD, tRP, tRC, tRAS and refresh related fields(MDREF register): REF_CNT, REF_SEL, REFR

35.12.15 MMDC Core Address Space Partition Register (MMDC_MDASP)

This register defines the partitioning between chip select 0 and chip select 1. For further information see [Chip select settings](#).

Address: 21B_0000h base + 40h offset = 21B_0040h

Bit	31	30	29	28	27	26	25	24	23	22	21	20	19	18	17	16	15	14	13	12	11	10	9	8	7	6	5	4	3	2	1	0	
R	0																CS0_END																
W																																	
Reset	0	0	0	0	0	0	0	0	0	0	0	0	0	0	0	0	0	0	0	0	0	0	0	0	0	0	0	1	1	1	1	1	1

MMDC_MDASP field descriptions

Field	Description
31–7 Reserved	This read-only field is reserved and always has the value 0.
CS0_END	Defines the absolute last address associated with CS0 with increments of 256Mb. CS0_END=AXI_ADDRESS[31:25] bits. MMDC0_MDASP[CS0_END] should be set to DDR_CS_SIZE/32M + 0x3f (channel 0 base address begins at 0x80000000)

35.12.16 MMDC Core AXI Reordering Control Register (MMDC_MAARCR)

This register determines the values of the weights used for the re-ordering arbitration engine. For further information see [Performance](#).

Address: 21B_0000h base + 400h offset = 21B_0400h

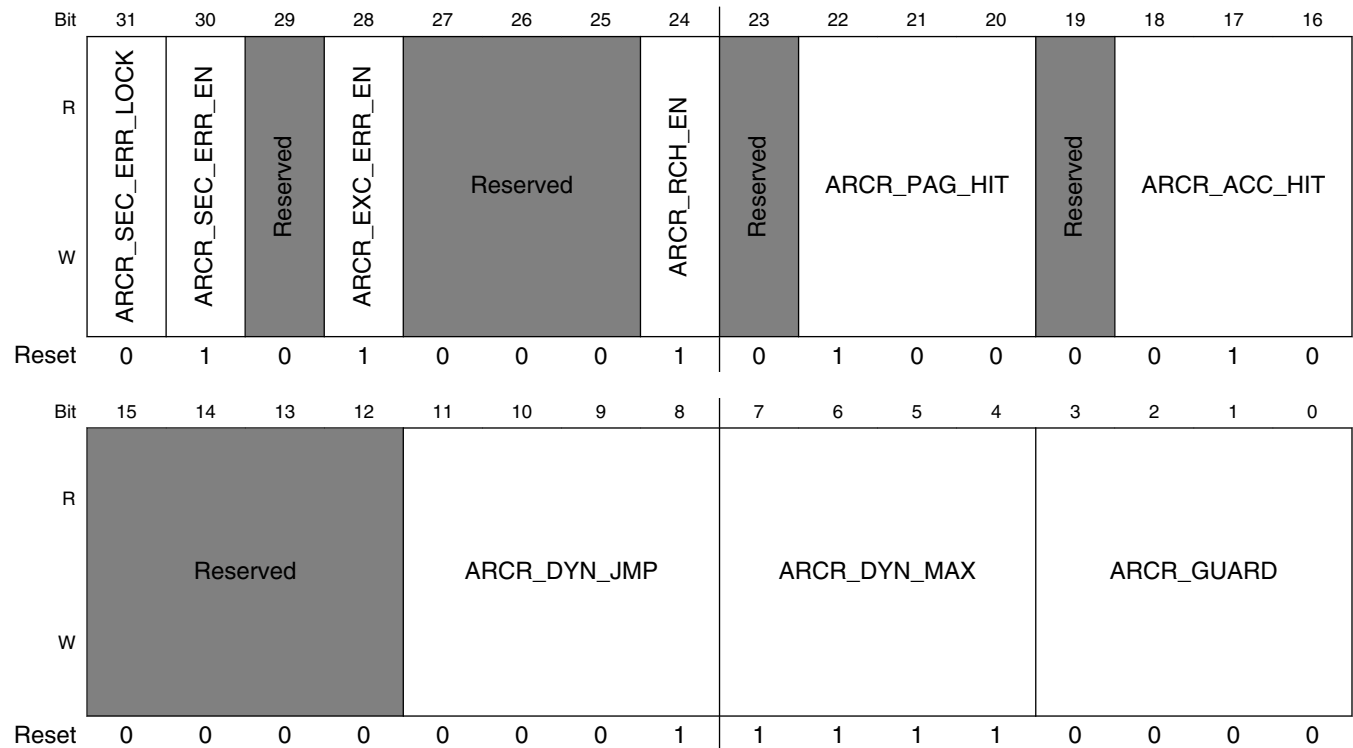

MMDC_MAARCR field descriptions

Field	Description
31 ARCR_SEC_ERR_LOCK	Once set, this bit locks ARCR_SEC_ERR_EN and prevents from its updating. This bit can be only cleared by reset Default value is 0x0 - encoding 0 (unlocked) 0 ARCR_SEC_ERR_EN is unlocked, so can be updated any moment 1 ARCR_SEC_ERR_EN is locked, so it can't be updated
30 ARCR_SEC_ERR_EN	This bit defines whether security read/write access violation result in SLV Error response or in OKAY response Default value is 0x1 - encoding 1(response is SLV Error, rresp/bresp=2'b10) 0 security violation results in OKAY response (rresp/bresp=2'b00) 1 security violation results in SLAVE Error response (rresp/bresp=2'b10)

Table continues on the next page...

MMDC_MAARCR field descriptions (continued)

Field	Description
29 -	This field is reserved. Reserved
28 ARCR_EXC_ERR_EN	This bit defines whether exclusive read/write access violation of AXI 6.2.4 rule result in SLV Error response or in OKAY response Default value is 0x1 - encoding 1(response is SLV Error) 0 violation of AXI exclusive rules (6.2.4) result in OKAY response (rresp/bresp=2'b00) 1 violation of AXI exclusive rules (6.2.4) result in SLAVE Error response (rresp/bresp=2'b10)
27–25 -	This field is reserved. Reserved
24 ARCR_RCH_EN	This bit defines whether Real time channel is activated and bypassed all other pending accesses, So accesses with QoS=='F' will be granted the highest priority in the optimization/reordering mechanism Default value is 0x1 - encoding 1 (Enabled) 0 normal prioritization, no bypassing 1 accesses with QoS=='F' bypass the arbitration
23 -	This field is reserved. Reserved
22–20 ARCR_PAG_HIT	ARCR Page Hit Rate. This value will be added by the optimization/reordering mechanism to any pending access that is targeted to an open DDR row. Default value of ARCR_PAG_HIT is 0x00100 - encoding 4.
19 -	This field is reserved. Reserved
18–16 ARCR_ACC_HIT	ARCR Access Hit Rate. This value will be added by the optimization/reordering mechanism to any pending access that has the same access type (read/write) as the previous access. Default value of is ARCR_ACC_HIT 0x0010 - encoding 2.
15–12 -	This field is reserved. Reserved
11–8 ARCR_DYN_JMP	ARCR Dynamic Jump. Each time an access is not chosen by the optimization/reordering mechanism then its dynamic score will be incremented by ARCR_DYN_JMP value. NOTE: Setting ARCR_DYN_JMP may cause starvation of low priority accesses NOTE: ARCR_DYN_JMP must be smaller than ARCR_DYN_MAX Default ARCR_DYN_JMP value is 0x0001 - encoding 1
7–4 ARCR_DYN_MAX	ARCR Dynamic Maximum. ARCR_DYN_MAX is the maximum dynamic score value that each access inside the optimization/reordering mechanism can get. 0000 0 0001 1 1111 15 (default)
ARCR_GUARD	ARCR Guard. After an access reached the maximum dynamic score value, it will wait additional ARCR_GUARD arbitration cycles and then will gain the highest priority in the optimization/reordering mechanism. 0000 15 (default) 0001 16 1111 30

35.12.17 MMDC Core Power Saving Control and Status Register (MMDC_MAPSR)

The MAPSR determines the power saving features of MMDC. For further information see [Power Saving and Clock Frequency Change modes](#).

NOTE

See chip-specific information for implementation on your device.

Address: 21B_0000h base + 404h offset = 21B_0404h

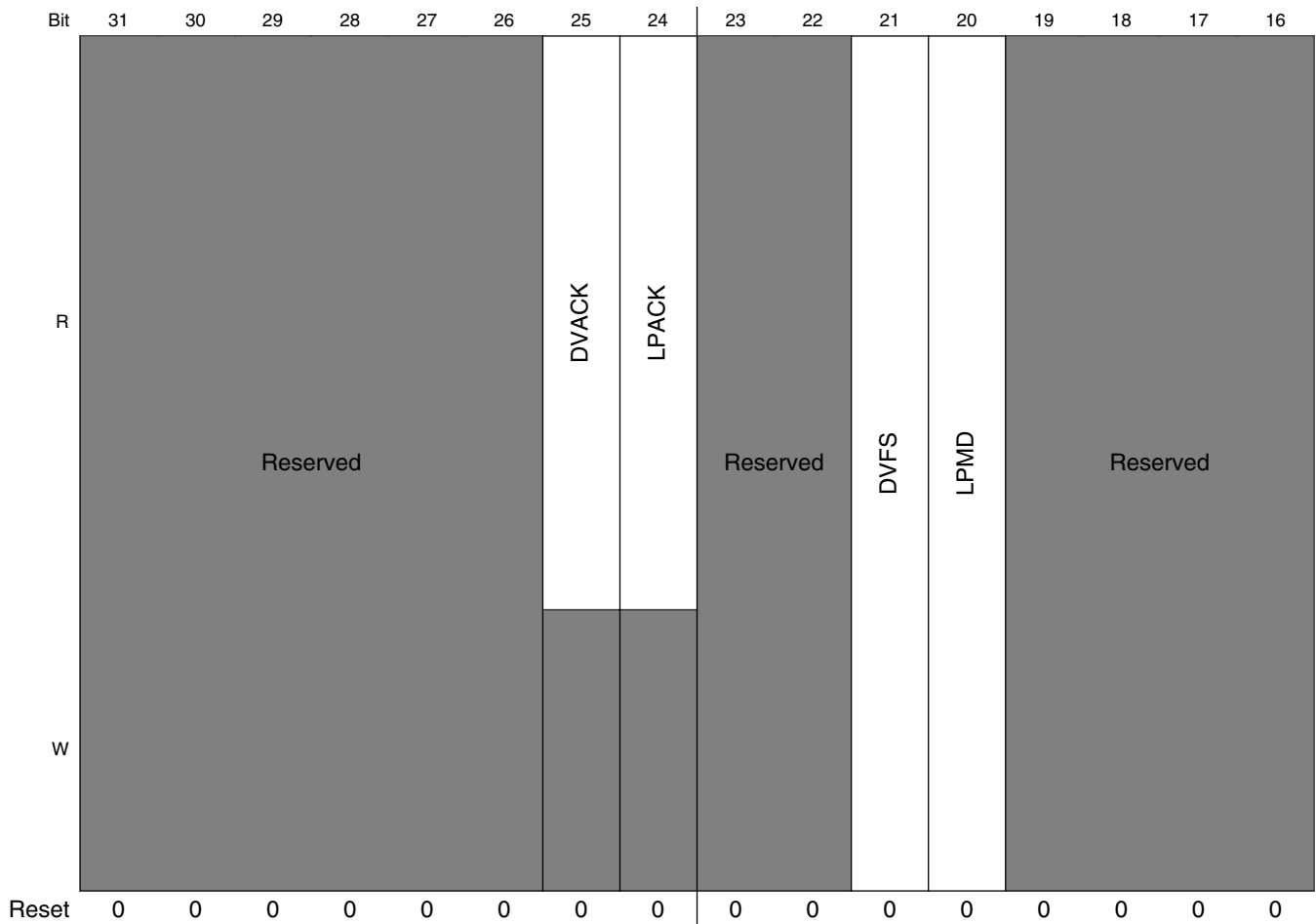

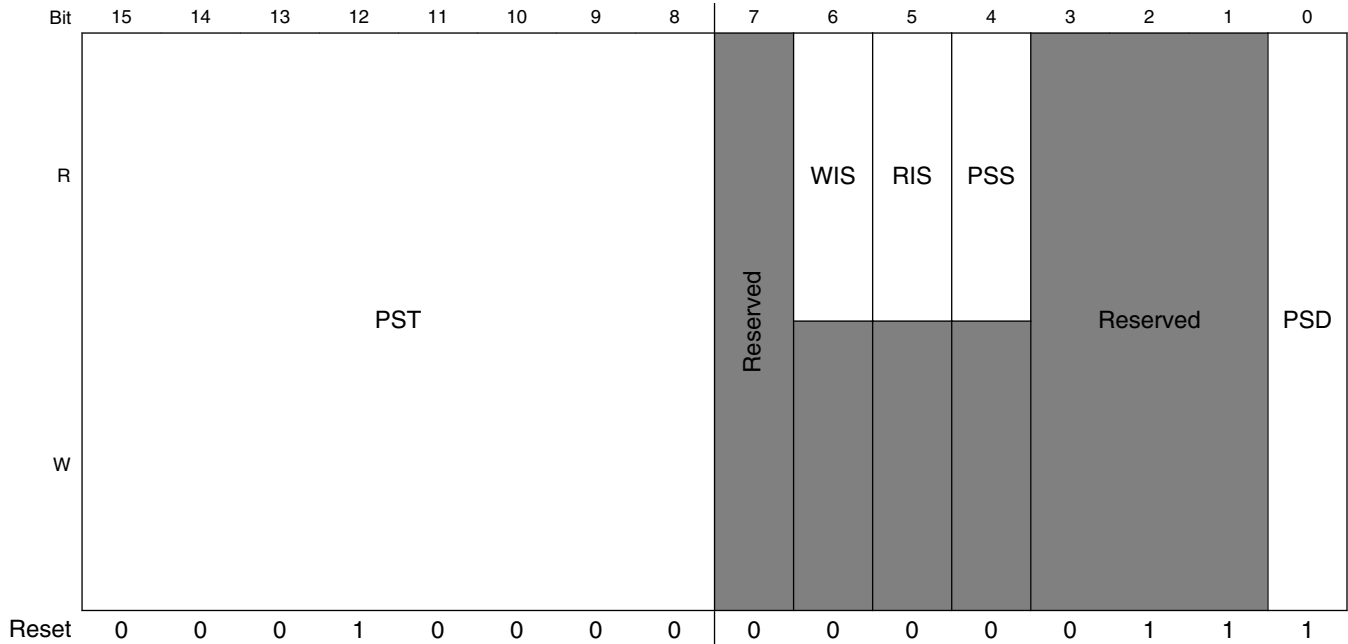

MMDC_MAPSR field descriptions

Field	Description
31–26 -	This field is reserved. Reserved
25 DVACK	DVFS/Self-Refresh acknowledge. This read only bit indicates whether a DVFS/self-refresh acknowledge was asserted and that the MMDC is in self-refresh mode.
24 LPACK	General low-power acknowledge. This read only bit indicates whether a low-power acknowledge was asserted and that MMDC is in self-refresh mode
23–22 -	This field is reserved. Reserved
21 DVFS	DVFS/Self-Refresh request. Software request for DVFS/self-refresh. Assertion of this bit will initiate a self-refresh entry sequence. 0 no DVFS/Self-Refresh entry request 1 DVFS/Self-Refresh entry request
20 LPMD	General LPMD request. Software request for LPMD. Assertion of this bit will yield in self-refresh entry sequence 0 no lpmd request 1 lpmd request
19–16 -	This field is reserved. Reserved
15–8 PST	Automatic Power saving timer. Valid only when PSD is set to "0". When the MMDC is idle for amount of cycles specified in that field then the DDR device will be entered automatically into self-refresh mode. The real value which is used is register-value multiplied by 64. 00000000 Reserved - this value is forbidden. 00000001 timer is configured to 64 clock cycles.

Table continues on the next page...

MMDC_MAPSR field descriptions (continued)

Field	Description
	00000010 timer is configured to 128 clock cycles. 00010000 (Default)- 1024 clock cycles. 11111111 timer clock is configured to 16320 clock cycles.
7 -	This field is reserved. Reserved.
6 WIS	Write Idle Status. This read only bit indicates whether write request buffer is idle (empty) or not. 0 not idle 1 idle
5 RIS	Read Idle Status. This read only bit indicates whether read request buffer is idle (empty) or not. 0 not idle 1 idle
4 PSS	Power Saving Status. This read only bit indicates whether the MMDC is in automatic power saving mode. 0 not in power saving mode 1 power saving mode
3-1 -	This field is reserved. Reserved.
0 PSD	Automatic Power Saving Disable. When the value of PSD is "0" (i.e. automatic power saving is enabled) then the PST is activated and MMDC will enter automatically to self-refresh while the number of idle cycle reached. NOTE: This bit must be disabled (i.e. set to "1") during calibration process 0 power saving enabled 1 power saving disabled (default)

35.12.18 MMDC Core Exclusive ID Monitor Register0 (MMDC_MAEXIDR0)

This register defines the ID to be monitored for exclusive accesses of monitor0 and monitor1. For further information see [Exclusive accesses handling](#) .

Address: 21B_0000h base + 408h offset = 21B_0408h

Bit	31	30	29	28	27	26	25	24	23	22	21	20	19	18	17	16	15	14	13	12	11	10	9	8	7	6	5	4	3	2	1	0
R	EXC_ID_MONITOR1																EXC_ID_MONITOR0															
W																																
Reset	0	0	0	0	0	0	0	0	0	0	1	0	0	0	0	0	0	0	0	0	0	0	0	0	0	0	0	0	0	0	0	0

MMDC_MAEXIDR0 field descriptions

Field	Description
31–16 EXC_ID_ MONITOR1	This field defines ID for Exclusive monitor#1. Default value is 0x0020
EXC_ID_ MONITOR0	This field defines ID for Exclusive monitor#0. Default value is 0x0000

35.12.19 MMDC Core Exclusive ID Monitor Register1 (MMDC_MAEXIDR1)

This register defines the ID to be monitored for exclusive accesses of monitor2 and monitor3. For further information see [Exclusive accesses handling](#) .

Address: 21B_0000h base + 40Ch offset = 21B_040Ch

Bit	31	30	29	28	27	26	25	24	23	22	21	20	19	18	17	16	15	14	13	12	11	10	9	8	7	6	5	4	3	2	1	0
R	EXC_ID_MONITOR3																EXC_ID_MONITOR2															
W	EXC_ID_MONITOR3																EXC_ID_MONITOR2															
Reset	0	0	0	0	0	0	0	0	0	0	1	1	0	0	0	0	0	0	0	0	0	0	0	0	1	0	0	0	0	0	0	

MMDC_MAEXIDR1 field descriptions

Field	Description
31–16 EXC_ID_ MONITOR3	This field defines ID for Exclusive monitor#3. Default value is 0x0060
EXC_ID_ MONITOR2	This field defines ID for Exclusive monitor#2. Default value is 0x0040

35.12.20 MMDC Core Debug and Profiling Control Register 0 (MMDC_MADPCR0)

Address: 21B_0000h base + 410h offset = 21B_0410h

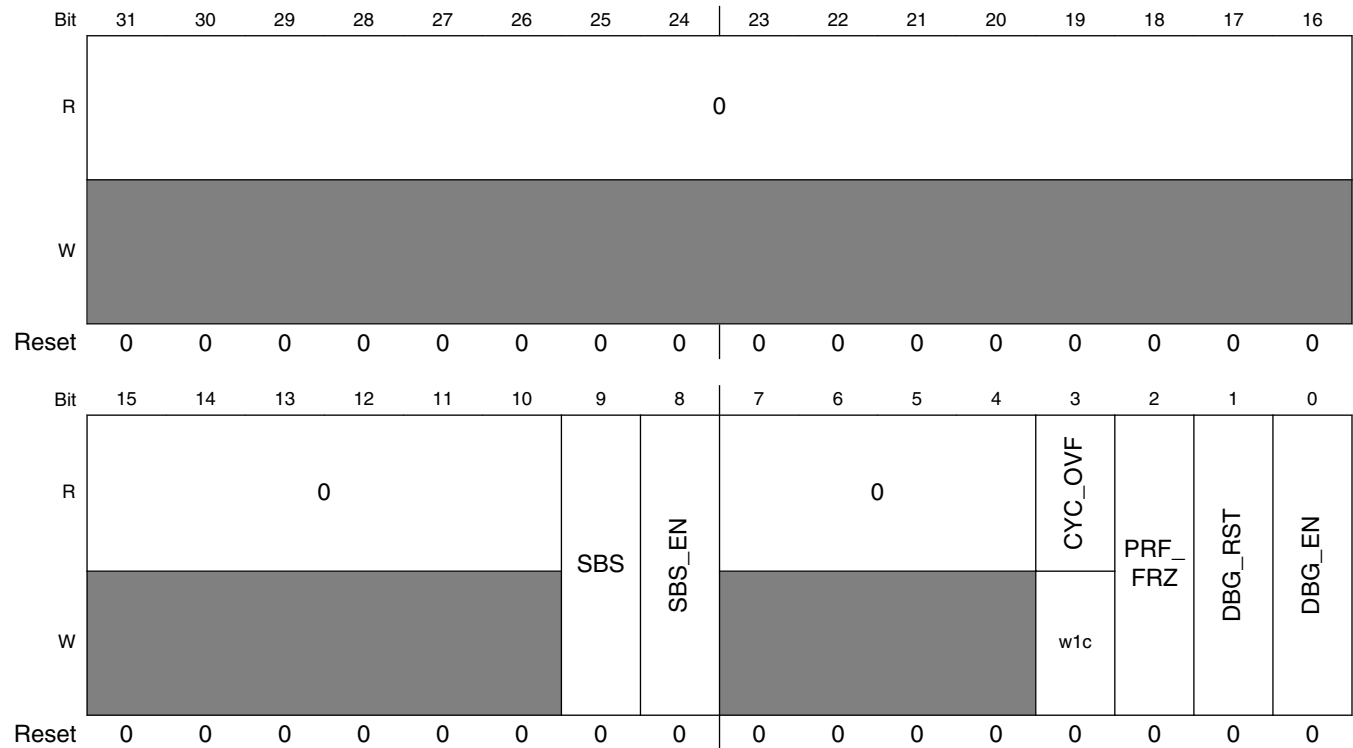

MMDC_MADPCR0 field descriptions

Field	Description
31–10 Reserved	This read-only field is reserved and always has the value 0.
9 SBS	Step By Step trigger. If SBS_EN is set to "1" then dispatching AXI pending access toward the DDR will done only if this bit is set to "1", otherwise no access will be dispatched toward the DDR. This bit is cleared when the pending access has been issued toward the DDR device. 1 Launch AXI pending access toward the DDR 0 No access will be launched toward the DDR
8 SBS_EN	Step By Step debug Enable. Enable step by step mode. Every time this mechanism is enabled then setting SBS to "1" will dispatch one pending AXI access to the DDR and in parallel its attributes will be observed in the status registers (MASBS0 and MASBS1). For further information see Step By Step (SBS) software monitor . 0 disable 1 enable
7–4 Reserved	This read-only field is reserved and always has the value 0.

Table continues on the next page...

MMDC_MADPCR0 field descriptions (continued)

Field	Description
3 CYC_OVF	Total Profiling Cycles Count Overflow. When profiling mechanism is enabled (DBG_EN is set to "1") then this bit is asserted when overflow of CYC_COUNT occurred. Cleared by writing 1 to it. 0 no overflow 1 overflow
2 PRF_FRZ	Profiling freeze. When this bit is asserted then the profiling mechanism will be froze and the associated status registers (MADPSR0-MADPSR5) will hold the current profiling values. 0 profiling counters are not frozen 1 profiling counters are frozen
1 DBG_RST	Debug and Profiling Reset. Reset all debug and profiling counters and components. 0 no reset 1 reset
0 DBG_EN	Debug and Profiling Enable. Enable debug and profiling mechanism. When this bit is asserted then the MMDC will perform a profiling based on the ID that is configured to MADPCR1. Upon assertion of PRF_FRZ the profiling will be froze and the profiling results will be sampled to the status registers (MADPSR0-MADPSR5). For further information see MMDC Profiling . 0 disable (default) 1 enable

35.12.21 MMDC Core Debug and Profiling Control Register 1 (MMDC_MADPCR1)

Address: 21B_0000h base + 414h offset = 21B_0414h

Bit	31	30	29	28	27	26	25	24	23	22	21	20	19	18	17	16	15	14	13	12	11	10	9	8	7	6	5	4	3	2	1	0
R	PRF_AXI_ID_MASK																PRF_AXI_ID															
W	PRF_AXI_ID_MASK																PRF_AXI_ID															
Reset	0	0	0	0	0	0	0	0	0	0	0	0	0	0	0	0	0	0	0	0	0	0	0	0	0	0	0	0	0	0	0	

MMDC_MADPCR1 field descriptions

Field	Description
31–16 PRF_AXI_ID_MASK	Profiling AXI ID Mask. AXI ID bits which masked by this value are chosen for profiling. 1 AXI ID specific bit is chosen for profiling 0 AXI ID specific bit is ignored (don't care)
PRF_AXI_ID	Profiling AXI ID. AXI IDs that match a bit-wise AND logic operation between PRF_AXI_ID and PRF_AXI_ID_MASK are chosen for profiling. Default value is 0x0, to choose any ID-s for profiling

35.12.22 MMDC Core Debug and Profiling Status Register 0 (MMDC_MADPSR0)

Address: 21B_0000h base + 418h offset = 21B_0418h

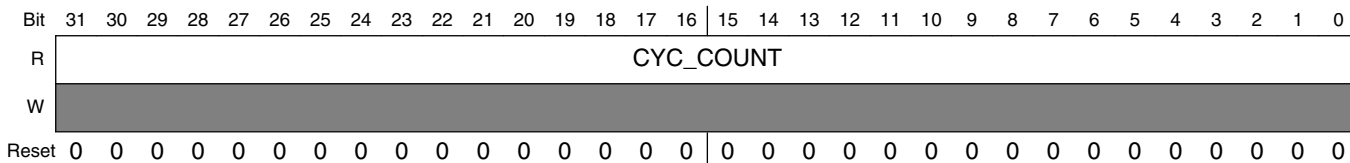

MMDC_MADPSR0 field descriptions

Field	Description
CYC_COUNT	Total Profiling cycle Count. This field reflects the total cycle count in case the profiling mechanism is enabled from assertion of DBG_EN and until PRF_FRZ is asserted

35.12.23 MMDC Core Debug and Profiling Status Register 1 (MMDC_MADPSR1)

The register reflects the total cycles during which the MMDC state machines were busy (both writes and reads). This information can be used for DDR Utilization calculation.

Address: 21B_0000h base + 41Ch offset = 21B_041Ch

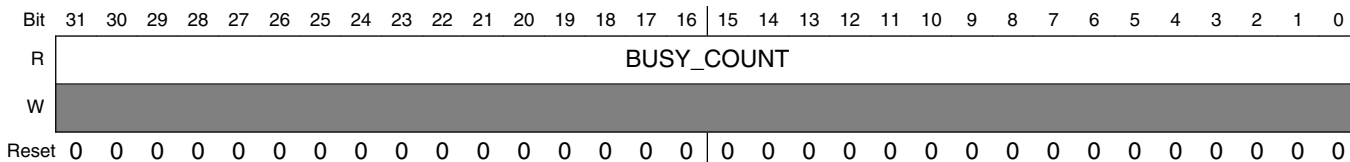

MMDC_MADPSR1 field descriptions

Field	Description
BUSY_COUNT	Profiling Busy Cycles Count. This field reflects the total number of cycles where the MMDC read and write state machines were busy during the profiling period. Can be used for DDR utilization calculations. Busy cycles are any MMDC clock cycles where the internal state machine is not idle. If any read or write requests are pending in the FIFOs, the MMDC is not idle.

35.12.24 MMDC Core Debug and Profiling Status Register 2 (MMDC_MADPSR2)

This register reflects the total number of read accesses (per AXI ID) toward MMDC.

Address: 21B_0000h base + 420h offset = 21B_0420h

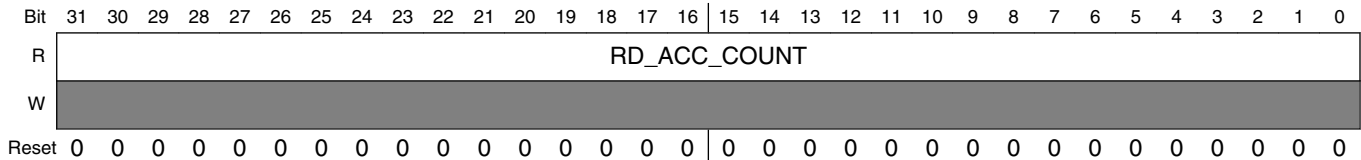

MMDC_MADPSR2 field descriptions

Field	Description
RD_ACC_COUNT	Profiling Read Access Count. This register reflects the total number of read accesses (per AXI ID) toward MMDC.

35.12.25 MMDC Core Debug and Profiling Status Register 3 (MMDC_MADPSR3)

This register reflects the total number of write accesses (per AXI ID) toward MMDC.

Address: 21B_0000h base + 424h offset = 21B_0424h

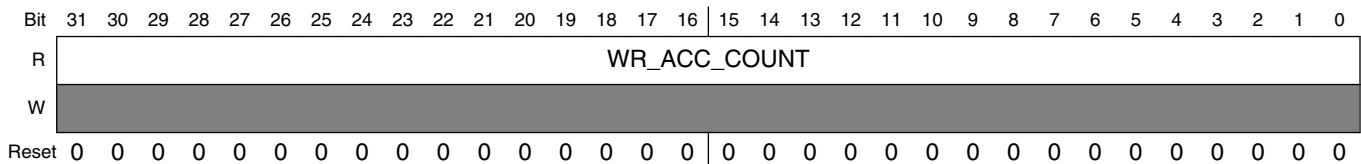

MMDC_MADPSR3 field descriptions

Field	Description
WR_ACC_COUNT	Profiling Write Access Count. This register reflects the total number of write accesses (per AXI ID) toward MMDC.

35.12.26 MMDC Core Debug and Profiling Status Register 4 (MMDC_MADPSR4)

This register reflects the total number of bytes that were transferred during read access (per AXI ID) toward MMDC.

Address: 21B_0000h base + 428h offset = 21B_0428h

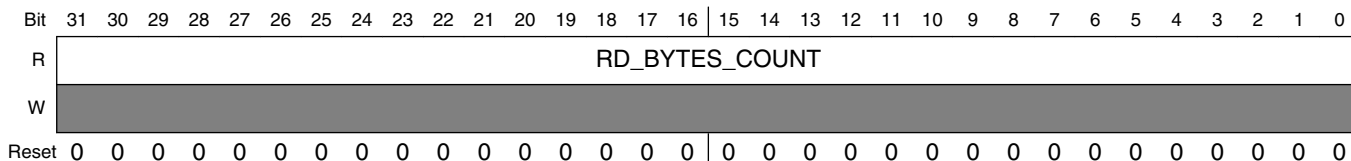

MMDC_MADPSR4 field descriptions

Field	Description
RD_BYTES_COUNT	Profiling Read Bytes Count. This register reflects the total number of bytes that were transferred during read access (per AXI ID) toward MMDC.

35.12.27 MMDC Core Debug and Profiling Status Register 5 (MMDC_MADPSR5)

This register reflects the total number of bytes that were transferred during write access (per AXI ID) toward MMDC.

Address: 21B_0000h base + 42Ch offset = 21B_042Ch

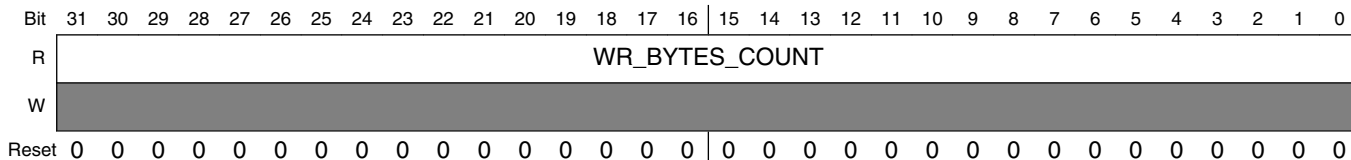

MMDC_MADPSR5 field descriptions

Field	Description
WR_BYTES_COUNT	Profiling Write Bytes Count. This register reflects the total number of bytes that were transferred during write access (per AXI ID) toward MMDC.

35.12.28 MMDC Core Step By Step Address Register (MMDC_MASBS0)

Address: 21B_0000h base + 430h offset = 21B_0430h

Bit	31	30	29	28	27	26	25	24	23	22	21	20	19	18	17	16	15	14	13	12	11	10	9	8	7	6	5	4	3	2	1	0
R	SBS_ADDR																															
W																																
Reset	0	0	0	0	0	0	0	0	0	0	0	0	0	0	0	0	0	0	0	0	0	0	0	0	0	0	0	0	0	0	0	0

MMDC_MASBS0 field descriptions

Field	Description
SBS_ADDR	Step By Step Address. These bits reflect the address of the pending request in case of step by step mode.

35.12.29 MMDC Core Step By Step Address Attributes Register (MMDC_MASBS1)

Address: 21B_0000h base + 434h offset = 21B_0434h

Bit	31	30	29	28	27	26	25	24	23	22	21	20	19	18	17	16	
R	SBS_AXI_ID																
W																	
Reset	0	0	0	0	0	0	0	0	0	0	0	0	0	0	0	0	
Bit	15	14	13	12	11	10	9	8	7	6	5	4	3	2	1	0	
R	SBS_LEN			SBS_BUFF	SBS_BURST			SBS_SIZE			SBS_PROT			SBS_LOCK		SBS_TYPE	SBS_VLD
W																	
Reset	0	0	0	0	0	0	0	0	0	0	0	0	0	0	0	0	

MMDC_MASBS1 field descriptions

Field	Description
31–16 SBS_AXI_ID	Step By Step AXI ID. These bits reflect the AXI ID of the pending request in case of step by step mode.
15–13 SBS_LEN	Step By Step Length. These bits reflect the AXI LENGTH of the pending request in case of step by step mode. 000 burst of length 1 001 burst of length 2 111 burst of length 8
12 SBS_BUFF	Step By Step Buffered. This bit reflect the AXI CACHE[0] of the pending request in case of step by step mode. Relevant only for write requests

Table continues on the next page...

MMDC_MASBS1 field descriptions (continued)

Field	Description
11-10 SBS_BURST	Step By Step Burst. These bits reflect the AXI BURST of the pending request in case of step by step mode. 00 FIXED 01 INCR burst 10 WRAP burst 11 reserved
9-7 SBS_SIZE	Step By Step Size. These bits reflect the AXI SIZE of the pending request in case of step by step mode. 000 8 bits 001 16 bits 010 32 bits 011 64 bits 100 128bits 101-111 Reserved
6-4 SBS_PROT	Step By Step Protection. These bits reflect the AXI PROT of the pending request in case of step by step mode.
3-2 SBS_LOCK	Step By Step Lock. These bits reflect the AXI LOCK of the pending request in case of step by step mode.
1 SBS_TYPE	Step By Step Request Type. These bits reflect the type (read/write) of the pending request in case of step by step mode. 0 write 1 read
0 SBS_VLD	Step By Step Valid. This bit reflects whether there is a pending request in case of step by step mode. 0 not valid 1 valid

35.12.30 MMDC Core General Purpose Register (MMDC_MAGENP)

This register is a general 32 bit read/write register.

Address: 21B_0000h base + 440h offset = 21B_0440h

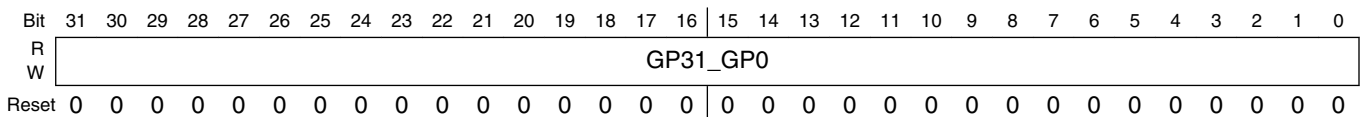

MMDC_MAGENP field descriptions

Field	Description
GP31_GP0	General purpose read/write bits.

35.12.31 MMDC PHY ZQ HW control register (MMDC_MPZQHWCTRL)

Address: 21B_0000h base + 800h offset = 21B_0800h

Bit	31	30	29	28	27	26	25	24	23	22	21	20	19	18	17	16
R	ZQ_EARLY_COMPARATOR_EN_TIMER					0	TZQ_CS			TZQ_OPER			TZQ_INIT			ZQ_HW_FOR
W																
Reset	1	0	1	0	0	0	0	1	0	0	1	1	1	0	0	0
Bit	15	14	13	12	11	10	9	8	7	6	5	4	3	2	1	0
R	ZQ_HW_PD_RES					ZQ_HW_PU_RES					ZQ_HW_PER				ZQ_MODE	
W																
Reset	0	0	0	0	0	0	0	0	0	0	0	0	0	0	0	0

MMDC_MPZQHWCTRL field descriptions

Field	Description
31–27 ZQ_EARLY_COMPARATOR_EN_TIMER	ZQ early comparator enable timer. This timer defines the interval between the warming up of the comparator of the i.MX ZQ calibration pad and the beginning of the ZQ calibration process with the pad 0x0 - 0x6 Reserved 0x7 8 cycles 0x14 21 cycles (Default) 0x1E 31 cycles 0x1F 32 cycles
26 Reserved	This read-only field is reserved and always has the value 0.
25–23 TZQ_CS	Device ZQ short time. This field holds the number of cycles that are required by the external DDR device to perform ZQ short calibration. Upon driving the command to the DDR device then no further accesses will be issued to the DDR device till satisfying that time. NOTE: In LPDDR2 the ZQ short time is taken from MPZQLP2CTL[ZQ_LP2_HW_ZQCS] NOTE: This field should not be update during ZQ calibration. 000 Reserved 001 Reserved 010 128 cycles (Default) 011 256 cycles 100 512 cycles 101 1024 cycles 110- 111 Reserved
22–20 TZQ_OPER	Device ZQ long/oper time. This field holds the number of cycles that are required by the external DDR device to perform ZQ long calibration except the first ZQ long command that is issued after reset. Upon driving the command to the DDR device then no further accesses will be issued to the DDR device till satisfying that time. NOTE: In LPDDR2 the ZQ oper time is taken from MPZQLP2CTL[ZQ_LP2_HW_ZQCL]

Table continues on the next page...

MMDC_MPZQHWCTRL field descriptions (continued)

Field	Description
	<p>NOTE: This field should not be update during ZQ calibration.</p> <p>000 Reserved 001 Reserved 010 128 cycles 011 256 cycles - Default (JEDEC value for DDR3) 100 512 cycles 101 1024 cycles 110- 111 Reserved</p>
19–17 TZQ_INIT	<p>Device ZQ long/init time. This field holds the number of cycles that are required by the external DDR device to perform ZQ long calibration right after reset. Upon driving the command to the DDR device then no further accesses will be issued to the DDR device till satisfying that time.</p> <p>NOTE: In LPDDR2 the ZQ init time is taken from MPZQLP2CTL[ZQ_LP2_HW_ZQINIT]</p> <p>NOTE: This field should not be update during ZQ calibration.</p> <p>000 Reserved 001 Reserved 010 128 cycles 011 256 cycles 100 512 cycles - Default (JEDEC value for DDR3) 101 1024 cycles 110- 111 Reserved</p>
16 ZQ_HW_FOR	<p>Force ZQ automatic calibration process with the i.MX ZQ calibration pad. When this bit is asserted then the MMDC will issue one ZQ automatic calibration process with the i.MX ZQ calibration pad. It is the user responsibility to make sure that all the accesses to DDR will be finished before asserting this bit using CON_REQ/CON_ACK mechanism. HW will negate this bit upon completion of the ZQ calibration process. Upon negation of this bit the ZQ HW calibration pull-up and pull-down results (ZQ_HW_PU_RES and ZQ_HW_PD_RES respectively) are valid</p> <p>NOTE: In order to enable this bit ZQ_MODE must be set to either "1" or "3"</p>
15–11 ZQ_HW_PD_RES	<p>ZQ HW calibration pull-down result. This field holds the pull-down resistor value calculated at the end of the ZQ automatic calibration process with the i.MX ZQ calibration pad.</p> <p>NOTE: An offset can be applied to this result, see MMDC_MPPDCMPR2[ZQ_PD_OFFSET].</p> <p>00000 Max. resistance. 11111 Min. resistance.</p>
10–6 ZQ_HW_PU_RES	<p>ZQ automatic calibration pull-up result. This field holds the pull-up resistor value calculated at the end of the ZQ automatic calibration process with the i.MX ZQ calibration pad.</p> <p>NOTE: An offset can be applied to this result, see MMDC_MPPDCMPR2[ZQ_PU_OFFSET]</p> <p>00000 Min. resistance. 11111 Max. resistance.</p>
5–2 ZQ_HW_PER	<p>ZQ periodic calibration time. This field determines how often the periodic ZQ calibration is performed. This field is applied for both ZQ short calibration and ZQ automatic calibration process with i.MX ZQ calibration pad. Whenever this timer is expired then according to ZQ_MODE the ZQ automatic calibration process with the i.MX ZQ calibration pad will be issued and/or short/long command will be issued to the external DDR device.</p>

Table continues on the next page...

MMDC_MPZQHWCTRL field descriptions (continued)

Field	Description
	<p>This field is ignored if ZQ_MODE equals "00"</p> <p>0000 ZQ calibration is performed every 1 ms. 0001 ZQ calibration is performed every 2 ms. 0010 ZQ calibration is performed every 4 ms. 1010 ZQ calibration is performed every 1 sec. 1110 ZQ calibration is performed every 16 sec. 1111 ZQ calibration is performed every 32 sec.</p>
ZQ_MODE	<p>ZQ calibration mode:</p> <p>0x0 No ZQ calibration is issued. (Default) 0x1 ZQ calibration is issued to i.MX ZQ calibration pad together with ZQ long command to the external DDR device only when exiting self refresh. 0x2 ZQ calibration command long/short is issued only to the external DDR device periodically and when exiting self refresh 0x3 ZQ calibration is issued to i.MX ZQ calibration pad together with ZQ calibration command long/short to the external DDR device periodically and when exiting self refresh</p>

35.12.32 MMDC PHY ZQ SW control register (MMDC_MPZQSWCTRL)

Address: 21B_0000h base + 804h offset = 21B_0804h

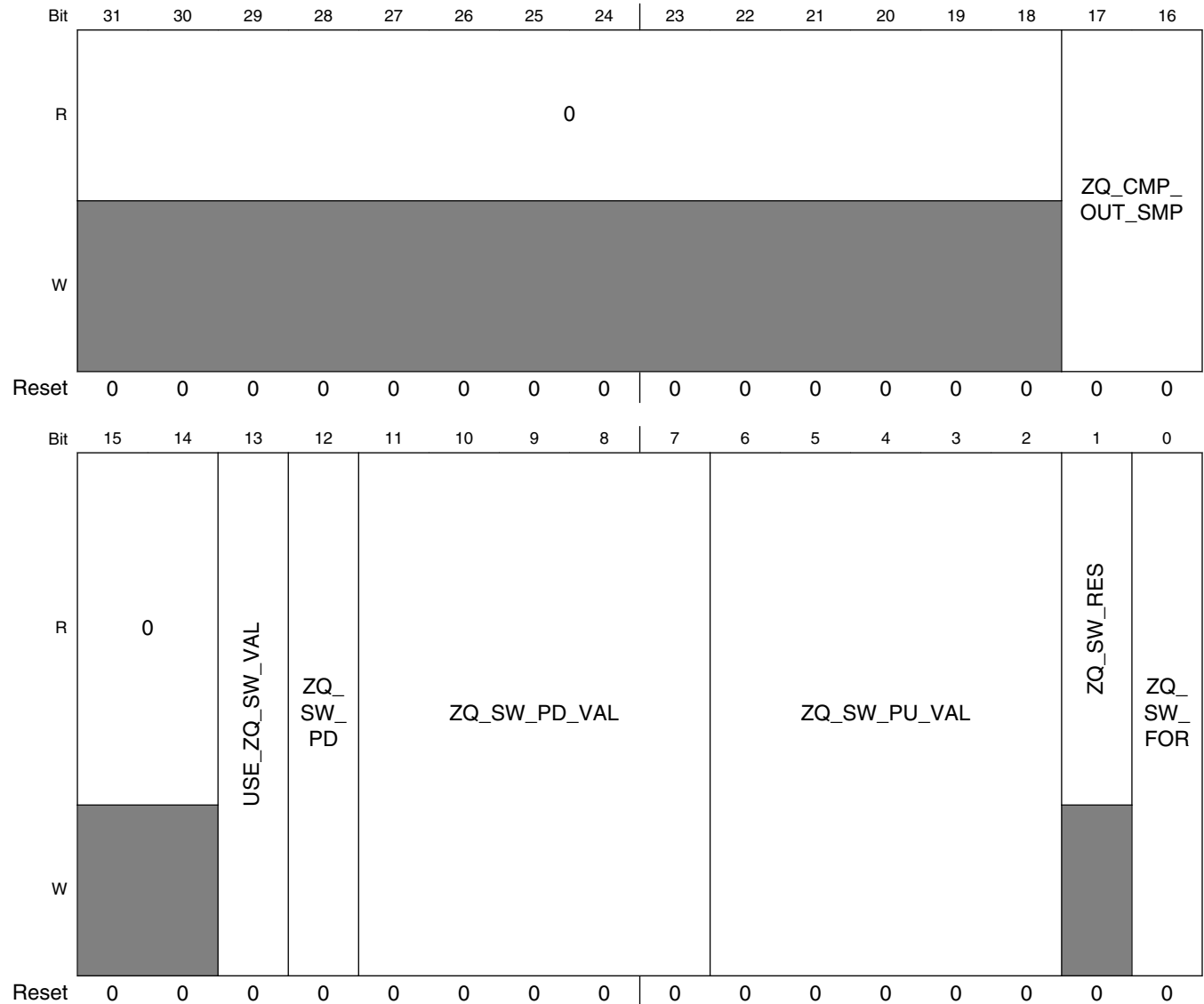

MMDC_MPZQSWCTRL field descriptions

Field	Description
31–18 Reserved	This read-only field is reserved and always has the value 0.
17–16 ZQ_CMP_OUT_SMP	Defines the amount of cycles between driving the ZQ signals to the ZQ pad and till sampling the comparator enable output while performing ZQ calibration process with the i.MX ZQ calibration pad 00 7 cycles 01 15 cycles

Table continues on the next page...

MMDC_MPZQSWCTRL field descriptions (continued)

Field	Description
	10 23 cycles 11 31 cycles
15–14 Reserved	This read-only field is reserved and always has the value 0.
13 USE_ZQ_SW_VAL	Use SW ZQ configured value for I/O pads resistor controls. This bit selects whether ZQ SW value or ZQ HW value will be driven to the I/O pads resistor controls. By default this bit is cleared and MMDC drives the HW ZQ status bits on the resistor controls of the I/O pads. NOTE: This bit should not be updated during ZQ calibration. 0 Fields ZQ_HW_PD_VAL & ZQ_HW_PU_VAL will be driven to I/O pads resistor controls. 1 Fields ZQ_SW_PD_VAL & ZQ_SW_PU_VAL will be driven to I/O pads resistor controls.
12 ZQ_SW_PD	ZQ software PU/PD calibration. This bit determines the calibration stage (PU or PD). 0 PU resistor calibration 1 PD resistor calibration
11–7 ZQ_SW_PD_VAL	ZQ software pull-down resistance. This field determines the value of the PD resistor during SW ZQ calibration. 00000 Max. resistance. 11111 Min. resistance.
6–2 ZQ_SW_PU_VAL	ZQ software pull-up resistance. This field determines the value of the PU resistor during SW ZQ calibration. 00000 Min. resistance. 11111 Max. resistance.
1 ZQ_SW_RES	ZQ software calibration result. This bit reflects the ZQ calibration voltage comparator value. 0 Current ZQ calibration voltage is less than VDD/2. 1 Current ZQ calibration voltage is more than VDD/2
0 ZQ_SW_FOR	ZQ SW calibration enable. This bit when asserted enables ZQ SW calibration. HW negates this bit upon completion of the ZQ SW calibration. Upon negation of this bit the ZQ SW calibration result (i.e. ZQ_SW_RES) is valid

35.12.33 MMDC PHY Write Leveling Configuration and Error Status Register (MMDC_MPWLGCR)

Address: 21B_0000h base + 808h offset = 21B_0808h

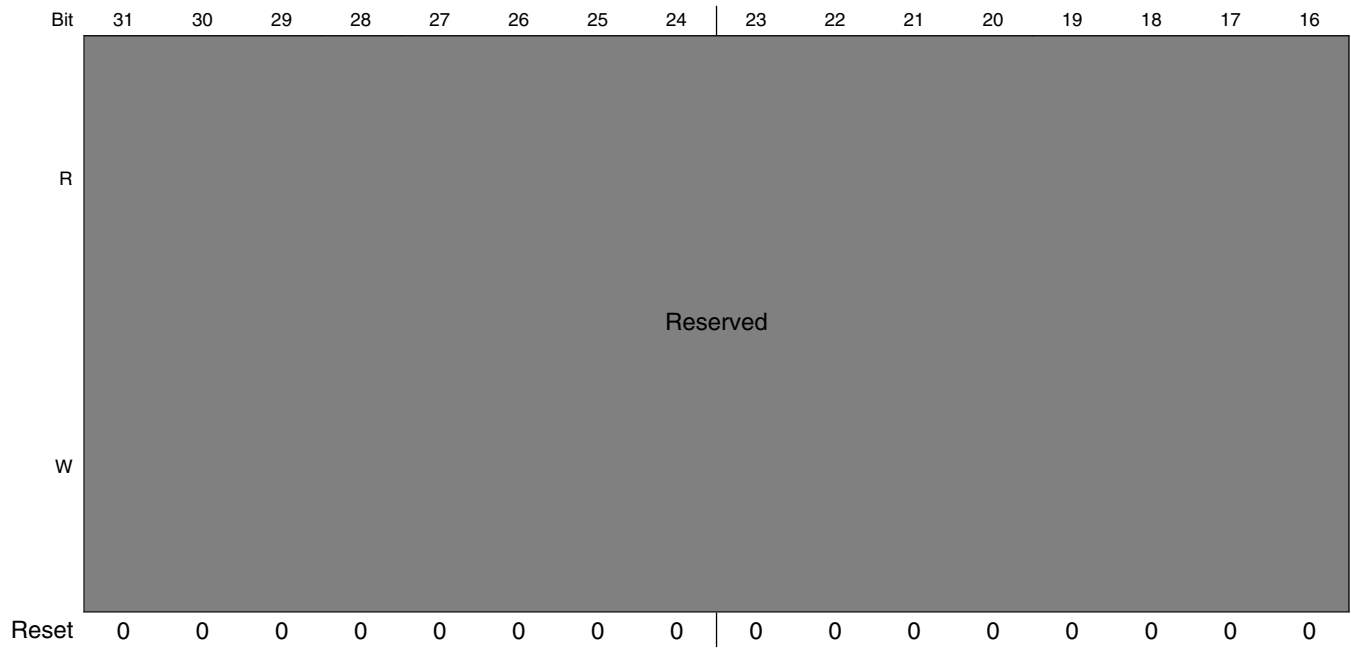

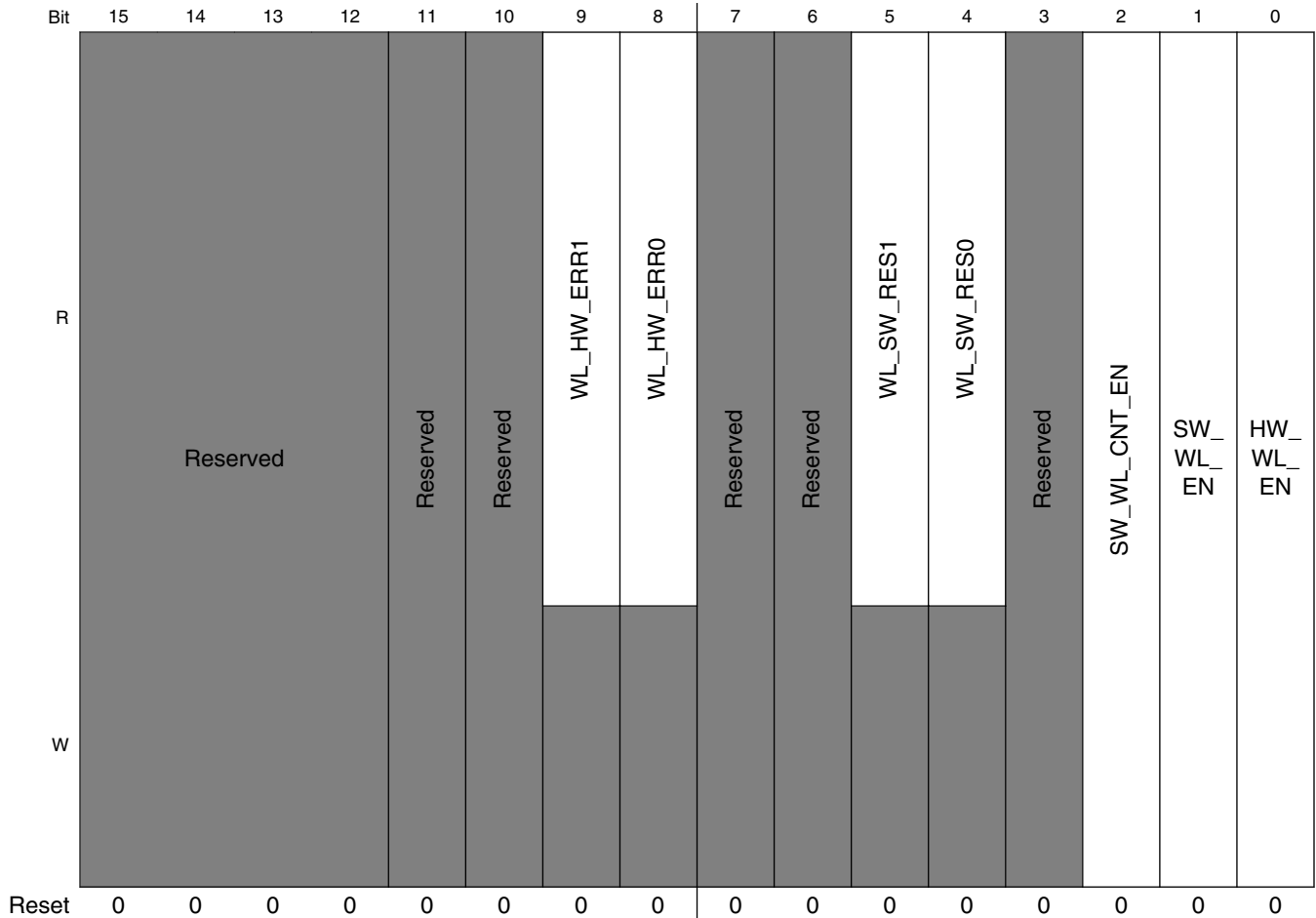

MMDC_MPWL_GCR field descriptions

Field	Description
31–12 -	This field is reserved. Reserved
11 -	This field is reserved. Reserved
10 -	This field is reserved. Reserved
9 WL_HW_ERR1	Byte1 write-leveling HW calibration error. This bit is asserted when an error was found on byte1 during write-leveling HW calibration. This bit is valid only upon completion of the write-leveling HW calibration (i.e. HW_WL_EN bit is de-asserted) 0 No error was found on byte1 during write-leveling HW calibration. 1 An error was found on byte1 during write-leveling HW calibration.
8 WL_HW_ERR0	Byte0 write-leveling HW calibration error. This bit is asserted when an error was found on byte0 during write-leveling HW calibration. This bit is valid only upon completion of the write-leveling HW calibration (i.e. HW_WL_EN bit is de-asserted)

Table continues on the next page...

MMDC_MPWLGCR field descriptions (continued)

Field	Description
	0 No error was found on byte0 during write-leveling HW calibration. 1 An error was found on byte0 during write-leveling HW calibration.
7 -	This field is reserved. Reserved
6 -	This field is reserved. Reserved
5 WL_SW_RES1	Byte1 write-leveling software result. This bit reflects the value that is driven by the DDR device on DQ8 during SW write-leveling. 0 DQS1 sampled low CK during SW write-leveling. 1 DQS1 sampled high CK during SW write-leveling.
4 WL_SW_RES0	Byte0 write-leveling software result. This bit reflects the value that is driven by the DDR device on DQ0 during SW write-leveling. 0 DQS0 sampled low CK during SW write-leveling. 1 DQS0 sampled high CK during SW write-leveling.
3 -	This field is reserved. Reserved
2 SW_WL_CNT_EN	SW write-leveling count down enable. This bit when asserted set a certain delay of (25+15) cycles from the setting of SW_WL_EN and before driving the DQS to the DDR device. This bit should be asserted before the first SW write-leveling request and after issuing the write leveling MRS command 0 MMDC doesn't count 25+15 cycles before issuing write-leveling DQS. 1 MMDC counts 25+15 cycles before issuing write-leveling DQS.
1 SW_WL_EN	Write-Leveling SW enable. If this bit is asserted then the MMDC will perform one write-leveling iteration with the DDR device (assuming that Write-Leveling procedure is already enabled in the DDR device through MRS command). HW negate this bit upon completion of the SW write-leveling. Negation of this bit also points that the write-leveling SW calibration result is valid NOTE: If this bit and the SW_WL_CNT_EN are enabled the MMDC counts 25 + 15 cycles before issuing the SW write-leveling DQS.
0 HW_WL_EN	Write-Leveling HW (automatic) enable. If this bit is asserted then the MMDC will perform the whole Write-Leveling sequence with the DDR device (assuming that Write-Leveling procedure is already enabled in the DDR device through MRS command). HW negates this bit upon completion of the HW write-leveling. Negation of this bit also points that the write-leveling HW calibration results are valid NOTE: Before issuing the first DQS the MMDC counts 25 + 15 cycles automatically as required by the standard.

35.12.34 MMDC PHY Write Leveling Delay Control Register 0 (MMDC_MPWLDECTRL0)

Address: 21B_0000h base + 80Ch offset = 21B_080Ch

Bit	31	30	29	28	27	26	25	24	23	22	21	20	19	18	17	16	
R	0					WL_CYC_DEL1		WL_HC_DEL1	0	WL_DL_ABS_OFFSET1							
W	[Shaded]					[Shaded]		[Shaded]	[Shaded]	[Shaded]							
Reset	0	0	0	0	0	0	0	0	0	0	0	0	0	0	0	0	0
Bit	15	14	13	12	11	10	9	8	7	6	5	4	3	2	1	0	
R	0					WL_CYC_DELO		WL_HC_DELO	0	WL_DL_ABS_OFFSET0							
W	[Shaded]					[Shaded]		[Shaded]	[Shaded]	[Shaded]							
Reset	0	0	0	0	0	0	0	0	0	0	0	0	0	0	0	0	

MMDC_MPWLDECTRL0 field descriptions

Field	Description
31–27 Reserved	This read-only field is reserved and always has the value 0.
26–25 WL_CYC_DEL1	<p>Write leveling cycle delay for Byte 1. This field indicates whether a delay of 1 or 2 cycles between CK and write DQS is added to the delay that is indicated in the associated WR_DL_ABS_OFFSET and WL_HC_DEL. So the total delay is the sum of $(WL_DL_ABS_OFFSET/256 \times \text{cycle}) + (WL_HC_DEL \times \text{half cycle}) + (WL_CYC_DEL \times \text{cycle})$.</p> <p>When both SW write-leveling is enabled (i.e. SW_WL_EN = 1) or HW write-leveling is enabled (i.e. HW_WL_EN = 1) then this value will be taken as is and will be added to the associated delay that is configured in WL_DL_OFFSET and WL_HC_DEL.</p> <p>NOTE: In HW write-leveling this field is not used for indication, as in WL_DL_OFFSET and WL_HC_DEL, but for configuration.</p> <p>0 No delay is added. 1 1 cycle delay is added. 2 2 cycles delay is added. 3 Reserved.</p>
24 WL_HC_DEL1	<p>Write leveling half cycle delay for Byte 1. This field indicates whether a delay of half cycle between CK and write DQS is added to the delay that is indicated in the associated WR_DL_ABS_OFFSET and WL_CYC_DEL. So the total delay is the sum of $(WL_DL_ABS_OFFSET/256 \times \text{cycle}) + (WL_HC_DEL \times \text{half cycle}) + (WL_CYC_DEL \times \text{cycle})$.</p> <p>When SW write-leveling is enabled (i.e. SW_WL_EN = 1) then this value will be taken as is and will be added to the associated delay that is configured in WL_DL_OFFSET and WL_CYC_DEL. When HW write-leveling is enabled (i.e. HW_WL_EN = 1) then this value will indicate (status) whether a delay of half cycle was added or not to the associated WL_DL_OFFSET and WL_CYC_DEL.</p>

Table continues on the next page...

MMDC_MPWLDECTRL0 field descriptions (continued)

Field	Description
	<p>0 No delay is added.</p> <p>1 Half cycle delay is added.</p>
23 Reserved	This read-only field is reserved and always has the value 0.
22–16 WL_DL_ABS_OFFSET1	<p>Absolute write-leveling delay offset for Byte 1. This field indicates the absolute delay between CK and write DQS of Byte1 with fractions of a clock period and up to half cycle. This value is process and frequency independent. The value of the delay can be calculated using the following equation $(WR_DL_ABS_OFFSET1 / 256) * \text{clock period}$</p> <p>When SW write-leveling is enabled (i.e. SW_WL_EN = 1) then this value will be taken as is to the associated delay-line. When HW write-leveling is enabled (i.e. HW_WL_EN = 1) then this value will indicate (status) the value that is taken to the associated delay-line at the end of the write-leveling calibration.</p> <p>NOTE: The delay-line has a resolution that may vary between device to device, therefore in some cases an increment of the delay by 1 step may be smaller than the delay-line resolution.</p>
15–11 Reserved	This read-only field is reserved and always has the value 0.
10–9 WL_CYC_DELO	<p>Write leveling cycle delay for Byte 0. This field indicates whether a delay of 1 or 2 cycles between CK and write DQS is added to the delay that is indicated in the associated WR_DL_ABS_OFFSET and WL_HC_DEL. So the total delay is the sum of $(WL_DL_ABS_OFFSET/256 * \text{cycle}) + (WL_HC_DEL * \text{half cycle}) + (WL_CYC_DEL * \text{cycle})$.</p> <p>When both SW write-leveling is enabled (i.e. SW_WL_EN = 1) or HW write-leveling is enabled (i.e. HW_WL_EN = 1) then this value will be taken as is and will be added to the associated delay that is configured in WL_DL_OFFSET and WL_HC_DEL.</p> <p>Note that in HW write-leveling this field is not used for indication, as in WL_DL_OFFSET and WL_HC_DEL, but for configuration.</p> <p>0 No delay is added.</p> <p>1 1 cycle delay is added.</p> <p>2 2 cycles delay is added.</p> <p>3 Reserved.</p>
8 WL_HC_DELO	<p>Write leveling half cycle delay for Byte 0. This field indicates whether a delay of half cycle between CK and write DQS is added to the delay that is indicated in the associated WR_DL_ABS_OFFSET and WL_CYC_DEL. So the total delay is the sum of $(WL_DL_ABS_OFFSET/256 * \text{cycle}) + (WL_HC_DEL * \text{half cycle}) + (WL_CYC_DEL * \text{cycle})$.</p> <p>When SW write-leveling is enabled (i.e. SW_WL_EN = 1) then this value will be taken as is and will be added to the associated delay that is configured in WL_DL_OFFSET and WL_CYC_DEL. When HW write-leveling is enabled (i.e. HW_WL_EN = 1) then this value will indicate (status) whether a delay of half cycle was added or not to the associated WL_DL_OFFSET and WL_CYC_DEL.</p> <p>0 No delay is added.</p> <p>1 Half cycle delay is added.</p>
7 Reserved	This read-only field is reserved and always has the value 0.
WL_DL_ABS_OFFSET0	Absolute write-leveling delay offset for Byte 0. This field indicates the absolute delay between CK and write DQS of Byte0 with fractions of a clock period and up to half cycle. This value is process and frequency independent. The value of the delay can be calculated using the following equation $(WR_DL_ABS_OFFSET0 / 256) * \text{clock period}$

Table continues on the next page...

MMDC_MPWLDECTRL0 field descriptions (continued)

Field	Description
	When SW write-leveling is enabled (i.e. SW_WL_EN = 1) then this value will be taken as is to the associated delay-line. When HW write-leveling is enabled (i.e. HW_WL_EN = 1) then this value will indicate (status) the value that is taken to the associated delay-line at the end of the write-leveling calibration. NOTE: The delay-line has a resolution that may vary between device to device, therefore in some cases an increment of the delay by 1 step may be smaller than the delay-line resolution.

35.12.35 MMDC PHY Write Leveling Delay Control Register 1 (MMDC_MPWLDECTRL1)

Address: 21B_0000h base + 810h offset = 21B_0810h

Bit	31	30	29	28	27	26	25	24	23	22	21	20	19	18	17	16
R	0					WL_CYC_DEL3		WL_HC_DEL3	0	WL_DL_ABS_OFFSET3						
W	[Shaded]					[Shaded]		[Shaded]	[Shaded]	[Shaded]						
Reset	0	0	0	0	0	0	0	0	0	0	0	0	0	0	0	0
Bit	15	14	13	12	11	10	9	8	7	6	5	4	3	2	1	0
R	0					WL_CYC_DEL2		WL_HC_DEL2	0	WL_DL_ABS_OFFSET2						
W	[Shaded]					[Shaded]		[Shaded]	[Shaded]	[Shaded]						
Reset	0	0	0	0	0	0	0	0	0	0	0	0	0	0	0	0

MMDC_MPWLDECTRL1 field descriptions

Field	Description
31–27 Reserved	This read-only field is reserved and always has the value 0.
26–25 WL_CYC_DEL3	Write leveling cycle delay for Byte 3. This field indicates whether a delay of 1 or 2 cycles between CK and write DQS is added to the delay that is indicated in the associated WL_DL_ABS_OFFSET and WL_HC_DEL. So the total delay is the sum of (WL_DL_ABS_OFFSET/256*cycle) + (WL_HC_DEL*half cycle) + (WL_CYC_DEL*cycle). When both SW write-leveling is enabled (i.e. SW_WL_EN = 1) or HW write-leveling is enabled (i.e. HW_WL_EN = 1) then this value will be taken as is and will be added to the associated delay that is configured in WL_DL_OFFSET and WL_HC_DEL. NOTE: In HW write-leveling this field is not used for indication, as in WL_DL_OFFSET and WL_HC_DEL, but for configuration. 0 No delay is added. 1 1 cycle delay is added.

Table continues on the next page...

MMDC_MPWLDECTRL1 field descriptions (continued)

Field	Description
	<p>2 2 cycles delay is added.</p> <p>3 Reserved.</p>
24 WL_HC_DEL3	<p>Write leveling half cycle delay for Byte 3. This field indicates whether a delay of half cycle between CK and write DQS is added to the delay that is indicated in the associated WL_DL_ABS_OFFSET and WL_CYC_DEL. So the total delay is the sum of $(WL_DL_ABS_OFFSET/256 \times \text{cycle}) + (WL_HC_DEL \times \text{half cycle}) + (WL_CYC_DEL \times \text{cycle})$.</p> <p>When SW write-leveling is enabled (i.e. SW_WL_EN = 1) then this value will be taken as is and will be added to the associated delay that is configured in WL_DL_OFFSET and WL_CYC_DEL. When HW write-leveling is enabled (i.e. HW_WL_EN = 1) then this value will indicate (status) whether a delay of half cycle was added or not to the associated WL_DL_OFFSET and WL_CYC_DEL.</p> <p>0 No delay is added. 1 Half cycle delay is added.</p>
23 Reserved	<p>This read-only field is reserved and always has the value 0.</p>
22–16 WL_DL_ABS_OFFSET3	<p>Absolute write-leveling delay offset for Byte 3. This field indicates the absolute delay between CK and write DQS of Byte3 with fractions of a clock period and up to half cycle. This value is process and frequency independent. The value of the delay can be calculated using the following equation $(WL_DL_ABS_OFFSET3 / 256) \times \text{clock period}$</p> <p>When SW write-leveling is enabled (i.e. SW_WL_EN = 1) then this value will be taken as is to the associated delay-line. When HW write-leveling is enabled (i.e. HW_WL_EN = 1) then this value will indicate (status) the value that is taken to the associated delay-line at the end of the write-leveling calibration.</p> <p>NOTE: The delay-line has a resolution that may vary between device to device, therefore in some cases an increment of the delay by 1 step may be smaller than the delay-line resolution.</p>
15–11 Reserved	<p>This read-only field is reserved and always has the value 0.</p>
10–9 WL_CYC_DEL2	<p>Write leveling cycle delay for Byte 2. This field indicates whether a delay of 1 or 2 cycles between CK and write DQS is added to the delay that is indicated in the associated WR_DL_ABS_OFFSET and WL_HC_DEL. So the total delay is the sum of $(WL_DL_ABS_OFFSET/256 \times \text{cycle}) + (WL_HC_DEL \times \text{half cycle}) + (WL_CYC_DEL \times \text{cycle})$.</p> <p>When both SW write-leveling is enabled (i.e. SW_WL_EN = 1) or HW write-leveling is enabled (i.e. HW_WL_EN = 1) then this value will be taken as is and will be added to the associated delay that is configured in WL_DL_OFFSET and WL_HC_DEL.</p> <p>NOTE: In HW write-leveling this field is not used for indication, as in WL_DL_OFFSET and WL_HC_DEL, but for configuration.</p> <p>0 No delay is added. 1 1 cycle delay is added. 2 2 cycles delay is added. 3 Reserved.</p>
8 WL_HC_DEL2	<p>Write leveling half cycle delay for Byte 2. This field indicates whether a delay of half cycle between CK and write DQS is added to the delay that is indicated in the associated WR_DL_ABS_OFFSET and WL_CYC_DEL. So the total delay is the sum of $(WL_DL_ABS_OFFSET/256 \times \text{cycle}) + (WL_HC_DEL \times \text{half cycle}) + (WL_CYC_DEL \times \text{cycle})$.</p> <p>When SW write-leveling is enabled (i.e. SW_WL_EN = 1) then this value will be taken as is and will be added to the associated delay that is configured in WL_DL_OFFSET and WL_CYC_DEL. When HW write-leveling is enabled (i.e. HW_WL_EN = 1) then this value will indicate (status) whether a delay of half cycle was added or not to the associated WL_DL_OFFSET and WL_CYC_DEL.</p>

Table continues on the next page...

MMDC_MPWLDECTRL1 field descriptions (continued)

Field	Description
	0 No delay is added. 1 Half cycle delay is added.
7 Reserved	This read-only field is reserved and always has the value 0.
WL_DL_ABS_ OFFSET2	<p>Absolute write-leveling delay offset for Byte 2. This field indicates the absolute delay between CK and write DQS of Byte1 with fractions of a clock period and up to half cycle. This value is process and frequency independent. The value of the delay can be calculated using the following equation $(WR_DL_ABS_OFFSET2 / 256) * \text{clock period}$</p> <p>When SW write-leveling is enabled (i.e. SW_WL_EN = 1) then this value will be taken as is to the associated delay-line. When HW write-leveling is enabled (i.e. HW_WL_EN = 1) then this value will indicate (status) the value that is taken to the associated delay-line at the end of the write-leveling calibration.</p> <p>NOTE: The delay-line has a resolution that may vary between device to device, therefore in some cases an increment of the delay by 1 step may be smaller than the delay-line resolution.</p>

35.12.36 MMDC PHY Write Leveling delay-line Status Register (MMDC_MPWLDLST)

This register holds the status of the four write leveling delay-lines.

Address: 21B_0000h base + 814h offset = 21B_0814h

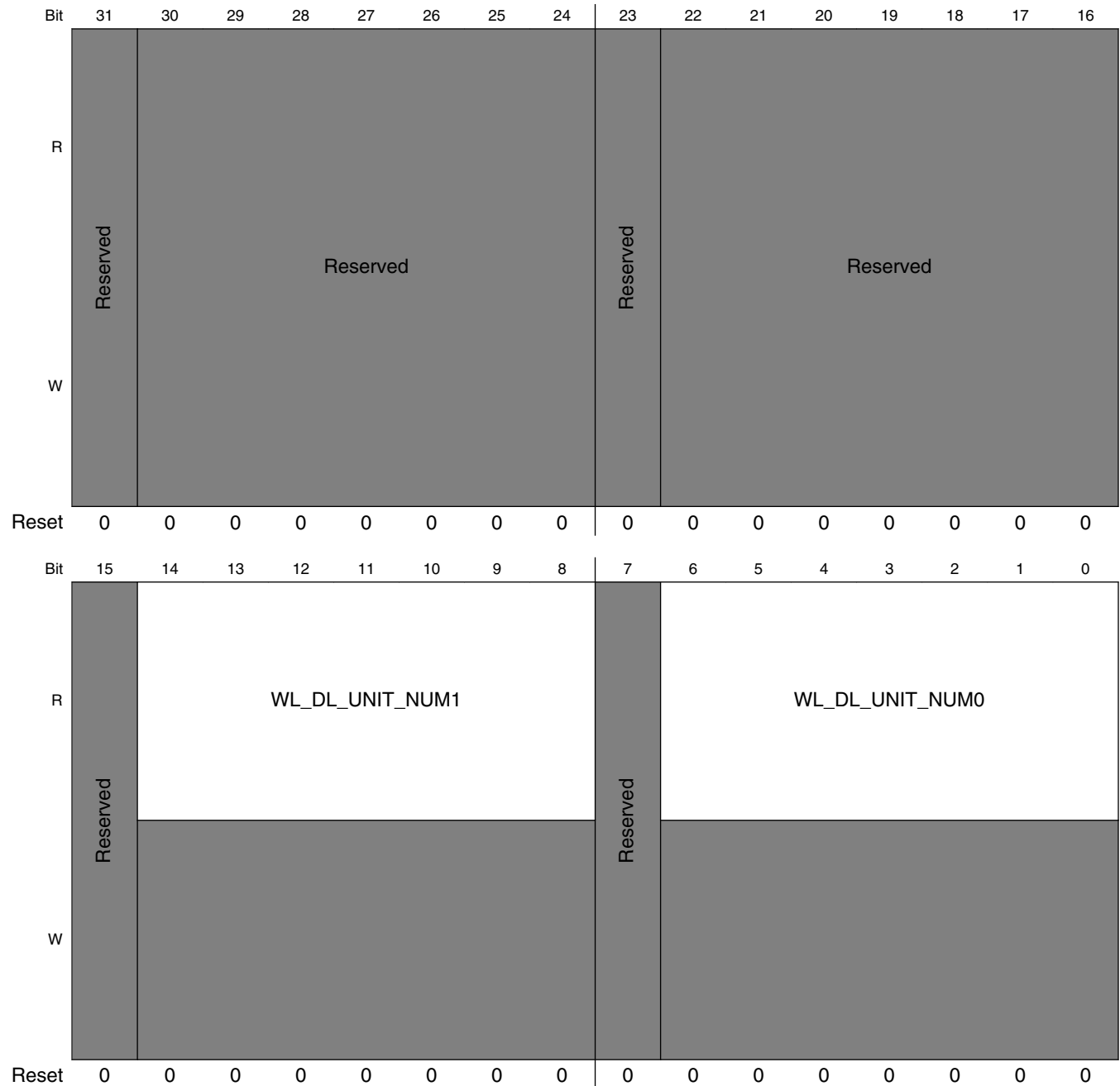

MMDC_MPWLDLST field descriptions

Field	Description
31 -	This field is reserved. Reserved
30–24 -	This field is reserved. Reserved
23 -	This field is reserved. Reserved
22–16 -	This field is reserved. Reserved
15 -	This field is reserved. Reserved
14–8 WL_DL_UNIT_NUM1	This field reflects the number of delay units that are actually used by write leveling delay-line 1.
7 -	This field is reserved. Reserved
WL_DL_UNIT_NUM0	This field reflects the number of delay units that are actually used by write leveling delay-line 0.

35.12.37 MMDC PHY ODT control register (MMDC_MPODTCTRL)

NOTE

In LPDDR2 mode this register should be cleared, so no termination will be activated

Address: 21B_0000h base + 818h offset = 21B_0818h

Bit	31	30	29	28	27	26	25	24	23	22	21	20	19	18	17	16	
R	0													Reserved			
W	Reserved																
Reset	0	0	0	0	0	0	0	0	0	0	0	0	0	0	0	0	
Bit	15	14	13	12	11	10	9	8	7	6	5	4	3	2	1	0	
R	0	Reserved				0	ODT1_INT_RES			0	ODT0_INT_RES			ODT_RD_ACT_EN	ODT_RD_PAS_EN	ODT_WR_ACT_EN	ODT_WR_PAS_EN
W	0	Reserved				0	ODT1_INT_RES			0	ODT0_INT_RES			ODT_RD_ACT_EN	ODT_RD_PAS_EN	ODT_WR_ACT_EN	ODT_WR_PAS_EN
Reset	0	0	0	0	0	0	0	0	0	0	0	0	0	0	0	0	

MMDC_MPODTCTRL field descriptions

Field	Description
31–19 Reserved	This read-only field is reserved and always has the value 0.
18–16 -	This field is reserved. Reserved
15 Reserved	This read-only field is reserved and always has the value 0.
14–12 -	This field is reserved. Reserved
11 Reserved	This read-only field is reserved and always has the value 0.
10–8 ODT1_INT_RES	On chip ODT byte1 resistor - This field determines the Rtt_Nom of the on chip ODT byte1 resistor during read accesses. 0000 Rtt_Nom Disabled. 001 Rtt_Nom 120 Ohm 010 Rtt_Nom 60 Ohm 011 Rtt_Nom 40 Ohm 100 Rtt_Nom 30 Ohm 101 Rtt_Nom 24 Ohm 110 Rtt_Nom 20 Ohm 111 Rtt_Nom 17 Ohm
7 Reserved	This read-only field is reserved and always has the value 0.
6–4 ODT0_INT_RES	On chip ODT byte0 resistor - This field determines the Rtt_Nom of the on chip ODT byte0 resistor during read accesses. 000 Rtt_Nom Disabled. 001 Rtt_Nom 120 Ohm 010 Rtt_Nom 60 Ohm 011 Rtt_Nom 40 Ohm 100 Rtt_Nom 30 Ohm 101 Rtt_Nom 24 Ohm 110 Rtt_Nom 20 Ohm 111 Rtt_Nom 17 Ohm
3 ODT_RD_ACT_EN	Active read CS ODT enable. The bit determines if ODT pin of the active CS will be asserted during read accesses. 0 Active CS ODT pin is disabled during read access. 1 Active CS ODT pin is enabled during read access.
2 ODT_RD_PAS_EN	Inactive read CS ODT enable. The bit determines if ODT pin of the inactive CS will be asserted during read accesses. 0 Inactive CS ODT pin is disabled during read accesses to other CS. 1 Inactive CS ODT pin is enabled during read accesses to other CS.
1 ODT_WR_ACT_EN	Active write CS ODT enable. The bit determines if ODT pin of the active CS will be asserted during write accesses.

Table continues on the next page...

MMDC_MPODTCTRL field descriptions (continued)

Field	Description
	0 Active CS ODT pin is disabled during write access. 1 Active CS ODT pin is enabled during write access.
0 ODT_WR_PAS_EN	Inactive write CS ODT enable. The bit determines if ODT pin of the inactive CS will be asserted during write accesses. 0 Inactive CS ODT pin is disabled during write accesses to other CS. 1 Inactive CS ODT pin is enabled during write accesses to other CS.

35.12.38 MMDC PHY Read DQ Byte0 Delay Register (MMDC_MPRDDQBY0DL)

This register is used to add fine-tuning adjustment to every bit in the read DQ byte0 relative to the read DQS. This delay is in addition to the read data calibration. If operating in 64-bit mode, there is an identical register that is mapped at the second base address.

Address: 21B_0000h base + 81Ch offset = 21B_081Ch

Bit	31	30	29	28	27	26	25	24	23	22	21	20	19	18	17	16				
R	0	rd_dq7_del				0	rd_dq6_del				0	rd_dq5_del				0	rd_dq4_del			
W																				
Reset	0	0	0	0	0	0	0	0	0	0	0	0	0	0	0	0				
Bit	15	14	13	12	11	10	9	8	7	6	5	4	3	2	1	0				
R	0	rd_dq3_del				0	rd_dq2_del				0	rd_dq1_del				0	rd_dq0_del			
W																				
Reset	0	0	0	0	0	0	0	0	0	0	0	0	0	0	0	0				

MMDC_MPRDDQBY0DL field descriptions

Field	Description
31 Reserved	This read-only field is reserved and always has the value 0.
30–28 rd_dq7_del	Read dqs0 to dq7 delay fine-tuning. This field holds the number of delay units that are added to dq7 relative to dqs0. 000 No change in dq7 delay 001 Add dq7 delay of 1 delay unit 010 Add dq7 delay of 2 delay units. 011 Add dq7 delay of 3 delay units. 100 Add dq7 delay of 4 delay units. 101 Add dq7 delay of 5 delay units. 110 Add dq7 delay of 6 delay units. 111 Add dq7 delay of 7 delay units.

Table continues on the next page...

MMDC_MPRDDQBY0DL field descriptions (continued)

Field	Description
27 Reserved	This read-only field is reserved and always has the value 0.
26–24 rd_dq6_del	Read dqs0 to dq6 delay fine-tuning. This field holds the number of delay units that are added to dq6 relative to dqs0. 000 No change in dq6 delay 001 Add dq6 delay of 1 delay unit 010 Add dq6 delay of 2 delay units. 011 Add dq6 delay of 3 delay units. 100 Add dq6 delay of 4 delay units. 101 Add dq6 delay of 5 delay units. 110 Add dq6 delay of 6 delay units. 111 Add dq6 delay of 7 delay units.
23 Reserved	This read-only field is reserved and always has the value 0.
22–20 rd_dq5_del	Read dqs0 to dq5 delay fine-tuning. This field holds the number of delay units that are added to dq5 relative to dqs0. 000 No change in dq5 delay 001 Add dq5 delay of 1 delay unit 010 Add dq5 delay of 2 delay units. 011 Add dq5 delay of 3 delay units. 100 Add dq5 delay of 4 delay units. 101 Add dq5 delay of 5 delay units. 110 Add dq5 delay of 6 delay units. 111 Add dq5 delay of 7 delay units.
19 Reserved	This read-only field is reserved and always has the value 0.
18–16 rd_dq4_del	Read dqs0 to dq4 delay fine-tuning. This field holds the number of delay units that are added to dq4 relative to dqs0. 000 No change in dq4 delay 001 Add dq4 delay of 1 delay unit 010 Add dq4 delay of 2 delay units. 011 Add dq4 delay of 3 delay units. 100 Add dq4 delay of 4 delay units. 101 Add dq4 delay of 5 delay units. 110 Add dq4 delay of 6 delay units. 111 Add dq4 delay of 7 delay units.
15 Reserved	This read-only field is reserved and always has the value 0.
14–12 rd_dq3_del	Read dqs0 to dq3 delay fine-tuning. This field holds the number of delay units that are added to dq3 relative to dqs0. 000 No change in dq3 delay 001 Add dq3 delay of 1 delay unit 010 Add dq3 delay of 2 delay units. 011 Add dq3 delay of 3 delay units.

Table continues on the next page...

MMDC_MPRDDQBY0DL field descriptions (continued)

Field	Description
	100 Add dq3 delay of 4 delay units. 101 Add dq3 delay of 5 delay units. 110 Add dq3 delay of 6 delay units. 111 Add dq3 delay of 7 delay units.
11 Reserved	This read-only field is reserved and always has the value 0.
10–8 rd_dq2_del	Read dqs0 to dq2 delay fine-tuning. This field holds the number of delay units that are added to dq2 relative to dqs0. 000 No change in dq2 delay 001 Add dq2 delay of 1 delay unit 010 Add dq2 delay of 2 delay units. 011 Add dq2 delay of 3 delay units. 100 Add dq2 delay of 4 delay units. 101 Add dq2 delay of 5 delay units. 110 Add dq2 delay of 6 delay units. 111 Add dq2 delay of 7 delay units.
7 Reserved	This read-only field is reserved and always has the value 0.
6–4 rd_dq1_del	Read dqs0 to dq1 delay fine-tuning. This field holds the number of delay units that are added to dq1 relative to dqs0. 000 No change in dq1 delay 001 Add dq1 delay of 1 delay unit 010 Add dq1 delay of 2 delay units. 011 Add dq1 delay of 3 delay units. 100 Add dq1 delay of 4 delay units. 101 Add dq1 delay of 5 delay units. 110 Add dq1 delay of 6 delay units. 111 Add dq1 delay of 7 delay units.
3 Reserved	This read-only field is reserved and always has the value 0.
rd_dq0_del	Read dqs0 to dq0 delay fine-tuning. This field holds the number of delay units that are added to dq0 relative to dqs0. 000 No change in dq0 delay 001 Add dq0 delay of 1 delay unit 010 Add dq0 delay of 2 delay units. 011 Add dq0 delay of 3 delay units. 100 Add dq0 delay of 4 delay units. 101 Add dq0 delay of 5 delay units. 110 Add dq0 delay of 6 delay units. 111 Add dq0 delay of 7 delay units.

35.12.39 MMDC PHY Read DQ Byte1 Delay Register (MMDC_MPRDDQBY1DL)

This register is used to add fine-tuning adjustment to every bit in the read DQ byte1 relative to the read DQS

Address: 21B_0000h base + 820h offset = 21B_0820h

Bit	31	30	29	28	27	26	25	24	23	22	21	20	19	18	17	16
R	0	rd_dq15_del			0	rd_dq14_del			0	rd_dq13_del			0	rd_dq12_del		
W																
Reset	0	0	0	0	0	0	0	0	0	0	0	0	0	0	0	0
Bit	15	14	13	12	11	10	9	8	7	6	5	4	3	2	1	0
R	0	rd_dq11_del			0	rd_dq10_del			0	rd_dq9_del			0	rd_dq8_del		
W																
Reset	0	0	0	0	0	0	0	0	0	0	0	0	0	0	0	0

MMDC_MPRDDQBY1DL field descriptions

Field	Description
31 Reserved	This read-only field is reserved and always has the value 0.
30–28 rd_dq15_del	Read dqs1 to dq15 delay fine-tuning. This field holds the number of delay units that are added to dq15 relative to dqs1. 000 No change in dq15 delay 001 Add dq15 delay of 1 delay unit 010 Add dq15 delay of 2 delay units. 011 Add dq15 delay of 3 delay units. 100 Add dq15 delay of 4 delay units. 101 Add dq15 delay of 5 delay units. 110 Add dq15 delay of 6 delay units. 111 Add dq15 delay of 7 delay units.
27 Reserved	This read-only field is reserved and always has the value 0.
26–24 rd_dq14_del	Read dqs1 to dq14 delay fine-tuning. This field holds the number of delay units that are added to dq14 relative to dqs1. 000 No change in dq14 delay 001 Add dq14 delay of 1 delay unit 010 Add dq14 delay of 2 delay units. 011 Add dq14 delay of 3 delay units. 100 Add dq14 delay of 4 delay units. 101 Add dq14 delay of 5 delay units. 110 Add dq14 delay of 6 delay units. 111 Add dq14 delay of 7 delay units.

Table continues on the next page...

MMDC_MPRDDQBY1DL field descriptions (continued)

Field	Description
23 Reserved	This read-only field is reserved and always has the value 0.
22–20 rd_dq13_del	Read dqs1 to dq13 delay fine-tuning. This field holds the number of delay units that are added to dq13 relative to dqs1. 000 No change in dq13 delay 001 Add dq13 delay of 1 delay unit 010 Add dq13 delay of 2 delay units. 011 Add dq13 delay of 3 delay units. 100 Add dq13 delay of 4 delay units. 101 Add dq13 delay of 5 delay units. 110 Add dq13 delay of 6 delay units. 111 Add dq13 delay of 7 delay units.
19 Reserved	This read-only field is reserved and always has the value 0.
18–16 rd_dq12_del	Read dqs1 to dq12 delay fine-tuning. This field holds the number of delay units that are added to dq12 relative to dqs1. 000 No change in dq12 delay 001 Add dq12 delay of 1 delay unit 010 Add dq12 delay of 2 delay units. 011 Add dq12 delay of 3 delay units. 100 Add dq12 delay of 4 delay units. 101 Add dq12 delay of 5 delay units. 110 Add dq12 delay of 6 delay units. 111 Add dq12 delay of 7 delay units.
15 Reserved	This read-only field is reserved and always has the value 0.
14–12 rd_dq11_del	Read dqs1 to dq11 delay fine-tuning. This field holds the number of delay units that are added to dq11 relative to dqs1. 000 No change in dq11 delay 001 Add dq11 delay of 1 delay unit 010 Add dq11 delay of 2 delay units. 011 Add dq11 delay of 3 delay units. 100 Add dq11 delay of 4 delay units. 101 Add dq11 delay of 5 delay units. 110 Add dq11 delay of 6 delay units. 111 Add dq11 delay of 7 delay units.
11 Reserved	This read-only field is reserved and always has the value 0.
10–8 rd_dq10_del	Read dqs1 to dq10 delay fine-tuning. This field holds the number of delay units that are added to dq10 relative to dqs1. 000 No change in dq10 delay 001 Add dq10 delay of 1 delay unit 010 Add dq10 delay of 2 delay units. 011 Add dq10 delay of 3 delay units.

Table continues on the next page...

MMDC_MPRDDQBY1DL field descriptions (continued)

Field	Description
	100 Add dq10 delay of 4 delay units. 101 Add dq10 delay of 5 delay unit 110 Add dq10 delay of 6 delay units. 111 Add dq10 delay of 7 delay units.
7 Reserved	This read-only field is reserved and always has the value 0.
6-4 rd_dq9_del	Read dqs1 to dq9 delay fine-tuning. This field holds the number of delay units that are added to dq9 relative to dqs1. 000 No change in dq9 delay 001 Add dq9 delay of 1 delay unit 010 Add dq9 delay of 2 delay units. 011 Add dq9 delay of 3 delay units. 100 Add dq9 delay of 4 delay units. 101 Add dq9 delay of 5 delay units. 110 Add dq9 delay of 6 delay units. 111 Add dq9 delay of 7 delay units.
3 Reserved	This read-only field is reserved and always has the value 0.
rd_dq8_del	Read dqs1 to dq8 delay fine-tuning. This field holds the number of delay units that are added to dq8 relative to dqs1. 000 No change in dq8 delay 001 Add dq8 delay of 1 delay unit 010 Add dq8 delay of 2 delay units. 011 Add dq8 delay of 3 delay units. 100 Add dq8 delay of 4 delay units. 101 Add dq8 delay of 5 delay units. 110 Add dq8 delay of 6 delay units. 111 Add dq8 delay of 7 delay units.

35.12.40 MMDC PHY Write DQ Byte0 Delay Register (MMDC_MPWRDQBY0DL)

This register is used to add fine-tuning adjustment to every bit in the write DQ byte0 relative to the write DQS

Address: 21B_0000h base + 82Ch offset = 21B_082Ch

Bit	31	30	29	28	27	26	25	24	23	22	21	20	19	18	17	16
R					0				0				0			
W	wr_dm0_del	wr_dq7_del					wr_dq6_del				wr_dq5_del				wr_dq4_del	
Reset	0	0	0	0	0	0	0	0	0	0	0	0	0	0	0	0
Bit	15	14	13	12	11	10	9	8	7	6	5	4	3	2	1	0
R	0				0				0				0			
W			wr_dq3_del				wr_dq2_del				wr_dq1_del				wr_dq0_del	
Reset	0	0	0	0	0	0	0	0	0	0	0	0	0	0	0	0

MMDC_MPWRDQBY0DL field descriptions

Field	Description
31–30 wr_dm0_del	Write dm0 delay fine-tuning. This field holds the number of delay units that are added to dm0 relative to dqs0. 00 No change in dm0 delay 01 Add dm0 delay of 1 delay unit. 10 Add dm0 delay of 2 delay units. 11 Add dm0 delay of 3 delay units.
29–28 wr_dq7_del	Write dq7 delay fine-tuning. This field holds the number of delay units that are added to dq7 relative to dqs0. 00 No change in dq7 delay 01 Add dq7 delay of 1 delay unit. 10 Add dq7 delay of 2 delay units. 11 Add dq7 delay of 3 delay units.
27–26 Reserved	This read-only field is reserved and always has the value 0.
25–24 wr_dq6_del	Write dq6 delay fine-tuning. This field holds the number of delay units that are added to dq6 relative to dqs0. 00 No change in dq6 delay 01 Add dq6 delay of 1 delay unit. 10 Add dq6 delay of 2 delay units. 11 Add dq6 delay of 3 delay units.
23–22 Reserved	This read-only field is reserved and always has the value 0.
21–20 wr_dq5_del	Write dq5 delay fine-tuning. This field holds the number of delay units that are added to dq5 relative to dqs0.

Table continues on the next page...

MMDC_MPWRDQBY0DL field descriptions (continued)

Field	Description
	00 No change in dq5 delay 01 Add dq5 delay of 1 delay unit. 10 Add dq5 delay of 2 delay units. 11 Add dq5 delay of 3 delay units.
19–18 Reserved	This read-only field is reserved and always has the value 0.
17–16 wr_dq4_del	Write dq4 delay fine-tuning. This field holds the number of delay units that are added to dq4 relative to dqs0. 00 No change in dq4 delay 01 Add dq4 delay of 1 delay unit.. 10 Add dq4 delay of 2 delay units. 11 Add dq4 delay of 3 delay units.
15–14 Reserved	This read-only field is reserved and always has the value 0.
13–12 wr_dq3_del	Write dq3 delay fine-tuning. This field holds the number of delay units that are added to dq3 relative to dqs0. 00 No change in dq3 delay 01 Add dq3 delay of 1 delay unit. 10 Add dq3 delay of 2 delay units. 11 Add dq3 delay of 3 delay units.
11–10 Reserved	This read-only field is reserved and always has the value 0.
9–8 wr_dq2_del	Write dq2 delay fine-tuning. This field holds the number of delay units that are added to dq2 relative to dqs0. 00 No change in dq2 delay 01 Add dq2 delay of 1 delay unit. 10 Add dq2 delay of 2 delay units. 11 Add dq2 delay of 3 delay units.
7–6 Reserved	This read-only field is reserved and always has the value 0.
5–4 wr_dq1_del	Write dq1 delay fine-tuning. This field holds the number of delay units that are added to dq1 relative to dqs0. 00 No change in dq1 delay 01 Add dq1 delay of 1 delay unit. 10 Add dq1 delay of 2 delay units. 11 Add dq1 delay of 3 delay units.
3–2 Reserved	This read-only field is reserved and always has the value 0.
wr_dq0_del	Write dq0 delay fine-tuning. This field holds the number of delay units that are added to dq0 relative to dqs0. 00 No change in dq0 delay 01 Add dq0 delay of 1 delay unit.

Table continues on the next page...

MMDC_MPWRDQBY0DL field descriptions (continued)

Field	Description
10	Add dq0 delay of 2 delay units.
11	Add dq0 delay of 3 delay units.

35.12.41 MMDC PHY Write DQ Byte1 Delay Register (MMDC_MPWRDQBY1DL)

This register is used to add fine-tuning adjustment to every bit in the write DQ byte1 relative to the write DQS

Address: 21B_0000h base + 830h offset = 21B_0830h

Bit	31	30	29	28	27	26	25	24	23	22	21	20	19	18	17	16
R					0				0				0			
W	wr_dm1_del	wr_dq15_del					wr_dq14_del				wr_dq13_del				wr_dq12_del	
Reset	0	0	0	0	0	0	0	0	0	0	0	0	0	0	0	0
Bit	15	14	13	12	11	10	9	8	7	6	5	4	3	2	1	0
R	0				0				0				0			
W			wr_dq11_del				wr_dq10_del				wr_dq9_del				wr_dq8_del	
Reset	0	0	0	0	0	0	0	0	0	0	0	0	0	0	0	0

MMDC_MPWRDQBY1DL field descriptions

Field	Description
31–30 wr_dm1_del	Write dm1 delay fine-tuning. This field holds the number of delay units that are added to dm1 relative to dqs1. 00 No change in dm1 delay 01 Add dm1 delay of 1 delay unit. 10 Add dm1 delay of 2 delay units. 11 Add dm1 delay of 3 delay units.
29–28 wr_dq15_del	Write dq15 delay fine-tuning. This field holds the number of delay units that are added to dq15 relative to dqs1. 00 No change in dq15 delay 01 Add dq15 delay of 1 delay unit. 10 Add dq15 delay of 2 delay units. 11 Add dq15 delay of 3 delay units.
27–26 Reserved	This read-only field is reserved and always has the value 0.
25–24 wr_dq14_del	Write dq14 delay fine-tuning. This field holds the number of delay units that are added to dq14 relative to dqs1. 00 No change in dq14 delay

Table continues on the next page...

MMDC_MPWRDQBY1DL field descriptions (continued)

Field	Description
	01 Add dq14 delay of 1 delay unit. 10 Add dq14 delay of 2 delay units. 11 Add dq14 delay of 3 delay units.
23–22 Reserved	This read-only field is reserved and always has the value 0.
21–20 wr_dq13_del	Write dq13 delay fine-tuning. This field holds the number of delay units that are added to dq13 relative to dqs1. 00 No change in dq13 delay 01 Add dq13 delay of 1 delay unit. 10 Add dq13 delay of 2 delay units. 11 Add dq13 delay of 3 delay units.
19–18 Reserved	This read-only field is reserved and always has the value 0.
17–16 wr_dq12_del	Write dq12 delay fine-tuning. This field holds the number of delay units that are added to dq12 relative to dqs1. 00 No change in dq12 delay 01 Add dq12 delay of 1 delay unit. 10 Add dq12 delay of 2 delay units. 11 Add dq12 delay of 3 delay units.
15–14 Reserved	This read-only field is reserved and always has the value 0.
13–12 wr_dq11_del	Write dq11 delay fine-tuning. This field holds the number of delay units that are added to dq11 relative to dqs1. 00 No change in dq11 delay 01 Add dq11 delay of 1 delay unit. 10 Add dq11 delay of 2 delay units. 11 Add dq11 delay of 3 delay units.
11–10 Reserved	This read-only field is reserved and always has the value 0.
9–8 wr_dq10_del	Write dq10 delay fine-tuning. This field holds the number of delay units that are added to dq10 relative to dqs1. 00 No change in dq10 delay 01 Add dq10 delay of 1 delay unit. 10 Add dq10 delay of 2 delay units. 11 Add dq10 delay of 3 delay units.
7–6 Reserved	This read-only field is reserved and always has the value 0.
5–4 wr_dq9_del	Write dq9 delay fine-tuning. This field holds the number of delay units that are added to dq9 relative to dqs1. 00 No change in dq9 delay 01 Add dq9 delay of 1 delay unit. 10 Add dq9 delay of 2 delay units. 11 Add dq9 delay of 3 delay units.

Table continues on the next page...

MMDC_MPWRDQBY1DL field descriptions (continued)

Field	Description
3–2 Reserved	This read-only field is reserved and always has the value 0.
wr_dq8_del	Write dq8 delay fine-tuning. This field holds the number of delay units that are added to dq8 relative to dqs1. 00 No change in dq8 delay 01 Add dq8 delay of 1 delay unit. 10 Add dq8 delay of 2 delay units. 11 Add dq8 delay of 3 delay units.

35.12.42 MMDC PHY Write DQ Byte2 Delay Register (MMDC_MPWRDQBY2DL)

This register is used to add fine-tuning adjustment to every bit in the write DQ byte2 relative to the write DQS

Address: 21B_0000h base + 834h offset = 21B_0834h

Bit	31	30	29	28	27	26	25	24	23	22	21	20	19	18	17	16
R					0				0				0			
W	wr_dm2_del	wr_dq23_del					wr_dq22_del				wr_dq21_del				wr_dq20_del	
Reset	0	0	0	0	0	0	0	0	0	0	0	0	0	0	0	0
Bit	15	14	13	12	11	10	9	8	7	6	5	4	3	2	1	0
R	0				0				0				0			
W		wr_dq19_del					wr_dq18_del				wr_dq17_del				wr_dq16_del	
Reset	0	0	0	0	0	0	0	0	0	0	0	0	0	0	0	0

MMDC_MPWRDQBY2DL field descriptions

Field	Description
31–30 wr_dm2_del	Write dm2 delay fine-tuning. This field holds the number of delay units that are added to dm2 relative to dqs2. 00 No change in dm2 delay 01 Add dm2 delay of 1 delay unit. 10 Add dm2 delay of 2 delay units. 11 Add dm2 delay of 3 delay units.
29–28 wr_dq23_del	Write dq23 delay fine tuning. This field holds the number of delay units that are added to dq23 relative to dqs2. 00 No change in dq23 delay 01 Add dq23 delay of 1 delay unit.

Table continues on the next page...

MMDC_MPWRDQBY2DL field descriptions (continued)

Field	Description
	10 Add dq23 delay of 2 delay units. 11 Add dq23 delay of 3 delay units.
27–26 Reserved	This read-only field is reserved and always has the value 0.
25–24 wr_dq22_del	Write dq22 delay fine tuning. This field holds the number of delay units that are added to dq22 relative to dqs2. 00 No change in dq22 delay 01 Add dq22 delay of 1 delay unit. 10 Add dq22 delay of 2 delay units. 11 Add dq22 delay of 3 delay units.
23–22 Reserved	This read-only field is reserved and always has the value 0.
21–20 wr_dq21_del	Write dq21 delay fine tuning. This field holds the number of delay units that are added to dq21 relative to dqs2. 00 No change in dq21 delay 01 Add dq21 delay of 1 delay unit. 10 Add dq21 delay of 2 delay units. 11 Add dq21 delay of 3 delay units.
19–18 Reserved	This read-only field is reserved and always has the value 0.
17–16 wr_dq20_del	Write dq20 delay fine tuning. This field holds the number of delay units that are added to dq20 relative to dqs2. 00 No change in dq20 delay 01 Add dq20 delay of 1 delay unit. 10 Add dq20 delay of 2 delay units. 11 Add dq20 delay of 3 delay units.
15–14 Reserved	This read-only field is reserved and always has the value 0.
13–12 wr_dq19_del	Write dq19 delay fine tuning. This field holds the number of delay units that are added to dq19 relative to dqs2. 00 No change in dq19 delay 01 Add dq19 delay of 1 delay unit. 10 Add dq19 delay of 2 delay units. 11 Add dq19 delay of 3 delay units.
11–10 Reserved	This read-only field is reserved and always has the value 0.
9–8 wr_dq18_del	Write dq18 delay fine tuning. This field holds the number of delay units that are added to dq18 relative to dqs2. 00 No change in dq18 delay 01 Add dq18 delay of 1 delay unit. 10 Add dq18 delay of 2 delay units. 11 Add dq18 delay of 3 delay units.

Table continues on the next page...

MMDC_MPWRDQBY2DL field descriptions (continued)

Field	Description
7–6 Reserved	This read-only field is reserved and always has the value 0.
5–4 wr_dq17_del	Write dq17 delay fine tuning. This field holds the number of delay units that are added to dq17 relative to dqs2. 00 No change in dq17 delay 01 Add dq17 delay of 1 delay unit. 10 Add dq17 delay of 2 delay units. 11 Add dq17 delay of 3 delay units.
3–2 Reserved	This read-only field is reserved and always has the value 0.
wr_dq16_del	Write dq16 delay fine tuning. This field holds the number of delay units that are added to dq16 relative to dqs2. 00 No change in dq16 delay 01 Add dq16 delay of 1 delay unit. 10 Add dq16 delay of 2 delay units. 11 Add dq16 delay of 3 delay units.

35.12.43 MMDC PHY Write DQ Byte3 Delay Register (MMDC_MPWRDQBY3DL)

This register is used to add fine-tuning adjustment to every bit in the write DQ byte3 relative to the write DQS

Address: 21B_0000h base + 838h offset = 21B_0838h

Bit	31	30	29	28	27	26	25	24	23	22	21	20	19	18	17	16
R					0				0				0			
W	wr_dm3_del	wr_dq31_del					wr_dq30_del				wr_dq29_del				wr_dq28_del	
Reset	0	0	0	0	0	0	0	0	0	0	0	0	0	0	0	0
Bit	15	14	13	12	11	10	9	8	7	6	5	4	3	2	1	0
R	0				0				0				0			
W			wr_dq27_del				wr_dq26_del				wr_dq25_del				wr_dq24_del	
Reset	0	0	0	0	0	0	0	0	0	0	0	0	0	0	0	0

MMDC_MPWRDQBY3DL field descriptions

Field	Description
31–30 wr_dm3_del	Write dm3 delay fine tuning. This field holds the number of delay units that are added to dm3 relative to dqs3. 00 No change in dm3 delay 01 Add dm3 delay of 1 delay unit.

Table continues on the next page...

MMDC_MPWRDQBY3DL field descriptions (continued)

Field	Description
	10 Add dm3 delay of 2 delay units. 11 Add dm3 delay of 3 delay units.
29–28 wr_dq31_del	Write dq31 delay fine tuning. This field holds the number of delay units that are added to dq31 relative to dqs3. 00 No change in dq31 delay 01 Add dq31 delay of 1 delay unit. 10 Add dq31 delay of 2 delay units. 11 Add dq31 delay of 3 delay units.
27–26 Reserved	This read-only field is reserved and always has the value 0.
25–24 wr_dq30_del	Write dq30 delay fine tuning. This field holds the number of delay units that are added to dq30 relative to dqs3. 00 No change in dq30 delay 01 Add dq30 delay of 1 delay unit. 10 Add dq30 delay of 2 delay units. 11 Add dq30 delay of 3 delay units.
23–22 Reserved	This read-only field is reserved and always has the value 0.
21–20 wr_dq29_del	Write dq29 delay fine tuning. This field holds the number of delay units that are added to dq29 relative to dqs3. 00 No change in dq29 delay 01 Add dq29 delay of 1 delay unit. 10 Add dq29 delay of 2 delay units. 11 Add dq29 delay of 3 delay units.
19–18 Reserved	This read-only field is reserved and always has the value 0.
17–16 wr_dq28_del	Write dq28 delay fine tuning. This field holds the number of delay units that are added to dq28 relative to dqs3. 00 No change in dq28 delay 01 Add dq28 delay of 1 delay unit. 10 Add dq28 delay of 2 delay units. 11 Add dq28 delay of 3 delay units.
15–14 Reserved	This read-only field is reserved and always has the value 0.
13–12 wr_dq27_del	Write dq27 delay fine tuning. This field holds the number of delay units that are added to dq27 relative to dqs3. 00 No change in dq27 delay 01 Add dq27 delay of 1 delay unit. 10 Add dq27 delay of 2 delay units. 11 Add dq27 delay of 3 delay units.
11–10 Reserved	This read-only field is reserved and always has the value 0.

Table continues on the next page...

MMDC_MPWRDQBY3DL field descriptions (continued)

Field	Description
9–8 wr_dq26_del	Write dq26 delay fine tuning. This field holds the number of delay units that are added to dq26 relative to dqs3. 00 No change in dq26 delay 01 Add dq26 delay of 1 delay unit. 10 Add dq26 delay of 2 delay units. 11 Add dq26 delay of 3 delay units.
7–6 Reserved	This read-only field is reserved and always has the value 0.
5–4 wr_dq25_del	Write dq25 delay fine tuning. This field holds the number of delay units that are added to dq25 relative to dqs3. 00 No change in dq25 delay 01 Add dq25 delay of 1 delay unit. 10 Add dq25 delay of 2 delay units. 11 Add dq25 delay of 3 delay units.
3–2 Reserved	This read-only field is reserved and always has the value 0.
wr_dq24_del	Write dq24 delay fine tuning. This field holds the number of delay units that are added to dq24 relative to dqs3. 00 No change in dq24 delay 01 Add dq24 delay of 1 delay unit. 10 Add dq24 delay of 2 delay units. 11 Add dq24 delay of 3 delay units.

35.12.44 MMDC PHY Read DQS Gating Control Register 0 (MMDC_MPDGCTRL0)

Address: 21B_0000h base + 83Ch offset = 21B_083Ch

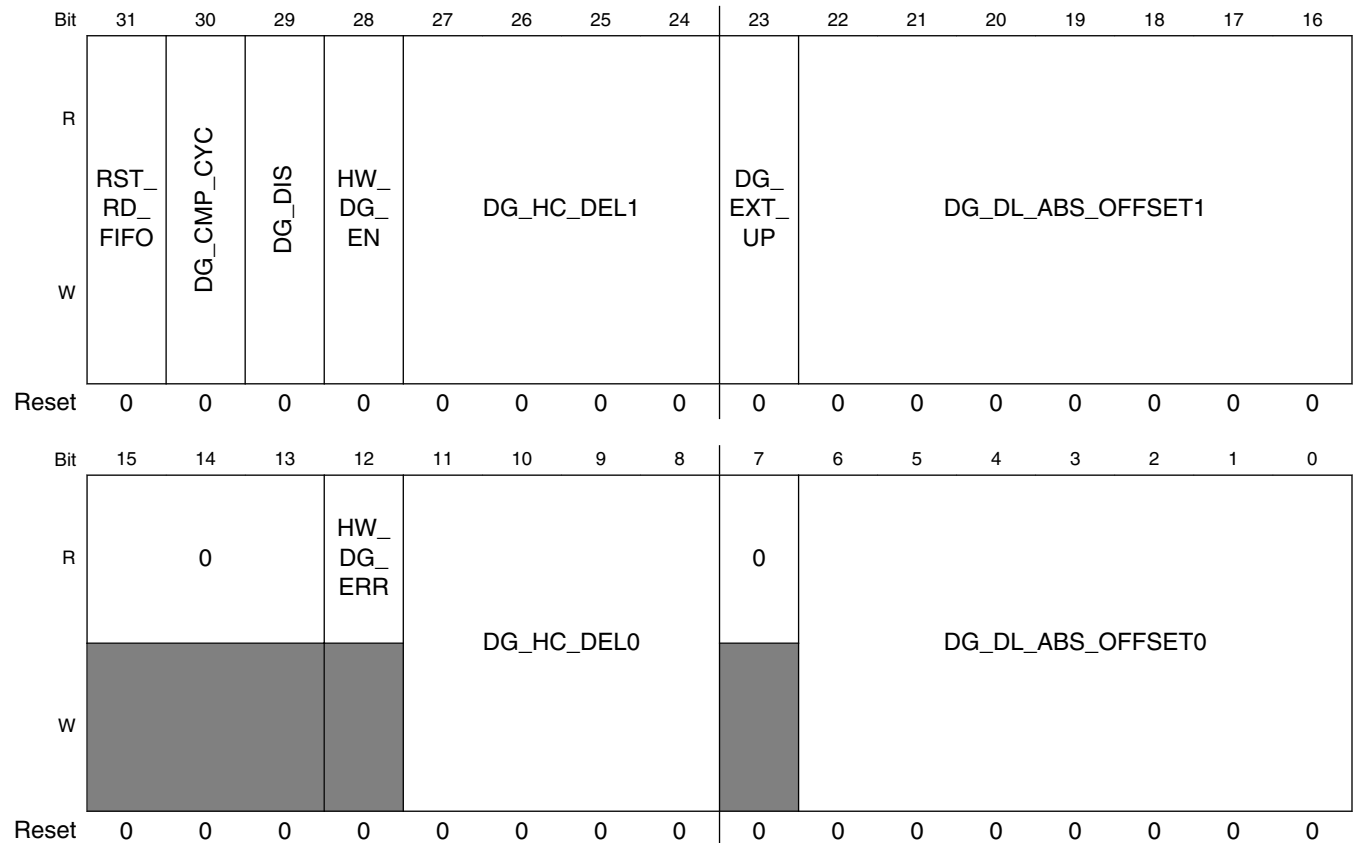

MMDC_MPDGCTRL0 field descriptions

Field	Description
31 RST_RD_FIFO	Reset Read Data FIFO and associated pointers. If this bit is asserted then the MMDC resets the read data FIFO and the associated pointers. This bit is self cleared after the FIFO reset is done.
30 DG_CMP_CYC	Read DQS gating sample cycle. If this bit is asserted then the MMDC waits 32 cycles before comparing the read data, Otherwise it waits 16 DDR cycles. 0 MMDC waits 16 DDR cycles 1 MMDC waits 32 DDR cycles
29 DG_DIS	Read DQS gating disable. If this bit is asserted then the MMDC disables the read DQS gating mechanism. If this bits is asserted (read DQS gating is disabled) then pull-up and pull-down resistors suppose to be used on DQS and DQS# respectively 0 Read DQS gating mechanism is enabled 1 Read DQS gating mechanism is disabled
28 HW_DG_EN	Enable automatic read DQS gating calibration. If this bit is asserted then the MMDC performs automatic read DQS gating calibration. HW negates this bit upon completion of the automatic read DQS gating.

Table continues on the next page...

MMDC_MPDGCTRL0 field descriptions (continued)

Field	Description
	<p>NOTE: Before issuing the first read command the MMDC counts 12 cycles.</p> <p>In LPDDR2 mode automatic (HW) read DQS gating should be disabled and Pull-up/pull-down resistors on DQS/DQS# should be enabled while ODT resistors must be disconnected.</p> <p>0 Disable automatic read DQS gating calibration 1 Start automatic read DQS gating calibration</p>
27–24 DG_HC_DEL1	<p>Read DQS gating half cycles delay for Byte1.</p> <p>This field indicates the delay in half cycles between read DQS gate and the middle of the read DQS preamble of Byte1. This delay is added to the delay that is generated by the read DQS1 gating delay-line, So the total read DQS gating delay is $(DG_HC_DEL\#)*0.5*cycle + (DG_DL_ABS_OFFSET\#)*1/256*cycle$</p> <p>Upon completion of the automatic read DQS gating calibration this field gets the value of the 4 MSB of $((HW_DG_LOW1 + HW_DG_UP1) / 2)$.</p> <p>0000 0 cycles delay. 0001 Half cycle delay. 0010 1 cycle delay 1101 6.5 cycles delay 1110 Reserved 1111 Reserved</p>
23 DG_EXT_UP	<p>DG extend upper boundary. By default the upper boundary of DQS gating HW calibration is set according to first failing comparison after at least one passing comparison. If this bit is asserted then the upper boundary is set according to the last passing comparison.</p>
22–16 DG_DL_ABS_OFFSET1	<p>Absolute read DQS gating delay offset for Byte1. This field indicates the absolute delay between read DQS gate and the middle of the read DQS preamble of Byte1 with fractions of a clock period and up to half cycle. The fraction is process and frequency independent. The delay of the delay-line would be $(DG_DL_ABS_OFFSET1 / 256)* MMDC\ AXI\ clock\ (fast\ clock)$.</p> <p>This field can also bit written by HW. Upon completion of the automatic read DQS gating calibration this field gets the value of the 7 LSB of $((HW_DG_LOW1 + HW_DG_UP1) / 2)$.</p> <p>NOTE: Not all changes will have effect on the actual delay. If the requested change is smaller than the delay-line resolution, then no change will occur.</p>
15–13 Reserved	<p>This read-only field is reserved and always has the value 0.</p>
12 HW_DG_ERR	<p>HW DQS gating error. This bit valid is asserted when an error was found during the read DQS gating HW calibration process. Error can occur when no valid value was found during HW calibration.</p> <p>This bit is valid only after HW_DG_EN is de-asserted.</p> <p>0 No error was found during the DQS gating HW calibration process. 1 An error was found during the DQS gating HW calibration process.</p>
11–8 DG_HC_DEL0	<p>Read DQS gating half cycles delay for Byte0</p> <p>. This field indicates the delay in half cycles between read DQS gate and the middle of the read DQS preamble of Byte0/4. This delay is added to the delay that is generated by the read DQS1 gating delay-line, So the total read DQS gating delay is $(DG_HC_DEL\#)*0.5*cycle + (DG_DL_ABS_OFFSET\#)*1/256*cycle$</p> <p>Upon completion of the automatic read DQS gating calibration this field gets the value of the 4 MSB of $((HW_DG_LOW1 + HW_DG_UP1) / 2)$.</p> <p>0000 0 cycles delay. 0001 Half cycle delay.</p>

Table continues on the next page...

MMDC_MPDGCTRL0 field descriptions (continued)

Field	Description
	0010 1 cycle delay 1101 6.5 cycles delay 1110 Reserved 1111 Reserved
7 Reserved	This read-only field is reserved and always has the value 0.
DG_DL_ABS_OFFSET0	Absolute read DQS gating delay offset for Byte0. This field indicates the absolute delay between read DQS gate and the middle of the read DQS preamble of Byte0 with fractions of a clock period and up to half cycle. The fraction is process and frequency independent. The delay of the delay-line would be $(DG_DL_ABS_OFFSET0 / 256) * MMDC\ AXI\ clock\ (fast\ clock)$. This field can also bit written by HW. Upon completion of the automatic read DQS gating calibration this field gets the value of the 7 LSB of $((HW_DG_LOW0 + HW_DG_UP0) / 2)$. NOTE: Not all changes will have effect on the actual delay. If the requested change is smaller than the delay-line resolution, then no change will occur.

35.12.45 MMDC PHY Read DQS Gating Control Register 1 (MMDC_MPDGCTRL1)

Address: 21B_0000h base + 840h offset = 21B_0840h

Bit	31	30	29	28	27	26	25	24	23	22	21	20	19	18	17	16
R	0				DG_HC_DEL3				0	DG_DL_ABS_OFFSET3						
W	0				0				0	0						
Reset	0	0	0	0	0	0	0	0	0	0	0	0	0	0	0	0
Bit	15	14	13	12	11	10	9	8	7	6	5	4	3	2	1	0
R	0				DG_HC_DEL2				0	DG_DL_ABS_OFFSET2						
W	0				0				0	0						
Reset	0	0	0	0	0	0	0	0	0	0	0	0	0	0	0	0

MMDC_MPDGCTRL1 field descriptions

Field	Description
31–28 Reserved	This read-only field is reserved and always has the value 0.
27–24 DG_HC_DEL3	Read DQS gating half cycles delay for Byte3 . This field indicates the delay in half cycles between read DQS gate and the middle of the read DQS preamble of Byte3/7. This delay is added to the delay that is generated by the read DQS1 gating delay-line, So the total read DQS gating delay is $(DG_HC_DEL\#)*0.5*cycle + (DG_DL_ABS_OFFSET\#)*1/256*cycle$ Upon completion of the automatic read DQS gating calibration this field gets the value of the 4 MSB of $((HW_DG_LOW3 + HW_DG_UP3) / 2)$. 0000 0 cycles delay. 0001 Half cycle delay.

Table continues on the next page...

MMDC_MPDGCTRL1 field descriptions (continued)

Field	Description
	0010 1 cycle delay 1101 6.5 cycles delay 1110 Reserved 1111 Reserved
23 Reserved	This read-only field is reserved and always has the value 0.
22–16 DG_DL_ABS_ OFFSET3	Absolute read DQS gating delay offset for Byte3. This field indicates the absolute delay between read DQS gate and the middle of the read DQS preamble of Byte3 with fractions of a clock period and up to half cycle. The fraction is process and frequency independent. The delay of the delay-line would be $(DG_DL_ABS_OFFSET3 / 256) * \text{MMDC AXI clock (fast clock)}$. This field can also bit written by HW. Upon completion of the automatic read DQS gating calibration this field gets the value of the 7 LSB of $((HW_DG_LOW3 + HW_DG_UP3) / 2)$. NOTE: Not all changes will have effect on the actual delay. If the requested change is smaller than the delay-line resolution, then no change will occur.
15–12 Reserved	This read-only field is reserved and always has the value 0.
11–8 DG_HC_DEL2	Read DQS gating half cycles delay for Byte2 . This field indicates the delay in half cycles between read DQS gate and the middle of the read DQS preamble of Byte2/5. This delay is added to the delay that is generated by the read DQS1 gating delay-line, So the total read DQS gating delay is $(DG_HC_DEL\#)*0.5*\text{cycle} + (DG_DL_ABS_OFFSET\#)*1/256*\text{cycle}$ Upon completion of the automatic read DQS gating calibration this field gets the value of the 4 MSB of $((HW_DG_LOW2 + HW_DG_UP2) / 2)$. 0000 0 cycles delay. 0001 Half cycle delay. 0010 1 cycle delay 1101 6.5 cycles delay 1110 Reserved 1111 Reserved
7 Reserved	This read-only field is reserved and always has the value 0.
DG_DL_ABS_ OFFSET2	Absolute read DQS gating delay offset for Byte2. This field indicates the absolute delay between read DQS gate and the middle of the read DQS preamble of Byte2 with fractions of a clock period and up to half cycle. The fraction is process and frequency independent. The delay of the delay-line would be $(DG_DL_ABS_OFFSET2 / 256) * \text{MMDC AXI clock (fast clock)}$. This field can also bit written by HW. Upon completion of the automatic read DQS gating calibration this field gets the value of the 7 LSB of $((HW_DG_LOW2 + HW_DG_UP2) / 2)$. NOTE: Not all changes will have effect on the actual delay. If the requested change is smaller than the delay-line resolution, then no change will occur.

35.12.46 MMDC PHY Read DQS Gating delay-line Status Register (MMDC_MPDGDLST0)

This register holds the status of the 4 dqs gating delay-lines.

Address: 21B_0000h base + 844h offset = 21B_0844h

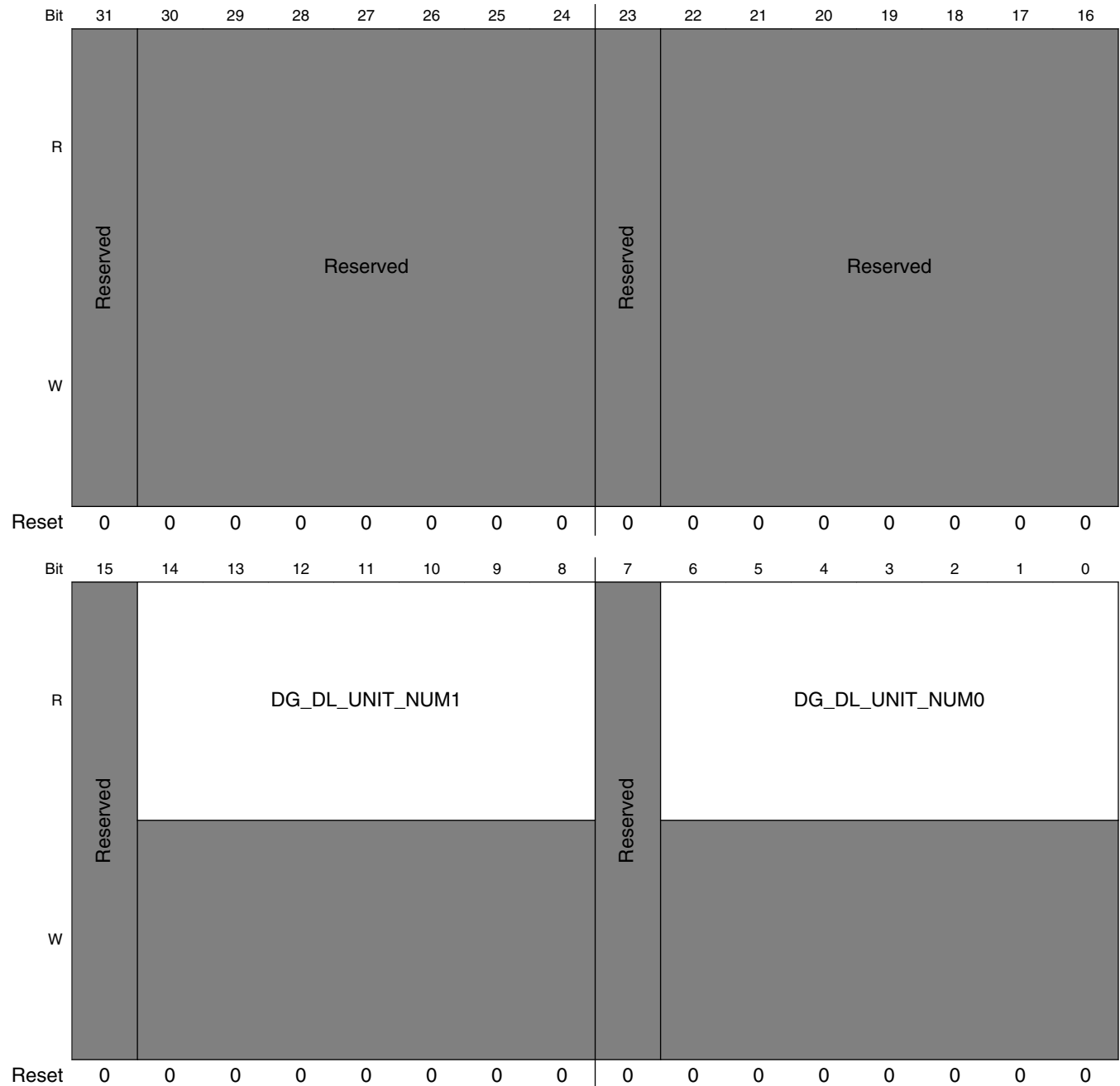

MMDC_MPDGDLST0 field descriptions

Field	Description
31 -	This field is reserved. Reserved
30–24 -	This field is reserved. Reserved
23 -	This field is reserved. Reserved
22–16 -	This field is reserved. Reserved
15 -	This field is reserved. Reserved
14–8 DG_DL_UNIT_ NUM1	This field reflects the number of delay units that are actually used by read DQS gating delay-line 1.
7 -	This field is reserved. Reserved
DG_DL_UNIT_ NUM0	This field reflects the number of delay units that are actually used by read DQS gating delay-line 0.

35.12.47 MMDC PHY Read delay-lines Configuration Register (MMDC_MPRDDLCTL)

This register controls read delay-lines functionality; it determines DQS delay relative to the associated DQ read access. The delay-line compensates for process variations and produces a constant delay regardless of the process, temperature and voltage.

Address: 21B_0000h base + 848h offset = 21B_0848h

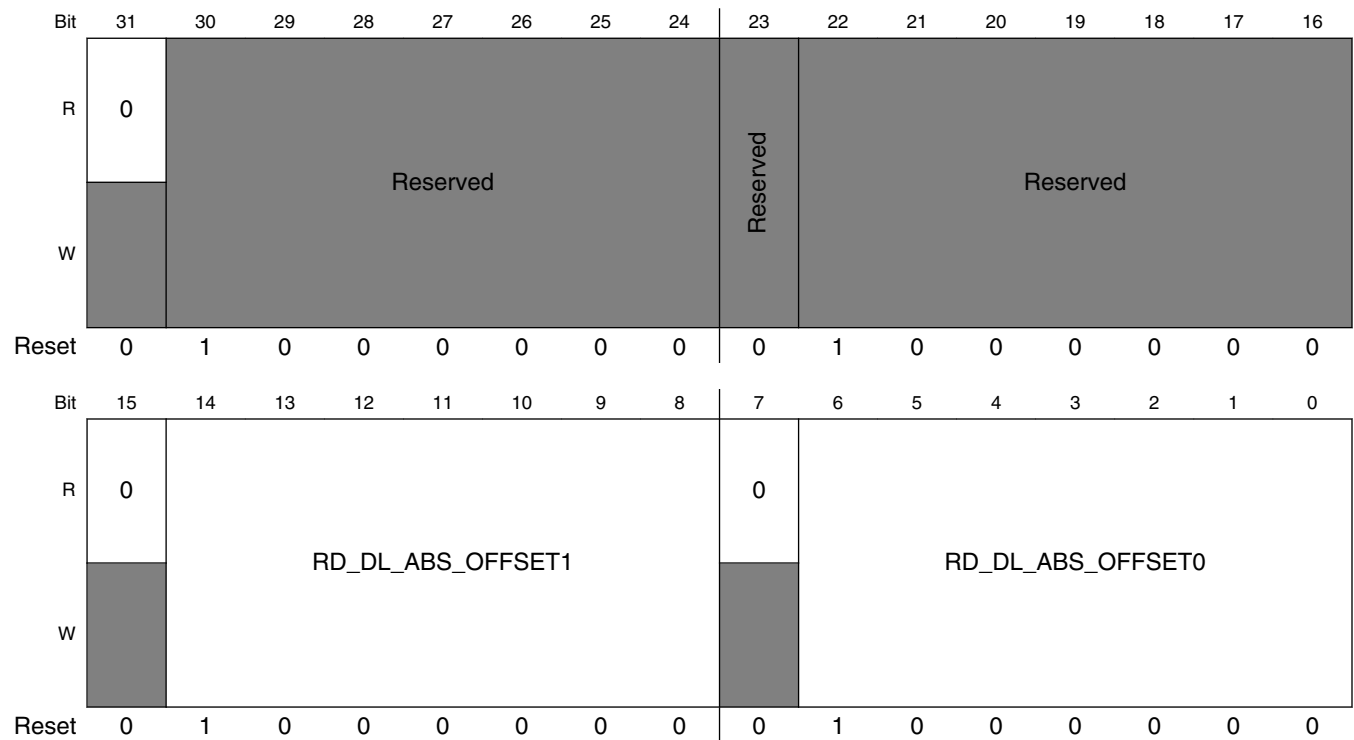

MMDC_MPRDDLCTL field descriptions

Field	Description
31 Reserved	This read-only field is reserved and always has the value 0.
30–24 -	This field is reserved. Reserved
23 -	This field is reserved. Reserved
22–16 -	This field is reserved. Reserved
15 Reserved	This read-only field is reserved and always has the value 0.

Table continues on the next page...

MMDC_MPRDDLCTL field descriptions (continued)

Field	Description
14–8 RD_DL_ABS_ OFFSET1	<p>Absolute read delay offset for Byte1. This field indicates the absolute delay between read DQS strobe and the read data of Byte1 with fractions of a clock period and up to half cycle. The fraction is process and frequency independent. The delay of the delay-line would be $(RD_DL_ABS_OFFSET1 / 256) * MMDC\ AXI\ clock\ (fast\ clock)$. So for the default value of 64 we get a quarter cycle delay.</p> <p>This field can also bit written by HW. Upon completion of the read delay-line HW calibration this field gets the value of $(HW_RD_DL_LOW1 + HW_RD_DL_UP1) / 2$</p> <p>NOTE: Not all changes will have effect on the actual delay. If the requested change is smaller than the delay-line resolution, then no change will occur.</p>
7 Reserved	This read-only field is reserved and always has the value 0.
RD_DL_ABS_ OFFSET0	<p>Absolute read delay offset for Byte0. This field indicates the absolute delay between read DQS strobe and the read data of Byte0 with fractions of a clock period and up to half cycle. The fraction is process and frequency independent. The delay of the delay-line would be $(RD_DL_ABS_OFFSET0 / 256) * MMDC\ AXI\ clock\ (fast\ clock)$. So for the default value of 64 we get a quarter cycle delay.</p> <p>This field can also bit written by HW. Upon completion of the read delay-line HW calibration this field gets the value of $(HW_RD_DL_LOW0 + HW_RD_DL_UP0) / 2$</p> <p>NOTE: Not all changes will have effect on the actual delay. If the requested change is smaller than the delay-line resolution, then no change will occur.</p>

35.12.48 MMDC PHY Read delay-lines Status Register (MMDC_MPRDDLST)

This register holds the status of the 4 read delay-lines.

Address: 21B_0000h base + 84Ch offset = 21B_084Ch

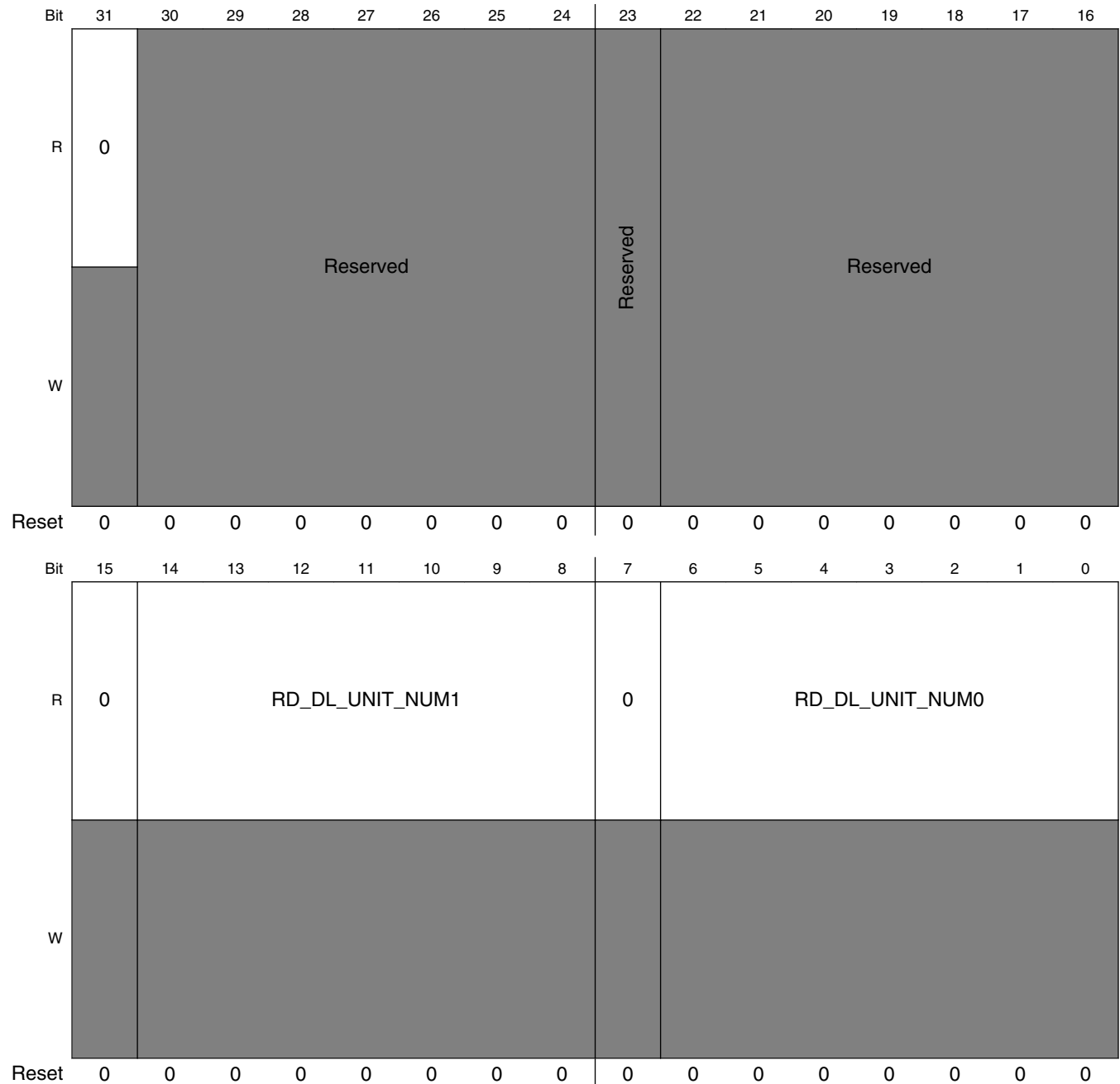

MMDC_MPRDDLST field descriptions

Field	Description
31 Reserved	This read-only field is reserved and always has the value 0.
30–24 -	This field is reserved. Reserved
23 -	This field is reserved. Reserved
22–16 -	This field is reserved. Reserved
15 Reserved	This read-only field is reserved and always has the value 0.
14–8 RD_DL_UNIT_ NUM1	This field reflects the number of delay units that are actually used by read delay-line 1.
7 Reserved	This read-only field is reserved and always has the value 0.
RD_DL_UNIT_ NUM0	This field reflects the number of delay units that are actually used by read delay-line 0.

35.12.49 MMDC PHY Write delay-lines Configuration Register (MMDC_MPWRDLCTL)

This register controls write delay-lines functionality, it determines DQ/DM delay relative to the associated DQS in write access. The delay-line compensates for process variations, and produces a constant delay regardless of the process, temperature and voltage.

Address: 21B_0000h base + 850h offset = 21B_0850h

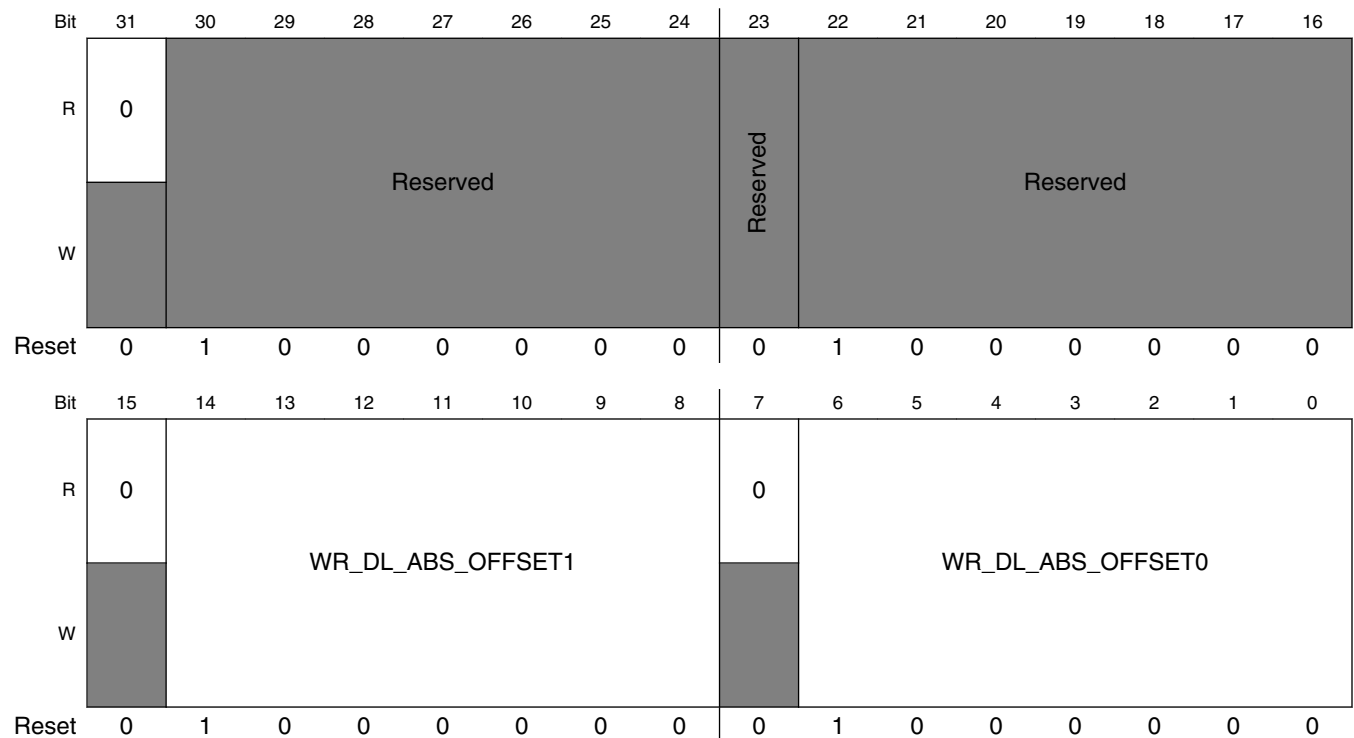

MMDC_MPWRDLCTL field descriptions

Field	Description
31 Reserved	This read-only field is reserved and always has the value 0.
30–24 -	This field is reserved. Reserved
23 -	This field is reserved. Reserved
22–16 -	This field is reserved. Reserved
15 Reserved	This read-only field is reserved and always has the value 0.

Table continues on the next page...

MMDC_MPWRDLCTL field descriptions (continued)

Field	Description
14–8 WR_DL_ABS_ OFFSET1	<p>Absolute write delay offset for Byte1. This field indicates the absolute delay between write DQS strobe and the write data of Byte1 with fractions of a clock period and up to half cycle. The fraction is process and frequency independent. The delay of the delay-line would be $(WR_DL_ABS_OFFSET1 / 256) * MMDC$ AXI clock (fast clock). So for the default value of 64 we get a quarter cycle delay.</p> <p>This field can also bit written by HW. Upon completion of the write delay-line HW calibration this field gets the value of $(HW_WR_DL_LOW1 + HW_WR_DL_UP1) / 2$</p> <p>NOTE: Not all changes of this value will affect the actual delay. If the requested change is smaller than the delay-line resolution, then no change will occur.</p>
7 Reserved	This read-only field is reserved and always has the value 0.
WR_DL_ABS_ OFFSET0	<p>Absolute write delay offset for Byte0. This field indicates the absolute delay between write DQS strobe and the write data of Byte3 with fractions of a clock period and up to half cycle. The fraction is process and frequency independent. The delay of the delay-line would be $(WR_DL_ABS_OFFSET0 / 256) * MMDC$ AXI clock (fast clock). So for the default value of 64 we get a quarter cycle delay.</p> <p>This field can also bit written by HW. Upon completion of the write delay-line HW calibration this field gets the value of $(HW_WR_DL_LOW0 + HW_WR_DL_UP0) / 2$</p> <p>NOTE: Not all changes of this value will affect the actual delay. If the requested change is smaller than the delay-line resolution, then no change will occur.</p>

35.12.50 MMDC PHY Write delay-lines Status Register (MMDC_MPWRDLST)

This register holds the status of the 4 write delay-line.

Address: 21B_0000h base + 854h offset = 21B_0854h

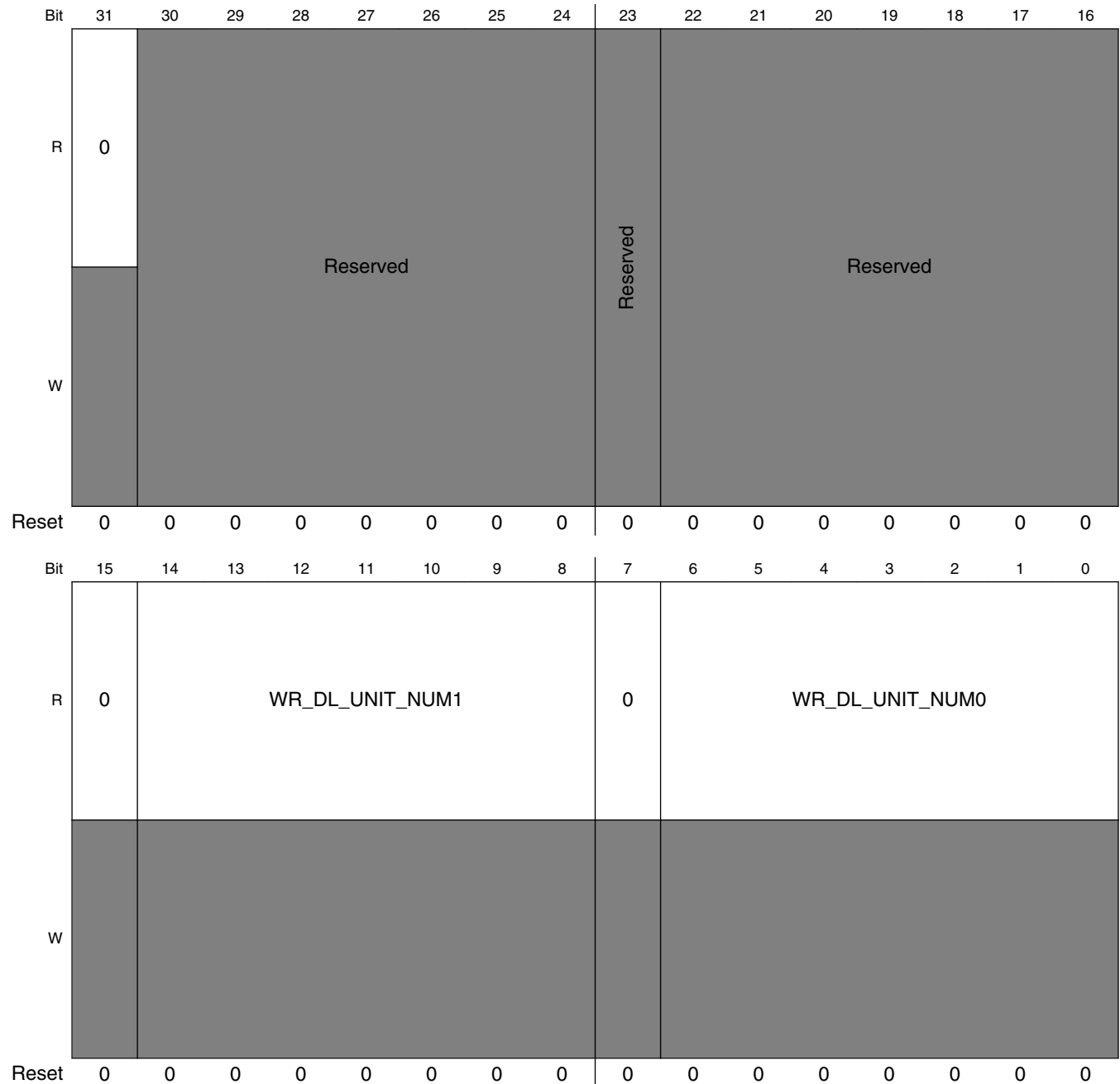

MMDC_MPWRDLST field descriptions

Field	Description
31 Reserved	This read-only field is reserved and always has the value 0.
30–24 -	This field is reserved. Reserved
23 -	This field is reserved. Reserved
22–16 -	This field is reserved. Reserved
15 Reserved	This read-only field is reserved and always has the value 0.
14–8 WR_DL_UNIT_NUM1	This field reflects the number of delay units that are actually used by write delay-line 1.
7 Reserved	This read-only field is reserved and always has the value 0.
WR_DL_UNIT_NUM0	This field reflects the number of delay units that are actually used by write delay-line 0.

35.12.51 MMDC PHY CK Control Register (MMDC_MPSTDCTRL)

This register controls the fine tuning of the primary clock (CK0).

Address: 21B_0000h base + 858h offset = 21B_0858h

Bit	31	30	29	28	27	26	25	24	23	22	21	20	19	18	17	16
R	0															
W																
Reset	0	0	0	0	0	0	0	0	0	0	0	0	0	0	0	0
Bit	15	14	13	12	11	10	9	8	7	6	5	4	3	2	1	0
R	0						SDclk0_del		0							
W																
Reset	0	0	0	0	0	0	0	0	0	0	0	0	0	0	0	0

MMDC_MPSTDCTRL field descriptions

Field	Description
31–10 Reserved	This read-only field is reserved and always has the value 0.
9–8 SDclk0_del	DDR clock0 delay fine tuning. This field holds the number of delay units that are added to DDR clock (CK0). 00 No change in DDR clock0 delay 01 Add DDR clock0 delay of 1 delay unit.

Table continues on the next page...

MMDC_MPSTDCTRL field descriptions (continued)

Field	Description
10	Add DDR clock0 delay of 2 delay units.
11	Add DDR clock0 delay of 3 delay units.
Reserved	This read-only field is reserved and always has the value 0.

35.12.52 MMDC ZQ LPDDR2 HW Control Register (MMDC_MPZQLP2CTL)

This register controls the idle time that takes the LPDDR2 device to perform ZQ calibration.

Address: 21B_0000h base + 85Ch offset = 21B_085Ch

Bit	31	30	29	28	27	26	25	24	23	22	21	20	19	18	17	16
R	0	ZQ_LP2_HW_ZQCS							ZQ_LP2_HW_ZQCL							
W																
Reset	0	0	0	1	1	0	1	1	0	1	0	1	1	1	1	1
Bit	15	14	13	12	11	10	9	8	7	6	5	4	3	2	1	0
R	0							ZQ_LP2_HW_ZQINIT								
W																
Reset	0	0	0	0	0	0	0	1	0	0	0	0	1	0	0	1

MMDC_MPZQLP2CTL field descriptions

Field	Description
31 Reserved	This read-only field is reserved and always has the value 0.
30–24 ZQ_LP2_HW_ZQCS	This register defines the period in cycles that it takes the memory device to perform a short ZQ calibration. This is the period of time that the MMDC has to wait after sending a short ZQ calibration and before sending other commands. This delay will also be used if ZQ reset is sent. 0x0-0x1A Reserved 0x1B 112 cycles (default) 0x1C 116 cycles 0x7E 508 cycles 0x7F 512 cycles
23–16 ZQ_LP2_HW_ZQCL	This register defines the period in cycles that it takes the memory device to perform a long ZQ calibration. This is the period of time that the MMDC has to wait after sending a long ZQ calibration and before sending other commands. 0x0-0x36 Reserved 0x37 112 cycles

Table continues on the next page...

MMDC_MPZQLP2CTL field descriptions (continued)

Field	Description
	0x38 114 cycles 0x5F 192 cycles (Default, JEDEC value, tZQCL, for LPDDR2, 360ns @ clock frequency 533MHz) 0xFE 510 cycles 0xFF 512 cycles
15–9 Reserved	This read-only field is reserved and always has the value 0.
ZQ_LP2_HW_ ZQINIT	This register defines the period in cycles that it takes the memory device to perform a Init ZQ calibration. This is the period of time that the MMDC has to wait after sending a init ZQ calibration and before sending other commands. 0x0-0x36 Reserved 0x37 112 cycles 0x38 114 cycles 0x109 532 cycles (Default, JEDEC value, tZQINIT, for LPDDR2, 1us @ clock frequency 533MHz) 0x1FE 1022 cycles 0x1FF 1024 cycles

35.12.53 MMDC PHY Read Delay HW Calibration Control Register (MMDC_MPRDDLHWCTL)

Address: 21B_0000h base + 860h offset = 21B_0860h

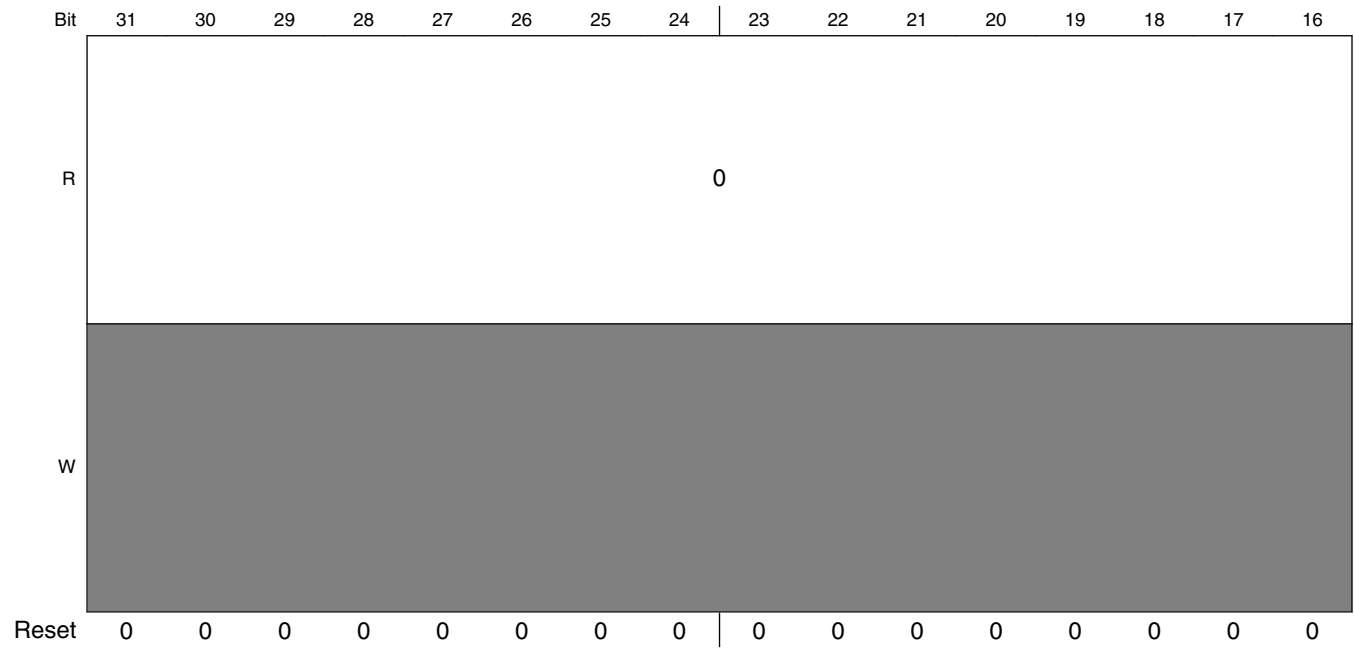

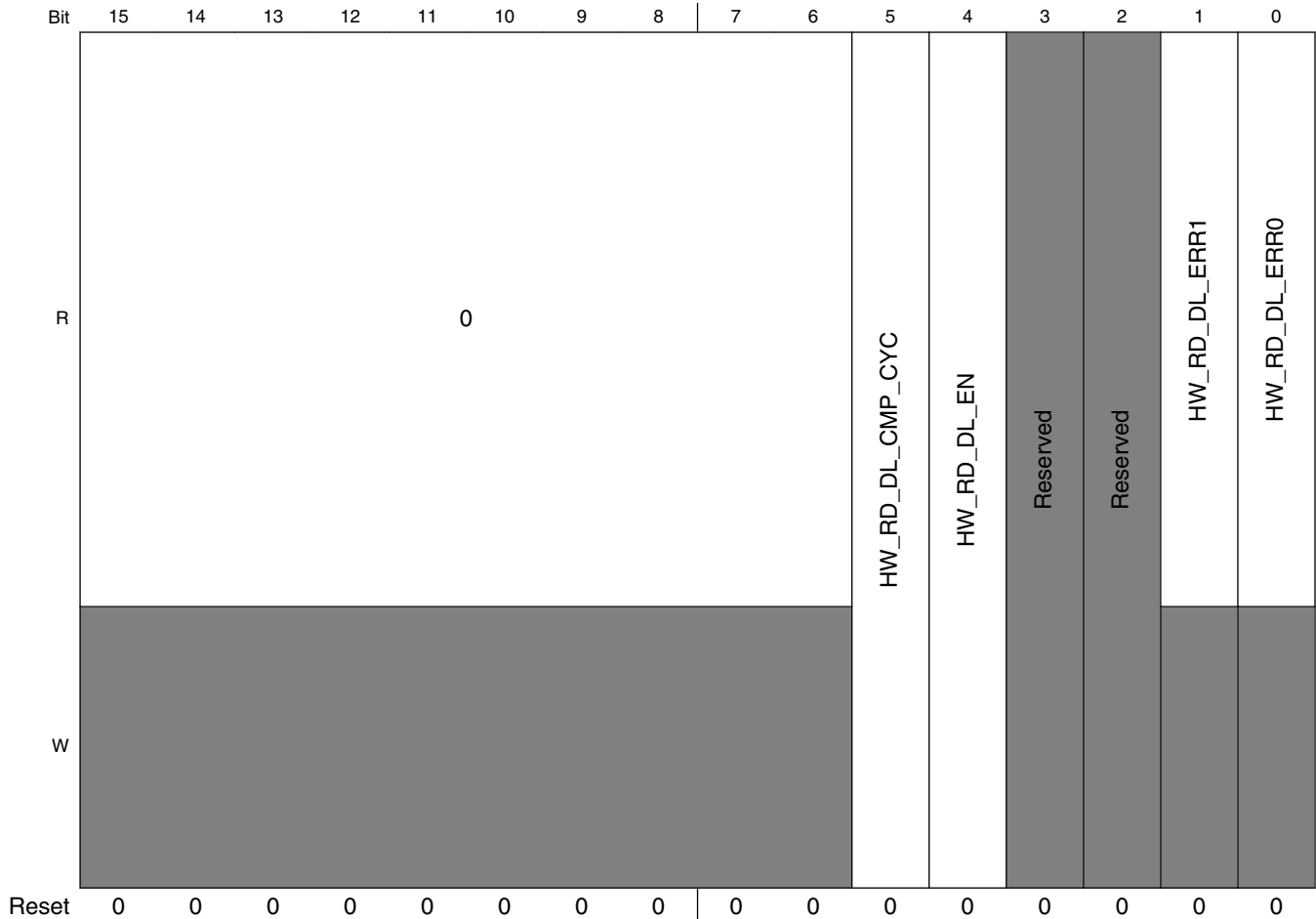

MMDC_MPRDDLHWCTL field descriptions

Field	Description
31–6 Reserved	This read-only field is reserved and always has the value 0.
5 HW_RD_DL_CMP_CYC	Automatic (HW) read sample cycle. If this bit is asserted then the MMDC will compare the read data 32 cycles after the MMDC sent the read command enable pulse else it compares the data after 16 cycles.
4 HW_RD_DL_EN	Enable automatic (HW) read calibration. If this bit is asserted then the MMDC will perform an automatic read calibration. HW should negate this bit upon completion of the calibration. Negation of this bit also points that the read calibration results are valid NOTE: Before issuing the first read command MMDC counts 12 cycles.
3 -	This field is reserved. Reserved
2 -	This field is reserved. Reserved
1 HW_RD_DL_ERR1	Automatic (HW) read calibration error of Byte1. If this bit is asserted then it indicates that an error was found during the HW calibration process of read delay-line 1. In case this bit is zero at the end of the calibration process then the boundary results can be found at MPRDDLHWST0 register. This bit is valid only after HW_RD_DL_EN is de-asserted.

Table continues on the next page...

MMDC_MPRDDLHWCTL field descriptions (continued)

Field	Description
	<p>0 No error was found in read delay-line 1 during the automatic (HW) read calibration process of read delay-line 1.</p> <p>1 An error was found in read delay-line 1 during the automatic (HW) read calibration process of read delay-line 1.</p>
<p>0 HW_RD_DL_erro</p>	<p>Automatic (HW) read calibration error of Byte0. If this bit is asserted then it indicates that an error was found during the HW calibration process of read delay-line 0. In case this bit is zero at the end of the calibration process then the boundary results can be found at MPRDDLHWST0 register. This bit is valid only after HW_RD_DL_EN is de-asserted.</p> <p>0 No error was found in read delay-line 0 during the automatic (HW) read calibration process of read delay-line 0.</p> <p>1 An error was found in read delay-line 0 during the automatic (HW) read calibration process of read delay-line 0.</p>

35.12.54 MMDC PHY Write Delay HW Calibration Control Register (MMDC_MPWRDLHWCTL)

Address: 21B_0000h base + 864h offset = 21B_0864h

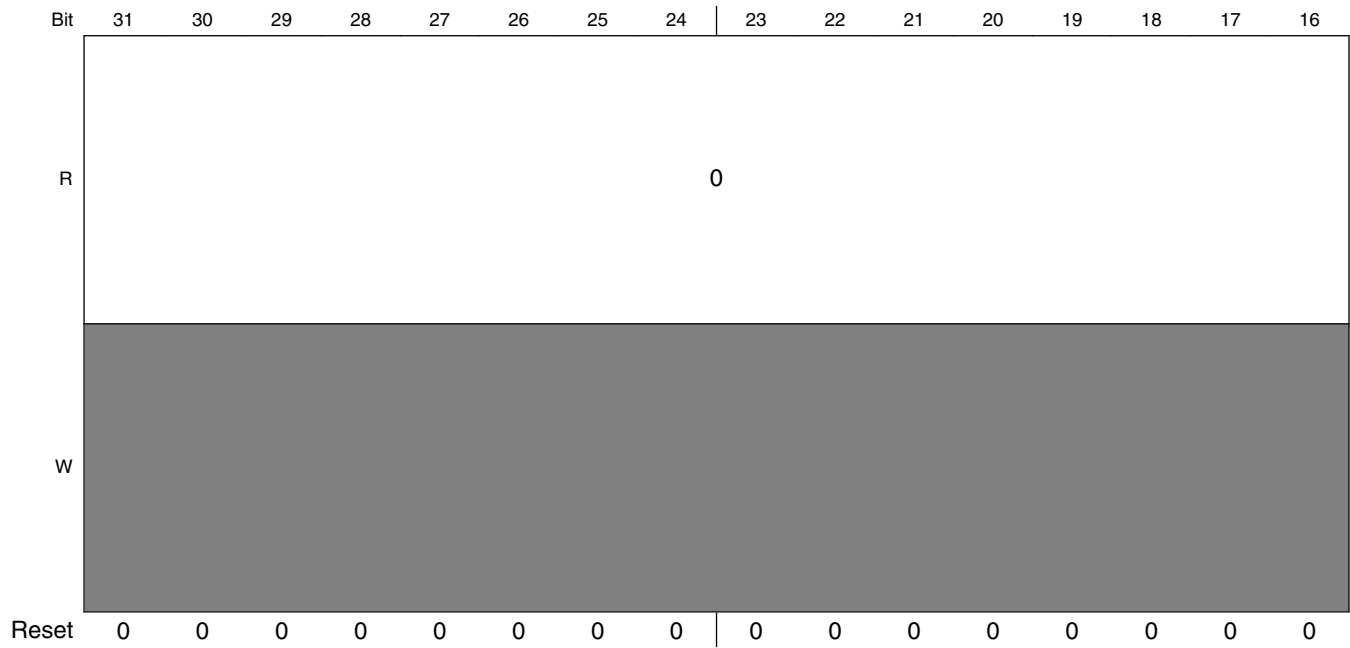

MMDC Memory Map/Register Definition

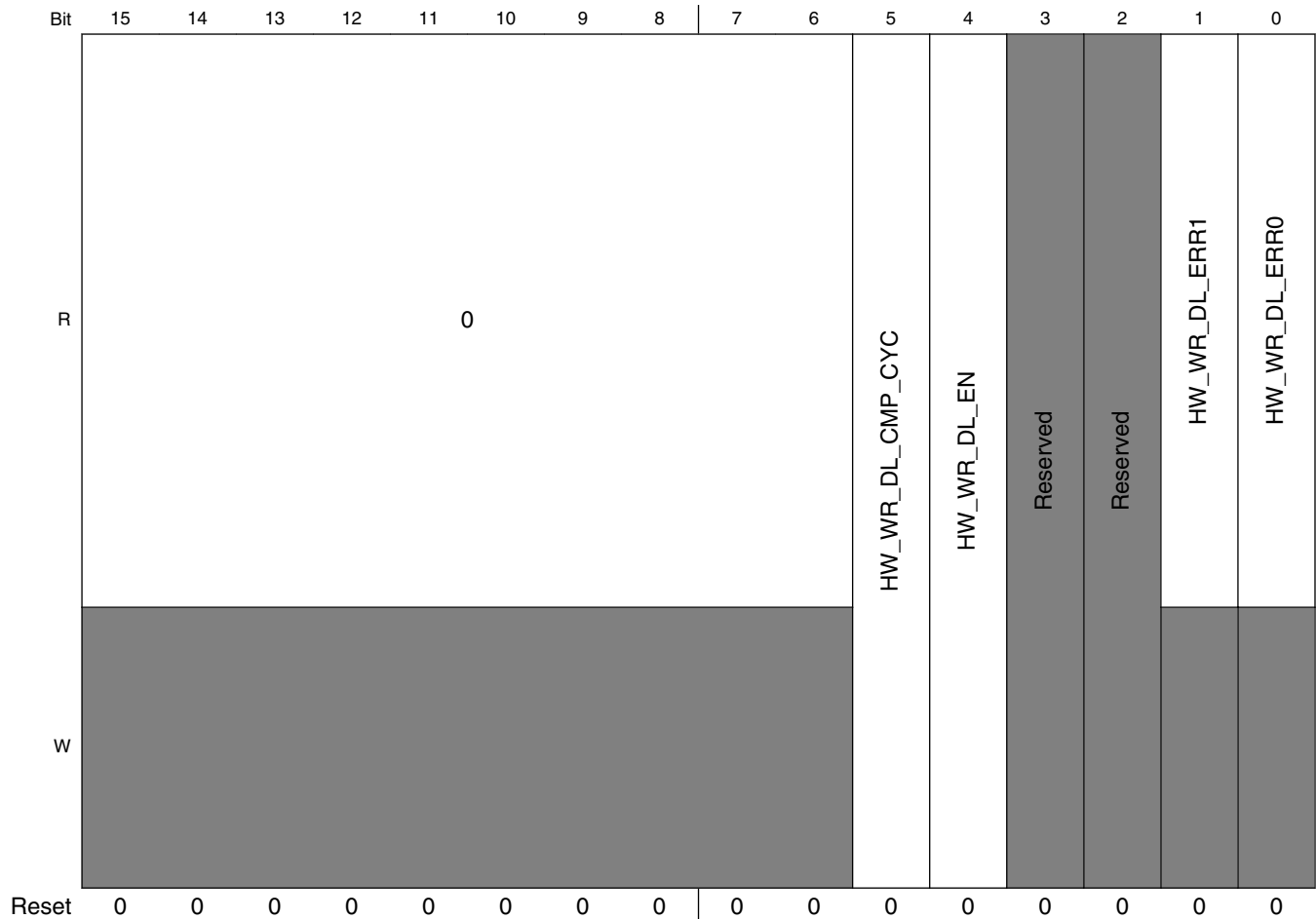

MMDC_MPWRDLHWCTL field descriptions

Field	Description
31–6 Reserved	This read-only field is reserved and always has the value 0.
5 HW_WR_DL_CMP_CYC	Write sample cycle. If this bit is asserted then the MMDC will compare the data 32 cycles after the MMDC sent the read command enable pulse else it compares the data after 16 cycles.
4 HW_WR_DL_EN	Enable automatic (HW) write calibration. If this bit is asserted then the MMDC will perform an automatic write calibration. HW should negate this bit upon completion of the calibration. Negation of this bit also indicates that the write calibration results are valid NOTE: Before issuing the first read command MMDC counts 12 cycles.
3 -	This field is reserved. Reserved
2 -	This field is reserved. Reserved
1 HW_WR_DL_ERR1	Automatic (HW) write calibration error of Byte1. If this bit is asserted then it indicates that an error was found during the HW calibration process of write delay-line 1. In case this bit is zero at the end of the calibration process then the boundary results can be found at MPWRDLHWST0 register. This bit is valid only after HW_WR_DL_EN is de-asserted.

Table continues on the next page...

MMDC_MPWRDLHWCTL field descriptions (continued)

Field	Description
	0 No error was found during the automatic (HW) write calibration process of write delay-line 1. 1 An error was found during the automatic (HW) write calibration process of write delay-line 1.
0 HW_WR_DL_ERR0	Automatic (HW) write calibration error of Byte0. If this bit is asserted then it indicates that an error was found during the HW calibration process of write delay-line 0. In case this bit is zero at the end of the calibration process then the boundary results can be found at MPWRDLHWST0 register. This bit is valid only after HW_WR_DL_EN is de-asserted. 0 No error was found during the automatic (HW) write calibration process of write delay-line 0. 1 An error was found during the automatic (HW) write calibration process of write delay-line 0.

35.12.55 MMDC PHY Read Delay HW Calibration Status Register 0 (MMDC_MPRDDLHWST0)

Address: 21B_0000h base + 868h offset = 21B_0868h

Bit	31	30	29	28	27	26	25	24	23	22	21	20	19	18	17	16
R	0	HW_RD_DL_UP1							0	HW_RD_DL_LOW1						
W																
Reset	0	0	0	0	0	0	0	0	0	0	0	0	0	0	0	0
Bit	15	14	13	12	11	10	9	8	7	6	5	4	3	2	1	0
R	0	HW_RD_DL_UP0							0	HW_RD_DL_LOW0						
W																
Reset	0	0	0	0	0	0	0	0	0	0	0	0	0	0	0	0

MMDC_MPRDDLHWST0 field descriptions

Field	Description
31 Reserved	This read-only field is reserved and always has the value 0.
30–24 HW_RD_DL_UP1	Automatic (HW) read calibration result of the upper boundary of Byte1. This field holds the automatic (HW) read calibration result of the upper boundary of Byte1
23 Reserved	This read-only field is reserved and always has the value 0.
22–16 HW_RD_DL_LOW1	Automatic (HW) read calibration result of the lower boundary of Byte1. This field holds the automatic (HW) read calibration result of the lower boundary of Byte1
15 Reserved	This read-only field is reserved and always has the value 0.
14–8 HW_RD_DL_UP0	Automatic (HW) read calibration result of the upper boundary of Byte0. This field holds the automatic (HW) read calibration result of the upper boundary of Byte0.
7 Reserved	This read-only field is reserved and always has the value 0.

Table continues on the next page...

MMDC_MPRDDLHWST0 field descriptions (continued)

Field	Description
HW_RD_DL_LOW0	Automatic (HW) read calibration result of the lower boundary of Byte0. This field holds the automatic (HW) read calibration result of the lower boundary of Byte0.

35.12.56 MMDC PHY Write Delay HW Calibration Status Register 0 (MMDC_MPWRDLHWST0)

Address: 21B_0000h base + 870h offset = 21B_0870h

Bit	31	30	29	28	27	26	25	24	23	22	21	20	19	18	17	16
R	0	HW_WR_DL_UP1							0	HW_WR_DL_LOW1						
W	[Reserved]															
Reset	0	0	0	0	0	0	0	0	0	0	0	0	0	0	0	0
Bit	15	14	13	12	11	10	9	8	7	6	5	4	3	2	1	0
R	0	HW_WR_DL_UP0							0	HW_WR_DL_LOW0						
W	[Reserved]															
Reset	0	0	0	0	0	0	0	0	0	0	0	0	0	0	0	0

MMDC_MPWRDLHWST0 field descriptions

Field	Description
31 Reserved	This read-only field is reserved and always has the value 0.
30–24 HW_WR_DL_UP1	Automatic (HW) write automatic (HW) write calibration result of the upper boundary of Byte1. This field holds the automatic (HW) write calibration result of the upper boundary of Byte1.
23 Reserved	This read-only field is reserved and always has the value 0.
22–16 HW_WR_DL_LOW1	Automatic (HW) write calibration result of the lower boundary of Byte1. This field holds the automatic (HW) write calibration result of the lower boundary of Byte1.
15 Reserved	This read-only field is reserved and always has the value 0.
14–8 HW_WR_DL_UP0	Automatic (HW) write calibration result of the upper boundary of Byte0. This field holds the automatic (HW) write calibration result of the upper boundary of Byte0.
7 Reserved	This read-only field is reserved and always has the value 0.
HW_WR_DL_LOW0	Automatic (HW) write calibration result of the lower boundary of Byte0. This field holds the automatic (HW) write calibration result of the lower boundary of Byte0.

35.12.57 MMDC PHY Write Leveling HW Error Register (MMDC_MPWLHWERR)

Address: 21B_0000h base + 878h offset = 21B_0878h

Bit	31	30	29	28	27	26	25	24	23	22	21	20	19	18	17	16	15	14	13	12	11	10	9	8	7	6	5	4	3	2	1	0
R	Reserved								Reserved								HW_WL1_DQ								HW_WL0_DQ							
W	Reserved								Reserved								Reserved								Reserved							
Reset	0	0	0	0	0	0	0	0	0	0	0	0	0	0	0	0	0	0	0	0	0	0	0	0	0	0	0	0	0	0	0	0

MMDC_MPWLHWERR field descriptions

Field	Description
31–24 -	This field is reserved. Reserved
23–16 -	This field is reserved. Reserved
15–8 HW_WL1_DQ	HW write-leveling calibration result of Byte1. This field holds the results for all the 8 write-leveling steps of Byte1. i.e. bit 0 holds the result of the write-leveling calibration of 0 delay, bit 1 holds the result of the write-leveling calibration of 1/8delay till bit 7 that holds the result of the write-leveling calibration of 7/8 delay
HW_WL0_DQ	HW write-leveling calibration result of Byte0. This field holds the results for all the 8 write-leveling steps of Byte0. i.e. bit 0 holds the result of the write-leveling calibration of 0 delay, bit 1 holds the result of the write-leveling calibration of 1/8delay till bit 7 that holds the result of the write-leveling calibration of 7/8 delay

35.12.58 MMDC PHY Read DQS Gating HW Status Register 0 (MMDC_MPDGHWST0)

Address: 21B_0000h base + 87Ch offset = 21B_087Ch

Bit	31	30	29	28	27	26	25	24	23	22	21	20	19	18	17	16	15	14	13	12	11	10	9	8	7	6	5	4	3	2	1	0
R	Reserved								HW_DG_UP0								Reserved								HW_DG_LOW0							
W	Reserved								Reserved								Reserved								Reserved							
Reset	0	0	0	0	0	0	0	0	0	0	0	0	0	0	0	0	0	0	0	0	0	0	0	0	0	0	0	0	0	0	0	0

MMDC_MPDGHWST0 field descriptions

Field	Description
31–27 -	This field is reserved. Reserved
26–16 HW_DG_UP0	HW DQS gating calibration result of the upper boundary of Byte0. This field holds the HW DQS gating calibration result of the upper boundary of Byte0.
15–11 -	This field is reserved. Reserved
HW_DG_LOW0	HW DQS gating calibration result of the lower boundary of Byte0. This field holds the HW DQS gating calibration result of the lower boundary of Byte0.

35.12.59 MMDC PHY Read DQS Gating HW Status Register 1 (MMDC_MPDGHWST1)

Address: 21B_0000h base + 880h offset = 21B_0880h

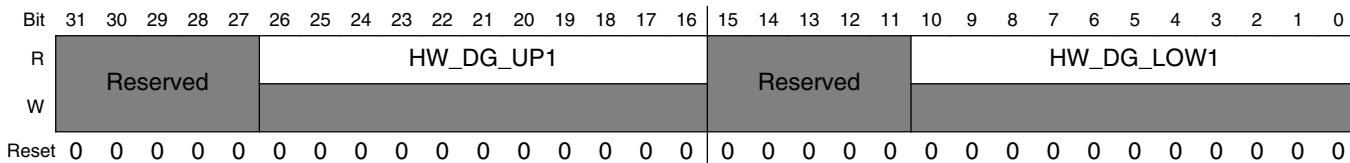

MMDC_MPDGHWST1 field descriptions

Field	Description
31–27 -	This field is reserved. Reserved
26–16 HW_DG_UP1	HW DQS gating calibration result of the upper boundary of Byte1. This field holds the HW DQS gating calibration result of the upper boundary of Byte1.
15–11 -	This field is reserved. Reserved
HW_DG_LOW1	HW DQS gating calibration result of the lower boundary of Byte1. This field holds the HW DQS gating calibration result of the lower boundary of Byte1.

35.12.60 MMDC PHY Read DQS Gating HW Status Register 2 (MMDC_MPDGHWST2)

Address: 21B_0000h base + 884h offset = 21B_0884h

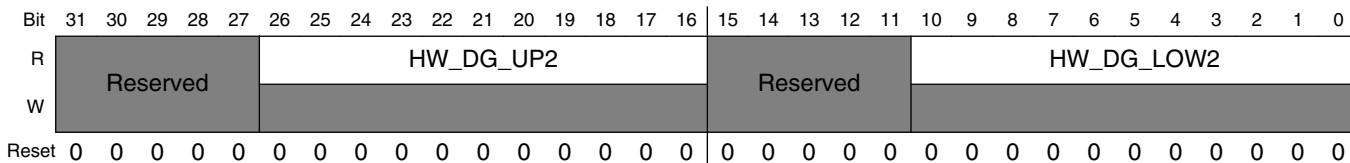

MMDC_MPDGHWST2 field descriptions

Field	Description
31–27 -	This field is reserved. Reserved
26–16 HW_DG_UP2	HW DQS gating calibration result of the upper boundary of Byte2. This field holds the HW DQS gating calibration result of the upper boundary of Byte2.
15–11 -	This field is reserved. Reserved
HW_DG_LOW2	HW DQS gating calibration result of the lower boundary of Byte2. This field holds the HW DQS gating calibration result of the lower boundary of Byte2.

35.12.61 MMDC PHY Read DQS Gating HW Status Register 3 (MMDC_MPDGHWST3)

Address: 21B_0000h base + 888h offset = 21B_0888h

Bit	31	30	29	28	27	26	25	24	23	22	21	20	19	18	17	16	15	14	13	12	11	10	9	8	7	6	5	4	3	2	1	0
R	Reserved				HW_DG_UP3								Reserved				HW_DG_LOW3															
W	Reserved																Reserved															
Reset	0	0	0	0	0	0	0	0	0	0	0	0	0	0	0	0	0	0	0	0	0	0	0	0	0	0	0	0	0	0	0	0

MMDC_MPDGHWST3 field descriptions

Field	Description
31–27 -	This field is reserved. Reserved
26–16 HW_DG_UP3	HW DQS gating calibration result of the upper boundary of Byte3. This field holds the HW DQS gating calibration result of the upper boundary of Byte3.
15–11 -	This field is reserved. Reserved
HW_DG_LOW3	HW DQS gating calibration result of the lower boundary of Byte3. This field holds the HW DQS gating calibration result of the lower boundary of Byte3.

35.12.62 MMDC PHY Pre-defined Compare Register 1 (MMDC_MPPDCMPR1)

This register holds the MMDC pre-defined compare value that will be used during automatic read, read DQS gating and write calibration process. The compare value can be the MPR value (as defined in the JEDEC) or can be programmed by the PDV1 and PDV2 fields. In case of DDR3 (BL=8) the MMDC will duplicate PDV1, PDV2 and drive that data on Beat4-7 of the same byte.

Address: 21B_0000h base + 88Ch offset = 21B_088Ch

Bit	31	30	29	28	27	26	25	24	23	22	21	20	19	18	17	16	15	14	13	12	11	10	9	8	7	6	5	4	3	2	1	0
R	PDV2																PDV1															
W	Reserved																															
Reset	0	0	0	0	0	0	0	0	0	0	0	0	0	0	0	0	0	0	0	0	0	0	0	0	0	0	0	0	0	0	0	0

MMDC_MPPDCMPR1 field descriptions

Field	Description
31–16 PDV2	MMDC Pre defined compare value2. This field holds the 2 MSB of the data that will be driven to the DDR device during automatic read, read DQS gating and write calibrations in case MPR(DDR3)/ DQ calibration

Table continues on the next page...

MMDC_MPPDCMPR1 field descriptions (continued)

Field	Description
	<p>(LPDDR2/LPDDR3) mode are disabled (MPR_CMP is disabled). Upon read access during the calibration the MMDC will compare the read data with the data that is stored in this field.</p> <p>NOTE: Before issue the read access the MMDC will invert the value of this field and drive it to the associate entry in the read comparison FIFO. For further information see Section 19.14.3.1.2, "Calibration with pre-defined value", Section 19.14.4.1.2, "Calibration with pre-defined value and Section 19.14.5.1, "HW (automatic) Write Calibration</p>
PDV1	<p>MMDC Pre defined compare value2. This field holds the 2 LSB of the data that will be driven to the DDR device during automatic read, read DQS gating and write calibrations in case MPR(DDR3)/ DQ calibration (LPDDR2/LPDDR3) mode are disabled (MPR_CMP is disabled). Upon read access during the calibration the MMDC will compare the read data with the data that is stored in this field.</p> <p>NOTE: Before issuing the read access, the MMDC will invert the value of this field and drive it to the associated entry in the read comparison FIFO.</p>

35.12.63 MMDC PHY Pre-defined Compare and CA delay-line Configuration Register (MMDC_MPPDCMPR2)

Address: 21B_0000h base + 890h offset = 21B_0890h

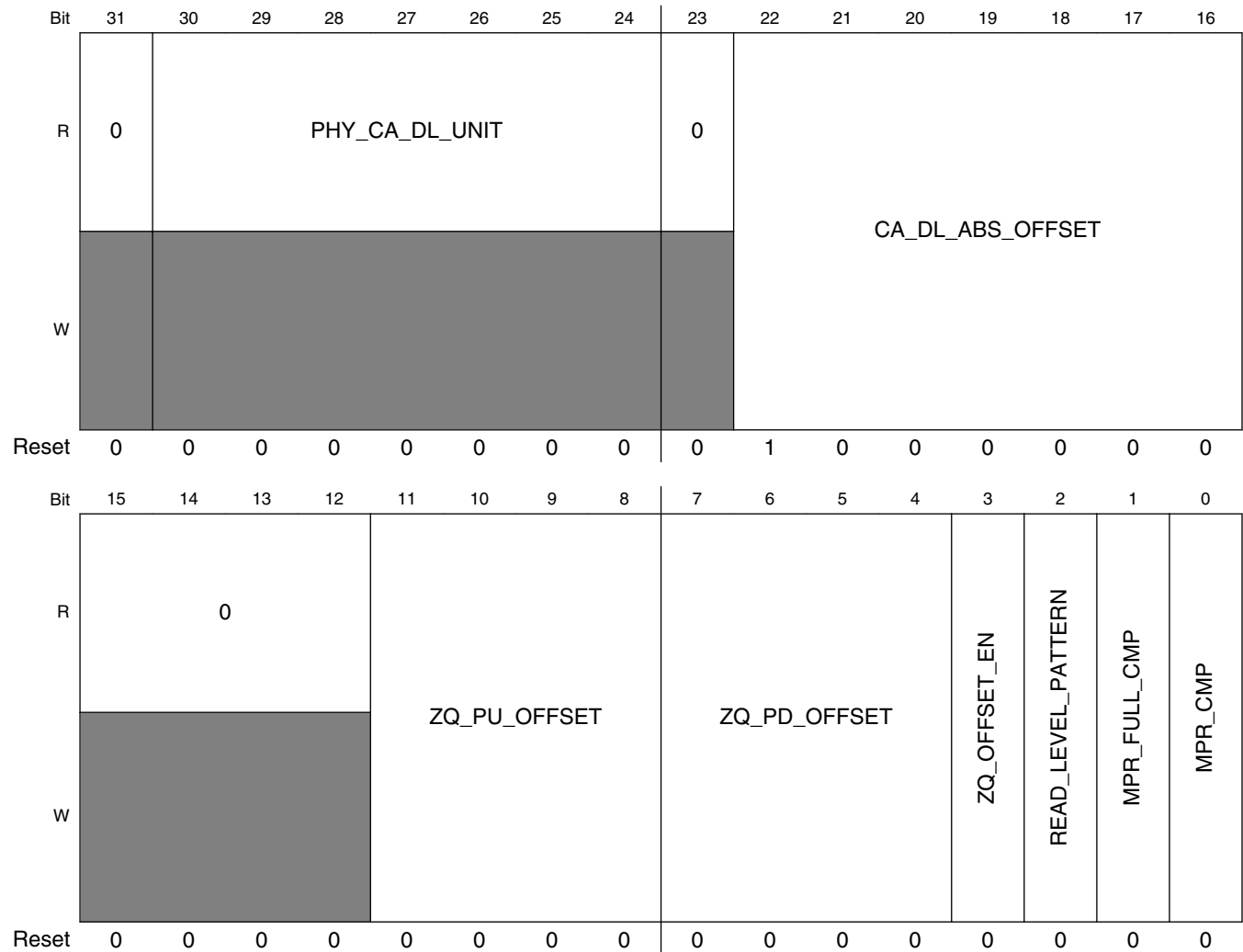

MMDC_MPPDCMPR2 field descriptions

Field	Description
31 Reserved	This read-only field is reserved and always has the value 0.
30–24 PHY_CA_DL_UNIT	This field reflects the number of delay units that are actually used by CA(Command/Address of LPDDR2) delay-line
23 Reserved	This read-only field is reserved and always has the value 0.

Table continues on the next page...

MMDC_MPPDCMPR2 field descriptions (continued)

Field	Description
22–16 CA_DL_ABS_OFFSET	Absolute CA (Command/Address of LPDDR2) offset. This field indicates the absolute delay between CA (Command/Address) bus and the DDR clock (CK) with fractions of a clock period and up to half cycle. The fraction is process and frequency independent. The delay of the delay-line would be $(CA_DL_ABS_OFFSET / 256) * MMDC\ AXI\ clock\ (fast\ clock)$. So for the default value of 64 we get a quarter cycle delay.
15–12 Reserved	This read-only field is reserved and always has the value 0.
11–8 ZQ_PU_OFFSET	<p>Programmable offset from -7 to 7 added to the MMDC_MPZQHWCTRL[ZQ_HW_PU_RES] field when ZQ_OFFSET_EN is enabled.</p> <p>Bit[11] determines direction: 'b0 = Offset is added to ZQ_HW_PU_RES field 'b1 = Offset is subtracted from ZQ_HW_PU_RES field</p> <p>Bits[10:8] = Amount of change to apply.</p> <p>0000 0 — Offset is added to ZQ_HW_PU_RES field 0001 1 — Offset is added to ZQ_HW_PU_RES field 0010 2 — Offset is added to ZQ_HW_PU_RES field 0011 3 — Offset is added to ZQ_HW_PU_RES field 0100 4 — Offset is added to ZQ_HW_PU_RES field 0101 5 — Offset is added to ZQ_HW_PU_RES field 0110 6 — Offset is added to ZQ_HW_PU_RES field 0111 7 — Offset is added to ZQ_HW_PU_RES field 1000 0 — Offset is subtracted from ZQ_HW_PU_RES field 1001 1 — Offset is subtracted from ZQ_HW_PU_RES field 1010 2 — Offset is subtracted from ZQ_HW_PU_RES field 1011 3 — Offset is subtracted from ZQ_HW_PU_RES field 1100 4 — Offset is subtracted from ZQ_HW_PU_RES field 1101 5 — Offset is subtracted from ZQ_HW_PU_RES field 1110 6 — Offset is subtracted from ZQ_HW_PU_RES field 1111 7 — Offset is subtracted from ZQ_HW_PU_RES field</p>
7–4 ZQ_PD_OFFSET	<p>Programmable offset from -7 to 7 added to the MMDC_MPZQHWCTRL[ZQ_HW_PD_RES] field when ZQ_OFFSET_EN is enabled.</p> <p>Bit[7] determines direction: 'b0 = Offset is added to ZQ_HW_PD_RES field 'b1 = Offset is subtracted from ZQ_HW_PD_RES field</p> <p>Bits[6:4] = Amount of change to apply.</p> <p>0000 0 — Offset is added to ZQ_HW_PD_RES field 0001 1 — Offset is added to ZQ_HW_PD_RES field 0010 2 — Offset is added to ZQ_HW_PD_RES field 0011 3 — Offset is added to ZQ_HW_PD_RES field 0100 4 — Offset is added to ZQ_HW_PD_RES field 0101 5 — Offset is added to ZQ_HW_PD_RES field 0110 6 — Offset is added to ZQ_HW_PD_RES field 0111 7 — Offset is added to ZQ_HW_PD_RES field 1000 0 — Offset is subtracted from ZQ_HW_PD_RES field</p>

Table continues on the next page...

MMDC_MPPDCMPR2 field descriptions (continued)

Field	Description
	1001 1 — Offset is subtracted from ZQ_HW_PD_RES field 1010 2 — Offset is subtracted from ZQ_HW_PD_RES field 1011 3 — Offset is subtracted from ZQ_HW_PD_RES field 1100 4 — Offset is subtracted from ZQ_HW_PD_RES field 1101 5 — Offset is subtracted from ZQ_HW_PD_RES field 1110 6 — Offset is subtracted from ZQ_HW_PD_RES field 1111 7 — Offset is subtracted from ZQ_HW_PD_RES field
3 ZQ_OFFSET_EN	0 Hardware ZQ offset disabled 1 Hardware ZQ offset enabled
2 READ_LEVEL_PATTERN	MPR(DDR3)/ DQ calibration (LPDDR2/LPDDR3) read compare pattern. In case MPR(DDR3)/ DQ calibration (LPDDR2/LPDDR3) modes are used during the calibration process (MPR_CMP is asserted) then this field indicates the read pattern for the comparison. 0 Compare with read pattern 1010 1 Compare with read pattern 0011 (Used only in LPDDR2/LPDDR3 mode)
1 MPR_FULL_CMP	MPR(DDR3)/ DQ calibration (LPDDR2/LPDDR3) full compare enable. In case MPR(DDR3)/ DQ calibration (LPDDR2/LPDDR3) modes are used during the calibration process (MPR_CMP is asserted) then this field indicates whether the MMDC will compare all the bits of the data that is read from the DDR device to the MPR pre-defined pattern. When this bit is de-asserted only LSB of each byte is compared.
0 MPR_CMP	MPR(DDR3)/ DQ calibration (LPDDR2/LPDDR3) compare enable. This bit indicates whether the MMDC will compare the read data during automatic read and read DQS calibration processes to the pre-defined patterns that are driven by the DDR device (READ_LEVEL_PATTERN as defined by JEDEC) or general pre-defined value that are stored in PDV1 and PDV2. When this bit is disabled data is compared to the data of the pre defined compare value field For further information see Read DQS Gating Calibration and Read Calibration .

35.12.64 MMDC PHY SW Dummy Access Register (MMDC_MPSWDAR0)

Address: 21B_0000h base + 894h offset = 21B_0894h

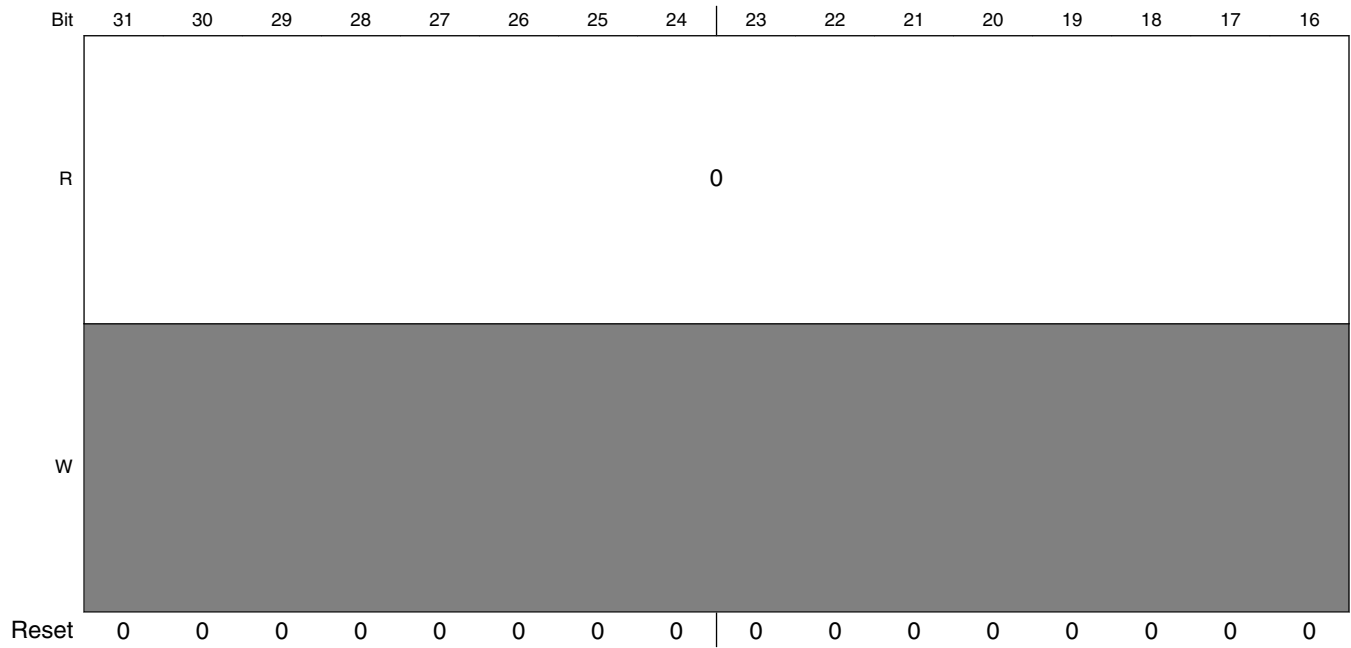

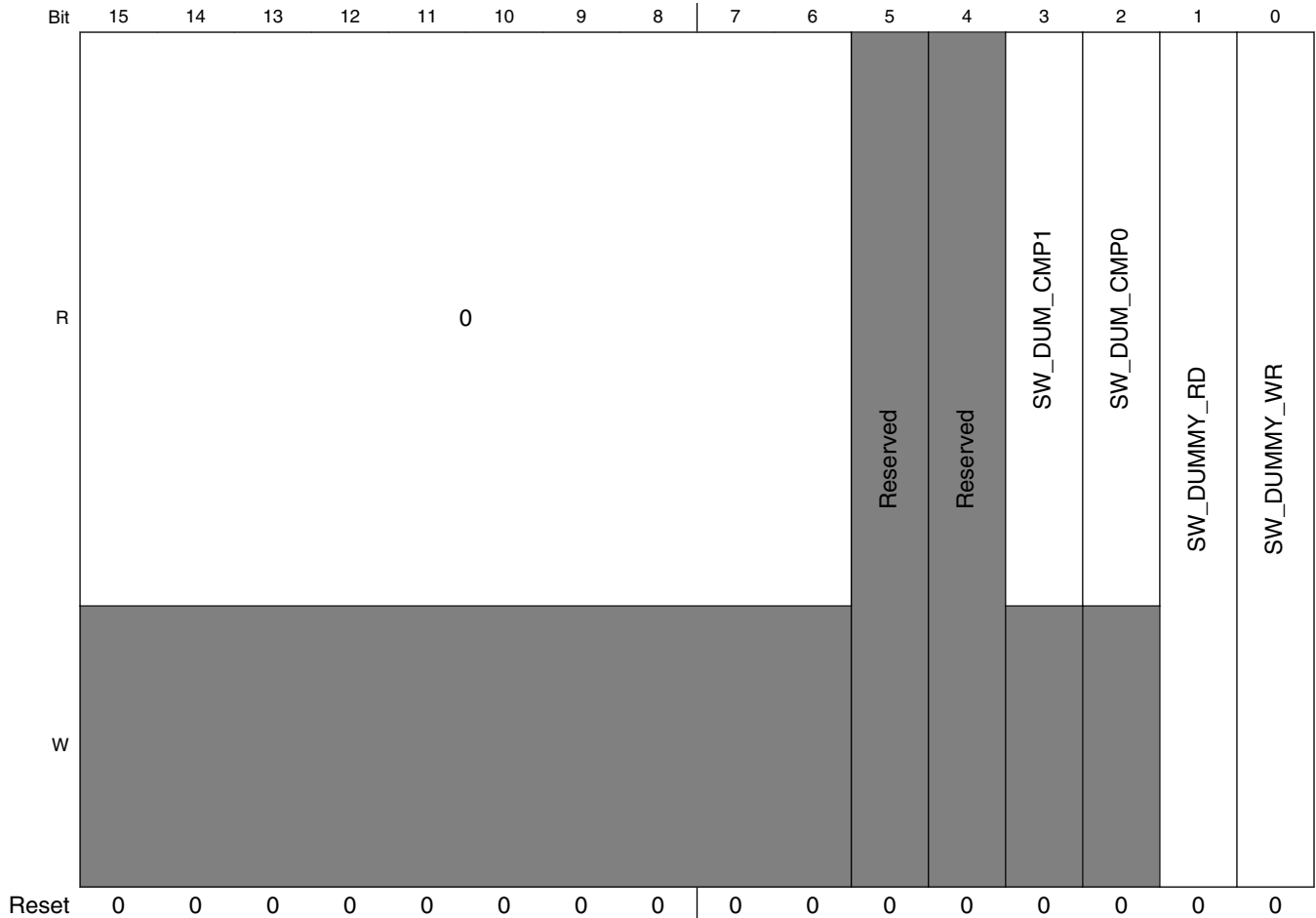

MMDC_MPSWDAR0 field descriptions

Field	Description
31–6 Reserved	This read-only field is reserved and always has the value 0.
5 -	This field is reserved. Reserved
4 -	This field is reserved. Reserved
3 SW_DUM_CMP1	SW dummy read byte1 compare results. This bit indicates the result of the read data comparison of Byte1 at the completion of SW_DUMMY_RD. This bit is valid only when SW_DUMMY_RD is de-asserted. 0 Dummy read fail 1 Dummy read pass
2 SW_DUM_CMP0	SW dummy read byte0 compare results. This bit indicates the result of the read data comparison of Byte0 at the completion of SW_DUMMY_RD. This bit is valid only when SW_DUMMY_RD is de-asserted. 0 Dummy read fail 1 Dummy read pass
1 SW_DUMMY_RD	SW dummy read. When this bit is asserted the MMDC will generate internally read access without intervention of the system toward bank 0, row 0, column 0. If MPR_CMP = 1 then the read data will be compared to MPPDCMPR2[READ_LEVEL_PATTERN] . If MPR_CMP =0 then the read data will be

Table continues on the next page...

MMDC_MPSWDAR0 field descriptions (continued)

Field	Description
	compared to MPPDCMPR1[PDV1], MPPDCMPR1[PDV2]. Upon completion of the access this bit is de-asserted automatically and the read data and comparison results are valid at MPSWDAR0[SW_DUM_CMP#] and MPSWDRDR0-MPSWDRDR7 respectively.
0 SW_DUMMY_ WR	SW dummy write. When this bit is asserted the MMDC will generate internally write access without intervention of the system toward bank 0, row 0, column 0, while the data is driven from MPPDCMPR1[PDV1] and MPPDCMPR1[PDV2]. The bit is de-asserted automatically upon completion of the access.

35.12.65 MMDC PHY SW Dummy Read Data Register 0 (MMDC_MPSWDRDR0)

Address: 21B_0000h base + 898h offset = 21B_0898h

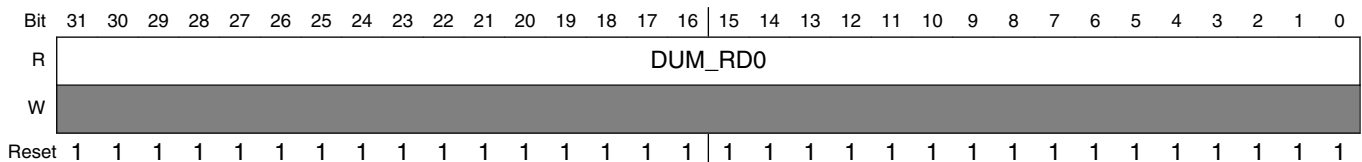

MMDC_MPSWDRDR0 field descriptions

Field	Description
DUM_RD0	Dummy read data0. This field holds the first data that is read from the DDR during SW dummy read access (i.e. when SW_DUMMY_RD = 1). This field is valid only when SW_DUMMY_RD is de-asserted

35.12.66 MMDC PHY SW Dummy Read Data Register 1 (MMDC_MPSWDRDR1)

Address: 21B_0000h base + 89Ch offset = 21B_089Ch

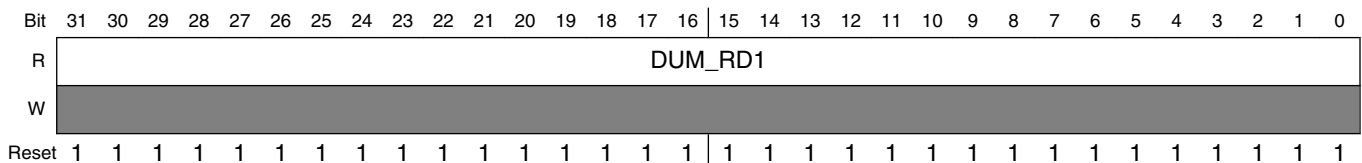

MMDC_MPSWDRDR1 field descriptions

Field	Description
DUM_RD1	Dummy read data1. This field holds the second data that is read from the DDR during SW dummy read access (i.e. when SW_DUMMY_RD = 1). This field is valid only when SW_DUMMY_RD is de-asserted

35.12.67 MMDC PHY SW Dummy Read Data Register 2 (MMDC_MPSWDRDR2)

Address: 21B_0000h base + 8A0h offset = 21B_08A0h

Bit	31	30	29	28	27	26	25	24	23	22	21	20	19	18	17	16	15	14	13	12	11	10	9	8	7	6	5	4	3	2	1	0
R	DUM_RD2																															
W																																
Reset	1	1	1	1	1	1	1	1	1	1	1	1	1	1	1	1	1	1	1	1	1	1	1	1	1	1	1	1	1	1	1	1

MMDC_MPSWDRDR2 field descriptions

Field	Description
DUM_RD2	Dummy read data2. This field holds the third data that is read from the DDR during SW dummy read access (i.e. when SW_DUMMY_RD = 1). This field is valid only when SW_DUMMY_RD is de-asserted.

35.12.68 MMDC PHY SW Dummy Read Data Register 3 (MMDC_MPSWDRDR3)

Address: 21B_0000h base + 8A4h offset = 21B_08A4h

Bit	31	30	29	28	27	26	25	24	23	22	21	20	19	18	17	16	15	14	13	12	11	10	9	8	7	6	5	4	3	2	1	0
R	DUM_RD3																															
W																																
Reset	1	1	1	1	1	1	1	1	1	1	1	1	1	1	1	1	1	1	1	1	1	1	1	1	1	1	1	1	1	1	1	1

MMDC_MPSWDRDR3 field descriptions

Field	Description
DUM_RD3	Dummy read data3. This field holds the fourth data that is read from the DDR during SW dummy read access (i.e. when SW_DUMMY_RD = 1). This field is valid only when SW_DUMMY_RD is de-asserted.

35.12.69 MMDC PHY SW Dummy Read Data Register 4 (MMDC_MPSWDRDR4)

Address: 21B_0000h base + 8A8h offset = 21B_08A8h

Bit	31	30	29	28	27	26	25	24	23	22	21	20	19	18	17	16	15	14	13	12	11	10	9	8	7	6	5	4	3	2	1	0
R	DUM_RD4																															
W																																
Reset	1	1	1	1	1	1	1	1	1	1	1	1	1	1	1	1	1	1	1	1	1	1	1	1	1	1	1	1	1	1	1	1

MMDC_MPSWDRDR4 field descriptions

Field	Description
DUM_RD4	Dummy read data4. This field holds the fifth data (only in case of burst length 8 (BL =1)) that is read from the DDR during SW dummy read access (i.e. when SW_DUMMY_RD = 1). This field is valid only when SW_DUMMY_RD is de-asserted.

35.12.70 MMDC PHY SW Dummy Read Data Register 5 (MMDC_MPSWDRDR5)

Address: 21B_0000h base + 8ACh offset = 21B_08ACh

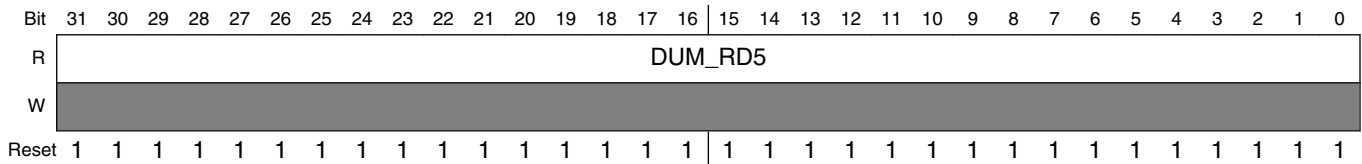

MMDC_MPSWDRDR5 field descriptions

Field	Description
DUM_RD5	Dummy read data5. This field holds the sixth data (only in case of burst length 8 (BL =1)) that is read from the DDR during SW dummy read access (i.e. when SW_DUMMY_RD = 1). This field is valid only when SW_DUMMY_RD is de-asserted.

35.12.71 MMDC PHY SW Dummy Read Data Register 6 (MMDC_MPSWDRDR6)

Address: 21B_0000h base + 8B0h offset = 21B_08B0h

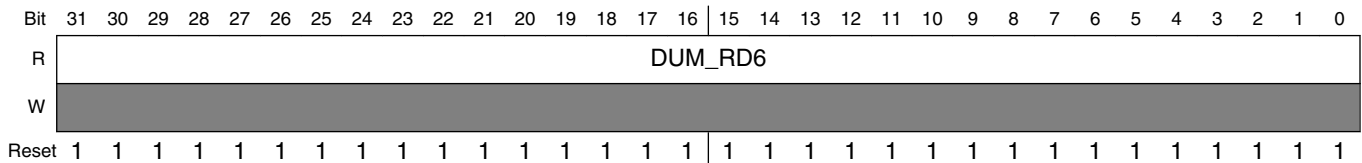

MMDC_MPSWDRDR6 field descriptions

Field	Description
DUM_RD6	Dummy read data6. This field holds the seventh data (only in case of burst length 8 (BL =1)) that is read from the DDR during SW dummy read access (i.e. when SW_DUMMY_RD = 1). This field is valid only when SW_DUMMY_RD is de-asserted.

35.12.72 MMDC PHY SW Dummy Read Data Register 7 (MMDC_MPSWDRDR7)

Address: 21B_0000h base + 8B4h offset = 21B_08B4h

Bit	31	30	29	28	27	26	25	24	23	22	21	20	19	18	17	16	15	14	13	12	11	10	9	8	7	6	5	4	3	2	1	0
R	DUM_RD7																															
W																																
Reset	1	1	1	1	1	1	1	1	1	1	1	1	1	1	1	1	1	1	1	1	1	1	1	1	1	1	1	1	1	1	1	1

MMDC_MPSWDRDR7 field descriptions

Field	Description
DUM_RD7	Dummy read data7. This field holds the eight data (only in case of burst length 8 (BL = 1)) that is read from the DDR during SW dummy read access (i.e. when SW_DUMMY_RD = 1). This field is valid only when SW_DUMMY_RD is de-asserted.

35.12.73 MMDC PHY Measure Unit Register (MMDC_MPMUR0)

Address: 21B_0000h base + 8B8h offset = 21B_08B8h

Bit	31	30	29	28	27	26	25	24	23	22	21	20	19	18	17	16
R	0								MU_UNIT_DEL_NUM							
W																
Reset	0	0	0	0	0	0	0	0	0	0	0	0	0	0	0	0
Bit	15	14	13	12	11	10	9	8	7	6	5	4	3	2	1	0
R	0				FRC_MSR	MU_BYP_EN	MU_BYP_VAL									
W																
Reset	0	0	0	0	0	0	0	0	0	0	0	0	0	0	0	0

MMDC_MPMUR0 field descriptions

Field	Description
31–26 Reserved	This read-only field is reserved and always has the value 0.
25–16 MU_UNIT_DEL_NUM	Number of delay units measured per cycle. This field is used in debug mode and holds the number of delay units that were measured by the measure unit per DDR clock cycle. The delay-lines that are used in every calibration process use that number for generating the desired delay.
15–12 Reserved	This read-only field is reserved and always has the value 0.
11 FRC_MSR	Force measurement on delay-lines. When this bit is asserted then a measurement process will be performed, where at the completion of the process the delay-lines will issue the desired delay. Upon completion of the measurement process the measure unit and the delay-lines will return to functional mode. This bit is self cleared.

Table continues on the next page...

MMDC_MPMUR0 field descriptions (continued)

Field	Description
	<p>NOTE: This bit should be used only during manual (SW) calibration and not while the DDR is functional (being accessed). After initial calibration is done the hardware performs periodic measurements to track any operating conditions changes. Hence, force measurements (FRC_MSR) should not be used. See Calibration Process for more information.</p> <p>NOTE: User should make sure that there is no active accesses to/from DDR before asserting this bit.</p> <p>0 No measurement is performed 1 Perform measurement process</p>
10 MU_BYP_EN	<p>Measure unit bypass enable. This field is used in debug mode and when it is asserted then the delay-lines will use the number of delay units that are indicated at MU_BYP_VAL, otherwise the delay-lines will use the number of delay units that was measured by the measurement unit and are indicated at MU_UNIT_DEL_NUM</p> <p>0 The delay-lines use delay units as indicated at MU_UNIT_DEL_NUM. 1 The delay-lines use delay units as indicated at MU_BYPASS_VAL.</p>
MU_BYP_VAL	<p>Number of delay units for measurement bypass. This field is used in debug mode and holds the number of delay units that will be used by the delay-lines when MU_BYP_EN is asserted.</p>

35.12.74 MMDC Write CA delay-line controller (MMDC_MPWRCADL)

This register is used to add fine-tuning adjustment to the CA (command/Address of LPDDR2 bus) relative to the DDR clock.

Address: 21B_0000h base + 8BCh offset = 21B_08BCh

Bit	31	30	29	28	27	26	25	24	23	22	21	20	19	18	17	16
R	0												WR_CA9_	WR_CA8_		
W													DEL	DEL		
Reset	0	0	0	0	0	0	0	0	0	0	0	0	0	0	0	0
Bit	15	14	13	12	11	10	9	8	7	6	5	4	3	2	1	0
R	WR_CA7_	WR_CA6_	WR_CA5_	WR_CA4_	WR_CA3_	WR_CA2_	WR_CA1_	WR_CA0_								
W	DEL	DEL	DEL	DEL	DEL	DEL	DEL	DEL								
Reset	0	0	0	0	0	0	0	0	0	0	0	0	0	0	0	0

MMDC_MPWRCADL field descriptions

Field	Description
31–20 Reserved	This read-only field is reserved and always has the value 0.
19–18 WR_CA9_DEL	CA (Command/Address LPDDR2 bus) bit 9 delay fine tuning. This field holds the number of delay units that are added to CA (Command/Address bus) bit 9 relative to the clock.

Table continues on the next page...

MMDC_MPWRCADL field descriptions (continued)

Field	Description
	00 No change in CA9 delay 01 Add CA9 delay of 1 delay unit 10 Add CA9 delay of 2 delay units. 11 Add CA9 delay of 3 delay units.
17–16 WR_CA8_DEL	CA (Command/Address LPDDR2 bus) bit 8 delay fine tuning. This field holds the number of delay units that are added to CA (Command/Address bus) bit 8 relative to the clock. 00 No change in CA8 delay 01 Add CA8 delay of 1 delay unit 10 Add CA8 delay of 2 delay units. 11 Add CA8 delay of 3 delay units.
15–14 WR_CA7_DEL	CA (Command/Address LPDDR2 bus) bit 7 delay fine tuning. This field holds the number of delay units that are added to CA (Command/Address bus) bit 7 relative to the clock. 00 No change in CA7 delay 01 Add CA7 delay of 1 delay unit 10 Add CA7 delay of 2 delay units. 11 Add CA7 delay of 3 delay units.
13–12 WR_CA6_DEL	CA (Command/Address LPDDR2 bus) bit 6 delay fine tuning. This field holds the number of delay units that are added to CA (Command/Address bus) bit 6 relative to the clock. 00 No change in CA6 delay 01 Add CA6 delay of 1 delay unit 10 Add CA6 delay of 2 delay units. 11 Add CA6 delay of 3 delay units.
11–10 WR_CA5_DEL	CA (Command/Address LPDDR2 bus) bit 5 delay fine tuning. This field holds the number of delay units that are added to CA (Command/Address bus) bit 5 relative to the clock. 00 No change in CA5 delay 01 Add CA5 delay of 1 delay unit 10 Add CA5 delay of 2 delay units. 11 Add CA5 delay of 3 delay units.
9–8 WR_CA4_DEL	CA (Command/Address LPDDR2 bus) bit 4 delay fine tuning. This field holds the number of delay units that are added to CA (Command/Address bus) bit 4 relative to the clock. 00 No change in CA4 delay 01 Add CA4 delay of 1 delay unit 10 Add CA4 delay of 2 delay units. 11 Add CA4 delay of 3 delay units.
7–6 WR_CA3_DEL	CA (Command/Address LPDDR2 bus) bit 3 delay fine tuning. This field holds the number of delay units that are added to CA (Command/Address bus) bit 3 relative to the clock. 00 No change in CA3 delay 01 Add CA3 delay of 1 delay unit 10 Add CA3 delay of 2 delay units. 11 Add CA3 delay of 3 delay units.
5–4 WR_CA2_DEL	CA (Command/Address LPDDR2 bus) bit 2 delay fine tuning. This field holds the number of delay units that are added to CA (Command/Address bus) bit 2 relative to the clock.

Table continues on the next page...

MMDC_MPWRCADL field descriptions (continued)

Field	Description
	00 No change in CA2 delay 01 Add CA2 delay of 1 delay unit 10 Add CA2 delay of 2 delay units. 11 Add CA2 delay of 3 delay units.
3-2 WR_CA1_DEL	CA (Command/Address LPDDR2 bus) bit 1 delay fine tuning. This field holds the number of delay units that are added to CA (Command/Address bus) bit 1 relative to the clock. 00 No change in CA1 delay 01 Add CA1 delay of 1 delay unit 10 Add CA1 delay of 2 delay units. 11 Add CA1 delay of 3 delay units.
WR_CA0_DEL	CA(Command/Address LPDDR2 bus) bit 0 delay fine tuning. This field holds the number of delay units that are added to CA (Command/Address bus) bit 0 relative to the clock. 00 No change in CA0 delay 01 Add CA0 delay of 1 delay unit 10 Add CA0 delay of 2 delay units. 11 Add CA0 delay of 3 delay units.

35.12.75 MMDC Duty Cycle Control Register (MMDC_MPDCCR)

This register is used to control the duty cycle of the DQS and the primary clock (CK0). Programming of this register is permitted by entering the DDR device into self-refresh mode through LPMD/DVFS mechanism.

MMDC1_MPDCCR only affects SDCLK0.

MMDC2_MPDCCR only affects SDCLK1.

NOTE

If the duty cycle is modified after DDR initialization, the DDR will have to be placed in self-refresh mode.

NOTE

The duty cycle may be changed during initial DDR initialization without having to be placed in self-refresh mode.

Address: 21B_0000h base + 8C0h offset = 21B_08C0h

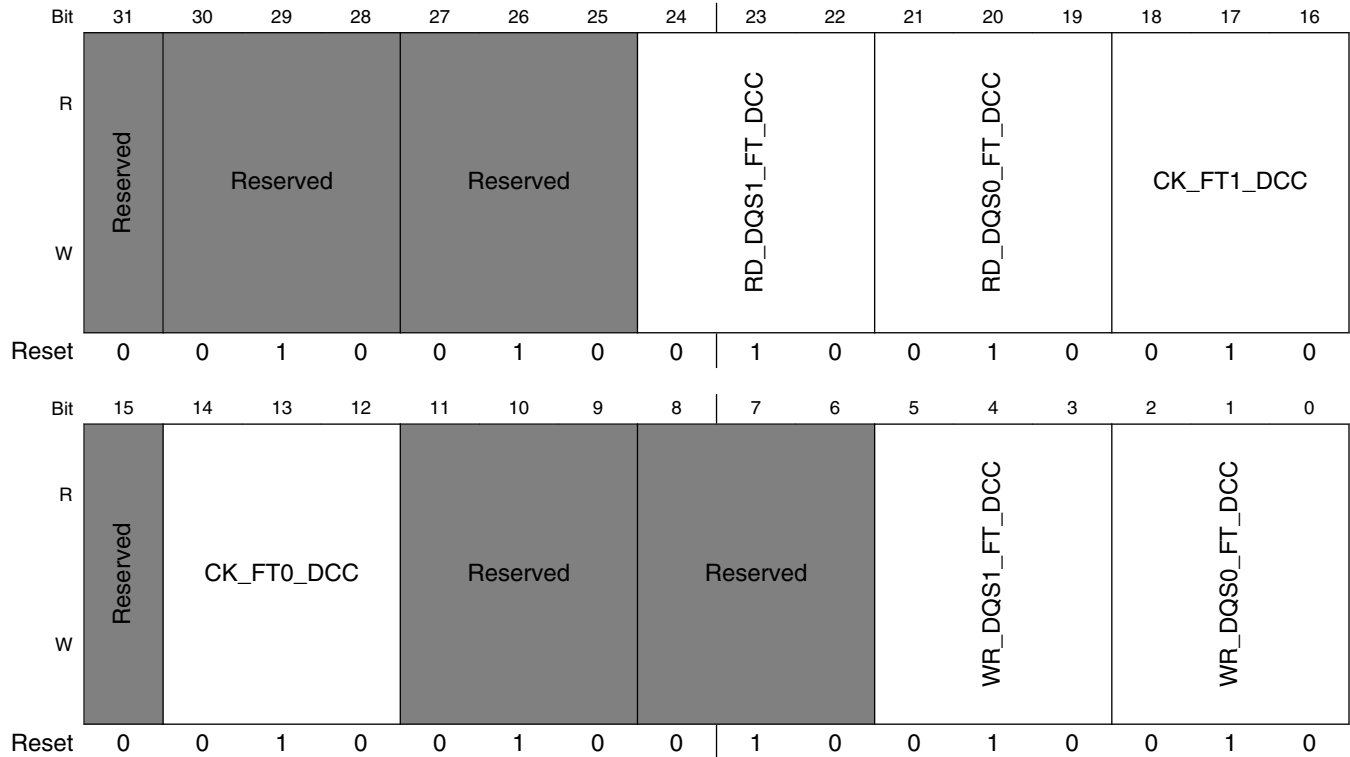

MMDC_MPDCCR field descriptions

Field	Description
31 -	This field is reserved. reserved
30–28 -	This field is reserved. Reserved
27–25 -	This field is reserved. Reserved
24–22 RD_DQS1_FT_DCC	Read DQS duty cycle fine tuning control of Byte1. This field controls the duty cycle of read DQS of Byte1 NOTE: All the other options are not allowed 001 51.5% low 48.5% high 010 50% duty cycle (default) 100 48.5% low 51.5% high
21–19 RD_DQS0_FT_DCC	Read DQS duty cycle fine tuning control of Byte0. This field controls the duty cycle of read DQS of Byte0 NOTE: All the other options are not allowed 001 51.5% low 48.5% high 010 50% duty cycle (default) 100 48.5% low 51.5% high
18–16 CK_FT1_DCC	Secondary duty cycle fine tuning control of DDR clock. This field controls the duty cycle of the DDR clock and is cascaded to CK_FT0_DCC NOTE: All the other options are not allowed

Table continues on the next page...

MMDC_MPDCCR field descriptions (continued)

Field	Description
	001 48.5% low 51.5% high 010 50% duty cycle (default) 100 51.5% low 48.5% high
15 -	This field is reserved. Reserved
14–12 CK_FT0_DCC	Primary duty cycle fine tuning control of DDR clock. This field controls the duty cycle of the DDR clock NOTE: All the other options are not allowed 001 48.5% low 51.5% high 010 50% duty cycle (default) 100 51.5% low 48.5% high
11–9 -	This field is reserved. Reserved
8–6 -	This field is reserved. Reserved
5–3 WR_DQS1_FT_DCC	Write DQS duty cycle fine tuning control of Byte1. This field controls the duty cycle of write DQS of Byte1 NOTE: All the other options are not allowed 001 51.5% low 48.5% high 010 50% duty cycle (default) 100 48.5% low 51.5% high
WR_DQS0_FT_DCC	Write DQS duty cycle fine tuning control of Byte0. This field controls the duty cycle of write DQS of Byte0 NOTE: All the other options are not allowed 001 51.5% low 48.5% high 010 50% duty cycle (default) 100 48.5% low 51.5% high

Chapter 36

Medium Quality Sound (MQS)

36.1 Overview

Medium quality sound (MQS) is used to generate medium quality audio via a standard GPIO in the pinmux, allowing the user to connect stereo speakers or headphones to a power amplifier without an additional DAC chip.

MQS accepts the following inputs:

- 2-channel, LSB-valid 16-bit, MSB shift-out first serial data (sdata)
- Frame sync asserting with the first bit of the frame (fs)
- Bit clock used to shift data out on the positive clock edge (bclk)

The 44 kHz or 48 kHz input signals from SAI1 are in left_justified format. MQS provides the SNR target as no more than 20 dB for the signals below 10 kHz. The signals above 10 kHz will have worse THD+N values.

MQS provides only simple audio reproduction. No internal pop, click or distortion artifact reduction methods are provided.

36.1.1 Block Diagram

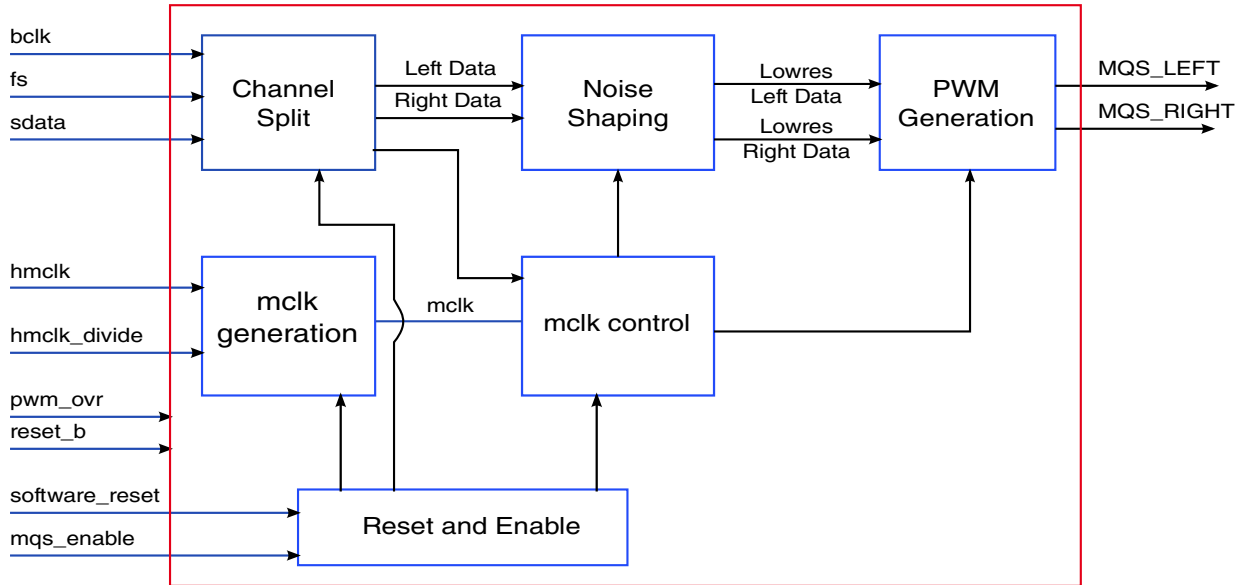

Figure 36-1. Block Diagram

MQS has the following sub-modules:

1. Channel Split: Splits the I2S signals into separate left channel and right channel audio data.
2. Noise Shaping: Uses the sigma-delta algorithm to generate low-resolution, very high sampling audio, while the audio sampling rate is increased.
3. PWM generation: Generates the bit stream to the GPIO, which is then used to drive the amplifier and then to drive the external speakers or headphones.
4. mclk generation: Used to generate the master clock (mclk). The frequency of mclk is determined by the final bit duration of PWM generation module.
5. mclk control: Used as a metronome to co-ordinate the different functional blocks working synchronously.
6. Reset and Enable: Used to generate the reset and enable logic to different clock domains.

36.2 External Signals

The following table describes the external signals of MQS:

Table 36-1. MQS External Signals

Signal	Description	Pad	Mode	Direction
MQS_LEFT	Left signal output	GPIO1_IO01	ALT4	O
		JTAG_TDI	ALT6	

Table continues on the next page...

Table 36-1. MQS External Signals (continued)

Signal	Description	Pad	Mode	Direction
MQS_RIGHT	Right signal output	LCD_DATA23	ALT1	O
		GPIO1_IO00	ALT4	
		JTAG_TDO	ALT6	
		LCD_DATA22	ALT1	

36.3 Interface Signals

MQS module has the following interface signals.

Signal Name	In/Out	BitWidth	Description	Comments
reset_b	In	1	asynchronous reset	
software_reset	In	1	Software reset	From GPR
mqs_enable	In	1	module enable	From GPR
pwm_ovr	In	1	PWM oversampling ratio1—64, 0--32	From GPR
hmclk	In	1	Maximum bit clock, used to generate the mclk, divider ratio is controlled by mqs_hmclk_divide	Max 66.5MHzTypical 24.576MHz
hmclk_divide	In	8	Divider ration control for mclk from hmclk	From GPR
bclk	In	1	bit clock from I2S signal	
fs	In	1	frame sync clock from I2S signal	
sdata	In	1	serial audio data from I2S signal	

36.4 Programming Considerations

MQS has no internal programmable registers. But it does have some programmability from IOMUXC_GPR2.

Register Bits	Name	Description
IOMUXC_GPR2[26]	MQS_OVERSAMPLE	Used to control the PWM oversampling rate compared with mclk. 1—64,

Table continues on the next page...

Programming Considerations

Register Bits	Name	Description
		0—32.
IOMUXC_GPR2[25]	MQS_EN	MQS enable. 1—Enable MQS, 0—Disable MQS
IOMUXC_GPR2[24]	MQS_SW_RST	MQS software reset. 1—Enable software reset for MQS 0—Exit software reset for MQS
IOMUXC_GPR2[23:16]	MQS_CLK_DIV[7:0]	Divider ration control for mclk from hmclk. 0—mclk frequency = hmclk frequency; 1—mclk frequency = $\frac{1}{2}$ *hmclk frequency; 2—mclk frequency = $\frac{1}{3}$ *hmclk frequency; ...; n—mclk frequency = $\frac{1}{(n+1)}$ *hmclk frequency

36.4.1 Usage Model

The user needs to program SAI1 to output 2-channel MSB-16 bit active I2S signal, and then program the related IOMUXC_GPR2 bits.

Due to the different devices connected to MQS, and different high frequency behaviors of the connected analog circuits, the user needs choose the appropriate MQS_CLK_DIV and MQS_OVERSAMPLE values for the best audible effects.

Chapter 37

On-Chip OTP Controller (OCOTP_CTRL)

37.1 Overview

This section contains information describing the requirements for the on-chip eFuse OTP controller along with details about the block functionality and implementation.

In this document, the words "eFuse" and "OTP" are interchangeable. OCOTP refers to the hardware block itself.

37.1.1 Features

The OCOTP provides the following features:

- Loading and housing of fuse content into shadow registers.
- Generation of HWV_FUSE (hardware visible fuse bus) and the HWV_REG bus which is made up of volatile PIO register based "fuses". The HWV_REG bits come from the SCS (Software Controllable Signals) register.
- Generation of STICKY_REG which is consist of sticky register bits.
- Provide program-protect and read-protect eFuse.
- Provide override and read protection of shadow register.
- CRC32 test for read-lock fuse content.

37.2 Clocks

The table found here describes the clock sources for OCOTP.

Please see [Clock Controller Module \(CCM\)](#) for clock setting, configuration and gating information.

Table 37-1. OCOTP Clocks

Clock name	Clock Root	Description
ipg_clk	ipg_clk_root	Peripheral clock
ipg_clk_s	ipg_clk_root	Peripheral access clock

37.3 Top-Level Symbol and Functional Overview

The figure found here shows the OCOTP system level diagram.

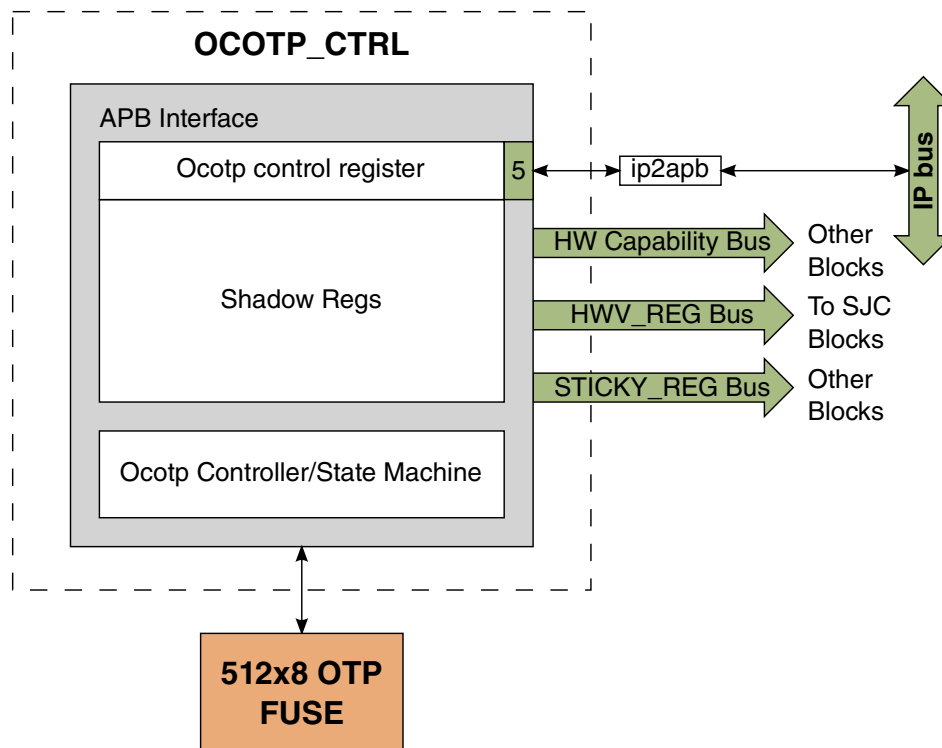

Figure 37-1. OCOTP System Level Diagram

37.3.1 Operation

The IP bus interface of the OCOTP provides two functions.

- Configure control registers for programming and reading fuse .
- Override and read shadow registers.

37.3.1.1 Shadow Register Reload

All fuse words in are shadowed. Therefore, fuse information is available through memory mapped shadow registers. If fuses are subsequently programmed, the shadow registers should be reloaded to keep them coherent with the fuse bank arrays.

The "reload shadows" feature allows the user to force a reload of the shadow registers (including HW_OCOTP_LOCK) without having to reset the device. To force a reload, complete the following steps:

1. Check that HW_OCOTP_CTRL[BUSY] and HW_OCOTP_CTRL[ERROR] are clear. Overlapped accesses are not supported by the controller. Any pending write , read or reload must be completed before a new access can be requested.
2. Set the HW_OCOTP_CTRL[RELOAD_SHADOWS] bit. OCOTP will read all the fuse one by one and put it into corresponding shadow register.
3. Wait for HW_OCOTP_CTRL[BUSY] and HW_OCOTP_CTRL[RELOAD_SHADOWS] to be cleared by the controller.

The controller will automatically clear the HW_OCOTP_CTRL[RELOAD_SHADOWS] bit after the successful completion of the operation.

37.3.1.2 Fuse and Shadow Register Read

All shadow registers are always readable through the APB bus except some secret keys regions. When their corresponding fuse lock bits are set, the shadow registers also become read locked. After read locking, reading from these registers will return 0xBADABADA.

In addition HW_OCOTP_CTRL[ERROR] will be set. It must be cleared by software before any new write , read or reload access can be issued. Subsequent reads to unlocked shadow locations will still work successfully however.

To read fuse words directly from correctly complete the following steps:

1. Check that HW_OCOTP_CTRL[BUSY] and HW_OCOTP_CTRL[ERROR] are clear. Overlapped accesses are not supported by the controller. Any pending write, read or reload must be completed before a read access can be requested.
2. Write the requested to HW_OCOTP_CTRL[ADDR].

37.3.1.3 Fuse and Shadow Register Writes

Shadow register bits can be overridden by software until the corresponding fuse lock bit for the region is set. When the lock shadow bit is set, the shadow registers for that lock region become write locked. The LOCK shadow register also has no shadow or fuse lock bits but it is always read only.

In order to avoid "rogue" code performing erroneous writes to OTP, a special unlocking sequence is required for writes to the fuse banks. To program fuse bank correctly complete the following steps:

1. Program HW_OCOTP_TIMING[STROBE_PROG] and HW_OCOTP_TIMING[RELAX]HW_OCOTP_TIMING2[RELAX_PEOG] fields with timing values to match the current frequency of the ipg_clk. OTP writes will work at maximum bus frequencies as long as the HW_OCOTP_TIMING2 parameters are set correctly.
2. Check that HW_OCOTP_CTRL[BUSY] and HW_OCOTP_CTRL[ERROR] are clear. Overlapped accesses are not supported by the controller. Any pending write or reload must be completed before a write access can be requested.
3. Write the requested to HW_OCOTP_CTRL[ADDR] and program the unlock code into HW_OCOTP_CTRL[WR_UNLOCK]. This must be programmed for each write access. The lock code is documented in the register description. Both the unlock code and address can be written in the same operation.
4. Write the data to the HW_OCOTP_DATA register. This will automatically set HW_OCOTP_CTRL[BUSY] and clear HW_OCOTP_CTRL[WR_UNLOCK]. To protect programming same OTP bit twice, before program OCOTP will automatically read fuse value in OTP and use read value to mask program data. The controller will use masked program data to program a 32-bit word in the OTP per the address in HW_OCOTP_CTRL[ADDR]. Bit fields with 1's will result in that OTP bit being programmed. Bit fields with 0's will be ignored. At the same time that the write is accepted, the controller makes an internal copy of HW_OCOTP_CTRL[ADDR] which cannot be updated until the next write sequence is initiated. This copy guarantees that erroneous writes to HW_OCOTP_CTRL[ADDR] will not affect an active write operation. It should also be noted that during the programming HW_OCOTP_DATA will shift right (with zero fill). This shifting is required to program the OTP serially. During the write operation, HW_OCOTP_DATA cannot be modified.
5. Once complete, the controller will clear BUSY. A write request to a protected or locked region will result in no OTP access and no setting of HW_OCOTP_CTRL[BUSY]. In addition HW_OCOTP_CTRL[ERROR] will be set. It must be cleared by software before any new write access can be issued.

It should be noted that write latencies to OTP are numbers of 10 micro-seconds. Write latencies is based on amount of bit filed which is 1. For example : program half fuse bits in one word need 10 us x 16.

For further details of OTP read/write operations see [eFUSE].

HW_OCOTP_CTRL[ERROR] will be set under the following conditions:

- A write is performed to a shadow register during a shadow reload (essentially, while HW_OCOTP_CTRL[RELOAD_SHADOWS] is set. In addition, the contents of the shadow register shall not be updated.
- A write is performed to a shadow register which has been locked.
- A read is performed to from a shadow register which has been read locked.
- A program is performed to a fuse which has been .
- A read is performed to from a fuse which has been read locked.

37.3.1.4 Write Postamble

Due to internal electrical characteristics of the OTP during writes, all OTP operations following a write must be separated by 2 us after the clearing of HW_OCOTP_CTRL_BUSY following the write. This guarantees programming voltages on-chip to reach a steady state when exiting a write sequence. This includes reads, shadow reloads, or other writes.

A recommended software sequence to meet the postamble requirements is as follows:

- Issue the write and poll for BUSY (as per [Fuse Shadow Memory Footprint](#)).
- Once BUSY is clear, use HW_DIGCTL_MICROSECONDS to wait 2 us.
- Perform the next OTP operation.

37.3.2 Fuse Shadow Memory Footprint

The OTP memory footprint shows in the following figure. The registers are grouped by lock region. Their names correspond to the PIO register and fusemap names.

Top-Level Symbol and Functional Overview

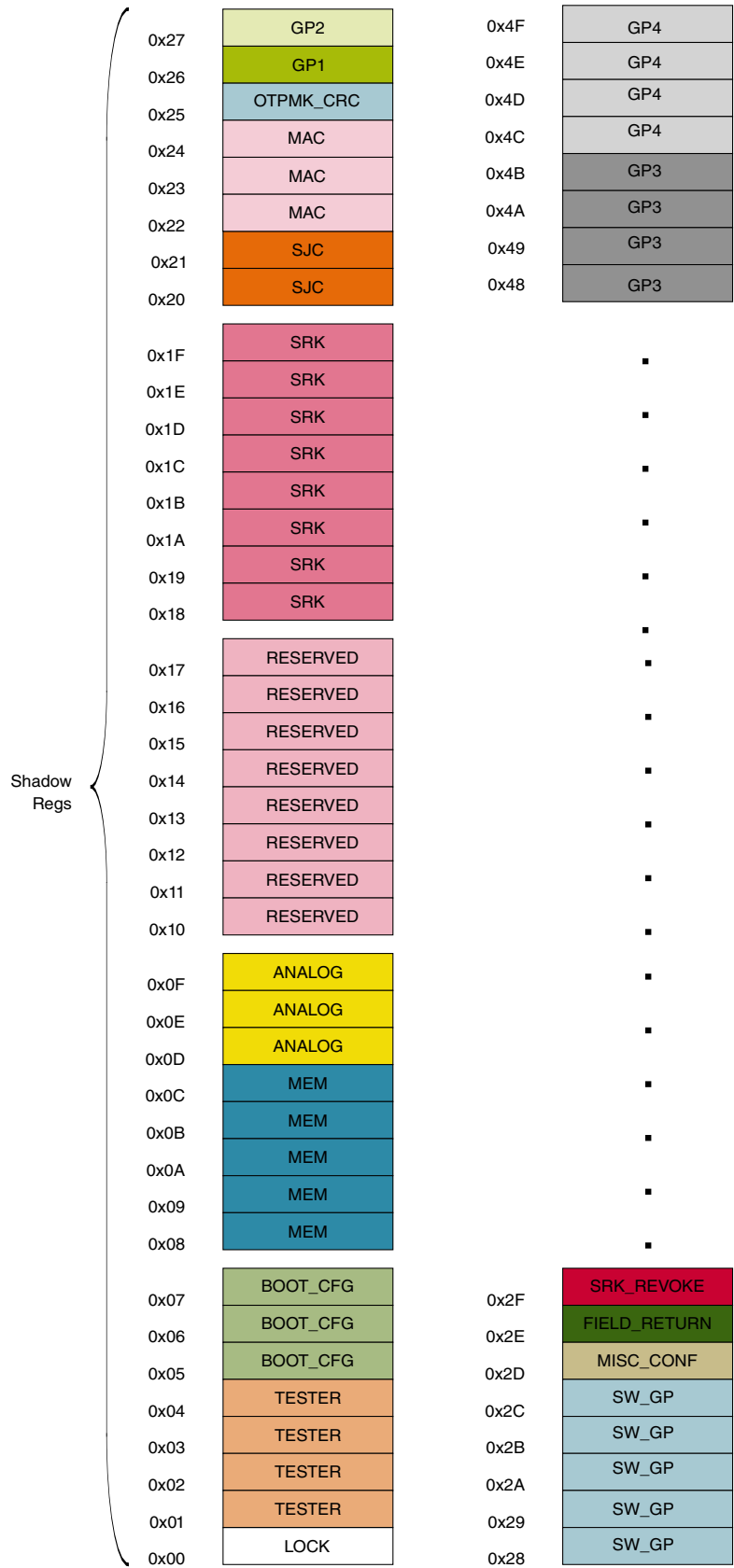

Figure 37-2. OTP Memory Footprint

37.3.3 OTP Read/Write Timing Parameters

There are three timing fields contained in the HW_OCOTP_TIMING and HW_OCOTP_TIMING2 register that specify counter limit values, which are used to specify the signal timing.

Both two timing parameters are specified in ipg_clk cycles. Since the ipg_clk frequency can be set to a range of values, these parameters must be adjusted with the clock to yield the appropriate delay.

37.3.4 Hardware Visible Fuses

The hmv_fuse bus emanates from the OCOTP block and goes to various other blocks inside the chip. This bus is made up of all the shadow register bits for all the 16 fuse banks.

Only a subset of these fuse bits are currently used by the hardware. The fuse bits are initially copied from the banks after reset is deasserted. When all fuse bits are loaded into their shadow registers, the OCOTP asserts the fuse_latched output signal.

The hmv_reg bus also comes from the OCOTP. Its source is the HW_OCOTP_SCS register. This register has 1 defined bit, the HAB_JDE bit, that is connected to the SJC block. The SCS bits are intended to be used as volatile fuse bits under software control. Additional bits will be defined as needed in future implementations.

The system-wide reset sequence must be coordinated by the system reset controller, so that the hmv_fuse and hmv_reg buses are stable and reflect the values of the fuses before they are used by the rest of the system.

37.3.5 Behavior During Reset

The OCOTP is always active. The shadow registers automatically load the appropriate OTP contents after reset is deasserted. During this load-time HW_OCOTP_CTRL_BUSY is set. The load time is similar to that of a "reload shadow" operation.

37.3.6 Secure JTAG control

The JTAG control fuses are used to allow or disallow JTAG access to secured resources.

Three JTAG security levels are envisioned, as shown in the table below.

Table 37-2. JTAG Security Level Control Bits

Security Mode	JTAG_SMODE	Description
No Debug	2'b11	The highest security level.
Secure JTAG	2'b01	Limit the JTAG access by using key based authentication mechanism.
JTAG Enable	2'b00	Low Security, all JTAG features are enabled.

37.4 Fuse Map

See the Fusemap chapter of this reference manual for more information.

37.5 OCOTP Memory Map/Register Definition

NOTE

When write/read unimplemented register address in `ocotp_ctrl`, `ocotp_ctrl` will not send error and read data will be 0.

OCOTP Hardware Register Format Summary

OCOTP memory map

Absolute address (hex)	Register name	Width (in bits)	Access	Reset value	Section/page
21B_C000	OTP Controller Control Register (OCOTP_CTRL)	32	R/W	0000_0000h	37.5.1/2392
21B_C004	OTP Controller Control Register (OCOTP_CTRL_SET)	32	R/W	0000_0000h	37.5.1/2392
21B_C008	OTP Controller Control Register (OCOTP_CTRL_CLR)	32	R/W	0000_0000h	37.5.1/2392
21B_C00C	OTP Controller Control Register (OCOTP_CTRL_TOG)	32	R/W	0000_0000h	37.5.1/2392
21B_C010	OTP Controller Timing Register (OCOTP_TIMING)	32	R/W	02C6_4116h	37.5.2/2394
21B_C020	OTP Controller Write Data Register (OCOTP_DATA)	32	R/W	0000_0000h	37.5.3/2394
21B_C030	OTP Controller Read Control Register (OCOTP_READ_CTRL)	32	R/W	0000_0000h	37.5.4/2395
21B_C040	OTP Controller Read Fuse Data Register (OCOTP_READ_FUSE_DATA)	32	R/W	0000_0000h	37.5.5/2396
21B_C050	Sticky bit Register (OCOTP_SW_STICKY)	32	R/W	0000_0000h	37.5.6/2396
21B_C060	Software Controllable Signals Register (OCOTP_SCS)	32	R/W	0000_0000h	37.5.7/2397
21B_C064	Software Controllable Signals Register (OCOTP_SCS_SET)	32	R/W	0000_0000h	37.5.7/2397

Table continues on the next page...

OCOTP memory map (continued)

Absolute address (hex)	Register name	Width (in bits)	Access	Reset value	Section/page
21B_C068	Software Controllable Signals Register (OCOTP_SCS_CLR)	32	R/W	0000_0000h	37.5.7/2397
21B_C06C	Software Controllable Signals Register (OCOTP_SCS_TOG)	32	R/W	0000_0000h	37.5.7/2397
21B_C070	OTP Controller CRC Test Address (OCOTP_CRC_ADDR)	32	R/W	0000_0000h	37.5.8/2398
21B_C080	OTP Controller CRC Value Register (OCOTP_CRC_VALUE)	32	R/W	0000_0000h	37.5.9/2399
21B_C090	OTP Controller Version Register (OCOTP_VERSION)	32	R/W	0300_0000h	37.5.10/2400
21B_C100	OTP Controller Timing Register 2 (OCOTP_TIMING2)	32	R/W	01C1_0042h	37.5.11/2400
21B_C400	Value of OTP Bank0 Word0 (Lock controls) (OCOTP_LOCK)	32	R	0000_0000h	37.5.12/2401
21B_C410	Value of OTP Bank0 Word1 (Configuration and Manufacturing Info.) (OCOTP_CFG0)	32	R/W	0000_0000h	37.5.13/2404
21B_C420	Value of OTP Bank0 Word2 (Configuration and Manufacturing Info.) (OCOTP_CFG1)	32	R/W	0000_0000h	37.5.14/2405
21B_C430	Value of OTP Bank0 Word3 (Configuration and Manufacturing Info.) (OCOTP_CFG2)	32	R/W	0000_0000h	37.5.15/2405
21B_C440	Value of OTP Bank0 Word4 (Configuration and Manufacturing Info.) (OCOTP_CFG3)	32	R/W	0000_0000h	37.5.16/2406
21B_C450	Value of OTP Bank0 Word5 (Configuration and Manufacturing Info.) (OCOTP_CFG4)	32	R/W	0000_0000h	37.5.17/2406
21B_C460	Value of OTP Bank0 Word6 (Configuration and Manufacturing Info.) (OCOTP_CFG5)	32	R/W	0000_0000h	37.5.18/2407
21B_C470	Value of OTP Bank0 Word7 (Configuration and Manufacturing Info.) (OCOTP_CFG6)	32	R/W	0000_0000h	37.5.19/2407
21B_C480	Value of OTP Bank1 Word0 (Memory Related Info.) (OCOTP_MEM0)	32	R/W	0000_0000h	37.5.20/2408
21B_C490	Value of OTP Bank1 Word1 (Memory Related Info.) (OCOTP_MEM1)	32	R/W	0000_0000h	37.5.21/2408
21B_C4A0	Value of OTP Bank1 Word2 (Memory Related Info.) (OCOTP_MEM2)	32	R/W	0000_0000h	37.5.22/2409
21B_C4B0	Value of OTP Bank1 Word3 (Memory Related Info.) (OCOTP_MEM3)	32	R/W	0000_0000h	37.5.23/2409
21B_C4C0	Value of OTP Bank1 Word4 (Memory Related Info.) (OCOTP_MEM4)	32	R/W	0000_0000h	37.5.24/2410
21B_C4D0	Value of OTP Bank1 Word5 (Memory Related Info.) (OCOTP_ANA0)	32	R/W	0000_0000h	37.5.25/2410
21B_C4E0	Value of OTP Bank1 Word6 (General Purpose Customer Defined Info.) (OCOTP_ANA1)	32	R/W	0000_0000h	37.5.26/2411
21B_C4F0	Value of OTP Bank1 Word7 (General Purpose Customer Defined Info.) (OCOTP_ANA2)	32	R/W	0000_0000h	37.5.27/2411
21B_C500	Value of OTP Bank2 Word0 (OTPMK Key) (OCOTP_OTPMK0)	32	R/W	0000_0000h	37.5.28/2412

Table continues on the next page...

OCOTP memory map (continued)

Absolute address (hex)	Register name	Width (in bits)	Access	Reset value	Section/page
21B_C510	Value of OTP Bank2 Word1 (OTPMK Key) (OCOTP_OTPMK1)	32	R/W	0000_0000h	37.5.29/2412
21B_C520	Value of OTP Bank2 Word2 (OTPMK Key) (OCOTP_OTPMK2)	32	R/W	0000_0000h	37.5.30/2413
21B_C530	Value of OTP Bank2 Word3 (OTPMK Key) (OCOTP_OTPMK3)	32	R/W	0000_0000h	37.5.31/2413
21B_C540	Value of OTP Bank2 Word4 (OTPMK Key) (OCOTP_OTPMK4)	32	R/W	0000_0000h	37.5.32/2414
21B_C550	Value of OTP Bank2 Word5 (OTPMK Key) (OCOTP_OTPMK5)	32	R/W	0000_0000h	37.5.33/2414
21B_C560	Value of OTP Bank2 Word6 (OTPMK Key) (OCOTP_OTPMK6)	32	R/W	0000_0000h	37.5.34/2415
21B_C570	Value of OTP Bank2 Word7 (OTPMK Key) (OCOTP_OTPMK7)	32	R/W	0000_0000h	37.5.35/2415
21B_C580	Shadow Register for OTP Bank3 Word0 (SRK Hash) (OCOTP_SRK0)	32	R/W	0000_0000h	37.5.36/2416
21B_C590	Shadow Register for OTP Bank3 Word1 (SRK Hash) (OCOTP_SRK1)	32	R/W	0000_0000h	37.5.37/2416
21B_C5A0	Shadow Register for OTP Bank3 Word2 (SRK Hash) (OCOTP_SRK2)	32	R/W	0000_0000h	37.5.38/2417
21B_C5B0	Shadow Register for OTP Bank3 Word3 (SRK Hash) (OCOTP_SRK3)	32	R/W	0000_0000h	37.5.39/2417
21B_C5C0	Shadow Register for OTP Bank3 Word4 (SRK Hash) (OCOTP_SRK4)	32	R/W	0000_0000h	37.5.40/2418
21B_C5D0	Shadow Register for OTP Bank3 Word5 (SRK Hash) (OCOTP_SRK5)	32	R/W	0000_0000h	37.5.41/2418
21B_C5E0	Shadow Register for OTP Bank3 Word6 (SRK Hash) (OCOTP_SRK6)	32	R/W	0000_0000h	37.5.42/2419
21B_C5F0	Shadow Register for OTP Bank3 Word7 (SRK Hash) (OCOTP_SRK7)	32	R/W	0000_0000h	37.5.43/2419
21B_C600	Value of OTP Bank4 Word0 (Secure JTAG Response Field) (OCOTP_SJC_RESP0)	32	R/W	0000_0000h	37.5.44/2420
21B_C610	Value of OTP Bank4 Word1 (Secure JTAG Response Field) (OCOTP_SJC_RESP1)	32	R/W	0000_0000h	37.5.45/2420
21B_C620	Value of OTP Bank4 Word2 (MAC Address) (OCOTP_MAC0)	32	R/W	0000_0000h	37.5.46/2421
21B_C630	Value of OTP Bank4 Word3 (MAC Address) (OCOTP_MAC1)	32	R/W	0000_0000h	37.5.47/2421
21B_C640	Value of OTP Bank4 Word4 (MAC Address) (OCOTP_RESERVED) (OCOTP_MAC)	32	R/W	0000_0000h	37.5.48/2421
21B_C650	Value of OTP Bank4 Word5 (CRC Key) (OCOTP_CRC)	32	R/W	0000_0000h	37.5.49/2422
21B_C660	Value of OTP Bank4 Word6 (General Purpose Customer Defined Info) (OCOTP_GP1)	32	R/W	0000_0000h	37.5.50/2422

Table continues on the next page...

OCOTP memory map (continued)

Absolute address (hex)	Register name	Width (in bits)	Access	Reset value	Section/page
21B_C670	Value of OTP Bank4 Word7 (General Purpose Customer Defined Info) (OCOTP_GP2)	32	R/W	0000_0000h	37.5.51/ 2423
21B_C680	Value of OTP Bank5 Word0 (SW GP) (OCOTP_SW_GP0)	32	R/W	0000_0000h	37.5.52/ 2423
21B_C690	Value of OTP Bank5 Word1 (SW GP) (OCOTP_SW_GP1)	32	R/W	0000_0000h	37.5.53/ 2424
21B_C6A0	Value of OTP Bank5 Word2 (SW GP) (OCOTP_SW_GP2)	32	R/W	0000_0000h	37.5.54/ 2424
21B_C6B0	Value of OTP Bank5 Word3 (SW GP) (OCOTP_SW_GP3)	32	R/W	0000_0000h	37.5.55/ 2424
21B_C6C0	Value of OTP Bank5 Word4 (SW GP) (OCOTP_SW_GP4)	32	R/W	0000_0000h	37.5.56/ 2425
21B_C6D0	Value of OTP Bank5 Word5 (Misc Conf) (OCOTP_MISC_CONF)	32	R/W	0000_0000h	37.5.57/ 2425
21B_C6E0	Value of OTP Bank5 Word6 (Field Return) (OCOTP_FIELD_RETURN)	32	R/W	0000_0000h	37.5.58/ 2426
21B_C6F0	Value of OTP Bank5 Word7 (SRK Revoke) (OCOTP_SRK_REVOKE)	32	R/W	0000_0000h	37.5.59/ 2426
21B_C800	Value of OTP Bank6 Word0 (ROM Patch) (OCOTP_ROM_PATCH0)	32	R/W	0000_0000h	37.5.60/ 2427
21B_C810	Value of OTP Bank6 Word1 (ROM Patch) (OCOTP_ROM_PATCH1)	32	R/W	0000_0000h	37.5.61/ 2427
21B_C820	Value of OTP Bank6 Word2 (ROM Patch) (OCOTP_ROM_PATCH2)	32	R/W	0000_0000h	37.5.62/ 2427
21B_C830	Value of OTP Bank6 Word3 (ROM Patch) (OCOTP_ROM_PATCH3)	32	R/W	0000_0000h	37.5.63/ 2428
21B_C840	Value of OTP Bank6 Word4 (ROM Patch) (OCOTP_ROM_PATCH4)	32	R/W	0000_0000h	37.5.64/ 2428
21B_C850	Value of OTP Bank6 Word5 (ROM Patch) (OCOTP_ROM_PATCH5)	32	R/W	0000_0000h	37.5.65/ 2429
21B_C860	Value of OTP Bank6 Word6 (ROM Patch) (OCOTP_ROM_PATCH6)	32	R/W	0000_0000h	37.5.66/ 2429
21B_C870	Value of OTP Bank6 Word7 (ROM Patch) (OCOTP_ROM_PATCH7)	32	R/W	0000_0000h	37.5.67/ 2430
21B_C880	Value of OTP Bank7 Word0 (General Purpose Customer Defined Info) (OCOTP_GP3_0)	32	R/W	0000_0000h	37.5.68/ 2430
21B_C890	Value of OTP Bank7 Word1 (General Purpose Customer Defined Info) (OCOTP_GP3_1)	32	R/W	0000_0000h	37.5.69/ 2430
21B_C8A0	Value of OTP Bank7 Word2 (General Purpose Customer Defined Info) (OCOTP_GP3_2)	32	R/W	0000_0000h	37.5.70/ 2431
21B_C8B0	Value of OTP Bank7 Word3 (General Purpose Customer Defined Info) (OCOTP_GP3_3)	32	R/W	0000_0000h	37.5.71/ 2431
21B_C8C0	Value of OTP Bank8 Word4 (General Purpose Customer Defined Info) (OCOTP_GP4_0)	32	R/W	0000_0000h	37.5.72/ 2432

Table continues on the next page...

OCOTP memory map (continued)

Absolute address (hex)	Register name	Width (in bits)	Access	Reset value	Section/page
21B_C8D0	Value of OTP Bank7 Word5 (General Purpose Customer Defined Info) (OCOTP_GP4_1)	32	R/W	0000_0000h	37.5.73/2432
21B_C8E0	Value of OTP Bank7 Word6 (General Purpose Customer Defined Info) (OCOTP_GP4_2)	32	R/W	0000_0000h	37.5.74/2433
21B_C8F0	Value of OTP Bank7 Word7 (General Purpose Customer Defined Info) (OCOTP_GP4_3)	32	R/W	0000_0000h	37.5.75/2433

37.5.1 OTP Controller Control Register (OCOTP_CTRLn)

The OCOTP Control and Status Register specifies the copy state, as well as the control required for random access of the OTP memory

OCOTP_CTRL: 0x000

OCOTP_CTRL_SET: 0x004

OCOTP_CTRL_CLR: 0x008

OCOTP_CTRL_TOG: 0x00C

The OCOTP Control and Status Register provides the necessary software interface for performing read and write operations to the On-Chip OTP (One-Time Programmable ROM). The control fields such as WR_UNLOCK, ADDR and BUSY/ERROR may be used in conjunction with the OCOTP_DATA register to perform write operations. Read operations to the On-Chip OTP are involving ADDR, BUSY/ERROR bit field and OCOTP_READ_CTRL register. Read value is saved in OCOTP_READ_FUSE_DATA register.

Address: 21B_C000h base + 0h offset + (4d × i), where i=0d to 3d

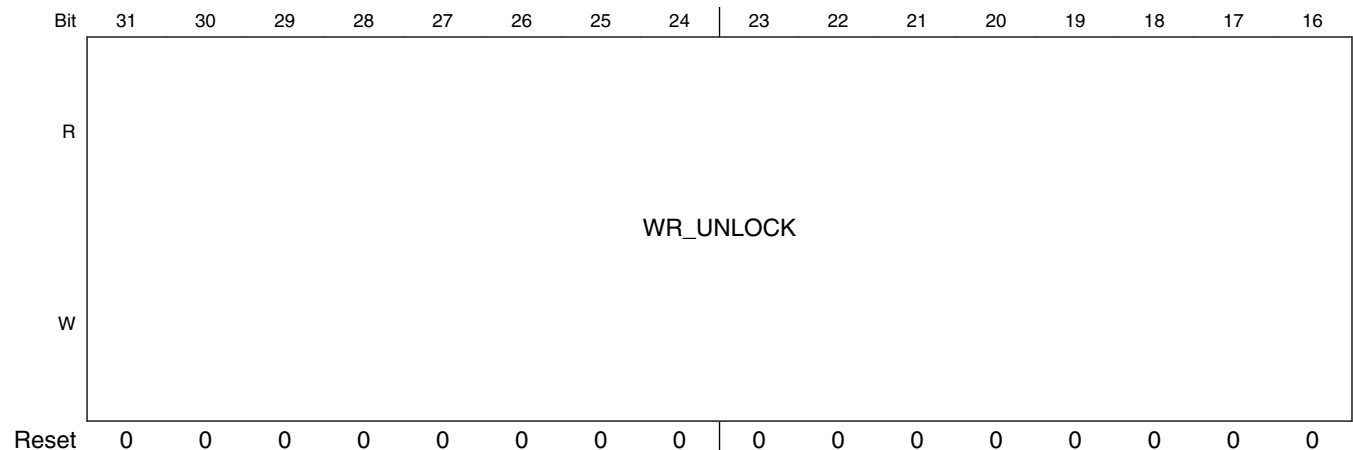

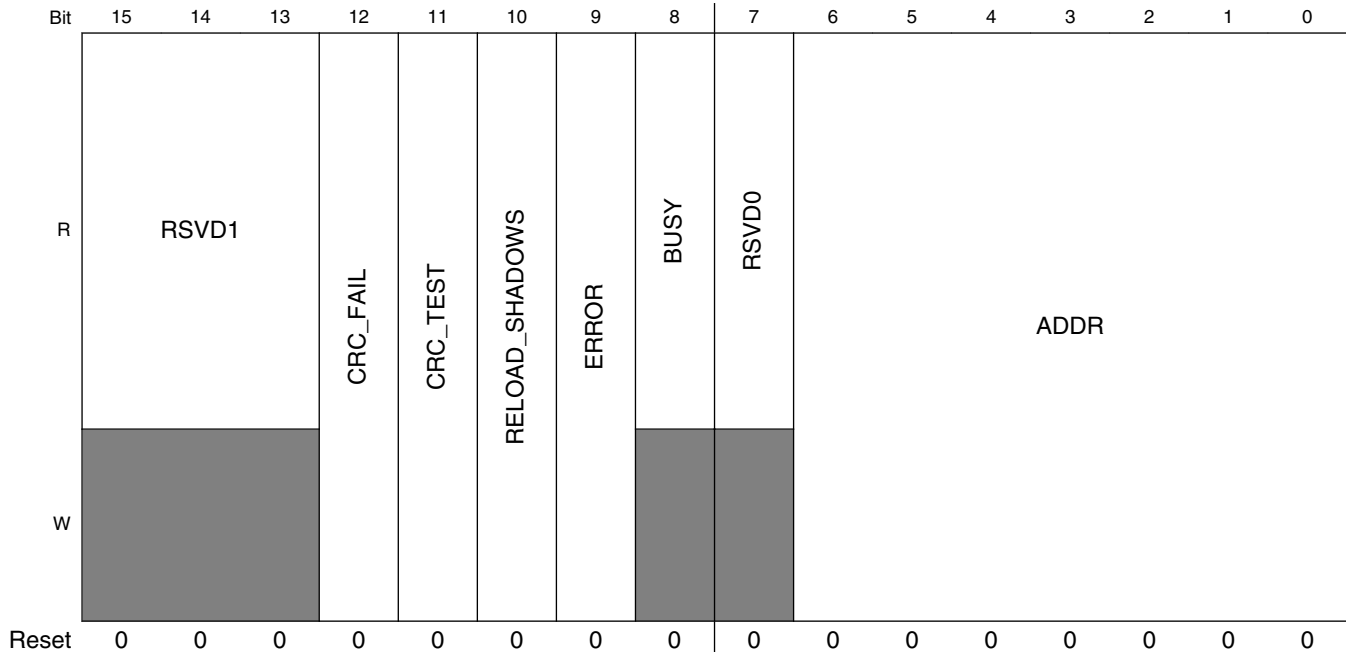

OCOTP_CTRLn field descriptions

Field	Description
31–16 WR_UNLOCK	Write 0x3E77 to enable OTP write accesses. NOTE: This register must be unlocked on a write-by-write basis (a write is initiated when HW_OCOTP_DATA is written), so the UNLOCK bitfield must contain the correct key value during all writes to HW_OCOTP_DATA, otherwise a write shall not be initiated. This field is automatically cleared after a successful write completion (clearing of BUSY). 0x3E77 KEY — Key needed to unlock HW_OCOTP_DATA register.
15–13 RSVD1	Reserved
12 CRC_FAIL	Set by controller when calculated CRC value is not equal to appointed CRC fuse word
11 CRC_TEST	Set to calculate CRC according to start address and end address in CRC_ADDR register. And compare with CRC fuse word according CRC address in CRC_ADDR register to generate CRC_FAIL flag
10 RELOAD_SHADOWS	Set to force re-loading the shadow registers (HW/SW capability and LOCK). This operation will automatically set BUSY. Once the shadow registers have been re-loaded, BUSY and RELOAD_SHADOWS are automatically cleared by the controller.
9 ERROR	Set by the controller when an access to a locked region(OTP or shadow register) is requested. Must be cleared before any further access can be performed. This bit can only be set by the controller. This bit is also set if the Pin interface is active and software requests an access to the OTP. In this instance, the ERROR bit cannot be cleared until the Pin interface access has completed. Reset this bit by writing a one to the SCT clear address space and not by a general write.
8 BUSY	OTP controller status bit. When active, no new write access or read access to OTP(including RELOAD_SHADOWS) can be performed. Cleared by controller when access complete. After reset (or after setting RELOAD_SHADOWS), this bit is set by the controller until the HW/SW and LOCK registers are successfully copied, after which time it is automatically cleared by the controller.
7 RSVD0	Reserved
ADDR	OTP write and read access address register. Specifies one of 64 word address locations (0x00 - 0x3f). If a valid access is accepted by the controller, the controller makes an internal copy of this value. This internal copy will not update until the access is complete.

37.5.2 OTP Controller Timing Register (OCOTP_TIMING)

The OCOTP Data Register is used for OTP Programming

This register specifies timing parameters for programming and reading the OCOTP fuse array.

Address: 21B_C000h base + 10h offset = 21B_C010h

Bit	31	30	29	28	27	26	25	24	23	22	21	20	19	18	17	16	15	14	13	12	11	10	9	8	7	6	5	4	3	2	1	0
R	RSRVD0				WAIT				STROBE_READ				RELAX				STROBE_PROG															
W	[Shaded]																															
Reset	0	0	0	0	0	0	1	0	1	1	0	0	0	1	1	0	0	1	0	0	0	0	0	1	0	0	0	1	0	1	1	0

OCOTP_TIMING field descriptions

Field	Description
31–28 RSRVD0	These bits always read back zero.
27–22 WAIT	This count value specifies time interval between auto read and write access in one time program. It is given in number of ipg_clk periods.
21–16 STROBE_READ	This count value specifies the strobe period in one time read OTP. $Trd = ((STROBE_READ+1) - 2 * (RELAX_READ + 1)) / ipg_clk_freq$. It is given in number of IPG_CLK periods.
15–12 RELAX	This count value specifies the time to add to all default timing parameters other than the Tpgm and Trd. It is given in number of ipg_clk periods.
STROBE_PROG	This count value specifies the strobe period in one time write OTP. $Tpgm = ((STROBE_PROG+1) - 2 * (RELAX_PROG + 1)) / ipg_clk_freq$. It is given in number of ipg_clk periods.

37.5.3 OTP Controller Write Data Register (OCOTP_DATA)

The OCOTP Data Register is used for OTP Programming

This register is used in conjunction with OCOTP_CTRL to perform one-time writes to the OTP. Please see the "Software Write Sequence" section for operating details.

Address: 21B_C000h base + 20h offset = 21B_C020h

Bit	31	30	29	28	27	26	25	24	23	22	21	20	19	18	17	16	15	14	13	12	11	10	9	8	7	6	5	4	3	2	1	0
R	DATA																															
W																																
Reset	0	0	0	0	0	0	0	0	0	0	0	0	0	0	0	0	0	0	0	0	0	0	0	0	0	0	0	0	0	0	0	0

OCOTP_DATA field descriptions

Field	Description
DATA	Used to initiate a write to OTP. Please see the "Software Write Sequence" section for operating details.

37.5.4 OTP Controller Read Control Register (OCOTP_READ_CTRL)

The Register is used for OTP Read Control.

This register is used in conjunction with OCOTP_CTRL to perform one time read to the OTP. Please see the "Software read Sequence" section for operating details.

Address: 21B_C000h base + 30h offset = 21B_C030h

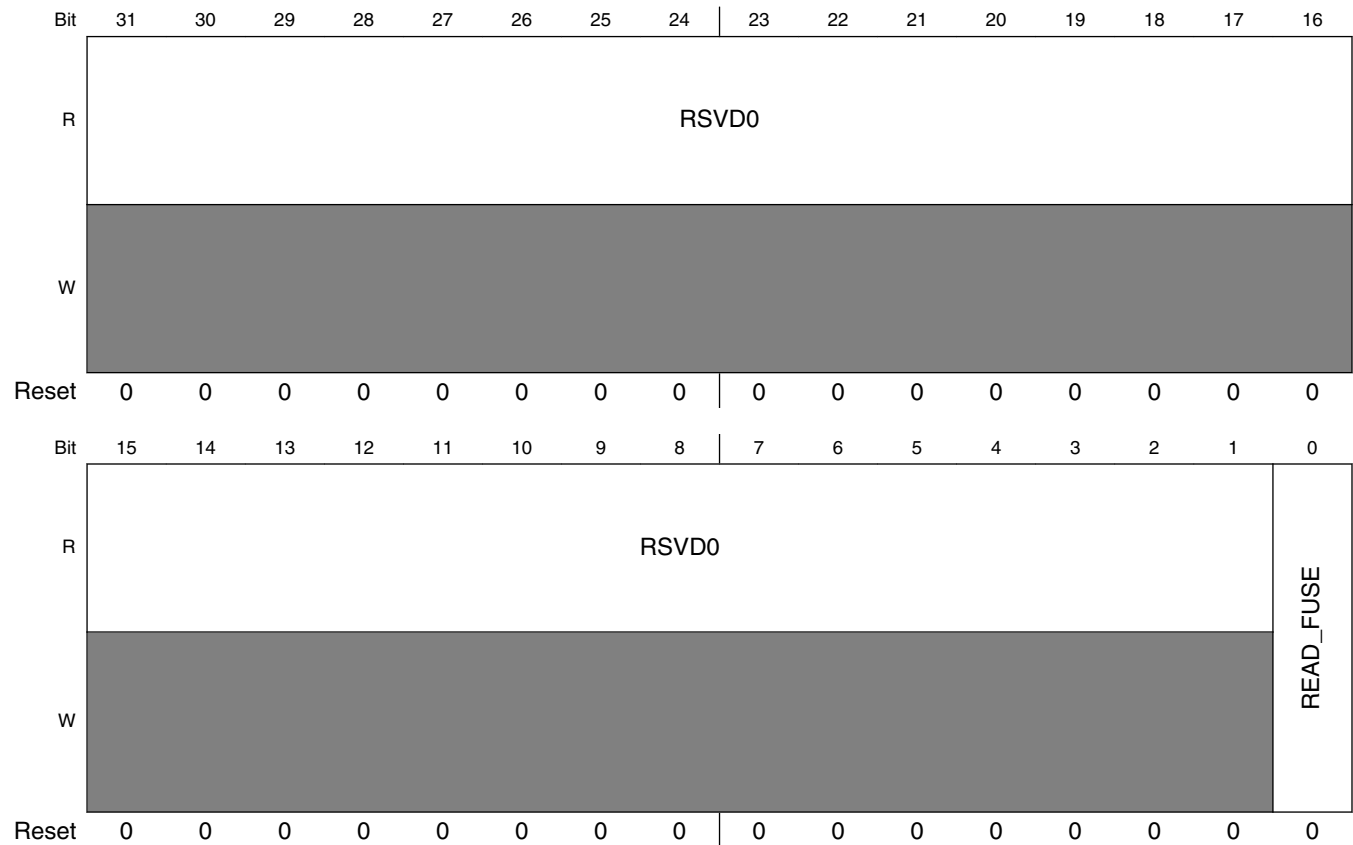

OCOTP_READ_CTRL field descriptions

Field	Description
31–1 RSVD0	Reserved
0 READ_FUSE	Used to initiate a read to OTP. Please see the "Software read Sequence" section for operating details.

37.5.5 OTP Controller Read Fuse Data Register (OCOTP_READ_FUSE_DATA)

The register is used for OTP read fuse data.

The data read from OTP

Address: 21B_C000h base + 40h offset = 21B_C040h

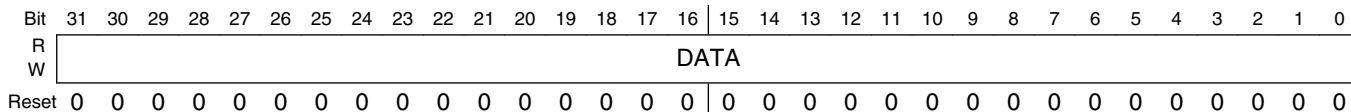

OCOTP_READ_FUSE_DATA field descriptions

Field	Description
DATA	The data read from OTP

37.5.6 Sticky bit Register (OCOTP_SW_STICKY)

Some SW sticky bits .

Some sticky bits are used by SW to lock some fuse area, shadow registers and other features.

Address: 21B_C000h base + 50h offset = 21B_C050h

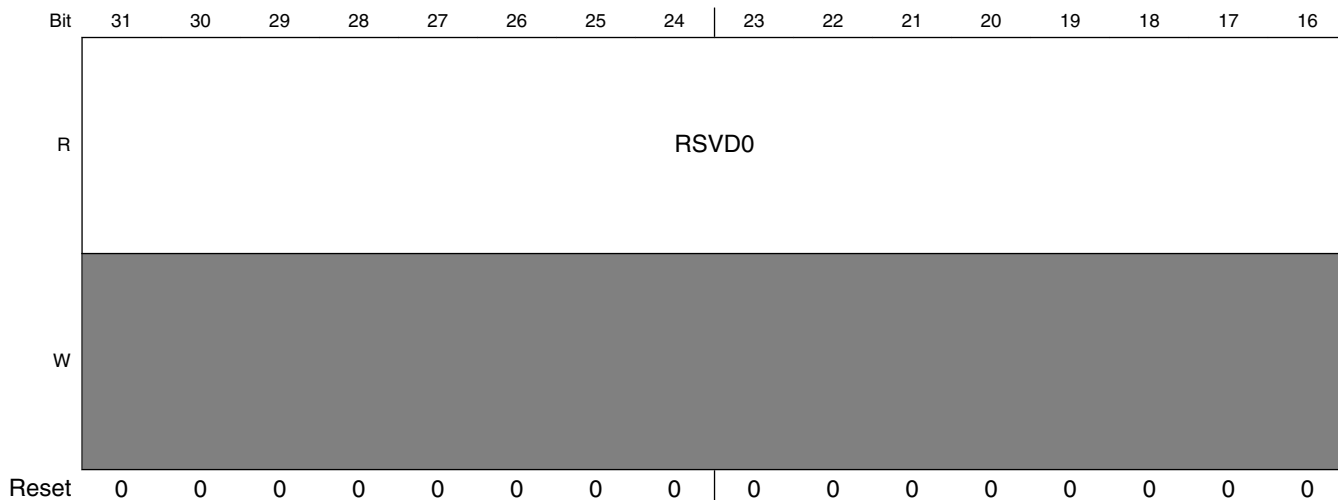

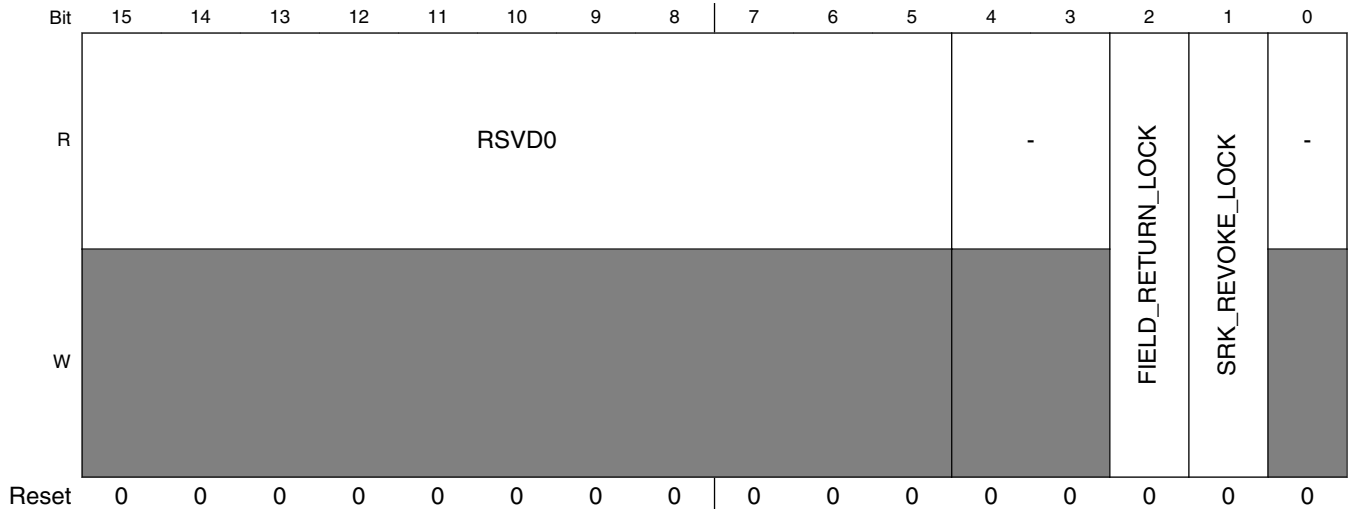

OCOTP_SW_STICKY field descriptions

Field	Description
31–5 RSVD0	Reserved
4–3 -	Reserved
2 FIELD_RETURN_LOCK	Shadow register write and OTP write lock for FIELD_RETURN region. When set, the writing of this region's shadow register and OTP fuse word are blocked. Once this bit is set, it is always high unless a POR is issued.
1 SRK_REVOKE_LOCK	Shadow register write and OTP write lock for SRK_REVOKE region. When set, the writing of this region's shadow register and OTP fuse word are blocked. Once this bit is set, it is always high unless a POR is issued.
0 -	Reserved

37.5.7 Software Controllable Signals Register (OCOTP_SCSn)

OCOTP_SCS: 0x060

OCOTP_SCS_SET: 0x064

OCOTP_SCS_CLR: 0x068

OCOTP_SCS_TOG: 0x06C

This register holds volatile configuration values that can be set and locked by trusted software. All values are returned to their default values after POR.

OCOTP Memory Map/Register Definition

Address: 21B_C000h base + 60h offset + (4d × i), where i=0d to 3d

Bit	31	30	29	28	27	26	25	24	23	22	21	20	19	18	17	16
R	<div style="display: flex; justify-content: space-between; align-items: center;"> LOCK SPARE </div>															
W																
Reset	0	0	0	0	0	0	0	0	0	0	0	0	0	0	0	0
Bit	15	14	13	12	11	10	9	8	7	6	5	4	3	2	1	0
R	<div style="display: flex; justify-content: space-between; align-items: center;"> SPARE HAB_JDE </div>															
W																
Reset	0	0	0	0	0	0	0	0	0	0	0	0	0	0	0	0

OCOTP_SCSn field descriptions

Field	Description
31 LOCK	When set, all of the bits in this register are locked and can not be changed through SW programming. This bit is only reset after a POR is issued.
30–1 SPARE	Unallocated read/write bits for implementation specific software use.
0 HAB_JDE	<p>HAB JTAG Debug Enable. This bit is used by the HAB to enable JTAG debugging, assuming that a properly signed command to do so is found and validated by the HAB.</p> <p>The HAB must lock the register before passing control to the OS whether or not JTAG debugging has been enabled.</p> <p>Once JTAG is enabled by this bit, it can not be disabled unless the system is reset by POR. 0: JTAG debugging is not enabled by the HAB (it may still be enabled by other mechanisms).</p> <p>1: JTAG debugging is enabled by the HAB (though this signal may be gated off).</p>

37.5.8 OTP Controller CRC Test Address (OCOTP_CRC_ADDR)

The address for CRC calculation

Address: 21B_C000h base + 70h offset = 21B_C070h

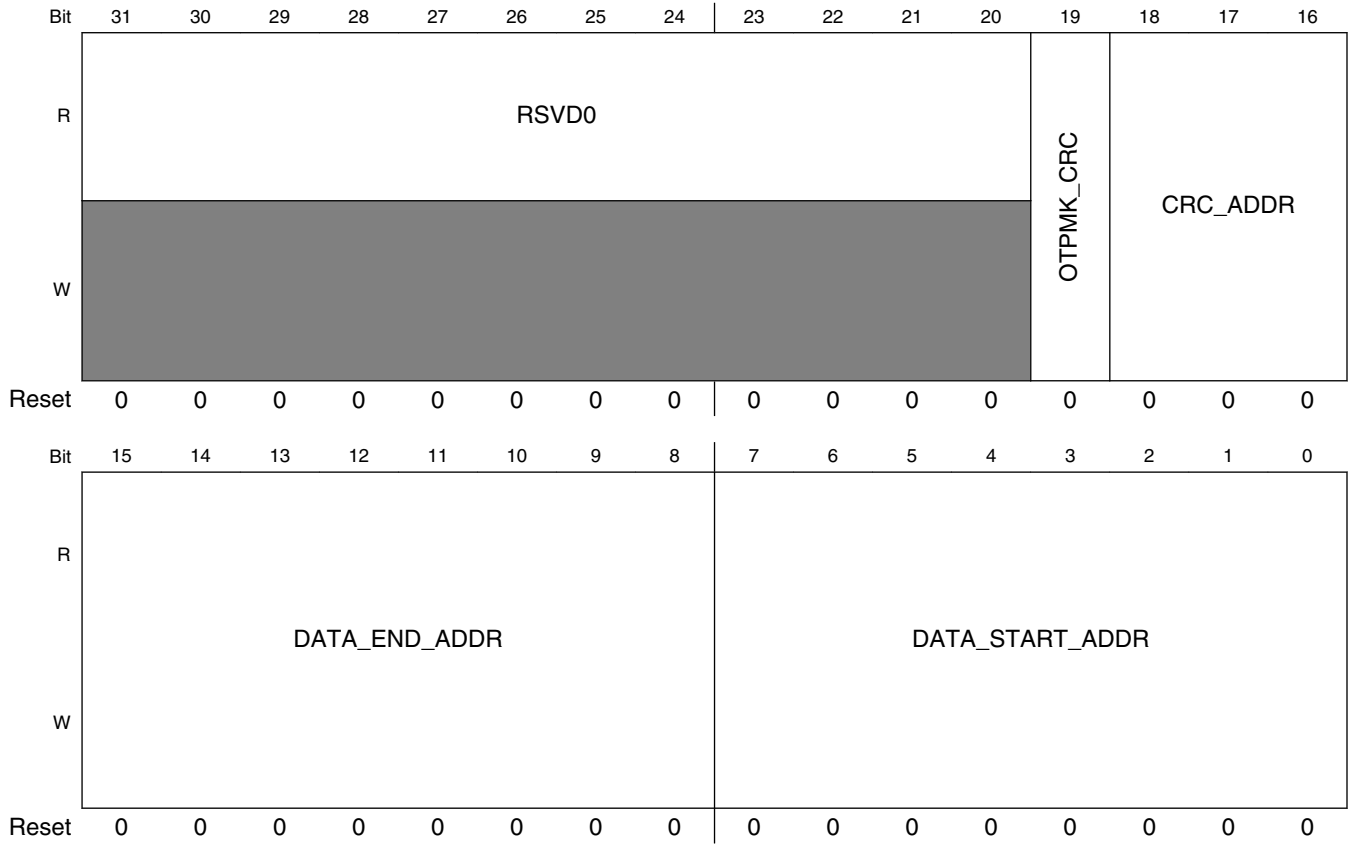

OCOTP_CRC_ADDR field descriptions

Field	Description
31–20 RSVD0	Reserved
19 OTPMK_CRC	Enable bit for CRC32 calculation address When OTPMK_CRC_ADDR_OTPMK_CRC bit sets to 1, calculation address sets to OTPMK_CRC (recommend).
18–16 CRC_ADDR	Address of 32-bit CRC result for comparing
15–8 DATA_END_ADDR	Start address of fuse location for CRC calculation
DATA_START_ADDR	End address of fuse location for CRC calculation

37.5.9 OTP Controller CRC Value Register (OCOTP_CRC_VALUE)

The CRC32 value is based on CRC_ADDR.

OCOTP Memory Map/Register Definition

Address: 21B_C000h base + 80h offset = 21B_C080h

Bit	31	30	29	28	27	26	25	24	23	22	21	20	19	18	17	16	15	14	13	12	11	10	9	8	7	6	5	4	3	2	1	0
R	DATA																															
W																																
Reset	0	0	0	0	0	0	0	0	0	0	0	0	0	0	0	0	0	0	0	0	0	0	0	0	0	0	0	0	0	0	0	0

OCOTP_CRC_VALUE field descriptions

Field	Description
DATA	The crc32 value based on CRC_ADDR

37.5.10 OTP Controller Version Register (OCOTP_VERSION)

This register always returns a known read value for debug purposes it indicates the version of the block.

This register indicates the RTL version in use.

Address: 21B_C000h base + 90h offset = 21B_C090h

Bit	31	30	29	28	27	26	25	24	23	22	21	20	19	18	17	16	15	14	13	12	11	10	9	8	7	6	5	4	3	2	1	0
R	MAJOR								MINOR								STEP															
W																																
Reset	0	0	0	0	0	0	1	1	0	0	0	0	0	0	0	0	0	0	0	0	0	0	0	0	0	0	0	0	0	0	0	0

OCOTP_VERSION field descriptions

Field	Description
31–24 MAJOR	Fixed read-only value reflecting the MAJOR field of the RTL version.
23–16 MINOR	Fixed read-only value reflecting the MINOR field of the RTL version.
STEP	Fixed read-only value reflecting the stepping of the RTL version.

37.5.11 OTP Controller Timing Register 2 (OCOTP_TIMING2)

Address: 21B_C000h base + 100h offset = 21B_C100h

Bit	31	30	29	28	27	26	25	24	23	22	21	20	19	18	17	16	15	14	13	12	11	10	9	8	7	6	5	4	3	2	1	0	
R	Reserved		RELAX1								RELAX_READ				Reserved		RELAX_PROG																
W																																	
Reset	0	0	0	0	0	0	0	1	1	1	0	0	0	0	0	1	0	0	0	0	0	0	0	0	0	1	0	0	0	0	0	1	0

OCOTP_TIMING2 field descriptions

Field	Description
31–29 Reserved	This field is reserved.
28–22 RELAX1	Not used, preserved
21–16 RELAX_READ	This count value specifies the time to add to read OTP for complement address enable cycle time.
15–12 Reserved	This field is reserved.
RELAX_PROG	This count value specifies the time to add to write OTP for complement address enable time.

37.5.12 Value of OTP Bank0 Word0 (Lock controls) (OCOTP_LOCK)

Copied from the OTP automatically after reset. Can be re-loaded by setting OCOTP_CTRL[RELOAD_SHADOWS]

Shadowed memory mapped access to OTP Bank 0, word 0 (ADDR = 0x00).

OCOTP Memory Map/Register Definition

Address: 21B_C000h base + 400h offset = 21B_C400h

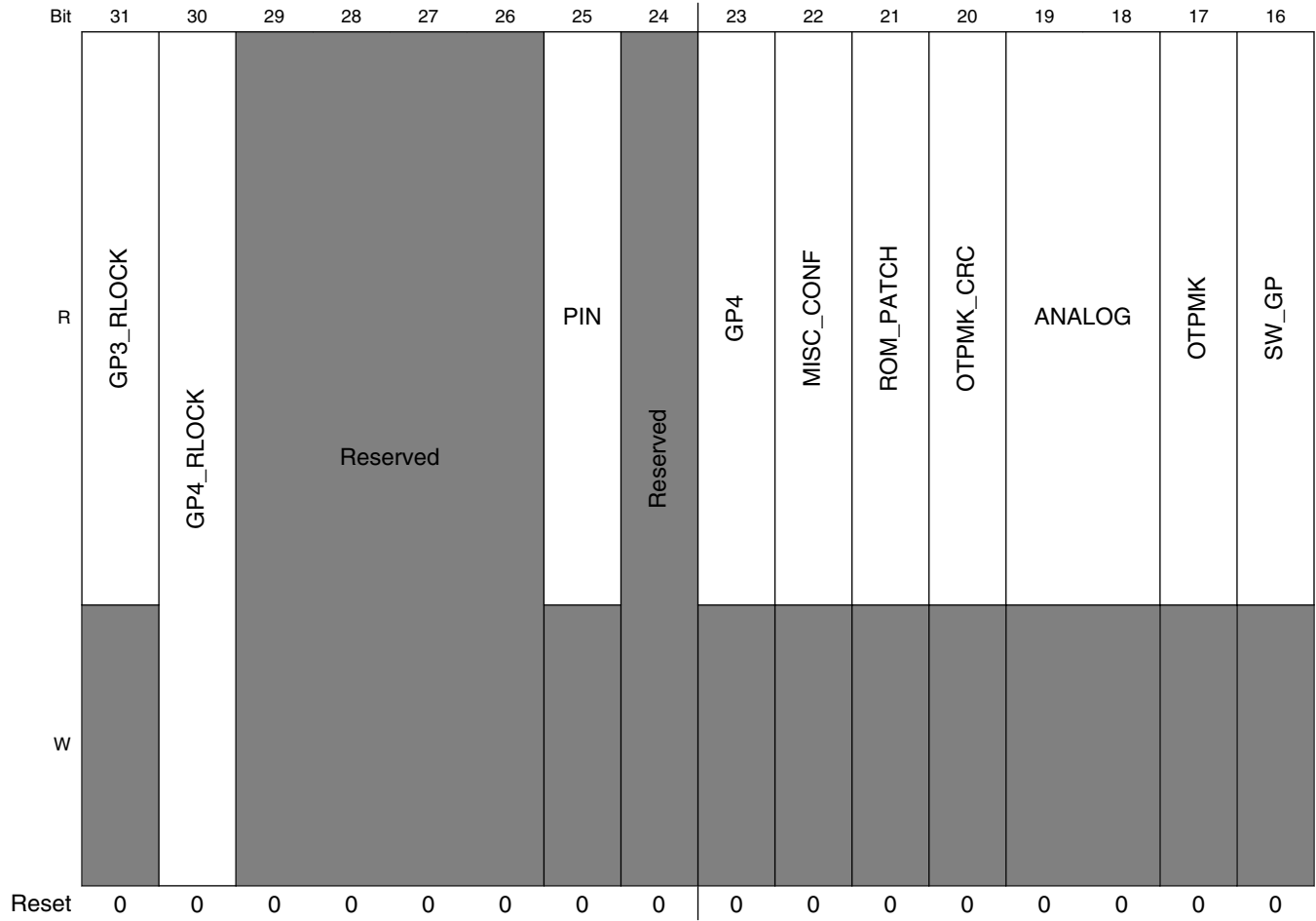

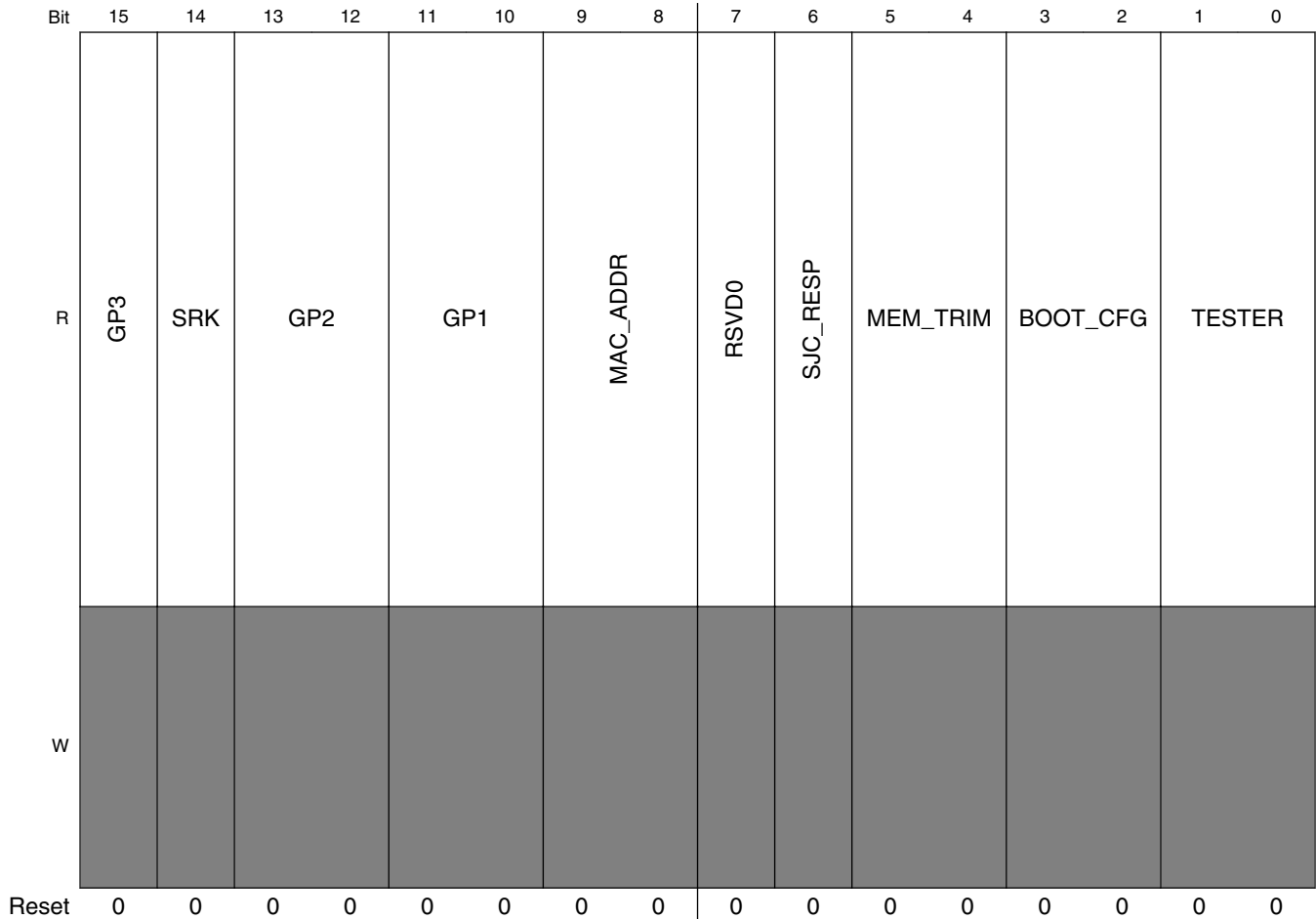

OCOTP_LOCK field descriptions

Field	Description
31 GP3_RLOCK	Status of shadow register and OTP read lock for GP3 region. When set, the reading of this region's shadow register and OTP fuse word are blocked.
30 GP4_RLOCK	Status of shadow register and OTP read lock for GP4 region. When set, the reading of this region's shadow register and OTP fuse word are blocked.
29–26 Reserved	This field is reserved.
25 PIN	Status of Pin access lock bit. When set, pin access is disabled.
24 Reserved	This field is reserved.
23 GP4	Status of shadow register and OTP write lock for GP4 region. When set, the writing of this region's shadow register and OTP fuse word are blocked.
22 MISC_CONF	Status of shadow register and OTP write lock for misc_conf region. When set, the writing of this region's shadow register and OTP fuse word are blocked.
21 ROM_PATCH	Status of shadow register and OTP write lock for rom_patch region. When set, the writing of this region's shadow register and OTP fuse word are blocked.
20 OTPMK_CRC	Status of shadow register and OTP write lock for otpmk crc region. When set, the writing of this region's shadow register and OTP fuse word are blocked.

Table continues on the next page...

OCOTP_LOCK field descriptions (continued)

Field	Description
19–18 ANALOG	Status of shadow register and OTP write lock for analog region. When bit 1 is set, the writing of this region's shadow register is blocked. When bit 0 is set, the writing of this region's OTP fuse word is blocked.
17 OTPMK	Status of shadow register and OTP write lock for OTPMK region. When set, the writing of this region's shadow register and OTP fuse word are blocked.
16 SW_GP	Status of shadow register and OTP write lock for SW_GP region. When set, the writing of this region's shadow register and OTP fuse word are blocked.
15 GP3	Status of shadow register and OTP write lock for GP3 region. When set, the writing of this region's shadow register and OTP fuse word are blocked.
14 SRK	Status of shadow register and OTP write lock for srk region. When set, the writing of this region's shadow register and OTP fuse word are blocked.
13–12 GP2	Status of shadow register and OTP write lock for gp2 region. When bit 1 is set, the writing of this region's shadow register is blocked. When bit 0 is set, the writing of this region's OTP fuse word is blocked.
11–10 GP1	Status of shadow register and OTP write lock for gp2 region. When bit 1 is set, the writing of this region's shadow register is blocked. When bit 0 is set, the writing of this region's OTP fuse word is blocked.
9–8 MAC_ADDR	Status of shadow register and OTP write lock for mac_addr region. When bit 1 is set, the writing of this region's shadow register is blocked. When bit 0 is set, the writing of this region's OTP fuse word is blocked.
7 RSVD0	Reserved
6 SJC_RESP	Status of shadow register read and write, OTP read and write lock for sjc_resp region. When set, the writing of this region's shadow register and OTP fuse word are blocked. The read of this region's shadow register and OTP fuse word are also blocked.
5–4 MEM_TRIM	Status of shadow register and OTP write lock for mem_trim region. When bit 1 is set, the writing of this region's shadow register is blocked. When bit 0 is set, the writing of this region's OTP fuse word is blocked.
3–2 BOOT_CFG	Status of shadow register and OTP write lock for boot_cfg region. When bit 1 is set, the writing of this region's shadow register is blocked. When bit 0 is set, the writing of this region's OTP fuse word is blocked.
TESTER	Status of shadow register and OTP write lock for tester region. When bit 1 is set, the writing of this region's shadow register is blocked. When bit 0 is set, the writing of this region's OTP fuse word is blocked.

37.5.13 Value of OTP Bank0 Word1 (Configuration and Manufacturing Info.) (OCOTP_CFG0)

Copied from the OTP automatically after reset. Can be re-loaded by setting OCOTP_CTRL[RELOAD_SHADOWS]

Shadowed memory mapped access to OTP Bank 0, word 1 (ADDR = 0x01).

Address: 21B_C000h base + 410h offset = 21B_C410h

Bit	31	30	29	28	27	26	25	24	23	22	21	20	19	18	17	16	15	14	13	12	11	10	9	8	7	6	5	4	3	2	1	0
R																																
W																																
Reset	0	0	0	0	0	0	0	0	0	0	0	0	0	0	0	0	0	0	0	0	0	0	0	0	0	0	0	0	0	0	0	0

OCOTP_CFG0 field descriptions

Field	Description
BITS	This register contains 32 bits of the Unique ID and SJC_CHALLENGE field. Reflects value of OTP Bank 0, word 1 (ADDR = 0x01). These bits become read-only after the HW_OCOTP_LOCK_TESTER[1] bit is set.

37.5.14 Value of OTP Bank0 Word2 (Configuration and Manufacturing Info.) (OCOTP_CFG1)

Copied from the OTP automatically after reset. Can be re-loaded by setting OCOTP_CTRL[RELOAD_SHADOWS]

Shadowed memory mapped access to OTP Bank 0, word 2 (ADDR = 0x02).

Address: 21B_C000h base + 420h offset = 21B_C420h

Bit	31	30	29	28	27	26	25	24	23	22	21	20	19	18	17	16	15	14	13	12	11	10	9	8	7	6	5	4	3	2	1	0
R																																
W																																
Reset	0	0	0	0	0	0	0	0	0	0	0	0	0	0	0	0	0	0	0	0	0	0	0	0	0	0	0	0	0	0	0	0

OCOTP_CFG1 field descriptions

Field	Description
BITS	This register contains 32 bits of the Unique ID and SJC_CHALLENGE field. Reflects value of OTP Bank 0, word 2 (ADDR = 0x02). These bits become read-only after the HW_OCOTP_LOCK_TESTER[1] bit is set.

37.5.15 Value of OTP Bank0 Word3 (Configuration and Manufacturing Info.) (OCOTP_CFG2)

Copied from the OTP automatically after reset. Can be re-loaded by setting OCOTP_CTRL[RELOAD_SHADOWS]

Shadowed memory mapped access to OTP Bank 0, word 3 (ADDR = 0x03).

Address: 21B_C000h base + 430h offset = 21B_C430h

Bit	31	30	29	28	27	26	25	24	23	22	21	20	19	18	17	16	15	14	13	12	11	10	9	8	7	6	5	4	3	2	1	0
R																																
W																																
Reset	0	0	0	0	0	0	0	0	0	0	0	0	0	0	0	0	0	0	0	0	0	0	0	0	0	0	0	0	0	0	0	0

OCOTP_CFG2 field descriptions

Field	Description
BITS	Reflects value of OTP Bank 0, word 3 (ADDR = 0x03). These bits become read-only after the HW_OCOTP_LOCK_TESTER[1] bit is set.

37.5.16 Value of OTP Bank0 Word4 (Configuration and Manufacturing Info.) (OCOTP_CFG3)

Copied from the OTP automatically after reset. Can be re-loaded by setting OCOTP_CTRL[RELOAD_SHADOWS]

Non-shadowed memory mapped access to OTP Bank 0, word 4 (ADDR = 0x04).

Address: 21B_C000h base + 440h offset = 21B_C440h

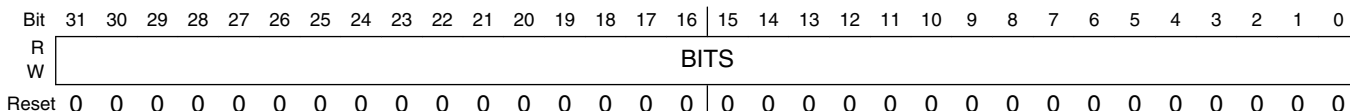

OCOTP_CFG3 field descriptions

Field	Description
BITS	Reflects value of OTP Bank 0, word 4 (ADDR = 0x04). These bits become read-only after the HW_OCOTP_LOCK_TESTER[1] bit is set.

37.5.17 Value of OTP Bank0 Word5 (Configuration and Manufacturing Info.) (OCOTP_CFG4)

Copied from the OTP automatically after reset. Can be re-loaded by setting OCOTP_CTRL[RELOAD_SHADOWS]

Shadowed memory mapped access to OTP Bank 0, word 5 (ADDR = 0x05).

Address: 21B_C000h base + 450h offset = 21B_C450h

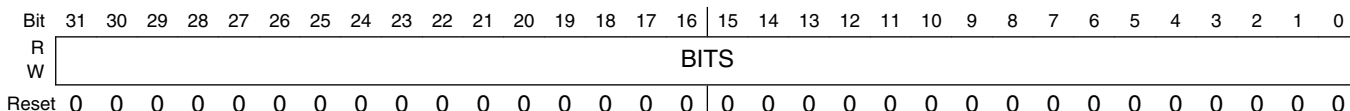

OCOTP_CFG4 field descriptions

Field	Description
BITS	Reflects value of OTP Bank 0, word 5 (ADDR = 0x05). These bits become read-only after the HW_OCOTP_LOCK_BOOT_CFG[1] bit is set.

37.5.18 Value of OTP Bank0 Word6 (Configuration and Manufacturing Info.) (OCOTP_CFG5)

Copied from the OTP automatically after reset. Can be re-loaded by setting OCOTP_CTRL[RELOAD_SHADOWS]

Shadowed memory mapped access to OTP Bank 0, word 6 (ADDR = 0x06).

Address: 21B_C000h base + 460h offset = 21B_C460h

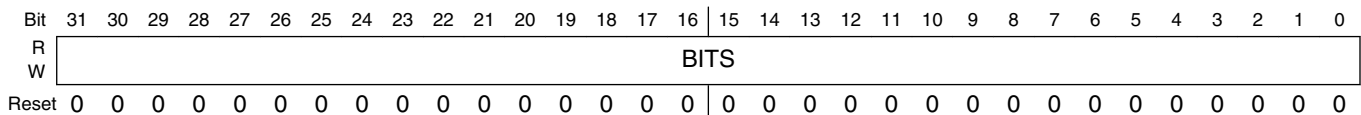

OCOTP_CFG5 field descriptions

Field	Description
BITS	Reflects value of OTP Bank 0, word 6 (ADDR = 0x06). These bits become read-only after the HW_OCOTP_LOCK_BOOT_CFG[1] bit is set.

37.5.19 Value of OTP Bank0 Word7 (Configuration and Manufacturing Info.) (OCOTP_CFG6)

Copied from the OTP automatically after reset. Can be re-loaded by setting OCOTP_CTRL[RELOAD_SHADOWS]

Shadowed memory mapped access to OTP Bank 0, word 7 (ADDR = 0x07).

Address: 21B_C000h base + 470h offset = 21B_C470h

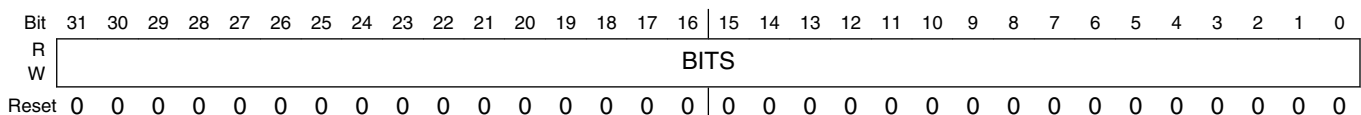

OCOTP_CFG6 field descriptions

Field	Description
BITS	Reflects value of OTP Bank 0, word 7 (ADDR = 0x07). These bits become read-only after the HW_OCOTP_LOCK_BOOT_CFG[1] bit is set.

37.5.20 Value of OTP Bank1 Word0 (Memory Related Info.) (OCOTP_MEM0)

Copied from the OTP automatically after reset. Can be re-loaded by setting OCOTP_CTRL[RELOAD_SHADOWS]

Shadowed memory mapped access to OTP bank 1, word 0 (ADDR = 0x08).

Address: 21B_C000h base + 480h offset = 21B_C480h

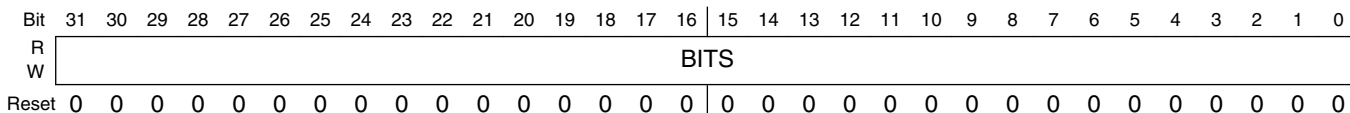

OCOTP_MEM0 field descriptions

Field	Description
BITS	Reflects value of OTP bank 1, word 0 (ADDR = 0x08). These bits become read-only after the HW_OCOTP_LOCK_MEM_TRIM[1] bit is set.

37.5.21 Value of OTP Bank1 Word1 (Memory Related Info.) (OCOTP_MEM1)

Copied from the OTP automatically after reset. Can be re-loaded by setting OCOTP_CTRL[RELOAD_SHADOWS]

Shadowed memory mapped access to OTP bank 1, word 1 (ADDR = 0x09).

Address: 21B_C000h base + 490h offset = 21B_C490h

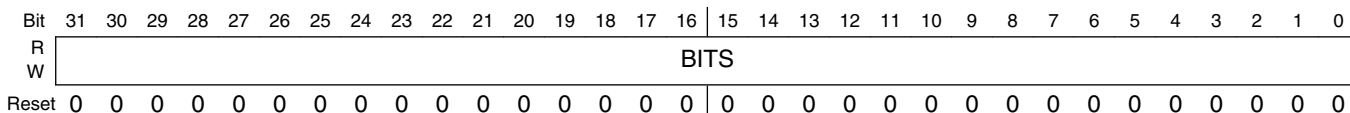

OCOTP_MEM1 field descriptions

Field	Description
BITS	Reflects value of OTP bank 1, word 1 (ADDR = 0x09). These bits become read-only after the HW_OCOTP_LOCK_MEM_TRIM[1] bit is set.

37.5.22 Value of OTP Bank1 Word2 (Memory Related Info.) (OCOTP_MEM2)

Copied from the OTP automatically after reset. Can be re-loaded by setting OCOTP_CTRL[RELOAD_SHADOWS]

Shadowed memory mapped access to OTP bank 1, word 2 (ADDR = 0x0A).

Address: 21B_C000h base + 4A0h offset = 21B_C4A0h

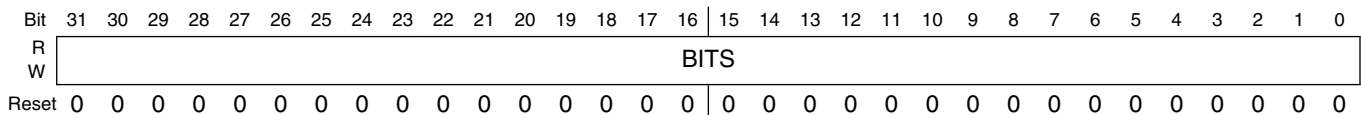

OCOTP_MEM2 field descriptions

Field	Description
BITS	Reflects value of OTP bank 1, word 2 (ADDR = 0x0A). These bits become read-only after the HW_OCOTP_LOCK_MEM_TRIM[1] bit is set.

37.5.23 Value of OTP Bank1 Word3 (Memory Related Info.) (OCOTP_MEM3)

Copied from the OTP automatically after reset. Can be re-loaded by setting OCOTP_CTRL[RELOAD_SHADOWS]

Shadowed memory mapped access to OTP bank 1, word 3 (ADDR = 0x0B).

Address: 21B_C000h base + 4B0h offset = 21B_C4B0h

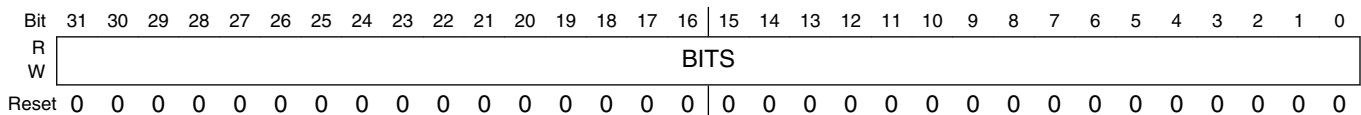

OCOTP_MEM3 field descriptions

Field	Description
BITS	Reflects value of OTP bank 1, word 3 (ADDR = 0x0B). These bits become read-only after the HW_OCOTP_LOCK_MEM_TRIM[1] bit is set.

37.5.24 Value of OTP Bank1 Word4 (Memory Related Info.) (OCOTP_MEM4)

Copied from the OTP automatically after reset. Can be re-loaded by setting OCOTP_CTRL[RELOAD_SHADOWS]

Shadowed memory mapped access to OTP bank 1, word 4 (ADDR = 0x0C).

Address: 21B_C000h base + 4C0h offset = 21B_C4C0h

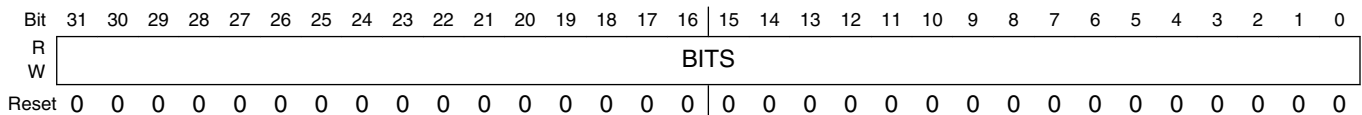

OCOTP_MEM4 field descriptions

Field	Description
BITS	Reflects value of OTP bank 1, word 4 (ADDR = 0x0C). These bits become read-only after the HW_OCOTP_LOCK_MEM_TRIM[1] bit is set.

37.5.25 Value of OTP Bank1 Word5 (Memory Related Info.) (OCOTP_ANA0)

Copied from the OTP automatically after reset. Can be re-loaded by setting OCOTP_CTRL[RELOAD_SHADOWS]

Shadowed memory mapped access to OTP bank 1, word 5 (ADDR = 0x0D).

Address: 21B_C000h base + 4D0h offset = 21B_C4D0h

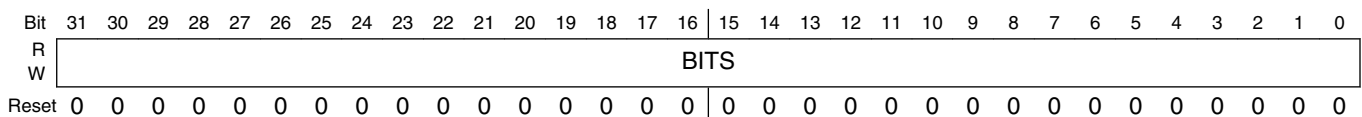

OCOTP_ANA0 field descriptions

Field	Description
BITS	Reflects value of OTP bank 1, word 5 (ADDR = 0x0D). These bits become read-only after the HW_OCOTP_LOCK_ANALOG[1] bit is set.

37.5.26 Value of OTP Bank1 Word6 (General Purpose Customer Defined Info.) (OCOTP_ANA1)

Copied from the OTP automatically after reset. Can be re-loaded by setting OCOTP_CTRL[RELOAD_SHADOWS]

Shadowed memory mapped access to OTP bank 1, word 6 (ADDR = 0x0E).

Address: 21B_C000h base + 4E0h offset = 21B_C4E0h

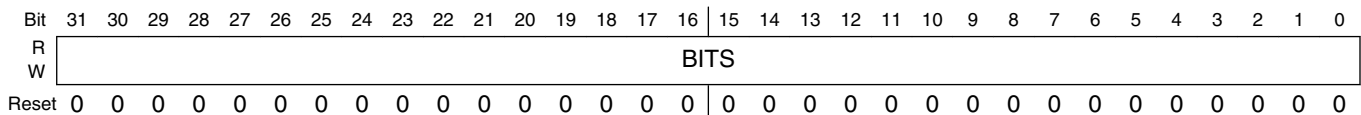

OCOTP_ANA1 field descriptions

Field	Description
BITS	Reflects value of OTP bank 1, word 6 (ADDR = 0x0E). These bits become read-only after the HW_OCOTP_LOCK_ANALOG[1] bit is set.

37.5.27 Value of OTP Bank1 Word7 (General Purpose Customer Defined Info.) (OCOTP_ANA2)

Copied from the OTP automatically after reset. Can be re-loaded by setting OCOTP_CTRL[RELOAD_SHADOWS]

Shadowed memory mapped access to OTP bank 1, word 7 (ADDR = 0x0F).

Address: 21B_C000h base + 4F0h offset = 21B_C4F0h

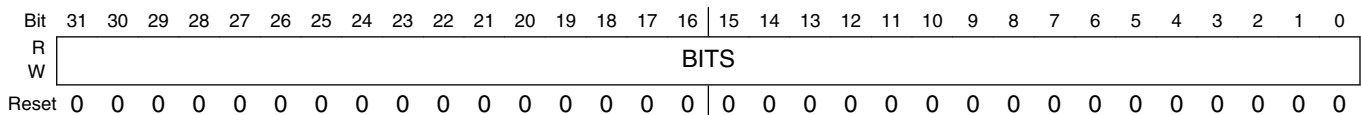

OCOTP_ANA2 field descriptions

Field	Description
BITS	Reflects value of OTP bank 1, word 7 (ADDR = 0x0F). These bits become read-only after the HW_OCOTP_LOCK_ANALOG[1] bit is set.

37.5.28 Value of OTP Bank2 Word0 (OTPMK Key) (OCOTP_OTPMK0)

Shadow register for the OTPMK Key word0 (Copy of OTP Bank 2, word 0 (ADDR = 0x10)). These bits can not be read and written after the HW_OCOTP_LOCK_OTPMK bit is set. If read, returns 0xBADA_BADA and sets HW_OCOTP_CTRL[ERROR].

Address: 21B_C000h base + 500h offset = 21B_C500h

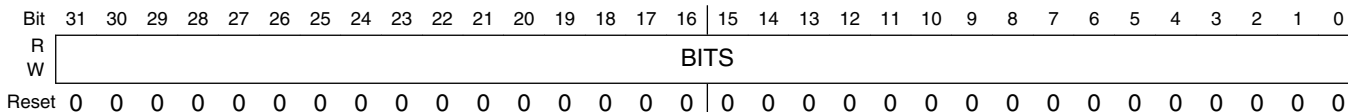

OCOTP_OTPMK0 field descriptions

Field	Description
BITS	Shadow register for the OTPMK Key word0 (Copy of OTP Bank 2, word 0 (ADDR = 0x10)). These bits can not be read and written after the HW_OCOTP_LOCK_OTPMK bit is set. If read, returns 0xBADA_BADA and sets HW_OCOTP_CTRL[ERROR].

37.5.29 Value of OTP Bank2 Word1 (OTPMK Key) (OCOTP_OTPMK1)

Copied from the OTP automatically after reset. Can be re-loaded by setting OCOTP_CTRL[RELOAD_SHADOWS]

Shadowed memory mapped access to OTP bank 2, word 1 (ADDR = 0x11).

Address: 21B_C000h base + 510h offset = 21B_C510h

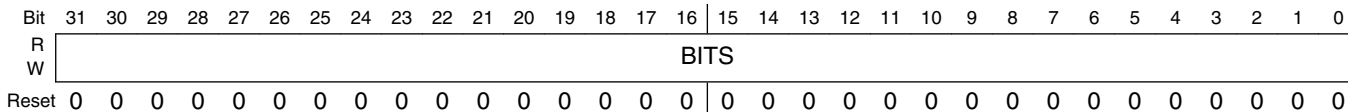

OCOTP_OTPMK1 field descriptions

Field	Description
BITS	Shadow register for the OTPMK Key word0 (Copy of OTP Bank 2, word 1 (ADDR = 0x11)). These bits can not be read and written after the HW_OCOTP_LOCK_OTPMK bit is set. If read, returns 0xBADA_BADA and sets HW_OCOTP_CTRL[ERROR].

37.5.30 Value of OTP Bank2 Word2 (OTPMK Key) (OCOTP_OTPMK2)

Copied from the OTP automatically after reset. Can be re-loaded by setting OCOTP_CTRL[RELOAD_SHADOWS]

Shadowed memory mapped access to OTP bank 2, word 2 (ADDR = 0x12).

Address: 21B_C000h base + 520h offset = 21B_C520h

Bit	31	30	29	28	27	26	25	24	23	22	21	20	19	18	17	16	15	14	13	12	11	10	9	8	7	6	5	4	3	2	1	0
R																																
W																																
Reset	0	0	0	0	0	0	0	0	0	0	0	0	0	0	0	0	0	0	0	0	0	0	0	0	0	0	0	0	0	0	0	0

OCOTP_OTPMK2 field descriptions

Field	Description
BITS	Shadow register for the OTPMK Key word0 (Copy of OTP Bank 2, word 2 (ADDR = 0x12)). These bits can not be read and written after the HW_OCOTP_LOCK_OTPMK bit is set. If read, returns 0xBADA_BADA and sets HW_OCOTP_CTRL[ERROR].

37.5.31 Value of OTP Bank2 Word3 (OTPMK Key) (OCOTP_OTPMK3)

Copied from the OTP automatically after reset. Can be re-loaded by setting OCOTP_CTRL[RELOAD_SHADOWS]

Shadowed memory mapped access to OTP bank 2, word 3 (ADDR = 0x13).

Address: 21B_C000h base + 530h offset = 21B_C530h

Bit	31	30	29	28	27	26	25	24	23	22	21	20	19	18	17	16	15	14	13	12	11	10	9	8	7	6	5	4	3	2	1	0
R																																
W																																
Reset	0	0	0	0	0	0	0	0	0	0	0	0	0	0	0	0	0	0	0	0	0	0	0	0	0	0	0	0	0	0	0	0

OCOTP_OTPMK3 field descriptions

Field	Description
BITS	Shadow register for the OTPMK Key word0 (Copy of OTP Bank 2, word 3 (ADDR = 0x13)). These bits can not be read and written after the HW_OCOTP_LOCK_OTPMK bit is set. If read, returns 0xBADA_BADA and sets HW_OCOTP_CTRL[ERROR].

37.5.32 Value of OTP Bank2 Word4 (OTPMK Key) (OCOTP_OTPMK4)

Copied from the OTP automatically after reset. Can be re-loaded by setting OCOTP_CTRL[RELOAD_SHADOWS]

Shadowed memory mapped access to OTP bank 2, word 4 (ADDR = 0x14).

Address: 21B_C000h base + 540h offset = 21B_C540h

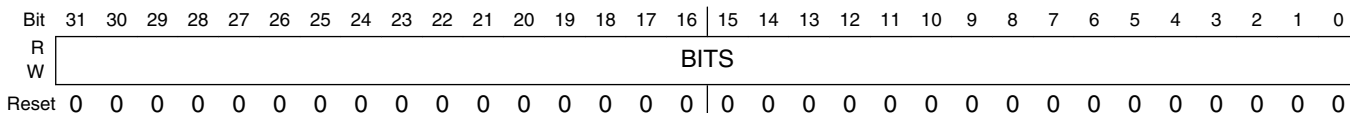

OCOTP_OTPMK4 field descriptions

Field	Description
BITS	Shadow register for the OTPMK Key word0 (Copy of OTP Bank 2, word 4 (ADDR = 0x14)). These bits can not be read and written after the HW_OCOTP_LOCK_OTPMK bit is set. If read, returns 0xBADA_BADA and sets HW_OCOTP_CTRL[ERROR].

37.5.33 Value of OTP Bank2 Word5 (OTPMK Key) (OCOTP_OTPMK5)

Copied from the OTP automatically after reset. Can be re-loaded by setting OCOTP_CTRL[RELOAD_SHADOWS]

Shadowed memory mapped access to OTP bank 2, word 5 (ADDR = 0x15).

Address: 21B_C000h base + 550h offset = 21B_C550h

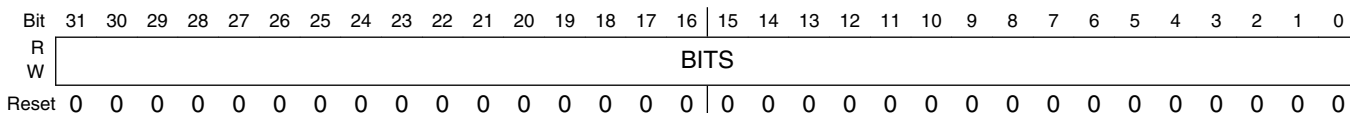

OCOTP_OTPMK5 field descriptions

Field	Description
BITS	Shadow register for the OTPMK Key word0 (Copy of OTP Bank 2, word 4 (ADDR = 0x14)). These bits can not be read and written after the HW_OCOTP_LOCK_OTPMK bit is set. If read, returns 0xBADA_BADA and sets HW_OCOTP_CTRL[ERROR].

37.5.34 Value of OTP Bank2 Word6 (OTPMK Key) (OCOTP_OTPMK6)

Copied from the OTP automatically after reset. Can be re-loaded by setting OCOTP_CTRL[RELOAD_SHADOWS]

Shadowed memory mapped access to OTP bank 2, word 6 (ADDR = 0x16).

Address: 21B_C000h base + 560h offset = 21B_C560h

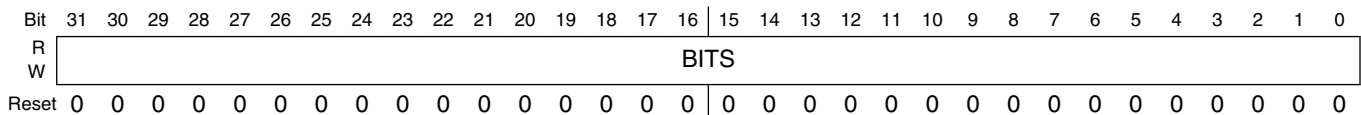

OCOTP_OTPMK6 field descriptions

Field	Description
BITS	Shadow register for the OTPMK Key word0 (Copy of OTP Bank 2, word 6 (ADDR = 0x16)). These bits can not be read and written after the HW_OCOTP_LOCK_OTPMK bit is set. If read, returns 0xBADA_BADA and sets HW_OCOTP_CTRL[ERROR].

37.5.35 Value of OTP Bank2 Word7 (OTPMK Key) (OCOTP_OTPMK7)

Copied from the OTP automatically after reset. Can be re-loaded by setting OCOTP_CTRL[RELOAD_SHADOWS]

Shadowed memory mapped access to OTP bank 2, word 7 (ADDR = 0x17).

Address: 21B_C000h base + 570h offset = 21B_C570h

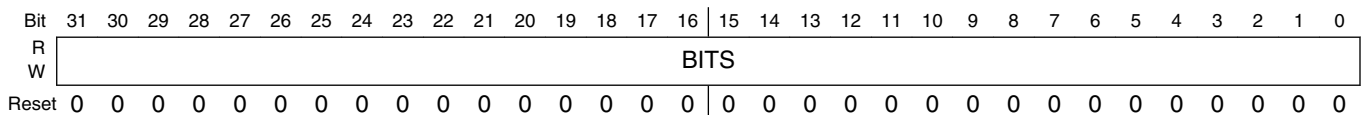

OCOTP_OTPMK7 field descriptions

Field	Description
BITS	Shadow register for the OTPMK Key word0 (Copy of OTP Bank 2, word 7 (ADDR = 0x17)). These bits can not be read and written after the HW_OCOTP_LOCK_OTPMK bit is set. If read, returns 0xBADA_BADA and sets HW_OCOTP_CTRL[ERROR].

37.5.36 Shadow Register for OTP Bank3 Word0 (SRK Hash) (OCOTP_SRK0)

Copied from the OTP automatically after reset. Can be re-loaded by setting OCOTP_CTRL[RELOAD_SHADOWS].

Shadowed memory mapped access to OTP Bank 3, word 0 (ADDR = 0x18).

Address: 21B_C000h base + 580h offset = 21B_C580h

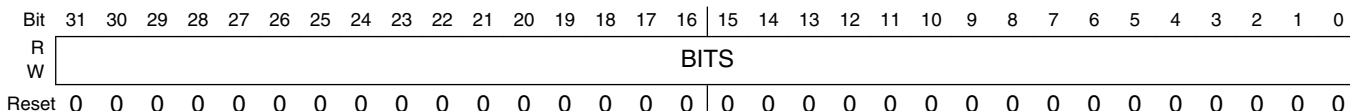

OCOTP_SRK0 field descriptions

Field	Description
BITS	Shadow register for the hash of the Super Root Key word0 (Copy of OTP Bank 3, word 0 (ADDR = 0x18)). These bits become read-only after the HW_OCOTP_LOCK_SRK bit is set.

37.5.37 Shadow Register for OTP Bank3 Word1 (SRK Hash) (OCOTP_SRK1)

Copied from the OTP automatically after reset. Can be re-loaded by setting OCOTP_CTRL[RELOAD_SHADOWS].

Shadowed memory mapped access to OTP Bank 3, word 1 (ADDR = 0x19).

Address: 21B_C000h base + 590h offset = 21B_C590h

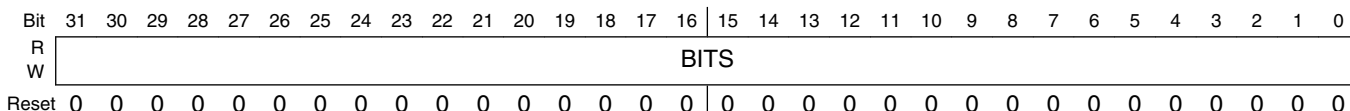

OCOTP_SRK1 field descriptions

Field	Description
BITS	Shadow register for the hash of the Super Root Key word1 (Copy of OTP Bank 3, word 1 (ADDR = 0x19)). These bits become read-only after the HW_OCOTP_LOCK_SRK bit is set.

37.5.38 Shadow Register for OTP Bank3 Word2 (SRK Hash) (OCOTP_SRK2)

Copied from the OTP automatically after reset. Can be re-loaded by setting OCOTP_CTRL[RELOAD_SHADOWS].

Shadowed memory mapped access to OTP Bank 3, word 2 (ADDR = 0x1A).

Address: 21B_C000h base + 5A0h offset = 21B_C5A0h

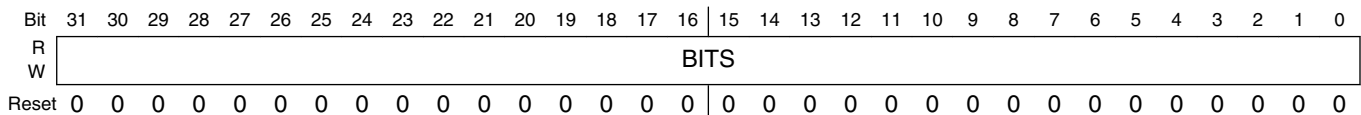

OCOTP_SRK2 field descriptions

Field	Description
BITS	Shadow register for the hash of the Super Root Key word2 (Copy of OTP Bank 3, word 2 (ADDR = 0x1A)). These bits become read-only after the HW_OCOTP_LOCK_SRK bit is set.

37.5.39 Shadow Register for OTP Bank3 Word3 (SRK Hash) (OCOTP_SRK3)

Copied from the OTP automatically after reset. Can be re-loaded by setting OCOTP_CTRL[RELOAD_SHADOWS].

Shadowed memory mapped access to OTP Bank 3, word 3 (ADDR = 0x1B).

Address: 21B_C000h base + 5B0h offset = 21B_C5B0h

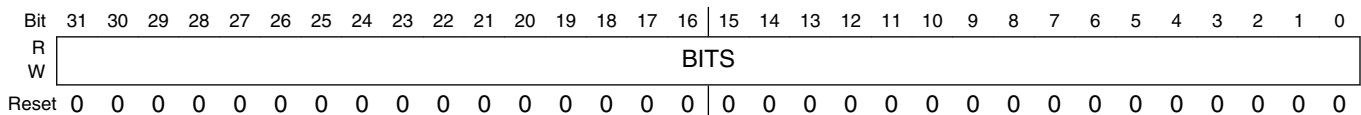

OCOTP_SRK3 field descriptions

Field	Description
BITS	Shadow register for the hash of the Super Root Key word3 (Copy of OTP Bank 3, word 3 (ADDR = 0x1B)). These bits become read-only after the HW_OCOTP_LOCK_SRK bit is set.

37.5.40 Shadow Register for OTP Bank3 Word4 (SRK Hash) (OCOTP_SRK4)

Copied from the OTP automatically after reset. Can be re-loaded by setting OCOTP_CTRL[RELOAD_SHADOWS].

Shadowed memory mapped access to OTP Bank 3, word 4 (ADDR = 0x1C).

Address: 21B_C000h base + 5C0h offset = 21B_C5C0h

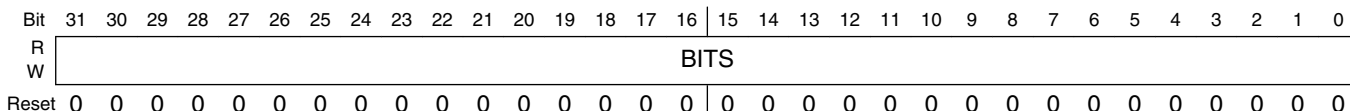

OCOTP_SRK4 field descriptions

Field	Description
BITS	Shadow register for the hash of the Super Root Key word4 (Copy of OTP Bank 3, word 4 (ADDR = 0x1C)). These bits become read-only after the HW_OCOTP_LOCK_SRK bit is set.

37.5.41 Shadow Register for OTP Bank3 Word5 (SRK Hash) (OCOTP_SRK5)

Copied from the OTP automatically after reset. Can be re-loaded by setting OCOTP_CTRL[RELOAD_SHADOWS].

Shadowed memory mapped access to OTP Bank 3, word 5 (ADDR = 0x1D).

Address: 21B_C000h base + 5D0h offset = 21B_C5D0h

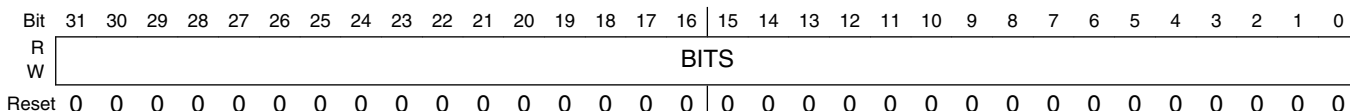

OCOTP_SRK5 field descriptions

Field	Description
BITS	Shadow register for the hash of the Super Root Key word5 (Copy of OTP Bank 3, word 5 (ADDR = 0x1D)). These bits become read-only after the HW_OCOTP_LOCK_SRK bit is set.

37.5.42 Shadow Register for OTP Bank3 Word6 (SRK Hash) (OCOTP_SRK6)

Copied from the OTP automatically after reset. Can be re-loaded by setting OCOTP_CTRL[RELOAD_SHADOWS].

Shadowed memory mapped access to OTP Bank 3, word 6 (ADDR = 0x1E).

Address: 21B_C000h base + 5E0h offset = 21B_C5E0h

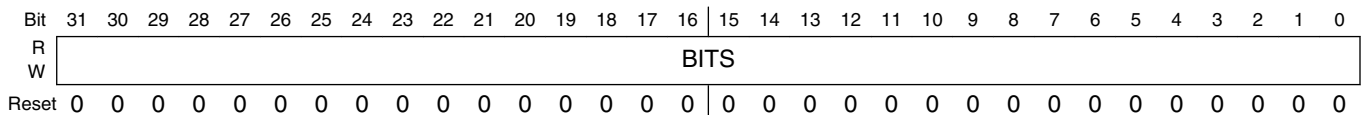

OCOTP_SRK6 field descriptions

Field	Description
BITS	Shadow register for the hash of the Super Root Key word6 (Copy of OTP Bank 3, word 6 (ADDR = 0x1E)). These bits become read-only after the HW_OCOTP_LOCK_SRK bit is set.

37.5.43 Shadow Register for OTP Bank3 Word7 (SRK Hash) (OCOTP_SRK7)

Copied from the OTP automatically after reset. Can be re-loaded by setting OCOTP_CTRL[RELOAD_SHADOWS].

Shadowed memory mapped access to OTP Bank 3, word 7 (ADDR = 0x1F).

Address: 21B_C000h base + 5F0h offset = 21B_C5F0h

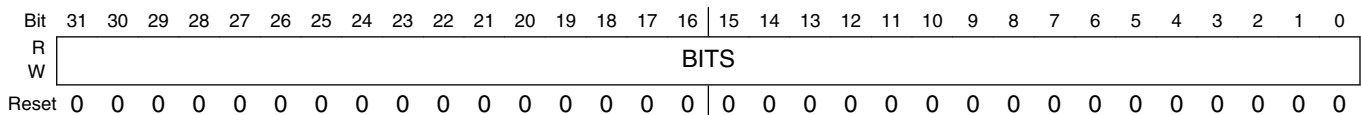

OCOTP_SRK7 field descriptions

Field	Description
BITS	Shadow register for the hash of the Super Root Key word7 (Copy of OTP Bank 3, word 7 (ADDR = 0x1F)). These bits become read-only after the HW_OCOTP_LOCK_SRK bit is set.

37.5.44 Value of OTP Bank4 Word0 (Secure JTAG Response Field) (OCOTP_SJC_RESP0)

Copied from the OTP automatically after reset. Can be re-loaded by setting OCOTP_CTRL[RELOAD_SHADOWS]

Shadowed memory mapped access to OTP Bank 4, word 0 (ADDR = 0x20).

Address: 21B_C000h base + 600h offset = 21B_C600h

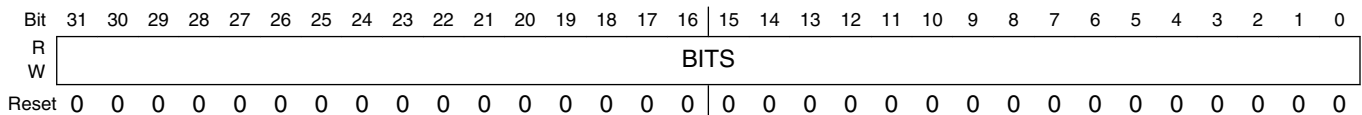

OCOTP_SJC_RESP0 field descriptions

Field	Description
BITS	Shadow register for the SJC_RESP Key word0 (Copy of OTP Bank 4, word 0 (ADDR = 0x20)). These bits can be not read and written after the HW_OCOTP_LOCK_SJC_RESP bit is set. If read, returns 0xBADA_BADA and sets HW_OCOTP_CTRL[ERROR].

37.5.45 Value of OTP Bank4 Word1 (Secure JTAG Response Field) (OCOTP_SJC_RESP1)

Copied from the OTP automatically after reset. Can be re-loaded by setting OCOTP_CTRL[RELOAD_SHADOWS]

Shadowed memory mapped access to OTP Bank 4, word 1 (ADDR = 0x21).

Address: 21B_C000h base + 610h offset = 21B_C610h

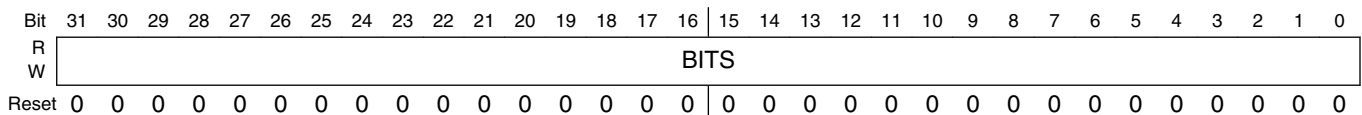

OCOTP_SJC_RESP1 field descriptions

Field	Description
BITS	Shadow register for the SJC_RESP Key word1 (Copy of OTP Bank 4, word 1 (ADDR = 0x21)). These bits can be not read and written after the HW_OCOTP_LOCK_SJC_RESP bit is set. If read, returns 0xBADA_BADA and sets HW_OCOTP_CTRL[ERROR].

37.5.46 Value of OTP Bank4 Word2 (MAC Address) (OCOTP_MAC0)

Copied from the OTP automatically after reset. Can be re-loaded by setting OCOTP_CTRL[RELOAD_SHADOWS]

Shadowed memory mapped access to OTP Bank 4, word 2 (ADDR = 0x22).

Address: 21B_C000h base + 620h offset = 21B_C620h

Bit	31	30	29	28	27	26	25	24	23	22	21	20	19	18	17	16	15	14	13	12	11	10	9	8	7	6	5	4	3	2	1	0
R	BITS																															
W																																
Reset	0	0	0	0	0	0	0	0	0	0	0	0	0	0	0	0	0	0	0	0	0	0	0	0	0	0	0	0	0	0	0	0

OCOTP_MAC0 field descriptions

Field	Description
BITS	Reflects value of OTP Bank 4, word 2 (ADDR = 0x22).

37.5.47 Value of OTP Bank4 Word3 (MAC Address) (OCOTP_MAC1)

Copied from the OTP automatically after reset. Can be re-loaded by setting OCOTP_CTRL[RELOAD_SHADOWS]

Shadowed memory mapped access to OTP Bank 4, word 3 (ADDR = 0x23).

Address: 21B_C000h base + 630h offset = 21B_C630h

Bit	31	30	29	28	27	26	25	24	23	22	21	20	19	18	17	16	15	14	13	12	11	10	9	8	7	6	5	4	3	2	1	0
R	BITS																															
W																																
Reset	0	0	0	0	0	0	0	0	0	0	0	0	0	0	0	0	0	0	0	0	0	0	0	0	0	0	0	0	0	0	0	0

OCOTP_MAC1 field descriptions

Field	Description
BITS	Reflects value of OTP Bank 4, word 3 (ADDR = 0x23).

37.5.48 Value of OTP Bank4 Word4 (MAC Address) (OCOTP_RESERVED) (OCOTP_MAC)

Copied from the OTP automatically after reset. Can be re-loaded by setting OCOTP_CTRL[RELOAD_SHADOWS]

OCOTP Memory Map/Register Definition

Shadowed memory mapped access to OTP Bank 4, word 4 (ADDR = 0x24).

Address: 21B_C000h base + 640h offset = 21B_C640h

Bit	31	30	29	28	27	26	25	24	23	22	21	20	19	18	17	16	15	14	13	12	11	10	9	8	7	6	5	4	3	2	1	0				
R																																				
W																																				
Reset	0	0	0	0	0	0	0	0	0	0	0	0	0	0	0	0	0	0	0	0	0	0	0	0	0	0	0	0	0	0	0	0	0	0	0	0

OCOTP_MAC field descriptions

Field	Description
BITS	Reflects value of OTP Bank 4, word 4 (ADDR = 0x24).

37.5.49 Value of OTP Bank4 Word5 (CRC Key) (OCOTP_CRC)

Copied from the OTP automatically after reset. Can be re-loaded by setting OCOTP_CTRL[RELOAD_SHADOWS]

Shadowed memory mapped access to OTP Bank 4, word 5 (ADDR = 0x25).

Address: 21B_C000h base + 650h offset = 21B_C650h

Bit	31	30	29	28	27	26	25	24	23	22	21	20	19	18	17	16	15	14	13	12	11	10	9	8	7	6	5	4	3	2	1	0				
R																																				
W																																				
Reset	0	0	0	0	0	0	0	0	0	0	0	0	0	0	0	0	0	0	0	0	0	0	0	0	0	0	0	0	0	0	0	0	0	0	0	0

OCOTP_CRC field descriptions

Field	Description
BITS	Reflects value of OTP Bank 4, word 5 (ADDR = 0x25).

37.5.50 Value of OTP Bank4 Word6 (General Purpose Customer Defined Info) (OCOTP_GP1)

Copied from the OTP automatically after reset. Can be re-loaded by setting OCOTP_CTRL[RELOAD_SHADOWS]

Shadowed memory mapped access to OTP Bank 4, word 6 (ADDR = 0x26).

Address: 21B_C000h base + 660h offset = 21B_C660h

Bit	31	30	29	28	27	26	25	24	23	22	21	20	19	18	17	16	15	14	13	12	11	10	9	8	7	6	5	4	3	2	1	0				
R																																				
W																																				
Reset	0	0	0	0	0	0	0	0	0	0	0	0	0	0	0	0	0	0	0	0	0	0	0	0	0	0	0	0	0	0	0	0	0	0	0	0

OCOTP_GP1 field descriptions

Field	Description
BITS	Reflects value of OTP Bank 4, word 6 (ADDR = 0x26).

37.5.51 Value of OTP Bank4 Word7 (General Purpose Customer Defined Info) (OCOTP_GP2)

Copied from the OTP automatically after reset. Can be re-loaded by setting OCOTP_CTRL[RELOAD_SHADOWS]

Shadowed memory mapped access to OTP Bank 4, word 7 (ADDR = 0x27).

Address: 21B_C000h base + 670h offset = 21B_C670h

Bit	31	30	29	28	27	26	25	24	23	22	21	20	19	18	17	16	15	14	13	12	11	10	9	8	7	6	5	4	3	2	1	0		
R																																		
W																																		
Reset	0	0	0	0	0	0	0	0	0	0	0	0	0	0	0	0	0	0	0	0	0	0	0	0	0	0	0	0	0	0	0	0	0	0

OCOTP_GP2 field descriptions

Field	Description
BITS	Reflects value of OTP Bank 4, word 7 (ADDR = 0x27).

37.5.52 Value of OTP Bank5 Word0 (SW GP) (OCOTP_SW_GP0)

Copied from the OTP automatically after reset. Can be re-loaded by setting OCOTP_CTRL[RELOAD_SHADOWS]

Shadowed memory mapped access to OTP Bank 5, word 0 (ADDR = 0x28).

Address: 21B_C000h base + 680h offset = 21B_C680h

Bit	31	30	29	28	27	26	25	24	23	22	21	20	19	18	17	16	15	14	13	12	11	10	9	8	7	6	5	4	3	2	1	0	
R																																	
W																																	
Reset	0	0	0	0	0	0	0	0	0	0	0	0	0	0	0	0	0	0	0	0	0	0	0	0	0	0	0	0	0	0	0	0	0

OCOTP_SW_GP0 field descriptions

Field	Description
BITS	Reflects value of OTP Bank 5, word 0 (ADDR = 0x28).

37.5.53 Value of OTP Bank5 Word1 (SW GP) (OCOTP_SW_GP1)

Copied from the OTP automatically after reset. Can be re-loaded by setting OCOTP_CTRL[RELOAD_SHADOWS]

Shadowed memory mapped access to OTP Bank 5, word 1 (ADDR = 0x29).

Address: 21B_C000h base + 690h offset = 21B_C690h

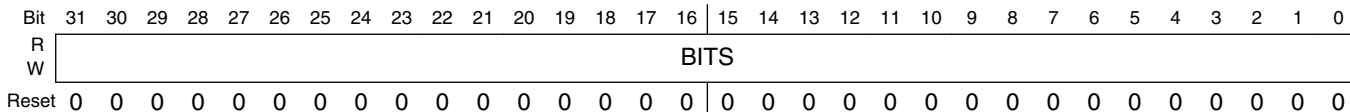

OCOTP_SW_GP1 field descriptions

Field	Description
BITS	Reflects value of OTP Bank 5, word 1 (ADDR = 0x29).

37.5.54 Value of OTP Bank5 Word2 (SW GP) (OCOTP_SW_GP2)

Copied from the OTP automatically after reset. Can be re-loaded by setting OCOTP_CTRL[RELOAD_SHADOWS]

Shadowed memory mapped access to OTP Bank 5, word 2 (ADDR = 0x2a).

Address: 21B_C000h base + 6A0h offset = 21B_C6A0h

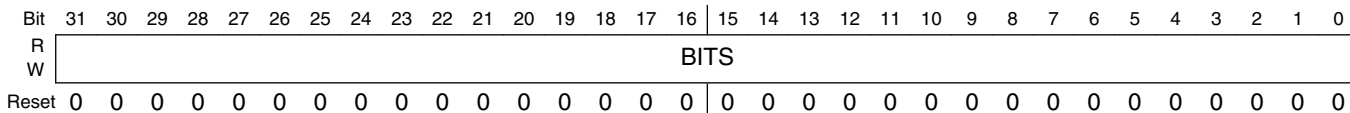

OCOTP_SW_GP2 field descriptions

Field	Description
BITS	Reflects value of OTP Bank 5, word 2 (ADDR = 0x2a).

37.5.55 Value of OTP Bank5 Word3 (SW GP) (OCOTP_SW_GP3)

Copied from the OTP automatically after reset. Can be re-loaded by setting OCOTP_CTRL[RELOAD_SHADOWS]

Shadowed memory mapped access to OTP Bank 5, word 3 (ADDR = 0x2b).

Address: 21B_C000h base + 6B0h offset = 21B_C6B0h

Bit	31	30	29	28	27	26	25	24	23	22	21	20	19	18	17	16	15	14	13	12	11	10	9	8	7	6	5	4	3	2	1	0
R																																
W																																
Reset	0	0	0	0	0	0	0	0	0	0	0	0	0	0	0	0	0	0	0	0	0	0	0	0	0	0	0	0	0	0	0	0

OCOTP_SW_GP3 field descriptions

Field	Description
BITS	Reflects value of OTP Bank 5, word 3 (ADDR = 0x2b).

37.5.56 Value of OTP Bank5 Word4 (SW GP) (OCOTP_SW_GP4)

Copied from the OTP automatically after reset. Can be re-loaded by setting OCOTP_CTRL[RELOAD_SHADOWS]

Shadowed memory mapped access to OTP Bank 5, word 4 (ADDR = 0x2c).

Address: 21B_C000h base + 6C0h offset = 21B_C6C0h

Bit	31	30	29	28	27	26	25	24	23	22	21	20	19	18	17	16	15	14	13	12	11	10	9	8	7	6	5	4	3	2	1	0
R																																
W																																
Reset	0	0	0	0	0	0	0	0	0	0	0	0	0	0	0	0	0	0	0	0	0	0	0	0	0	0	0	0	0	0	0	0

OCOTP_SW_GP4 field descriptions

Field	Description
BITS	Reflects value of OTP Bank 5, word 4 (ADDR = 0x2c).

37.5.57 Value of OTP Bank5 Word5 (Misc Conf) (OCOTP_MISC_CONF)

Copied from the OTP automatically after reset. Can be re-loaded by setting OCOTP_CTRL[RELOAD_SHADOWS]

Shadowed memory mapped access to OTP Bank 5, word 5 (ADDR = 0x2d).

Address: 21B_C000h base + 6D0h offset = 21B_C6D0h

Bit	31	30	29	28	27	26	25	24	23	22	21	20	19	18	17	16	15	14	13	12	11	10	9	8	7	6	5	4	3	2	1	0
R																																
W																																
Reset	0	0	0	0	0	0	0	0	0	0	0	0	0	0	0	0	0	0	0	0	0	0	0	0	0	0	0	0	0	0	0	0

OCOTP_MISC_CONF field descriptions

Field	Description
BITS	Reflects value of OTP Bank 5, word 5 (ADDR = 0x2d).

37.5.58 Value of OTP Bank5 Word6 (Field Return) (OCOTP_FIELD_RETURN)

Copied from the OTP automatically after reset. Can be re-loaded by setting OCOTP_CTRL[RELOAD_SHADOWS]

Shadowed memory mapped access to OTP Bank 5, word 6 (ADDR = 0x2e).

Address: 21B_C000h base + 6E0h offset = 21B_C6E0h

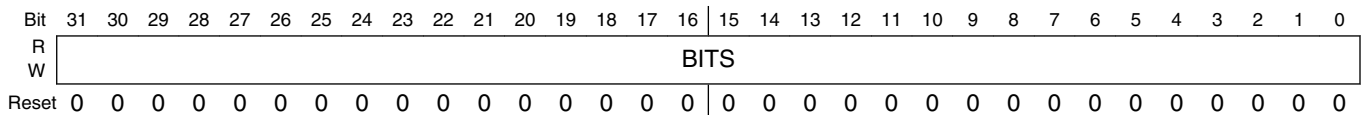

OCOTP_FIELD_RETURN field descriptions

Field	Description
BITS	Reflects value of OTP Bank 5, word 6 (ADDR = 0x2e).

37.5.59 Value of OTP Bank5 Word7 (SRK Revoke) (OCOTP_SRK_REVOKE)

Copied from the OTP automatically after reset. Can be re-loaded by setting OCOTP_CTRL[RELOAD_SHADOWS]

Shadowed memory mapped access to OTP Bank 5, word 7 (ADDR = 0x2f).

Address: 21B_C000h base + 6F0h offset = 21B_C6F0h

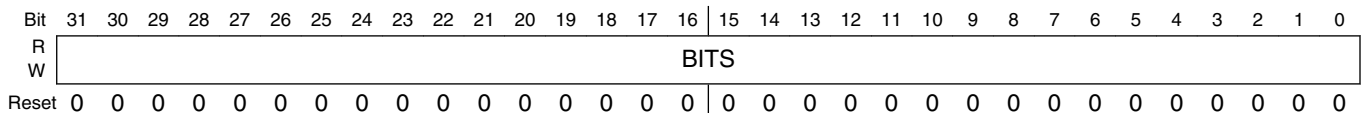

OCOTP_SRK_REVOKE field descriptions

Field	Description
BITS	Reflects value of OTP Bank 5, word 7 (ADDR = 0x2f).

37.5.60 Value of OTP Bank6 Word0 (ROM Patch) (OCOTP_ROM_PATCH0)

Copied from the OTP automatically after reset. Can be re-loaded by setting HW_OCOTP_CTRL[RELOAD_SHADOWS]

Shadowed memory mapped access to OTP Bank 6, word 0 (ADDR = 0x30).

Address: 21B_C000h base + 800h offset = 21B_C800h

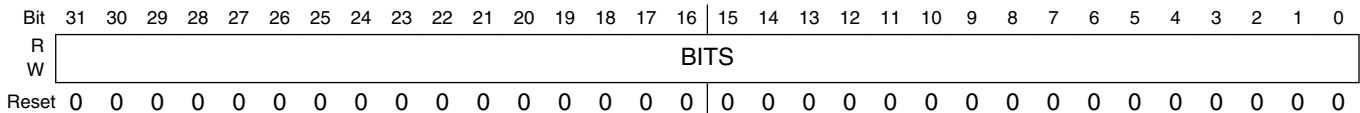

OCOTP_ROM_PATCH0 field descriptions

Field	Description
BITS	Reflects value of OTP Bank 6, word 0 (ADDR = 0x30).

37.5.61 Value of OTP Bank6 Word1 (ROM Patch) (OCOTP_ROM_PATCH1)

Copied from the OTP automatically after reset. Can be re-loaded by setting HW_OCOTP_CTRL[RELOAD_SHADOWS]

Shadowed memory mapped access to OTP Bank 6, word 1 (ADDR = 0x31).

Address: 21B_C000h base + 810h offset = 21B_C810h

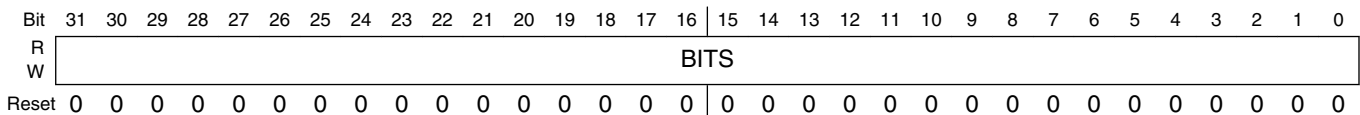

OCOTP_ROM_PATCH1 field descriptions

Field	Description
BITS	Reflects value of OTP Bank 6, word 1 (ADDR = 0x31).

37.5.62 Value of OTP Bank6 Word2 (ROM Patch) (OCOTP_ROM_PATCH2)

Copied from the OTP automatically after reset. Can be re-loaded by setting HW_OCOTP_CTRL[RELOAD_SHADOWS]

OCOTP Memory Map/Register Definition

Shadowed memory mapped access to OTP Bank 6, word 2 (ADDR = 0x32).

Address: 21B_C000h base + 820h offset = 21B_C820h

Bit	31	30	29	28	27	26	25	24	23	22	21	20	19	18	17	16	15	14	13	12	11	10	9	8	7	6	5	4	3	2	1	0				
R																																				
W																																				
Reset	0	0	0	0	0	0	0	0	0	0	0	0	0	0	0	0	0	0	0	0	0	0	0	0	0	0	0	0	0	0	0	0	0	0	0	0

OCOTP_ROM_PATCH2 field descriptions

Field	Description
BITS	Reflects value of OTP Bank 6, word 2 (ADDR = 0x32).

37.5.63 Value of OTP Bank6 Word3 (ROM Patch) (OCOTP_ROM_PATCH3)

Copied from the OTP automatically after reset. Can be re-loaded by setting HW_OCOTP_CTRL[RELOAD_SHADOWS]

Shadowed memory mapped access to OTP Bank 6, word 3 (ADDR = 0x33).

Address: 21B_C000h base + 830h offset = 21B_C830h

Bit	31	30	29	28	27	26	25	24	23	22	21	20	19	18	17	16	15	14	13	12	11	10	9	8	7	6	5	4	3	2	1	0					
R																																					
W																																					
Reset	0	0	0	0	0	0	0	0	0	0	0	0	0	0	0	0	0	0	0	0	0	0	0	0	0	0	0	0	0	0	0	0	0	0	0	0	0

OCOTP_ROM_PATCH3 field descriptions

Field	Description
BITS	Reflects value of OTP Bank 6, word 3 (ADDR = 0x33).

37.5.64 Value of OTP Bank6 Word4 (ROM Patch) (OCOTP_ROM_PATCH4)

Copied from the OTP automatically after reset. Can be re-loaded by setting HW_OCOTP_CTRL[RELOAD_SHADOWS]

Shadowed memory mapped access to OTP Bank 6, word 4 (ADDR = 0x34).

Address: 21B_C000h base + 840h offset = 21B_C840h

Bit	31	30	29	28	27	26	25	24	23	22	21	20	19	18	17	16	15	14	13	12	11	10	9	8	7	6	5	4	3	2	1	0					
R																																					
W																																					
Reset	0	0	0	0	0	0	0	0	0	0	0	0	0	0	0	0	0	0	0	0	0	0	0	0	0	0	0	0	0	0	0	0	0	0	0	0	0

OCOTP_ROM_PATCH4 field descriptions

Field	Description
BITS	Reflects value of OTP Bank 6, word 4 (ADDR = 0x34).

37.5.65 Value of OTP Bank6 Word5 (ROM Patch) (OCOTP_ROM_PATCH5)

Copied from the OTP automatically after reset. Can be re-loaded by setting HW_OCOTP_CTRL[RELOAD_SHADOWS]

Shadowed memory mapped access to OTP Bank 6, word 5 (ADDR = 0x35).

Address: 21B_C000h base + 850h offset = 21B_C850h

Bit	31	30	29	28	27	26	25	24	23	22	21	20	19	18	17	16	15	14	13	12	11	10	9	8	7	6	5	4	3	2	1	0
R																																
W																																
Reset	0	0	0	0	0	0	0	0	0	0	0	0	0	0	0	0	0	0	0	0	0	0	0	0	0	0	0	0	0	0	0	0

OCOTP_ROM_PATCH5 field descriptions

Field	Description
BITS	Reflects value of OTP Bank 6, word 5 (ADDR = 0x35).

37.5.66 Value of OTP Bank6 Word6 (ROM Patch) (OCOTP_ROM_PATCH6)

Copied from the OTP automatically after reset. Can be re-loaded by setting HW_OCOTP_CTRL[RELOAD_SHADOWS]

Shadowed memory mapped access to OTP Bank 6, word 6 (ADDR = 0x36).

Address: 21B_C000h base + 860h offset = 21B_C860h

Bit	31	30	29	28	27	26	25	24	23	22	21	20	19	18	17	16	15	14	13	12	11	10	9	8	7	6	5	4	3	2	1	0
R																																
W																																
Reset	0	0	0	0	0	0	0	0	0	0	0	0	0	0	0	0	0	0	0	0	0	0	0	0	0	0	0	0	0	0	0	0

OCOTP_ROM_PATCH6 field descriptions

Field	Description
BITS	Reflects value of OTP Bank 6, word 6 (ADDR = 0x36).

37.5.67 Value of OTP Bank6 Word7 (ROM Patch) (OCOTP_ROM_PATCH7)

Copied from the OTP automatically after reset. Can be re-loaded by setting HW_OCOTP_CTRL[RELOAD_SHADOWS]

Shadowed memory mapped access to OTP Bank 6, word 7 (ADDR = 0x37).

Address: 21B_C000h base + 870h offset = 21B_C870h

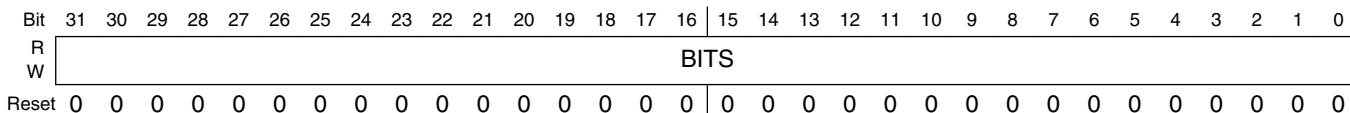

OCOTP_ROM_PATCH7 field descriptions

Field	Description
BITS	Reflects value of OTP Bank 6, word 7 (ADDR = 0x37).

37.5.68 Value of OTP Bank7 Word0 (General Purpose Customer Defined Info) (OCOTP_GP3_0)

Copied from the OTP automatically after reset. Can be re-loaded by setting HW_OCOTP_CTRL[RELOAD_SHADOWS]

Shadowed memory mapped access to OTP Bank 7, word 0 (ADDR = 0x38).

Address: 21B_C000h base + 880h offset = 21B_C880h

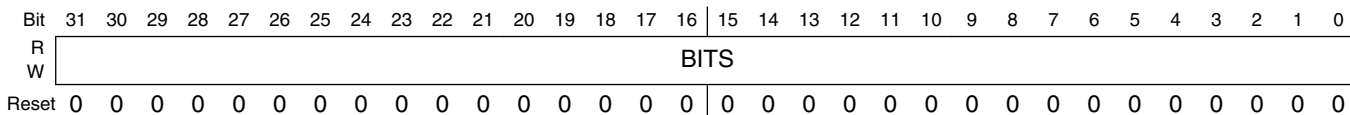

OCOTP_GP3_0 field descriptions

Field	Description
BITS	Reflects value of OTP Bank 8, word 0 (ADDR = 0x40).

37.5.69 Value of OTP Bank7 Word1 (General Purpose Customer Defined Info) (OCOTP_GP3_1)

Copied from the OTP automatically after reset. Can be re-loaded by setting HW_OCOTP_CTRL[RELOAD_SHADOWS]

Shadowed memory mapped access to OTP Bank 7, word 1 (ADDR = 0x39).

Address: 21B_C000h base + 890h offset = 21B_C890h

Bit	31	30	29	28	27	26	25	24	23	22	21	20	19	18	17	16	15	14	13	12	11	10	9	8	7	6	5	4	3	2	1	0
R																																
W																																
Reset	0	0	0	0	0	0	0	0	0	0	0	0	0	0	0	0	0	0	0	0	0	0	0	0	0	0	0	0	0	0	0	0

OCOTP_GP3_1 field descriptions

Field	Description
BITS	Reflects value of OTP Bank 8, word 1 (ADDR = 0x41).

37.5.70 Value of OTP Bank7 Word2 (General Purpose Customer Defined Info) (OCOTP_GP3_2)

Copied from the OTP automatically after reset. Can be re-loaded by setting HW_OCOTP_CTRL[RELOAD_SHADOWS]

Shadowed memory mapped access to OTP Bank 7, word 2 (ADDR = 0x3A).

Address: 21B_C000h base + 8A0h offset = 21B_C8A0h

Bit	31	30	29	28	27	26	25	24	23	22	21	20	19	18	17	16	15	14	13	12	11	10	9	8	7	6	5	4	3	2	1	0
R																																
W																																
Reset	0	0	0	0	0	0	0	0	0	0	0	0	0	0	0	0	0	0	0	0	0	0	0	0	0	0	0	0	0	0	0	0

OCOTP_GP3_2 field descriptions

Field	Description
BITS	Reflects value of OTP Bank 8, word 2 (ADDR = 0x42).

37.5.71 Value of OTP Bank7 Word3 (General Purpose Customer Defined Info) (OCOTP_GP3_3)

Copied from the OTP automatically after reset. Can be re-loaded by setting HW_OCOTP_CTRL[RELOAD_SHADOWS]

Shadowed memory mapped access to OTP Bank 7, word 3 (ADDR = 0x3B).

Address: 21B_C000h base + 8B0h offset = 21B_C8B0h

Bit	31	30	29	28	27	26	25	24	23	22	21	20	19	18	17	16	15	14	13	12	11	10	9	8	7	6	5	4	3	2	1	0
R																																
W																																
Reset	0	0	0	0	0	0	0	0	0	0	0	0	0	0	0	0	0	0	0	0	0	0	0	0	0	0	0	0	0	0	0	0

OCOTP_GP3_3 field descriptions

Field	Description
BITS	Reflects value of OTP Bank 8, word 3 (ADDR = 0x43).

37.5.72 Value of OTP Bank8 Word4 (General Purpose Customer Defined Info) (OCOTP_GP4_0)

Copied from the OTP automatically after reset. Can be re-loaded by setting HW_OCOTP_CTRL[RELOAD_SHADOWS]

Shadowed memory mapped access to OTP Bank 7, word 4 (ADDR = 0x3C).

Address: 21B_C000h base + 8C0h offset = 21B_C8C0h

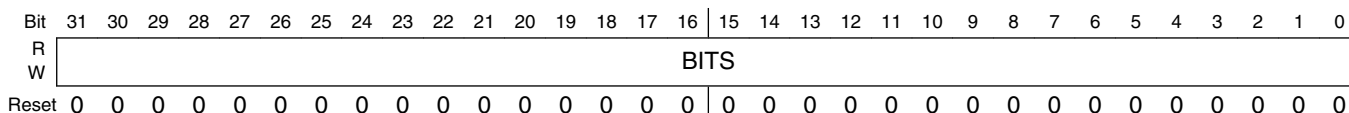

OCOTP_GP4_0 field descriptions

Field	Description
BITS	Reflects value of OTP Bank 8, word 4 (ADDR = 0x44).

37.5.73 Value of OTP Bank7 Word5 (General Purpose Customer Defined Info) (OCOTP_GP4_1)

Copied from the OTP automatically after reset. Can be re-loaded by setting HW_OCOTP_CTRL[RELOAD_SHADOWS]

Shadowed memory mapped access to OTP Bank 7, word 5 (ADDR = 0x3D).

Address: 21B_C000h base + 8D0h offset = 21B_C8D0h

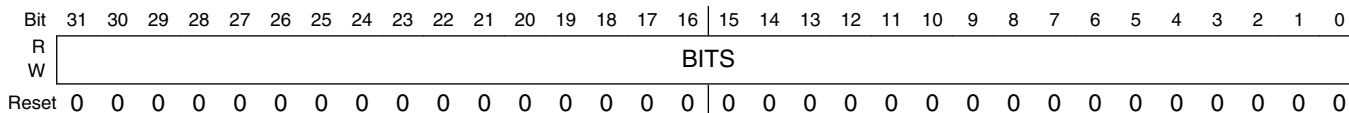

OCOTP_GP4_1 field descriptions

Field	Description
BITS	Reflects value of OTP Bank 8, word 5 (ADDR = 0x45).

37.5.74 Value of OTP Bank7 Word6 (General Purpose Customer Defined Info) (OCOTP_GP4_2)

Copied from the OTP automatically after reset. Can be re-loaded by setting HW_OCOTP_CTRL[RELOAD_SHADOWS]

Shadowed memory mapped access to OTP Bank 7, word 6 (ADDR = 0x3E).

Address: 21B_C000h base + 8E0h offset = 21B_C8E0h

Bit	31	30	29	28	27	26	25	24	23	22	21	20	19	18	17	16	15	14	13	12	11	10	9	8	7	6	5	4	3	2	1	0
R	BITS																															
W																																
Reset	0	0	0	0	0	0	0	0	0	0	0	0	0	0	0	0	0	0	0	0	0	0	0	0	0	0	0	0	0	0	0	0

OCOTP_GP4_2 field descriptions

Field	Description
BITS	Reflects value of OTP Bank 8, word 6 (ADDR = 0x46).

37.5.75 Value of OTP Bank7 Word7 (General Purpose Customer Defined Info) (OCOTP_GP4_3)

Copied from the OTP automatically after reset. Can be re-loaded by setting HW_OCOTP_CTRL[RELOAD_SHADOWS]

Shadowed memory mapped access to OTP Bank 7, word 7 (ADDR = 0x3F).

Address: 21B_C000h base + 8F0h offset = 21B_C8F0h

Bit	31	30	29	28	27	26	25	24	23	22	21	20	19	18	17	16	15	14	13	12	11	10	9	8	7	6	5	4	3	2	1	0
R	BITS																															
W																																
Reset	0	0	0	0	0	0	0	0	0	0	0	0	0	0	0	0	0	0	0	0	0	0	0	0	0	0	0	0	0	0	0	0

OCOTP_GP4_3 field descriptions

Field	Description
BITS	Reflects value of OTP Bank 8, word 7 (ADDR = 0x47).

Chapter 38

On-Chip RAM Memory Controller (OCRAM)

38.1 Overview

There is 1 OCRAM controller implemented in the chip. One controller is for the 128KB on-chip RAM.

The on-chip RAM block is implemented as an slave module on the 64-bit system AXI bus. Designed as a simple on-chip memory controller, it supports only one AXI port with memory banks. For the AXI port, the read and write transactions are handled by two independent modules. As it is possible to have simultaneous read and write request from the AXI bus, each memory bank has an arbiter with round-robin scheme. After arbitration, the granted read or write access command can then be issued to the memory cell through a read/write MUX.

The memory banks are organized with the lower 2 bits of the address which is the AXI bus address and is 64 bits aligned interleaved. This allows a read access and a write access to be processed at the same time if they are targeted to different memory banks.

Various options are provided for adding a pipeline or wait-states in a read/write access, in order to ensure flexible timing control at both high and low frequencies.

The internal block diagram is shown in the figure below.

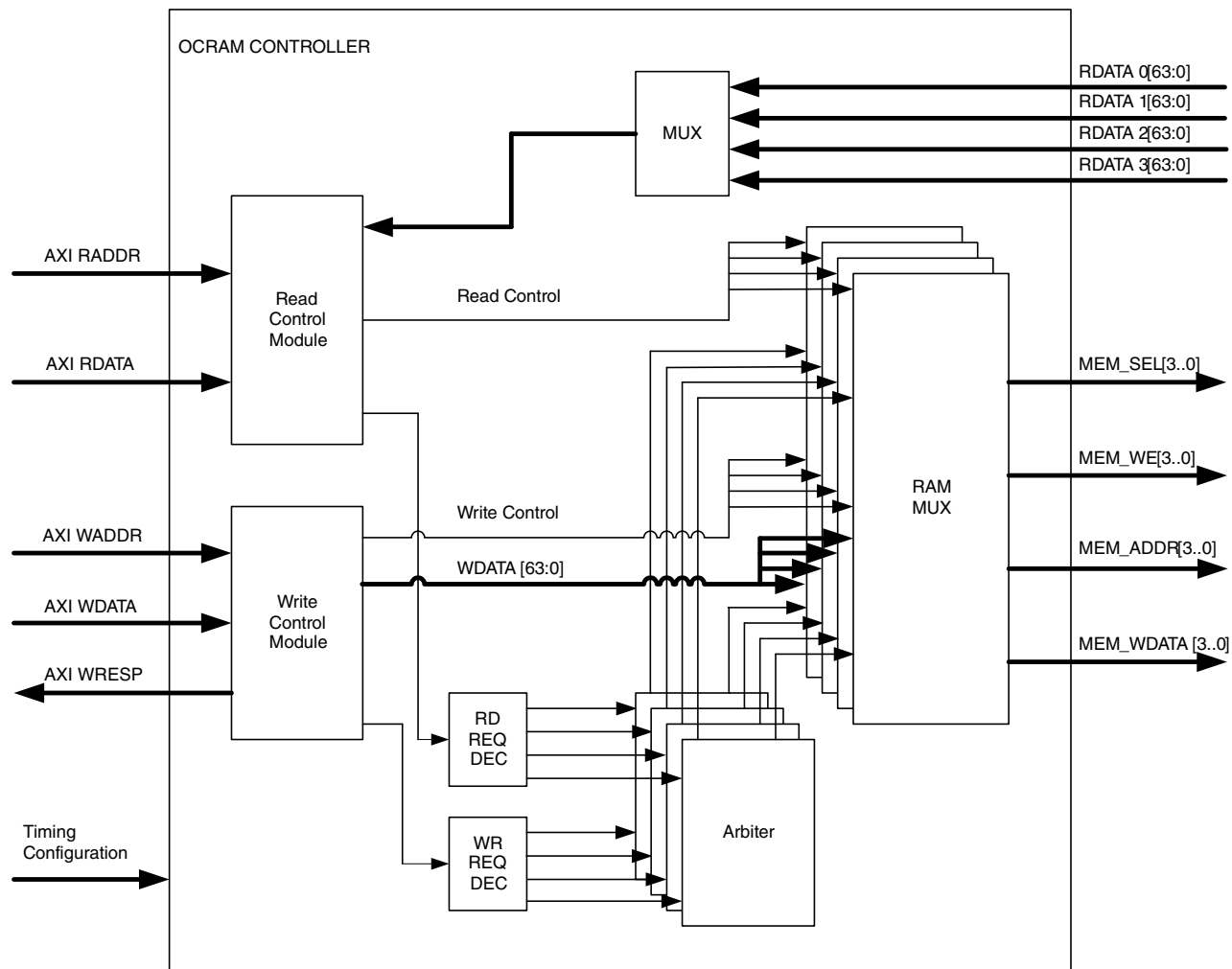

Figure 38-1. On-chip RAM Block Diagram

38.2 Basic Functions

38.2.1 Read/Write Arbitration

The detailed rules used in arbitration are as follows:

- If there is no granted read or write in the last cycle, and there is only a read request or a write request, the request will be granted.
- If there is no granted read or write in the last cycle, and there are both read or write requests coming in at the same time, the read request will be granted first.

- If a granted read/write transaction has just finished, the write/read request will have the higher priority in the next cycle.
- If the first read/write access request in a transaction is granted, all the data transfer in this burst will be finished before the next arbitration begins, that is, the round-robin arbitration mechanism is based on AXI transaction, not data access.

38.3 Advanced Features

This section describes some advanced features designed to avoid timing issues when the on-chip RAM is working at high frequency.

All of the features can be disabled/enabled by programming the corresponding fields of the General Purpose Register (IOMUXC.GPR3) bits [24:21] and bits [3:0] in the IOMUX chapter.

38.3.1 Read Data Wait State

When the wait state is enabled, it will take 2 cycles for each read access (each beat of a read burst).

This can avoid the potential timing problem caused by the longer memory access time at higher frequency.

When this feature is disabled, it only takes 1 clock cycle to finish a read transaction. That is, read data is available in the next cycle of read request becomes valid on the bus.

For the normal OCRAM, the read data wait state is configurable via IOMUXC.GPR3[21].

38.3.2 Read Address Pipeline

When this feature is enabled, the read address from the AXI master is delayed 1 cycle before it can be accepted by the on-chip RAM.

This can avoid setup time issues for the read access on the memory cell at high frequency. Enabling this feature can cost, at most, 1 more clock cycle for each AXI read transaction, that is, at most 1 more clock cycle for each read burst with multiple beats of data.

When this feature is disabled, the read address from the AXI master can be accepted by the on-chip RAM without delay, and data can become ready for master at next clock cycle (if no other access and no read data wait).

For the normal OCRAM, the read address pipeline is configurable via IOMUXC.GPR3[22]. For the L2 cache as OCRAM, the read address pipeline is configurable via IOMUXC.GPR3[1].

38.3.3 Write Data Pipeline

When this feature is enabled, the write data from the AXI master would be delayed 1 cycle before it can be accepted by the on-chip RAM.

This can avoid setup time issue for the write access on the memory cell at high frequency. Enabling this feature would cost at most 1 more clock cycle for each AXI write transaction, that is, at most 1 more clock cycle for each write burst with multiple beats of data.

When this feature is disabled, the write data from the AXI master can be accepted by the on-chip RAM without delay, and data can be written to memory at this cycle (if no other access and write address is also ready at this cycle).

For the normal OCRAM, the write data pipeline is configurable via IOMUXC.GPR3[23]. For the L2 cache as OCRAM, the write data pipeline is configurable via IOMUXC.GPR3[2].

38.3.4 Write Address Pipeline

When this feature is enabled, the write address from the AXI master would be delayed 1 cycle before it can be accepted by the on-chip RAM.

This can avoid setup time issue for the write access on the memory cell at high frequency. Enabling this feature would take at most 1 more clock cycle for each AXI write transaction, that is, at most 1 more clock cycle for each write burst with multiple beats of data.

When this feature is disabled, the write address from the AXI master can be accepted by the on-chip RAM without delay, and data can be written to memory at this cycle (if no other access and write data is also ready at this cycle).

For the normal OCRAM, the write address pipeline is configurable via IOMUXC.GPR3[24]. For the L2 cache as OCRAM, the write address pipeline is configurable via IOMUXC.GPR3[3].

38.4 Programmable Registers

There are no programmable registers in this block; however, OCRAM configurable bits can be found in the IOMUX Controller (IOMUXC) general purpose registers found here.

- TrustZone bits: IOMUXC_GPR10
- WAIT state / Pipeline bits: IOMUXC_GPR3

Chapter 39

Power Management Unit (PMU)

39.1 Overview

The power management unit (PMU) is designed to simplify the external power interface. The power system can be split into the input power sources and their characteristics, the integrated power transforming and controlling elements, and the final load interconnection and requirements.

A typical power system uses the PMU is depicted in the following diagram.

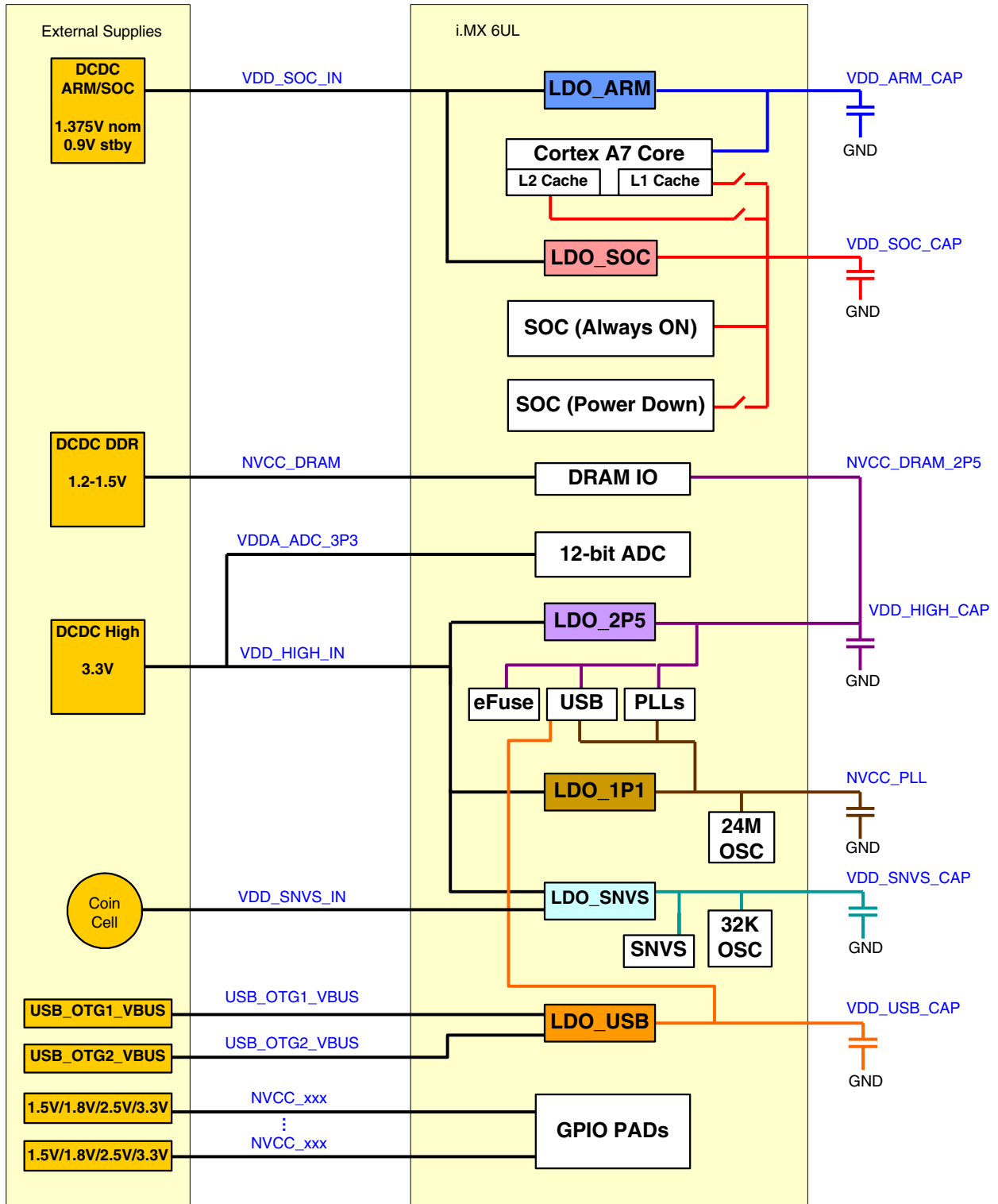

Figure 39-1. Power system overview

Using seven LDO regulators, the number of external supplies is greatly reduced. Not counting the backup coin and USB inputs, the number of external supplies is reduced to two. Missing from this external supply total is the number of necessary external supplies to power the desired memory interface; that number varies depending on the type of external memory selected. Other supplies may also be necessary to supply the voltage to the different I/O power segments if their I/O voltages have to be different from what is provided above.

39.2 Digital LDO Regulators

The PMU has three digital LDO regulators. They are referred to as "digital" because of the logic loads they drive, not because of their construction. These regulators have three basic modes that are unique to the digital regulators.

- **Power Gate**—The regulation FET is switched off fully, limiting the current draw from the supply. The analog part of the regulator is powered down, limiting the power consumption. The output voltage falls to a level at which the residual leakage of the power FET balances with the leakage of the load. (TARG = 0x00)
- **Analog regulation mode**—The regulation FET is controlled such that the output voltage of the regulator equals the programmed target voltage. The target voltage is fully programmable in 25mV steps.

These modes allow the regulators to implement voltage scaling and power gating and allow bypass. With the bypass feature, all of the accuracy and control requirements can be shifted to the external supply source if capable and desired.

These digital regulators also feature brownout detection which is helpful when supplies are starting to collapse. The voltage value where brownout is signaled is programmable as an offset from the programmed target voltage. The controls are located in the PMU_MISC2 register. The core is interrupted on a brownout.

The two digital regulators are known as LDO_ARM, , and LDO_SOC. As shown in the power system overview figure, the ARM regulator powers the ARM cores. All regulators support generous programming ranges in 25mV steps. It is possible to program voltages above the process limit for the chip, thus causing permanent damage. Likewise, it is possible to program the voltage so low that the chip cannot continue to operate or even retain state without clocks. Care should be taken with these settings.

Care must be taken when raising the output voltage of the regulator rapidly. This can cause large currents to flow into the output cap of the regulator up to the limits of the input supply. When the input supply capability is exceeded, this can cause an input supply dip that may affect other regulators on the same supply. Therefore, the rate of

voltage change on the output of the regulator should be limited. When powering up the regulator, the integrated current limiter controls the ramp rate. This limiter is only effective when transitioning from the off state of the regulator (bypassed or power gated).

However, in a DVFS situation, the same high rate of change can occur if the target voltage is raised rapidly by software. To limit the rate of change, the hardware controlling the regulator effects a piecewise linear ramp by stepping the output voltage in 25mV steps until the desired output voltage is reached. The slope of the ramp is controlled by the time spent at each 25mV step and is controlled by the step time field in the PMU_MISC2 register. The same situation is not a problem when the output voltage is dropped as the load pulls down the output cap. As a result, any reduction in the programmed regulator target voltage is immediately effective with the actual supply voltage falling at a rate controlled by the load on the regulator.

39.3 Analog LDO Regulators

There are two analog regulators described here.

39.3.1 LDO 1P1

The LDO_1P1 module on the chip implements a programmable linear-regulator function from a higher analog supply voltage (2.8 V–3.3 V) to produce a nominal 1.1 V output voltage.

The output of the regulator can be programmed in 25 mV steps from 0.8 V to 1.4 V. The regulator has been designed to be stable with a minimum external low-ESR decoupling capacitance, though the actual capacitance required should be determined by the application. A programmable brownout detector is included in the regulator which can be used by the system to determine when the load capability of the regulator is being exceeded, so the necessary steps can be taken.

Current limiting can be enabled by setting the PMU_REG_1P1[ENABLE_ILIMIT] bit to allow for in-rush current requirements during startup if needed. Active pulldown can also be enabled by setting the PMU_REG_1P1[ENABLE_PULLDOWN] bit for systems requiring this feature.

39.3.2 LDO 2P5

The LDO_2P5 module on the chip implements a programmable linear-regulator function from a higher analog supply voltage (2.8V-3.3V) to produce a nominal 2.5V output voltage.

The output of the regulator can be programmed in 25mV steps from 2.0V to 2.75V. The regulator has been designed to be stable with a minimum external low-ESR decoupling capacitance, though the actual capacitance required should be determined by the application. A programmable brown-out detector is included in the regulator which can be used by the system to determine when the load capability of the regulator is being exceeded to take the necessary steps.

Current-limiting can be enabled by setting the REG_PMU_2P5[ENABLE_ILIMIT] bit to allow for in-rush current requirements during start-up if needed. Active-pulldown can also be enabled by setting the REG_PMU_2P5[ENABLE_PULLDOWN] bit for systems requiring this feature.

39.3.3 Low Power Operation

The 1.1 V and 2.5 V LDO includes an alternate, self-biased, low-precision, weak regulator which can be enabled for applications needing to keep the 1.1 V and 2.5 V output voltage alive during low-power modes where the main regulator and its associated global bandgap reference module are disabled.

The output of this weak regulator is not programmable and is a function of its input power supply as well as load current. The low-power mode is enabled by setting high the PMU_REG_1P1[ENABLE_WEAK_LINREG] and PMU_REG_2P5[ENABLE_WEAK_LINREG] bit of the regulator. It is recommended that the following sequence be followed to enable this mode:

1. Throttle down the 1.1 V / 2.5 V attached load to its low-power maintain state.
2. Disable the main 1.1 V / 2.5 V regulator driver by clearing the PMU_REG_1P1[ENABLE_LINREG] / PMU_REG_2P5[ENABLE_LINREG] bit.
3. Enable the weak 1.1 V / 2.5 V regulator by setting the PMU_REG_1P1[ENABLE_WEAK_LINREG] / PMU_REG_2P5[ENABLE_WEAK_LINREG] bit.

To go back to full-power operation, reverse the steps outlined above. Note that the external decoupling cap is supporting the power supply between steps 2 and 3. Therefore step 3 should happen appropriately in time relative to the discharge of the supporting capacitor.

39.4 USB LDO Regulator

The USB_LDO module on the chip implements a programmable linear-regulator function from the USB VBUS voltages (typically 5 V) to produce a nominal 3.0 V output voltage.

The output of the regulator can be programmed in 25 mV steps, from 2.625V to 3.4 V . The regulator has been designed to be stable with a minimum external low-ESR decoupling capacitor of 4.7 μ F, though the actual capacitance required should be determined by the application. A programmable brownout detector is included in the regulator which can be used by the system to determine when the load capability of the regulator is being exceeded, so the necessary steps can be taken. This regulator has a built-in power mux which allows the user to choose to run the regulator from either VBUS supply when both are present. If only one of the VBUS voltages is present, then the regulator automatically selects this supply. Current limit is also included to help the system meet in-rush current targets.

Upon attachment of VBUS, this regulator starts up in a low-power, self-preservation mode to prevent over-voltage conditions on the chip. It is expected that the user transition to full regulation by enabling the regulator and disabling the in-rush current limits via its control registers. Upon VBUS removal, it is further expected that the regulator controls are returned to their reset state.

39.5 SNVS Regulator

The SNVS regulator takes the SNVS_IN supply and generates the SNVS_CAP supply, which powers the real time clock and SNVS blocks.

If VDDHIGH_IN is present, then the SNVS_IN supply is internally shorted to the VDDHIGH_IN supply to allow coin cell recharging if necessary. The output voltage is roughly one third of SNVS_IN.

39.6 PMU Memory Map/Register Definition

The register definitions that affect the behavior of the digital LDO regulators follow.

NOTE

Some of the registers are collections of bits that affect multiple components on the chip. Those that are not pertinent to this chapter have comments in the related register bitfields.

If a full description is desired, please consult the full register programming reference in the related block.

PMU memory map

Absolute address (hex)	Register name	Width (in bits)	Access	Reset value	Section/page
20C_8110	Regulator 1P1 Register (PMU_REG_1P1)	32	R/W	0000_1073h	39.6.1/2449
20C_8114	Regulator 1P1 Register (PMU_REG_1P1_SET)	32	R/W	0000_1073h	39.6.1/2449
20C_8118	Regulator 1P1 Register (PMU_REG_1P1_CLR)	32	R/W	0000_1073h	39.6.1/2449
20C_811C	Regulator 1P1 Register (PMU_REG_1P1_TOG)	32	R/W	0000_1073h	39.6.1/2449
20C_8120	Regulator 3P0 Register (PMU_REG_3P0)	32	R/W	0000_0F74h	39.6.2/2452
20C_8124	Regulator 3P0 Register (PMU_REG_3P0_SET)	32	R/W	0000_0F74h	39.6.2/2452
20C_8128	Regulator 3P0 Register (PMU_REG_3P0_CLR)	32	R/W	0000_0F74h	39.6.2/2452
20C_812C	Regulator 3P0 Register (PMU_REG_3P0_TOG)	32	R/W	0000_0F74h	39.6.2/2452
20C_8130	Regulator 2P5 Register (PMU_REG_2P5)	32	R/W	0000_1073h	39.6.3/2454
20C_8134	Regulator 2P5 Register (PMU_REG_2P5_SET)	32	R/W	0000_1073h	39.6.3/2454
20C_8138	Regulator 2P5 Register (PMU_REG_2P5_CLR)	32	R/W	0000_1073h	39.6.3/2454
20C_813C	Regulator 2P5 Register (PMU_REG_2P5_TOG)	32	R/W	0000_1073h	39.6.3/2454
20C_8140	Digital Regulator Core Register (PMU_REG_CORE)	32	R/W	0048_2012h	39.6.4/2456
20C_8144	Digital Regulator Core Register (PMU_REG_CORE_SET)	32	R/W	0048_2012h	39.6.4/2456
20C_8148	Digital Regulator Core Register (PMU_REG_CORE_CLR)	32	R/W	0048_2012h	39.6.4/2456
20C_814C	Digital Regulator Core Register (PMU_REG_CORE_TOG)	32	R/W	0048_2012h	39.6.4/2456
20C_8150	Miscellaneous Register 0 (PMU_MISC0)	32	R/W	0400_0000h	39.6.5/2458
20C_8154	Miscellaneous Register 0 (PMU_MISC0_SET)	32	R/W	0400_0000h	39.6.5/2458
20C_8158	Miscellaneous Register 0 (PMU_MISC0_CLR)	32	R/W	0400_0000h	39.6.5/2458
20C_815C	Miscellaneous Register 0 (PMU_MISC0_TOG)	32	R/W	0400_0000h	39.6.5/2458
20C_8160	Miscellaneous Register 1 (PMU_MISC1)	32	R/W	0000_0000h	39.6.6/2462
20C_8164	Miscellaneous Register 1 (PMU_MISC1_SET)	32	R/W	0000_0000h	39.6.6/2462
20C_8168	Miscellaneous Register 1 (PMU_MISC1_CLR)	32	R/W	0000_0000h	39.6.6/2462
20C_816C	Miscellaneous Register 1 (PMU_MISC1_TOG)	32	R/W	0000_0000h	39.6.6/2462
20C_8170	Miscellaneous Control Register (PMU_MISC2)	32	R/W	0027_2727h	39.6.7/2464
20C_8174	Miscellaneous Control Register (PMU_MISC2_SET)	32	R/W	0027_2727h	39.6.7/2464

Table continues on the next page...

PMU memory map (continued)

Absolute address (hex)	Register name	Width (in bits)	Access	Reset value	Section/page
20C_8178	Miscellaneous Control Register (PMU_MISC2_CLR)	32	R/W	0027_2727h	39.6.7/2464
20C_817C	Miscellaneous Control Register (PMU_MISC2_TOG)	32	R/W	0027_2727h	39.6.7/2464
20C_8270	Low Power Control Register (PMU_LOWPWR_CTRL)	32	R/W	0000_4009h	39.6.8/2469
20C_8274	Low Power Control Register (PMU_LOWPWR_CTRL_SET)	32	R/W	0000_4009h	39.6.8/2469
20C_8278	Low Power Control Register (PMU_LOWPWR_CTRL_CLR)	32	R/W	0000_4009h	39.6.8/2469
20C_827C	Low Power Control Register (PMU_LOWPWR_CTRL_TOG)	32	R/W	0000_4009h	39.6.8/2469

39.6.1 Regulator 1P1 Register (PMU_REG_1P1n)

This register defines the control and status bits for the 1.1V regulator. This regulator is designed to power the digital portions of the analog cells.

Address: 20C_8000h base + 110h offset + (4d × i), where i=0d to 3d

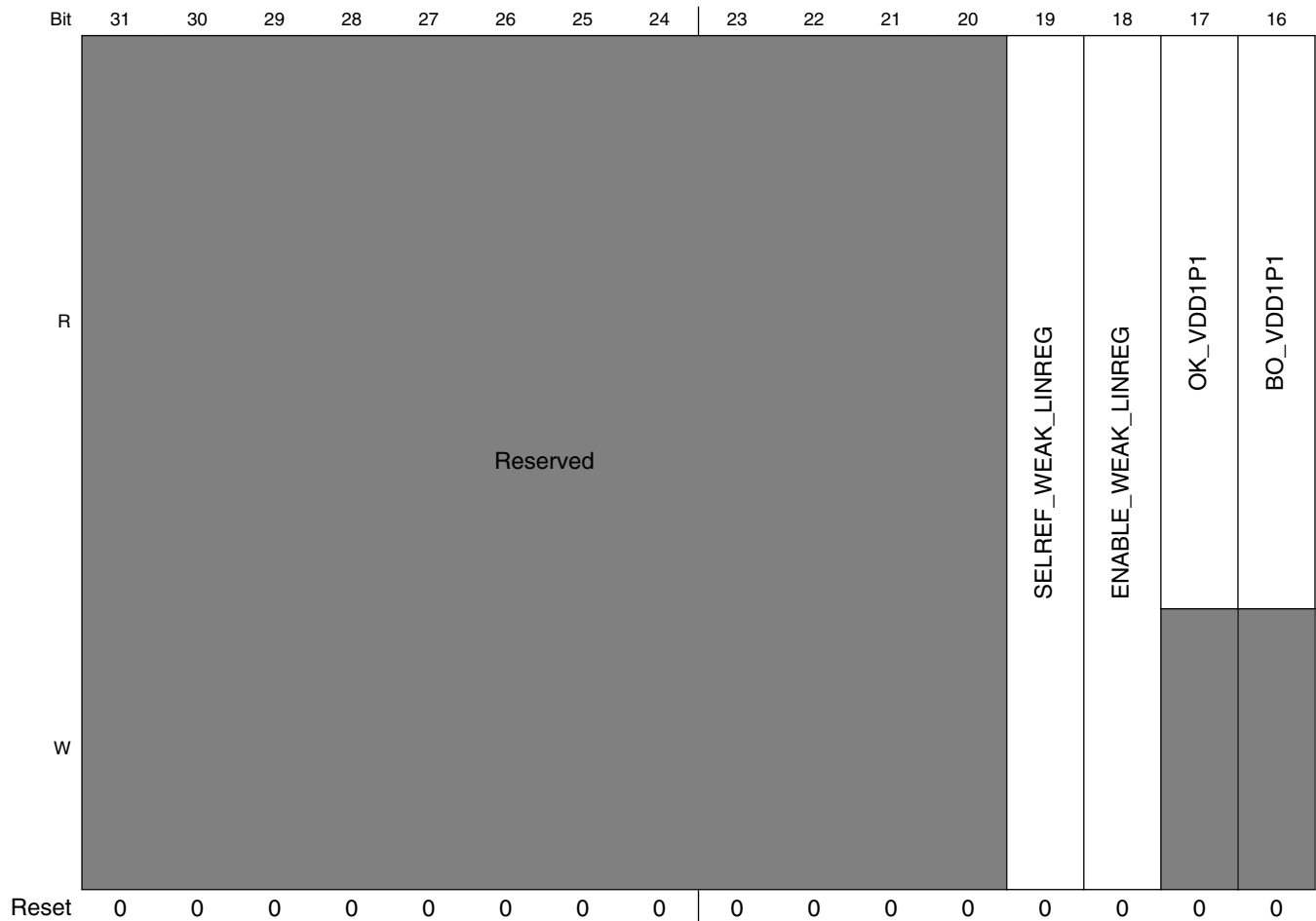

PMU Memory Map/Register Definition

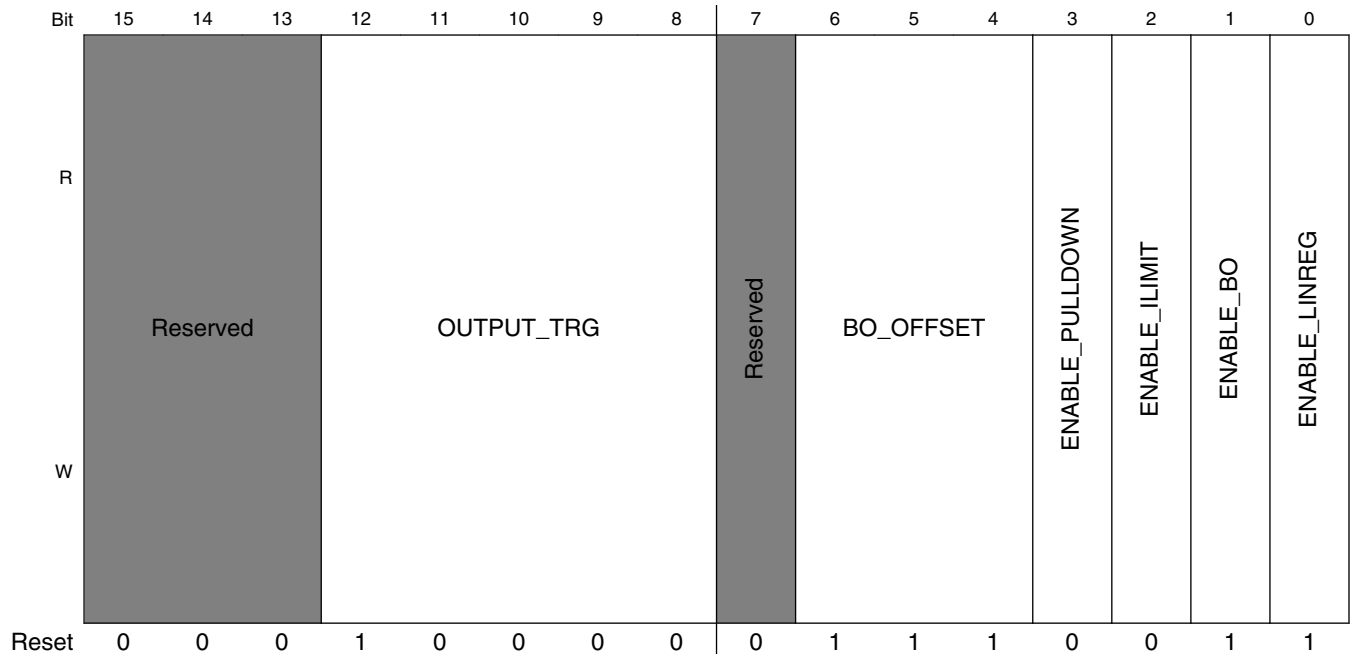

PMU_REG_1P1n field descriptions

Field	Description
31–20 -	This field is reserved.
19 SELREF_ WEAK_LINREG	Selects the source for the reference voltage of the weak 1p1 regulator. 0 Weak-linreg output tracks low-power-bandgap voltage 1 Weak-linreg output tracks VDD_SOC_CAP voltage
18 ENABLE_ WEAK_LINREG	Enables the weak 1p1 regulator. This regulator can be used when the main 1p1 regulator is disabled, under low-power conditions.
17 OK_VDD1P1	Status bit that signals when the regulator output is ok. 1 = regulator output > brownout target
16 BO_VDD1P1	Status bit that signals when a brownout is detected on the regulator output.
15–13 -	This field is reserved.
12–8 OUTPUT_TRG	Control bits to adjust the regulator output voltage. Each LSB is worth 25mV. Programming examples are detailed below. Other output target voltages may be interpolated from these examples. Choices must be in this range: 0x1b >= output_trg >= 0x04 NOTE: There may be reduced chip functionality or reliability at the extremes of the programming range. 0x04 0.8V 0x10 1.1V 0x1b 1.375V
7 -	This field is reserved.

Table continues on the next page...

PMU_REG_1P1n field descriptions (continued)

Field	Description
6-4 BO_OFFSET	Control bits to adjust the regulator brownout offset voltage in 25mV steps. The reset brown-offset is 175mV below the programmed target code. Brownout target = OUTPUT_TRG - BO_OFFSET. Some steps may be irrelevant because of input supply limitations or load operation.
3 ENABLE_ PULLDOWN	Control bit to enable the pull-down circuitry in the regulator
2 ENABLE_ILIMIT	Control bit to enable the current-limit circuitry in the regulator.
1 ENABLE_BO	Control bit to enable the brownout circuitry in the regulator.
0 ENABLE_ LINREG	Control bit to enable the regulator output.

39.6.2 Regulator 3P0 Register (PMU_REG_3P0n)

This register defines the control and status bits for the 3.0V regulator powered by the host USB VBUS pin.

Address: 20C_8000h base + 120h offset + (4d × i), where i=0d to 3d

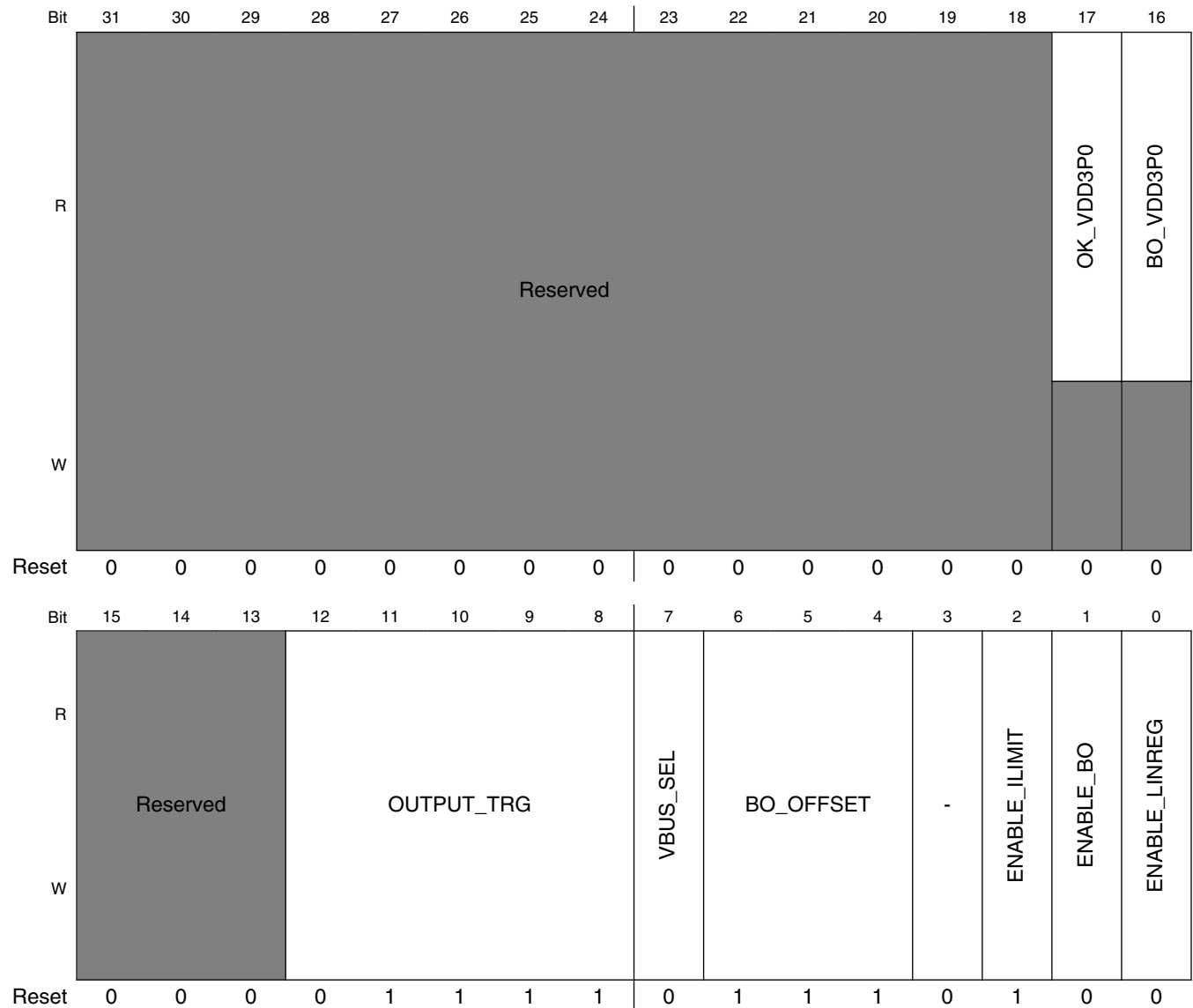

PMU_REG_3P0n field descriptions

Field	Description
31-18 -	This field is reserved.

Table continues on the next page...

PMU_REG_3P0n field descriptions (continued)

Field	Description
17 OK_VDD3P0	Status bit that signals when the regulator output is ok. 1 = regulator output > brownout target
16 BO_VDD3P0	Status bit that signals when a brownout is detected on the regulator output.
15–13 -	This field is reserved.
12–8 OUTPUT_TRG	Control bits to adjust the regulator output voltage. Each LSB is worth 25mV. Programming examples are detailed below. Other output target voltages may be interpolated from these examples. NOTE: There may be reduced chip functionality or reliability at the extremes of the programming range. 0x00 2.625V 0x0f 3.000V 0x1f 3.400V
7 VBUS_SEL	Select input voltage source for LDO_3P0 from either USB_OTG1_VBUS or USB_OTG2_VBUS. If only one of the two VBUS voltages is present, it is automatically selected. 1 USB_OTG1_VBUS — Utilize VBUS OTG1 power 0 USB_OTG2_VBUS — Utilize VBUS OTG2 power
6–4 BO_OFFSET	Control bits to adjust the regulator brownout offset voltage in 25mV steps. The reset brown-offset is 175mV below the programmed target code. Brownout target = OUTPUT_TRG - BO_OFFSET. Some steps may not be relevant because of input supply limitations or load operation.
3 -	Reserved
2 ENABLE_ILIMIT	Control bit to enable the current-limit circuitry in the regulator.
1 ENABLE_BO	Control bit to enable the brownout circuitry in the regulator.
0 ENABLE_LINREG	Control bit to enable the regulator output to be set by the programmed target voltage setting and internal bandgap reference.

39.6.3 Regulator 2P5 Register (PMU_REG_2P5n)

This register defines the control and status bits for the 2.5V regulator.

Address: 20C_8000h base + 130h offset + (4d × i), where i=0d to 3d

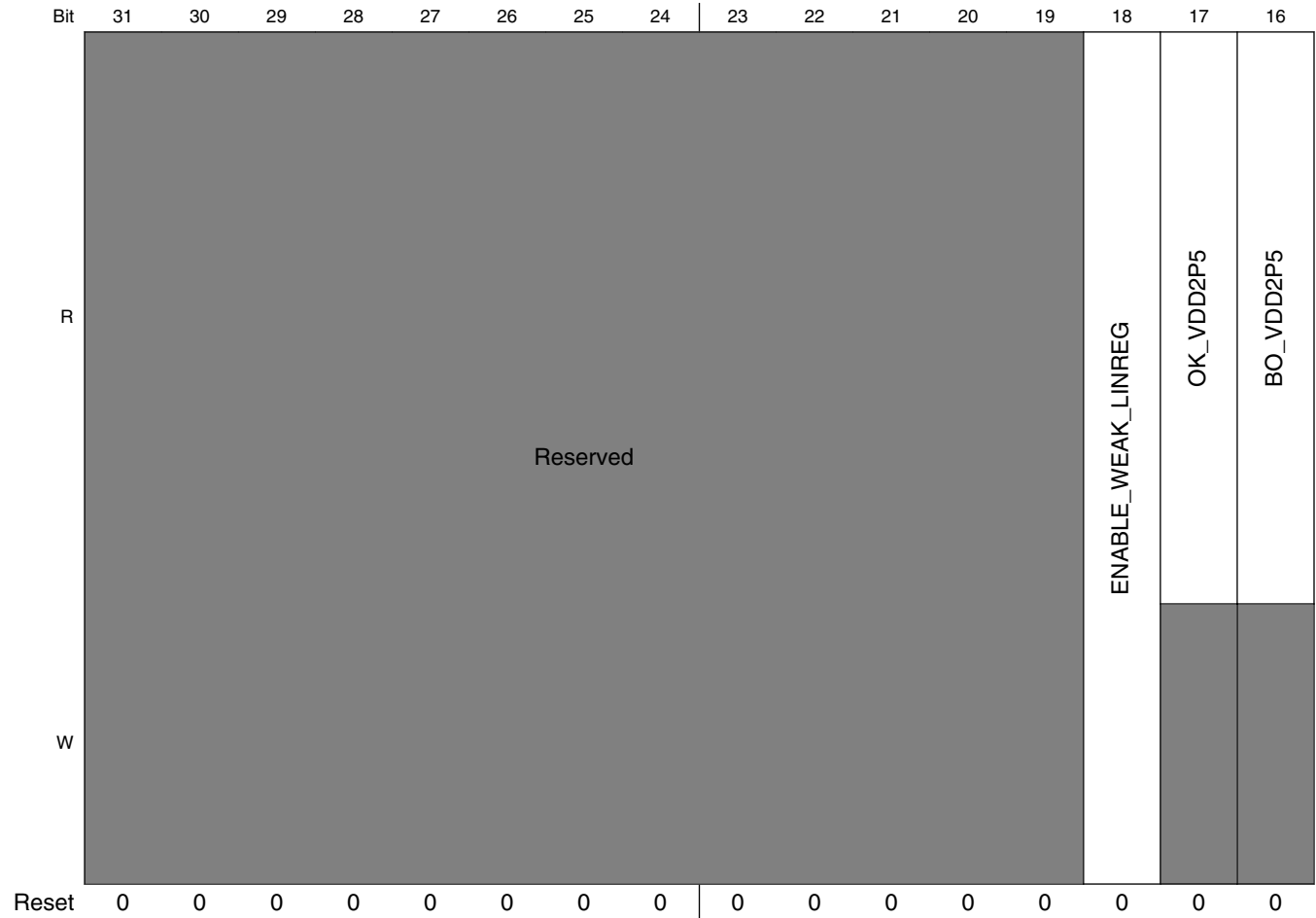

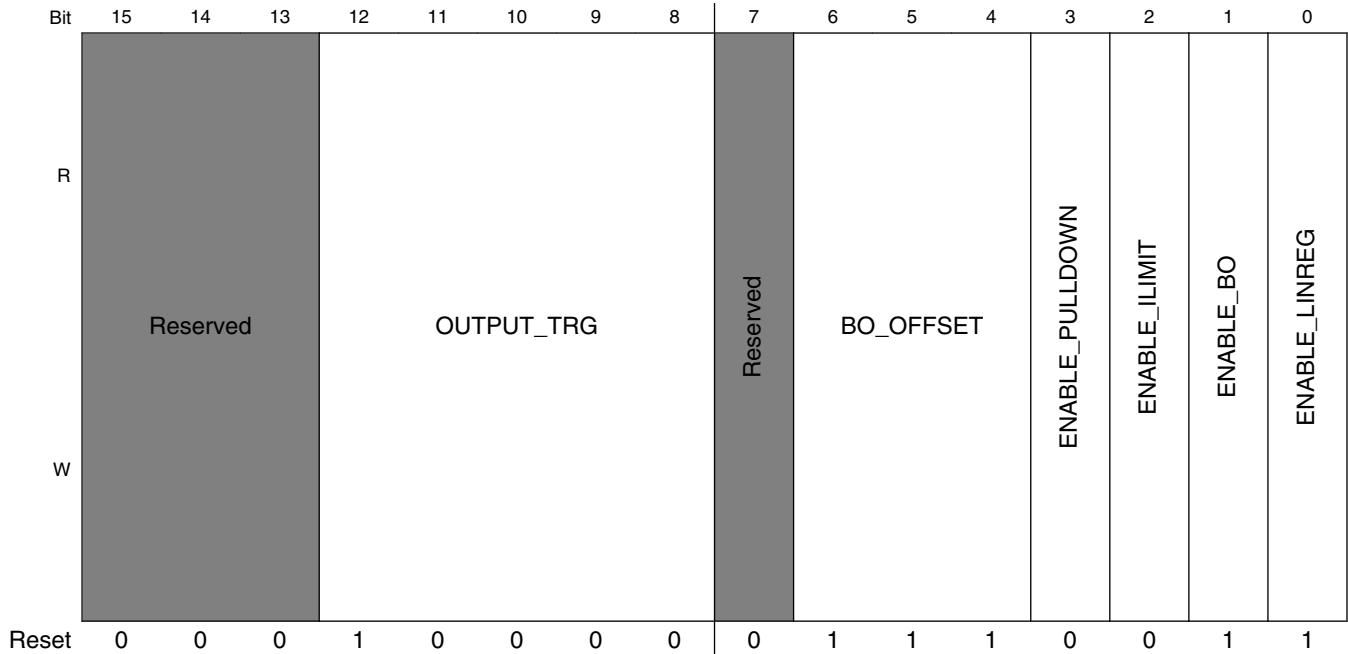

PMU_REG_2P5n field descriptions

Field	Description
31–19 -	This field is reserved.
18 ENABLE_WEAK_LINREG	Enables the weak 2p5 regulator. This low power regulator is used when the main 2p5 regulator is disabled to keep the 2.5V output roughly at 2.5V. Scales directly with the value of VDDHIGH_IN.
17 OK_VDD2P5	Status bit that signals when the regulator output is ok. 1 = regulator output > brownout target
16 BO_VDD2P5	Status bit that signals when a brownout is detected on the regulator output.
15–13 -	This field is reserved.
12–8 OUTPUT_TRG	Control bits to adjust the regulator output voltage. Each LSB is worth 25mV. Programming examples are detailed below. Other output target voltages may be interpolated from these examples. NOTE: There may be reduced chip functionality or reliability at the extremes of the programming range. 0x00 2.10V 0x10 2.50V 0x1f 2.875V
7 -	This field is reserved.
6–4 BO_OFFSET	Control bits to adjust the regulator brownout offset voltage in 25mV steps. The reset brown-offset is 175mV below the programmed target code. Brownout target = OUTPUT_TRG - BO_OFFSET. Some steps may be irrelevant because of input supply limitations or load operation.
3 ENABLE_PULLDOWN	Control bit to enable the pull-down circuitry in the regulator

Table continues on the next page...

PMU_REG_2P5n field descriptions (continued)

Field	Description
2 ENABLE_ILIMIT	Control bit to enable the current-limit circuitry in the regulator.
1 ENABLE_BO	Control bit to enable the brownout circuitry in the regulator.
0 ENABLE_LINREG	Control bit to enable the regulator output.

39.6.4 Digital Regulator Core Register (PMU_REG_COREn)

This register defines the function of the digital regulators

Address: 20C_8000h base + 140h offset + (4d × i), where i=0d to 3d

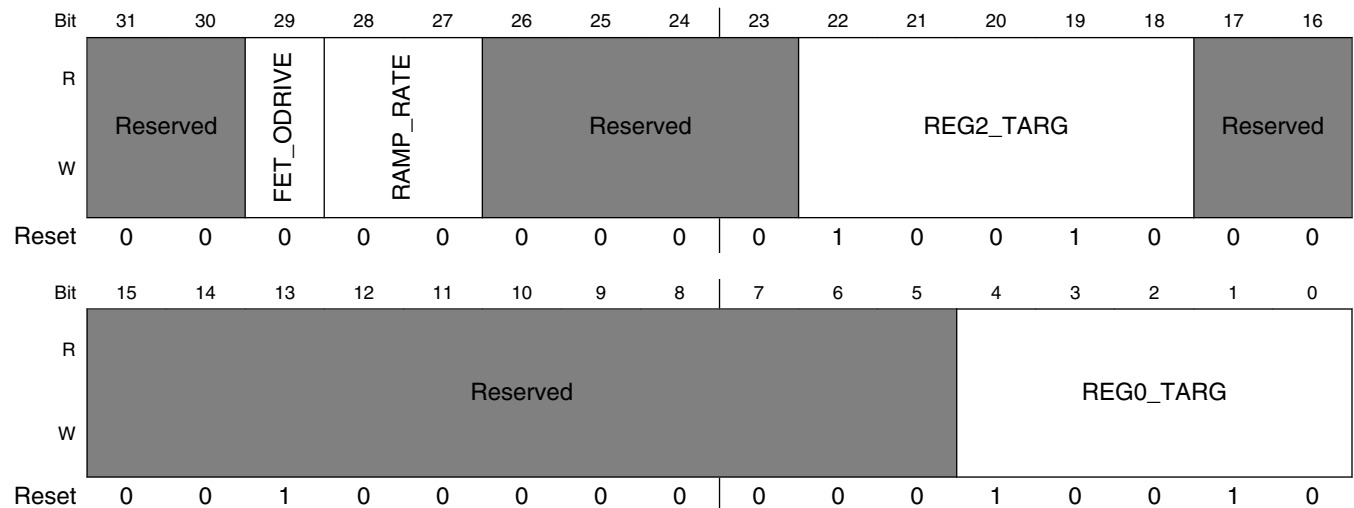

PMU_REG_COREn field descriptions

Field	Description
31–30 -	This field is reserved.
29 FET_ODRIVE	If set, increases the gate drive on power gating FETs to reduce leakage in the off state. Care must be taken to apply this bit only when the input supply voltage to the power FET is less than 1.1V. NOTE: This bit should only be used in low-power modes where the external input supply voltage is nominally 0.9V.
28–27 RAMP_RATE	Regulator voltage ramp rate. 00 Fast 01 Medium Fast

Table continues on the next page...

PMU_REG_COREn field descriptions (continued)

Field	Description
	10 Medium Slow 11 Slow
26–23 -	This field is reserved.
22–18 REG2_TARG	<p>This field defines the target voltage for the SOC power domain. Single-bit increments reflect 25mV core voltage steps. Some steps may not be relevant because of input supply limitations or load operation.</p> <p>NOTE: This register is capable of programming an over-voltage condition on the device. Consult the datasheet Operating Ranges table for the allowed voltages.</p> <p>00000 Power gated off 00001 Target core voltage = 0.725V 00010 Target core voltage = 0.750V 00011 Target core voltage = 0.775V ... 10000 Target core voltage = 1.100V ... 11110 Target core voltage = 1.450V 11111 Power FET switched full on. No regulation.</p>
17–5 -	This field is reserved.
REG0_TARG	<p>This field defines the target voltage for the ARM core power domain. Single-bit increments reflect 25mV core voltage steps. Some steps may not be relevant because of input supply limitations or load operation.</p> <p>NOTE: This register is capable of programming an over-voltage condition on the device. Consult the datasheet Operating Ranges table for the allowed voltages.</p> <p>00000 Power gated off 00001 Target core voltage = 0.725V 00010 Target core voltage = 0.750V 00011 Target core voltage = 0.775V ... 10000 Target core voltage = 1.100V ... 11110 Target core voltage = 1.450V 11111 Power FET switched full on. No regulation.</p>

39.6.5 Miscellaneous Register 0 (PMU_MISC0n)

This register defines the control and status bits for miscellaneous analog blocks.

Address: 20C_8000h base + 150h offset + (4d × i), where i=0d to 3d

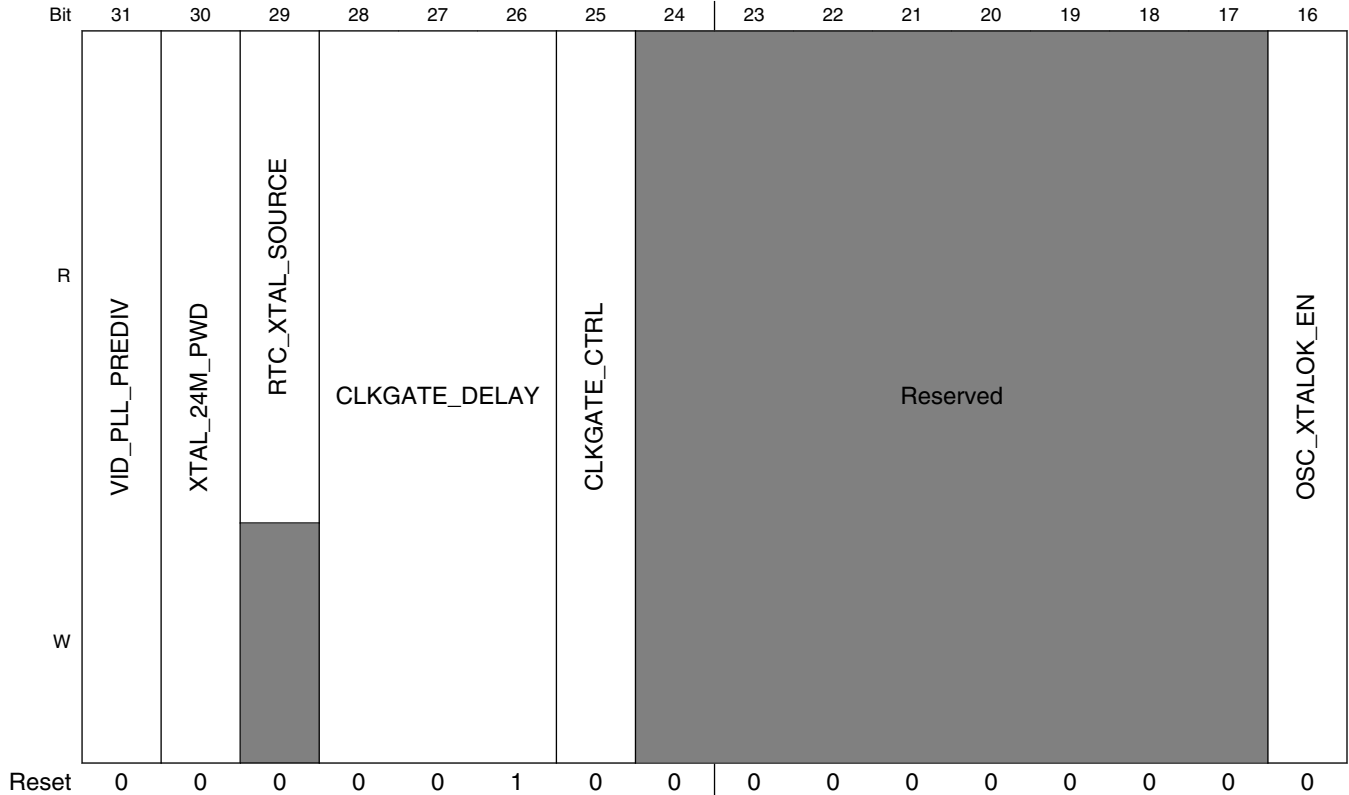

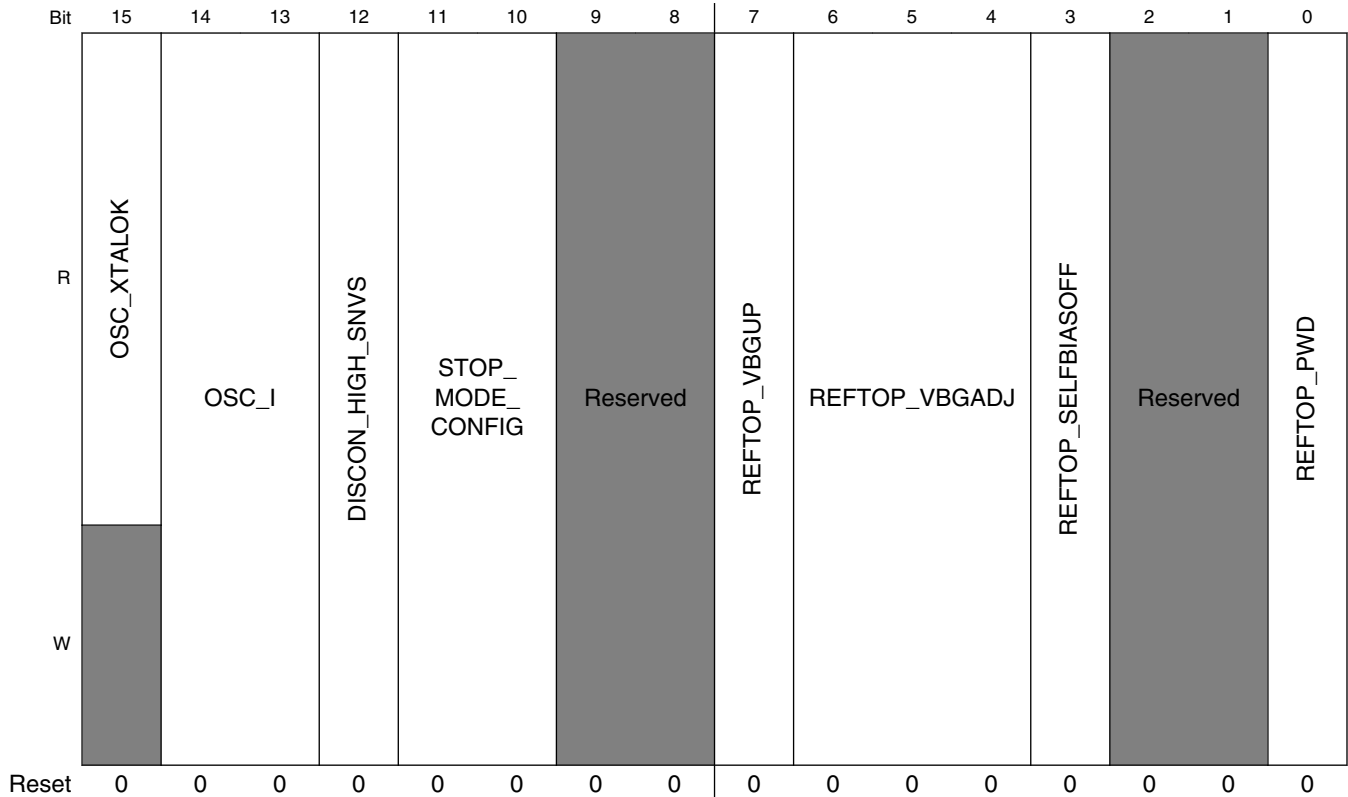

PMU_MISC0n field descriptions

Field	Description
31 VID_PLL_PREDIV	Predivider for the source clock of the PLL's. 0 Divide by 1 1 Divide by 2
30 XTAL_24M_PWD	This field powers down the 24M crystal oscillator if set true.
29 RTC_XTAL_SOURCE	This field indicates which chip source is being used for the rtc clock. 0 Internal ring oscillator 1 RTC_XTAL
28-26 CLKGATE_DELAY	This field specifies the delay between powering up the XTAL 24MHz clock and releasing the clock to the digital logic inside the analog block. NOTE: Do not change the field during a low power event. This is not a field that the user would normally need to modify. NOTE: Not related to PMU. 000 0.5ms 001 1.0ms 010 2.0ms 011 3.0ms 100 4.0ms

Table continues on the next page...

PMU_MISC0n field descriptions (continued)

Field	Description
	101 5.0ms 110 6.0ms 111 7.0ms
25 CLKGATE_CTRL	This bit allows disabling the clock gate (always ungated) for the xtal 24MHz clock that clocks the digital logic in the analog block. NOTE: Do not change the field during a low power event. This is not a field that the user would normally need to modify. NOTE: Not related to PMU. 0 ALLOW_AUTO_GATE — Allow the logic to automatically gate the clock when the XTAL is powered down. 1 NO_AUTO_GATE — Prevent the logic from ever gating off the clock.
24–17 -	This field is reserved. Always set to zero.
16 OSC_XTALOK_EN	This bit enables the detector that signals when the 24MHz crystal oscillator is stable. NOTE: Not related to PMU, Clocking content
15 OSC_XTALOK	Status bit that signals that the output of the 24-MHz crystal oscillator is stable. Generated from a timer and active detection of the actual frequency. NOTE: Not related to PMU, clocking content.
14–13 OSC_I	This field determines the bias current in the 24MHz oscillator. The aim is to start up with the highest bias current, which can be decreased after startup if it is determined to be acceptable. NOTE: Not related to PMU. 00 NOMINAL — Nominal 01 MINUS_12_5_PERCENT — Decrease current by 12.5% 10 MINUS_25_PERCENT — Decrease current by 25.0% 11 MINUS_37_5_PERCENT — Decrease current by 37.5%
12 DISCON_HIGH_SNVS	This bit controls a switch from VDD_HIGH_IN to VDD_SNVS_IN. 0 Turn on the switch 1 Turn off the switch
11–10 STOP_MODE_CONFIG	Configure the analog behavior in stop mode. 00 SUSPEND (DSM) — All analog except rtc powered down on stop mode assertion. 01 STANDBY — Analog regulators are ON. 10 STOP (lower power) — Analog regulators are ON. 11 STOP (very lower power) — Analog regulators are OFF.
9–8 -	This field is reserved. Reserved
7 REFTOP_VBGUP	Status bit that signals the analog bandgap voltage is up and stable. 1 - Stable.

Table continues on the next page...

PMU_MISCO n field descriptions (continued)

Field	Description
6-4 REFTOP_ VBGADJ	000 Nominal VBG 001 VBG+0.78% 010 VBG+1.56% 011 VBG+2.34% 100 VBG-0.78% 101 VBG-1.56% 110 VBG-2.34% 111 VBG-3.12%
3 REFTOP_ SELFBIASOFF	Control bit to disable the self-bias circuit in the analog bandgap. The self-bias circuit is used by the bandgap during startup. This bit should be set after the bandgap has stabilized and is necessary for best noise performance of analog blocks using the outputs of the bandgap. NOTE: Value should be returned to zero before removing vddhigh_in or asserting bit 0 of this register (REFTOP_PWD) to assure proper restart of the circuit. 0 Uses coarse bias currents for startup 1 Uses bandgap-based bias currents for best performance.
2-1 -	This field is reserved.
0 REFTOP_PWD	Control bit to power-down the analog bandgap reference circuitry. NOTE: A note of caution, the bandgap is necessary for correct operation of most of the LDO, pll, and other analog functions on the die.

39.6.6 Miscellaneous Register 1 (PMU_MISC1n)

This register defines the control and status bits for miscellaneous analog blocks.

Address: 20C_8000h base + 160h offset + (4d × i), where i=0d to 3d

Bit	31	30	29	28	27	26	25	24	23	22	21	20	19	18	17	16	
R	IRQ_DIG_BO	IRQ_ANA_BO	IRQ_TEMPHIGH	IRQ_TEMFLOW	IRQ_TEMPPANIC	Reserved										PFD_528_AUTOGATE_EN	PFD_480_AUTOGATE_EN
W	w1c	w1c	w1c	w1c	w1c												
Reset	0	0	0	0	0	0	0	0	0	0	0	0	0	0	0	0	
Bit	15	14	13	12	11	10	9	8	7	6	5	4	3	2	1	0	
R	Reserved		Reserved	LVDSCLK1_IBEN	Reserved	LVDSCLK1_OBEN	Reserved					LVDS1_CLK_SEL					
W																	
Reset	0	0	0	0	0	0	0	0	0	0	0	0	0	0	0	0	

PMU_MISC1n field descriptions

Field	Description
31 IRQ_DIG_BO	This status bit is set to one when when any of the digital regulator brownout interrupts assert. Check the regulator status bits to discover which regulator interrupt asserted.
30 IRQ_ANA_BO	This status bit is set to one when when any of the analog regulator brownout interrupts assert. Check the regulator status bits to discover which regulator interrupt asserted.
29 IRQ_TEMPHIGH	This status bit is set to one when the temperature sensor high interrupt asserts for high temperature. NOTE: Not related to PMU, Temperature Monitor content.
28 IRQ_TEMPLOW	This status bit is set to one when the temperature sensor low interrupt asserts for low temperature. NOTE: Not related to PMU, Temperature Monitor content.
27 IRQ_TEMP PANIC	This status bit is set to one when the temperature sensor panic interrupt asserts for a panic high temperature. NOTE: Not related to PMU, Temperature Monitor content.
26–18 -	This field is reserved. Reserved
17 PFD_528_ AUTOGATE_EN	This enables a feature that will clkgate (reset) all PFD_528 clocks anytime the PLL_528 is unlocked or powered off.
16 PFD_480_ AUTOGATE_EN	This enables a feature that will clkgate (reset) all PFD_480 clocks anytime the USB1_PLL_480 is unlocked or powered off.
15–14 -	This field is reserved. Reserved
13 -	This field is reserved. Reserved
12 LVDSCLK1_ IBEN	This enables the LVDS input buffer for anaclk1/1b. Do not enable input and output buffers simultaneously. NOTE: Not related to PMU, Clocking content.
11 -	This field is reserved. Reserved
10 LVDSCLK1_ OBEN	This enables the LVDS output buffer for anaclk1/1b. Do not enable input and output buffers simultaneously. NOTE: Not related to PMU, clocking content.
9–5 -	This field is reserved. Reserved
LVDS1_CLK_ SEL	This field selects the clk to be routed to anaclk1/1b. NOTE: Not related to PMU. 00000 ARM_PLL — Arm PLL 00001 SYS_PLL — System PLL 00010 PFD4 — ref_pfd4_clk == pll2_pfd0_clk 00011 PFD5 — ref_pfd5_clk == pll2_pfd1_clk

Table continues on the next page...

PMU_MISC1n field descriptions (continued)

Field	Description
00100	PFD6 — ref_pfd6_clk == pll2_pfd2_clk
00101	PFD7 — ref_pfd7_clk == pll2_pfd3_clk
00110	AUDIO_PLL — Audio PLL
00111	VIDEO_PLL — Video PLL
01001	ETHERNET_REF — ethernet ref clock (ENET_PLL)
01100	USB1_PLL — USB1 PLL clock
01101	USB2_PLL — USB2 PLL clock
01110	PFD0 — ref_pfd0_clk == pll3_pfd0_clk
01111	PFD1 — ref_pfd1_clk == pll3_pfd1_clk
10000	PFD2 — ref_pfd2_clk == pll3_pfd2_clk
10001	PFD3 — ref_pfd3_clk == pll3_pfd3_clk
10010	XTAL — xtal (24M)
10101 to 11111	- — ref_pfd7_clk == pll2_pfd3_clk

39.6.7 Miscellaneous Control Register (PMU_MISC2n)

This register defines the control for miscellaneous PMU Analog blocks.

NOTE

This register is shared with CCM.

Address: 20C_8000h base + 170h offset + (4d × i), where i=0d to 3d

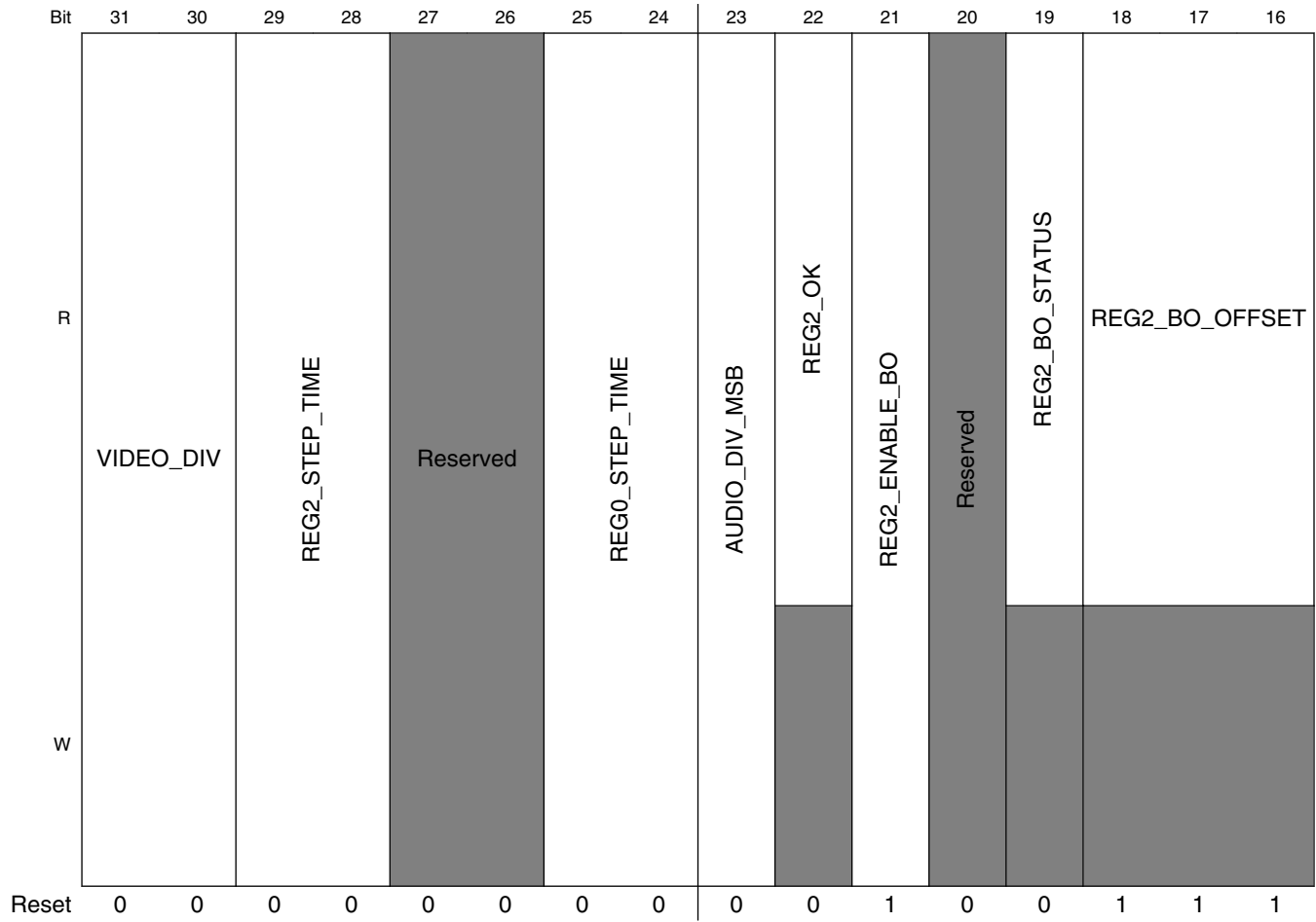

PMU Memory Map/Register Definition

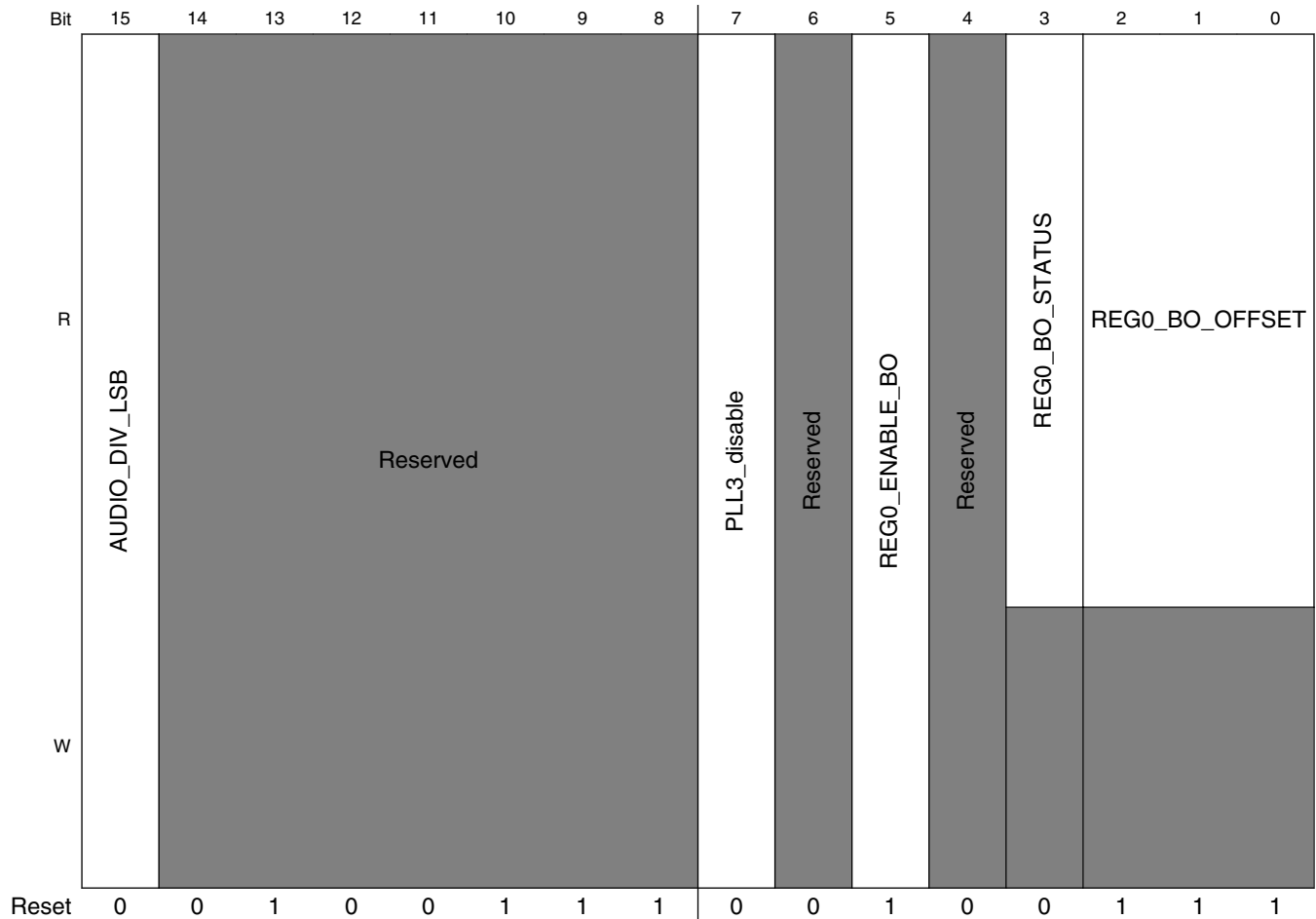

PMU_MISC2n field descriptions

Field	Description
31–30 VIDEO_DIV	<p>Post-divider for video. The output clock of the video PLL should be gated prior to changing this divider to prevent glitches. This divider is feed by PLL_VIDEOOn[POST_DIV_SELECT] to achieve division ratios of /1, /2, /4, /8, and /16.</p> <p>NOTE: Not related to PMU. See Clock Controller Module (CCM) for more information.</p> <p>00 divide by 1 (Default) 01 divide by 2 10 divide by 1 11 divide by 4</p>
29–28 REG2_STEP_ TIME	<p>Number of clock periods (24MHz clock).</p> <p>00 64_CLOCKS — 64 01 128_CLOCKS — 128 10 256_CLOCKS — 256 11 512_CLOCKS — 512</p>
27–26 -	<p>This field is reserved. Reserved</p>

Table continues on the next page...

PMU_MISC2n field descriptions (continued)

Field	Description
25–24 REG0_STEP_ TIME	Number of clock periods (24MHz clock). 00 64_CLOCKS — 64 01 128_CLOCKS — 128 10 256_CLOCKS — 256 11 512_CLOCKS — 512
23 AUDIO_DIV_ MSB	MSB of Post-divider for Audio PLL. The output clock of the video PLL should be gated prior to changing this divider to prevent glitches. This divider is feed by PLL_AUDION[POST_DIV_SELECT] to achieve division ratios of /1, /2, /4, /8, and /16. NOTE: MSB bit value pertains to the first bit, please program the LSB bit (bit 15) as well to change divider value NOTE: Not related to PMU. See Clock Controller Module (CCM) for more information. 00 divide by 1 (Default) 01 divide by 2 10 divide by 1 11 divide by 4
22 REG2_OK	Signals that the voltage is above the brownout level for the SOC supply. 1 = regulator output > brownout_target
21 REG2_ENABLE_ BO	Enables the brownout detection.
20 -	This field is reserved.
19 REG2_BO_ STATUS	Reg2 brownout status bit.
18–16 REG2_BO_ OFFSET	This field defines the brown out voltage offset for the xPU power domain. IRQ_DIG_BO is also asserted. Single-bit increments reflect 25mV brownout voltage steps. The reset brown-offset is 175mV below the programmed target code. Brownout target = OUTPUT_TRG - BO_OFFSET. Some steps may be irrelevant because of input supply limitations or load operation. 100 Brownout offset = 0.100V 111 Brownout offset = 0.175V
15 AUDIO_DIV_LSB	LSB of Post-divider for Audio PLL. The output clock of the video PLL should be gated prior to changing this divider to prevent glitches. This divider is feed by PLL_AUDION[POST_DIV_SELECT] to achieve division ratios of /1, /2, /4, /8, and /16. NOTE: LSB bit value pertains to the last bit, please program the MSB bit (bit 23) as well, to change divider value NOTE: Not related to PMU. See Clock Controller Module (CCM) for more information. 00 divide by 1 (Default) 01 divide by 2 10 divide by 1 11 divide by 4
14–8 -	This field is reserved.

Table continues on the next page...

PMU_MISC2n field descriptions (continued)

Field	Description
7 PLL3_disable	Default value of "0". Should be set to "1" to turn off the USB-PLL(PLL3) in run mode. NOTE: Not related to PMU. See Clock Controller Module (CCM) for more information.
6 -	This field is reserved.
5 REG0_ENABLE_ BO	Enables the brownout detection.
4 -	This field is reserved.
3 REG0_BO_ STATUS	Reg0 brownout status bit. 1 Brownout, supply is below target minus brownout offset.
REG0_BO_ OFFSET	This field defines the brown out voltage offset for the CORE power domain. IRQ_DIG_BO is also asserted. Single-bit increments reflect 25mV brownout voltage steps. Some steps may be irrelevant because of input supply limitations or load operation. 100 Brownout offset = 0.100V 111 Brownout offset = 0.175V

39.6.8 Low Power Control Register (PMU_LOWPWR_CTRLn)

This register defines the low power configuration bits.

Address: 20C_8000h base + 270h offset + (4d × i), where i=0d to 3d

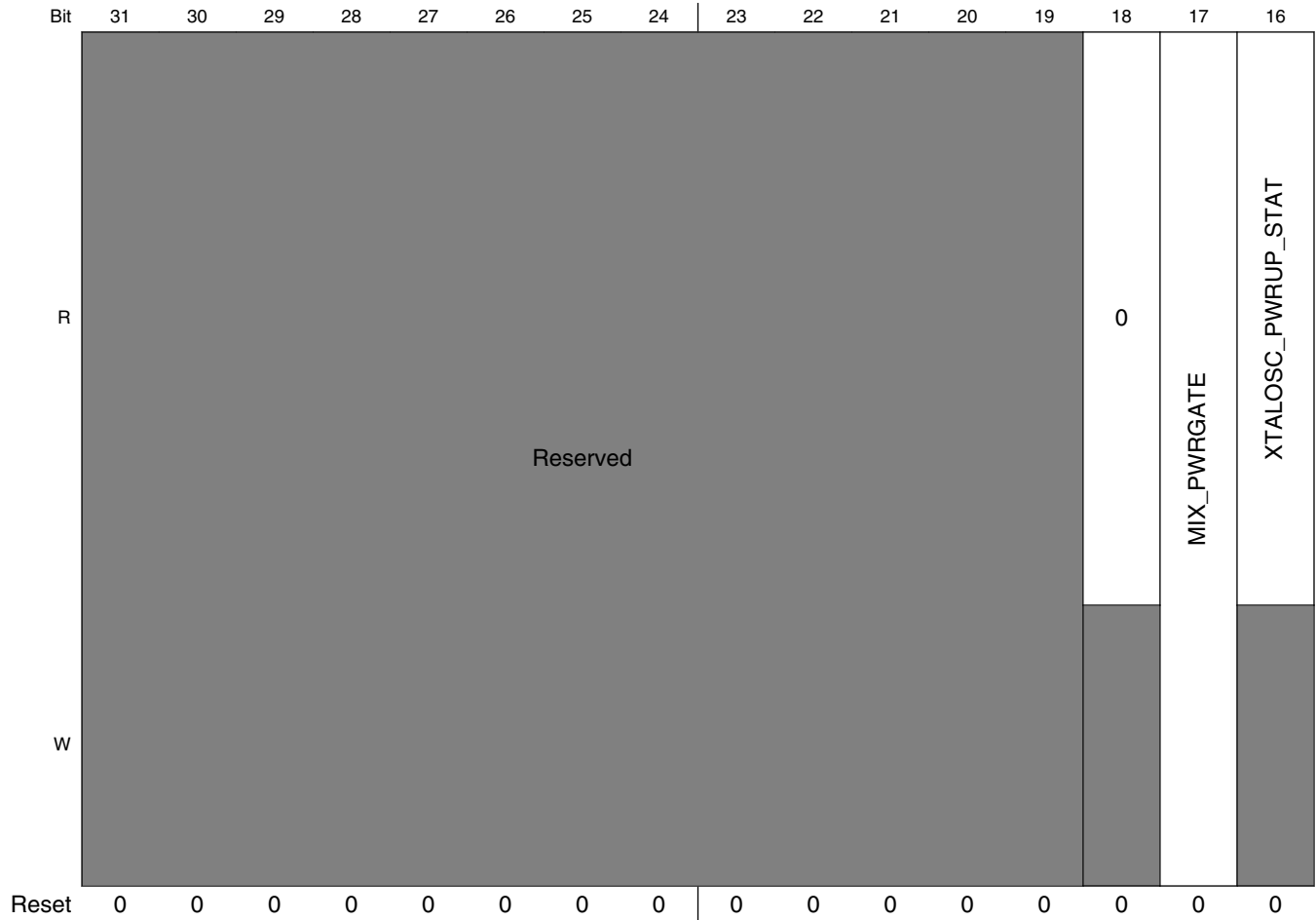

PMU Memory Map/Register Definition

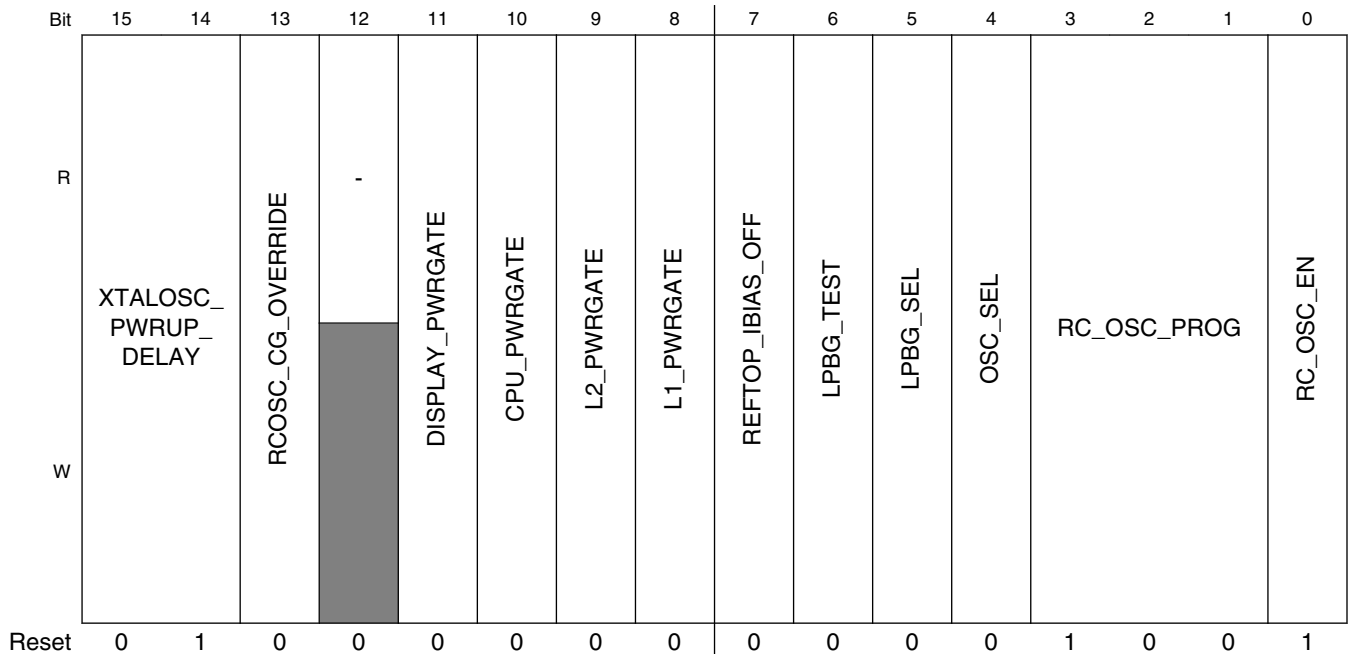

PMU_LOWPWR_CTRL n field descriptions

Field	Description
31–19 -	This field is reserved.
18 Reserved	This read-only field is reserved and always has the value 0.
17 MIX_PWRGATE	Display power gate control. Used as software mask. Set to zero to force ungated.
16 XTALOSC_PWRUP_STAT	Status of the 24MHz xtal oscillator. NOTE: Not related to PMU. 0 Not stable 1 Stable and ready to use
15–14 XTALOSC_PWRUP_DELAY	Specifies the time delay between when the 24MHz xtal is powered up until it is stable and ready to use. NOTE: Not related to PMU. 00 0.25ms 01 0.5ms 10 1ms 11 2ms
13 RCOSC_CG_OVERRIDE	For debug purposes only. This bit effects clock gating of certain digital logic clocked by the 24MHz clk. NOTE: Not related to PMU.
12 -	Reserved

Table continues on the next page...

PMU_LOWPWR_CTRLn field descriptions (continued)

Field	Description
11 DISPLAY_ PWRGATE	Display logic power gate control. Used as software override.
10 CPU_PWRGATE	CPU power gate control. Used as software override. Attention: Test purpose only
9 L2_PWRGATE	L2 power gate control. Used as software override.
8 L1_PWRGATE	L1 power gate control. Used as software override.
7 REFTOP_IBIAS_ OFF	Low power reftop ibias disable.
6 LPBG_TEST	Low power bandgap test bit.
5 LPBG_SEL	Bandgap select. 0 Normal power bandgap 1 Low power bandgap
4 OSC_SEL	Select the source for the 24MHz clock. NOTE: Not related to PMU. 0 XTAL OSC 1 RC OSC
3-1 RC_OSC_PROG	RC osc. tuning values. NOTE: Not related to PMU.
0 RC_OSC_EN	RC Osc. enable control. NOTE: Not related to PMU. 0 Use XTAL OSC to source the 24MHz clock 1 Use RC OSC

Chapter 40

Pulse Width Modulation (PWM)

40.1 Overview

The Pulse Width Modulation (PWM) has a 16-bit counter, and is optimized to generate sound from stored sample audio images and it can also generate tones. It uses 16-bit resolution and a 4 x 16 data FIFO.

This section presents an overview of the PWM. A block diagram of the PWM module is shown in the figure below.

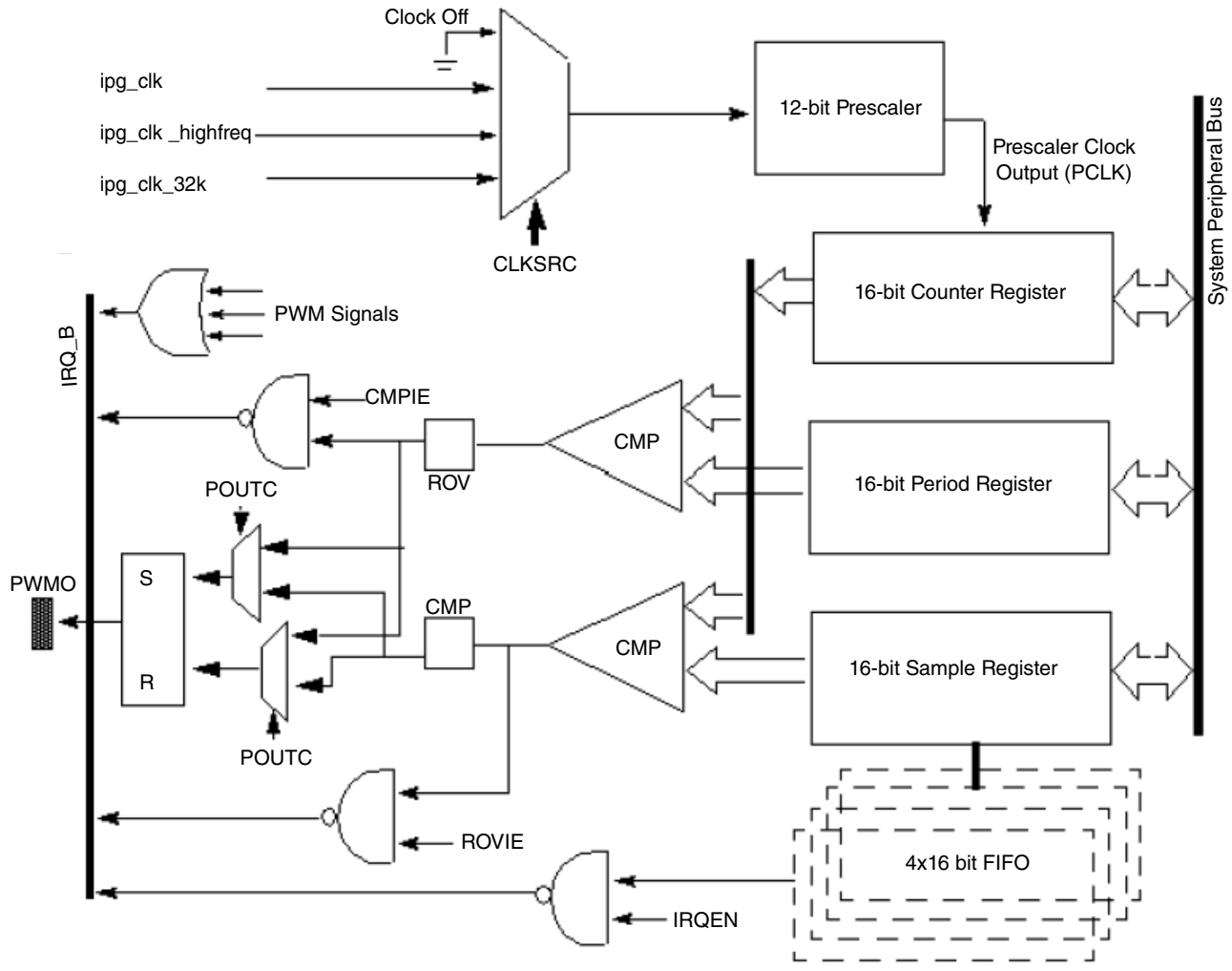

Figure 40-1. Pulse-Width Modulator Block Diagram

The following features characterize the PWM:

- 16-bit up-counter with clock source selection
- 4 x 16 FIFO to minimize interrupt overhead
- 12-bit prescaler for division of clock
- Sound and melody generation
- Active high or active low configured output
- Can be programmed to be active in low-power mode
- Can be programmed to be active in debug mode
- Interrupts at compare and rollover

40.2 External Signals

The PWM follows IP Bus protocol when interfacing with the processor core. PWM does not have any interface signals with any other block inside the chip except for clock and reset inputs from the Clock Control Module (CCM), System Reset Controller (SRC), and interrupt signals to the processor interrupt handler. There is a single output signal.

The following table outlines the external signals.

Table 40-1. PWM External Signals

Signal	Description	Pad	Mode	Direction
PWM1_OUT	This is the PWM1 functional output of the PWM. A modulated signal of the block is observed at this pin. It can be viewed as a clock signal whose period and duty cycle can be varied with different settings of the cycle of 50%.	ENET1_RX_DATA0	ALT2	O
		GPIO1_IO08	ALT0	
		LCD_DATA00	ALT1	
PWM2_OUT	This is the PWM2 functional output of the PWM. A modulated signal of the block is observed at this pin. It can be viewed as a clock signal whose period and duty cycle can be varied with different settings of the cycle of 50%.	ENET1_RX_DATA1	ALT2	O
		GPIO1_IO09	ALT0	
		LCD_DATA01	ALT1	
PWM3_OUT	This is the PWM3 functional output of the PWM. A modulated signal of the block is observed at this pin. It can be viewed as a clock signal whose period and duty cycle can be varied with different settings of the cycle of 50%.	GPIO1_IO04	ALT1	O
		LCD_DATA02	ALT1	
		NAND_ALE	ALT3	
PWM4_OUT	This is the PWM4 functional output of the PWM. A modulated signal of the block is observed at this pin. It can be viewed as a clock signal whose period and duty cycle can be varied with different settings of the cycle of 50%.	GPIO1_IO05	ALT1	O
		LCD_DATA03	ALT1	
		NAND_WP_B	ALT3	
PWM5_OUT	This is the PWM5 functional output of the PWM. A modulated signal of the block is observed at this pin. It can be viewed as a clock signal whose period and duty cycle can be varied with different settings of the cycle of 50%.	ENET1_TX_DATA1	ALT2	O
		LCD_DATA18	ALT1	
		NAND_DQS	ALT3	
PWM6_OUT	This is the PWM6 functional output of the PWM. A modulated signal of the block is observed at this pin. It can be viewed as a clock signal whose period and duty cycle can be varied with different settings of the cycle of 50%.	ENET1_TX_EN	ALT2	O
		JTAG_TDI	ALT4	
		LCD_DATA19	ALT1	
PWM7_OUT	This is the PWM7 functional output of the PWM. A modulated signal of	CSI_VSYNC	ALT6	O
		ENET1_TX_CLK	ALT2	

Table continues on the next page...

Table 40-1. PWM External Signals (continued)

Signal	Description	Pad	Mode	Direction
	the block is observed at this pin. It can be viewed as a clock signal whose period and duty cycle can be varied with different settings of the cycle of 50%.	JTAG_TCK	ALT4	
PWM8_OUT	This is the PWM8 functional output of the PWM. A modulated signal of the block is observed at this pin. It can be viewed as a clock signal whose period and duty cycle can be varied with different settings of the cycle of 50%.	CSI_HSYNC	ALT6	O
		ENET1_RX_ER	ALT2	
		JTAG_TRST_B	ALT4	

40.3 Clocks

The table found here describes the clock sources for PWM. Please see [Clock Controller Module \(CCM\)](#) for clock setting, configuration and gating information.

Table 40-2. PWM Clocks

Clock name	Clock Root	Description
ipg_clk	ipg_clk_root	Peripheral clock
ipg_clk_32k	ckil_sync_clk_root	low-frequency reference clock (32 kHz)
ipg_clk_highfreq	perclk_clk_root	high-frequency reference clock
ipg_clk_s	ipg_clk_root	Peripheral access clock

The clock that feeds the prescaler can be selected from:

- High-frequency reference clock (ipg_clk_highfreq) pat_ref or CKIH

This is a high frequency clock, provided by the Clock Control Module (CCM). This clock should be on in the low power mode when the ipg_clk is turned off. Thus, the PWM can be run on this clock in the low power mode. The CCM is expected to provide this clock after synchronizing it to ahb_clk in the normal functional mode and then switch to the unsynchronized version in the low power mode.

- Low-frequency reference clock (ipg_clk_32k, CKIL)

This is the 32 KHz low reference clock which is provided by the CCM. This clock should be on in the low power mode when `ipg_clk` is turned off. Thus, PWM can be run on this clock in the low power mode. The CCM is expected to provide this clock after synchronizing it to `ahb_clk` in the normal functional mode and then switch to the unsynchronized version in the low power mode.

- Peripheral clock (`ipg_clk`)

This clock should be on in normal operations. In low power mode, it can be switched off.

- Peripheral access clock (`ipg_clk_s`)

This clock is used for register read/write.

The clock input source is determined by the PWM control register field `PWM_CR[CLKSRC]`. The `CLKSRC` value should only be changed when the PWM is disabled.

A change in the value of the `PRESCALER` field of the control register is immediately reflected on its output clock frequency.

40.4 Functional Description

The following sections detail the PWM operation and function.

40.4.1 Operation

The output of the PWM is a toggling signal whose frequency and duty cycle can be modulated by programming the appropriate registers. It has a 16-bit up counter which counts from `0x0000` until the counter value equals the `PWM_PR + 1`. After this match occurs the counter is reset to `0x0000`.

At the beginning of a count period cycle, the `PWMO` pin is set to one (default) and the counter begins counting up from `0x0000`. The sample value in the sample FIFO is compared on each count of prescaler clock. When the sample and count values match, the `PWMO` signal is cleared to zero (default). The counter continues counting until the period match occurs and subsequently another period cycle begins.

When the PWM is enabled, the counter starts running and generates an output with the reset values in the period and sample registers. It is recommended that the programming of these registers be done before PWM is enabled.

A hardware reset results in all the PWM count and sample registers being cleared and the FIFO being flushed. The control register shows that FIFO is empty and it can be written into, and the PWM is disabled. A software reset has the same results, however the state of the DBGEN, STOPEN, DOZEN, and WAITEN bits in the control register are not affected. Software reset can be asserted even when the PWM is in disabled state.

40.4.1.1 FIFO

Digital sample values can be loaded into the pulse-width modulator as 16-bit words. The endianness can be changed using the BCTR and HCTR bits of the control register. A 4-word (16-bit) FIFO minimizes interrupt overhead. A maskable interrupt is generated when the number of data words fall below the water level set by the FWM field in the control register.

A write to the PWM_SAR sample register results in the value being stored into the FIFO if it is not full. A write when the FIFO is full sets FWE (FIFO write error) bit in the status register and the FIFO contents remain unchanged. The FIFO can be written at any time, but can be read only when the PWM is enabled. The PWM_SR[FIFOAV] field shows how many data words are currently contained in the FIFO and whether or not it can be written into.

A read on the sample register yields the current FIFO value that is being used, or will be used, by the PWM for generation on the output signal. Therefore, a write and a subsequent read on the sample register may result in different values being obtained.

40.4.1.2 Rollover and Compare Event

The counter is reset to 0x0000 after its value equals the PWM_PR[PERIOD] + 1 and resumes counting thereafter. This event is referred to as a rollover. For example, if PWM_PR[PERIOD] = 0x0000, the counter is reset when it equals 0x0001. When PWM_PR[PERIOD] = 0xFFFF or 0xFFFE, the counter is reset when it equals 0xFFFF. For more information, see the PWM Period Register (PWM_PR) description.

During a rollover event the output is either set (default), reset or has no effect according to the programming of the POUTC field in the control register. This event can also generate an interrupt if the respective interrupt enable bit is set in the control register.

When the counter value reaches the sample value, the output of the PWM is reset (default), set or has no effect according to the programming of the POUTC field of control register. This event is referred to as a compare event. This event can also generate an interrupt if the respective interrupt enable bit is set in the control register.

If the rollover event sets the PWM output signal, the compare event will reset it and vice versa for a particular programming configuration of POUTC field.

40.4.1.3 Low Power Mode Behavior

In low power mode, if the clock from the selected clock source is available, the PWM counter continues to run and an output is produced, depending on whether the control bit for that mode is set or not. In the absence of the clock itself, or if the corresponding low power bit in the control register is 0, the counter is reset and resumes counting when it exits the low power mode.

40.4.1.4 Debug Mode Behavior

In debug mode, PWM has the option of continuing to run or be halted. If the DBGEN bit is not set in the PWM_PWMCR, the PWM is halted. If the DBGEN bit is set, then the PWM will continue to run in the debug mode.

40.5 Enable Sequence for the PWM

The sequence found here should be used to enable the PWM.

1. Configure the desired settings for the PWM Control Register (PWM_x_PWMCR) while keeping the PWM disabled (PWM_x_PWMCR[0]=0).
2. Enable the desired interrupts in the PWM Interrupt Register (PWM_x_PWMIR).
3. One to three initial samples may be written to the PWM Sample Register (PWM_x_PWMSAR). The initial sample values will be loaded into the PWM FIFO even if the PWM is not yet enabled. Do not write a 4th sample because the FIFO will become full and trigger a FIFO Write Error (FWE). This error will prevent the PWM from starting once it is enabled.
4. Check the FIFO Write Error status bit (FWE), the Compare status bit (CMP) and the Roll-over status bit (ROV) in the PWM Status Register (PWM_x_PWMSR) to make sure they are all zero. Any non-zero status bits should be cleared by writing a 1 to them.
5. Write the desired period to the PWM Period Register (PWM_x_PWMPR).
6. Enable the PWM by writing a 1 to the PWM Enable bit, PWM_x_PWMCR[0], while maintaining the other register bits in their previously configured state.

40.6 Disable Sequence for the PWM

The PWM can be disabled at any time by clearing the PWM enable bit, PWM_x_PWMCR[0] to 0.

Any data remaining in the FIFO will not be produced at the PWM output after the PWM has been disabled and will remain in the FIFO until the PWM is enabled again. A software reset (setting PWM_x_PWMCR[3] to 1) or a hardware reset will clear the FIFO and any remaining data will be lost.

40.7 PWM Memory Map/Register Definition

The PWM includes six user-accessible 32-bit registers.

PWM memory map

Absolute address (hex)	Register name	Width (in bits)	Access	Reset value	Section/page
208_0000	PWM Control Register (PWM1_PWMCR)	32	R/W	0000_0000h	40.7.1/2482
208_0004	PWM Status Register (PWM1_PWMSR)	32	w1c	0000_0008h	40.7.2/2484
208_0008	PWM Interrupt Register (PWM1_PWMIR)	32	R/W	0000_0000h	40.7.3/2485
208_000C	PWM Sample Register (PWM1_PWMSAR)	32	R/W	0000_0000h	40.7.4/2486
208_0010	PWM Period Register (PWM1_PWMPR)	32	R/W	0000_FFFEh	40.7.5/2487
208_0014	PWM Counter Register (PWM1_PWMCNR)	32	R	0000_0000h	40.7.6/2488
208_4000	PWM Control Register (PWM2_PWMCR)	32	R/W	0000_0000h	40.7.1/2482
208_4004	PWM Status Register (PWM2_PWMSR)	32	w1c	0000_0008h	40.7.2/2484
208_4008	PWM Interrupt Register (PWM2_PWMIR)	32	R/W	0000_0000h	40.7.3/2485
208_400C	PWM Sample Register (PWM2_PWMSAR)	32	R/W	0000_0000h	40.7.4/2486
208_4010	PWM Period Register (PWM2_PWMPR)	32	R/W	0000_FFFEh	40.7.5/2487
208_4014	PWM Counter Register (PWM2_PWMCNR)	32	R	0000_0000h	40.7.6/2488
208_8000	PWM Control Register (PWM3_PWMCR)	32	R/W	0000_0000h	40.7.1/2482
208_8004	PWM Status Register (PWM3_PWMSR)	32	w1c	0000_0008h	40.7.2/2484
208_8008	PWM Interrupt Register (PWM3_PWMIR)	32	R/W	0000_0000h	40.7.3/2485
208_800C	PWM Sample Register (PWM3_PWMSAR)	32	R/W	0000_0000h	40.7.4/2486
208_8010	PWM Period Register (PWM3_PWMPR)	32	R/W	0000_FFFEh	40.7.5/2487
208_8014	PWM Counter Register (PWM3_PWMCNR)	32	R	0000_0000h	40.7.6/2488
208_C000	PWM Control Register (PWM4_PWMCR)	32	R/W	0000_0000h	40.7.1/2482
208_C004	PWM Status Register (PWM4_PWMSR)	32	w1c	0000_0008h	40.7.2/2484
208_C008	PWM Interrupt Register (PWM4_PWMIR)	32	R/W	0000_0000h	40.7.3/2485
208_C00C	PWM Sample Register (PWM4_PWMSAR)	32	R/W	0000_0000h	40.7.4/2486

Table continues on the next page...

PWM memory map (continued)

Absolute address (hex)	Register name	Width (in bits)	Access	Reset value	Section/page
208_C010	PWM Period Register (PWM4_PWMPR)	32	R/W	0000_FFFEh	40.7.5/2487
208_C014	PWM Counter Register (PWM4_PWMCNR)	32	R	0000_0000h	40.7.6/2488
20F_0000	PWM Control Register (PWM5_PWMCR)	32	R/W	0000_0000h	40.7.1/2482
20F_0004	PWM Status Register (PWM5_PWMSR)	32	w1c	0000_0008h	40.7.2/2484
20F_0008	PWM Interrupt Register (PWM5_PWMIR)	32	R/W	0000_0000h	40.7.3/2485
20F_000C	PWM Sample Register (PWM5_PWMSAR)	32	R/W	0000_0000h	40.7.4/2486
20F_0010	PWM Period Register (PWM5_PWMPR)	32	R/W	0000_FFFEh	40.7.5/2487
20F_0014	PWM Counter Register (PWM5_PWMCNR)	32	R	0000_0000h	40.7.6/2488
20F_4000	PWM Control Register (PWM6_PWMCR)	32	R/W	0000_0000h	40.7.1/2482
20F_4004	PWM Status Register (PWM6_PWMSR)	32	w1c	0000_0008h	40.7.2/2484
20F_4008	PWM Interrupt Register (PWM6_PWMIR)	32	R/W	0000_0000h	40.7.3/2485
20F_400C	PWM Sample Register (PWM6_PWMSAR)	32	R/W	0000_0000h	40.7.4/2486
20F_4010	PWM Period Register (PWM6_PWMPR)	32	R/W	0000_FFFEh	40.7.5/2487
20F_4014	PWM Counter Register (PWM6_PWMCNR)	32	R	0000_0000h	40.7.6/2488
20F_8000	PWM Control Register (PWM7_PWMCR)	32	R/W	0000_0000h	40.7.1/2482
20F_8004	PWM Status Register (PWM7_PWMSR)	32	w1c	0000_0008h	40.7.2/2484
20F_8008	PWM Interrupt Register (PWM7_PWMIR)	32	R/W	0000_0000h	40.7.3/2485
20F_800C	PWM Sample Register (PWM7_PWMSAR)	32	R/W	0000_0000h	40.7.4/2486
20F_8010	PWM Period Register (PWM7_PWMPR)	32	R/W	0000_FFFEh	40.7.5/2487
20F_8014	PWM Counter Register (PWM7_PWMCNR)	32	R	0000_0000h	40.7.6/2488
20F_C000	PWM Control Register (PWM8_PWMCR)	32	R/W	0000_0000h	40.7.1/2482
20F_C004	PWM Status Register (PWM8_PWMSR)	32	w1c	0000_0008h	40.7.2/2484
20F_C008	PWM Interrupt Register (PWM8_PWMIR)	32	R/W	0000_0000h	40.7.3/2485
20F_C00C	PWM Sample Register (PWM8_PWMSAR)	32	R/W	0000_0000h	40.7.4/2486
20F_C010	PWM Period Register (PWM8_PWMPR)	32	R/W	0000_FFFEh	40.7.5/2487
20F_C014	PWM Counter Register (PWM8_PWMCNR)	32	R	0000_0000h	40.7.6/2488

40.7.1 PWM Control Register (PWMx_PWMCR)

The PWM control register (PWM_PWMCR) is used to configure the operating settings of the PWM. It contains the prescaler for the clock division.

Address: Base address + 0h offset

Bit	31	30	29	28	27	26	25	24	23	22	21	20	19	18	17	16
R	0				FWM		STOPEN	DOZEN	WAITEN	DBGEN	BCTR	HCTR	POUTC		CLKSRC	
W	0				0		0	0	0	0	0	0	0		0	
Reset	0	0	0	0	0	0	0	0	0	0	0	0	0	0	0	0
Bit	15	14	13	12	11	10	9	8	7	6	5	4	3	2	1	0
R	PRESCALER												SWR	REPEAT	EN	
W	0												0	0	0	
Reset	0	0	0	0	0	0	0	0	0	0	0	0	0	0	0	0

PWMx_PWMCR field descriptions

Field	Description
31–28 Reserved	This field is reserved. This read-only field is reserved and always has the value 0.
27–26 FWM	FIFO Water Mark. These bits are used to set the data level at which the FIFO empty flag will be set and the corresponding interrupt generated 00 FIFO empty flag is set when there are more than or equal to 1 empty slots in FIFO 01 FIFO empty flag is set when there are more than or equal to 2 empty slots in FIFO 10 FIFO empty flag is set when there are more than or equal to 3 empty slots in FIFO 11 FIFO empty flag is set when there are more than or equal to 4 empty slots in FIFO
25 STOPEN	Stop Mode Enable. This bit keeps the PWM functional while in stop mode. When this bit is cleared, the input clock is gated off in stop mode. This bit is not affected by software reset. It is cleared by hardware reset. 0 Inactive in stop mode 1 Active in stop mode
24 DOZEN	Doze Mode Enable. This bit keeps the PWM functional in doze mode. When this bit is cleared, the input clock is gated off in doze mode. This bit is not affected by software reset. It is cleared by hardware reset. 0 Inactive in doze mode 1 Active in doze mode
23 WAITEN	Wait Mode Enable. This bit keeps the PWM functional in wait mode. When this bit is cleared, the input clock is gated off in wait mode. This bit is not affected by software reset. It is cleared by hardware reset.

Table continues on the next page...

PWMx_PWMCR field descriptions (continued)

Field	Description
	0 Inactive in wait mode 1 Active in wait mode
22 DBGEN	Debug Mode Enable. This bit keeps the PWM functional in debug mode. When this bit is cleared, the input clock is gated off in debug mode. This bit is not affected by software reset. It is cleared by hardware reset. 0 Inactive in debug mode 1 Active in debug mode
21 BCTR	Byte Data Swap Control. This bit determines the byte ordering of the 16-bit data when it goes into the FIFO from the sample register. 0 byte ordering remains the same 1 byte ordering is reversed
20 HCTR	Half-word Data Swap Control. This bit determines which half word data from the 32-bit IP Bus interface is written into the lower 16 bits of the sample register. 0 Half word swapping does not take place 1 Half words from write data bus are swapped
19–18 POUTC	PWM Output Configuration. This bit field determines the mode of PWM output on the output pin. 00 Output pin is set at rollover and cleared at comparison 01 Output pin is cleared at rollover and set at comparison 10 PWM output is disconnected 11 PWM output is disconnected
17–16 CLKSRC	Select Clock Source. These bits determine which clock input will be selected for running the counter. After reset the system functional clock is selected. The input clock can also be turned off if these bits are set to 00. This field value should only be changed when the PWM is disabled 00 Clock is off 01 ipg_clk 10 ipg_clk_highfreq 11 ipg_clk_32k
15–4 PRESCALER	Counter Clock Prescaler Value. This bit field determines the value by which the clock will be divided before it goes to the counter. 0x000 Divide by 1 0x001 Divide by 2 0xff Divide by 4096
3 SWR	Software Reset. PWM is reset when this bit is set to 1. It is a self clearing bit. A write 1 to this bit is a single wait state write cycle. When the block is in reset state this bit is set and is cleared when the reset procedure is over. Setting this bit resets all the registers to their reset values except for the DBGEN, STOPEN, DOZEN, and WAITEN bits in this control register. 0 PWM is out of reset 1 PWM is undergoing reset
2–1 REPEAT	Sample Repeat. This bit field determines the number of times each sample from the FIFO is to be used. 00 Use each sample once 01 Use each sample twice 10 Use each sample four times 11 Use each sample eight times

Table continues on the next page...

PWMx_PWMCR field descriptions (continued)

Field	Description
0 EN	<p>PWM Enable. This bit enables the PWM. If this bit is not enabled, the clock prescaler and the counter is reset. When the PWM is enabled, it begins a new period, the output pin is set to start a new period while the prescaler and counter are released and counting begins.</p> <p>To make the PWM work with softreset and disable/enable, users can do software reset by setting the SWR bit, wait software reset done, configure the registers, and then enable the PWM by setting this bit to "1"</p> <p>Users can also disable/enable the PWM if PWM would like to be stopped and resumed with same registers configurations .</p> <p>0 PWM disabled 1 PWM enabled</p>

40.7.2 PWM Status Register (PWMx_PWMSR)

The PWM status register (PWM_PWMSR) contains seven bits which display the state of the FIFO and the occurrence of rollover and compare events. The FIFOAV bit is read-only but the other four bits can be cleared by writing 1 to them. The FE, ROV, and CMP bits are associated with FIFO-Empty, Roll-over, and Compare interrupts, respectively.

Address: Base address + 4h offset

Bit	31	30	29	28	27	26	25	24	23	22	21	20	19	18	17	16
R	0															
W	[Shaded]															
Reset	0	0	0	0	0	0	0	0	0	0	0	0	0	0	0	0
Bit	15	14	13	12	11	10	9	8	7	6	5	4	3	2	1	0
R	0								FWE	CMP	ROV	FE	FIFOAV			
W	[Shaded]								w1c	w1c	w1c	w1c	[Shaded]			
Reset	0	0	0	0	0	0	0	0	0	0	0	0	1	0	0	0

PWMx_PWMSR field descriptions

Field	Description
31–7 Reserved	This field is reserved. This read-only field is reserved and always has the value 0.
6 FWE	<p>FIFO Write Error Status. This bit shows that an attempt has been made to write FIFO when it is full.</p> <p>0 FIFO write error not occurred 1 FIFO write error occurred</p>
5 CMP	<p>Compare Status. This bit shows that a compare event has occurred.</p> <p>0 Compare event not occurred 1 Compare event occurred</p>

Table continues on the next page...

PWMx_PWMSR field descriptions (continued)

Field	Description
4 ROV	Roll-over Status. This bit shows that a roll-over event has occurred. 0 Roll-over event not occurred 1 Roll-over event occurred
3 FE	FIFO Empty Status Bit. This bit indicates the FIFO data level in comparison to the water level set by FWM field in the control register. 0 Data level is above water mark 1 When the data level falls below the mark set by FWM field
FIFOAV	FIFO Available. These read-only bits indicate the data level remaining in the FIFO. An attempted write to these bits will not affect their value and no transfer error is generated. 000 No data available 001 1 word of data in FIFO 010 2 words of data in FIFO 011 3 words of data in FIFO 100 4 words of data in FIFO 101 unused 110 unused 111 unused

40.7.3 PWM Interrupt Register (PWMx_PWMIR)

The PWM Interrupt register (PWM_PWMIR) contains three bits which control the generation of the compare, rollover and FIFO empty interrupts.

Address: Base address + 8h offset

Bit	31	30	29	28	27	26	25	24	23	22	21	20	19	18	17	16
R	0															
W																
Reset	0	0	0	0	0	0	0	0	0	0	0	0	0	0	0	0
Bit	15	14	13	12	11	10	9	8	7	6	5	4	3	2	1	0
R	0													CIE	RIE	FIE
W																
Reset	0	0	0	0	0	0	0	0	0	0	0	0	0	0	0	0

PWMx_PWMIR field descriptions

Field	Description
31–3 Reserved	This field is reserved. This read-only field is reserved and always has the value 0.
2 CIE	Compare Interrupt Enable. This bit controls the generation of the Compare interrupt.

Table continues on the next page...

PWMx_PWMIR field descriptions (continued)

Field	Description
	0 Compare Interrupt not enabled 1 Compare Interrupt enabled
1 RIE	Roll-over Interrupt Enable. This bit controls the generation of the Rollover interrupt. 0 Roll-over interrupt not enabled 1 Roll-over Interrupt enabled
0 FIE	FIFO Empty Interrupt Enable. This bit controls the generation of the FIFO Empty interrupt. 0 FIFO Empty interrupt disabled 1 FIFO Empty interrupt enabled

40.7.4 PWM Sample Register (PWMx_PWMSAR)

The PWM sample register (PWM_PWMSAR) is the input to the FIFO. 16-bit words are loaded into the FIFO. The FIFO can be written at any time, but can be read only when the PWM is enabled. The PWM will run at the last set duty-cycle setting if all the values of the FIFO has been utilized, until the FIFO is reloaded or the PWM is disabled. When a new value is written, the duty cycle changes after the current period is over.

A value of zero in the sample register will result in the PWMO output signal always being low/high (POUTC = 00 it will be low and POUTC = 01 it will be high), and no output waveform will be produced. If the value in this register is higher than the PERIOD + 1, the output will never be set/reset depending on POUTC value.

Address: Base address + Ch offset

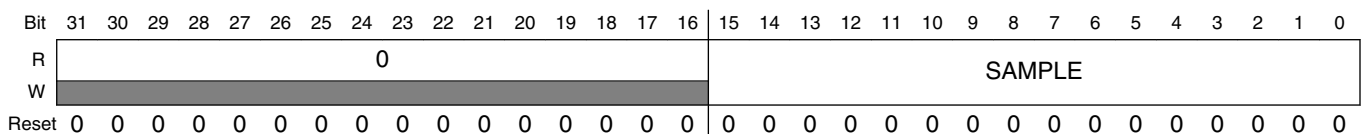

PWMx_PWMSAR field descriptions

Field	Description
31–16 Reserved	This field is reserved. This read-only field is reserved and always has the value 0.
SAMPLE	Sample Value. This is the input to the 4x16 FIFO. The value in this register denotes the value of the sample being currently used.

40.7.5 PWM Period Register (PWMx_PWMPR)

The PWM period register (PWM_PWMPR) determines the period of the PWM output signal. After the counter value matches PERIOD + 1, the counter is reset to start another period.

$$\text{PWMO (Hz)} = \text{PCLK(Hz)} / (\text{period} + 2)$$

A value of zero in the PWM_PWMPR will result in a period of two clock cycles for the output signal. Writing 0xFFFF to this register will achieve the same result as writing 0xFFFE.

A change in the period value due to a write in PWM_PWMPR results in the counter being reset to zero and the start of a new count period.

NOTE

Settings PWM_PWMPR to 0xFFFF when PWMx_PWMCR REPEAT bits are set to non-zero values is not allowed.

Address: Base address + 10h offset

Bit	31	30	29	28	27	26	25	24	23	22	21	20	19	18	17	16	15	14	13	12	11	10	9	8	7	6	5	4	3	2	1	0
R	0																PERIOD															
W	1																1															
Reset	0	0	0	0	0	0	0	0	0	0	0	0	0	0	0	0	1	1	1	1	1	1	1	1	1	1	1	1	1	1	1	0

PWMx_PWMPR field descriptions

Field	Description
31–16 Reserved	This field is reserved. This read-only field is reserved and always has the value 0.
PERIOD	Period Value. These bits determine the Period of the count cycle. The counter counts up to [Period Value] +1 and is then reset to 0x0000.

40.7.6 PWM Counter Register (PWMx_PWMCNR)

The read-only pulse-width modulator counter register (PWM_PWMCNR) contains the current count value and can be read at any time without disturbing the counter.

Address: Base address + 14h offset

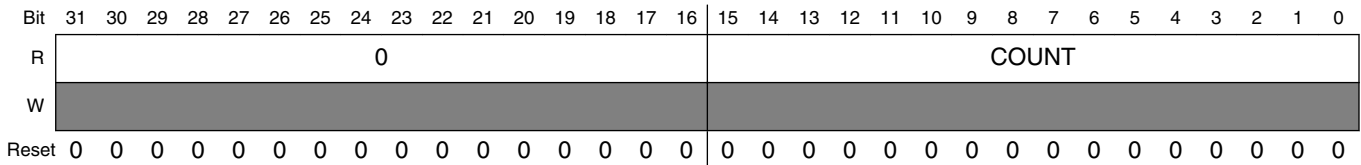

PWMx_PWMCNR field descriptions

Field	Description
31–16 Reserved	This field is reserved. This read-only field is reserved and always has the value 0.
COUNT	Counter Value. These bits are the counter register value and denotes the current count state the counter register is in.

Chapter 41

Pixel Pipeline (PXP)

41.1 Overview

This document describes the micro-architecture for the Pixel Processing Pipeline used to process graphics buffers or composite video and graphics data before sending to an LCD display or TV encoder.

It is used to minimize the memory footprint required for the display pipeline and provide an area and performance optimized to both SDRAM-less and SRAM-based systems.

The PXP integrates of several independent processing stages into a cohesive strategy to create flexible pixel pipeline.

The PXP combines the following into a single processing engine:

- Scaling
- Color Space Conversion (CSC)
- Secondary Color Space Conversion (CSC2)
- Pixel Conversion Lookup Memory Table (LUT)
- Rotation
- Dithering and Waveform Processing

By integrating multiple blocks, intermediate buffer operations to external memory are removed, reducing external memory bandwidth, power, and software control complexity. The PXP block diagram is shown below.

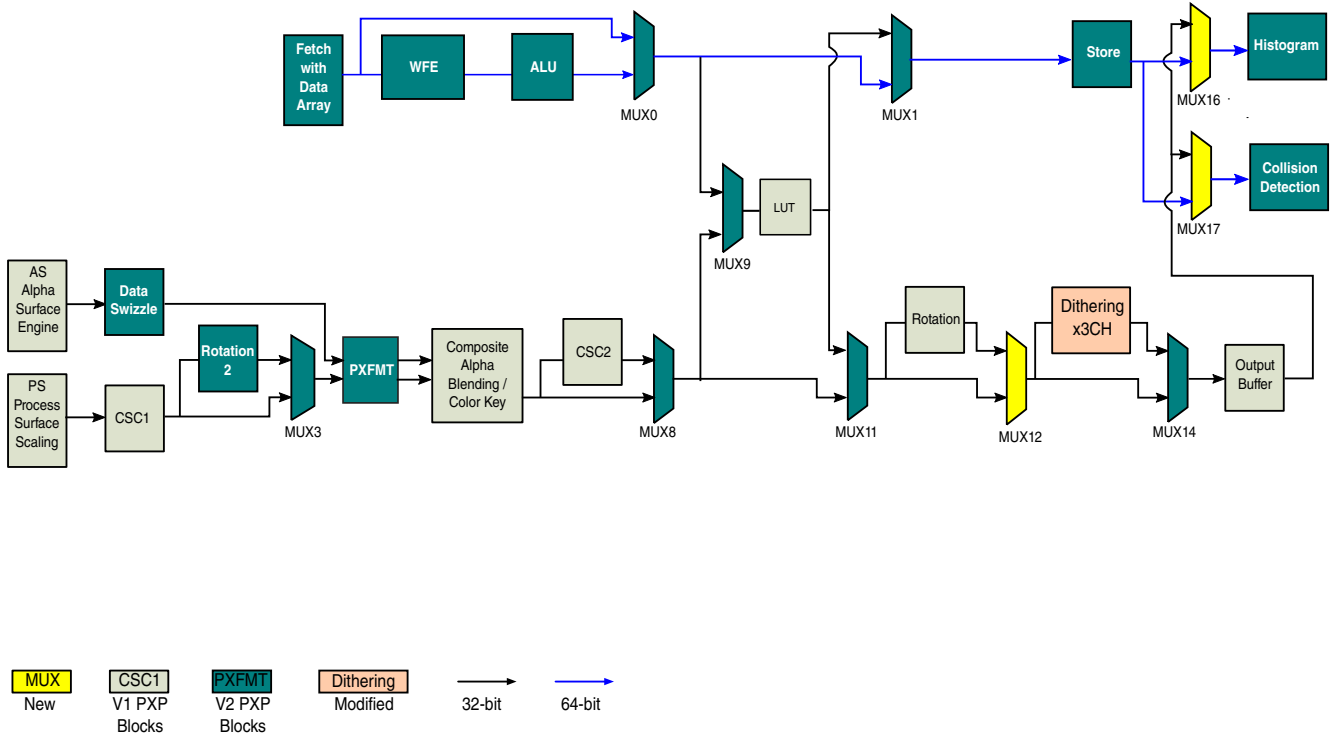

Figure 41-1. PXP Architecture

41.2 Clocks

The following table describes the clock sources for PXP. Please see [Clock Controller Module \(CCM\)](#) for clock setting, configuration and gating information.

Table 41-1. PXP Clocks

Clock name	Clock Root	Description
clk	axi_clk_root	PXP clock

41.3 Top-level architecture

The PXP consist of several pipelined blocks that perform the video source frame scaling, color space conversion, alpha-blending/color key algorithm, secondary CSC, pixel correction, input and/or output rotation, dithering and waveform processing.

The legacy blocks operate within the requirements of the legacy PXP architecture, and perform operations on either 8x8 or 16x16 pixel blocks in the representative source buffers. The legacy pipeline operate within the context of two iteration counters that iterate through the appropriate grid of input blocks to produce the rotated output grid blocks in scan-line order. The dither blocks included in the legacy pipeline also operate in a block mode while the waveform processing engines (WFE) will operate in a scan line format based on the active size.

Figure 41-1 shows the high-level architecture of the scaling, color space conversion, blending, pixel correction, rotation engines, dithering, waveform processing, along with histogram. The Alpha Surface Engine fetches one RGB graphics plane alpha surface (AS). The scaling engine fetches a single processed surface (PS), which can be blended with the AS surface. The scaling engine also supports an alpha channel for the PS image. Although the legacy PXP processes NxN pixel macro blocks, each of the AS or PS surfaces can have any pixel alignment within the output buffer. There are no restrictions and any pixel coordinates within the output buffer are valid. The upper left origin of the output buffer is defined as pixel 0,0. The upper left and lower right coordinates for each of the AS and PS are inclusive within the output buffer.

Figure 41-2 represents a sample output buffer configuration with both an AS and PS included. The alignment of each AS and PS within the output buffer can be at any arbitrary pixel locations. For example, the PS has an upper left coordinate (ULC) of 2,2 and a lower right coordinate (LRC) at pixel 13,13. The maximum value for the ULC and LRC for each of the AS and PS is bounded by the LRC of the output buffer, 15,15 for this example.

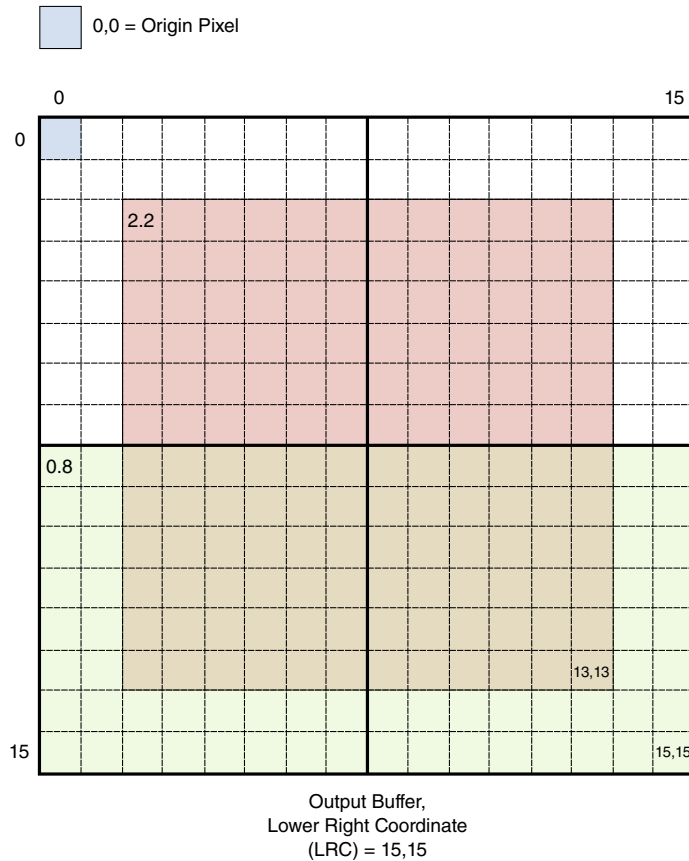

Figure 41-2. Sample output buffer configuration

The AS engine supports RGB pixel formats, and the PS engine supports ARGB, RGB, YUV, and YCbCr pixel formats. The CSC1 can be used to convert to RGB pixel formats so that the PS surface can be blended with the AS surfaces in the compositing engine in the RGB color space. There are two rotate engines in the PXP pipeline. Rotation can occur after image composition, at the output of the PS engine, or both. In the first scenario, all the data produced by the AS and PS engines is rotated. When the rotation module is programmed to rotate only PS images, the AS is not rotated, and AS pixels are combined with rotated PS surfaces. The CSC2 unit can convert to any RGB, YUV, or YCbCr color spaces for final output. Pixels can be corrected using a programmable LUT resource to achieve any desired pixels effects. For detailed information, please refer to [Output Modes to RGBW4444CFA](#). The dither engine supports ordered dithering mode in addition to the standard quantization and pass-through modes. The WFE is a programmable engine that can be programmed as required to process each pixel and pixel meta data. The Histogram sub-block collects statistics about the pixel data passing through it that is useful to the EPDC in waveform selection and displaying the frame. The Histogram also contains mask and comparison functionality that can be used for collision detection and reporting the collided area within an update area.

The PXP also supports two parallel image processing paths. The legacy flow can operate in parallel with waveform processing engines. Please refer to HW_PXP_CTRL and HW_PXP_CTRL2 for details on how to enable each of the individual data flows. In addition to this, LUT engine can be used as either part of the legacy flow or as a part of the second parallel data flow.

41.3.1 Processing Details

The legacy PXP architecture has been driven primarily by the requirement that the output buffer must be processed and rotated without intermediate frame buffer stored in external memory.

This reduces the use of external memory bandwidth requirements thus reducing overall system power consumed. The new architecture has two sets of fetch and store engines to enable parallel image processing and the ability to use only parts of the block like the WFE or parts of the legacy flow.

Since the output of the rotation block must be NxN pixel blocks in scan order, the entire legacy pipeline will operate on NxN pixel blocks. In essence, the pipeline will be able to operate on blocks in a random access fashion, but the entire pipeline will operate within the context of two iteration counters that will iterate through the horizontal and vertical input blocks to generate the required output block.

Legacy Processing Pipeline

The control block will coordinate the processing of the pixel blocks within the source and destination image buffers. It begins by issuing a command to each stage of the pipeline requesting that operations be done for the block at offset x, y. When the block accepts the command, it asserts its acknowledge signal for a single cycle to indicate the acceptance and allow the control unit to move to the next block.

When the PS and AS fetch engines have received a command, they will fetch the required data and place it into their fetch buffers. If compositing the RGB AS surface with the PS surface, then the output of the PS engine needs to be converted to the RGB color space using CSC1, since all compositing occurs in the RGB color space. For YUV output pixel formats, the CSC1 unit can be enabled to convert pixels into the RGB space for subsequent compositing with AS pixels. Then, the CSC2 module can convert the resulting pixels back into the YUV output color space. If the final output color space is YUV and there is no compositing required (AS not present, for example), then both the CSC units can be bypassed and the pixel data path will pass the YUV pixels to the rotation engine. For YUV output formats, scaling operations, LUT, rotation, and

dithering operations are still valid, but blending RGB AS surfaces with YUV PS surfaces is NOT supported. The two CSC units in the overall pixel data path must be used to achieve the desired source frame compositing and output pixel formatting.

The alpha blender/color key module will process a pixel any time that both inputs present valid data.

A handshake will be created between each stage and a pipeline controller to handle the advance of the pipeline and generation of the iteration counters. The pipeline controller will also maintain the interlocks with the LCD interface for the case where the LCD display and pixel processing pipeline use the SRAM to maintain the double buffer block intermediate buffer.

The New Processing Pipelines

The WFE fetch and store engines work in scan line format. The WFE fetch engine has internal memory of 32 words where each word is 64 bits. The store engines can coordinate data flow through the pipeline to the next fetch engine such as LCDIF for display. In handshake mode, the store engine writes data to the memory and signals, the fetch engine of the next stage that the programmed number of lines are ready to be fetched.

41.3.2 Scaling Operation

The scaling engine operates on YUV (or YCbCr) 422 or 420 and any RGB formatted pixels. Each color plane is sourced from color planes indicated by different base address registers.

The scaling source data can be stored as 3 individual planes for each Y, U, and V data, stored as two planes as a single Y and interleaved UV plane, or stored as a single plane with YUV/RGB interleaved on a per byte basis.

The scaled output image is presented to the CSC module as YUV444 or RGB888 pixels with a single byte for each color channel. The scaler can reduce an input image by a maximum factor of 16. In this case, the output image will be 1/16 the dimension of the input image in each of the X and Y axis. There are no limits, essentially, on increasing the source image size. The theoretical maximum increase is 4096 since a 12 bit fractional step function is used when scaling an input image. Scaling in either axis, X or Y is independent, so a source image can appear stretched in either direction.

All source images pass through the scale engine. The PXP alpha blend module and AS pixel streams are in the RGB888 format, so PS pixel buffers must be converted to the RGB888 format for alpha blending. The scaling engine works with the CSC1 module to translate YUV/YCbCr pixel formats to RGB888 for output frame buffer compositing

using the alpha blender. The CSC2 module can be bypassed or enabled to convert pixels to any output color space. In the case of processing RGB pixels in the PS engine. The CSC1 unit can be bypassed so compositing can occur in the alpha engine.

The scaling operation is divided into two scaling steps. The first step is a decimation scaler, and the second step is a bilinear filter. The decimation filter provides a maximum down scaling factor of 8, and the subsequent bilinear filter provides a maximum scaling factor of 2. Combined, the maximum scaling factor can be up to 16. The decimation and bilinear scaling engines are independently programmable. There is also an initial offset that is programmable to allow more source data to be considered in the bilinear scaling engine.

41.3.3 Decimation Image Scaling

The first of two scaling engines is the decimation filter.

The intent of the decimation filter is to use as much source data as is possible to create the output image frame buffer. The decimation filter simply discards certain pixels from the source PS image depending on the reduction selected.

For RGB pixel formats, each color channel is treated equally since there is the same amount of pixel data within each color plane. For YUV422/420 formats, the chroma samples are already subsampled by 2. In these decimation scenarios, the chroma decimation factor is adjusted to account for the pre-decimation of the chroma samples. For example, since YUV422 is already sub-sampled by 2 horizontally, an X decimation factor of 2 does not apply to the YUV422 pixels in the X direction. All the chroma samples are passed on to the bilinear filter in this case. As another example, an X decimation factor of 4 will decimate the chroma samples by 2, since this factor combined with the pre-decimation factor of 2 in the pixel source buffers totals an overall decimation factor of 4.

The following example will show which pixels (in green) in a source RGB buffer that are passed to the bilinear filter for an X decimation factor of 2 and a Y decimation factor of 4. All pixels coincident with dashed lines are discarded.

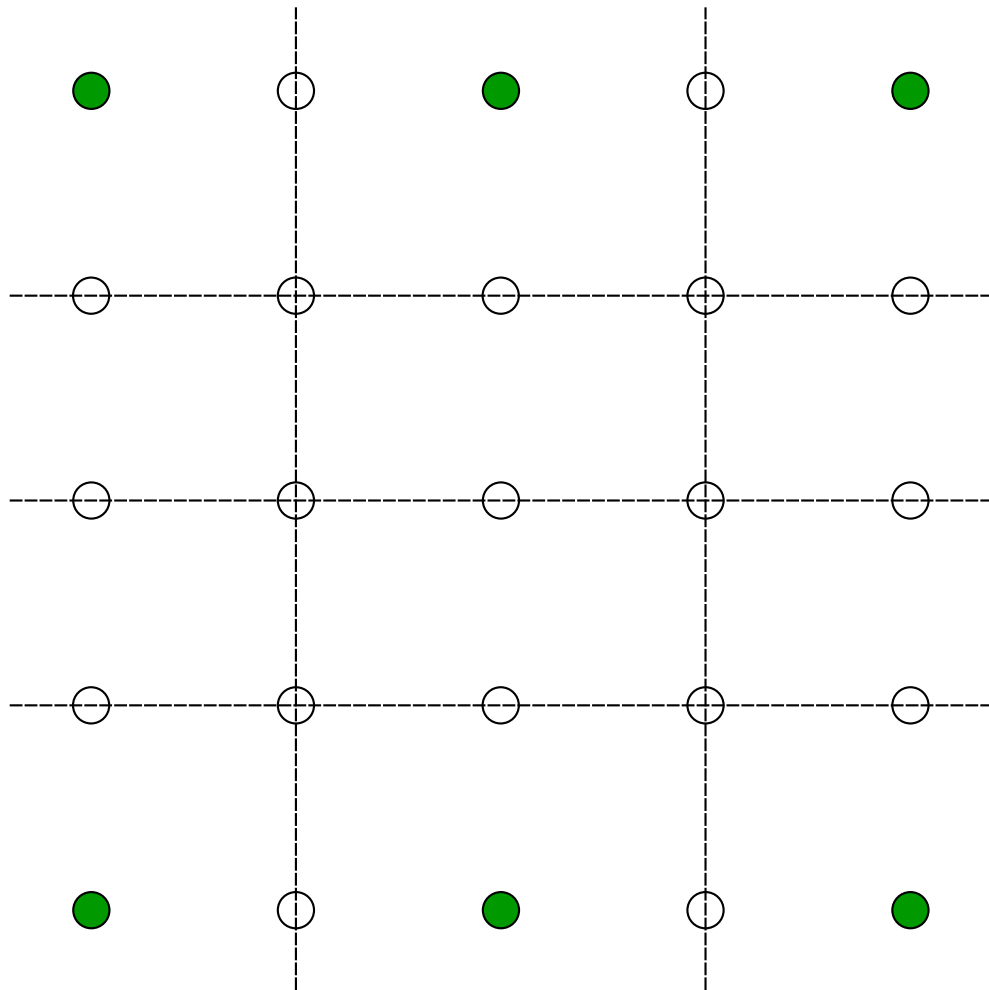

Figure 41-3. RGB decimation X /2, Y /4

Using the same decimation factor as the above scenario for RGB pixels, but using YUV420 source buffers, it can be shown that the decimation factor for the Y and UV components of data are decimated differently. This is due to the pre-decimation of the chroma samples in the source frame buffers. Figure 4: YUV420 decimation X /2, Y /4 indicates that the U/V samples in the X direction are not decimated, but the Y samples in the X direction are decimated by the factor of 2.

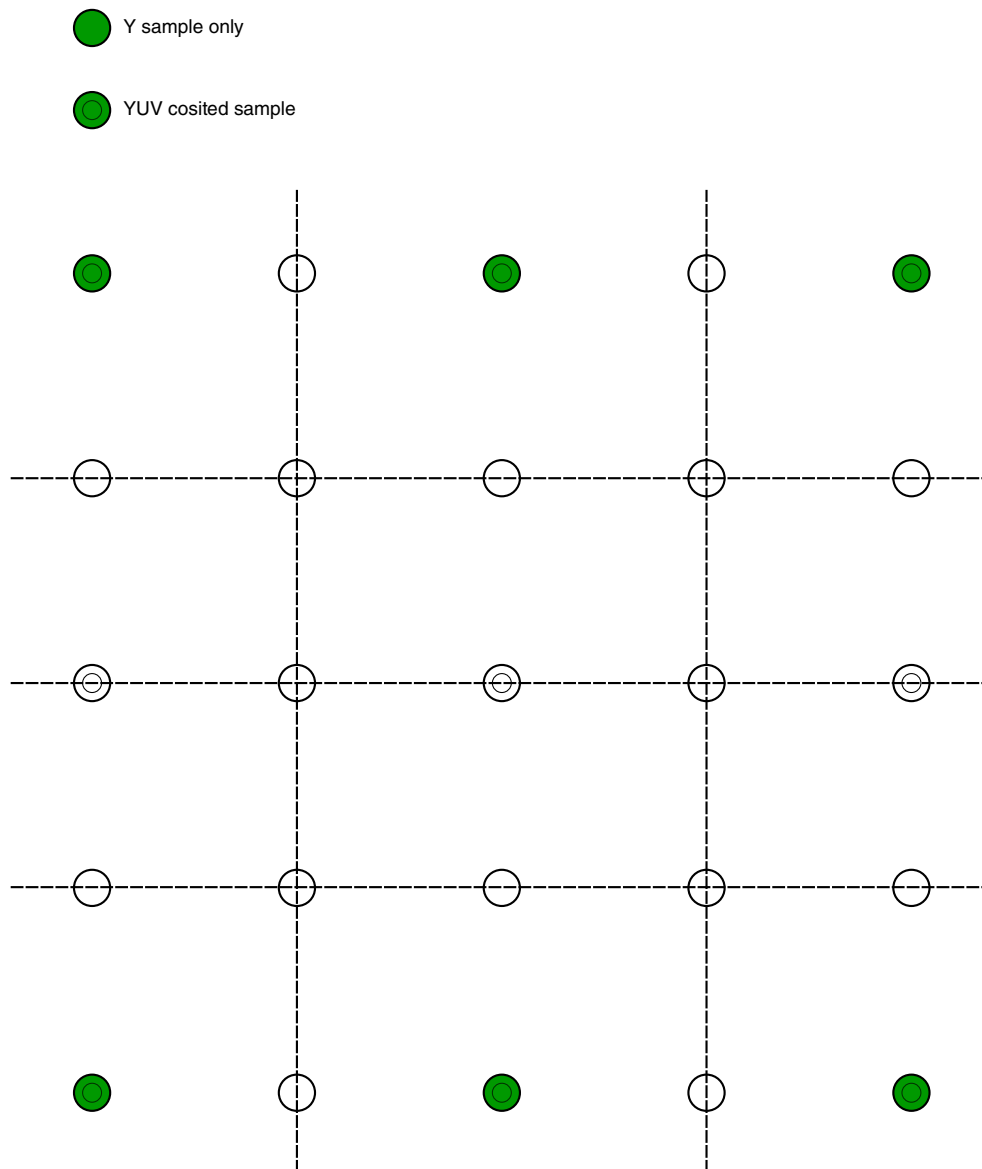

Figure 41-4. YUV420 decimation X /2, Y /4

41.3.4 Bilinear Image Scaling Filter

The PXP implements a bilinear scaling filter to resize an input image to a different resolution for display output.

The bilinear filter is a weighted average of the four nearest pixels that can be sourced to approximate the pixel in the output frame buffer.

When scaling YUV data, the UV values are offset by 0x80 (top bit inverted) to shift the signed UV bits into an unsigned equivalent with a range of 0 to 255. YCbCr data does not have to be shifted since it is defined as an unsigned byte. The REG_CSC1_COEF0[YCBCR_MODE] bit controls whether this operation is applied to the input UV bytes.

After scaling, the offset is removed so that the range for UV data is signed from -128 to 127.

The reason for this adjustment is based on the implementation of an unsigned scaling engine, and therefore, is to ensure that the scaled values are handled properly. Consider the following table:

Format	pixel0	pixel1	average	Result
decimal	-2	+2	0	Correct
CbCr	0x7E	0x82	0x80	Correct (0x80 is 0 in CbCr)
UV	0xFE	0x02	0x80	Incorrect (0x80 is -128 in UV)
decimal	-32	+16	-8	Correct
CbCr	0x60	0x90	0x78	Correct (0x78 is -8 in CbCr)
UV	0xE0	0x10	0x78	Incorrect (0x78 is +120 in UV)

To compute the output pixel value at position as indicated by P, consider the diagram below.

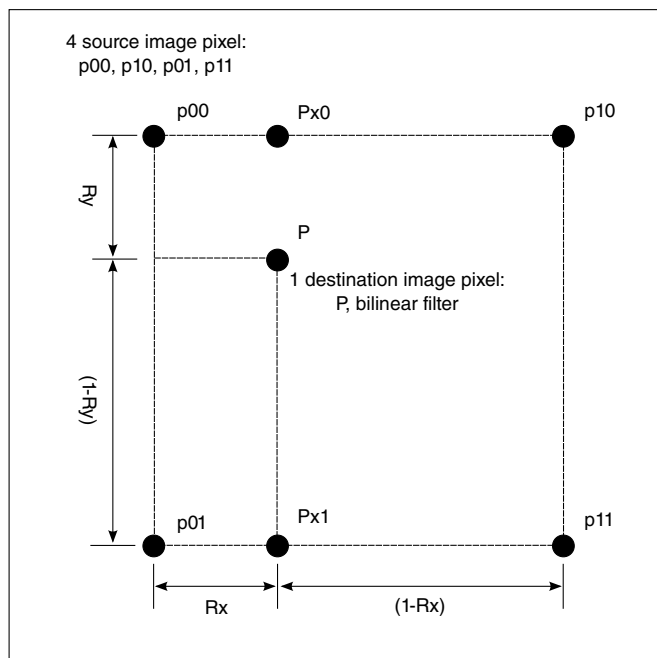

Figure 41-5. Output Pixel Value

A step function is used to indicate the position of the pixel "P" in the output frame. This position may not coincide with a single pixel position in the input frame buffer. In this case, the four closest pixels in the input frame are used to approximate the value of the pixel in the output frame.

The PXP scaler first computes a linear filter in the X axis to create the two intermediate pixel values P_{x0} and P_{x1} . The step function's X fractional component is used to provide the weighting factor for blending p_{00} with p_{10} to provide P_{x0} . Likewise, P_{x1} is also derived from a linear filter using p_{01} and p_{11} .

The equations for P_{x0} and P_{x1} are as follows:

$$P_{x0} = p_{00} * (1 - R_x) + p_{10} * R_x$$

$$P_{x1} = p_{01} * (1 - R_x) + p_{11} * R_x$$

The PXP scaler uses the intermediate X pixels P_{x0} and P_{x1} and implements a bilinear filter on these two pixel values to produce the final pixel value at position P. The remainder of the step function for the Y axis is used to compute the weighted average pixel result. The equation for final filtered pixel is:

$$P = P_{x0} * (1 - R_y) + P_{x1} * R_y$$

41.3.5 YUV 4:2:2 Image Scaling

The following figure illustrates the positioning of YUV samples for the 4:2:2 formats. There are twice as many Y luma samples then U and V chroma samples horizontally.

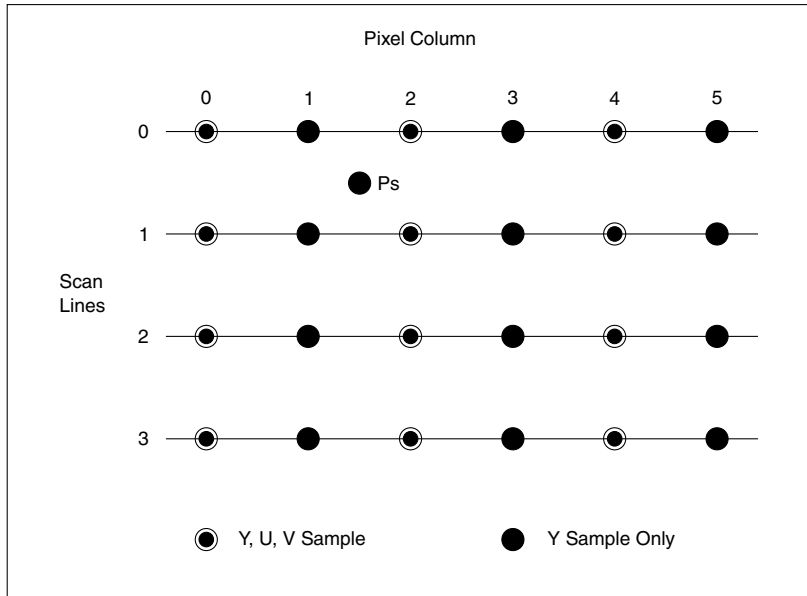

Figure 41-6. YUV Sample Positioning, 4:2:2

Consider the scaled output pixel P_s (pixel scaled) which has an accumulated step function of $X=1.5$ and $Y=0.5$. The remainder for the step function is $R_x = 0.5$ and $R_y = 0.5$. Or, the sub pixel position of output pixel P_s is half way between line 0 and 1 and half way between column 1 and 2.

The Y output component of P_s is simply the bilinear function of the four nearest Y samples from the input image. Specifically, the Y values at [1,0], [2,0], [1,1], and [2,1] are used to compute the Y for P_s .

For the U and V components of P_s , there are no samples present in the column position 1. The bilinear filter uses chroma components located at [0,0], [2,0], [0,1] and [2,1]. Since the chroma components are not sub sampled vertically, the remainder used to combine pixels vertically is $R_y=0.5$ (the same as for Y). However, horizontally, the scaling engine shifts the remainder by a factor of 2. So an X axis step function value of $X=1.5$ has a remainder $R_x=0.75$. Source chroma values are not replicated, they are completely interpolated using the four nearest chroma samples to approximate U and V at P_s .

41.3.6 YUV 4:2:0 Image Scaling

The following figure illustrates the positioning of YUV samples for the 4:2:0 formats. Chroma is sub sampled both horizontally and vertically. In this format, the chroma frame buffers contain $\frac{1}{4}$ the data that the luma frame buffers store.

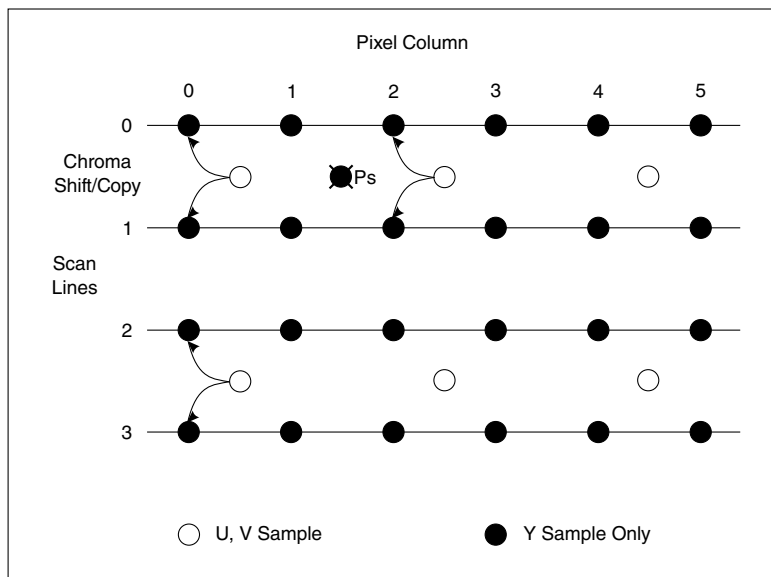

Figure 41-7. YUV Sample Positioning, 4:2:0

The Y output component for all scaled pixels in 4:2:0 formats are the same as for the 4:2:2 pixel formats.

The U and V output components have two considerations when computing the output pixel Ps.

1. All chroma samples from the input source image are shifted left and up by $\frac{1}{2}$ a sample position of the input pixel matrix.
2. Odd scan lines are replicated using the previous even chroma scan line values. So, output image chroma values that map between even to odd scan lines are replicated in the vertical axis. In contrast, output image chroma values between odd to even scan lines are interpolated vertically.

The chroma values are interpolated horizontally as in the 4:2:2 pixel format.

As an example, consider the interpolated pixel Ps in the 4:2:0 diagram above. For the Y component, the interpolated output luma is a function of the Y values in the source frame buffer at position [1,0], [2,0], [1,1], [2,1].

For the U and V interpolated samples, the chroma values on scan line position 0.5 are shifted so that they coincide with the even luma sample points. They are also replicated so that a single chroma scan line is used twice. The chroma scan line at 0.5 is replicated to represent the 4:2:2 sample points for scan line 0 and 1. The chroma scan line at 2.5 is replicated to represent the 4:2:2 sample points for scan line 2 and 3. This pattern of chroma replication occurs for the entire source frame buffer during the scaling operation.

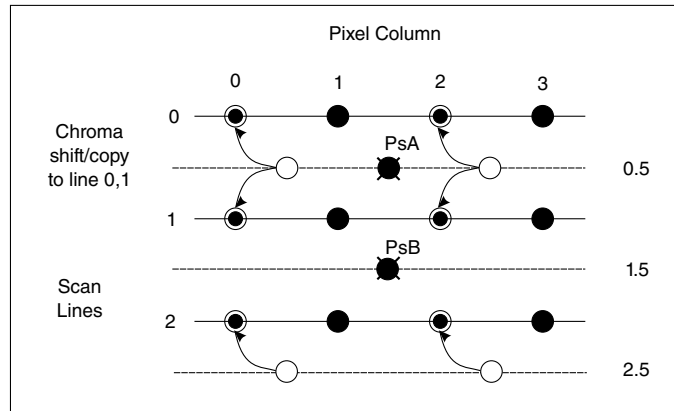

Figure 41-8. Scaled Chroma Computation Examples

The preceding diagram has two examples for the computation of the scaled chroma output pixel. For chroma at output position PsA (vertical position 0.5), interpolation occurs in the X axis using chroma values at column 0 and column 2. However, since line 0 and line 1 have equal chroma values due to chroma line replication, scaling in the Y axis results in replication of chroma values.

For chroma at output position PsB (vertical position 1.5), interpolation occurs in both the X and Y axis. The Y axis is an interpolation since the chroma values copied to scan line 1 and 2 and not the same.

In summary, any output image pixels that map to an odd scan line above and an even scan line below are interpolated vertically. Output image pixels that map to an even scan line above and an odd scan line below are replicated vertically.

41.3.7 RGB/YUV444 Image Scaling

For all RGB formats, the RGB pixels are converted up to RGB888 with 8 bits per each color component.

Then each color component is passed to the scaling engine and each component is treated in the same manor. The RGB scaling operation is the same as for the Y scaling operation described in the preceding sections. Also, YUV444 contains a byte for each color plane at each pixel location, so all three color components are scaled in the same manor.

41.3.8 Color Space Conversion (CSC)

There are two modules in the PXP to convert pixels between color spaces. They are referred to as CSC1 and CSC2.

CSC1 exists after the scaling unit and is dedicated to converting from YUV to RGB. CSC2 is a full duplex color space converter in that it can convert into either RGB or YUV (or YCbCr) color spaces depending on the desired output pixel format. All coefficients are programmed as two's complement numbers and both CSC units can be bypassed if CSC is not desired at either position of these CSC units in the pixel data path.

41.3.9 CSC1 Operation

The CSC1 module receives scaled YUV/YCbCr444 pixels from the scale engine and converts the pixels to the RGB888 color space only if CSC1 is enabled.

The CSC1 module will convert only to the RGB color space and it can be bypassed to allow YUV pixels through the data path. These pixels are loaded into the pixel FIFO for processing by subsequent modules in the pixel data path.

The following equations are used to perform YUV/YCbCr -> RGB conversion. The constants will be stored in the PXP control registers as two's complement values to allow flexibility in the implementation and to allow for differences in the video encode and decode operations. In addition, this provides a software mechanism to manipulate brightness or contrast.

$$R = C0(Y+Yoffset) + C1(V+UVoffset)$$

$$G = C0(Y+Yoffset) + C3(U+UVoffset) + C2(V+UVoffset)$$

$$B = C0(Y+Yoffset) + C4(U+UVoffset)$$

Note: In the equations above, U and V are synonymous with Cb and Cr in regards to the color space format of the source frame buffer.

Saturation of each color channel is checked and corrected for excursions outside the nominal YUV/YCbCr color spaces. Overflow for the three channels are saturated at 0x255 and underflow is saturated at 0x00.

The table below indicates the expected coefficients for YUV and YCbCr modes of operation:

Coefficient	YUV	YCbCr
Yoffset	0x000	0x1F0 (-16)
UVoffset	0x000	0x180 (-128)
C0	0x100 (1.00)	0x12A (1.164)
C1	0x123 (1.140)	0x198 (1.596)
C2	0x76B (-0.581)	0x730 (-0.813)
C3	0x79B (-0.394)	0x79C (-0.392)
C4	0x208 (2.032)	0x204 (2.017)

41.3.10 YUV versus YCbCr Support

By default, the PXP color space coefficients are set to support the conversion of YUV data to RGB data.

If YCbCr input is present, software must change the coefficient registers appropriately (see the register definitions for values). Software must also set the YCBCR_MODE bit in the COEFF0 register to ensure proper conversion of YUV versus YCBCR data.

41.3.11 CSC2 operation

The CSC2 module receives pixels in any color space and can convert the pixels into any of RGB, YUV, or YCbCr color spaces.

All coefficients are programmable and in the two's complement notation. The output pixels are passed onto the LUT and rotation engine for further processing.

The following equations indicate the CSC2 modules ALU architecture.

Selecting RGB output in REG_CSC2_CTRL[CSC_MODE] configures the ALU in the following manor:

$$R = A1(Y-D1) + A2(U-D2) + A3(V-D3)$$

$$G = B1(Y-D1) + B2(U-D2) + B3(V-D3)$$

$$B = C1(Y-D1) + C2(U-D2) + C3(V-D3)$$

Selecting YUV output configures the ALU in the alternate manor:

$$Y = A1*R + A2*G + A3*B + D1$$

$$U = B1*R + B2*G + B3*B + D2$$

$$V = C1*R + C2*G + C3*B + D3$$

Saturation of each color channel is checked and corrected for excursions outside the nominal color space. Overflow for the three channels are saturated at 0x255 and underflow is saturated at 0x00.

41.3.12 Alpha Blending/Color Key

Regardless of pixel input format, the PS and AS pixels are normalized to 32-bits, organized as one alpha and three data bytes. Alpha blending occurs in the RGB space, if blending is required, PS pixels should be converted to RGB space. If no alpha blending is required, then YUV pixels can bypass the alpha blending ALU without color space conversion. All pixels are processed by the pixel ALU, but the ALU operations can be disabled to achieve pixel pass through for either PS or AS or fetch data channels source pixels.

41.3.13 Alpha Blend

There are two alpha blend modes in this module. First is the normal blending mode using single alpha parameter. Second is the porter-duff blending mode used in 2D. Both modes alpha blend modes are described in the sub-sections below.

41.3.13.1 Normal Alpha Blend

The alpha value for an individual pixel represents a mathematical weighting factor applied to the AS pixel. An alpha value of 0x00 corresponds to a transparent pixel and a value of 0xFF corresponds to an opaque pixel.

The effective alpha value for an AS pixel is determined by the AS_CTRL[ALPHA] and AS_CTRL[ALPHA_CTRL] register fields. If AS_CTRL[ALPHA_CTRL] = ALPHA_OVERRIDE, the alpha value for the pixel is taken from the AS_CTRL[ALPHA]. This can be useful for applying a constant alpha to an entire image or for image formats that don't include an alpha value. If AS_CTRL[ALPHA_CTRL] = ALPHA_MULTIPLY, the pixel's alpha value will be multiplied by the pixel's ALPHA value in order to allow scaling of the pixel's alpha or to provide better control for pixel formats such as RGB1555, which only contains a single bit of alpha.

For each color channel, the equation used to blend two source pixels is defined below:

$Gá$ = PIO programmed global alpha (8-bit value).

$Eá$ = Embedded alpha associated with AS pixel.

$á$ = $Gá * Eá + 0x80$

The result for the red channel as an example:

$R[7:0] = (á * PS.r) + ((1 - á) * AS.r)$

When $á$ is 0xff, the PS pixel will not be blended with the AS pixel, but PS will be passed as the output pixel and will not be blended with AS. In this case, AS will be discarded. Likewise, if $á$ is 0x00 for a given pixel, PS will be loaded as the output pixel.

AS_CTRL[ALPHA_INVERT] provides the option to invert the final alpha value. This essentially inverts the effect the alpha value has on the AS and PS blending operation.

41.3.13.2 Porter-Duff Alpha Blend

Porter-Duff blend includes 12 blending modes to describe digital image composite. These processes include Clear, Source Only, Destination Only, Source Over, Source In, Source Out, Source Atop, Destination Over, Destination In, Destination Out, Destination Atop and XOR. Through these process it can achieve any 2D image composite.

To control the blending modes, please see below picture. All the registers showed below are included in HW_PXP_ALPHA_A_CTRL.

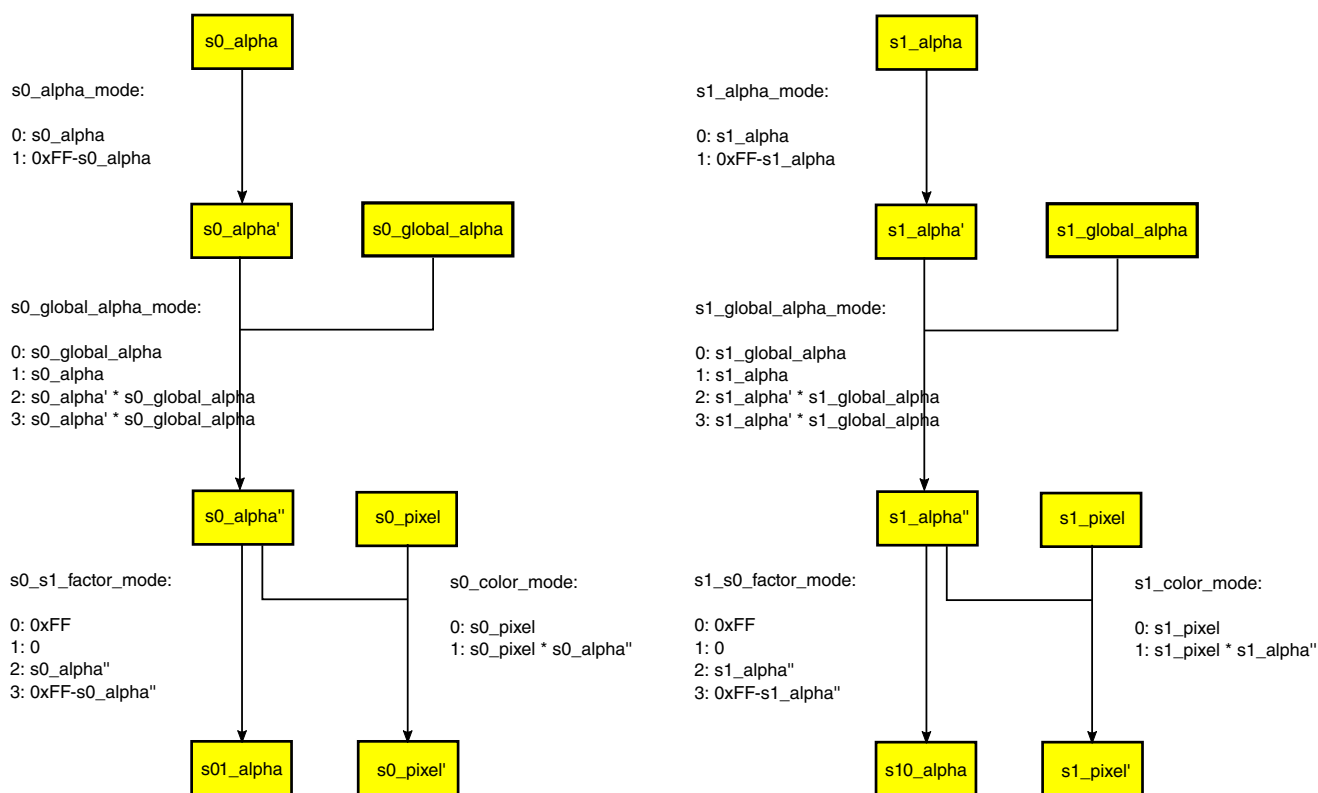

Figure 41-9. Porter-Duff Alpha Blend

41.3.14 Color Key

The color key function is provided to create transparent effects on the output pixel.

Color keying is applied on the input pixels after they are converted to 8-bits for each red, green, and blue color channels (color keys are not applied directly to 16-bit pixel formats but to their corresponding 24-bit representation). A color key range is programmable for

both PS and AS pixels. If the PS 24-bit pixel is within the PS color key range, then AS is passed through the pixel pipeline. In this case, alpha blending does NOT occur. Conversely, if PS is within the AS color key range, then PS is passed via the PXP data pipeline. If both PS and AS color key tests pass, then the back ground color register is passed onto following PXP processing components in the pipeline.

The condition for color keying to be satisfied is:

$$CK0.r.low \leq PS.r \leq CK0.r.high$$

$$CK0.g.low \leq PS.g \leq CK0.g.high$$

$$CK0.b.low \leq PS.b \leq CK0.b.high$$

For example, if the "red" 8-bit value for the PS pixel (or PS.r) is between the color key low and high values (CK0.r.l and CK0.r.h), the condition is true for the red color plane. When ALL three color planes meet this condition, then only the PS pixel is loaded into the output register.

To disable color keying, program the low color key register value to 0xff and the high value to 0x00. This will guarantee that the color key range test will never be true.

41.3.15 LUT

The lookup table (LUT) is used to modify pixels in a manner that is not linear and that cannot be achieved by the color space conversion modules.

Nonlinear response to the input pixels can be achieved based on how the lookup table is programmed.

Programming of the direct access LUT table can be facilitated by single PIO register writes or DMA access. For efficient loading of the LUT, DMA access should be used.

41.3.16 Lookup Modes

The LUT has four lookup modes. The lookup modes determine how the src_pixel is used to address the LUT memory.

The four lookup modes are:

1. DIRECT_Y8
2. DIRECT_RGB444
3. DIRECT_RGB454
4. CACHE_RGB565

The DIRECT modes access the LUT memory as a monolithic SRAM. The CACHE_RGB565 will access the memory as a 2-way set associative cache.

41.3.17 DIRECT_Y8

DIRECT_Y8 is used for a 256-byte lookup. In DIRECT_Y8, the most significant byte of the pixel is used to address the LUT entry.

This byte reflects the Y/R channel of the pixel data path. Luma, or monochrome, transformations are possible with this lookup mode. The address is generated as: `src_pixel[23:16]`. In DIRECT_Y8 operation, the memory is byte addressable.

41.3.18 DIRECT_RGB444

DIRECT_RGB444 is used for a 8KB (4K pixel) RGB444 to RGB565 lookup.

Pixel formats that are in the YUV color space at the position of the LUT in the PXP data path can also be converted. To take advantage of the full 16KB memory, the `REG_LUT_CTRL[SEL_8KB]` bit can be used to select the upper or lower 8KB memory, thus facilitating the use of 2 separate 444 LUT tables. In DIRECT_RGB444, the `src_pixel` is RGB/YUV[23;0] data is used to generate the lookup address. The address is generated as: {R/Y[23:20],G/U[15:12],B/V[7:4]}. In DIRECT_RGB444, the memory is pixel (2 byte) addressable.

41.3.19 DIRECT_RGB454

DIRECT_RGB454 is used for a 16KB (8K pixel) RGB454 to RGB565 lookup.

Pixel formats that are in the YUV color space at the position of the LUT in the PXP data path can also be converted. In DIRECT_RGB454, the `src_pixel` is RGB/YUV[23;0] data is used to generate the lookup address. The address is generated as: {R/Y[23:20],G/U[15:11],B/V[7:4]}. In DIRECT_RGB454, the memory is pixel (2 byte) addressable.

41.3.20 CACHE_RGB565

The CACHE_RGB565 lookup is used for a 128KB (65K pixel) RGB/YUV565 to RGB/YUV565 lookup.

The 128KB memory requirement is too costly from an area perspective to implement a complete lookup table in the LUT's on chip memory. For this reason, a LRU (least recently used) 16KB 2-way set associative cache has been implemented to reference the full 128KB lookup table stored in external memory.

The 2-way set associative cache is organized in the following way:

- 16KB total data storage
- 512 entries split between 256 ways
- 6 pixels/entry cache line

Cache efficiency is very critical. For a cache miss, the PXP will be stalled until the cache line can be filled. For a 32 bit DDR memory interface, the latency can be calculated as follows:

cycles latency for read command through DDR controller + CAS Latency + # burst cycles for read data to be returned + # cycles latency for data through DDR controller to LUT + 1 cycle for cache access of new data

The src_pixel is RGB[23:0] data used to generate the lookup address. To improve the cache efficiency the RGB/YUV565 address and the lookup table must be formatted in the following way:

Address: $A[15:0] = R_7G_7G_6B_7 R_6G_5B_6 R_5G_4B_5 R_4G_3B_4 R_3G_2B_3$

The address is organized as follows:

- A[15:12] tag address, used to compare a hit between cache ways
- A[11:4] index address, used to select cache set (i.e. row of memory)
- A[3:0] block address, used to select Pixel in the cache line

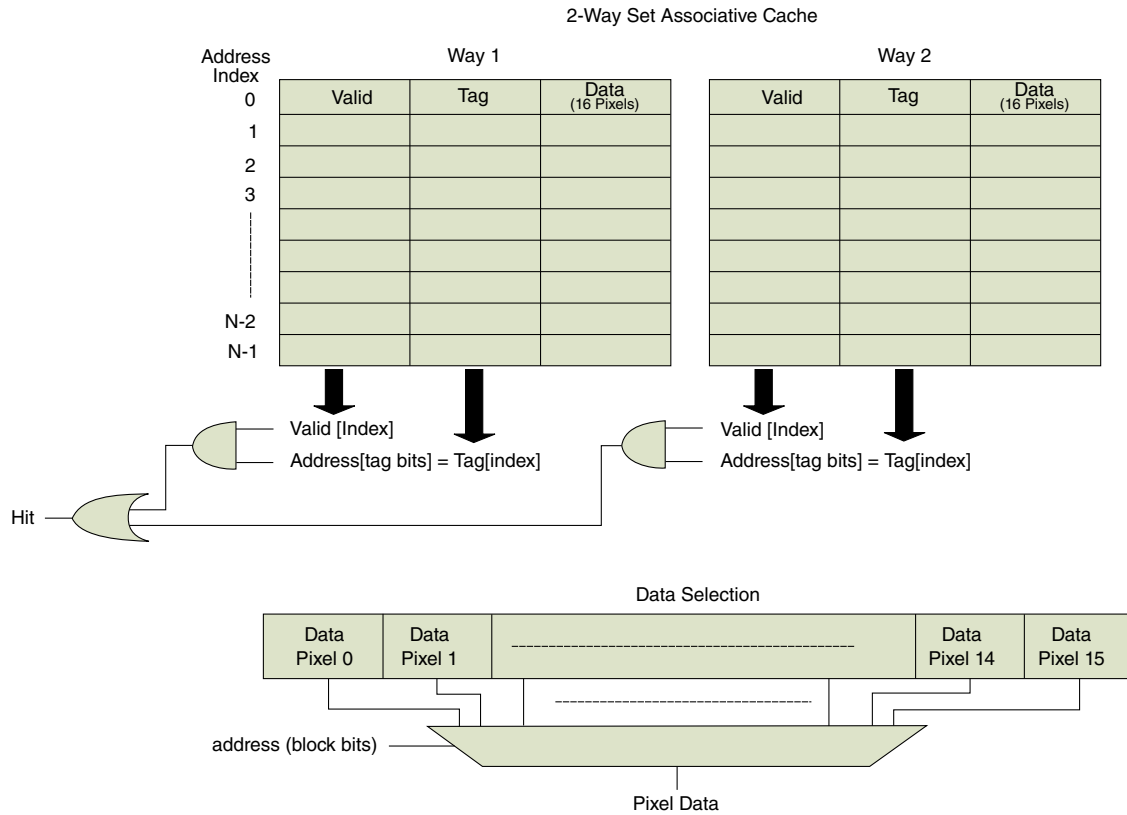

Figure 41-10. 2-Way Set Associative Cache and Data Selection

41.3.21 Output Modes

The LUT has three output modes for color space conversion.

1. Y8
2. RGBW4444CFA
3. RGB888

41.3.22 Y8

With `out_mode` set to Y8, in conjunction with `DIRECT_Y8` lookup mode, the intended operation is Gama Correction.

Only the third byte is processed by the lookup table. The third byte is represented by the Y value or the R value in the data path since pixel data is either YUV[23:0] or RGB[23:0] where the Y or R byte encompass bits [23:16] respectfully. So, bits 15:0 are

always bypassed and left unchanged. Currently, the LUT is intended to process Y data when any YUV, Y8, or Y4 output pixel formats are selected. However, this resource can be enabled and used for any conceivable purpose.

Note: When the DIRECT_RGB444, DIRECT_RGB454 or CACHE_RGB565 lookup mode is selected in conjunction with the Y8 output mode the low order byte of the two bytes read from the LUT memory will be used as the Gama Correction value.

41.3.23 RGBW4444CFA

With REG_LUT_CTRL[OUT_MODE] set to RGBW4444CFA, the REG_CFA[DATA] is used to select one nibble from the LUT 16 bit output value.

The LUT memory lookup will contain a RGBW4444 value. The REG_CFA[DATA] will select the R,G,B or W nibble as the pixel value to present to the PXP data path based on the matrix defined by the REG_CFA[DATA] register. The 4 bit value is presented in the Y, or third byte lane, of the PXP data path. The final pixel transferred to the next PXP stage is {CFA[3:0],CFA[3:0],LUT[15:0]}

41.3.23.1 CFA Correction

The 32-bit REG__CFA[DATA] register is used to encode 16 CFA correction values.

The CFA correction values are encoded as follows:

- 00 selects R
- 01 selects G
- 10 selects B
- 11 selects W

The CFA correction uses 4x4 block processing. Figure 5; CFA mapping translation shows how CFA 4x4 blocks will iterate over the PXP's 8x8 or 16x16 pixel block being processed:

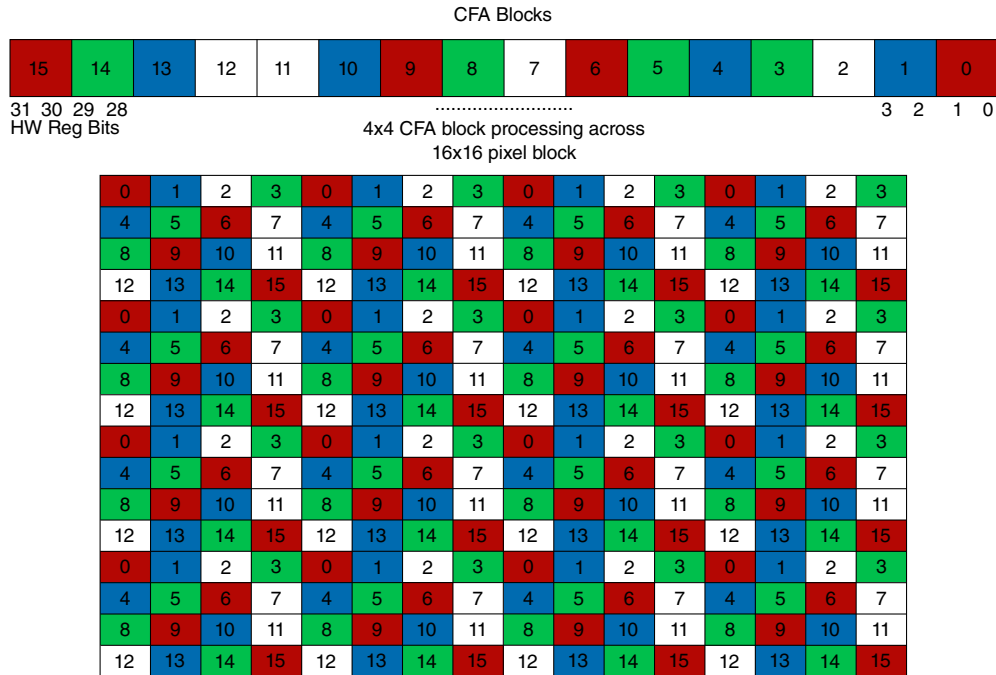

Figure 41-11. CFA mapping translation

41.3.24 RGB888

With out_mode set to RGB888, the memory output data is interpolated from RGB565 to RGB888.

The RGB[23:0] data is formatted as follows: R[7:3]R[7:5],G[7:2]G[7:6],B[7:3]B[7:5].

41.3.25 Rotation

Rotation can occur after compositing the AS and PS buffers in the output stage.

To rotate graphics, the hardware must read pixels in one direction across a frame buffer and write them in a alternate orientation. For the 90 and 270 degree cases, this means that lines of pixels must either be read or written vertically in a frame buffer.

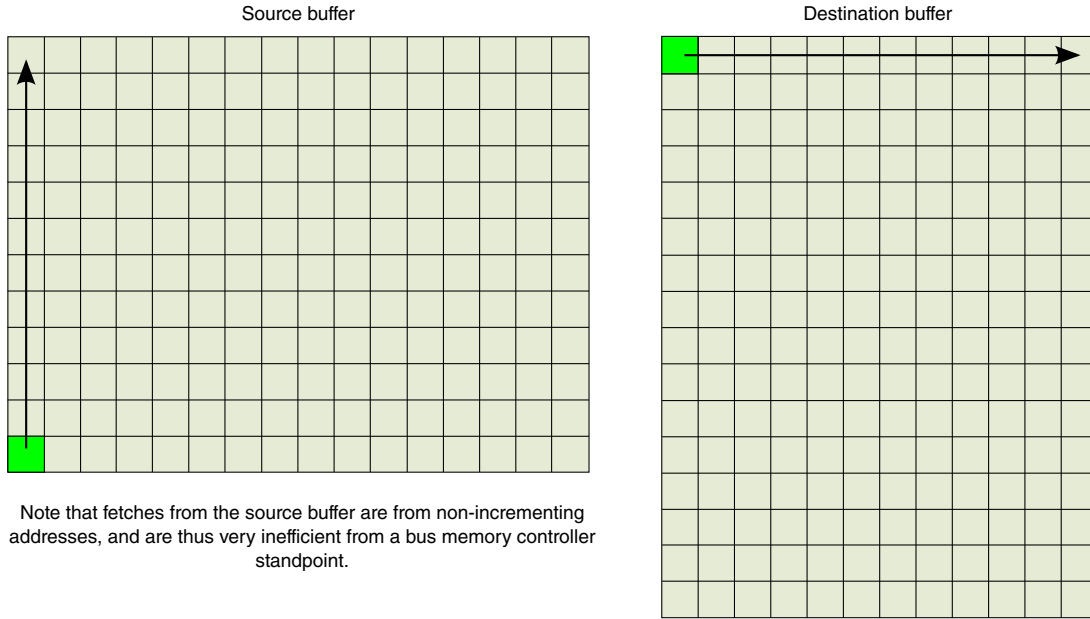

Figure 41-12. Rotation Read and Write

In order to rotate efficiently, multiple columns must be rotated to enable the engine to both fetch and store bursts of pixels, thus improving memory performance. The simplest method of doing this is to operate on square blocks of pixels. To rotate the image, each sub-block of pixels must be rotated by the required rotation angle.

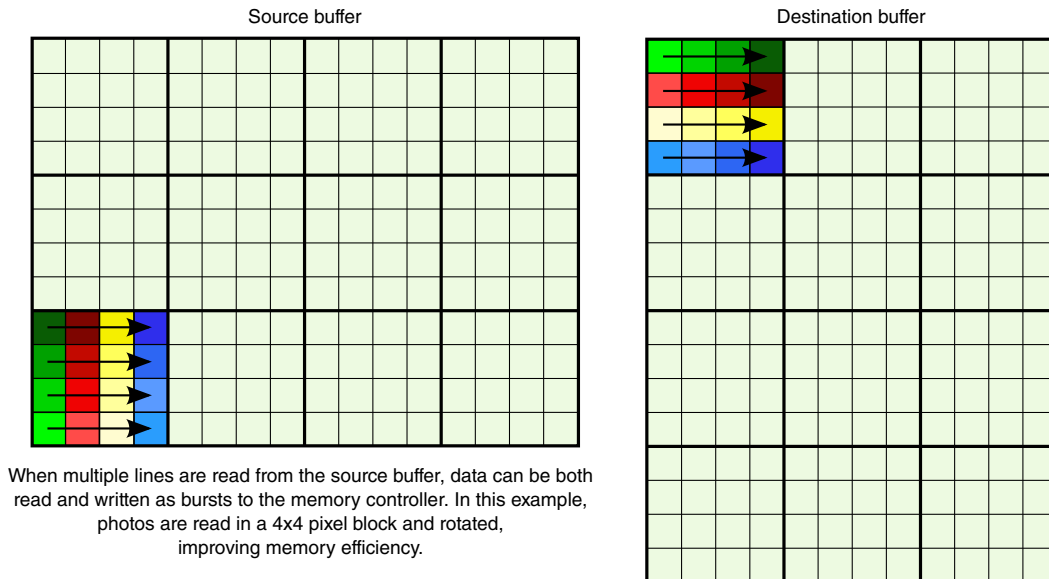

Figure 41-13. Rotated Sub-blocks

To manage the rotation process, the source image can be broken into a grid of sub-blocks that have coordinates as shown in the diagram below. In addition to rotating the sub-block, each block must be translated to a new coordinate location. For each of the rotation angles (0, 90, 180, 270), it is possible to define a simple algorithm for computing the new translated grid address. The hardware must then simply compute the memory address from the base grid address for both load and store operations.

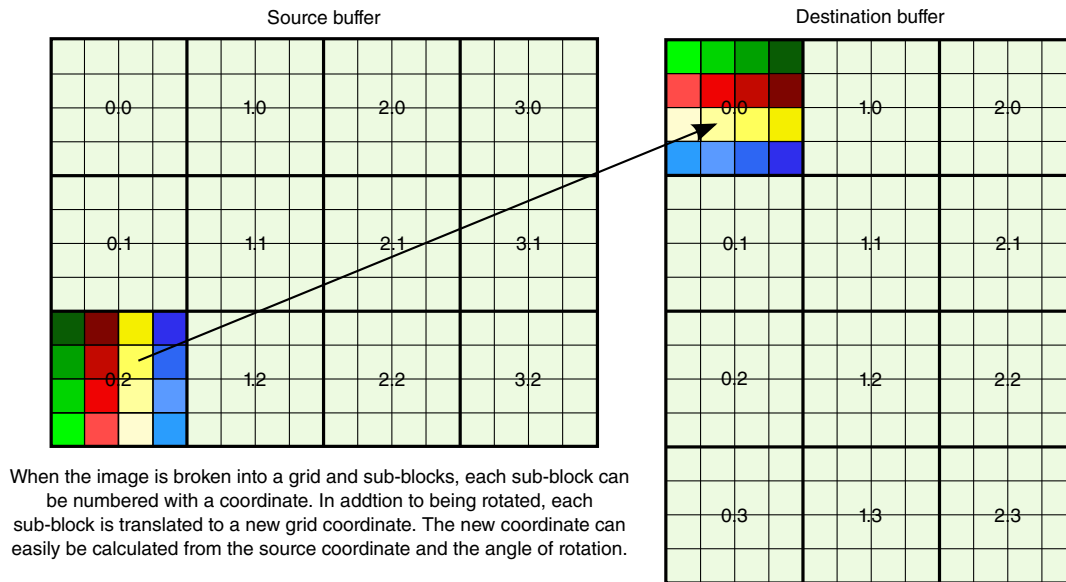

Figure 41-14. Grid of Sub-Blocks with Coordinates

In order to balance the requirements of reasonable burst sizes to the memory controller as well as keep the hardware storage requirements to a minimum, the blending/rotation engine will operate on either 8x8 or 16x16 pixel blocks. When using the Rotate engine with the input fetch engine, you need to program the input fetch engine to work in 8x8 block mode.

NOTE

An important artifact of the PXP is when rotating a source image and the output is NOT divisible by the block size selected. The output engine essentially truncates any output pixels after the desired number of pixels has been written. Since the output buffer is written as a horizontal row of blocks, the incorrect pixels could be truncated and the final output image can look shifted. In the case where the block size is programmed to 8x8, and the output size that is programmed is 12x12, then there is a remainder of 4 pixels that will be truncated in either the X and/or Y axis when the PXP operation

is complete. The output will be shifted by 4 pixels in this example. To compensate for this, the source base address needs to be adjusted so the correct pixels get truncated and the image does not look shifted. In this example, with 90 degrees of rotation, the PS base address should be adjusted by 4 times the actual PS base address $-(4 * \text{pitch})$.

41.3.26 Output Buffer

The output buffer engine accepts data from the PXP pixel pipeline and issues requests to transfer the output pixels to external DRAM or the internal SRAM double buffer row of blocks.

41.3.27 Address calculator

Each of the blocks will manage its own fetch address using a common address calculator block that computes real addresses from a base address and relative block offset from the base.

Each block will then perform the multiple line fetches (or stores) required to perform the operation. This hides all the address buffer computations from the processing blocks and allows each block to simply track the coordinate of the block it is working on.

41.3.28 Block size selection

The PXP can be configured to process blocks that are either 8x8 pixels or 16x16 pixels with the REG_CTRL[BLOCK_SIZE] control bit.

When selecting a 16x16 pixel block size, the accesses to fetch AS and PS images and write the final frame buffer are more efficient since twice as much data is requested and processed per memory request.

When optimizing the system for memory bandwidth and image processing time, configure the PXP to process 16x16 pixel blocks.

41.3.29 Interlaced Video Support

The PXP has some minimal ability to generate interlaced video content from a progressive source. There two available options, based on the bandwidth requirements and how software is managing video frames.

The PXP can either interlace on the input side (by reading every other line of input data) or on the output side (by writing the individual lines of video into two separate fields). Generally, output interleaving should be used since it is the most flexible mode (it allows scaling and full overlay support) and it only requires a single pass of the PXP to generate two separate output fields.

Input interleaving can be beneficial in cases where the PXP is running at 60fps, since it requires fewer fetches to produce the output data. There is no direct hardware support for input interleaving, in that, there is no configuration bit that can be set to alter how the PXP processes a frame for input interleaving. Input interleaving is achieved by simply setting the source frame buffer pitch value to twice the value it would normally be set to for the equivalent progressive frame. The output parameters also need to be consistent with the desired processing effect. For example, the vertical resolution would be set to account for the reduced resolution to process the interlaced input buffers.

41.3.30 LCDIF Handshake

The PXP and LCDIF support a mode where the internal SRAM can be used for the frame buffer to minimize external memory bandwidth required.

This is accomplished by creating two buffers in SRAM, a double buffer row of blocks, where each correspond to 8/16-lines of the frame buffer. The buffers must be consecutive and allocated as a single block of data.

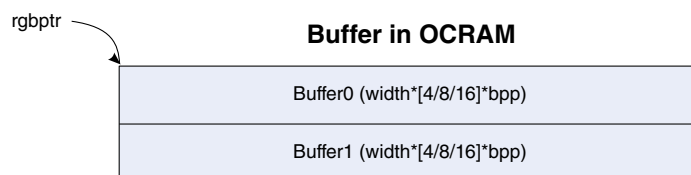

Figure 41-15. Buffer in OCRAM

The storage required can be calculated for an 8x8 block size as

- storage = 16 (lines) * rotated_row_length * pixel_size

and for 16x16 block size as

- $\text{storage} = 32 \text{ (lines)} * \text{rotated_row_length} * \text{pixel_size}$

where $\text{pixel_size} = 4$ for 32bpp or 2 for 16bpp modes. The following table lists the storage requirements for common image sizes using 8x8 block size:

Image Size	Storage (16bpp)	Storage (24bpp)	Storage (32bpp)
320x240 (QVGA) - 0/180 rotation	10KB	15KB	20KB
320x240 (QVGA) - 90/270 rotation	7.5KB	11.5KB	15KB
640x480 (VGA) - 0/180 rotation	20KB	30KB	40KB
640x480 (VGA) - 90/270 rotation	15KB	22.5KB	30KB

The following diagram shows how the minimal rotation buffer would be organized. As the engine and LCD progress down the image, they continually swap roles of filling and emptying each eight-line buffer.

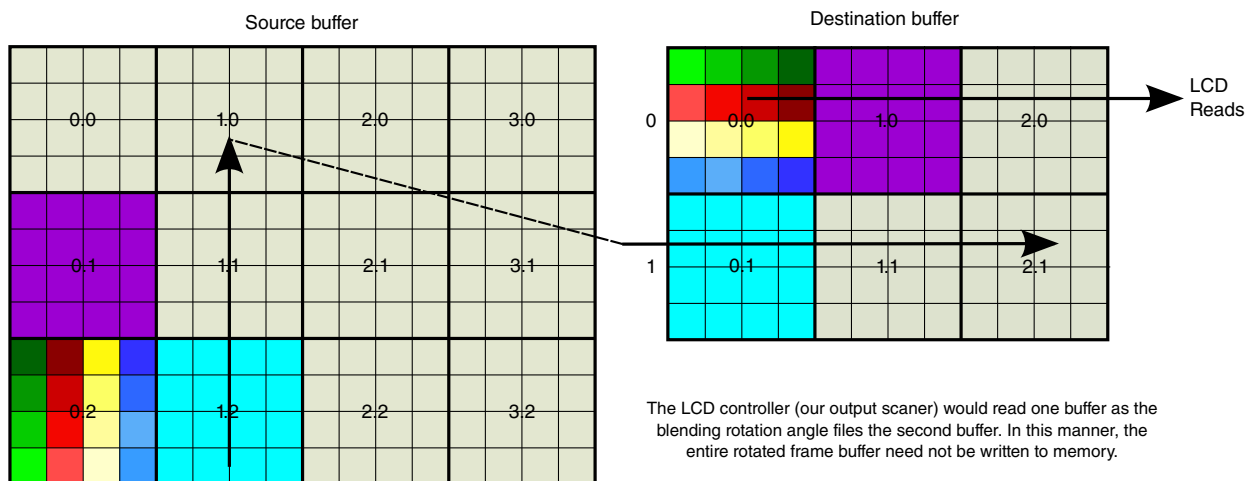

Figure 41-16. Minimal Rotation Buffer Organization

When this mode is enabled, the PXP will process one row of pixel blocks and write the results to the first SRAM buffer (buffer 0). The PXP will then alternate between writing subsequent rows to buffer 0 and buffer 1. After the PXP generates the data for one buffer, the LCDIF will begin reading that buffer and send the contents to the display device. Once the LCDIF finishes reading a buffer, it will start displaying from the other buffer while the PXP continues filling the previously processed buffer.

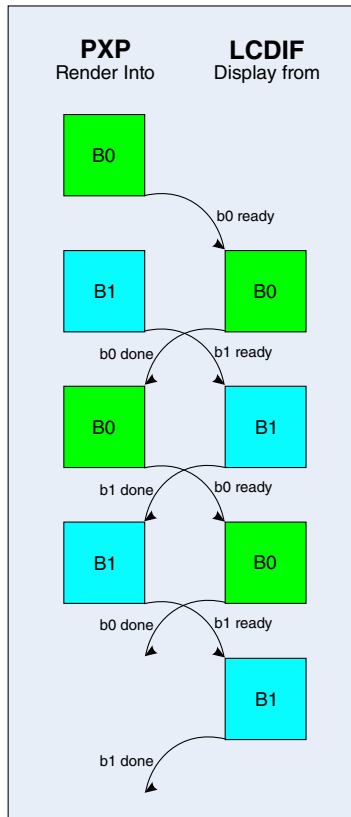

Figure 41-17. PXP and LCDIF Buffer Sharing

To accomplish the buffer sharing, the PXP and LCDIF will maintain buffer status using a pair of handshake signals. When a buffer is filled by the PXP, it will assert the `pxp_lcdif_bx_ready` (where x is 0 or 1) signal to indicate to the LCDIF that the buffer has valid data. The LCDIF will then release the buffer by asserting the `lcdif_pxp_bx_done` signal.

The basic protocol is shown in the diagram below:

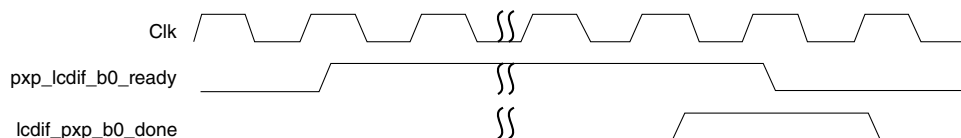

Figure 41-18. Buffer Sharing Protocol

The PXP will continue to assert the `bx_ready` signal until the corresponding `bx_done` signal is sampled high for one clock cycle. It will then deassert the `bn_ready` until the next time the buffer has been filled. After the PXP samples the `bx_done` signal asserted, it is free to begin filling the buffer with the next block size lines of display data. If a buffer has not been released when the PXP is ready to process data for that buffer, it will suspend rendering operations until the buffer has been released by the LCDIF.

41.3.31 LCDIF Abort

When the memory subsystem is not loaded, the PXP should be able to render the buffers faster than the LCDIF can drain the buffers.

It is possible under some scenarios (high LCDIF output rates with high memory latency) that the PXP may not be able to keep up with the LCDIF, even in the SRAM mode of operation. When this happens, the LCDIF will signal that it has completed one of the buffers before the other has been rendered by the PXP. This condition will be detected by the PXP's control logic as an "LCDIF Abort", which will cause the PXP to abort processing in the current row and proceed to the following row. It will acknowledge the abort to the LCDIF by raising the `buffer_ready` signal for the current buffer to enable the LCDIF to begin displaying the partially-filled buffer. While an abort will create artifacts in the video display, it does minimize the artifacts by limiting them to the remaining pixels blocks in the current row versus ruining the entire frame buffer.

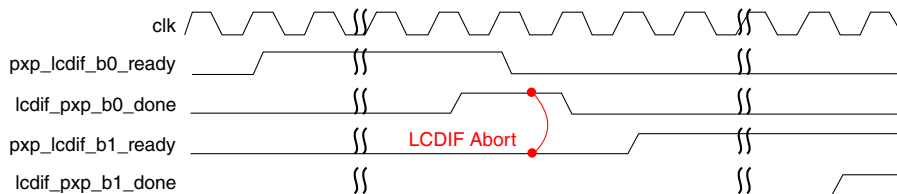

Figure 41-19. LCDIF Abort

41.3.32 Theory of Operation

The PXP can be used to accelerate graphics operations by offloading graphics processing from the processor. The block can perform alpha blending and color key substitution on two RGB graphics buffers.

The PXP is organized as having a processed surface (PS) and an alpha surface (AS) that can be blended with the processed surface. There are no restrictions on the location of the AS or PS within the output surface (OS). As the PXP processes NxN blocks, operations

are performed on a pixel by pixel basis. The AS and PS pixels are alpha blended, color keyed, process by CSC and LUT resources as individual pixel components. This allows efficient block processing with supporting arbitrary alignment for both the AS and PS surfaces. The resulting pixel block is then written to the corresponding block in the output buffer.

41.3.33 Pixel Handling

All pixels are internally represented as 32-bit values regardless of input or output pixel formats. The pixels get converted in the AS and PS buffer engines to 24-bit pixel values. There is also an 8-bit alpha value at stages up to the alpha blender within the PXP for blending within the RGB color space. Compositing of AS and PS images can only occur in the RGB color space. If compositing is not required, then YUV pixels can be transferred and processed at all PXP pixel resource components.. The color orientation of pixels within the PXP can be controlled by the CSC1, CSC2 , and LUT resources.

For RGB, input pixels are converted into 22-bit pixel values using the following rules for both AS and PS:

1. 32-bit ARGB8888 pixels are read directly with no conversion.
2. 32-bit RGB888 pixels are assumed to have an alpha value of 0xFF (full opaque).
3. 6-bit RGB565 and RGB555 values are expanded into the corresponding 24-bit color space and assigned an alpha value of 0xFF (opaque). The expansion process replicates the upper pixel bits into the lower pixel bits (for instance a 16-bit RGB555 triplet of 0x1F/0x10/0x07 would be expanded to 0xFF/0x84/0x39).
4. 16-bit RGB1555 values are expanded into the corresponding 24-bit color space and assigned an alpha value of either 0x00 or 0xFF, based on the 1-bit alpha value in the pixel. The ALPHA_MULTIPLY function is useful in this scenario to allow scaling of the opaque pixels to a semi-transparent value.

Alpha values can be passed through the entire PXP data path and output in ARGB888 and ARGB555 pixel modes. Also, output pixels can be assigned an alpha value using the REG_OUT_CTRL[ALPHA] register. 16-bit pixels values are formed from the most significant bits of the 24-bit pixel values.

When YUV/YCbCr output formats are selected, all pixels are internally represented as either RGB or YUV pixels values. The CSC2 or LUT can convert internal RGB/YUV pixels into the correct output format. In this way, any PS color space can be blended with AS RGB pixels and output in any color space.

41.3.34 Output Buffer Composition

The output buffer will be rendered by composing each pixel block from the associated PS and AS buffers.

The AS pixel buffer can be blended or color-keyed with the associated data from the PS buffer (either the PS image pixels or REG_PS_BACKGROUND register based on PS programmed coordinates).

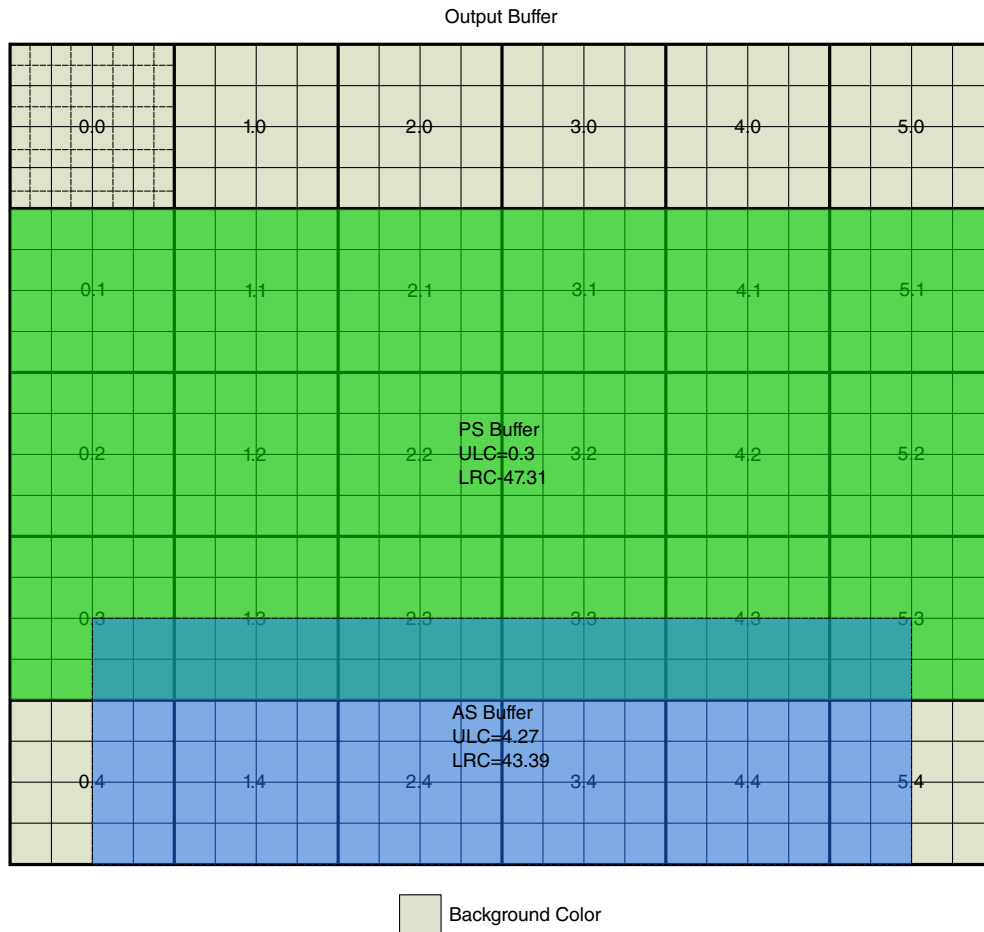

Figure 41-20. Output Buffer Composition

41.3.35 PS Image Processing

As the PXP processes image buffers, it iterates over the output buffer by fetching the corresponding input buffer blocks and processing the pixels embedded in these.

41.3.36 Letterboxing

At each pixel coordinate, the control logic determines if the PS pixel (argument also applies to AS pixels) will be used in rendering the output pixel.

This is determined by checking the output pixel's coordinates against the REG_OUT_PS_ULC and REG_OUT_PS_LRC (ULC and LRC in short) register contents. For pixels outside this region, the PS pixel will be loaded with the pixel value from REG_PS_BACKGROUND, which can be used to effectively control the letterboxing color. There are no block size or block boundary restrictions when setting the ULC or LRC for either the AS or PS. The only restriction is that the ULC and LRC are within the OUT LRC extents.

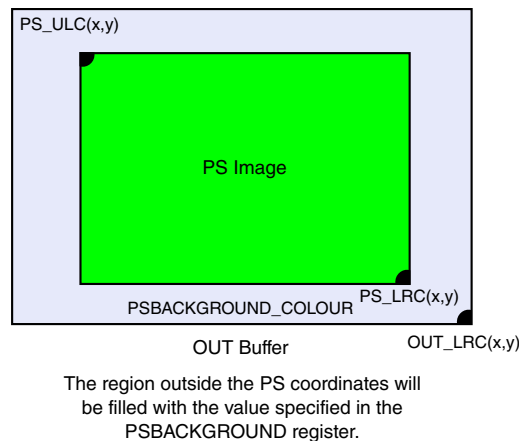

Figure 41-21. OUT Buffer

41.3.37 Clipping source images

A subset of the PS buffer can be used in rendering the output buffer. The PXP_PS_BUF register can indicate an offset into the PS buffer that will be used for display within the OUTPUT buffer.

The pixel at the address defined in the PXP_PS_BUF register will be the pixel that is displayed at the pixel coordinate indicated by PXP_OUT_PS_ULC within the output buffer. Essentially, the PXP_PS_BUF register can be used to establish an offset into the PS buffer thus clipping all PS buffer pixels that are at a lower address. The PXP_PS_PITCH will always indicate the number of bytes that are vertically adjacent in

the PS buffer. The settings in the PXP_PS_BUF, PXP_OUT_PS_ULC, and PXP_OUT_PS_LRC will determine the subset of the PS buffer, or clipped PS source buffer, that will be used in the output buffer.

It is important to note that when scaling the PS buffer, the coordinates of the PS buffer within the output buffer need to be consistent with the scaling factors and original PS buffer size.

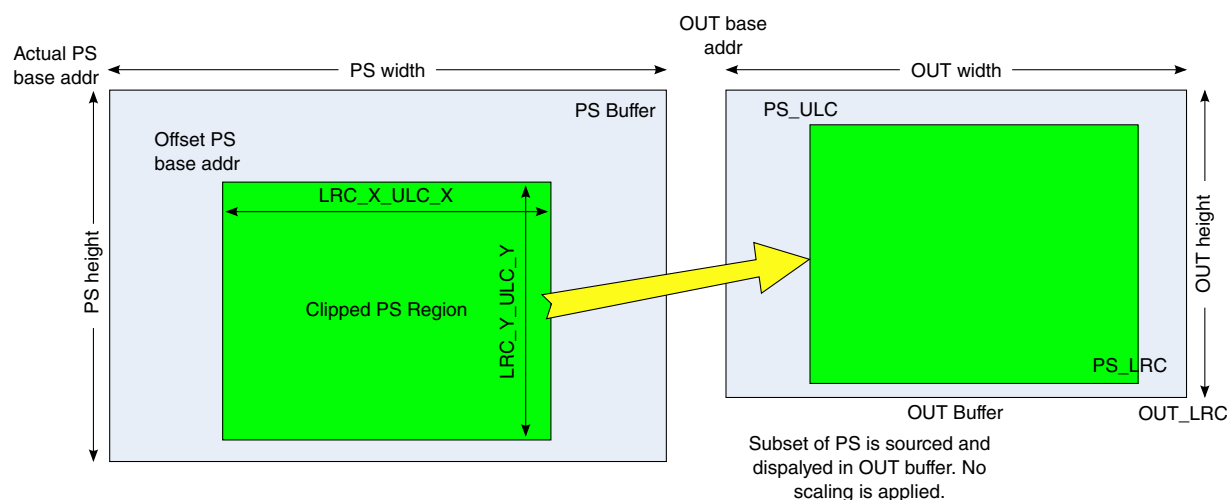

Figure 41-22. PS Buffer Scaling

When sourcing a subset of the PS image, it should fall completely within the PS buffer to avoid displaying incorrect data. The following conditions should be met:

$$x_base_addr_offset + x_scale * (LRC_X - ULC_X) \leq PS_pitch$$

$$y_base_addr_offset + y_scale * (LRC_Y - ULC_Y) \leq PS_size$$

The PXP hardware does not check for these conditions and will render the image as programmed. The following case could indicate invalid programming parameters for the PXP:

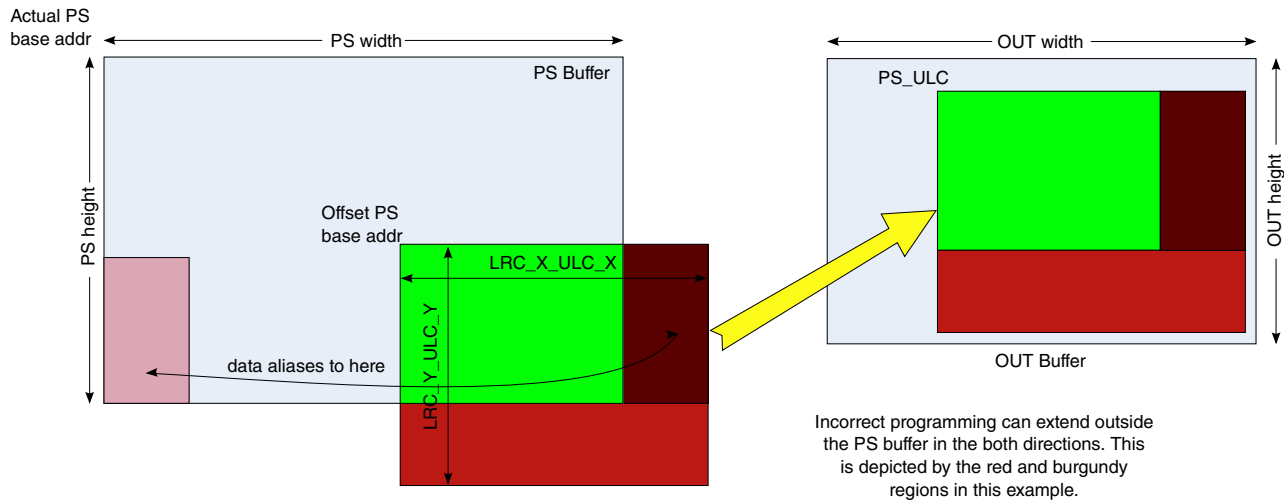

Figure 41-23. Example with Invalid Parameters

41.3.38 Color Key Processing

Pixels may be made transparent to the corresponding AS by using the PS color key registers.

If a PS pixel matches the range specified by the REG_PS_COLORKEYLOW and REG_PS_COLORKEYHIGH registers, the pixel from the associated AS will be displayed. If no AS is present for the pixel, a black pixel will be generated since the default AS pixel is 0x00000000 (transparent black pixel).

The most common use for this is when a bitmap does not support an alpha-field or for applications such as "green screen" where an image is substituted for a solid background color .



Figure 41-24. The PS image (player) and AS image (stadium)

The green portion of the background image can be color keyed to display the contents of the AS buffer for locations that match the color range. For this example, the color range is:

PS Colorkey: 00<R<80 70<G<ff 00<B<80

The resulting image becomes:



Figure 41-25. Resulting Image

41.3.39 In Place Processing (PS buffer is destination buffer)

The PXP also has the ability to process an image and write the resulting buffer back to the original PS buffer. This is referred to as "in place" rendering.

This could be useful for basic blit operations into the PS buffer. IN_PLACE operations are achieved by programming the OUT base address to the pixel location in the PS buffer that marks the upper left pixel of the update region. The actual region that is updated should be indicated by programming the ULC = (0,0) and the LRC = (X,Y). The region bounded by the coordinates will be updated, and the rest of the PS buffer will not be modified.

41.3.40 Alpha Surface (AS) Processing

The AS surface has a complete set of registers that determines how the AS effects the final OUT surface.

Most of the registers that exist for the PS surface also are defined for the AS surface where applicable. This is provided to replicate the SW interface for each PS and AS processes.

41.3.41 Alpha Handling

Alpha values in the AS are embedded in the source image pixels. For AS pixel formats that do not support an alpha value, the pixel is assigned an alpha value of 0xFF (opaque).

This can be modified by the AS control by setting either the ALPHA_MULTIPLY or ALPHA_OVERRIDE bit in the associated AS_CTRL register. If ALPHA_MULTIPLY is enabled, the 8-bit ALPHA value from the AS_CTRL register is multiplied by the source alpha before blending with the PS image. If the ALPHA_OVERRIDE bit is set, the 8-bit ALPHA value is simply substituted for the pixel.

41.3.42 Color Key Processing (AS_CTRL)

The AS_CTRL register also contains an ENABLE_COLORKEY bit that can be used to enable or disable color key substitution for the AS.

When enabled, the pixel values are compared to the ASCOLORKEYLOW and ASCOLORKEYHIGH registers to determine if a match has occurred. When an AS pixel matches the color key range, the pixel from the AS image is considered transparent and the corresponding PS pixel is rendered. If both the PS and AS pixels match their corresponding color key ranges, the AS pixel is displayed unmodified.

AS color keys are handled in a manner similar to PS color keys. The same images used in the PS color key example could be used with the images swapped. In this case, matches on the AS image to the ASCOLORKEY register would display the PS pixels.

41.4 Output Image Processing

Several PXP options affect the resulting output image.

41.4.1 Output Image Size

The PXP generates an output image in the resolution programmed by the REG_OUT_LRC. As the PXP processes pixels, it iterates over the NxN blocks (in output scan-block order) based on the final image resolution.

41.4.2 Output Format

The result of PXP operations are written to the buffer pointed to by the REG_OUT_BUF/REG_OUT_BUF2 registers. The pixel format is controlled by the REG_OUT_CTRL[FORMAT] bit-field.

32-bit pixels are formed directly from the internal 24-bit representations and 16-bit pixel formats are generated by truncating the internal 24-bit values to the appropriate number of bits. For formats supporting an alpha value, the PXP assigns the alpha using the 8-bit value in the REG_OUT_CTRL[ALPHA] field. For ARGB1555, the most significant alpha bit is appended to the output pixel. Also, for ARGB4444, the most significant nibble is appended to the output pixel. Single and dual buffer YUV output formats are also available. Since each pixel in the data path is represented by a full YUV444 24bpp value, decimation reduces the output in cases of YUV422/420 output formats.

41.4.3 Rotation/Flip operations

The PXP supports four rotation angles in conjunction with vertical and horizontal flip options. The flip operations effectively take place before the rotation.

Rotations of 0, 90, 180, and 270 degrees are supported and any combination of rotation and flip are supported. There is no performance difference between any of these modes of operation.

41.5 Queuing PXP transactions

The PXP supports a primitive ability to queue up one operation while the current operation is running. This is enabled through the use of the REG_NEXT register.

When this register is written, it enables the PXP to reload its current register contents with the data found at the location pointed to by this address when it completes processing of the current frame. This feature may be useful in helping to reduce the interrupt latency in servicing the PXP, especially in cases where the PXP and LCDIF are using the on-chip SRAM buffer handshake (since the PXP must begin generating next frame data immediately).

If the PXP is idle when the REG_NEXT register is written, the PXP treats this as an indication that it should immediately load the values at the pointer and begin processing the frame. This ability should allow software to use the same routines when programming the PXP (so that the first frame doesn't differ from subsequent frames).

When loading values from the NEXT register, all registers in the PXP are reloaded. Some register loads have no effect

After writing the REG_NEXT register, the PXP will set the REG_NEXT[ENABLED] bit of the REG_NEXT register to indicate that the next command has been queued. Software should first check the status of this bit to ensure that a previous command has not been enabled. Likewise, after programming the first frame in a sequence of frames, software should poll this bit until it is sampled logic 1'b0 before queuing the next operation.

The PXP will issue interrupts from frames as they complete, regardless of whether they were started by writing the control registers directly or using the REG_NEXT register. When software receives an interrupt, it should check/clear the PXP's status register as normal, poll the REG_PXP[ENABLED] bit, and then issue the next operation. A queued operation may be cancelled by issuing a CLEAR operation to the REG_PXP[ENABLED] register bit. The SET and TOGGLE operations should never be used with this register.

41.6 Error Handling

The PXP does minimal checking on the control registers, so it is important that these are correctly specified. The PXP does monitor the bus transactions for errors and will report errors in the status register.

Upon receipt of a bus error, the PXP will set the ERROR interrupt and abort any further operations. Bus errors can be generated from any system access that results in an error response returned from the internal SIM Bus errors in the PXP are signaled as either a read or a write error, but do not indicate the failing address. Software may deduce the failing address from the current block status indicators.

41.6.1 Known PXP Limitations/Issues

The PXP has the following known limitations:

1. When using the NEXT register, the interrupt enable setting should remain the same for all frames. If not, the PXP will change the interrupt enable register value and possible cause the loss of an interrupt.
2. Rotations of 180/270 are not supported when performing LCD handshakes

41.7 Dither Engine Block

There are 3 instances of the dither processing block (Dither0, Dither1 and Dither2) instantiated in the system and each has separate controls.

The dither engine takes in a buffer of 8 bit components at a time in block order from the previous module that is connected to its input. It is designed to process ~1 pixel/clock. It can process the pixels in a number of ways. It can write out the pixels unmodified (pass through), it can quantize the pixels from 8 bits to any smaller number of bits down to 1 bpp. The dithering algorithms supported is Ordered dithering.

A LUT (Look Up Table) transform can be configured to be done on the pixel either before or after dither dithering but not both. In addition there is a “final” independent register based LUT that can be applied at the end of the dither process just before the pixel is written out to the output buffer. The LUT values for this final LUT are programmed by software into register.

There are 3 instances of the dither processing block (Dither0, Dither1 and Dither2) instantiated in the system and each has separate controls.

41.7.1 Top Level Connections

The dithering engine is connected to the output of the rotation engine, but it can be bypassed by programming Mux 11. See the figure below:

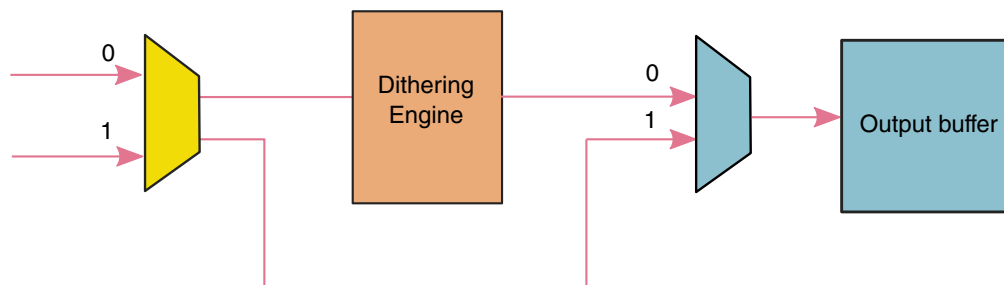

Figure 41-26. Dither Engine External Connections

The Dither Engine must be configured and enabled through the `HW_DITHER_CTRL` control register. The data flow is controlled through the valid, ready and pixel handshake signals with the Fetch and Store blocks. The Dither Engine must be enabled and given all required information such as LUT configuration, etc. After starting, the Fetch Engine will signal to the dither engine when it has data for processing.

The dimension information of the operation is not programmed in the Dither engine. It comes from the higher level pxp control register fields.

41.7.2 Dither Engine Design

The following diagram shows the detailed internal structure of the Dither Engine.

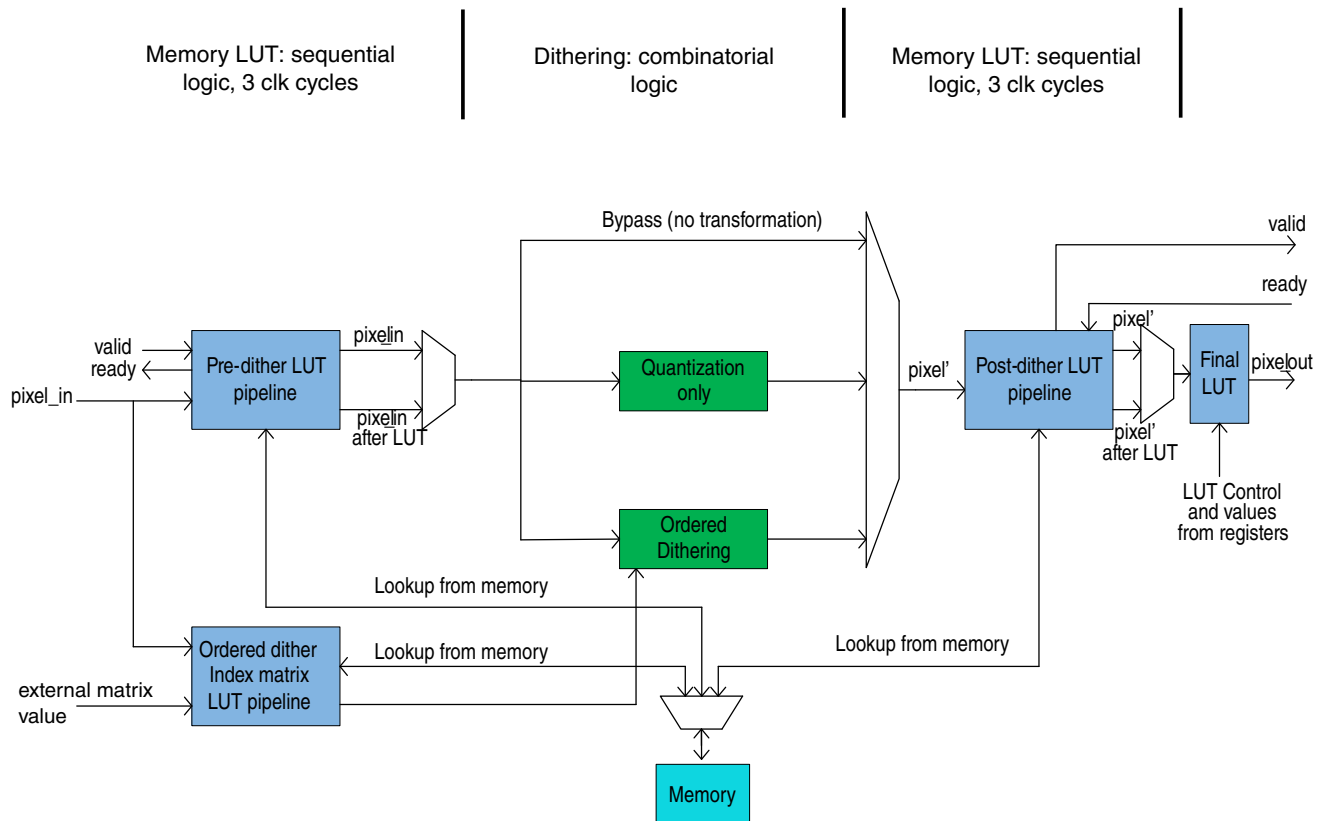

Figure 41-27. Detailed Block Diagram

1. Y8 configuration:- In this configuration only Dither0 is enabled. The Fetch Engine will fetch Y8 data and feed it to Dither0. Dither0 then writes resultant data, Y4 for instance, to the Store engine.
 2. RGB configuration:- In this mode all three dither engine instances are enabled. The Fetch Engine reads in RGB data from memory and gives 8 bits of the triplet to each dither engine. The resulting quantized or dithered data from each dither engine is passed to the same Store engine as in Y8 configuration and the Store Engine synchronizes, packs the data back together and writes it memory.
1. Pass Through:- In this mode the pixel data passes through unmodified
 2. Floyd-Steinberg Dithering:- This mode quantizes and dithers the pixels according to the standard Floyd-Steinberg algorithm that can be found in the literature. This algorithm employs an error dispersion technique that saves a fraction of the quantization error from each pixel and adds those partial errors to neighboring pixels. Therefore, the error memory buffers shown in the diagram are used in this mode to save the partial errors and retrieve them as they are needed when processing corresponding pixels in the next row below the current row.

3. **Atkinson Dithering:-** This mode employs the standard Atkinson dithering algorithm to quantize and dither the pixels. The standard algorithm in the literature is implemented. Atkinson is an error dispersion algorithm similar to Floyd-Steinberg except that the partial error coefficients are different and the error is dispersed two lines below the current row instead of one line below.
4. **Ordered Dithering:-** This is a standard algorithm that applies an index, or Bayer matrix to the pixels. Applying this matrix has the effect of changing the likelihood of a pixel being rounded up or down when being quantized. If this mode is specified, it requires use of the LUT memory so the `HW_PXP_DITHER_CTRL.LUT_MODE` field must be set to 0, or off. The `IDX_MATRIXx_SIZE` field specifies the dimensions of the index, or Bayer matrix. This is used to properly index into the LUT memory to retrieve the correct corresponding value to apply to the current pixel.
5. **Quantization only:-** This mode simply quantizes the pixel from 8 down to whatever bits per pixel are specified in the `NUM_QUANT_BIT` field. No dithering algorithm is used.

Before a detailed discussion of block functionality, it is important to note that there are 3 instances of the dither block within the PXP. All three, Dither0, Dither1 and Dither2 are connected to the same Fetch and Store engines. The system works in two configurations

1. **Y8 configuration:-** In this configuration only Dither0 is enabled. The Fetch Engine will fetch Y8 data and feed it to Dither0. Dither0 then writes resultant data, Y4 for instance, to the Store engine.
2. **RGB configuration:-** In this mode all three dither engine instances are enabled. The Fetch Engine reads in RGB data from memory and gives 8 bits of the triplet to each dither engine. The resulting quantized or dithered data from each dither engine is packed to 24 bit RGB and be written to memory by Store Engine.

The Dither Engine has the functionality to do a register based final LUT at the end of dither processing. This LUT is controlled by the `FINAL_LUT_ENABLE` bit. Notice that in the `HW_PXP_DITHER_CTRL` register there are separate `ENABLEx`, `DITHER_MODEx` and `IDX_MATRIXx_SIZE` controls for each engine. The `NUM_QUANT_BIT` and `LUT_MODE` control fields are common and apply to all dither engine instances.

To be included in a pxp processing flow operation, the `HW_PXP_CTRL_ENABLE_DITHER` bit must be set when the operation is executed. This is in addition to the `HW_PXP_DITHER_CTRL.ENABLEx` bits.

The process flow through the Dither Engine is detailed in the following sections.

Step1: Pre-Dither

The pixels are read into the pre-dither pipeline sub-block through the handshake with the Fetch Engine/ If there is error data or Ordered dither LUT matrix data that corresponds with the current pixel (this is mode dependent) then all these elements are fetched, synchronized and presented to the dither stage (green blocks in the above figure) simultaneously. The pre-dither, post_dither and Ordered dither matrix LUT pipeline module instances keep the data synchronized and flowing through the block. The pixel can go through a lookup table before the dither stage in the Pre-dither LUT pipeline or after in the Post-dither LUT pipeline. These blocks and the Ordered dither index pipeline block share the LUT memory through the LUT Memory Controller block. There is only one memory that is shared between these three functions and only one use can be selected for a given operation. In other words, the block can be configured to use pre-dither lookup, post-dither lookup or ordered dither mode but only one at a time. The pre or post lookup function is enabled through the HW_PXP_DITHER_CTRL.LUT_MODE field. Ordered dithering is enabled through the HW_PXP_DITHER_CTRL.DITHER_MODE_x field (Again, the memory can be used for only one purpose during any given operation). The LUT function uses an 8 bit address (the input data) to lookup 8 bits of data. The LUT memory must be pre-configured with the desired lookup table data.

Step2: Dither

After the pre-dither stage, the pixel and colateral data passes through the dither stage. There are 3 programmable modes in this stage that are specified with the HW_PXP_DITHER_CTRL.DITHER_MODE_x field.

1. Pass Through:- In this mode the pixel data passes through unmodified
2. Ordered Dithering:- This is a standard algorithm that applies an index, or bayer matrix to the pixels. Applying this matrix has the effect of changing the likelihood of a pixel being rounded up or down when being quantized. If this mode is specified, it requires use of the LUT memory so the HW_PXP_DITHER_CTRL.LUT_MODE field must be set to 0, or off. The IDX_MATRIX_x_SIZE field specifies the dimensions of the index, or bayer matrix. This is used to properly index into the LUT memory to retrieve the correct corresponding value to apply to the current pixel.
3. Quantization only:- This mode simply quantizes the pixel from 8 down to whatever bits per pixel are specified in the NUM_QUANT_BIT field. No dithering algorithm is used.

The output of this step is the quantized/dithered pixel packed into the most significant bits of an 8 bit byte. The unused bits in the lower part of the byte will be set to zero.

Step3: Post-Dither

The post-dither block is similar to its pre-dither counterpart. The processed pixel is queued up in preparation for write to the Store Engine. If `DITHER_MODEx` is not equal to Ordered mode, and a lookup operation is not selected in the pre-dither step, the `LUT_MODE` can be set to select a lookup operation in this step using the LUT memory.

Step4: Final Lookup

This combinatorial LUT step takes bits [7:4] of the output pixel and looks up an 8 bit value from the 16 value LUT to generate the final output pixel to the Store Engine. The LUT values are programmed into the LUT through the `HW_PXP_DITHER_FINAL_LUT_DATA0 - 3` registers. This operation is enabled through the `HW_PXP_DITHER_CTRL.FINAL_LUT_ENABLE` register field. This LUT is only available on the Dither0 instance.

41.7.3 Pipelined Data Flow

It is possible that the fetch engine could stall when there are valid pixels in various stages of the dither block. In this case the dither pipelines will not stall but will continue to drain and move data out to the store engine. Also, if the Store Engine stalls for a period of time and can not take any more data, flow control is implemented within the Dither block back to the Fetch Engine so that no pixel or error data is lost or becomes unsynchronized.

There are three `BUSY` bits in the `HW_PXP_DITHER_CTRL` register, one for each Dither Engine instance that software can poll to discover if the engine is busy or idle.

41.7.4 Initialization of Dedicated Memories

The internal memories for the Dither Engine instances, including 3 LUT memories can all be initialized through the register interface. This is done by configuring the `HW_PXP_MEM_CTRL` register and then writing the initialization data into the `HW_PXP_INIT_MEM_DATA` register. This simple interface is used as follows. Write the `HW_PXP_MEM_CTRL.SELECT` field with a value between 0-4 corresponding to the memory to be initialized. Write the `HW_PXP_MEM_CTRL.ADDR` field with the starting memory address to be written. Set the `HW_PXP_MEM_CTRL.START` field to begin the initialization operation. Note at all these fields can be set with a single write to the register. Then write the `HW_PXP_MEM_DATA` register with the data to be written to the location at `HW_PXP_MEM_CTRL.ADDR`. Each write to the data register increments and value of address so repeated writes to this register will put the data into sequential memory locations beginning with the offset in the `ADDR` field. The LUT memories are 8 bits wide. When 32 bit `DATA` writes occur with one of those memories

selected, the lower 8 bits are written. To fill these memories 256 writes to the HW_PXP_MEM_DATA register are required. Note that initialization for these memories are not necessary.

41.7.5 Register Configuration Interface

The HW_PXP_DITHER_CTRL register control fields to be set for each operation are included in the following table.

Signal or Group	Description
ENABLE	The hardware signal enables the dither block to function.
DITHER_MODE	Dither mode 0: passthrough, 3: Ordered, 4: no dithering quantization only, 1,2,5,6,7: Reserved. There is one field for each Dither Engine instance.
NUM_QUANT_BIT	How many bits to quantize to. Valid values are 7 down to 1.
LUT_MODE	Configures a LUT operation from local memory. The options are either pre-dither, post-dither or off. This setting affects all three Dither Engine instances.
IDX_MATRIXx_SIZE	These fields, one per instance, specifies the dimension (the matrix is square) of the Index Matrix used in Ordered dither mode.
FINAL_LUT_ENABLE	This field is only applicable to instance 0 of the three Dither Engines and enables/disables the final register based LUT of the output pixel just before outputting it to the Store Engine.

41.8 Waveform Engines

41.8.1 Overview

The WFE (Waveform Engine) is a very flexible, programmable engine that can be used to implement various algorithms to transform the incoming data to the output. It is always used in connection with the Fetch Engine on the input side and a Store Engine on the output. These three sub-blocks work as a unit. There is an optional ALU block between the WFE and Store engines that can be used to make further modifications to the WFE output before storing the output. See the figure below.

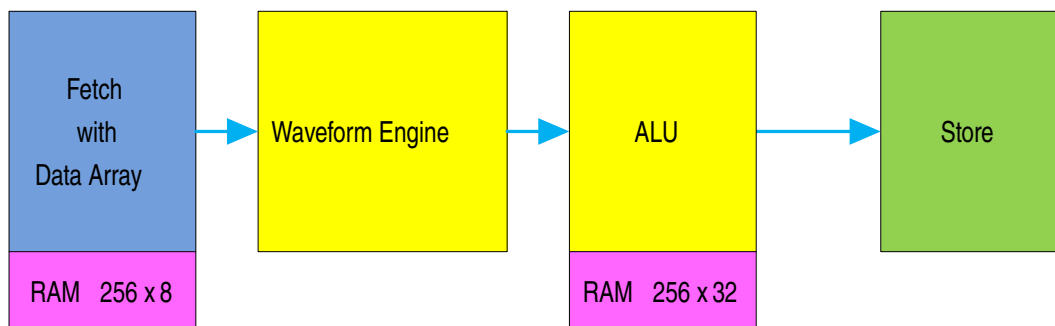

Figure 41-28. Block Diagram

The WFE can process one pixel and associated data per clock.

The Fetch Engine fetches and formats the input pixel data streams according to the requirements and programming of the WFE. The WFE takes in the data from the Fetch Engine through a standard valid/ready signalling interface.

Inside the WFE the data passes through a 3 stage pipeline. Each stage consists of various programmable logic elements including muxes, lookup tables, comparitors, ALU's and registers. The output information calculated in the WFE is output to the Store Engine also using a standard valid/ready signalling interface.

The Store Engine reads the data from the WFE in the programmed format reformats the data according to working buffer pixel formats and stores the frame and associated data to memory.

41.8.2 Functionality

There is one WFE instance arranged in the PXP standard flow. It can be used as WFE-A or WFE-B.

In the standard usecase WFE-A is used for pixel collision detection and also to compute grayscale color transition information used later in the REGL/D algorithm. WFE-B engine takes in pixel information and the results of WFE-A processing and implements the REAGL/D algorithm on the data. The output results in all the information necessary for the EPDC block to update the E-INK panel.

The definitions, functionality and programming of the logical elements within the WFE is proprietary information. The register programming necessary for any given function required will be supplied. The WFE block can be independently held in reset by setting the HW_PXP_WFE_x_CTRL[SW_RESET] bit to 1. This bit should only be set when the HW_PXP_WFE_x_CTRL[ENABLE] bit is 0.

41.9 PXP Store Engine Block Description

41.9.1 Overview

The essential function of the Store Engine is to store input data from the input sub-block to memory or directly output to next sub-block. The input source is 32 bits per channel per valid clock. There is one instance of the Store Engine in the PXP. The main supported features are:

- Two DMA controllers thus it can work on two channel data storage at the output at the same time. If there is only one stream data input, store engine should use channel 0 but not channel 1.
- Accepts as input up to 8 bytes data (two channels, 32 bits each) and 8 bits flag input. After shift operation it can store up to 64bpp per valid clock to memory.
- Data fill function for initialization. It can fill a fixed 32 bit data value to a specified memory buffer.
- Handshake mode with a downstream connected data Fetch Engine. It supports 1 line, 4 lines, 8 lines and 16 lines scan handshake with and 1 line, 3 lines and 5 lines array handshake modes. The Store Engine signals to the Fetch Engine when data is available for processing thus eliminating the need for software intervention through interrupt service routines.
- Bypass mode which directly outputs the data to the downstream connected Fetch Engine after shift operation. This is done through a valid/ready data interface.
- Support for 8x8 and 16x16 block mode and scanline mode.
- Support for 8, 16 and 32 bpp input data format.

41.9.2 Top-Level Architecture

The following figure shows the high level architecture of the block. The basic flow is as follows:

1. Interface with driving sub-block, read in and synchronize data channels.
2. Shift data function swizzles data fields as specified.
3. Data is steared to the output channels and packed for output.
4. Data is output to memory through the AXI masters or sent to receiving sub-block through the bypass interface.

PXP Store Engine Block Description

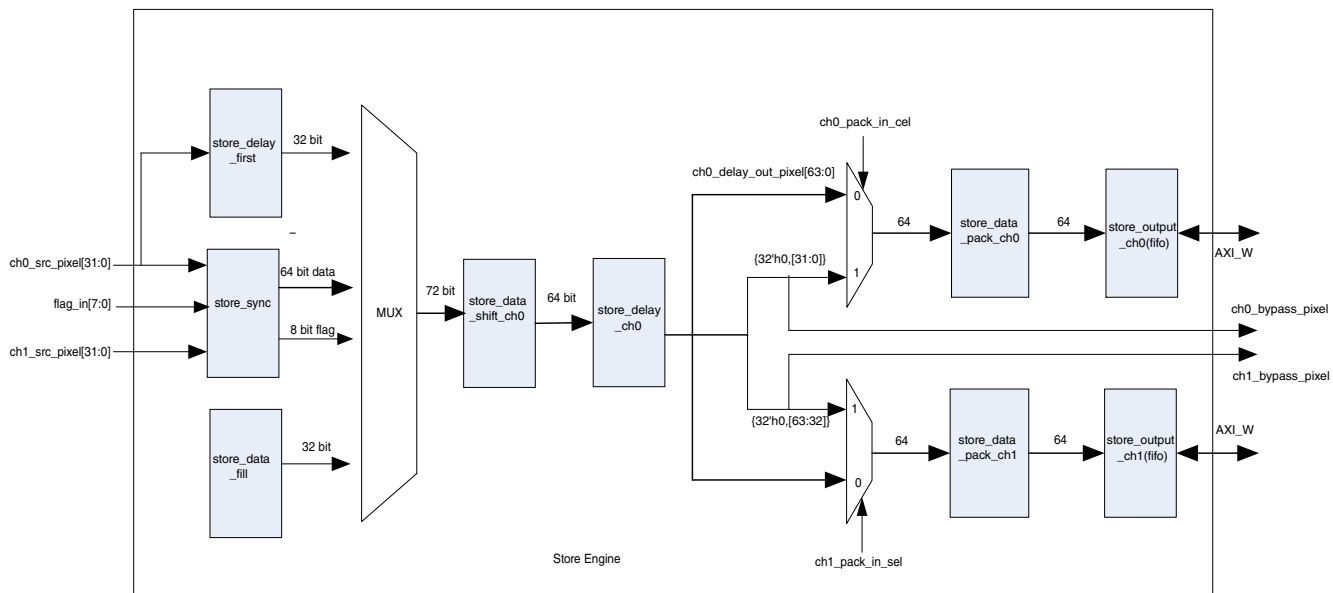
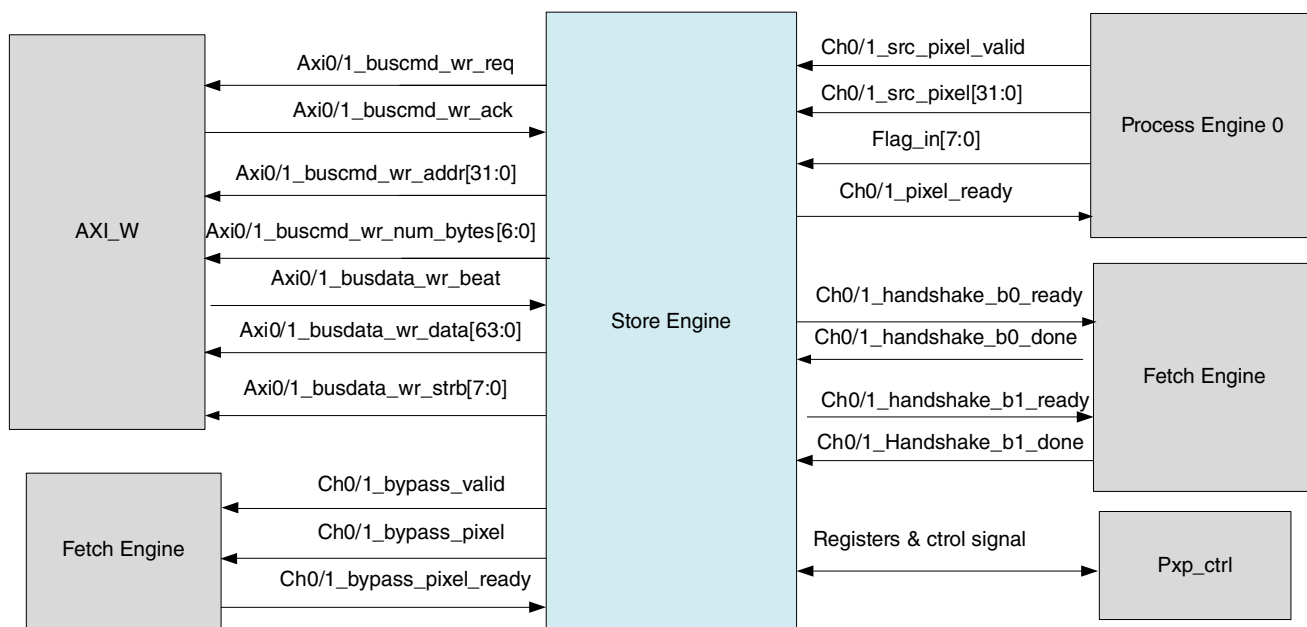

Figure 41-29. High Level Block Diagram

The following figure shows the Store Engine supported connections. On the input side the Store engine can take data from a process engine like the WFE-A through the normal interface. It can output data to memory through the AXI arbitor or directly to the connected Fetch Engine through either the bypass or handshake interfaces. The block is configured and controlled through software programming of PIO registers.



41.9.3 Store Engine Design

41.9.3.1 Input Data Source

1. Fixed Data Input

The Store Engine supports a fill function which writes a fixed value to a specific set of memory locations. The data received from the input is ignored. This function is usually used to initialize a memory buffer. The address of the buffer to fill is set in the HW_PXP_x_STORE_FILL_DATA_CH0 register. Also, this mode can only work through channel 0 and not channel 1.

In this mode HW_PXP_INPUT_STORE_CTRL_CH0.FILL_DATA_EN=1. The fixed value is set in FILL_DATA_CH0 register. How many bits are valid from HW_PXP_INPUT_STORE_FILL_DATA_CH0 register is decided by HW_PXP_x_STORE_SHIFT_CTRL_CH0.OUTPUT_ACTIVE_BPP.

2. Normal Data Input

Store Engine supports two 32 bits wide data channels and 8 bits flag input. If there is only one channel of data input, the channel 0 must be used not channel 1. In this case, HW_PXP_INPUT_STORE_CTRL_CH0.COMBINE_2CHANNEL=0.

If both channels and 8 bits flag input contain valid data, then the COMBINE_2CHANNEL bit should be set to 1. The Store Engine will then combine the two channels of data into 64 bits of data send them with the 8 bits of flags to the shift module. After shift, the Store Engine will choose the active bits from the 64 bit output according to HW_PXP_x_STORE_SHIFT_CTRL_CHx.OUTPUT_ACTIVE_BPP and then pack them in preparation for output.

41.9.3.2 Store data shift operation

The data shift operation supports up to 8 data fields and 8 flag components to be shifted to any position within the 64 bit word. The data fields can be any width. This function is a way to reorder or reformat the component parts of the 64 bit word output. As data flows through the Store Engine each data word is processed the same way according to register configuration.

The following registers are used in shift operation. The pairs of {HW_PXP_x_STORE_D_MASKx_H_CHx, HW_PXP_x_STORE_D_MASKx_L_CHx} make up the 64 bits of mask for each MASKx component. There are a set of masks for each channel in each instance. The D_SHIFT_FLAG0 ~ D_SHIFT_FLAG7 fields in the HW_PXP_x_STORE_D/F_SHIFT_L/D_CHx registers specify which direction to shift (0: right shift 1: left shift) each data component0 ~ component7 after the mask is applied. The D_SHIFT_WIDTH0 through D_SHIFT_WIDTH7 fields specify how many bits to right or left shift each data component 0 through7 after the mask is applied.

The shift function works the same for the 8 bits of flag data. There are analogous “F_SHIFT” registers that contain the F_MASKx, F_SHIFT_FLAGx and F_SHIFT_WIDTHx register fields for swizzling the input flags.

The figure below shows how the shift function works.

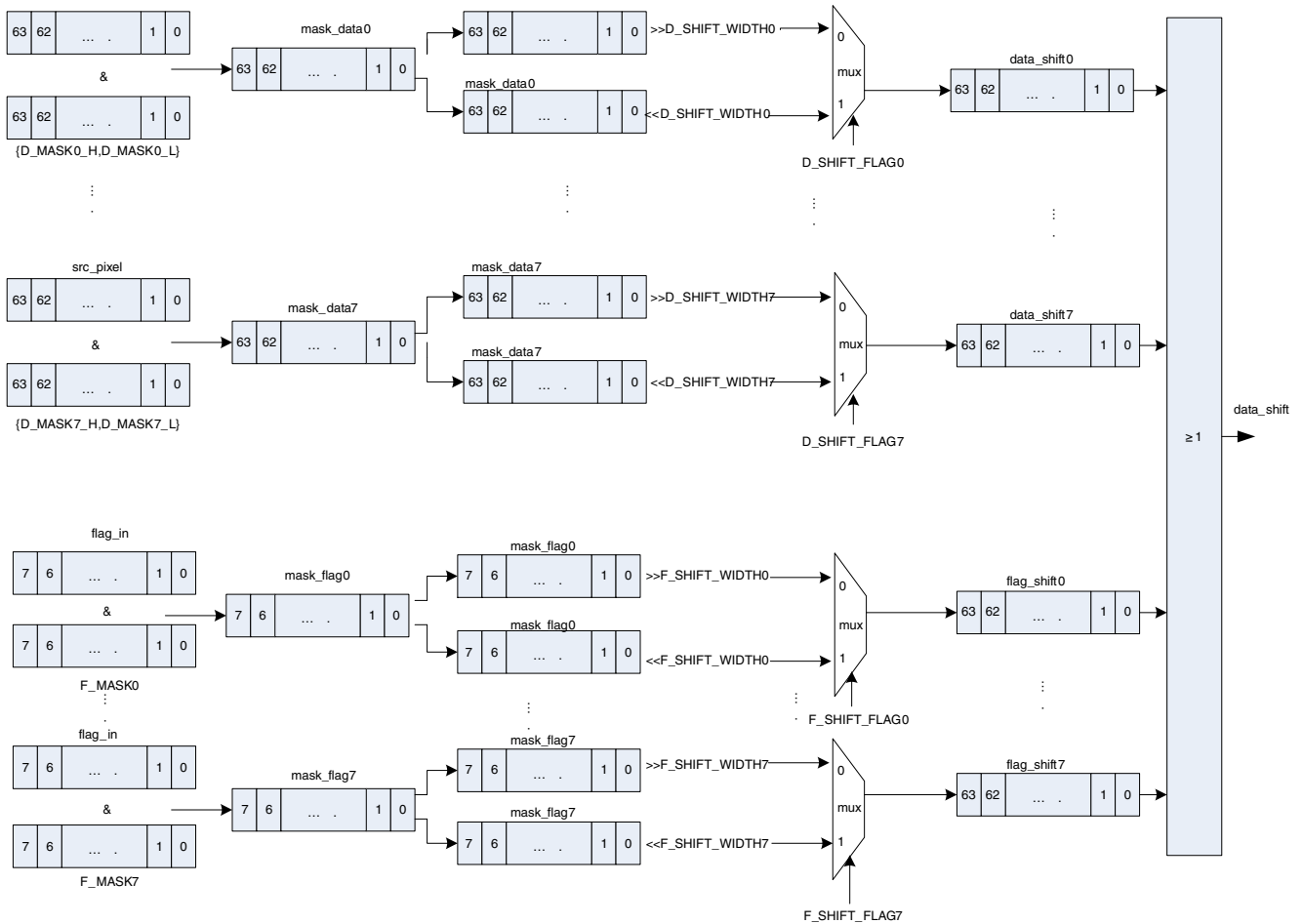

41.9.3.3 Data Packing

After data shift, the 64 bits of data can be divided to two 32bit words depending on the value of the HW_PXP_x_STORE_CTRL_CHx.PACK_IN_SEL bits. If HW_PXP_x_STORE_CTRL_CH0.PACK_IN_SEL = 0, it will select active bits from all 64 bits of data. If equal to 1, it will select active bits from the lower 32 bits data.

For channel 1, if HW_PXP_x_STORE_CTRL_CH1.PACK_IN_SEL = 0, it will also select active bits from all 64 bits data and if equal to 1, it will select active bits from the higher 32 bits data.

Store Engine supports 8bpp, 16bpp, 32bpp and 64bpp active bits per pixel according to OUTPUT_ACTIVE_BPP register setting. When either channel's PACK_IN_SEL = 1 only 8bpp, 16bpp, 32bpp can be selected.

After shift and data output selection, the packing module will pack the data into a 64 bit string and store to a FIFO before writing out to memory.

Packing style according to active bpp is showed below.

OUTPUT_ACTIVE_BPP	Active bpp from 64 shift output data	Packed data
0	8 bits	{pix7, pix6, pix5, pix4, pix3, pix2, pix1, pix0}
1	16 bits	{pix3, pix2, pix1, pix0}
2	32 bits	{pix1, pix0}
3	64 bits	{pix0}

41.9.3.4 Data Store Format

- **Scanline mode**

When HW_PXP_x_STORE_CTRL_CHx.BLOCK_EN=0, the Store Engine will store data the line by line in scanline mode. The AXI burst length is set by the HW_PXP_x_STORE_CTRL_CHx.WR_NUM_BYTES register field. In Scanline mode, it can support 8, 16, 32 and 64 bytes in a burst.

- **Block mode**

When HW_PXP_x_STORE_CTRL_CHx.BLOCK_EN=1, the Store Engine support 8x8 and 16x16 block mode according to HW_PXP_x_STORE_CTRL_CHx.BLOCK_16 register bit. When BLOCK_16=1, the block size is 16*16 while if BLOCK_16=0 the size is 8*8 blocks. When

BLOCK_EN=1, then

HW_PXP_x_STORE_SHIFT_CTRL_CHx.OUTPUT_ACTIVE_BPP cannot be 3, that is, block mode can not work on a 64bpp data stream.

When the Store Engine is configured block mode, the upstream Fetch Engine should be configured in block mode and with the same block size as well.

When the total width or total height of image is no divisible by 8 or 16, the upstream Fetch Engine will fetch extra pixels or lines to fill out the final partial blocks. For example, if the size is 23*23, and block mode is 8*8, Fetch Engine will fetch 24*24 data pixels and output to store engine. The Store Engine has a crop function for this. That is, the extra pixels or lines will not be stored to memory by the Store Engine. This is accomplished by the hardware using the AXI bus byte enables.

In block mode, the number of AXI bus write bytes is internally calculated from the OUTPUT_ACTIVE_BPP and BLOCK_16 (block size) register fields rather than the WR_NUM_BYTES field.

One limitation exists with block mode configuration. No YUV422 output format is not supported. So

HW_PXP_x_STORE_SHIFT_CTRL_CHx.OUT_YUV422_1P_EN and OUT_YUV422_2P_EN must be disabled.

41.9.3.5 Output Format Modes

- **Normal mode**

If HW_PXP_x_STORE_CTRL_CHx.STORE_BYPASS_EN = 0,

HW_PXP_x_STORE_CTRL_CHx.STORE_MEMORY_EN=1 and

HW_PXP_x_STORE_CTRL_CHx.HANDSHAKE_EN=0, the Store Engine is working in normal mode.

In normal mode, the Store Engine will store the input data to memory frame by frame. The store frame start address is set in HW_PXP_x_STORE_ADDR_x_CHx. Two address registers exist for each channel. The second one is used for YUV422 2 plane mode.

The Store Engine will stop storing data when the frame of data is finished. Another pxp_start signal will trigger the next frame operation. The frame size is specified by the HW_PXP_x_STORE_SIZE_CHx registers. The values should be set up for each channel in use. If both channels are being used, the height and width values in the

HW_PXP_x_STORE_SIZE_CH0 and HW_PXP_x_STORE_SIZE_CH1 registers may be different but the total number of pixels in the frame must be the same. The only exception to this is when both channels are being used and the Store Engine is outputting data in handshake mode. In handshake mode the width and height must be set the same in both channel size registers.

If the data shift mode is set to YUV422 single plane or 2 plane, two pixels, 64 bits, are read in and 32 bits are written. If the YUV data is coming from the upstream Fetch Engine it will be in YUV444 format as {8'h0, Y0, U0, V0, 8'h0, Y1, U1, V1}. Even though the YUV422 mode is set, the shift function must be set to shift the components into their proper position. For instance, for 1p mode, the shift MASK, FLAG and WIDTH parameters need to be set up on the 64 bits of pixel data to format each 32 bits (2 pixels) to be written out as {Y0, U0, Y1, V0}. Likewise in 2p mode, the ch0 data would be shifted to yield {Y0, Y1} with ch1 as {U0, V0} for the first two pixels.

- **Bypass mode**

If STORE_BYPASS_EN=1, STORE_MEMORY_EN=0, The Store Engine will output the input data, after the shift function, directly to the downstream Fetch Engine instead of storing to memory. The AXI bus is inactive in this case. The data is output using the valid/ready external interface to the downstream connected Fetch Engine.

In bypass mode, if HW_PXP_x_STORE_CTRL_CH0.CH_EN=1, it will output the lower 32 bits of data. If HW_PXP_x_STORE_CTRL_CH1.CH_EN=1, it will output the high 32 bits of data.

- **Dual mode**

If STORE_BYPASS_EN = 1 and HW_PXP_x_STORE_CTRL_CHx.STORE_MEMORY_EN = 1, the Store Engine is configured in Dual mode. That is, the Store Engine supports bypassing the data and also storing it to memory at the same time.

- **Handshake mode**

The Store Engine supports a 1 line scan handshake.

The array handshake is used in cases where the Fetch Engine is in array mode. One line handshake config indicates that the Fetch Engine is working on 1x1 array mode. The 3 line handshake indicates the Fetch Engine work is in 3x3 array while 5 line handshake indicates 5x5 array mode.

To accomplish the buffer sharing, Store Engine and the attached Fetch Engine will maintain buffer status using a pair of handshake signals. When a buffer is filled by the Store Engine, it will assert the `handshake_bx_ready` (where x is 0 or 1) signal to indicate to the fetch engine that the buffer has valid data. The prefetch engine will then release the buffer by asserting the `handshake_bx_done` signal.

The basic protocol and timing is shown in the diagram below:

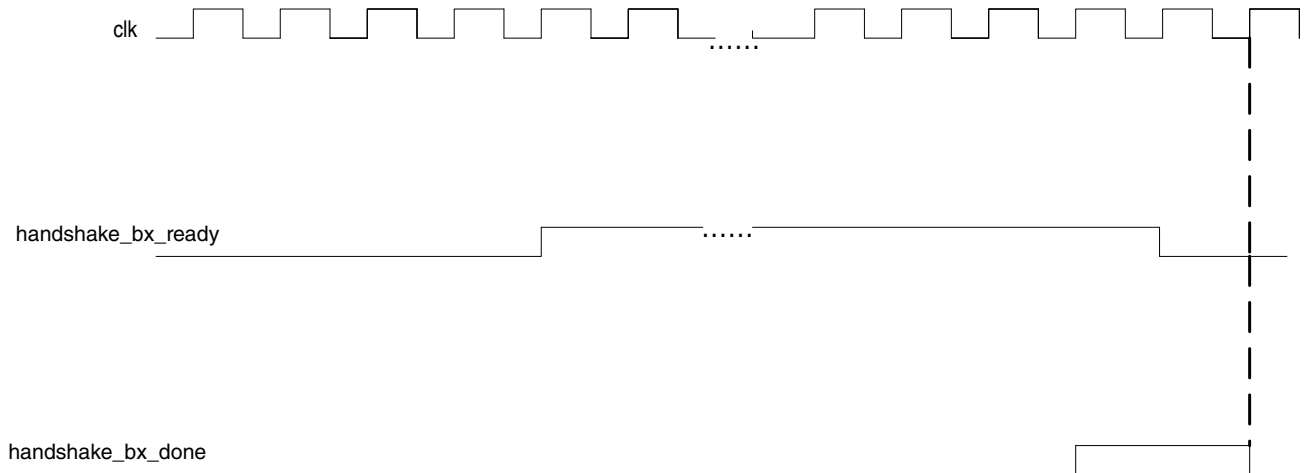

Unlike scanline handshake, there is only 1 buffer in memory. The buffer size is $(array_line + 1)$.

- 1 line array handshake

When `HW_PXP_x_STORE_CTRL_CHx.ARRAY_LINE_NUM = 0`, the configuration is 1 line handshake mode. The buffer size is $2 * OUT_PITCH$ (2 lines). The first ready occurs when the Store Engine finishes writing 1 line.

- 3 line array handshake

When `ARRAY_LINE_NUM = 1`, the configuration is 3 line handshake mode. The buffer size is $4 * OUT_PITCH$. The first ready occurs when the Store Engine finishes writing 2 lines.

- 5 line array handshake

When `ARRAY_LINE_NUM=2`, the configuration is 5 line handshake mode. The buffer size is $6 * OUT_PITCH$. The first ready occurs when store engine finishes writing 3 lines.

For scanline handshake with next fetch engine, it is similar to LCDIF Handshake section without abort special process.

41.9.3.6 Limitations

When both channels are active, they should be configured to work in the same mode. For example, if channel 0 is configured for bypass mode then channel 1 must also be configured the same way.

41.10 Histogram

The histogram block collects statistics about the pixel -5data passing through it. Its primary function is to compare the value against programmed values representing the allowed values in different bpp (bits per pixel) modes or bins. A flag value of 1 is recorded if all the pixel values were a match for one of the values programmed for that bit per pixel mode or bin. If there is a mismatch for at least one pixel then the update is not completely contained within that bin and the output flag is 0. There are 5 bits reported. One for each of 1-5 bpp. The results for each bpp bin are always reported. These results are a necessary input to the EPDC for selecting the proper waveform for update to the panel. The pixel value and the compare values are always 6 bits wide although the max effective bpp is 5.

There is also a mask function that can be used to filter out update pixels and exclude them from histogram calculations. It's primary use-case is to collect and report collisions of the current update being processed through the WFE-A and report to software how many pixels collided with current live updates, if any, and the coordinates of the minimum rectangle within the update that contains all collided pixels.

There are two identical instances of the histogram block in the system. They both can be programmed through a system mux to take data from the outbuf sub-block from the legacy flow and WFE.

41.10.1 Basic Operation

The basic controls for each histogram engine are contained within their HW_PXP_HIST_x_CTRL and HW_PXP_HIST_x_MASK registers. We will use histogram A registers for explanation purposes in the description below.

The HW_PXP_HIST_A_CTRL.ENABLE bit turns on the histogram block to process pixels. It must be turned on and off manually. The HW_PXP_HIST_A_CTRL.CLEAR bit must be set to clear the histogram results. The bit is self-clearing. The input data (pixel) to the block is 72 bits wide. The comparison is done on 6 bits of pixel data. Any

contiguous 6 bits in the 72 bit string can be chosen for comparison using the HW_PXP_HIST_A_CTRL.PIXEL_OFFSET and HW_PXP_HIST_A_CTRL.PIXEL_WIDTH fields. The offset specifies the starting bit position in the string and the width field specifies the width which should not be wider than 6 bits in the current implementation. The mode values for comparison are contained in the HW_PXP_HISTx_PARAMx register fields. Even though these fields are 6 bits wide, 5 bits is the effective width as the histogram can check for 32 unique pixel values in the largest mode, HIST32.

The result of which bpp modes were a match for all pixels since the output was cleared are continuously updated in the HW_PXP_HIST_A_CTRL.STATUS field. There is one bit for each bpp mode. All histogram bpp modes are checked simultaneously. The HW_PXP_HIST_A_BUF_SIZE fields specify the height and width of the update area. This allows the histogram engine to keep track of the relative coordinates of each new pixel it receives. It assumes the pixels are fed to it in raster order, left to right and top to bottom.

41.10.2 Mask Functionality

There is also a mask function within the histogram engine that tests a specified string of bits from the input against values programmed into the mask register. The use-case for this is to report collision detection back to controlling software. If the mask test passes then the pixel is active and is processed in the engine and statistics collected. If the pixel is not active then it is discarded and not processed – does not contribute to the output results. Based on the outcome of this mask test, there are some additional results that are output to register fields. They are the number of active pixels, the coordinates of the smallest bounding box including all active pixels and an array of 64 bits where the offset of each bit corresponds to the pixel value of processed pixel. The bit is set for each valid pixel value processed.

The configuration of the mask function is contained in the HW_PXP_HIST_x_MASK register. The HW_PXP_HIST_A_MASK.MASK_EN bit turns on the function. . The HW_PXP_HIST_A_CTRL.CLEAR bit clears the results. The HW_PXP_HIST_A_MASK.MASK_MODE field specifies the logical operation for the test. The options are “equal”, “not equal”, “inside” or “outside.” The HW_PXP_HIST_A_MASK.MASK_VALUE0 and HW_PXP_HIST_A_MASK.MASK_VALUE1 are used for comparison with the incoming value depending on the mode chosen. The starting bit of mask field in the 72 bit input data is specified by the HW_PXP_HIST_A_MASK.MASK_OFFSET register field and the width is given by HW_PXP_HIST_A_MASK.MASK_WIDTH. The width of the mask is a maximum of 8 bits. If the mask mode test passes for a given input then

the HW_PXP_HIST_A_TOTAL_PIXEL read only value is incremented. The x and y coordinates of the pixel are used to calculate the minimum rectangle the will enclose all valid pixels. This information can be read from the HW_PXP_HIST_A_ACTIVE_AREA_X and HW_PXP_HIST_A_ACTIVE_AREA_Y registers. Also, the values of the valid pixels are recorded in the HW_PXP_HIST_A_RAW_STAT0 and HW_PXP_HIST_A_RAW_STAT0 registers. These registers make up 64 one bit fields where the offsets of the bit that are set are the pixel values of the active pixels. (The values as specified by the HW_PXP_HIST_A_CTRL.PIXEL_OFFSET and HW_PXP_HIST_A_CTRL.PIXEL_WIDTH fields.)

41.10.3 Collision use-case Example

In this example, the histogram engine is used to test for and report collision information within the update. Refer to the figure below. With normal WFE-A processing, within the 72 bit output there will be a one bit collision flag that is assert to 1 if there was a collision on that update pixel. There will also be a 6 bit field that specifies the EPDC LUT number for that pixel in the working buffer. If there was a collision this LUT number identifies the unique colliding live update. To convey all this information to software using the histogram engine, the HW_PXP_HIST_A_CTRL.PIXEL_OFFSET and HW_PXP_HIST_A_CTRL.PIXEL_WIDTH should be set to point to the current LUT in the input bus. The HW_PXP_HIST_A_MASK.MASK_OFFSET and HW_PXP_HIST_A_MASK.MASK_WIDTH fields should be set to point to the collision bit. The HW_PXP_HIST_A_MASK.MASK_MODE should be 0 or “equal” and the HW_PXP_HIST_A_MASK.MASK_VALUE0 should be set to 1.

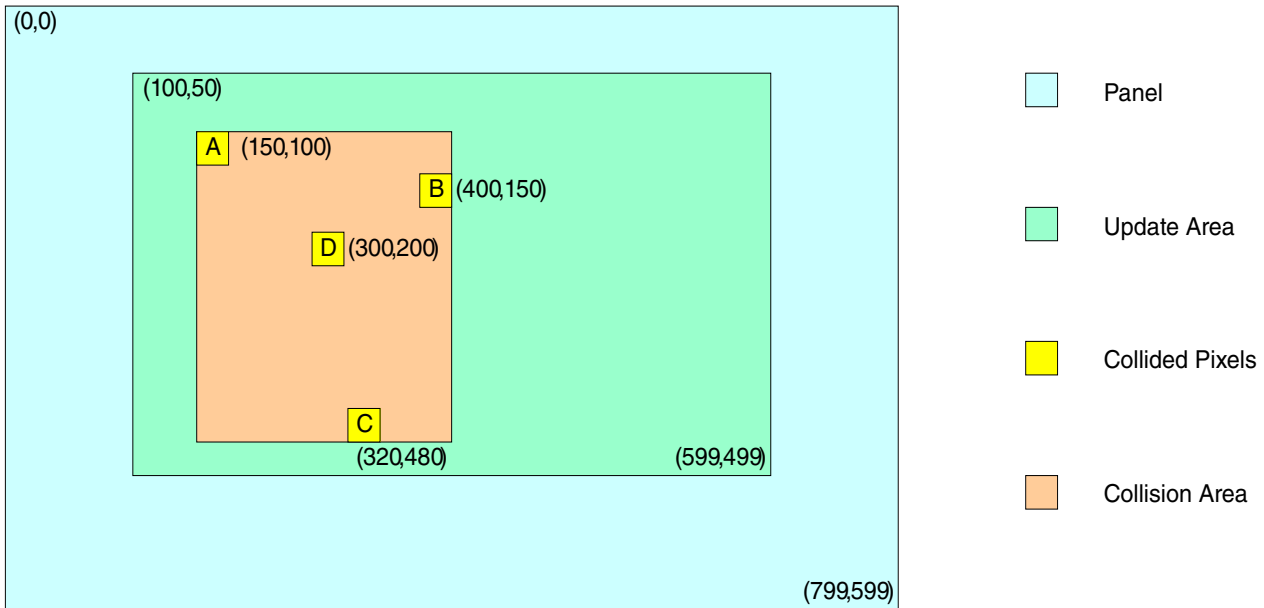

The figure above shows the processed results of our example. There is an update region, 499x449, offset within the 800x600 panel display. After enabling the histogram and processing the update, there is a collided region within the update region and 4 collided pixels were detected. The results are as follows.

The HW_PXP_HIST_A_TOTAL_PIXEL register would equal to 4 showing that 4 pixels were found by the mask function to have their collision bits set.

The relative collision area are would be given in the HW_PXP_HIST_A_ACTIVE_AREA_X and Y register as MIN_X_OFFSET = 50, MAX_X_OFFSET = 300, MIN_Y_OFFSET = 50, MAX_Y_OFFSET = 380.

If pixel A is being updated by LUT 1, pixel B and C are being updated LUT 5, and pixel D is being updated by LUT 12, then the LUT Collision Status = 0x00001022 (bit 1, 2, 12 are set). That is HW_PXP_HIST_A_RAW_STAT0 would be equal to 0x00001022 and HW_PXP_HIST_A_RAW_STAT1 would be 0x00000000.

41.11 PXP Memory Map/Register Definition

PXP Hardware Register Format Summary

PXP memory map

Absolute address (hex)	Register name	Width (in bits)	Access	Reset value	Section/page
21C_C000	Control Register 0 (PXP_HW_PXP_CTRL)	32	R/W	C701_0000h	41.11.1/2573
21C_C004	Control Register 0 (PXP_HW_PXP_CTRL_SET)	32	R/W	C701_0000h	41.11.1/2573
21C_C008	Control Register 0 (PXP_HW_PXP_CTRL_CLR)	32	R/W	C701_0000h	41.11.1/2573
21C_C00C	Control Register 0 (PXP_HW_PXP_CTRL_TOG)	32	R/W	C701_0000h	41.11.1/2573
21C_C010	Status Register (PXP_HW_PXP_STAT)	32	R/W	0000_0000h	41.11.2/2576
21C_C014	Status Register (PXP_HW_PXP_STAT_SET)	32	R/W	0000_0000h	41.11.2/2576
21C_C018	Status Register (PXP_HW_PXP_STAT_CLR)	32	R/W	0000_0000h	41.11.2/2576
21C_C01C	Status Register (PXP_HW_PXP_STAT_TOG)	32	R/W	0000_0000h	41.11.2/2576
21C_C020	Output Buffer Control Register (PXP_HW_PXP_OUT_CTRL)	32	R/W	0000_0000h	41.11.3/2578
21C_C024	Output Buffer Control Register (PXP_HW_PXP_OUT_CTRL_SET)	32	R/W	0000_0000h	41.11.3/2578
21C_C028	Output Buffer Control Register (PXP_HW_PXP_OUT_CTRL_CLR)	32	R/W	0000_0000h	41.11.3/2578
21C_C02C	Output Buffer Control Register (PXP_HW_PXP_OUT_CTRL_TOG)	32	R/W	0000_0000h	41.11.3/2578
21C_C030	Output Frame Buffer Pointer (PXP_HW_PXP_OUT_BUF)	32	R/W	0000_0000h	41.11.4/2579
21C_C040	Output Frame Buffer Pointer #2 (PXP_HW_PXP_OUT_BUF2)	32	R/W	0000_0000h	41.11.5/2579
21C_C050	Output Buffer Pitch (PXP_HW_PXP_OUT_PITCH)	32	R/W	0000_0000h	41.11.6/2580
21C_C060	Output Surface Lower Right Coordinate (PXP_HW_PXP_OUT_LRC)	32	R/W	0000_0000h	41.11.7/2580
21C_C070	Processed Surface Upper Left Coordinate (PXP_HW_PXP_OUT_PS_ULC)	32	R/W	0000_0000h	41.11.8/2581
21C_C080	Processed Surface Lower Right Coordinate (PXP_HW_PXP_OUT_PS_LRC)	32	R/W	0000_0000h	41.11.9/2582
21C_C090	Alpha Surface Upper Left Coordinate (PXP_HW_PXP_OUT_AS_ULC)	32	R/W	0000_0000h	41.11.10/2583
21C_C0A0	Alpha Surface Lower Right Coordinate (PXP_HW_PXP_OUT_AS_LRC)	32	R/W	0000_0000h	41.11.11/2583
21C_C0B0	Processed Surface (PS) Control Register (PXP_HW_PXP_PS_CTRL)	32	R/W	0000_0000h	41.11.12/2584
21C_C0B4	Processed Surface (PS) Control Register (PXP_HW_PXP_PS_CTRL_SET)	32	R/W	0000_0000h	41.11.12/2584

Table continues on the next page...

PXP memory map (continued)

Absolute address (hex)	Register name	Width (in bits)	Access	Reset value	Section/page
21C_C0B8	Processed Surface (PS) Control Register (PXP_HW_PXP_PS_CTRL_CLR)	32	R/W	0000_0000h	41.11.12/2584
21C_C0BC	Processed Surface (PS) Control Register (PXP_HW_PXP_PS_CTRL_TOG)	32	R/W	0000_0000h	41.11.12/2584
21C_C0C0	PS Input Buffer Address (PXP_HW_PXP_PS_BUF)	32	R/W	0000_0000h	41.11.13/2585
21C_C0D0	PS U/Cb or 2 Plane UV Input Buffer Address (PXP_HW_PXP_PS_UBUF)	32	R/W	0000_0000h	41.11.14/2585
21C_C0E0	PS V/Cr Input Buffer Address (PXP_HW_PXP_PS_VBUF)	32	R/W	0000_0000h	41.11.15/2586
21C_C0F0	Processed Surface Pitch (PXP_HW_PXP_PS_PITCH)	32	R/W	0000_0000h	41.11.16/2586
21C_C100	PS Background Color (PXP_HW_PXP_PS_BACKGROUND_0)	32	R/W	0000_0000h	41.11.17/2587
21C_C110	PS Scale Factor Register (PXP_HW_PXP_PS_SCALE)	32	R/W	1000_1000h	41.11.18/2588
21C_C120	PS Scale Offset Register (PXP_HW_PXP_PS_OFFSET)	32	R/W	0000_0000h	41.11.19/2589
21C_C130	PS Color Key Low (PXP_HW_PXP_PS_CLRKEYLOW_0)	32	R/W	00FF_FFFFh	41.11.20/2590
21C_C140	PS Color Key High (PXP_HW_PXP_PS_CLRKEYHIGH_0)	32	R/W	0000_0000h	41.11.21/2590
21C_C150	Alpha Surface Control (PXP_HW_PXP_AS_CTRL)	32	R/W	0000_0000h	41.11.22/2591
21C_C160	Alpha Surface Buffer Pointer (PXP_HW_PXP_AS_BUF)	32	R/W	0000_0000h	41.11.23/2592
21C_C170	Alpha Surface Pitch (PXP_HW_PXP_AS_PITCH)	32	R/W	0000_0000h	41.11.24/2592
21C_C180	Overlay Color Key Low (PXP_HW_PXP_AS_CLRKEYLOW_0)	32	R/W	00FF_FFFFh	41.11.25/2593
21C_C190	Overlay Color Key High (PXP_HW_PXP_AS_CLRKEYHIGH_0)	32	R/W	0000_0000h	41.11.26/2594
21C_C1A0	Color Space Conversion Coefficient Register 0 (PXP_HW_PXP_CSC1_COEF0)	32	R/W	0400_0000h	41.11.27/2595
21C_C1B0	Color Space Conversion Coefficient Register 1 (PXP_HW_PXP_CSC1_COEF1)	32	R/W	0123_0208h	41.11.28/2596
21C_C1C0	Color Space Conversion Coefficient Register 2 (PXP_HW_PXP_CSC1_COEF2)	32	R/W	079B_076Ch	41.11.29/2597
21C_C1D0	Color Space Conversion Control Register. (PXP_HW_PXP_CSC2_CTRL)	32	R/W	0000_0001h	41.11.30/2598
21C_C1E0	Color Space Conversion Coefficient Register 0 (PXP_HW_PXP_CSC2_COEF0)	32	R/W	0000_0000h	41.11.31/2598
21C_C1F0	Color Space Conversion Coefficient Register 1 (PXP_HW_PXP_CSC2_COEF1)	32	R/W	0000_0000h	41.11.32/2599

Table continues on the next page...

PXP memory map (continued)

Absolute address (hex)	Register name	Width (in bits)	Access	Reset value	Section/page
21C_C200	Color Space Conversion Coefficient Register 2 (PXP_HW_PXP_CSC2_COEF2)	32	R/W	0000_0000h	41.11.33/2600
21C_C210	Color Space Conversion Coefficient Register 3 (PXP_HW_PXP_CSC2_COEF3)	32	R/W	0000_0000h	41.11.34/2600
21C_C220	Color Space Conversion Coefficient Register 4 (PXP_HW_PXP_CSC2_COEF4)	32	R/W	0000_0000h	41.11.35/2601
21C_C230	Color Space Conversion Coefficient Register 5 (PXP_HW_PXP_CSC2_COEF5)	32	R/W	0000_0000h	41.11.36/2601
21C_C240	Lookup Table Control Register. (PXP_HW_PXP_LUT_CTRL)	32	R/W	8001_0000h	41.11.37/2602
21C_C250	Lookup Table Control Register. (PXP_HW_PXP_LUT_ADDR)	32	R/W	0000_0000h	41.11.38/2604
21C_C260	Lookup Table Data Register. (PXP_HW_PXP_LUT_DATA)	32	R/W	0000_0000h	41.11.39/2605
21C_C270	Lookup Table External Memory Address Register. (PXP_HW_PXP_LUT_EXTMEM)	32	R/W	0000_0000h	41.11.40/2605
21C_C280	Color Filter Array Register. (PXP_HW_PXP_CFA)	32	R/W	0000_0000h	41.11.41/2606
21C_C290	PXP Alpha Engine A Control Register. (PXP_HW_PXP_ALPHA_A_CTRL)	32	R/W	0000_0000h	41.11.42/2607
21C_C2C0	PS Background Color 1 (PXP_HW_PXP_PS_BACKGROUND_1)	32	R/W	0000_0000h	41.11.43/2608
21C_C2D0	PS Color Key Low 1 (PXP_HW_PXP_PS_CLRKEYLOW_1)	32	R/W	00FF_FFFFh	41.11.44/2609
21C_C2E0	PS Color Key High 1 (PXP_HW_PXP_PS_CLRKEYHIGH_1)	32	R/W	0000_0000h	41.11.45/2609
21C_C2F0	Overlay Color Key Low (PXP_HW_PXP_AS_CLRKEYLOW_1)	32	R/W	00FF_FFFFh	41.11.46/2610
21C_C300	Overlay Color Key High (PXP_HW_PXP_AS_CLRKEYHIGH_1)	32	R/W	0000_0000h	41.11.47/2611
21C_C310	Control Register 2 (PXP_HW_PXP_CTRL2)	32	R/W	0000_0000h	41.11.48/2612
21C_C314	Control Register 2 (PXP_HW_PXP_CTRL2_SET)	32	R/W	0000_0000h	41.11.48/2612
21C_C318	Control Register 2 (PXP_HW_PXP_CTRL2_CLR)	32	R/W	0000_0000h	41.11.48/2612
21C_C31C	Control Register 2 (PXP_HW_PXP_CTRL2_TOG)	32	R/W	0000_0000h	41.11.48/2612
21C_C320	PXP Power Control Register. (PXP_HW_PXP_POWER_REG0)	32	R/W	0000_0000h	41.11.49/2613
21C_C330	PXP Power Control Register 1. (PXP_HW_PXP_POWER_REG1)	32	R/W	0000_0000h	41.11.50/2614
21C_C340	PXP_HW_PXP_DATA_PATH_CTRL0	32	R/W	5104_5A20h	41.11.51/2615

Table continues on the next page...

PXP memory map (continued)

Absolute address (hex)	Register name	Width (in bits)	Access	Reset value	Section/page
21C_C344	PXP_HW_PXP_DATA_PATH_CTRL0_SET	32	R/W	5104_5A20h	41.11.51/2615
21C_C348	PXP_HW_PXP_DATA_PATH_CTRL0_CLR	32	R/W	5104_5A20h	41.11.51/2615
21C_C34C	PXP_HW_PXP_DATA_PATH_CTRL0_TOG	32	R/W	5104_5A20h	41.11.51/2615
21C_C350	PXP_HW_PXP_DATA_PATH_CTRL1	32	R/W	0000_0000h	41.11.52/2616
21C_C354	PXP_HW_PXP_DATA_PATH_CTRL1_SET	32	R/W	0000_0000h	41.11.52/2616
21C_C358	PXP_HW_PXP_DATA_PATH_CTRL1_CLR	32	R/W	0000_0000h	41.11.52/2616
21C_C35C	PXP_HW_PXP_DATA_PATH_CTRL1_TOG	32	R/W	0000_0000h	41.11.52/2616
21C_C360	Initialize memory buffer control Register (PXP_HW_PXP_INIT_MEM_CTRL)	32	R/W	0000_0000h	41.11.53/2617
21C_C364	Initialize memory buffer control Register (PXP_HW_PXP_INIT_MEM_CTRL_SET)	32	R/W	0000_0000h	41.11.53/2617
21C_C368	Initialize memory buffer control Register (PXP_HW_PXP_INIT_MEM_CTRL_CLR)	32	R/W	0000_0000h	41.11.53/2617
21C_C36C	Initialize memory buffer control Register (PXP_HW_PXP_INIT_MEM_CTRL_TOG)	32	R/W	0000_0000h	41.11.53/2617
21C_C370	Write data Register (PXP_HW_PXP_INIT_MEM_DATA)	32	R/W	0000_0000h	41.11.54/2618
21C_C380	Write data Register (PXP_HW_PXP_INIT_MEM_DATA_HIGH)	32	R/W	0000_0000h	41.11.55/2618
21C_C390	PXP IRQ Mask Register (PXP_HW_PXP_IRQ_MASK)	32	R/W	0000_0000h	41.11.56/2619
21C_C394	PXP IRQ Mask Register (PXP_HW_PXP_IRQ_MASK_SET)	32	R/W	0000_0000h	41.11.56/2619
21C_C398	PXP IRQ Mask Register (PXP_HW_PXP_IRQ_MASK_CLR)	32	R/W	0000_0000h	41.11.56/2619
21C_C39C	PXP IRQ Mask Register (PXP_HW_PXP_IRQ_MASK_TOG)	32	R/W	0000_0000h	41.11.56/2619
21C_C3A0	PXP Interrupt Register (PXP_HW_PXP_IRQ)	32	R/W	0000_0000h	41.11.57/2620
21C_C3A4	PXP Interrupt Register (PXP_HW_PXP_IRQ_SET)	32	R/W	0000_0000h	41.11.57/2620
21C_C3A8	PXP Interrupt Register (PXP_HW_PXP_IRQ_CLR)	32	R/W	0000_0000h	41.11.57/2620
21C_C3AC	PXP Interrupt Register (PXP_HW_PXP_IRQ_TOG)	32	R/W	0000_0000h	41.11.57/2620
21C_C3B0	PXP NEXT Buffer Enable select Register (PXP_HW_PXP_NEXT_EN)	32	R/W	0000_0000h	41.11.58/2621

Table continues on the next page...

PXP memory map (continued)

Absolute address (hex)	Register name	Width (in bits)	Access	Reset value	Section/page
21C_C3B4	PXP NEXT Buffer Enable select Register (PXP_HW_PXP_NEXT_EN_SET)	32	R/W	0000_0000h	41.11.58/2621
21C_C3B8	PXP NEXT Buffer Enable select Register (PXP_HW_PXP_NEXT_EN_CLR)	32	R/W	0000_0000h	41.11.58/2621
21C_C3BC	PXP NEXT Buffer Enable select Register (PXP_HW_PXP_NEXT_EN_TOG)	32	R/W	0000_0000h	41.11.58/2621
21C_C400	Next Frame Pointer (PXP_HW_PXP_NEXT)	32	R/W	0000_0000h	41.11.59/2622
21C_C410	Debug Control Register (PXP_HW_PXP_DEBUGCTRL)	32	R/W	0000_0000h	41.11.60/2623
21C_C420	Debug Register (PXP_HW_PXP_DEBUG)	32	R/W	0000_0000h	41.11.61/2624
21C_C430	Version Register (PXP_HW_PXP_VERSION)	32	R/W	0300_0000h	41.11.62/2624
21C_CA00	PXP_HW_PXP_DITHER_STORE_SIZE_CH0	32	R/W	0000_0000h	41.11.63/2625
21C_D100	Fetch engine Control for WFE B Register (PXP_HW_PXP_WFB_FETCH_CTRL)	32	R/W	0000_0000h	41.11.64/2625
21C_D104	Fetch engine Control for WFE B Register (PXP_HW_PXP_WFB_FETCH_CTRL_SET)	32	R/W	0000_0000h	41.11.64/2625
21C_D108	Fetch engine Control for WFE B Register (PXP_HW_PXP_WFB_FETCH_CTRL_CLR)	32	R/W	0000_0000h	41.11.64/2625
21C_D10C	Fetch engine Control for WFE B Register (PXP_HW_PXP_WFB_FETCH_CTRL_TOG)	32	R/W	0000_0000h	41.11.64/2625
21C_D110	PXP_HW_PXP_WFB_FETCH_BUF1_ADDR	32	R/W	0000_0000h	41.11.65/2627
21C_D120	PXP_HW_PXP_WFB_FETCH_BUF1_PITCH	32	R/W	0000_0000h	41.11.66/2628
21C_D130	PXP_HW_PXP_WFB_FETCH_BUF1_SIZE	32	R/W	0000_0000h	41.11.67/2628
21C_D140	PXP_HW_PXP_WFB_FETCH_BUF2_ADDR	32	R/W	0000_0000h	41.11.68/2629
21C_D150	PXP_HW_PXP_WFB_FETCH_BUF2_PITCH	32	R/W	0000_0000h	41.11.69/2629
21C_D160	PXP_HW_PXP_WFB_FETCH_BUF2_SIZE	32	R/W	0000_0000h	41.11.70/2630
21C_D170	PXP_HW_PXP_WFB_ARRAY_PIXEL0_MASK	32	R/W	2000_0000h	41.11.71/2630
21C_D180	PXP_HW_PXP_WFB_ARRAY_PIXEL1_MASK	32	R/W	2000_0000h	41.11.72/2632
21C_D190	PXP_HW_PXP_WFB_ARRAY_PIXEL2_MASK	32	R/W	2000_0000h	41.11.73/2633
21C_D1A0	PXP_HW_PXP_WFB_ARRAY_PIXEL3_MASK	32	R/W	2000_0000h	41.11.74/2634

Table continues on the next page...

PXP memory map (continued)

Absolute address (hex)	Register name	Width (in bits)	Access	Reset value	Section/page
21C_D1B0	PXP_HW_PXP_WFB_ARRAY_PIXEL4_MASK	32	R/W	2000_0000h	41.11.75/2636
21C_D1C0	PXP_HW_PXP_WFB_ARRAY_PIXEL5_MASK	32	R/W	2000_0000h	41.11.76/2637
21C_D1D0	PXP_HW_PXP_WFB_ARRAY_PIXEL6_MASK	32	R/W	2000_0000h	41.11.77/2638
21C_D1E0	PXP_HW_PXP_WFB_ARRAY_PIXEL7_MASK	32	R/W	2000_0000h	41.11.78/2640
21C_D1F0	PXP_HW_PXP_WFB_ARRAY_FLAG0_MASK	32	R/W	2000_0000h	41.11.79/2641
21C_D200	PXP_HW_PXP_WFB_ARRAY_FLAG1_MASK	32	R/W	2000_0000h	41.11.80/2642
21C_D210	PXP_HW_PXP_WFB_ARRAY_FLAG2_MASK	32	R/W	2000_0000h	41.11.81/2644
21C_D220	PXP_HW_PXP_WFB_ARRAY_FLAG3_MASK	32	R/W	2000_0000h	41.11.82/2645
21C_D230	PXP_HW_PXP_WFB_ARRAY_FLAG4_MASK	32	R/W	2000_0000h	41.11.83/2646
21C_D240	PXP_HW_PXP_WFB_ARRAY_FLAG5_MASK	32	R/W	2000_0000h	41.11.84/2648
21C_D250	PXP_HW_PXP_WFB_ARRAY_FLAG6_MASK	32	R/W	2000_0000h	41.11.85/2649
21C_D260	PXP_HW_PXP_WFB_ARRAY_FLAG7_MASK	32	R/W	2000_0000h	41.11.86/2650
21C_D270	PXP_HW_PXP_WFB_FETCH_BUF1_CORD	32	R/W	0000_0000h	41.11.87/2651
21C_D280	PXP_HW_PXP_WFB_FETCH_BUF2_CORD	32	R/W	0000_0000h	41.11.88/2652
21C_D290	PXP_HW_PXP_WFB_ARRAY_FLAG8_MASK	32	R/W	2000_0000h	41.11.89/2653
21C_D2A0	PXP_HW_PXP_WFB_ARRAY_FLAG9_MASK	32	R/W	2000_0000h	41.11.90/2654
21C_D2B0	PXP_HW_PXP_WFB_ARRAY_FLAG10_MASK	32	R/W	2000_0000h	41.11.91/2655
21C_D2C0	PXP_HW_PXP_WFB_ARRAY_FLAG11_MASK	32	R/W	2000_0000h	41.11.92/2657
21C_D2D0	PXP_HW_PXP_WFB_ARRAY_FLAG12_MASK	32	R/W	2000_0000h	41.11.93/2658
21C_D2E0	PXP_HW_PXP_WFB_ARRAY_FLAG13_MASK	32	R/W	2000_0000h	41.11.94/2659
21C_D2F0	PXP_HW_PXP_WFB_ARRAY_FLAG14_MASK	32	R/W	2000_0000h	41.11.95/2661
21C_D300	PXP_HW_PXP_WFB_ARRAY_FLAG15_MASK	32	R/W	2000_0000h	41.11.96/2662

Table continues on the next page...

PXP memory map (continued)

Absolute address (hex)	Register name	Width (in bits)	Access	Reset value	Section/page
21C_D310	PXP_HW_PXP_WFB_ARRAY_REG0	32	R/W	0000_0000h	41.11.97/2663
21C_D320	PXP_HW_PXP_WFB_ARRAY_REG1	32	R/W	0000_0000h	41.11.98/2664
21C_D330	PXP_HW_PXP_WFB_ARRAY_REG2	32	R/W	0000_0000h	41.11.99/2665
21C_D340	Store engine Control Channel 0 Register (PXP_HW_PXP_WFE_B_STORE_CTRL_CH0)	32	R/W	0002_0200h	41.11.100/2666
21C_D344	Store engine Control Channel 0 Register (PXP_HW_PXP_WFE_B_STORE_CTRL_CH0_SET)	32	R/W	0002_0200h	41.11.100/2666
21C_D348	Store engine Control Channel 0 Register (PXP_HW_PXP_WFE_B_STORE_CTRL_CH0_CLR)	32	R/W	0002_0200h	41.11.100/2666
21C_D34C	Store engine Control Channel 0 Register (PXP_HW_PXP_WFE_B_STORE_CTRL_CH0_TOG)	32	R/W	0002_0200h	41.11.100/2666
21C_D350	Store engine Control Channel 1 Register (PXP_HW_PXP_WFE_B_STORE_CTRL_CH1)	32	R/W	0002_0200h	41.11.101/2668
21C_D354	Store engine Control Channel 1 Register (PXP_HW_PXP_WFE_B_STORE_CTRL_CH1_SET)	32	R/W	0002_0200h	41.11.101/2668
21C_D358	Store engine Control Channel 1 Register (PXP_HW_PXP_WFE_B_STORE_CTRL_CH1_CLR)	32	R/W	0002_0200h	41.11.101/2668
21C_D35C	Store engine Control Channel 1 Register (PXP_HW_PXP_WFE_B_STORE_CTRL_CH1_TOG)	32	R/W	0002_0200h	41.11.101/2668
21C_D360	Store engine status Channel 0 Register (PXP_HW_PXP_WFE_B_STORE_STATUS_CH0)	32	R/W	0000_0000h	41.11.102/2669
21C_D370	Store engine status Channel 1 Register (PXP_HW_PXP_WFE_B_STORE_STATUS_CH1)	32	R/W	0000_0000h	41.11.103/2670
21C_D380	PXP_HW_PXP_WFE_B_STORE_SIZE_CH0	32	R/W	0000_0000h	41.11.104/2670
21C_D390	PXP_HW_PXP_WFE_B_STORE_SIZE_CH1	32	R/W	0000_0000h	41.11.105/2671
21C_D3A0	PXP_HW_PXP_WFE_B_STORE_PITCH	32	R/W	0000_0000h	41.11.106/2671
21C_D3B0	PXP_HW_PXP_WFE_B_STORE_SHIFT_CTRL_CH0	32	R/W	0000_0000h	41.11.107/2672
21C_D3B4	PXP_HW_PXP_WFE_B_STORE_SHIFT_CTRL_CH0_SET	32	R/W	0000_0000h	41.11.107/2672
21C_D3B8	PXP_HW_PXP_WFE_B_STORE_SHIFT_CTRL_CH0_CLR	32	R/W	0000_0000h	41.11.107/2672
21C_D3BC	PXP_HW_PXP_WFE_B_STORE_SHIFT_CTRL_CH0_TOG	32	R/W	0000_0000h	41.11.107/2672
21C_D3C0	PXP_HW_PXP_WFE_B_STORE_SHIFT_CTRL_CH1	32	R/W	0000_0000h	41.11.108/2673
21C_D3C4	PXP_HW_PXP_WFE_B_STORE_SHIFT_CTRL_CH1_SET	32	R/W	0000_0000h	41.11.108/2673

Table continues on the next page...

PXP memory map (continued)

Absolute address (hex)	Register name	Width (in bits)	Access	Reset value	Section/page
21C_D3C8	PXP_HW_PXP_WFE_B_STORE_SHIFT_CTRL_CH1_CLR	32	R/W	0000_0000h	41.11.108/2673
21C_D3CC	PXP_HW_PXP_WFE_B_STORE_SHIFT_CTRL_CH1_TOG	32	R/W	0000_0000h	41.11.108/2673
21C_D410	PXP_HW_PXP_WFE_B_STORE_ADDR_0_CH0	32	R/W	0000_0000h	41.11.109/2674
21C_D420	PXP_HW_PXP_WFE_B_STORE_ADDR_1_CH0	32	R/W	0000_0000h	41.11.110/2674
21C_D430	PXP_HW_PXP_WFE_B_STORE_FILL_DATA_CH0	32	R/W	0000_0000h	41.11.111/2675
21C_D440	PXP_HW_PXP_WFE_B_STORE_ADDR_0_CH1	32	R/W	0000_0000h	41.11.112/2675
21C_D450	PXP_HW_PXP_WFE_B_STORE_ADDR_1_CH1	32	R/W	0000_0000h	41.11.113/2676
21C_D460	PXP_HW_PXP_WFE_B_STORE_D_MASK0_H_CH0	32	R/W	0000_0000h	41.11.114/2676
21C_D470	PXP_HW_PXP_WFE_B_STORE_D_MASK0_L_CH0	32	R/W	0000_0000h	41.11.115/2677
21C_D480	PXP_HW_PXP_WFE_B_STORE_D_MASK1_H_CH0	32	R/W	0000_0000h	41.11.116/2677
21C_D490	PXP_HW_PXP_WFE_B_STORE_D_MASK1_L_CH0	32	R/W	0000_0000h	41.11.117/2678
21C_D4A0	PXP_HW_PXP_WFE_B_STORE_D_MASK2_H_CH0	32	R/W	0000_0000h	41.11.118/2678
21C_D4B0	PXP_HW_PXP_WFE_B_STORE_D_MASK2_L_CH0	32	R/W	0000_0000h	41.11.119/2679
21C_D4C0	PXP_HW_PXP_WFE_B_STORE_D_MASK3_H_CH0	32	R/W	0000_0000h	41.11.120/2679
21C_D4D0	PXP_HW_PXP_WFE_B_STORE_D_MASK3_L_CH0	32	R/W	0000_0000h	41.11.121/2680
21C_D4E0	PXP_HW_PXP_WFE_B_STORE_D_MASK4_H_CH0	32	R/W	0000_0000h	41.11.122/2680
21C_D4F0	PXP_HW_PXP_WFE_B_STORE_D_MASK4_L_CH0	32	R/W	0000_0000h	41.11.123/2681
21C_D500	PXP_HW_PXP_WFE_B_STORE_D_MASK5_H_CH0	32	R/W	0000_0000h	41.11.124/2681
21C_D510	PXP_HW_PXP_WFE_B_STORE_D_MASK5_L_CH0	32	R/W	0000_0000h	41.11.125/2682
21C_D520	PXP_HW_PXP_WFE_B_STORE_D_MASK6_H_CH0	32	R/W	0000_0000h	41.11.126/2682
21C_D530	PXP_HW_PXP_WFE_B_STORE_D_MASK6_L_CH0	32	R/W	0000_0000h	41.11.127/2683
21C_D540	PXP_HW_PXP_WFE_B_STORE_D_MASK7_H_CH0	32	R/W	0000_0000h	41.11.128/2683

Table continues on the next page...

PXP memory map (continued)

Absolute address (hex)	Register name	Width (in bits)	Access	Reset value	Section/page
21C_D550	PXP_HW_PXP_WFE_B_STORE_D_MASK7_L_CH0	32	R/W	0000_0000h	41.11.129/2684
21C_D560	PXP_HW_PXP_WFE_B_STORE_D_SHIFT_L_CH0	32	R/W	0000_0000h	41.11.130/2684
21C_D570	PXP_HW_PXP_WFE_B_STORE_D_SHIFT_H_CH0	32	R/W	0000_0000h	41.11.131/2686
21C_D580	PXP_HW_PXP_WFE_B_STORE_F_SHIFT_L_CH0	32	R/W	0000_0000h	41.11.132/2687
21C_D590	PXP_HW_PXP_WFE_B_STORE_F_SHIFT_H_CH0	32	R/W	0000_0000h	41.11.133/2689
21C_D5A0	PXP_HW_PXP_WFE_B_STORE_F_MASK_L_CH0	32	R/W	0000_0000h	41.11.134/2690
21C_D5B0	PXP_HW_PXP_WFE_B_STORE_F_MASK_H_CH0	32	R/W	0000_0000h	41.11.135/2691
21C_D5D0	PXP_HW_PXP_FETCH_WFE_B_DEBUG	32	R/W	0000_0000h	41.11.136/2691
21C_D670	Dither Control Register 0 (PXP_HW_PXP_DITHER_CTRL)	32	R/W	0151_4000h	41.11.137/2693
21C_D674	Dither Control Register 0 (PXP_HW_PXP_DITHER_CTRL_SET)	32	R/W	0151_4000h	41.11.137/2693
21C_D678	Dither Control Register 0 (PXP_HW_PXP_DITHER_CTRL_CLR)	32	R/W	0151_4000h	41.11.137/2693
21C_D67C	Dither Control Register 0 (PXP_HW_PXP_DITHER_CTRL_TOG)	32	R/W	0151_4000h	41.11.137/2693
21C_D680	Final stage lookup value Register (PXP_HW_PXP_DITHER_FINAL_LUT_DATA0)	32	R/W	0000_0000h	41.11.138/2695
21C_D684	Final stage lookup value Register (PXP_HW_PXP_DITHER_FINAL_LUT_DATA0_SET)	32	R/W	0000_0000h	41.11.138/2695
21C_D688	Final stage lookup value Register (PXP_HW_PXP_DITHER_FINAL_LUT_DATA0_CLR)	32	R/W	0000_0000h	41.11.138/2695
21C_D68C	Final stage lookup value Register (PXP_HW_PXP_DITHER_FINAL_LUT_DATA0_TOG)	32	R/W	0000_0000h	41.11.138/2695
21C_D690	Final stage lookup value Register (PXP_HW_PXP_DITHER_FINAL_LUT_DATA1)	32	R/W	0000_0000h	41.11.139/2695
21C_D694	Final stage lookup value Register (PXP_HW_PXP_DITHER_FINAL_LUT_DATA1_SET)	32	R/W	0000_0000h	41.11.139/2695
21C_D698	Final stage lookup value Register (PXP_HW_PXP_DITHER_FINAL_LUT_DATA1_CLR)	32	R/W	0000_0000h	41.11.139/2695
21C_D69C	Final stage lookup value Register (PXP_HW_PXP_DITHER_FINAL_LUT_DATA1_TOG)	32	R/W	0000_0000h	41.11.139/2695
21C_D6A0	Final stage lookup value Register (PXP_HW_PXP_DITHER_FINAL_LUT_DATA2)	32	R/W	0000_0000h	41.11.140/2696
21C_D6A4	Final stage lookup value Register (PXP_HW_PXP_DITHER_FINAL_LUT_DATA2_SET)	32	R/W	0000_0000h	41.11.140/2696

Table continues on the next page...

PXP memory map (continued)

Absolute address (hex)	Register name	Width (in bits)	Access	Reset value	Section/page
21C_D6A8	Final stage lookup value Register (PXP_HW_PXP_DITHER_FINAL_LUT_DATA2_CLR)	32	R/W	0000_0000h	41.11.140/2696
21C_D6AC	Final stage lookup value Register (PXP_HW_PXP_DITHER_FINAL_LUT_DATA2_TOG)	32	R/W	0000_0000h	41.11.140/2696
21C_D6B0	Final stage lookup value Register (PXP_HW_PXP_DITHER_FINAL_LUT_DATA3)	32	R/W	0000_0000h	41.11.141/2696
21C_D6B4	Final stage lookup value Register (PXP_HW_PXP_DITHER_FINAL_LUT_DATA3_SET)	32	R/W	0000_0000h	41.11.141/2696
21C_D6B8	Final stage lookup value Register (PXP_HW_PXP_DITHER_FINAL_LUT_DATA3_CLR)	32	R/W	0000_0000h	41.11.141/2696
21C_D6BC	Final stage lookup value Register (PXP_HW_PXP_DITHER_FINAL_LUT_DATA3_TOG)	32	R/W	0000_0000h	41.11.141/2696
21C_DD00	PXP_HW_PXP_WFE_B_CTRL	32	R/W	0000_0000h	41.11.142/2697
21C_DD04	PXP_HW_PXP_WFE_B_CTRL_SET	32	R/W	0000_0000h	41.11.142/2697
21C_DD08	PXP_HW_PXP_WFE_B_CTRL_CLR	32	R/W	0000_0000h	41.11.142/2697
21C_DD0C	PXP_HW_PXP_WFE_B_CTRL_TOG	32	R/W	0000_0000h	41.11.142/2697
21C_DD10	PXP_HW_PXP_WFE_B_DIMENSIONS	32	R/W	0000_0000h	41.11.143/2698
21C_DD20	PXP_HW_PXP_WFE_B_OFFSET	32	R/W	0000_0000h	41.11.144/2698
21C_DD30	PXP_HW_PXP_WFE_B_SW_DATA_REGS	32	R/W	0000_0000h	41.11.145/2699
21C_DD40	PXP_HW_PXP_WFE_B_SW_FLAG_REGS	32	R/W	0000_0000h	41.11.146/2700
21C_DD50	PXP_HW_PXP_WFE_B_STAGE1_MUX0	32	R/W	0000_0000h	41.11.147/2701
21C_DD54	PXP_HW_PXP_WFE_B_STAGE1_MUX0_SET	32	R/W	0000_0000h	41.11.147/2701
21C_DD58	PXP_HW_PXP_WFE_B_STAGE1_MUX0_CLR	32	R/W	0000_0000h	41.11.147/2701
21C_DD5C	PXP_HW_PXP_WFE_B_STAGE1_MUX0_TOG	32	R/W	0000_0000h	41.11.147/2701
21C_DD60	PXP_HW_PXP_WFE_B_STAGE1_MUX1	32	R/W	0000_0000h	41.11.148/2702
21C_DD64	PXP_HW_PXP_WFE_B_STAGE1_MUX1_SET	32	R/W	0000_0000h	41.11.148/2702
21C_DD68	PXP_HW_PXP_WFE_B_STAGE1_MUX1_CLR	32	R/W	0000_0000h	41.11.148/2702
21C_DD6C	PXP_HW_PXP_WFE_B_STAGE1_MUX1_TOG	32	R/W	0000_0000h	41.11.148/2702

Table continues on the next page...

PXP memory map (continued)

Absolute address (hex)	Register name	Width (in bits)	Access	Reset value	Section/page
21C_DD70	PXP_HW_PXP_WFE_B_STAGE1_MUX2	32	R/W	0000_0000h	41.11.149/2703
21C_DD74	PXP_HW_PXP_WFE_B_STAGE1_MUX2_SET	32	R/W	0000_0000h	41.11.149/2703
21C_DD78	PXP_HW_PXP_WFE_B_STAGE1_MUX2_CLR	32	R/W	0000_0000h	41.11.149/2703
21C_DD7C	PXP_HW_PXP_WFE_B_STAGE1_MUX2_TOG	32	R/W	0000_0000h	41.11.149/2703
21C_DD80	PXP_HW_PXP_WFE_B_STAGE1_MUX3	32	R/W	0000_0000h	41.11.150/2704
21C_DD84	PXP_HW_PXP_WFE_B_STAGE1_MUX3_SET	32	R/W	0000_0000h	41.11.150/2704
21C_DD88	PXP_HW_PXP_WFE_B_STAGE1_MUX3_CLR	32	R/W	0000_0000h	41.11.150/2704
21C_DD8C	PXP_HW_PXP_WFE_B_STAGE1_MUX3_TOG	32	R/W	0000_0000h	41.11.150/2704
21C_DD90	PXP_HW_PXP_WFE_B_STAGE1_MUX4	32	R/W	0000_0000h	41.11.151/2705
21C_DD94	PXP_HW_PXP_WFE_B_STAGE1_MUX4_SET	32	R/W	0000_0000h	41.11.151/2705
21C_DD98	PXP_HW_PXP_WFE_B_STAGE1_MUX4_CLR	32	R/W	0000_0000h	41.11.151/2705
21C_DD9C	PXP_HW_PXP_WFE_B_STAGE1_MUX4_TOG	32	R/W	0000_0000h	41.11.151/2705
21C_DDA0	PXP_HW_PXP_WFE_B_STAGE1_MUX5	32	R/W	0000_000Ch	41.11.152/2706
21C_DDA4	PXP_HW_PXP_WFE_B_STAGE1_MUX5_SET	32	R/W	0000_000Ch	41.11.152/2706
21C_DDA8	PXP_HW_PXP_WFE_B_STAGE1_MUX5_CLR	32	R/W	0000_000Ch	41.11.152/2706
21C_DDAC	PXP_HW_PXP_WFE_B_STAGE1_MUX5_TOG	32	R/W	0000_000Ch	41.11.152/2706
21C_DDB0	PXP_HW_PXP_WFE_B_STAGE1_MUX6	32	R/W	0000_0000h	41.11.153/2707
21C_DDB4	PXP_HW_PXP_WFE_B_STAGE1_MUX6_SET	32	R/W	0000_0000h	41.11.153/2707
21C_DDB8	PXP_HW_PXP_WFE_B_STAGE1_MUX6_CLR	32	R/W	0000_0000h	41.11.153/2707
21C_DDBC	PXP_HW_PXP_WFE_B_STAGE1_MUX6_TOG	32	R/W	0000_0000h	41.11.153/2707
21C_DDC0	PXP_HW_PXP_WFE_B_STAGE1_MUX7	32	R/W	0000_0000h	41.11.154/2708
21C_DDC4	PXP_HW_PXP_WFE_B_STAGE1_MUX7_SET	32	R/W	0000_0000h	41.11.154/2708

Table continues on the next page...

PXP memory map (continued)

Absolute address (hex)	Register name	Width (in bits)	Access	Reset value	Section/page
21C_DDC8	PXP_HW_PXP_WFE_B_STAGE1_MUX7_CLR	32	R/W	0000_0000h	41.11.154/2708
21C_DDCC	PXP_HW_PXP_WFE_B_STAGE1_MUX7_TOG	32	R/W	0000_0000h	41.11.154/2708
21C_DDD0	PXP_HW_PXP_WFE_B_STAGE1_MUX8	32	R/W	0000_0000h	41.11.155/2709
21C_DDD4	PXP_HW_PXP_WFE_B_STAGE1_MUX8_SET	32	R/W	0000_0000h	41.11.155/2709
21C_DDD8	PXP_HW_PXP_WFE_B_STAGE1_MUX8_CLR	32	R/W	0000_0000h	41.11.155/2709
21C_DDDC	PXP_HW_PXP_WFE_B_STAGE1_MUX8_TOG	32	R/W	0000_0000h	41.11.155/2709
21C_DDE0	PXP_HW_PXP_WFE_B_STAGE2_MUX0	32	R/W	0000_0000h	41.11.156/2709
21C_DDE4	PXP_HW_PXP_WFE_B_STAGE2_MUX0_SET	32	R/W	0000_0000h	41.11.156/2709
21C_DDE8	PXP_HW_PXP_WFE_B_STAGE2_MUX0_CLR	32	R/W	0000_0000h	41.11.156/2709
21C_DDEC	PXP_HW_PXP_WFE_B_STAGE2_MUX0_TOG	32	R/W	0000_0000h	41.11.156/2709
21C_DDF0	PXP_HW_PXP_WFE_B_STAGE2_MUX1	32	R/W	0000_0000h	41.11.157/2710
21C_DDF4	PXP_HW_PXP_WFE_B_STAGE2_MUX1_SET	32	R/W	0000_0000h	41.11.157/2710
21C_DDF8	PXP_HW_PXP_WFE_B_STAGE2_MUX1_CLR	32	R/W	0000_0000h	41.11.157/2710
21C_DDFC	PXP_HW_PXP_WFE_B_STAGE2_MUX1_TOG	32	R/W	0000_0000h	41.11.157/2710
21C_DE00	PXP_HW_PXP_WFE_B_STAGE2_MUX2	32	R/W	0000_0000h	41.11.158/2711
21C_DE04	PXP_HW_PXP_WFE_B_STAGE2_MUX2_SET	32	R/W	0000_0000h	41.11.158/2711
21C_DE08	PXP_HW_PXP_WFE_B_STAGE2_MUX2_CLR	32	R/W	0000_0000h	41.11.158/2711
21C_DE0C	PXP_HW_PXP_WFE_B_STAGE2_MUX2_TOG	32	R/W	0000_0000h	41.11.158/2711
21C_DE10	PXP_HW_PXP_WFE_B_STAGE2_MUX3	32	R/W	0000_0000h	41.11.159/2712
21C_DE14	PXP_HW_PXP_WFE_B_STAGE2_MUX3_SET	32	R/W	0000_0000h	41.11.159/2712
21C_DE18	PXP_HW_PXP_WFE_B_STAGE2_MUX3_CLR	32	R/W	0000_0000h	41.11.159/2712
21C_DE1C	PXP_HW_PXP_WFE_B_STAGE2_MUX3_TOG	32	R/W	0000_0000h	41.11.159/2712

Table continues on the next page...

PXP memory map (continued)

Absolute address (hex)	Register name	Width (in bits)	Access	Reset value	Section/page
21C_DE20	PXP_HW_PXP_WFE_B_STAGE2_MUX4	32	R/W	0000_0000h	41.11.160/2713
21C_DE24	PXP_HW_PXP_WFE_B_STAGE2_MUX4_SET	32	R/W	0000_0000h	41.11.160/2713
21C_DE28	PXP_HW_PXP_WFE_B_STAGE2_MUX4_CLR	32	R/W	0000_0000h	41.11.160/2713
21C_DE2C	PXP_HW_PXP_WFE_B_STAGE2_MUX4_TOG	32	R/W	0000_0000h	41.11.160/2713
21C_DE30	PXP_HW_PXP_WFE_B_STAGE2_MUX5	32	R/W	0000_0000h	41.11.161/2714
21C_DE34	PXP_HW_PXP_WFE_B_STAGE2_MUX5_SET	32	R/W	0000_0000h	41.11.161/2714
21C_DE38	PXP_HW_PXP_WFE_B_STAGE2_MUX5_CLR	32	R/W	0000_0000h	41.11.161/2714
21C_DE3C	PXP_HW_PXP_WFE_B_STAGE2_MUX5_TOG	32	R/W	0000_0000h	41.11.161/2714
21C_DE40	PXP_HW_PXP_WFE_B_STAGE2_MUX6	32	R/W	0000_0000h	41.11.162/2715
21C_DE44	PXP_HW_PXP_WFE_B_STAGE2_MUX6_SET	32	R/W	0000_0000h	41.11.162/2715
21C_DE48	PXP_HW_PXP_WFE_B_STAGE2_MUX6_CLR	32	R/W	0000_0000h	41.11.162/2715
21C_DE4C	PXP_HW_PXP_WFE_B_STAGE2_MUX6_TOG	32	R/W	0000_0000h	41.11.162/2715
21C_DE50	PXP_HW_PXP_WFE_B_STAGE2_MUX7	32	R/W	0000_0000h	41.11.163/2716
21C_DE54	PXP_HW_PXP_WFE_B_STAGE2_MUX7_SET	32	R/W	0000_0000h	41.11.163/2716
21C_DE58	PXP_HW_PXP_WFE_B_STAGE2_MUX7_CLR	32	R/W	0000_0000h	41.11.163/2716
21C_DE5C	PXP_HW_PXP_WFE_B_STAGE2_MUX7_TOG	32	R/W	0000_0000h	41.11.163/2716
21C_DE60	PXP_HW_PXP_WFE_B_STAGE2_MUX8	32	R/W	0000_0000h	41.11.164/2717
21C_DE64	PXP_HW_PXP_WFE_B_STAGE2_MUX8_SET	32	R/W	0000_0000h	41.11.164/2717
21C_DE68	PXP_HW_PXP_WFE_B_STAGE2_MUX8_CLR	32	R/W	0000_0000h	41.11.164/2717
21C_DE6C	PXP_HW_PXP_WFE_B_STAGE2_MUX8_TOG	32	R/W	0000_0000h	41.11.164/2717
21C_DE70	PXP_HW_PXP_WFE_B_STAGE2_MUX9	32	R/W	0000_0000h	41.11.165/2718
21C_DE74	PXP_HW_PXP_WFE_B_STAGE2_MUX9_SET	32	R/W	0000_0000h	41.11.165/2718

Table continues on the next page...

PXP memory map (continued)

Absolute address (hex)	Register name	Width (in bits)	Access	Reset value	Section/page
21C_DE78	PXP_HW_PXP_WFE_B_STAGE2_MUX9_CLR	32	R/W	0000_0000h	41.11.165/2718
21C_DE7C	PXP_HW_PXP_WFE_B_STAGE2_MUX9_TOG	32	R/W	0000_0000h	41.11.165/2718
21C_DE80	PXP_HW_PXP_WFE_B_STAGE2_MUX10	32	R/W	0000_000Ch	41.11.166/2719
21C_DE84	PXP_HW_PXP_WFE_B_STAGE2_MUX10_SET	32	R/W	0000_000Ch	41.11.166/2719
21C_DE88	PXP_HW_PXP_WFE_B_STAGE2_MUX10_CLR	32	R/W	0000_000Ch	41.11.166/2719
21C_DE8C	PXP_HW_PXP_WFE_B_STAGE2_MUX10_TOG	32	R/W	0000_000Ch	41.11.166/2719
21C_DE90	PXP_HW_PXP_WFE_B_STAGE2_MUX11	32	R/W	0000_0000h	41.11.167/2720
21C_DE94	PXP_HW_PXP_WFE_B_STAGE2_MUX11_SET	32	R/W	0000_0000h	41.11.167/2720
21C_DE98	PXP_HW_PXP_WFE_B_STAGE2_MUX11_CLR	32	R/W	0000_0000h	41.11.167/2720
21C_DE9C	PXP_HW_PXP_WFE_B_STAGE2_MUX11_TOG	32	R/W	0000_0000h	41.11.167/2720
21C_DEA0	PXP_HW_PXP_WFE_B_STAGE2_MUX12	32	R/W	0000_0000h	41.11.168/2721
21C_DEA4	PXP_HW_PXP_WFE_B_STAGE2_MUX12_SET	32	R/W	0000_0000h	41.11.168/2721
21C_DEA8	PXP_HW_PXP_WFE_B_STAGE2_MUX12_CLR	32	R/W	0000_0000h	41.11.168/2721
21C_DEAC	PXP_HW_PXP_WFE_B_STAGE2_MUX12_TOG	32	R/W	0000_0000h	41.11.168/2721
21C_DEB0	PXP_HW_PXP_WFE_B_STAGE3_MUX0	32	R/W	0000_0000h	41.11.169/2721
21C_DEB4	PXP_HW_PXP_WFE_B_STAGE3_MUX0_SET	32	R/W	0000_0000h	41.11.169/2721
21C_DEB8	PXP_HW_PXP_WFE_B_STAGE3_MUX0_CLR	32	R/W	0000_0000h	41.11.169/2721
21C_DEBC	PXP_HW_PXP_WFE_B_STAGE3_MUX0_TOG	32	R/W	0000_0000h	41.11.169/2721
21C_DEC0	PXP_HW_PXP_WFE_B_STAGE3_MUX1	32	R/W	0000_0000h	41.11.170/2722
21C_DEC4	PXP_HW_PXP_WFE_B_STAGE3_MUX1_SET	32	R/W	0000_0000h	41.11.170/2722
21C_DEC8	PXP_HW_PXP_WFE_B_STAGE3_MUX1_CLR	32	R/W	0000_0000h	41.11.170/2722
21C_DECC	PXP_HW_PXP_WFE_B_STAGE3_MUX1_TOG	32	R/W	0000_0000h	41.11.170/2722

Table continues on the next page...

PXP memory map (continued)

Absolute address (hex)	Register name	Width (in bits)	Access	Reset value	Section/page
21C_DED0	PXP_HW_PXP_WFE_B_STAGE3_MUX2	32	R/W	0000_0000h	41.11.171/2723
21C_DED4	PXP_HW_PXP_WFE_B_STAGE3_MUX2_SET	32	R/W	0000_0000h	41.11.171/2723
21C_DED8	PXP_HW_PXP_WFE_B_STAGE3_MUX2_CLR	32	R/W	0000_0000h	41.11.171/2723
21C_DEDC	PXP_HW_PXP_WFE_B_STAGE3_MUX2_TOG	32	R/W	0000_0000h	41.11.171/2723
21C_DEE0	PXP_HW_PXP_WFE_B_STAGE3_MUX3	32	R/W	0000_0000h	41.11.172/2724
21C_DEE4	PXP_HW_PXP_WFE_B_STAGE3_MUX3_SET	32	R/W	0000_0000h	41.11.172/2724
21C_DEE8	PXP_HW_PXP_WFE_B_STAGE3_MUX3_CLR	32	R/W	0000_0000h	41.11.172/2724
21C_DEEC	PXP_HW_PXP_WFE_B_STAGE3_MUX3_TOG	32	R/W	0000_0000h	41.11.172/2724
21C_DEF0	PXP_HW_PXP_WFE_B_STAGE3_MUX4	32	R/W	0000_0000h	41.11.173/2725
21C_DEF4	PXP_HW_PXP_WFE_B_STAGE3_MUX4_SET	32	R/W	0000_0000h	41.11.173/2725
21C_DEF8	PXP_HW_PXP_WFE_B_STAGE3_MUX4_CLR	32	R/W	0000_0000h	41.11.173/2725
21C_DEFC	PXP_HW_PXP_WFE_B_STAGE3_MUX4_TOG	32	R/W	0000_0000h	41.11.173/2725
21C_DF00	PXP_HW_PXP_WFE_B_STAGE3_MUX5	32	R/W	0000_0000h	41.11.174/2726
21C_DF04	PXP_HW_PXP_WFE_B_STAGE3_MUX5_SET	32	R/W	0000_0000h	41.11.174/2726
21C_DF08	PXP_HW_PXP_WFE_B_STAGE3_MUX5_CLR	32	R/W	0000_0000h	41.11.174/2726
21C_DF0C	PXP_HW_PXP_WFE_B_STAGE3_MUX5_TOG	32	R/W	0000_0000h	41.11.174/2726
21C_DF10	PXP_HW_PXP_WFE_B_STAGE3_MUX6	32	R/W	0000_0000h	41.11.175/2727
21C_DF14	PXP_HW_PXP_WFE_B_STAGE3_MUX6_SET	32	R/W	0000_0000h	41.11.175/2727
21C_DF18	PXP_HW_PXP_WFE_B_STAGE3_MUX6_CLR	32	R/W	0000_0000h	41.11.175/2727
21C_DF1C	PXP_HW_PXP_WFE_B_STAGE3_MUX6_TOG	32	R/W	0000_0000h	41.11.175/2727
21C_DF20	PXP_HW_PXP_WFE_B_STAGE3_MUX7	32	R/W	0000_0000h	41.11.176/2728
21C_DF24	PXP_HW_PXP_WFE_B_STAGE3_MUX7_SET	32	R/W	0000_0000h	41.11.176/2728

Table continues on the next page...

PXP memory map (continued)

Absolute address (hex)	Register name	Width (in bits)	Access	Reset value	Section/page
21C_DF28	PXP_HW_PXP_WFE_B_STAGE3_MUX7_CLR	32	R/W	0000_0000h	41.11.176/2728
21C_DF2C	PXP_HW_PXP_WFE_B_STAGE3_MUX7_TOG	32	R/W	0000_0000h	41.11.176/2728
21C_DF30	PXP_HW_PXP_WFE_B_STAGE3_MUX8	32	R/W	0000_0000h	41.11.177/2729
21C_DF34	PXP_HW_PXP_WFE_B_STAGE3_MUX8_SET	32	R/W	0000_0000h	41.11.177/2729
21C_DF38	PXP_HW_PXP_WFE_B_STAGE3_MUX8_CLR	32	R/W	0000_0000h	41.11.177/2729
21C_DF3C	PXP_HW_PXP_WFE_B_STAGE3_MUX8_TOG	32	R/W	0000_0000h	41.11.177/2729
21C_DF40	PXP_HW_PXP_WFE_B_STAGE3_MUX9	32	R/W	0000_0000h	41.11.178/2730
21C_DF44	PXP_HW_PXP_WFE_B_STAGE3_MUX9_SET	32	R/W	0000_0000h	41.11.178/2730
21C_DF48	PXP_HW_PXP_WFE_B_STAGE3_MUX9_CLR	32	R/W	0000_0000h	41.11.178/2730
21C_DF4C	PXP_HW_PXP_WFE_B_STAGE3_MUX9_TOG	32	R/W	0000_0000h	41.11.178/2730
21C_DF50	PXP_HW_PXP_WFE_B_STAGE3_MUX10	32	R/W	0000_0000h	41.11.179/2731
21C_DF54	PXP_HW_PXP_WFE_B_STAGE3_MUX10_SET	32	R/W	0000_0000h	41.11.179/2731
21C_DF58	PXP_HW_PXP_WFE_B_STAGE3_MUX10_CLR	32	R/W	0000_0000h	41.11.179/2731
21C_DF5C	PXP_HW_PXP_WFE_B_STAGE3_MUX10_TOG	32	R/W	0000_0000h	41.11.179/2731
21C_DF60	PXP_HW_PXP_WFE_B_STG1_5X8_OUT0_0	32	R/W	0000_0000h	41.11.180/2732
21C_DF70	PXP_HW_PXP_WFE_B_STG1_5X8_OUT0_1	32	R/W	0000_0000h	41.11.181/2732
21C_DF80	PXP_HW_PXP_WFE_B_STG1_5X8_OUT0_2	32	R/W	0000_0000h	41.11.182/2733
21C_DF90	PXP_HW_PXP_WFE_B_STG1_5X8_OUT0_3	32	R/W	0000_0000h	41.11.183/2734
21C_DFA0	PXP_HW_PXP_WFE_B_STG1_5X8_OUT0_4	32	R/W	0000_0000h	41.11.184/2734
21C_DFB0	PXP_HW_PXP_WFE_B_STG1_5X8_OUT0_5	32	R/W	0000_0000h	41.11.185/2735
21C_DFC0	PXP_HW_PXP_WFE_B_STG1_5X8_OUT0_6	32	R/W	0000_0000h	41.11.186/2736
21C_DFD0	PXP_HW_PXP_WFE_B_STG1_5X8_OUT0_7	32	R/W	0000_0000h	41.11.187/2736

Table continues on the next page...

PXP memory map (continued)

Absolute address (hex)	Register name	Width (in bits)	Access	Reset value	Section/page
21C_DFE0	PXP_HW_PXP_WFE_B_STG1_5X8_OUT1_0	32	R/W	0000_0000h	41.11.188/2737
21C_DFF0	PXP_HW_PXP_WFE_B_STG1_5X8_OUT1_1	32	R/W	0000_0000h	41.11.189/2738
21C_E000	PXP_HW_PXP_WFE_B_STG1_5X8_OUT1_2	32	R/W	0000_0000h	41.11.190/2738
21C_E010	PXP_HW_PXP_WFE_B_STG1_5X8_OUT1_3	32	R/W	0000_0000h	41.11.191/2739
21C_E020	PXP_HW_PXP_WFE_B_STG1_5X8_OUT1_4	32	R/W	0000_0000h	41.11.192/2740
21C_E030	PXP_HW_PXP_WFE_B_STG1_5X8_OUT1_5	32	R/W	0000_0000h	41.11.193/2740
21C_E040	PXP_HW_PXP_WFE_B_STG1_5X8_OUT1_6	32	R/W	0000_0000h	41.11.194/2741
21C_E050	PXP_HW_PXP_WFE_B_STG1_5X8_OUT1_7	32	R/W	0000_0000h	41.11.195/2742
21C_E060	PXP_HW_PXP_WFE_B_STAGE1_5X8_MASKS_0	32	R/W	0000_0000h	41.11.196/2742
21C_E070	PXP_HW_PXP_WFE_B_STG1_5X1_OUT0	32	R/W	0000_0000h	41.11.197/2743
21C_E080	PXP_HW_PXP_WFE_B_STG1_5X1_MASKS	32	R/W	0000_0000h	41.11.198/2745
21C_E090	PXP_HW_PXP_WFE_B_STG1_8X1_OUT0_0	32	R/W	0000_0000h	41.11.199/2746
21C_E0A0	PXP_HW_PXP_WFE_B_STG1_8X1_OUT0_1	32	R/W	0000_0000h	41.11.200/2748
21C_E0B0	PXP_HW_PXP_WFE_B_STG1_8X1_OUT0_2	32	R/W	0000_0000h	41.11.201/2750
21C_E0C0	PXP_HW_PXP_WFE_B_STG1_8X1_OUT0_3	32	R/W	0000_0000h	41.11.202/2752
21C_E0D0	PXP_HW_PXP_WFE_B_STG1_8X1_OUT0_4	32	R/W	0000_0000h	41.11.203/2754
21C_E0E0	PXP_HW_PXP_WFE_B_STG1_8X1_OUT0_5	32	R/W	0000_0000h	41.11.204/2756
21C_E0F0	PXP_HW_PXP_WFE_B_STG1_8X1_OUT0_6	32	R/W	0000_0000h	41.11.205/2758
21C_E100	PXP_HW_PXP_WFE_B_STG1_8X1_OUT0_7	32	R/W	0000_0000h	41.11.206/2760
21C_E110	PXP_HW_PXP_WFE_B_STG1_8X1_OUT1_0	32	R/W	0000_0000h	41.11.207/2762
21C_E120	PXP_HW_PXP_WFE_B_STG1_8X1_OUT1_1	32	R/W	0000_0000h	41.11.208/2764
21C_E130	PXP_HW_PXP_WFE_B_STG1_8X1_OUT1_2	32	R/W	0000_0000h	41.11.209/2766

Table continues on the next page...

PXP memory map (continued)

Absolute address (hex)	Register name	Width (in bits)	Access	Reset value	Section/page
21C_E140	PXP_HW_PXP_WFE_B_STG1_8X1_OUT1_3	32	R/W	0000_0000h	41.11.210/2768
21C_E150	PXP_HW_PXP_WFE_B_STG1_8X1_OUT1_4	32	R/W	0000_0000h	41.11.211/2770
21C_E160	PXP_HW_PXP_WFE_B_STG1_8X1_OUT1_5	32	R/W	0000_0000h	41.11.212/2772
21C_E170	PXP_HW_PXP_WFE_B_STG1_8X1_OUT1_6	32	R/W	0000_0000h	41.11.213/2774
21C_E180	PXP_HW_PXP_WFE_B_STG1_8X1_OUT1_7	32	R/W	0000_0000h	41.11.214/2776
21C_E190	PXP_HW_PXP_WFE_B_STG1_8X1_OUT2_0	32	R/W	0000_0000h	41.11.215/2778
21C_E1A0	PXP_HW_PXP_WFE_B_STG1_8X1_OUT2_1	32	R/W	0000_0000h	41.11.216/2780
21C_E1B0	PXP_HW_PXP_WFE_B_STG1_8X1_OUT2_2	32	R/W	0000_0000h	41.11.217/2782
21C_E1C0	PXP_HW_PXP_WFE_B_STG1_8X1_OUT2_3	32	R/W	0000_0000h	41.11.218/2784
21C_E1D0	PXP_HW_PXP_WFE_B_STG1_8X1_OUT2_4	32	R/W	0000_0000h	41.11.219/2786
21C_E1E0	PXP_HW_PXP_WFE_B_STG1_8X1_OUT2_5	32	R/W	0000_0000h	41.11.220/2788
21C_E1F0	PXP_HW_PXP_WFE_B_STG1_8X1_OUT2_6	32	R/W	0000_0000h	41.11.221/2790
21C_E200	PXP_HW_PXP_WFE_B_STG1_8X1_OUT2_7	32	R/W	0000_0000h	41.11.222/2792
21C_E210	PXP_HW_PXP_WFE_B_STG1_8X1_OUT3_0	32	R/W	0000_0000h	41.11.223/2794
21C_E220	PXP_HW_PXP_WFE_B_STG1_8X1_OUT3_1	32	R/W	0000_0000h	41.11.224/2796
21C_E230	PXP_HW_PXP_WFE_B_STG1_8X1_OUT3_2	32	R/W	0000_0000h	41.11.225/2798
21C_E240	PXP_HW_PXP_WFE_B_STG1_8X1_OUT3_3	32	R/W	0000_0000h	41.11.226/2800
21C_E250	PXP_HW_PXP_WFE_B_STG1_8X1_OUT3_4	32	R/W	0000_0000h	41.11.227/2802
21C_E260	PXP_HW_PXP_WFE_B_STG1_8X1_OUT3_5	32	R/W	0000_0000h	41.11.228/2804
21C_E270	PXP_HW_PXP_WFE_B_STG1_8X1_OUT3_6	32	R/W	0000_0000h	41.11.229/2806
21C_E280	PXP_HW_PXP_WFE_B_STG1_8X1_OUT3_7	32	R/W	0000_0000h	41.11.230/2808
21C_E290	PXP_HW_PXP_WFE_B_STG1_8X1_OUT4_0	32	R/W	0000_0000h	41.11.231/2810

Table continues on the next page...

PXP memory map (continued)

Absolute address (hex)	Register name	Width (in bits)	Access	Reset value	Section/page
21C_E2A0	PXP_HW_PXP_WFE_B_STG1_8X1_OUT4_1	32	R/W	0000_0000h	41.11.232/2812
21C_E2B0	PXP_HW_PXP_WFE_B_STG1_8X1_OUT4_2	32	R/W	0000_0000h	41.11.233/2814
21C_E2C0	PXP_HW_PXP_WFE_B_STG1_8X1_OUT4_3	32	R/W	0000_0000h	41.11.234/2816
21C_E2D0	PXP_HW_PXP_WFE_B_STG1_8X1_OUT4_4	32	R/W	0000_0000h	41.11.235/2818
21C_E2E0	PXP_HW_PXP_WFE_B_STG1_8X1_OUT4_5	32	R/W	0000_0000h	41.11.236/2820
21C_E2F0	PXP_HW_PXP_WFE_B_STG1_8X1_OUT4_6	32	R/W	0000_0000h	41.11.237/2822
21C_E300	PXP_HW_PXP_WFE_B_STG1_8X1_OUT4_7	32	R/W	0000_0000h	41.11.238/2824
21C_E310	PXP_HW_PXP_WFE_B_STG2_5X6_OUT0_0	32	R/W	0000_0000h	41.11.239/2826
21C_E320	PXP_HW_PXP_WFE_B_STG2_5X6_OUT0_1	32	R/W	0000_0000h	41.11.240/2827
21C_E330	PXP_HW_PXP_WFE_B_STG2_5X6_OUT0_2	32	R/W	0000_0000h	41.11.241/2828
21C_E340	PXP_HW_PXP_WFE_B_STG2_5X6_OUT0_3	32	R/W	0000_0000h	41.11.242/2829
21C_E350	PXP_HW_PXP_WFE_B_STG2_5X6_OUT0_4	32	R/W	0000_0000h	41.11.243/2830
21C_E360	PXP_HW_PXP_WFE_B_STG2_5X6_OUT0_5	32	R/W	0000_0000h	41.11.244/2831
21C_E370	PXP_HW_PXP_WFE_B_STG2_5X6_OUT0_6	32	R/W	0000_0000h	41.11.245/2832
21C_E380	PXP_HW_PXP_WFE_B_STG2_5X6_OUT0_7	32	R/W	0000_0000h	41.11.246/2833
21C_E390	PXP_HW_PXP_WFE_B_STG2_5X6_OUT1_0	32	R/W	0000_0000h	41.11.247/2834
21C_E3A0	PXP_HW_PXP_WFE_B_STG2_5X6_OUT1_1	32	R/W	0000_0000h	41.11.248/2835
21C_E3B0	PXP_HW_PXP_WFE_B_STG2_5X6_OUT1_2	32	R/W	0000_0000h	41.11.249/2836
21C_E3C0	PXP_HW_PXP_WFE_B_STG2_5X6_OUT1_3	32	R/W	0000_0000h	41.11.250/2837
21C_E3D0	PXP_HW_PXP_WFE_B_STG2_5X6_OUT1_4	32	R/W	0000_0000h	41.11.251/2838
21C_E3E0	PXP_HW_PXP_WFE_B_STG2_5X6_OUT1_5	32	R/W	0000_0000h	41.11.252/2839
21C_E3F0	PXP_HW_PXP_WFE_B_STG2_5X6_OUT1_6	32	R/W	0000_0000h	41.11.253/2840

Table continues on the next page...

PXP memory map (continued)

Absolute address (hex)	Register name	Width (in bits)	Access	Reset value	Section/page
21C_E400	PXP_HW_PXP_WFE_B_STG2_5X6_OUT1_7	32	R/W	0000_0000h	41.11.254/2841
21C_E410	PXP_HW_PXP_WFE_B_STG2_5X6_OUT2_0	32	R/W	0000_0000h	41.11.255/2842
21C_E420	PXP_HW_PXP_WFE_B_STG2_5X6_OUT2_1	32	R/W	0000_0000h	41.11.256/2843
21C_E430	PXP_HW_PXP_WFE_B_STG2_5X6_OUT2_2	32	R/W	0000_0000h	41.11.257/2844
21C_E440	PXP_HW_PXP_WFE_B_STG2_5X6_OUT2_3	32	R/W	0000_0000h	41.11.258/2845
21C_E450	PXP_HW_PXP_WFE_B_STG2_5X6_OUT2_4	32	R/W	0000_0000h	41.11.259/2846
21C_E460	PXP_HW_PXP_WFE_B_STG2_5X6_OUT2_5	32	R/W	0000_0000h	41.11.260/2847
21C_E470	PXP_HW_PXP_WFE_B_STG2_5X6_OUT2_6	32	R/W	0000_0000h	41.11.261/2848
21C_E480	PXP_HW_PXP_WFE_B_STG2_5X6_OUT2_7	32	R/W	0000_0000h	41.11.262/2849
21C_E490	PXP_HW_PXP_WFE_B_STG2_5X6_OUT3_0	32	R/W	0000_0000h	41.11.263/2850
21C_E4A0	PXP_HW_PXP_WFE_B_STG2_5X6_OUT3_1	32	R/W	0000_0000h	41.11.264/2851
21C_E4B0	PXP_HW_PXP_WFE_B_STG2_5X6_OUT3_2	32	R/W	0000_0000h	41.11.265/2852
21C_E4C0	PXP_HW_PXP_WFE_B_STG2_5X6_OUT3_3	32	R/W	0000_0000h	41.11.266/2853
21C_E4E0	PXP_HW_PXP_WFE_B_STG2_5X6_OUT3_4	32	R/W	0000_0000h	41.11.267/2854
21C_E4F0	PXP_HW_PXP_WFE_B_STG2_5X6_OUT3_5	32	R/W	0000_0000h	41.11.268/2855
21C_E500	PXP_HW_PXP_WFE_B_STG2_5X6_OUT3_6	32	R/W	0000_0000h	41.11.269/2856
21C_E510	PXP_HW_PXP_WFE_B_STG2_5X6_OUT3_7	32	R/W	0000_0000h	41.11.270/2857
21C_E520	PXP_HW_PXP_WFE_B_STAGE2_5X6_MASKS_0	32	R/W	0000_0000h	41.11.271/2858
21C_E530	PXP_HW_PXP_WFE_B_STAGE2_5X6_ADDR_0	32	R/W	0000_0000h	41.11.272/2859
21C_E540	PXP_HW_PXP_WFE_B_STG2_5X1_OUT0	32	R/W	0000_0000h	41.11.273/2860
21C_E550	PXP_HW_PXP_WFE_B_STG2_5X1_OUT1	32	R/W	0000_0000h	41.11.274/2862
21C_E560	PXP_HW_PXP_WFE_B_STG2_5X1_OUT2	32	R/W	0000_0000h	41.11.275/2864

Table continues on the next page...

PXP memory map (continued)

Absolute address (hex)	Register name	Width (in bits)	Access	Reset value	Section/page
21C_E570	PXP_HW_PXP_WFE_B_STG2_5X1_OUT3	32	R/W	0000_0000h	41.11.276/2866
21C_E580	PXP_HW_PXP_WFE_B_STG2_5X1_MASKS	32	R/W	0000_0000h	41.11.277/2868
21C_E590	PXP_HW_PXP_WFE_B_STG3_F8X1_OUT0_0	32	R/W	0000_0000h	41.11.278/2869
21C_E5A0	PXP_HW_PXP_WFE_B_STG3_F8X1_OUT0_1	32	R/W	0000_0000h	41.11.279/2871
21C_E5B0	PXP_HW_PXP_WFE_B_STG3_F8X1_OUT0_2	32	R/W	0000_0000h	41.11.280/2873
21C_E5C0	PXP_HW_PXP_WFE_B_STG3_F8X1_OUT0_3	32	R/W	0000_0000h	41.11.281/2875
21C_E5D0	PXP_HW_PXP_WFE_B_STG3_F8X1_OUT0_4	32	R/W	0000_0000h	41.11.282/2877
21C_E5E0	PXP_HW_PXP_WFE_B_STG3_F8X1_OUT0_5	32	R/W	0000_0000h	41.11.283/2879
21C_E5F0	PXP_HW_PXP_WFE_B_STG3_F8X1_OUT0_6	32	R/W	0000_0000h	41.11.284/2881
21C_E600	PXP_HW_PXP_WFE_B_STG3_F8X1_OUT0_7	32	R/W	0000_0000h	41.11.285/2883
21C_E610	PXP_HW_PXP_WFE_B_STG3_F8X1_OUT1_0	32	R/W	0000_0000h	41.11.286/2885
21C_E620	PXP_HW_PXP_WFE_B_STG3_F8X1_OUT1_1	32	R/W	0000_0000h	41.11.287/2887
21C_E630	PXP_HW_PXP_WFE_B_STG3_F8X1_OUT1_2	32	R/W	0000_0000h	41.11.288/2889
21C_E640	PXP_HW_PXP_WFE_B_STG3_F8X1_OUT1_3	32	R/W	0000_0000h	41.11.289/2891
21C_E650	PXP_HW_PXP_WFE_B_STG3_F8X1_OUT1_4	32	R/W	0000_0000h	41.11.290/2893
21C_E660	PXP_HW_PXP_WFE_B_STG3_F8X1_OUT1_5	32	R/W	0000_0000h	41.11.291/2895
21C_E670	PXP_HW_PXP_WFE_B_STG3_F8X1_OUT1_6	32	R/W	0000_0000h	41.11.292/2897
21C_E680	PXP_HW_PXP_WFE_B_STG3_F8X1_OUT1_7	32	R/W	0000_0000h	41.11.293/2899
21C_E690	PXP_HW_PXP_WFE_B_STG3_F8X1_OUT2_0	32	R/W	0000_0000h	41.11.294/2901
21C_E6A0	PXP_HW_PXP_WFE_B_STG3_F8X1_OUT2_1	32	R/W	0000_0000h	41.11.295/2903
21C_E6B0	PXP_HW_PXP_WFE_B_STG3_F8X1_OUT2_2	32	R/W	0000_0000h	41.11.296/2905
21C_E6C0	PXP_HW_PXP_WFE_B_STG3_F8X1_OUT2_3	32	R/W	0000_0000h	41.11.297/2907

Table continues on the next page...

PXP memory map (continued)

Absolute address (hex)	Register name	Width (in bits)	Access	Reset value	Section/page
21C_E6D0	PXP_HW_PXP_WFE_B_STG3_F8X1_OUT2_4	32	R/W	0000_0000h	41.11.298/2909
21C_E6E0	PXP_HW_PXP_WFE_B_STG3_F8X1_OUT2_5	32	R/W	0000_0000h	41.11.299/2911
21C_E6F0	PXP_HW_PXP_WFE_B_STG3_F8X1_OUT2_6	32	R/W	0000_0000h	41.11.300/2913
21C_E700	PXP_HW_PXP_WFE_B_STG3_F8X1_OUT2_7	32	R/W	0000_0000h	41.11.301/2915
21C_E710	PXP_HW_PXP_WFE_B_STG3_F8X1_OUT3_0	32	R/W	0000_0000h	41.11.302/2917
21C_E720	PXP_HW_PXP_WFE_B_STG3_F8X1_OUT3_1	32	R/W	0000_0000h	41.11.303/2919
21C_E730	PXP_HW_PXP_WFE_B_STG3_F8X1_OUT3_2	32	R/W	0000_0000h	41.11.304/2921
21C_E740	PXP_HW_PXP_WFE_B_STG3_F8X1_OUT3_3	32	R/W	0000_0000h	41.11.305/2923
21C_E750	PXP_HW_PXP_WFE_B_STG3_F8X1_OUT3_4	32	R/W	0000_0000h	41.11.306/2925
21C_E760	PXP_HW_PXP_WFE_B_STG3_F8X1_OUT3_5	32	R/W	0000_0000h	41.11.307/2927
21C_E770	PXP_HW_PXP_WFE_B_STG3_F8X1_OUT3_6	32	R/W	0000_0000h	41.11.308/2929
21C_E780	PXP_HW_PXP_WFE_B_STG3_F8X1_OUT3_7	32	R/W	0000_0000h	41.11.309/2931
21C_E790	PXP_HW_PXP_WFE_B_STG3_F8X1_MASKS	32	R/W	0000_0000h	41.11.310/2933
21C_E8A0	PXP_HW_PXP_ALU_B_CTRL	32	R/W	0000_1000h	41.11.311/2934
21C_E8A4	PXP_HW_PXP_ALU_B_CTRL_SET	32	R/W	0000_1000h	41.11.311/2934
21C_E8A8	PXP_HW_PXP_ALU_B_CTRL_CLR	32	R/W	0000_1000h	41.11.311/2934
21C_E8AC	PXP_HW_PXP_ALU_B_CTRL_TOG	32	R/W	0000_1000h	41.11.311/2934
21C_E8B0	PXP_HW_PXP_ALU_B_BUF_SIZE	32	R/W	0000_0000h	41.11.312/2935
21C_E8C0	PXP_HW_PXP_ALU_B_INST_ENTRY	32	R/W	0000_0000h	41.11.313/2936
21C_E8D0	PXP_HW_PXP_ALU_B_PARAM	32	R/W	0000_0000h	41.11.314/2936
21C_E8E0	PXP_HW_PXP_ALU_B_CONFIG	32	R/W	0000_0000h	41.11.315/2937
21C_E8F0	PXP_HW_PXP_ALU_B_LUT_CONFIG	32	R/W	0000_0000h	41.11.316/2937

Table continues on the next page...

PXP memory map (continued)

Absolute address (hex)	Register name	Width (in bits)	Access	Reset value	Section/page
21C_E8F4	PXP_HW_PXP_ALU_B_LUT_CONFIG_SET	32	R/W	0000_0000h	41.11.316/2937
21C_E8F8	PXP_HW_PXP_ALU_B_LUT_CONFIG_CLR	32	R/W	0000_0000h	41.11.316/2937
21C_E8FC	PXP_HW_PXP_ALU_B_LUT_CONFIG_TOG	32	R/W	0000_0000h	41.11.316/2937
21C_E900	PXP_HW_PXP_ALU_B_LUT_DATA0	32	R/W	0000_0000h	41.11.317/2938
21C_E910	PXP_HW_PXP_ALU_B_LUT_DATA1	32	R/W	0000_0000h	41.11.318/2938
21C_E920	PXP_HW_PXP_ALU_B_DBG	32	R/W	0000_0000h	41.11.319/2939
21C_EA00	Histogram Control Register. (PXP_HW_PXP_HIST_A_CTRL)	32	R/W	0500_1F00h	41.11.320/2940
21C_EA10	Histogram Pixel Mask Register. (PXP_HW_PXP_HIST_A_MASK)	32	R/W	0000_0000h	41.11.321/2941
21C_EA20	Histogram Pixel Buffer Size Register. (PXP_HW_PXP_HIST_A_BUF_SIZE)	32	R/W	0000_0000h	41.11.322/2942
21C_EA30	Total Number of Pixels Used by Histogram Engine. (PXP_HW_PXP_HIST_A_TOTAL_PIXEL)	32	R/W	0000_0000h	41.11.323/2942
21C_EA40	The X Coordinate Offset for Active Area. (PXP_HW_PXP_HIST_A_ACTIVE_AREA_X)	32	R/W	0000_0000h	41.11.324/2943
21C_EA50	The Y Coordinate Offset for Active Area. (PXP_HW_PXP_HIST_A_ACTIVE_AREA_Y)	32	R/W	0000_0000h	41.11.325/2943
21C_EA60	Histogram Result Based on RAW Pixel Value. (PXP_HW_PXP_HIST_A_RAW_STAT0)	32	R/W	0000_0000h	41.11.326/2944
21C_EA70	Histogram Result Based on RAW Pixel Value. (PXP_HW_PXP_HIST_A_RAW_STAT1)	32	R/W	0000_0000h	41.11.327/2944
21C_EA80	Histogram Control Register. (PXP_HW_PXP_HIST_B_CTRL)	32	R/W	0500_1F00h	41.11.328/2945
21C_EA90	Histogram Pixel Mask Register. (PXP_HW_PXP_HIST_B_MASK)	32	R/W	0000_0000h	41.11.329/2946
21C_EAA0	Histogram Pixel Buffer Size Register. (PXP_HW_PXP_HIST_B_BUF_SIZE)	32	R/W	0000_0000h	41.11.330/2947
21C_EAB0	Total Number of Pixels Used by Histogram Engine. (PXP_HW_PXP_HIST_B_TOTAL_PIXEL)	32	R/W	0000_0000h	41.11.331/2948
21C_EAC0	The X Coordinate Offset for Active Area. (PXP_HW_PXP_HIST_B_ACTIVE_AREA_X)	32	R/W	0000_0000h	41.11.332/2948
21C_EAD0	The Y Coordinate Offset for Active Area. (PXP_HW_PXP_HIST_B_ACTIVE_AREA_Y)	32	R/W	0000_0000h	41.11.333/2949
21C_EAE0	Histogram Result Based on RAW Pixel Value. (PXP_HW_PXP_HIST_B_RAW_STAT0)	32	R/W	0000_0000h	41.11.334/2949
21C_EAF0	Histogram Result Based on RAW Pixel Value. (PXP_HW_PXP_HIST_B_RAW_STAT1)	32	R/W	0000_0000h	41.11.335/2950

Table continues on the next page...

PXP memory map (continued)

Absolute address (hex)	Register name	Width (in bits)	Access	Reset value	Section/page
21C_EB00	2-level Histogram Parameter Register. (PXP_HW_PXP_HIST2_PARAM)	32	R/W	0000_0F00h	41.11.336/2950
21C_EB10	4-level Histogram Parameter Register. (PXP_HW_PXP_HIST4_PARAM)	32	R/W	0F0A_0500h	41.11.337/2951
21C_EB20	8-level Histogram Parameter 0 Register. (PXP_HW_PXP_HIST8_PARAM0)	32	R/W	0604_0200h	41.11.338/2951
21C_EB30	8-level Histogram Parameter 1 Register. (PXP_HW_PXP_HIST8_PARAM1)	32	R/W	0F0D_0B09h	41.11.339/2952
21C_EB40	16-level Histogram Parameter 0 Register. (PXP_HW_PXP_HIST16_PARAM0)	32	R/W	0302_0100h	41.11.340/2953
21C_EB50	16-level Histogram Parameter 1 Register. (PXP_HW_PXP_HIST16_PARAM1)	32	R/W	0706_0504h	41.11.341/2954
21C_EB60	16-level Histogram Parameter 2 Register. (PXP_HW_PXP_HIST16_PARAM2)	32	R/W	0B0A_0908h	41.11.342/2954
21C_EB70	16-level Histogram Parameter 3 Register. (PXP_HW_PXP_HIST16_PARAM3)	32	R/W	0F0E_0D0Ch	41.11.343/2955
21C_EB80	32-level Histogram Parameter 0 Register. (PXP_HW_PXP_HIST32_PARAM0)	32	R/W	0302_0100h	41.11.344/2956
21C_EB90	32-level Histogram Parameter 1 Register. (PXP_HW_PXP_HIST32_PARAM1)	32	R/W	0706_0504h	41.11.345/2957
21C_EBA0	32-level Histogram Parameter 2 Register. (PXP_HW_PXP_HIST32_PARAM2)	32	R/W	0B0A_0908h	41.11.346/2957
21C_EBB0	32-level Histogram Parameter 3 Register. (PXP_HW_PXP_HIST32_PARAM3)	32	R/W	0F0E_0D0Ch	41.11.347/2958
21C_EBC0	32-level Histogram Parameter 0 Register. (PXP_HW_PXP_HIST32_PARAM4)	32	R/W	0302_0100h	41.11.348/2959
21C_EBD0	32-level Histogram Parameter 1 Register. (PXP_HW_PXP_HIST32_PARAM5)	32	R/W	0706_0504h	41.11.349/2960
21C_EBE0	32-level Histogram Parameter 2 Register. (PXP_HW_PXP_HIST32_PARAM6)	32	R/W	0B0A_0908h	41.11.350/2960
21C_EBF0	32-level Histogram Parameter 3 Register. (PXP_HW_PXP_HIST32_PARAM7)	32	R/W	0F0E_0D0Ch	41.11.351/2961
21C_ECF0	PXP_HW_PXP_HANDSHAKE_READY_MUX0	32	R/W	7654_3210h	41.11.352/2962
21C_ED10	PXP_HW_PXP_HANDSHAKE_DONE_MUX0	32	R/W	7654_3210h	41.11.353/2962

41.11.1 Control Register 0 (PXP_HW_PXP_CTRLn)

The Control register contains the primary controls for the PXP block.

Address: 21C_C000h base + 0h offset + (4d × i), where i=0d to 3d

Bit	31	30	29	28	27	26	25	24	23	22	21	20	19	18	17	16		
R			0								0			0				
W	SFTRST	CLKGATE		EN_REPEAT	ENABLE_ROTATE1	ENABLE_ROTATE0	ENABLE_LUT	ENABLE_CSC2	BLOCK_SIZE				ENABLE_WFE_B		ENABLE_DITHER	ENABLE_PS_AS_OUT		
Reset	1	1	0	0	0	1	1	1	0	0	0	0	0	0	0	1		
Bit	15	14	13	12	11	10	9	8	7	6	5	4	3	2	1	0		
R										0								
W	VFLIP1	HFLIP1		ROTATE1		VFLIP0		HFLIP0					HANDSHAKE_ABORT_SKIP	ENABLE_LCD0_HANDSHAKE	LUT_DMA_IRQ_ENABLE	NEXT_IRQ_ENABLE	IRQ_ENABLE	ENABLE
Reset	0	0	0	0	0	0	0	0	0	0	0	0	0	0	0	0	0	0

PXP_HW_PXP_CTRLn field descriptions

Field	Description
31 SFTRST	Set this bit to zero to enable normal PXP operation. Set this bit to one (default) to disable clocking with the PXP and hold it in its reset (lowest power) state. This bit can be turned on and then off to reset the PXP block to its default state.
30 CLKGATE	This bit must be set to zero for normal operation. When set to one it gates off the clocks to the block.
29 Reserved	This read-only field is reserved and always has the value 0.
28 EN_REPEAT	Enable the PXP to run continuously. When this bit is set, the PXP will repeat based on the current configuration register settings. If this bit is not set, the PXP will complete the process and enter the idle state ready to accept the next frame to be processed. This bit should be set when the LCDIF handshake mode is enabled so that the next frame is automatically generated for the next screen refresh cycle. If it not set and the handshake mode is enabled, the CPU will have to initiate the PXP for the next refresh cycle. When the PXP NEXT feature is used, it has priority over the REPEAT mode, in that the new register settings are fetched first, and then the next PXP operation will continue.
27 ENABLE_ROTATE1	Enable the ROTATE1 engine in the PXP primary processing flow.

Table continues on the next page...

PXP_HW_PXP_CTRL_n field descriptions (continued)

Field	Description
26 ENABLE_ROTATE0	Enable the ROTATE0 engine in the PXP primary processing flow.
25 ENABLE_LUT	Enable the LUT engine in the PXP primary processing flow.
24 ENABLE_CSC2	Enable the CSC2 engine in the PXP primary processing flow.
23 BLOCK_SIZE	Select the block size to process through the Rotate block.
22–20 Reserved	This read-only field is reserved and always has the value 0.
19 ENABLE_WFE_B	Enable the WFE-B engine in the PXP primary processing flow.
18 Reserved	This read-only field is reserved and always has the value 0.
17 ENABLE_DITHER	Enable the Dithering engine in the PXP primary processing flow.
16 ENABLE_PS_AS_OUT	Enable the PS engine, AS engine, OUTBUF in the PXP primary processing flow.
15 VFLIP1	Indicates that the input should be flipped vertically (effect applied before rotation).
14 HFLIP1	Indicates that the input should be flipped horizontally (effect applied before rotation).
13–12 ROTATE1	Indicates the clockwise rotation to be applied at the input buffer. The rotation effect is defined as occurring after the FLIP_X and FLIP_Y permutation.
11 VFLIP0	Indicates that the output buffer should be flipped vertically (effect applied before rotation).
10 HFLIP0	Indicates that the output buffer should be flipped horizontally (effect applied before rotation).
9–8 ROTATE0	Indicates the clockwise rotation to be applied at the output buffer. The rotation effect is defined as occurring after the FLIP_X and FLIP_Y permutation.
7–6 Reserved	This read-only field is reserved and always has the value 0.
5 HANDSHAKE_ABORT_SKIP	When skip is enable, even the abort asserted, pxp will not assert the ready directly but wait for whole block line complete.
4 ENABLE_LCD0_HANDSHAKE	Enable handshake with LCD0 controller. When this is set, the PXP will not process an entire framebuffer, but will instead process rows of NxN blocks in a double-buffer handshake with the LCDIF. This enables the use of the onboard SRAM for a partial frame buffer.
3 LUT_DMA_IRQ_ENABLE	LUT DMA interrupt enable. When set, the PXP will issue an interrupt when the LUT DMA has finished transferring data.
2 NEXT_IRQ_ENABLE	Next command interrupt enable. When set, the PXP will issue an interrupt when a queued command initiated by a write to the PXP_NEXT register has been loaded into the PXP's registers. This interrupt also indicates that a new command may now be queued.

Table continues on the next page...

PXP_HW_PXP_CTRL_n field descriptions (continued)

Field	Description
1 IRQ_ENABLE	Interrupt enable. NOTE: When using the HW_PXP_NEXT functionality to reprogram the PXP, the new value of this bit will be used and may therefore enable or disable an interrupt unintentionally.
0 ENABLE	Enables PXP operation with specified parameters. The ENABLE bit will remain set while the PXP is active and will be cleared once the current operation completes. Software should use the IRQ bit in the HW_PXP_STAT when polling for PXP completion.

41.11.2 Status Register (PXP_HW_PXP_STATn)

This register provides PXP interrupt status and the current X/Y block coordinate that is being processed.

Address: 21C_C000h base + 10h offset + (4d × i), where i=0d to 3d

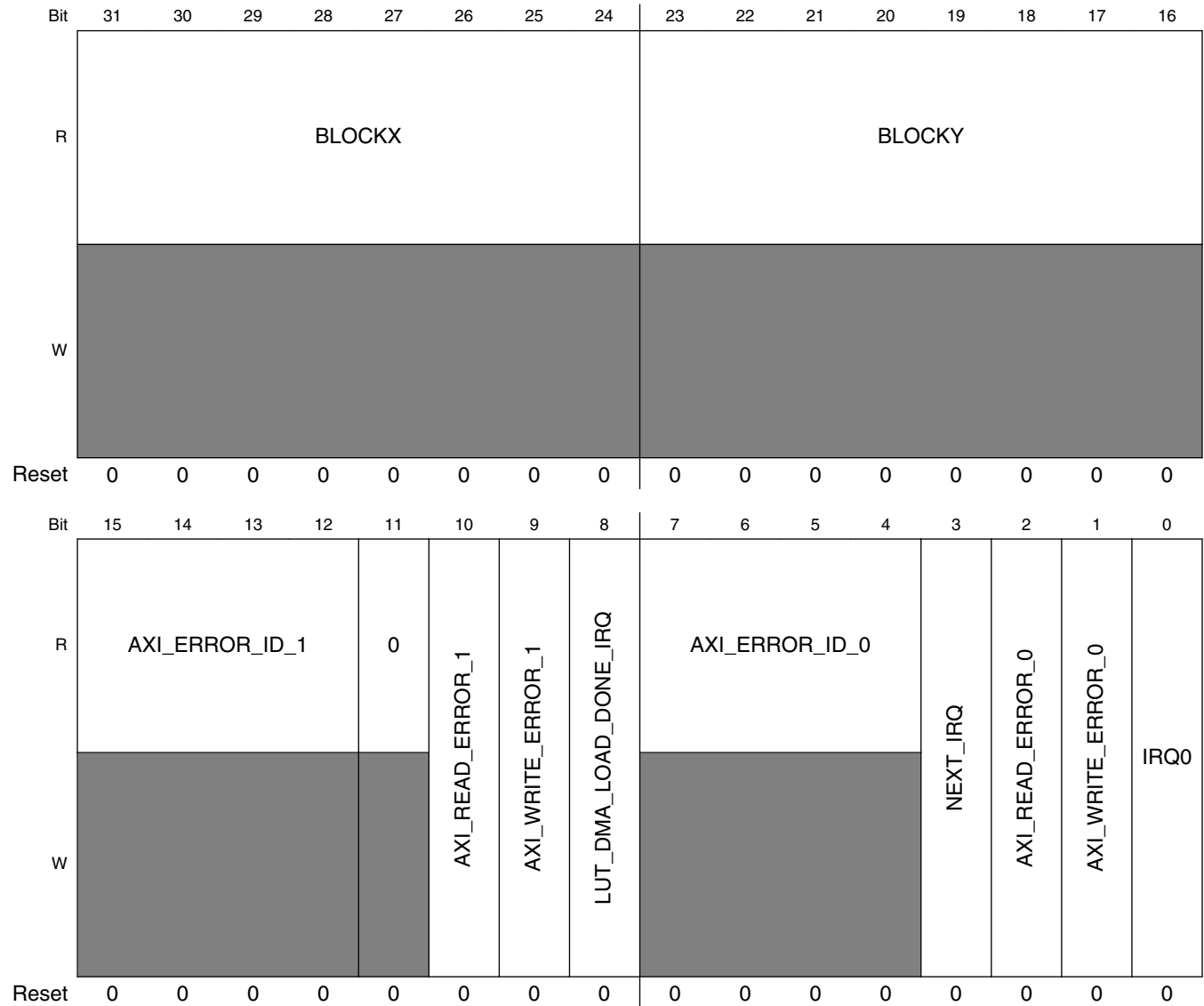

PXP_HW_PXP_STATn field descriptions

Field	Description
31–24 BLOCKX	Indicates the X coordinate of the block currently being rendered.

Table continues on the next page...

PXP_HW_PXP_STATn field descriptions (continued)

Field	Description
23–16 BLOCKY	Indicates the X coordinate of the block currently being rendered.
15–12 AXI_ERROR_ID_1	Indicates the AXI1 ID of the failing bus operation.
11 Reserved	This read-only field is reserved and always has the value 0.
10 AXI_READ_ERROR_1	Indicates PXP encountered an AXI read error and processing has been terminated.
9 AXI_WRITE_ERROR_1	Indicates PXP encountered an AXI write error and processing has been terminated.
8 LUT_DMA_LOAD_DONE_IRQ	Indicates that the LUT DMA transfer has completed.
7–4 AXI_ERROR_ID_0	Indicates the AXI0 ID of the failing bus operation.
3 NEXT_IRQ	Indicates that a command issued with the "Next Command" functionality has been issued and that a new command may be initiated with a write to the PXP_NEXT register.
2 AXI_READ_ERROR_0	Indicates PXP encountered an AXI read error and processing has been terminated.
1 AXI_WRITE_ERROR_0	Indicates PXP encountered an AXI write error and processing has been terminated.
0 IRQ0	Indicates current PXP interrupt status. The IRQ is routed through the pxp_irq when the IRQ_ENABLE bit in the control register is set.

41.11.3 Output Buffer Control Register (PXP_HW_PXP_OUT_CTRLn)

Control register to determine OUT buffer processing.

Address: 21C_C000h base + 20h offset + (4d × i), where i=0d to 3d

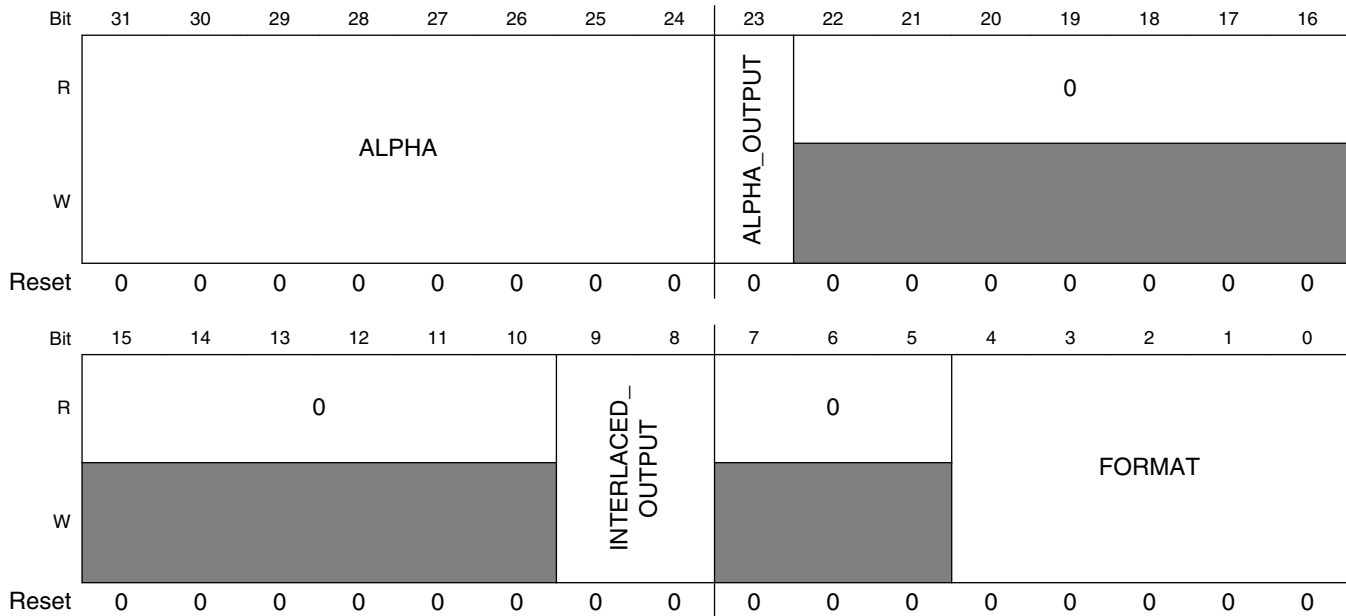

PXP_HW_PXP_OUT_CTRLn field descriptions

Field	Description
31-24 ALPHA	When generating an output buffer with an alpha component, the value in this field will be used when enabled to override the alpha passed through the pixel data pipeline.
23 ALPHA_OUTPUT	Indicates that alpha component in output buffer pixels should be overwritten by REG_OUT_CTRL[ALPHA] register. If 0, retain their alpha value from the computed alpha for that pixel.
22-10 Reserved	This read-only field is reserved and always has the value 0.
9-8 INTERLACED_OUTPUT	Determines how the PXP writes it's output data. Output interlacing should not be used in conjunction with input interlacing. Splitting frames into fields is most efficient using output interlacing. 2-plane output formats AND interlaced output is NOT supported.
7-5 Reserved	This read-only field is reserved and always has the value 0.
FORMAT	Output framebuffer format. The UV byte lanes are synonymous with CbCr byte lanes for YUV output pixel formats. For example, the YUV2P420 format should be selected when the output is YCbCr 2-plane 420 output format.

41.11.4 Output Frame Buffer Pointer (PXP_HW_PXP_OUT_BUF)

This register is used by the logic to point to the current output location for the output frame buffer.

Address: 21C_C000h base + 30h offset = 21C_C030h

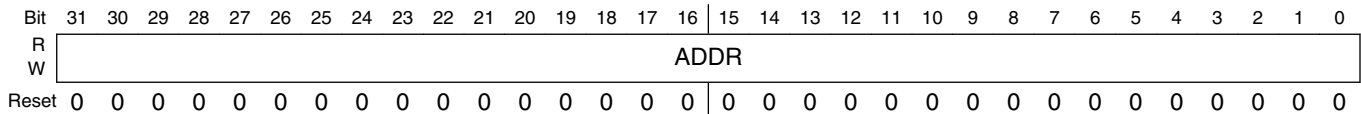

PXP_HW_PXP_OUT_BUF field descriptions

Field	Description
ADDR	Current address pointer for the output frame buffer. The address can have any byte alignment. 64B alignment is recommended for optimal performance.

41.11.5 Output Frame Buffer Pointer #2 (PXP_HW_PXP_OUT_BUF2)

This register is used by the logic to point to the current output location for the field 1 or UV output frame buffer.

Address: 21C_C000h base + 40h offset = 21C_C040h

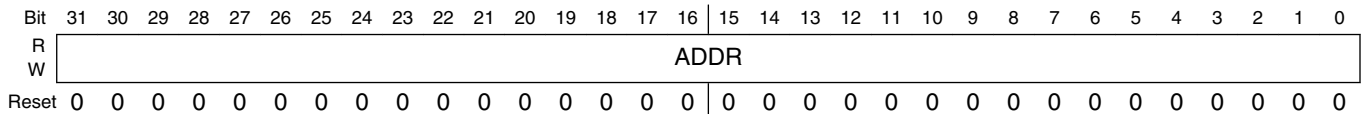

PXP_HW_PXP_OUT_BUF2 field descriptions

Field	Description
ADDR	Current address pointer for the output frame buffer. The address can have any byte alignment. 64B alignment is recommended for optimal performance.

41.11.6 Output Buffer Pitch (PXP_HW_PXP_OUT_PITCH)

Any byte value will indicate the vertical pitch. This value will be used in output pixel address calculations.

Address: 21C_C000h base + 50h offset = 21C_C050h

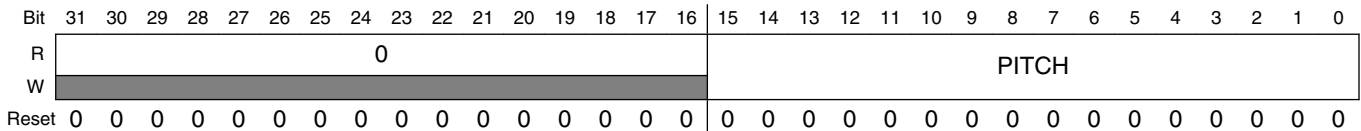

PXP_HW_PXP_OUT_PITCH field descriptions

Field	Description
31–16 Reserved	This read-only field is reserved and always has the value 0.
PITCH	Indicates the number of bytes in memory between two vertically adjacent pixels.

41.11.7 Output Surface Lower Right Coordinate (PXP_HW_PXP_OUT_LRC)

This register sets the size of the output frame buffer in pixels, not blocks. The frame buffer need not be a multiple of NxN pixels. Partial blocks will be written for output frame buffer sizes that are not divisible by N pixels in either dimension.

Address: 21C_C000h base + 60h offset = 21C_C060h

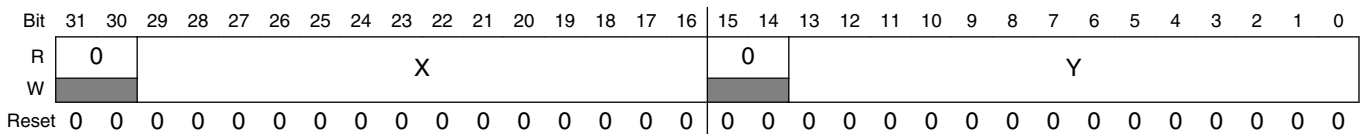

PXP_HW_PXP_OUT_LRC field descriptions

Field	Description
31–30 Reserved	This read-only field is reserved and always has the value 0.
29–16 X	Indicates number of horizontal PIXELS in the output surface (non-rotated). The output buffer pixel width minus 1 should be programmed. The image size is not required to be a multiple of 8 pixels. The PXP will clip the pixel output at this boundary.

Table continues on the next page...

PXP_HW_PXP_OUT_LRC field descriptions (continued)

Field	Description
15–14 Reserved	This read-only field is reserved and always has the value 0.
Y	Indicates the number of vertical PIXELS in the output surface (non-rotated). The output buffer pixel height minus 1 should be programmed. The image size is not required to be a multiple of 8 pixels. The PXP will clip the pixel output at this boundary.

41.11.8 Processed Surface Upper Left Coordinate (PXP_HW_PXP_OUT_PS_ULC)

This register contains the upper left coordinate of the Processed Surface in the output frame buffer (in pixels). Values that are within the REG_OUT_LRC[X,Y] extents are valid. The lowest valid value for these fields is 0,0. If the value of the REG_OUT_PS_ULC is greater than the REG_OUT_LRC, then no PS pixels will be fetched from memory, but only REG_PS_BACKGROUND pixels will be processed by the PS engine. Pixel locations that are greater than or equal to the PS upper left coordinates, less than or equal to the PS lower right coordinates, and within the REG_OUT_LRC extents will use the PS to render pixels into the output buffer.

Address: 21C_C000h base + 70h offset = 21C_C070h

Bit	31	30	29	28	27	26	25	24	23	22	21	20	19	18	17	16	15	14	13	12	11	10	9	8	7	6	5	4	3	2	1	0
R	0																0															
W																																
Reset	0	0	0	0	0	0	0	0	0	0	0	0	0	0	0	0	0	0	0	0	0	0	0	0	0	0	0	0	0	0	0	

PXP_HW_PXP_OUT_PS_ULC field descriptions

Field	Description
31–30 Reserved	This read-only field is reserved and always has the value 0.
29–16 X	This field indicates the upper left X-coordinate (in pixels) of the processed surface (PS) in the output buffer.
15–14 Reserved	This read-only field is reserved and always has the value 0.
Y	This field indicates the upper left Y-coordinate (in pixels) of the processed surface in the output buffer.

41.11.9 Processed Surface Lower Right Coordinate (PXP_HW_PXP_OUT_PS_LRC)

This register contains the lower right coordinate of the Processed Surface in the output frame buffer (in pixels). Values that are within the REG_OUT_LRC[X,Y] extents are valid. The lowest valid value for these fields is 0,0. Pixel locations that are greater than or equal to the PS upper left coordinates, less than or equal to the PS lower right coordinates, and within the REG_OUT_LRC extents will use the PS to render pixels into the output buffer.

Address: 21C_C000h base + 80h offset = 21C_C080h

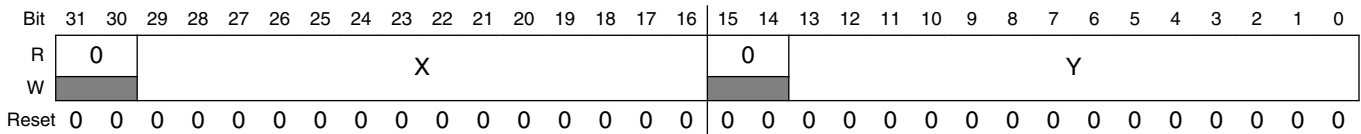

PXP_HW_PXP_OUT_PS_LRC field descriptions

Field	Description
31–30 Reserved	This read-only field is reserved and always has the value 0.
29–16 X	This field indicates the lower right X-coordinate (in pixels) of the processed surface (PS) in the output frame buffer.
15–14 Reserved	This read-only field is reserved and always has the value 0.
Y	This field indicates the lower right Y-coordinate (in pixels) of the processed surface in the output frame buffer.

41.11.10 Alpha Surface Upper Left Coordinate (PXP_HW_PXP_OUT_AS_ULC)

This register contains the upper left coordinate of AS in the output frame buffer (in pixels). Values that are within the REG_OUT_LRC[X,Y] extents are valid. The lowest valid value for these fields is 0,0. Pixel locations that are greater than or equal to the upper left coordinates will use the AS to render pixels in the output buffer.

Address: 21C_C000h base + 90h offset = 21C_C090h

Bit	31	30	29	28	27	26	25	24	23	22	21	20	19	18	17	16	15	14	13	12	11	10	9	8	7	6	5	4	3	2	1	0
R	0																0															
W																																
Reset	0	0	0	0	0	0	0	0	0	0	0	0	0	0	0	0	0	0	0	0	0	0	0	0	0	0	0	0	0	0	0	0

PXP_HW_PXP_OUT_AS_ULC field descriptions

Field	Description
31–30 Reserved	This read-only field is reserved and always has the value 0.
29–16 X	This field indicates the upper left X-coordinate (in pixels) of the alpha surface (AS) in the output frame buffer.
15–14 Reserved	This read-only field is reserved and always has the value 0.
Y	This field indicates the upper left Y-coordinate (in pixels) of the alpha surface in the output frame buffer.

41.11.11 Alpha Surface Lower Right Coordinate (PXP_HW_PXP_OUT_AS_LRC)

This register contains the lower right coordinate of AS in the output frame buffer (in pixels). Values that are within the REG_OUT_LRC[X,Y] extents are valid. The lowest valid value for these fields is 0,0. Pixel locations that are less than or equal to the lower right coordinates will use the AS to render pixels in the output buffer.

Address: 21C_C000h base + A0h offset = 21C_C0A0h

Bit	31	30	29	28	27	26	25	24	23	22	21	20	19	18	17	16	15	14	13	12	11	10	9	8	7	6	5	4	3	2	1	0
R	0																0															
W																																
Reset	0	0	0	0	0	0	0	0	0	0	0	0	0	0	0	0	0	0	0	0	0	0	0	0	0	0	0	0	0	0	0	0

PXP_HW_PXP_OUT_AS_LRC field descriptions

Field	Description
31–30 Reserved	This read-only field is reserved and always has the value 0.
29–16 X	This field indicates the lower right X-coordinate (in pixels) of the alpha surface (AS) in the output frame buffer.
15–14 Reserved	This read-only field is reserved and always has the value 0.
Y	This field indicates the lower right Y-coordinate (in pixels) of the alpha surface in the output frame buffer.

41.11.12 Processed Surface (PS) Control Register (PXP_HW_PXP_PS_CTRLn)

Control register to determine PS buffer processing.

Address: 21C_C000h base + B0h offset + (4d × i), where i=0d to 3d

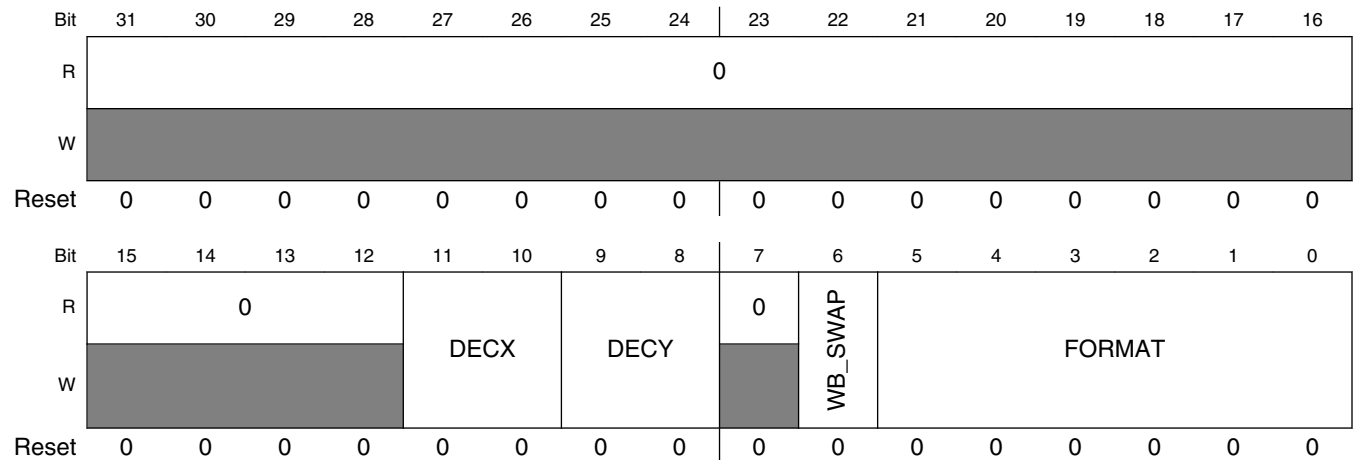

PXP_HW_PXP_PS_CTRLn field descriptions

Field	Description
31–12 Reserved	This read-only field is reserved and always has the value 0.
11–10 DECX	Horizontal pre decimation filter control.
9–8 DECY	Verticle pre decimation filter control.
7 Reserved	This read-only field is reserved and always has the value 0.
6 WB_SWAP	Swap bytes in words. For each 16 bit word, the two bytes will be swapped.
FORMAT	PS buffer format. To select between YUV and YCbCr formats, see bit 31 of the CSC1_COEF0 register.

41.11.13 PS Input Buffer Address (PXP_HW_PXP_PS_BUF)

This register contains the pointer to the Luma/RGB buffer. If the application requires an offset into the PS buffer, then this address can be set so that the desired offset is achieved. Any byte address is valid. For best performance, 64B alignment is recommended.

Address: 21C_C000h base + C0h offset = 21C_C0C0h

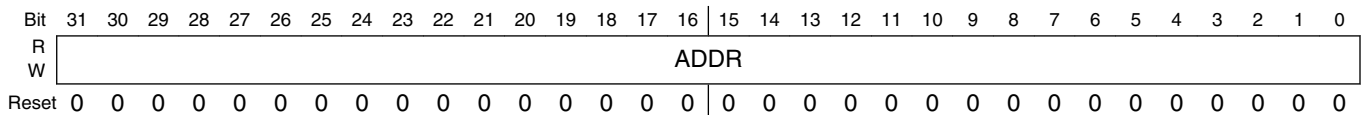

PXP_HW_PXP_PS_BUF field descriptions

Field	Description
ADDR	Address pointer for the PS RGB or Y (luma) input buffer.

41.11.14 PS U/Cb or 2 Plane UV Input Buffer Address (PXP_HW_PXP_PS_UBUF)

This register contains the pointer to the Chroma U/Cb or 2 plane UV buffer. This register is unused when processing 1-plane buffer formats. If the application requires an offset into the PS buffer, then this address can be set so that the desired offset is achieved. Any byte address is valid. For best performance, 64B alignment is recommended.

Address: 21C_C000h base + D0h offset = 21C_C0D0h

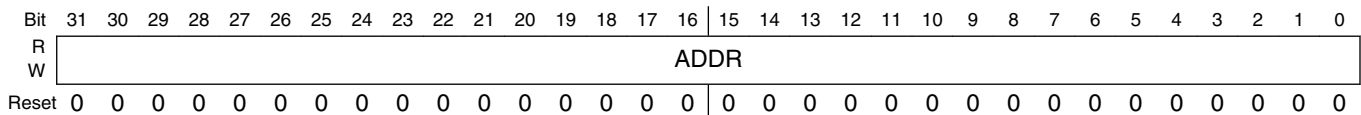

PXP_HW_PXP_PS_UBUF field descriptions

Field	Description
ADDR	Address pointer for the PS U/Cb or 2 plane UV Chroma input buffer.

41.11.15 PS V/Cr Input Buffer Address (PXP_HW_PXP_PS_VBUF)

This register contains the pointer to the Chroma V/Cr buffer. For Y8/Y4 modes, the low 16 bits are used as the monochrome U and V values in the data path. Bits [15:8] represent the U data byte, and bits [7:0] represent the V data byte. Other than with Y8/Y4 input buffer formats, this register is unused when processing 1 or 2-plane buffer formats. If the application requires an offset into the PS buffer, then this address can be set so that the desired offset is achieved. Any byte address is valid. For best performance, 64B alignment is recommended.

Address: 21C_C000h base + E0h offset = 21C_C0E0h

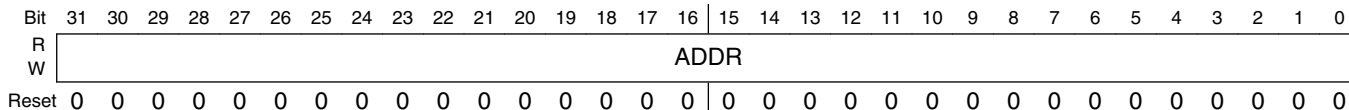

PXP_HW_PXP_PS_VBUF field descriptions

Field	Description
ADDR	Address pointer for the PS V/Cr Chroma input buffer.

41.11.16 Processed Surface Pitch (PXP_HW_PXP_PS_PITCH)

Any byte value will indicate the vertical pitch of the PS source frame buffer. This value will be used in PS pixel address calculations. This value has no relation to the UL and LR registers. It specifies how many bytes are between two vertically adjacent pixels in the input PS surface. For multi-plane formats, the Y buffer pitch should be programmed. For 2-plane YUV422, the UV pitch is the same as the Y pitch. For 3-plane YUV422, the U and V pitch is 1/2 the Y pitch. For 2-plane YUV420, the UV pitch is 1/2 the Y pitch. For 3-plane YUV420, the U and V pitch is 1/4 the Y pitch. All source buffers should comply with these U and V resolution reductions with respect to their Y source buffers.

Address: 21C_C000h base + F0h offset = 21C_C0F0h

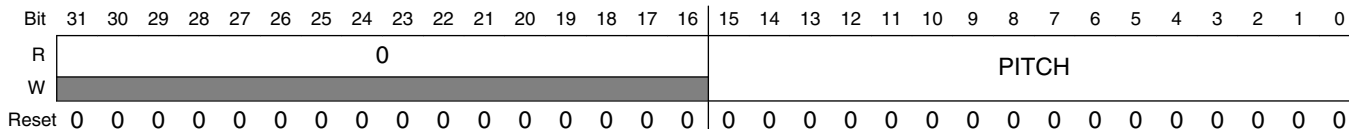

PXP_HW_PXP_PS_PITCH field descriptions

Field	Description
31–16 Reserved	This read-only field is reserved and always has the value 0.
PITCH	Indicates the number of bytes in memory between two vertically adjacent pixels.

**41.11.17 PS Background Color
(PXP_HW_PXP_PS_BACKGROUND_0)**

This register contains a pixel value to be used for any PS pixels that fall outside the PS extents. This is effectively a background or letterbox color. The CSC1 control and datapath pixel format should be considered when selecting the background color.

Address: 21C_C000h base + 100h offset = 21C_C100h

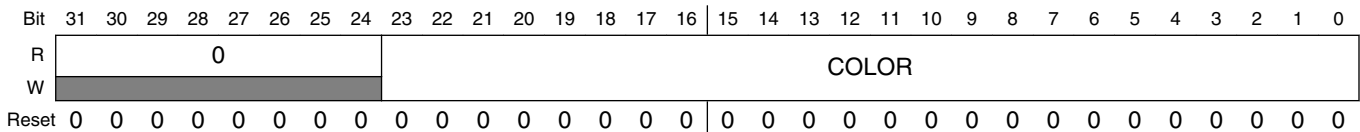
**PXP_HW_PXP_PS_BACKGROUND_0 field descriptions**

Field	Description
31–24 Reserved	This read-only field is reserved and always has the value 0.
COLOR	Background color (in 24bpp format) for any pixels not within the buffer range specified by the PS ULC/LRC.

41.11.18 PS Scale Factor Register (PXP_HW_PXP_PS_SCALE)

The maximum down scaling factor is 1/2 such that the output image in either axis is 1/2 the size of the source. The maximum up scaling factor is 2^12 for either axis. The reciprocal of the scale factor should be loaded into this register. To reduce the PS buffer by a factor of two in the output frame buffer, a value of 10.0000_0000_0000 should be loaded into this register. To scale up by a factor of 4, the value of 1/4, or 00.0100_0000_0000, should be loaded into this register. To scale up by 8/5, the value of 00.1010_0000_0000 should be loaded.

Address: 21C_C000h base + 110h offset = 21C_C110h

Bit	31	30	29	28	27	26	25	24	23	22	21	20	19	18	17	16
R	0															
W		YSCALE														
Reset	0	0	0	1	0	0	0	0	0	0	0	0	0	0	0	0
Bit	15	14	13	12	11	10	9	8	7	6	5	4	3	2	1	0
R	0															
W		XSCALE														
Reset	0	0	0	1	0	0	0	0	0	0	0	0	0	0	0	0

PXP_HW_PXP_PS_SCALE field descriptions

Field	Description
31 Reserved	This read-only field is reserved and always has the value 0.
30-16 YSCALE	This is a two bit integer and 12 bit fractional representation (##.####_####_####) of the Y scaling factor for the PS source buffer. The maximum value programmed should be 2 since scaling down by a factor greater than 2 is not supported with the bilinear filter. Decimation and the bilinear filter should be used together to achieve scaling by more than a factor of 2.
15 Reserved	This read-only field is reserved and always has the value 0.
XSCALE	This is a two bit integer and 12 bit fractional representation (##.####_####_####) of the X scaling factor for the PS source buffer. The maximum value programmed should be 2 since scaling down by a factor greater than 2 is not supported with the bilinear filter. Decimation and the bilinear filter should be used together to achieve scaling by more than a factor of 2.

41.11.19 PS Scale Offset Register (PXP_HW_PXP_PS_OFFSET)

The X and Y offset provides the ability to access the source image with a per sub-pixel granularity. This provides the capability to use all source pixels to effect the output PS image. The fixed offset values can be used for sub-pixel adjustments in the bilinear scaling filter. For example, when scaling an image down by a factor of 2, an initial offset of 0x0 would result in sub-sampling every other pixel. If a fixed offset of 0x800 (1/2), all pixels are used in scaling the final output pixel value. In this case, the first output pixel would be the sum of $(1/2 * P_0) + (1/2 * P_1)$. This fixed offset is applied after the decimation filter stage, and before the bilinear filter stage.

Address: 21C_C000h base + 120h offset = 21C_C120h

Bit	31	30	29	28	27	26	25	24	23	22	21	20	19	18	17	16	15	14	13	12	11	10	9	8	7	6	5	4	3	2	1	0
R	0				YOFFSET												0				XOFFSET											
W	0				0												0				0											
Reset	0	0	0	0	0	0	0	0	0	0	0	0	0	0	0	0	0	0	0	0	0	0	0	0	0	0	0	0	0	0	0	0

PXP_HW_PXP_PS_OFFSET field descriptions

Field	Description
31–28 Reserved	This read-only field is reserved and always has the value 0.
27–16 YOFFSET	This is a 12 bit fractional representation (0.####_####_####) of the Y scaling offset. This represents a fixed pixel offset which gets added to the scaled address to determine source data for the scaling engine.
15–12 Reserved	This read-only field is reserved and always has the value 0.
XOFFSET	This is a 12 bit fractional representation (0.####_####_####) of the X scaling offset. This represents a fixed pixel offset which gets added to the scaled address to determine source data for the scaling engine.

41.11.20 PS Color Key Low (PXP_HW_PXP_PS_CLRKEYLOW_0)

When processing an image, if the PXP finds a pixel in the PS buffer with a color that falls in the range between REG_PS_CLRKEYLOW and REG_PS_CLRKEYHIGH, it will insert the pixel from the AS channel. If the current AS pixel is letterboxed or if the AS also matches its colorkey range, the REG_PS_BACKGROUND color is passed down the pixel pipeline.

Address: 21C_C000h base + 130h offset = 21C_C130h

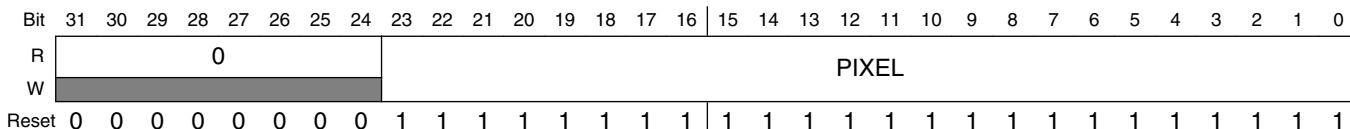

PXP_HW_PXP_PS_CLRKEYLOW_0 field descriptions

Field	Description
31-24 Reserved	This read-only field is reserved and always has the value 0.
PIXEL	Low range of color key applied to PS buffer. To disable PS colorkeying, set the low colorkey to 0xFFFFFFFF and the high colorkey to 0x000000.

41.11.21 PS Color Key High (PXP_HW_PXP_PS_CLRKEYHIGH_0)

When processing an image, if the PXP finds a pixel in the PS buffer with a color that falls in the range between REG_PS_CLRKEYLOW and REG_PS_CLRKEYHIGH, it will insert the pixel from the AS channel. If the current AS pixel is letterboxed or if the AS also matches its colorkey range, the REG_PS_BACKGROUND color is passed down the pixel pipeline.

Address: 21C_C000h base + 140h offset = 21C_C140h

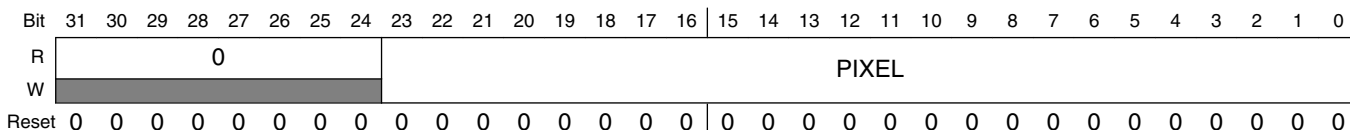

PXP_HW_PXP_PS_CLRKEYHIGH_0 field descriptions

Field	Description
31–24 Reserved	This read-only field is reserved and always has the value 0.
PIXEL	High range of color key applied to PS buffer. To disable PS colorkeying, set the low colorkey to 0xFFFFFFFF and the high colorkey to 0x000000.

41.11.22 Alpha Surface Control (PXP_HW_PXP_AS_CTRL)

Control register to determine AS buffer processing.

Address: 21C_C000h base + 150h offset = 21C_C150h

Bit	31	30	29	28	27	26	25	24	23	22	21	20	19	18	17	16
R	0										ALPHA1_ INVERT	ALPHA0_ INVERT	ROP			
W																
Reset	0	0	0	0	0	0	0	0	0	0	0	0	0	0	0	0
Bit	15	14	13	12	11	10	9	8	7	6	5	4	3	2	1	0
R	ALPHA								FORMAT				ENABLE_ COLORKEY	ALPHA_ CTRL		0
W																
Reset	0	0	0	0	0	0	0	0	0	0	0	0	0	0	0	0

PXP_HW_PXP_AS_CTRL field descriptions

Field	Description
31–22 Reserved	This read-only field is reserved and always has the value 0.
21 ALPHA1_ INVERT	Setting this bit to logic 0 will not alter the alpha1 value. A logic 1 will invert the alpha1 value and apply (1-alpha) for image composition.
20 ALPHA0_ INVERT	Setting this bit to logic 0 will not alter the alpha0 value. A logic 1 will invert the alpha0 value and apply (1-alpha) for image composition.
19–16 ROP	Indicates a raster operation to perform when enabled. Raster operations are enabled through the ALPHA_CTRL field.

Table continues on the next page...

PXP_HW_PXP_AS_CTRL field descriptions (continued)

Field	Description
15–8 ALPHA	Alpha modifier used when the ALPHA_MULTIPLY or ALPHA_OVERRIDE values are programmed in REG_AS_CTRL[ALPHA_CTRL]. The output alpha value will either be replaced (ALPHA_OVERRIDE) or scaled (ALPHA_MULTIPLY) when selected.
7–4 FORMAT	Indicates the input buffer format for AS.
3 ENABLE_ COLORKEY	Indicates that colorkey functionality is enabled for this alpha surface. Pixels found in the alpha surface colorkey range will be displayed as transparent (the PS pixel will be used).
2–1 ALPHA_CTRL	Determines how the alpha value is constructed for this alpha surface. Indicates that the value in the ALPHA field should be used instead of the alpha values present in the input pixels.
0 Reserved	This read-only field is reserved and always has the value 0.

41.11.23 Alpha Surface Buffer Pointer (PXP_HW_PXP_AS_BUF)

This register is used to indicate the base address of the AS buffer.

Address: 21C_C000h base + 160h offset = 21C_C160h

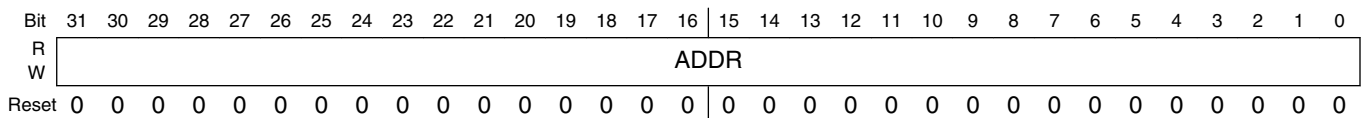

PXP_HW_PXP_AS_BUF field descriptions

Field	Description
ADDR	Address pointer for the alpha surface 0 buffer.

41.11.24 Alpha Surface Pitch (PXP_HW_PXP_AS_PITCH)

Any byte value will indicate the vertical pitch. This value will be used in AS pixel address calculations. This value has no relation to the UL and LR registers. It specifies how many bytes are between two vertically adjacent pixels in the input AS surface.

Address: 21C_C000h base + 170h offset = 21C_C170h

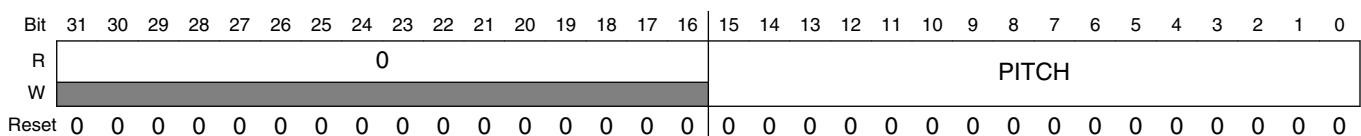

PXP_HW_PXP_AS_PITCH field descriptions

Field	Description
31–16 Reserved	This read-only field is reserved and always has the value 0.
PITCH	Indicates the number of bytes in memory between two vertically adjacent pixels.

**41.11.25 Overlay Color Key Low
(PXP_HW_PXP_AS_CLRKEYLOW_0)**

When processing an image, the if the PXP finds a pixel in the current overlay image with a color that falls in the range from the ASCOLORKEYLOW to ASCOLORKEYHIGH range, it will use the PS pixel value for that location. If no PS image is present or if the PS image also matches its colorkey range, the PS background color is used. Colorkey operations are higher priority than alpha or ROP operations.

Address: 21C_C000h base + 180h offset = 21C_C180h

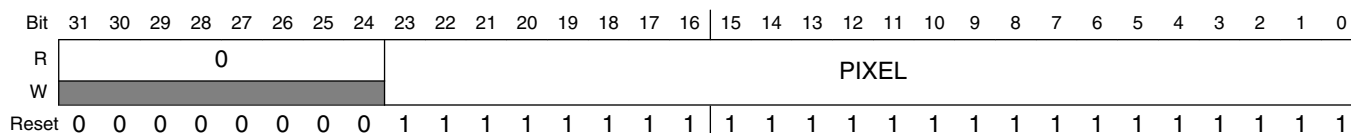
**PXP_HW_PXP_AS_CLRKEYLOW_0 field descriptions**

Field	Description
31–24 Reserved	This read-only field is reserved and always has the value 0.
PIXEL	Low range of RGB color key applied to AS buffer. Each overlay has an independent colorkey enable.

41.11.26 Overlay Color Key High (PXP_HW_PXP_AS_CLRKEYHIGH_0)

When processing an image, the if the PXP finds a pixel in the current overlay image with a color that falls in the range from the ASCOLORKEYLOW to ASCOLORKEYHIGH range, it will use the PS pixel value for that location. If no PS image is present or if the PS image also matches its colorkey range, the PS background color is used. Colorkey operations are higher priority than alpha or ROP operations.

Address: 21C_C000h base + 190h offset = 21C_C190h

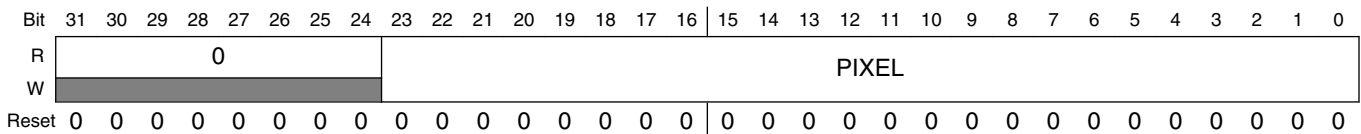

PXP_HW_PXP_AS_CLRKEYHIGH_0 field descriptions

Field	Description
31–24 Reserved	This read-only field is reserved and always has the value 0.
PIXEL	High range of RGB color key applied to AS buffer. Each overlay has an independent colorkey enable.

41.11.27 Color Space Conversion Coefficient Register 0 (PXP_HW_PXP_CSC1_COEF0)

The Coefficient 0 register contains coefficients used in the color space conversion algorithm. The Y and UV offsets are added to the source buffer to normalize them before the conversion. C0 is the coefficient that is used to multiply the luma component of the data for all three RGB components.

Address: 21C_C000h base + 1A0h offset = 21C_C1A0h

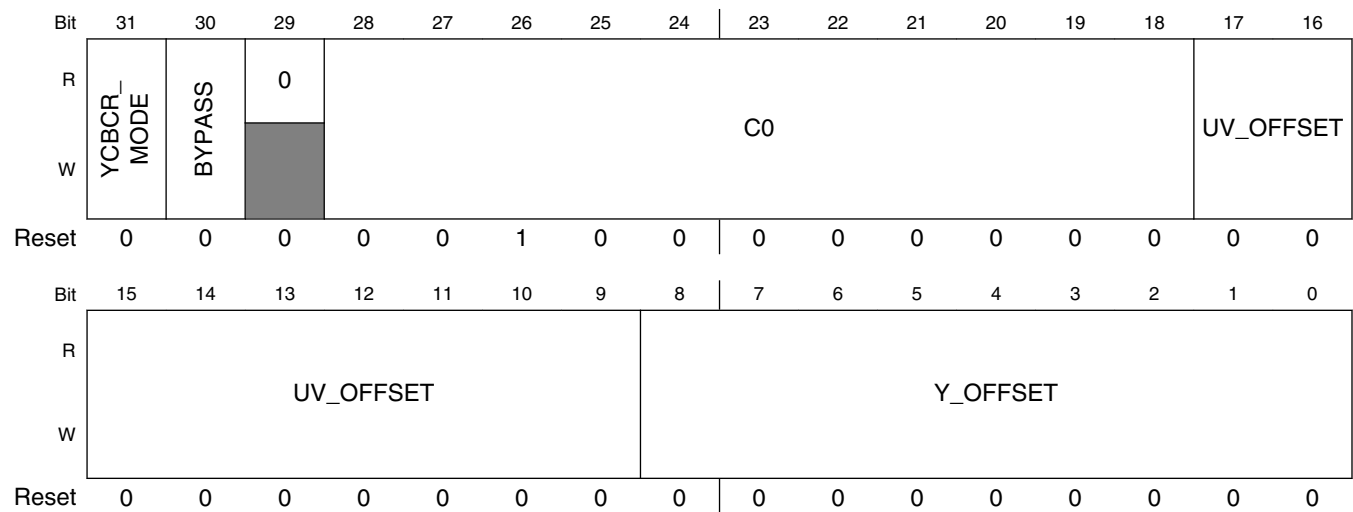

PXP_HW_PXP_CSC1_COEF0 field descriptions

Field	Description
31 YCBCR_MODE	Set to 1 when performing YCbCr conversion to RGB. Set to 0 when converting YUV to RGB data. This bit changes the behavior of the scaler when performing U/V scaling.
30 BYPASS	Bypass the CSC unit in the scaling engine. When set to logic 1, bypass is enabled and the output pixels will be in the YUV/YCbCr color space. When set to logic 0, the CSC unit is enabled and the pixels will be converted based on the programmed coefficients.
29 Reserved	This read-only field is reserved and always has the value 0.
28–18 C0	Two's complement Y multiplier coefficient. YUV=0x100 (1.000) YCbCr=0x12A (1.164)
17–9 UV_OFFSET	Two's complement phase offset implicit for CbCr data. Generally used for YCbCr to RGB conversion. YCbCr=0x180, YUV=0x000 (typically -128 or 0x180 to indicate normalized -0.5 to 0.5 range)
Y_OFFSET	Two's complement amplitude offset implicit in the Y data. For YUV, this is typically 0 and for YCbCr, this is typically -16 (0x1F0)

41.11.28 Color Space Conversion Coefficient Register 1 (PXP_HW_PXP_CSC1_COEF1)

The Coefficient 1 register contains coefficients used in the color space conversion algorithm. C1 is the coefficient that is used to multiply the chroma (Cr/V) component of the data for the red component. C4 is the coefficient that is used to multiply the chroma (Cb/U) component of the data for the blue component. Both values should be coded as a two's compliment fixed point number with 8 bits right of the decimal.

Address: 21C_C000h base + 1B0h offset = 21C_C1B0h

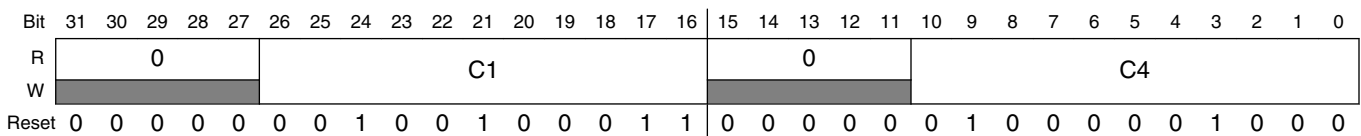

PXP_HW_PXP_CSC1_COEF1 field descriptions

Field	Description
31–27 Reserved	This read-only field is reserved and always has the value 0.
26–16 C1	Two's compliment Red V/Cr multiplier coefficient. YUV=0x123 (1.140) YCbCr=0x198 (1.596)
15–11 Reserved	This read-only field is reserved and always has the value 0.
C4	Two's compliment Blue U/Cb multiplier coefficient. YUV=0x208 (2.032) YCbCr=0x204 (2.017)

41.11.29 Color Space Conversion Coefficient Register 2 (PXP_HW_PXP_CSC1_COEF2)

The Coefficient 2 register contains coefficients used in the color space conversion algorithm. C2 is the coefficient that is used to multiply the chroma (Cr/V) component of the data for the green component. C3 is the coefficient that is used to multiply the chroma (Cb/U) component of the data for the green component. Both values should be coded as a two's complement fixed point number with 8 bits right of the decimal.

Address: 21C_C000h base + 1C0h offset = 21C_C1C0h

Bit	31	30	29	28	27	26	25	24	23	22	21	20	19	18	17	16	15	14	13	12	11	10	9	8	7	6	5	4	3	2	1	0
R	0					C2											0					C3										
W	1					0											1					0										
Reset	0	0	0	0	0	1	1	1	1	0	0	1	1	0	1	1	0	0	0	0	0	1	1	1	0	1	1	0	1	1	0	0

PXP_HW_PXP_CSC1_COEF2 field descriptions

Field	Description
31–27 Reserved	This read-only field is reserved and always has the value 0.
26–16 C2	Two's compliment Green V/Cr multiplier coefficient. YUV=0x76B (-0.581) YCbCr=0x730 (-0.813)
15–11 Reserved	This read-only field is reserved and always has the value 0.
C3	Two's compliment Green U/Cb multiplier coefficient. YUV=0x79C (-0.394) YCbCr=0x79C (-0.392)

41.11.30 Color Space Conversion Control Register. (PXP_HW_PXP_CSC2_CTRL)

The CSC control register will configure the CSC module to perform color space conversion between the RGB/YUV/YCbCr color spaces.

Address: 21C_C000h base + 1D0h offset = 21C_C1D0h

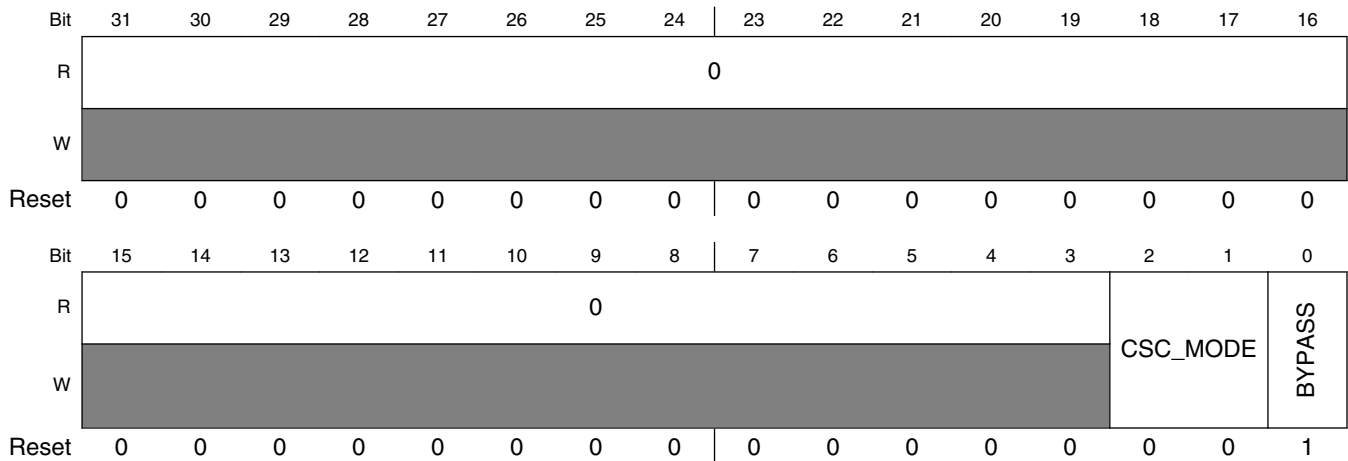

PXP_HW_PXP_CSC2_CTRL field descriptions

Field	Description
31–3 Reserved	This read-only field is reserved and always has the value 0.
2–1 CSC_MODE	This field controls how the CSC unit operates on pixels when the CSC is not bypassed.
0 BYPASS	This bit controls whether the pixels entering the CSC2 unit get converted or not. When BYPASS is set, no operations occur on the pixels. When BYPASS is cleared, the selected CSC operation takes place.

41.11.31 Color Space Conversion Coefficient Register 0 (PXP_HW_PXP_CSC2_COEF0)

Address: 21C_C000h base + 1E0h offset = 21C_C1E0h

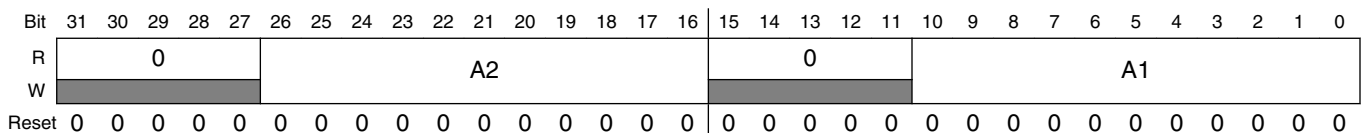

PXP_HW_PXP_CSC2_COEF0 field descriptions

Field	Description
31–27 Reserved	This read-only field is reserved and always has the value 0.
26–16 A2	Two's compliment coefficient offset. This coefficient has a sign bit, 2 bits integer, and 8 bits of fraction as ###.####_####.
15–11 Reserved	This read-only field is reserved and always has the value 0.
A1	Two's compliment coefficient offset. This coefficient has a sign bit, 2 bits integer, and 8 bits of fraction as ###.####_####.

41.11.32 Color Space Conversion Coefficient Register 1 (PXP_HW_PXP_CSC2_COEF1)

Address: 21C_C000h base + 1F0h offset = 21C_C1F0h

Bit	31	30	29	28	27	26	25	24	23	22	21	20	19	18	17	16	15	14	13	12	11	10	9	8	7	6	5	4	3	2	1	0	
R	0					B1											0					A3											
W	0					0											0					0											
Reset	0	0	0	0	0	0	0	0	0	0	0	0	0	0	0	0	0	0	0	0	0	0	0	0	0	0	0	0	0	0	0	0	0

PXP_HW_PXP_CSC2_COEF1 field descriptions

Field	Description
31–27 Reserved	This read-only field is reserved and always has the value 0.
26–16 B1	Two's compliment coefficient offset. This coefficient has a sign bit, 2 bits integer, and 8 bits of fraction as ###.####_####.
15–11 Reserved	This read-only field is reserved and always has the value 0.
A3	Two's compliment coefficient offset. This coefficient has a sign bit, 2 bits integer, and 8 bits of fraction as ###.####_####.

41.11.33 Color Space Conversion Coefficient Register 2 (PXP_HW_PXP_CSC2_COEF2)

Address: 21C_C000h base + 200h offset = 21C_C200h

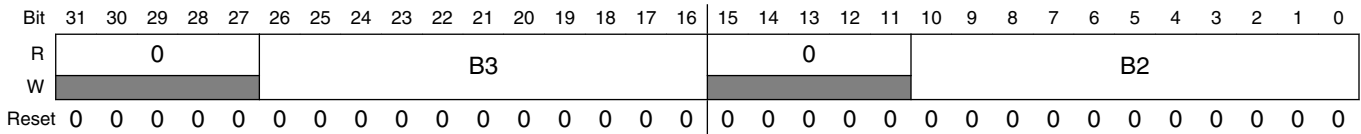

PXP_HW_PXP_CSC2_COEF2 field descriptions

Field	Description
31–27 Reserved	This read-only field is reserved and always has the value 0.
26–16 B3	Two's compliment coefficient offset. This coefficient has a sign bit, 2 bits integer, and 8 bits of fraction as ###.####_####.
15–11 Reserved	This read-only field is reserved and always has the value 0.
B2	Two's compliment coefficient offset. This coefficient has a sign bit, 2 bits integer, and 8 bits of fraction as ###.####_####.

41.11.34 Color Space Conversion Coefficient Register 3 (PXP_HW_PXP_CSC2_COEF3)

Address: 21C_C000h base + 210h offset = 21C_C210h

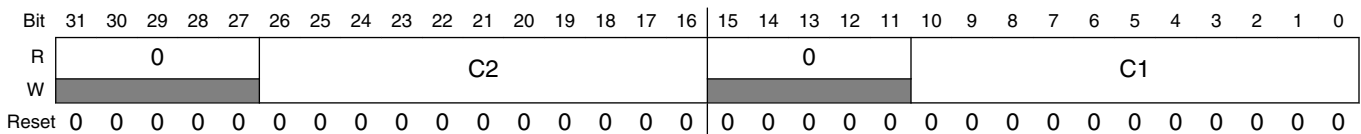

PXP_HW_PXP_CSC2_COEF3 field descriptions

Field	Description
31–27 Reserved	This read-only field is reserved and always has the value 0.
26–16 C2	Two's compliment coefficient offset. This coefficient has a sign bit, 2 bits integer, and 8 bits of fraction as ###.####_####.
15–11 Reserved	This read-only field is reserved and always has the value 0.

Table continues on the next page...

PXP_HW_PXP_CSC2_COEF3 field descriptions (continued)

Field	Description
C1	Two's compliment coefficient offset. This coefficient has a sign bit, 2 bits integer, and 8 bits of fraction as ###.###_####.

41.11.35 Color Space Conversion Coefficient Register 4 (PXP_HW_PXP_CSC2_COEF4)

Address: 21C_C000h base + 220h offset = 21C_C220h

Bit	31	30	29	28	27	26	25	24	23	22	21	20	19	18	17	16	15	14	13	12	11	10	9	8	7	6	5	4	3	2	1	0	
R	0								D1								0				C3												
W	0								0								0				0												
Reset	0	0	0	0	0	0	0	0	0	0	0	0	0	0	0	0	0	0	0	0	0	0	0	0	0	0	0	0	0	0	0	0	0

PXP_HW_PXP_CSC2_COEF4 field descriptions

Field	Description
31–25 Reserved	This read-only field is reserved and always has the value 0.
24–16 D1	Two's compliment coefficient integer offset to be added.
15–11 Reserved	This read-only field is reserved and always has the value 0.
C3	Two's compliment coefficient offset. This coefficient has a sign bit, 2 bits integer, and 8 bits of fraction as ###.###_####.

41.11.36 Color Space Conversion Coefficient Register 5 (PXP_HW_PXP_CSC2_COEF5)

Address: 21C_C000h base + 230h offset = 21C_C230h

Bit	31	30	29	28	27	26	25	24	23	22	21	20	19	18	17	16	15	14	13	12	11	10	9	8	7	6	5	4	3	2	1	0	
R	0								D3								0				D2												
W	0								0								0				0												
Reset	0	0	0	0	0	0	0	0	0	0	0	0	0	0	0	0	0	0	0	0	0	0	0	0	0	0	0	0	0	0	0	0	0

PXP_HW_PXP_CSC2_COEF5 field descriptions

Field	Description
31–25 Reserved	This read-only field is reserved and always has the value 0.
24–16 D3	Two's compliment coefficient integer offset to be added.
15–9 Reserved	This read-only field is reserved and always has the value 0.
D2	Two's compliment D1 coefficient integer offset to be added.

**41.11.37 Lookup Table Control Register.
(PXP_HW_PXP_LUT_CTRL)**

The Y8 LUT input mode will take the high order data path byte and transform it using the LUT memory. This is an 8-bit to 8-bit transformation. The two low order bytes bypass the LUT and are not transformed, but bypassed without modification. This option can be used for monochrome gamma correction. The Direct Lookup mode will use the high nibble of each data byte and truncate the low nibble to generate the lookup address, i.e. R[7:0]G[7:0]B[7:0] -> R[7:4]G[7:4]B[7:4]. 4K pixels (12-bit address) with 2 bytes per pixel is supported in this mode. Cached Lookup mode will use the high order bits, R[7:3],G[7:2],B[7:3] or RGB565, to address the cached LUT memory. 64KB LUT tables, using 16KB of internal LUT memory, can be indirectly transformed to 16-bit output pixels (as in RGBW4444/RGB565). This is used for 16bpp gamma correction or EPD color panel support. Cache misses are internally managed by the PXP LUT Cache controller.

Address: 21C_C000h base + 240h offset = 21C_C240h

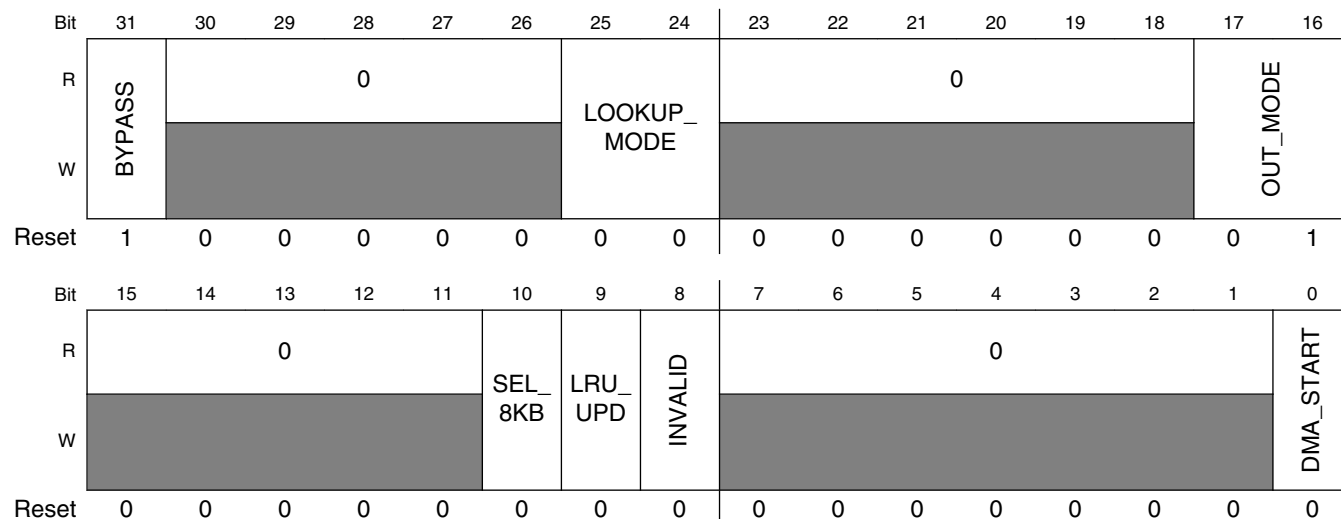

PXP_HW_PXP_LUT_CTRL field descriptions

Field	Description
31 BYPASS	Setting this bit will bypass the LUT memory resource completely. No pixel transformations will occur at this stage of the PXP pixel rprocessing pipeline.
30–26 Reserved	This read-only field is reserved and always has the value 0.
25–24 LOOKUP_MODE	Configure the input address for the 16KB LUT memory. The address into the LUT uses different parts of the pixel data path bytes. The data path is defined as three bytes, conceptually as RGB/YUV/YCbCr[23:0]. Also referred to as R/Y[7:0],G/U[7:0],B/V[7:0]
23–18 Reserved	This read-only field is reserved and always has the value 0.
17–16 OUT_MODE	Select the output mode of operation for the LUT resource. There are four bytes [3-0] in the data path at the output of the LUT resource. Byte lane 3 is always bypassed and usually contains an alpha value. The LUT can be programmed to transform bytes 2,1,0 according to the options available in this field.
15–11 Reserved	This read-only field is reserved and always has the value 0.
10 SEL_8KB	Selects which 8KB bank of memory to use for direct 12bpp lookup modes. Logic 0 indicates first 8KB, logic 1 indicates second 8KB. Two direct LUT arrays can be stored and one can be selected for a given PXP operation.
9 LRU_UPD	Least Recently Used Policy Update Control: 1=> block LRU update for hit after miss. 0=> update LRU for all hits including hit after miss.
8 INVALID	Invalidate the cache LRU and valid bits. This bit will automatically reset when set to a logic 1.
7–1 Reserved	This read-only field is reserved and always has the value 0.
0 DMA_START	Setting this bit will result in the DMA operation to load the PXP LUT memory based on REG_LUT_ADDR_NUM_BYTES, REG_LUT_ADDR_ADDR, and REG_LUT_MEM_ADDR. This bit will automatically reset when set to a logic 1. Note: The LOOKUP_MODE must not be set to CACHE_RGB565 when starting and performing DMA transfers.

41.11.38 Lookup Table Control Register. (PXP_HW_PXP_LUT_ADDR)

The Y8 LUT input mode will take the high order data path byte and transform it using the LUT memory. This is an 8-bit to 8-bit transformation. The two low order bytes bypass the LUT and are not transformed, but bypassed without modification. This option can be used for monochrome gamma correction. The Direct Lookup mode will use the high nibble of each data byte and truncate the low nibble to generate the lookup address, i.e. R[7:0]G[7:0]B[7:0] -> R[7:4]G[7:4]B[7:4]. 4K pixels (12-bit address) with 2 bytes per pixel is supported in this mode. Cached Lookup mode will use the high order bits, R[7:3],G[7:2],B[7:3] or RGB565, to address the cached LUT memory. 64KB LUT tables, using 16KB of internal LUT memory, can be indirectly transformed to 16-bit output pixels (as in RGBW4444/RGB565). This is used for 16bpp gamma correction or EPD color panel support. Cache misses are internally managed by the PXP LUT Cache controller.

Address: 21C_C000h base + 250h offset = 21C_C250h

Bit	31	30	29	28	27	26	25	24	23	22	21	20	19	18	17	16
R	0															
W		NUM_BYTES														
Reset	0	0	0	0	0	0	0	0	0	0	0	0	0	0	0	0
Bit	15	14	13	12	11	10	9	8	7	6	5	4	3	2	1	0
R	0															
W		ADDR														
Reset	0	0	0	0	0	0	0	0	0	0	0	0	0	0	0	0

PXP_HW_PXP_LUT_ADDR field descriptions

Field	Description
31 Reserved	This read-only field is reserved and always has the value 0.
30–16 NUM_BYTES	Indicates the number of bytes to load via a DMA operation. This field must be divisible by 8 and the least significant 3 bits must be 0. The value 8 indicates load 8 bytes from the external address indicated by REG_LUT_MEM_ADDR to the LUT memory location indicated by REG_LUT_CTRL_ADDR.
15–14 Reserved	This read-only field is reserved and always has the value 0.
ADDR	LUT indexed address pointer. This address into the LUT memory is always four byte aligned for PIO access, and eight byte aligned for DMA access. The least two significant bits are not used to drive the LUT memory array. For PIO LUT access, when the LUT data register is written, the contents of the LUT at the address specified by this address field will be loaded with a 32-bit DWORD. This address pointer will be incremented after the LUT data is written. This will provide recursive writes to the LUT data register to initialize the entire LUT array with recursive writes to the LUT data register. For DMA access, this register indicates the LUT memory address of the 8 byte QWORD to be loaded. When using the NUM_BYTES

Table continues on the next page...

PXP_HW_PXP_LUT_ADDR field descriptions (continued)

Field	Description
	field to load more than 8 bytes, the register should be programmed with the first LUT memory location to be filled and each load of the LUT memory will increment this address field until NUM_BYTES has been loaded.

**41.11.39 Lookup Table Data Register.
(PXP_HW_PXP_LUT_DATA)**

Address: 21C_C000h base + 260h offset = 21C_C260h

Bit	31	30	29	28	27	26	25	24	23	22	21	20	19	18	17	16	15	14	13	12	11	10	9	8	7	6	5	4	3	2	1	0		
R																		DATA																
W																		DATA																
Reset	0	0	0	0	0	0	0	0	0	0	0	0	0	0	0	0	0	0	0	0	0	0	0	0	0	0	0	0	0	0	0	0		

PXP_HW_PXP_LUT_DATA field descriptions

Field	Description
DATA	Writing this field will load 4 bytes, aligned to four byte boundaries, of data indexed by the ADDR field of the REG_LUT_CTRL register.

**41.11.40 Lookup Table External Memory Address Register.
(PXP_HW_PXP_LUT_EXTMEM)**

For DMA LUT memory loads, this is the base address from which data will be sourced to store into the LUT memory array. For Cached LUT memory pixel transformations, this register will store the base address of the full 64K pixel LUT translation table.

Address: 21C_C000h base + 270h offset = 21C_C270h

Bit	31	30	29	28	27	26	25	24	23	22	21	20	19	18	17	16	15	14	13	12	11	10	9	8	7	6	5	4	3	2	1	0		
R																		ADDR																
W																		ADDR																
Reset	0	0	0	0	0	0	0	0	0	0	0	0	0	0	0	0	0	0	0	0	0	0	0	0	0	0	0	0	0	0	0	0		

PXP_HW_PXP_LUT_EXTMEM field descriptions

Field	Description
ADDR	This register contains the external memory address used for LUT memory operation.

41.11.41 Color Filter Array Register. (PXP_HW_PXP_CFA)

There are sixteen 2 bit values in this register each mapping a selected component to the output pixel. The two bit values are defined as 0=>R, 1=>G, 2=>B, and 3=>W. The first byte represents the repetitive pattern of RGBW pixels in the CFA for the first line segment of each processed PXP block. The second byte represents the pattern in the second line segment of the block, and so on. The first byte repeats two times for 8x8 macro block mode, and repeats four times for 16x16 block mode.

Address: 21C_C000h base + 280h offset = 21C_C280h

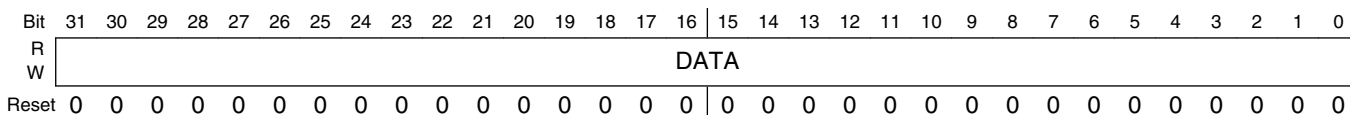

PXP_HW_PXP_CFA field descriptions

Field	Description
DATA	This register contains the Color Filter Array pattern for decimation of RGBW4444 16 bit pixels to individual R, G, B, W values. The pattern represents a replicated 4x4 color filter array for the entire output frame buffer.

41.11.42 PXP Alpha Engine A Control Register. (PXP_HW_PXP_ALPHA_A_CTRL)

Address: 21C_C000h base + 290h offset = 21C_C290h

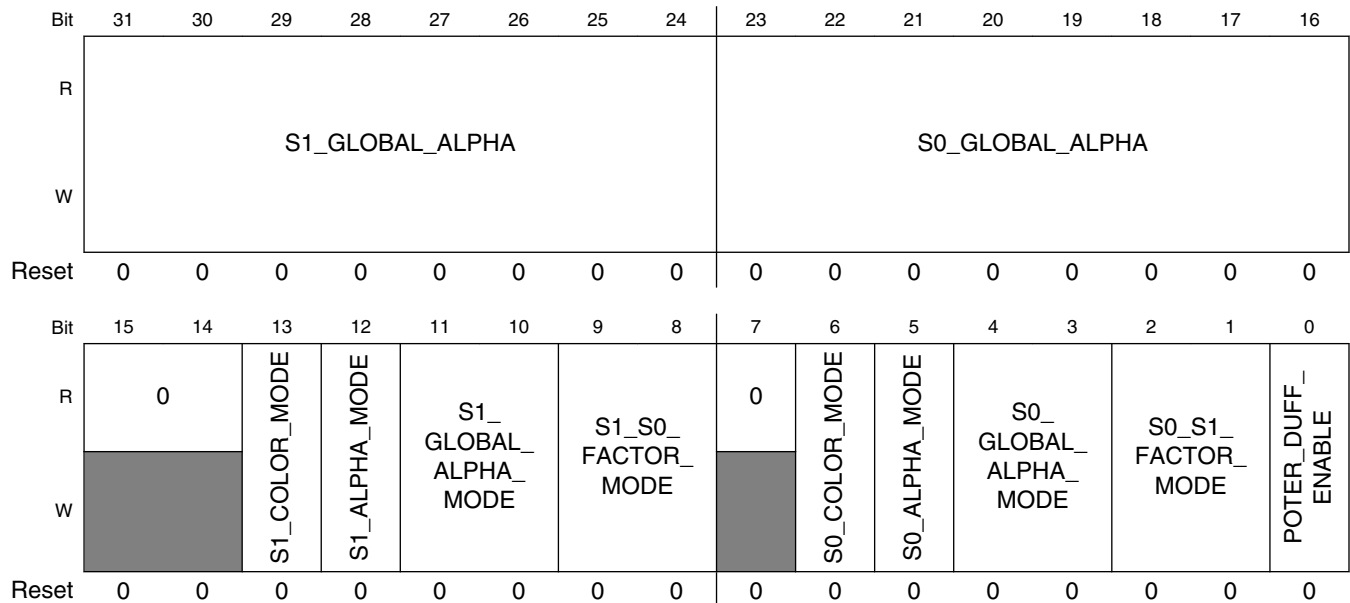

PXP_HW_PXP_ALPHA_A_CTRL field descriptions

Field	Description
31–24 S1_GLOBAL_ALPHA	s1 global alpha
23–16 S0_GLOBAL_ALPHA	s0 global alpha
15–14 Reserved	This read-only field is reserved and always has the value 0.
13 S1_COLOR_MODE	s1 color mode
12 S1_ALPHA_MODE	s1 alpha mode
11–10 S1_GLOBAL_ALPHA_MODE	s1 global alpha mode
9–8 S1_S0_FACTOR_MODE	s1 to s0 factor mode

Table continues on the next page...

PXP_HW_PXP_ALPHA_A_CTRL field descriptions (continued)

Field	Description
7 Reserved	This read-only field is reserved and always has the value 0.
6 S0_COLOR_MODE	s0 color mode
5 S0_ALPHA_MODE	s0 alpha mode
4-3 S0_GLOBAL_ALPHA_MODE	s0 global alpha mode
2-1 S0_S1_FACTOR_MODE	s0 to s1 factor mode
0 POTER_DUFF_ENABLE	poter_duff enable

41.11.43 PS Background Color 1 (PXP_HW_PXP_PS_BACKGROUND_1)

This register contains a pixel value to be used for any PS pixels that fall outside the PS extents. This is effectively a background or letterbox color. The CSC1 control and datapath pixel format should be considered when selecting the background color.

Address: 21C_C000h base + 2C0h offset = 21C_C2C0h

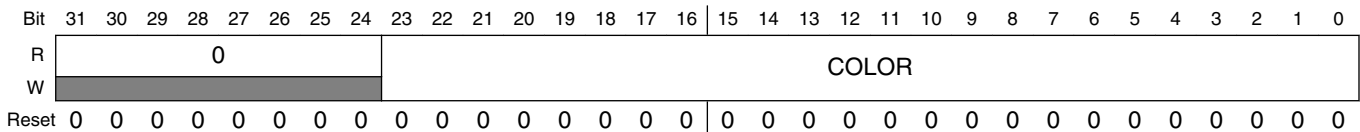

PXP_HW_PXP_PS_BACKGROUND_1 field descriptions

Field	Description
31-24 Reserved	This read-only field is reserved and always has the value 0.
COLOR	Background color (in 24bpp format) for any pixels not within the buffer range specified by the PS ULC/LRC.

41.11.44 PS Color Key Low 1 (PXP_HW_PXP_PS_CLRKEYLOW_1)

When processing an image, if the PXP finds a pixel in the PS buffer with a color that falls in the range between REG_PS_CLRKEYLOW and REG_PS_CLRKEYHIGH, it will insert the pixel from the AS channel. If the current AS pixel is letterboxed or if the AS also matches its colorkey range, the REG_PS_BACKGROUND color is passed down the pixel pipeline.

Address: 21C_C000h base + 2D0h offset = 21C_C2D0h

Bit	31	30	29	28	27	26	25	24	23	22	21	20	19	18	17	16	15	14	13	12	11	10	9	8	7	6	5	4	3	2	1	0
R	0								PIXEL																							
W	0								1																							
Reset	0	0	0	0	0	0	0	0	1	1	1	1	1	1	1	1	1	1	1	1	1	1	1	1	1	1	1	1	1	1	1	

PXP_HW_PXP_PS_CLRKEYLOW_1 field descriptions

Field	Description
31–24 Reserved	This read-only field is reserved and always has the value 0.
PIXEL	Low range of color key applied to PS buffer. To disable PS colorkeying, set the low colorkey to 0xFFFFFFFF and the high colorkey to 0x000000.

41.11.45 PS Color Key High 1 (PXP_HW_PXP_PS_CLRKEYHIGH_1)

When processing an image, if the PXP finds a pixel in the PS buffer with a color that falls in the range between REG_PS_CLRKEYLOW and REG_PS_CLRKEYHIGH, it will insert the pixel from the AS channel. If the current AS pixel is letterboxed or if the AS also matches its colorkey range, the REG_PS_BACKGROUND color is passed down the pixel pipeline.

Address: 21C_C000h base + 2E0h offset = 21C_C2E0h

Bit	31	30	29	28	27	26	25	24	23	22	21	20	19	18	17	16	15	14	13	12	11	10	9	8	7	6	5	4	3	2	1	0
R	0								PIXEL																							
W	0								0																							
Reset	0	0	0	0	0	0	0	0	0	0	0	0	0	0	0	0	0	0	0	0	0	0	0	0	0	0	0	0	0	0	0	

PXP_HW_PXP_PS_CLRKEYHIGH_1 field descriptions

Field	Description
31–24 Reserved	This read-only field is reserved and always has the value 0.
PIXEL	High range of color key applied to PS buffer. To disable PS colorkeying, set the low colorkey to 0xFFFFFFFF and the high colorkey to 0x000000.

41.11.46 Overlay Color Key Low (PXP_HW_PXP_AS_CLRKEYLOW_1)

When processing an image, the if the PXP finds a pixel in the current overlay image with a color that falls in the range from the ASCOLORKEYLOW to ASCOLORKEYHIGH range, it will use the PS pixel value for that location. If no PS image is present or if the PS image also matches its colorkey range, the PS background color is used. Colorkey operations are higher priority than alpha or ROP operations.

Address: 21C_C000h base + 2F0h offset = 21C_C2F0h

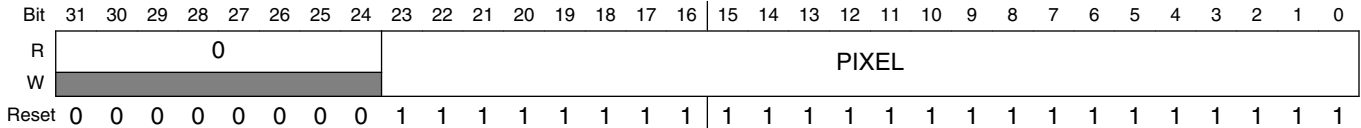

PXP_HW_PXP_AS_CLRKEYLOW_1 field descriptions

Field	Description
31–24 Reserved	This read-only field is reserved and always has the value 0.
PIXEL	Low range of RGB color key applied to AS buffer. Each overlay has an independent colorkey enable.

41.11.47 Overlay Color Key High (PXP_HW_PXP_AS_CLRKEYHIGH_1)

When processing an image, the if the PXP finds a pixel in the current overlay image with a color that falls in the range from the ASCOLORKEYLOW to ASCOLORKEYHIGH range, it will use the PS pixel value for that location. If no PS image is present or if the PS image also matches its colorkey range, the PS background color is used. Colorkey operations are higher priority than alpha or ROP operations.

Address: 21C_C000h base + 300h offset = 21C_C300h

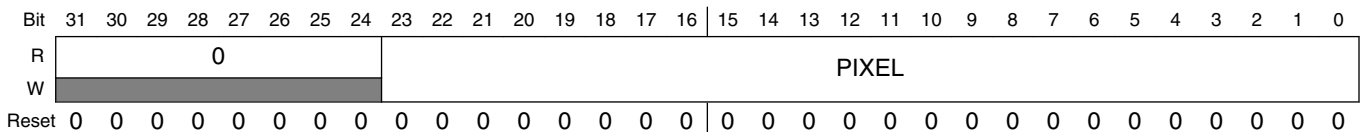

PXP_HW_PXP_AS_CLRKEYHIGH_1 field descriptions

Field	Description
31–24 Reserved	This read-only field is reserved and always has the value 0.
PIXEL	High range of RGB color key applied to AS buffer. Each overlay has an independent colorkey enable.

41.11.48 Control Register 2 (PXP_HW_PXP_CTRL2n)

The Control register contains the controls for the secondary data flow in PXP block.

Address: 21C_C000h base + 310h offset + (4d × i), where i=0d to 3d

Bit	31	30	29	28	27	26	25	24	23	22	21	20	19	18	17	16
R	0				ENABLE_ROTATE1	ENABLE_ROTATE0	ENABLE_LUT	ENABLE_CSC2	BLOCK_SIZE	0			ENABLE_WFE_B	0	ENABLE_DITHER	0
W	[Reserved]				ENABLE_ROTATE1	ENABLE_ROTATE0	ENABLE_LUT	ENABLE_CSC2	BLOCK_SIZE	[Reserved]			ENABLE_WFE_B	0	ENABLE_DITHER	[Reserved]
Reset	0	0	0	0	0	0	0	0	0	0	0	0	0	0	0	0
Bit	15	14	13	12	11	10	9	8	7	6	5	4	3	2	1	0
R	VFLIP1	HFLIP1	ROTATE1		VFLIP0	HFLIP0	ROTATE0		0							ENABLE
W	VFLIP1	HFLIP1	ROTATE1		VFLIP0	HFLIP0	ROTATE0		[Reserved]							ENABLE
Reset	0	0	0	0	0	0	0	0	0	0	0	0	0	0	0	0

PXP_HW_PXP_CTRL2n field descriptions

Field	Description
31–28 Reserved	This read-only field is reserved and always has the value 0.
27 ENABLE_ROTATE1	Enable the ROTATE1 engine in the PXP secondary processing flow.
26 ENABLE_ROTATE0	Enable the ROTATE0 engine in the PXP secondary processing flow.
25 ENABLE_LUT	Enable the LUT engine in the PXP secondary processing flow.
24 ENABLE_CSC2	Enable the CSC2 engine in the PXP secondary processing flow.
23 BLOCK_SIZE	Select the block size to process through the Rotate block.
22–20 Reserved	This read-only field is reserved and always has the value 0.
19 ENABLE_WFE_B	Enable the WFE-B engine in the PXP secondary processing flow.
18 Reserved	This read-only field is reserved and always has the value 0.

Table continues on the next page...

PXP_HW_PXP_CTRL2n field descriptions (continued)

Field	Description
17 ENABLE_DITHER	Enable the Dithering engine in the PXP secondary processing flow.
16 Reserved	This read-only field is reserved and always has the value 0.
15 VFLIP1	Indicates that the input should be flipped vertically (effect applied before rotation).
14 HFLIP1	Indicates that the input should be flipped horizontally (effect applied before rotation).
13–12 ROTATE1	Indicates the clockwise rotation to be applied at the input buffer. The rotation effect is defined as occurring after the FLIP_X and FLIP_Y permutation.
11 VFLIP0	Indicates that the output buffer should be flipped vertically (effect applied before rotation).
10 HFLIP0	Indicates that the output buffer should be flipped horizontally (effect applied before rotation).
9–8 ROTATE0	Indicates the clockwise rotation to be applied at the output buffer. The rotation effect is defined as occurring after the FLIP_X and FLIP_Y permutation.
7–1 Reserved	This read-only field is reserved and always has the value 0.
0 ENABLE	Enables PXP secondary data processing flow with specified parameters. The ENABLE bit will remain set while the PXP is active and will be cleared once the current operation completes. Software should use the IRQ bit in the HW_PXP_STAT when polling for PXP completion.

**41.11.49 PXP Power Control Register.
(PXP_HW_PXP_POWER_REG0)**

Address: 21C_C000h base + 320h offset = 21C_C320h

Bit	31	30	29	28	27	26	25	24	23	22	21	20	19	18	17	16	15	14	13	12	11	10	9	8	7	6	5	4	3	2	1	0
R																	ROTO_	LUT_LP_	LUT_LP_	LUT_LP_												
W	CTRL																MEM_	STATE_	STATE_	STATE_												
																	LP_	WAY1_	WAY0_	WAY0_												
																	STATE	BANKN	BANKN	BANK0												
Reset	0	0	0	0	0	0	0	0	0	0	0	0	0	0	0	0	0	0	0	0	0	0	0	0	0	0	0	0	0	0	0	

PXP_HW_PXP_POWER_REG0 field descriptions

Field	Description
31–12 CTRL	This register contains power control for the PXP.
11–9 ROTO_MEM_LP_STATE	Select the low power state of the ROT 0 memory.

Table continues on the next page...

PXP_HW_PXP_POWER_REG0 field descriptions (continued)

Field	Description
8-6 LUT_LP_STATE_WAY1_BANKN	Select the low power state of the LUT's WAY0-BANK0,1,2,3 memory.
5-3 LUT_LP_STATE_WAY0_BANKN	Select the low power state of the LUT's WAY0-BANK1,2,3 memory.
LUT_LP_STATE_WAY0_BANK0	Select the low power state of the LUT's WAY0-BANK0 memory.

**41.11.50 PXP Power Control Register 1.
(PXP_HW_PXP_POWER_REG1)**

Address: 21C_C000h base + 330h offset = 21C_C330h

Bit	31	30	29	28	27	26	25	24	23	22	21	20	19	18	17	16
R	0								ALU_B_MEM_LP_STATE	ALU_A_MEM_LP_STATE			DITH2_LUT_MEM_LP_STATE			
W	[Shaded]															
Reset	0	0	0	0	0	0	0	0	0	0	0	0	0	0	0	0
Bit	15	14	13	12	11	10	9	8	7	6	5	4	3	2	1	0
R	DITH2_LUT_MEM_LP_STATE	DITH1_LUT_MEM_LP_STATE			DITH0_ERR1_MEM_LP_STATE			DITH0_ERR0_MEM_LP_STATE			DITH0_LUT_MEM_LP_STATE		ROT1_MEM_LP_STATE			
W																
Reset	0	0	0	0	0	0	0	0	0	0	0	0	0	0	0	0

PXP_HW_PXP_POWER_REG1 field descriptions

Field	Description
31-24 Reserved	This read-only field is reserved and always has the value 0.
23-21 ALU_B_MEM_LP_STATE	Select the low power state of the ALU B memory.
20-18 ALU_A_MEM_LP_STATE	Select the low power state of the ALU A memory.

Table continues on the next page...

PXP_HW_PXP_POWER_REG1 field descriptions (continued)

Field	Description
17–15 DITH2_LUT_ MEM_LP_STATE	Select the low power state of the dither2 LUT memory.
14–12 DITH1_LUT_ MEM_LP_STATE	Select the low power state of the dither1 LUT memory.
11–9 DITH0_ERR1_ MEM_LP_STATE	Select the low power state of the dither0 ERR1 memory.
8–6 DITH0_ERR0_ MEM_LP_STATE	Select the low power state of the dither0 ERR0 memory.
5–3 DITH0_LUT_ MEM_LP_STATE	Select the low power state of the dither0 LUT memory.
ROT1_MEM_LP_ STATE	Select the low power state of the ROT 1 memory.

41.11.51 This register helps decide the data path gthrough the PXP. (PXP_HW_PXP_DATA_PATH_CTRL0n)

The Control register contains the control bits for the data path through the PXP.

Address: 21C_C000h base + 340h offset + (4d × i), where i=0d to 3d

Bit	31	30	29	28	27	26	25	24	23	22	21	20	19	18	17	16
R	0				0						0					
W																
Reset	0	1	0	1	0	0	0	1	0	0	0	0	0	1	0	0
Bit	15	14	13	12	11	10	9	8	7	6	5	4	3	2	1	0
R	0		0		0		0									
W																
Reset	0	1	0	1	1	0	1	0	0	0	1	0	0	0	0	0

PXP_HW_PXP_DATA_PATH_CTRL0n field descriptions

Field	Description
31–30 Reserved	This read-only field is reserved and always has the value 0.
29–28 MUX14_SEL	This field chooses the data path through MUX 14.
27–26 Reserved	This read-only field is reserved and always has the value 0.

Table continues on the next page...

PXP_HW_PXP_DATA_PATH_CTRL0n field descriptions (continued)

Field	Description
25–24 MUX12_SEL	This field chooses the data path through MUX 13.
23–22 MUX11_SEL	This field chooses the data path through MUX 11.
21–20 Reserved	This read-only field is reserved and always has the value 0.
19–18 MUX9_SEL	This field chooses the data path through MUX 9.
17–16 MUX8_SEL	This field chooses the data path through MUX 8.
15–14 Reserved	This read-only field is reserved and always has the value 0.
13–12 Reserved	This read-only field is reserved and always has the value 0.
11–10 Reserved	This read-only field is reserved and always has the value 0.
9–8 Reserved	This read-only field is reserved and always has the value 0.
7–6 MUX3_SEL	This field chooses the data path through MUX 3.
5–4 Reserved	This read-only field is reserved and always has the value 0.
3–2 MUX1_SEL	This field chooses the data path through MUX 1.
MUX0_SEL	This mux chooses the data that will go through the WFEB engine.

41.11.52 This register helps decide the data path gthrough the PXP. (PXP_HW_PXP_DATA_PATH_CTRL1n)

The Control register contains the control bits for the data path through the PXP.

Address: 21C_C000h base + 350h offset + (4d × i), where i=0d to 3d

Bit	31	30	29	28	27	26	25	24	23	22	21	20	19	18	17	16
R	0															
W																
Reset	0	0	0	0	0	0	0	0	0	0	0	0	0	0	0	0
Bit	15	14	13	12	11	10	9	8	7	6	5	4	3	2	1	0
R	0												MUX17_SEL	MUX16_SEL		
W																
Reset	0	0	0	0	0	0	0	0	0	0	0	0	0	0	0	0

PXP_HW_PXP_DATA_PATH_CTRL1n field descriptions

Field	Description
31–4 Reserved	This read-only field is reserved and always has the value 0.
3–2 MUX17_SEL	This field chooses the data path through MUX 17.
MUX16_SEL	This mux chooses the data path through MUX 16.

41.11.53 Initialize memory buffer control Register (PXP_HW_PXP_INIT_MEM_CTRLn)

This register controls IRQ the intializing of internal pxp rams.

Address: 21C_C000h base + 360h offset + (4d × i), where i=0d to 3d

Bit	31	30	29	28	27	26	25	24	23	22	21	20	19	18	17	16
R	START								0							
W	SELECT															
Reset	0	0	0	0	0	0	0	0	0	0	0	0	0	0	0	0
Bit	15	14	13	12	11	10	9	8	7	6	5	4	3	2	1	0
R	ADDR															
W																
Reset	0	0	0	0	0	0	0	0	0	0	0	0	0	0	0	0

PXP_HW_PXP_INIT_MEM_CTRLn field descriptions

Field	Description
31 START	Enable writing to the memory.
30–27 SELECT	Select which memory to write.
26–16 Reserved	This read-only field is reserved and always has the value 0.
ADDR	Base address to start writing. The control logic will increment the address value internally each time the data register is written.

41.11.54 Write data Register (PXP_HW_PXP_INIT_MEM_DATA)

This register holds the data word to initialize internal pxp rams.

Address: 21C_C000h base + 370h offset = 21C_C370h

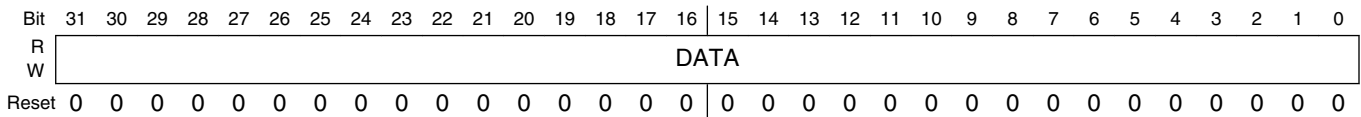

PXP_HW_PXP_INIT_MEM_DATA field descriptions

Field	Description
DATA	Data value to be written to the memory. A write to this register kicks off a write cycle to the memory selected.

41.11.55 Write data Register (PXP_HW_PXP_INIT_MEM_DATA_HIGH)

This register holds the upper data word to initialize internal pxp fetch rams.

Address: 21C_C000h base + 380h offset = 21C_C380h

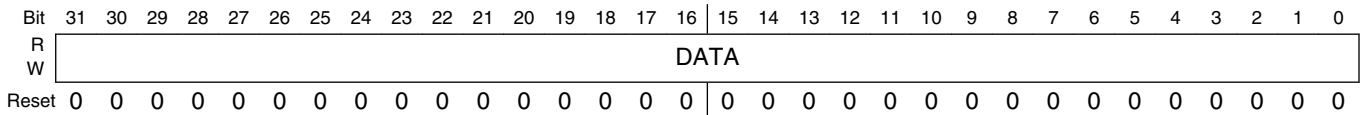

PXP_HW_PXP_INIT_MEM_DATA_HIGH field descriptions

Field	Description
DATA	Data value to be written to the most significant 32 bits of the fetch memories. this register must be written before the HW_PXP_INIT_MEM_DATA as that register triggers the write cycle to memory.

41.11.56 PXP IRQ Mask Register (PXP_HW_PXP_IRQ_MASK n)

This register controls IRQ masks for all PXP interrupts

Address: 21C_C000h base + 390h offset + (4d × i), where i=0d to 3d

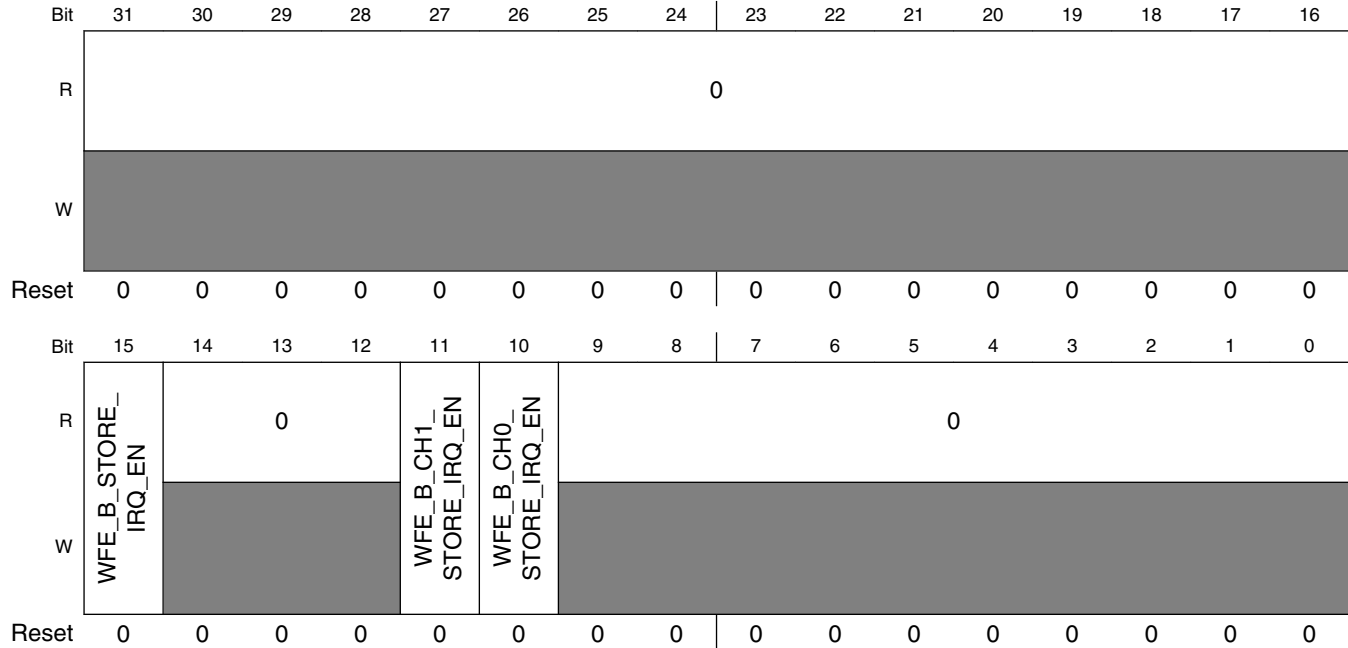

PXP_HW_PXP_IRQ_MASK n field descriptions

Field	Description
31–16 Reserved	This read-only field is reserved and always has the value 0.
15 WFE_B_STORE_IRQ_EN	Enable WFE B store engine interrupt detection.
14–12 Reserved	This read-only field is reserved and always has the value 0.
11 WFE_B_CH1_STORE_IRQ_EN	Enable WFE B ch1 store engine interrupt detection.
10 WFE_B_CH0_STORE_IRQ_EN	Enable WFE B ch0 store engine interrupt detection.
Reserved	This read-only field is reserved and always has the value 0.

41.11.57 PXP Interrupt Register (PXP_HW_PXP_IRQn)

This register houses the interrupt bits for the Prefetch and Store Engines

Address: 21C_C000h base + 3A0h offset + (4d × i), where i=0d to 3d

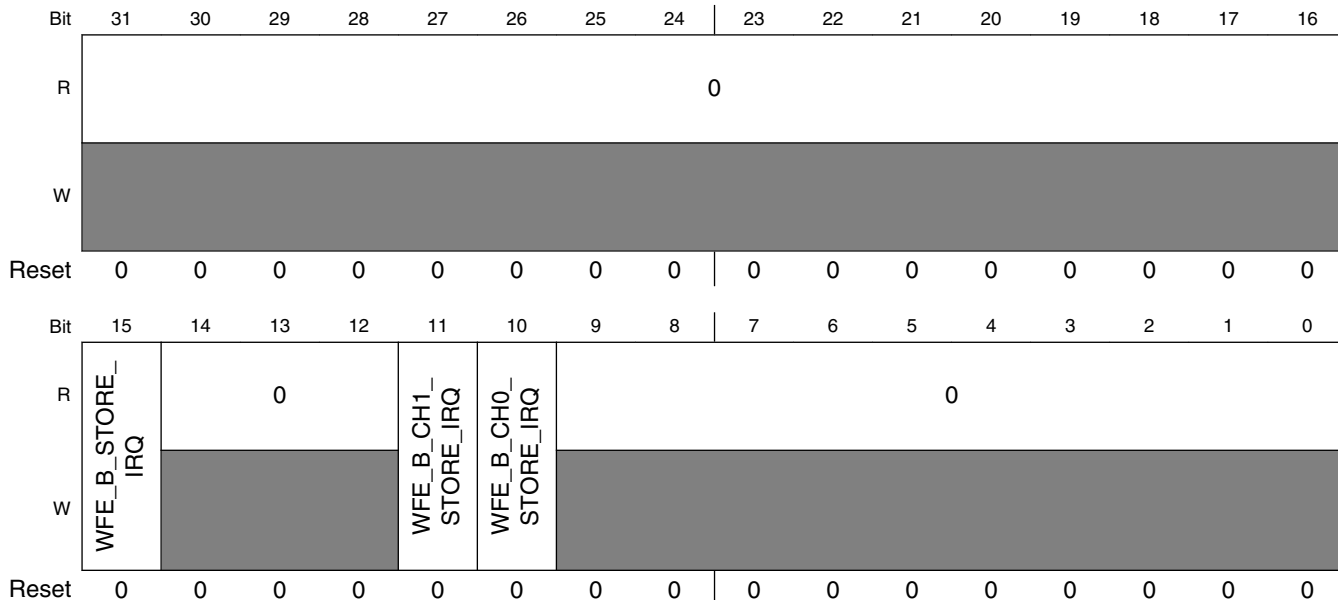

PXP_HW_PXP_IRQn field descriptions

Field	Description
31–16 Reserved	This read-only field is reserved and always has the value 0.
15 WFE_B_STORE_IRQ	WFE B store engine Interrupt
14–12 Reserved	This read-only field is reserved and always has the value 0.
11 WFE_B_CH1_STORE_IRQ	WFE B ch1 store engine Interrupt
10 WFE_B_CH0_STORE_IRQ	WFE B ch0 store engine Interrupt
Reserved	This read-only field is reserved and always has the value 0.

41.11.58 PXP NEXT Buffer Enable select Register (PXP_HW_PXP_NEXT_ENn)

This register controls the PXP Next buffer Enable.

Address: 21C_C000h base + 3B0h offset + (4d × i), where i=0d to 3d

Bit	31	30	29	28	27	26	25	24		23	22	21	20	19	18	17	16
R	0																
W	[Shaded]																
Reset	0	0	0	0	0	0	0	0		0	0	0	0	0	0	0	0
Bit	15	14	13	12	11	10	9	8		7	6	5	4	3	2	1	0
R	0														WFEB	LEGACY	
W	[Shaded]																
Reset	0	0	0	0	0	0	0	0		0	0	0	0	0	0	0	0

PXP_HW_PXP_NEXT_ENn field descriptions

Field	Description
31–2 Reserved	This read-only field is reserved and always has the value 0.
1 WFEB	Enable WFE B Next Buffer function. The WFEB and the LEGACY bit can't be set to 1 at same time.
0 LEGACY	Enable Legacy Next Buffer function. The WFEB_B and the LEGACY bit can't be set to 1 at same time.

41.11.59 Next Frame Pointer (PXP_HW_PXP_NEXT)

To enable this functionality, software must write this register while the PXP is processing the current data frame (if the PXP is currently idle, this will also initiate an immediate load of registers from the pointer). The process of writing this register (WRITE operation) will set a semaphore in hardware to notify the control logic that a register reload operation must be performed when the current frame processing is complete. At the end of a frame, the PXP will fetch the register settings from this location, signal an interrupt to software, then proceed with rendering the next frame of data. Software may cancel the reload operation by issuing a CLEAR operation to this register. SET and TOGGLE operations should not be used when addressing this register. All registers will be reloaded with the exception of the following: STAT, CSCCOEFn, NEXT, VERSION. All other registers will be loaded in the order they appear in the register map. Once the pointer's contents have been loaded into the PXP's registers, the NEXT_IRQ interrupt will be issued (see the PXP_STATUS register).

Address: 21C_C000h base + 400h offset = 21C_C400h

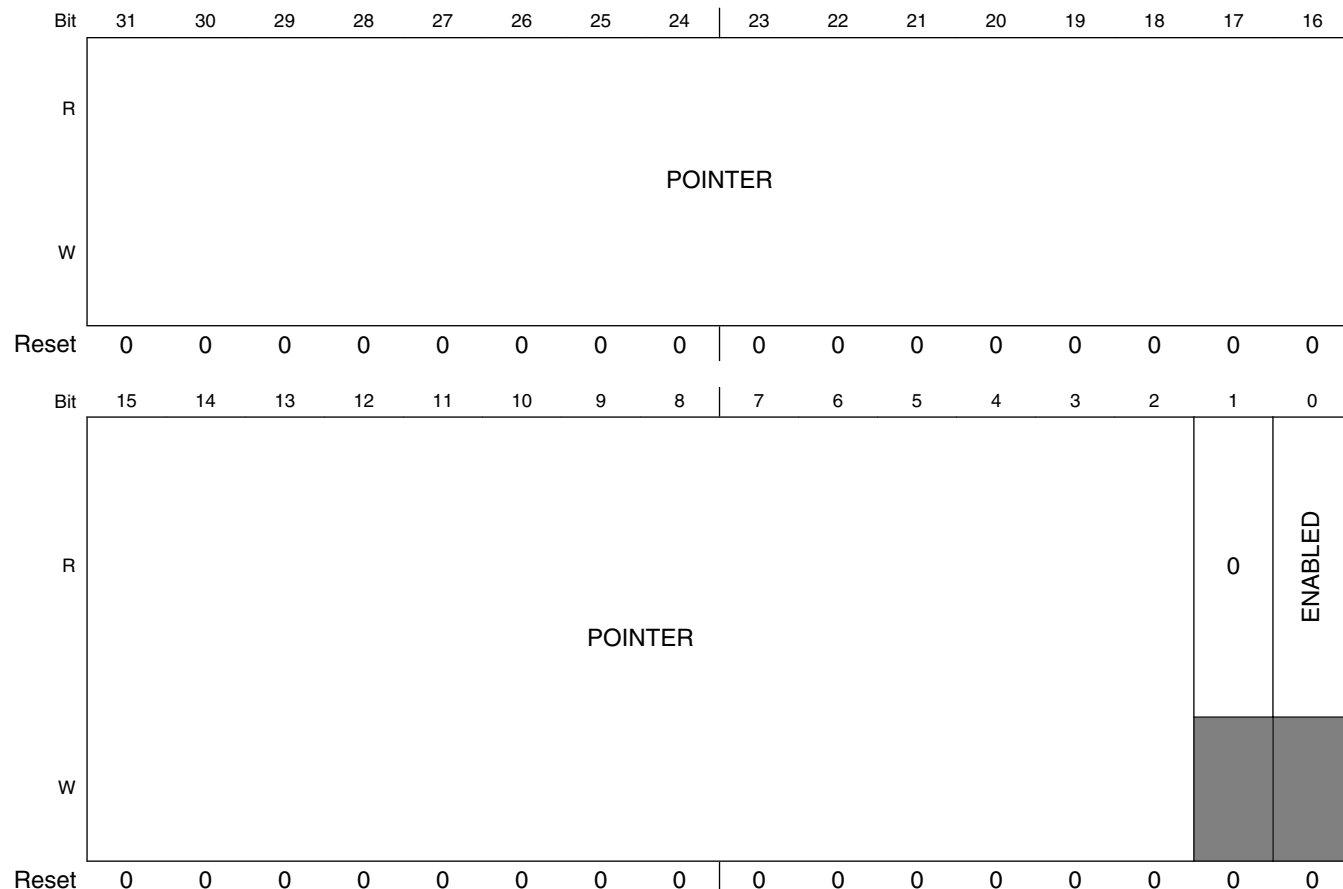

PXP_HW_PXP_NEXT field descriptions

Field	Description
31–2 POINTER	A pointer to a data structure containing register values to be used when processing the next frame. The pointer must be 32-bit aligned and should reside in on-chip or off-chip memory.
1 Reserved	This read-only field is reserved and always has the value 0.
0 ENABLED	Indicates that the "next frame" functionality has been enabled. This bit reflects the status of the hardware semaphore indicating that a reload operation is pending at the end of the current frame.

41.11.60 Debug Control Register (PXP_HW_PXP_DEBUGCTRL)

This register controls the PXP Debug features. This register is not intended for customer use.

Address: 21C_C000h base + 410h offset = 21C_C410h

Bit	31	30	29	28	27	26	25	24	23	22	21	20	19	18	17	16	15	14	13	12	11	10	9	8	7	6	5	4	3	2	1	0
R	0																LUT_CLR_STAT_CNT				SELECT											
W	0																0				0											
Reset	0	0	0	0	0	0	0	0	0	0	0	0	0	0	0	0	0	0	0	0	0	0	0	0	0	0	0	0	0	0	0	

PXP_HW_PXP_DEBUGCTRL field descriptions

Field	Description
31–12 Reserved	This read-only field is reserved and always has the value 0.
11–8 LUT_CLR_STAT_CNT	Clear LUT status counters.
SELECT	Index into one of the PXP debug registers. The data for the selected register will be returned

41.11.61 Debug Register (PXP_HW_PXP_DEBUG)

The debug control register will select the desired debug field to be read through this register offset. This register is not intended for customer use.

Address: 21C_C000h base + 420h offset = 21C_C420h

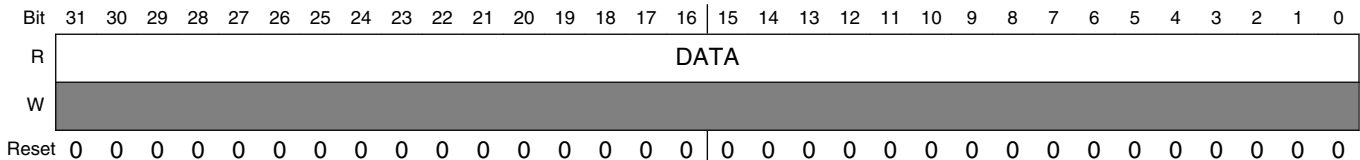

PXP_HW_PXP_DEBUG field descriptions

Field	Description
DATA	Debug data

41.11.62 Version Register (PXP_HW_PXP_VERSION)

This register indicates the RTL version in use. This register is not intended for customer use.

Address: 21C_C000h base + 430h offset = 21C_C430h

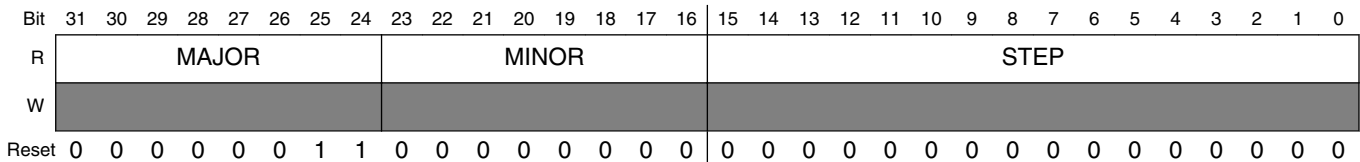

PXP_HW_PXP_VERSION field descriptions

Field	Description
31–24 MAJOR	Fixed read-only value reflecting the MAJOR field of the RTL version.
23–16 MINOR	Fixed read-only value reflecting the MINOR field of the RTL version.
STEP	Fixed read-only value reflecting the stepping of the RTL version.

41.11.63 This register defines the control bits for the pxp store_engine sub-block. (PXP_HW_PXP_DITHER_STORE_SIZE_CH0)

The Control register contains the control bits for the pxp store_engine sub-block.

Address: 21C_C000h base + A00h offset = 21C_CA00h

Bit	31	30	29	28	27	26	25	24	23	22	21	20	19	18	17	16	15	14	13	12	11	10	9	8	7	6	5	4	3	2	1	0
R	OUT_HEIGHT																OUT_WIDTH															
W																																
Reset	0	0	0	0	0	0	0	0	0	0	0	0	0	0	0	0	0	0	0	0	0	0	0	0	0	0	0	0	0	0	0	0

PXP_HW_PXP_DITHER_STORE_SIZE_CH0 field descriptions

Field	Description
31–16 OUT_HEIGHT	actual output height -1
OUT_WIDTH	actual output width -1

41.11.64 Fetch engine Control for WFE B Register (PXP_HW_PXP_WFB_FETCH_CTRLn)

This register defines the control bits for the pxp wfb fetch sub-block.

Address: 21C_C000h base + 1100h offset + (4d × i), where i=0d to 3d

Bit	31	30	29	28	27	26	25	24	23	22	21	20	19	18	17	16
R	BUF2_DONE_ IRQ_EN	BUF1_DONE_ IRQ_EN	BUF2_DONE_ IRQ	BUF1_DONE_ IRQ	0				BF2_LINE_ MODE	BF2_BYTES_PP		BF1_LINE_ MODE		BF1_BYTES_PP		
W																
Reset	0	0	0	0	0	0	0	0	0	0	0	0	0	0	0	0
Bit	15	14	13	12	11	10	9	8	7	6	5	4	3	2	1	0
R	0		BF2_BORDER_ MODE	BF2_BURST_ LEN	BF2_BYPASS_ MODE	BF2_HSK_ MODE	BF2_SRAM_IF	BF2_EN	0		BF1_BORDER_ MODE	BF1_BURST_ LEN	BF1_BYPASS_ MODE	BF1_HSK_ MODE	BF1_SRAM_IF	BF1_EN
W																
Reset	0	0	0	0	0	0	0	0	0	0	0	0	0	0	0	0

PXP_HW_PXP_WFB_FETCH_CTRLn field descriptions

Field	Description
31 BUF2_DONE_ IRQ_EN	This bit is set to enable buffer2 fetch done interrupt.
30 BUF1_DONE_ IRQ_EN	This bit is set to enable buffer1 fetch done interrupt.
29 BUF2_DONE_ IRQ	This bit is set to indicate that buffer2 fetch done interrupt, this bit is cleared by writing a one to its SCT clear address
28 BUF1_DONE_ IRQ	This bit is set to indicate that buffer1 fetch done interrupt, this bit is cleared by writing a one to its SCT clear address
27–24 Reserved	This read-only field is reserved and always has the value 0.
23–22 BF2_LINE_ MODE	Indicates the number of lines to be fetched
21–20 BF2_BYTES_PP	This indicate how many bytes in each pixel for the buffer
19–18 BF1_LINE_ MODE	Indicates the number of lines to be fetched
17–16 BF1_BYTES_PP	This indicate how many bytes in each pixel for the buffer
15–14 Reserved	This read-only field is reserved and always has the value 0.
13 BF2_BORDER_ MODE	Indicate buffer2 border pixels select
12 BF2_BURST_ LEN	Indicate buffer2 AXI burst length
11 BF2_BYPASS_ MODE	Indicate buffer2 use bypass pixels or not
10 BF2_HSK_ MODE	Mode of operation
9 BF2_SRAM_IF	Fetch Source
8 BF2_EN	BF2 enable bit.
7–6 Reserved	This read-only field is reserved and always has the value 0.
5 BF1_BORDER_ MODE	Indicate buffer1 border pixels select

Table continues on the next page...

PXP_HW_PXP_WFB_FETCH_CTRLn field descriptions (continued)

Field	Description
4 BF1_BURST_LEN	Indicate buffer1 AXI burst length
3 BF1_BYPASS_MODE	Indicate buffer1 use bypass pixels or not
2 BF1_HSK_MODE	Mode of operation
1 BF1_SRAM_IF	Fetch Source
0 BF1_EN	BF1 enable bit.

41.11.65 This register defines the control bits for the pxp wfb fetch sub-block. (PXP_HW_PXP_WFB_FETCH_BUF1_ADDR)

This register defines the control bits for the pxp wfb fetch sub-block.

Address: 21C_C000h base + 1110h offset = 21C_D110h

Bit	31	30	29	28	27	26	25	24	23	22	21	20	19	18	17	16	15	14	13	12	11	10	9	8	7	6	5	4	3	2	1	0		
R																																		
W																																		
Reset	0	0	0	0	0	0	0	0	0	0	0	0	0	0	0	0	0	0	0	0	0	0	0	0	0	0	0	0	0	0	0	0		

PXP_HW_PXP_WFB_FETCH_BUF1_ADDR field descriptions

Field	Description
BUF_ADDR	This indicate the base address for wfb buffer1 fetch

**41.11.66 This register defines the control bits for the pxp wfb fetch sub-block.
(PXP_HW_PXP_WFB_FETCH_BUF1_PITCH)**

This register defines the control bits for the pxp wfb fetch sub-block.

Address: 21C_C000h base + 1120h offset = 21C_D120h

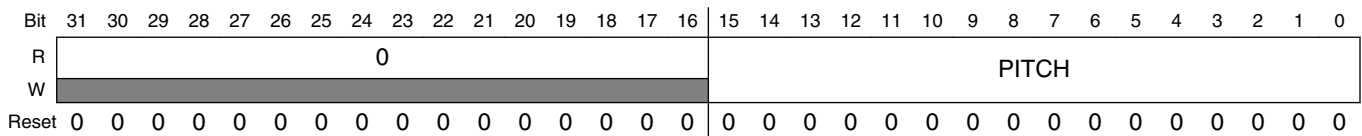

PXP_HW_PXP_WFB_FETCH_BUF1_PITCH field descriptions

Field	Description
31–16 Reserved	This read-only field is reserved and always has the value 0.
PITCH	This indicate the number of bytes in memory between two vertically adjacent pixels.

**41.11.67 This register defines the control bits for the pxp wfb fetch sub-block.
(PXP_HW_PXP_WFB_FETCH_BUF1_SIZE)**

This register defines the control bits for the pxp wfb fetch sub-block.

Address: 21C_C000h base + 1130h offset = 21C_D130h

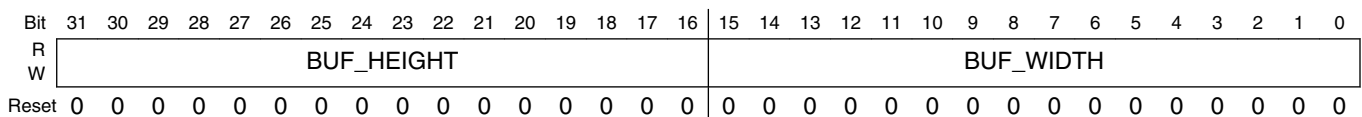

PXP_HW_PXP_WFB_FETCH_BUF1_SIZE field descriptions

Field	Description
31–16 BUF_HEIGHT	This indicate the buffer height in pixels.
BUF_WIDTH	This indicate the buffer width in pixels.

41.11.68 This register defines the control bits for the pxp wfb fetch sub-block. (PXP_HW_PXP_WFB_FETCH_BUF2_ADDR)

This register defines the control bits for the pxp wfb fetch sub-block.

Address: 21C_C000h base + 1140h offset = 21C_D140h

Bit	31	30	29	28	27	26	25	24	23	22	21	20	19	18	17	16	15	14	13	12	11	10	9	8	7	6	5	4	3	2	1	0
R	0																BUF_ADDR															
W	0																0															
Reset	0	0	0	0	0	0	0	0	0	0	0	0	0	0	0	0	0	0	0	0	0	0	0	0	0	0	0	0	0	0	0	0

PXP_HW_PXP_WFB_FETCH_BUF2_ADDR field descriptions

Field	Description
BUF_ADDR	This indicate the base address for wfb buffer2 fetch

41.11.69 This register defines the control bits for the pxp wfb fetch sub-block. (PXP_HW_PXP_WFB_FETCH_BUF2_PITCH)

This register defines the control bits for the pxp wfb fetch sub-block.

Address: 21C_C000h base + 1150h offset = 21C_D150h

Bit	31	30	29	28	27	26	25	24	23	22	21	20	19	18	17	16	15	14	13	12	11	10	9	8	7	6	5	4	3	2	1	0
R	0																PITCH															
W	0																0															
Reset	0	0	0	0	0	0	0	0	0	0	0	0	0	0	0	0	0	0	0	0	0	0	0	0	0	0	0	0	0	0	0	0

PXP_HW_PXP_WFB_FETCH_BUF2_PITCH field descriptions

Field	Description
31–16 Reserved	This read-only field is reserved and always has the value 0.
PITCH	This indicate the number of bytes in memory between two vertically adjacent pixels.

41.11.70 This register defines the control bits for the pxp wfb fetch sub-block. (PXP_HW_PXP_WFB_FETCH_BUF2_SIZE)

This register defines the control bits for the pxp wfb fetch sub-block.

Address: 21C_C000h base + 1160h offset = 21C_D160h

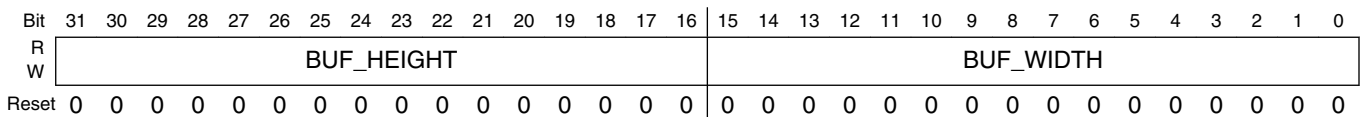

PXP_HW_PXP_WFB_FETCH_BUF2_SIZE field descriptions

Field	Description
31-16 BUF_HEIGHT	This indicates the buffer height in pixels.
BUF_WIDTH	This indicates the buffer width in pixels.

41.11.71 This register defines the control bits for the pxp wfb fetch sub-block. (PXP_HW_PXP_WFB_ARRAY_PIXEL0_MASK)

This register defines the control bits for the pxp wfb fetch sub-block.

Address: 21C_C000h base + 1170h offset = 21C_D170h

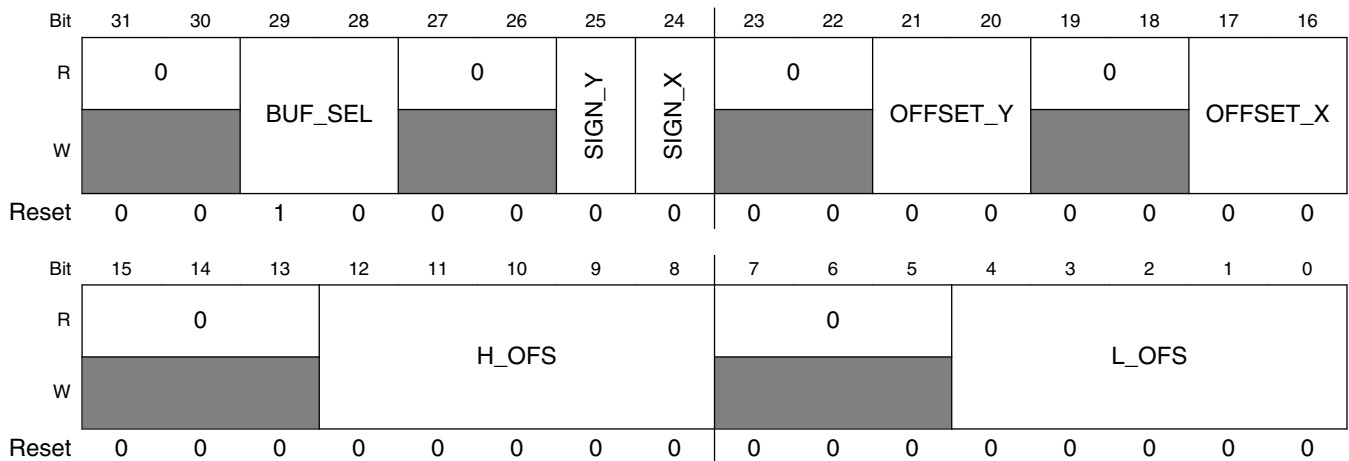

PXP_HW_PXP_WFB_ARRAY_PIXEL0_MASK field descriptions

Field	Description
31–30 Reserved	This read-only field is reserved and always has the value 0.
29–28 BUF_SEL	Select between Buffer 1 and 2
27–26 Reserved	This read-only field is reserved and always has the value 0.
25 SIGN_Y	Offset sign
24 SIGN_X	Offset sign
23–22 Reserved	This read-only field is reserved and always has the value 0.
21–20 OFFSET_Y	This indicates the Y offset position for the pixel.
19–18 Reserved	This read-only field is reserved and always has the value 0.
17–16 OFFSET_X	This indicates the X offset position for the pixel.
15–13 Reserved	This read-only field is reserved and always has the value 0.
12–8 H_OFS	This indicates the right bit position on the original pixel
7–5 Reserved	This read-only field is reserved and always has the value 0.
L_OFS	This indicates the left bit position on the original pixel

41.11.72 This register defines the control bits for the pxp wfb fetch sub-block. (PXP_HW_PXP_WFB_ARRAY_PIXEL1_MASK)

This register defines the control bits for the pxp wfb fetch sub-block.

Address: 21C_C000h base + 1180h offset = 21C_D180h

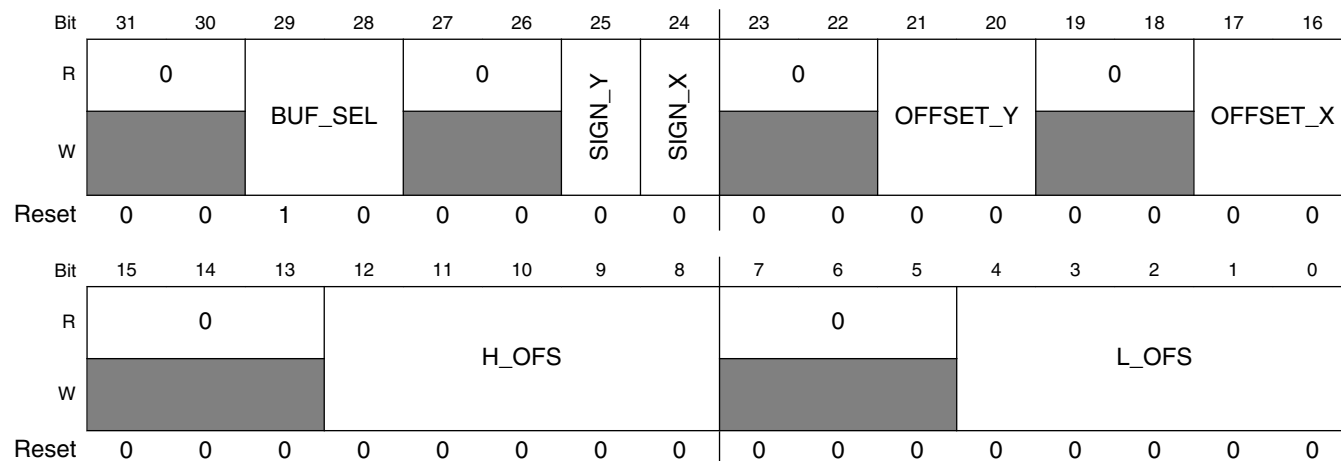

PXP_HW_PXP_WFB_ARRAY_PIXEL1_MASK field descriptions

Field	Description
31–30 Reserved	This read-only field is reserved and always has the value 0.
29–28 BUF_SEL	Select between Buffer 1 and 2
27–26 Reserved	This read-only field is reserved and always has the value 0.
25 SIGN_Y	Offset sign
24 SIGN_X	Offset sign
23–22 Reserved	This read-only field is reserved and always has the value 0.
21–20 OFFSET_Y	This indicates the Y offset position for the pixel.
19–18 Reserved	This read-only field is reserved and always has the value 0.
17–16 OFFSET_X	This indicates the X offset position for the pixel.
15–13 Reserved	This read-only field is reserved and always has the value 0.

Table continues on the next page...

PXP_HW_PXP_WFB_ARRAY_PIXEL1_MASK field descriptions (continued)

Field	Description
12–8 H_OFS	This indicates the right bit position on the original pixel
7–5 Reserved	This read-only field is reserved and always has the value 0.
L_OFS	This indicates the left bit position on the original pixel

41.11.73 This register defines the control bits for the pxp wfb fetch sub-block. (PXP_HW_PXP_WFB_ARRAY_PIXEL2_MASK)

This register defines the control bits for the pxp wfb fetch sub-block.

Address: 21C_C000h base + 1190h offset = 21C_D190h

Bit	31	30	29	28	27	26	25	24	23	22	21	20	19	18	17	16
R	0				0		SIGN_Y	SIGN_X	0				0			
W			BUF_SEL							OFFSET_Y						OFFSET_X
Reset	0	0	1	0	0	0	0	0	0	0	0	0	0	0	0	0
Bit	15	14	13	12	11	10	9	8	7	6	5	4	3	2	1	0
R	0								0							
W																
Reset	0	0	0	0	0	0	0	0	0	0	0	0	0	0	0	0

PXP_HW_PXP_WFB_ARRAY_PIXEL2_MASK field descriptions

Field	Description
31–30 Reserved	This read-only field is reserved and always has the value 0.
29–28 BUF_SEL	Select between Buffer 1 and 2
27–26 Reserved	This read-only field is reserved and always has the value 0.
25 SIGN_Y	Offset sign
24 SIGN_X	Offset sign

Table continues on the next page...

PXP_HW_PXP_WFB_ARRAY_PIXEL2_MASK field descriptions (continued)

Field	Description
23–22 Reserved	This read-only field is reserved and always has the value 0.
21–20 OFFSET_Y	This indicates the Y offset position for the pixel.
19–18 Reserved	This read-only field is reserved and always has the value 0.
17–16 OFFSET_X	This indicates the X offset position for the pixel.
15–13 Reserved	This read-only field is reserved and always has the value 0.
12–8 H_OFS	This indicates the right bit position on the original pixel
7–5 Reserved	This read-only field is reserved and always has the value 0.
L_OFS	This indicates the left bit position on the original pixel

**41.11.74 This register defines the control bits for the ppx wfb fetch sub-block.
(PXP_HW_PXP_WFB_ARRAY_PIXEL3_MASK)**

This register defines the control bits for the ppx wfb fetch sub-block.

Address: 21C_C000h base + 11A0h offset = 21C_D1A0h

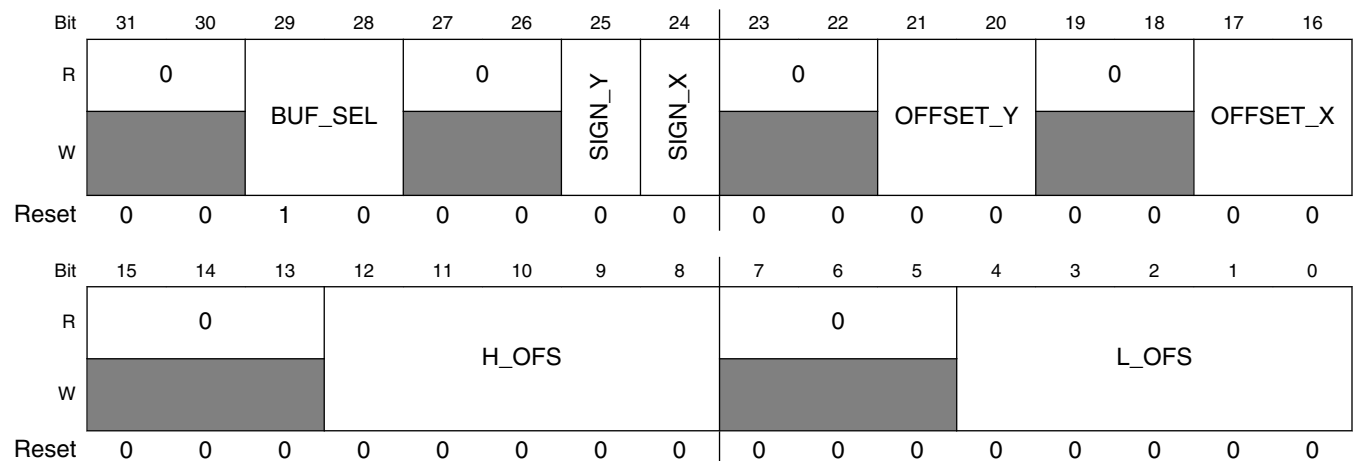

PXP_HW_PXP_WFB_ARRAY_PIXEL3_MASK field descriptions

Field	Description
31–30 Reserved	This read-only field is reserved and always has the value 0.
29–28 BUF_SEL	Select between Buffer 1 and 2
27–26 Reserved	This read-only field is reserved and always has the value 0.
25 SIGN_Y	Offset sign
24 SIGN_X	Offset sign
23–22 Reserved	This read-only field is reserved and always has the value 0.
21–20 OFFSET_Y	This indicates the Y offset position for the pixel.
19–18 Reserved	This read-only field is reserved and always has the value 0.
17–16 OFFSET_X	This indicates the X offset position for the pixel.
15–13 Reserved	This read-only field is reserved and always has the value 0.
12–8 H_OFS	This indicates the right bit position on the original pixel
7–5 Reserved	This read-only field is reserved and always has the value 0.
L_OFS	This indicates the left bit position on the original pixel

41.11.75 This register defines the control bits for the pxp wfb fetch sub-block. (PXP_HW_PXP_WFB_ARRAY_PIXEL4_MASK)

This register defines the control bits for the pxp wfb fetch sub-block.

Address: 21C_C000h base + 11B0h offset = 21C_D1B0h

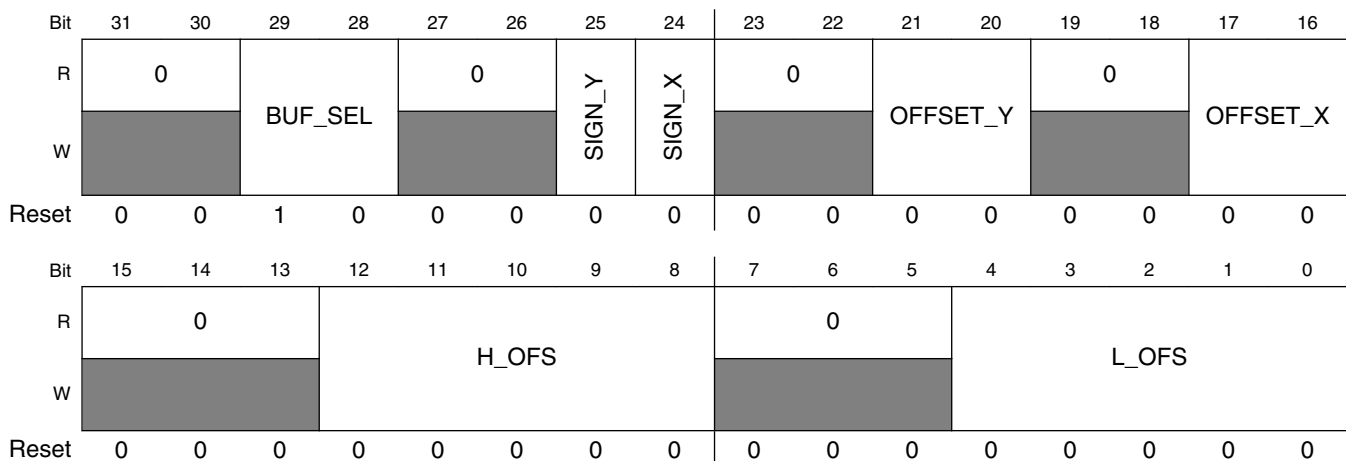

PXP_HW_PXP_WFB_ARRAY_PIXEL4_MASK field descriptions

Field	Description
31–30 Reserved	This read-only field is reserved and always has the value 0.
29–28 BUF_SEL	Select between Buffer 1 and 2
27–26 Reserved	This read-only field is reserved and always has the value 0.
25 SIGN_Y	Offset sign
24 SIGN_X	Offset sign
23–22 Reserved	This read-only field is reserved and always has the value 0.
21–20 OFFSET_Y	This indicates the Y offset position for the pixel.
19–18 Reserved	This read-only field is reserved and always has the value 0.
17–16 OFFSET_X	This indicates the X offset position for the pixel.
15–13 Reserved	This read-only field is reserved and always has the value 0.

Table continues on the next page...

PXP_HW_PXP_WFB_ARRAY_PIXEL4_MASK field descriptions (continued)

Field	Description
12–8 H_OFS	This indicates the right bit position on the original pixel
7–5 Reserved	This read-only field is reserved and always has the value 0.
L_OFS	This indicates the left bit position on the original pixel

41.11.76 This register defines the control bits for the pxp wfb fetch sub-block. (PXP_HW_PXP_WFB_ARRAY_PIXEL5_MASK)

This register defines the control bits for the pxp wfb fetch sub-block.

Address: 21C_C000h base + 11C0h offset = 21C_D1C0h

Bit	31	30	29	28	27	26	25	24	23	22	21	20	19	18	17	16
R	0				0		SIGN_Y	SIGN_X	0				0			
W			BUF_SEL								OFFSET_Y					OFFSET_X
Reset	0	0	1	0	0	0	0	0	0	0	0	0	0	0	0	0
Bit	15	14	13	12	11	10	9	8	7	6	5	4	3	2	1	0
R	0								0							
W																
Reset	0	0	0	0	0	0	0	0	0	0	0	0	0	0	0	0

PXP_HW_PXP_WFB_ARRAY_PIXEL5_MASK field descriptions

Field	Description
31–30 Reserved	This read-only field is reserved and always has the value 0.
29–28 BUF_SEL	Select between Buffer 1 and 2
27–26 Reserved	This read-only field is reserved and always has the value 0.
25 SIGN_Y	Offset sign
24 SIGN_X	Offset sign

Table continues on the next page...

PXP_HW_PXP_WFB_ARRAY_PIXEL5_MASK field descriptions (continued)

Field	Description
23–22 Reserved	This read-only field is reserved and always has the value 0.
21–20 OFFSET_Y	This indicates the Y offset position for the pixel.
19–18 Reserved	This read-only field is reserved and always has the value 0.
17–16 OFFSET_X	This indicates the X offset position for the pixel.
15–13 Reserved	This read-only field is reserved and always has the value 0.
12–8 H_OFS	This indicates the right bit position on the original pixel
7–5 Reserved	This read-only field is reserved and always has the value 0.
L_OFS	This indicates the left bit position on the original pixel

**41.11.77 This register defines the control bits for the ppx wfb fetch sub-block.
(PXP_HW_PXP_WFB_ARRAY_PIXEL6_MASK)**

This register defines the control bits for the ppx wfb fetch sub-block.

Address: 21C_C000h base + 11D0h offset = 21C_D1D0h

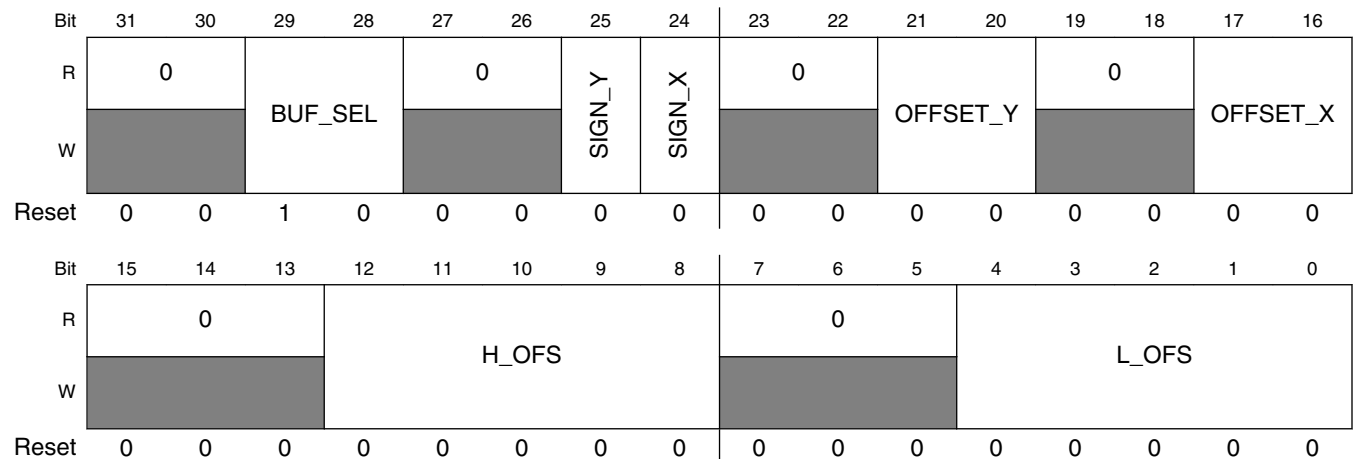

PXP_HW_PXP_WFB_ARRAY_PIXEL6_MASK field descriptions

Field	Description
31–30 Reserved	This read-only field is reserved and always has the value 0.
29–28 BUF_SEL	Select between Buffer 1 and 2
27–26 Reserved	This read-only field is reserved and always has the value 0.
25 SIGN_Y	Offset sign
24 SIGN_X	Offset sign
23–22 Reserved	This read-only field is reserved and always has the value 0.
21–20 OFFSET_Y	This indicates the Y offset position for the pixel.
19–18 Reserved	This read-only field is reserved and always has the value 0.
17–16 OFFSET_X	This indicates the X offset position for the pixel.
15–13 Reserved	This read-only field is reserved and always has the value 0.
12–8 H_OFS	This indicates the right bit position on the original pixel
7–5 Reserved	This read-only field is reserved and always has the value 0.
L_OFS	This indicates the left bit position on the original pixel

41.11.78 This register defines the control bits for the pxp wfb fetch sub-block. (PXP_HW_PXP_WFB_ARRAY_PIXEL7_MASK)

This register defines the control bits for the pxp wfb fetch sub-block.

Address: 21C_C000h base + 11E0h offset = 21C_D1E0h

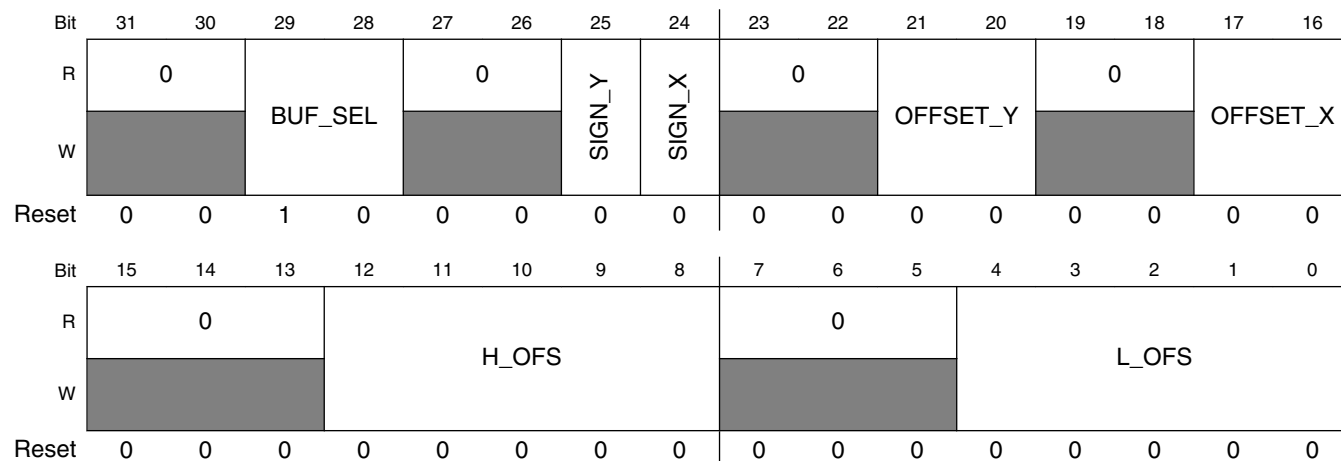

PXP_HW_PXP_WFB_ARRAY_PIXEL7_MASK field descriptions

Field	Description
31–30 Reserved	This read-only field is reserved and always has the value 0.
29–28 BUF_SEL	Select between Buffer 1 and 2
27–26 Reserved	This read-only field is reserved and always has the value 0.
25 SIGN_Y	Offset sign
24 SIGN_X	Offset sign
23–22 Reserved	This read-only field is reserved and always has the value 0.
21–20 OFFSET_Y	This indicates the Y offset position for the pixel.
19–18 Reserved	This read-only field is reserved and always has the value 0.
17–16 OFFSET_X	This indicates the X offset position for the pixel.
15–13 Reserved	This read-only field is reserved and always has the value 0.

Table continues on the next page...

PXP_HW_PXP_WFB_ARRAY_PIXEL7_MASK field descriptions (continued)

Field	Description
12–8 H_OFS	This indicates the right bit position on the original pixel
7–5 Reserved	This read-only field is reserved and always has the value 0.
L_OFS	This indicates the left bit position on the original pixel

41.11.79 This register defines the control bits for the pxp wfb fetch sub-block. (PXP_HW_PXP_WFB_ARRAY_FLAG0_MASK)

This register defines the control bits for the pxp wfb fetch sub-block.

Address: 21C_C000h base + 11F0h offset = 21C_D1F0h

Bit	31	30	29	28	27	26	25	24	23	22	21	20	19	18	17	16
R	0				0		SIGN_Y	SIGN_X	0				0			
W			BUF_SEL							OFFSET_Y					OFFSET_X	
Reset	0	0	1	0	0	0	0	0	0	0	0	0	0	0	0	0
Bit	15	14	13	12	11	10	9	8	7	6	5	4	3	2	1	0
R	0								0							
W																
Reset	0	0	0	0	0	0	0	0	0	0	0	0	0	0	0	0

PXP_HW_PXP_WFB_ARRAY_FLAG0_MASK field descriptions

Field	Description
31–30 Reserved	This read-only field is reserved and always has the value 0.
29–28 BUF_SEL	Select between Buffer 1 and 2
27–26 Reserved	This read-only field is reserved and always has the value 0.
25 SIGN_Y	Offset sign
24 SIGN_X	Offset sign

Table continues on the next page...

PXP_HW_PXP_WFB_ARRAY_FLAG0_MASK field descriptions (continued)

Field	Description
23–22 Reserved	This read-only field is reserved and always has the value 0.
21–20 OFFSET_Y	This indicates the Y offset position for the pixel.
19–18 Reserved	This read-only field is reserved and always has the value 0.
17–16 OFFSET_X	This indicates the X offset position for the pixel.
15–13 Reserved	This read-only field is reserved and always has the value 0.
12–8 H_OFS	This indicates the right bit position on the original pixel
7–5 Reserved	This read-only field is reserved and always has the value 0.
L_OFS	This indicates the left bit position on the original pixel

**41.11.80 This register defines the control bits for the ppx wfb fetch sub-block.
(PXP_HW_PXP_WFB_ARRAY_FLAG1_MASK)**

This register defines the control bits for the ppx wfb fetch sub-block.

Address: 21C_C000h base + 1200h offset = 21C_D200h

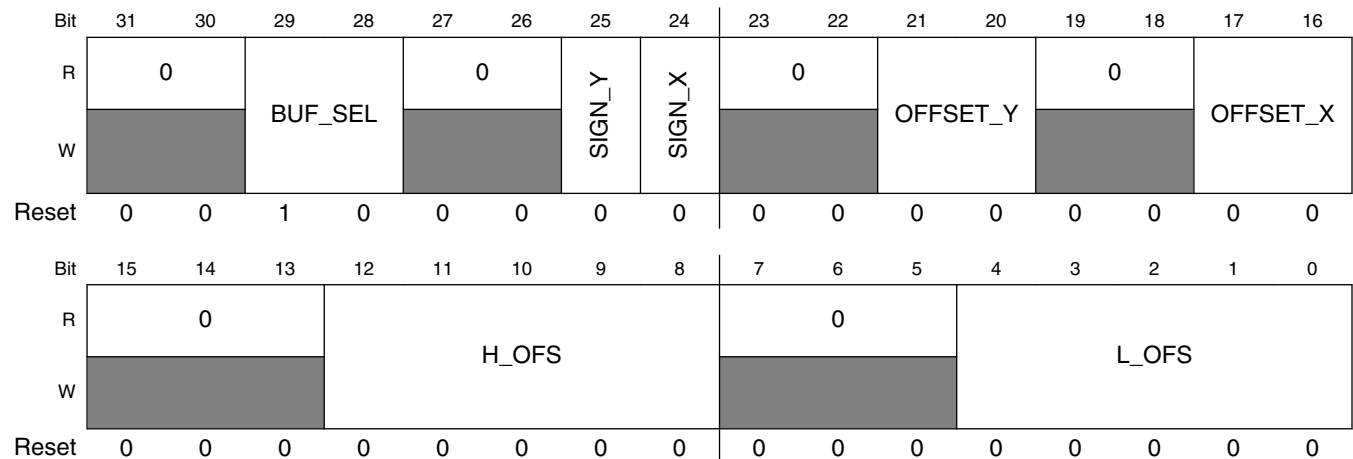

PXP_HW_PXP_WFB_ARRAY_FLAG1_MASK field descriptions

Field	Description
31–30 Reserved	This read-only field is reserved and always has the value 0.
29–28 BUF_SEL	Select between Buffer 1 and 2
27–26 Reserved	This read-only field is reserved and always has the value 0.
25 SIGN_Y	Offset sign
24 SIGN_X	Offset sign
23–22 Reserved	This read-only field is reserved and always has the value 0.
21–20 OFFSET_Y	This indicates the Y offset position for the pixel.
19–18 Reserved	This read-only field is reserved and always has the value 0.
17–16 OFFSET_X	This indicates the X offset position for the pixel.
15–13 Reserved	This read-only field is reserved and always has the value 0.
12–8 H_OFS	This indicates the right bit position on the original pixel
7–5 Reserved	This read-only field is reserved and always has the value 0.
L_OFS	This indicates the left bit position on the original pixel

41.11.81 This register defines the control bits for the pxp wfb fetch sub-block. (PXP_HW_PXP_WFB_ARRAY_FLAG2_MASK)

This register defines the control bits for the pxp wfb fetch sub-block.

Address: 21C_C000h base + 1210h offset = 21C_D210h

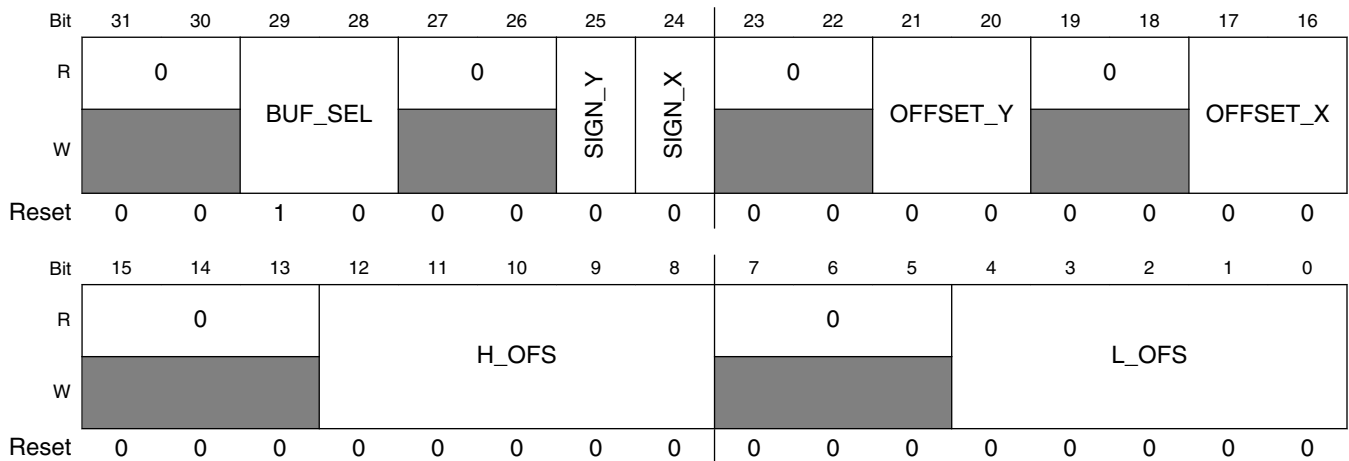

PXP_HW_PXP_WFB_ARRAY_FLAG2_MASK field descriptions

Field	Description
31–30 Reserved	This read-only field is reserved and always has the value 0.
29–28 BUF_SEL	Select between Buffer 1 and 2
27–26 Reserved	This read-only field is reserved and always has the value 0.
25 SIGN_Y	Offset sign
24 SIGN_X	Offset sign
23–22 Reserved	This read-only field is reserved and always has the value 0.
21–20 OFFSET_Y	This indicates the Y offset position for the pixel.
19–18 Reserved	This read-only field is reserved and always has the value 0.
17–16 OFFSET_X	This indicates the X offset position for the pixel.
15–13 Reserved	This read-only field is reserved and always has the value 0.

Table continues on the next page...

PXP_HW_PXP_WFB_ARRAY_FLAG2_MASK field descriptions (continued)

Field	Description
12–8 H_OFS	This indicates the right bit position on the original pixel
7–5 Reserved	This read-only field is reserved and always has the value 0.
L_OFS	This indicates the left bit position on the original pixel

41.11.82 This register defines the control bits for the pxp wfb fetch sub-block. (PXP_HW_PXP_WFB_ARRAY_FLAG3_MASK)

This register defines the control bits for the pxp wfb fetch sub-block.

Address: 21C_C000h base + 1220h offset = 21C_D220h

Bit	31	30	29	28	27	26	25	24	23	22	21	20	19	18	17	16
R	0				0		SIGN_Y	SIGN_X	0				0			
W			BUF_SEL								OFFSET_Y					OFFSET_X
Reset	0	0	1	0	0	0	0	0	0	0	0	0	0	0	0	0
Bit	15	14	13	12	11	10	9	8	7	6	5	4	3	2	1	0
R	0								0							
W																
Reset	0	0	0	0	0	0	0	0	0	0	0	0	0	0	0	0

PXP_HW_PXP_WFB_ARRAY_FLAG3_MASK field descriptions

Field	Description
31–30 Reserved	This read-only field is reserved and always has the value 0.
29–28 BUF_SEL	Select between Buffer 1 and 2
27–26 Reserved	This read-only field is reserved and always has the value 0.
25 SIGN_Y	Offset sign
24 SIGN_X	Offset sign

Table continues on the next page...

PXP_HW_PXP_WFB_ARRAY_FLAG3_MASK field descriptions (continued)

Field	Description
23–22 Reserved	This read-only field is reserved and always has the value 0.
21–20 OFFSET_Y	This indicates the Y offset position for the pixel.
19–18 Reserved	This read-only field is reserved and always has the value 0.
17–16 OFFSET_X	This indicates the X offset position for the pixel.
15–13 Reserved	This read-only field is reserved and always has the value 0.
12–8 H_OFS	This indicates the right bit position on the original pixel
7–5 Reserved	This read-only field is reserved and always has the value 0.
L_OFS	This indicates the left bit position on the original pixel

**41.11.83 This register defines the control bits for the ppx wfb fetch sub-block.
(PXP_HW_PXP_WFB_ARRAY_FLAG4_MASK)**

This register defines the control bits for the ppx wfb fetch sub-block.

Address: 21C_C000h base + 1230h offset = 21C_D230h

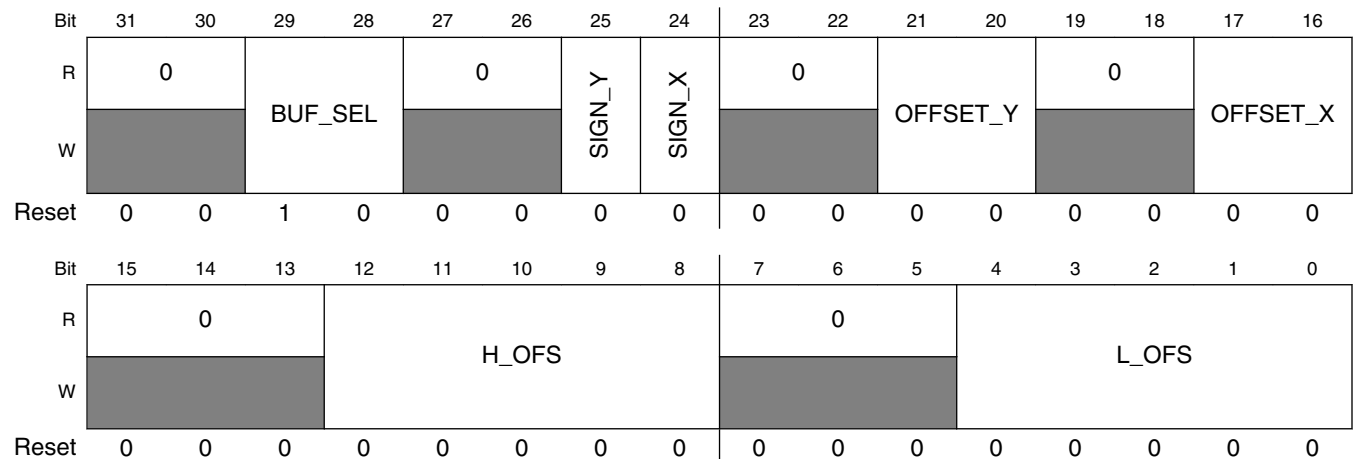

PXP_HW_PXP_WFB_ARRAY_FLAG4_MASK field descriptions

Field	Description
31–30 Reserved	This read-only field is reserved and always has the value 0.
29–28 BUF_SEL	Select between Buffer 1 and 2
27–26 Reserved	This read-only field is reserved and always has the value 0.
25 SIGN_Y	Offset sign
24 SIGN_X	Offset sign
23–22 Reserved	This read-only field is reserved and always has the value 0.
21–20 OFFSET_Y	This indicates the Y offset position for the pixel.
19–18 Reserved	This read-only field is reserved and always has the value 0.
17–16 OFFSET_X	This indicates the X offset position for the pixel.
15–13 Reserved	This read-only field is reserved and always has the value 0.
12–8 H_OFS	This indicates the right bit position on the original pixel
7–5 Reserved	This read-only field is reserved and always has the value 0.
L_OFS	This indicates the left bit position on the original pixel

41.11.84 This register defines the control bits for the pxp wfb fetch sub-block. (PXP_HW_PXP_WFB_ARRAY_FLAG5_MASK)

This register defines the control bits for the pxp wfb fetch sub-block.

Address: 21C_C000h base + 1240h offset = 21C_D240h

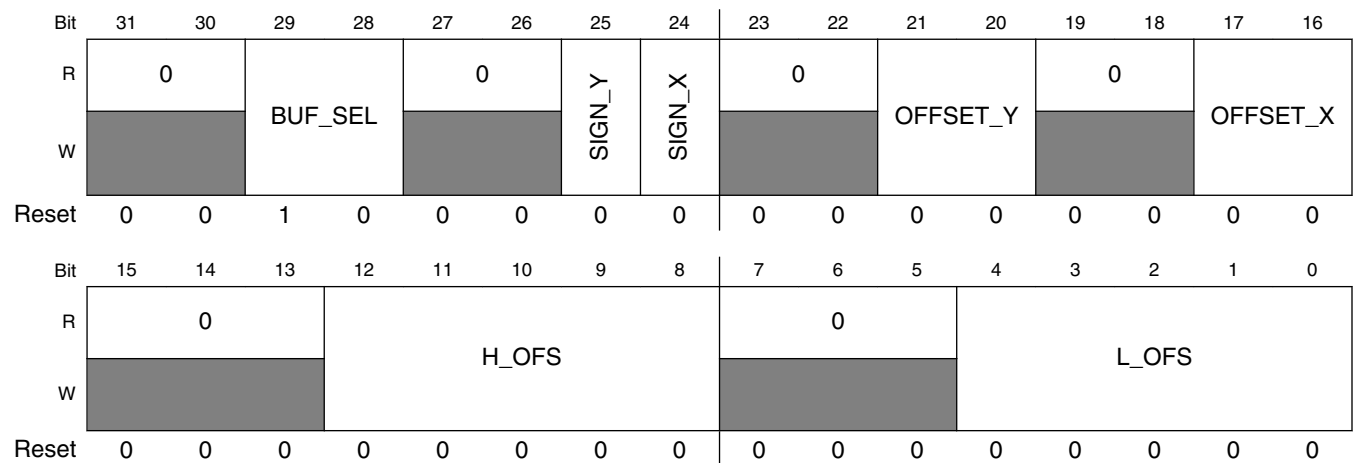

PXP_HW_PXP_WFB_ARRAY_FLAG5_MASK field descriptions

Field	Description
31–30 Reserved	This read-only field is reserved and always has the value 0.
29–28 BUF_SEL	Select between Buffer 1 and 2
27–26 Reserved	This read-only field is reserved and always has the value 0.
25 SIGN_Y	Offset sign
24 SIGN_X	Offset sign
23–22 Reserved	This read-only field is reserved and always has the value 0.
21–20 OFFSET_Y	This indicates the Y offset position for the pixel.
19–18 Reserved	This read-only field is reserved and always has the value 0.
17–16 OFFSET_X	This indicates the X offset position for the pixel.
15–13 Reserved	This read-only field is reserved and always has the value 0.

Table continues on the next page...

PXP_HW_PXP_WFB_ARRAY_FLAG5_MASK field descriptions (continued)

Field	Description
12–8 H_OFS	This indicates the right bit position on the original pixel
7–5 Reserved	This read-only field is reserved and always has the value 0.
L_OFS	This indicates the left bit position on the original pixel

41.11.85 This register defines the control bits for the pxp wfb fetch sub-block. (PXP_HW_PXP_WFB_ARRAY_FLAG6_MASK)

This register defines the control bits for the pxp wfb fetch sub-block.

Address: 21C_C000h base + 1250h offset = 21C_D250h

Bit	31	30	29	28	27	26	25	24	23	22	21	20	19	18	17	16
R	0				0		SIGN_Y	SIGN_X	0				0			
W			BUF_SEL							OFFSET_Y						OFFSET_X
Reset	0	0	1	0	0	0	0	0	0	0	0	0	0	0	0	0
Bit	15	14	13	12	11	10	9	8	7	6	5	4	3	2	1	0
R	0								0							
W																
Reset	0	0	0	0	0	0	0	0	0	0	0	0	0	0	0	0

PXP_HW_PXP_WFB_ARRAY_FLAG6_MASK field descriptions

Field	Description
31–30 Reserved	This read-only field is reserved and always has the value 0.
29–28 BUF_SEL	Select between Buffer 1 and 2
27–26 Reserved	This read-only field is reserved and always has the value 0.
25 SIGN_Y	Offset sign
24 SIGN_X	Offset sign

Table continues on the next page...

PXP_HW_PXP_WFB_ARRAY_FLAG6_MASK field descriptions (continued)

Field	Description
23–22 Reserved	This read-only field is reserved and always has the value 0.
21–20 OFFSET_Y	This indicates the Y offset position for the pixel.
19–18 Reserved	This read-only field is reserved and always has the value 0.
17–16 OFFSET_X	This indicates the X offset position for the pixel.
15–13 Reserved	This read-only field is reserved and always has the value 0.
12–8 H_OFS	This indicates the right bit position on the original pixel
7–5 Reserved	This read-only field is reserved and always has the value 0.
L_OFS	This indicates the left bit position on the original pixel

**41.11.86 This register defines the control bits for the ppx wfb fetch sub-block.
(PXP_HW_PXP_WFB_ARRAY_FLAG7_MASK)**

This register defines the control bits for the ppx wfb fetch sub-block.

Address: 21C_C000h base + 1260h offset = 21C_D260h

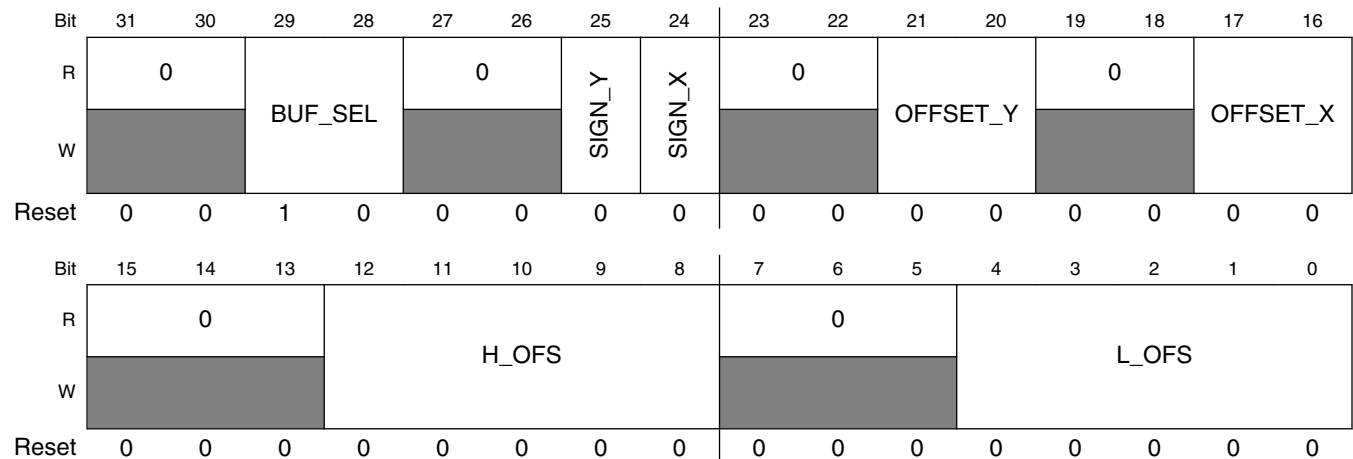

PXP_HW_PXP_WFB_ARRAY_FLAG7_MASK field descriptions

Field	Description
31–30 Reserved	This read-only field is reserved and always has the value 0.
29–28 BUF_SEL	Select between Buffer 1 and 2
27–26 Reserved	This read-only field is reserved and always has the value 0.
25 SIGN_Y	Offset sign
24 SIGN_X	Offset sign
23–22 Reserved	This read-only field is reserved and always has the value 0.
21–20 OFFSET_Y	This indicates the Y offset position for the pixel.
19–18 Reserved	This read-only field is reserved and always has the value 0.
17–16 OFFSET_X	This indicates the X offset position for the pixel.
15–13 Reserved	This read-only field is reserved and always has the value 0.
12–8 H_OFS	This indicates the right bit position on the original pixel
7–5 Reserved	This read-only field is reserved and always has the value 0.
L_OFS	This indicates the left bit position on the original pixel

41.11.87 This register defines the control bits for the pxp wfa fetch sub-block. (PXP_HW_PXP_WFB_FETCH_BUF1_CORD)

This register defines the control bits for the pxp wfa fetch sub-block.

Address: 21C_C000h base + 1270h offset = 21C_D270h

Bit	31	30	29	28	27	26	25	24	23	22	21	20	19	18	17	16	15	14	13	12	11	10	9	8	7	6	5	4	3	2	1	0
R	0																0															
W																																
Reset	0	0	0	0	0	0	0	0	0	0	0	0	0	0	0	0	0	0	0	0	0	0	0	0	0	0	0	0	0	0	0	0

PXP_HW_PXP_WFB_FETCH_BUF1_CORD field descriptions

Field	Description
31–30 Reserved	This read-only field is reserved and always has the value 0.
29–16 YCORD	This indicate Y co-ordinate in pixels.
15–14 Reserved	This read-only field is reserved and always has the value 0.
XCORD	This indicate X co-ordinate in pixels.

**41.11.88 This register defines the control bits for the pxp wfa fetch sub-block.
(PXP_HW_PXP_WFB_FETCH_BUF2_CORD)**

This register defines the control bits for the pxp wfa fetch sub-block.

Address: 21C_C000h base + 1280h offset = 21C_D280h

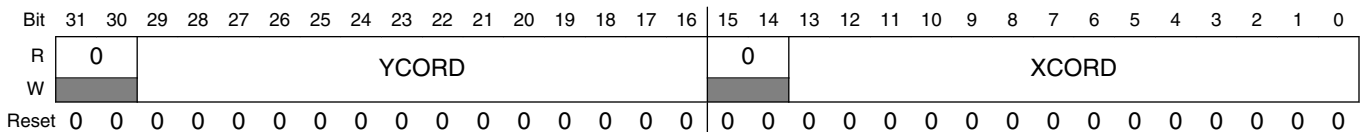

PXP_HW_PXP_WFB_FETCH_BUF2_CORD field descriptions

Field	Description
31–30 Reserved	This read-only field is reserved and always has the value 0.
29–16 YCORD	This indicate Y co-ordinate in pixels.
15–14 Reserved	This read-only field is reserved and always has the value 0.
XCORD	This indicate X co-ordinate in pixels.

41.11.89 This register defines the control bits for the pxp wfa fetch sub-block. (PXP_HW_PXP_WFB_ARRAY_FLAG8_MASK)

This register defines the control bits for the pxp wfa fetch sub-block.

Address: 21C_C000h base + 1290h offset = 21C_D290h

Bit	31	30	29	28	27	26	25	24	23	22	21	20	19	18	17	16		
R	0		BUF_SEL		0		SIGN_Y	SIGN_X	0		OFFSET_Y		0		OFFSET_X			
W	■				■				■				■					
Reset	0	0	1	0	0	0	0	0	0	0	0	0	0	0	0	0		
Bit	15	14	13	12	11	10	9	8	7	6	5	4	3	2	1	0		
R	0			H_OFS								0			L_OFS			
W	■											■						
Reset	0	0	0	0	0	0	0	0	0	0	0	0	0	0	0	0		

PXP_HW_PXP_WFB_ARRAY_FLAG8_MASK field descriptions

Field	Description
31–30 Reserved	This read-only field is reserved and always has the value 0.
29–28 BUF_SEL	Select between Buffer 1 and 2
27–26 Reserved	This read-only field is reserved and always has the value 0.
25 SIGN_Y	Offset sign
24 SIGN_X	Offset sign
23–22 Reserved	This read-only field is reserved and always has the value 0.
21–20 OFFSET_Y	This indicates the Y offset position for the pixel.
19–18 Reserved	This read-only field is reserved and always has the value 0.
17–16 OFFSET_X	This indicates the X offset position for the pixel.
15–13 Reserved	This read-only field is reserved and always has the value 0.

Table continues on the next page...

PXP_HW_PXP_WFB_ARRAY_FLAG8_MASK field descriptions (continued)

Field	Description
12–8 H_OFS	This indicates the right bit position on the original pixel
7–5 Reserved	This read-only field is reserved and always has the value 0.
L_OFS	This indicates the left bit position on the original pixel

**41.11.90 This register defines the control bits for the pxp wfa fetch sub-block.
(PXP_HW_PXP_WFB_ARRAY_FLAG9_MASK)**

This register defines the control bits for the pxp wfa fetch sub-block.

Address: 21C_C000h base + 12A0h offset = 21C_D2A0h

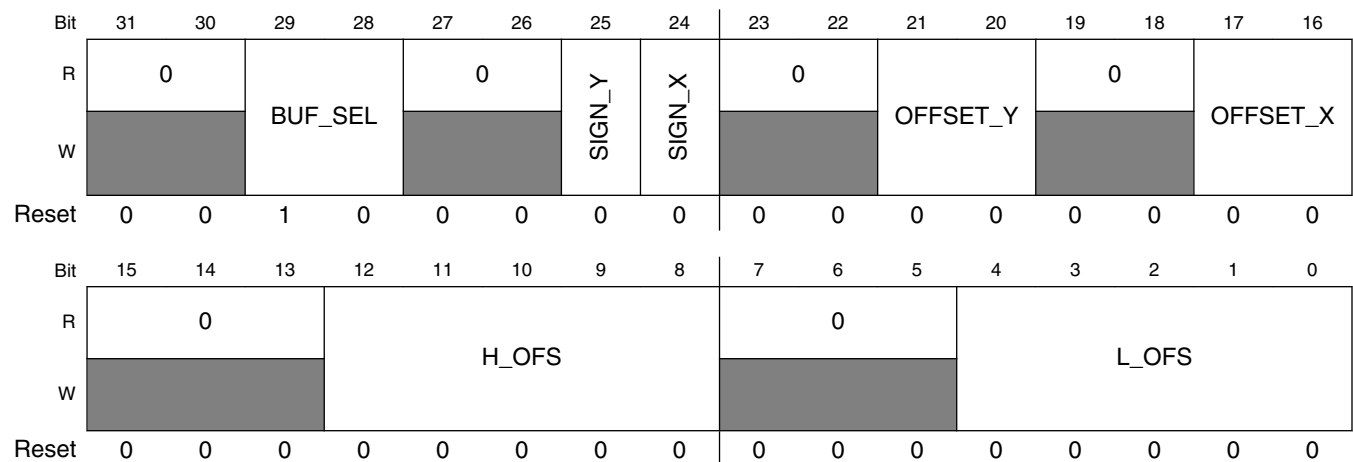

PXP_HW_PXP_WFB_ARRAY_FLAG9_MASK field descriptions

Field	Description
31–30 Reserved	This read-only field is reserved and always has the value 0.
29–28 BUF_SEL	Select between Buffer 1 and 2
27–26 Reserved	This read-only field is reserved and always has the value 0.
25 SIGN_Y	Offset sign
24 SIGN_X	Offset sign

Table continues on the next page...

PXP_HW_PXP_WFB_ARRAY_FLAG9_MASK field descriptions (continued)

Field	Description
23–22 Reserved	This read-only field is reserved and always has the value 0.
21–20 OFFSET_Y	This indicates the Y offset position for the pixel.
19–18 Reserved	This read-only field is reserved and always has the value 0.
17–16 OFFSET_X	This indicates the X offset position for the pixel.
15–13 Reserved	This read-only field is reserved and always has the value 0.
12–8 H_OFS	This indicates the right bit position on the original pixel
7–5 Reserved	This read-only field is reserved and always has the value 0.
L_OFS	This indicates the left bit position on the original pixel

41.11.91 This register defines the control bits for the pxp wfa fetch sub-block. (PXP_HW_PXP_WFB_ARRAY_FLAG10_MASK)

This register defines the control bits for the pxp wfa fetch sub-block.

Address: 21C_C000h base + 12B0h offset = 21C_D2B0h

Bit	31	30	29	28	27	26	25	24	23	22	21	20	19	18	17	16
R	0				0		SIGN_Y	SIGN_X	0				0			
W			BUF_SEL								OFFSET_Y					OFFSET_X
Reset	0	0	1	0	0	0	0	0	0	0	0	0	0	0	0	0
Bit	15	14	13	12	11	10	9	8	7	6	5	4	3	2	1	0
R	0								0							
W																
Reset	0	0	0	0	0	0	0	0	0	0	0	0	0	0	0	0

PXP_HW_PXP_WFB_ARRAY_FLAG10_MASK field descriptions

Field	Description
31–30 Reserved	This read-only field is reserved and always has the value 0.
29–28 BUF_SEL	Select between Buffer 1 and 2
27–26 Reserved	This read-only field is reserved and always has the value 0.
25 SIGN_Y	Offset sign
24 SIGN_X	Offset sign
23–22 Reserved	This read-only field is reserved and always has the value 0.
21–20 OFFSET_Y	This indicates the Y offset position for the pixel.
19–18 Reserved	This read-only field is reserved and always has the value 0.
17–16 OFFSET_X	This indicates the X offset position for the pixel.
15–13 Reserved	This read-only field is reserved and always has the value 0.
12–8 H_OFS	This indicates the right bit position on the original pixel
7–5 Reserved	This read-only field is reserved and always has the value 0.
L_OFS	This indicates the left bit position on the original pixel

41.11.92 This register defines the control bits for the pxp wfa fetch sub-block. (PXP_HW_PXP_WFB_ARRAY_FLAG11_MASK)

This register defines the control bits for the pxp wfa fetch sub-block.

Address: 21C_C000h base + 12C0h offset = 21C_D2C0h

Bit	31	30	29	28	27	26	25	24	23	22	21	20	19	18	17	16
R	0		BUF_SEL		0		SIGN_Y	SIGN_X	0		OFFSET_Y		0		OFFSET_X	
W	■				■				■				■			
Reset	0	0	1	0	0	0	0	0	0	0	0	0	0	0	0	0
Bit	15	14	13	12	11	10	9	8	7	6	5	4	3	2	1	0
R	0			H_OFS					0			L_OFS				
W	■								■							
Reset	0	0	0	0	0	0	0	0	0	0	0	0	0	0	0	0

PXP_HW_PXP_WFB_ARRAY_FLAG11_MASK field descriptions

Field	Description
31–30 Reserved	This read-only field is reserved and always has the value 0.
29–28 BUF_SEL	Select between Buffer 1 and 2
27–26 Reserved	This read-only field is reserved and always has the value 0.
25 SIGN_Y	Offset sign
24 SIGN_X	Offset sign
23–22 Reserved	This read-only field is reserved and always has the value 0.
21–20 OFFSET_Y	This indicates the Y offset position for the pixel.
19–18 Reserved	This read-only field is reserved and always has the value 0.
17–16 OFFSET_X	This indicates the X offset position for the pixel.
15–13 Reserved	This read-only field is reserved and always has the value 0.

Table continues on the next page...

PXP_HW_PXP_WFB_ARRAY_FLAG11_MASK field descriptions (continued)

Field	Description
12–8 H_OFS	This indicates the right bit position on the original pixel
7–5 Reserved	This read-only field is reserved and always has the value 0.
L_OFS	This indicates the left bit position on the original pixel

**41.11.93 This register defines the control bits for the pxp wfa fetch sub-block.
(PXP_HW_PXP_WFB_ARRAY_FLAG12_MASK)**

This register defines the control bits for the pxp wfa fetch sub-block.

Address: 21C_C000h base + 12D0h offset = 21C_D2D0h

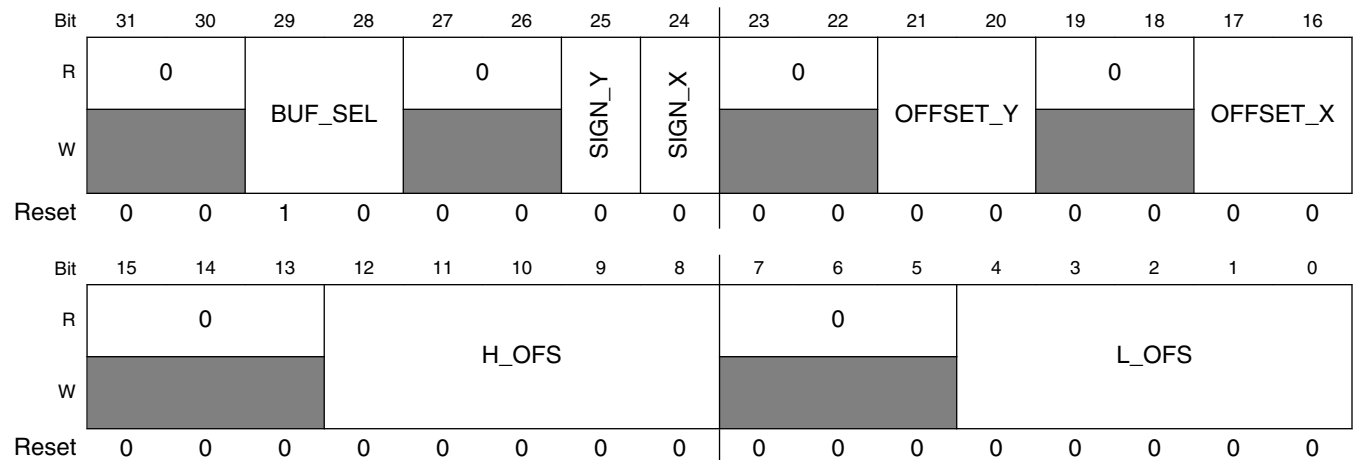

PXP_HW_PXP_WFB_ARRAY_FLAG12_MASK field descriptions

Field	Description
31–30 Reserved	This read-only field is reserved and always has the value 0.
29–28 BUF_SEL	Select between Buffer 1 and 2
27–26 Reserved	This read-only field is reserved and always has the value 0.
25 SIGN_Y	Offset sign
24 SIGN_X	Offset sign

Table continues on the next page...

PXP_HW_PXP_WFB_ARRAY_FLAG12_MASK field descriptions (continued)

Field	Description
23–22 Reserved	This read-only field is reserved and always has the value 0.
21–20 OFFSET_Y	This indicates the Y offset position for the pixel.
19–18 Reserved	This read-only field is reserved and always has the value 0.
17–16 OFFSET_X	This indicates the X offset position for the pixel.
15–13 Reserved	This read-only field is reserved and always has the value 0.
12–8 H_OFS	This indicates the right bit position on the original pixel
7–5 Reserved	This read-only field is reserved and always has the value 0.
L_OFS	This indicates the left bit position on the original pixel

41.11.94 This register defines the control bits for the pxp wfa fetch sub-block. (PXP_HW_PXP_WFB_ARRAY_FLAG13_MASK)

This register defines the control bits for the pxp wfa fetch sub-block.

Address: 21C_C000h base + 12E0h offset = 21C_D2E0h

Bit	31	30	29	28	27	26	25	24	23	22	21	20	19	18	17	16
R	0				0		SIGN_Y	SIGN_X	0				0			
W			BUF_SEL								OFFSET_Y					OFFSET_X
Reset	0	0	1	0	0	0	0	0	0	0	0	0	0	0	0	0
Bit	15	14	13	12	11	10	9	8	7	6	5	4	3	2	1	0
R	0								0							
W																
Reset	0	0	0	0	0	0	0	0	0	0	0	0	0	0	0	0

PXP_HW_PXP_WFB_ARRAY_FLAG13_MASK field descriptions

Field	Description
31–30 Reserved	This read-only field is reserved and always has the value 0.
29–28 BUF_SEL	Select between Buffer 1 and 2
27–26 Reserved	This read-only field is reserved and always has the value 0.
25 SIGN_Y	Offset sign
24 SIGN_X	Offset sign
23–22 Reserved	This read-only field is reserved and always has the value 0.
21–20 OFFSET_Y	This indicates the Y offset position for the pixel.
19–18 Reserved	This read-only field is reserved and always has the value 0.
17–16 OFFSET_X	This indicates the X offset position for the pixel.
15–13 Reserved	This read-only field is reserved and always has the value 0.
12–8 H_OFS	This indicates the right bit position on the original pixel
7–5 Reserved	This read-only field is reserved and always has the value 0.
L_OFS	This indicates the left bit position on the original pixel

41.11.95 This register defines the control bits for the pxp wfa fetch sub-block. (PXP_HW_PXP_WFB_ARRAY_FLAG14_MASK)

This register defines the control bits for the pxp wfa fetch sub-block.

Address: 21C_C000h base + 12F0h offset = 21C_D2F0h

Bit	31	30	29	28	27	26	25	24	23	22	21	20	19	18	17	16		
R	0		BUF_SEL		0		SIGN_Y	SIGN_X	0		OFFSET_Y		0		OFFSET_X			
W	■				■				■				■					
Reset	0	0	1	0	0	0	0	0	0	0	0	0	0	0	0	0		
Bit	15	14	13	12	11	10	9	8	7	6	5	4	3	2	1	0		
R	0			H_OFS								0			L_OFS			
W	■											■						
Reset	0	0	0	0	0	0	0	0	0	0	0	0	0	0	0	0		

PXP_HW_PXP_WFB_ARRAY_FLAG14_MASK field descriptions

Field	Description
31–30 Reserved	This read-only field is reserved and always has the value 0.
29–28 BUF_SEL	Select between Buffer 1 and 2
27–26 Reserved	This read-only field is reserved and always has the value 0.
25 SIGN_Y	Offset sign
24 SIGN_X	Offset sign
23–22 Reserved	This read-only field is reserved and always has the value 0.
21–20 OFFSET_Y	This indicates the Y offset position for the pixel.
19–18 Reserved	This read-only field is reserved and always has the value 0.
17–16 OFFSET_X	This indicates the X offset position for the pixel.
15–13 Reserved	This read-only field is reserved and always has the value 0.

Table continues on the next page...

PXP_HW_PXP_WFB_ARRAY_FLAG14_MASK field descriptions (continued)

Field	Description
12–8 H_OFS	This indicates the right bit position on the original pixel
7–5 Reserved	This read-only field is reserved and always has the value 0.
L_OFS	This indicates the left bit position on the original pixel

**41.11.96 This register defines the control bits for the pxp wfa fetch sub-block.
(PXP_HW_PXP_WFB_ARRAY_FLAG15_MASK)**

This register defines the control bits for the pxp wfa fetch sub-block.

Address: 21C_C000h base + 1300h offset = 21C_D300h

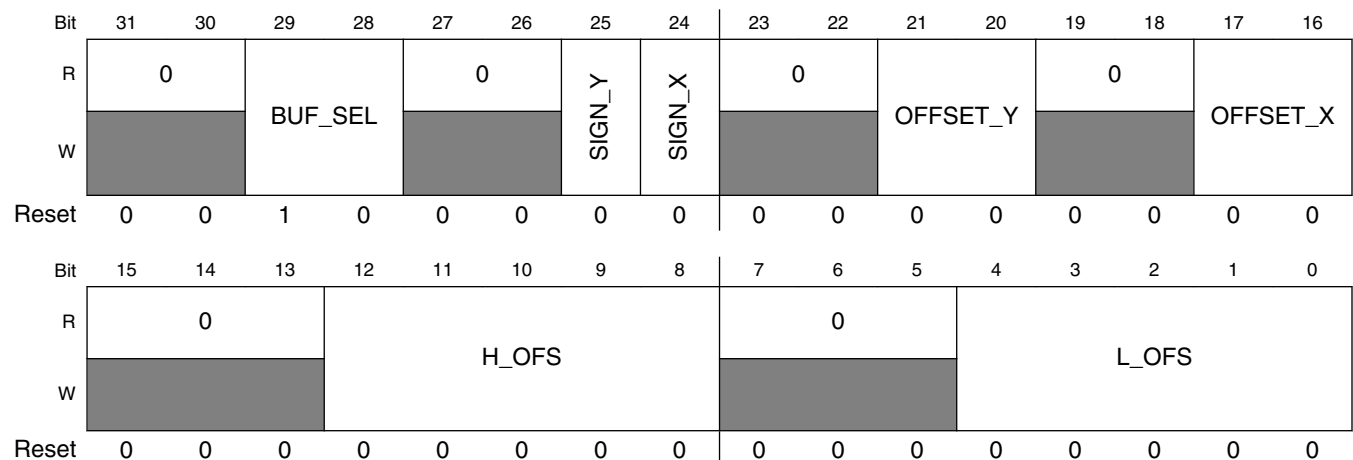

PXP_HW_PXP_WFB_ARRAY_FLAG15_MASK field descriptions

Field	Description
31–30 Reserved	This read-only field is reserved and always has the value 0.
29–28 BUF_SEL	Select between Buffer 1 and 2
27–26 Reserved	This read-only field is reserved and always has the value 0.
25 SIGN_Y	Offset sign
24 SIGN_X	Offset sign

Table continues on the next page...

PXP_HW_PXP_WFB_ARRAY_FLAG15_MASK field descriptions (continued)

Field	Description
23–22 Reserved	This read-only field is reserved and always has the value 0.
21–20 OFFSET_Y	This indicates the Y offset position for the pixel.
19–18 Reserved	This read-only field is reserved and always has the value 0.
17–16 OFFSET_X	This indicates the X offset position for the pixel.
15–13 Reserved	This read-only field is reserved and always has the value 0.
12–8 H_OFS	This indicates the right bit position on the original pixel
7–5 Reserved	This read-only field is reserved and always has the value 0.
L_OFS	This indicates the left bit position on the original pixel

41.11.97 This register defines software define pixels for wfb fetch sub-block. (PXP_HW_PXP_WFB_ARRAY_REG0)

This register defines software define pixels for wfb fetch sub-block.

Address: 21C_C000h base + 1310h offset = 21C_D310h

Bit	31	30	29	28	27	26	25	24	23	22	21	20	19	18	17	16	15	14	13	12	11	10	9	8	7	6	5	4	3	2	1	0																
R	SW_PIXLE3								SW_PIXLE2								SW_PIXLE1								SW_PIXLE0																							
W																																																
Reset	0	0	0	0	0	0	0	0	0	0	0	0	0	0	0	0	0	0	0	0	0	0	0	0	0	0	0	0	0	0	0	0	0	0	0	0	0	0	0	0	0	0	0	0	0	0	0	0

PXP_HW_PXP_WFB_ARRAY_REG0 field descriptions

Field	Description
31–24 SW_PIXLE3	Software define pixel3
23–16 SW_PIXLE2	Software define pixel2
15–8 SW_PIXLE1	Software define pixel1
SW_PIXLE0	Software define pixel0

41.11.98 This register defines software define pixels for wfb fetch sub-block. (PXP_HW_PXP_WFB_ARRAY_REG1)

This register defines software define pixels for wfb fetch sub-block.

Address: 21C_C000h base + 1320h offset = 21C_D320h

Bit	31	30	29	28	27	26	25	24	23	22	21	20	19	18	17	16	15	14	13	12	11	10	9	8	7	6	5	4	3	2	1	0																
R	SW_PIXLE7								SW_PIXLE6								SW_PIXLE5								SW_PIXLE4																							
W																																																
Reset	0	0	0	0	0	0	0	0	0	0	0	0	0	0	0	0	0	0	0	0	0	0	0	0	0	0	0	0	0	0	0	0	0	0	0	0	0	0	0	0	0	0	0	0	0	0	0	0

PXP_HW_PXP_WFB_ARRAY_REG1 field descriptions

Field	Description
31–24 SW_PIXLE7	Software define pixel7
23–16 SW_PIXLE6	Software define pixel6
15–8 SW_PIXLE5	Software define pixel5
SW_PIXLE4	Software define pixel4

41.11.99 This register defines software define pixels for wfb fetch sub-block. (PXP_HW_PXP_WFB_ARRAY_REG2)

This register defines software define flags for wfb fetch sub-block.

Address: 21C_C000h base + 1330h offset = 21C_D330h

Bit	31	30	29	28	27	26	25	24	23	22	21	20	19	18	17	16
R	0															
W																
Reset	0	0	0	0	0	0	0	0	0	0	0	0	0	0	0	0
Bit	15	14	13	12	11	10	9	8	7	6	5	4	3	2	1	0
R	SW_FLAG15	SW_FLAG14	SW_FLAG13	SW_FLAG12	SW_FLAG11	SW_FLAG10	SW_FLAG9	SW_FLAG8	SW_FLAG7	SW_FLAG6	SW_FLAG5	SW_FLAG4	SW_FLAG3	SW_FLAG2	SW_FLAG1	SW_FLAG0
W	SW_FLAG15	SW_FLAG14	SW_FLAG13	SW_FLAG12	SW_FLAG11	SW_FLAG10	SW_FLAG9	SW_FLAG8	SW_FLAG7	SW_FLAG6	SW_FLAG5	SW_FLAG4	SW_FLAG3	SW_FLAG2	SW_FLAG1	SW_FLAG0
Reset	0	0	0	0	0	0	0	0	0	0	0	0	0	0	0	0

PXP_HW_PXP_WFB_ARRAY_REG2 field descriptions

Field	Description
31–16 Reserved	This read-only field is reserved and always has the value 0.
15 SW_FLAG15	Software define flag15
14 SW_FLAG14	Software define flag14
13 SW_FLAG13	Software define flag13
12 SW_FLAG12	Software define flag12
11 SW_FLAG11	Software define flag11
10 SW_FLAG10	Software define flag10
9 SW_FLAG9	Software define flag9
8 SW_FLAG8	Software define flag8
7 SW_FLAG7	Software define flag7

Table continues on the next page...

PXP_HW_PXP_WFB_ARRAY_REG2 field descriptions (continued)

Field	Description
6 SW_FLAG6	Software define flag6
5 SW_FLAG5	Software define flag5
4 SW_FLAG4	Software define flag4
3 SW_FLAG3	Software define flag3
2 SW_FLAG2	Software define flag2
1 SW_FLAG1	Software define flag1
0 SW_FLAG0	Software define flag0

41.11.100 Store engine Control Channel 0 Register (PXP_HW_PXP_WFE_B_STORE_CTRL_CH0n)

The Control register contains the control bits for the pxp store_engine sub-block.

Address: 21C_C000h base + 1340h offset + (4d × i), where i=0d to 3d

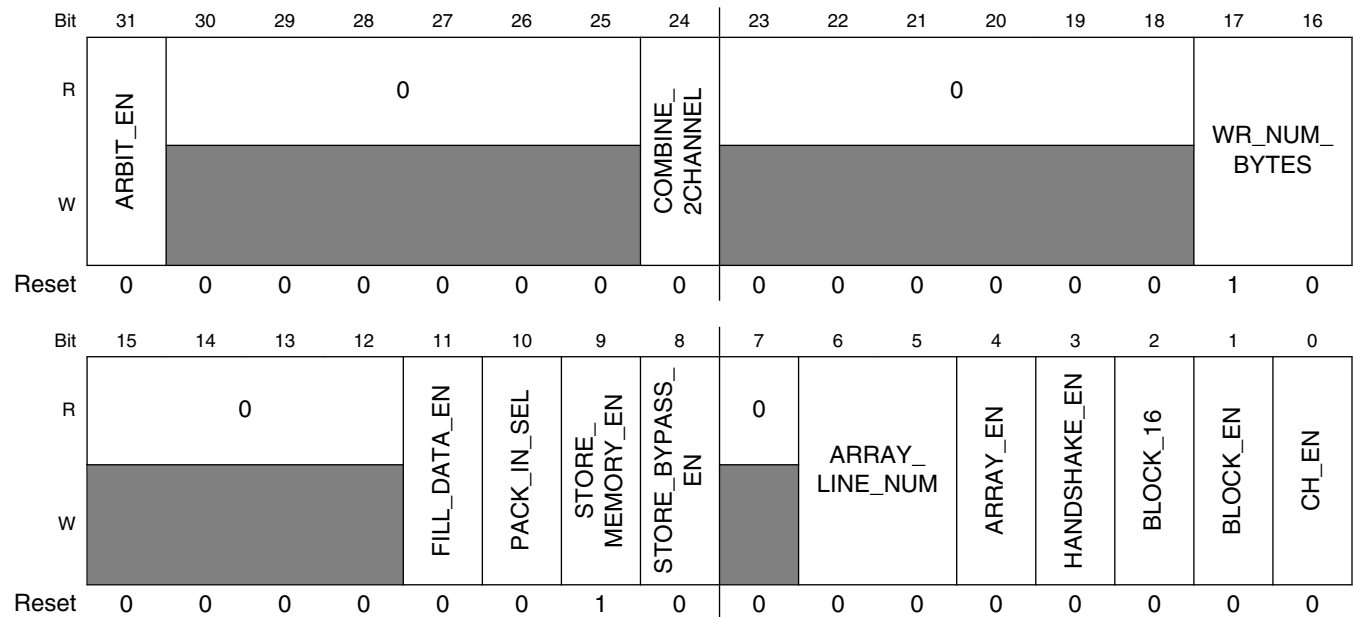

PXP_HW_PXP_WFE_B_STORE_CTRL_CH0n field descriptions

Field	Description
31 ARBIT_EN	Arbitration Enable
30–25 Reserved	This read-only field is reserved and always has the value 0.
24 COMBINE_2CHANNEL	Combine 2 channel Enable
23–18 Reserved	This read-only field is reserved and always has the value 0.
17–16 WR_NUM_BYTES	Bytes in a write burst
15–12 Reserved	This read-only field is reserved and always has the value 0.
11 FILL_DATA_EN	enable bit for fill data
10 PACK_IN_SEL	pack_in_sel
9 STORE_MEMORY_EN	store memory enable
8 STORE_BYPASS_EN	enable bit for store bypass
7 Reserved	This read-only field is reserved and always has the value 0.
6–5 ARRAY_LINE_NUM	Selects Array Size
4 ARRAY_EN	Array Enable
3 HANDSHAKE_EN	Enable bit for handshake with the store engine.
2 BLOCK_16	Determines the block size.
1 BLOCK_EN	Chooses the store mode.
0 CH_EN	Channel enable.

41.11.101 Store engine Control Channel 1 Register (PXP_HW_PXP_WFE_B_STORE_CTRL_CH1n)

The Control register contains the control bits for the pxp prefetch_engine sub-block.

Address: 21C_C000h base + 1350h offset + (4d × i), where i=0d to 3d

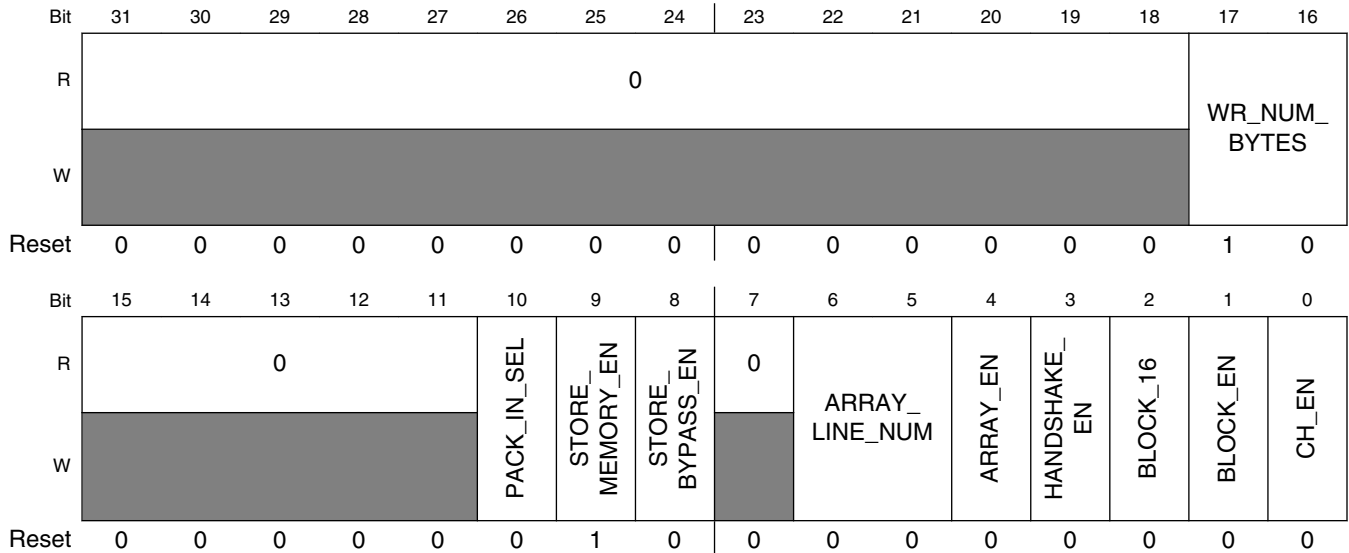

PXP_HW_PXP_WFE_B_STORE_CTRL_CH1n field descriptions

Field	Description
31–18 Reserved	This read-only field is reserved and always has the value 0.
17–16 WR_NUM_BYTES	Bytes in a write burst
15–11 Reserved	This read-only field is reserved and always has the value 0.
10 PACK_IN_SEL	pack_in_sel
9 STORE_MEMORY_EN	store memory enable
8 STORE_BYPASS_EN	enable bit for store bypass
7 Reserved	This read-only field is reserved and always has the value 0.
6–5 ARRAY_LINE_NUM	Selects Array Size

Table continues on the next page...

PXP_HW_PXP_WFE_B_STORE_CTRL_CH1n field descriptions (continued)

Field	Description
4 ARRAY_EN	Array Enable
3 HANDSHAKE_EN	Enable bit for handshake with the fetch engine.
2 BLOCK_16	Determines the block size.
1 BLOCK_EN	Chooses the store mode.
0 CH_EN	Channel enable.

41.11.102 Store engine status Channel 0 Register (PXP_HW_PXP_WFE_B_STORE_STATUS_CH0)

The Control register contains the control bits for the pxp store_engine sub-block.

Address: 21C_C000h base + 1360h offset = 21C_D360h

Bit	31	30	29	28	27	26	25	24	23	22	21	20	19	18	17	16	15	14	13	12	11	10	9	8	7	6	5	4	3	2	1	0
R	STORE_BLOCK_Y																STORE_BLOCK_X															
W	0																															
Reset	0	0	0	0	0	0	0	0	0	0	0	0	0	0	0	0	0	0	0	0	0	0	0	0	0	0	0	0	0	0	0	0

PXP_HW_PXP_WFE_B_STORE_STATUS_CH0 field descriptions

Field	Description
31–16 STORE_BLOCK_Y	When in scan mode, this field indicates the current Y coordinate of the frame. In block mode, it indicates the Y coordinate of the block currently being rendered.
STORE_BLOCK_X	When in scan mode, this field is always 0. In block mode, it indicates the X coordinate of the block currently being rendered.

41.11.103 Store engine status Channel 1 Register (PXP_HW_PXP_WFE_B_STORE_STATUS_CH1)

The Control register contains the control bits for the pxp store_engine sub-block.

Address: 21C_C000h base + 1370h offset = 21C_D370h

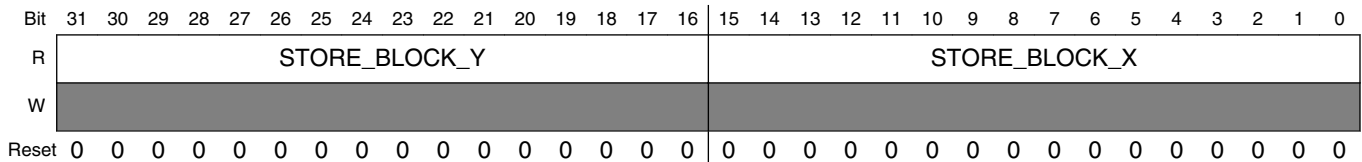

PXP_HW_PXP_WFE_B_STORE_STATUS_CH1 field descriptions

Field	Description
31–16 STORE_BLOCK_Y	When in scan mode, this field indicates the current Y coordinate of the frame. In block mode, it indicates the Y coordinate of the block currently being rendered.
STORE_BLOCK_X	When in scan mode, this field is always 0. In block mode, it indicates the X coordinate of the block currently being rendered.

41.11.104 This register defines the control bits for the pxp store_engine sub-block. (PXP_HW_PXP_WFE_B_STORE_SIZE_CH0)

The Control register contains the control bits for the pxp store_engine sub-block.

Address: 21C_C000h base + 1380h offset = 21C_D380h

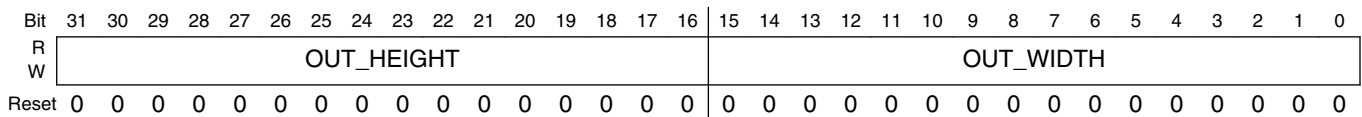

PXP_HW_PXP_WFE_B_STORE_SIZE_CH0 field descriptions

Field	Description
31–16 OUT_HEIGHT	actual output height -1
OUT_WIDTH	actual output width -1

41.11.105 This register defines the control bits for the pxp store_engine sub-block. (PXP_HW_PXP_WFE_B_STORE_SIZE_CH1)

The Control register contains the control bits for the pxp store_engine sub-block.

Address: 21C_C000h base + 1390h offset = 21C_D390h

Bit	31	30	29	28	27	26	25	24	23	22	21	20	19	18	17	16	15	14	13	12	11	10	9	8	7	6	5	4	3	2	1	0
R	OUT_HEIGHT																OUT_WIDTH															
W																																
Reset	0	0	0	0	0	0	0	0	0	0	0	0	0	0	0	0	0	0	0	0	0	0	0	0	0	0	0	0	0	0	0	0

PXP_HW_PXP_WFE_B_STORE_SIZE_CH1 field descriptions

Field	Description
31–16 OUT_HEIGHT	actual output height -1
OUT_WIDTH	actual output width -1

41.11.106 This register defines the control bits for the pxp store_engine sub-block. (PXP_HW_PXP_WFE_B_STORE_PITCH)

The Control register contains the control bits for the pxp store_engine sub-block.

Address: 21C_C000h base + 13A0h offset = 21C_D3A0h

Bit	31	30	29	28	27	26	25	24	23	22	21	20	19	18	17	16	15	14	13	12	11	10	9	8	7	6	5	4	3	2	1	0
R	CH1_OUT_PITCH																CH0_OUT_PITCH															
W																																
Reset	0	0	0	0	0	0	0	0	0	0	0	0	0	0	0	0	0	0	0	0	0	0	0	0	0	0	0	0	0	0	0	0

PXP_HW_PXP_WFE_B_STORE_PITCH field descriptions

Field	Description
31–16 CH1_OUT_PITCH	This field indicates the channel 1 input pitch
CH0_OUT_PITCH	This field indicates the channel 0 input pitch

41.11.107 This register defines the control bits for the pxp store_engine sub-block. (PXP_HW_PXP_WFE_B_STORE_SHIFT_CTRL_CH0n)

The Control register contains the control bits for the pxp store_engine sub-block.

Address: 21C_C000h base + 13B0h offset + (4d × i), where i=0d to 3d

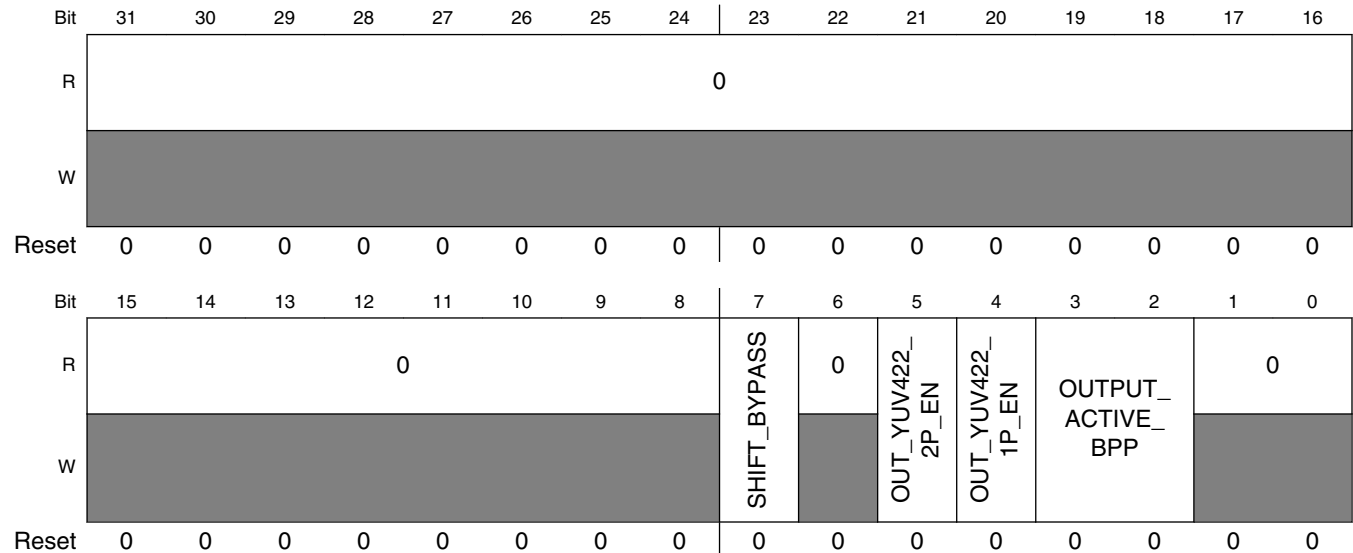

PXP_HW_PXP_WFE_B_STORE_SHIFT_CTRL_CH0n field descriptions

Field	Description
31–8 Reserved	This read-only field is reserved and always has the value 0.
7 SHIFT_BYPASS	CH0 shift bypass
6 Reserved	This read-only field is reserved and always has the value 0.
5 OUT_YUV422_2P_EN	Enable for YUV422 2 plane
4 OUT_YUV422_1P_EN	Enable for YUV422 1 plane
3–2 OUTPUT_ACTIVE_BPP	Output Active BPP
Reserved	This read-only field is reserved and always has the value 0.

41.11.108 This register defines the control bits for the pxp store_engine sub-block. (PXP_HW_PXP_WFE_B_STORE_SHIFT_CTRL_CH1n)

The Control register contains the control bits for the pxp prefetch_engine sub-block.

Address: 21C_C000h base + 13C0h offset + (4d × i), where i=0d to 3d

Bit	31	30	29	28	27	26	25	24	23	22	21	20	19	18	17	16
R	0															
W	[Reserved]															
Reset	0	0	0	0	0	0	0	0	0	0	0	0	0	0	0	0
Bit	15	14	13	12	11	10	9	8	7	6	5	4	3	2	1	0
R	0														0	
W	[Reserved]										OUT_YUV422_2P_EN	OUT_YUV422_1P_EN	OUTPUT_ACTIVE_BPP	[Reserved]		
Reset	0	0	0	0	0	0	0	0	0	0	0	0	0	0	0	0

PXP_HW_PXP_WFE_B_STORE_SHIFT_CTRL_CH1n field descriptions

Field	Description
31–6 Reserved	This read-only field is reserved and always has the value 0.
5 OUT_YUV422_2P_EN	Enable for YUV422 2 plane
4 OUT_YUV422_1P_EN	Enable for YUV422 1 plane
3–2 OUTPUT_ACTIVE_BPP	Output Active BPP
Reserved	This read-only field is reserved and always has the value 0.

**41.11.109 This register defines the control bits for the pxp store_engine sub-block.
(PXP_HW_PXP_WFE_B_STORE_ADDR_0_CH0)**

The Control register contains the control bits for the pxp store_engine sub-block.

Address: 21C_C000h base + 1410h offset = 21C_D410h

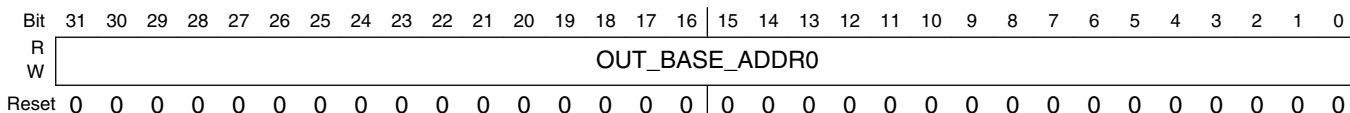

PXP_HW_PXP_WFE_B_STORE_ADDR_0_CH0 field descriptions

Field	Description
OUT_BASE_ADDR0	input base address0. For 2 channel, indicated the channel0 base address. For 1 channel and YUV422 2 plane, indicate the Y base address

**41.11.110 This register defines the control bits for the pxp store_engine sub-block.
(PXP_HW_PXP_WFE_B_STORE_ADDR_1_CH0)**

The Control register contains the control bits for the pxp store_engine sub-block.

Address: 21C_C000h base + 1420h offset = 21C_D420h

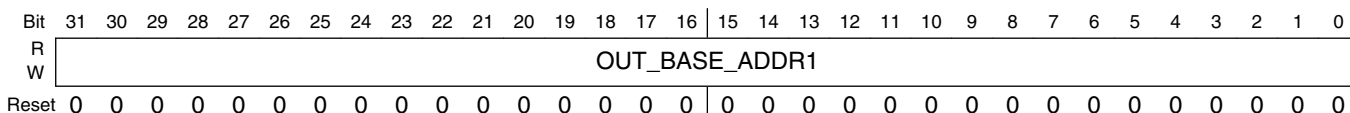

PXP_HW_PXP_WFE_B_STORE_ADDR_1_CH0 field descriptions

Field	Description
OUT_BASE_ADDR1	input base address1. For 2 channel, indicated the channel1 base address. For 1 channel and YUV422 2 plane, indicate the Y base address

41.11.111 This register defines the control bits for the pxp store_engine sub-block. (PXP_HW_PXP_WFE_B_STORE_FILL_DATA_CH0)

The Control register contains the control bits for the pxp store_engine sub-block.

Address: 21C_C000h base + 1430h offset = 21C_D430h

Bit	31	30	29	28	27	26	25	24	23	22	21	20	19	18	17	16	15	14	13	12	11	10	9	8	7	6	5	4	3	2	1	0
R																																
W	FILL_DATA_CH0																															
Reset	0	0	0	0	0	0	0	0	0	0	0	0	0	0	0	0	0	0	0	0	0	0	0	0	0	0	0	0	0	0	0	0

PXP_HW_PXP_WFE_B_STORE_FILL_DATA_CH0 field descriptions

Field	Description
FILL_DATA_CH0	when using fill_data mode,store engine channel0 will store the fill_data value defined here.

41.11.112 This register defines the control bits for the pxp store_engine sub-block. (PXP_HW_PXP_WFE_B_STORE_ADDR_0_CH1)

The Control register contains the control bits for the pxp store_engine sub-block.

Address: 21C_C000h base + 1440h offset = 21C_D440h

Bit	31	30	29	28	27	26	25	24	23	22	21	20	19	18	17	16	15	14	13	12	11	10	9	8	7	6	5	4	3	2	1	0
R																																
W	OUT_BASE_ADDR0																															
Reset	0	0	0	0	0	0	0	0	0	0	0	0	0	0	0	0	0	0	0	0	0	0	0	0	0	0	0	0	0	0	0	0

PXP_HW_PXP_WFE_B_STORE_ADDR_0_CH1 field descriptions

Field	Description
OUT_BASE_ADDR0	input base address0. For 2 channel, indicated the channel0 base address. For 1 channel and YUV422 2 plane, indicate the Y base address

**41.11.113 This register defines the control bits for the pxp store_engine sub-block.
(PXP_HW_PXP_WFE_B_STORE_ADDR_1_CH1)**

The Control register contains the control bits for the pxp store_engine sub-block.

Address: 21C_C000h base + 1450h offset = 21C_D450h

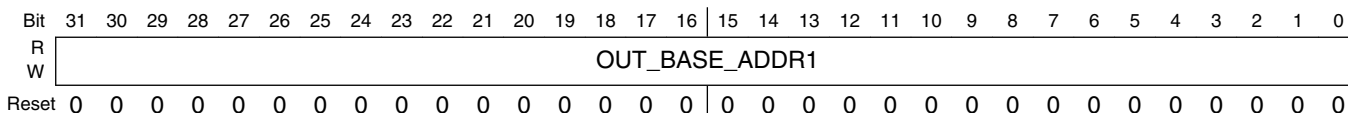

PXP_HW_PXP_WFE_B_STORE_ADDR_1_CH1 field descriptions

Field	Description
OUT_BASE_ADDR1	input base address1. For 2 channel, indicated the channel1 base address. For 1 channel and YUV422 2 plane, indicate the Y base address

**41.11.114 This register defines the control bits for the pxp store_engine sub-block.
(PXP_HW_PXP_WFE_B_STORE_D_MASK0_H_CH0)**

The Control register contains the control bits for the pxp store_engine sub-block.

Address: 21C_C000h base + 1460h offset = 21C_D460h

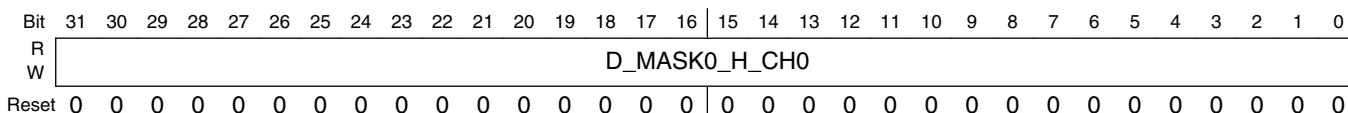

PXP_HW_PXP_WFE_B_STORE_D_MASK0_H_CH0 field descriptions

Field	Description
D_MASK0_H_CH0	data mask0 high byte

41.11.115 This register defines the control bits for the pxp store_engine sub-block. (PXP_HW_PXP_WFE_B_STORE_D_MASK0_L_CH0)

The Control register contains the control bits for the pxp store_engine sub-block.

Address: 21C_C000h base + 1470h offset = 21C_D470h

Bit	31	30	29	28	27	26	25	24	23	22	21	20	19	18	17	16	15	14	13	12	11	10	9	8	7	6	5	4	3	2	1	0
R																																
W																																
Reset	0	0	0	0	0	0	0	0	0	0	0	0	0	0	0	0	0	0	0	0	0	0	0	0	0	0	0	0	0	0	0	0

PXP_HW_PXP_WFE_B_STORE_D_MASK0_L_CH0 field descriptions

Field	Description
D_MASK0_L_CH0	data mask0 low byte

41.11.116 This register defines the control bits for the pxp store_engine sub-block. (PXP_HW_PXP_WFE_B_STORE_D_MASK1_H_CH0)

The Control register contains the control bits for the pxp store_engine sub-block.

Address: 21C_C000h base + 1480h offset = 21C_D480h

Bit	31	30	29	28	27	26	25	24	23	22	21	20	19	18	17	16	15	14	13	12	11	10	9	8	7	6	5	4	3	2	1	0
R																																
W																																
Reset	0	0	0	0	0	0	0	0	0	0	0	0	0	0	0	0	0	0	0	0	0	0	0	0	0	0	0	0	0	0	0	0

PXP_HW_PXP_WFE_B_STORE_D_MASK1_H_CH0 field descriptions

Field	Description
D_MASK1_H_CH0	data mask1 high byte

**41.11.117 This register defines the control bits for the pxp store_engine sub-block.
(PXP_HW_PXP_WFE_B_STORE_D_MASK1_L_CH0)**

The Control register contains the control bits for the pxp store_engine sub-block.

Address: 21C_C000h base + 1490h offset = 21C_D490h

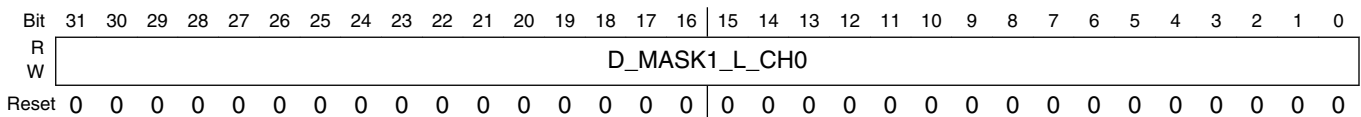

PXP_HW_PXP_WFE_B_STORE_D_MASK1_L_CH0 field descriptions

Field	Description
D_MASK1_L_CH0	data mask1 low byte

**41.11.118 This register defines the control bits for the pxp store_engine sub-block.
(PXP_HW_PXP_WFE_B_STORE_D_MASK2_H_CH0)**

The Control register contains the control bits for the pxp store_engine sub-block.

Address: 21C_C000h base + 14A0h offset = 21C_D4A0h

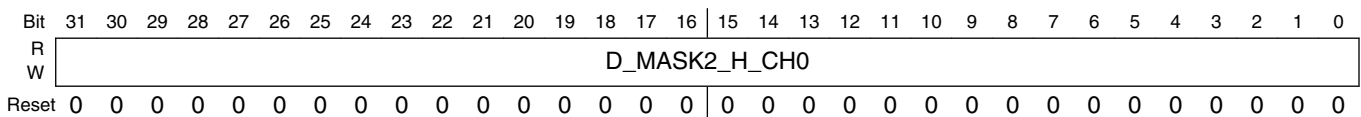

PXP_HW_PXP_WFE_B_STORE_D_MASK2_H_CH0 field descriptions

Field	Description
D_MASK2_H_CH0	data mask2 high byte

41.11.119 This register defines the control bits for the pxp store_engine sub-block. (PXP_HW_PXP_WFE_B_STORE_D_MASK2_L_CH0)

The Control register contains the control bits for the pxp store_engine sub-block.

Address: 21C_C000h base + 14B0h offset = 21C_D4B0h

Bit	31	30	29	28	27	26	25	24	23	22	21	20	19	18	17	16	15	14	13	12	11	10	9	8	7	6	5	4	3	2	1	0
R																																
W																																
Reset	0	0	0	0	0	0	0	0	0	0	0	0	0	0	0	0	0	0	0	0	0	0	0	0	0	0	0	0	0	0	0	0

PXP_HW_PXP_WFE_B_STORE_D_MASK2_L_CH0 field descriptions

Field	Description
D_MASK2_L_CH0	data mask2 low byte

41.11.120 This register defines the control bits for the pxp store_engine sub-block. (PXP_HW_PXP_WFE_B_STORE_D_MASK3_H_CH0)

The Control register contains the control bits for the pxp store_engine sub-block.

Address: 21C_C000h base + 14C0h offset = 21C_D4C0h

Bit	31	30	29	28	27	26	25	24	23	22	21	20	19	18	17	16	15	14	13	12	11	10	9	8	7	6	5	4	3	2	1	0
R																																
W																																
Reset	0	0	0	0	0	0	0	0	0	0	0	0	0	0	0	0	0	0	0	0	0	0	0	0	0	0	0	0	0	0	0	0

PXP_HW_PXP_WFE_B_STORE_D_MASK3_H_CH0 field descriptions

Field	Description
D_MASK3_H_CH0	data mask3 high byte

**41.11.121 This register defines the control bits for the pxp store_engine sub-block.
(PXP_HW_PXP_WFE_B_STORE_D_MASK3_L_CH0)**

The Control register contains the control bits for the pxp store_engine sub-block.

Address: 21C_C000h base + 14D0h offset = 21C_D4D0h

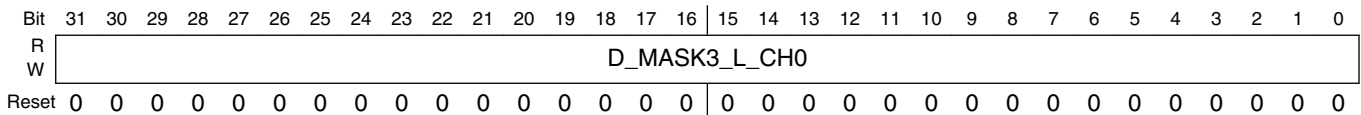

PXP_HW_PXP_WFE_B_STORE_D_MASK3_L_CH0 field descriptions

Field	Description
D_MASK3_L_CH0	data mask3 low byte

**41.11.122 This register defines the control bits for the pxp store_engine sub-block.
(PXP_HW_PXP_WFE_B_STORE_D_MASK4_H_CH0)**

The Control register contains the control bits for the pxp store_engine sub-block.

Address: 21C_C000h base + 14E0h offset = 21C_D4E0h

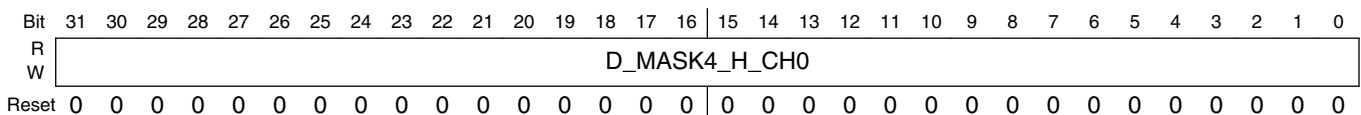

PXP_HW_PXP_WFE_B_STORE_D_MASK4_H_CH0 field descriptions

Field	Description
D_MASK4_H_CH0	data mask4 high byte

41.11.123 This register defines the control bits for the pxp store_engine sub-block. (PXP_HW_PXP_WFE_B_STORE_D_MASK4_L_CH0)

The Control register contains the control bits for the pxp store_engine sub-block.

Address: 21C_C000h base + 14F0h offset = 21C_D4F0h

Bit	31	30	29	28	27	26	25	24	23	22	21	20	19	18	17	16	15	14	13	12	11	10	9	8	7	6	5	4	3	2	1	0
R																																
W																																
Reset	0	0	0	0	0	0	0	0	0	0	0	0	0	0	0	0	0	0	0	0	0	0	0	0	0	0	0	0	0	0	0	0

PXP_HW_PXP_WFE_B_STORE_D_MASK4_L_CH0 field descriptions

Field	Description
D_MASK4_L_CH0	data mask4 low byte

41.11.124 This register defines the control bits for the pxp store_engine sub-block. (PXP_HW_PXP_WFE_B_STORE_D_MASK5_H_CH0)

The Control register contains the control bits for the pxp store_engine sub-block.

Address: 21C_C000h base + 1500h offset = 21C_D500h

Bit	31	30	29	28	27	26	25	24	23	22	21	20	19	18	17	16	15	14	13	12	11	10	9	8	7	6	5	4	3	2	1	0
R																																
W																																
Reset	0	0	0	0	0	0	0	0	0	0	0	0	0	0	0	0	0	0	0	0	0	0	0	0	0	0	0	0	0	0	0	0

PXP_HW_PXP_WFE_B_STORE_D_MASK5_H_CH0 field descriptions

Field	Description
D_MASK5_H_CH0	data mask5 high byte

**41.11.125 This register defines the control bits for the pxp store_engine sub-block.
(PXP_HW_PXP_WFE_B_STORE_D_MASK5_L_CH0)**

The Control register contains the control bits for the pxp store_engine sub-block.

Address: 21C_C000h base + 1510h offset = 21C_D510h

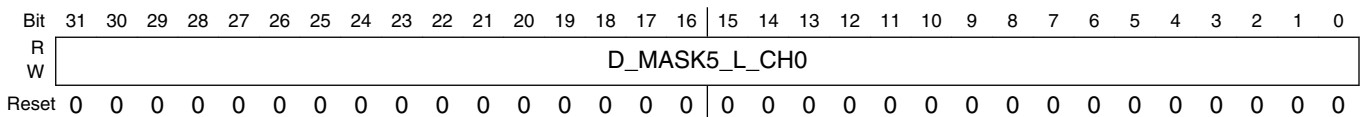

PXP_HW_PXP_WFE_B_STORE_D_MASK5_L_CH0 field descriptions

Field	Description
D_MASK5_L_CH0	data mask5 low byte

**41.11.126 This register defines the control bits for the pxp store_engine sub-block.
(PXP_HW_PXP_WFE_B_STORE_D_MASK6_H_CH0)**

The Control register contains the control bits for the pxp store_engine sub-block.

Address: 21C_C000h base + 1520h offset = 21C_D520h



PXP_HW_PXP_WFE_B_STORE_D_MASK6_H_CH0 field descriptions

Field	Description
D_MASK6_H_CH0	data mask6 high byte

41.11.127 This register defines the control bits for the pxp store_engine sub-block. (PXP_HW_PXP_WFE_B_STORE_D_MASK6_L_CH0)

The Control register contains the control bits for the pxp store_engine sub-block.

Address: 21C_C000h base + 1530h offset = 21C_D530h

Bit	31	30	29	28	27	26	25	24	23	22	21	20	19	18	17	16	15	14	13	12	11	10	9	8	7	6	5	4	3	2	1	0
R																																
W																																
Reset	0	0	0	0	0	0	0	0	0	0	0	0	0	0	0	0	0	0	0	0	0	0	0	0	0	0	0	0	0	0	0	0

PXP_HW_PXP_WFE_B_STORE_D_MASK6_L_CH0 field descriptions

Field	Description
D_MASK6_L_CH0	data mask6 low byte

41.11.128 This register defines the control bits for the pxp store_engine sub-block. (PXP_HW_PXP_WFE_B_STORE_D_MASK7_H_CH0)

The Control register contains the control bits for the pxp store_engine sub-block.

Address: 21C_C000h base + 1540h offset = 21C_D540h

Bit	31	30	29	28	27	26	25	24	23	22	21	20	19	18	17	16	15	14	13	12	11	10	9	8	7	6	5	4	3	2	1	0
R																																
W																																
Reset	0	0	0	0	0	0	0	0	0	0	0	0	0	0	0	0	0	0	0	0	0	0	0	0	0	0	0	0	0	0	0	0

PXP_HW_PXP_WFE_B_STORE_D_MASK7_H_CH0 field descriptions

Field	Description
D_MASK7_H_CH0	data mask7 high byte

**41.11.129 This register defines the control bits for the pxp store_engine sub-block.
(PXP_HW_PXP_WFE_B_STORE_D_MASK7_L_CH0)**

The Control register contains the control bits for the pxp store_engine sub-block.

Address: 21C_C000h base + 1550h offset = 21C_D550h

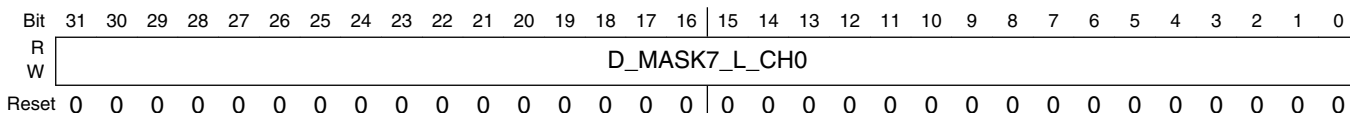

PXP_HW_PXP_WFE_B_STORE_D_MASK7_L_CH0 field descriptions

Field	Description
D_MASK7_L_CH0	data mask7 low byte

**41.11.130 This register defines the control bits for the pxp store_engine sub-block.
(PXP_HW_PXP_WFE_B_STORE_D_SHIFT_L_CH0)**

The Control register contains the control bits for the pxp store_engine sub-block.

Address: 21C_C000h base + 1560h offset = 21C_D560h

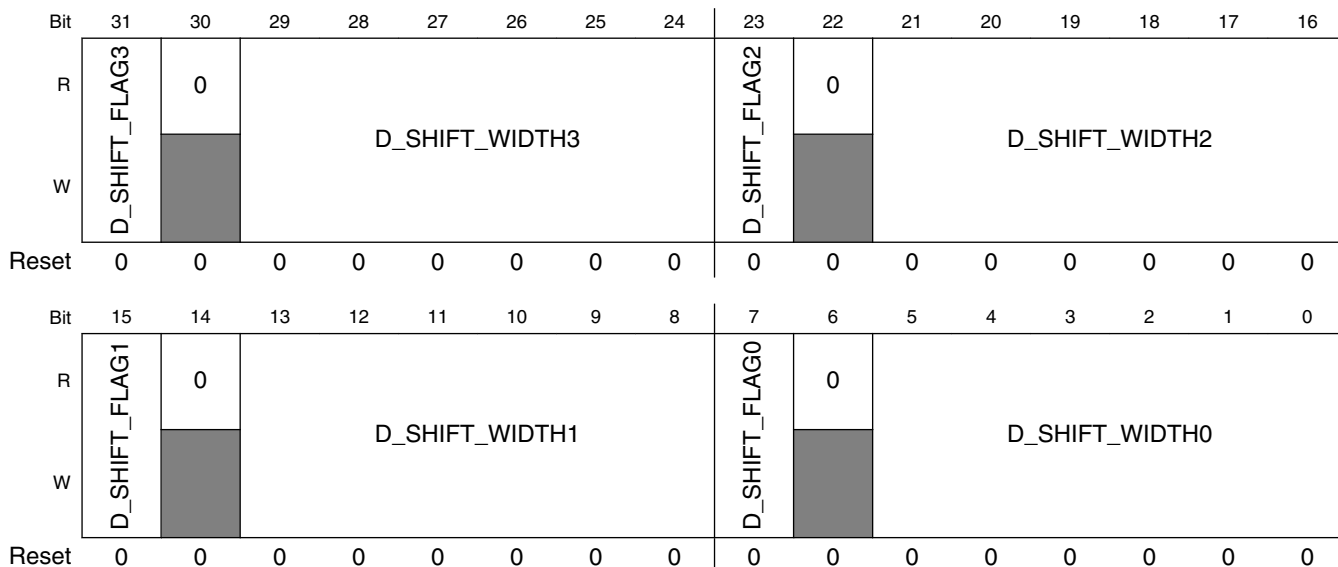

PXP_HW_PXP_WFE_B_STORE_D_SHIFT_L_CH0 field descriptions

Field	Description
31 D_SHIFT_FLAG3	data shift flag 3
30 Reserved	This read-only field is reserved and always has the value 0.
29–24 D_SHIFT_WIDTH3	data shift width 3
23 D_SHIFT_FLAG2	data shift flag 2
22 Reserved	This read-only field is reserved and always has the value 0.
21–16 D_SHIFT_WIDTH2	data shift width 2
15 D_SHIFT_FLAG1	data shift flag 1
14 Reserved	This read-only field is reserved and always has the value 0.
13–8 D_SHIFT_WIDTH1	data shift width 1
7 D_SHIFT_FLAG0	data shift flag 0
6 Reserved	This read-only field is reserved and always has the value 0.
D_SHIFT_WIDTH0	data shift width 0

**41.11.131 This register defines the control bits for the pxp store_engine sub-block.
(PXP_HW_PXP_WFE_B_STORE_D_SHIFT_H_CH0)**

The Control register contains the control bits for the pxp store_engine sub-block.

Address: 21C_C000h base + 1570h offset = 21C_D570h

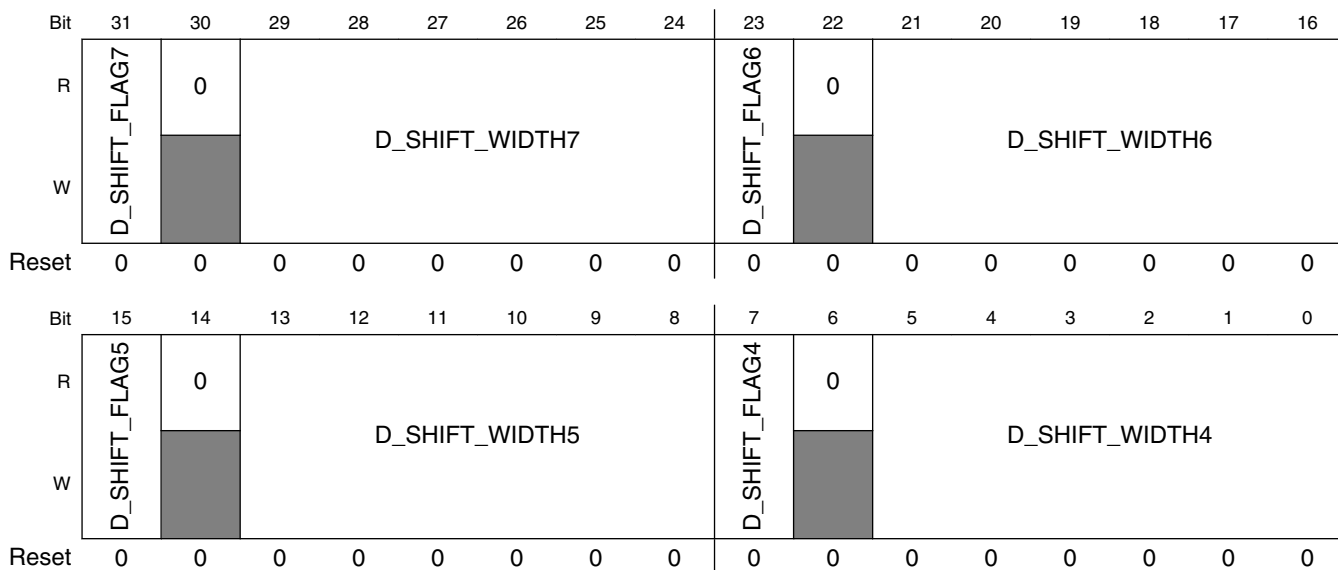

PXP_HW_PXP_WFE_B_STORE_D_SHIFT_H_CH0 field descriptions

Field	Description
31 D_SHIFT_FLAG7	data shift flag 7
30 Reserved	This read-only field is reserved and always has the value 0.
29–24 D_SHIFT_WIDTH7	data shift width 3
23 D_SHIFT_FLAG6	data shift flag 6
22 Reserved	This read-only field is reserved and always has the value 0.
21–16 D_SHIFT_WIDTH6	data shift width 6
15 D_SHIFT_FLAG5	data shift flag 5
14 Reserved	This read-only field is reserved and always has the value 0.

Table continues on the next page...

PXP_HW_PXP_WFE_B_STORE_D_SHIFT_H_CH0 field descriptions (continued)

Field	Description
13–8 D_SHIFT_WIDTH5	data shift width 5
7 D_SHIFT_FLAG4	data shift flag 4
6 Reserved	This read-only field is reserved and always has the value 0.
D_SHIFT_WIDTH4	data shift width 4

41.11.132 This register defines the control bits for the pxp store_engine sub-block. (PXP_HW_PXP_WFE_B_STORE_F_SHIFT_L_CH0)

The Control register contains the control bits for the pxp store_engine sub-block.

Address: 21C_C000h base + 1580h offset = 21C_D580h

Bit	31	30	29	28	27	26	25	24	23	22	21	20	19	18	17	16
R	0	F_SHIFT_FLAG3	F_SHIFT_WIDTH3						0	F_SHIFT_FLAG2	F_SHIFT_WIDTH2					
W																
Reset	0	0	0	0	0	0	0	0	0	0	0	0	0	0	0	0
Bit	15	14	13	12	11	10	9	8	7	6	5	4	3	2	1	0
R	0	F_SHIFT_FLAG1	F_SHIFT_WIDTH1						0	F_SHIFT_FLAG0	F_SHIFT_WIDTH0					
W																
Reset	0	0	0	0	0	0	0	0	0	0	0	0	0	0	0	0

PXP_HW_PXP_WFE_B_STORE_F_SHIFT_L_CH0 field descriptions

Field	Description
31 Reserved	This read-only field is reserved and always has the value 0.
30 F_SHIFT_FLAG3	flag shift flag3

Table continues on the next page...

PXP_HW_PXP_WFE_B_STORE_F_SHIFT_L_CH0 field descriptions (continued)

Field	Description
29–24 F_SHIFT_ WIDTH3	flag shift width 3
23 Reserved	This read-only field is reserved and always has the value 0.
22 F_SHIFT_FLAG2	flag shift flag2
21–16 F_SHIFT_ WIDTH2	flag shift width 2
15 Reserved	This read-only field is reserved and always has the value 0.
14 F_SHIFT_FLAG1	flag shift flag1
13–8 F_SHIFT_ WIDTH1	flag shift width 1
7 Reserved	This read-only field is reserved and always has the value 0.
6 F_SHIFT_FLAG0	flag shift flag0
F_SHIFT_ WIDTH0	flag shift width 0

41.11.133 This register defines the control bits for the pxp store_engine sub-block. (PXP_HW_PXP_WFE_B_STORE_F_SHIFT_H_CH0)

The Control register contains the control bits for the pxp store_engine sub-block.

Address: 21C_C000h base + 1590h offset = 21C_D590h

Bit	31	30	29	28	27	26	25	24	23	22	21	20	19	18	17	16
R	0								0							
W		F_SHIFT_FLAG7		F_SHIFT_WIDTH7						F_SHIFT_FLAG6		F_SHIFT_WIDTH6				
Reset	0	0	0	0	0	0	0	0	0	0	0	0	0	0	0	0
Bit	15	14	13	12	11	10	9	8	7	6	5	4	3	2	1	0
R	0								0							
W		F_SHIFT_FLAG5		F_SHIFT_WIDTH5						F_SHIFT_FLAG4		F_SHIFT_WIDTH4				
Reset	0	0	0	0	0	0	0	0	0	0	0	0	0	0	0	0

PXP_HW_PXP_WFE_B_STORE_F_SHIFT_H_CH0 field descriptions

Field	Description
31 Reserved	This read-only field is reserved and always has the value 0.
30 F_SHIFT_FLAG7	flag shift flag7
29–24 F_SHIFT_WIDTH7	flag shift width 7
23 Reserved	This read-only field is reserved and always has the value 0.
22 F_SHIFT_FLAG6	flag shift flag6
21–16 F_SHIFT_WIDTH6	flag shift width 5
15 Reserved	This read-only field is reserved and always has the value 0.
14 F_SHIFT_FLAG5	flag shift flag5

Table continues on the next page...

PXP_HW_PXP_WFE_B_STORE_F_SHIFT_H_CH0 field descriptions (continued)

Field	Description
13–8 F_SHIFT_WIDTH5	flag shift width 5
7 Reserved	This read-only field is reserved and always has the value 0.
6 F_SHIFT_FLAG4	flag shift flag4
F_SHIFT_WIDTH4	flag shift width 4

**41.11.134 This register defines the control bits for the pxp store_engine sub-block.
(PXP_HW_PXP_WFE_B_STORE_F_MASK_L_CH0)**

The Control register contains the control bits for the pxp store_engine sub-block.

Address: 21C_C000h base + 15A0h offset = 21C_D5A0h

Bit	31	30	29	28	27	26	25	24	23	22	21	20	19	18	17	16	15	14	13	12	11	10	9	8	7	6	5	4	3	2	1	0
R																																
W	F_MASK3								F_MASK2								F_MASK1								F_MASK0							
Reset	0	0	0	0	0	0	0	0	0	0	0	0	0	0	0	0	0	0	0	0	0	0	0	0	0	0	0	0	0	0	0	0

PXP_HW_PXP_WFE_B_STORE_F_MASK_L_CH0 field descriptions

Field	Description
31–24 F_MASK3	flag mask3
23–16 F_MASK2	flag mask2
15–8 F_MASK1	flag mask1
F_MASK0	flag mask0

41.11.135 This register defines the control bits for the pxp store_engine sub-block. (PXP_HW_PXP_WFE_B_STORE_F_MASK_H_CH0)

The Control register contains the control bits for the pxp store_engine sub-block.

Address: 21C_C000h base + 15B0h offset = 21C_D5B0h

Bit	31	30	29	28	27	26	25	24	23	22	21	20	19	18	17	16	15	14	13	12	11	10	9	8	7	6	5	4	3	2	1	0
R	F_MASK7							F_MASK6							F_MASK5							F_MASK4										
W																																
Reset	0	0	0	0	0	0	0	0	0	0	0	0	0	0	0	0	0	0	0	0	0	0	0	0	0	0	0	0	0	0	0	0

PXP_HW_PXP_WFE_B_STORE_F_MASK_H_CH0 field descriptions

Field	Description
31–24 F_MASK7	flag mask7
23–16 F_MASK6	flag mask6
15–8 F_MASK5	flag mask5
F_MASK4	flag mask4

41.11.136 This register holds the debug bits for the prefetch engine for WFE B. (PXP_HW_PXP_FETCH_WFE_B_DEBUG)

The Control register contains the debug information for the pxp array fetch block.

Address: 21C_C000h base + 15D0h offset = 21C_D5D0h

Bit	31	30	29	28	27	26	25	24	23	22	21	20	19	18	17	16
R	0			BUF_SEL	ITEM_SEL				DEBUG_VALUE							
W																
Reset	0	0	0	0	0	0	0	0	0	0	0	0	0	0	0	0
Bit	15	14	13	12	11	10	9	8	7	6	5	4	3	2	1	0
R	DEBUG_VALUE															
W																
Reset	0	0	0	0	0	0	0	0	0	0	0	0	0	0	0	0

PXP_HW_PXP_FETCH_WFE_B_DEBUG field descriptions

Field	Description
31–29 Reserved	This read-only field is reserved and always has the value 0.
28 BUF_SEL	Index into WFE A BUFFER.
27–24 ITEM_SEL	Index into one of the PXP debug registers. The data for the selected register will be returned
DEBUG_VALUE	Debug information for array fetch.

41.11.137 Dither Control Register 0 (PXP_HW_PXP_DITHER_CTRL n)

The Control register contains the primary controls for the PXP block.

Address: 21C_C000h base + 1670h offset + (4d × i), where i=0d to 3d

Bit	31	30	29	28	27	26	25	24	23	22	21	20	19	18	17	16
R	BUSY0	BUSY1	BUSY2	0				ORDERED_ROUND_MODE	FINAL_LUT_ENABLE	IDX_MATRIX2_SIZE		IDX_MATRIX1_SIZE		IDX_MATRIX0_SIZE		LUT_MODE
W	[Shaded]															
Reset	0	0	0	0	0	0	0	1	0	1	0	1	0	0	0	1
Bit	15	14	13	12	11	10	9	8	7	6	5	4	3	2	1	0
R	LUT_MODE		NUM_QUANT_BIT			DITHER_MODE2			DITHER_MODE1		DITHER_MODE0			ENABLE2	ENABLE1	ENABLE0
W																
Reset	0	1	0	0	0	0	0	0	0	0	0	0	0	0	0	0

PXP_HW_PXP_DITHER_CTRLn field descriptions

Field	Description
31 BUSY0	When set indicates if the dither engine 0 is busy -- started but not finished processing all of the pixels in the current frame.
30 BUSY1	When set indicates if the dither engine 1 is busy -- started but not finished processing all of the pixels in the current frame.
29 BUSY2	When set indicates if the dither engine 2 is busy -- started but not finished processing all of the pixels in the current frame.
28–25 Reserved	This read-only field is reserved and always has the value 0.
24 ORDERED_ ROUND_MODE	For test purposes. In ordered mode only, this field specifies to use rounding or truncation when calculating the output pixel.
23 FINAL_LUT_ ENABLE	Enables a final stage register based LUT at the last stage before output. the lookup transform values come from register bits, not internal memory. Therefore they must be setup by the user by writing to the registers before processing.
22–21 IDX_MATRIX2_ SIZE	For Dither Engine 2. Specify dimension (assumed square) of the index matrix in the LUT memory so proper indexing can occur.
20–19 IDX_MATRIX1_ SIZE	For Dither Engine 1. Specify dimension (assumed square) of the index matrix in the LUT memory so proper indexing can occur.
18–17 IDX_MATRIX0_ SIZE	For Dither Engine 0. Specify dimension (assumed square) of the index matrix in the LUT memory so proper indexing can occur.
16–15 LUT_MODE	Specify to use memory lut to transform pixel. Lookup pre or post dithering cannot be used with Ordered dithering. This field only has reference to the internal memory based LUT function. There is a final stage LUT that is enabled through the FINAL_LUT_ENABLE field in this register. This final stage LUT can be enabled in any dither mode or LUT mode.
14–12 NUM_QUANT_ BIT	Number of bits to quantize down to. From 8 to (0-7).
11–9 DITHER_MODE2	Dither mode.
8–6 DITHER_MODE1	Dither mode.
5–3 DITHER_MODE0	Dither mode.
2 ENABLE2	Enables the dither engine 2
1 ENABLE1	Enables the dither engine 1
0 ENABLE0	Enables the dither engine 0

41.11.138 Final stage lookup value Register (PXP_HW_PXP_DITHER_FINAL_LUT_DATA0n)

This register contains lookup data values for the final stage register based dither LUT.

Address: 21C_C000h base + 1680h offset + (4d × i), where i=0d to 3d

Bit	31	30	29	28	27	26	25	24	23	22	21	20	19	18	17	16	15	14	13	12	11	10	9	8	7	6	5	4	3	2	1	0
R	DATA3								DATA2								DATA1								DATA0							
W																																
Reset	0	0	0	0	0	0	0	0	0	0	0	0	0	0	0	0	0	0	0	0	0	0	0	0	0	0	0	0	0	0	0	0

PXP_HW_PXP_DITHER_FINAL_LUT_DATA0n field descriptions

Field	Description
31–24 DATA3	Final stage LUT data value.
23–16 DATA2	Final stage LUT data value.
15–8 DATA1	Final stage LUT data value.
DATA0	Final stage LUT data value.

41.11.139 Final stage lookup value Register (PXP_HW_PXP_DITHER_FINAL_LUT_DATA1n)

This register contains lookup data values for the final stage register based dither LUT.

Address: 21C_C000h base + 1690h offset + (4d × i), where i=0d to 3d

Bit	31	30	29	28	27	26	25	24	23	22	21	20	19	18	17	16	15	14	13	12	11	10	9	8	7	6	5	4	3	2	1	0
R	DATA7								DATA6								DATA5								DATA4							
W																																
Reset	0	0	0	0	0	0	0	0	0	0	0	0	0	0	0	0	0	0	0	0	0	0	0	0	0	0	0	0	0	0	0	0

PXP_HW_PXP_DITHER_FINAL_LUT_DATA1n field descriptions

Field	Description
31–24 DATA7	Final stage LUT data value.
23–16 DATA6	Final stage LUT data value.
15–8 DATA5	Final stage LUT data value.
DATA4	Final stage LUT data value.

41.11.140 Final stage lookup value Register (PXP_HW_PXP_DITHER_FINAL_LUT_DATA2n)

This register contains lookup data values for the final stage register based dither LUT.

Address: 21C_C000h base + 16A0h offset + (4d × i), where i=0d to 3d

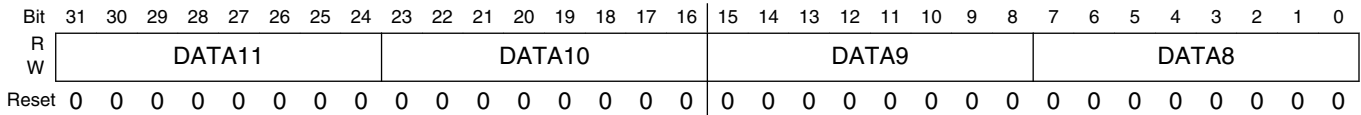

PXP_HW_PXP_DITHER_FINAL_LUT_DATA2n field descriptions

Field	Description
31–24 DATA11	Final stage LUT data value.
23–16 DATA10	Final stage LUT data value.
15–8 DATA9	Final stage LUT data value.
DATA8	Final stage LUT data value.

41.11.141 Final stage lookup value Register (PXP_HW_PXP_DITHER_FINAL_LUT_DATA3n)

This register contains lookup data values for the final stage register based dither LUT.

Address: 21C_C000h base + 16B0h offset + (4d × i), where i=0d to 3d

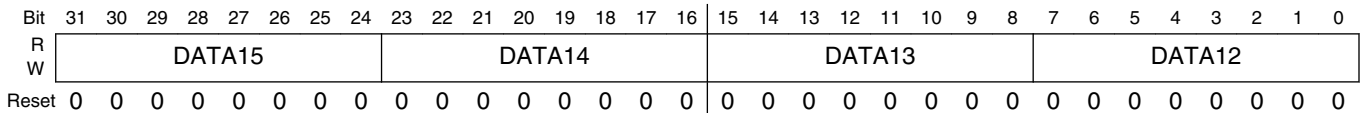

PXP_HW_PXP_DITHER_FINAL_LUT_DATA3n field descriptions

Field	Description
31–24 DATA15	Final stage LUT data value.
23–16 DATA14	Final stage LUT data value.
15–8 DATA13	Final stage LUT data value.
DATA12	Final stage LUT data value.

41.11.142 This register defines the control bits for the pxp wfe sub-block (PXP_HW_PXP_WFE_B_CTRLn)

The Control register contains the control bits for the pxp wfe sub-block.

Address: 21C_C000h base + 1D00h offset + (4d × i), where i=0d to 3d

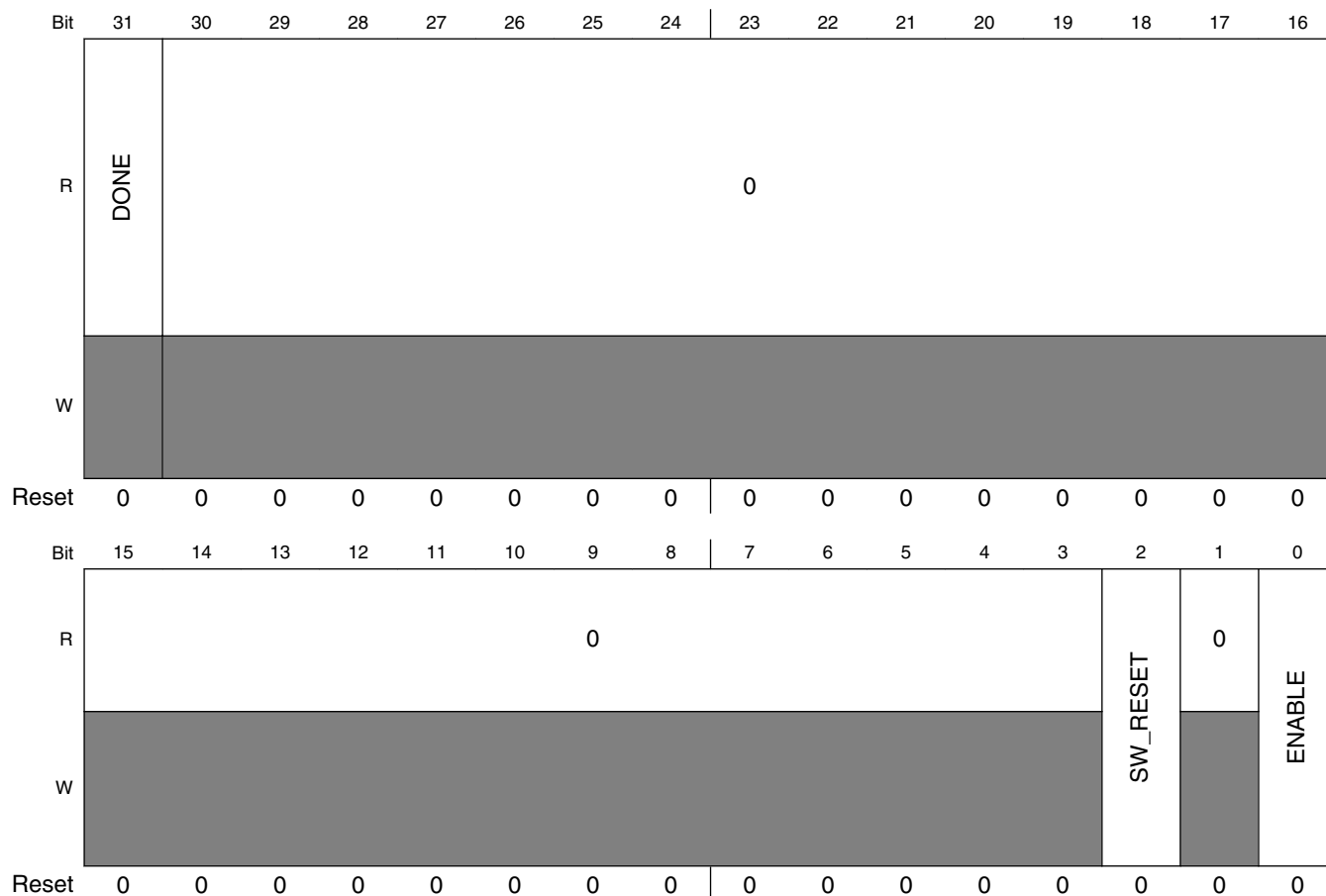

PXP_HW_PXP_WFE_B_CTRLn field descriptions

Field	Description
31 DONE	This field indicates that the WFE B has completed processing the update memory region.
30–3 Reserved	This read-only field is reserved and always has the value 0.
2 SW_RESET	Reset WFE B state. This is a active high reset value.
1 Reserved	This read-only field is reserved and always has the value 0.
0 ENABLE	Enables the WFE B Block

41.11.143 This register defines the control bits for the pxp wfe sub-block (PXP_HW_PXP_WFE_B_DIMENSIONS)

The Control register contains the control bits for the pxp wfe sub-block.

Address: 21C_C000h base + 1D10h offset = 21C_DD10h

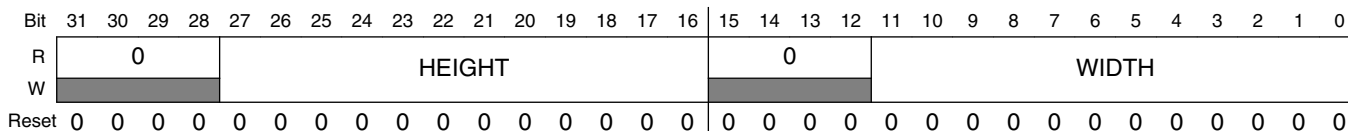

PXP_HW_PXP_WFE_B_DIMENSIONS field descriptions

Field	Description
31–28 Reserved	This read-only field is reserved and always has the value 0.
27–16 HEIGHT	This field defines the height in pixels of the update region.
15–12 Reserved	This read-only field is reserved and always has the value 0.
WIDTH	This bit defines the width in pixels of the update region.

41.11.144 This register defines the control bits for the pxp wfe sub-block (PXP_HW_PXP_WFE_B_OFFSET)

The Control register contains the control bits for the pxp wfe sub-block.

Address: 21C_C000h base + 1D20h offset = 21C_DD20h

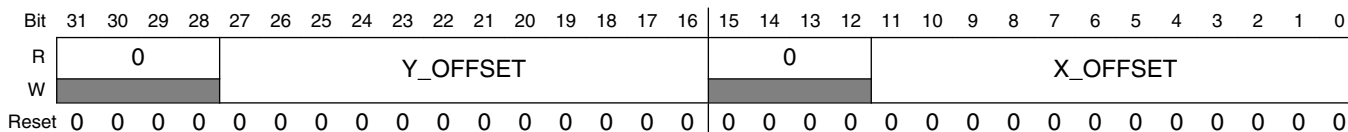

PXP_HW_PXP_WFE_B_OFFSET field descriptions

Field	Description
31–28 Reserved	This read-only field is reserved and always has the value 0.
27–16 Y_OFFSET	This field defines the distance from the frame origin to the update region origin in the Y direction.

Table continues on the next page...

PXP_HW_PXP_WFE_B_OFFSET field descriptions (continued)

Field	Description
15–12 Reserved	This read-only field is reserved and always has the value 0.
X_OFFSET	This field defines the distance from the frame origin to the update region origin in the X direction.

41.11.145 This register defines the control bits for the pxp wfe sub-block (PXP_HW_PXP_WFE_B_SW_DATA_REGS)

The Control register contains the control bits for the pxp wfe sub-block.

Address: 21C_C000h base + 1D30h offset = 21C_DD30h

Bit	31	30	29	28	27	26	25	24	23	22	21	20	19	18	17	16	15	14	13	12	11	10	9	8	7	6	5	4	3	2	1	0
R																																
W																																
Reset	0	0	0	0	0	0	0	0	0	0	0	0	0	0	0	0	0	0	0	0	0	0	0	0	0	0	0	0	0	0		

PXP_HW_PXP_WFE_B_SW_DATA_REGS field descriptions

Field	Description
31–24 VAL3	This is a SW register that holds a programmable data value.
23–16 VAL2	This is a SW register that holds a programmable data value.
15–8 VAL1	This is a SW register that holds a programmable data value.
VAL0	This is a SW register that holds a programmable data value.

41.11.146 This register defines the control bits for the pxp wfe sub-block (PXP_HW_PXP_WFE_B_SW_FLAG_REGS)

The Control register contains the control bits for the pxp wfe sub-block.

Address: 21C_C000h base + 1D40h offset = 21C_DD40h

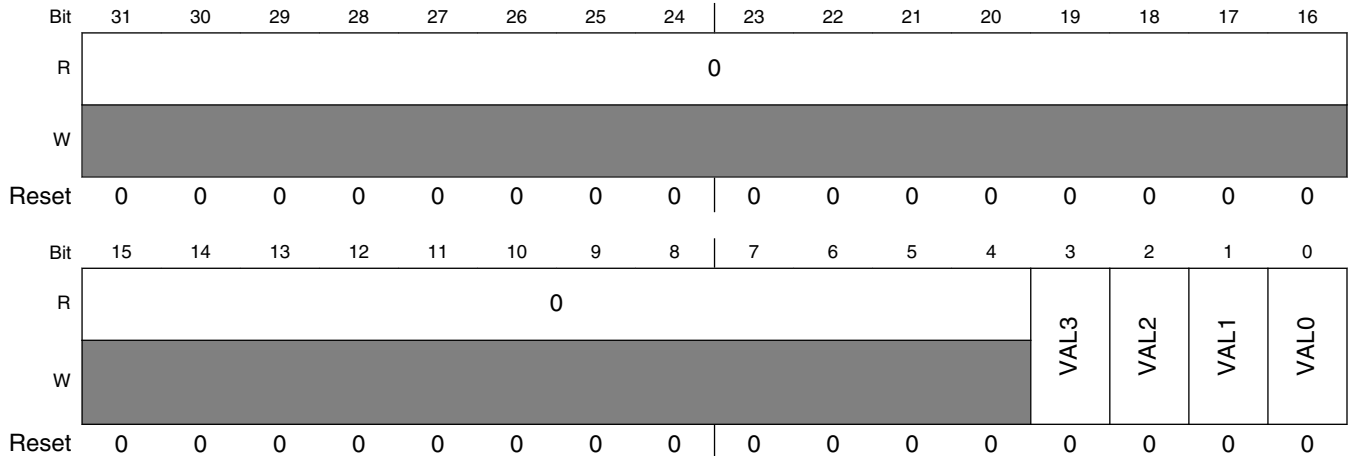

PXP_HW_PXP_WFE_B_SW_FLAG_REGS field descriptions

Field	Description
31–4 Reserved	This read-only field is reserved and always has the value 0.
3 VAL3	This is a SW register that holds a programmable flag value.
2 VAL2	This is a SW register that holds a programmable flag value.
1 VAL1	This is a SW register that holds a programmable flag value.
0 VAL0	This is a SW register that holds a programmable flag value.

41.11.147 This register defines the control bits for the pxp wfe sub-block (PXP_HW_PXP_WFE_B_STAGE1_MUX0n)

Mux value to select one of the flags or data inputs of the pipeline stage. Each mux corresponds to one of the inputs to each of the logic elements (e.g. alu, comparator, LUT, etc). Some logic elements have one mux and others have two or more. The mux numbers are mapped to the pipeline according to the hardware configuration. Please see the reference design for the mux map.

Address: 21C_C000h base + 1D50h offset + (4d × i), where i=0d to 3d

Bit	31	30	29	28	27	26	25	24	23	22	21	20	19	18	17	16	15	14	13	12	11	10	9	8	7	6	5	4	3	2	1	0
R	0								0								0								0							
W																																
Reset	0	0	0	0	0	0	0	0	0	0	0	0	0	0	0	0	0	0	0	0	0	0	0	0	0	0	0	0	0	0	0	0

PXP_HW_PXP_WFE_B_STAGE1_MUX0n field descriptions

Field	Description
31–30 Reserved	This read-only field is reserved and always has the value 0.
29–24 MUX3	Input 4 data select bits for 5x8 LUT 0.
23–22 Reserved	This read-only field is reserved and always has the value 0.
21–16 MUX2	Input 3 data select bits for 5x8 LUT 0.
15–14 Reserved	This read-only field is reserved and always has the value 0.
13–8 MUX1	Input 2 data select bits for 5x8 LUT 0.
7–6 Reserved	This read-only field is reserved and always has the value 0.
MUX0	Input 1 data select bits for 5x8 LUT 0.

41.11.148 This register defines the control bits for the pxp wfe sub-block (PXP_HW_PXP_WFE_B_STAGE1_MUX1n)

Mux value to select one of the flags or data inputs of the pipeline stage. Each mux corresponds to one of the inputs to each of the logic elements (e.g. alu, comparator, LUT, etc). Some logic elements have one mux and others have two or more. The mux numbers are mapped to the pipeline according to the hardware configuration. Please see the reference design for the mux map.

Address: 21C_C000h base + 1D60h offset + (4d × i), where i=0d to 3d

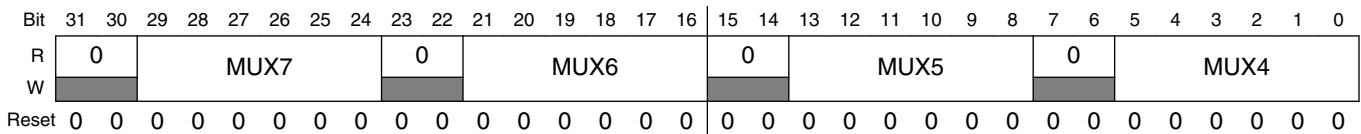

PXP_HW_PXP_WFE_B_STAGE1_MUX1n field descriptions

Field	Description
31–30 Reserved	This read-only field is reserved and always has the value 0.
29–24 MUX7	Input 3 data select bits for 5x8 LUT 1.
23–22 Reserved	This read-only field is reserved and always has the value 0.
21–16 MUX6	Input 2 data select bits for 5x8 LUT 1.
15–14 Reserved	This read-only field is reserved and always has the value 0.
13–8 MUX5	Input 1 data select bits for 5x8 LUT 1.
7–6 Reserved	This read-only field is reserved and always has the value 0.
MUX4	Input 5 data select bits for 5x8 LUT 0.

41.11.149 This register defines the control bits for the pxp wfe sub-block (PXP_HW_PXP_WFE_B_STAGE1_MUX2n)

Mux value to select one of the flags or data inputs of the pipeline stage. Each mux corresponds to one of the inputs to each of the logic elements (e.g. alu, comparator, LUT, etc). Some logic elements have one mux and others have two or more. The mux numbers are mapped to the pipeline according to the hardware configuration. Please see the reference design for the mux map.

Address: 21C_C000h base + 1D70h offset + (4d × i), where i=0d to 3d

Bit	31	30	29	28	27	26	25	24	23	22	21	20	19	18	17	16	15	14	13	12	11	10	9	8	7	6	5	4	3	2	1	0
R	0								0								0								0							
W																																
Reset	0	0	0	0	0	0	0	0	0	0	0	0	0	0	0	0	0	0	0	0	0	0	0	0	0	0	0	0	0	0	0	0

PXP_HW_PXP_WFE_B_STAGE1_MUX2n field descriptions

Field	Description
31–30 Reserved	This read-only field is reserved and always has the value 0.
29–24 MUX11	Input 2 data select bits for 5x1 LUT 0.
23–22 Reserved	This read-only field is reserved and always has the value 0.
21–16 MUX10	Input 1 data select bits for 5x1 LUT 0.
15–14 Reserved	This read-only field is reserved and always has the value 0.
13–8 MUX9	Input 5 data select bits for 5x8 LUT 1.
7–6 Reserved	This read-only field is reserved and always has the value 0.
MUX8	Input 4 data select bits for 5x8 LUT 1.

41.11.150 This register defines the control bits for the pxp wfe sub-block (PXP_HW_PXP_WFE_B_STAGE1_MUX3n)

Mux value to select one of the flags or data inputs of the pipeline stage. Each mux corresponds to one of the inputs to each of the logic elements (e.g. alu, comparator, LUT, etc). Some logic elements have one mux and others have two or more. The mux numbers are mapped to the pipeline according to the hardware configuration. Please see the reference design for the mux map.

Address: 21C_C000h base + 1D80h offset + (4d × i), where i=0d to 3d

Bit	31	30	29	28	27	26	25	24	23	22	21	20	19	18	17	16	15	14	13	12	11	10	9	8	7	6	5	4	3	2	1	0
R	0								0								0								0							
W																																
Reset	0	0	0	0	0	0	0	0	0	0	0	0	0	0	0	0	0	0	0	0	0	0	0	0	0	0	0	0	0	0	0	0

PXP_HW_PXP_WFE_B_STAGE1_MUX3n field descriptions

Field	Description
31–30 Reserved	This read-only field is reserved and always has the value 0.
29–24 MUX15	Data select bits for D8x1 LUT 0.
23–22 Reserved	This read-only field is reserved and always has the value 0.
21–16 MUX14	Input 5 data select bits for 5x1 LUT 0.
15–14 Reserved	This read-only field is reserved and always has the value 0.
13–8 MUX13	Input 4 data select bits for 5x1 LUT 0.
7–6 Reserved	This read-only field is reserved and always has the value 0.
MUX12	Input 3 data select bits for 5x1 LUT 0.

41.11.151 This register defines the control bits for the pxp wfe sub-block (PXP_HW_PXP_WFE_B_STAGE1_MUX4n)

Mux value to select one of the flags or data inputs of the pipeline stage. Each mux corresponds to one of the inputs to each of the logic elements (e.g. alu, comparator, LUT, etc). Some logic elements have one mux and others have two or more. The mux numbers are mapped to the pipeline according to the hardware configuration. Please see the reference design for the mux map.

Address: 21C_C000h base + 1D90h offset + (4d × i), where i=0d to 3d

Bit	31	30	29	28	27	26	25	24	23	22	21	20	19	18	17	16	15	14	13	12	11	10	9	8	7	6	5	4	3	2	1	0
R	0								0								0								0							
W																																
Reset	0	0	0	0	0	0	0	0	0	0	0	0	0	0	0	0	0	0	0	0	0	0	0	0	0	0	0	0	0	0	0	0

PXP_HW_PXP_WFE_B_STAGE1_MUX4n field descriptions

Field	Description
31–30 Reserved	This read-only field is reserved and always has the value 0.
29–24 MUX19	Data select bits for D8x1 LUT 4.
23–22 Reserved	This read-only field is reserved and always has the value 0.
21–16 MUX18	Data select bits for D8x1 LUT 3.
15–14 Reserved	This read-only field is reserved and always has the value 0.
13–8 MUX17	Data select bits for D8x1 LUT 2.
7–6 Reserved	This read-only field is reserved and always has the value 0.
MUX16	Data select bits for D8x1 LUT 1.

41.11.152 This register defines the control bits for the pxp wfe sub-block (PXP_HW_PXP_WFE_B_STAGE1_MUX5n)

Mux value to select one of the flags or data inputs of the pipeline stage. Each mux corresponds to one of the inputs to each of the logic elements (e.g. alu, comparator, LUT, etc). Some logic elements have one mux and others have two or more. The mux numbers are mapped to the pipeline according to the hardware configuration. Please see the reference design for the mux map.

Address: 21C_C000h base + 1DA0h offset + (4d × i), where i=0d to 3d

Bit	31	30	29	28	27	26	25	24	23	22	21	20	19	18	17	16	15	14	13	12	11	10	9	8	7	6	5	4	3	2	1	0
R	0								0								0								0							
W																																
Reset	0	0	0	0	0	0	0	0	0	0	0	0	0	0	0	0	0	0	0	0	0	0	0	0	0	0	0	0	1	1	0	0

PXP_HW_PXP_WFE_B_STAGE1_MUX5n field descriptions

Field	Description
31–30 Reserved	This read-only field is reserved and always has the value 0.
29–24 MUX23	Input data select bits for Comparator 0.
23–22 Reserved	This read-only field is reserved and always has the value 0.
21–16 MUX22	Input data select bits for ALU 0.
15–14 Reserved	This read-only field is reserved and always has the value 0.
13–8 MUX21	Input data select bits for ALU 0.
7–6 Reserved	This read-only field is reserved and always has the value 0.
MUX20	Instruction select bits for ALU 0.

41.11.153 This register defines the control bits for the pxp wfe sub-block (PXP_HW_PXP_WFE_B_STAGE1_MUX6n)

Mux value to select one of the flags or data inputs of the pipeline stage. Each mux corresponds to one of the inputs to each of the logic elements (e.g. alu, comparator, LUT, etc). Some logic elements have one mux and others have two or more. The mux numbers are mapped to the pipeline according to the hardware configuration. Please see the reference design for the mux map.

Address: 21C_C000h base + 1DB0h offset + (4d × i), where i=0d to 3d

Bit	31	30	29	28	27	26	25	24	23	22	21	20	19	18	17	16	15	14	13	12	11	10	9	8	7	6	5	4	3	2	1	0
R	0								0								0								0							
W																																
Reset	0	0	0	0	0	0	0	0	0	0	0	0	0	0	0	0	0	0	0	0	0	0	0	0	0	0	0	0	0	0	0	0

PXP_HW_PXP_WFE_B_STAGE1_MUX6n field descriptions

Field	Description
31–30 Reserved	This read-only field is reserved and always has the value 0.
29–24 MUX27	Input data select bits for Comparator 2.
23–22 Reserved	This read-only field is reserved and always has the value 0.
21–16 MUX26	Input data select bits for Comparator 1.
15–14 Reserved	This read-only field is reserved and always has the value 0.
13–8 MUX25	Input data select bits for Comparator 1.
7–6 Reserved	This read-only field is reserved and always has the value 0.
MUX24	Input data select bits for Comparator 0.

41.11.154 This register defines the control bits for the pxp wfe sub-block (PXP_HW_PXP_WFE_B_STAGE1_MUX7n)

Mux value to select one of the flags or data inputs of the pipeline stage. Each mux corresponds to one of the inputs to each of the logic elements (e.g. alu, comparator, LUT, etc). Some logic elements have one mux and others have two or more. The mux numbers are mapped to the pipeline according to the hardware configuration. Please see the reference design for the mux map.

Address: 21C_C000h base + 1DC0h offset + (4d × i), where i=0d to 3d

Bit	31	30	29	28	27	26	25	24	23	22	21	20	19	18	17	16	15	14	13	12	11	10	9	8	7	6	5	4	3	2	1	0
R	0								0								0								0							
W																																
Reset	0	0	0	0	0	0	0	0	0	0	0	0	0	0	0	0	0	0	0	0	0	0	0	0	0	0	0	0	0	0	0	0

PXP_HW_PXP_WFE_B_STAGE1_MUX7n field descriptions

Field	Description
31–30 Reserved	This read-only field is reserved and always has the value 0.
29–24 MUX31	Input data select bits for Comparator 4.
23–22 Reserved	This read-only field is reserved and always has the value 0.
21–16 MUX30	Input data select bits for Comparator 3.
15–14 Reserved	This read-only field is reserved and always has the value 0.
13–8 MUX29	Input data select bits for Comparator 3.
7–6 Reserved	This read-only field is reserved and always has the value 0.
MUX28	Input data select bits for Comparator 2.

41.11.155 This register defines the control bits for the pxp wfe sub-block (PXP_HW_PXP_WFE_B_STAGE1_MUX8n)

Mux value to select one of the flags or data inputs of the pipeline stage. Each mux corresponds to one of the inputs to each of the logic elements (e.g. alu, comparator, LUT, etc). Some logic elements have one mux and others have two or more. The mux numbers are mapped to the pipeline according to the hardware configuration. Please see the reference design for the mux map.

Address: 21C_C000h base + 1DD0h offset + (4d × i), where i=0d to 3d

Bit	31	30	29	28	27	26	25	24	23	22	21	20	19	18	17	16	15	14	13	12	11	10	9	8	7	6	5	4	3	2	1	0
R	0																MUX32															
W	0																0															
Reset	0	0	0	0	0	0	0	0	0	0	0	0	0	0	0	0	0	0	0	0	0	0	0	0	0	0	0	0	0	0	0	0

PXP_HW_PXP_WFE_B_STAGE1_MUX8n field descriptions

Field	Description
31–6 Reserved	This read-only field is reserved and always has the value 0.
MUX32	Input data select bits for Comparator 4.

41.11.156 This register defines the control bits for the pxp wfe sub-block (PXP_HW_PXP_WFE_B_STAGE2_MUX0n)

Mux value to select one of the flags or data inputs of the pipeline stage. Each mux corresponds to one of the inputs to each of the logic elements (e.g. alu, comparator, LUT, etc). Some logic elements have one mux and others have two or more. The mux numbers are mapped to the pipeline according to the hardware configuration. Please see the reference design for the mux map.

Address: 21C_C000h base + 1DE0h offset + (4d × i), where i=0d to 3d

Bit	31	30	29	28	27	26	25	24	23	22	21	20	19	18	17	16	15	14	13	12	11	10	9	8	7	6	5	4	3	2	1	0
R	0	MUX3						0	MUX2						0	MUX1						0	MUX0									
W	0	0						0	0						0	0						0	0									
Reset	0	0	0	0	0	0	0	0	0	0	0	0	0	0	0	0	0	0	0	0	0	0	0	0	0	0	0	0	0	0	0	0

PXP_HW_PXP_WFE_B_STAGE2_MUX0n field descriptions

Field	Description
31–30 Reserved	This read-only field is reserved and always has the value 0.
29–24 MUX3	Input 4 data select bits for 5x6 LUT 0.
23–22 Reserved	This read-only field is reserved and always has the value 0.
21–16 MUX2	Input 3 data select bits for 5x6 LUT 0.
15–14 Reserved	This read-only field is reserved and always has the value 0.
13–8 MUX1	Input 2 data select bits for 5x6 LUT 0.
7–6 Reserved	This read-only field is reserved and always has the value 0.
MUX0	Input 1 data select bits for 5x6 LUT 0.

41.11.157 This register defines the control bits for the pxp wfe sub-block (PXP_HW_PXP_WFE_B_STAGE2_MUX1n)

Mux value to select one of the flags or data inputs of the pipeline stage. Each mux corresponds to one of the inputs to each of the logic elements (e.g. alu, comparator, LUT, etc). Some logic elements have one mux and others have two or more. The mux numbers are mapped to the pipeline according to the hardware configuration. Please see the reference design for the mux map.

Address: 21C_C000h base + 1DF0h offset + (4d × i), where i=0d to 3d

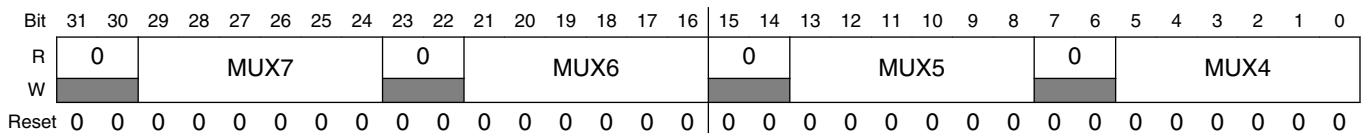

PXP_HW_PXP_WFE_B_STAGE2_MUX1n field descriptions

Field	Description
31–30 Reserved	This read-only field is reserved and always has the value 0.
29–24 MUX7	Input 3 data select bits for 5x6 LUT 1.
23–22 Reserved	This read-only field is reserved and always has the value 0.

Table continues on the next page...

PXP_HW_PXP_WFE_B_STAGE2_MUX1n field descriptions (continued)

Field	Description
21–16 MUX6	Input 2 data select bits for 5x6 LUT 1.
15–14 Reserved	This read-only field is reserved and always has the value 0.
13–8 MUX5	Input 1 data select bits for 5x6 LUT 1.
7–6 Reserved	This read-only field is reserved and always has the value 0.
MUX4	Input 5 data select bits for 5x6 LUT 0.

41.11.158 This register defines the control bits for the pxp wfe sub-block (PXP_HW_PXP_WFE_B_STAGE2_MUX2n)

Mux value to select one of the flags or data inputs of the pipeline stage. Each mux corresponds to one of the inputs to each of the logic elements (e.g. alu, comparator, LUT, etc). Some logic elements have one mux and others have two or more. The mux numbers are mapped to the pipeline according to the hardware configuration. Please see the reference design for the mux map.

Address: 21C_C000h base + 1E00h offset + (4d × i), where i=0d to 3d

Bit	31	30	29	28	27	26	25	24	23	22	21	20	19	18	17	16	15	14	13	12	11	10	9	8	7	6	5	4	3	2	1	0
R	0								0								0								0							
W																																
Reset	0	0	0	0	0	0	0	0	0	0	0	0	0	0	0	0	0	0	0	0	0	0	0	0	0	0	0	0	0	0	0	0

PXP_HW_PXP_WFE_B_STAGE2_MUX2n field descriptions

Field	Description
31–30 Reserved	This read-only field is reserved and always has the value 0.
29–24 MUX11	Input 2 data select bits for 5x6 LUT 2.
23–22 Reserved	This read-only field is reserved and always has the value 0.
21–16 MUX10	Input 1 data select bits for 5x6 LUT 2.
15–14 Reserved	This read-only field is reserved and always has the value 0.
13–8 MUX9	Input 5 data select bits for 5x6 LUT 1.

Table continues on the next page...

PXP_HW_PXP_WFE_B_STAGE2_MUX2n field descriptions (continued)

Field	Description
7–6 Reserved	This read-only field is reserved and always has the value 0.
MUX8	Input 4 data select bits for 5x6 LUT 1.

41.11.159 This register defines the control bits for the pxp wfe sub-block (PXP_HW_PXP_WFE_B_STAGE2_MUX3n)

Mux value to select one of the flags or data inputs of the pipeline stage. Each mux corresponds to one of the inputs to each of the logic elements (e.g. alu, comparator, LUT, etc). Some logic elements have one mux and others have two or more. The mux numbers are mapped to the pipeline according to the hardware configuration. Please see the reference design for the mux map.

Address: 21C_C000h base + 1E10h offset + (4d × i), where i=0d to 3d

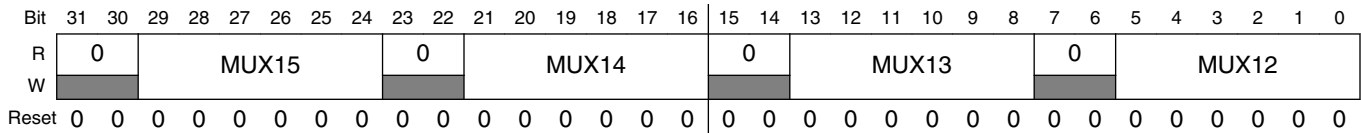

PXP_HW_PXP_WFE_B_STAGE2_MUX3n field descriptions

Field	Description
31–30 Reserved	This read-only field is reserved and always has the value 0.
29–24 MUX15	Input 1 data select bits for 5x6 LUT 3.
23–22 Reserved	This read-only field is reserved and always has the value 0.
21–16 MUX14	Input 5 data select bits for 5x6 LUT 2.
15–14 Reserved	This read-only field is reserved and always has the value 0.
13–8 MUX13	Input 4 data select bits for 5x6 LUT 2.
7–6 Reserved	This read-only field is reserved and always has the value 0.
MUX12	Input 3 data select bits for 5x6 LUT 2.

41.11.160 This register defines the control bits for the pxp wfe sub-block (PXP_HW_PXP_WFE_B_STAGE2_MUX4n)

Mux value to select one of the flags or data inputs of the pipeline stage. Each mux corresponds to one of the inputs to each of the logic elements (e.g. alu, comparator, LUT, etc). Some logic elements have one mux and others have two or more. The mux numbers are mapped to the pipeline according to the hardware configuration. Please see the reference design for the mux map.

Address: 21C_C000h base + 1E20h offset + (4d × i), where i=0d to 3d

Bit	31	30	29	28	27	26	25	24	23	22	21	20	19	18	17	16	15	14	13	12	11	10	9	8	7	6	5	4	3	2	1	0
R	0								0								0								0							
W																																
Reset	0	0	0	0	0	0	0	0	0	0	0	0	0	0	0	0	0	0	0	0	0	0	0	0	0	0	0	0	0	0	0	0

PXP_HW_PXP_WFE_B_STAGE2_MUX4n field descriptions

Field	Description
31–30 Reserved	This read-only field is reserved and always has the value 0.
29–24 MUX19	Input 5 data select bits for 5x1 LUT 3.
23–22 Reserved	This read-only field is reserved and always has the value 0.
21–16 MUX18	Input 4 data select bits for 5x6 LUT 3.
15–14 Reserved	This read-only field is reserved and always has the value 0.
13–8 MUX17	Input 3 data select bits for 5x6 LUT 3.
7–6 Reserved	This read-only field is reserved and always has the value 0.
MUX16	Input 2 data select bits for 5x6 LUT 3.

41.11.161 This register defines the control bits for the pxp wfe sub-block (PXP_HW_PXP_WFE_B_STAGE2_MUX5n)

Mux value to select one of the flags or data inputs of the pipeline stage. Each mux corresponds to one of the inputs to each of the logic elements (e.g. alu, comparator, LUT, etc). Some logic elements have one mux and others have two or more. The mux numbers are mapped to the pipeline according to the hardware configuration. Please see the reference design for the mux map.

Address: 21C_C000h base + 1E30h offset + (4d × i), where i=0d to 3d

Bit	31	30	29	28	27	26	25	24	23	22	21	20	19	18	17	16	15	14	13	12	11	10	9	8	7	6	5	4	3	2	1	0
R	0								0								0								0							
W																																
Reset	0	0	0	0	0	0	0	0	0	0	0	0	0	0	0	0	0	0	0	0	0	0	0	0	0	0	0	0	0	0	0	0

PXP_HW_PXP_WFE_B_STAGE2_MUX5n field descriptions

Field	Description
31–30 Reserved	This read-only field is reserved and always has the value 0.
29–24 MUX23	Input 4 data select bits for 5x1 LUT 0.
23–22 Reserved	This read-only field is reserved and always has the value 0.
21–16 MUX22	Input 3 data select bits for 5x1 LUT 0.
15–14 Reserved	This read-only field is reserved and always has the value 0.
13–8 MUX21	Input 2 data select bits for 5x1 LUT 0.
7–6 Reserved	This read-only field is reserved and always has the value 0.
MUX20	Input 1 data select bits for 5x1 LUT 0.

41.11.162 This register defines the control bits for the pxp wfe sub-block (PXP_HW_PXP_WFE_B_STAGE2_MUX6n)

Mux value to select one of the flags or data inputs of the pipeline stage. Each mux corresponds to one of the inputs to each of the logic elements (e.g. alu, comparator, LUT, etc). Some logic elements have one mux and others have two or more. The mux numbers are mapped to the pipeline according to the hardware configuration. Please see the reference design for the mux map.

Address: 21C_C000h base + 1E40h offset + (4d × i), where i=0d to 3d

Bit	31	30	29	28	27	26	25	24	23	22	21	20	19	18	17	16	15	14	13	12	11	10	9	8	7	6	5	4	3	2	1	0
R	0								0								0								0							
W																																
Reset	0	0	0	0	0	0	0	0	0	0	0	0	0	0	0	0	0	0	0	0	0	0	0	0	0	0	0	0	0	0	0	0

PXP_HW_PXP_WFE_B_STAGE2_MUX6n field descriptions

Field	Description
31–30 Reserved	This read-only field is reserved and always has the value 0.
29–24 MUX27	Input 3 data select bits for 5x1 LUT 1.
23–22 Reserved	This read-only field is reserved and always has the value 0.
21–16 MUX26	Input 2 data select bits for 5x1 LUT 1.
15–14 Reserved	This read-only field is reserved and always has the value 0.
13–8 MUX25	Input 1 data select bits for 5x1 LUT 1.
7–6 Reserved	This read-only field is reserved and always has the value 0.
MUX24	Input 5 data select bits for 5x1 LUT 0.

41.11.163 This register defines the control bits for the pxp wfe sub-block (PXP_HW_PXP_WFE_B_STAGE2_MUX7n)

Mux value to select one of the flags or data inputs of the pipeline stage. Each mux corresponds to one of the inputs to each of the logic elements (e.g. alu, comparator, LUT, etc). Some logic elements have one mux and others have two or more. The mux numbers are mapped to the pipeline according to the hardware configuration. Please see the reference design for the mux map.

Address: 21C_C000h base + 1E50h offset + (4d × i), where i=0d to 3d

Bit	31	30	29	28	27	26	25	24	23	22	21	20	19	18	17	16	15	14	13	12	11	10	9	8	7	6	5	4	3	2	1	0
R	0								0								0								0							
W																																
Reset	0	0	0	0	0	0	0	0	0	0	0	0	0	0	0	0	0	0	0	0	0	0	0	0	0	0	0	0	0	0	0	0

PXP_HW_PXP_WFE_B_STAGE2_MUX7n field descriptions

Field	Description
31–30 Reserved	This read-only field is reserved and always has the value 0.
29–24 MUX31	Input 2 data select bits for 5x1 LUT 2.
23–22 Reserved	This read-only field is reserved and always has the value 0.
21–16 MUX30	Input 1 data select bits for 5x1 LUT 2.
15–14 Reserved	This read-only field is reserved and always has the value 0.
13–8 MUX29	Input 5 data select bits for 5x1 LUT 1.
7–6 Reserved	This read-only field is reserved and always has the value 0.
MUX28	Input 4 data select bits for 5x1 LUT 1.

41.11.164 This register defines the control bits for the pxp wfe sub-block (PXP_HW_PXP_WFE_B_STAGE2_MUX8n)

Mux value to select one of the flags or data inputs of the pipeline stage. Each mux corresponds to one of the inputs to each of the logic elements (e.g. alu, comparator, LUT, etc). Some logic elements have one mux and others have two or more. The mux numbers are mapped to the pipeline according to the hardware configuration. Please see the reference design for the mux map.

Address: 21C_C000h base + 1E60h offset + (4d × i), where i=0d to 3d

Bit	31	30	29	28	27	26	25	24	23	22	21	20	19	18	17	16	15	14	13	12	11	10	9	8	7	6	5	4	3	2	1	0
R	0								0								0								0							
W																																
Reset	0	0	0	0	0	0	0	0	0	0	0	0	0	0	0	0	0	0	0	0	0	0	0	0	0	0	0	0	0	0	0	0

PXP_HW_PXP_WFE_B_STAGE2_MUX8n field descriptions

Field	Description
31–30 Reserved	This read-only field is reserved and always has the value 0.
29–24 MUX35	Input 1 data select bits for 5x1 LUT 3.
23–22 Reserved	This read-only field is reserved and always has the value 0.
21–16 MUX34	Input 5 data select bits for 5x1 LUT 2.
15–14 Reserved	This read-only field is reserved and always has the value 0.
13–8 MUX33	Input 4 data select bits for 5x1 LUT 2.
7–6 Reserved	This read-only field is reserved and always has the value 0.
MUX32	Input 3 data select bits for 5x1 LUT 2.

41.11.165 This register defines the control bits for the pxp wfe sub-block (PXP_HW_PXP_WFE_B_STAGE2_MUX9n)

Mux value to select one of the flags or data inputs of the pipeline stage. Each mux corresponds to one of the inputs to each of the logic elements (e.g. alu, comparator, LUT, etc). Some logic elements have one mux and others have two or more. The mux numbers are mapped to the pipeline according to the hardware configuration. Please see the reference design for the mux map.

Address: 21C_C000h base + 1E70h offset + (4d × i), where i=0d to 3d

Bit	31	30	29	28	27	26	25	24	23	22	21	20	19	18	17	16	15	14	13	12	11	10	9	8	7	6	5	4	3	2	1	0
R	0								0								0								0							
W																																
Reset	0	0	0	0	0	0	0	0	0	0	0	0	0	0	0	0	0	0	0	0	0	0	0	0	0	0	0	0	0	0	0	0

PXP_HW_PXP_WFE_B_STAGE2_MUX9n field descriptions

Field	Description
31–30 Reserved	This read-only field is reserved and always has the value 0.
29–24 MUX39	Input 5 data select bits for 5x1 LUT 3.
23–22 Reserved	This read-only field is reserved and always has the value 0.
21–16 MUX38	Input 4 data select bits for 5x1 LUT 3.
15–14 Reserved	This read-only field is reserved and always has the value 0.
13–8 MUX37	Input 3 data select bits for 5x1 LUT 3.
7–6 Reserved	This read-only field is reserved and always has the value 0.
MUX36	Input 2 data select bits for 5x1 LUT 3.

41.11.166 This register defines the control bits for the pxp wfe sub-block (PXP_HW_PXP_WFE_B_STAGE2_MUX10n)

Mux value to select one of the flags or data inputs of the pipeline stage. Each mux corresponds to one of the inputs to each of the logic elements (e.g. alu, comparator, LUT, etc). Some logic elements have one mux and others have two or more. The mux numbers are mapped to the pipeline according to the hardware configuration. Please see the reference design for the mux map.

Address: 21C_C000h base + 1E80h offset + (4d × i), where i=0d to 3d

Bit	31	30	29	28	27	26	25	24	23	22	21	20	19	18	17	16	15	14	13	12	11	10	9	8	7	6	5	4	3	2	1	0
R	0								0								0								0							
W																																
Reset	0	0	0	0	0	0	0	0	0	0	0	0	0	0	0	0	0	0	0	0	0	0	0	0	0	0	0	0	1	1	0	0

PXP_HW_PXP_WFE_B_STAGE2_MUX10n field descriptions

Field	Description
31–30 Reserved	This read-only field is reserved and always has the value 0.
29–24 MUX43	Input data select bits for Comparator 0.
23–22 Reserved	This read-only field is reserved and always has the value 0.
21–16 MUX42	Input data select bits for ALU 0.
15–14 Reserved	This read-only field is reserved and always has the value 0.
13–8 MUX41	Input data select bits for ALU 0.
7–6 Reserved	This read-only field is reserved and always has the value 0.
MUX40	Instruction select bits for ALU 0.

41.11.167 This register defines the control bits for the pxp wfe sub-block (PXP_HW_PXP_WFE_B_STAGE2_MUX11n)

Mux value to select one of the flags or data inputs of the pipeline stage. Each mux corresponds to one of the inputs to each of the logic elements (e.g. alu, comparator, LUT, etc). Some logic elements have one mux and others have two or more. The mux numbers are mapped to the pipeline according to the hardware configuration. Please see the reference design for the mux map.

Address: 21C_C000h base + 1E90h offset + (4d × i), where i=0d to 3d

Bit	31	30	29	28	27	26	25	24	23	22	21	20	19	18	17	16	15	14	13	12	11	10	9	8	7	6	5	4	3	2	1	0
R	0								0								0								0							
W																																
Reset	0	0	0	0	0	0	0	0	0	0	0	0	0	0	0	0	0	0	0	0	0	0	0	0	0	0	0	0	0	0	0	0

PXP_HW_PXP_WFE_B_STAGE2_MUX11n field descriptions

Field	Description
31–30 Reserved	This read-only field is reserved and always has the value 0.
29–24 MUX47	Input data select bits for Comparator 2.
23–22 Reserved	This read-only field is reserved and always has the value 0.
21–16 MUX46	Input data select bits for Comparator 1.
15–14 Reserved	This read-only field is reserved and always has the value 0.
13–8 MUX45	Input data select bits for Comparator 1.
7–6 Reserved	This read-only field is reserved and always has the value 0.
MUX44	Input data select bits for Comparator 0.

41.11.168 This register defines the control bits for the pxp wfe sub-block (PXP_HW_PXP_WFE_B_STAGE2_MUX12n)

Mux value to select one of the flags or data inputs of the pipeline stage. Each mux corresponds to one of the inputs to each of the logic elements (e.g. alu, comparator, LUT, etc). Some logic elements have one mux and others have two or more. The mux numbers are mapped to the pipeline according to the hardware configuration. Please see the reference design for the mux map.

Address: 21C_C000h base + 1EA0h offset + (4d × i), where i=0d to 3d

Bit	31	30	29	28	27	26	25	24	23	22	21	20	19	18	17	16	15	14	13	12	11	10	9	8	7	6	5	4	3	2	1	0
R	0																MUX48															
W	0																0															
Reset	0	0	0	0	0	0	0	0	0	0	0	0	0	0	0	0	0	0	0	0	0	0	0	0	0	0	0	0	0	0	0	0

PXP_HW_PXP_WFE_B_STAGE2_MUX12n field descriptions

Field	Description
31–6 Reserved	This read-only field is reserved and always has the value 0.
MUX48	Input data select bits for Comparator 2.

41.11.169 This register defines the control bits for the pxp wfe sub-block (PXP_HW_PXP_WFE_B_STAGE3_MUX0n)

Mux value to select one of the flags or data inputs of the pipeline stage. Each mux corresponds to one of the inputs to each of the logic elements (e.g. alu, comparator, LUT, etc). Some logic elements have one mux and others have two or more. The mux numbers are mapped to the pipeline according to the hardware configuration. Please see the reference design for the mux map.

Address: 21C_C000h base + 1EB0h offset + (4d × i), where i=0d to 3d

Bit	31	30	29	28	27	26	25	24	23	22	21	20	19	18	17	16	15	14	13	12	11	10	9	8	7	6	5	4	3	2	1	0
R	0	MUX3						0	MUX2						0	MUX1						0	MUX0									
W	0	0						0	0						0	0						0	0									
Reset	0	0	0	0	0	0	0	0	0	0	0	0	0	0	0	0	0	0	0	0	0	0	0	0	0	0	0	0	0	0	0	0

PXP_HW_PXP_WFE_B_STAGE3_MUX0n field descriptions

Field	Description
31–30 Reserved	This read-only field is reserved and always has the value 0.
29–24 MUX3	Input 4 flag select bits for F8x1 LUT0.
23–22 Reserved	This read-only field is reserved and always has the value 0.
21–16 MUX2	Input 3 flag select bits for F8x1 LUT0.
15–14 Reserved	This read-only field is reserved and always has the value 0.
13–8 MUX1	Input 2 flag select bits for F8x1 LUT 0.
7–6 Reserved	This read-only field is reserved and always has the value 0.
MUX0	Input 1 flag select bits for F8x1 LUT 0.

41.11.170 This register defines the control bits for the pxp wfe sub-block (PXP_HW_PXP_WFE_B_STAGE3_MUX1n)

Mux value to select one of the flags or data inputs of the pipeline stage. Each mux corresponds to one of the inputs to each of the logic elements (e.g. alu, comparator, LUT, etc). Some logic elements have one mux and others have two or more. The mux numbers are mapped to the pipeline according to the hardware configuration. Please see the reference design for the mux map.

Address: 21C_C000h base + 1EC0h offset + (4d × i), where i=0d to 3d

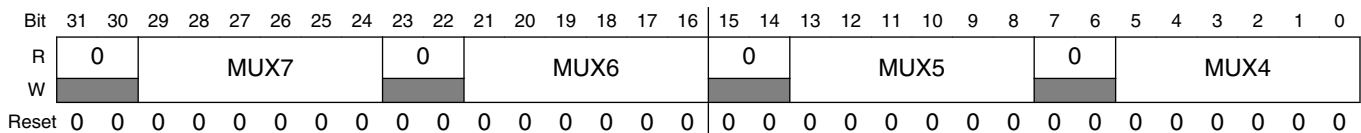

PXP_HW_PXP_WFE_B_STAGE3_MUX1n field descriptions

Field	Description
31–30 Reserved	This read-only field is reserved and always has the value 0.
29–24 MUX7	Input 8 flag select bits for F8x1 LUT 0.
23–22 Reserved	This read-only field is reserved and always has the value 0.

Table continues on the next page...

PXP_HW_PXP_WFE_B_STAGE3_MUX1n field descriptions (continued)

Field	Description
21–16 MUX6	Input 7 flag select bits for F8x1 LUT 0.
15–14 Reserved	This read-only field is reserved and always has the value 0.
13–8 MUX5	Input 6 flag select bits for F8x1 LUT 0.
7–6 Reserved	This read-only field is reserved and always has the value 0.
MUX4	Input 5 flag select bits for F8x1 LUT 0.

41.11.171 This register defines the control bits for the pxp wfe sub-block (PXP_HW_PXP_WFE_B_STAGE3_MUX2n)

Mux value to select one of the flags or data inputs of the pipeline stage. Each mux corresponds to one of the inputs to each of the logic elements (e.g. alu, comparator, LUT, etc). Some logic elements have one mux and others have two or more. The mux numbers are mapped to the pipeline according to the hardware configuration. Please see the reference design for the mux map.

Address: 21C_C000h base + 1ED0h offset + (4d × i), where i=0d to 3d

Bit	31	30	29	28	27	26	25	24	23	22	21	20	19	18	17	16	15	14	13	12	11	10	9	8	7	6	5	4	3	2	1	0
R	0								0								0								0							
W																																
Reset	0	0	0	0	0	0	0	0	0	0	0	0	0	0	0	0	0	0	0	0	0	0	0	0	0	0	0	0	0	0	0	0

PXP_HW_PXP_WFE_B_STAGE3_MUX2n field descriptions

Field	Description
31–30 Reserved	This read-only field is reserved and always has the value 0.
29–24 MUX11	Input 4 flag select bits for F8x1 LUT 1.
23–22 Reserved	This read-only field is reserved and always has the value 0.
21–16 MUX10	Input 3 flag select bits for F8x1 LUT 1.
15–14 Reserved	This read-only field is reserved and always has the value 0.
13–8 MUX9	Input 2 flag select bits for F8x1 LUT 1.

Table continues on the next page...

PXP_HW_PXP_WFE_B_STAGE3_MUX2n field descriptions (continued)

Field	Description
7–6 Reserved	This read-only field is reserved and always has the value 0.
MUX8	Input 1 flag select bits for F8x1 LUT 1.

41.11.172 This register defines the control bits for the pxp wfe sub-block (PXP_HW_PXP_WFE_B_STAGE3_MUX3n)

Mux value to select one of the flags or data inputs of the pipeline stage. Each mux corresponds to one of the inputs to each of the logic elements (e.g. alu, comparator, LUT, etc). Some logic elements have one mux and others have two or more. The mux numbers are mapped to the pipeline according to the hardware configuration. Please see the reference design for the mux map.

Address: 21C_C000h base + 1EE0h offset + (4d × i), where i=0d to 3d

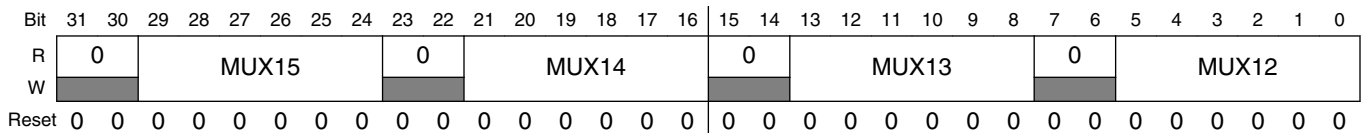

PXP_HW_PXP_WFE_B_STAGE3_MUX3n field descriptions

Field	Description
31–30 Reserved	This read-only field is reserved and always has the value 0.
29–24 MUX15	Input 8 flag select bits for F8x1 LUT 1.
23–22 Reserved	This read-only field is reserved and always has the value 0.
21–16 MUX14	Input 7 flag select bits for F8x1 LUT 1.
15–14 Reserved	This read-only field is reserved and always has the value 0.
13–8 MUX13	Input 6 flag select bits for F8x1 LUT 1.
7–6 Reserved	This read-only field is reserved and always has the value 0.
MUX12	Input 5 flag select bits for F8x1 LUT 1.

41.11.173 This register defines the control bits for the pxp wfe sub-block (PXP_HW_PXP_WFE_B_STAGE3_MUX4n)

Mux value to select one of the flags or data inputs of the pipeline stage. Each mux corresponds to one of the inputs to each of the logic elements (e.g. alu, comparator, LUT, etc). Some logic elements have one mux and others have two or more. The mux numbers are mapped to the pipeline according to the hardware configuration. Please see the reference design for the mux map.

Address: 21C_C000h base + 1EF0h offset + (4d × i), where i=0d to 3d

Bit	31	30	29	28	27	26	25	24	23	22	21	20	19	18	17	16	15	14	13	12	11	10	9	8	7	6	5	4	3	2	1	0
R	0								0								0								0							
W																																
Reset	0	0	0	0	0	0	0	0	0	0	0	0	0	0	0	0	0	0	0	0	0	0	0	0	0	0	0	0	0	0	0	0

PXP_HW_PXP_WFE_B_STAGE3_MUX4n field descriptions

Field	Description
31–30 Reserved	This read-only field is reserved and always has the value 0.
29–24 MUX19	Input 4 flag select bits for F8x1 LUT 2.
23–22 Reserved	This read-only field is reserved and always has the value 0.
21–16 MUX18	Input 3 flag select bits for F8x1 LUT 2.
15–14 Reserved	This read-only field is reserved and always has the value 0.
13–8 MUX17	Input 2 flag select bits for F8x1 LUT 2.
7–6 Reserved	This read-only field is reserved and always has the value 0.
MUX16	Input 1 flag select bits for F8x1 LUT 2.

41.11.174 This register defines the control bits for the pxp wfe sub-block (PXP_HW_PXP_WFE_B_STAGE3_MUX5n)

Mux value to select one of the flags or data inputs of the pipeline stage. Each mux corresponds to one of the inputs to each of the logic elements (e.g. alu, comparator, LUT, etc). Some logic elements have one mux and others have two or more. The mux numbers are mapped to the pipeline according to the hardware configuration. Please see the reference design for the mux map.

Address: 21C_C000h base + 1F00h offset + (4d × i), where i=0d to 3d

Bit	31	30	29	28	27	26	25	24	23	22	21	20	19	18	17	16	15	14	13	12	11	10	9	8	7	6	5	4	3	2	1	0
R	0								0								0								0							
W																																
Reset	0	0	0	0	0	0	0	0	0	0	0	0	0	0	0	0	0	0	0	0	0	0	0	0	0	0	0	0	0	0	0	0

PXP_HW_PXP_WFE_B_STAGE3_MUX5n field descriptions

Field	Description
31–30 Reserved	This read-only field is reserved and always has the value 0.
29–24 MUX23	Input 8 flag select bits for F8x1 LUT 2.
23–22 Reserved	This read-only field is reserved and always has the value 0.
21–16 MUX22	Input 7 flag select bits for F8x1 LUT 2.
15–14 Reserved	This read-only field is reserved and always has the value 0.
13–8 MUX21	Input 6 flag select bits for F8x1 LUT 2.
7–6 Reserved	This read-only field is reserved and always has the value 0.
MUX20	Input 5 flag select bits for F8x1 LUT 2.

41.11.175 This register defines the control bits for the pxp wfe sub-block (PXP_HW_PXP_WFE_B_STAGE3_MUX6n)

Mux value to select one of the flags or data inputs of the pipeline stage. Each mux corresponds to one of the inputs to each of the logic elements (e.g. alu, comparator, LUT, etc). Some logic elements have one mux and others have two or more. The mux numbers are mapped to the pipeline according to the hardware configuration. Please see the reference design for the mux map.

Address: 21C_C000h base + 1F10h offset + (4d × i), where i=0d to 3d

Bit	31	30	29	28	27	26	25	24	23	22	21	20	19	18	17	16	15	14	13	12	11	10	9	8	7	6	5	4	3	2	1	0
R	0								0								0								0							
W																																
Reset	0	0	0	0	0	0	0	0	0	0	0	0	0	0	0	0	0	0	0	0	0	0	0	0	0	0	0	0	0	0	0	0

PXP_HW_PXP_WFE_B_STAGE3_MUX6n field descriptions

Field	Description
31–30 Reserved	This read-only field is reserved and always has the value 0.
29–24 MUX27	Input 4 flag select bits for F8x1 LUT 3.
23–22 Reserved	This read-only field is reserved and always has the value 0.
21–16 MUX26	Input 3 flag select bits for F8x1 LUT 3.
15–14 Reserved	This read-only field is reserved and always has the value 0.
13–8 MUX25	Input 2 flag select bits for F8x1 LUT 3.
7–6 Reserved	This read-only field is reserved and always has the value 0.
MUX24	Input 1 flag select bits for F8x1 LUT 3.

41.11.176 This register defines the control bits for the pxp wfe sub-block (PXP_HW_PXP_WFE_B_STAGE3_MUX7n)

Mux value to select one of the flags or data inputs of the pipeline stage. Each mux corresponds to one of the inputs to each of the logic elements (e.g. alu, comparator, LUT, etc). Some logic elements have one mux and others have two or more. The mux numbers are mapped to the pipeline according to the hardware configuration. Please see the reference design for the mux map.

Address: 21C_C000h base + 1F20h offset + (4d × i), where i=0d to 3d

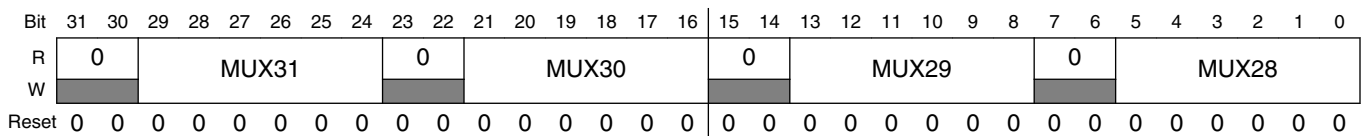

PXP_HW_PXP_WFE_B_STAGE3_MUX7n field descriptions

Field	Description
31–30 Reserved	This read-only field is reserved and always has the value 0.
29–24 MUX31	Input 8 flag select bits for F8x1 LUT 3.
23–22 Reserved	This read-only field is reserved and always has the value 0.
21–16 MUX30	Input 7 flag select bits for F8x1 LUT 3.
15–14 Reserved	This read-only field is reserved and always has the value 0.
13–8 MUX29	Input 6 flag select bits for F8x1 LUT 3.
7–6 Reserved	This read-only field is reserved and always has the value 0.
MUX28	Input 5 flag select bits for F8x1 LUT 3.

41.11.177 This register defines the control bits for the pxp wfe sub-block (PXP_HW_PXP_WFE_B_STAGE3_MUX8n)

Mux value to select one of the flags or data inputs of the pipeline stage. Each mux corresponds to one of the inputs to each of the logic elements (e.g. alu, comparator, LUT, etc). Some logic elements have one mux and others have two or more. The mux numbers are mapped to the pipeline according to the hardware configuration. Please see the reference design for the mux map.

Address: 21C_C000h base + 1F30h offset + (4d × i), where i=0d to 3d

Bit	31	30	29	28	27	26	25	24	23	22	21	20	19	18	17	16	15	14	13	12	11	10	9	8	7	6	5	4	3	2	1	0
R	0								0								0								0							
W																																
Reset	0	0	0	0	0	0	0	0	0	0	0	0	0	0	0	0	0	0	0	0	0	0	0	0	0	0	0	0	0	0	0	0

PXP_HW_PXP_WFE_B_STAGE3_MUX8n field descriptions

Field	Description
31–30 Reserved	This read-only field is reserved and always has the value 0.
29–24 MUX35	Input data select bits for DMUX 3.
23–22 Reserved	This read-only field is reserved and always has the value 0.
21–16 MUX34	Input data select bits for DMUX 2.
15–14 Reserved	This read-only field is reserved and always has the value 0.
13–8 MUX33	Input data select bits for DMUX 1.
7–6 Reserved	This read-only field is reserved and always has the value 0.
MUX32	Input data select bits for DMUX 0.

41.11.178 This register defines the control bits for the pxp wfe sub-block (PXP_HW_PXP_WFE_B_STAGE3_MUX9n)

Mux value to select one of the flags or data inputs of the pipeline stage. Each mux corresponds to one of the inputs to each of the logic elements (e.g. alu, comparator, LUT, etc). Some logic elements have one mux and others have two or more. The mux numbers are mapped to the pipeline according to the hardware configuration. Please see the reference design for the mux map.

Address: 21C_C000h base + 1F40h offset + (4d × i), where i=0d to 3d

Bit	31	30	29	28	27	26	25	24	23	22	21	20	19	18	17	16	15	14	13	12	11	10	9	8	7	6	5	4	3	2	1	0
R	0								0								0								0							
W																																
Reset	0	0	0	0	0	0	0	0	0	0	0	0	0	0	0	0	0	0	0	0	0	0	0	0	0	0	0	0	0	0	0	0

PXP_HW_PXP_WFE_B_STAGE3_MUX9n field descriptions

Field	Description
31–30 Reserved	This read-only field is reserved and always has the value 0.
29–24 MUX39	Input data select bits for DMUX 7.
23–22 Reserved	This read-only field is reserved and always has the value 0.
21–16 MUX38	Input data select bits for DMUX 6.
15–14 Reserved	This read-only field is reserved and always has the value 0.
13–8 MUX37	Input data select bits for DMUX 5.
7–6 Reserved	This read-only field is reserved and always has the value 0.
MUX36	Input data select bits for DMUX 4.

41.11.179 This register defines the control bits for the pxp wfe sub-block (PXP_HW_PXP_WFE_B_STAGE3_MUX10n)

Mux value to select one of the flags or data inputs of the pipeline stage. Each mux corresponds to one of the inputs to each of the logic elements (e.g. alu, comparator, LUT, etc). Some logic elements have one mux and others have two or more. The mux numbers are mapped to the pipeline according to the hardware configuration. Please see the reference design for the mux map.

Address: 21C_C000h base + 1F50h offset + (4d × i), where i=0d to 3d

Bit	31	30	29	28	27	26	25	24	23	22	21	20	19	18	17	16	15	14	13	12	11	10	9	8	7	6	5	4	3	2	1	0
R	0								0								0								0							
W																																
Reset	0	0	0	0	0	0	0	0	0	0	0	0	0	0	0	0	0	0	0	0	0	0	0	0	0	0	0	0	0	0	0	0

PXP_HW_PXP_WFE_B_STAGE3_MUX10n field descriptions

Field	Description
31–30 Reserved	This read-only field is reserved and always has the value 0.
29–24 MUX43	Input flag select bits for FMUX 3.
23–22 Reserved	This read-only field is reserved and always has the value 0.
21–16 MUX42	Input flag select bits for FMUX 2.
15–14 Reserved	This read-only field is reserved and always has the value 0.
13–8 MUX41	Input flag select bits for FMUX 1.
7–6 Reserved	This read-only field is reserved and always has the value 0.
MUX40	Input flag select bits for FMUX 0.

41.11.180 This register defines the control bits for the pxp wfe sub-block (PXP_HW_PXP_WFE_B_STG1_5X8_OUT0_0)

The 5x8 LUT output value for input value n. This output value determines which input to select (flag, data).

Address: 21C_C000h base + 1F60h offset = 21C_DF60h

Bit	31	30	29	28	27	26	25	24	23	22	21	20	19	18	17	16	15	14	13	12	11	10	9	8	7	6	5	4	3	2	1	0
R	LUTOUT3								LUTOUT2								LUTOUT1								LUTOUT0							
W																																
Reset	0	0	0	0	0	0	0	0	0	0	0	0	0	0	0	0	0	0	0	0	0	0	0	0	0	0	0	0	0	0	0	0

PXP_HW_PXP_WFE_B_STG1_5X8_OUT0_0 field descriptions

Field	Description
31-24 LUTOUT3	LUTOUT 3
23-16 LUTOUT2	LUTOUT 2
15-8 LUTOUT1	LUTOUT 1
LUTOUT0	LUTOUT 0

41.11.181 This register defines the control bits for the pxp wfe sub-block (PXP_HW_PXP_WFE_B_STG1_5X8_OUT0_1)

The 5x8 LUT output value for input value n. This output value determines which input to select (flag, data).

Address: 21C_C000h base + 1F70h offset = 21C_DF70h

Bit	31	30	29	28	27	26	25	24	23	22	21	20	19	18	17	16	15	14	13	12	11	10	9	8	7	6	5	4	3	2	1	0
R	LUTOUT7								LUTOUT6								LUTOUT5								LUTOUT4							
W																																
Reset	0	0	0	0	0	0	0	0	0	0	0	0	0	0	0	0	0	0	0	0	0	0	0	0	0	0	0	0	0	0	0	0

PXP_HW_PXP_WFE_B_STG1_5X8_OUT0_1 field descriptions

Field	Description
31–24 LUTOUT7	LUTOUT 3
23–16 LUTOUT6	LUTOUT 2
15–8 LUTOUT5	LUTOUT 1
LUTOUT4	LUTOUT 0

**41.11.182 This register defines the control bits for the pxp wfe sub-block
(PXP_HW_PXP_WFE_B_STG1_5X8_OUT0_2)**

The 5x8 LUT output value for input value n. This output value determines which input to select (flag, data).

Address: 21C_C000h base + 1F80h offset = 21C_DF80h

Bit	31	30	29	28	27	26	25	24	23	22	21	20	19	18	17	16	15	14	13	12	11	10	9	8	7	6	5	4	3	2	1	0		
R	LUTOUT11								LUTOUT10								LUTOUT9								LUTOUT8									
W																																		
Reset	0	0	0	0	0	0	0	0	0	0	0	0	0	0	0	0	0	0	0	0	0	0	0	0	0	0	0	0	0	0	0	0	0	0

PXP_HW_PXP_WFE_B_STG1_5X8_OUT0_2 field descriptions

Field	Description
31–24 LUTOUT11	LUTOUT 3
23–16 LUTOUT10	LUTOUT 2
15–8 LUTOUT9	LUTOUT 1
LUTOUT8	LUTOUT 0

41.11.183 This register defines the control bits for the pxp wfe sub-block (PXP_HW_PXP_WFE_B_STG1_5X8_OUT0_3)

The 5x8 LUT output value for input value n. This output value determines which input to select (flag, data).

Address: 21C_C000h base + 1F90h offset = 21C_DF90h

Bit	31	30	29	28	27	26	25	24	23	22	21	20	19	18	17	16	15	14	13	12	11	10	9	8	7	6	5	4	3	2	1	0
R	LUTOUT15								LUTOUT14								LUTOUT13								LUTOUT12							
W	LUTOUT15								LUTOUT14								LUTOUT13								LUTOUT12							
Reset	0	0	0	0	0	0	0	0	0	0	0	0	0	0	0	0	0	0	0	0	0	0	0	0	0	0	0	0	0	0	0	0

PXP_HW_PXP_WFE_B_STG1_5X8_OUT0_3 field descriptions

Field	Description
31-24 LUTOUT15	LUTOUT 3
23-16 LUTOUT14	LUTOUT 2
15-8 LUTOUT13	LUTOUT 1
LUTOUT12	LUTOUT 0

41.11.184 This register defines the control bits for the pxp wfe sub-block (PXP_HW_PXP_WFE_B_STG1_5X8_OUT0_4)

The 5x8 LUT output value for input value n. This output value determines which input to select (flag, data).

Address: 21C_C000h base + 1FA0h offset = 21C_DFA0h

Bit	31	30	29	28	27	26	25	24	23	22	21	20	19	18	17	16	15	14	13	12	11	10	9	8	7	6	5	4	3	2	1	0
R	LUTOUT19								LUTOUT18								LUTOUT17								LUTOUT16							
W	LUTOUT19								LUTOUT18								LUTOUT17								LUTOUT16							
Reset	0	0	0	0	0	0	0	0	0	0	0	0	0	0	0	0	0	0	0	0	0	0	0	0	0	0	0	0	0	0	0	0

PXP_HW_PXP_WFE_B_STG1_5X8_OUT0_4 field descriptions

Field	Description
31–24 LUTOUT19	LUTOUT 3
23–16 LUTOUT18	LUTOUT 2
15–8 LUTOUT17	LUTOUT 1
LUTOUT16	LUTOUT 0

41.11.185 This register defines the control bits for the pxp wfe sub-block (PXP_HW_PXP_WFE_B_STG1_5X8_OUT0_5)

The 5x8 LUT output value for input value n. This output value determines which input to select (flag, data).

Address: 21C_C000h base + 1FB0h offset = 21C_DFB0h

Bit	31	30	29	28	27	26	25	24	23	22	21	20	19	18	17	16	15	14	13	12	11	10	9	8	7	6	5	4	3	2	1	0								
R	LUTOUT23								LUTOUT22								LUTOUT21								LUTOUT20															
W																																								
Reset	0	0	0	0	0	0	0	0	0	0	0	0	0	0	0	0	0	0	0	0	0	0	0	0	0	0	0	0	0	0	0	0	0	0	0	0	0	0	0	0

PXP_HW_PXP_WFE_B_STG1_5X8_OUT0_5 field descriptions

Field	Description
31–24 LUTOUT23	LUTOUT 3
23–16 LUTOUT22	LUTOUT 2
15–8 LUTOUT21	LUTOUT 1
LUTOUT20	LUTOUT 0

41.11.186 This register defines the control bits for the pxp wfe sub-block (PXP_HW_PXP_WFE_B_STG1_5X8_OUT0_6)

The 5x8 LUT output value for input value n. This output value determines which input to select (flag, data).

Address: 21C_C000h base + 1FC0h offset = 21C_DFC0h

Bit	31	30	29	28	27	26	25	24	23	22	21	20	19	18	17	16	15	14	13	12	11	10	9	8	7	6	5	4	3	2	1	0
R	LUTOUT27								LUTOUT26								LUTOUT25								LUTOUT24							
W	LUTOUT27								LUTOUT26								LUTOUT25								LUTOUT24							
Reset	0	0	0	0	0	0	0	0	0	0	0	0	0	0	0	0	0	0	0	0	0	0	0	0	0	0	0	0	0	0	0	0

PXP_HW_PXP_WFE_B_STG1_5X8_OUT0_6 field descriptions

Field	Description
31–24 LUTOUT27	LUTOUT 3
23–16 LUTOUT26	LUTOUT 2
15–8 LUTOUT25	LUTOUT 1
LUTOUT24	LUTOUT 0

41.11.187 This register defines the control bits for the pxp wfe sub-block (PXP_HW_PXP_WFE_B_STG1_5X8_OUT0_7)

The 5x8 LUT output value for input value n. This output value determines which input to select (flag, data).

Address: 21C_C000h base + 1FD0h offset = 21C_DFD0h

Bit	31	30	29	28	27	26	25	24	23	22	21	20	19	18	17	16	15	14	13	12	11	10	9	8	7	6	5	4	3	2	1	0
R	LUTOUT31								LUTOUT30								LUTOUT29								LUTOUT28							
W	LUTOUT31								LUTOUT30								LUTOUT29								LUTOUT28							
Reset	0	0	0	0	0	0	0	0	0	0	0	0	0	0	0	0	0	0	0	0	0	0	0	0	0	0	0	0	0	0	0	0

PXP_HW_PXP_WFE_B_STG1_5X8_OUT0_7 field descriptions

Field	Description
31–24 LUTOUT31	LUTOUT 3
23–16 LUTOUT30	LUTOUT 2
15–8 LUTOUT29	LUTOUT 1
LUTOUT28	LUTOUT 0

41.11.188 This register defines the control bits for the pxp wfe sub-block (PXP_HW_PXP_WFE_B_STG1_5X8_OUT1_0)

The 5x8 LUT output value for input value n. This output value determines which input to select (flag, data).

Address: 21C_C000h base + 1FE0h offset = 21C_DFE0h

Bit	31	30	29	28	27	26	25	24	23	22	21	20	19	18	17	16	15	14	13	12	11	10	9	8	7	6	5	4	3	2	1	0
R	LUTOUT3								LUTOUT2								LUTOUT1								LUTOUT0							
W	LUTOUT3								LUTOUT2								LUTOUT1								LUTOUT0							
Reset	0	0	0	0	0	0	0	0	0	0	0	0	0	0	0	0	0	0	0	0	0	0	0	0	0	0	0	0	0	0	0	0

PXP_HW_PXP_WFE_B_STG1_5X8_OUT1_0 field descriptions

Field	Description
31–24 LUTOUT3	LUTOUT 3
23–16 LUTOUT2	LUTOUT 2
15–8 LUTOUT1	LUTOUT 1
LUTOUT0	LUTOUT 0

41.11.189 This register defines the control bits for the pxp wfe sub-block (PXP_HW_PXP_WFE_B_STG1_5X8_OUT1_1)

The 5x8 LUT output value for input value n. This output value determines which input to select (flag, data).

Address: 21C_C000h base + 1FF0h offset = 21C_DFF0h

Bit	31	30	29	28	27	26	25	24	23	22	21	20	19	18	17	16	15	14	13	12	11	10	9	8	7	6	5	4	3	2	1	0
R																																
W	LUTOUT7							LUTOUT6							LUTOUT5							LUTOUT4										
Reset	0	0	0	0	0	0	0	0	0	0	0	0	0	0	0	0	0	0	0	0	0	0	0	0	0	0	0	0	0	0	0	0

PXP_HW_PXP_WFE_B_STG1_5X8_OUT1_1 field descriptions

Field	Description
31-24 LUTOUT7	LUTOUT 3
23-16 LUTOUT6	LUTOUT 2
15-8 LUTOUT5	LUTOUT 1
LUTOUT4	LUTOUT 0

41.11.190 This register defines the control bits for the pxp wfe sub-block (PXP_HW_PXP_WFE_B_STG1_5X8_OUT1_2)

The 5x8 LUT output value for input value n. This output value determines which input to select (flag, data).

Address: 21C_C000h base + 2000h offset = 21C_E000h

Bit	31	30	29	28	27	26	25	24	23	22	21	20	19	18	17	16	15	14	13	12	11	10	9	8	7	6	5	4	3	2	1	0
R																																
W	LUTOUT11							LUTOUT10							LUTOUT9							LUTOUT8										
Reset	0	0	0	0	0	0	0	0	0	0	0	0	0	0	0	0	0	0	0	0	0	0	0	0	0	0	0	0	0	0	0	0

PXP_HW_PXP_WFE_B_STG1_5X8_OUT1_2 field descriptions

Field	Description
31–24 LUTOUT11	LUTOUT 3
23–16 LUTOUT10	LUTOUT 2
15–8 LUTOUT9	LUTOUT 1
LUTOUT8	LUTOUT 0

41.11.191 This register defines the control bits for the pxp wfe sub-block (PXP_HW_PXP_WFE_B_STG1_5X8_OUT1_3)

The 5x8 LUT output value for input value n. This output value determines which input to select (flag, data).

Address: 21C_C000h base + 2010h offset = 21C_E010h

Bit	31	30	29	28	27	26	25	24	23	22	21	20	19	18	17	16	15	14	13	12	11	10	9	8	7	6	5	4	3	2	1	0																
R	LUTOUT15								LUTOUT14								LUTOUT13								LUTOUT12																							
W																																																
Reset	0	0	0	0	0	0	0	0	0	0	0	0	0	0	0	0	0	0	0	0	0	0	0	0	0	0	0	0	0	0	0	0	0	0	0	0	0	0	0	0	0	0	0	0	0	0	0	0

PXP_HW_PXP_WFE_B_STG1_5X8_OUT1_3 field descriptions

Field	Description
31–24 LUTOUT15	LUTOUT 3
23–16 LUTOUT14	LUTOUT 2
15–8 LUTOUT13	LUTOUT 1
LUTOUT12	LUTOUT 0

41.11.192 This register defines the control bits for the pxp wfe sub-block (PXP_HW_PXP_WFE_B_STG1_5X8_OUT1_4)

The 5x8 LUT output value for input value n. This output value determines which input to select (flag, data).

Address: 21C_C000h base + 2020h offset = 21C_E020h

Bit	31	30	29	28	27	26	25	24	23	22	21	20	19	18	17	16	15	14	13	12	11	10	9	8	7	6	5	4	3	2	1	0
R																																
W																																
Reset	0	0	0	0	0	0	0	0	0	0	0	0	0	0	0	0	0	0	0	0	0	0	0	0	0	0	0	0	0	0	0	0

PXP_HW_PXP_WFE_B_STG1_5X8_OUT1_4 field descriptions

Field	Description
31-24 LUTOUT19	LUTOUT 3
23-16 LUTOUT18	LUTOUT 2
15-8 LUTOUT17	LUTOUT 1
LUTOUT16	LUTOUT 0

41.11.193 This register defines the control bits for the pxp wfe sub-block (PXP_HW_PXP_WFE_B_STG1_5X8_OUT1_5)

The 5x8 LUT output value for input value n. This output value determines which input to select (flag, data).

Address: 21C_C000h base + 2030h offset = 21C_E030h

Bit	31	30	29	28	27	26	25	24	23	22	21	20	19	18	17	16	15	14	13	12	11	10	9	8	7	6	5	4	3	2	1	0
R																																
W																																
Reset	0	0	0	0	0	0	0	0	0	0	0	0	0	0	0	0	0	0	0	0	0	0	0	0	0	0	0	0	0	0	0	0

PXP_HW_PXP_WFE_B_STG1_5X8_OUT1_5 field descriptions

Field	Description
31–24 LUTOUT23	LUTOUT 3
23–16 LUTOUT22	LUTOUT 2
15–8 LUTOUT21	LUTOUT 1
LUTOUT20	LUTOUT 0

41.11.194 This register defines the control bits for the pxp wfe sub-block (PXP_HW_PXP_WFE_B_STG1_5X8_OUT1_6)

The 5x8 LUT output value for input value n. This output value determines which input to select (flag, data).

Address: 21C_C000h base + 2040h offset = 21C_E040h

Bit	31	30	29	28	27	26	25	24	23	22	21	20	19	18	17	16	15	14	13	12	11	10	9	8	7	6	5	4	3	2	1	0																
R	LUTOUT27								LUTOUT26								LUTOUT25								LUTOUT24																							
W																																																
Reset	0	0	0	0	0	0	0	0	0	0	0	0	0	0	0	0	0	0	0	0	0	0	0	0	0	0	0	0	0	0	0	0	0	0	0	0	0	0	0	0	0	0	0	0	0	0	0	0

PXP_HW_PXP_WFE_B_STG1_5X8_OUT1_6 field descriptions

Field	Description
31–24 LUTOUT27	LUTOUT 3
23–16 LUTOUT26	LUTOUT 2
15–8 LUTOUT25	LUTOUT 1
LUTOUT24	LUTOUT 0

41.11.195 This register defines the control bits for the pxp wfe sub-block (PXP_HW_PXP_WFE_B_STG1_5X8_OUT1_7)

The 5x8 LUT output value for input value n. This output value determines which input to select (flag, data).

Address: 21C_C000h base + 2050h offset = 21C_E050h

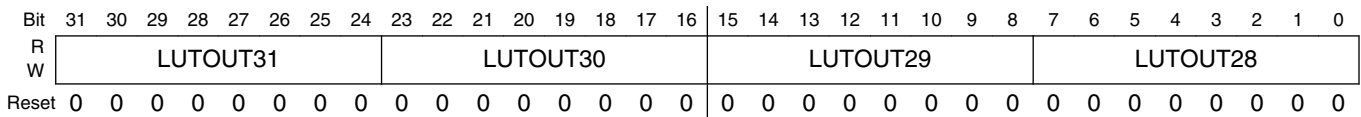

PXP_HW_PXP_WFE_B_STG1_5X8_OUT1_7 field descriptions

Field	Description
31-24 LUTOUT31	LUTOUT 3
23-16 LUTOUT30	LUTOUT 2
15-8 LUTOUT29	LUTOUT 1
LUTOUT28	LUTOUT 0

41.11.196 Each set mask bit enables one of the corresponding flag input bits. There is one mask per 5x8 LUT. (PXP_HW_PXP_WFE_B_STAGE1_5X8_MASKS_0)

Each set mask bit enables one of the corresponding flag input bits. There is one mask per 5x8 LUT.

Address: 21C_C000h base + 2060h offset = 21C_E060h

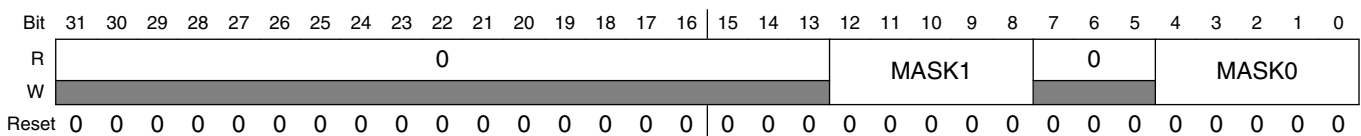

PXP_HW_PXP_WFE_B_STAGE1_5X8_MASKS_0 field descriptions

Field	Description
31–13 Reserved	This read-only field is reserved and always has the value 0.
12–8 MASK1	This field selects the input flags that are valid for 5x8 LUT 1. Bit 0 = input 1, Bit 1 = input 2 and so on.
7–5 Reserved	This read-only field is reserved and always has the value 0.
MASK0	This field selects the input flags that are valid for 5x8 LUT 0. Bit 0 = input 1, Bit 1 = input 2 and so on.

41.11.197 This register defines the output values (new flag) for the 5x1 LUTs in stage 1. (PXP_HW_PXP_WFE_B_STG1_5X1_OUT0)

The 5x1 LUT output value for input value n. This output value results in a flag that is added to the flag array.

Address: 21C_C000h base + 2070h offset = 21C_E070h

Bit	31	30	29	28	27	26	25	24	23	22	21	20	19	18	17	16
R	LUTOUT31	LUTOUT30	LUTOUT29	LUTOUT28	LUTOUT27	LUTOUT26	LUTOUT25	LUTOUT24	LUTOUT23	LUTOUT22	LUTOUT21	LUTOUT20	LUTOUT19	LUTOUT18	LUTOUT17	LUTOUT16
W																
Reset	0	0	0	0	0	0	0	0	0	0	0	0	0	0	0	0
Bit	15	14	13	12	11	10	9	8	7	6	5	4	3	2	1	0
R	LUTOUT15	LUTOUT14	LUTOUT13	LUTOUT12	LUTOUT11	LUTOUT10	LUTOUT9	LUTOUT8	LUTOUT7	LUTOUT6	LUTOUT5	LUTOUT4	LUTOUT3	LUTOUT2	LUTOUT1	LUTOUT0
W																
Reset	0	0	0	0	0	0	0	0	0	0	0	0	0	0	0	0

PXP_HW_PXP_WFE_B_STG1_5X1_OUT0 field descriptions

Field	Description
31 LUTOUT31	LUT OUT
30 LUTOUT30	LUT OUT
29 LUTOUT29	LUT OUT
28 LUTOUT28	LUT OUT

Table continues on the next page...

PXP_HW_PXP_WFE_B_STG1_5X1_OUT0 field descriptions (continued)

Field	Description
27 LUTOUT27	LUT OUT
26 LUTOUT26	LUT OUT
25 LUTOUT25	LUT OUT
24 LUTOUT24	LUT OUT
23 LUTOUT23	LUT OUT
22 LUTOUT22	LUT OUT
21 LUTOUT21	LUT OUT
20 LUTOUT20	LUT OUT
19 LUTOUT19	LUT OUT
18 LUTOUT18	LUT OUT
17 LUTOUT17	LUT OUT
16 LUTOUT16	LUT OUT
15 LUTOUT15	LUT OUT
14 LUTOUT14	LUT OUT
13 LUTOUT13	LUT OUT
12 LUTOUT12	LUT OUT
11 LUTOUT11	LUT OUT
10 LUTOUT10	LUT OUT
9 LUTOUT9	LUT OUT
8 LUTOUT8	LUT OUT
7 LUTOUT7	LUT OUT
6 LUTOUT6	LUT OUT
5 LUTOUT5	LUT OUT

Table continues on the next page...

PXP_HW_PXP_WFE_B_STG1_5X1_OUT0 field descriptions (continued)

Field	Description
4 LUTOUT4	LUT OUT
3 LUTOUT3	LUT OUT
2 LUTOUT2	LUT OUT
1 LUTOUT1	LUT OUT
0 LUTOUT0	LUT OUT

41.11.198 Each set mask bit enables one of the corresponding flag input bits. There is one mask per 5x1 LUT. (PXP_HW_PXP_WFE_B_STG1_5X1_MASKS)

Each set mask bit enables one of the corresponding flag input bits. There is one mask per 5x1 LUT.

Address: 21C_C000h base + 2080h offset = 21C_E080h

Bit	31	30	29	28	27	26	25	24	23	22	21	20	19	18	17	16	15	14	13	12	11	10	9	8	7	6	5	4	3	2	1	0
R	0																MASK0															
W																																
Reset	0	0	0	0	0	0	0	0	0	0	0	0	0	0	0	0	0	0	0	0	0	0	0	0	0	0	0	0	0	0	0	0

PXP_HW_PXP_WFE_B_STG1_5X1_MASKS field descriptions

Field	Description
31–5 Reserved	This read-only field is reserved and always has the value 0.
MASK0	This field selects the input flags that are valid for 5x1 LUT 0. Bit 0 = input 1, Bit 1 = input 2 and so on.

**41.11.199 This register defines the output values (new flag) for the 8x1 LUTs in stage 1.
(PXP_HW_PXP_WFE_B_STG1_8X1_OUT0_0)**

The 5x1 LUT output value for input value n. This output value results in a flag that is added to the flag array.

Address: 21C_C000h base + 2090h offset = 21C_E090h

Bit	31	30	29	28	27	26	25	24	23	22	21	20	19	18	17	16
R	LUTOUT31	LUTOUT30	LUTOUT29	LUTOUT28	LUTOUT27	LUTOUT26	LUTOUT25	LUTOUT24	LUTOUT23	LUTOUT22	LUTOUT21	LUTOUT20	LUTOUT19	LUTOUT18	LUTOUT17	LUTOUT16
W																
Reset	0	0	0	0	0	0	0	0	0	0	0	0	0	0	0	0
Bit	15	14	13	12	11	10	9	8	7	6	5	4	3	2	1	0
R	LUTOUT15	LUTOUT14	LUTOUT13	LUTOUT12	LUTOUT11	LUTOUT10	LUTOUT9	LUTOUT8	LUTOUT7	LUTOUT6	LUTOUT5	LUTOUT4	LUTOUT3	LUTOUT2	LUTOUT1	LUTOUT0
W																
Reset	0	0	0	0	0	0	0	0	0	0	0	0	0	0	0	0

PXP_HW_PXP_WFE_B_STG1_8X1_OUT0_0 field descriptions

Field	Description
31 LUTOUT31	LUT OUT
30 LUTOUT30	LUT OUT
29 LUTOUT29	LUT OUT
28 LUTOUT28	LUT OUT
27 LUTOUT27	LUT OUT
26 LUTOUT26	LUT OUT
25 LUTOUT25	LUT OUT
24 LUTOUT24	LUT OUT
23 LUTOUT23	LUT OUT

Table continues on the next page...

PXP_HW_PXP_WFE_B_STG1_8X1_OUT0_0 field descriptions (continued)

Field	Description
22 LUTOUT22	LUT OUT
21 LUTOUT21	LUT OUT
20 LUTOUT20	LUT OUT
19 LUTOUT19	LUT OUT
18 LUTOUT18	LUT OUT
17 LUTOUT17	LUT OUT
16 LUTOUT16	LUT OUT
15 LUTOUT15	LUT OUT
14 LUTOUT14	LUT OUT
13 LUTOUT13	LUT OUT
12 LUTOUT12	LUT OUT
11 LUTOUT11	LUT OUT
10 LUTOUT10	LUT OUT
9 LUTOUT9	LUT OUT
8 LUTOUT8	LUT OUT
7 LUTOUT7	LUT OUT
6 LUTOUT6	LUT OUT
5 LUTOUT5	LUT OUT
4 LUTOUT4	LUT OUT
3 LUTOUT3	LUT OUT
2 LUTOUT2	LUT OUT
1 LUTOUT1	LUT OUT
0 LUTOUT0	LUT OUT

**41.11.200 This register defines the output values (new flag) for the 8x1 LUTs in stage 1.
(PXP_HW_PXP_WFE_B_STG1_8X1_OUT0_1)**

The 5x1 LUT output value for input value n. This output value results in a flag that is added to the flag array.

Address: 21C_C000h base + 20A0h offset = 21C_E0A0h

Bit	31	30	29	28	27	26	25	24	23	22	21	20	19	18	17	16
R	LUTOUT63	LUTOUT62	LUTOUT61	LUTOUT60	LUTOUT59	LUTOUT58	LUTOUT57	LUTOUT56	LUTOUT55	LUTOUT54	LUTOUT53	LUTOUT52	LUTOUT51	LUTOUT50	LUTOUT49	LUTOUT48
W																
Reset	0	0	0	0	0	0	0	0	0	0	0	0	0	0	0	0
Bit	15	14	13	12	11	10	9	8	7	6	5	4	3	2	1	0
R	LUTOUT47	LUTOUT46	LUTOUT45	LUTOUT44	LUTOUT43	LUTOUT42	LUTOUT41	LUTOUT40	LUTOUT39	LUTOUT38	LUTOUT37	LUTOUT36	LUTOUT35	LUTOUT34	LUTOUT33	LUTOUT32
W																
Reset	0	0	0	0	0	0	0	0	0	0	0	0	0	0	0	0

PXP_HW_PXP_WFE_B_STG1_8X1_OUT0_1 field descriptions

Field	Description
31 LUTOUT63	LUT OUT
30 LUTOUT62	LUT OUT
29 LUTOUT61	LUT OUT
28 LUTOUT60	LUT OUT
27 LUTOUT59	LUT OUT
26 LUTOUT58	LUT OUT
25 LUTOUT57	LUT OUT
24 LUTOUT56	LUT OUT
23 LUTOUT55	LUT OUT

Table continues on the next page...

PXP_HW_PXP_WFE_B_STG1_8X1_OUT0_1 field descriptions (continued)

Field	Description
22 LUTOUT54	LUT OUT
21 LUTOUT53	LUT OUT
20 LUTOUT52	LUT OUT
19 LUTOUT51	LUT OUT
18 LUTOUT50	LUT OUT
17 LUTOUT49	LUT OUT
16 LUTOUT48	LUT OUT
15 LUTOUT47	LUT OUT
14 LUTOUT46	LUT OUT
13 LUTOUT45	LUT OUT
12 LUTOUT44	LUT OUT
11 LUTOUT43	LUT OUT
10 LUTOUT42	LUT OUT
9 LUTOUT41	LUT OUT
8 LUTOUT40	LUT OUT
7 LUTOUT39	LUT OUT
6 LUTOUT38	LUT OUT
5 LUTOUT37	LUT OUT
4 LUTOUT36	LUT OUT
3 LUTOUT35	LUT OUT
2 LUTOUT34	LUT OUT
1 LUTOUT33	LUT OUT
0 LUTOUT32	LUT OUT

**41.11.201 This register defines the output values (new flag) for the 8x1 LUTs in stage 1.
(PXP_HW_PXP_WFE_B_STG1_8X1_OUT0_2)**

The 5x1 LUT output value for input value n. This output value results in a flag that is added to the flag array.

Address: 21C_C000h base + 20B0h offset = 21C_E0B0h

Bit	31	30	29	28	27	26	25	24	23	22	21	20	19	18	17	16
R	LUTOUT95	LUTOUT94	LUTOUT93	LUTOUT92	LUTOUT91	LUTOUT90	LUTOUT89	LUTOUT88	LUTOUT87	LUTOUT86	LUTOUT85	LUTOUT84	LUTOUT83	LUTOUT82	LUTOUT81	LUTOUT80
W																
Reset	0	0	0	0	0	0	0	0	0	0	0	0	0	0	0	0
Bit	15	14	13	12	11	10	9	8	7	6	5	4	3	2	1	0
R	LUTOUT79	LUTOUT78	LUTOUT77	LUTOUT76	LUTOUT75	LUTOUT74	LUTOUT73	LUTOUT72	LUTOUT71	LUTOUT70	LUTOUT69	LUTOUT68	LUTOUT67	LUTOUT66	LUTOUT65	LUTOUT64
W																
Reset	0	0	0	0	0	0	0	0	0	0	0	0	0	0	0	0

PXP_HW_PXP_WFE_B_STG1_8X1_OUT0_2 field descriptions

Field	Description
31 LUTOUT95	LUT OUT
30 LUTOUT94	LUT OUT
29 LUTOUT93	LUT OUT
28 LUTOUT92	LUT OUT
27 LUTOUT91	LUT OUT
26 LUTOUT90	LUT OUT
25 LUTOUT89	LUT OUT
24 LUTOUT88	LUT OUT
23 LUTOUT87	LUT OUT

Table continues on the next page...

PXP_HW_PXP_WFE_B_STG1_8X1_OUT0_2 field descriptions (continued)

Field	Description
22 LUTOUT86	LUT OUT
21 LUTOUT85	LUT OUT
20 LUTOUT84	LUT OUT
19 LUTOUT83	LUT OUT
18 LUTOUT82	LUT OUT
17 LUTOUT81	LUT OUT
16 LUTOUT80	LUT OUT
15 LUTOUT79	LUT OUT
14 LUTOUT78	LUT OUT
13 LUTOUT77	LUT OUT
12 LUTOUT76	LUT OUT
11 LUTOUT75	LUT OUT
10 LUTOUT74	LUT OUT
9 LUTOUT73	LUT OUT
8 LUTOUT72	LUT OUT
7 LUTOUT71	LUT OUT
6 LUTOUT70	LUT OUT
5 LUTOUT69	LUT OUT
4 LUTOUT68	LUT OUT
3 LUTOUT67	LUT OUT
2 LUTOUT66	LUT OUT
1 LUTOUT65	LUT OUT
0 LUTOUT64	LUT OUT

**41.11.202 This register defines the output values (new flag) for the 8x1 LUTs in stage 1.
(PXP_HW_PXP_WFE_B_STG1_8X1_OUT0_3)**

The 5x1 LUT output value for input value n. This output value results in a flag that is added to the flag array.

Address: 21C_C000h base + 20C0h offset = 21C_E0C0h

Bit	31	30	29	28	27	26	25	24	23	22	21	20	19	18	17	16
R	LUTOUT127	LUTOUT126	LUTOUT125	LUTOUT124	LUTOUT123	LUTOUT122	LUTOUT121	LUTOUT120	LUTOUT119	LUTOUT118	LUTOUT117	LUTOUT116	LUTOUT115	LUTOUT114	LUTOUT113	LUTOUT112
W	LUTOUT127	LUTOUT126	LUTOUT125	LUTOUT124	LUTOUT123	LUTOUT122	LUTOUT121	LUTOUT120	LUTOUT119	LUTOUT118	LUTOUT117	LUTOUT116	LUTOUT115	LUTOUT114	LUTOUT113	LUTOUT112
Reset	0	0	0	0	0	0	0	0	0	0	0	0	0	0	0	0
Bit	15	14	13	12	11	10	9	8	7	6	5	4	3	2	1	0
R	LUTOUT111	LUTOUT110	LUTOUT109	LUTOUT108	LUTOUT107	LUTOUT106	LUTOUT105	LUTOUT104	LUTOUT103	LUTOUT102	LUTOUT101	LUTOUT100	LUTOUT99	LUTOUT98	LUTOUT97	LUTOUT96
W	LUTOUT111	LUTOUT110	LUTOUT109	LUTOUT108	LUTOUT107	LUTOUT106	LUTOUT105	LUTOUT104	LUTOUT103	LUTOUT102	LUTOUT101	LUTOUT100	LUTOUT99	LUTOUT98	LUTOUT97	LUTOUT96
Reset	0	0	0	0	0	0	0	0	0	0	0	0	0	0	0	0

PXP_HW_PXP_WFE_B_STG1_8X1_OUT0_3 field descriptions

Field	Description
31 LUTOUT127	LUT OUT
30 LUTOUT126	LUT OUT
29 LUTOUT125	LUT OUT
28 LUTOUT124	LUT OUT
27 LUTOUT123	LUT OUT
26 LUTOUT122	LUT OUT
25 LUTOUT121	LUT OUT
24 LUTOUT120	LUT OUT

Table continues on the next page...

PXP_HW_PXP_WFE_B_STG1_8X1_OUT0_3 field descriptions (continued)

Field	Description
23 LUTOUT119	LUT OUT
22 LUTOUT118	LUT OUT
21 LUTOUT117	LUT OUT
20 LUTOUT116	LUT OUT
19 LUTOUT115	LUT OUT
18 LUTOUT114	LUT OUT
17 LUTOUT113	LUT OUT
16 LUTOUT112	LUT OUT
15 LUTOUT111	LUT OUT
14 LUTOUT110	LUT OUT
13 LUTOUT109	LUT OUT
12 LUTOUT108	LUT OUT
11 LUTOUT107	LUT OUT
10 LUTOUT106	LUT OUT
9 LUTOUT105	LUT OUT
8 LUTOUT104	LUT OUT
7 LUTOUT103	LUT OUT
6 LUTOUT102	LUT OUT
5 LUTOUT101	LUT OUT
4 LUTOUT100	LUT OUT
3 LUTOUT99	LUT OUT
2 LUTOUT98	LUT OUT
1 LUTOUT97	LUT OUT

Table continues on the next page...

PXP_HW_PXP_WFE_B_STG1_8X1_OUT0_3 field descriptions (continued)

Field	Description
0 LUTOUT96	LUT OUT

**41.11.203 This register defines the output values (new flag) for the 8x1 LUTs in stage 1.
(PXP_HW_PXP_WFE_B_STG1_8X1_OUT0_4)**

The 5x1 LUT output value for input value n. This output value results in a flag that is added to the flag array.

Address: 21C_C000h base + 20D0h offset = 21C_E0D0h

Bit	31	30	29	28	27	26	25	24	23	22	21	20	19	18	17	16
R	LUTOUT159	LUTOUT158	LUTOUT157	LUTOUT156	LUTOUT155	LUTOUT154	LUTOUT153	LUTOUT152	LUTOUT151	LUTOUT150	LUTOUT149	LUTOUT148	LUTOUT147	LUTOUT146	LUTOUT145	LUTOUT144
W	LUTOUT159	LUTOUT158	LUTOUT157	LUTOUT156	LUTOUT155	LUTOUT154	LUTOUT153	LUTOUT152	LUTOUT151	LUTOUT150	LUTOUT149	LUTOUT148	LUTOUT147	LUTOUT146	LUTOUT145	LUTOUT144
Reset	0	0	0	0	0	0	0	0	0	0	0	0	0	0	0	0
Bit	15	14	13	12	11	10	9	8	7	6	5	4	3	2	1	0
R	LUTOUT143	LUTOUT142	LUTOUT141	LUTOUT140	LUTOUT139	LUTOUT138	LUTOUT137	LUTOUT136	LUTOUT135	LUTOUT134	LUTOUT133	LUTOUT132	LUTOUT131	LUTOUT130	LUTOUT129	LUTOUT128
W	LUTOUT143	LUTOUT142	LUTOUT141	LUTOUT140	LUTOUT139	LUTOUT138	LUTOUT137	LUTOUT136	LUTOUT135	LUTOUT134	LUTOUT133	LUTOUT132	LUTOUT131	LUTOUT130	LUTOUT129	LUTOUT128
Reset	0	0	0	0	0	0	0	0	0	0	0	0	0	0	0	0

PXP_HW_PXP_WFE_B_STG1_8X1_OUT0_4 field descriptions

Field	Description
31 LUTOUT159	LUT OUT
30 LUTOUT158	LUT OUT
29 LUTOUT157	LUT OUT
28 LUTOUT156	LUT OUT
27 LUTOUT155	LUT OUT

Table continues on the next page...

PXP_HW_PXP_WFE_B_STG1_8X1_OUT0_4 field descriptions (continued)

Field	Description
26 LUTOUT154	LUT OUT
25 LUTOUT153	LUT OUT
24 LUTOUT152	LUT OUT
23 LUTOUT151	LUT OUT
22 LUTOUT150	LUT OUT
21 LUTOUT149	LUT OUT
20 LUTOUT148	LUT OUT
19 LUTOUT147	LUT OUT
18 LUTOUT146	LUT OUT
17 LUTOUT145	LUT OUT
16 LUTOUT144	LUT OUT
15 LUTOUT143	LUT OUT
14 LUTOUT142	LUT OUT
13 LUTOUT141	LUT OUT
12 LUTOUT140	LUT OUT
11 LUTOUT139	LUT OUT
10 LUTOUT138	LUT OUT
9 LUTOUT137	LUT OUT
8 LUTOUT136	LUT OUT
7 LUTOUT135	LUT OUT
6 LUTOUT134	LUT OUT
5 LUTOUT133	LUT OUT
4 LUTOUT132	LUT OUT

Table continues on the next page...

PXP_HW_PXP_WFE_B_STG1_8X1_OUT0_4 field descriptions (continued)

Field	Description
3 LUTOUT131	LUT OUT
2 LUTOUT130	LUT OUT
1 LUTOUT129	LUT OUT
0 LUTOUT128	LUT OUT

**41.11.204 This register defines the output values (new flag) for the 8x1 LUTs in stage 1.
(PXP_HW_PXP_WFE_B_STG1_8X1_OUT0_5)**

The 5x1 LUT output value for input value n. This output value results in a flag that is added to the flag array.

Address: 21C_C000h base + 20E0h offset = 21C_E0E0h

Bit	31	30	29	28	27	26	25	24	23	22	21	20	19	18	17	16
R	LUTOUT191	LUTOUT190	LUTOUT189	LUTOUT188	LUTOUT187	LUTOUT186	LUTOUT185	LUTOUT184	LUTOUT183	LUTOUT182	LUTOUT181	LUTOUT180	LUTOUT179	LUTOUT178	LUTOUT177	LUTOUT176
W	LUTOUT191	LUTOUT190	LUTOUT189	LUTOUT188	LUTOUT187	LUTOUT186	LUTOUT185	LUTOUT184	LUTOUT183	LUTOUT182	LUTOUT181	LUTOUT180	LUTOUT179	LUTOUT178	LUTOUT177	LUTOUT176
Reset	0	0	0	0	0	0	0	0	0	0	0	0	0	0	0	0
Bit	15	14	13	12	11	10	9	8	7	6	5	4	3	2	1	0
R	LUTOUT175	LUTOUT174	LUTOUT173	LUTOUT172	LUTOUT171	LUTOUT170	LUTOUT169	LUTOUT168	LUTOUT167	LUTOUT166	LUTOUT165	LUTOUT164	LUTOUT163	LUTOUT162	LUTOUT161	LUTOUT160
W	LUTOUT175	LUTOUT174	LUTOUT173	LUTOUT172	LUTOUT171	LUTOUT170	LUTOUT169	LUTOUT168	LUTOUT167	LUTOUT166	LUTOUT165	LUTOUT164	LUTOUT163	LUTOUT162	LUTOUT161	LUTOUT160
Reset	0	0	0	0	0	0	0	0	0	0	0	0	0	0	0	0

PXP_HW_PXP_WFE_B_STG1_8X1_OUT0_5 field descriptions

Field	Description
31 LUTOUT191	LUT OUT
30 LUTOUT190	LUT OUT

Table continues on the next page...

PXP_HW_PXP_WFE_B_STG1_8X1_OUT0_5 field descriptions (continued)

Field	Description
29 LUTOUT189	LUT OUT
28 LUTOUT188	LUT OUT
27 LUTOUT187	LUT OUT
26 LUTOUT186	LUT OUT
25 LUTOUT185	LUT OUT
24 LUTOUT184	LUT OUT
23 LUTOUT183	LUT OUT
22 LUTOUT182	LUT OUT
21 LUTOUT181	LUT OUT
20 LUTOUT180	LUT OUT
19 LUTOUT179	LUT OUT
18 LUTOUT178	LUT OUT
17 LUTOUT177	LUT OUT
16 LUTOUT176	LUT OUT
15 LUTOUT175	LUT OUT
14 LUTOUT174	LUT OUT
13 LUTOUT173	LUT OUT
12 LUTOUT172	LUT OUT
11 LUTOUT171	LUT OUT
10 LUTOUT170	LUT OUT
9 LUTOUT169	LUT OUT
8 LUTOUT168	LUT OUT
7 LUTOUT167	LUT OUT

Table continues on the next page...

PXP_HW_PXP_WFE_B_STG1_8X1_OUT0_5 field descriptions (continued)

Field	Description
6 LUTOUT166	LUT OUT
5 LUTOUT165	LUT OUT
4 LUTOUT164	LUT OUT
3 LUTOUT163	LUT OUT
2 LUTOUT162	LUT OUT
1 LUTOUT161	LUT OUT
0 LUTOUT160	LUT OUT

**41.11.205 This register defines the output values (new flag) for the 8x1 LUTs in stage 1.
(PXP_HW_PXP_WFE_B_STG1_8X1_OUT0_6)**

The 5x1 LUT output value for input value n. This output value results in a flag that is added to the flag array.

Address: 21C_C000h base + 20F0h offset = 21C_E0F0h

Bit	31	30	29	28	27	26	25	24	23	22	21	20	19	18	17	16
R	LUTOUT223	LUTOUT222	LUTOUT221	LUTOUT220	LUTOUT219	LUTOUT218	LUTOUT217	LUTOUT216	LUTOUT215	LUTOUT214	LUTOUT213	LUTOUT212	LUTOUT211	LUTOUT210	LUTOUT209	LUTOUT208
W	LUTOUT223	LUTOUT222	LUTOUT221	LUTOUT220	LUTOUT219	LUTOUT218	LUTOUT217	LUTOUT216	LUTOUT215	LUTOUT214	LUTOUT213	LUTOUT212	LUTOUT211	LUTOUT210	LUTOUT209	LUTOUT208
Reset	0	0	0	0	0	0	0	0	0	0	0	0	0	0	0	0
Bit	15	14	13	12	11	10	9	8	7	6	5	4	3	2	1	0
R	LUTOUT207	LUTOUT206	LUTOUT205	LUTOUT204	LUTOUT203	LUTOUT202	LUTOUT201	LUTOUT200	LUTOUT199	LUTOUT198	LUTOUT197	LUTOUT196	LUTOUT195	LUTOUT194	LUTOUT193	LUTOUT192
W	LUTOUT207	LUTOUT206	LUTOUT205	LUTOUT204	LUTOUT203	LUTOUT202	LUTOUT201	LUTOUT200	LUTOUT199	LUTOUT198	LUTOUT197	LUTOUT196	LUTOUT195	LUTOUT194	LUTOUT193	LUTOUT192
Reset	0	0	0	0	0	0	0	0	0	0	0	0	0	0	0	0

PXP_HW_PXP_WFE_B_STG1_8X1_OUT0_6 field descriptions

Field	Description
31 LUTOUT223	LUT OUT
30 LUTOUT222	LUT OUT
29 LUTOUT221	LUT OUT
28 LUTOUT220	LUT OUT
27 LUTOUT219	LUT OUT
26 LUTOUT218	LUT OUT
25 LUTOUT217	LUT OUT
24 LUTOUT216	LUT OUT
23 LUTOUT215	LUT OUT
22 LUTOUT214	LUT OUT
21 LUTOUT213	LUT OUT
20 LUTOUT212	LUT OUT
19 LUTOUT211	LUT OUT
18 LUTOUT210	LUT OUT
17 LUTOUT209	LUT OUT
16 LUTOUT208	LUT OUT
15 LUTOUT207	LUT OUT
14 LUTOUT206	LUT OUT
13 LUTOUT205	LUT OUT
12 LUTOUT204	LUT OUT
11 LUTOUT203	LUT OUT
10 LUTOUT202	LUT OUT
9 LUTOUT201	LUT OUT

Table continues on the next page...

PXP_HW_PXP_WFE_B_STG1_8X1_OUT0_6 field descriptions (continued)

Field	Description
8 LUTOUT200	LUT OUT
7 LUTOUT199	LUT OUT
6 LUTOUT198	LUT OUT
5 LUTOUT197	LUT OUT
4 LUTOUT196	LUT OUT
3 LUTOUT195	LUT OUT
2 LUTOUT194	LUT OUT
1 LUTOUT193	LUT OUT
0 LUTOUT192	LUT OUT

41.11.206 This register defines the output values (new flag) for the 8x1 LUTs in stage 1. (PXP_HW_PXP_WFE_B_STG1_8X1_OUT0_7)

The 5x1 LUT output value for input value n. This output value results in a flag that is added to the flag array.

Address: 21C_C000h base + 2100h offset = 21C_E100h

Bit	31	30	29	28	27	26	25	24	23	22	21	20	19	18	17	16
R	LUTOUT255	LUTOUT254	LUTOUT253	LUTOUT252	LUTOUT251	LUTOUT250	LUTOUT249	LUTOUT248	LUTOUT247	LUTOUT246	LUTOUT245	LUTOUT244	LUTOUT243	LUTOUT242	LUTOUT241	LUTOUT240
W	LUTOUT255	LUTOUT254	LUTOUT253	LUTOUT252	LUTOUT251	LUTOUT250	LUTOUT249	LUTOUT248	LUTOUT247	LUTOUT246	LUTOUT245	LUTOUT244	LUTOUT243	LUTOUT242	LUTOUT241	LUTOUT240
Reset	0	0	0	0	0	0	0	0	0	0	0	0	0	0	0	0
Bit	15	14	13	12	11	10	9	8	7	6	5	4	3	2	1	0
R	LUTOUT239	LUTOUT238	LUTOUT237	LUTOUT236	LUTOUT235	LUTOUT234	LUTOUT233	LUTOUT232	LUTOUT231	LUTOUT230	LUTOUT229	LUTOUT228	LUTOUT227	LUTOUT226	LUTOUT225	LUTOUT224
W	LUTOUT239	LUTOUT238	LUTOUT237	LUTOUT236	LUTOUT235	LUTOUT234	LUTOUT233	LUTOUT232	LUTOUT231	LUTOUT230	LUTOUT229	LUTOUT228	LUTOUT227	LUTOUT226	LUTOUT225	LUTOUT224
Reset	0	0	0	0	0	0	0	0	0	0	0	0	0	0	0	0

PXP_HW_PXP_WFE_B_STG1_8X1_OUT0_7 field descriptions

Field	Description
31 LUTOUT255	LUT OUT
30 LUTOUT254	LUT OUT
29 LUTOUT253	LUT OUT
28 LUTOUT252	LUT OUT
27 LUTOUT251	LUT OUT
26 LUTOUT250	LUT OUT
25 LUTOUT249	LUT OUT
24 LUTOUT248	LUT OUT
23 LUTOUT247	LUT OUT
22 LUTOUT246	LUT OUT
21 LUTOUT245	LUT OUT
20 LUTOUT244	LUT OUT
19 LUTOUT243	LUT OUT
18 LUTOUT242	LUT OUT
17 LUTOUT241	LUT OUT
16 LUTOUT240	LUT OUT
15 LUTOUT239	LUT OUT
14 LUTOUT238	LUT OUT
13 LUTOUT237	LUT OUT
12 LUTOUT236	LUT OUT
11 LUTOUT235	LUT OUT
10 LUTOUT234	LUT OUT
9 LUTOUT233	LUT OUT

Table continues on the next page...

PXP_HW_PXP_WFE_B_STG1_8X1_OUT0_7 field descriptions (continued)

Field	Description
8 LUTOUT232	LUT OUT
7 LUTOUT231	LUT OUT
6 LUTOUT230	LUT OUT
5 LUTOUT229	LUT OUT
4 LUTOUT228	LUT OUT
3 LUTOUT227	LUT OUT
2 LUTOUT226	LUT OUT
1 LUTOUT225	LUT OUT
0 LUTOUT224	LUT OUT

**41.11.207 This register defines the output values (new flag) for the 8x1 LUTs in stage 1.
(PXP_HW_PXP_WFE_B_STG1_8X1_OUT1_0)**

The 5x1 LUT output value for input value n. This output value results in a flag that is added to the flag array.

Address: 21C_C000h base + 2110h offset = 21C_E110h

Bit	31	30	29	28	27	26	25	24	23	22	21	20	19	18	17	16
R	LUTOUT31	LUTOUT30	LUTOUT29	LUTOUT28	LUTOUT27	LUTOUT26	LUTOUT25	LUTOUT24	LUTOUT23	LUTOUT22	LUTOUT21	LUTOUT20	LUTOUT19	LUTOUT18	LUTOUT17	LUTOUT16
W	LUTOUT31	LUTOUT30	LUTOUT29	LUTOUT28	LUTOUT27	LUTOUT26	LUTOUT25	LUTOUT24	LUTOUT23	LUTOUT22	LUTOUT21	LUTOUT20	LUTOUT19	LUTOUT18	LUTOUT17	LUTOUT16
Reset	0	0	0	0	0	0	0	0	0	0	0	0	0	0	0	0
Bit	15	14	13	12	11	10	9	8	7	6	5	4	3	2	1	0
R	LUTOUT15	LUTOUT14	LUTOUT13	LUTOUT12	LUTOUT11	LUTOUT10	LUTOUT9	LUTOUT8	LUTOUT7	LUTOUT6	LUTOUT5	LUTOUT4	LUTOUT3	LUTOUT2	LUTOUT1	LUTOUT0
W	LUTOUT15	LUTOUT14	LUTOUT13	LUTOUT12	LUTOUT11	LUTOUT10	LUTOUT9	LUTOUT8	LUTOUT7	LUTOUT6	LUTOUT5	LUTOUT4	LUTOUT3	LUTOUT2	LUTOUT1	LUTOUT0
Reset	0	0	0	0	0	0	0	0	0	0	0	0	0	0	0	0

PXP_HW_PXP_WFE_B_STG1_8X1_OUT1_0 field descriptions

Field	Description
31 LUTOUT31	LUT OUT
30 LUTOUT30	LUT OUT
29 LUTOUT29	LUT OUT
28 LUTOUT28	LUT OUT
27 LUTOUT27	LUT OUT
26 LUTOUT26	LUT OUT
25 LUTOUT25	LUT OUT
24 LUTOUT24	LUT OUT
23 LUTOUT23	LUT OUT
22 LUTOUT22	LUT OUT
21 LUTOUT21	LUT OUT
20 LUTOUT20	LUT OUT
19 LUTOUT19	LUT OUT
18 LUTOUT18	LUT OUT
17 LUTOUT17	LUT OUT
16 LUTOUT16	LUT OUT
15 LUTOUT15	LUT OUT
14 LUTOUT14	LUT OUT
13 LUTOUT13	LUT OUT
12 LUTOUT12	LUT OUT
11 LUTOUT11	LUT OUT
10 LUTOUT10	LUT OUT
9 LUTOUT9	LUT OUT

Table continues on the next page...

PXP_HW_PXP_WFE_B_STG1_8X1_OUT1_0 field descriptions (continued)

Field	Description
8 LUTOUT8	LUT OUT
7 LUTOUT7	LUT OUT
6 LUTOUT6	LUT OUT
5 LUTOUT5	LUT OUT
4 LUTOUT4	LUT OUT
3 LUTOUT3	LUT OUT
2 LUTOUT2	LUT OUT
1 LUTOUT1	LUT OUT
0 LUTOUT0	LUT OUT

**41.11.208 This register defines the output values (new flag) for the 8x1 LUTs in stage 1.
(PXP_HW_PXP_WFE_B_STG1_8X1_OUT1_1)**

The 5x1 LUT output value for input value n. This output value results in a flag that is added to the flag array.

Address: 21C_C000h base + 2120h offset = 21C_E120h

Bit	31	30	29	28	27	26	25	24	23	22	21	20	19	18	17	16
R	LUTOUT63	LUTOUT62	LUTOUT61	LUTOUT60	LUTOUT59	LUTOUT58	LUTOUT57	LUTOUT56	LUTOUT55	LUTOUT54	LUTOUT53	LUTOUT52	LUTOUT51	LUTOUT50	LUTOUT49	LUTOUT48
W	LUTOUT63	LUTOUT62	LUTOUT61	LUTOUT60	LUTOUT59	LUTOUT58	LUTOUT57	LUTOUT56	LUTOUT55	LUTOUT54	LUTOUT53	LUTOUT52	LUTOUT51	LUTOUT50	LUTOUT49	LUTOUT48
Reset	0	0	0	0	0	0	0	0	0	0	0	0	0	0	0	0
Bit	15	14	13	12	11	10	9	8	7	6	5	4	3	2	1	0
R	LUTOUT47	LUTOUT46	LUTOUT45	LUTOUT44	LUTOUT43	LUTOUT42	LUTOUT41	LUTOUT40	LUTOUT39	LUTOUT38	LUTOUT37	LUTOUT36	LUTOUT35	LUTOUT34	LUTOUT33	LUTOUT32
W	LUTOUT47	LUTOUT46	LUTOUT45	LUTOUT44	LUTOUT43	LUTOUT42	LUTOUT41	LUTOUT40	LUTOUT39	LUTOUT38	LUTOUT37	LUTOUT36	LUTOUT35	LUTOUT34	LUTOUT33	LUTOUT32
Reset	0	0	0	0	0	0	0	0	0	0	0	0	0	0	0	0

PXP_HW_PXP_WFE_B_STG1_8X1_OUT1_1 field descriptions

Field	Description
31 LUTOUT63	LUT OUT
30 LUTOUT62	LUT OUT
29 LUTOUT61	LUT OUT
28 LUTOUT60	LUT OUT
27 LUTOUT59	LUT OUT
26 LUTOUT58	LUT OUT
25 LUTOUT57	LUT OUT
24 LUTOUT56	LUT OUT
23 LUTOUT55	LUT OUT
22 LUTOUT54	LUT OUT
21 LUTOUT53	LUT OUT
20 LUTOUT52	LUT OUT
19 LUTOUT51	LUT OUT
18 LUTOUT50	LUT OUT
17 LUTOUT49	LUT OUT
16 LUTOUT48	LUT OUT
15 LUTOUT47	LUT OUT
14 LUTOUT46	LUT OUT
13 LUTOUT45	LUT OUT
12 LUTOUT44	LUT OUT
11 LUTOUT43	LUT OUT
10 LUTOUT42	LUT OUT
9 LUTOUT41	LUT OUT

Table continues on the next page...

PXP_HW_PXP_WFE_B_STG1_8X1_OUT1_1 field descriptions (continued)

Field	Description
8 LUTOUT40	LUT OUT
7 LUTOUT39	LUT OUT
6 LUTOUT38	LUT OUT
5 LUTOUT37	LUT OUT
4 LUTOUT36	LUT OUT
3 LUTOUT35	LUT OUT
2 LUTOUT34	LUT OUT
1 LUTOUT33	LUT OUT
0 LUTOUT32	LUT OUT

**41.11.209 This register defines the output values (new flag) for the 8x1 LUTs in stage 1.
(PXP_HW_PXP_WFE_B_STG1_8X1_OUT1_2)**

The 5x1 LUT output value for input value n. This output value results in a flag that is added to the flag array.

Address: 21C_C000h base + 2130h offset = 21C_E130h

Bit	31	30	29	28	27	26	25	24	23	22	21	20	19	18	17	16
R	LUTOUT95	LUTOUT94	LUTOUT93	LUTOUT92	LUTOUT91	LUTOUT90	LUTOUT89	LUTOUT88	LUTOUT87	LUTOUT86	LUTOUT85	LUTOUT84	LUTOUT83	LUTOUT82	LUTOUT81	LUTOUT80
W	LUTOUT95	LUTOUT94	LUTOUT93	LUTOUT92	LUTOUT91	LUTOUT90	LUTOUT89	LUTOUT88	LUTOUT87	LUTOUT86	LUTOUT85	LUTOUT84	LUTOUT83	LUTOUT82	LUTOUT81	LUTOUT80
Reset	0	0	0	0	0	0	0	0	0	0	0	0	0	0	0	0
Bit	15	14	13	12	11	10	9	8	7	6	5	4	3	2	1	0
R	LUTOUT79	LUTOUT78	LUTOUT77	LUTOUT76	LUTOUT75	LUTOUT74	LUTOUT73	LUTOUT72	LUTOUT71	LUTOUT70	LUTOUT69	LUTOUT68	LUTOUT67	LUTOUT66	LUTOUT65	LUTOUT64
W	LUTOUT79	LUTOUT78	LUTOUT77	LUTOUT76	LUTOUT75	LUTOUT74	LUTOUT73	LUTOUT72	LUTOUT71	LUTOUT70	LUTOUT69	LUTOUT68	LUTOUT67	LUTOUT66	LUTOUT65	LUTOUT64
Reset	0	0	0	0	0	0	0	0	0	0	0	0	0	0	0	0

PXP_HW_PXP_WFE_B_STG1_8X1_OUT1_2 field descriptions

Field	Description
31 LUTOUT95	LUT OUT
30 LUTOUT94	LUT OUT
29 LUTOUT93	LUT OUT
28 LUTOUT92	LUT OUT
27 LUTOUT91	LUT OUT
26 LUTOUT90	LUT OUT
25 LUTOUT89	LUT OUT
24 LUTOUT88	LUT OUT
23 LUTOUT87	LUT OUT
22 LUTOUT86	LUT OUT
21 LUTOUT85	LUT OUT
20 LUTOUT84	LUT OUT
19 LUTOUT83	LUT OUT
18 LUTOUT82	LUT OUT
17 LUTOUT81	LUT OUT
16 LUTOUT80	LUT OUT
15 LUTOUT79	LUT OUT
14 LUTOUT78	LUT OUT
13 LUTOUT77	LUT OUT
12 LUTOUT76	LUT OUT
11 LUTOUT75	LUT OUT
10 LUTOUT74	LUT OUT
9 LUTOUT73	LUT OUT

Table continues on the next page...

PXP_HW_PXP_WFE_B_STG1_8X1_OUT1_2 field descriptions (continued)

Field	Description
8 LUTOUT72	LUT OUT
7 LUTOUT71	LUT OUT
6 LUTOUT70	LUT OUT
5 LUTOUT69	LUT OUT
4 LUTOUT68	LUT OUT
3 LUTOUT67	LUT OUT
2 LUTOUT66	LUT OUT
1 LUTOUT65	LUT OUT
0 LUTOUT64	LUT OUT

**41.11.210 This register defines the output values (new flag) for the 8x1 LUTs in stage 1.
(PXP_HW_PXP_WFE_B_STG1_8X1_OUT1_3)**

The 5x1 LUT output value for input value n. This output value results in a flag that is added to the flag array.

Address: 21C_C000h base + 2140h offset = 21C_E140h

Bit	31	30	29	28	27	26	25	24	23	22	21	20	19	18	17	16
R	LUTOUT127	LUTOUT126	LUTOUT125	LUTOUT124	LUTOUT123	LUTOUT122	LUTOUT121	LUTOUT120	LUTOUT119	LUTOUT118	LUTOUT117	LUTOUT116	LUTOUT115	LUTOUT114	LUTOUT113	LUTOUT112
W	LUTOUT127	LUTOUT126	LUTOUT125	LUTOUT124	LUTOUT123	LUTOUT122	LUTOUT121	LUTOUT120	LUTOUT119	LUTOUT118	LUTOUT117	LUTOUT116	LUTOUT115	LUTOUT114	LUTOUT113	LUTOUT112
Reset	0	0	0	0	0	0	0	0	0	0	0	0	0	0	0	0
Bit	15	14	13	12	11	10	9	8	7	6	5	4	3	2	1	0
R	LUTOUT111	LUTOUT110	LUTOUT109	LUTOUT108	LUTOUT107	LUTOUT106	LUTOUT105	LUTOUT104	LUTOUT103	LUTOUT102	LUTOUT101	LUTOUT100	LUTOUT99	LUTOUT98	LUTOUT97	LUTOUT96
W	LUTOUT111	LUTOUT110	LUTOUT109	LUTOUT108	LUTOUT107	LUTOUT106	LUTOUT105	LUTOUT104	LUTOUT103	LUTOUT102	LUTOUT101	LUTOUT100	LUTOUT99	LUTOUT98	LUTOUT97	LUTOUT96
Reset	0	0	0	0	0	0	0	0	0	0	0	0	0	0	0	0

PXP_HW_PXP_WFE_B_STG1_8X1_OUT1_3 field descriptions

Field	Description
31 LUTOUT127	LUT OUT
30 LUTOUT126	LUT OUT
29 LUTOUT125	LUT OUT
28 LUTOUT124	LUT OUT
27 LUTOUT123	LUT OUT
26 LUTOUT122	LUT OUT
25 LUTOUT121	LUT OUT
24 LUTOUT120	LUT OUT
23 LUTOUT119	LUT OUT
22 LUTOUT118	LUT OUT
21 LUTOUT117	LUT OUT
20 LUTOUT116	LUT OUT
19 LUTOUT115	LUT OUT
18 LUTOUT114	LUT OUT
17 LUTOUT113	LUT OUT
16 LUTOUT112	LUT OUT
15 LUTOUT111	LUT OUT
14 LUTOUT110	LUT OUT
13 LUTOUT109	LUT OUT
12 LUTOUT108	LUT OUT
11 LUTOUT107	LUT OUT
10 LUTOUT106	LUT OUT
9 LUTOUT105	LUT OUT

Table continues on the next page...

PXP_HW_PXP_WFE_B_STG1_8X1_OUT1_3 field descriptions (continued)

Field	Description
8 LUTOUT104	LUT OUT
7 LUTOUT103	LUT OUT
6 LUTOUT102	LUT OUT
5 LUTOUT101	LUT OUT
4 LUTOUT100	LUT OUT
3 LUTOUT99	LUT OUT
2 LUTOUT98	LUT OUT
1 LUTOUT97	LUT OUT
0 LUTOUT96	LUT OUT

**41.11.211 This register defines the output values (new flag) for the 8x1 LUTs in stage 1.
(PXP_HW_PXP_WFE_B_STG1_8X1_OUT1_4)**

The 5x1 LUT output value for input value n. This output value results in a flag that is added to the flag array.

Address: 21C_C000h base + 2150h offset = 21C_E150h

Bit	31	30	29	28	27	26	25	24	23	22	21	20	19	18	17	16
R	LUTOUT159	LUTOUT158	LUTOUT157	LUTOUT156	LUTOUT155	LUTOUT154	LUTOUT153	LUTOUT152	LUTOUT151	LUTOUT150	LUTOUT149	LUTOUT148	LUTOUT147	LUTOUT146	LUTOUT145	LUTOUT144
W	LUTOUT159	LUTOUT158	LUTOUT157	LUTOUT156	LUTOUT155	LUTOUT154	LUTOUT153	LUTOUT152	LUTOUT151	LUTOUT150	LUTOUT149	LUTOUT148	LUTOUT147	LUTOUT146	LUTOUT145	LUTOUT144
Reset	0	0	0	0	0	0	0	0	0	0	0	0	0	0	0	0
Bit	15	14	13	12	11	10	9	8	7	6	5	4	3	2	1	0
R	LUTOUT143	LUTOUT142	LUTOUT141	LUTOUT140	LUTOUT139	LUTOUT138	LUTOUT137	LUTOUT136	LUTOUT135	LUTOUT134	LUTOUT133	LUTOUT132	LUTOUT131	LUTOUT130	LUTOUT129	LUTOUT128
W	LUTOUT143	LUTOUT142	LUTOUT141	LUTOUT140	LUTOUT139	LUTOUT138	LUTOUT137	LUTOUT136	LUTOUT135	LUTOUT134	LUTOUT133	LUTOUT132	LUTOUT131	LUTOUT130	LUTOUT129	LUTOUT128
Reset	0	0	0	0	0	0	0	0	0	0	0	0	0	0	0	0

PXP_HW_PXP_WFE_B_STG1_8X1_OUT1_4 field descriptions

Field	Description
31 LUTOUT159	LUT OUT
30 LUTOUT158	LUT OUT
29 LUTOUT157	LUT OUT
28 LUTOUT156	LUT OUT
27 LUTOUT155	LUT OUT
26 LUTOUT154	LUT OUT
25 LUTOUT153	LUT OUT
24 LUTOUT152	LUT OUT
23 LUTOUT151	LUT OUT
22 LUTOUT150	LUT OUT
21 LUTOUT149	LUT OUT
20 LUTOUT148	LUT OUT
19 LUTOUT147	LUT OUT
18 LUTOUT146	LUT OUT
17 LUTOUT145	LUT OUT
16 LUTOUT144	LUT OUT
15 LUTOUT143	LUT OUT
14 LUTOUT142	LUT OUT
13 LUTOUT141	LUT OUT
12 LUTOUT140	LUT OUT
11 LUTOUT139	LUT OUT
10 LUTOUT138	LUT OUT
9 LUTOUT137	LUT OUT

Table continues on the next page...

PXP_HW_PXP_WFE_B_STG1_8X1_OUT1_4 field descriptions (continued)

Field	Description
8 LUTOUT136	LUT OUT
7 LUTOUT135	LUT OUT
6 LUTOUT134	LUT OUT
5 LUTOUT133	LUT OUT
4 LUTOUT132	LUT OUT
3 LUTOUT131	LUT OUT
2 LUTOUT130	LUT OUT
1 LUTOUT129	LUT OUT
0 LUTOUT128	LUT OUT

**41.11.212 This register defines the output values (new flag) for the 8x1 LUTs in stage 1.
(PXP_HW_PXP_WFE_B_STG1_8X1_OUT1_5)**

The 5x1 LUT output value for input value n. This output value results in a flag that is added to the flag array.

Address: 21C_C000h base + 2160h offset = 21C_E160h

Bit	31	30	29	28	27	26	25	24	23	22	21	20	19	18	17	16
R	LUTOUT191	LUTOUT190	LUTOUT189	LUTOUT188	LUTOUT187	LUTOUT186	LUTOUT185	LUTOUT184	LUTOUT183	LUTOUT182	LUTOUT181	LUTOUT180	LUTOUT179	LUTOUT178	LUTOUT177	LUTOUT176
W	LUTOUT191	LUTOUT190	LUTOUT189	LUTOUT188	LUTOUT187	LUTOUT186	LUTOUT185	LUTOUT184	LUTOUT183	LUTOUT182	LUTOUT181	LUTOUT180	LUTOUT179	LUTOUT178	LUTOUT177	LUTOUT176
Reset	0	0	0	0	0	0	0	0	0	0	0	0	0	0	0	0
Bit	15	14	13	12	11	10	9	8	7	6	5	4	3	2	1	0
R	LUTOUT175	LUTOUT174	LUTOUT173	LUTOUT172	LUTOUT171	LUTOUT170	LUTOUT169	LUTOUT168	LUTOUT167	LUTOUT166	LUTOUT165	LUTOUT164	LUTOUT163	LUTOUT162	LUTOUT161	LUTOUT160
W	LUTOUT175	LUTOUT174	LUTOUT173	LUTOUT172	LUTOUT171	LUTOUT170	LUTOUT169	LUTOUT168	LUTOUT167	LUTOUT166	LUTOUT165	LUTOUT164	LUTOUT163	LUTOUT162	LUTOUT161	LUTOUT160
Reset	0	0	0	0	0	0	0	0	0	0	0	0	0	0	0	0

PXP_HW_PXP_WFE_B_STG1_8X1_OUT1_5 field descriptions

Field	Description
31 LUTOUT191	LUT OUT
30 LUTOUT190	LUT OUT
29 LUTOUT189	LUT OUT
28 LUTOUT188	LUT OUT
27 LUTOUT187	LUT OUT
26 LUTOUT186	LUT OUT
25 LUTOUT185	LUT OUT
24 LUTOUT184	LUT OUT
23 LUTOUT183	LUT OUT
22 LUTOUT182	LUT OUT
21 LUTOUT181	LUT OUT
20 LUTOUT180	LUT OUT
19 LUTOUT179	LUT OUT
18 LUTOUT178	LUT OUT
17 LUTOUT177	LUT OUT
16 LUTOUT176	LUT OUT
15 LUTOUT175	LUT OUT
14 LUTOUT174	LUT OUT
13 LUTOUT173	LUT OUT
12 LUTOUT172	LUT OUT
11 LUTOUT171	LUT OUT
10 LUTOUT170	LUT OUT
9 LUTOUT169	LUT OUT

Table continues on the next page...

PXP_HW_PXP_WFE_B_STG1_8X1_OUT1_5 field descriptions (continued)

Field	Description
8 LUTOUT168	LUT OUT
7 LUTOUT167	LUT OUT
6 LUTOUT166	LUT OUT
5 LUTOUT165	LUT OUT
4 LUTOUT164	LUT OUT
3 LUTOUT163	LUT OUT
2 LUTOUT162	LUT OUT
1 LUTOUT161	LUT OUT
0 LUTOUT160	LUT OUT

**41.11.213 This register defines the output values (new flag) for the 8x1 LUTs in stage 1.
(PXP_HW_PXP_WFE_B_STG1_8X1_OUT1_6)**

The 5x1 LUT output value for input value n. This output value results in a flag that is added to the flag array.

Address: 21C_C000h base + 2170h offset = 21C_E170h

Bit	31	30	29	28	27	26	25	24	23	22	21	20	19	18	17	16
R	LUTOUT223	LUTOUT222	LUTOUT221	LUTOUT220	LUTOUT219	LUTOUT218	LUTOUT217	LUTOUT216	LUTOUT215	LUTOUT214	LUTOUT213	LUTOUT212	LUTOUT211	LUTOUT210	LUTOUT209	LUTOUT208
W	LUTOUT223	LUTOUT222	LUTOUT221	LUTOUT220	LUTOUT219	LUTOUT218	LUTOUT217	LUTOUT216	LUTOUT215	LUTOUT214	LUTOUT213	LUTOUT212	LUTOUT211	LUTOUT210	LUTOUT209	LUTOUT208
Reset	0	0	0	0	0	0	0	0	0	0	0	0	0	0	0	0
Bit	15	14	13	12	11	10	9	8	7	6	5	4	3	2	1	0
R	LUTOUT207	LUTOUT206	LUTOUT205	LUTOUT204	LUTOUT203	LUTOUT202	LUTOUT201	LUTOUT200	LUTOUT199	LUTOUT198	LUTOUT197	LUTOUT196	LUTOUT195	LUTOUT194	LUTOUT193	LUTOUT192
W	LUTOUT207	LUTOUT206	LUTOUT205	LUTOUT204	LUTOUT203	LUTOUT202	LUTOUT201	LUTOUT200	LUTOUT199	LUTOUT198	LUTOUT197	LUTOUT196	LUTOUT195	LUTOUT194	LUTOUT193	LUTOUT192
Reset	0	0	0	0	0	0	0	0	0	0	0	0	0	0	0	0

PXP_HW_PXP_WFE_B_STG1_8X1_OUT1_6 field descriptions

Field	Description
31 LUTOUT223	LUT OUT
30 LUTOUT222	LUT OUT
29 LUTOUT221	LUT OUT
28 LUTOUT220	LUT OUT
27 LUTOUT219	LUT OUT
26 LUTOUT218	LUT OUT
25 LUTOUT217	LUT OUT
24 LUTOUT216	LUT OUT
23 LUTOUT215	LUT OUT
22 LUTOUT214	LUT OUT
21 LUTOUT213	LUT OUT
20 LUTOUT212	LUT OUT
19 LUTOUT211	LUT OUT
18 LUTOUT210	LUT OUT
17 LUTOUT209	LUT OUT
16 LUTOUT208	LUT OUT
15 LUTOUT207	LUT OUT
14 LUTOUT206	LUT OUT
13 LUTOUT205	LUT OUT
12 LUTOUT204	LUT OUT
11 LUTOUT203	LUT OUT
10 LUTOUT202	LUT OUT
9 LUTOUT201	LUT OUT

Table continues on the next page...

PXP_HW_PXP_WFE_B_STG1_8X1_OUT1_6 field descriptions (continued)

Field	Description
8 LUTOUT200	LUT OUT
7 LUTOUT199	LUT OUT
6 LUTOUT198	LUT OUT
5 LUTOUT197	LUT OUT
4 LUTOUT196	LUT OUT
3 LUTOUT195	LUT OUT
2 LUTOUT194	LUT OUT
1 LUTOUT193	LUT OUT
0 LUTOUT192	LUT OUT

**41.11.214 This register defines the output values (new flag) for the 8x1 LUTs in stage 1.
(PXP_HW_PXP_WFE_B_STG1_8X1_OUT1_7)**

The 5x1 LUT output value for input value n. This output value results in a flag that is added to the flag array.

Address: 21C_C000h base + 2180h offset = 21C_E180h

Bit	31	30	29	28	27	26	25	24	23	22	21	20	19	18	17	16
R	LUTOUT255	LUTOUT254	LUTOUT253	LUTOUT252	LUTOUT251	LUTOUT250	LUTOUT249	LUTOUT248	LUTOUT247	LUTOUT246	LUTOUT245	LUTOUT244	LUTOUT243	LUTOUT242	LUTOUT241	LUTOUT240
W	LUTOUT255	LUTOUT254	LUTOUT253	LUTOUT252	LUTOUT251	LUTOUT250	LUTOUT249	LUTOUT248	LUTOUT247	LUTOUT246	LUTOUT245	LUTOUT244	LUTOUT243	LUTOUT242	LUTOUT241	LUTOUT240
Reset	0	0	0	0	0	0	0	0	0	0	0	0	0	0	0	0
Bit	15	14	13	12	11	10	9	8	7	6	5	4	3	2	1	0
R	LUTOUT239	LUTOUT238	LUTOUT237	LUTOUT236	LUTOUT235	LUTOUT234	LUTOUT233	LUTOUT232	LUTOUT231	LUTOUT230	LUTOUT229	LUTOUT228	LUTOUT227	LUTOUT226	LUTOUT225	LUTOUT224
W	LUTOUT239	LUTOUT238	LUTOUT237	LUTOUT236	LUTOUT235	LUTOUT234	LUTOUT233	LUTOUT232	LUTOUT231	LUTOUT230	LUTOUT229	LUTOUT228	LUTOUT227	LUTOUT226	LUTOUT225	LUTOUT224
Reset	0	0	0	0	0	0	0	0	0	0	0	0	0	0	0	0

PXP_HW_PXP_WFE_B_STG1_8X1_OUT1_7 field descriptions

Field	Description
31 LUTOUT255	LUT OUT
30 LUTOUT254	LUT OUT
29 LUTOUT253	LUT OUT
28 LUTOUT252	LUT OUT
27 LUTOUT251	LUT OUT
26 LUTOUT250	LUT OUT
25 LUTOUT249	LUT OUT
24 LUTOUT248	LUT OUT
23 LUTOUT247	LUT OUT
22 LUTOUT246	LUT OUT
21 LUTOUT245	LUT OUT
20 LUTOUT244	LUT OUT
19 LUTOUT243	LUT OUT
18 LUTOUT242	LUT OUT
17 LUTOUT241	LUT OUT
16 LUTOUT240	LUT OUT
15 LUTOUT239	LUT OUT
14 LUTOUT238	LUT OUT
13 LUTOUT237	LUT OUT
12 LUTOUT236	LUT OUT
11 LUTOUT235	LUT OUT
10 LUTOUT234	LUT OUT
9 LUTOUT233	LUT OUT

Table continues on the next page...

PXP_HW_PXP_WFE_B_STG1_8X1_OUT1_7 field descriptions (continued)

Field	Description
8 LUTOUT232	LUT OUT
7 LUTOUT231	LUT OUT
6 LUTOUT230	LUT OUT
5 LUTOUT229	LUT OUT
4 LUTOUT228	LUT OUT
3 LUTOUT227	LUT OUT
2 LUTOUT226	LUT OUT
1 LUTOUT225	LUT OUT
0 LUTOUT224	LUT OUT

**41.11.215 This register defines the output values (new flag) for the 8x1 LUTs in stage 1.
(PXP_HW_PXP_WFE_B_STG1_8X1_OUT2_0)**

The 5x1 LUT output value for input value n. This output value results in a flag that is added to the flag array.

Address: 21C_C000h base + 2190h offset = 21C_E190h

Bit	31	30	29	28	27	26	25	24	23	22	21	20	19	18	17	16
R	LUTOUT31	LUTOUT30	LUTOUT29	LUTOUT28	LUTOUT27	LUTOUT26	LUTOUT25	LUTOUT24	LUTOUT23	LUTOUT22	LUTOUT21	LUTOUT20	LUTOUT19	LUTOUT18	LUTOUT17	LUTOUT16
W	LUTOUT31	LUTOUT30	LUTOUT29	LUTOUT28	LUTOUT27	LUTOUT26	LUTOUT25	LUTOUT24	LUTOUT23	LUTOUT22	LUTOUT21	LUTOUT20	LUTOUT19	LUTOUT18	LUTOUT17	LUTOUT16
Reset	0	0	0	0	0	0	0	0	0	0	0	0	0	0	0	0
Bit	15	14	13	12	11	10	9	8	7	6	5	4	3	2	1	0
R	LUTOUT15	LUTOUT14	LUTOUT13	LUTOUT12	LUTOUT11	LUTOUT10	LUTOUT9	LUTOUT8	LUTOUT7	LUTOUT6	LUTOUT5	LUTOUT4	LUTOUT3	LUTOUT2	LUTOUT1	LUTOUT0
W	LUTOUT15	LUTOUT14	LUTOUT13	LUTOUT12	LUTOUT11	LUTOUT10	LUTOUT9	LUTOUT8	LUTOUT7	LUTOUT6	LUTOUT5	LUTOUT4	LUTOUT3	LUTOUT2	LUTOUT1	LUTOUT0
Reset	0	0	0	0	0	0	0	0	0	0	0	0	0	0	0	0

PXP_HW_PXP_WFE_B_STG1_8X1_OUT2_0 field descriptions

Field	Description
31 LUTOUT31	LUT OUT
30 LUTOUT30	LUT OUT
29 LUTOUT29	LUT OUT
28 LUTOUT28	LUT OUT
27 LUTOUT27	LUT OUT
26 LUTOUT26	LUT OUT
25 LUTOUT25	LUT OUT
24 LUTOUT24	LUT OUT
23 LUTOUT23	LUT OUT
22 LUTOUT22	LUT OUT
21 LUTOUT21	LUT OUT
20 LUTOUT20	LUT OUT
19 LUTOUT19	LUT OUT
18 LUTOUT18	LUT OUT
17 LUTOUT17	LUT OUT
16 LUTOUT16	LUT OUT
15 LUTOUT15	LUT OUT
14 LUTOUT14	LUT OUT
13 LUTOUT13	LUT OUT
12 LUTOUT12	LUT OUT
11 LUTOUT11	LUT OUT
10 LUTOUT10	LUT OUT
9 LUTOUT9	LUT OUT

Table continues on the next page...

PXP_HW_PXP_WFE_B_STG1_8X1_OUT2_0 field descriptions (continued)

Field	Description
8 LUTOUT8	LUT OUT
7 LUTOUT7	LUT OUT
6 LUTOUT6	LUT OUT
5 LUTOUT5	LUT OUT
4 LUTOUT4	LUT OUT
3 LUTOUT3	LUT OUT
2 LUTOUT2	LUT OUT
1 LUTOUT1	LUT OUT
0 LUTOUT0	LUT OUT

**41.11.216 This register defines the output values (new flag) for the 8x1 LUTs in stage 1.
(PXP_HW_PXP_WFE_B_STG1_8X1_OUT2_1)**

The 5x1 LUT output value for input value n. This output value results in a flag that is added to the flag array.

Address: 21C_C000h base + 21A0h offset = 21C_E1A0h

Bit	31	30	29	28	27	26	25	24	23	22	21	20	19	18	17	16
R	LUTOUT63	LUTOUT62	LUTOUT61	LUTOUT60	LUTOUT59	LUTOUT58	LUTOUT57	LUTOUT56	LUTOUT55	LUTOUT54	LUTOUT53	LUTOUT52	LUTOUT51	LUTOUT50	LUTOUT49	LUTOUT48
W	LUTOUT63	LUTOUT62	LUTOUT61	LUTOUT60	LUTOUT59	LUTOUT58	LUTOUT57	LUTOUT56	LUTOUT55	LUTOUT54	LUTOUT53	LUTOUT52	LUTOUT51	LUTOUT50	LUTOUT49	LUTOUT48
Reset	0	0	0	0	0	0	0	0	0	0	0	0	0	0	0	0
Bit	15	14	13	12	11	10	9	8	7	6	5	4	3	2	1	0
R	LUTOUT47	LUTOUT46	LUTOUT45	LUTOUT44	LUTOUT43	LUTOUT42	LUTOUT41	LUTOUT40	LUTOUT39	LUTOUT38	LUTOUT37	LUTOUT36	LUTOUT35	LUTOUT34	LUTOUT33	LUTOUT32
W	LUTOUT47	LUTOUT46	LUTOUT45	LUTOUT44	LUTOUT43	LUTOUT42	LUTOUT41	LUTOUT40	LUTOUT39	LUTOUT38	LUTOUT37	LUTOUT36	LUTOUT35	LUTOUT34	LUTOUT33	LUTOUT32
Reset	0	0	0	0	0	0	0	0	0	0	0	0	0	0	0	0

PXP_HW_PXP_WFE_B_STG1_8X1_OUT2_1 field descriptions

Field	Description
31 LUTOUT63	LUT OUT
30 LUTOUT62	LUT OUT
29 LUTOUT61	LUT OUT
28 LUTOUT60	LUT OUT
27 LUTOUT59	LUT OUT
26 LUTOUT58	LUT OUT
25 LUTOUT57	LUT OUT
24 LUTOUT56	LUT OUT
23 LUTOUT55	LUT OUT
22 LUTOUT54	LUT OUT
21 LUTOUT53	LUT OUT
20 LUTOUT52	LUT OUT
19 LUTOUT51	LUT OUT
18 LUTOUT50	LUT OUT
17 LUTOUT49	LUT OUT
16 LUTOUT48	LUT OUT
15 LUTOUT47	LUT OUT
14 LUTOUT46	LUT OUT
13 LUTOUT45	LUT OUT
12 LUTOUT44	LUT OUT
11 LUTOUT43	LUT OUT
10 LUTOUT42	LUT OUT
9 LUTOUT41	LUT OUT

Table continues on the next page...

PXP_HW_PXP_WFE_B_STG1_8X1_OUT2_1 field descriptions (continued)

Field	Description
8 LUTOUT40	LUT OUT
7 LUTOUT39	LUT OUT
6 LUTOUT38	LUT OUT
5 LUTOUT37	LUT OUT
4 LUTOUT36	LUT OUT
3 LUTOUT35	LUT OUT
2 LUTOUT34	LUT OUT
1 LUTOUT33	LUT OUT
0 LUTOUT32	LUT OUT

**41.11.217 This register defines the output values (new flag) for the 8x1 LUTs in stage 1.
(PXP_HW_PXP_WFE_B_STG1_8X1_OUT2_2)**

The 5x1 LUT output value for input value n. This output value results in a flag that is added to the flag array.

Address: 21C_C000h base + 21B0h offset = 21C_E1B0h

Bit	31	30	29	28	27	26	25	24	23	22	21	20	19	18	17	16
R	LUTOUT95	LUTOUT94	LUTOUT93	LUTOUT92	LUTOUT91	LUTOUT90	LUTOUT89	LUTOUT88	LUTOUT87	LUTOUT86	LUTOUT85	LUTOUT84	LUTOUT83	LUTOUT82	LUTOUT81	LUTOUT80
W	LUTOUT95	LUTOUT94	LUTOUT93	LUTOUT92	LUTOUT91	LUTOUT90	LUTOUT89	LUTOUT88	LUTOUT87	LUTOUT86	LUTOUT85	LUTOUT84	LUTOUT83	LUTOUT82	LUTOUT81	LUTOUT80
Reset	0	0	0	0	0	0	0	0	0	0	0	0	0	0	0	0
Bit	15	14	13	12	11	10	9	8	7	6	5	4	3	2	1	0
R	LUTOUT79	LUTOUT78	LUTOUT77	LUTOUT76	LUTOUT75	LUTOUT74	LUTOUT73	LUTOUT72	LUTOUT71	LUTOUT70	LUTOUT69	LUTOUT68	LUTOUT67	LUTOUT66	LUTOUT65	LUTOUT64
W	LUTOUT79	LUTOUT78	LUTOUT77	LUTOUT76	LUTOUT75	LUTOUT74	LUTOUT73	LUTOUT72	LUTOUT71	LUTOUT70	LUTOUT69	LUTOUT68	LUTOUT67	LUTOUT66	LUTOUT65	LUTOUT64
Reset	0	0	0	0	0	0	0	0	0	0	0	0	0	0	0	0

PXP_HW_PXP_WFE_B_STG1_8X1_OUT2_2 field descriptions

Field	Description
31 LUTOUT95	LUT OUT
30 LUTOUT94	LUT OUT
29 LUTOUT93	LUT OUT
28 LUTOUT92	LUT OUT
27 LUTOUT91	LUT OUT
26 LUTOUT90	LUT OUT
25 LUTOUT89	LUT OUT
24 LUTOUT88	LUT OUT
23 LUTOUT87	LUT OUT
22 LUTOUT86	LUT OUT
21 LUTOUT85	LUT OUT
20 LUTOUT84	LUT OUT
19 LUTOUT83	LUT OUT
18 LUTOUT82	LUT OUT
17 LUTOUT81	LUT OUT
16 LUTOUT80	LUT OUT
15 LUTOUT79	LUT OUT
14 LUTOUT78	LUT OUT
13 LUTOUT77	LUT OUT
12 LUTOUT76	LUT OUT
11 LUTOUT75	LUT OUT
10 LUTOUT74	LUT OUT
9 LUTOUT73	LUT OUT

Table continues on the next page...

PXP_HW_PXP_WFE_B_STG1_8X1_OUT2_2 field descriptions (continued)

Field	Description
8 LUTOUT72	LUT OUT
7 LUTOUT71	LUT OUT
6 LUTOUT70	LUT OUT
5 LUTOUT69	LUT OUT
4 LUTOUT68	LUT OUT
3 LUTOUT67	LUT OUT
2 LUTOUT66	LUT OUT
1 LUTOUT65	LUT OUT
0 LUTOUT64	LUT OUT

41.11.218 This register defines the output values (new flag) for the 8x1 LUTs in stage 1. (PXP_HW_PXP_WFE_B_STG1_8X1_OUT2_3)

The 5x1 LUT output value for input value n. This output value results in a flag that is added to the flag array.

Address: 21C_C000h base + 21C0h offset = 21C_E1C0h

Bit	31	30	29	28	27	26	25	24	23	22	21	20	19	18	17	16
R	LUTOUT127	LUTOUT126	LUTOUT125	LUTOUT124	LUTOUT123	LUTOUT122	LUTOUT121	LUTOUT120	LUTOUT119	LUTOUT118	LUTOUT117	LUTOUT116	LUTOUT115	LUTOUT114	LUTOUT113	LUTOUT112
W	LUTOUT127	LUTOUT126	LUTOUT125	LUTOUT124	LUTOUT123	LUTOUT122	LUTOUT121	LUTOUT120	LUTOUT119	LUTOUT118	LUTOUT117	LUTOUT116	LUTOUT115	LUTOUT114	LUTOUT113	LUTOUT112
Reset	0	0	0	0	0	0	0	0	0	0	0	0	0	0	0	0
Bit	15	14	13	12	11	10	9	8	7	6	5	4	3	2	1	0
R	LUTOUT111	LUTOUT110	LUTOUT109	LUTOUT108	LUTOUT107	LUTOUT106	LUTOUT105	LUTOUT104	LUTOUT103	LUTOUT102	LUTOUT101	LUTOUT100	LUTOUT99	LUTOUT98	LUTOUT97	LUTOUT96
W	LUTOUT111	LUTOUT110	LUTOUT109	LUTOUT108	LUTOUT107	LUTOUT106	LUTOUT105	LUTOUT104	LUTOUT103	LUTOUT102	LUTOUT101	LUTOUT100	LUTOUT99	LUTOUT98	LUTOUT97	LUTOUT96
Reset	0	0	0	0	0	0	0	0	0	0	0	0	0	0	0	0

PXP_HW_PXP_WFE_B_STG1_8X1_OUT2_3 field descriptions

Field	Description
31 LUTOUT127	LUT OUT
30 LUTOUT126	LUT OUT
29 LUTOUT125	LUT OUT
28 LUTOUT124	LUT OUT
27 LUTOUT123	LUT OUT
26 LUTOUT122	LUT OUT
25 LUTOUT121	LUT OUT
24 LUTOUT120	LUT OUT
23 LUTOUT119	LUT OUT
22 LUTOUT118	LUT OUT
21 LUTOUT117	LUT OUT
20 LUTOUT116	LUT OUT
19 LUTOUT115	LUT OUT
18 LUTOUT114	LUT OUT
17 LUTOUT113	LUT OUT
16 LUTOUT112	LUT OUT
15 LUTOUT111	LUT OUT
14 LUTOUT110	LUT OUT
13 LUTOUT109	LUT OUT
12 LUTOUT108	LUT OUT
11 LUTOUT107	LUT OUT
10 LUTOUT106	LUT OUT
9 LUTOUT105	LUT OUT

Table continues on the next page...

PXP_HW_PXP_WFE_B_STG1_8X1_OUT2_3 field descriptions (continued)

Field	Description
8 LUTOUT104	LUT OUT
7 LUTOUT103	LUT OUT
6 LUTOUT102	LUT OUT
5 LUTOUT101	LUT OUT
4 LUTOUT100	LUT OUT
3 LUTOUT99	LUT OUT
2 LUTOUT98	LUT OUT
1 LUTOUT97	LUT OUT
0 LUTOUT96	LUT OUT

41.11.219 This register defines the output values (new flag) for the 8x1 LUTs in stage 1. (PXP_HW_PXP_WFE_B_STG1_8X1_OUT2_4)

The 5x1 LUT output value for input value n. This output value results in a flag that is added to the flag array.

Address: 21C_C000h base + 21D0h offset = 21C_E1D0h

Bit	31	30	29	28	27	26	25	24	23	22	21	20	19	18	17	16
R	LUTOUT159	LUTOUT158	LUTOUT157	LUTOUT156	LUTOUT155	LUTOUT154	LUTOUT153	LUTOUT152	LUTOUT151	LUTOUT150	LUTOUT149	LUTOUT148	LUTOUT147	LUTOUT146	LUTOUT145	LUTOUT144
W	LUTOUT159	LUTOUT158	LUTOUT157	LUTOUT156	LUTOUT155	LUTOUT154	LUTOUT153	LUTOUT152	LUTOUT151	LUTOUT150	LUTOUT149	LUTOUT148	LUTOUT147	LUTOUT146	LUTOUT145	LUTOUT144
Reset	0	0	0	0	0	0	0	0	0	0	0	0	0	0	0	0
Bit	15	14	13	12	11	10	9	8	7	6	5	4	3	2	1	0
R	LUTOUT143	LUTOUT142	LUTOUT141	LUTOUT140	LUTOUT139	LUTOUT138	LUTOUT137	LUTOUT136	LUTOUT135	LUTOUT134	LUTOUT133	LUTOUT132	LUTOUT131	LUTOUT130	LUTOUT129	LUTOUT128
W	LUTOUT143	LUTOUT142	LUTOUT141	LUTOUT140	LUTOUT139	LUTOUT138	LUTOUT137	LUTOUT136	LUTOUT135	LUTOUT134	LUTOUT133	LUTOUT132	LUTOUT131	LUTOUT130	LUTOUT129	LUTOUT128
Reset	0	0	0	0	0	0	0	0	0	0	0	0	0	0	0	0

PXP_HW_PXP_WFE_B_STG1_8X1_OUT2_4 field descriptions

Field	Description
31 LUTOUT159	LUT OUT
30 LUTOUT158	LUT OUT
29 LUTOUT157	LUT OUT
28 LUTOUT156	LUT OUT
27 LUTOUT155	LUT OUT
26 LUTOUT154	LUT OUT
25 LUTOUT153	LUT OUT
24 LUTOUT152	LUT OUT
23 LUTOUT151	LUT OUT
22 LUTOUT150	LUT OUT
21 LUTOUT149	LUT OUT
20 LUTOUT148	LUT OUT
19 LUTOUT147	LUT OUT
18 LUTOUT146	LUT OUT
17 LUTOUT145	LUT OUT
16 LUTOUT144	LUT OUT
15 LUTOUT143	LUT OUT
14 LUTOUT142	LUT OUT
13 LUTOUT141	LUT OUT
12 LUTOUT140	LUT OUT
11 LUTOUT139	LUT OUT
10 LUTOUT138	LUT OUT
9 LUTOUT137	LUT OUT

Table continues on the next page...

PXP_HW_PXP_WFE_B_STG1_8X1_OUT2_4 field descriptions (continued)

Field	Description
8 LUTOUT136	LUT OUT
7 LUTOUT135	LUT OUT
6 LUTOUT134	LUT OUT
5 LUTOUT133	LUT OUT
4 LUTOUT132	LUT OUT
3 LUTOUT131	LUT OUT
2 LUTOUT130	LUT OUT
1 LUTOUT129	LUT OUT
0 LUTOUT128	LUT OUT

41.11.220 This register defines the output values (new flag) for the 8x1 LUTs in stage 1. (PXP_HW_PXP_WFE_B_STG1_8X1_OUT2_5)

The 5x1 LUT output value for input value n. This output value results in a flag that is added to the flag array.

Address: 21C_C000h base + 21E0h offset = 21C_E1E0h

Bit	31	30	29	28	27	26	25	24	23	22	21	20	19	18	17	16
R	LUTOUT191	LUTOUT190	LUTOUT189	LUTOUT188	LUTOUT187	LUTOUT186	LUTOUT185	LUTOUT184	LUTOUT183	LUTOUT182	LUTOUT181	LUTOUT180	LUTOUT179	LUTOUT178	LUTOUT177	LUTOUT176
W	LUTOUT191	LUTOUT190	LUTOUT189	LUTOUT188	LUTOUT187	LUTOUT186	LUTOUT185	LUTOUT184	LUTOUT183	LUTOUT182	LUTOUT181	LUTOUT180	LUTOUT179	LUTOUT178	LUTOUT177	LUTOUT176
Reset	0	0	0	0	0	0	0	0	0	0	0	0	0	0	0	0
Bit	15	14	13	12	11	10	9	8	7	6	5	4	3	2	1	0
R	LUTOUT175	LUTOUT174	LUTOUT173	LUTOUT172	LUTOUT171	LUTOUT170	LUTOUT169	LUTOUT168	LUTOUT167	LUTOUT166	LUTOUT165	LUTOUT164	LUTOUT163	LUTOUT162	LUTOUT161	LUTOUT160
W	LUTOUT175	LUTOUT174	LUTOUT173	LUTOUT172	LUTOUT171	LUTOUT170	LUTOUT169	LUTOUT168	LUTOUT167	LUTOUT166	LUTOUT165	LUTOUT164	LUTOUT163	LUTOUT162	LUTOUT161	LUTOUT160
Reset	0	0	0	0	0	0	0	0	0	0	0	0	0	0	0	0

PXP_HW_PXP_WFE_B_STG1_8X1_OUT2_5 field descriptions

Field	Description
31 LUTOUT191	LUT OUT
30 LUTOUT190	LUT OUT
29 LUTOUT189	LUT OUT
28 LUTOUT188	LUT OUT
27 LUTOUT187	LUT OUT
26 LUTOUT186	LUT OUT
25 LUTOUT185	LUT OUT
24 LUTOUT184	LUT OUT
23 LUTOUT183	LUT OUT
22 LUTOUT182	LUT OUT
21 LUTOUT181	LUT OUT
20 LUTOUT180	LUT OUT
19 LUTOUT179	LUT OUT
18 LUTOUT178	LUT OUT
17 LUTOUT177	LUT OUT
16 LUTOUT176	LUT OUT
15 LUTOUT175	LUT OUT
14 LUTOUT174	LUT OUT
13 LUTOUT173	LUT OUT
12 LUTOUT172	LUT OUT
11 LUTOUT171	LUT OUT
10 LUTOUT170	LUT OUT
9 LUTOUT169	LUT OUT

Table continues on the next page...

PXP_HW_PXP_WFE_B_STG1_8X1_OUT2_5 field descriptions (continued)

Field	Description
8 LUTOUT168	LUT OUT
7 LUTOUT167	LUT OUT
6 LUTOUT166	LUT OUT
5 LUTOUT165	LUT OUT
4 LUTOUT164	LUT OUT
3 LUTOUT163	LUT OUT
2 LUTOUT162	LUT OUT
1 LUTOUT161	LUT OUT
0 LUTOUT160	LUT OUT

**41.11.221 This register defines the output values (new flag) for the 8x1 LUTs in stage 1.
(PXP_HW_PXP_WFE_B_STG1_8X1_OUT2_6)**

The 5x1 LUT output value for input value n. This output value results in a flag that is added to the flag array.

Address: 21C_C000h base + 21F0h offset = 21C_E1F0h

Bit	31	30	29	28	27	26	25	24	23	22	21	20	19	18	17	16
R	LUTOUT223	LUTOUT222	LUTOUT221	LUTOUT220	LUTOUT219	LUTOUT218	LUTOUT217	LUTOUT216	LUTOUT215	LUTOUT214	LUTOUT213	LUTOUT212	LUTOUT211	LUTOUT210	LUTOUT209	LUTOUT208
W	LUTOUT223	LUTOUT222	LUTOUT221	LUTOUT220	LUTOUT219	LUTOUT218	LUTOUT217	LUTOUT216	LUTOUT215	LUTOUT214	LUTOUT213	LUTOUT212	LUTOUT211	LUTOUT210	LUTOUT209	LUTOUT208
Reset	0	0	0	0	0	0	0	0	0	0	0	0	0	0	0	0
Bit	15	14	13	12	11	10	9	8	7	6	5	4	3	2	1	0
R	LUTOUT207	LUTOUT206	LUTOUT205	LUTOUT204	LUTOUT203	LUTOUT202	LUTOUT201	LUTOUT200	LUTOUT199	LUTOUT198	LUTOUT197	LUTOUT196	LUTOUT195	LUTOUT194	LUTOUT193	LUTOUT192
W	LUTOUT207	LUTOUT206	LUTOUT205	LUTOUT204	LUTOUT203	LUTOUT202	LUTOUT201	LUTOUT200	LUTOUT199	LUTOUT198	LUTOUT197	LUTOUT196	LUTOUT195	LUTOUT194	LUTOUT193	LUTOUT192
Reset	0	0	0	0	0	0	0	0	0	0	0	0	0	0	0	0

PXP_HW_PXP_WFE_B_STG1_8X1_OUT2_6 field descriptions

Field	Description
31 LUTOUT223	LUT OUT
30 LUTOUT222	LUT OUT
29 LUTOUT221	LUT OUT
28 LUTOUT220	LUT OUT
27 LUTOUT219	LUT OUT
26 LUTOUT218	LUT OUT
25 LUTOUT217	LUT OUT
24 LUTOUT216	LUT OUT
23 LUTOUT215	LUT OUT
22 LUTOUT214	LUT OUT
21 LUTOUT213	LUT OUT
20 LUTOUT212	LUT OUT
19 LUTOUT211	LUT OUT
18 LUTOUT210	LUT OUT
17 LUTOUT209	LUT OUT
16 LUTOUT208	LUT OUT
15 LUTOUT207	LUT OUT
14 LUTOUT206	LUT OUT
13 LUTOUT205	LUT OUT
12 LUTOUT204	LUT OUT
11 LUTOUT203	LUT OUT
10 LUTOUT202	LUT OUT
9 LUTOUT201	LUT OUT

Table continues on the next page...

PXP_HW_PXP_WFE_B_STG1_8X1_OUT2_6 field descriptions (continued)

Field	Description
8 LUTOUT200	LUT OUT
7 LUTOUT199	LUT OUT
6 LUTOUT198	LUT OUT
5 LUTOUT197	LUT OUT
4 LUTOUT196	LUT OUT
3 LUTOUT195	LUT OUT
2 LUTOUT194	LUT OUT
1 LUTOUT193	LUT OUT
0 LUTOUT192	LUT OUT

**41.11.222 This register defines the output values (new flag) for the 8x1 LUTs in stage 1.
(PXP_HW_PXP_WFE_B_STG1_8X1_OUT2_7)**

The 5x1 LUT output value for input value n. This output value results in a flag that is added to the flag array.

Address: 21C_C000h base + 2200h offset = 21C_E200h

Bit	31	30	29	28	27	26	25	24	23	22	21	20	19	18	17	16
R	LUTOUT255	LUTOUT254	LUTOUT253	LUTOUT252	LUTOUT251	LUTOUT250	LUTOUT249	LUTOUT248	LUTOUT247	LUTOUT246	LUTOUT245	LUTOUT244	LUTOUT243	LUTOUT242	LUTOUT241	LUTOUT240
W	LUTOUT255	LUTOUT254	LUTOUT253	LUTOUT252	LUTOUT251	LUTOUT250	LUTOUT249	LUTOUT248	LUTOUT247	LUTOUT246	LUTOUT245	LUTOUT244	LUTOUT243	LUTOUT242	LUTOUT241	LUTOUT240
Reset	0	0	0	0	0	0	0	0	0	0	0	0	0	0	0	0
Bit	15	14	13	12	11	10	9	8	7	6	5	4	3	2	1	0
R	LUTOUT239	LUTOUT238	LUTOUT237	LUTOUT236	LUTOUT235	LUTOUT234	LUTOUT233	LUTOUT232	LUTOUT231	LUTOUT230	LUTOUT229	LUTOUT228	LUTOUT227	LUTOUT226	LUTOUT225	LUTOUT224
W	LUTOUT239	LUTOUT238	LUTOUT237	LUTOUT236	LUTOUT235	LUTOUT234	LUTOUT233	LUTOUT232	LUTOUT231	LUTOUT230	LUTOUT229	LUTOUT228	LUTOUT227	LUTOUT226	LUTOUT225	LUTOUT224
Reset	0	0	0	0	0	0	0	0	0	0	0	0	0	0	0	0

PXP_HW_PXP_WFE_B_STG1_8X1_OUT2_7 field descriptions

Field	Description
31 LUTOUT255	LUT OUT
30 LUTOUT254	LUT OUT
29 LUTOUT253	LUT OUT
28 LUTOUT252	LUT OUT
27 LUTOUT251	LUT OUT
26 LUTOUT250	LUT OUT
25 LUTOUT249	LUT OUT
24 LUTOUT248	LUT OUT
23 LUTOUT247	LUT OUT
22 LUTOUT246	LUT OUT
21 LUTOUT245	LUT OUT
20 LUTOUT244	LUT OUT
19 LUTOUT243	LUT OUT
18 LUTOUT242	LUT OUT
17 LUTOUT241	LUT OUT
16 LUTOUT240	LUT OUT
15 LUTOUT239	LUT OUT
14 LUTOUT238	LUT OUT
13 LUTOUT237	LUT OUT
12 LUTOUT236	LUT OUT
11 LUTOUT235	LUT OUT
10 LUTOUT234	LUT OUT
9 LUTOUT233	LUT OUT

Table continues on the next page...

PXP_HW_PXP_WFE_B_STG1_8X1_OUT2_7 field descriptions (continued)

Field	Description
8 LUTOUT232	LUT OUT
7 LUTOUT231	LUT OUT
6 LUTOUT230	LUT OUT
5 LUTOUT229	LUT OUT
4 LUTOUT228	LUT OUT
3 LUTOUT227	LUT OUT
2 LUTOUT226	LUT OUT
1 LUTOUT225	LUT OUT
0 LUTOUT224	LUT OUT

**41.11.223 This register defines the output values (new flag) for the 8x1 LUTs in stage 1.
(PXP_HW_PXP_WFE_B_STG1_8X1_OUT3_0)**

The 5x1 LUT output value for input value n. This output value results in a flag that is added to the flag array.

Address: 21C_C000h base + 2210h offset = 21C_E210h

Bit	31	30	29	28	27	26	25	24	23	22	21	20	19	18	17	16
R	LUTOUT31	LUTOUT30	LUTOUT29	LUTOUT28	LUTOUT27	LUTOUT26	LUTOUT25	LUTOUT24	LUTOUT23	LUTOUT22	LUTOUT21	LUTOUT20	LUTOUT19	LUTOUT18	LUTOUT17	LUTOUT16
W	LUTOUT31	LUTOUT30	LUTOUT29	LUTOUT28	LUTOUT27	LUTOUT26	LUTOUT25	LUTOUT24	LUTOUT23	LUTOUT22	LUTOUT21	LUTOUT20	LUTOUT19	LUTOUT18	LUTOUT17	LUTOUT16
Reset	0	0	0	0	0	0	0	0	0	0	0	0	0	0	0	0
Bit	15	14	13	12	11	10	9	8	7	6	5	4	3	2	1	0
R	LUTOUT15	LUTOUT14	LUTOUT13	LUTOUT12	LUTOUT11	LUTOUT10	LUTOUT9	LUTOUT8	LUTOUT7	LUTOUT6	LUTOUT5	LUTOUT4	LUTOUT3	LUTOUT2	LUTOUT1	LUTOUT0
W	LUTOUT15	LUTOUT14	LUTOUT13	LUTOUT12	LUTOUT11	LUTOUT10	LUTOUT9	LUTOUT8	LUTOUT7	LUTOUT6	LUTOUT5	LUTOUT4	LUTOUT3	LUTOUT2	LUTOUT1	LUTOUT0
Reset	0	0	0	0	0	0	0	0	0	0	0	0	0	0	0	0

PXP_HW_PXP_WFE_B_STG1_8X1_OUT3_0 field descriptions

Field	Description
31 LUTOUT31	LUT OUT
30 LUTOUT30	LUT OUT
29 LUTOUT29	LUT OUT
28 LUTOUT28	LUT OUT
27 LUTOUT27	LUT OUT
26 LUTOUT26	LUT OUT
25 LUTOUT25	LUT OUT
24 LUTOUT24	LUT OUT
23 LUTOUT23	LUT OUT
22 LUTOUT22	LUT OUT
21 LUTOUT21	LUT OUT
20 LUTOUT20	LUT OUT
19 LUTOUT19	LUT OUT
18 LUTOUT18	LUT OUT
17 LUTOUT17	LUT OUT
16 LUTOUT16	LUT OUT
15 LUTOUT15	LUT OUT
14 LUTOUT14	LUT OUT
13 LUTOUT13	LUT OUT
12 LUTOUT12	LUT OUT
11 LUTOUT11	LUT OUT
10 LUTOUT10	LUT OUT
9 LUTOUT9	LUT OUT

Table continues on the next page...

PXP_HW_PXP_WFE_B_STG1_8X1_OUT3_0 field descriptions (continued)

Field	Description
8 LUTOUT8	LUT OUT
7 LUTOUT7	LUT OUT
6 LUTOUT6	LUT OUT
5 LUTOUT5	LUT OUT
4 LUTOUT4	LUT OUT
3 LUTOUT3	LUT OUT
2 LUTOUT2	LUT OUT
1 LUTOUT1	LUT OUT
0 LUTOUT0	LUT OUT

**41.11.224 This register defines the output values (new flag) for the 8x1 LUTs in stage 1.
(PXP_HW_PXP_WFE_B_STG1_8X1_OUT3_1)**

The 5x1 LUT output value for input value n. This output value results in a flag that is added to the flag array.

Address: 21C_C000h base + 2220h offset = 21C_E220h

Bit	31	30	29	28	27	26	25	24	23	22	21	20	19	18	17	16
R	LUTOUT63	LUTOUT62	LUTOUT61	LUTOUT60	LUTOUT59	LUTOUT58	LUTOUT57	LUTOUT56	LUTOUT55	LUTOUT54	LUTOUT53	LUTOUT52	LUTOUT51	LUTOUT50	LUTOUT49	LUTOUT48
W																
Reset	0	0	0	0	0	0	0	0	0	0	0	0	0	0	0	0
Bit	15	14	13	12	11	10	9	8	7	6	5	4	3	2	1	0
R	LUTOUT47	LUTOUT46	LUTOUT45	LUTOUT44	LUTOUT43	LUTOUT42	LUTOUT41	LUTOUT40	LUTOUT39	LUTOUT38	LUTOUT37	LUTOUT36	LUTOUT35	LUTOUT34	LUTOUT33	LUTOUT32
W																
Reset	0	0	0	0	0	0	0	0	0	0	0	0	0	0	0	0

PXP_HW_PXP_WFE_B_STG1_8X1_OUT3_1 field descriptions

Field	Description
31 LUTOUT63	LUT OUT
30 LUTOUT62	LUT OUT
29 LUTOUT61	LUT OUT
28 LUTOUT60	LUT OUT
27 LUTOUT59	LUT OUT
26 LUTOUT58	LUT OUT
25 LUTOUT57	LUT OUT
24 LUTOUT56	LUT OUT
23 LUTOUT55	LUT OUT
22 LUTOUT54	LUT OUT
21 LUTOUT53	LUT OUT
20 LUTOUT52	LUT OUT
19 LUTOUT51	LUT OUT
18 LUTOUT50	LUT OUT
17 LUTOUT49	LUT OUT
16 LUTOUT48	LUT OUT
15 LUTOUT47	LUT OUT
14 LUTOUT46	LUT OUT
13 LUTOUT45	LUT OUT
12 LUTOUT44	LUT OUT
11 LUTOUT43	LUT OUT
10 LUTOUT42	LUT OUT
9 LUTOUT41	LUT OUT

Table continues on the next page...

PXP_HW_PXP_WFE_B_STG1_8X1_OUT3_1 field descriptions (continued)

Field	Description
8 LUTOUT40	LUT OUT
7 LUTOUT39	LUT OUT
6 LUTOUT38	LUT OUT
5 LUTOUT37	LUT OUT
4 LUTOUT36	LUT OUT
3 LUTOUT35	LUT OUT
2 LUTOUT34	LUT OUT
1 LUTOUT33	LUT OUT
0 LUTOUT32	LUT OUT

**41.11.225 This register defines the output values (new flag) for the 8x1 LUTs in stage 1.
(PXP_HW_PXP_WFE_B_STG1_8X1_OUT3_2)**

The 5x1 LUT output value for input value n. This output value results in a flag that is added to the flag array.

Address: 21C_C000h base + 2230h offset = 21C_E230h

Bit	31	30	29	28	27	26	25	24	23	22	21	20	19	18	17	16
R	LUTOUT95	LUTOUT94	LUTOUT93	LUTOUT92	LUTOUT91	LUTOUT90	LUTOUT89	LUTOUT88	LUTOUT87	LUTOUT86	LUTOUT85	LUTOUT84	LUTOUT83	LUTOUT82	LUTOUT81	LUTOUT80
W	LUTOUT95	LUTOUT94	LUTOUT93	LUTOUT92	LUTOUT91	LUTOUT90	LUTOUT89	LUTOUT88	LUTOUT87	LUTOUT86	LUTOUT85	LUTOUT84	LUTOUT83	LUTOUT82	LUTOUT81	LUTOUT80
Reset	0	0	0	0	0	0	0	0	0	0	0	0	0	0	0	0
Bit	15	14	13	12	11	10	9	8	7	6	5	4	3	2	1	0
R	LUTOUT79	LUTOUT78	LUTOUT77	LUTOUT76	LUTOUT75	LUTOUT74	LUTOUT73	LUTOUT72	LUTOUT71	LUTOUT70	LUTOUT69	LUTOUT68	LUTOUT67	LUTOUT66	LUTOUT65	LUTOUT64
W	LUTOUT79	LUTOUT78	LUTOUT77	LUTOUT76	LUTOUT75	LUTOUT74	LUTOUT73	LUTOUT72	LUTOUT71	LUTOUT70	LUTOUT69	LUTOUT68	LUTOUT67	LUTOUT66	LUTOUT65	LUTOUT64
Reset	0	0	0	0	0	0	0	0	0	0	0	0	0	0	0	0

PXP_HW_PXP_WFE_B_STG1_8X1_OUT3_2 field descriptions

Field	Description
31 LUTOUT95	LUT OUT
30 LUTOUT94	LUT OUT
29 LUTOUT93	LUT OUT
28 LUTOUT92	LUT OUT
27 LUTOUT91	LUT OUT
26 LUTOUT90	LUT OUT
25 LUTOUT89	LUT OUT
24 LUTOUT88	LUT OUT
23 LUTOUT87	LUT OUT
22 LUTOUT86	LUT OUT
21 LUTOUT85	LUT OUT
20 LUTOUT84	LUT OUT
19 LUTOUT83	LUT OUT
18 LUTOUT82	LUT OUT
17 LUTOUT81	LUT OUT
16 LUTOUT80	LUT OUT
15 LUTOUT79	LUT OUT
14 LUTOUT78	LUT OUT
13 LUTOUT77	LUT OUT
12 LUTOUT76	LUT OUT
11 LUTOUT75	LUT OUT
10 LUTOUT74	LUT OUT
9 LUTOUT73	LUT OUT

Table continues on the next page...

PXP_HW_PXP_WFE_B_STG1_8X1_OUT3_2 field descriptions (continued)

Field	Description
8 LUTOUT72	LUT OUT
7 LUTOUT71	LUT OUT
6 LUTOUT70	LUT OUT
5 LUTOUT69	LUT OUT
4 LUTOUT68	LUT OUT
3 LUTOUT67	LUT OUT
2 LUTOUT66	LUT OUT
1 LUTOUT65	LUT OUT
0 LUTOUT64	LUT OUT

41.11.226 This register defines the output values (new flag) for the 8x1 LUTs in stage 1. (PXP_HW_PXP_WFE_B_STG1_8X1_OUT3_3)

The 5x1 LUT output value for input value n. This output value results in a flag that is added to the flag array.

Address: 21C_C000h base + 2240h offset = 21C_E240h

Bit	31	30	29	28	27	26	25	24	23	22	21	20	19	18	17	16
R	LUTOUT127	LUTOUT126	LUTOUT125	LUTOUT124	LUTOUT123	LUTOUT122	LUTOUT121	LUTOUT120	LUTOUT119	LUTOUT118	LUTOUT117	LUTOUT116	LUTOUT115	LUTOUT114	LUTOUT113	LUTOUT112
W	LUTOUT127	LUTOUT126	LUTOUT125	LUTOUT124	LUTOUT123	LUTOUT122	LUTOUT121	LUTOUT120	LUTOUT119	LUTOUT118	LUTOUT117	LUTOUT116	LUTOUT115	LUTOUT114	LUTOUT113	LUTOUT112
Reset	0	0	0	0	0	0	0	0	0	0	0	0	0	0	0	0
Bit	15	14	13	12	11	10	9	8	7	6	5	4	3	2	1	0
R	LUTOUT111	LUTOUT110	LUTOUT109	LUTOUT108	LUTOUT107	LUTOUT106	LUTOUT105	LUTOUT104	LUTOUT103	LUTOUT102	LUTOUT101	LUTOUT100	LUTOUT99	LUTOUT98	LUTOUT97	LUTOUT96
W	LUTOUT111	LUTOUT110	LUTOUT109	LUTOUT108	LUTOUT107	LUTOUT106	LUTOUT105	LUTOUT104	LUTOUT103	LUTOUT102	LUTOUT101	LUTOUT100	LUTOUT99	LUTOUT98	LUTOUT97	LUTOUT96
Reset	0	0	0	0	0	0	0	0	0	0	0	0	0	0	0	0

PXP_HW_PXP_WFE_B_STG1_8X1_OUT3_3 field descriptions

Field	Description
31 LUTOUT127	LUT OUT
30 LUTOUT126	LUT OUT
29 LUTOUT125	LUT OUT
28 LUTOUT124	LUT OUT
27 LUTOUT123	LUT OUT
26 LUTOUT122	LUT OUT
25 LUTOUT121	LUT OUT
24 LUTOUT120	LUT OUT
23 LUTOUT119	LUT OUT
22 LUTOUT118	LUT OUT
21 LUTOUT117	LUT OUT
20 LUTOUT116	LUT OUT
19 LUTOUT115	LUT OUT
18 LUTOUT114	LUT OUT
17 LUTOUT113	LUT OUT
16 LUTOUT112	LUT OUT
15 LUTOUT111	LUT OUT
14 LUTOUT110	LUT OUT
13 LUTOUT109	LUT OUT
12 LUTOUT108	LUT OUT
11 LUTOUT107	LUT OUT
10 LUTOUT106	LUT OUT
9 LUTOUT105	LUT OUT

Table continues on the next page...

PXP_HW_PXP_WFE_B_STG1_8X1_OUT3_3 field descriptions (continued)

Field	Description
8 LUTOUT104	LUT OUT
7 LUTOUT103	LUT OUT
6 LUTOUT102	LUT OUT
5 LUTOUT101	LUT OUT
4 LUTOUT100	LUT OUT
3 LUTOUT99	LUT OUT
2 LUTOUT98	LUT OUT
1 LUTOUT97	LUT OUT
0 LUTOUT96	LUT OUT

41.11.227 This register defines the output values (new flag) for the 8x1 LUTs in stage 1. (PXP_HW_PXP_WFE_B_STG1_8X1_OUT3_4)

The 5x1 LUT output value for input value n. This output value results in a flag that is added to the flag array.

Address: 21C_C000h base + 2250h offset = 21C_E250h

Bit	31	30	29	28	27	26	25	24	23	22	21	20	19	18	17	16
R	LUTOUT159	LUTOUT158	LUTOUT157	LUTOUT156	LUTOUT155	LUTOUT154	LUTOUT153	LUTOUT152	LUTOUT151	LUTOUT150	LUTOUT149	LUTOUT148	LUTOUT147	LUTOUT146	LUTOUT145	LUTOUT144
W	LUTOUT159	LUTOUT158	LUTOUT157	LUTOUT156	LUTOUT155	LUTOUT154	LUTOUT153	LUTOUT152	LUTOUT151	LUTOUT150	LUTOUT149	LUTOUT148	LUTOUT147	LUTOUT146	LUTOUT145	LUTOUT144
Reset	0	0	0	0	0	0	0	0	0	0	0	0	0	0	0	0
Bit	15	14	13	12	11	10	9	8	7	6	5	4	3	2	1	0
R	LUTOUT143	LUTOUT142	LUTOUT141	LUTOUT140	LUTOUT139	LUTOUT138	LUTOUT137	LUTOUT136	LUTOUT135	LUTOUT134	LUTOUT133	LUTOUT132	LUTOUT131	LUTOUT130	LUTOUT129	LUTOUT128
W	LUTOUT143	LUTOUT142	LUTOUT141	LUTOUT140	LUTOUT139	LUTOUT138	LUTOUT137	LUTOUT136	LUTOUT135	LUTOUT134	LUTOUT133	LUTOUT132	LUTOUT131	LUTOUT130	LUTOUT129	LUTOUT128
Reset	0	0	0	0	0	0	0	0	0	0	0	0	0	0	0	0

PXP_HW_PXP_WFE_B_STG1_8X1_OUT3_4 field descriptions

Field	Description
31 LUTOUT159	LUT OUT
30 LUTOUT158	LUT OUT
29 LUTOUT157	LUT OUT
28 LUTOUT156	LUT OUT
27 LUTOUT155	LUT OUT
26 LUTOUT154	LUT OUT
25 LUTOUT153	LUT OUT
24 LUTOUT152	LUT OUT
23 LUTOUT151	LUT OUT
22 LUTOUT150	LUT OUT
21 LUTOUT149	LUT OUT
20 LUTOUT148	LUT OUT
19 LUTOUT147	LUT OUT
18 LUTOUT146	LUT OUT
17 LUTOUT145	LUT OUT
16 LUTOUT144	LUT OUT
15 LUTOUT143	LUT OUT
14 LUTOUT142	LUT OUT
13 LUTOUT141	LUT OUT
12 LUTOUT140	LUT OUT
11 LUTOUT139	LUT OUT
10 LUTOUT138	LUT OUT
9 LUTOUT137	LUT OUT

Table continues on the next page...

PXP_HW_PXP_WFE_B_STG1_8X1_OUT3_4 field descriptions (continued)

Field	Description
8 LUTOUT136	LUT OUT
7 LUTOUT135	LUT OUT
6 LUTOUT134	LUT OUT
5 LUTOUT133	LUT OUT
4 LUTOUT132	LUT OUT
3 LUTOUT131	LUT OUT
2 LUTOUT130	LUT OUT
1 LUTOUT129	LUT OUT
0 LUTOUT128	LUT OUT

41.11.228 This register defines the output values (new flag) for the 8x1 LUTs in stage 1. (PXP_HW_PXP_WFE_B_STG1_8X1_OUT3_5)

The 5x1 LUT output value for input value n. This output value results in a flag that is added to the flag array.

Address: 21C_C000h base + 2260h offset = 21C_E260h

Bit	31	30	29	28	27	26	25	24	23	22	21	20	19	18	17	16
R	LUTOUT191	LUTOUT190	LUTOUT189	LUTOUT188	LUTOUT187	LUTOUT186	LUTOUT185	LUTOUT184	LUTOUT183	LUTOUT182	LUTOUT181	LUTOUT180	LUTOUT179	LUTOUT178	LUTOUT177	LUTOUT176
W	LUTOUT191	LUTOUT190	LUTOUT189	LUTOUT188	LUTOUT187	LUTOUT186	LUTOUT185	LUTOUT184	LUTOUT183	LUTOUT182	LUTOUT181	LUTOUT180	LUTOUT179	LUTOUT178	LUTOUT177	LUTOUT176
Reset	0	0	0	0	0	0	0	0	0	0	0	0	0	0	0	0
Bit	15	14	13	12	11	10	9	8	7	6	5	4	3	2	1	0
R	LUTOUT175	LUTOUT174	LUTOUT173	LUTOUT172	LUTOUT171	LUTOUT170	LUTOUT169	LUTOUT168	LUTOUT167	LUTOUT166	LUTOUT165	LUTOUT164	LUTOUT163	LUTOUT162	LUTOUT161	LUTOUT160
W	LUTOUT175	LUTOUT174	LUTOUT173	LUTOUT172	LUTOUT171	LUTOUT170	LUTOUT169	LUTOUT168	LUTOUT167	LUTOUT166	LUTOUT165	LUTOUT164	LUTOUT163	LUTOUT162	LUTOUT161	LUTOUT160
Reset	0	0	0	0	0	0	0	0	0	0	0	0	0	0	0	0

PXP_HW_PXP_WFE_B_STG1_8X1_OUT3_5 field descriptions

Field	Description
31 LUTOUT191	LUT OUT
30 LUTOUT190	LUT OUT
29 LUTOUT189	LUT OUT
28 LUTOUT188	LUT OUT
27 LUTOUT187	LUT OUT
26 LUTOUT186	LUT OUT
25 LUTOUT185	LUT OUT
24 LUTOUT184	LUT OUT
23 LUTOUT183	LUT OUT
22 LUTOUT182	LUT OUT
21 LUTOUT181	LUT OUT
20 LUTOUT180	LUT OUT
19 LUTOUT179	LUT OUT
18 LUTOUT178	LUT OUT
17 LUTOUT177	LUT OUT
16 LUTOUT176	LUT OUT
15 LUTOUT175	LUT OUT
14 LUTOUT174	LUT OUT
13 LUTOUT173	LUT OUT
12 LUTOUT172	LUT OUT
11 LUTOUT171	LUT OUT
10 LUTOUT170	LUT OUT
9 LUTOUT169	LUT OUT

Table continues on the next page...

PXP_HW_PXP_WFE_B_STG1_8X1_OUT3_5 field descriptions (continued)

Field	Description
8 LUTOUT168	LUT OUT
7 LUTOUT167	LUT OUT
6 LUTOUT166	LUT OUT
5 LUTOUT165	LUT OUT
4 LUTOUT164	LUT OUT
3 LUTOUT163	LUT OUT
2 LUTOUT162	LUT OUT
1 LUTOUT161	LUT OUT
0 LUTOUT160	LUT OUT

41.11.229 This register defines the output values (new flag) for the 8x1 LUTs in stage 1. (PXP_HW_PXP_WFE_B_STG1_8X1_OUT3_6)

The 5x1 LUT output value for input value n. This output value results in a flag that is added to the flag array.

Address: 21C_C000h base + 2270h offset = 21C_E270h

Bit	31	30	29	28	27	26	25	24	23	22	21	20	19	18	17	16
R	LUTOUT223	LUTOUT222	LUTOUT221	LUTOUT220	LUTOUT219	LUTOUT218	LUTOUT217	LUTOUT216	LUTOUT215	LUTOUT214	LUTOUT213	LUTOUT212	LUTOUT211	LUTOUT210	LUTOUT209	LUTOUT208
W	LUTOUT223	LUTOUT222	LUTOUT221	LUTOUT220	LUTOUT219	LUTOUT218	LUTOUT217	LUTOUT216	LUTOUT215	LUTOUT214	LUTOUT213	LUTOUT212	LUTOUT211	LUTOUT210	LUTOUT209	LUTOUT208
Reset	0	0	0	0	0	0	0	0	0	0	0	0	0	0	0	0
Bit	15	14	13	12	11	10	9	8	7	6	5	4	3	2	1	0
R	LUTOUT207	LUTOUT206	LUTOUT205	LUTOUT204	LUTOUT203	LUTOUT202	LUTOUT201	LUTOUT200	LUTOUT199	LUTOUT198	LUTOUT197	LUTOUT196	LUTOUT195	LUTOUT194	LUTOUT193	LUTOUT192
W	LUTOUT207	LUTOUT206	LUTOUT205	LUTOUT204	LUTOUT203	LUTOUT202	LUTOUT201	LUTOUT200	LUTOUT199	LUTOUT198	LUTOUT197	LUTOUT196	LUTOUT195	LUTOUT194	LUTOUT193	LUTOUT192
Reset	0	0	0	0	0	0	0	0	0	0	0	0	0	0	0	0

PXP_HW_PXP_WFE_B_STG1_8X1_OUT3_6 field descriptions

Field	Description
31 LUTOUT223	LUT OUT
30 LUTOUT222	LUT OUT
29 LUTOUT221	LUT OUT
28 LUTOUT220	LUT OUT
27 LUTOUT219	LUT OUT
26 LUTOUT218	LUT OUT
25 LUTOUT217	LUT OUT
24 LUTOUT216	LUT OUT
23 LUTOUT215	LUT OUT
22 LUTOUT214	LUT OUT
21 LUTOUT213	LUT OUT
20 LUTOUT212	LUT OUT
19 LUTOUT211	LUT OUT
18 LUTOUT210	LUT OUT
17 LUTOUT209	LUT OUT
16 LUTOUT208	LUT OUT
15 LUTOUT207	LUT OUT
14 LUTOUT206	LUT OUT
13 LUTOUT205	LUT OUT
12 LUTOUT204	LUT OUT
11 LUTOUT203	LUT OUT
10 LUTOUT202	LUT OUT
9 LUTOUT201	LUT OUT

Table continues on the next page...

PXP_HW_PXP_WFE_B_STG1_8X1_OUT3_6 field descriptions (continued)

Field	Description
8 LUTOUT200	LUT OUT
7 LUTOUT199	LUT OUT
6 LUTOUT198	LUT OUT
5 LUTOUT197	LUT OUT
4 LUTOUT196	LUT OUT
3 LUTOUT195	LUT OUT
2 LUTOUT194	LUT OUT
1 LUTOUT193	LUT OUT
0 LUTOUT192	LUT OUT

41.11.230 This register defines the output values (new flag) for the 8x1 LUTs in stage 1. (PXP_HW_PXP_WFE_B_STG1_8X1_OUT3_7)

The 5x1 LUT output value for input value n. This output value results in a flag that is added to the flag array.

Address: 21C_C000h base + 2280h offset = 21C_E280h

Bit	31	30	29	28	27	26	25	24	23	22	21	20	19	18	17	16
R	LUTOUT255	LUTOUT254	LUTOUT253	LUTOUT252	LUTOUT251	LUTOUT250	LUTOUT249	LUTOUT248	LUTOUT247	LUTOUT246	LUTOUT245	LUTOUT244	LUTOUT243	LUTOUT242	LUTOUT241	LUTOUT240
W	LUTOUT255	LUTOUT254	LUTOUT253	LUTOUT252	LUTOUT251	LUTOUT250	LUTOUT249	LUTOUT248	LUTOUT247	LUTOUT246	LUTOUT245	LUTOUT244	LUTOUT243	LUTOUT242	LUTOUT241	LUTOUT240
Reset	0	0	0	0	0	0	0	0	0	0	0	0	0	0	0	0
Bit	15	14	13	12	11	10	9	8	7	6	5	4	3	2	1	0
R	LUTOUT239	LUTOUT238	LUTOUT237	LUTOUT236	LUTOUT235	LUTOUT234	LUTOUT233	LUTOUT232	LUTOUT231	LUTOUT230	LUTOUT229	LUTOUT228	LUTOUT227	LUTOUT226	LUTOUT225	LUTOUT224
W	LUTOUT239	LUTOUT238	LUTOUT237	LUTOUT236	LUTOUT235	LUTOUT234	LUTOUT233	LUTOUT232	LUTOUT231	LUTOUT230	LUTOUT229	LUTOUT228	LUTOUT227	LUTOUT226	LUTOUT225	LUTOUT224
Reset	0	0	0	0	0	0	0	0	0	0	0	0	0	0	0	0

PXP_HW_PXP_WFE_B_STG1_8X1_OUT3_7 field descriptions

Field	Description
31 LUTOUT255	LUT OUT
30 LUTOUT254	LUT OUT
29 LUTOUT253	LUT OUT
28 LUTOUT252	LUT OUT
27 LUTOUT251	LUT OUT
26 LUTOUT250	LUT OUT
25 LUTOUT249	LUT OUT
24 LUTOUT248	LUT OUT
23 LUTOUT247	LUT OUT
22 LUTOUT246	LUT OUT
21 LUTOUT245	LUT OUT
20 LUTOUT244	LUT OUT
19 LUTOUT243	LUT OUT
18 LUTOUT242	LUT OUT
17 LUTOUT241	LUT OUT
16 LUTOUT240	LUT OUT
15 LUTOUT239	LUT OUT
14 LUTOUT238	LUT OUT
13 LUTOUT237	LUT OUT
12 LUTOUT236	LUT OUT
11 LUTOUT235	LUT OUT
10 LUTOUT234	LUT OUT
9 LUTOUT233	LUT OUT

Table continues on the next page...

PXP_HW_PXP_WFE_B_STG1_8X1_OUT3_7 field descriptions (continued)

Field	Description
8 LUTOUT232	LUT OUT
7 LUTOUT231	LUT OUT
6 LUTOUT230	LUT OUT
5 LUTOUT229	LUT OUT
4 LUTOUT228	LUT OUT
3 LUTOUT227	LUT OUT
2 LUTOUT226	LUT OUT
1 LUTOUT225	LUT OUT
0 LUTOUT224	LUT OUT

**41.11.231 This register defines the output values (new flag) for the 8x1 LUTs in stage 1.
(PXP_HW_PXP_WFE_B_STG1_8X1_OUT4_0)**

The 5x1 LUT output value for input value n. This output value results in a flag that is added to the flag array.

Address: 21C_C000h base + 2290h offset = 21C_E290h

Bit	31	30	29	28	27	26	25	24	23	22	21	20	19	18	17	16
R	LUTOUT31	LUTOUT30	LUTOUT29	LUTOUT28	LUTOUT27	LUTOUT26	LUTOUT25	LUTOUT24	LUTOUT23	LUTOUT22	LUTOUT21	LUTOUT20	LUTOUT19	LUTOUT18	LUTOUT17	LUTOUT16
W	LUTOUT31	LUTOUT30	LUTOUT29	LUTOUT28	LUTOUT27	LUTOUT26	LUTOUT25	LUTOUT24	LUTOUT23	LUTOUT22	LUTOUT21	LUTOUT20	LUTOUT19	LUTOUT18	LUTOUT17	LUTOUT16
Reset	0	0	0	0	0	0	0	0	0	0	0	0	0	0	0	0
Bit	15	14	13	12	11	10	9	8	7	6	5	4	3	2	1	0
R	LUTOUT15	LUTOUT14	LUTOUT13	LUTOUT12	LUTOUT11	LUTOUT10	LUTOUT9	LUTOUT8	LUTOUT7	LUTOUT6	LUTOUT5	LUTOUT4	LUTOUT3	LUTOUT2	LUTOUT1	LUTOUT0
W	LUTOUT15	LUTOUT14	LUTOUT13	LUTOUT12	LUTOUT11	LUTOUT10	LUTOUT9	LUTOUT8	LUTOUT7	LUTOUT6	LUTOUT5	LUTOUT4	LUTOUT3	LUTOUT2	LUTOUT1	LUTOUT0
Reset	0	0	0	0	0	0	0	0	0	0	0	0	0	0	0	0

PXP_HW_PXP_WFE_B_STG1_8X1_OUT4_0 field descriptions

Field	Description
31 LUTOUT31	LUT OUT
30 LUTOUT30	LUT OUT
29 LUTOUT29	LUT OUT
28 LUTOUT28	LUT OUT
27 LUTOUT27	LUT OUT
26 LUTOUT26	LUT OUT
25 LUTOUT25	LUT OUT
24 LUTOUT24	LUT OUT
23 LUTOUT23	LUT OUT
22 LUTOUT22	LUT OUT
21 LUTOUT21	LUT OUT
20 LUTOUT20	LUT OUT
19 LUTOUT19	LUT OUT
18 LUTOUT18	LUT OUT
17 LUTOUT17	LUT OUT
16 LUTOUT16	LUT OUT
15 LUTOUT15	LUT OUT
14 LUTOUT14	LUT OUT
13 LUTOUT13	LUT OUT
12 LUTOUT12	LUT OUT
11 LUTOUT11	LUT OUT
10 LUTOUT10	LUT OUT
9 LUTOUT9	LUT OUT

Table continues on the next page...

PXP_HW_PXP_WFE_B_STG1_8X1_OUT4_0 field descriptions (continued)

Field	Description
8 LUTOUT8	LUT OUT
7 LUTOUT7	LUT OUT
6 LUTOUT6	LUT OUT
5 LUTOUT5	LUT OUT
4 LUTOUT4	LUT OUT
3 LUTOUT3	LUT OUT
2 LUTOUT2	LUT OUT
1 LUTOUT1	LUT OUT
0 LUTOUT0	LUT OUT

**41.11.232 This register defines the output values (new flag) for the 8x1 LUTs in stage 1.
(PXP_HW_PXP_WFE_B_STG1_8X1_OUT4_1)**

The 5x1 LUT output value for input value n. This output value results in a flag that is added to the flag array.

Address: 21C_C000h base + 22A0h offset = 21C_E2A0h

Bit	31	30	29	28	27	26	25	24	23	22	21	20	19	18	17	16
R	LUTOUT63	LUTOUT62	LUTOUT61	LUTOUT60	LUTOUT59	LUTOUT58	LUTOUT57	LUTOUT56	LUTOUT55	LUTOUT54	LUTOUT53	LUTOUT52	LUTOUT51	LUTOUT50	LUTOUT49	LUTOUT48
W	LUTOUT63	LUTOUT62	LUTOUT61	LUTOUT60	LUTOUT59	LUTOUT58	LUTOUT57	LUTOUT56	LUTOUT55	LUTOUT54	LUTOUT53	LUTOUT52	LUTOUT51	LUTOUT50	LUTOUT49	LUTOUT48
Reset	0	0	0	0	0	0	0	0	0	0	0	0	0	0	0	0
Bit	15	14	13	12	11	10	9	8	7	6	5	4	3	2	1	0
R	LUTOUT47	LUTOUT46	LUTOUT45	LUTOUT44	LUTOUT43	LUTOUT42	LUTOUT41	LUTOUT40	LUTOUT39	LUTOUT38	LUTOUT37	LUTOUT36	LUTOUT35	LUTOUT34	LUTOUT33	LUTOUT32
W	LUTOUT47	LUTOUT46	LUTOUT45	LUTOUT44	LUTOUT43	LUTOUT42	LUTOUT41	LUTOUT40	LUTOUT39	LUTOUT38	LUTOUT37	LUTOUT36	LUTOUT35	LUTOUT34	LUTOUT33	LUTOUT32
Reset	0	0	0	0	0	0	0	0	0	0	0	0	0	0	0	0

PXP_HW_PXP_WFE_B_STG1_8X1_OUT4_1 field descriptions

Field	Description
31 LUTOUT63	LUT OUT
30 LUTOUT62	LUT OUT
29 LUTOUT61	LUT OUT
28 LUTOUT60	LUT OUT
27 LUTOUT59	LUT OUT
26 LUTOUT58	LUT OUT
25 LUTOUT57	LUT OUT
24 LUTOUT56	LUT OUT
23 LUTOUT55	LUT OUT
22 LUTOUT54	LUT OUT
21 LUTOUT53	LUT OUT
20 LUTOUT52	LUT OUT
19 LUTOUT51	LUT OUT
18 LUTOUT50	LUT OUT
17 LUTOUT49	LUT OUT
16 LUTOUT48	LUT OUT
15 LUTOUT47	LUT OUT
14 LUTOUT46	LUT OUT
13 LUTOUT45	LUT OUT
12 LUTOUT44	LUT OUT
11 LUTOUT43	LUT OUT
10 LUTOUT42	LUT OUT
9 LUTOUT41	LUT OUT

Table continues on the next page...

PXP_HW_PXP_WFE_B_STG1_8X1_OUT4_1 field descriptions (continued)

Field	Description
8 LUTOUT40	LUT OUT
7 LUTOUT39	LUT OUT
6 LUTOUT38	LUT OUT
5 LUTOUT37	LUT OUT
4 LUTOUT36	LUT OUT
3 LUTOUT35	LUT OUT
2 LUTOUT34	LUT OUT
1 LUTOUT33	LUT OUT
0 LUTOUT32	LUT OUT

**41.11.233 This register defines the output values (new flag) for the 8x1 LUTs in stage 1.
(PXP_HW_PXP_WFE_B_STG1_8X1_OUT4_2)**

The 5x1 LUT output value for input value n. This output value results in a flag that is added to the flag array.

Address: 21C_C000h base + 22B0h offset = 21C_E2B0h

Bit	31	30	29	28	27	26	25	24	23	22	21	20	19	18	17	16
R	LUTOUT95	LUTOUT94	LUTOUT93	LUTOUT92	LUTOUT91	LUTOUT90	LUTOUT89	LUTOUT88	LUTOUT87	LUTOUT86	LUTOUT85	LUTOUT84	LUTOUT83	LUTOUT82	LUTOUT81	LUTOUT80
W	LUTOUT95	LUTOUT94	LUTOUT93	LUTOUT92	LUTOUT91	LUTOUT90	LUTOUT89	LUTOUT88	LUTOUT87	LUTOUT86	LUTOUT85	LUTOUT84	LUTOUT83	LUTOUT82	LUTOUT81	LUTOUT80
Reset	0	0	0	0	0	0	0	0	0	0	0	0	0	0	0	0
Bit	15	14	13	12	11	10	9	8	7	6	5	4	3	2	1	0
R	LUTOUT79	LUTOUT78	LUTOUT77	LUTOUT76	LUTOUT75	LUTOUT74	LUTOUT73	LUTOUT72	LUTOUT71	LUTOUT70	LUTOUT69	LUTOUT68	LUTOUT67	LUTOUT66	LUTOUT65	LUTOUT64
W	LUTOUT79	LUTOUT78	LUTOUT77	LUTOUT76	LUTOUT75	LUTOUT74	LUTOUT73	LUTOUT72	LUTOUT71	LUTOUT70	LUTOUT69	LUTOUT68	LUTOUT67	LUTOUT66	LUTOUT65	LUTOUT64
Reset	0	0	0	0	0	0	0	0	0	0	0	0	0	0	0	0

PXP_HW_PXP_WFE_B_STG1_8X1_OUT4_2 field descriptions

Field	Description
31 LUTOUT95	LUT OUT
30 LUTOUT94	LUT OUT
29 LUTOUT93	LUT OUT
28 LUTOUT92	LUT OUT
27 LUTOUT91	LUT OUT
26 LUTOUT90	LUT OUT
25 LUTOUT89	LUT OUT
24 LUTOUT88	LUT OUT
23 LUTOUT87	LUT OUT
22 LUTOUT86	LUT OUT
21 LUTOUT85	LUT OUT
20 LUTOUT84	LUT OUT
19 LUTOUT83	LUT OUT
18 LUTOUT82	LUT OUT
17 LUTOUT81	LUT OUT
16 LUTOUT80	LUT OUT
15 LUTOUT79	LUT OUT
14 LUTOUT78	LUT OUT
13 LUTOUT77	LUT OUT
12 LUTOUT76	LUT OUT
11 LUTOUT75	LUT OUT
10 LUTOUT74	LUT OUT
9 LUTOUT73	LUT OUT

Table continues on the next page...

PXP_HW_PXP_WFE_B_STG1_8X1_OUT4_2 field descriptions (continued)

Field	Description
8 LUTOUT72	LUT OUT
7 LUTOUT71	LUT OUT
6 LUTOUT70	LUT OUT
5 LUTOUT69	LUT OUT
4 LUTOUT68	LUT OUT
3 LUTOUT67	LUT OUT
2 LUTOUT66	LUT OUT
1 LUTOUT65	LUT OUT
0 LUTOUT64	LUT OUT

41.11.234 This register defines the output values (new flag) for the 8x1 LUTs in stage 1. (PXP_HW_PXP_WFE_B_STG1_8X1_OUT4_3)

The 5x1 LUT output value for input value n. This output value results in a flag that is added to the flag array.

Address: 21C_C000h base + 22C0h offset = 21C_E2C0h

Bit	31	30	29	28	27	26	25	24	23	22	21	20	19	18	17	16
R	LUTOUT127	LUTOUT126	LUTOUT125	LUTOUT124	LUTOUT123	LUTOUT122	LUTOUT121	LUTOUT120	LUTOUT119	LUTOUT118	LUTOUT117	LUTOUT116	LUTOUT115	LUTOUT114	LUTOUT113	LUTOUT112
W	LUTOUT127	LUTOUT126	LUTOUT125	LUTOUT124	LUTOUT123	LUTOUT122	LUTOUT121	LUTOUT120	LUTOUT119	LUTOUT118	LUTOUT117	LUTOUT116	LUTOUT115	LUTOUT114	LUTOUT113	LUTOUT112
Reset	0	0	0	0	0	0	0	0	0	0	0	0	0	0	0	0
Bit	15	14	13	12	11	10	9	8	7	6	5	4	3	2	1	0
R	LUTOUT111	LUTOUT110	LUTOUT109	LUTOUT108	LUTOUT107	LUTOUT106	LUTOUT105	LUTOUT104	LUTOUT103	LUTOUT102	LUTOUT101	LUTOUT100	LUTOUT99	LUTOUT98	LUTOUT97	LUTOUT96
W	LUTOUT111	LUTOUT110	LUTOUT109	LUTOUT108	LUTOUT107	LUTOUT106	LUTOUT105	LUTOUT104	LUTOUT103	LUTOUT102	LUTOUT101	LUTOUT100	LUTOUT99	LUTOUT98	LUTOUT97	LUTOUT96
Reset	0	0	0	0	0	0	0	0	0	0	0	0	0	0	0	0

PXP_HW_PXP_WFE_B_STG1_8X1_OUT4_3 field descriptions

Field	Description
31 LUTOUT127	LUT OUT
30 LUTOUT126	LUT OUT
29 LUTOUT125	LUT OUT
28 LUTOUT124	LUT OUT
27 LUTOUT123	LUT OUT
26 LUTOUT122	LUT OUT
25 LUTOUT121	LUT OUT
24 LUTOUT120	LUT OUT
23 LUTOUT119	LUT OUT
22 LUTOUT118	LUT OUT
21 LUTOUT117	LUT OUT
20 LUTOUT116	LUT OUT
19 LUTOUT115	LUT OUT
18 LUTOUT114	LUT OUT
17 LUTOUT113	LUT OUT
16 LUTOUT112	LUT OUT
15 LUTOUT111	LUT OUT
14 LUTOUT110	LUT OUT
13 LUTOUT109	LUT OUT
12 LUTOUT108	LUT OUT
11 LUTOUT107	LUT OUT
10 LUTOUT106	LUT OUT
9 LUTOUT105	LUT OUT

Table continues on the next page...

PXP_HW_PXP_WFE_B_STG1_8X1_OUT4_3 field descriptions (continued)

Field	Description
8 LUTOUT104	LUT OUT
7 LUTOUT103	LUT OUT
6 LUTOUT102	LUT OUT
5 LUTOUT101	LUT OUT
4 LUTOUT100	LUT OUT
3 LUTOUT99	LUT OUT
2 LUTOUT98	LUT OUT
1 LUTOUT97	LUT OUT
0 LUTOUT96	LUT OUT

**41.11.235 This register defines the output values (new flag) for the 8x1 LUTs in stage 1.
(PXP_HW_PXP_WFE_B_STG1_8X1_OUT4_4)**

The 5x1 LUT output value for input value n. This output value results in a flag that is added to the flag array.

Address: 21C_C000h base + 22D0h offset = 21C_E2D0h

Bit	31	30	29	28	27	26	25	24	23	22	21	20	19	18	17	16
R	LUTOUT159	LUTOUT158	LUTOUT157	LUTOUT156	LUTOUT155	LUTOUT154	LUTOUT153	LUTOUT152	LUTOUT151	LUTOUT150	LUTOUT149	LUTOUT148	LUTOUT147	LUTOUT146	LUTOUT145	LUTOUT144
W	LUTOUT159	LUTOUT158	LUTOUT157	LUTOUT156	LUTOUT155	LUTOUT154	LUTOUT153	LUTOUT152	LUTOUT151	LUTOUT150	LUTOUT149	LUTOUT148	LUTOUT147	LUTOUT146	LUTOUT145	LUTOUT144
Reset	0	0	0	0	0	0	0	0	0	0	0	0	0	0	0	0
Bit	15	14	13	12	11	10	9	8	7	6	5	4	3	2	1	0
R	LUTOUT143	LUTOUT142	LUTOUT141	LUTOUT140	LUTOUT139	LUTOUT138	LUTOUT137	LUTOUT136	LUTOUT135	LUTOUT134	LUTOUT133	LUTOUT132	LUTOUT131	LUTOUT130	LUTOUT129	LUTOUT128
W	LUTOUT143	LUTOUT142	LUTOUT141	LUTOUT140	LUTOUT139	LUTOUT138	LUTOUT137	LUTOUT136	LUTOUT135	LUTOUT134	LUTOUT133	LUTOUT132	LUTOUT131	LUTOUT130	LUTOUT129	LUTOUT128
Reset	0	0	0	0	0	0	0	0	0	0	0	0	0	0	0	0

PXP_HW_PXP_WFE_B_STG1_8X1_OUT4_4 field descriptions

Field	Description
31 LUTOUT159	LUT OUT
30 LUTOUT158	LUT OUT
29 LUTOUT157	LUT OUT
28 LUTOUT156	LUT OUT
27 LUTOUT155	LUT OUT
26 LUTOUT154	LUT OUT
25 LUTOUT153	LUT OUT
24 LUTOUT152	LUT OUT
23 LUTOUT151	LUT OUT
22 LUTOUT150	LUT OUT
21 LUTOUT149	LUT OUT
20 LUTOUT148	LUT OUT
19 LUTOUT147	LUT OUT
18 LUTOUT146	LUT OUT
17 LUTOUT145	LUT OUT
16 LUTOUT144	LUT OUT
15 LUTOUT143	LUT OUT
14 LUTOUT142	LUT OUT
13 LUTOUT141	LUT OUT
12 LUTOUT140	LUT OUT
11 LUTOUT139	LUT OUT
10 LUTOUT138	LUT OUT
9 LUTOUT137	LUT OUT

Table continues on the next page...

PXP_HW_PXP_WFE_B_STG1_8X1_OUT4_4 field descriptions (continued)

Field	Description
8 LUTOUT136	LUT OUT
7 LUTOUT135	LUT OUT
6 LUTOUT134	LUT OUT
5 LUTOUT133	LUT OUT
4 LUTOUT132	LUT OUT
3 LUTOUT131	LUT OUT
2 LUTOUT130	LUT OUT
1 LUTOUT129	LUT OUT
0 LUTOUT128	LUT OUT

41.11.236 This register defines the output values (new flag) for the 8x1 LUTs in stage 1. (PXP_HW_PXP_WFE_B_STG1_8X1_OUT4_5)

The 5x1 LUT output value for input value n. This output value results in a flag that is added to the flag array.

Address: 21C_C000h base + 22E0h offset = 21C_E2E0h

Bit	31	30	29	28	27	26	25	24	23	22	21	20	19	18	17	16
R	LUTOUT191	LUTOUT190	LUTOUT189	LUTOUT188	LUTOUT187	LUTOUT186	LUTOUT185	LUTOUT184	LUTOUT183	LUTOUT182	LUTOUT181	LUTOUT180	LUTOUT179	LUTOUT178	LUTOUT177	LUTOUT176
W	LUTOUT191	LUTOUT190	LUTOUT189	LUTOUT188	LUTOUT187	LUTOUT186	LUTOUT185	LUTOUT184	LUTOUT183	LUTOUT182	LUTOUT181	LUTOUT180	LUTOUT179	LUTOUT178	LUTOUT177	LUTOUT176
Reset	0	0	0	0	0	0	0	0	0	0	0	0	0	0	0	0
Bit	15	14	13	12	11	10	9	8	7	6	5	4	3	2	1	0
R	LUTOUT175	LUTOUT174	LUTOUT173	LUTOUT172	LUTOUT171	LUTOUT170	LUTOUT169	LUTOUT168	LUTOUT167	LUTOUT166	LUTOUT165	LUTOUT164	LUTOUT163	LUTOUT162	LUTOUT161	LUTOUT160
W	LUTOUT175	LUTOUT174	LUTOUT173	LUTOUT172	LUTOUT171	LUTOUT170	LUTOUT169	LUTOUT168	LUTOUT167	LUTOUT166	LUTOUT165	LUTOUT164	LUTOUT163	LUTOUT162	LUTOUT161	LUTOUT160
Reset	0	0	0	0	0	0	0	0	0	0	0	0	0	0	0	0

PXP_HW_PXP_WFE_B_STG1_8X1_OUT4_5 field descriptions

Field	Description
31 LUTOUT191	LUT OUT
30 LUTOUT190	LUT OUT
29 LUTOUT189	LUT OUT
28 LUTOUT188	LUT OUT
27 LUTOUT187	LUT OUT
26 LUTOUT186	LUT OUT
25 LUTOUT185	LUT OUT
24 LUTOUT184	LUT OUT
23 LUTOUT183	LUT OUT
22 LUTOUT182	LUT OUT
21 LUTOUT181	LUT OUT
20 LUTOUT180	LUT OUT
19 LUTOUT179	LUT OUT
18 LUTOUT178	LUT OUT
17 LUTOUT177	LUT OUT
16 LUTOUT176	LUT OUT
15 LUTOUT175	LUT OUT
14 LUTOUT174	LUT OUT
13 LUTOUT173	LUT OUT
12 LUTOUT172	LUT OUT
11 LUTOUT171	LUT OUT
10 LUTOUT170	LUT OUT
9 LUTOUT169	LUT OUT

Table continues on the next page...

PXP_HW_PXP_WFE_B_STG1_8X1_OUT4_5 field descriptions (continued)

Field	Description
8 LUTOUT168	LUT OUT
7 LUTOUT167	LUT OUT
6 LUTOUT166	LUT OUT
5 LUTOUT165	LUT OUT
4 LUTOUT164	LUT OUT
3 LUTOUT163	LUT OUT
2 LUTOUT162	LUT OUT
1 LUTOUT161	LUT OUT
0 LUTOUT160	LUT OUT

41.11.237 This register defines the output values (new flag) for the 8x1 LUTs in stage 1. (PXP_HW_PXP_WFE_B_STG1_8X1_OUT4_6)

The 5x1 LUT output value for input value n. This output value results in a flag that is added to the flag array.

Address: 21C_C000h base + 22F0h offset = 21C_E2F0h

Bit	31	30	29	28	27	26	25	24	23	22	21	20	19	18	17	16
R	LUTOUT223	LUTOUT222	LUTOUT221	LUTOUT220	LUTOUT219	LUTOUT218	LUTOUT217	LUTOUT216	LUTOUT215	LUTOUT214	LUTOUT213	LUTOUT212	LUTOUT211	LUTOUT210	LUTOUT209	LUTOUT208
W	LUTOUT223	LUTOUT222	LUTOUT221	LUTOUT220	LUTOUT219	LUTOUT218	LUTOUT217	LUTOUT216	LUTOUT215	LUTOUT214	LUTOUT213	LUTOUT212	LUTOUT211	LUTOUT210	LUTOUT209	LUTOUT208
Reset	0	0	0	0	0	0	0	0	0	0	0	0	0	0	0	0
Bit	15	14	13	12	11	10	9	8	7	6	5	4	3	2	1	0
R	LUTOUT207	LUTOUT206	LUTOUT205	LUTOUT204	LUTOUT203	LUTOUT202	LUTOUT201	LUTOUT200	LUTOUT199	LUTOUT198	LUTOUT197	LUTOUT196	LUTOUT195	LUTOUT194	LUTOUT193	LUTOUT192
W	LUTOUT207	LUTOUT206	LUTOUT205	LUTOUT204	LUTOUT203	LUTOUT202	LUTOUT201	LUTOUT200	LUTOUT199	LUTOUT198	LUTOUT197	LUTOUT196	LUTOUT195	LUTOUT194	LUTOUT193	LUTOUT192
Reset	0	0	0	0	0	0	0	0	0	0	0	0	0	0	0	0

PXP_HW_PXP_WFE_B_STG1_8X1_OUT4_6 field descriptions

Field	Description
31 LUTOUT223	LUT OUT
30 LUTOUT222	LUT OUT
29 LUTOUT221	LUT OUT
28 LUTOUT220	LUT OUT
27 LUTOUT219	LUT OUT
26 LUTOUT218	LUT OUT
25 LUTOUT217	LUT OUT
24 LUTOUT216	LUT OUT
23 LUTOUT215	LUT OUT
22 LUTOUT214	LUT OUT
21 LUTOUT213	LUT OUT
20 LUTOUT212	LUT OUT
19 LUTOUT211	LUT OUT
18 LUTOUT210	LUT OUT
17 LUTOUT209	LUT OUT
16 LUTOUT208	LUT OUT
15 LUTOUT207	LUT OUT
14 LUTOUT206	LUT OUT
13 LUTOUT205	LUT OUT
12 LUTOUT204	LUT OUT
11 LUTOUT203	LUT OUT
10 LUTOUT202	LUT OUT
9 LUTOUT201	LUT OUT

Table continues on the next page...

PXP_HW_PXP_WFE_B_STG1_8X1_OUT4_6 field descriptions (continued)

Field	Description
8 LUTOUT200	LUT OUT
7 LUTOUT199	LUT OUT
6 LUTOUT198	LUT OUT
5 LUTOUT197	LUT OUT
4 LUTOUT196	LUT OUT
3 LUTOUT195	LUT OUT
2 LUTOUT194	LUT OUT
1 LUTOUT193	LUT OUT
0 LUTOUT192	LUT OUT

**41.11.238 This register defines the output values (new flag) for the 8x1 LUTs in stage 1.
(PXP_HW_PXP_WFE_B_STG1_8X1_OUT4_7)**

The 5x1 LUT output value for input value n. This output value results in a flag that is added to the flag array.

Address: 21C_C000h base + 2300h offset = 21C_E300h

Bit	31	30	29	28	27	26	25	24	23	22	21	20	19	18	17	16
R	LUTOUT255	LUTOUT254	LUTOUT253	LUTOUT252	LUTOUT251	LUTOUT250	LUTOUT249	LUTOUT248	LUTOUT247	LUTOUT246	LUTOUT245	LUTOUT244	LUTOUT243	LUTOUT242	LUTOUT241	LUTOUT240
W	LUTOUT255	LUTOUT254	LUTOUT253	LUTOUT252	LUTOUT251	LUTOUT250	LUTOUT249	LUTOUT248	LUTOUT247	LUTOUT246	LUTOUT245	LUTOUT244	LUTOUT243	LUTOUT242	LUTOUT241	LUTOUT240
Reset	0	0	0	0	0	0	0	0	0	0	0	0	0	0	0	0
Bit	15	14	13	12	11	10	9	8	7	6	5	4	3	2	1	0
R	LUTOUT239	LUTOUT238	LUTOUT237	LUTOUT236	LUTOUT235	LUTOUT234	LUTOUT233	LUTOUT232	LUTOUT231	LUTOUT230	LUTOUT229	LUTOUT228	LUTOUT227	LUTOUT226	LUTOUT225	LUTOUT224
W	LUTOUT239	LUTOUT238	LUTOUT237	LUTOUT236	LUTOUT235	LUTOUT234	LUTOUT233	LUTOUT232	LUTOUT231	LUTOUT230	LUTOUT229	LUTOUT228	LUTOUT227	LUTOUT226	LUTOUT225	LUTOUT224
Reset	0	0	0	0	0	0	0	0	0	0	0	0	0	0	0	0

PXP_HW_PXP_WFE_B_STG1_8X1_OUT4_7 field descriptions

Field	Description
31 LUTOUT255	LUT OUT
30 LUTOUT254	LUT OUT
29 LUTOUT253	LUT OUT
28 LUTOUT252	LUT OUT
27 LUTOUT251	LUT OUT
26 LUTOUT250	LUT OUT
25 LUTOUT249	LUT OUT
24 LUTOUT248	LUT OUT
23 LUTOUT247	LUT OUT
22 LUTOUT246	LUT OUT
21 LUTOUT245	LUT OUT
20 LUTOUT244	LUT OUT
19 LUTOUT243	LUT OUT
18 LUTOUT242	LUT OUT
17 LUTOUT241	LUT OUT
16 LUTOUT240	LUT OUT
15 LUTOUT239	LUT OUT
14 LUTOUT238	LUT OUT
13 LUTOUT237	LUT OUT
12 LUTOUT236	LUT OUT
11 LUTOUT235	LUT OUT
10 LUTOUT234	LUT OUT
9 LUTOUT233	LUT OUT

Table continues on the next page...

PXP_HW_PXP_WFE_B_STG1_8X1_OUT4_7 field descriptions (continued)

Field	Description
8 LUTOUT232	LUT OUT
7 LUTOUT231	LUT OUT
6 LUTOUT230	LUT OUT
5 LUTOUT229	LUT OUT
4 LUTOUT228	LUT OUT
3 LUTOUT227	LUT OUT
2 LUTOUT226	LUT OUT
1 LUTOUT225	LUT OUT
0 LUTOUT224	LUT OUT

41.11.239 This register defines the control bits for the pxp wfe sub-block (PXP_HW_PXP_WFE_B_STG2_5X6_OUT0_0)

The 5x6 LUT output value for input value n. This output value determines which input to select (flag, data).

Address: 21C_C000h base + 2310h offset = 21C_E310h

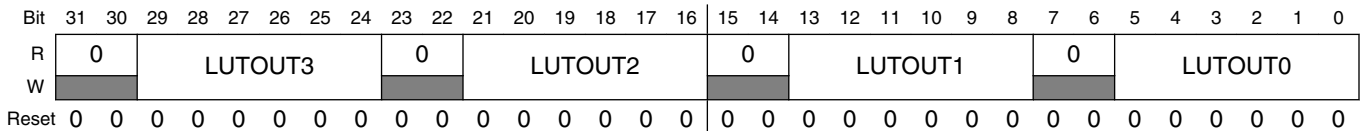

PXP_HW_PXP_WFE_B_STG2_5X6_OUT0_0 field descriptions

Field	Description
31–30 Reserved	This read-only field is reserved and always has the value 0.
29–24 LUTOUT3	LUTOUT 3
23–22 Reserved	This read-only field is reserved and always has the value 0.

Table continues on the next page...

PXP_HW_PXP_WFE_B_STG2_5X6_OUT0_0 field descriptions (continued)

Field	Description
21–16 LUTOUT2	LUTOUT 2
15–14 Reserved	This read-only field is reserved and always has the value 0.
13–8 LUTOUT1	LUTOUT 1
7–6 Reserved	This read-only field is reserved and always has the value 0.
LUTOUT0	LUTOUT 0

41.11.240 This register defines the control bits for the pxp wfe sub-block (PXP_HW_PXP_WFE_B_STG2_5X6_OUT0_1)

The 5x6 LUT output value for input value n. This output value determines which input to select (flag, data).

Address: 21C_C000h base + 2320h offset = 21C_E320h

Bit	31	30	29	28	27	26	25	24	23	22	21	20	19	18	17	16	15	14	13	12	11	10	9	8	7	6	5	4	3	2	1	0
R	0								0								0								0							
W																																
Reset	0	0	0	0	0	0	0	0	0	0	0	0	0	0	0	0	0	0	0	0	0	0	0	0	0	0	0	0	0	0	0	0

PXP_HW_PXP_WFE_B_STG2_5X6_OUT0_1 field descriptions

Field	Description
31–30 Reserved	This read-only field is reserved and always has the value 0.
29–24 LUTOUT7	LUTOUT 7
23–22 Reserved	This read-only field is reserved and always has the value 0.
21–16 LUTOUT6	LUTOUT 6
15–14 Reserved	This read-only field is reserved and always has the value 0.
13–8 LUTOUT5	LUTOUT 5
7–6 Reserved	This read-only field is reserved and always has the value 0.
LUTOUT4	LUTOUT 4

41.11.241 This register defines the control bits for the pxp wfe sub-block (PXP_HW_PXP_WFE_B_STG2_5X6_OUT0_2)

The 5x6 LUT output value for input value n. This output value determines which input to select (flag, data).

Address: 21C_C000h base + 2330h offset = 21C_E330h

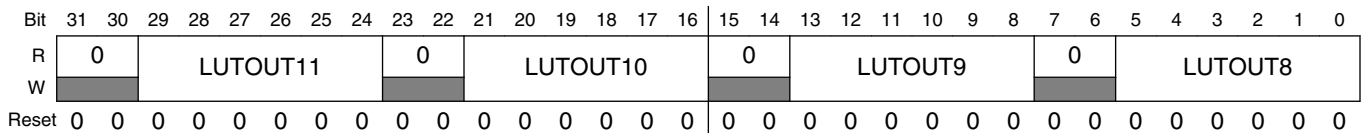

PXP_HW_PXP_WFE_B_STG2_5X6_OUT0_2 field descriptions

Field	Description
31–30 Reserved	This read-only field is reserved and always has the value 0.
29–24 LUTOUT11	LUTOUT 11
23–22 Reserved	This read-only field is reserved and always has the value 0.
21–16 LUTOUT10	LUTOUT 10
15–14 Reserved	This read-only field is reserved and always has the value 0.
13–8 LUTOUT9	LUTOUT 9
7–6 Reserved	This read-only field is reserved and always has the value 0.
LUTOUT8	LUTOUT 8

41.11.242 This register defines the control bits for the pxp wfe sub-block (PXP_HW_PXP_WFE_B_STG2_5X6_OUT0_3)

The 5x6 LUT output value for input value n. This output value determines which input to select (flag, data).

Address: 21C_C000h base + 2340h offset = 21C_E340h

Bit	31	30	29	28	27	26	25	24	23	22	21	20	19	18	17	16	15	14	13	12	11	10	9	8	7	6	5	4	3	2	1	0
R	0								0								0								0							
W																																
Reset	0	0	0	0	0	0	0	0	0	0	0	0	0	0	0	0	0	0	0	0	0	0	0	0	0	0	0	0	0	0	0	0

PXP_HW_PXP_WFE_B_STG2_5X6_OUT0_3 field descriptions

Field	Description
31–30 Reserved	This read-only field is reserved and always has the value 0.
29–24 LUTOUT15	LUTOUT 15
23–22 Reserved	This read-only field is reserved and always has the value 0.
21–16 LUTOUT14	LUTOUT 14
15–14 Reserved	This read-only field is reserved and always has the value 0.
13–8 LUTOUT13	LUTOUT 13
7–6 Reserved	This read-only field is reserved and always has the value 0.
LUTOUT12	LUTOUT 12

41.11.243 This register defines the control bits for the pxp wfe sub-block (PXP_HW_PXP_WFE_B_STG2_5X6_OUT0_4)

The 5x6 LUT output value for input value n. This output value determines which input to select (flag, data).

Address: 21C_C000h base + 2350h offset = 21C_E350h

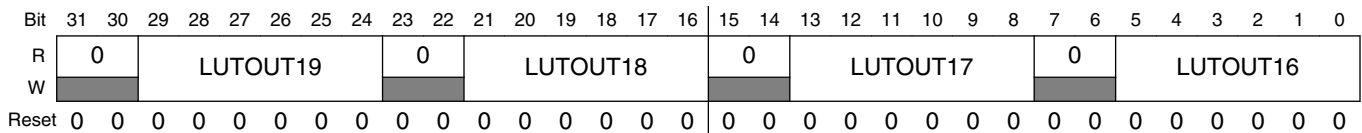

PXP_HW_PXP_WFE_B_STG2_5X6_OUT0_4 field descriptions

Field	Description
31–30 Reserved	This read-only field is reserved and always has the value 0.
29–24 LUTOUT19	LUTOUT 19
23–22 Reserved	This read-only field is reserved and always has the value 0.
21–16 LUTOUT18	LUTOUT 18
15–14 Reserved	This read-only field is reserved and always has the value 0.
13–8 LUTOUT17	LUTOUT 17
7–6 Reserved	This read-only field is reserved and always has the value 0.
LUTOUT16	LUTOUT 16

41.11.244 This register defines the control bits for the pxp wfe sub-block (PXP_HW_PXP_WFE_B_STG2_5X6_OUT0_5)

The 5x6 LUT output value for input value n. This output value determines which input to select (flag, data).

Address: 21C_C000h base + 2360h offset = 21C_E360h

Bit	31	30	29	28	27	26	25	24	23	22	21	20	19	18	17	16	15	14	13	12	11	10	9	8	7	6	5	4	3	2	1	0
R	0								0								0								0							
W																																
Reset	0	0	0	0	0	0	0	0	0	0	0	0	0	0	0	0	0	0	0	0	0	0	0	0	0	0	0	0	0	0	0	0

PXP_HW_PXP_WFE_B_STG2_5X6_OUT0_5 field descriptions

Field	Description
31–30 Reserved	This read-only field is reserved and always has the value 0.
29–24 LUTOUT23	LUTOUT 23
23–22 Reserved	This read-only field is reserved and always has the value 0.
21–16 LUTOUT22	LUTOUT 22
15–14 Reserved	This read-only field is reserved and always has the value 0.
13–8 LUTOUT21	LUTOUT 21
7–6 Reserved	This read-only field is reserved and always has the value 0.
LUTOUT20	LUTOUT 20

41.11.245 This register defines the control bits for the pxp wfe sub-block (PXP_HW_PXP_WFE_B_STG2_5X6_OUT0_6)

The 5x6 LUT output value for input value n. This output value determines which input to select (flag, data).

Address: 21C_C000h base + 2370h offset = 21C_E370h

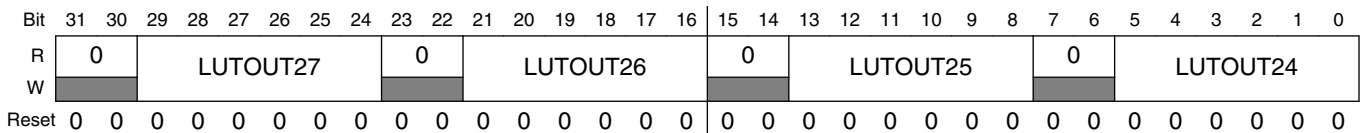

PXP_HW_PXP_WFE_B_STG2_5X6_OUT0_6 field descriptions

Field	Description
31–30 Reserved	This read-only field is reserved and always has the value 0.
29–24 LUTOUT27	LUTOUT 27
23–22 Reserved	This read-only field is reserved and always has the value 0.
21–16 LUTOUT26	LUTOUT 26
15–14 Reserved	This read-only field is reserved and always has the value 0.
13–8 LUTOUT25	LUTOUT 25
7–6 Reserved	This read-only field is reserved and always has the value 0.
LUTOUT24	LUTOUT 24

41.11.246 This register defines the control bits for the pxp wfe sub-block (PXP_HW_PXP_WFE_B_STG2_5X6_OUT0_7)

The 5x6 LUT output value for input value n. This output value determines which input to select (flag, data).

Address: 21C_C000h base + 2380h offset = 21C_E380h

Bit	31	30	29	28	27	26	25	24	23	22	21	20	19	18	17	16	15	14	13	12	11	10	9	8	7	6	5	4	3	2	1	0
R	0								0								0								0							
W																																
Reset	0	0	0	0	0	0	0	0	0	0	0	0	0	0	0	0	0	0	0	0	0	0	0	0	0	0	0	0	0	0	0	0

PXP_HW_PXP_WFE_B_STG2_5X6_OUT0_7 field descriptions

Field	Description
31–30 Reserved	This read-only field is reserved and always has the value 0.
29–24 LUTOUT31	LUTOUT 31
23–22 Reserved	This read-only field is reserved and always has the value 0.
21–16 LUTOUT30	LUTOUT 30
15–14 Reserved	This read-only field is reserved and always has the value 0.
13–8 LUTOUT29	LUTOUT 29
7–6 Reserved	This read-only field is reserved and always has the value 0.
LUTOUT28	LUTOUT 28

41.11.247 This register defines the control bits for the pxp wfe sub-block (PXP_HW_PXP_WFE_B_STG2_5X6_OUT1_0)

The 5x6 LUT output value for input value n. This output value determines which input to select (flag, data).

Address: 21C_C000h base + 2390h offset = 21C_E390h

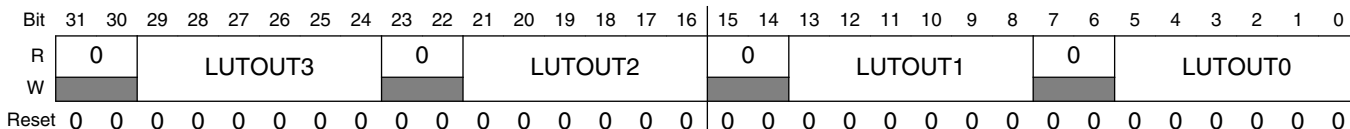

PXP_HW_PXP_WFE_B_STG2_5X6_OUT1_0 field descriptions

Field	Description
31–30 Reserved	This read-only field is reserved and always has the value 0.
29–24 LUTOUT3	LUTOUT 3
23–22 Reserved	This read-only field is reserved and always has the value 0.
21–16 LUTOUT2	LUTOUT 2
15–14 Reserved	This read-only field is reserved and always has the value 0.
13–8 LUTOUT1	LUTOUT 1
7–6 Reserved	This read-only field is reserved and always has the value 0.
LUTOUT0	LUTOUT 0

41.11.248 This register defines the control bits for the pxp wfe sub-block (PXP_HW_PXP_WFE_B_STG2_5X6_OUT1_1)

The 5x6 LUT output value for input value n. This output value determines which input to select (flag, data).

Address: 21C_C000h base + 23A0h offset = 21C_E3A0h

Bit	31	30	29	28	27	26	25	24	23	22	21	20	19	18	17	16	15	14	13	12	11	10	9	8	7	6	5	4	3	2	1	0
R	0								0								0								0							
W																																
Reset	0	0	0	0	0	0	0	0	0	0	0	0	0	0	0	0	0	0	0	0	0	0	0	0	0	0	0	0	0	0	0	0

PXP_HW_PXP_WFE_B_STG2_5X6_OUT1_1 field descriptions

Field	Description
31–30 Reserved	This read-only field is reserved and always has the value 0.
29–24 LUTOUT7	LUTOUT 7
23–22 Reserved	This read-only field is reserved and always has the value 0.
21–16 LUTOUT6	LUTOUT 6
15–14 Reserved	This read-only field is reserved and always has the value 0.
13–8 LUTOUT5	LUTOUT 5
7–6 Reserved	This read-only field is reserved and always has the value 0.
LUTOUT4	LUTOUT 4

41.11.249 This register defines the control bits for the pxp wfe sub-block (PXP_HW_PXP_WFE_B_STG2_5X6_OUT1_2)

The 5x6 LUT output value for input value n. This output value determines which input to select (flag, data).

Address: 21C_C000h base + 23B0h offset = 21C_E3B0h

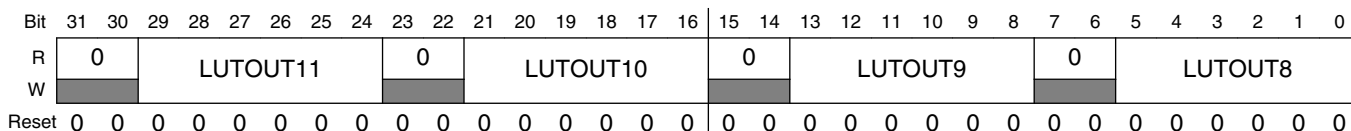

PXP_HW_PXP_WFE_B_STG2_5X6_OUT1_2 field descriptions

Field	Description
31–30 Reserved	This read-only field is reserved and always has the value 0.
29–24 LUTOUT11	LUTOUT 11
23–22 Reserved	This read-only field is reserved and always has the value 0.
21–16 LUTOUT10	LUTOUT 10
15–14 Reserved	This read-only field is reserved and always has the value 0.
13–8 LUTOUT9	LUTOUT 9
7–6 Reserved	This read-only field is reserved and always has the value 0.
LUTOUT8	LUTOUT 8

41.11.250 This register defines the control bits for the pxp wfe sub-block (PXP_HW_PXP_WFE_B_STG2_5X6_OUT1_3)

The 5x6 LUT output value for input value n. This output value determines which input to select (flag, data).

Address: 21C_C000h base + 23C0h offset = 21C_E3C0h

Bit	31	30	29	28	27	26	25	24	23	22	21	20	19	18	17	16	15	14	13	12	11	10	9	8	7	6	5	4	3	2	1	0
R	0								0								0								0							
W																																
Reset	0	0	0	0	0	0	0	0	0	0	0	0	0	0	0	0	0	0	0	0	0	0	0	0	0	0	0	0	0	0	0	0

PXP_HW_PXP_WFE_B_STG2_5X6_OUT1_3 field descriptions

Field	Description
31–30 Reserved	This read-only field is reserved and always has the value 0.
29–24 LUTOUT15	LUTOUT 15
23–22 Reserved	This read-only field is reserved and always has the value 0.
21–16 LUTOUT14	LUTOUT 14
15–14 Reserved	This read-only field is reserved and always has the value 0.
13–8 LUTOUT13	LUTOUT 13
7–6 Reserved	This read-only field is reserved and always has the value 0.
LUTOUT12	LUTOUT 12

41.11.251 This register defines the control bits for the pxp wfe sub-block (PXP_HW_PXP_WFE_B_STG2_5X6_OUT1_4)

The 5x6 LUT output value for input value n. This output value determines which input to select (flag, data).

Address: 21C_C000h base + 23D0h offset = 21C_E3D0h

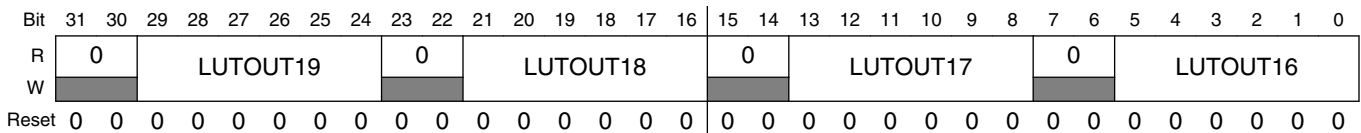

PXP_HW_PXP_WFE_B_STG2_5X6_OUT1_4 field descriptions

Field	Description
31–30 Reserved	This read-only field is reserved and always has the value 0.
29–24 LUTOUT19	LUTOUT 19
23–22 Reserved	This read-only field is reserved and always has the value 0.
21–16 LUTOUT18	LUTOUT 18
15–14 Reserved	This read-only field is reserved and always has the value 0.
13–8 LUTOUT17	LUTOUT 17
7–6 Reserved	This read-only field is reserved and always has the value 0.
LUTOUT16	LUTOUT 16

41.11.252 This register defines the control bits for the pxp wfe sub-block (PXP_HW_PXP_WFE_B_STG2_5X6_OUT1_5)

The 5x6 LUT output value for input value n. This output value determines which input to select (flag, data).

Address: 21C_C000h base + 23E0h offset = 21C_E3E0h

Bit	31	30	29	28	27	26	25	24	23	22	21	20	19	18	17	16	15	14	13	12	11	10	9	8	7	6	5	4	3	2	1	0
R	0								0								0								0							
W																																
Reset	0	0	0	0	0	0	0	0	0	0	0	0	0	0	0	0	0	0	0	0	0	0	0	0	0	0	0	0	0	0	0	0

PXP_HW_PXP_WFE_B_STG2_5X6_OUT1_5 field descriptions

Field	Description
31–30 Reserved	This read-only field is reserved and always has the value 0.
29–24 LUTOUT23	LUTOUT 23
23–22 Reserved	This read-only field is reserved and always has the value 0.
21–16 LUTOUT22	LUTOUT 22
15–14 Reserved	This read-only field is reserved and always has the value 0.
13–8 LUTOUT21	LUTOUT 21
7–6 Reserved	This read-only field is reserved and always has the value 0.
LUTOUT20	LUTOUT 20

41.11.253 This register defines the control bits for the pxp wfe sub-block (PXP_HW_PXP_WFE_B_STG2_5X6_OUT1_6)

The 5x6 LUT output value for input value n. This output value determines which input to select (flag, data).

Address: 21C_C000h base + 23F0h offset = 21C_E3F0h

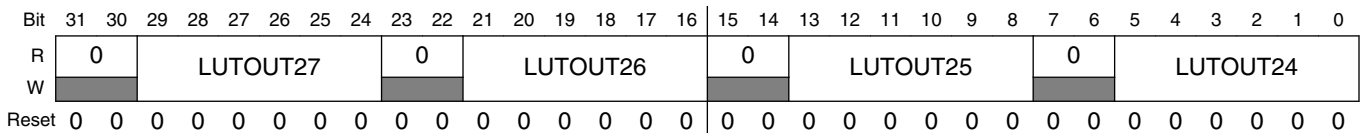

PXP_HW_PXP_WFE_B_STG2_5X6_OUT1_6 field descriptions

Field	Description
31–30 Reserved	This read-only field is reserved and always has the value 0.
29–24 LUTOUT27	LUTOUT 27
23–22 Reserved	This read-only field is reserved and always has the value 0.
21–16 LUTOUT26	LUTOUT 26
15–14 Reserved	This read-only field is reserved and always has the value 0.
13–8 LUTOUT25	LUTOUT 25
7–6 Reserved	This read-only field is reserved and always has the value 0.
LUTOUT24	LUTOUT 24

41.11.254 This register defines the control bits for the pxp wfe sub-block (PXP_HW_PXP_WFE_B_STG2_5X6_OUT1_7)

The 5x6 LUT output value for input value n. This output value determines which input to select (flag, data).

Address: 21C_C000h base + 2400h offset = 21C_E400h

Bit	31	30	29	28	27	26	25	24	23	22	21	20	19	18	17	16	15	14	13	12	11	10	9	8	7	6	5	4	3	2	1	0
R	0								0								0								0							
W																																
Reset	0	0	0	0	0	0	0	0	0	0	0	0	0	0	0	0	0	0	0	0	0	0	0	0	0	0	0	0	0	0	0	0

PXP_HW_PXP_WFE_B_STG2_5X6_OUT1_7 field descriptions

Field	Description
31–30 Reserved	This read-only field is reserved and always has the value 0.
29–24 LUTOUT31	LUTOUT 31
23–22 Reserved	This read-only field is reserved and always has the value 0.
21–16 LUTOUT30	LUTOUT 30
15–14 Reserved	This read-only field is reserved and always has the value 0.
13–8 LUTOUT29	LUTOUT 29
7–6 Reserved	This read-only field is reserved and always has the value 0.
LUTOUT28	LUTOUT 28

41.11.255 This register defines the control bits for the pxp wfe sub-block (PXP_HW_PXP_WFE_B_STG2_5X6_OUT2_0)

The 5x6 LUT output value for input value n. This output value determines which input to select (flag, data).

Address: 21C_C000h base + 2410h offset = 21C_E410h

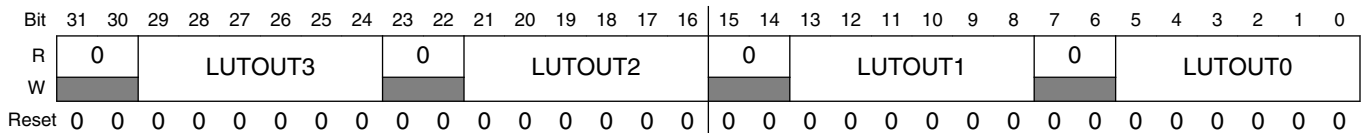

PXP_HW_PXP_WFE_B_STG2_5X6_OUT2_0 field descriptions

Field	Description
31–30 Reserved	This read-only field is reserved and always has the value 0.
29–24 LUTOUT3	LUTOUT 3
23–22 Reserved	This read-only field is reserved and always has the value 0.
21–16 LUTOUT2	LUTOUT 2
15–14 Reserved	This read-only field is reserved and always has the value 0.
13–8 LUTOUT1	LUTOUT 1
7–6 Reserved	This read-only field is reserved and always has the value 0.
LUTOUT0	LUTOUT 0

41.11.256 This register defines the control bits for the pxp wfe sub-block (PXP_HW_PXP_WFE_B_STG2_5X6_OUT2_1)

The 5x6 LUT output value for input value n. This output value determines which input to select (flag, data).

Address: 21C_C000h base + 2420h offset = 21C_E420h

Bit	31	30	29	28	27	26	25	24	23	22	21	20	19	18	17	16	15	14	13	12	11	10	9	8	7	6	5	4	3	2	1	0
R	0								0								0								0							
W																																
Reset	0	0	0	0	0	0	0	0	0	0	0	0	0	0	0	0	0	0	0	0	0	0	0	0	0	0	0	0	0	0	0	0

PXP_HW_PXP_WFE_B_STG2_5X6_OUT2_1 field descriptions

Field	Description
31–30 Reserved	This read-only field is reserved and always has the value 0.
29–24 LUTOUT7	LUTOUT 7
23–22 Reserved	This read-only field is reserved and always has the value 0.
21–16 LUTOUT6	LUTOUT 6
15–14 Reserved	This read-only field is reserved and always has the value 0.
13–8 LUTOUT5	LUTOUT 5
7–6 Reserved	This read-only field is reserved and always has the value 0.
LUTOUT4	LUTOUT 4

41.11.257 This register defines the control bits for the pxp wfe sub-block (PXP_HW_PXP_WFE_B_STG2_5X6_OUT2_2)

The 5x6 LUT output value for input value n. This output value determines which input to select (flag, data).

Address: 21C_C000h base + 2430h offset = 21C_E430h

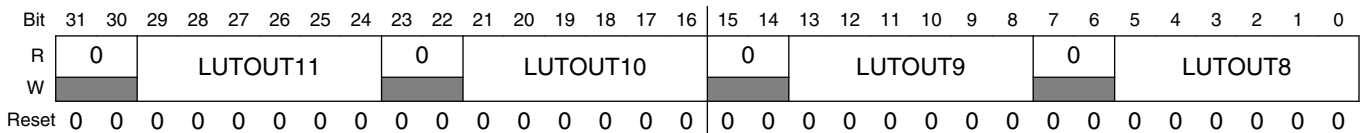

PXP_HW_PXP_WFE_B_STG2_5X6_OUT2_2 field descriptions

Field	Description
31–30 Reserved	This read-only field is reserved and always has the value 0.
29–24 LUTOUT11	LUTOUT 11
23–22 Reserved	This read-only field is reserved and always has the value 0.
21–16 LUTOUT10	LUTOUT 10
15–14 Reserved	This read-only field is reserved and always has the value 0.
13–8 LUTOUT9	LUTOUT 9
7–6 Reserved	This read-only field is reserved and always has the value 0.
LUTOUT8	LUTOUT 8

41.11.258 This register defines the control bits for the pxp wfe sub-block (PXP_HW_PXP_WFE_B_STG2_5X6_OUT2_3)

The 5x6 LUT output value for input value n. This output value determines which input to select (flag, data).

Address: 21C_C000h base + 2440h offset = 21C_E440h

Bit	31	30	29	28	27	26	25	24	23	22	21	20	19	18	17	16	15	14	13	12	11	10	9	8	7	6	5	4	3	2	1	0
R	0		LUTOUT15						0		LUTOUT14						0		LUTOUT13						0		LUTOUT12					
W	0		0						0		0						0		0						0		0					
Reset	0	0	0	0	0	0	0	0	0	0	0	0	0	0	0	0	0	0	0	0	0	0	0	0	0	0	0	0	0	0	0	0

PXP_HW_PXP_WFE_B_STG2_5X6_OUT2_3 field descriptions

Field	Description
31–30 Reserved	This read-only field is reserved and always has the value 0.
29–24 LUTOUT15	LUTOUT 15
23–22 Reserved	This read-only field is reserved and always has the value 0.
21–16 LUTOUT14	LUTOUT 14
15–14 Reserved	This read-only field is reserved and always has the value 0.
13–8 LUTOUT13	LUTOUT 13
7–6 Reserved	This read-only field is reserved and always has the value 0.
LUTOUT12	LUTOUT 12

41.11.259 This register defines the control bits for the pxp wfe sub-block (PXP_HW_PXP_WFE_B_STG2_5X6_OUT2_4)

The 5x6 LUT output value for input value n. This output value determines which input to select (flag, data).

Address: 21C_C000h base + 2450h offset = 21C_E450h

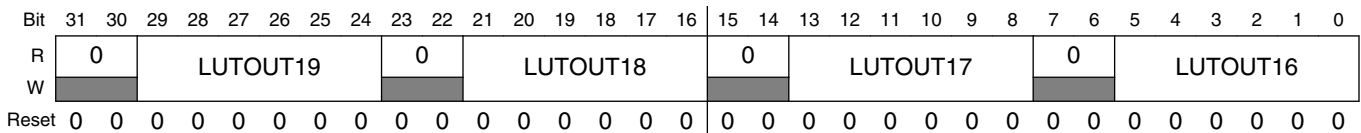

PXP_HW_PXP_WFE_B_STG2_5X6_OUT2_4 field descriptions

Field	Description
31–30 Reserved	This read-only field is reserved and always has the value 0.
29–24 LUTOUT19	LUTOUT 19
23–22 Reserved	This read-only field is reserved and always has the value 0.
21–16 LUTOUT18	LUTOUT 18
15–14 Reserved	This read-only field is reserved and always has the value 0.
13–8 LUTOUT17	LUTOUT 17
7–6 Reserved	This read-only field is reserved and always has the value 0.
LUTOUT16	LUTOUT 16

41.11.260 This register defines the control bits for the pxp wfe sub-block (PXP_HW_PXP_WFE_B_STG2_5X6_OUT2_5)

The 5x6 LUT output value for input value n. This output value determines which input to select (flag, data).

Address: 21C_C000h base + 2460h offset = 21C_E460h

Bit	31	30	29	28	27	26	25	24	23	22	21	20	19	18	17	16	15	14	13	12	11	10	9	8	7	6	5	4	3	2	1	0
R	0								0								0								0							
W																																
Reset	0	0	0	0	0	0	0	0	0	0	0	0	0	0	0	0	0	0	0	0	0	0	0	0	0	0	0	0	0	0	0	0

PXP_HW_PXP_WFE_B_STG2_5X6_OUT2_5 field descriptions

Field	Description
31–30 Reserved	This read-only field is reserved and always has the value 0.
29–24 LUTOUT23	LUTOUT 23
23–22 Reserved	This read-only field is reserved and always has the value 0.
21–16 LUTOUT22	LUTOUT 22
15–14 Reserved	This read-only field is reserved and always has the value 0.
13–8 LUTOUT21	LUTOUT 21
7–6 Reserved	This read-only field is reserved and always has the value 0.
LUTOUT20	LUTOUT 20

41.11.261 This register defines the control bits for the pxp wfe sub-block (PXP_HW_PXP_WFE_B_STG2_5X6_OUT2_6)

The 5x6 LUT output value for input value n. This output value determines which input to select (flag, data).

Address: 21C_C000h base + 2470h offset = 21C_E470h

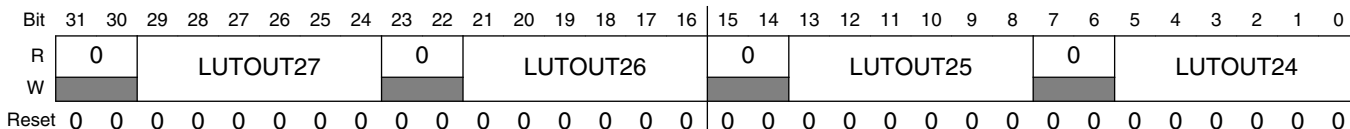

PXP_HW_PXP_WFE_B_STG2_5X6_OUT2_6 field descriptions

Field	Description
31–30 Reserved	This read-only field is reserved and always has the value 0.
29–24 LUTOUT27	LUTOUT 27
23–22 Reserved	This read-only field is reserved and always has the value 0.
21–16 LUTOUT26	LUTOUT 26
15–14 Reserved	This read-only field is reserved and always has the value 0.
13–8 LUTOUT25	LUTOUT 25
7–6 Reserved	This read-only field is reserved and always has the value 0.
LUTOUT24	LUTOUT 24

41.11.262 This register defines the control bits for the pxp wfe sub-block (PXP_HW_PXP_WFE_B_STG2_5X6_OUT2_7)

The 5x6 LUT output value for input value n. This output value determines which input to select (flag, data).

Address: 21C_C000h base + 2480h offset = 21C_E480h

Bit	31	30	29	28	27	26	25	24	23	22	21	20	19	18	17	16	15	14	13	12	11	10	9	8	7	6	5	4	3	2	1	0
R	0		LUTOUT31						0		LUTOUT30						0		LUTOUT29						0		LUTOUT28					
W	0		0						0		0						0		0						0		0					
Reset	0	0	0	0	0	0	0	0	0	0	0	0	0	0	0	0	0	0	0	0	0	0	0	0	0	0	0	0	0	0	0	0

PXP_HW_PXP_WFE_B_STG2_5X6_OUT2_7 field descriptions

Field	Description
31–30 Reserved	This read-only field is reserved and always has the value 0.
29–24 LUTOUT31	LUTOUT 31
23–22 Reserved	This read-only field is reserved and always has the value 0.
21–16 LUTOUT30	LUTOUT 30
15–14 Reserved	This read-only field is reserved and always has the value 0.
13–8 LUTOUT29	LUTOUT 29
7–6 Reserved	This read-only field is reserved and always has the value 0.
LUTOUT28	LUTOUT 28

41.11.263 This register defines the control bits for the pxp wfe sub-block (PXP_HW_PXP_WFE_B_STG2_5X6_OUT3_0)

The 5x6 LUT output value for input value n. This output value determines which input to select (flag, data).

Address: 21C_C000h base + 2490h offset = 21C_E490h

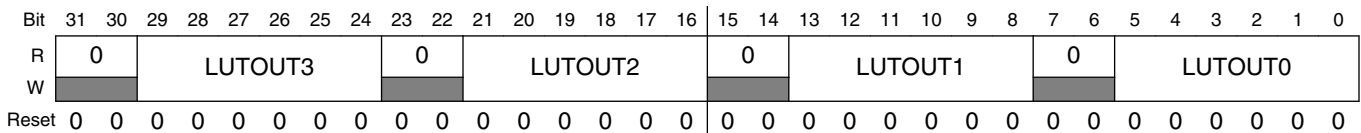

PXP_HW_PXP_WFE_B_STG2_5X6_OUT3_0 field descriptions

Field	Description
31–30 Reserved	This read-only field is reserved and always has the value 0.
29–24 LUTOUT3	LUTOUT 3
23–22 Reserved	This read-only field is reserved and always has the value 0.
21–16 LUTOUT2	LUTOUT 2
15–14 Reserved	This read-only field is reserved and always has the value 0.
13–8 LUTOUT1	LUTOUT 1
7–6 Reserved	This read-only field is reserved and always has the value 0.
LUTOUT0	LUTOUT 0

41.11.264 This register defines the control bits for the pxp wfe sub-block (PXP_HW_PXP_WFE_B_STG2_5X6_OUT3_1)

The 5x6 LUT output value for input value n. This output value determines which input to select (flag, data).

Address: 21C_C000h base + 24A0h offset = 21C_E4A0h

Bit	31	30	29	28	27	26	25	24	23	22	21	20	19	18	17	16	15	14	13	12	11	10	9	8	7	6	5	4	3	2	1	0
R	0								0								0								0							
W																																
Reset	0	0	0	0	0	0	0	0	0	0	0	0	0	0	0	0	0	0	0	0	0	0	0	0	0	0	0	0	0	0	0	0

PXP_HW_PXP_WFE_B_STG2_5X6_OUT3_1 field descriptions

Field	Description
31–30 Reserved	This read-only field is reserved and always has the value 0.
29–24 LUTOUT7	LUTOUT 7
23–22 Reserved	This read-only field is reserved and always has the value 0.
21–16 LUTOUT6	LUTOUT 6
15–14 Reserved	This read-only field is reserved and always has the value 0.
13–8 LUTOUT5	LUTOUT 5
7–6 Reserved	This read-only field is reserved and always has the value 0.
LUTOUT4	LUTOUT 4

41.11.265 This register defines the control bits for the pxp wfe sub-block (PXP_HW_PXP_WFE_B_STG2_5X6_OUT3_2)

The 5x6 LUT output value for input value n. This output value determines which input to select (flag, data).

Address: 21C_C000h base + 24B0h offset = 21C_E4B0h

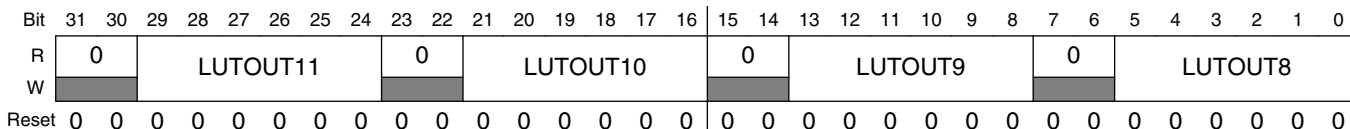

PXP_HW_PXP_WFE_B_STG2_5X6_OUT3_2 field descriptions

Field	Description
31–30 Reserved	This read-only field is reserved and always has the value 0.
29–24 LUTOUT11	LUTOUT 11
23–22 Reserved	This read-only field is reserved and always has the value 0.
21–16 LUTOUT10	LUTOUT 10
15–14 Reserved	This read-only field is reserved and always has the value 0.
13–8 LUTOUT9	LUTOUT 9
7–6 Reserved	This read-only field is reserved and always has the value 0.
LUTOUT8	LUTOUT 8

41.11.266 This register defines the control bits for the pxp wfe sub-block (PXP_HW_PXP_WFE_B_STG2_5X6_OUT3_3)

The 5x6 LUT output value for input value n. This output value determines which input to select (flag, data).

Address: 21C_C000h base + 24C0h offset = 21C_E4C0h

Bit	31	30	29	28	27	26	25	24	23	22	21	20	19	18	17	16	15	14	13	12	11	10	9	8	7	6	5	4	3	2	1	0
R	0		LUTOUT15						0		LUTOUT14						0		LUTOUT13						0		LUTOUT12					
W	0		0						0		0						0		0						0		0					
Reset	0	0	0	0	0	0	0	0	0	0	0	0	0	0	0	0	0	0	0	0	0	0	0	0	0	0	0	0	0	0	0	0

PXP_HW_PXP_WFE_B_STG2_5X6_OUT3_3 field descriptions

Field	Description
31–30 Reserved	This read-only field is reserved and always has the value 0.
29–24 LUTOUT15	LUTOUT 15
23–22 Reserved	This read-only field is reserved and always has the value 0.
21–16 LUTOUT14	LUTOUT 14
15–14 Reserved	This read-only field is reserved and always has the value 0.
13–8 LUTOUT13	LUTOUT 13
7–6 Reserved	This read-only field is reserved and always has the value 0.
LUTOUT12	LUTOUT 12

41.11.267 This register defines the control bits for the pxp wfe sub-block (PXP_HW_PXP_WFE_B_STG2_5X6_OUT3_4)

The 5x6 LUT output value for input value n. This output value determines which input to select (flag, data).

Address: 21C_C000h base + 24E0h offset = 21C_E4E0h

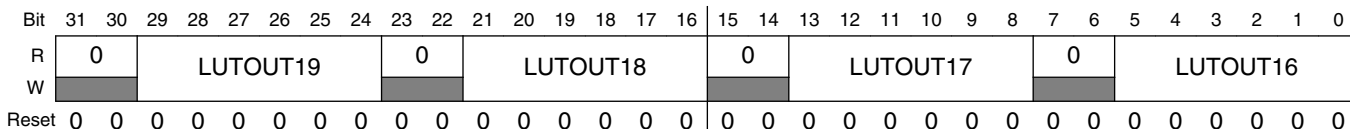

PXP_HW_PXP_WFE_B_STG2_5X6_OUT3_4 field descriptions

Field	Description
31–30 Reserved	This read-only field is reserved and always has the value 0.
29–24 LUTOUT19	LUTOUT 19
23–22 Reserved	This read-only field is reserved and always has the value 0.
21–16 LUTOUT18	LUTOUT 18
15–14 Reserved	This read-only field is reserved and always has the value 0.
13–8 LUTOUT17	LUTOUT 17
7–6 Reserved	This read-only field is reserved and always has the value 0.
LUTOUT16	LUTOUT 16

41.11.268 This register defines the control bits for the pxp wfe sub-block (PXP_HW_PXP_WFE_B_STG2_5X6_OUT3_5)

The 5x6 LUT output value for input value n. This output value determines which input to select (flag, data).

Address: 21C_C000h base + 24F0h offset = 21C_E4F0h

Bit	31	30	29	28	27	26	25	24	23	22	21	20	19	18	17	16	15	14	13	12	11	10	9	8	7	6	5	4	3	2	1	0
R	0								0								0								0							
W																																
Reset	0	0	0	0	0	0	0	0	0	0	0	0	0	0	0	0	0	0	0	0	0	0	0	0	0	0	0	0	0	0	0	0

PXP_HW_PXP_WFE_B_STG2_5X6_OUT3_5 field descriptions

Field	Description
31–30 Reserved	This read-only field is reserved and always has the value 0.
29–24 LUTOUT23	LUTOUT 23
23–22 Reserved	This read-only field is reserved and always has the value 0.
21–16 LUTOUT22	LUTOUT 22
15–14 Reserved	This read-only field is reserved and always has the value 0.
13–8 LUTOUT21	LUTOUT 21
7–6 Reserved	This read-only field is reserved and always has the value 0.
LUTOUT20	LUTOUT 20

41.11.269 This register defines the control bits for the pxp wfe sub-block (PXP_HW_PXP_WFE_B_STG2_5X6_OUT3_6)

The 5x6 LUT output value for input value n. This output value determines which input to select (flag, data).

Address: 21C_C000h base + 2500h offset = 21C_E500h

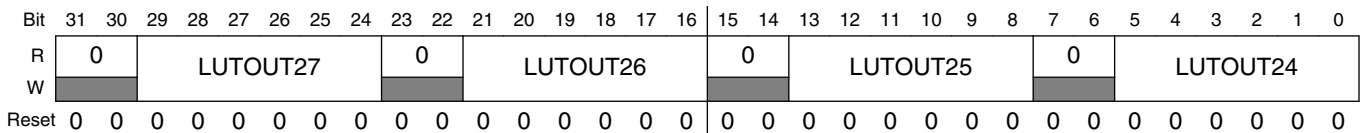

PXP_HW_PXP_WFE_B_STG2_5X6_OUT3_6 field descriptions

Field	Description
31–30 Reserved	This read-only field is reserved and always has the value 0.
29–24 LUTOUT27	LUTOUT 27
23–22 Reserved	This read-only field is reserved and always has the value 0.
21–16 LUTOUT26	LUTOUT 26
15–14 Reserved	This read-only field is reserved and always has the value 0.
13–8 LUTOUT25	LUTOUT 25
7–6 Reserved	This read-only field is reserved and always has the value 0.
LUTOUT24	LUTOUT 24

41.11.270 This register defines the control bits for the pxp wfe sub-block (PXP_HW_PXP_WFE_B_STG2_5X6_OUT3_7)

The 5x6 LUT output value for input value n. This output value determines which input to select (flag, data).

Address: 21C_C000h base + 2510h offset = 21C_E510h

Bit	31	30	29	28	27	26	25	24	23	22	21	20	19	18	17	16	15	14	13	12	11	10	9	8	7	6	5	4	3	2	1	0
R	0								0								0								0							
W																																
Reset	0	0	0	0	0	0	0	0	0	0	0	0	0	0	0	0	0	0	0	0	0	0	0	0	0	0	0	0	0	0	0	0

PXP_HW_PXP_WFE_B_STG2_5X6_OUT3_7 field descriptions

Field	Description
31–30 Reserved	This read-only field is reserved and always has the value 0.
29–24 LUTOUT31	LUTOUT 31
23–22 Reserved	This read-only field is reserved and always has the value 0.
21–16 LUTOUT30	LUTOUT 30
15–14 Reserved	This read-only field is reserved and always has the value 0.
13–8 LUTOUT29	LUTOUT 29
7–6 Reserved	This read-only field is reserved and always has the value 0.
LUTOUT28	LUTOUT 28

41.11.271 Each set mask bit enables one of the corresponding flag input bits. There is one mask per 5x6 LUT. (PXP_HW_PXP_WFE_B_STAGE2_5X6_MASKS_0)

Each set mask bit enables one of the corresponding flag input bits. There is one mask per 5x6 LUT.

Address: 21C_C000h base + 2520h offset = 21C_E520h

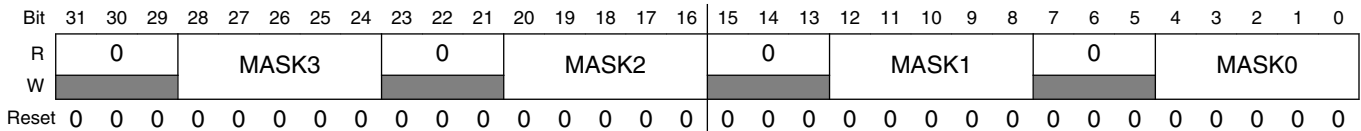

PXP_HW_PXP_WFE_B_STAGE2_5X6_MASKS_0 field descriptions

Field	Description
31–29 Reserved	This read-only field is reserved and always has the value 0.
28–24 MASK3	This field selects the input flags that are valid for 5x6 LUT 1. Bit 0 = input 1, Bit 1 = input 2 and so on.
23–21 Reserved	This read-only field is reserved and always has the value 0.
20–16 MASK2	This field selects the input flags that are valid for 5x6 LUT 0. Bit 0 = input 1, Bit 1 = input 2 and so on.
15–13 Reserved	This read-only field is reserved and always has the value 0.
12–8 MASK1	This field selects the input flags that are valid for 5x6 LUT 1. Bit 0 = input 1, Bit 1 = input 2 and so on.
7–5 Reserved	This read-only field is reserved and always has the value 0.
MASK0	This field selects the input flags that are valid for 5x6 LUT 0. Bit 0 = input 1, Bit 1 = input 2 and so on.

41.11.272 Each Address specifies the MUX position in the MUX array. There is one MUXADDR per 5x6 LUT. (PXP_HW_PXP_WFE_B_STAGE2_5X6_ADDR_0)

Address: 21C_C000h base + 2530h offset = 21C_E530h

Bit	31	30	29	28	27	26	25	24	23	22	21	20	19	18	17	16	15	14	13	12	11	10	9	8	7	6	5	4	3	2	1	0
R	0								0								0								0							
W																																
Reset	0	0	0	0	0	0	0	0	0	0	0	0	0	0	0	0	0	0	0	0	0	0	0	0	0	0	0	0	0	0	0	0

PXP_HW_PXP_WFE_B_STAGE2_5X6_ADDR_0 field descriptions

Field	Description
31–30 Reserved	This read-only field is reserved and always has the value 0.
29–24 MUXADDR3	This field reflects the address of the next stage element. The corresponding 5x6 lut output will become the select to this element.
23–22 Reserved	This read-only field is reserved and always has the value 0.
21–16 MUXADDR2	This field reflects the address of the next stage element. The corresponding 5x6 lut output will become the select to this element.
15–14 Reserved	This read-only field is reserved and always has the value 0.
13–8 MUXADDR1	This field reflects the address of the next stage element. The corresponding 5x6 lut output will become the select to this element.
7–6 Reserved	This read-only field is reserved and always has the value 0.
MUXADDR0	This field reflects the address of the next stage element. The corresponding 5x6 lut output will become the select to this element.

41.11.273 This register defines the output values (new flag) for the 5x1 LUTs in stage 2. (PXP_HW_PXP_WFE_B_STG2_5X1_OUT0)

The 5x1 LUT output value for input value n. This output value results in a flag that is added to the flag array.

Address: 21C_C000h base + 2540h offset = 21C_E540h

Bit	31	30	29	28	27	26	25	24	23	22	21	20	19	18	17	16
R	LUTOUT31	LUTOUT30	LUTOUT29	LUTOUT28	LUTOUT27	LUTOUT26	LUTOUT25	LUTOUT24	LUTOUT23	LUTOUT22	LUTOUT21	LUTOUT20	LUTOUT19	LUTOUT18	LUTOUT17	LUTOUT16
W																
Reset	0	0	0	0	0	0	0	0	0	0	0	0	0	0	0	0
Bit	15	14	13	12	11	10	9	8	7	6	5	4	3	2	1	0
R	LUTOUT15	LUTOUT14	LUTOUT13	LUTOUT12	LUTOUT11	LUTOUT10	LUTOUT9	LUTOUT8	LUTOUT7	LUTOUT6	LUTOUT5	LUTOUT4	LUTOUT3	LUTOUT2	LUTOUT1	LUTOUT0
W																
Reset	0	0	0	0	0	0	0	0	0	0	0	0	0	0	0	0

PXP_HW_PXP_WFE_B_STG2_5X1_OUT0 field descriptions

Field	Description
31 LUTOUT31	LUT OUT
30 LUTOUT30	LUT OUT
29 LUTOUT29	LUT OUT
28 LUTOUT28	LUT OUT
27 LUTOUT27	LUT OUT
26 LUTOUT26	LUT OUT
25 LUTOUT25	LUT OUT
24 LUTOUT24	LUT OUT
23 LUTOUT23	LUT OUT

Table continues on the next page...

PXP_HW_PXP_WFE_B_STG2_5X1_OUT0 field descriptions (continued)

Field	Description
22 LUTOUT22	LUT OUT
21 LUTOUT21	LUT OUT
20 LUTOUT20	LUT OUT
19 LUTOUT19	LUT OUT
18 LUTOUT18	LUT OUT
17 LUTOUT17	LUT OUT
16 LUTOUT16	LUT OUT
15 LUTOUT15	LUT OUT
14 LUTOUT14	LUT OUT
13 LUTOUT13	LUT OUT
12 LUTOUT12	LUT OUT
11 LUTOUT11	LUT OUT
10 LUTOUT10	LUT OUT
9 LUTOUT9	LUT OUT
8 LUTOUT8	LUT OUT
7 LUTOUT7	LUT OUT
6 LUTOUT6	LUT OUT
5 LUTOUT5	LUT OUT
4 LUTOUT4	LUT OUT
3 LUTOUT3	LUT OUT
2 LUTOUT2	LUT OUT
1 LUTOUT1	LUT OUT
0 LUTOUT0	LUT OUT

41.11.274 This register defines the output values (new flag) for the 5x1 LUTs in stage 2. (PXP_HW_PXP_WFE_B_STG2_5X1_OUT1)

The 5x1 LUT output value for input value n. This output value results in a flag that is added to the flag array.

Address: 21C_C000h base + 2550h offset = 21C_E550h

Bit	31	30	29	28	27	26	25	24	23	22	21	20	19	18	17	16
R	LUTOUT31	LUTOUT30	LUTOUT29	LUTOUT28	LUTOUT27	LUTOUT26	LUTOUT25	LUTOUT24	LUTOUT23	LUTOUT22	LUTOUT21	LUTOUT20	LUTOUT19	LUTOUT18	LUTOUT17	LUTOUT16
W																
Reset	0	0	0	0	0	0	0	0	0	0	0	0	0	0	0	0
Bit	15	14	13	12	11	10	9	8	7	6	5	4	3	2	1	0
R	LUTOUT15	LUTOUT14	LUTOUT13	LUTOUT12	LUTOUT11	LUTOUT10	LUTOUT9	LUTOUT8	LUTOUT7	LUTOUT6	LUTOUT5	LUTOUT4	LUTOUT3	LUTOUT2	LUTOUT1	LUTOUT0
W																
Reset	0	0	0	0	0	0	0	0	0	0	0	0	0	0	0	0

PXP_HW_PXP_WFE_B_STG2_5X1_OUT1 field descriptions

Field	Description
31 LUTOUT31	LUT OUT
30 LUTOUT30	LUT OUT
29 LUTOUT29	LUT OUT
28 LUTOUT28	LUT OUT
27 LUTOUT27	LUT OUT
26 LUTOUT26	LUT OUT
25 LUTOUT25	LUT OUT
24 LUTOUT24	LUT OUT
23 LUTOUT23	LUT OUT

Table continues on the next page...

PXP_HW_PXP_WFE_B_STG2_5X1_OUT1 field descriptions (continued)

Field	Description
22 LUTOUT22	LUT OUT
21 LUTOUT21	LUT OUT
20 LUTOUT20	LUT OUT
19 LUTOUT19	LUT OUT
18 LUTOUT18	LUT OUT
17 LUTOUT17	LUT OUT
16 LUTOUT16	LUT OUT
15 LUTOUT15	LUT OUT
14 LUTOUT14	LUT OUT
13 LUTOUT13	LUT OUT
12 LUTOUT12	LUT OUT
11 LUTOUT11	LUT OUT
10 LUTOUT10	LUT OUT
9 LUTOUT9	LUT OUT
8 LUTOUT8	LUT OUT
7 LUTOUT7	LUT OUT
6 LUTOUT6	LUT OUT
5 LUTOUT5	LUT OUT
4 LUTOUT4	LUT OUT
3 LUTOUT3	LUT OUT
2 LUTOUT2	LUT OUT
1 LUTOUT1	LUT OUT
0 LUTOUT0	LUT OUT

41.11.275 This register defines the output values (new flag) for the 5x1 LUTs in stage 2. (PXP_HW_PXP_WFE_B_STG2_5X1_OUT2)

The 5x1 LUT output value for input value n. This output value results in a flag that is added to the flag array.

Address: 21C_C000h base + 2560h offset = 21C_E560h

Bit	31	30	29	28	27	26	25	24	23	22	21	20	19	18	17	16
R	LUTOUT31	LUTOUT30	LUTOUT29	LUTOUT28	LUTOUT27	LUTOUT26	LUTOUT25	LUTOUT24	LUTOUT23	LUTOUT22	LUTOUT21	LUTOUT20	LUTOUT19	LUTOUT18	LUTOUT17	LUTOUT16
W																
Reset	0	0	0	0	0	0	0	0	0	0	0	0	0	0	0	0
Bit	15	14	13	12	11	10	9	8	7	6	5	4	3	2	1	0
R	LUTOUT15	LUTOUT14	LUTOUT13	LUTOUT12	LUTOUT11	LUTOUT10	LUTOUT9	LUTOUT8	LUTOUT7	LUTOUT6	LUTOUT5	LUTOUT4	LUTOUT3	LUTOUT2	LUTOUT1	LUTOUT0
W																
Reset	0	0	0	0	0	0	0	0	0	0	0	0	0	0	0	0

PXP_HW_PXP_WFE_B_STG2_5X1_OUT2 field descriptions

Field	Description
31 LUTOUT31	LUT OUT
30 LUTOUT30	LUT OUT
29 LUTOUT29	LUT OUT
28 LUTOUT28	LUT OUT
27 LUTOUT27	LUT OUT
26 LUTOUT26	LUT OUT
25 LUTOUT25	LUT OUT
24 LUTOUT24	LUT OUT
23 LUTOUT23	LUT OUT

Table continues on the next page...

PXP_HW_PXP_WFE_B_STG2_5X1_OUT2 field descriptions (continued)

Field	Description
22 LUTOUT22	LUT OUT
21 LUTOUT21	LUT OUT
20 LUTOUT20	LUT OUT
19 LUTOUT19	LUT OUT
18 LUTOUT18	LUT OUT
17 LUTOUT17	LUT OUT
16 LUTOUT16	LUT OUT
15 LUTOUT15	LUT OUT
14 LUTOUT14	LUT OUT
13 LUTOUT13	LUT OUT
12 LUTOUT12	LUT OUT
11 LUTOUT11	LUT OUT
10 LUTOUT10	LUT OUT
9 LUTOUT9	LUT OUT
8 LUTOUT8	LUT OUT
7 LUTOUT7	LUT OUT
6 LUTOUT6	LUT OUT
5 LUTOUT5	LUT OUT
4 LUTOUT4	LUT OUT
3 LUTOUT3	LUT OUT
2 LUTOUT2	LUT OUT
1 LUTOUT1	LUT OUT
0 LUTOUT0	LUT OUT

41.11.276 This register defines the output values (new flag) for the 5x1 LUTs in stage 2. (PXP_HW_PXP_WFE_B_STG2_5X1_OUT3)

The 5x1 LUT output value for input value n. This output value results in a flag that is added to the flag array.

Address: 21C_C000h base + 2570h offset = 21C_E570h

Bit	31	30	29	28	27	26	25	24	23	22	21	20	19	18	17	16
R	LUTOUT31	LUTOUT30	LUTOUT29	LUTOUT28	LUTOUT27	LUTOUT26	LUTOUT25	LUTOUT24	LUTOUT23	LUTOUT22	LUTOUT21	LUTOUT20	LUTOUT19	LUTOUT18	LUTOUT17	LUTOUT16
W																
Reset	0	0	0	0	0	0	0	0	0	0	0	0	0	0	0	0
Bit	15	14	13	12	11	10	9	8	7	6	5	4	3	2	1	0
R	LUTOUT15	LUTOUT14	LUTOUT13	LUTOUT12	LUTOUT11	LUTOUT10	LUTOUT9	LUTOUT8	LUTOUT7	LUTOUT6	LUTOUT5	LUTOUT4	LUTOUT3	LUTOUT2	LUTOUT1	LUTOUT0
W																
Reset	0	0	0	0	0	0	0	0	0	0	0	0	0	0	0	0

PXP_HW_PXP_WFE_B_STG2_5X1_OUT3 field descriptions

Field	Description
31 LUTOUT31	LUT OUT
30 LUTOUT30	LUT OUT
29 LUTOUT29	LUT OUT
28 LUTOUT28	LUT OUT
27 LUTOUT27	LUT OUT
26 LUTOUT26	LUT OUT
25 LUTOUT25	LUT OUT
24 LUTOUT24	LUT OUT
23 LUTOUT23	LUT OUT

Table continues on the next page...

PXP_HW_PXP_WFE_B_STG2_5X1_OUT3 field descriptions (continued)

Field	Description
22 LUTOUT22	LUT OUT
21 LUTOUT21	LUT OUT
20 LUTOUT20	LUT OUT
19 LUTOUT19	LUT OUT
18 LUTOUT18	LUT OUT
17 LUTOUT17	LUT OUT
16 LUTOUT16	LUT OUT
15 LUTOUT15	LUT OUT
14 LUTOUT14	LUT OUT
13 LUTOUT13	LUT OUT
12 LUTOUT12	LUT OUT
11 LUTOUT11	LUT OUT
10 LUTOUT10	LUT OUT
9 LUTOUT9	LUT OUT
8 LUTOUT8	LUT OUT
7 LUTOUT7	LUT OUT
6 LUTOUT6	LUT OUT
5 LUTOUT5	LUT OUT
4 LUTOUT4	LUT OUT
3 LUTOUT3	LUT OUT
2 LUTOUT2	LUT OUT
1 LUTOUT1	LUT OUT
0 LUTOUT0	LUT OUT

41.11.277 Each set mask bit enables one of the corresponding flag input bits. There is one mask per 5x1 LUT. (PXP_HW_PXP_WFE_B_STG2_5X1_MASKS)

Each set mask bit enables one of the corresponding flag input bits. There is one mask per 5x1 LUT.

Address: 21C_C000h base + 2580h offset = 21C_E580h

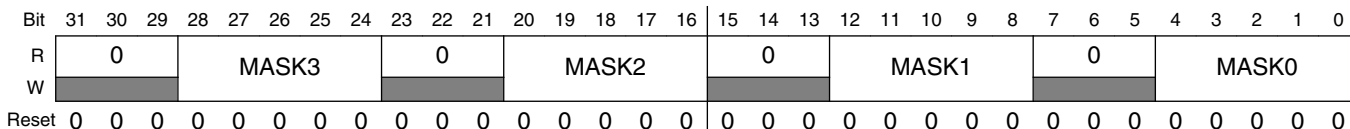

PXP_HW_PXP_WFE_B_STG2_5X1_MASKS field descriptions

Field	Description
31–29 Reserved	This read-only field is reserved and always has the value 0.
28–24 MASK3	This field selects the input flags that are valid for 5x1 LUT 1. Bit 0 = input 1, Bit 1 = input 2 and so on.
23–21 Reserved	This read-only field is reserved and always has the value 0.
20–16 MASK2	This field selects the input flags that are valid for 5x1 LUT 0. Bit 0 = input 1, Bit 1 = input 2 and so on.
15–13 Reserved	This read-only field is reserved and always has the value 0.
12–8 MASK1	This field selects the input flags that are valid for 5x1 LUT 1. Bit 0 = input 1, Bit 1 = input 2 and so on.
7–5 Reserved	This read-only field is reserved and always has the value 0.
MASK0	This field selects the input flags that are valid for 5x1 LUT 0. Bit 0 = input 1, Bit 1 = input 2 and so on.

41.11.278 This register defines the output values (new flag) for the 8x1 LUTs in stage 3. (PXP_HW_PXP_WFE_B_STG3_F8X1_OUT0_0)

The 5x1 LUT output value for input value n. This output value results in a flag that is added to the flag array.

Address: 21C_C000h base + 2590h offset = 21C_E590h

Bit	31	30	29	28	27	26	25	24	23	22	21	20	19	18	17	16
R	LUTOUT31	LUTOUT30	LUTOUT29	LUTOUT28	LUTOUT27	LUTOUT26	LUTOUT25	LUTOUT24	LUTOUT23	LUTOUT22	LUTOUT21	LUTOUT20	LUTOUT19	LUTOUT18	LUTOUT17	LUTOUT16
W																
Reset	0	0	0	0	0	0	0	0	0	0	0	0	0	0	0	0
Bit	15	14	13	12	11	10	9	8	7	6	5	4	3	2	1	0
R	LUTOUT15	LUTOUT14	LUTOUT13	LUTOUT12	LUTOUT11	LUTOUT10	LUTOUT9	LUTOUT8	LUTOUT7	LUTOUT6	LUTOUT5	LUTOUT4	LUTOUT3	LUTOUT2	LUTOUT1	LUTOUT0
W																
Reset	0	0	0	0	0	0	0	0	0	0	0	0	0	0	0	0

PXP_HW_PXP_WFE_B_STG3_F8X1_OUT0_0 field descriptions

Field	Description
31 LUTOUT31	LUT OUT
30 LUTOUT30	LUT OUT
29 LUTOUT29	LUT OUT
28 LUTOUT28	LUT OUT
27 LUTOUT27	LUT OUT
26 LUTOUT26	LUT OUT
25 LUTOUT25	LUT OUT
24 LUTOUT24	LUT OUT
23 LUTOUT23	LUT OUT

Table continues on the next page...

PXP_HW_PXP_WFE_B_STG3_F8X1_OUT0_0 field descriptions (continued)

Field	Description
22 LUTOUT22	LUT OUT
21 LUTOUT21	LUT OUT
20 LUTOUT20	LUT OUT
19 LUTOUT19	LUT OUT
18 LUTOUT18	LUT OUT
17 LUTOUT17	LUT OUT
16 LUTOUT16	LUT OUT
15 LUTOUT15	LUT OUT
14 LUTOUT14	LUT OUT
13 LUTOUT13	LUT OUT
12 LUTOUT12	LUT OUT
11 LUTOUT11	LUT OUT
10 LUTOUT10	LUT OUT
9 LUTOUT9	LUT OUT
8 LUTOUT8	LUT OUT
7 LUTOUT7	LUT OUT
6 LUTOUT6	LUT OUT
5 LUTOUT5	LUT OUT
4 LUTOUT4	LUT OUT
3 LUTOUT3	LUT OUT
2 LUTOUT2	LUT OUT
1 LUTOUT1	LUT OUT
0 LUTOUT0	LUT OUT

41.11.279 This register defines the output values (new flag) for the 8x1 LUTs in stage 3. (PXP_HW_PXP_WFE_B_STG3_F8X1_OUT0_1)

The 5x1 LUT output value for input value n. This output value results in a flag that is added to the flag array.

Address: 21C_C000h base + 25A0h offset = 21C_E5A0h

Bit	31	30	29	28	27	26	25	24	23	22	21	20	19	18	17	16
R	LUTOUT63	LUTOUT62	LUTOUT61	LUTOUT60	LUTOUT59	LUTOUT58	LUTOUT57	LUTOUT56	LUTOUT55	LUTOUT54	LUTOUT53	LUTOUT52	LUTOUT51	LUTOUT50	LUTOUT49	LUTOUT48
W																
Reset	0	0	0	0	0	0	0	0	0	0	0	0	0	0	0	0
Bit	15	14	13	12	11	10	9	8	7	6	5	4	3	2	1	0
R	LUTOUT47	LUTOUT46	LUTOUT45	LUTOUT44	LUTOUT43	LUTOUT42	LUTOUT41	LUTOUT40	LUTOUT39	LUTOUT38	LUTOUT37	LUTOUT36	LUTOUT35	LUTOUT34	LUTOUT33	LUTOUT32
W																
Reset	0	0	0	0	0	0	0	0	0	0	0	0	0	0	0	0

PXP_HW_PXP_WFE_B_STG3_F8X1_OUT0_1 field descriptions

Field	Description
31 LUTOUT63	LUT OUT
30 LUTOUT62	LUT OUT
29 LUTOUT61	LUT OUT
28 LUTOUT60	LUT OUT
27 LUTOUT59	LUT OUT
26 LUTOUT58	LUT OUT
25 LUTOUT57	LUT OUT
24 LUTOUT56	LUT OUT
23 LUTOUT55	LUT OUT

Table continues on the next page...

PXP_HW_PXP_WFE_B_STG3_F8X1_OUT0_1 field descriptions (continued)

Field	Description
22 LUTOUT54	LUT OUT
21 LUTOUT53	LUT OUT
20 LUTOUT52	LUT OUT
19 LUTOUT51	LUT OUT
18 LUTOUT50	LUT OUT
17 LUTOUT49	LUT OUT
16 LUTOUT48	LUT OUT
15 LUTOUT47	LUT OUT
14 LUTOUT46	LUT OUT
13 LUTOUT45	LUT OUT
12 LUTOUT44	LUT OUT
11 LUTOUT43	LUT OUT
10 LUTOUT42	LUT OUT
9 LUTOUT41	LUT OUT
8 LUTOUT40	LUT OUT
7 LUTOUT39	LUT OUT
6 LUTOUT38	LUT OUT
5 LUTOUT37	LUT OUT
4 LUTOUT36	LUT OUT
3 LUTOUT35	LUT OUT
2 LUTOUT34	LUT OUT
1 LUTOUT33	LUT OUT
0 LUTOUT32	LUT OUT

41.11.280 This register defines the output values (new flag) for the 8x1 LUTs in stage 3. (PXP_HW_PXP_WFE_B_STG3_F8X1_OUT0_2)

The 5x1 LUT output value for input value n. This output value results in a flag that is added to the flag array.

Address: 21C_C000h base + 25B0h offset = 21C_E5B0h

Bit	31	30	29	28	27	26	25	24	23	22	21	20	19	18	17	16
R	LUTOUT95	LUTOUT94	LUTOUT93	LUTOUT92	LUTOUT91	LUTOUT90	LUTOUT89	LUTOUT88	LUTOUT87	LUTOUT86	LUTOUT85	LUTOUT84	LUTOUT83	LUTOUT82	LUTOUT81	LUTOUT80
W																
Reset	0	0	0	0	0	0	0	0	0	0	0	0	0	0	0	0
Bit	15	14	13	12	11	10	9	8	7	6	5	4	3	2	1	0
R	LUTOUT79	LUTOUT78	LUTOUT77	LUTOUT76	LUTOUT75	LUTOUT74	LUTOUT73	LUTOUT72	LUTOUT71	LUTOUT70	LUTOUT69	LUTOUT68	LUTOUT67	LUTOUT66	LUTOUT65	LUTOUT64
W																
Reset	0	0	0	0	0	0	0	0	0	0	0	0	0	0	0	0

PXP_HW_PXP_WFE_B_STG3_F8X1_OUT0_2 field descriptions

Field	Description
31 LUTOUT95	LUT OUT
30 LUTOUT94	LUT OUT
29 LUTOUT93	LUT OUT
28 LUTOUT92	LUT OUT
27 LUTOUT91	LUT OUT
26 LUTOUT90	LUT OUT
25 LUTOUT89	LUT OUT
24 LUTOUT88	LUT OUT
23 LUTOUT87	LUT OUT

Table continues on the next page...

PXP_HW_PXP_WFE_B_STG3_F8X1_OUT0_2 field descriptions (continued)

Field	Description
22 LUTOUT86	LUT OUT
21 LUTOUT85	LUT OUT
20 LUTOUT84	LUT OUT
19 LUTOUT83	LUT OUT
18 LUTOUT82	LUT OUT
17 LUTOUT81	LUT OUT
16 LUTOUT80	LUT OUT
15 LUTOUT79	LUT OUT
14 LUTOUT78	LUT OUT
13 LUTOUT77	LUT OUT
12 LUTOUT76	LUT OUT
11 LUTOUT75	LUT OUT
10 LUTOUT74	LUT OUT
9 LUTOUT73	LUT OUT
8 LUTOUT72	LUT OUT
7 LUTOUT71	LUT OUT
6 LUTOUT70	LUT OUT
5 LUTOUT69	LUT OUT
4 LUTOUT68	LUT OUT
3 LUTOUT67	LUT OUT
2 LUTOUT66	LUT OUT
1 LUTOUT65	LUT OUT
0 LUTOUT64	LUT OUT

41.11.281 This register defines the output values (new flag) for the 8x1 LUTs in stage 3. (PXP_HW_PXP_WFE_B_STG3_F8X1_OUT0_3)

The 5x1 LUT output value for input value n. This output value results in a flag that is added to the flag array.

Address: 21C_C000h base + 25C0h offset = 21C_E5C0h

Bit	31	30	29	28	27	26	25	24	23	22	21	20	19	18	17	16
R	LUTOUT127	LUTOUT126	LUTOUT125	LUTOUT124	LUTOUT123	LUTOUT122	LUTOUT121	LUTOUT120	LUTOUT119	LUTOUT118	LUTOUT117	LUTOUT116	LUTOUT115	LUTOUT114	LUTOUT113	LUTOUT112
W																
Reset	0	0	0	0	0	0	0	0	0	0	0	0	0	0	0	0
Bit	15	14	13	12	11	10	9	8	7	6	5	4	3	2	1	0
R	LUTOUT111	LUTOUT110	LUTOUT109	LUTOUT108	LUTOUT107	LUTOUT106	LUTOUT105	LUTOUT104	LUTOUT103	LUTOUT102	LUTOUT101	LUTOUT100	LUTOUT99	LUTOUT98	LUTOUT97	LUTOUT96
W																
Reset	0	0	0	0	0	0	0	0	0	0	0	0	0	0	0	0

PXP_HW_PXP_WFE_B_STG3_F8X1_OUT0_3 field descriptions

Field	Description
31 LUTOUT127	LUT OUT
30 LUTOUT126	LUT OUT
29 LUTOUT125	LUT OUT
28 LUTOUT124	LUT OUT
27 LUTOUT123	LUT OUT
26 LUTOUT122	LUT OUT
25 LUTOUT121	LUT OUT
24 LUTOUT120	LUT OUT

Table continues on the next page...

PXP_HW_PXP_WFE_B_STG3_F8X1_OUT0_3 field descriptions (continued)

Field	Description
23 LUTOUT119	LUT OUT
22 LUTOUT118	LUT OUT
21 LUTOUT117	LUT OUT
20 LUTOUT116	LUT OUT
19 LUTOUT115	LUT OUT
18 LUTOUT114	LUT OUT
17 LUTOUT113	LUT OUT
16 LUTOUT112	LUT OUT
15 LUTOUT111	LUT OUT
14 LUTOUT110	LUT OUT
13 LUTOUT109	LUT OUT
12 LUTOUT108	LUT OUT
11 LUTOUT107	LUT OUT
10 LUTOUT106	LUT OUT
9 LUTOUT105	LUT OUT
8 LUTOUT104	LUT OUT
7 LUTOUT103	LUT OUT
6 LUTOUT102	LUT OUT
5 LUTOUT101	LUT OUT
4 LUTOUT100	LUT OUT
3 LUTOUT99	LUT OUT
2 LUTOUT98	LUT OUT
1 LUTOUT97	LUT OUT

Table continues on the next page...

PXP_HW_PXP_WFE_B_STG3_F8X1_OUT0_3 field descriptions (continued)

Field	Description
0 LUTOUT96	LUT OUT

**41.11.282 This register defines the output values (new flag) for the 8x1 LUTs in stage 3.
(PXP_HW_PXP_WFE_B_STG3_F8X1_OUT0_4)**

The 5x1 LUT output value for input value n. This output value results in a flag that is added to the flag array.

Address: 21C_C000h base + 25D0h offset = 21C_E5D0h

Bit	31	30	29	28	27	26	25	24	23	22	21	20	19	18	17	16
R	LUTOUT159	LUTOUT158	LUTOUT157	LUTOUT156	LUTOUT155	LUTOUT154	LUTOUT153	LUTOUT152	LUTOUT151	LUTOUT150	LUTOUT149	LUTOUT148	LUTOUT147	LUTOUT146	LUTOUT145	LUTOUT144
W	LUTOUT159	LUTOUT158	LUTOUT157	LUTOUT156	LUTOUT155	LUTOUT154	LUTOUT153	LUTOUT152	LUTOUT151	LUTOUT150	LUTOUT149	LUTOUT148	LUTOUT147	LUTOUT146	LUTOUT145	LUTOUT144
Reset	0	0	0	0	0	0	0	0	0	0	0	0	0	0	0	0
Bit	15	14	13	12	11	10	9	8	7	6	5	4	3	2	1	0
R	LUTOUT143	LUTOUT142	LUTOUT141	LUTOUT140	LUTOUT139	LUTOUT138	LUTOUT137	LUTOUT136	LUTOUT135	LUTOUT134	LUTOUT133	LUTOUT132	LUTOUT131	LUTOUT130	LUTOUT129	LUTOUT128
W	LUTOUT143	LUTOUT142	LUTOUT141	LUTOUT140	LUTOUT139	LUTOUT138	LUTOUT137	LUTOUT136	LUTOUT135	LUTOUT134	LUTOUT133	LUTOUT132	LUTOUT131	LUTOUT130	LUTOUT129	LUTOUT128
Reset	0	0	0	0	0	0	0	0	0	0	0	0	0	0	0	0

PXP_HW_PXP_WFE_B_STG3_F8X1_OUT0_4 field descriptions

Field	Description
31 LUTOUT159	LUT OUT
30 LUTOUT158	LUT OUT
29 LUTOUT157	LUT OUT
28 LUTOUT156	LUT OUT
27 LUTOUT155	LUT OUT

Table continues on the next page...

PXP_HW_PXP_WFE_B_STG3_F8X1_OUT0_4 field descriptions (continued)

Field	Description
26 LUTOUT154	LUT OUT
25 LUTOUT153	LUT OUT
24 LUTOUT152	LUT OUT
23 LUTOUT151	LUT OUT
22 LUTOUT150	LUT OUT
21 LUTOUT149	LUT OUT
20 LUTOUT148	LUT OUT
19 LUTOUT147	LUT OUT
18 LUTOUT146	LUT OUT
17 LUTOUT145	LUT OUT
16 LUTOUT144	LUT OUT
15 LUTOUT143	LUT OUT
14 LUTOUT142	LUT OUT
13 LUTOUT141	LUT OUT
12 LUTOUT140	LUT OUT
11 LUTOUT139	LUT OUT
10 LUTOUT138	LUT OUT
9 LUTOUT137	LUT OUT
8 LUTOUT136	LUT OUT
7 LUTOUT135	LUT OUT
6 LUTOUT134	LUT OUT
5 LUTOUT133	LUT OUT
4 LUTOUT132	LUT OUT

Table continues on the next page...

PXP_HW_PXP_WFE_B_STG3_F8X1_OUT0_4 field descriptions (continued)

Field	Description
3 LUTOUT131	LUT OUT
2 LUTOUT130	LUT OUT
1 LUTOUT129	LUT OUT
0 LUTOUT128	LUT OUT

**41.11.283 This register defines the output values (new flag) for the 8x1 LUTs in stage 3.
(PXP_HW_PXP_WFE_B_STG3_F8X1_OUT0_5)**

The 5x1 LUT output value for input value n. This output value results in a flag that is added to the flag array.

Address: 21C_C000h base + 25E0h offset = 21C_E5E0h

Bit	31	30	29	28	27	26	25	24	23	22	21	20	19	18	17	16
R	LUTOUT191	LUTOUT190	LUTOUT189	LUTOUT188	LUTOUT187	LUTOUT186	LUTOUT185	LUTOUT184	LUTOUT183	LUTOUT182	LUTOUT181	LUTOUT180	LUTOUT179	LUTOUT178	LUTOUT177	LUTOUT176
W	LUTOUT191	LUTOUT190	LUTOUT189	LUTOUT188	LUTOUT187	LUTOUT186	LUTOUT185	LUTOUT184	LUTOUT183	LUTOUT182	LUTOUT181	LUTOUT180	LUTOUT179	LUTOUT178	LUTOUT177	LUTOUT176
Reset	0	0	0	0	0	0	0	0	0	0	0	0	0	0	0	0
Bit	15	14	13	12	11	10	9	8	7	6	5	4	3	2	1	0
R	LUTOUT175	LUTOUT174	LUTOUT173	LUTOUT172	LUTOUT171	LUTOUT170	LUTOUT169	LUTOUT168	LUTOUT167	LUTOUT166	LUTOUT165	LUTOUT164	LUTOUT163	LUTOUT162	LUTOUT161	LUTOUT160
W	LUTOUT175	LUTOUT174	LUTOUT173	LUTOUT172	LUTOUT171	LUTOUT170	LUTOUT169	LUTOUT168	LUTOUT167	LUTOUT166	LUTOUT165	LUTOUT164	LUTOUT163	LUTOUT162	LUTOUT161	LUTOUT160
Reset	0	0	0	0	0	0	0	0	0	0	0	0	0	0	0	0

PXP_HW_PXP_WFE_B_STG3_F8X1_OUT0_5 field descriptions

Field	Description
31 LUTOUT191	LUT OUT
30 LUTOUT190	LUT OUT

Table continues on the next page...

PXP_HW_PXP_WFE_B_STG3_F8X1_OUT0_5 field descriptions (continued)

Field	Description
29 LUTOUT189	LUT OUT
28 LUTOUT188	LUT OUT
27 LUTOUT187	LUT OUT
26 LUTOUT186	LUT OUT
25 LUTOUT185	LUT OUT
24 LUTOUT184	LUT OUT
23 LUTOUT183	LUT OUT
22 LUTOUT182	LUT OUT
21 LUTOUT181	LUT OUT
20 LUTOUT180	LUT OUT
19 LUTOUT179	LUT OUT
18 LUTOUT178	LUT OUT
17 LUTOUT177	LUT OUT
16 LUTOUT176	LUT OUT
15 LUTOUT175	LUT OUT
14 LUTOUT174	LUT OUT
13 LUTOUT173	LUT OUT
12 LUTOUT172	LUT OUT
11 LUTOUT171	LUT OUT
10 LUTOUT170	LUT OUT
9 LUTOUT169	LUT OUT
8 LUTOUT168	LUT OUT
7 LUTOUT167	LUT OUT

Table continues on the next page...

PXP_HW_PXP_WFE_B_STG3_F8X1_OUT0_5 field descriptions (continued)

Field	Description
6 LUTOUT166	LUT OUT
5 LUTOUT165	LUT OUT
4 LUTOUT164	LUT OUT
3 LUTOUT163	LUT OUT
2 LUTOUT162	LUT OUT
1 LUTOUT161	LUT OUT
0 LUTOUT160	LUT OUT

**41.11.284 This register defines the output values (new flag) for the 8x1 LUTs in stage 3.
(PXP_HW_PXP_WFE_B_STG3_F8X1_OUT0_6)**

The 5x1 LUT output value for input value n. This output value results in a flag that is added to the flag array.

Address: 21C_C000h base + 25F0h offset = 21C_E5F0h

Bit	31	30	29	28	27	26	25	24	23	22	21	20	19	18	17	16
R	LUTOUT223	LUTOUT222	LUTOUT221	LUTOUT220	LUTOUT219	LUTOUT218	LUTOUT217	LUTOUT216	LUTOUT215	LUTOUT214	LUTOUT213	LUTOUT212	LUTOUT211	LUTOUT210	LUTOUT209	LUTOUT208
W	LUTOUT223	LUTOUT222	LUTOUT221	LUTOUT220	LUTOUT219	LUTOUT218	LUTOUT217	LUTOUT216	LUTOUT215	LUTOUT214	LUTOUT213	LUTOUT212	LUTOUT211	LUTOUT210	LUTOUT209	LUTOUT208
Reset	0	0	0	0	0	0	0	0	0	0	0	0	0	0	0	0
Bit	15	14	13	12	11	10	9	8	7	6	5	4	3	2	1	0
R	LUTOUT207	LUTOUT206	LUTOUT205	LUTOUT204	LUTOUT203	LUTOUT202	LUTOUT201	LUTOUT200	LUTOUT199	LUTOUT198	LUTOUT197	LUTOUT196	LUTOUT195	LUTOUT194	LUTOUT193	LUTOUT192
W	LUTOUT207	LUTOUT206	LUTOUT205	LUTOUT204	LUTOUT203	LUTOUT202	LUTOUT201	LUTOUT200	LUTOUT199	LUTOUT198	LUTOUT197	LUTOUT196	LUTOUT195	LUTOUT194	LUTOUT193	LUTOUT192
Reset	0	0	0	0	0	0	0	0	0	0	0	0	0	0	0	0

PXP_HW_PXP_WFE_B_STG3_F8X1_OUT0_6 field descriptions

Field	Description
31 LUTOUT223	LUT OUT
30 LUTOUT222	LUT OUT
29 LUTOUT221	LUT OUT
28 LUTOUT220	LUT OUT
27 LUTOUT219	LUT OUT
26 LUTOUT218	LUT OUT
25 LUTOUT217	LUT OUT
24 LUTOUT216	LUT OUT
23 LUTOUT215	LUT OUT
22 LUTOUT214	LUT OUT
21 LUTOUT213	LUT OUT
20 LUTOUT212	LUT OUT
19 LUTOUT211	LUT OUT
18 LUTOUT210	LUT OUT
17 LUTOUT209	LUT OUT
16 LUTOUT208	LUT OUT
15 LUTOUT207	LUT OUT
14 LUTOUT206	LUT OUT
13 LUTOUT205	LUT OUT
12 LUTOUT204	LUT OUT
11 LUTOUT203	LUT OUT
10 LUTOUT202	LUT OUT
9 LUTOUT201	LUT OUT

Table continues on the next page...

PXP_HW_PXP_WFE_B_STG3_F8X1_OUT0_6 field descriptions (continued)

Field	Description
8 LUTOUT200	LUT OUT
7 LUTOUT199	LUT OUT
6 LUTOUT198	LUT OUT
5 LUTOUT197	LUT OUT
4 LUTOUT196	LUT OUT
3 LUTOUT195	LUT OUT
2 LUTOUT194	LUT OUT
1 LUTOUT193	LUT OUT
0 LUTOUT192	LUT OUT

41.11.285 This register defines the output values (new flag) for the 8x1 LUTs in stage 3. (PXP_HW_PXP_WFE_B_STG3_F8X1_OUT0_7)

The 5x1 LUT output value for input value n. This output value results in a flag that is added to the flag array.

Address: 21C_C000h base + 2600h offset = 21C_E600h

Bit	31	30	29	28	27	26	25	24	23	22	21	20	19	18	17	16
R	LUTOUT255	LUTOUT254	LUTOUT253	LUTOUT252	LUTOUT251	LUTOUT250	LUTOUT249	LUTOUT248	LUTOUT247	LUTOUT246	LUTOUT245	LUTOUT244	LUTOUT243	LUTOUT242	LUTOUT241	LUTOUT240
W	LUTOUT255	LUTOUT254	LUTOUT253	LUTOUT252	LUTOUT251	LUTOUT250	LUTOUT249	LUTOUT248	LUTOUT247	LUTOUT246	LUTOUT245	LUTOUT244	LUTOUT243	LUTOUT242	LUTOUT241	LUTOUT240
Reset	0	0	0	0	0	0	0	0	0	0	0	0	0	0	0	0
Bit	15	14	13	12	11	10	9	8	7	6	5	4	3	2	1	0
R	LUTOUT239	LUTOUT238	LUTOUT237	LUTOUT236	LUTOUT235	LUTOUT234	LUTOUT233	LUTOUT232	LUTOUT231	LUTOUT230	LUTOUT229	LUTOUT228	LUTOUT227	LUTOUT226	LUTOUT225	LUTOUT224
W	LUTOUT239	LUTOUT238	LUTOUT237	LUTOUT236	LUTOUT235	LUTOUT234	LUTOUT233	LUTOUT232	LUTOUT231	LUTOUT230	LUTOUT229	LUTOUT228	LUTOUT227	LUTOUT226	LUTOUT225	LUTOUT224
Reset	0	0	0	0	0	0	0	0	0	0	0	0	0	0	0	0

PXP_HW_PXP_WFE_B_STG3_F8X1_OUT0_7 field descriptions

Field	Description
31 LUTOUT255	LUT OUT
30 LUTOUT254	LUT OUT
29 LUTOUT253	LUT OUT
28 LUTOUT252	LUT OUT
27 LUTOUT251	LUT OUT
26 LUTOUT250	LUT OUT
25 LUTOUT249	LUT OUT
24 LUTOUT248	LUT OUT
23 LUTOUT247	LUT OUT
22 LUTOUT246	LUT OUT
21 LUTOUT245	LUT OUT
20 LUTOUT244	LUT OUT
19 LUTOUT243	LUT OUT
18 LUTOUT242	LUT OUT
17 LUTOUT241	LUT OUT
16 LUTOUT240	LUT OUT
15 LUTOUT239	LUT OUT
14 LUTOUT238	LUT OUT
13 LUTOUT237	LUT OUT
12 LUTOUT236	LUT OUT
11 LUTOUT235	LUT OUT
10 LUTOUT234	LUT OUT
9 LUTOUT233	LUT OUT

Table continues on the next page...

PXP_HW_PXP_WFE_B_STG3_F8X1_OUT0_7 field descriptions (continued)

Field	Description
8 LUTOUT232	LUT OUT
7 LUTOUT231	LUT OUT
6 LUTOUT230	LUT OUT
5 LUTOUT229	LUT OUT
4 LUTOUT228	LUT OUT
3 LUTOUT227	LUT OUT
2 LUTOUT226	LUT OUT
1 LUTOUT225	LUT OUT
0 LUTOUT224	LUT OUT

**41.11.286 This register defines the output values (new flag) for the 8x1 LUTs in stage 3.
(PXP_HW_PXP_WFE_B_STG3_F8X1_OUT1_0)**

The 5x1 LUT output value for input value n. This output value results in a flag that is added to the flag array.

Address: 21C_C000h base + 2610h offset = 21C_E610h

Bit	31	30	29	28	27	26	25	24	23	22	21	20	19	18	17	16
R	LUTOUT31	LUTOUT30	LUTOUT29	LUTOUT28	LUTOUT27	LUTOUT26	LUTOUT25	LUTOUT24	LUTOUT23	LUTOUT22	LUTOUT21	LUTOUT20	LUTOUT19	LUTOUT18	LUTOUT17	LUTOUT16
W	LUTOUT31	LUTOUT30	LUTOUT29	LUTOUT28	LUTOUT27	LUTOUT26	LUTOUT25	LUTOUT24	LUTOUT23	LUTOUT22	LUTOUT21	LUTOUT20	LUTOUT19	LUTOUT18	LUTOUT17	LUTOUT16
Reset	0	0	0	0	0	0	0	0	0	0	0	0	0	0	0	0
Bit	15	14	13	12	11	10	9	8	7	6	5	4	3	2	1	0
R	LUTOUT15	LUTOUT14	LUTOUT13	LUTOUT12	LUTOUT11	LUTOUT10	LUTOUT9	LUTOUT8	LUTOUT7	LUTOUT6	LUTOUT5	LUTOUT4	LUTOUT3	LUTOUT2	LUTOUT1	LUTOUT0
W	LUTOUT15	LUTOUT14	LUTOUT13	LUTOUT12	LUTOUT11	LUTOUT10	LUTOUT9	LUTOUT8	LUTOUT7	LUTOUT6	LUTOUT5	LUTOUT4	LUTOUT3	LUTOUT2	LUTOUT1	LUTOUT0
Reset	0	0	0	0	0	0	0	0	0	0	0	0	0	0	0	0

PXP_HW_PXP_WFE_B_STG3_F8X1_OUT1_0 field descriptions

Field	Description
31 LUTOUT31	LUT OUT
30 LUTOUT30	LUT OUT
29 LUTOUT29	LUT OUT
28 LUTOUT28	LUT OUT
27 LUTOUT27	LUT OUT
26 LUTOUT26	LUT OUT
25 LUTOUT25	LUT OUT
24 LUTOUT24	LUT OUT
23 LUTOUT23	LUT OUT
22 LUTOUT22	LUT OUT
21 LUTOUT21	LUT OUT
20 LUTOUT20	LUT OUT
19 LUTOUT19	LUT OUT
18 LUTOUT18	LUT OUT
17 LUTOUT17	LUT OUT
16 LUTOUT16	LUT OUT
15 LUTOUT15	LUT OUT
14 LUTOUT14	LUT OUT
13 LUTOUT13	LUT OUT
12 LUTOUT12	LUT OUT
11 LUTOUT11	LUT OUT
10 LUTOUT10	LUT OUT
9 LUTOUT9	LUT OUT

Table continues on the next page...

PXP_HW_PXP_WFE_B_STG3_F8X1_OUT1_0 field descriptions (continued)

Field	Description
8 LUTOUT8	LUT OUT
7 LUTOUT7	LUT OUT
6 LUTOUT6	LUT OUT
5 LUTOUT5	LUT OUT
4 LUTOUT4	LUT OUT
3 LUTOUT3	LUT OUT
2 LUTOUT2	LUT OUT
1 LUTOUT1	LUT OUT
0 LUTOUT0	LUT OUT

41.11.287 This register defines the output values (new flag) for the 8x1 LUTs in stage 3.
(PXP_HW_PXP_WFE_B_STG3_F8X1_OUT1_1)

The 5x1 LUT output value for input value n. This output value results in a flag that is added to the flag array.

Address: 21C_C000h base + 2620h offset = 21C_E620h

Bit	31	30	29	28	27	26	25	24	23	22	21	20	19	18	17	16
R	LUTOUT63	LUTOUT62	LUTOUT61	LUTOUT60	LUTOUT59	LUTOUT58	LUTOUT57	LUTOUT56	LUTOUT55	LUTOUT54	LUTOUT53	LUTOUT52	LUTOUT51	LUTOUT50	LUTOUT49	LUTOUT48
W																
Reset	0	0	0	0	0	0	0	0	0	0	0	0	0	0	0	0
Bit	15	14	13	12	11	10	9	8	7	6	5	4	3	2	1	0
R	LUTOUT47	LUTOUT46	LUTOUT45	LUTOUT44	LUTOUT43	LUTOUT42	LUTOUT41	LUTOUT40	LUTOUT39	LUTOUT38	LUTOUT37	LUTOUT36	LUTOUT35	LUTOUT34	LUTOUT33	LUTOUT32
W																
Reset	0	0	0	0	0	0	0	0	0	0	0	0	0	0	0	0

PXP_HW_PXP_WFE_B_STG3_F8X1_OUT1_1 field descriptions

Field	Description
31 LUTOUT63	LUT OUT
30 LUTOUT62	LUT OUT
29 LUTOUT61	LUT OUT
28 LUTOUT60	LUT OUT
27 LUTOUT59	LUT OUT
26 LUTOUT58	LUT OUT
25 LUTOUT57	LUT OUT
24 LUTOUT56	LUT OUT
23 LUTOUT55	LUT OUT
22 LUTOUT54	LUT OUT
21 LUTOUT53	LUT OUT
20 LUTOUT52	LUT OUT
19 LUTOUT51	LUT OUT
18 LUTOUT50	LUT OUT
17 LUTOUT49	LUT OUT
16 LUTOUT48	LUT OUT
15 LUTOUT47	LUT OUT
14 LUTOUT46	LUT OUT
13 LUTOUT45	LUT OUT
12 LUTOUT44	LUT OUT
11 LUTOUT43	LUT OUT
10 LUTOUT42	LUT OUT
9 LUTOUT41	LUT OUT

Table continues on the next page...

PXP_HW_PXP_WFE_B_STG3_F8X1_OUT1_1 field descriptions (continued)

Field	Description
8 LUTOUT40	LUT OUT
7 LUTOUT39	LUT OUT
6 LUTOUT38	LUT OUT
5 LUTOUT37	LUT OUT
4 LUTOUT36	LUT OUT
3 LUTOUT35	LUT OUT
2 LUTOUT34	LUT OUT
1 LUTOUT33	LUT OUT
0 LUTOUT32	LUT OUT

**41.11.288 This register defines the output values (new flag) for the 8x1 LUTs in stage 3.
(PXP_HW_PXP_WFE_B_STG3_F8X1_OUT1_2)**

The 5x1 LUT output value for input value n. This output value results in a flag that is added to the flag array.

Address: 21C_C000h base + 2630h offset = 21C_E630h

Bit	31	30	29	28	27	26	25	24	23	22	21	20	19	18	17	16
R	LUTOUT95	LUTOUT94	LUTOUT93	LUTOUT92	LUTOUT91	LUTOUT90	LUTOUT89	LUTOUT88	LUTOUT87	LUTOUT86	LUTOUT85	LUTOUT84	LUTOUT83	LUTOUT82	LUTOUT81	LUTOUT80
W	LUTOUT95	LUTOUT94	LUTOUT93	LUTOUT92	LUTOUT91	LUTOUT90	LUTOUT89	LUTOUT88	LUTOUT87	LUTOUT86	LUTOUT85	LUTOUT84	LUTOUT83	LUTOUT82	LUTOUT81	LUTOUT80
Reset	0	0	0	0	0	0	0	0	0	0	0	0	0	0	0	0
Bit	15	14	13	12	11	10	9	8	7	6	5	4	3	2	1	0
R	LUTOUT79	LUTOUT78	LUTOUT77	LUTOUT76	LUTOUT75	LUTOUT74	LUTOUT73	LUTOUT72	LUTOUT71	LUTOUT70	LUTOUT69	LUTOUT68	LUTOUT67	LUTOUT66	LUTOUT65	LUTOUT64
W	LUTOUT79	LUTOUT78	LUTOUT77	LUTOUT76	LUTOUT75	LUTOUT74	LUTOUT73	LUTOUT72	LUTOUT71	LUTOUT70	LUTOUT69	LUTOUT68	LUTOUT67	LUTOUT66	LUTOUT65	LUTOUT64
Reset	0	0	0	0	0	0	0	0	0	0	0	0	0	0	0	0

PXP_HW_PXP_WFE_B_STG3_F8X1_OUT1_2 field descriptions

Field	Description
31 LUTOUT95	LUT OUT
30 LUTOUT94	LUT OUT
29 LUTOUT93	LUT OUT
28 LUTOUT92	LUT OUT
27 LUTOUT91	LUT OUT
26 LUTOUT90	LUT OUT
25 LUTOUT89	LUT OUT
24 LUTOUT88	LUT OUT
23 LUTOUT87	LUT OUT
22 LUTOUT86	LUT OUT
21 LUTOUT85	LUT OUT
20 LUTOUT84	LUT OUT
19 LUTOUT83	LUT OUT
18 LUTOUT82	LUT OUT
17 LUTOUT81	LUT OUT
16 LUTOUT80	LUT OUT
15 LUTOUT79	LUT OUT
14 LUTOUT78	LUT OUT
13 LUTOUT77	LUT OUT
12 LUTOUT76	LUT OUT
11 LUTOUT75	LUT OUT
10 LUTOUT74	LUT OUT
9 LUTOUT73	LUT OUT

Table continues on the next page...

PXP_HW_PXP_WFE_B_STG3_F8X1_OUT1_2 field descriptions (continued)

Field	Description
8 LUTOUT72	LUT OUT
7 LUTOUT71	LUT OUT
6 LUTOUT70	LUT OUT
5 LUTOUT69	LUT OUT
4 LUTOUT68	LUT OUT
3 LUTOUT67	LUT OUT
2 LUTOUT66	LUT OUT
1 LUTOUT65	LUT OUT
0 LUTOUT64	LUT OUT

**41.11.289 This register defines the output values (new flag) for the 8x1 LUTs in stage 3.
(PXP_HW_PXP_WFE_B_STG3_F8X1_OUT1_3)**

The 5x1 LUT output value for input value n. This output value results in a flag that is added to the flag array.

Address: 21C_C000h base + 2640h offset = 21C_E640h

Bit	31	30	29	28	27	26	25	24	23	22	21	20	19	18	17	16
R	LUTOUT127	LUTOUT126	LUTOUT125	LUTOUT124	LUTOUT123	LUTOUT122	LUTOUT121	LUTOUT120	LUTOUT119	LUTOUT118	LUTOUT117	LUTOUT116	LUTOUT115	LUTOUT114	LUTOUT113	LUTOUT112
W	LUTOUT127	LUTOUT126	LUTOUT125	LUTOUT124	LUTOUT123	LUTOUT122	LUTOUT121	LUTOUT120	LUTOUT119	LUTOUT118	LUTOUT117	LUTOUT116	LUTOUT115	LUTOUT114	LUTOUT113	LUTOUT112
Reset	0	0	0	0	0	0	0	0	0	0	0	0	0	0	0	0
Bit	15	14	13	12	11	10	9	8	7	6	5	4	3	2	1	0
R	LUTOUT111	LUTOUT110	LUTOUT109	LUTOUT108	LUTOUT107	LUTOUT106	LUTOUT105	LUTOUT104	LUTOUT103	LUTOUT102	LUTOUT101	LUTOUT100	LUTOUT99	LUTOUT98	LUTOUT97	LUTOUT96
W	LUTOUT111	LUTOUT110	LUTOUT109	LUTOUT108	LUTOUT107	LUTOUT106	LUTOUT105	LUTOUT104	LUTOUT103	LUTOUT102	LUTOUT101	LUTOUT100	LUTOUT99	LUTOUT98	LUTOUT97	LUTOUT96
Reset	0	0	0	0	0	0	0	0	0	0	0	0	0	0	0	0

PXP_HW_PXP_WFE_B_STG3_F8X1_OUT1_3 field descriptions

Field	Description
31 LUTOUT127	LUT OUT
30 LUTOUT126	LUT OUT
29 LUTOUT125	LUT OUT
28 LUTOUT124	LUT OUT
27 LUTOUT123	LUT OUT
26 LUTOUT122	LUT OUT
25 LUTOUT121	LUT OUT
24 LUTOUT120	LUT OUT
23 LUTOUT119	LUT OUT
22 LUTOUT118	LUT OUT
21 LUTOUT117	LUT OUT
20 LUTOUT116	LUT OUT
19 LUTOUT115	LUT OUT
18 LUTOUT114	LUT OUT
17 LUTOUT113	LUT OUT
16 LUTOUT112	LUT OUT
15 LUTOUT111	LUT OUT
14 LUTOUT110	LUT OUT
13 LUTOUT109	LUT OUT
12 LUTOUT108	LUT OUT
11 LUTOUT107	LUT OUT
10 LUTOUT106	LUT OUT
9 LUTOUT105	LUT OUT

Table continues on the next page...

PXP_HW_PXP_WFE_B_STG3_F8X1_OUT1_3 field descriptions (continued)

Field	Description
8 LUTOUT104	LUT OUT
7 LUTOUT103	LUT OUT
6 LUTOUT102	LUT OUT
5 LUTOUT101	LUT OUT
4 LUTOUT100	LUT OUT
3 LUTOUT99	LUT OUT
2 LUTOUT98	LUT OUT
1 LUTOUT97	LUT OUT
0 LUTOUT96	LUT OUT

**41.11.290 This register defines the output values (new flag) for the 8x1 LUTs in stage 3.
(PXP_HW_PXP_WFE_B_STG3_F8X1_OUT1_4)**

The 5x1 LUT output value for input value n. This output value results in a flag that is added to the flag array.

Address: 21C_C000h base + 2650h offset = 21C_E650h

Bit	31	30	29	28	27	26	25	24	23	22	21	20	19	18	17	16
R	LUTOUT159	LUTOUT158	LUTOUT157	LUTOUT156	LUTOUT155	LUTOUT154	LUTOUT153	LUTOUT152	LUTOUT151	LUTOUT150	LUTOUT149	LUTOUT148	LUTOUT147	LUTOUT146	LUTOUT145	LUTOUT144
W	LUTOUT159	LUTOUT158	LUTOUT157	LUTOUT156	LUTOUT155	LUTOUT154	LUTOUT153	LUTOUT152	LUTOUT151	LUTOUT150	LUTOUT149	LUTOUT148	LUTOUT147	LUTOUT146	LUTOUT145	LUTOUT144
Reset	0	0	0	0	0	0	0	0	0	0	0	0	0	0	0	0
Bit	15	14	13	12	11	10	9	8	7	6	5	4	3	2	1	0
R	LUTOUT143	LUTOUT142	LUTOUT141	LUTOUT140	LUTOUT139	LUTOUT138	LUTOUT137	LUTOUT136	LUTOUT135	LUTOUT134	LUTOUT133	LUTOUT132	LUTOUT131	LUTOUT130	LUTOUT129	LUTOUT128
W	LUTOUT143	LUTOUT142	LUTOUT141	LUTOUT140	LUTOUT139	LUTOUT138	LUTOUT137	LUTOUT136	LUTOUT135	LUTOUT134	LUTOUT133	LUTOUT132	LUTOUT131	LUTOUT130	LUTOUT129	LUTOUT128
Reset	0	0	0	0	0	0	0	0	0	0	0	0	0	0	0	0

PXP_HW_PXP_WFE_B_STG3_F8X1_OUT1_4 field descriptions

Field	Description
31 LUTOUT159	LUT OUT
30 LUTOUT158	LUT OUT
29 LUTOUT157	LUT OUT
28 LUTOUT156	LUT OUT
27 LUTOUT155	LUT OUT
26 LUTOUT154	LUT OUT
25 LUTOUT153	LUT OUT
24 LUTOUT152	LUT OUT
23 LUTOUT151	LUT OUT
22 LUTOUT150	LUT OUT
21 LUTOUT149	LUT OUT
20 LUTOUT148	LUT OUT
19 LUTOUT147	LUT OUT
18 LUTOUT146	LUT OUT
17 LUTOUT145	LUT OUT
16 LUTOUT144	LUT OUT
15 LUTOUT143	LUT OUT
14 LUTOUT142	LUT OUT
13 LUTOUT141	LUT OUT
12 LUTOUT140	LUT OUT
11 LUTOUT139	LUT OUT
10 LUTOUT138	LUT OUT
9 LUTOUT137	LUT OUT

Table continues on the next page...

PXP_HW_PXP_WFE_B_STG3_F8X1_OUT1_4 field descriptions (continued)

Field	Description
8 LUTOUT136	LUT OUT
7 LUTOUT135	LUT OUT
6 LUTOUT134	LUT OUT
5 LUTOUT133	LUT OUT
4 LUTOUT132	LUT OUT
3 LUTOUT131	LUT OUT
2 LUTOUT130	LUT OUT
1 LUTOUT129	LUT OUT
0 LUTOUT128	LUT OUT

**41.11.291 This register defines the output values (new flag) for the 8x1 LUTs in stage 3.
(PXP_HW_PXP_WFE_B_STG3_F8X1_OUT1_5)**

The 5x1 LUT output value for input value n. This output value results in a flag that is added to the flag array.

Address: 21C_C000h base + 2660h offset = 21C_E660h

Bit	31	30	29	28	27	26	25	24	23	22	21	20	19	18	17	16
R	LUTOUT191	LUTOUT190	LUTOUT189	LUTOUT188	LUTOUT187	LUTOUT186	LUTOUT185	LUTOUT184	LUTOUT183	LUTOUT182	LUTOUT181	LUTOUT180	LUTOUT179	LUTOUT178	LUTOUT177	LUTOUT176
W	LUTOUT191	LUTOUT190	LUTOUT189	LUTOUT188	LUTOUT187	LUTOUT186	LUTOUT185	LUTOUT184	LUTOUT183	LUTOUT182	LUTOUT181	LUTOUT180	LUTOUT179	LUTOUT178	LUTOUT177	LUTOUT176
Reset	0	0	0	0	0	0	0	0	0	0	0	0	0	0	0	0
Bit	15	14	13	12	11	10	9	8	7	6	5	4	3	2	1	0
R	LUTOUT175	LUTOUT174	LUTOUT173	LUTOUT172	LUTOUT171	LUTOUT170	LUTOUT169	LUTOUT168	LUTOUT167	LUTOUT166	LUTOUT165	LUTOUT164	LUTOUT163	LUTOUT162	LUTOUT161	LUTOUT160
W	LUTOUT175	LUTOUT174	LUTOUT173	LUTOUT172	LUTOUT171	LUTOUT170	LUTOUT169	LUTOUT168	LUTOUT167	LUTOUT166	LUTOUT165	LUTOUT164	LUTOUT163	LUTOUT162	LUTOUT161	LUTOUT160
Reset	0	0	0	0	0	0	0	0	0	0	0	0	0	0	0	0

PXP_HW_PXP_WFE_B_STG3_F8X1_OUT1_5 field descriptions

Field	Description
31 LUTOUT191	LUT OUT
30 LUTOUT190	LUT OUT
29 LUTOUT189	LUT OUT
28 LUTOUT188	LUT OUT
27 LUTOUT187	LUT OUT
26 LUTOUT186	LUT OUT
25 LUTOUT185	LUT OUT
24 LUTOUT184	LUT OUT
23 LUTOUT183	LUT OUT
22 LUTOUT182	LUT OUT
21 LUTOUT181	LUT OUT
20 LUTOUT180	LUT OUT
19 LUTOUT179	LUT OUT
18 LUTOUT178	LUT OUT
17 LUTOUT177	LUT OUT
16 LUTOUT176	LUT OUT
15 LUTOUT175	LUT OUT
14 LUTOUT174	LUT OUT
13 LUTOUT173	LUT OUT
12 LUTOUT172	LUT OUT
11 LUTOUT171	LUT OUT
10 LUTOUT170	LUT OUT
9 LUTOUT169	LUT OUT

Table continues on the next page...

PXP_HW_PXP_WFE_B_STG3_F8X1_OUT1_5 field descriptions (continued)

Field	Description
8 LUTOUT168	LUT OUT
7 LUTOUT167	LUT OUT
6 LUTOUT166	LUT OUT
5 LUTOUT165	LUT OUT
4 LUTOUT164	LUT OUT
3 LUTOUT163	LUT OUT
2 LUTOUT162	LUT OUT
1 LUTOUT161	LUT OUT
0 LUTOUT160	LUT OUT

**41.11.292 This register defines the output values (new flag) for the 8x1 LUTs in stage 3.
(PXP_HW_PXP_WFE_B_STG3_F8X1_OUT1_6)**

The 5x1 LUT output value for input value n. This output value results in a flag that is added to the flag array.

Address: 21C_C000h base + 2670h offset = 21C_E670h

Bit	31	30	29	28	27	26	25	24	23	22	21	20	19	18	17	16
R	LUTOUT223	LUTOUT222	LUTOUT221	LUTOUT220	LUTOUT219	LUTOUT218	LUTOUT217	LUTOUT216	LUTOUT215	LUTOUT214	LUTOUT213	LUTOUT212	LUTOUT211	LUTOUT210	LUTOUT209	LUTOUT208
W	LUTOUT223	LUTOUT222	LUTOUT221	LUTOUT220	LUTOUT219	LUTOUT218	LUTOUT217	LUTOUT216	LUTOUT215	LUTOUT214	LUTOUT213	LUTOUT212	LUTOUT211	LUTOUT210	LUTOUT209	LUTOUT208
Reset	0	0	0	0	0	0	0	0	0	0	0	0	0	0	0	0
Bit	15	14	13	12	11	10	9	8	7	6	5	4	3	2	1	0
R	LUTOUT207	LUTOUT206	LUTOUT205	LUTOUT204	LUTOUT203	LUTOUT202	LUTOUT201	LUTOUT200	LUTOUT199	LUTOUT198	LUTOUT197	LUTOUT196	LUTOUT195	LUTOUT194	LUTOUT193	LUTOUT192
W	LUTOUT207	LUTOUT206	LUTOUT205	LUTOUT204	LUTOUT203	LUTOUT202	LUTOUT201	LUTOUT200	LUTOUT199	LUTOUT198	LUTOUT197	LUTOUT196	LUTOUT195	LUTOUT194	LUTOUT193	LUTOUT192
Reset	0	0	0	0	0	0	0	0	0	0	0	0	0	0	0	0

PXP_HW_PXP_WFE_B_STG3_F8X1_OUT1_6 field descriptions

Field	Description
31 LUTOUT223	LUT OUT
30 LUTOUT222	LUT OUT
29 LUTOUT221	LUT OUT
28 LUTOUT220	LUT OUT
27 LUTOUT219	LUT OUT
26 LUTOUT218	LUT OUT
25 LUTOUT217	LUT OUT
24 LUTOUT216	LUT OUT
23 LUTOUT215	LUT OUT
22 LUTOUT214	LUT OUT
21 LUTOUT213	LUT OUT
20 LUTOUT212	LUT OUT
19 LUTOUT211	LUT OUT
18 LUTOUT210	LUT OUT
17 LUTOUT209	LUT OUT
16 LUTOUT208	LUT OUT
15 LUTOUT207	LUT OUT
14 LUTOUT206	LUT OUT
13 LUTOUT205	LUT OUT
12 LUTOUT204	LUT OUT
11 LUTOUT203	LUT OUT
10 LUTOUT202	LUT OUT
9 LUTOUT201	LUT OUT

Table continues on the next page...

PXP_HW_PXP_WFE_B_STG3_F8X1_OUT1_6 field descriptions (continued)

Field	Description
8 LUTOUT200	LUT OUT
7 LUTOUT199	LUT OUT
6 LUTOUT198	LUT OUT
5 LUTOUT197	LUT OUT
4 LUTOUT196	LUT OUT
3 LUTOUT195	LUT OUT
2 LUTOUT194	LUT OUT
1 LUTOUT193	LUT OUT
0 LUTOUT192	LUT OUT

41.11.293 This register defines the output values (new flag) for the 8x1 LUTs in stage 3. (PXP_HW_PXP_WFE_B_STG3_F8X1_OUT1_7)

The 5x1 LUT output value for input value n. This output value results in a flag that is added to the flag array.

Address: 21C_C000h base + 2680h offset = 21C_E680h

Bit	31	30	29	28	27	26	25	24	23	22	21	20	19	18	17	16
R	LUTOUT255	LUTOUT254	LUTOUT253	LUTOUT252	LUTOUT251	LUTOUT250	LUTOUT249	LUTOUT248	LUTOUT247	LUTOUT246	LUTOUT245	LUTOUT244	LUTOUT243	LUTOUT242	LUTOUT241	LUTOUT240
W	LUTOUT255	LUTOUT254	LUTOUT253	LUTOUT252	LUTOUT251	LUTOUT250	LUTOUT249	LUTOUT248	LUTOUT247	LUTOUT246	LUTOUT245	LUTOUT244	LUTOUT243	LUTOUT242	LUTOUT241	LUTOUT240
Reset	0	0	0	0	0	0	0	0	0	0	0	0	0	0	0	0
Bit	15	14	13	12	11	10	9	8	7	6	5	4	3	2	1	0
R	LUTOUT239	LUTOUT238	LUTOUT237	LUTOUT236	LUTOUT235	LUTOUT234	LUTOUT233	LUTOUT232	LUTOUT231	LUTOUT230	LUTOUT229	LUTOUT228	LUTOUT227	LUTOUT226	LUTOUT225	LUTOUT224
W	LUTOUT239	LUTOUT238	LUTOUT237	LUTOUT236	LUTOUT235	LUTOUT234	LUTOUT233	LUTOUT232	LUTOUT231	LUTOUT230	LUTOUT229	LUTOUT228	LUTOUT227	LUTOUT226	LUTOUT225	LUTOUT224
Reset	0	0	0	0	0	0	0	0	0	0	0	0	0	0	0	0

PXP_HW_PXP_WFE_B_STG3_F8X1_OUT1_7 field descriptions

Field	Description
31 LUTOUT255	LUT OUT
30 LUTOUT254	LUT OUT
29 LUTOUT253	LUT OUT
28 LUTOUT252	LUT OUT
27 LUTOUT251	LUT OUT
26 LUTOUT250	LUT OUT
25 LUTOUT249	LUT OUT
24 LUTOUT248	LUT OUT
23 LUTOUT247	LUT OUT
22 LUTOUT246	LUT OUT
21 LUTOUT245	LUT OUT
20 LUTOUT244	LUT OUT
19 LUTOUT243	LUT OUT
18 LUTOUT242	LUT OUT
17 LUTOUT241	LUT OUT
16 LUTOUT240	LUT OUT
15 LUTOUT239	LUT OUT
14 LUTOUT238	LUT OUT
13 LUTOUT237	LUT OUT
12 LUTOUT236	LUT OUT
11 LUTOUT235	LUT OUT
10 LUTOUT234	LUT OUT
9 LUTOUT233	LUT OUT

Table continues on the next page...

PXP_HW_PXP_WFE_B_STG3_F8X1_OUT1_7 field descriptions (continued)

Field	Description
8 LUTOUT232	LUT OUT
7 LUTOUT231	LUT OUT
6 LUTOUT230	LUT OUT
5 LUTOUT229	LUT OUT
4 LUTOUT228	LUT OUT
3 LUTOUT227	LUT OUT
2 LUTOUT226	LUT OUT
1 LUTOUT225	LUT OUT
0 LUTOUT224	LUT OUT

**41.11.294 This register defines the output values (new flag) for the 8x1 LUTs in stage 3.
(PXP_HW_PXP_WFE_B_STG3_F8X1_OUT2_0)**

The 5x1 LUT output value for input value n. This output value results in a flag that is added to the flag array.

Address: 21C_C000h base + 2690h offset = 21C_E690h

Bit	31	30	29	28	27	26	25	24	23	22	21	20	19	18	17	16
R	LUTOUT31	LUTOUT30	LUTOUT29	LUTOUT28	LUTOUT27	LUTOUT26	LUTOUT25	LUTOUT24	LUTOUT23	LUTOUT22	LUTOUT21	LUTOUT20	LUTOUT19	LUTOUT18	LUTOUT17	LUTOUT16
W	LUTOUT31	LUTOUT30	LUTOUT29	LUTOUT28	LUTOUT27	LUTOUT26	LUTOUT25	LUTOUT24	LUTOUT23	LUTOUT22	LUTOUT21	LUTOUT20	LUTOUT19	LUTOUT18	LUTOUT17	LUTOUT16
Reset	0	0	0	0	0	0	0	0	0	0	0	0	0	0	0	0
Bit	15	14	13	12	11	10	9	8	7	6	5	4	3	2	1	0
R	LUTOUT15	LUTOUT14	LUTOUT13	LUTOUT12	LUTOUT11	LUTOUT10	LUTOUT9	LUTOUT8	LUTOUT7	LUTOUT6	LUTOUT5	LUTOUT4	LUTOUT3	LUTOUT2	LUTOUT1	LUTOUT0
W	LUTOUT15	LUTOUT14	LUTOUT13	LUTOUT12	LUTOUT11	LUTOUT10	LUTOUT9	LUTOUT8	LUTOUT7	LUTOUT6	LUTOUT5	LUTOUT4	LUTOUT3	LUTOUT2	LUTOUT1	LUTOUT0
Reset	0	0	0	0	0	0	0	0	0	0	0	0	0	0	0	0

PXP_HW_PXP_WFE_B_STG3_F8X1_OUT2_0 field descriptions

Field	Description
31 LUTOUT31	LUT OUT
30 LUTOUT30	LUT OUT
29 LUTOUT29	LUT OUT
28 LUTOUT28	LUT OUT
27 LUTOUT27	LUT OUT
26 LUTOUT26	LUT OUT
25 LUTOUT25	LUT OUT
24 LUTOUT24	LUT OUT
23 LUTOUT23	LUT OUT
22 LUTOUT22	LUT OUT
21 LUTOUT21	LUT OUT
20 LUTOUT20	LUT OUT
19 LUTOUT19	LUT OUT
18 LUTOUT18	LUT OUT
17 LUTOUT17	LUT OUT
16 LUTOUT16	LUT OUT
15 LUTOUT15	LUT OUT
14 LUTOUT14	LUT OUT
13 LUTOUT13	LUT OUT
12 LUTOUT12	LUT OUT
11 LUTOUT11	LUT OUT
10 LUTOUT10	LUT OUT
9 LUTOUT9	LUT OUT

Table continues on the next page...

PXP_HW_PXP_WFE_B_STG3_F8X1_OUT2_0 field descriptions (continued)

Field	Description
8 LUTOUT8	LUT OUT
7 LUTOUT7	LUT OUT
6 LUTOUT6	LUT OUT
5 LUTOUT5	LUT OUT
4 LUTOUT4	LUT OUT
3 LUTOUT3	LUT OUT
2 LUTOUT2	LUT OUT
1 LUTOUT1	LUT OUT
0 LUTOUT0	LUT OUT

**41.11.295 This register defines the output values (new flag) for the 8x1 LUTs in stage 3.
(PXP_HW_PXP_WFE_B_STG3_F8X1_OUT2_1)**

The 5x1 LUT output value for input value n. This output value results in a flag that is added to the flag array.

Address: 21C_C000h base + 26A0h offset = 21C_E6A0h

Bit	31	30	29	28	27	26	25	24	23	22	21	20	19	18	17	16
R	LUTOUT63	LUTOUT62	LUTOUT61	LUTOUT60	LUTOUT59	LUTOUT58	LUTOUT57	LUTOUT56	LUTOUT55	LUTOUT54	LUTOUT53	LUTOUT52	LUTOUT51	LUTOUT50	LUTOUT49	LUTOUT48
W																
Reset	0	0	0	0	0	0	0	0	0	0	0	0	0	0	0	0
Bit	15	14	13	12	11	10	9	8	7	6	5	4	3	2	1	0
R	LUTOUT47	LUTOUT46	LUTOUT45	LUTOUT44	LUTOUT43	LUTOUT42	LUTOUT41	LUTOUT40	LUTOUT39	LUTOUT38	LUTOUT37	LUTOUT36	LUTOUT35	LUTOUT34	LUTOUT33	LUTOUT32
W																
Reset	0	0	0	0	0	0	0	0	0	0	0	0	0	0	0	0

PXP_HW_PXP_WFE_B_STG3_F8X1_OUT2_1 field descriptions

Field	Description
31 LUTOUT63	LUT OUT
30 LUTOUT62	LUT OUT
29 LUTOUT61	LUT OUT
28 LUTOUT60	LUT OUT
27 LUTOUT59	LUT OUT
26 LUTOUT58	LUT OUT
25 LUTOUT57	LUT OUT
24 LUTOUT56	LUT OUT
23 LUTOUT55	LUT OUT
22 LUTOUT54	LUT OUT
21 LUTOUT53	LUT OUT
20 LUTOUT52	LUT OUT
19 LUTOUT51	LUT OUT
18 LUTOUT50	LUT OUT
17 LUTOUT49	LUT OUT
16 LUTOUT48	LUT OUT
15 LUTOUT47	LUT OUT
14 LUTOUT46	LUT OUT
13 LUTOUT45	LUT OUT
12 LUTOUT44	LUT OUT
11 LUTOUT43	LUT OUT
10 LUTOUT42	LUT OUT
9 LUTOUT41	LUT OUT

Table continues on the next page...

PXP_HW_PXP_WFE_B_STG3_F8X1_OUT2_1 field descriptions (continued)

Field	Description
8 LUTOUT40	LUT OUT
7 LUTOUT39	LUT OUT
6 LUTOUT38	LUT OUT
5 LUTOUT37	LUT OUT
4 LUTOUT36	LUT OUT
3 LUTOUT35	LUT OUT
2 LUTOUT34	LUT OUT
1 LUTOUT33	LUT OUT
0 LUTOUT32	LUT OUT

**41.11.296 This register defines the output values (new flag) for the 8x1 LUTs in stage 3.
(PXP_HW_PXP_WFE_B_STG3_F8X1_OUT2_2)**

The 5x1 LUT output value for input value n. This output value results in a flag that is added to the flag array.

Address: 21C_C000h base + 26B0h offset = 21C_E6B0h

Bit	31	30	29	28	27	26	25	24	23	22	21	20	19	18	17	16
R	LUTOUT95	LUTOUT94	LUTOUT93	LUTOUT92	LUTOUT91	LUTOUT90	LUTOUT89	LUTOUT88	LUTOUT87	LUTOUT86	LUTOUT85	LUTOUT84	LUTOUT83	LUTOUT82	LUTOUT81	LUTOUT80
W	LUTOUT95	LUTOUT94	LUTOUT93	LUTOUT92	LUTOUT91	LUTOUT90	LUTOUT89	LUTOUT88	LUTOUT87	LUTOUT86	LUTOUT85	LUTOUT84	LUTOUT83	LUTOUT82	LUTOUT81	LUTOUT80
Reset	0	0	0	0	0	0	0	0	0	0	0	0	0	0	0	0
Bit	15	14	13	12	11	10	9	8	7	6	5	4	3	2	1	0
R	LUTOUT79	LUTOUT78	LUTOUT77	LUTOUT76	LUTOUT75	LUTOUT74	LUTOUT73	LUTOUT72	LUTOUT71	LUTOUT70	LUTOUT69	LUTOUT68	LUTOUT67	LUTOUT66	LUTOUT65	LUTOUT64
W	LUTOUT79	LUTOUT78	LUTOUT77	LUTOUT76	LUTOUT75	LUTOUT74	LUTOUT73	LUTOUT72	LUTOUT71	LUTOUT70	LUTOUT69	LUTOUT68	LUTOUT67	LUTOUT66	LUTOUT65	LUTOUT64
Reset	0	0	0	0	0	0	0	0	0	0	0	0	0	0	0	0

PXP_HW_PXP_WFE_B_STG3_F8X1_OUT2_2 field descriptions

Field	Description
31 LUTOUT95	LUT OUT
30 LUTOUT94	LUT OUT
29 LUTOUT93	LUT OUT
28 LUTOUT92	LUT OUT
27 LUTOUT91	LUT OUT
26 LUTOUT90	LUT OUT
25 LUTOUT89	LUT OUT
24 LUTOUT88	LUT OUT
23 LUTOUT87	LUT OUT
22 LUTOUT86	LUT OUT
21 LUTOUT85	LUT OUT
20 LUTOUT84	LUT OUT
19 LUTOUT83	LUT OUT
18 LUTOUT82	LUT OUT
17 LUTOUT81	LUT OUT
16 LUTOUT80	LUT OUT
15 LUTOUT79	LUT OUT
14 LUTOUT78	LUT OUT
13 LUTOUT77	LUT OUT
12 LUTOUT76	LUT OUT
11 LUTOUT75	LUT OUT
10 LUTOUT74	LUT OUT
9 LUTOUT73	LUT OUT

Table continues on the next page...

PXP_HW_PXP_WFE_B_STG3_F8X1_OUT2_2 field descriptions (continued)

Field	Description
8 LUTOUT72	LUT OUT
7 LUTOUT71	LUT OUT
6 LUTOUT70	LUT OUT
5 LUTOUT69	LUT OUT
4 LUTOUT68	LUT OUT
3 LUTOUT67	LUT OUT
2 LUTOUT66	LUT OUT
1 LUTOUT65	LUT OUT
0 LUTOUT64	LUT OUT

**41.11.297 This register defines the output values (new flag) for the 8x1 LUTs in stage 3.
(PXP_HW_PXP_WFE_B_STG3_F8X1_OUT2_3)**

The 5x1 LUT output value for input value n. This output value results in a flag that is added to the flag array.

Address: 21C_C000h base + 26C0h offset = 21C_E6C0h

Bit	31	30	29	28	27	26	25	24	23	22	21	20	19	18	17	16
R	LUTOUT127	LUTOUT126	LUTOUT125	LUTOUT124	LUTOUT123	LUTOUT122	LUTOUT121	LUTOUT120	LUTOUT119	LUTOUT118	LUTOUT117	LUTOUT116	LUTOUT115	LUTOUT114	LUTOUT113	LUTOUT112
W	LUTOUT127	LUTOUT126	LUTOUT125	LUTOUT124	LUTOUT123	LUTOUT122	LUTOUT121	LUTOUT120	LUTOUT119	LUTOUT118	LUTOUT117	LUTOUT116	LUTOUT115	LUTOUT114	LUTOUT113	LUTOUT112
Reset	0	0	0	0	0	0	0	0	0	0	0	0	0	0	0	0
Bit	15	14	13	12	11	10	9	8	7	6	5	4	3	2	1	0
R	LUTOUT111	LUTOUT110	LUTOUT109	LUTOUT108	LUTOUT107	LUTOUT106	LUTOUT105	LUTOUT104	LUTOUT103	LUTOUT102	LUTOUT101	LUTOUT100	LUTOUT99	LUTOUT98	LUTOUT97	LUTOUT96
W	LUTOUT111	LUTOUT110	LUTOUT109	LUTOUT108	LUTOUT107	LUTOUT106	LUTOUT105	LUTOUT104	LUTOUT103	LUTOUT102	LUTOUT101	LUTOUT100	LUTOUT99	LUTOUT98	LUTOUT97	LUTOUT96
Reset	0	0	0	0	0	0	0	0	0	0	0	0	0	0	0	0

PXP_HW_PXP_WFE_B_STG3_F8X1_OUT2_3 field descriptions

Field	Description
31 LUTOUT127	LUT OUT
30 LUTOUT126	LUT OUT
29 LUTOUT125	LUT OUT
28 LUTOUT124	LUT OUT
27 LUTOUT123	LUT OUT
26 LUTOUT122	LUT OUT
25 LUTOUT121	LUT OUT
24 LUTOUT120	LUT OUT
23 LUTOUT119	LUT OUT
22 LUTOUT118	LUT OUT
21 LUTOUT117	LUT OUT
20 LUTOUT116	LUT OUT
19 LUTOUT115	LUT OUT
18 LUTOUT114	LUT OUT
17 LUTOUT113	LUT OUT
16 LUTOUT112	LUT OUT
15 LUTOUT111	LUT OUT
14 LUTOUT110	LUT OUT
13 LUTOUT109	LUT OUT
12 LUTOUT108	LUT OUT
11 LUTOUT107	LUT OUT
10 LUTOUT106	LUT OUT
9 LUTOUT105	LUT OUT

Table continues on the next page...

PXP_HW_PXP_WFE_B_STG3_F8X1_OUT2_3 field descriptions (continued)

Field	Description
8 LUTOUT104	LUT OUT
7 LUTOUT103	LUT OUT
6 LUTOUT102	LUT OUT
5 LUTOUT101	LUT OUT
4 LUTOUT100	LUT OUT
3 LUTOUT99	LUT OUT
2 LUTOUT98	LUT OUT
1 LUTOUT97	LUT OUT
0 LUTOUT96	LUT OUT

**41.11.298 This register defines the output values (new flag) for the 8x1 LUTs in stage 3.
(PXP_HW_PXP_WFE_B_STG3_F8X1_OUT2_4)**

The 5x1 LUT output value for input value n. This output value results in a flag that is added to the flag array.

Address: 21C_C000h base + 26D0h offset = 21C_E6D0h

Bit	31	30	29	28	27	26	25	24	23	22	21	20	19	18	17	16
R	LUTOUT159	LUTOUT158	LUTOUT157	LUTOUT156	LUTOUT155	LUTOUT154	LUTOUT153	LUTOUT152	LUTOUT151	LUTOUT150	LUTOUT149	LUTOUT148	LUTOUT147	LUTOUT146	LUTOUT145	LUTOUT144
W	LUTOUT159	LUTOUT158	LUTOUT157	LUTOUT156	LUTOUT155	LUTOUT154	LUTOUT153	LUTOUT152	LUTOUT151	LUTOUT150	LUTOUT149	LUTOUT148	LUTOUT147	LUTOUT146	LUTOUT145	LUTOUT144
Reset	0	0	0	0	0	0	0	0	0	0	0	0	0	0	0	0
Bit	15	14	13	12	11	10	9	8	7	6	5	4	3	2	1	0
R	LUTOUT143	LUTOUT142	LUTOUT141	LUTOUT140	LUTOUT139	LUTOUT138	LUTOUT137	LUTOUT136	LUTOUT135	LUTOUT134	LUTOUT133	LUTOUT132	LUTOUT131	LUTOUT130	LUTOUT129	LUTOUT128
W	LUTOUT143	LUTOUT142	LUTOUT141	LUTOUT140	LUTOUT139	LUTOUT138	LUTOUT137	LUTOUT136	LUTOUT135	LUTOUT134	LUTOUT133	LUTOUT132	LUTOUT131	LUTOUT130	LUTOUT129	LUTOUT128
Reset	0	0	0	0	0	0	0	0	0	0	0	0	0	0	0	0

PXP_HW_PXP_WFE_B_STG3_F8X1_OUT2_4 field descriptions

Field	Description
31 LUTOUT159	LUT OUT
30 LUTOUT158	LUT OUT
29 LUTOUT157	LUT OUT
28 LUTOUT156	LUT OUT
27 LUTOUT155	LUT OUT
26 LUTOUT154	LUT OUT
25 LUTOUT153	LUT OUT
24 LUTOUT152	LUT OUT
23 LUTOUT151	LUT OUT
22 LUTOUT150	LUT OUT
21 LUTOUT149	LUT OUT
20 LUTOUT148	LUT OUT
19 LUTOUT147	LUT OUT
18 LUTOUT146	LUT OUT
17 LUTOUT145	LUT OUT
16 LUTOUT144	LUT OUT
15 LUTOUT143	LUT OUT
14 LUTOUT142	LUT OUT
13 LUTOUT141	LUT OUT
12 LUTOUT140	LUT OUT
11 LUTOUT139	LUT OUT
10 LUTOUT138	LUT OUT
9 LUTOUT137	LUT OUT

Table continues on the next page...

PXP_HW_PXP_WFE_B_STG3_F8X1_OUT2_4 field descriptions (continued)

Field	Description
8 LUTOUT136	LUT OUT
7 LUTOUT135	LUT OUT
6 LUTOUT134	LUT OUT
5 LUTOUT133	LUT OUT
4 LUTOUT132	LUT OUT
3 LUTOUT131	LUT OUT
2 LUTOUT130	LUT OUT
1 LUTOUT129	LUT OUT
0 LUTOUT128	LUT OUT

**41.11.299 This register defines the output values (new flag) for the 8x1 LUTs in stage 3.
(PXP_HW_PXP_WFE_B_STG3_F8X1_OUT2_5)**

The 5x1 LUT output value for input value n. This output value results in a flag that is added to the flag array.

Address: 21C_C000h base + 26E0h offset = 21C_E6E0h

Bit	31	30	29	28	27	26	25	24	23	22	21	20	19	18	17	16
R	LUTOUT191	LUTOUT190	LUTOUT189	LUTOUT188	LUTOUT187	LUTOUT186	LUTOUT185	LUTOUT184	LUTOUT183	LUTOUT182	LUTOUT181	LUTOUT180	LUTOUT179	LUTOUT178	LUTOUT177	LUTOUT176
W	LUTOUT191	LUTOUT190	LUTOUT189	LUTOUT188	LUTOUT187	LUTOUT186	LUTOUT185	LUTOUT184	LUTOUT183	LUTOUT182	LUTOUT181	LUTOUT180	LUTOUT179	LUTOUT178	LUTOUT177	LUTOUT176
Reset	0	0	0	0	0	0	0	0	0	0	0	0	0	0	0	0
Bit	15	14	13	12	11	10	9	8	7	6	5	4	3	2	1	0
R	LUTOUT175	LUTOUT174	LUTOUT173	LUTOUT172	LUTOUT171	LUTOUT170	LUTOUT169	LUTOUT168	LUTOUT167	LUTOUT166	LUTOUT165	LUTOUT164	LUTOUT163	LUTOUT162	LUTOUT161	LUTOUT160
W	LUTOUT175	LUTOUT174	LUTOUT173	LUTOUT172	LUTOUT171	LUTOUT170	LUTOUT169	LUTOUT168	LUTOUT167	LUTOUT166	LUTOUT165	LUTOUT164	LUTOUT163	LUTOUT162	LUTOUT161	LUTOUT160
Reset	0	0	0	0	0	0	0	0	0	0	0	0	0	0	0	0

PXP_HW_PXP_WFE_B_STG3_F8X1_OUT2_5 field descriptions

Field	Description
31 LUTOUT191	LUT OUT
30 LUTOUT190	LUT OUT
29 LUTOUT189	LUT OUT
28 LUTOUT188	LUT OUT
27 LUTOUT187	LUT OUT
26 LUTOUT186	LUT OUT
25 LUTOUT185	LUT OUT
24 LUTOUT184	LUT OUT
23 LUTOUT183	LUT OUT
22 LUTOUT182	LUT OUT
21 LUTOUT181	LUT OUT
20 LUTOUT180	LUT OUT
19 LUTOUT179	LUT OUT
18 LUTOUT178	LUT OUT
17 LUTOUT177	LUT OUT
16 LUTOUT176	LUT OUT
15 LUTOUT175	LUT OUT
14 LUTOUT174	LUT OUT
13 LUTOUT173	LUT OUT
12 LUTOUT172	LUT OUT
11 LUTOUT171	LUT OUT
10 LUTOUT170	LUT OUT
9 LUTOUT169	LUT OUT

Table continues on the next page...

PXP_HW_PXP_WFE_B_STG3_F8X1_OUT2_5 field descriptions (continued)

Field	Description
8 LUTOUT168	LUT OUT
7 LUTOUT167	LUT OUT
6 LUTOUT166	LUT OUT
5 LUTOUT165	LUT OUT
4 LUTOUT164	LUT OUT
3 LUTOUT163	LUT OUT
2 LUTOUT162	LUT OUT
1 LUTOUT161	LUT OUT
0 LUTOUT160	LUT OUT

41.11.300 This register defines the output values (new flag) for the 8x1 LUTs in stage 3. (PXP_HW_PXP_WFE_B_STG3_F8X1_OUT2_6)

The 5x1 LUT output value for input value n. This output value results in a flag that is added to the flag array.

Address: 21C_C000h base + 26F0h offset = 21C_E6F0h

Bit	31	30	29	28	27	26	25	24	23	22	21	20	19	18	17	16
R	LUTOUT223	LUTOUT222	LUTOUT221	LUTOUT220	LUTOUT219	LUTOUT218	LUTOUT217	LUTOUT216	LUTOUT215	LUTOUT214	LUTOUT213	LUTOUT212	LUTOUT211	LUTOUT210	LUTOUT209	LUTOUT208
W	LUTOUT223	LUTOUT222	LUTOUT221	LUTOUT220	LUTOUT219	LUTOUT218	LUTOUT217	LUTOUT216	LUTOUT215	LUTOUT214	LUTOUT213	LUTOUT212	LUTOUT211	LUTOUT210	LUTOUT209	LUTOUT208
Reset	0	0	0	0	0	0	0	0	0	0	0	0	0	0	0	0
Bit	15	14	13	12	11	10	9	8	7	6	5	4	3	2	1	0
R	LUTOUT207	LUTOUT206	LUTOUT205	LUTOUT204	LUTOUT203	LUTOUT202	LUTOUT201	LUTOUT200	LUTOUT199	LUTOUT198	LUTOUT197	LUTOUT196	LUTOUT195	LUTOUT194	LUTOUT193	LUTOUT192
W	LUTOUT207	LUTOUT206	LUTOUT205	LUTOUT204	LUTOUT203	LUTOUT202	LUTOUT201	LUTOUT200	LUTOUT199	LUTOUT198	LUTOUT197	LUTOUT196	LUTOUT195	LUTOUT194	LUTOUT193	LUTOUT192
Reset	0	0	0	0	0	0	0	0	0	0	0	0	0	0	0	0

PXP_HW_PXP_WFE_B_STG3_F8X1_OUT2_6 field descriptions

Field	Description
31 LUTOUT223	LUT OUT
30 LUTOUT222	LUT OUT
29 LUTOUT221	LUT OUT
28 LUTOUT220	LUT OUT
27 LUTOUT219	LUT OUT
26 LUTOUT218	LUT OUT
25 LUTOUT217	LUT OUT
24 LUTOUT216	LUT OUT
23 LUTOUT215	LUT OUT
22 LUTOUT214	LUT OUT
21 LUTOUT213	LUT OUT
20 LUTOUT212	LUT OUT
19 LUTOUT211	LUT OUT
18 LUTOUT210	LUT OUT
17 LUTOUT209	LUT OUT
16 LUTOUT208	LUT OUT
15 LUTOUT207	LUT OUT
14 LUTOUT206	LUT OUT
13 LUTOUT205	LUT OUT
12 LUTOUT204	LUT OUT
11 LUTOUT203	LUT OUT
10 LUTOUT202	LUT OUT
9 LUTOUT201	LUT OUT

Table continues on the next page...

PXP_HW_PXP_WFE_B_STG3_F8X1_OUT2_6 field descriptions (continued)

Field	Description
8 LUTOUT200	LUT OUT
7 LUTOUT199	LUT OUT
6 LUTOUT198	LUT OUT
5 LUTOUT197	LUT OUT
4 LUTOUT196	LUT OUT
3 LUTOUT195	LUT OUT
2 LUTOUT194	LUT OUT
1 LUTOUT193	LUT OUT
0 LUTOUT192	LUT OUT

41.11.301 This register defines the output values (new flag) for the 8x1 LUTs in stage 3. (PXP_HW_PXP_WFE_B_STG3_F8X1_OUT2_7)

The 5x1 LUT output value for input value n. This output value results in a flag that is added to the flag array.

Address: 21C_C000h base + 2700h offset = 21C_E700h

Bit	31	30	29	28	27	26	25	24	23	22	21	20	19	18	17	16
R	LUTOUT255	LUTOUT254	LUTOUT253	LUTOUT252	LUTOUT251	LUTOUT250	LUTOUT249	LUTOUT248	LUTOUT247	LUTOUT246	LUTOUT245	LUTOUT244	LUTOUT243	LUTOUT242	LUTOUT241	LUTOUT240
W	LUTOUT255	LUTOUT254	LUTOUT253	LUTOUT252	LUTOUT251	LUTOUT250	LUTOUT249	LUTOUT248	LUTOUT247	LUTOUT246	LUTOUT245	LUTOUT244	LUTOUT243	LUTOUT242	LUTOUT241	LUTOUT240
Reset	0	0	0	0	0	0	0	0	0	0	0	0	0	0	0	0
Bit	15	14	13	12	11	10	9	8	7	6	5	4	3	2	1	0
R	LUTOUT239	LUTOUT238	LUTOUT237	LUTOUT236	LUTOUT235	LUTOUT234	LUTOUT233	LUTOUT232	LUTOUT231	LUTOUT230	LUTOUT229	LUTOUT228	LUTOUT227	LUTOUT226	LUTOUT225	LUTOUT224
W	LUTOUT239	LUTOUT238	LUTOUT237	LUTOUT236	LUTOUT235	LUTOUT234	LUTOUT233	LUTOUT232	LUTOUT231	LUTOUT230	LUTOUT229	LUTOUT228	LUTOUT227	LUTOUT226	LUTOUT225	LUTOUT224
Reset	0	0	0	0	0	0	0	0	0	0	0	0	0	0	0	0

PXP_HW_PXP_WFE_B_STG3_F8X1_OUT2_7 field descriptions

Field	Description
31 LUTOUT255	LUT OUT
30 LUTOUT254	LUT OUT
29 LUTOUT253	LUT OUT
28 LUTOUT252	LUT OUT
27 LUTOUT251	LUT OUT
26 LUTOUT250	LUT OUT
25 LUTOUT249	LUT OUT
24 LUTOUT248	LUT OUT
23 LUTOUT247	LUT OUT
22 LUTOUT246	LUT OUT
21 LUTOUT245	LUT OUT
20 LUTOUT244	LUT OUT
19 LUTOUT243	LUT OUT
18 LUTOUT242	LUT OUT
17 LUTOUT241	LUT OUT
16 LUTOUT240	LUT OUT
15 LUTOUT239	LUT OUT
14 LUTOUT238	LUT OUT
13 LUTOUT237	LUT OUT
12 LUTOUT236	LUT OUT
11 LUTOUT235	LUT OUT
10 LUTOUT234	LUT OUT
9 LUTOUT233	LUT OUT

Table continues on the next page...

PXP_HW_PXP_WFE_B_STG3_F8X1_OUT2_7 field descriptions (continued)

Field	Description
8 LUTOUT232	LUT OUT
7 LUTOUT231	LUT OUT
6 LUTOUT230	LUT OUT
5 LUTOUT229	LUT OUT
4 LUTOUT228	LUT OUT
3 LUTOUT227	LUT OUT
2 LUTOUT226	LUT OUT
1 LUTOUT225	LUT OUT
0 LUTOUT224	LUT OUT

**41.11.302 This register defines the output values (new flag) for the 8x1 LUTs in stage 3.
(PXP_HW_PXP_WFE_B_STG3_F8X1_OUT3_0)**

The 5x1 LUT output value for input value n. This output value results in a flag that is added to the flag array.

Address: 21C_C000h base + 2710h offset = 21C_E710h

Bit	31	30	29	28	27	26	25	24	23	22	21	20	19	18	17	16
R	LUTOUT31	LUTOUT30	LUTOUT29	LUTOUT28	LUTOUT27	LUTOUT26	LUTOUT25	LUTOUT24	LUTOUT23	LUTOUT22	LUTOUT21	LUTOUT20	LUTOUT19	LUTOUT18	LUTOUT17	LUTOUT16
W	LUTOUT31	LUTOUT30	LUTOUT29	LUTOUT28	LUTOUT27	LUTOUT26	LUTOUT25	LUTOUT24	LUTOUT23	LUTOUT22	LUTOUT21	LUTOUT20	LUTOUT19	LUTOUT18	LUTOUT17	LUTOUT16
Reset	0	0	0	0	0	0	0	0	0	0	0	0	0	0	0	0
Bit	15	14	13	12	11	10	9	8	7	6	5	4	3	2	1	0
R	LUTOUT15	LUTOUT14	LUTOUT13	LUTOUT12	LUTOUT11	LUTOUT10	LUTOUT9	LUTOUT8	LUTOUT7	LUTOUT6	LUTOUT5	LUTOUT4	LUTOUT3	LUTOUT2	LUTOUT1	LUTOUT0
W	LUTOUT15	LUTOUT14	LUTOUT13	LUTOUT12	LUTOUT11	LUTOUT10	LUTOUT9	LUTOUT8	LUTOUT7	LUTOUT6	LUTOUT5	LUTOUT4	LUTOUT3	LUTOUT2	LUTOUT1	LUTOUT0
Reset	0	0	0	0	0	0	0	0	0	0	0	0	0	0	0	0

PXP_HW_PXP_WFE_B_STG3_F8X1_OUT3_0 field descriptions

Field	Description
31 LUTOUT31	LUT OUT
30 LUTOUT30	LUT OUT
29 LUTOUT29	LUT OUT
28 LUTOUT28	LUT OUT
27 LUTOUT27	LUT OUT
26 LUTOUT26	LUT OUT
25 LUTOUT25	LUT OUT
24 LUTOUT24	LUT OUT
23 LUTOUT23	LUT OUT
22 LUTOUT22	LUT OUT
21 LUTOUT21	LUT OUT
20 LUTOUT20	LUT OUT
19 LUTOUT19	LUT OUT
18 LUTOUT18	LUT OUT
17 LUTOUT17	LUT OUT
16 LUTOUT16	LUT OUT
15 LUTOUT15	LUT OUT
14 LUTOUT14	LUT OUT
13 LUTOUT13	LUT OUT
12 LUTOUT12	LUT OUT
11 LUTOUT11	LUT OUT
10 LUTOUT10	LUT OUT
9 LUTOUT9	LUT OUT

Table continues on the next page...

PXP_HW_PXP_WFE_B_STG3_F8X1_OUT3_0 field descriptions (continued)

Field	Description
8 LUTOUT8	LUT OUT
7 LUTOUT7	LUT OUT
6 LUTOUT6	LUT OUT
5 LUTOUT5	LUT OUT
4 LUTOUT4	LUT OUT
3 LUTOUT3	LUT OUT
2 LUTOUT2	LUT OUT
1 LUTOUT1	LUT OUT
0 LUTOUT0	LUT OUT

**41.11.303 This register defines the output values (new flag) for the 8x1 LUTs in stage 3.
(PXP_HW_PXP_WFE_B_STG3_F8X1_OUT3_1)**

The 5x1 LUT output value for input value n. This output value results in a flag that is added to the flag array.

Address: 21C_C000h base + 2720h offset = 21C_E720h

Bit	31	30	29	28	27	26	25	24	23	22	21	20	19	18	17	16
R	LUTOUT63	LUTOUT62	LUTOUT61	LUTOUT60	LUTOUT59	LUTOUT58	LUTOUT57	LUTOUT56	LUTOUT55	LUTOUT54	LUTOUT53	LUTOUT52	LUTOUT51	LUTOUT50	LUTOUT49	LUTOUT48
W																
Reset	0	0	0	0	0	0	0	0	0	0	0	0	0	0	0	0
Bit	15	14	13	12	11	10	9	8	7	6	5	4	3	2	1	0
R	LUTOUT47	LUTOUT46	LUTOUT45	LUTOUT44	LUTOUT43	LUTOUT42	LUTOUT41	LUTOUT40	LUTOUT39	LUTOUT38	LUTOUT37	LUTOUT36	LUTOUT35	LUTOUT34	LUTOUT33	LUTOUT32
W																
Reset	0	0	0	0	0	0	0	0	0	0	0	0	0	0	0	0

PXP_HW_PXP_WFE_B_STG3_F8X1_OUT3_1 field descriptions

Field	Description
31 LUTOUT63	LUT OUT
30 LUTOUT62	LUT OUT
29 LUTOUT61	LUT OUT
28 LUTOUT60	LUT OUT
27 LUTOUT59	LUT OUT
26 LUTOUT58	LUT OUT
25 LUTOUT57	LUT OUT
24 LUTOUT56	LUT OUT
23 LUTOUT55	LUT OUT
22 LUTOUT54	LUT OUT
21 LUTOUT53	LUT OUT
20 LUTOUT52	LUT OUT
19 LUTOUT51	LUT OUT
18 LUTOUT50	LUT OUT
17 LUTOUT49	LUT OUT
16 LUTOUT48	LUT OUT
15 LUTOUT47	LUT OUT
14 LUTOUT46	LUT OUT
13 LUTOUT45	LUT OUT
12 LUTOUT44	LUT OUT
11 LUTOUT43	LUT OUT
10 LUTOUT42	LUT OUT
9 LUTOUT41	LUT OUT

Table continues on the next page...

PXP_HW_PXP_WFE_B_STG3_F8X1_OUT3_1 field descriptions (continued)

Field	Description
8 LUTOUT40	LUT OUT
7 LUTOUT39	LUT OUT
6 LUTOUT38	LUT OUT
5 LUTOUT37	LUT OUT
4 LUTOUT36	LUT OUT
3 LUTOUT35	LUT OUT
2 LUTOUT34	LUT OUT
1 LUTOUT33	LUT OUT
0 LUTOUT32	LUT OUT

41.11.304 This register defines the output values (new flag) for the 8x1 LUTs in stage 3.
(PXP_HW_PXP_WFE_B_STG3_F8X1_OUT3_2)

The 5x1 LUT output value for input value n. This output value results in a flag that is added to the flag array.

Address: 21C_C000h base + 2730h offset = 21C_E730h

Bit	31	30	29	28	27	26	25	24	23	22	21	20	19	18	17	16
R	LUTOUT95	LUTOUT94	LUTOUT93	LUTOUT92	LUTOUT91	LUTOUT90	LUTOUT89	LUTOUT88	LUTOUT87	LUTOUT86	LUTOUT85	LUTOUT84	LUTOUT83	LUTOUT82	LUTOUT81	LUTOUT80
W	LUTOUT95	LUTOUT94	LUTOUT93	LUTOUT92	LUTOUT91	LUTOUT90	LUTOUT89	LUTOUT88	LUTOUT87	LUTOUT86	LUTOUT85	LUTOUT84	LUTOUT83	LUTOUT82	LUTOUT81	LUTOUT80
Reset	0	0	0	0	0	0	0	0	0	0	0	0	0	0	0	0
Bit	15	14	13	12	11	10	9	8	7	6	5	4	3	2	1	0
R	LUTOUT79	LUTOUT78	LUTOUT77	LUTOUT76	LUTOUT75	LUTOUT74	LUTOUT73	LUTOUT72	LUTOUT71	LUTOUT70	LUTOUT69	LUTOUT68	LUTOUT67	LUTOUT66	LUTOUT65	LUTOUT64
W	LUTOUT79	LUTOUT78	LUTOUT77	LUTOUT76	LUTOUT75	LUTOUT74	LUTOUT73	LUTOUT72	LUTOUT71	LUTOUT70	LUTOUT69	LUTOUT68	LUTOUT67	LUTOUT66	LUTOUT65	LUTOUT64
Reset	0	0	0	0	0	0	0	0	0	0	0	0	0	0	0	0

PXP_HW_PXP_WFE_B_STG3_F8X1_OUT3_2 field descriptions

Field	Description
31 LUTOUT95	LUT OUT
30 LUTOUT94	LUT OUT
29 LUTOUT93	LUT OUT
28 LUTOUT92	LUT OUT
27 LUTOUT91	LUT OUT
26 LUTOUT90	LUT OUT
25 LUTOUT89	LUT OUT
24 LUTOUT88	LUT OUT
23 LUTOUT87	LUT OUT
22 LUTOUT86	LUT OUT
21 LUTOUT85	LUT OUT
20 LUTOUT84	LUT OUT
19 LUTOUT83	LUT OUT
18 LUTOUT82	LUT OUT
17 LUTOUT81	LUT OUT
16 LUTOUT80	LUT OUT
15 LUTOUT79	LUT OUT
14 LUTOUT78	LUT OUT
13 LUTOUT77	LUT OUT
12 LUTOUT76	LUT OUT
11 LUTOUT75	LUT OUT
10 LUTOUT74	LUT OUT
9 LUTOUT73	LUT OUT

Table continues on the next page...

PXP_HW_PXP_WFE_B_STG3_F8X1_OUT3_2 field descriptions (continued)

Field	Description
8 LUTOUT72	LUT OUT
7 LUTOUT71	LUT OUT
6 LUTOUT70	LUT OUT
5 LUTOUT69	LUT OUT
4 LUTOUT68	LUT OUT
3 LUTOUT67	LUT OUT
2 LUTOUT66	LUT OUT
1 LUTOUT65	LUT OUT
0 LUTOUT64	LUT OUT

**41.11.305 This register defines the output values (new flag) for the 8x1 LUTs in stage 3.
(PXP_HW_PXP_WFE_B_STG3_F8X1_OUT3_3)**

The 5x1 LUT output value for input value n. This output value results in a flag that is added to the flag array.

Address: 21C_C000h base + 2740h offset = 21C_E740h

Bit	31	30	29	28	27	26	25	24	23	22	21	20	19	18	17	16
R	LUTOUT127	LUTOUT126	LUTOUT125	LUTOUT124	LUTOUT123	LUTOUT122	LUTOUT121	LUTOUT120	LUTOUT119	LUTOUT118	LUTOUT117	LUTOUT116	LUTOUT115	LUTOUT114	LUTOUT113	LUTOUT112
W	LUTOUT127	LUTOUT126	LUTOUT125	LUTOUT124	LUTOUT123	LUTOUT122	LUTOUT121	LUTOUT120	LUTOUT119	LUTOUT118	LUTOUT117	LUTOUT116	LUTOUT115	LUTOUT114	LUTOUT113	LUTOUT112
Reset	0	0	0	0	0	0	0	0	0	0	0	0	0	0	0	0
Bit	15	14	13	12	11	10	9	8	7	6	5	4	3	2	1	0
R	LUTOUT111	LUTOUT110	LUTOUT109	LUTOUT108	LUTOUT107	LUTOUT106	LUTOUT105	LUTOUT104	LUTOUT103	LUTOUT102	LUTOUT101	LUTOUT100	LUTOUT99	LUTOUT98	LUTOUT97	LUTOUT96
W	LUTOUT111	LUTOUT110	LUTOUT109	LUTOUT108	LUTOUT107	LUTOUT106	LUTOUT105	LUTOUT104	LUTOUT103	LUTOUT102	LUTOUT101	LUTOUT100	LUTOUT99	LUTOUT98	LUTOUT97	LUTOUT96
Reset	0	0	0	0	0	0	0	0	0	0	0	0	0	0	0	0

PXP_HW_PXP_WFE_B_STG3_F8X1_OUT3_3 field descriptions

Field	Description
31 LUTOUT127	LUT OUT
30 LUTOUT126	LUT OUT
29 LUTOUT125	LUT OUT
28 LUTOUT124	LUT OUT
27 LUTOUT123	LUT OUT
26 LUTOUT122	LUT OUT
25 LUTOUT121	LUT OUT
24 LUTOUT120	LUT OUT
23 LUTOUT119	LUT OUT
22 LUTOUT118	LUT OUT
21 LUTOUT117	LUT OUT
20 LUTOUT116	LUT OUT
19 LUTOUT115	LUT OUT
18 LUTOUT114	LUT OUT
17 LUTOUT113	LUT OUT
16 LUTOUT112	LUT OUT
15 LUTOUT111	LUT OUT
14 LUTOUT110	LUT OUT
13 LUTOUT109	LUT OUT
12 LUTOUT108	LUT OUT
11 LUTOUT107	LUT OUT
10 LUTOUT106	LUT OUT
9 LUTOUT105	LUT OUT

Table continues on the next page...

PXP_HW_PXP_WFE_B_STG3_F8X1_OUT3_3 field descriptions (continued)

Field	Description
8 LUTOUT104	LUT OUT
7 LUTOUT103	LUT OUT
6 LUTOUT102	LUT OUT
5 LUTOUT101	LUT OUT
4 LUTOUT100	LUT OUT
3 LUTOUT99	LUT OUT
2 LUTOUT98	LUT OUT
1 LUTOUT97	LUT OUT
0 LUTOUT96	LUT OUT

41.11.306 This register defines the output values (new flag) for the 8x1 LUTs in stage 3.
(PXP_HW_PXP_WFE_B_STG3_F8X1_OUT3_4)

The 5x1 LUT output value for input value n. This output value results in a flag that is added to the flag array.

Address: 21C_C000h base + 2750h offset = 21C_E750h

Bit	31	30	29	28	27	26	25	24	23	22	21	20	19	18	17	16
R	LUTOUT159	LUTOUT158	LUTOUT157	LUTOUT156	LUTOUT155	LUTOUT154	LUTOUT153	LUTOUT152	LUTOUT151	LUTOUT150	LUTOUT149	LUTOUT148	LUTOUT147	LUTOUT146	LUTOUT145	LUTOUT144
W	LUTOUT159	LUTOUT158	LUTOUT157	LUTOUT156	LUTOUT155	LUTOUT154	LUTOUT153	LUTOUT152	LUTOUT151	LUTOUT150	LUTOUT149	LUTOUT148	LUTOUT147	LUTOUT146	LUTOUT145	LUTOUT144
Reset	0	0	0	0	0	0	0	0	0	0	0	0	0	0	0	0
Bit	15	14	13	12	11	10	9	8	7	6	5	4	3	2	1	0
R	LUTOUT143	LUTOUT142	LUTOUT141	LUTOUT140	LUTOUT139	LUTOUT138	LUTOUT137	LUTOUT136	LUTOUT135	LUTOUT134	LUTOUT133	LUTOUT132	LUTOUT131	LUTOUT130	LUTOUT129	LUTOUT128
W	LUTOUT143	LUTOUT142	LUTOUT141	LUTOUT140	LUTOUT139	LUTOUT138	LUTOUT137	LUTOUT136	LUTOUT135	LUTOUT134	LUTOUT133	LUTOUT132	LUTOUT131	LUTOUT130	LUTOUT129	LUTOUT128
Reset	0	0	0	0	0	0	0	0	0	0	0	0	0	0	0	0

PXP_HW_PXP_WFE_B_STG3_F8X1_OUT3_4 field descriptions

Field	Description
31 LUTOUT159	LUT OUT
30 LUTOUT158	LUT OUT
29 LUTOUT157	LUT OUT
28 LUTOUT156	LUT OUT
27 LUTOUT155	LUT OUT
26 LUTOUT154	LUT OUT
25 LUTOUT153	LUT OUT
24 LUTOUT152	LUT OUT
23 LUTOUT151	LUT OUT
22 LUTOUT150	LUT OUT
21 LUTOUT149	LUT OUT
20 LUTOUT148	LUT OUT
19 LUTOUT147	LUT OUT
18 LUTOUT146	LUT OUT
17 LUTOUT145	LUT OUT
16 LUTOUT144	LUT OUT
15 LUTOUT143	LUT OUT
14 LUTOUT142	LUT OUT
13 LUTOUT141	LUT OUT
12 LUTOUT140	LUT OUT
11 LUTOUT139	LUT OUT
10 LUTOUT138	LUT OUT
9 LUTOUT137	LUT OUT

Table continues on the next page...

PXP_HW_PXP_WFE_B_STG3_F8X1_OUT3_4 field descriptions (continued)

Field	Description
8 LUTOUT136	LUT OUT
7 LUTOUT135	LUT OUT
6 LUTOUT134	LUT OUT
5 LUTOUT133	LUT OUT
4 LUTOUT132	LUT OUT
3 LUTOUT131	LUT OUT
2 LUTOUT130	LUT OUT
1 LUTOUT129	LUT OUT
0 LUTOUT128	LUT OUT

**41.11.307 This register defines the output values (new flag) for the 8x1 LUTs in stage 3.
(PXP_HW_PXP_WFE_B_STG3_F8X1_OUT3_5)**

The 5x1 LUT output value for input value n. This output value results in a flag that is added to the flag array.

Address: 21C_C000h base + 2760h offset = 21C_E760h

Bit	31	30	29	28	27	26	25	24	23	22	21	20	19	18	17	16
R	LUTOUT191	LUTOUT190	LUTOUT189	LUTOUT188	LUTOUT187	LUTOUT186	LUTOUT185	LUTOUT184	LUTOUT183	LUTOUT182	LUTOUT181	LUTOUT180	LUTOUT179	LUTOUT178	LUTOUT177	LUTOUT176
W	LUTOUT191	LUTOUT190	LUTOUT189	LUTOUT188	LUTOUT187	LUTOUT186	LUTOUT185	LUTOUT184	LUTOUT183	LUTOUT182	LUTOUT181	LUTOUT180	LUTOUT179	LUTOUT178	LUTOUT177	LUTOUT176
Reset	0	0	0	0	0	0	0	0	0	0	0	0	0	0	0	0
Bit	15	14	13	12	11	10	9	8	7	6	5	4	3	2	1	0
R	LUTOUT175	LUTOUT174	LUTOUT173	LUTOUT172	LUTOUT171	LUTOUT170	LUTOUT169	LUTOUT168	LUTOUT167	LUTOUT166	LUTOUT165	LUTOUT164	LUTOUT163	LUTOUT162	LUTOUT161	LUTOUT160
W	LUTOUT175	LUTOUT174	LUTOUT173	LUTOUT172	LUTOUT171	LUTOUT170	LUTOUT169	LUTOUT168	LUTOUT167	LUTOUT166	LUTOUT165	LUTOUT164	LUTOUT163	LUTOUT162	LUTOUT161	LUTOUT160
Reset	0	0	0	0	0	0	0	0	0	0	0	0	0	0	0	0

PXP_HW_PXP_WFE_B_STG3_F8X1_OUT3_5 field descriptions

Field	Description
31 LUTOUT191	LUT OUT
30 LUTOUT190	LUT OUT
29 LUTOUT189	LUT OUT
28 LUTOUT188	LUT OUT
27 LUTOUT187	LUT OUT
26 LUTOUT186	LUT OUT
25 LUTOUT185	LUT OUT
24 LUTOUT184	LUT OUT
23 LUTOUT183	LUT OUT
22 LUTOUT182	LUT OUT
21 LUTOUT181	LUT OUT
20 LUTOUT180	LUT OUT
19 LUTOUT179	LUT OUT
18 LUTOUT178	LUT OUT
17 LUTOUT177	LUT OUT
16 LUTOUT176	LUT OUT
15 LUTOUT175	LUT OUT
14 LUTOUT174	LUT OUT
13 LUTOUT173	LUT OUT
12 LUTOUT172	LUT OUT
11 LUTOUT171	LUT OUT
10 LUTOUT170	LUT OUT
9 LUTOUT169	LUT OUT

Table continues on the next page...

PXP_HW_PXP_WFE_B_STG3_F8X1_OUT3_5 field descriptions (continued)

Field	Description
8 LUTOUT168	LUT OUT
7 LUTOUT167	LUT OUT
6 LUTOUT166	LUT OUT
5 LUTOUT165	LUT OUT
4 LUTOUT164	LUT OUT
3 LUTOUT163	LUT OUT
2 LUTOUT162	LUT OUT
1 LUTOUT161	LUT OUT
0 LUTOUT160	LUT OUT

41.11.308 This register defines the output values (new flag) for the 8x1 LUTs in stage 3. (PXP_HW_PXP_WFE_B_STG3_F8X1_OUT3_6)

The 5x1 LUT output value for input value n. This output value results in a flag that is added to the flag array.

Address: 21C_C000h base + 2770h offset = 21C_E770h

Bit	31	30	29	28	27	26	25	24	23	22	21	20	19	18	17	16
R	LUTOUT223	LUTOUT222	LUTOUT221	LUTOUT220	LUTOUT219	LUTOUT218	LUTOUT217	LUTOUT216	LUTOUT215	LUTOUT214	LUTOUT213	LUTOUT212	LUTOUT211	LUTOUT210	LUTOUT209	LUTOUT208
W	LUTOUT223	LUTOUT222	LUTOUT221	LUTOUT220	LUTOUT219	LUTOUT218	LUTOUT217	LUTOUT216	LUTOUT215	LUTOUT214	LUTOUT213	LUTOUT212	LUTOUT211	LUTOUT210	LUTOUT209	LUTOUT208
Reset	0	0	0	0	0	0	0	0	0	0	0	0	0	0	0	0
Bit	15	14	13	12	11	10	9	8	7	6	5	4	3	2	1	0
R	LUTOUT207	LUTOUT206	LUTOUT205	LUTOUT204	LUTOUT203	LUTOUT202	LUTOUT201	LUTOUT200	LUTOUT199	LUTOUT198	LUTOUT197	LUTOUT196	LUTOUT195	LUTOUT194	LUTOUT193	LUTOUT192
W	LUTOUT207	LUTOUT206	LUTOUT205	LUTOUT204	LUTOUT203	LUTOUT202	LUTOUT201	LUTOUT200	LUTOUT199	LUTOUT198	LUTOUT197	LUTOUT196	LUTOUT195	LUTOUT194	LUTOUT193	LUTOUT192
Reset	0	0	0	0	0	0	0	0	0	0	0	0	0	0	0	0

PXP_HW_PXP_WFE_B_STG3_F8X1_OUT3_6 field descriptions

Field	Description
31 LUTOUT223	LUT OUT
30 LUTOUT222	LUT OUT
29 LUTOUT221	LUT OUT
28 LUTOUT220	LUT OUT
27 LUTOUT219	LUT OUT
26 LUTOUT218	LUT OUT
25 LUTOUT217	LUT OUT
24 LUTOUT216	LUT OUT
23 LUTOUT215	LUT OUT
22 LUTOUT214	LUT OUT
21 LUTOUT213	LUT OUT
20 LUTOUT212	LUT OUT
19 LUTOUT211	LUT OUT
18 LUTOUT210	LUT OUT
17 LUTOUT209	LUT OUT
16 LUTOUT208	LUT OUT
15 LUTOUT207	LUT OUT
14 LUTOUT206	LUT OUT
13 LUTOUT205	LUT OUT
12 LUTOUT204	LUT OUT
11 LUTOUT203	LUT OUT
10 LUTOUT202	LUT OUT
9 LUTOUT201	LUT OUT

Table continues on the next page...

PXP_HW_PXP_WFE_B_STG3_F8X1_OUT3_6 field descriptions (continued)

Field	Description
8 LUTOUT200	LUT OUT
7 LUTOUT199	LUT OUT
6 LUTOUT198	LUT OUT
5 LUTOUT197	LUT OUT
4 LUTOUT196	LUT OUT
3 LUTOUT195	LUT OUT
2 LUTOUT194	LUT OUT
1 LUTOUT193	LUT OUT
0 LUTOUT192	LUT OUT

**41.11.309 This register defines the output values (new flag) for the 8x1 LUTs in stage 3.
(PXP_HW_PXP_WFE_B_STG3_F8X1_OUT3_7)**

The 5x1 LUT output value for input value n. This output value results in a flag that is added to the flag array.

Address: 21C_C000h base + 2780h offset = 21C_E780h

Bit	31	30	29	28	27	26	25	24	23	22	21	20	19	18	17	16
R	LUTOUT255	LUTOUT254	LUTOUT253	LUTOUT252	LUTOUT251	LUTOUT250	LUTOUT249	LUTOUT248	LUTOUT247	LUTOUT246	LUTOUT245	LUTOUT244	LUTOUT243	LUTOUT242	LUTOUT241	LUTOUT240
W	LUTOUT255	LUTOUT254	LUTOUT253	LUTOUT252	LUTOUT251	LUTOUT250	LUTOUT249	LUTOUT248	LUTOUT247	LUTOUT246	LUTOUT245	LUTOUT244	LUTOUT243	LUTOUT242	LUTOUT241	LUTOUT240
Reset	0	0	0	0	0	0	0	0	0	0	0	0	0	0	0	0
Bit	15	14	13	12	11	10	9	8	7	6	5	4	3	2	1	0
R	LUTOUT239	LUTOUT238	LUTOUT237	LUTOUT236	LUTOUT235	LUTOUT234	LUTOUT233	LUTOUT232	LUTOUT231	LUTOUT230	LUTOUT229	LUTOUT228	LUTOUT227	LUTOUT226	LUTOUT225	LUTOUT224
W	LUTOUT239	LUTOUT238	LUTOUT237	LUTOUT236	LUTOUT235	LUTOUT234	LUTOUT233	LUTOUT232	LUTOUT231	LUTOUT230	LUTOUT229	LUTOUT228	LUTOUT227	LUTOUT226	LUTOUT225	LUTOUT224
Reset	0	0	0	0	0	0	0	0	0	0	0	0	0	0	0	0

PXP_HW_PXP_WFE_B_STG3_F8X1_OUT3_7 field descriptions

Field	Description
31 LUTOUT255	LUT OUT
30 LUTOUT254	LUT OUT
29 LUTOUT253	LUT OUT
28 LUTOUT252	LUT OUT
27 LUTOUT251	LUT OUT
26 LUTOUT250	LUT OUT
25 LUTOUT249	LUT OUT
24 LUTOUT248	LUT OUT
23 LUTOUT247	LUT OUT
22 LUTOUT246	LUT OUT
21 LUTOUT245	LUT OUT
20 LUTOUT244	LUT OUT
19 LUTOUT243	LUT OUT
18 LUTOUT242	LUT OUT
17 LUTOUT241	LUT OUT
16 LUTOUT240	LUT OUT
15 LUTOUT239	LUT OUT
14 LUTOUT238	LUT OUT
13 LUTOUT237	LUT OUT
12 LUTOUT236	LUT OUT
11 LUTOUT235	LUT OUT
10 LUTOUT234	LUT OUT
9 LUTOUT233	LUT OUT

Table continues on the next page...

PXP_HW_PXP_WFE_B_STG3_F8X1_OUT3_7 field descriptions (continued)

Field	Description
8 LUTOUT232	LUT OUT
7 LUTOUT231	LUT OUT
6 LUTOUT230	LUT OUT
5 LUTOUT229	LUT OUT
4 LUTOUT228	LUT OUT
3 LUTOUT227	LUT OUT
2 LUTOUT226	LUT OUT
1 LUTOUT225	LUT OUT
0 LUTOUT224	LUT OUT

41.11.310 Each set mask bit enables one of the corresponding flag input bits. There is one mask per 8x1 LUT. (PXP_HW_PXP_WFE_B_STG3_F8X1_MASKS)

Each set mask bit enables one of the corresponding flag input bits. There is one mask per 8x1 LUT.

Address: 21C_C000h base + 2790h offset = 21C_E790h

Bit	31	30	29	28	27	26	25	24	23	22	21	20	19	18	17	16	15	14	13	12	11	10	9	8	7	6	5	4	3	2	1	0
R																																
W																																
Reset	0	0	0	0	0	0	0	0	0	0	0	0	0	0	0	0	0	0	0	0	0	0	0	0	0	0	0	0	0	0	0	

PXP_HW_PXP_WFE_B_STG3_F8X1_MASKS field descriptions

Field	Description
31–24 MASK3	This field selects the input flags that are valid for 8x1 LUT 1. Bit 0 = input 1, Bit 1 = input 2 and so on.
23–16 MASK2	This field selects the input flags that are valid for 8x1 LUT 0. Bit 0 = input 1, Bit 1 = input 2 and so on.
15–8 MASK1	This field selects the input flags that are valid for 8x1 LUT 1. Bit 0 = input 1, Bit 1 = input 2 and so on.
MASK0	This field selects the input flags that are valid for 8x1 LUT 0. Bit 0 = input 1, Bit 1 = input 2 and so on.

41.11.311 This register defines the control bits for the pxp alu sub-block. (PXP_HW_PXP_ALU_B_CTRLn)

Address: 21C_C000h base + 28A0h offset + (4d × i), where i=0d to 3d

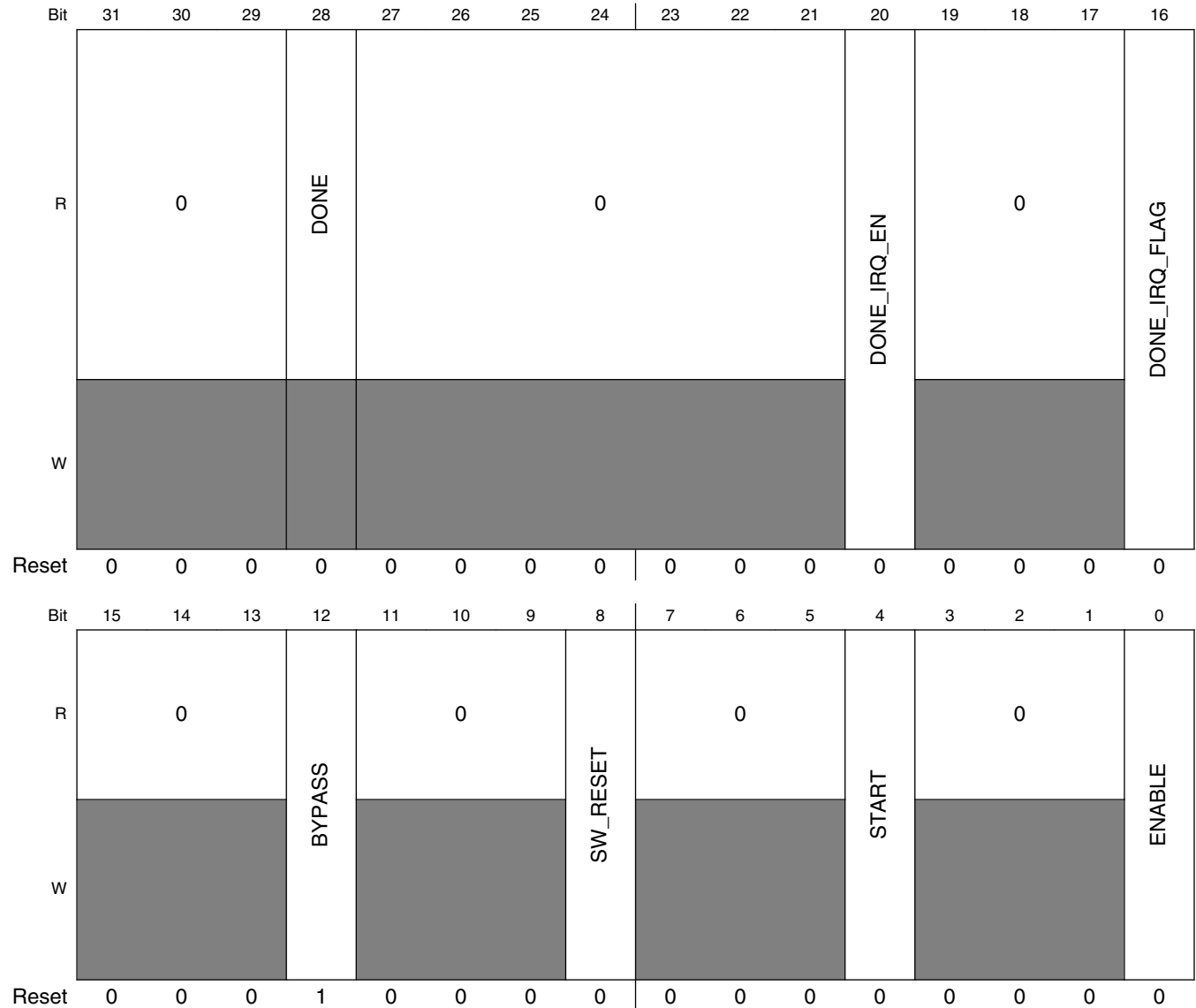

PXP_HW_PXP_ALU_B_CTRLn field descriptions

Field	Description
31–29 Reserved	This read-only field is reserved and always has the value 0.
28 DONE	This bit will be set when the processing for a frame is done.

Table continues on the next page...

PXP_HW_PXP_ALU_B_CTRLn field descriptions (continued)

Field	Description
27–21 Reserved	This read-only field is reserved and always has the value 0.
20 DONE_IRQ_EN	Enable the done irq
19–17 Reserved	This read-only field is reserved and always has the value 0.
16 DONE_IRQ_FLAG	Done IRQ flag, it will be set when done is set, it will be cleared by write 1 to it.
15–13 Reserved	This read-only field is reserved and always has the value 0.
12 BYPASS	Bypass
11–9 Reserved	This read-only field is reserved and always has the value 0.
8 SW_RESET	Write to 1 to do a software reset to the alu, self-clear.
7–5 Reserved	This read-only field is reserved and always has the value 0.
4 START	Write 1 to start operation, self-clear
3–1 Reserved	This read-only field is reserved and always has the value 0.
0 ENABLE	Enable

**41.11.312 This register defines the size of the buffer to be processed by the alu engine.
(PXP_HW_PXP_ALU_B_BUF_SIZE)**

Address: 21C_C000h base + 28B0h offset = 21C_E8B0h

Bit	31	30	29	28	27	26	25	24	23	22	21	20	19	18	17	16	15	14	13	12	11	10	9	8	7	6	5	4	3	2	1	0	
R	0				BUF_HEIGHT												0				BUF_WIDTH												
W	0																0																
Reset	0	0	0	0	0	0	0	0	0	0	0	0	0	0	0	0	0	0	0	0	0	0	0	0	0	0	0	0	0	0	0	0	0

PXP_HW_PXP_ALU_B_BUF_SIZE field descriptions

Field	Description
31–28 Reserved	This read-only field is reserved and always has the value 0.

Table continues on the next page...

PXP_HW_PXP_ALU_B_BUF_SIZE field descriptions (continued)

Field	Description
27–16 BUF_HEIGHT	This indicate the buffer height in pixels
15–12 Reserved	This read-only field is reserved and always has the value 0.
BUF_WIDTH	This indicate the buffer width in pixels

41.11.313 This register defines the Entry Address for the Instruction Memory of the ALU. (PXP_HW_PXP_ALU_B_INST_ENTRY)

Address: 21C_C000h base + 28C0h offset = 21C_E8C0h

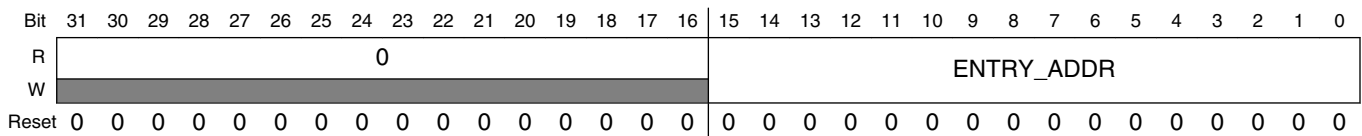

PXP_HW_PXP_ALU_B_INST_ENTRY field descriptions

Field	Description
31–16 Reserved	This read-only field is reserved and always has the value 0.
ENTRY_ADDR	Entry address for the instruction memory of ALU

41.11.314 This register defines the parameter used by SW running on ALU. (PXP_HW_PXP_ALU_B_PARAM)

Address: 21C_C000h base + 28D0h offset = 21C_E8D0h

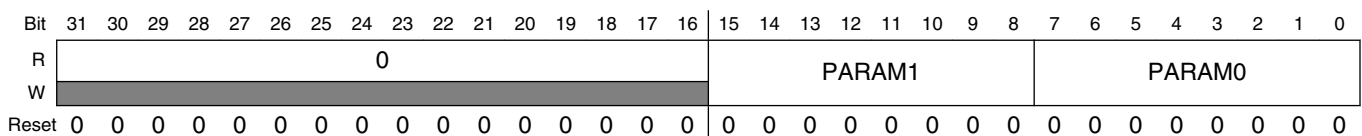

PXP_HW_PXP_ALU_B_PARAM field descriptions

Field	Description
31–16 Reserved	This read-only field is reserved and always has the value 0.
15–8 PARAM1	Parameter1 used for the SW running on ALU
PARAM0	Parameter0 used for the SW running on ALU

41.11.315 This register defines the hw configuration options for the alu core. (PXP_HW_PXP_ALU_B_CONFIG)

Address: 21C_C000h base + 28E0h offset = 21C_E8E0h

Bit	31	30	29	28	27	26	25	24	23	22	21	20	19	18	17	16	15	14	13	12	11	10	9	8	7	6	5	4	3	2	1	0
R	BUF_ADDR																															
W																																
Reset	0	0	0	0	0	0	0	0	0	0	0	0	0	0	0	0	0	0	0	0	0	0	0	0	0	0	0	0	0	0	0	0

PXP_HW_PXP_ALU_B_CONFIG field descriptions

Field	Description
BUF_ADDR	Configuration for the ALU core

41.11.316 This register defines the hw configuration options for the LUT (PXP_HW_PXP_ALU_B_LUT_CONFIG_n)

Address: 21C_C000h base + 28F0h offset + (4d × i), where i=0d to 3d

Bit	31	30	29	28	27	26	25	24	23	22	21	20	19	18	17	16	
R	0																
W																	
Reset	0	0	0	0	0	0	0	0	0	0	0	0	0	0	0	0	
Bit	15	14	13	12	11	10	9	8	7	6	5	4	3	2	1	0	
R	0								MODE				0				EN
W																	
Reset	0	0	0	0	0	0	0	0	0	0	0	0	0	0	0	0	

PXP_HW_PXP_ALU_B_LUT_CONFIGn field descriptions

Field	Description
31–6 Reserved	This read-only field is reserved and always has the value 0.
5–4 MODE	LUT operation mode setting
3–1 Reserved	This read-only field is reserved and always has the value 0.
0 EN	Enable LUT function

41.11.317 This register defines the lower 32-bit data for the LUT (PXP_HW_PXP_ALU_B_LUT_DATA0)

Address: 21C_C000h base + 2900h offset = 21C_E900h

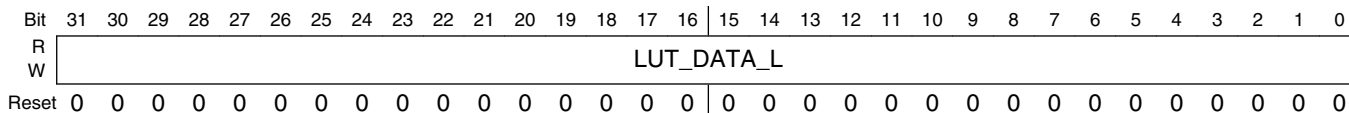

PXP_HW_PXP_ALU_B_LUT_DATA0 field descriptions

Field	Description
LUT_DATA_L	Lower 32-bit Data for the LUT

41.11.318 This register defines the higher 32-bit data for the LUT (PXP_HW_PXP_ALU_B_LUT_DATA1)

Address: 21C_C000h base + 2910h offset = 21C_E910h

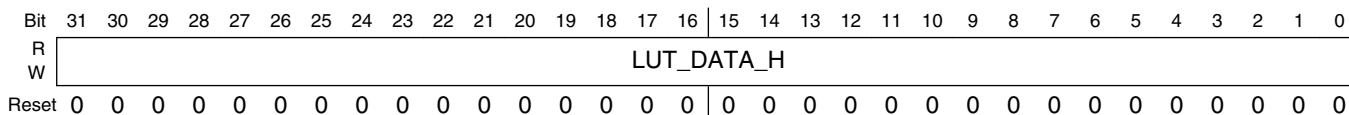

PXP_HW_PXP_ALU_B_LUT_DATA1 field descriptions

Field	Description
LUT_DATA_H	Higher 32-bit Data for the LUT

41.11.319 This register is used for debugging alu block (PXP_HW_PXP_ALU_B_DBG)

Address: 21C_C000h base + 2920h offset = 21C_E920h

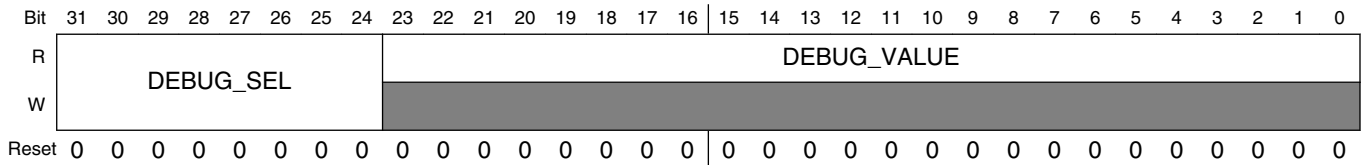

PXP_HW_PXP_ALU_B_DBG field descriptions

Field	Description
31–24 DEBUG_SEL	Select the signal to be monitored
DEBUG_VALUE	Value of the signals to be monitored

41.11.320 Histogram Control Register. (PXP_HW_PXP_HIST_A_CTRL)

Address: 21C_C000h base + 2A00h offset = 21C_EA00h

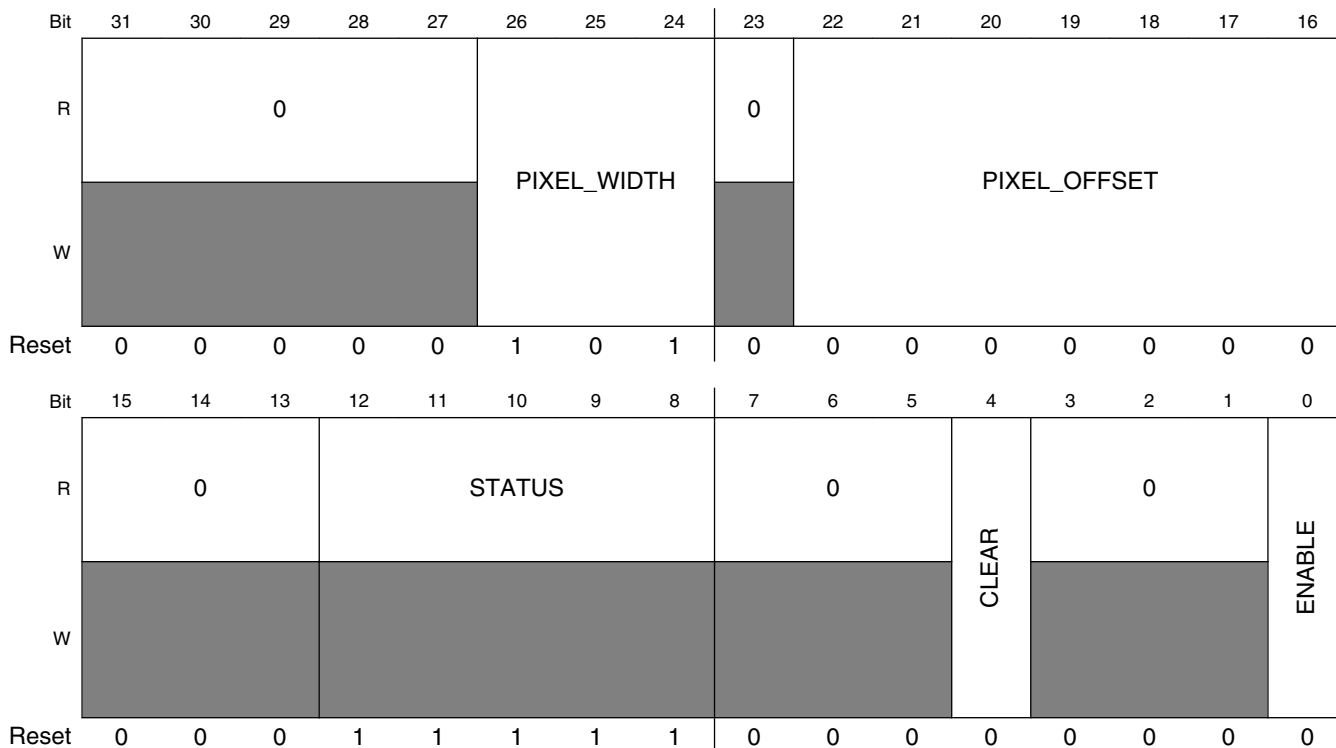

PXP_HW_PXP_HIST_A_CTRL field descriptions

Field	Description
31–27 Reserved	This read-only field is reserved and always has the value 0.
26–24 PIXEL_WIDTH	The width of the pixel to be used for histogram calculation
23 Reserved	This read-only field is reserved and always has the value 0.
22–16 PIXEL_OFFSET	The offset of the pixel to be used for histogram calculation
15–13 Reserved	This read-only field is reserved and always has the value 0.
12–8 STATUS	Indicates which histogram matched the processed bitmap. Bit[0] indicates that the bitmap pixels were fully contained within the HIST2 (black / white) histogram. Bit[1] indicates that the bitmap pixels were fully contained within the HIST4 (2-bit grayscale) histogram. Bit[2] indicates that the bitmap pixels were fully contained within the HIST8 (3-bit grayscale) histogram. Bit[3] indicates that the bitmap pixels were fully

Table continues on the next page...

PXP_HW_PXP_HIST_A_CTRL field descriptions (continued)

Field	Description
	contained within the HIST16 (4-bit grayscale) histogram. Bit[4] indicates that the bitmap pixels were fully contained within the HIST32 (5-bit grayscale) histogram.
7–5 Reserved	This read-only field is reserved and always has the value 0.
4 CLEAR	Write 1 to clear the histogram result and will be self-clear after clear function finished
3–1 Reserved	This read-only field is reserved and always has the value 0.
0 ENABLE	Enable the Histogram Engine

**41.11.321 Histogram Pixel Mask Register.
(PXP_HW_PXP_HIST_A_MASK)**

Address: 21C_C000h base + 2A10h offset = 21C_EA10h

Bit	31	30	29	28	27	26	25	24	23	22	21	20	19	18	17	16
R	MASK_VALUE1								MASK_VALUE0							
W																
Reset	0	0	0	0	0	0	0	0	0	0	0	0	0	0	0	0
Bit	15	14	13	12	11	10	9	8	7	6	5	4	3	2	1	0
R	MASK_WIDTH			MASK_OFFSET					MASK_MODE		0			MASK_EN		
W																
Reset	0	0	0	0	0	0	0	0	0	0	0	0	0	0	0	0

PXP_HW_PXP_HIST_A_MASK field descriptions

Field	Description
31–24 MASK_VALUE1	The value1 for mask condition checking
23–16 MASK_VALUE0	The value0 for mask condition checking
15–13 MASK_WIDTH	The width of the field to be checked against mask condition
12–6 MASK_OFFSET	The offset of the field to be checked against mask condition

Table continues on the next page...

PXP_HW_PXP_HIST_A_MASK field descriptions (continued)

Field	Description
5-4 MASK_MODE	Operation mode of pixel mask function
3-1 Reserved	This read-only field is reserved and always has the value 0.
0 MASK_EN	Enable the Pixel Mask Function in Histogram

**41.11.322 Histogram Pixel Buffer Size Register.
(PXP_HW_PXP_HIST_A_BUF_SIZE)**

Address: 21C_C000h base + 2A20h offset = 21C_EA20h

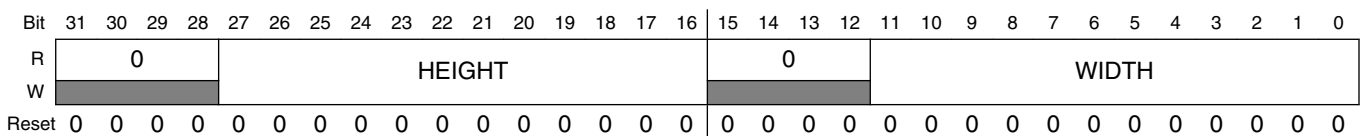

PXP_HW_PXP_HIST_A_BUF_SIZE field descriptions

Field	Description
31-28 Reserved	This read-only field is reserved and always has the value 0.
27-16 HEIGHT	This indicate the buffer height in pixels
15-12 Reserved	This read-only field is reserved and always has the value 0.
WIDTH	This indicate the buffer width in pixels

**41.11.323 Total Number of Pixels Used by Histogram Engine.
(PXP_HW_PXP_HIST_A_TOTAL_PIXEL)**

Address: 21C_C000h base + 2A30h offset = 21C_EA30h

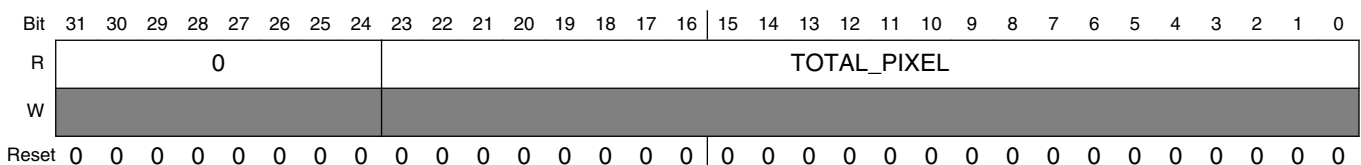

PXP_HW_PXP_HIST_A_TOTAL_PIXEL field descriptions

Field	Description
31–24 Reserved	This read-only field is reserved and always has the value 0.
TOTAL_PIXEL	Total number of pixels used by histogram engine, the pixels got masked will be skipped

**41.11.324 The X Coordinate Offset for Active Area.
(PXP_HW_PXP_HIST_A_ACTIVE_AREA_X)**

Address: 21C_C000h base + 2A40h offset = 21C_EA40h

Bit	31	30	29	28	27	26	25	24	23	22	21	20	19	18	17	16	15	14	13	12	11	10	9	8	7	6	5	4	3	2	1	0						
R	0				MAX_X_OFFSET												0				MIN_X_OFFSET																	
W	0																																					
Reset	0	0	0	0	0	0	0	0	0	0	0	0	0	0	0	0	0	0	0	0	0	0	0	0	0	0	0	0	0	0	0	0	0	0	0	0	0	0

PXP_HW_PXP_HIST_A_ACTIVE_AREA_X field descriptions

Field	Description
31–28 Reserved	This read-only field is reserved and always has the value 0.
27–16 MAX_X_OFFSET	Maximum X coordinate offset for the active area in histogram processing
15–12 Reserved	This read-only field is reserved and always has the value 0.
MIN_X_OFFSET	Minimal X coordinate offset for the active area in histogram processing

**41.11.325 The Y Coordinate Offset for Active Area.
(PXP_HW_PXP_HIST_A_ACTIVE_AREA_Y)**

Address: 21C_C000h base + 2A50h offset = 21C_EA50h

Bit	31	30	29	28	27	26	25	24	23	22	21	20	19	18	17	16	15	14	13	12	11	10	9	8	7	6	5	4	3	2	1	0						
R	0				MAX_Y_OFFSET												0				MIN_Y_OFFSET																	
W	0																																					
Reset	0	0	0	0	0	0	0	0	0	0	0	0	0	0	0	0	0	0	0	0	0	0	0	0	0	0	0	0	0	0	0	0	0	0	0	0	0	0

PXP_HW_PXP_HIST_A_ACTIVE_AREA_Y field descriptions

Field	Description
31–28 Reserved	This read-only field is reserved and always has the value 0.
27–16 MAX_Y_OFFSET	Maximum Y coordinate offset for the active area in histogram processing
15–12 Reserved	This read-only field is reserved and always has the value 0.
MIN_Y_OFFSET	Minimul Y coordinate offset for the active area in histogram processing

**41.11.326 Histogram Result Based on RAW Pixel Value.
(PXP_HW_PXP_HIST_A_RAW_STAT0)**

Address: 21C_C000h base + 2A60h offset = 21C_EA60h

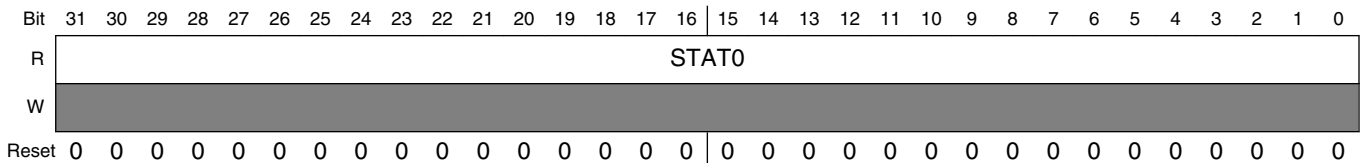

PXP_HW_PXP_HIST_A_RAW_STAT0 field descriptions

Field	Description
STAT0	Lower 32-bit result fo the histogram calculation

**41.11.327 Histogram Result Based on RAW Pixel Value.
(PXP_HW_PXP_HIST_A_RAW_STAT1)**

Address: 21C_C000h base + 2A70h offset = 21C_EA70h

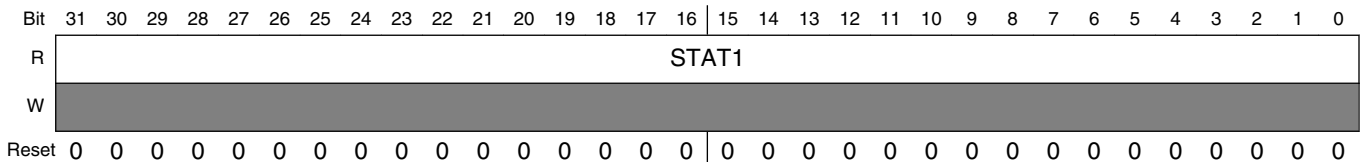

PXP_HW_PXP_HIST_A_RAW_STAT1 field descriptions

Field	Description
STAT1	Higher 32-bit result for the histogram calculation

41.11.328 Histogram Control Register. (PXP_HW_PXP_HIST_B_CTRL)

Address: 21C_C000h base + 2A80h offset = 21C_EA80h

Bit	31	30	29	28	27	26	25	24	23	22	21	20	19	18	17	16	
R	0					PIXEL_WIDTH				0	PIXEL_OFFSET						
W	[Shaded]					[Shaded]				[Shaded]	[Shaded]						
Reset	0	0	0	0	0	1	0	1	0	0	0	0	0	0	0	0	
Bit	15	14	13	12	11	10	9	8	7	6	5	4	3	2	1	0	
R	0		STATUS						0			CLEAR	0			ENABLE	
W	[Shaded]		[Shaded]						[Shaded]				[Shaded]				
Reset	0	0	0	1	1	1	1	1	0	0	0	0	0	0	0	0	

PXP_HW_PXP_HIST_B_CTRL field descriptions

Field	Description
31–27 Reserved	This read-only field is reserved and always has the value 0.
26–24 PIXEL_WIDTH	The width of the pixel to be used for histogram calculation
23 Reserved	This read-only field is reserved and always has the value 0.
22–16 PIXEL_OFFSET	The offset of the pixel to be used for histogram calculation

Table continues on the next page...

PXP_HW_PXP_HIST_B_CTRL field descriptions (continued)

Field	Description
15–13 Reserved	This read-only field is reserved and always has the value 0.
12–8 STATUS	Indicates which histogram matched the processed bitmap. Bit[0] indicates that the bitmap pixels were fully contained within the HIST2 (black / white) histogram. Bit[1] indicates that the bitmap pixels were fully contained within the HIST4 (2-bit grayscale) histogram. Bit[2] indicates that the bitmap pixels were fully contained within the HIST8 (3-bit grayscale) histogram. Bit[3] indicates that the bitmap pixels were fully contained within the HIST16 (4-bit grayscale) histogram. Bit[4] indicates that the bitmap pixels were fully contained within the HIST32 (5-bit grayscale) histogram.
7–5 Reserved	This read-only field is reserved and always has the value 0.
4 CLEAR	Write 1 to clear the histogram result and will be self-clear after clear function finished
3–1 Reserved	This read-only field is reserved and always has the value 0.
0 ENABLE	Enable the Histogram Engine

**41.11.329 Histogram Pixel Mask Register.
(PXP_HW_PXP_HIST_B_MASK)**

Address: 21C_C000h base + 2A90h offset = 21C_EA90h

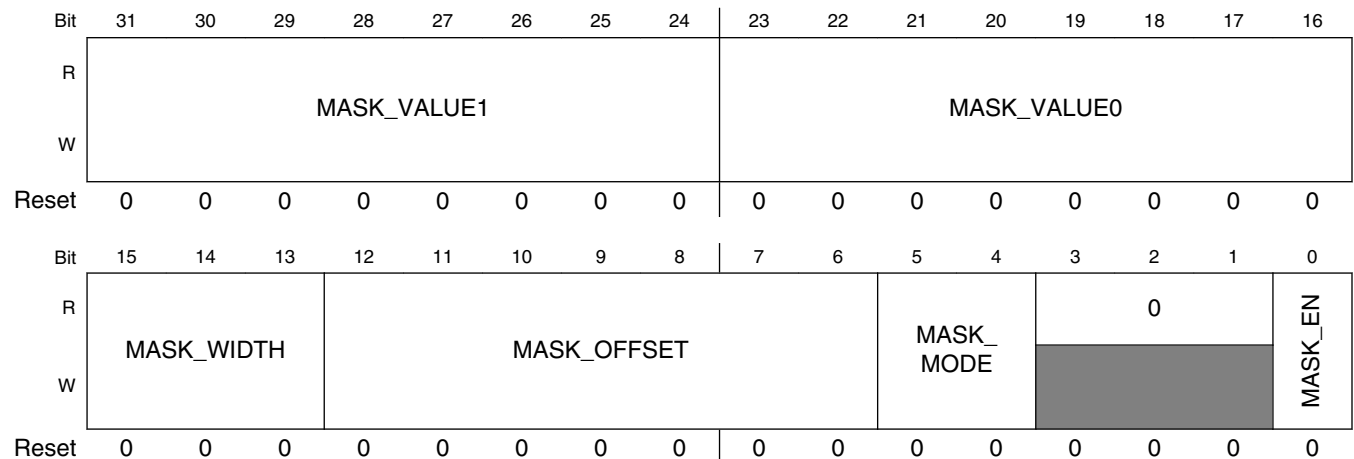

PXP_HW_PXP_HIST_B_MASK field descriptions

Field	Description
31–24 MASK_VALUE1	The value1 for mask condition checking

Table continues on the next page...

PXP_HW_PXP_HIST_B_MASK field descriptions (continued)

Field	Description
23–16 MASK_VALUE0	The value0 for mask condition checking
15–13 MASK_WIDTH	The width of the field to be checked against mask condition
12–6 MASK_OFFSET	The offset of the field to be checked against mask condition
5–4 MASK_MODE	Operation mode of pixel mask function
3–1 Reserved	This read-only field is reserved and always has the value 0.
0 MASK_EN	Enable the Pixel Mask Function in Histogram

**41.11.330 Histogram Pixel Buffer Size Register.
(PXP_HW_PXP_HIST_B_BUF_SIZE)**

Address: 21C_C000h base + 2AA0h offset = 21C_EAA0h

Bit	31	30	29	28	27	26	25	24	23	22	21	20	19	18	17	16	15	14	13	12	11	10	9	8	7	6	5	4	3	2	1	0	
R	0				HEIGHT												0				WIDTH												
W	0				0												0				0												
Reset	0	0	0	0	0	0	0	0	0	0	0	0	0	0	0	0	0	0	0	0	0	0	0	0	0	0	0	0	0	0	0	0	0

PXP_HW_PXP_HIST_B_BUF_SIZE field descriptions

Field	Description
31–28 Reserved	This read-only field is reserved and always has the value 0.
27–16 HEIGHT	This indicate the buffer height in pixels
15–12 Reserved	This read-only field is reserved and always has the value 0.
WIDTH	This indicate the buffer width in pixels

41.11.331 Total Number of Pixels Used by Histogram Engine. (PXP_HW_PXP_HIST_B_TOTAL_PIXEL)

Address: 21C_C000h base + 2AB0h offset = 21C_EAB0h

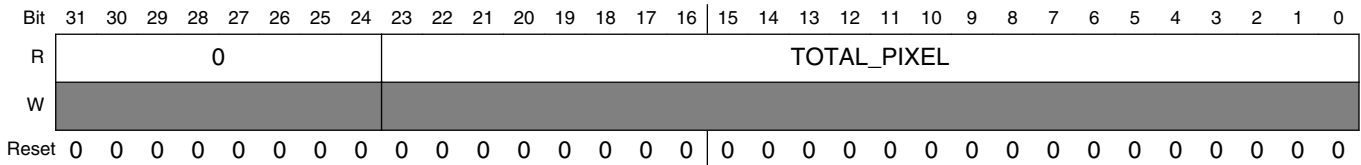

PXP_HW_PXP_HIST_B_TOTAL_PIXEL field descriptions

Field	Description
31–24 Reserved	This read-only field is reserved and always has the value 0.
TOTAL_PIXEL	Total number of pixels used by histogram engine, the pixels got masked will be skipped

41.11.332 The X Coordinate Offset for Active Area. (PXP_HW_PXP_HIST_B_ACTIVE_AREA_X)

Address: 21C_C000h base + 2AC0h offset = 21C_EAC0h

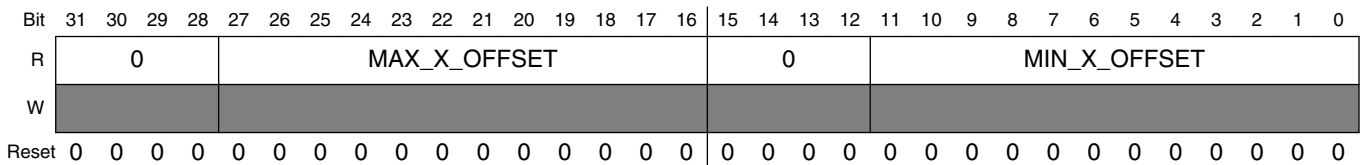

PXP_HW_PXP_HIST_B_ACTIVE_AREA_X field descriptions

Field	Description
31–28 Reserved	This read-only field is reserved and always has the value 0.
27–16 MAX_X_OFFSET	Maximum X coordinate offset for the active area in histogram processing
15–12 Reserved	This read-only field is reserved and always has the value 0.
MIN_X_OFFSET	Minimul X coordinate offset for the active area in histogram processing

41.11.333 The Y Coordinate Offset for Active Area. (PXP_HW_PXP_HIST_B_ACTIVE_AREA_Y)

Address: 21C_C000h base + 2AD0h offset = 21C_EAD0h

Bit	31	30	29	28	27	26	25	24	23	22	21	20	19	18	17	16	15	14	13	12	11	10	9	8	7	6	5	4	3	2	1	0	
R	0				MAX_Y_OFFSET												0				MIN_Y_OFFSET												
W	[Shaded]																																
Reset	0	0	0	0	0	0	0	0	0	0	0	0	0	0	0	0	0	0	0	0	0	0	0	0	0	0	0	0	0	0	0	0	0

PXP_HW_PXP_HIST_B_ACTIVE_AREA_Y field descriptions

Field	Description
31–28 Reserved	This read-only field is reserved and always has the value 0.
27–16 MAX_Y_OFFSET	Maximum Y coordinate offset for the active area in histogram processing
15–12 Reserved	This read-only field is reserved and always has the value 0.
MIN_Y_OFFSET	Minimul Y coordinate offset for the active area in histogram processing

41.11.334 Histogram Result Based on RAW Pixel Value. (PXP_HW_PXP_HIST_B_RAW_STAT0)

Address: 21C_C000h base + 2AE0h offset = 21C_EAE0h

Bit	31	30	29	28	27	26	25	24	23	22	21	20	19	18	17	16	15	14	13	12	11	10	9	8	7	6	5	4	3	2	1	0
R	STAT0																															
W	[Shaded]																															
Reset	0	0	0	0	0	0	0	0	0	0	0	0	0	0	0	0	0	0	0	0	0	0	0	0	0	0	0	0	0	0	0	0

PXP_HW_PXP_HIST_B_RAW_STAT0 field descriptions

Field	Description
STAT0	Lower 32-bit result fo the histogram calculation

41.11.335 Histogram Result Based on RAW Pixel Value. (PXP_HW_PXP_HIST_B_RAW_STAT1)

Address: 21C_C000h base + 2AF0h offset = 21C_EAF0h

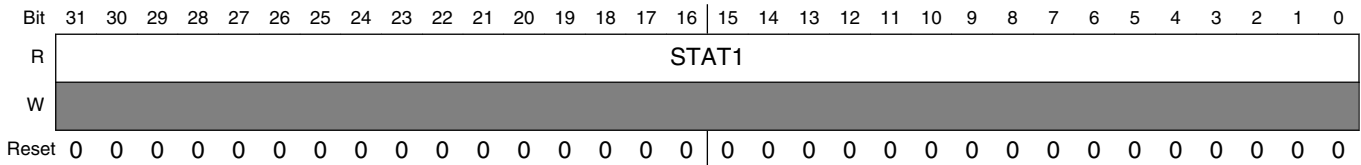

PXP_HW_PXP_HIST_B_RAW_STAT1 field descriptions

Field	Description
STAT1	Higher 32-bit result for the histogram calculation

41.11.336 2-level Histogram Parameter Register. (PXP_HW_PXP_HIST2_PARAM)

Address: 21C_C000h base + 2B00h offset = 21C_EB00h

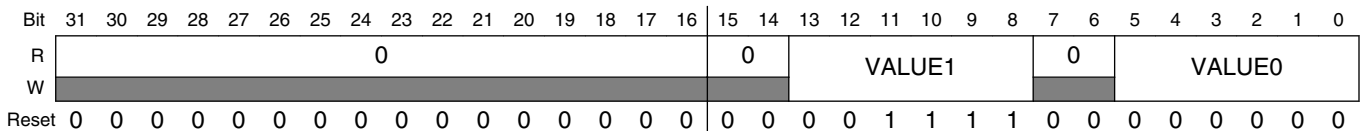

PXP_HW_PXP_HIST2_PARAM field descriptions

Field	Description
31–16 Reserved	This read-only field is reserved and always has the value 0.
15–14 Reserved	This read-only field is reserved and always has the value 0.
13–8 VALUE1	White value for 2-level histogram
7–6 Reserved	This read-only field is reserved and always has the value 0.
VALUE0	Black value for 2-level histogram

41.11.337 4-level Histogram Parameter Register. (PXP_HW_PXP_HIST4_PARAM)

Address: 21C_C000h base + 2B10h offset = 21C_EB10h

Bit	31	30	29	28	27	26	25	24	23	22	21	20	19	18	17	16	15	14	13	12	11	10	9	8	7	6	5	4	3	2	1	0
R	0								0								0								0							
W																																
Reset	0	0	0	0	1	1	1	1	0	0	0	0	1	0	1	0	0	0	0	0	0	0	1	0	1	0	0	0	0	0	0	0

PXP_HW_PXP_HIST4_PARAM field descriptions

Field	Description
31–30 Reserved	This read-only field is reserved and always has the value 0.
29–24 VALUE3	GRAY3 (White) value for 4-level histogram
23–22 Reserved	This read-only field is reserved and always has the value 0.
21–16 VALUE2	GRAY2 value for 4-level histogram
15–14 Reserved	This read-only field is reserved and always has the value 0.
13–8 VALUE1	GRAY1 value for 4-level histogram
7–6 Reserved	This read-only field is reserved and always has the value 0.
VALUE0	GRAY0 (Black) value for 4-level histogram

41.11.338 8-level Histogram Parameter 0 Register. (PXP_HW_PXP_HIST8_PARAM0)

Address: 21C_C000h base + 2B20h offset = 21C_EB20h

Bit	31	30	29	28	27	26	25	24	23	22	21	20	19	18	17	16	15	14	13	12	11	10	9	8	7	6	5	4	3	2	1	0
R	0								0								0								0							
W																																
Reset	0	0	0	0	0	1	1	0	0	0	0	0	0	1	0	0	0	0	0	0	0	0	0	1	0	0	0	0	0	0	0	0

PXP_HW_PXP_HIST8_PARAM0 field descriptions

Field	Description
31–30 Reserved	This read-only field is reserved and always has the value 0.
29–24 VALUE3	GRAY3 value for 8-level histogram
23–22 Reserved	This read-only field is reserved and always has the value 0.
21–16 VALUE2	GRAY2 value for 8-level histogram
15–14 Reserved	This read-only field is reserved and always has the value 0.
13–8 VALUE1	GRAY1 value for 8-level histogram
7–6 Reserved	This read-only field is reserved and always has the value 0.
VALUE0	GRAY0 (Black) value for 8-level histogram

**41.11.339 8-level Histogram Parameter 1 Register.
(PXP_HW_PXP_HIST8_PARAM1)**

Address: 21C_C000h base + 2B30h offset = 21C_EB30h

Bit	31	30	29	28	27	26	25	24	23	22	21	20	19	18	17	16	15	14	13	12	11	10	9	8	7	6	5	4	3	2	1	0
R	0								0								0								0							
W																																
Reset	0	0	0	0	1	1	1	1	0	0	0	0	1	1	0	1	0	0	0	0	1	0	1	1	0	0	0	0	1	0	0	1

PXP_HW_PXP_HIST8_PARAM1 field descriptions

Field	Description
31–30 Reserved	This read-only field is reserved and always has the value 0.
29–24 VALUE7	GRAY7 (White) value for 8-level histogram
23–22 Reserved	This read-only field is reserved and always has the value 0.
21–16 VALUE6	GRAY6 value for 8-level histogram
15–14 Reserved	This read-only field is reserved and always has the value 0.
13–8 VALUE5	GRAY5 value for 8-level histogram

Table continues on the next page...

PXP_HW_PXP_HIST8_PARAM1 field descriptions (continued)

Field	Description
7–6 Reserved	This read-only field is reserved and always has the value 0.
VALUE4	GRAY4 value for 8-level histogram

**41.11.340 16-level Histogram Parameter 0 Register.
(PXP_HW_PXP_HIST16_PARAM0)**

Address: 21C_C000h base + 2B40h offset = 21C_EB40h

Bit	31	30	29	28	27	26	25	24	23	22	21	20	19	18	17	16	15	14	13	12	11	10	9	8	7	6	5	4	3	2	1	0
R	0								0								0								0							
W																																
Reset	0	0	0	0	0	0	0	1	0	0	0	0	0	0	0	1	0	0	0	0	0	0	0	0	1	0	0	0	0	0	0	0

PXP_HW_PXP_HIST16_PARAM0 field descriptions

Field	Description
31–30 Reserved	This read-only field is reserved and always has the value 0.
29–24 VALUE3	GRAY3 value for 16-level histogram
23–22 Reserved	This read-only field is reserved and always has the value 0.
21–16 VALUE2	GRAY2 value for 16-level histogram
15–14 Reserved	This read-only field is reserved and always has the value 0.
13–8 VALUE1	GRAY1 value for 16-level histogram
7–6 Reserved	This read-only field is reserved and always has the value 0.
VALUE0	GRAY0 (Black) value for 16-level histogram

41.11.341 16-level Histogram Parameter 1 Register. (PXP_HW_PXP_HIST16_PARAM1)

Address: 21C_C000h base + 2B50h offset = 21C_EB50h

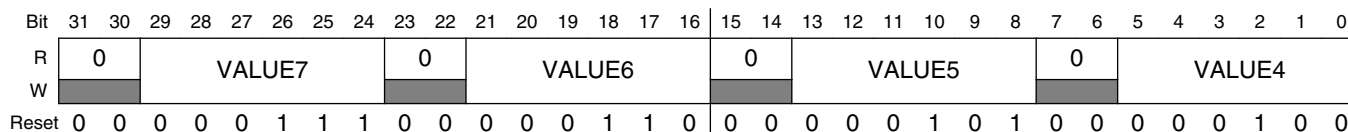

PXP_HW_PXP_HIST16_PARAM1 field descriptions

Field	Description
31–30 Reserved	This read-only field is reserved and always has the value 0.
29–24 VALUE7	GRAY7 value for 16-level histogram
23–22 Reserved	This read-only field is reserved and always has the value 0.
21–16 VALUE6	GRAY6 value for 16-level histogram
15–14 Reserved	This read-only field is reserved and always has the value 0.
13–8 VALUE5	GRAY5 value for 16-level histogram
7–6 Reserved	This read-only field is reserved and always has the value 0.
VALUE4	GRAY4 value for 16-level histogram

41.11.342 16-level Histogram Parameter 2 Register. (PXP_HW_PXP_HIST16_PARAM2)

Address: 21C_C000h base + 2B60h offset = 21C_EB60h

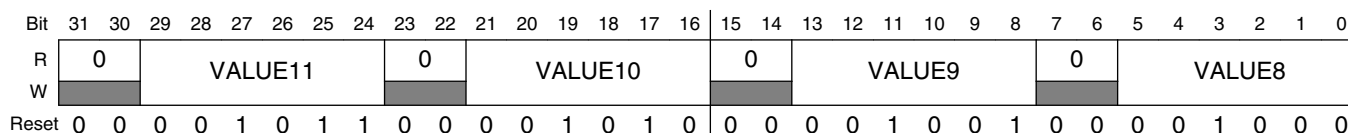

PXP_HW_PXP_HIST16_PARAM2 field descriptions

Field	Description
31–30 Reserved	This read-only field is reserved and always has the value 0.
29–24 VALUE11	GRAY11 value for 16-level histogram
23–22 Reserved	This read-only field is reserved and always has the value 0.
21–16 VALUE10	GRAY10 value for 16-level histogram
15–14 Reserved	This read-only field is reserved and always has the value 0.
13–8 VALUE9	GRAY9 value for 16-level histogram
7–6 Reserved	This read-only field is reserved and always has the value 0.
VALUE8	GRAY8 value for 16-level histogram

**41.11.343 16-level Histogram Parameter 3 Register.
(PXP_HW_PXP_HIST16_PARAM3)**

Address: 21C_C000h base + 2B70h offset = 21C_EB70h

Bit	31	30	29	28	27	26	25	24	23	22	21	20	19	18	17	16	15	14	13	12	11	10	9	8	7	6	5	4	3	2	1	0
R	0								0								0								0							
W																																
Reset	0	0	0	0	1	1	1	1	0	0	0	0	1	1	1	0	0	0	0	0	1	1	0	1	0	0	0	0	1	1	0	0

PXP_HW_PXP_HIST16_PARAM3 field descriptions

Field	Description
31–30 Reserved	This read-only field is reserved and always has the value 0.
29–24 VALUE15	GRAY15 (White) value for 16-level histogram
23–22 Reserved	This read-only field is reserved and always has the value 0.
21–16 VALUE14	GRAY14 value for 16-level histogram
15–14 Reserved	This read-only field is reserved and always has the value 0.
13–8 VALUE13	GRAY13 value for 16-level histogram

Table continues on the next page...

PXP_HW_PXP_HIST16_PARAM3 field descriptions (continued)

Field	Description
7-6 Reserved	This read-only field is reserved and always has the value 0.
VALUE12	GRAY12 value for 16-level histogram

**41.11.344 32-level Histogram Parameter 0 Register.
(PXP_HW_PXP_HIST32_PARAM0)**

Address: 21C_C000h base + 2B80h offset = 21C_EB80h

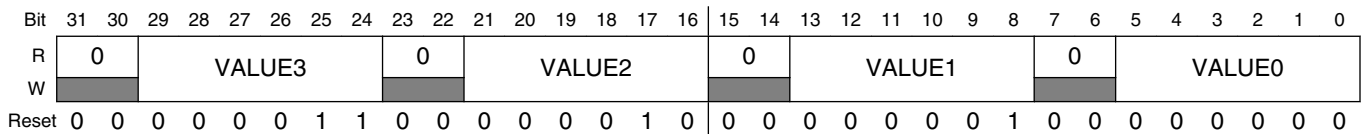

PXP_HW_PXP_HIST32_PARAM0 field descriptions

Field	Description
31-30 Reserved	This read-only field is reserved and always has the value 0.
29-24 VALUE3	GRAY3 value for 32-level histogram
23-22 Reserved	This read-only field is reserved and always has the value 0.
21-16 VALUE2	GRAY2 value for 32-level histogram
15-14 Reserved	This read-only field is reserved and always has the value 0.
13-8 VALUE1	GRAY1 value for 32-level histogram
7-6 Reserved	This read-only field is reserved and always has the value 0.
VALUE0	GRAY0 (Black) value for 32-level histogram

41.11.345 32-level Histogram Parameter 1 Register. (PXP_HW_PXP_HIST32_PARAM1)

Address: 21C_C000h base + 2B90h offset = 21C_EB90h

Bit	31	30	29	28	27	26	25	24	23	22	21	20	19	18	17	16	15	14	13	12	11	10	9	8	7	6	5	4	3	2	1	0
R	0	VALUE7							0	VALUE6							0	VALUE5							0	VALUE4						
W	█							█							█							█										
Reset	0	0	0	0	0	1	1	1	0	0	0	0	0	1	1	0	0	0	0	0	0	1	0	1	0	0	0	0	0	1	0	0

PXP_HW_PXP_HIST32_PARAM1 field descriptions

Field	Description
31–30 Reserved	This read-only field is reserved and always has the value 0.
29–24 VALUE7	GRAY7 value for 32-level histogram
23–22 Reserved	This read-only field is reserved and always has the value 0.
21–16 VALUE6	GRAY6 value for 32-level histogram
15–14 Reserved	This read-only field is reserved and always has the value 0.
13–8 VALUE5	GRAY5 value for 32-level histogram
7–6 Reserved	This read-only field is reserved and always has the value 0.
VALUE4	GRAY4 value for 32-level histogram

41.11.346 32-level Histogram Parameter 2 Register. (PXP_HW_PXP_HIST32_PARAM2)

Address: 21C_C000h base + 2BA0h offset = 21C_EBA0h

Bit	31	30	29	28	27	26	25	24	23	22	21	20	19	18	17	16	15	14	13	12	11	10	9	8	7	6	5	4	3	2	1	0
R	0	VALUE11							0	VALUE10							0	VALUE9							0	VALUE8						
W	█							█							█							█										
Reset	0	0	0	0	1	0	1	1	0	0	0	0	1	0	1	0	0	0	0	0	1	0	0	1	0	0	0	0	1	0	0	0

PXP_HW_PXP_HIST32_PARAM2 field descriptions

Field	Description
31–30 Reserved	This read-only field is reserved and always has the value 0.
29–24 VALUE11	GRAY11 value for 32-level histogram
23–22 Reserved	This read-only field is reserved and always has the value 0.
21–16 VALUE10	GRAY10 value for 32-level histogram
15–14 Reserved	This read-only field is reserved and always has the value 0.
13–8 VALUE9	GRAY9 value for 32-level histogram
7–6 Reserved	This read-only field is reserved and always has the value 0.
VALUE8	GRAY8 value for 32-level histogram

**41.11.347 32-level Histogram Parameter 3 Register.
(PXP_HW_PXP_HIST32_PARAM3)**

Address: 21C_C000h base + 2BB0h offset = 21C_EBB0h

Bit	31	30	29	28	27	26	25	24	23	22	21	20	19	18	17	16	15	14	13	12	11	10	9	8	7	6	5	4	3	2	1	0
R	0								0								0								0							
W																																
Reset	0	0	0	0	1	1	1	1	0	0	0	0	1	1	1	0	0	0	0	0	1	1	0	1	0	0	0	0	1	1	0	0

PXP_HW_PXP_HIST32_PARAM3 field descriptions

Field	Description
31–30 Reserved	This read-only field is reserved and always has the value 0.
29–24 VALUE15	GRAY15 (White) value for 32-level histogram
23–22 Reserved	This read-only field is reserved and always has the value 0.
21–16 VALUE14	GRAY14 value for 32-level histogram
15–14 Reserved	This read-only field is reserved and always has the value 0.
13–8 VALUE13	GRAY13 value for 32-level histogram

Table continues on the next page...

PXP_HW_PXP_HIST32_PARAM3 field descriptions (continued)

Field	Description
7–6 Reserved	This read-only field is reserved and always has the value 0.
VALUE12	GRAY12 value for 32-level histogram

**41.11.348 32-level Histogram Parameter 0 Register.
(PXP_HW_PXP_HIST32_PARAM4)**

Address: 21C_C000h base + 2BC0h offset = 21C_EBC0h

Bit	31	30	29	28	27	26	25	24	23	22	21	20	19	18	17	16	15	14	13	12	11	10	9	8	7	6	5	4	3	2	1	0
R	0	VALUE19							0	VALUE18							0	VALUE17							0	VALUE16						
W																																
Reset	0	0	0	0	0	0	0	1	0	0	0	0	0	0	0	1	0	0	0	0	0	0	0	0	1	0	0	0	0	0	0	0

PXP_HW_PXP_HIST32_PARAM4 field descriptions

Field	Description
31–30 Reserved	This read-only field is reserved and always has the value 0.
29–24 VALUE19	GRAY19 value for 32-level histogram
23–22 Reserved	This read-only field is reserved and always has the value 0.
21–16 VALUE18	GRAY18 value for 32-level histogram
15–14 Reserved	This read-only field is reserved and always has the value 0.
13–8 VALUE17	GRAY17 value for 32-level histogram
7–6 Reserved	This read-only field is reserved and always has the value 0.
VALUE16	GRAY16 (Black) value for 32-level histogram

41.11.349 32-level Histogram Parameter 1 Register. (PXP_HW_PXP_HIST32_PARAM5)

Address: 21C_C000h base + 2BD0h offset = 21C_EBD0h

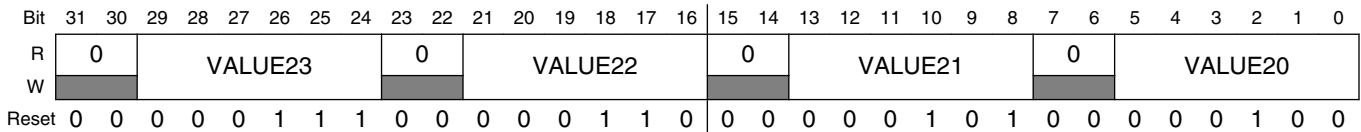

PXP_HW_PXP_HIST32_PARAM5 field descriptions

Field	Description
31–30 Reserved	This read-only field is reserved and always has the value 0.
29–24 VALUE23	GRAY23 value for 32-level histogram
23–22 Reserved	This read-only field is reserved and always has the value 0.
21–16 VALUE22	GRAY22 value for 32-level histogram
15–14 Reserved	This read-only field is reserved and always has the value 0.
13–8 VALUE21	GRAY21 value for 32-level histogram
7–6 Reserved	This read-only field is reserved and always has the value 0.
VALUE20	GRAY20 value for 32-level histogram

41.11.350 32-level Histogram Parameter 2 Register. (PXP_HW_PXP_HIST32_PARAM6)

Address: 21C_C000h base + 2BE0h offset = 21C_EBE0h

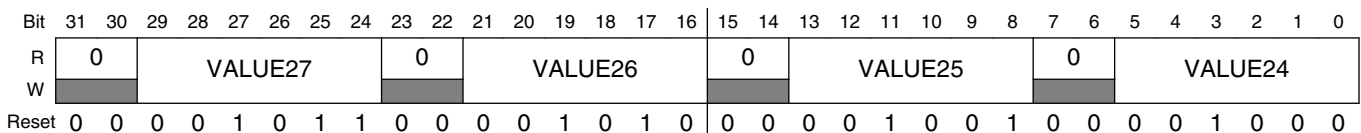

PXP_HW_PXP_HIST32_PARAM6 field descriptions

Field	Description
31–30 Reserved	This read-only field is reserved and always has the value 0.
29–24 VALUE27	GRAY27 value for 32-level histogram
23–22 Reserved	This read-only field is reserved and always has the value 0.
21–16 VALUE26	GRAY26 value for 32-level histogram
15–14 Reserved	This read-only field is reserved and always has the value 0.
13–8 VALUE25	GRAY25 value for 32-level histogram
7–6 Reserved	This read-only field is reserved and always has the value 0.
VALUE24	GRAY24 value for 32-level histogram

41.11.351 32-level Histogram Parameter 3 Register. (PXP_HW_PXP_HIST32_PARAM7)

Address: 21C_C000h base + 2BF0h offset = 21C_EBF0h

Bit	31	30	29	28	27	26	25	24	23	22	21	20	19	18	17	16	15	14	13	12	11	10	9	8	7	6	5	4	3	2	1	0
R	0	VALUE31							0	VALUE30							0	VALUE29							0	VALUE28						
W																																
Reset	0	0	0	0	1	1	1	1	0	0	0	0	1	1	1	0	0	0	0	0	1	1	0	1	0	0	0	0	1	1	0	0

PXP_HW_PXP_HIST32_PARAM7 field descriptions

Field	Description
31–30 Reserved	This read-only field is reserved and always has the value 0.
29–24 VALUE31	GRAY31 (White) value for 32-level histogram
23–22 Reserved	This read-only field is reserved and always has the value 0.
21–16 VALUE30	GRAY30 value for 32-level histogram
15–14 Reserved	This read-only field is reserved and always has the value 0.
13–8 VALUE29	GRAY29 value for 32-level histogram

Table continues on the next page...

PXP_HW_PXP_HIST32_PARAM7 field descriptions (continued)

Field	Description
7-6 Reserved	This read-only field is reserved and always has the value 0.
VALUE28	GRAY28 value for 32-level histogram

**41.11.352 This register defines the pxp subblock handshake signals ready mux on top level.
(PXP_HW_PXP_HANDSHAKE_READY_MUX0)**

Address: 21C_C000h base + 2CF0h offset = 21C_ECF0h

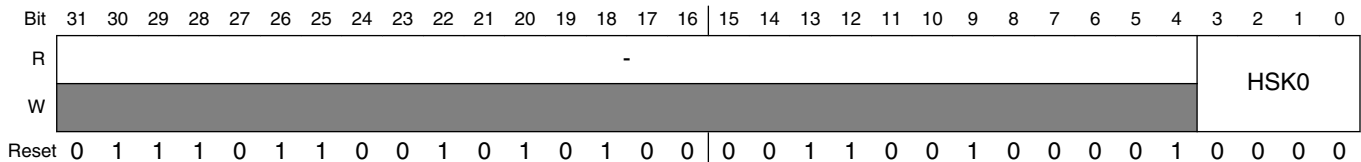

PXP_HW_PXP_HANDSHAKE_READY_MUX0 field descriptions

Field	Description
31-4 -	Reserved
HSK0	Subblock double buffer handshake signals MUX 0: Ready signal source is from pxp_control; 1: Ready signal source is from pxp_store_wfe_b CH0; 2: Ready signal source is from pxp_store_wfe_b CH1;

**41.11.353 This register defines the pxp subblock handshake signals done mux on top level.
(PXP_HW_PXP_HANDSHAKE_DONE_MUX0)**

Address: 21C_C000h base + 2D10h offset = 21C_ED10h

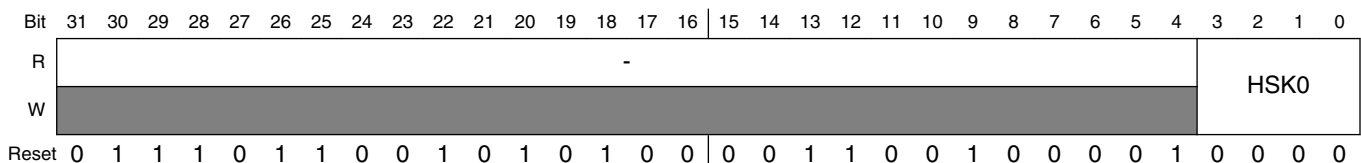

PXP_HW_PXP_HANDSHAKE_DONE_MUX0 field descriptions

Field	Description
31–4 -	Reserved
HSK0	Subblock double buffer handshake signals MUX 0: Done signal source is from LCDIF; 1: Done signal source is from pxp_fetch_wfe_b CH0; 2: Done signal source is from pxp_fetch_wfe_b CH1;

Chapter 42

Quad Serial Peripheral Interface (QuadSPI)

42.1 Overview

The Quad Serial Peripheral Interface (QuadSPI) block acts as an interface to one or two external serial flash devices, each with up to four bidirectional data lines. The following figure is a block diagram of the QuadSPI module.

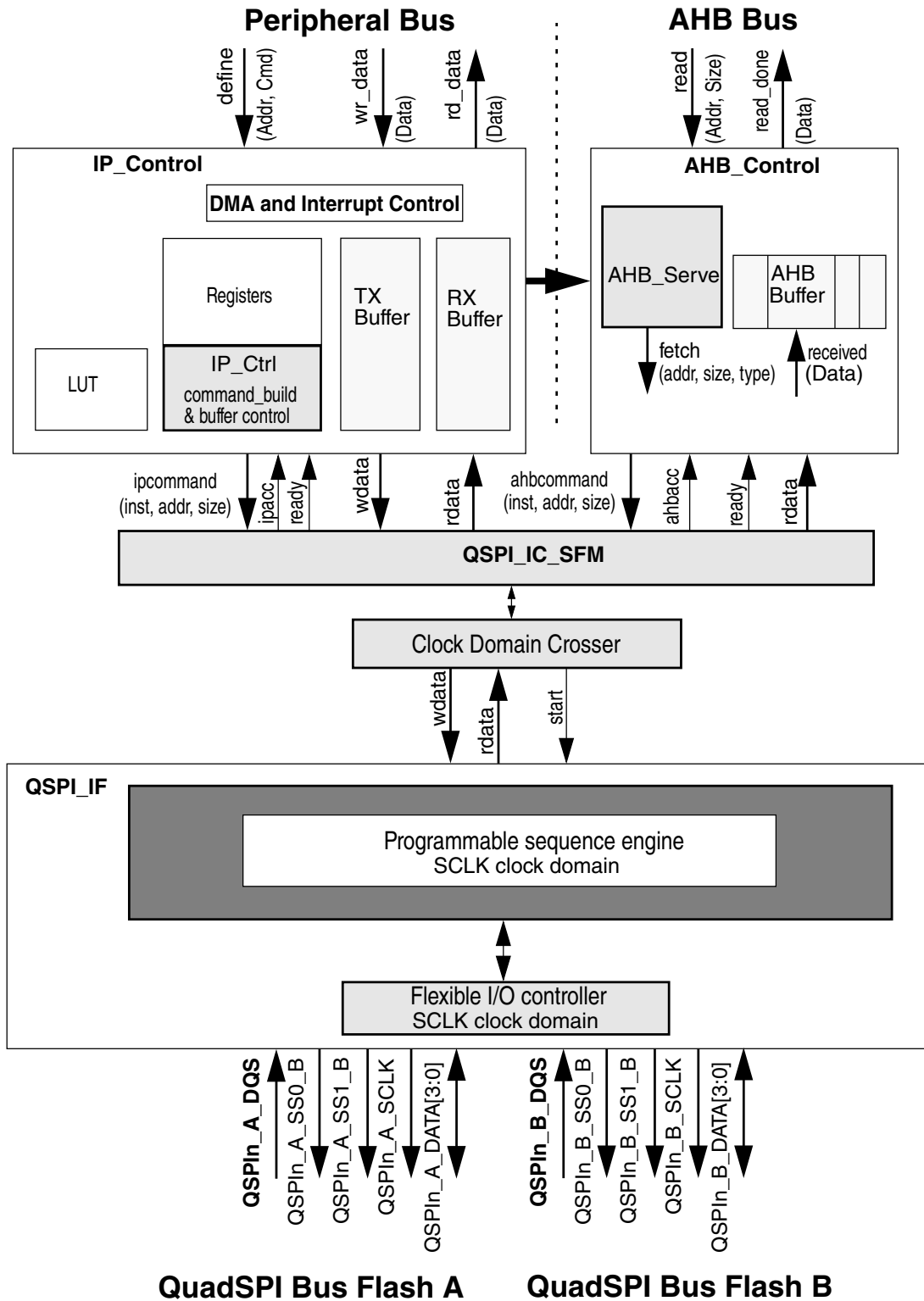

Figure 42-1. QuadSPI Block Diagram

The following figure describes the serial flash clock diagram in QuadSPI:

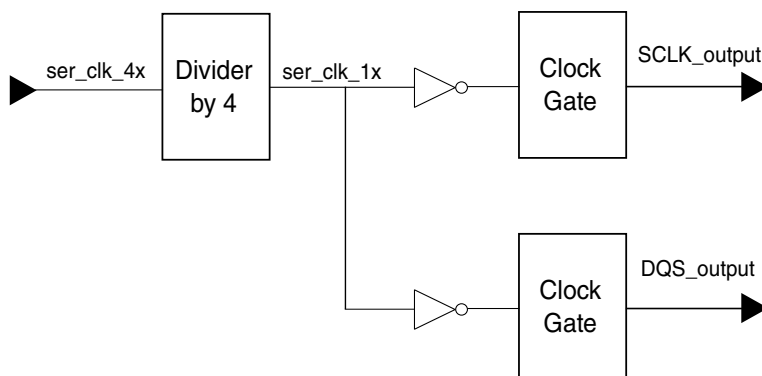

Figure 42-2. Flash Clock Diagram

ser_clk_4x is the serial clock root from CCM

ser_clk_1x' is generated clock from 'ser_clk_4x' divided by 4

SCLK_output is serial output clock generated from 'ser_clk_1x' with inverter and clock gate, it's used as Clock by external serial flash device.

DQS_output is serial flash data strobe signal generated from 'ser_clk_1x' with inverter and clock gate. This signal could be loopback from pad and used as sampling clock for serial flash data.

42.1.1 Features

The QuadSPI supports the following features:

- Flexible sequence engine to support various flash vendor devices.
- Single, dual, quad mode of operation.
- DDR/DTR mode wherein the data is generated on every edge of the serial flash clock.
- Support for flash data strobe signal for data sampling in DDR and SDR mode.
- Two identical serial flash devices can be connected and accessed in parallel for data read operations, forming one (virtual) flash memory with doubled readout bandwidth.
- DMA support to read RX Buffer data via AMBA AHB bus (64-bit width interface) or IP registers space (32-bit access).
 - Inner loop size of DMA access can be configured.
- Multi master accesses with priority

- Flexible and configurable buffer for each master
- Thirteen interrupt conditions (see [Table 42-10](#))
- Memory mapped read access to connected flash devices.
- Programmable sequence engine to cater to future command/protocol changes and able to support all existing vendor commands and operations.
 - Supports 3-byte and 4-byte addressing.
 - TXFIFO size is 512Byte
 - RXFIFO size is 128Byte
 - AHB BUF size is 1KByte

42.1.2 QuadSPI Modes of Operation

This section provides information about the modes in which the QuadSPI module can be used.

42.1.2.1 Normal Mode

In this mode, one or two external serial flash memory devices can be accessed. Further details about this mode of operation can be found in [Modes of Operation \(Normal Mode\)](#).

42.1.2.2 Module Disable Mode

This mode is used for power management of the device containing the QuadSPI module. It is controlled by signals external to the QuadSPI. The clock to the non-memory mapped logic in the QuadSPI can be stopped while in Module Disable Mode.

42.1.3 Acronyms and Abbreviations

The following table contains acronyms and abbreviations used in this document.

Table 42-1. Acronyms and Abbreviations

Terms	Description
AHB	Advanced High-performance Bus, version of AMBA
AMBA	Advanced Microcontroller Bus Architecture

Table continues on the next page...

Table 42-1. Acronyms and Abbreviations (continued)

Terms	Description
BE	Big Endian Byte Ordering
CS	Chip Select
DMA	Direct Memory Access
MB	Megabyte. Each MB is 1024 * 1024 bytes
IFM	Individual Flash Mode
PFM	Parallel Flash Mode
LSB	Least Significant Bit
MSB	Most Significant Bit
PCS	Peripheral Chip Select
QSPI, QuadSPI	Quad Serial Peripheral Interface
SCK	Serial Communications Clock
w1c	Write 1 to clear, writing a 1 to this field resets the flag

42.1.4 Glossary for QuadSPI module

Table 42-2. Glossary

Term	Definition
AHB Command	An AHB Command is a SFM Command triggered by a read access to the address range belonging to the memory mapped access defined in Table 42-7 . Refer to AHB Commands for details.
Asserted	A signal that is asserted is in its active state. An active low signal changes from logic level one to logic level zero when asserted, and an active high signal changes from logic level zero to logic level one.
Clear	To clear a bit or bits means to establish logic level zero on the bit or bits.
Clock Phase	Determines when the data should be sampled relative to the active edge of SCK
Clock Polarity	Determines the idle state of the SCK signal.
Drain	To remove entries from a FIFO by software or hardware.
Endianness	Byte Ordering scheme.
Field	Two or more register bits grouped together.
Fill	To add entries to a FIFO by software or hardware.
Host	Refers to another functional block in the device containing the QuadSPI module
Instruction Code	8 bits defining the type of command to be executed.
IP Command	An IP Command is a SFM Command triggered by writing into the QSPI_IPCR[SEQID] field.
Logic level one	The voltage that corresponds to Boolean true (1) state.
Logic level zero	The voltage that corresponds to Boolean false (0) state.
Negated	A signal that is negated is in its inactive state. An active low signal changes from logic level 0 to logic level 1 when negated, and an active high signal changes from logic level 1 to logic level 0.
QSPI_AMBA_BASE	First address of QuadSPI address space on system memory map.
QSPI_ARDB_BASE	First address of QuadSPI Rx Buffer on system memory map.

Table continues on the next page...

Table 42-2. Glossary (continued)

Term	Definition
Set	To set a bit or bits means to establish logic level one on the bit or bits.
RX Buffer PUSH Event	Addition of valid entries into the RX Buffer. In the default case each Buffer PUSH Event adds 2 entries to the RX Buffer since the interface to the serial clock domain is 64 bits in width. Depending on the number of bytes read from the serial flash device it is possible for the very last Buffer PUSH Event that only one entry is added. The QSPI_RBSR[RDBFL] field is incremented by the number of entries added to the RX Buffer.
RX Buffer POP Event	Removal of valid entries from the RX Buffer. Each Buffer POP Event removes (QSPI_RBCT[WMRK] + 1) valid entries from the buffer. The QSPI_RBSR[RDBFL] field is decremented by the same number and the QSPI_RBSR[RDCTR] field is incremented accordingly.
Individual Flash Mode	Access to a single, individual serial flash device. Refer to Serial Flash Access Schemes for details.
Parallel Flash Mode	Read access to two serial flash devices attached to the QuadSPI module in parallel. Refer to Serial Flash Access Schemes for details.
SFM Command	Serial Flash Memory Command. A SFM command consists of an instruction code and all other parameters (for example, size or mode bytes) needed for that specific instruction code. Triggering a command either initiates a transaction on the external serial flash or results in an error. Refer to Table 42-20 for details on errors.
Single/Dual/Quad Instructions	Depending on the serial flash device connected to the QuadSPI module there will be instructions using a different number of data lines. <ul style="list-style-type: none"> • Single: Single line I/O with one data out and one data in line to/from the serial flash device. • Dual: Dual line I/O with two bidirectional I/O lines, driven alternatively by the serial flash device or the QuadSPI module • Quad: Quad line I/O with 4 bidirectional I/O lines, driven alternatively by the serial flash device or the QuadSPI
Transaction	A transaction consists of all flags, data and signals in either direction to execute a command for an attached serial flash device. It is a combination of chip select, sclk, instruction code, address, mode-and/or dummy bytes, transmit and/or receive data.
LUT	Look-up table.

42.2 External Signals

The following table describes the external signals of QSPI:

Table 42-3. QSPI External Signals

Signal	Description	Pad	Mode	Direction
QSPI_A_DATA0	I/O data signal 1 port 0 for serial flash device A	NAND_READY_B	ALT0	I/O
QSPI_A_DATA1	I/O data signal 1 port 1 for serial flash device A	NAND_CE0_B	ALT0	I/O
QSPI_A_DATA2	I/O data signal 1 port 2 for serial flash device A	NAND_CE1_B	ALT0	I/O
QSPI_A_DATA3	I/O data signal 1 port 3 for serial flash device A	NAND_CLE	ALT0	I/O

Table continues on the next page...

**Table 42-3. QSPI External Signals
(continued)**

Signal	Description	Pad	Mode	Direction
QSPI_A_SS0_B	Chip select 1 port 0 for serial flash device A	NAND_DQS	ALT0	O
QSPI_A_SS1_B	Chip select 1 port 1 for serial flash device A	NAND_DATA07	ALT0	O
QSPI_A_DQS	Data strobe signal 1 to serial flash device A	NAND_ALE	ALT0	I
QSPI_A_SCLK	Serial clock output 1 to serial flash device A	NAND_WP_B	ALT0	O
QSPI_B_DATA0	I/O data signal 1 port 0 for serial flash device B	NAND_DATA02	ALT0	I/O
QSPI_B_DATA1	I/O data signal 1 port 1 for serial flash device B	NAND_DATA03	ALT0	I/O
QSPI_B_DATA2	I/O data signal 1 port 2 for serial flash device B	NAND_DATA04	ALT0	I/O
QSPI_B_DATA3	I/O data signal 1 port 3 for serial flash device B	NAND_DATA05	ALT0	I/O
QSPI_B_SS0_B	Chip select 1 port 0 for serial flash device B	NAND_WE_B	ALT0	O
QSPI_B_SS1_B	Chip select 1 port 1 for serial flash device B	NAND_DATA00	ALT0	O
QSPI_B_DQS	Data strobe signal 1 to serial flash device B	NAND_DATA01	ALT0	I
QSPI_B_SCLK	Serial clock output 1 to serial flash device B	NAND_RE_B	ALT0	O

42.2.1 Driving External Signals

The different phases of serial flash access scheme are shown in the following figure.

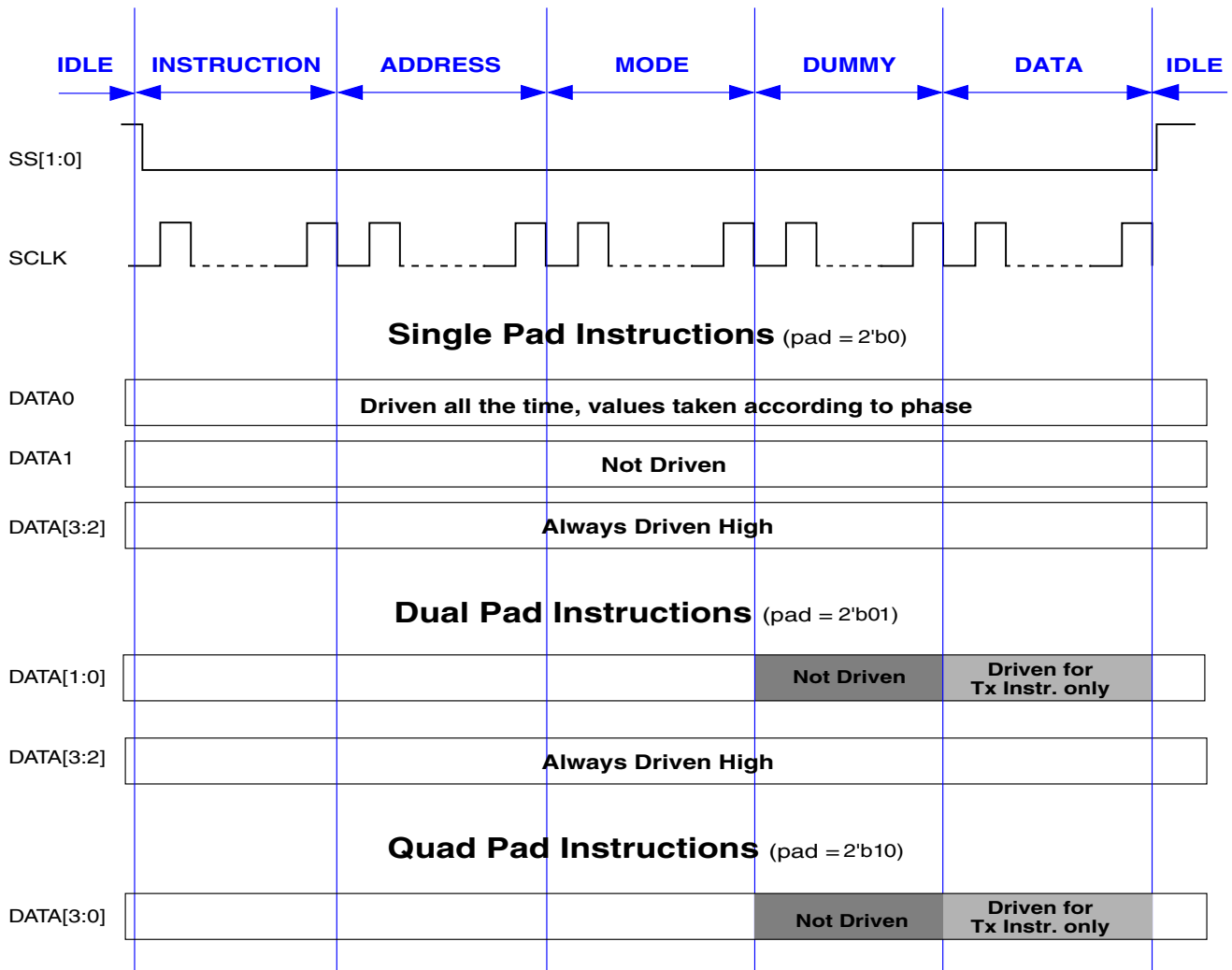

Figure 42-3. Serial Flash Access Scheme

The different phases and the I/O driving characteristics of the QuadSPI module are characterized in the following way:

- **IDLE:** Serial flash device not selected. No interaction with the serial flash device. All DATA signals driven.
- **INSTRUCTION:** Serial flash device selected. The instruction is sent to the serial flash device. All DATA signals are driven.
- **ADDRESS:** Serial Flash Address is sent to the device. All DATA signals are driven. Note that this phase is not applicable for all SFM Commands.
- **MODE:** Mode bytes are sent to the serial flash device. All DATA signals are driven. Note that this phase is not applicable for all SFM Commands.

- **DUMMY:** Dummy clocks are provided to the serial flash device. Refer to the [Figure 42-3](#) for the DATA signals driven. The actual data lines required for the SFM Command executed are not driven for data read commands. Note that this phase is not applicable for all SFM Commands.
- **DATA:** Serial flash data are sent to or received from the serial flash device. Refer to the preceding figure for the DATA signals driven. The actual data lines required for the SFM Command executed are not driven for data read commands. Note that this phase is not applicable for all SFM Commands.

The SS[1:0] and SCLK signals are driven permanently throughout all the phases.

In Individual Flash Mode this applies to the selected flash device. In Parallel Flash Mode this applies to both serial flash devices simultaneously.

42.3 Memory Map and Register Definition

This section provides the memory map and register definitions of the QuadSPI module.

42.3.1 Register Write Access

This section describes the write access restriction terms that apply to all registers, which can be one of the following:

- **Register Write Access Restriction**

For each register bit and register field, the write access conditions are specified in the detailed register description. A description of the write access conditions is given in the following table. If, for a specific register bit or field, none of the given write access conditions is fulfilled, any write attempt to this register bit or field is ignored without any notification. The values of the bits or fields are not changed.

The condition term [A or B] indicates that the register or field can be written to if at least one of the conditions is fulfilled.

Table 42-4. Register Write Access Restrictions

Condition	Description
Anytime	No write access restriction.
Disabled Mode	Write access only if $QSPI_MCR[MDIS] = 1$.

Table continues on the next page...

**Table 42-4. Register Write Access Restrictions
(continued)**

Condition	Description
Normal Mode	Write access only if the module is in <i>Normal Mode</i> .

- **Register Write Access Requirements**

All registers can be accessed with 8-bit, 16-bit, and 32-bit wide operations. For some of the registers, at least a 16/32-bit wide write access is required to ensure correct operation. This write access requirement is stated in the detailed register description for each register affected.

42.3.2 Serial Flash Address Assignment

The serial flash address assignment may be modified by writing into [Serial Flash A1 Top Address \(QuadSPI_SFA1AD\)](#) and [Serial Flash A2 Top Address \(QuadSPI_SFA2AD\)](#) for device A and into [Serial Flash B1 Top Address \(QuadSPI_SFB1AD\)](#) and [Serial Flash B2 Top Address \(QuadSPI_SFB2AD\)](#) for device B. The following table shows how different access modes are related to the address specified for the next SFM Command. Note that this address assignment is valid for both IP and AHB commands.

Table 42-5. Serial Flash Address Assignment

Parameter	Function	Access Mode
QSPI_AMBA_BASE (31:10) - 22 bits)	QuadSPI AHB base address	
TOP_ADDR_MEMA1(T PADA1)	Top address for the external flash A1 (first device of the dual die flash A, or the first of the two independent flashes sharing the IOFA)	Any access to the address space between TOP_ADDR_MEMA1 and QSPI_AMBA_BASE will be routed to Serial Flash A1
TOP_ADDR_MEMA2(T PADA2)	Top address for the external flash A2 (second device of the dual die flash A, or the second of the two independent flashes sharing the IOFA).	Any access to the address space between TOP_ADDR_MEMA2 and TOP_ADDR_MEMA1 will be routed to Serial Flash A2
TOP_ADDR_MEMB1(T PADB1)	Top address for the external flash B1 (first device of the dual die flash B, or the first of the two independent flashes sharing the IOFB)	Any access to the address space between TOP_ADDR_MEMB1 and TOP_ADDR_MEMA2 will be routed to Serial Flash B1
TOP_ADDR_MEMB2(T PADB2)	Top address for the external flash B2 (second device of the dual die flash B or the second of the two independent flashes sharing the IOFB)	Any access to the address space between TOP_ADDR_MEMB2 and TOP_ADDR_MEMB1 will be routed to Serial Flash A2

42.3.3 AMBA Bus Register Memory Map

QSPI_AMBA_BASE defines the address to be used as start address of the serial flash device as defined by the system memory map..

Table 42-6. QuadSPI AMBA Bus Memory Map

Address	Register Name
Memory Mapped Serial Flash Data - Individual Flash Mode on Flash A	
QSPI_AMBA_BASE to (TOP_ADDR_MEMA2 - 0x01)	Memory Mapped Serial Flash Data - Individual Flash Mode on Flash A Refer to Memory Mapped Serial Flash Data - Individual Flash Mode on Flash A for details and to Table 42-14 and Table 42-18 for information about the byte ordering.
Memory Mapped Serial Flash Data - Individual Flash Mode on Flash B	
TOP_ADDR_MEMA2 to (TOP_ADDR_MEMB2 - 0x01)	Memory Mapped Serial Flash Data - Individual Flash Mode on Flash B Refer to Memory Mapped Serial Flash Data - Individual Flash Mode on Flash B for details and to Table 42-14 and Table 42-18 for information about the byte ordering.
Parallel Flash Mode	
QSPI_AMBA_BASE to (TOP_ADDR_MEMB2 - 0x01)	Parallel Flash Mode Refer to Parallel Flash Mode for details and to Table 42-17 and Table 42-18 for information about the byte ordering.
AHB RX Data Buffer (QSPI_ARDB0 to QSPI_ARDB31)	
QSPI_ARDB_BASE to... (32 * 4 Byte) QSPI_ARDB_BASE + 0x0000_01FF	AHB RX Data Buffer (QSPI_ARDB0 to QSPI_ARDB31) Refer to Table 42-14 and Table 42-16 for information about the byte ordering.

Note

Any read access to non-implemented addresses will provide undefined results.

In case single die flash devices, TOP_ADDR_MEMA2 and TOP_ADDR_MEMB2 should be initialized/programmed to TOP_ADDR_MEMA1 and TOP_ADDR_MEMB1 respectively- in effect, setting the size of these devices to 0. This would ensure that the complete memory map is assigned to only one flash device.

Parallel Flash Mode is valid only for commands related to data read from the serial flash. The first device of flash A has to be paired with the first device of flash B and the second device of flash A has to be paired with the second device of flash B in parallel mode. Parallel mode is selected via the QSPI_BFGENCR[PAR_EN] bit for all masters in AHB driven mode and via the QSPI_IPCR[PAR_EN] in IP driven mode. In

parallel mode, the incoming address (SFAR address in case of IP initiated transactions and the incoming AHB address in case of AHB initiated transactions) is divided by 2 and sent to the two flashes connected in parallel.

Any IP Command other than data read in Parallel Flash Mode will result in the assertion of the QSPI_FR[IUEF] flag and any AHB Command other than data read in Parallel Flash Mode will result in the assertion of the QSPI_FR[ABSEF] flag.

In the Individual Flash Modes, the 3/4 address bytes (as programmed in the instruction/operand in the sequence) available for the flash address is determined by SFADR [23:0] or SFADR [31:0] as given in the table above.

In Parallel Flash Mode, both flashes are read with the same starting address of 3/4 (as programmed in the instruction/operand in the sequence) bytes in size. This address is derived from SFADR [24:1] or SFADR [31:1] as given in the table above. The LSB of the SFADR field is used to select the appropriate bits of both flash devices to combine the byte corresponding to the selected address.

42.3.4 AHB Bus Register Memory Map Descriptions

This chapter contains definitions of registers in the AMBA address space.

42.3.4.1 AHB Bus Access Considerations

It has to be noted that all logic in the QuadSPI module implementing the AHB Bus access is designed to read the content of an external serial flash device. Therefore the following restrictions apply to the QuadSPI module with respect to accesses to the AHB bus:

- Any write access is answered with the ERROR condition according to the AMBA AHB Specification. No write occurs.
- Any AHB Command resulting in the assertion of the QSPI_FR[ABSEF] flag is answered with the ERROR condition according to the AMBA_AHB specification. The resulting AHB Command is ignored.

- AHB Bus access types fully supported are NONSEQ and BUSY.
- AHB access type SEQ is treated in the same way like NONSEQ. Refer to the AMBA AHB Specification for further details.

42.3.4.2 Memory Mapped Serial Flash Data - Individual Flash Mode on Flash A

Starting with address `QSPI_AMBA_BASE` the content of the first external serial flash devices is mapped into the address space of the device containing the QuadSPI module. Serial flash address byte address `0x0` corresponds to bus address `QSPI_AMBA_BASE` with increasing order. Assuming that a dual-die flash is connected on the first set of external pads, the address space is divided into two parts, one for each device of the dual die package. Refer to the following table for the address mapping. The byte ordering for 32 bit access is given in [Table 42-14](#) and for 64 bit read access the byte ordering is given in [Table 42-18](#).

Table 42-7. Memory Mapped Individual Flash Mode - Flash A Address Scheme

Memory Mapped Address 32 Bit Access	Memory Mapped Address 64 Bit Access	Serial Flash Byte Address	Flash Device
<code>QSPI_AMBA_BASE + 0x00</code>	<code>QSPI_AMBA_BASE + 0x00</code>	<code>0x00_0000 to 0x00_0003</code>	A1
<code>QSPI_AMBA_BASE + 0x04</code>		<code>0x00_0004 to 0x00_0007</code>	
...		...	
<code>TOP_ADDR_MEMA1 - 0x08</code>	<code>TOP_ADDR_MEMA1 - 0x08</code>	<code>(TOP_ADDR_MEMA1 - 0x08) to (TOP_ADDR_MEMA1 - 0x04 - 0x01)</code>	
<code>TOP_ADDR_MEMA1 - 0x04</code>		<code>(TOP_ADDR_MEMA1 - 0x04) to (TOP_ADDR_MEMA1 - 0x01)</code>	
<code>TOP_ADDR_MEMA1 + 0x00</code>	<code>TOP_ADDR_MEMA1 + 0x00_0000</code>	<code>0x00_0000 to 0x00_0003</code>	A2
<code>TOP_ADDR_MEMA1 + 0x04</code>		<code>0x00_0004 to 0x00_0007</code>	
.....		...	
<code>TOP_ADDR_MEMA2 - 0x08</code>	<code>TOP_ADDR_MEMA2 - 0x08</code>	<code>(TOP_ADDR_MEMA2 - 0x08) to (TOP_ADDR_MEMA2 - 0x04 - 0x01)</code>	
<code>TOP_ADDR_MEMA2 - 0x04</code>		<code>(TOP_ADDR_MEMA2 - 0x04) to (TOP_ADDR_MEMA2 - 0x01)</code>	

The available address range depends from the size of the external serial flash device. Any access beyond the size of the external serial flash provides undefined results.

For details concerning the read process refer to [Flash Read](#).

42.3.4.3 Memory Mapped Serial Flash Data - Individual Flash Mode on Flash B

Starting with address TOP_ADDR_MEMA2 the content of the first external serial flash devices is mapped into the address space of the device containing the QuadSPI module. Serial flash address byte address 0x0 corresponds to bus address TOP_ADDR_MEMA2 with increasing order. Assuming that a dual-die flash is connected on the first set of external pads, the address space is divided into two parts, one for each device of the dual die package. Refer the following table for the address mapping. The byte ordering for 32 bit access is given in [Table 42-14](#) and for 64 bit read access the byte ordering is given in [Table 42-18](#).

Table 42-8. Memory Mapped Individual Flash Mode - Flash B Address Scheme

Memory Mapped Address 32 Bit Access	Memory Mapped Address 64 Bit Access	Serial Flash Byte Address	Flash Device
TOP_ADDR_MEMA2 + 0x00	TOP_ADDR_MEMA2 + 0x00	0x00_0000 to 0x00_0003	B1
TOP_ADDR_MEMA2 + 0x04		0x00_0004 to 0x00_0007	
...	
TOP_ADDR_MEMB1 - 0x08	TOP_ADDR_MEMB1 - 0x08	(TOP_ADDR_MEMB1 - TOP_ADDR_MEMA2 - 0x08) to (TOP_ADDR_MEMB1 - TOP_ADDR_MEMA2 - 0x04 - 0x01)	
TOP_ADDR_MEMB1 - 0x04		(TOP_ADDR_MEMB1 - TOP_ADDR_MEMA2 - 0x04) to (TOP_ADDR_MEMB1 - TOP_ADDR_MEMA2 - 0x01)	
TOP_ADDR_MEMB1 + 0x00	TOP_ADDR_MEMB1 + 0x00_0000	0x00_0000 to 0x00_0003	B2
TOP_ADDR_MEMB1 + 0x04		0x00_0004 to 0x00_0007	
.....	
TOP_ADDR_MEMB2 - 0x08	TOP_ADDR_MEMA2 - 0x08	(TOP_ADDR_MEMB2 - TOP_ADDR_MEMB1 - 0x08) to (TOP_ADDR_MEMB2 - TOP_ADDR_MEMB1 - 0x04 - 0x01)	
TOP_ADDR_MEMB2 - 0x04		(TOP_ADDR_MEMB2 - TOP_ADDR_MEMB1 - 0x04) to (TOP_ADDR_MEMB2 - TOP_ADDR_MEMB1 - 0x01)	

The available address range depends from the size of the external serial flash device. Any access beyond the size of the external serial flash provides undefined results.

For details concerning the read process refer to [Flash Read](#).

42.3.4.4 Parallel Flash Mode

Any of the AHB flexible-buffers can be configured to work in parallel flash mode by programming the QSPI_BFGENCR[PAR_EN] bit to '1'. When parallel mode is set, Flash A1 is paired with Flash B1 and Flash A2 is paired with Flash B2. In parallel mode, software should ensure that the size of Flash A1(A2) is equal to the size of Flash B1(B2).

Reads from any even AHB bus address provides bits [7:4] of both serial flash devices and reads from any odd AHB bus address provides bits [3:0] of both flash devices. Refer to the following table for the address mapping. The byte ordering for 32 bit access is given in [Table 42-16](#) and for 64 bit read access the byte ordering is given in [Table 42-18](#).

Table 42-9. Memory Mapped Parallel Flash Mode Address Scheme

Memory Mapped Address 32 Bit Access	Memory Mapped Address 64 Bit Access	Serial Flash A Byte Address	Serial Flash B Byte Address
QSPI_AMBA_BASE + 0x0000_0000	QSPI_AMBA_BASE + 0x00 For details, please refer to Parallel mode and Dual Die Flashes .	0x00_0000	0x00_0000
QSPI_AMBA_BASE + 0x0000_0004		-	-
		0x00_0001	0x00_0001
		0x00_0002	0x00_0002
		-	-
		0x00_0003	0x00_0003
QSPI_AMBA_BASE + 0x0000_0008	QSPI_AMBA_BASE + 0x08	0x00_0004	0x00_0004
		-	-
		0x00_0005	0x00_0005
QSPI_AMBA_BASE + 0x0000_000C		-	-
		0x00_0006	0x00_0006
		-	-
		0x00_0007	0x00_0007
...
TOP_ADDR_MEMB2 - 0x08	TOP_ADDR_MEMB2 - 0x08	$(TOP_ADDR_MEMB2 - QSPI_AMBA_BASE - 0x08)/2$	$(TOP_ADDR_MEMB2 - QSPI_AMBA_BASE - 0x08)/2$
TOP_ADDR_MEMB2 - 0x04		$(TOP_ADDR_MEMB2 - QSPI_AMBA_BASE - 0x04)/2 + 0x01$	$(TOP_ADDR_MEMB2 - QSPI_AMBA_BASE - 0x04)/2 + 0x01$

The available address range covers 27 address bits, corresponding to 128 MB per flash device. The usable space depends from the size of the external serial flash devices. Any access beyond the size of the external serial flash provides undefined results.

For details concerning the read process refer to [Flash Read](#).

42.4 Interrupt Signals

The interrupt request lines of the QuadSPI module are mapped to the internal flags according to the following table.

Table 42-10. Assignment of Interrupt Request Lines

IRQ/DMA line	QSPI_FR Flag	Interrupt Description
ipi_int_tfff	TBFF	TX Buffer Fill
ipi_int_tcf	TFF	Peripheral Command Transaction Finished
ipi_int_rdf	RBDF	RX Buffer Drain
ipi_int_overrun		Buffer Overflow/Underrun Error Logical OR from:
	RBOF	RX Buffer Overrun
	TBUF	TX Buffer Underrun
	ABOF	AHB Buffer Overflow
ipi_int_cerr		Serial Flash Command Error Logical OR from:
	IPAEF	Peripheral access while AHB busy Error
	IPIEF	Peripheral Command could not be triggered Error
	IPGEF	Peripheral access while AHB Grant Error
ipi_int_ored	IUEF	Peripheral Command Usage Error
	DLPFF, TBFF, TFF, ILLINE, RBDF, RBOF, TBUF, ABSEF, ABOF, IPAEF, IPIEF, IPGEF, IUEF	Logical OR from all the QSPI_FR flags mentioned

42.5 Functional Description

This section provides the functional information of the QuadSPI module.

42.5.1 Serial Flash Access Schemes

The Quad Serial Peripheral Interface (QuadSPI) block acts as an interface to one single or two external serial flash devices, each with up to 4 bidirectional data lines. Depending from the serial flash devices attached to the QuadSPI module the following access schemes are possible:

Table 42-11. Access Schemes for Serial Flash Data Access

Access Scheme	One Flash Device on Port A	One Flash Device on Port B	Two identical Flash Devices connected on Port A and Port B
Individual Flash Mode: Access to Flash A	Yes	N/a	Yes
Individual Flash Mode: Access to Flash B	N/a	Yes	Yes
Parallel Flash Mode: Read from Flash A and Flash B	N/a	N/a	Yes

Note

If two flash devices are accessed in Parallel Flash Mode, they are accessed with identical control signals. Special alignment on per-flash basis is **not** possible. It is within the responsibility of the application to ensure that the identical signals are applicable to both flash devices.

In Parallel Flash Mode, both external serial flash devices appear logically as one single memory doubled in size with respect to one individual flash device.

If two different flash devices are attached, they can be operated only in Individual Flash Mode.

In the Parallel Flash Mode, only data read commands are supported. Any other IP Command will result in an error condition signaled by the assertion of the QSPI_FR[IUEF] flag and any other AHB Command will result in the assertion of the QSPI_FR[ABSEF] flag.

In the Individual Flash Mode, all supported commands are available.

Unless explicitly noted, all the following descriptions relate to the Individual Flash Mode.

42.5.2 Modes of Operation

Refer to [QuadSPI Modes of Operation](#) for an overview over the possible operational modes of the QuadSPI block.

- Normal Mode can be used for write or read accesses to an external serial flash device.

- Serial Flash Write: Data can be programmed into the flash via the IP interface only. Refer to [Flash Programming](#) for further details.
- Serial Flash Read: Read the contents of the serial flash device. Two separate read channels are available via RX Buffer and AHB Buffer, see [Flash Read](#).
- Stop Mode: The mode is used for power management. When a request is made to enter Stop Mode, the QuadSPI block acknowledges the request and completes the SFM Command in progress, then the system clocks to the QuadSPI block may be shut off
- Module Disable Mode: The mode is used for power management. The clock to the non-memory mapped logic in the QuadSPI can be stopped while in Module Disable Mode. The module enters the mode by setting QSPI_MCR[MDIS].

42.5.3 Normal Mode

This mode is used to allow communication with an external serial flash device. Compared to the standard SPI protocol, this communication method uses up to 4 bidirectional data lines operating at high data rates. The communication to the external serial flash device consists of an instruction code and optional address, mode, dummy and data transfers. The flexible programmable core engine described below is immune to a wide variety of command/protocol differences in the serial flash devices provided by various flash vendors.

42.5.3.1 Programmable Sequence Engine

The core of the QuadSPI module is a programmable sequence engine that works on "instruction-operand" pairs. The core controller executes each programmed instruction sequentially. The complete list of instructions and the corresponding operands is given in the following table.

Table 42-12. Instruction set

Instruction	Instruction encoding	Pins	Operand	Action on Serial Flash(es)
CMD	6'd1	N=2'd{0,1,2} 2'd0 - One pad 2'd1 - Two pads	8 bit command value	Provide the serial flash with operand on the number of pads specified

Table continues on the next page...

Table 42-12. Instruction set (continued)

Instruction	Instruction encoding	Pins	Operand	Action on Serial Flash(es)
ADDR	6'd2	2'd2 - Four pads	Number of address bits to be sent (for example, 8'd24 => 24 address bits required)	Provide the serial flash with address cycles according to the operand on the number of pads specified. The actual address to be provided will be derived from the incoming address in case of AHB initiated transactions and the value of SFAR in case of IPS initiated transactions .
DUMMY	6'd3		Number of dummy clock cycles (should be <= 64 cycles)	Provide the serial flash with dummy cycles as per the operand. The PAD information defines the number of pads in input mode. (for example, one pad implies that pad 1 is not driven, rest all are driven)
MODE	6'd4		8 bit mode value	Provide the serial flash with 8 bit operand on the number of pads specified
MODE2	6'd5	N=2'd{0,1}	2 bit mode value	Provide the serial flash with 2 bit operand on the number of pads ¹ specified
MODE4	6'd6	N=2'd{0,1,2}	4 bit mode value	Provide the serial flash with 4 bit operand on the number of pads ² specified
READ	6'd7	N=2'd{0,1,2} 2'd0 - One pad 2'd1 - Two pads 2'd2 - Four pads	Read data size in bytes (for AHB transactions, the user's application should ensure that data size is a multiple of 8 bytes)	Read data from flash on the number of pads specified. The data size may be overwritten by writing to the ADATSZ field of the QSPI_BUFxCR registers for AHB initiated transactions and IDATSZ field of IP Configuration Register (QuadSPI_IPCR) for IP initiated transactions.
WRITE			6'd8	Write data size in bytes
JMP_ON_CS	6'd9	NA	Instruction number	Every time the CS is deasserted, jump to the instruction pointed to by the operand. This instruction allows the programmer to specify the behavior of the controller when a new read transaction is initiated following a CS deassertion.
ADDR_DDR	6'd10	N=2'd{0,1,2} 2'd0 - One pad 2'd1 - Two pads 2'd2 - Four pads	Number of address bits to be sent (for example, 8'd24 => 24 address bits required)	Provide the serial flash with address cycles according to the operand on the number of pads specified at each clock edge of serial flash clock. The actual address to be provided will be derived from the incoming address in case of AHB initiated transactions and the value of QSPI_SFAR in case of IPS initiated transactions .
MODE_DDR			6'd11	8 bit mode value
MODE2_DDR	6'd12	N=2'd{0}	2 bit mode value	Provide the serial flash with 2 bit operand on the number of pads specified at each clock edge of serial flash ³
MODE4_DDR	6'd13	N=2'd{0,1}	4 bit mode value	Provide the serial flash with 4 bit operand on the number of pads specified at each clock edge of serial flash ⁴ .

Table continues on the next page...

Table 42-12. Instruction set (continued)

Instruction	Instruction encoding	Pins	Operand	Action on Serial Flash(es)
READ_DDR	6'd14	N=2'd{0,1,2} 2'd0 - One pad 2'd1 - Two pads 2'd2 - Four pads	Read data size in bytes (for AHB transactions, the user's application should ensure that data size is in multiple of 8 bytes)	Read data from flash on the number of pads specified at each clock edge of serial flash. The data size may be overwritten by writing to the ADATSZ field of the QSPI_BUFxCR registers for AHB initiated transactions and IDATSZ field of IP Configuration Register (QuadSPI_IPCR) for IP initiated transactions
WRITE_DDR	6'd15		Write data size in bytes	Write data on the number of pads specified at each clock edge of serial flash. The data size may be overwritten by writing to the IDATSZ field of IP Configuration Register (QuadSPI_IPCR) register
DATA_LEARN ⁵	6'd16		8 bit Data learning pattern	Find the correct sampling point with the data learning pattern. When this instruction is encountered, the QSPI_SMPR[DDRSMP] values are ignored and the controller finds the correct sampling point on its own by sampling the data learning pattern. ⁶
STOP	8'd0	NA	NA	Stop execution; deassert CS

- For a one pad instruction, MODE2 will take 2 serial flash clock cycles on the flash interface.
- For a one pad instruction, MODE4 will take 4 serial flash clock cycles on the flash interface. For a 4 pad instruction, MODE4 will take 1 serial flash clock cycle on the flash interface.
- For a one pad instruction, MODE2_DDR will take 1 serial flash clock cycle on the flash interface.
- For a one pad instruction, MODE4_DDR will take 2 serial flash clock cycles on the flash interface. For a 4 pad instruction MODE4_DDR will take half a cycle on the serial flash interface.
- Data learning is not implemented on this chip.
- t is not recommended to have 0x00 or 0xFF as the data learning pattern.

A sequence of such instruction-operand pairs may be pre-populated in the LUT according to the device connected on board. Each instruction-operand pair is of 16 bits (2 bytes) each. Every sequence pre-programmed in the LUT is referred to by its index.

The programmable sequence engine allows the user to configure the QuadSPI module according to the serial flash connected on board. The flexible structure is easily adaptable to new command/protocol changes from different vendors.

42.5.3.2 Flexible AHB buffers

In order to reduce the latency of the reads for AHB masters, the data read from the serial flash is buffered in flexible AHB buffers. There are four such flexible buffers. The size of each of these buffers is configurable with the minimum size being 0 Bytes and maximum size being the size of the complete buffer instantiated. The size of buffer 0 is defined as being from 0 to QSPI_BUF0IND. The Size of buffer 1 is from QSPI_BUF0IND to

QSPI_BUF1IND, buffer2 is from QSPI_BUF1IND to QSPI_BUF2IND and buffer 3 is from QSPI_BUF2IND to the size of the complete buffer, which is given in the chip-specific QuadSPI information.

Each flexible AHB buffer is associated with the following

1. An AHB master. Optionally, buffer3 may be configured as an "all master" buffer by setting the QSPI_BUF3CR[ALLMST] bit. When buffer3 is configured in such a way, any access from a master not associated with any other buffer is routed to buffer3.
2. A datasize field representing the amount of data to be fetched from the flash on every "missed" access.

The master port number of every incoming request is checked and the data is returned/fetched into the corresponding associated buffer. Every "missed" access to the buffer causes the controller to clear the buffer and fetch QSPI_BUFxCR[ADATSZ] amount of data from the serial flash. As such, there is no benefit in configuring a buffer size of greater than ADATSZ, as the locations greater than ADATSZ will never be used. For any AHB access, the sequence pointed to by the QSPI_BFGENCR[SEQID] field is used for the flash transaction initiated. The data is returned to the master as soon as the requested amount is read from the serial flash. The controller however, continues to prefetch the rest of the data in anticipation of a next consecutive request. [Figure 42-4](#) shows the flexible AHB buffers.

The QSPI_BFGENCR[SEQID] field points to an index of the LUT. Refer to [Look-up Table](#) for details.

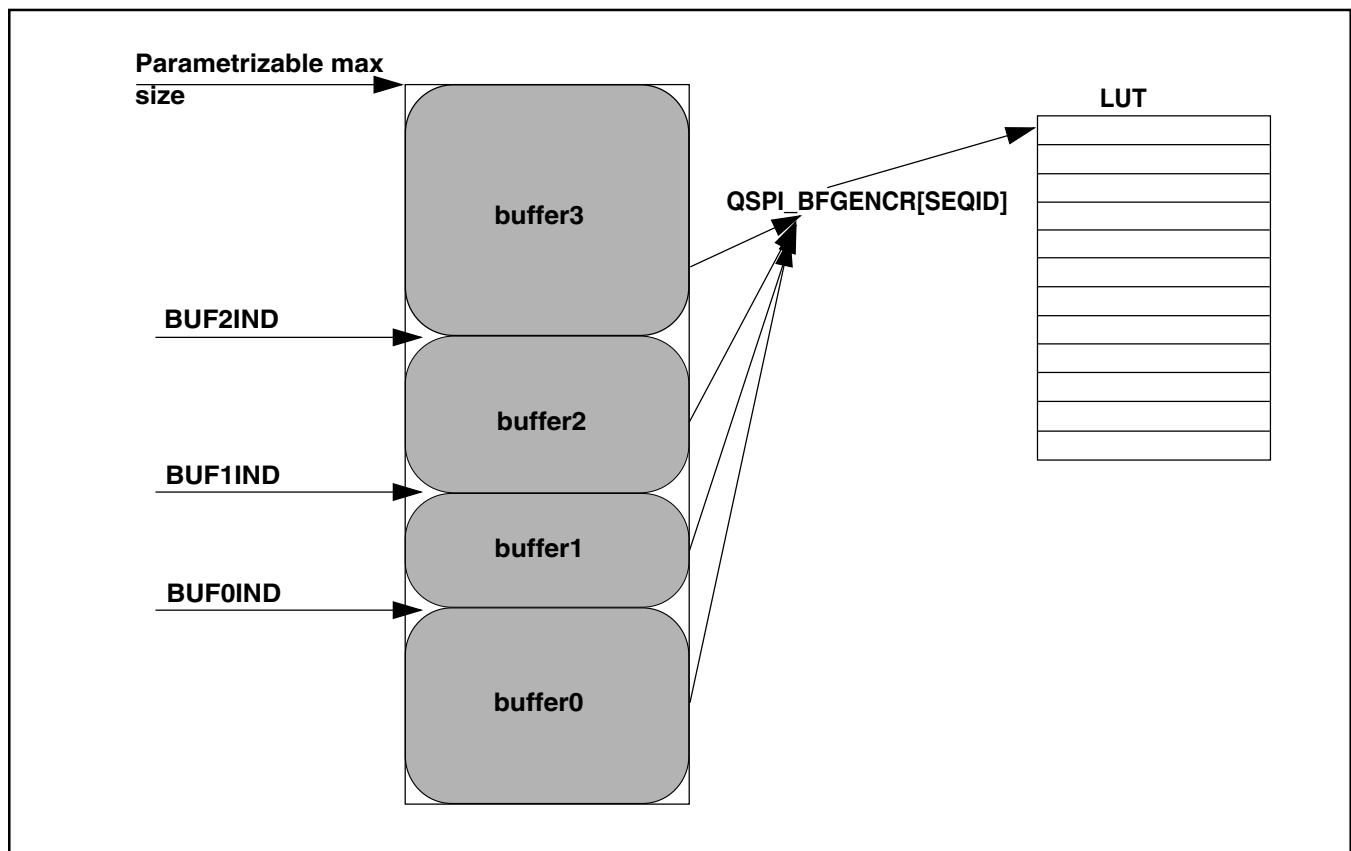

Figure 42-4. Flexible AHB Buffers

Buffer0 may optionally be configured to be associated with a high priority master by setting the QSPU_BUF0CR[HP_EN] bit. An access by a high priority master suspends any ongoing prefetch to any of the other buffers. The ongoing prefetch is suspended and the high priority master is serviced first. Once the high priority masters access completes, the suspended transaction is resumed (before any other AHB access is entertained). The status of the suspended buffer can be read from [Sequence Suspend Status Register \(QuadSPI_SPNDST\)](#).

42.5.3.3 Suspend-Abort Mechanism

Any low priority AHB access can be suspended by a high priority AHB master request. The ongoing transaction is suspended at 64 bit boundary. The suspended transaction is restarted after the high priority master is served and the high priority transaction including data prefetch is completed. While a transaction is in suspended state, it may be aborted if a transaction by the same suspended master is made to a location which is different from the location of the suspended transaction.

Any ongoing transaction is aborted if a request from the same master arrives for a location other than the location at which the transaction is going on. The abort can happen at any point of time.

42.5.3.4 Look-up Table

The Look-up-table or LUT consists of a number of pre-programmed sequences. Each sequence is basically a sequence of instruction-operand pairs which when executed sequentially generates a valid serial flash transaction. Each sequence can have a maximum of 8 instruction-operand pairs. The LUT can hold a maximum of 16 sequences. The figure below shows the basic structure of the sequence in the LUT.

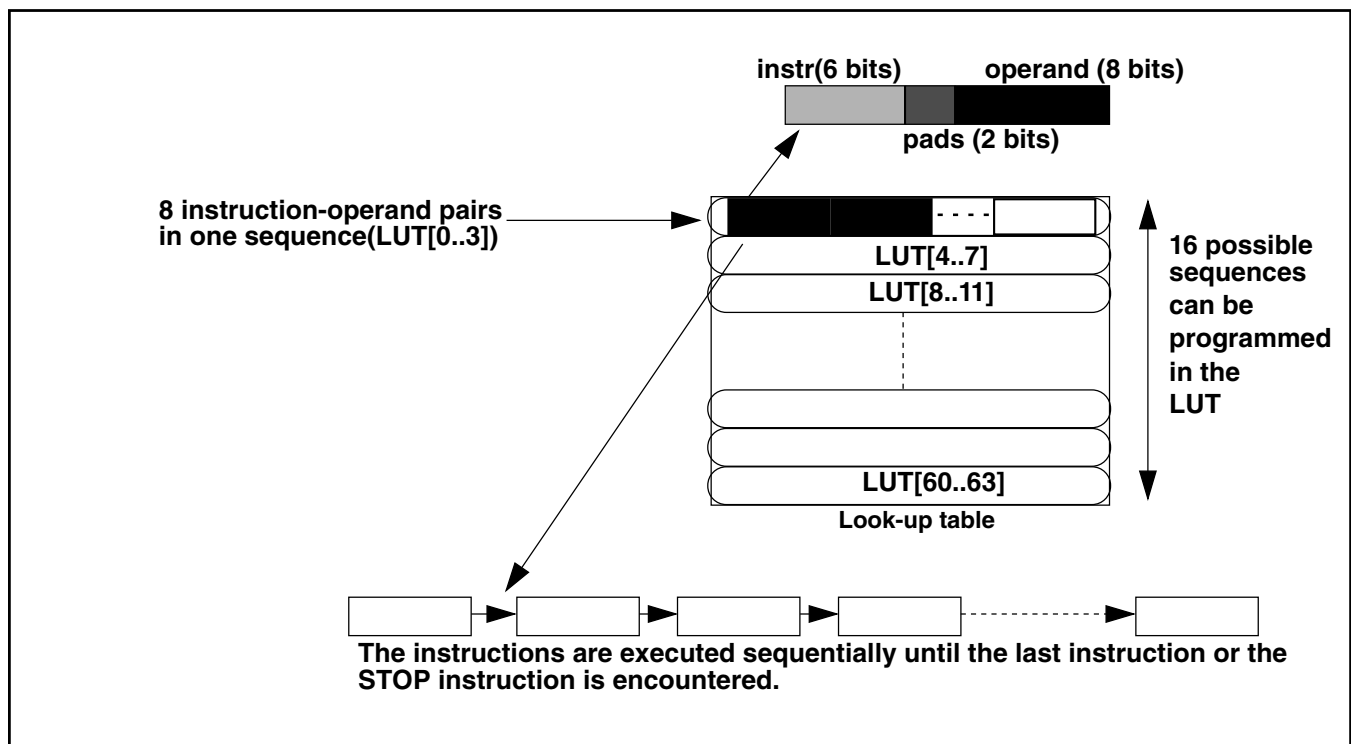

Figure 42-5. LUT and sequence structure

At reset, the index 0 of the look-up-table (LUT[0..3]) is programmed with a basic read sequence as given in [Table 42-13](#). After reset the complete LUT may be reprogrammed according to the device connected on board. In order to protect its contents during a code runover the LUT may be locked, after which a write to the LUT will not be successful until it has been unlocked again. The key for locking or unlocking the LUT is **0x5AF05AF0**. The process for locking and un-locking the LUT is as follows:

Locking the LUT

1. Write the key (**0x5AF05AF0**) in to the [LUT Key Register \(QuadSPI_LUTKEY\)](#).

Functional Description

- Write 0b01 to the [LUT Lock Configuration Register \(QuadSPI_LCKCR\)](#). Note that this IPS transaction should immediately follow the above IPS transaction (no other IPS transaction can be issued in between). A successful write into this register locks the LUT.

Unlocking the LUT

- Write the key (**0x5AF05AF0**) into the [LUT Key Register \(QuadSPI_LUTKEY\)](#)
- Write 0b10 to the [LUT Lock Configuration Register \(QuadSPI_LCKCR\)](#). Note that this IPS transaction should immediately follow the above IPS transaction (no other IPS transaction can be issued in between). A successful write into this register unlocks the LUT.

The lock status of the LUT can be read from `QSPI_LCKCR[UNLOCK]` and `QSPI_LCKCR[LOCK]` bit.

Some example sequences are defined in [Example Sequences](#). The reset sequence at LUT index 0 is given in the following table.

Table 42-13. Reset sequence

Instruction	Pad	Operand	Comment
CMD	0x00	0x03	Read Data byte command on one pad
ADDR	0x00	0x18	24 Addr bits to be sent on one pad
READ	0x00	0x08	Read 64 bits
JMP_ON_CS	0x00	0x00	Jump to instruction 0 (CMD)

42.5.3.5 Issuing SFM Commands

Each access to the external device follows the same sequence:

- The user must pre-populate the LUT with the serial flash command sequences that are required for the flash device being used.
- The QuadSPI module starts executing the instructions in the sequence one by one. The transaction starts and the status bit `QSPI_SR[BUSY]` is set.
- Communication with the external serial flash device is started and the transaction is executed.

4. When the transaction is finished (all transmit- and receive operations with the external serial flash device are finished) the status bit QSPI_SR[BUSY] is reset. In case of an IP Command the QSPI_FR[TFF] flag is asserted.

Further details are given in below in [Flash Programming](#) and [Flash Read](#).

You can trigger the processing of SFM commands in the QuadSPI module in one of the following ways:

- **Using IP commands**

For IP Commands the required components need to be written into the following registers:

- Write the serial flash address to be used by the instruction into QSPI_SFAR, refer to [Serial Flash Address Register \(QSPI_SFAR\)](#). For IP Commands not related to specific addresses, the base address of the related flash need to be programmed. For example, for an instruction which does not require an address (i.e. write enable instruction) the SFAR should be programmed with the base address of the memory the command is to be sent to.
- Write the sequence ID and data size details in the [IP Configuration Register \(QSPI_IPCR\)](#).
- Note that the write into the QSPI_IPCR[SEQID] field must be the last step of the sequence. It is possible to combine all fields of the QSPI_IPCR into one single write. Refer to [IP Configuration Register \(QSPI_IPCR\)](#) for details.

Note that there are some conditions where no IP Command is executed after writing the QSPI_IPCR[SEQID] field and the write operation itself is ignored. They are described in [Command Arbitration](#).

- **Using AHB commands**

Any AHB memory mapped access is routed to one of the buffers depending on the master port number of the request. If the access is a "miss", a new serial flash transaction is started. The transaction is based on the sequence pointed to by the BFGENCR[SEQID] field as described in [Flexible AHB buffers](#).

An AHB access is termed memory mapped when the access is to the memory mapped serial flashes, as described in [Memory Mapped Serial Flash Data - Individual Flash Mode on Flash A](#) and [Memory Mapped Serial Flash Data - Individual Flash Mode on Flash B](#).

Again the possible error conditions are described in [Command Arbitration](#).

42.5.3.6 Flash Programming

In all cases the memory sector to be written needs to be erased first. The programming sequence itself is then initiated in the following way:

1. Check that the TX Buffer is empty. If the QSPI_SR[TXEDA] bit is set then the TX Buffer must be cleared by writing 1 into the QSPI_MCR[CLR_TXF] bit.
2. Program the address related to the command in the QSPI_SFAR register.
3. Provide initial data for the program command into the circular buffer via register TX Buffer Data Register (QSPI_TBDR) . At least four word of data must be written into the TX Buffer up to a maximum of 32.
4. Program the QSPI_IPCR register to trigger the command. The QSPI_IPCR[SEQID] should point to an index of the LUT which has the flash program sequence pre-programmed. The IDATSZ field should be set to denote the size of the write.
5. Depending on the amount of data required, step 3 must be repeated until all the required data have been written into the QSPI_TBDR register. The QSPI_SR[TXFULL] can be used to check if the buffer is ready to receive more data. At any time, the QSPI_TBSR[TRCTR] field can be read to check how many words have been written actually into the TX Buffer.

Upon writing the QSPI_IPCR[SEQID] field (refer to step 4) the QuadSPI module will start to execute the programmed sequence. It is the responsibility of the software to ensure that a correct sequence is programmed into the LUT in accordance with the flash memory connected to the module. The data is fetched from the TX Buffer. It consists of **32** entries of 32-bits and is organized as a circular FIFO, whose read pointer is incremented by four after each fetch. When all data are transmitted, the QuadSPI module will return from 'busy' to 'idle'. However, this is not true for the external device since the internal programming is still ongoing. It is up to the user to monitor the relevant status information available from the serial flash device and to ensure that the programming is finished properly.

42.5.3.7 Flash Read

Host access to the data stored in the external serial flash device is done in two steps. First, the data must be read into the internal buffers and in the second step these internal buffers can be read by the host.

1. **Reading Serial Flash Data into the QuadSPI Module Internal Buffers**

A read access to the external serial flash device can be triggered in two different ways:

- **IP Command Read:** For **reading flash data into the RX Buffer** the user must provide the correct sequence ID in the QuadSPI_IPCR[SEQID] register. The sequence ID points to a sequence in the LUT. It is the responsibility of the software to ensure that a correct read sequence is programmed in the LUT in accordance with the serial flash device connected on board. The user should program the Serial Flash Address Register (QSPI_SFAR) and the IP Configuration Register (QSPI_IPCR) registers. All available read commands supported by the external serial flash are possible.

Optionally it is possible to clear the RX Buffer pointer prior to triggering the IP Command by writing a 1 into the QuadSPI_MCR[CLR_RXF] field.

From these inputs, the complete transaction is built when the QSPI_IPCR[SEQID] field is written. The transaction related to the read access starts and the requested number of bytes is fetched from the external serial flash device into the RX Buffer. Since the read access is triggered by an IP command, the IP_ACC status bit and the BUSY bit are both set (both are located in the Status Register (QSPI_SR)). A count of the number of entries currently in the Rx Buffer can be obtained from QSPI_RBCT[RXBRD].

The communication with the external serial flash is stopped when the specified number of bytes has been read (successful completion of the transaction).

- **AHB Command Read:** For **reading flash data into the AHB Buffer** the user must set up a read access by a master to the address range in the system memory map which the external serial flash devices are mapped to. The user should also program the buffer registers corresponding to the AHB master initiating the request, this depends on the configuration of the QSPI_RBCT[RXBRD]. The user should provide the correct sequence ID into the buffer generic configuration register (QSPI_BFGENCR). It is the responsibility of the software to ensure that a correct read sequence is programmed in the LUT in accordance with the serial flash device connected on board. Flash device selection and access mode are determined by the address accessed in the AHB address space associated to the QuadSPI module (refer to [Memory Mapped Serial Flash Data - Individual Flash Mode on Flash A](#), [Memory Mapped Serial Flash Data - Individual Flash Mode on Flash B](#) and [Parallel Flash Mode](#).)

On each AHB read access to the memory mapped area the valid data in the AHB Buffer is checked against the address requested in the actual read. When the AHB read request can't be served from the content of the AHB Buffer, the buffer is flushed and the sequence pointed to by the sequence ID is executed by the

controller. The requested number of buffer entries defined in the `QSPI_BUFxCR[ADATSZ]` field is then fetched from the external serial flash device into the internal AHB Buffer. Since the read access is triggered via the AHB bus, the `QSPI_SR[AHB_ACC]` status bit is set driving in turn the `QSPI_SR[BUSY]` bit until the transaction is finished. The communication with the external serial flash is stopped when the specified number of entries has been filled.

2. Data Transfer from the QuadSPI Module Internal Buffers

The data read out from the external serial flash device by the QuadSPI module is stored in the internal buffers. The means of accessing the data from the buffer differs depending on which buffer the data has been loaded to. Refer to [Block Diagram](#) for details about the two available buffers, the RX Buffer and the AHB Buffer, in the QuadSPI module:

This Buffer is transparent to the user and is non-memory mapped

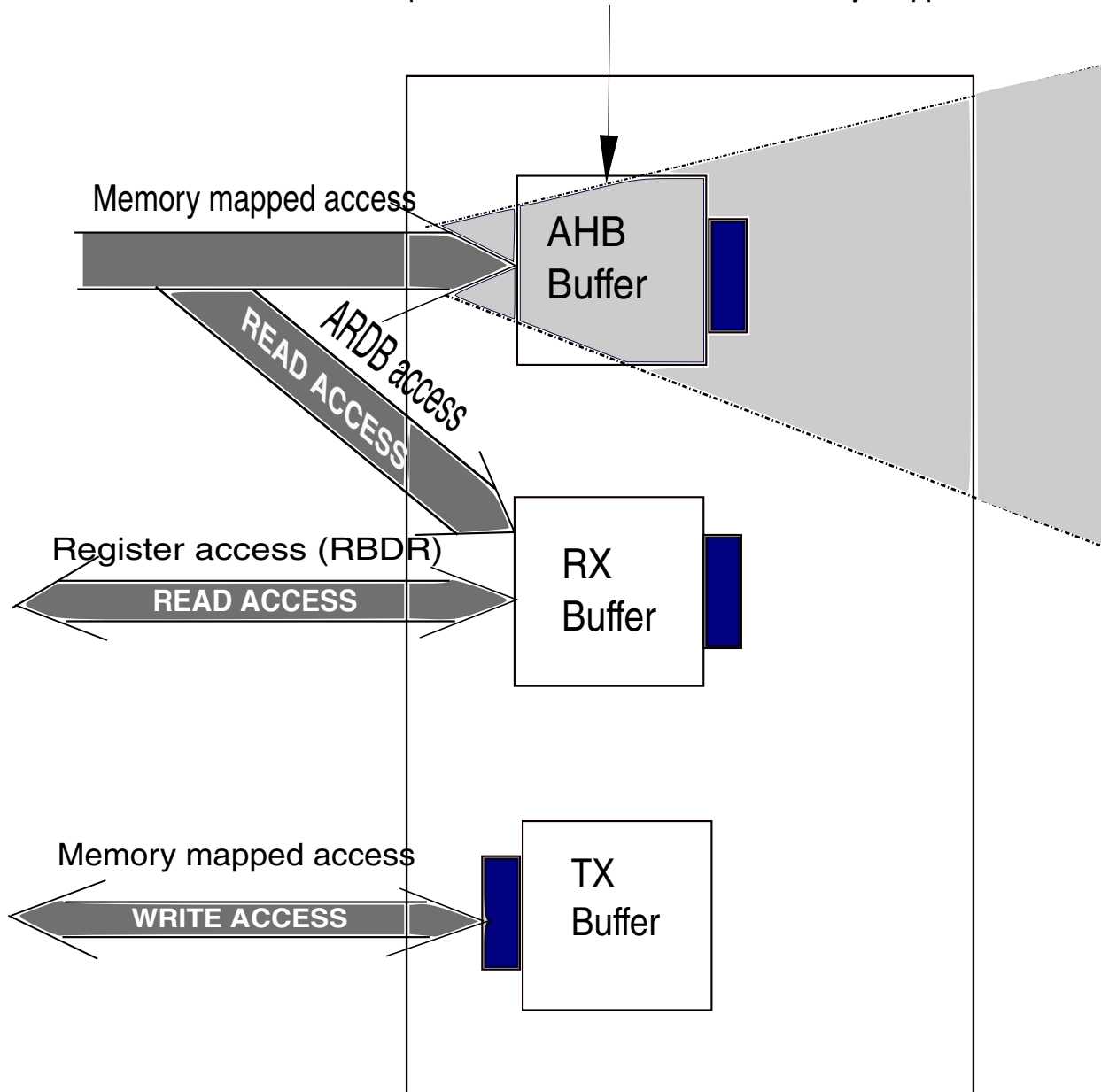

Note:  Byte Swapper for endianness

Figure 42-6. QuadSPI memory map

- The RX Buffer is implemented as FIFO of depth 32 entries of 4 bytes. Its content is accessible in two different address areas both referring to the identical data and the same physical memory.

In the IPS address space in the area associated to QSPI_RBDR0 to QSPI_RBDR31

In the AHB address space in the area associated to QSPI_ARDB0 to QSPI_ARDB31. Two successive entries are accessed with one single 64 bit AHB read operation.

RX Buffer operation can be summarized as follows: The QSPI_RBCT[WMRK] field determines at which fill level the RXWE bit is asserted and how many entries are removed from the RX Buffer on each Buffer POP operation. So the QSPI_SR[RXWE] bit indicates that the configured number of data entries is available in the RX Buffer and the QSPI_RBSR[RDBFL] field indicates how many valid entries are available in total. Note that the first entry (QSPI_RBDR0 or QSPI_ARDB0) always corresponds to the first valid entry in the RX Buffer. The software needs to manage the number of valid data bytes itself.

Further details can be found in [RX Buffer Data Register \(QuadSPI_RBDR \$n\$ \)](#) and in [AHB RX Data Buffer \(QSPI_ARDB0 to QSPI_ARDB31\)](#).

- **Flag-based Data Read of the RX Buffer** is done by polling the QSPI_SR[RXWE] bit. When it is asserted the valid entries can be read either via the IPS address space (QSPI_RBDR n) or the AHB address space (QSPI_ARDB n). A Buffer POP operation must be triggered by the application by writing a 1 into the QSPI_FR[RBDF] bit - this automatically updates the FIFO to point to the next entry as defined by RBCT[WMRK]. For example, if WMRK is set to 3, then the buffer will discard 16 bytes of data.
- **DMA controlled Data Read of the RX Buffer** is done by using the DMA module. The application must ensure that the DMA controller of the related device is programmed appropriately like it is described in [DMA Usage](#).

DMA controlled read out is triggered fully automatically by the assertion of the QSPI_SR[RXWE] bit. The related Buffer POP operation is also handled completely inside the QuadSPI module. Like in the case above, accessing the RX Buffer content either on QSPI_RBDR n or QSPI_ARDB n related addresses is equivalent.

- **AHB Buffer data read via memory mapped access:** This kind of access is done by reading one of the addresses assigned to the external serial flash device(s) within the range given in [Table 42-6](#) table *under the condition that the data requested are already present in the AHB Buffer or it is currently being read from the serial flash device by the instruction in progress*. If this is not the case a memory mapped AHB command read is triggered as described above. If the requested data is already available in the AHB Buffer they are provided directly to the host.

When AHB access are made to the flash memory mapped address, the data will be fetched and returned to the AHB interface. Till the data is being fetched the AHB interface would be stalled. As soon as the data from the requested address has been read by the QuadSPI module the AHB read access is served. So it is possible to run sequential reads from the AHB buffer at arbitrary speed without

the need to monitor any information about the availability of the data. Nevertheless this access scheme stalls the AHB bus for the time required to read the data from the serial flash device. A better way is (when it is known the access is sequential) to have a prefetch enabled (by programming the ADATSZ field) such that before the next sequential AHB access come, the data is already fetched into the buffer.

As long as the host restricts its accesses to the data already in the buffer and the data currently fetched from the serial flash, it is possible to run the host read from the AHB Buffer in parallel to the serial flash read into the AHB Buffer.

42.5.3.8 Byte Ordering of Serial Flash Read Data

In this paragraph the byte ordering of the serial flash data is given. The basic scheme is that the **first** byte read out of the serial flash device - which is addressed by the QSPL_SFAR[SFADR] field - corresponds to bit position QSPL_RBDR0[31:24] register for IP Command read. In contrast to that for AHB Command read the bytes are always positioned according to the byte ordering of the AHB bus.

- **Byte Ordering in Individual Flash Mode**

The following table gives the byte ordering scheme of how the byte oriented data space of the serial flash device is mapped into one single 32 bit entry of the RX Buffer or the AHB Buffer. The table is valid within the following context:

- Flash A or Flash B in Individual Flash Mode
- All AHB data read commands with access size of 32 bit

Table 42-14. Byte Ordering in Individual Flash Mode

Serial Flash Byte Numbering	3	2	1	0
Buffer Entry Bit Position [31:0] (32 Bit data width)	[31:24]	[23:16]	[15:8]	[7:0]

Note

For IP Commands the read size can be given in number of bytes. If this number is not a multiple of 4, then the last buffer entry is not completely filled with the missing higher numbered bytes at undefined values.

For AHB Commands, reads, starting from an address not aligned to 32 bit boundaries, the requested bytes are given at the appropriate positions according to the AMBA AHB specification.

• **Byte Ordering in Parallel Flash Mode**

In Parallel Flash Mode each byte is combined out of 2 half bytes which are read in parallel from the two serial flash devices. The following tables shows how the flash content is separated into the half bytes and how the half bytes are assembled to the content of the QSPI_RBDR0 register.

Table 42-15. Serial Flash Device Half Byte Ordering

Serial Flash Device Byte #	Flash A Bit Position		Flash B Bit Position	
	[7:4]	[3:0]	[7:4]	[3:0]
0	fah0	fal0	fbh0	fb10
1	fah1	fal1	fbh1	fb11
2	fah2	fal2	fbh2	fb12
3	fah3	fal3	fbh3	fb13
4	fah4	fal4	fbh4	fb14
5	fah5	fal5	fbh5	fb15
6	fah6	fal6	fbh6	fb16
7	fah7	fal7	fbh7	fb17
8	fah8	fal8	fbh8	fb18

The table entry naming reflects the half byte positioning in the serial flash devices:

- **<fa>h0** means **Flash A**, **<fb>h0** means **Flash B**.
- **fa<h>0** means half byte in **high position**, **fa<l>0** means half byte in **low position**.
- **fah<0>** means **physical byte address 0** in the serial flash device, **fal<1>** means **physical byte address 1** in the serial flash device.

Table 42-16. Byte Ordering in Parallel Flash Mode - RX Buffer

QSPI_SFAR[SFADR] set to 0x000_0000

Table continues on the next page...

Table 42-16. Byte Ordering in Parallel Flash Mode - RX Buffer (continued)

QSPI_RBDR0 QSPI_ARDB0	fal1	fbl1	fah1	fbh1	fa0	fb0	fah0	fbh0
QSPI_RBDR1 QSPI_ARDB1	fal3	fbl3	fah3	fbh3	fa2	fb2	fah2	fbh2
QSPI_SFAR[SFADR] set to 0x000_0001								
QSPI_RBDR0 QSPI_ARDB0	fa2	fb2	fah2	fbh2	fa1	fb1	fah1	fbh1
QSPI_RBDR1 QSPI_ARDB1	fa4	fb4	fah4	fbh4	fa3	fb3	fah3	fbh3

Note

For IP Commands the read size can be given in number of bytes. If this number is not a multiple of 4 the last buffer entry is not completely filled with the missing higher numbered bytes at undefined values.

* Applicable only for single io mode.

Table 42-17. Byte Ordering in Parallel Flash Mode - AHB Buffer

AHB Address (32 Bit Access)	fal1	fbl1	fah1	fbh1	fa0	fb0	fah0	fbh0
AHB Address 0x800_0004 (32 Bit Access)	fal3	fbl3	fah3	fbh3	fa2	fb2	fah2	fbh2

Note

For AHB Command read starting from an address not aligned to 32 bit boundaries or AHB access size smaller than 32 bit the requested bytes are given at the appropriate positions according to the AMBA AHB specification.

- **Buffer Entry Ordering for 64 Bit Read Access**

Functional Description

For read access via the AHB interface 64 bit access is possible. Each 64 bit access reads 2 32 bit entries simultaneously. The ordering of these 32 bit entries within the 64 bit word is given in the following table.

Table 42-18. 64 Bit Read Access Buffer Entry Ordering

AHB Read Data Bit Position [63:0]	[63:32]	[31:0]
Buffer Entry #	Odd (1, 3, 5, ...)	Even (0, 2, 4, ...)

42.5.3.9 Normal Mode Interrupt and DMA Requests

The QuadSPI module has different flags that can only generate interrupt requests and one flag that can generate interrupt as well as DMA requests. The following table lists the eight conditions. Note that the flags mentioned in the table are related to the [Flag Register \(QSPI_FR\)](#).

Table 42-19. Interrupt and DMA Request Conditions

Condition	Flag(QSPI_FR)	DMA
Data Learn pattern Failure	DLPPF	-
TX Buffer Fill	TBFF	-
TX Buffer Underrun	TBUF	-
Illegal Instruction Error	ILLINE	-
RX Buffer Drain	RBDF	X
RX Buffer Overflow	RBOF	-
AHB Buffer Overflow	ABOF	-
AHB Sequence Error	ABSEF	-
IP Command Usage Error	IUEF	-
IP Command Trigger during AHB Access Error	IPAEF	-
IP Command Trigger could not be executed Error	IPIEF	-
IP Access during AHB Grant Error	IPGEF	-
IP Command related Transaction Finished	TFF	-

Each condition has a flag bit in the [Flag Register \(QSPI_FR\)](#) and a Request Enable bit in the [DMA Request Select and Enable Register \(QSPI_RSER\)](#). The RX Buffer Drain Flag (RBDF) has separate enable bits for generating IRQ and DMA requests. Note that not all flags have an individual IRQ line. Check the devices Interrupt Vector Table for more details.

- Transmit Buffer Fill Interrupt Request:

The Transmit Buffer Fill IRQ indicates that the TX Buffer can accept new data. It is asserted if the QSPI_FR[TBFF] flag is asserted and if the corresponding enable bit (QSIP_RSER[TBFIE]) is set. Refer to [TX Buffer Operation](#), for details about the assertion of the QSPI_FR[TBFF] flag.

- Receive Buffer Drain Interrupt or DMA Request:

The Receive Buffer Drain IRQ derived from the QSPI_FR[RBDF] flag indicates that the RX Buffer of the QuadSPI module has data available from the serial flash device to be read by the host. It remains set as long as the QSPI_RBSR[RXWE] bit is set. The QSPI_RSER[RBDIE] bit enables the related IRQ.

Aside from the IRQ it is possible to handle RX Buffer drain by DMA. If the QSPI_RSER[RBDDE] bit is set, a DMA request will be triggered when the RX Buffer contains more than QSPI_RBCT[WMRK] valid entries. The application must set the environment appropriately (for example, the DMA controller) for the DMA transfers.

- Buffer Overflow/Underrun Interrupt Request:

The Buffer Overflow/Underrun IRQ is a combination of the following flags (all located in the QSPI_FR register with the related enable bits in the QSPI_RSER register):

- TBUF - TX Buffer Underrun, enabled by TBUIE
- RBOF - RX Buffer Overflow, enabled by RBOIE
- ABOF - AHB Buffer Overflow, enabled by ABOIE

The Transmit Buffer Underrun indicates that an underrun condition in the TX Buffer has occurred. It is generated when a write instruction is triggered whilst the Tx Buffer is empty and the QSPI_RSER[TFUFIE] bit is set.

The Receive Buffer Overflow indicates that an overflow condition in the RX Buffer has occurred. It is generated when the RX Buffer is full, an additional read transfer attempts to write into the RX Buffer and the QSPI_RSER[RBOIE] bit is set.

The AHB Buffer Overflow indicates that an overflow condition in the AHB Buffer has occurred. It is generated when the AHB Buffer is full, an additional read transfer attempts to write into the AHB Buffer and the QSPI_RSER[ABOIE] bit is set.

The data from the transfers that generated the individual overflow conditions is ignored.

- Serial Flash Command Error Interrupt Request

If the IPAEF, IPIEF, IPGEF or IUEF flags in the QSPI_FR are set, and the related interrupt enable bits in the QSPI_RSER are also set, then an interrupt is requested.

- Transaction Finished Interrupt Request

The IP Command Transaction Finished IRQ indicates the completion of the current IP Command. It is triggered by the QSPI_FR[TFF] flag and is masked by the QSPI_RSER[TFIE] bit.

42.5.3.10 TX Buffer Operation

The TX Buffer provides the data used for page programming. For proper operation it is required to provide at least four entry in the TX Buffer prior to starting the execution of the page programming command. The application must ensure that the required number of data bytes is written into the TX Buffer fast enough as long as the command is executed without a TX Buffer overflow or underrun.

The QuadSPI module sets the QSPI_FR[TBFF] flag so long as the TX Buffer is not full and can accept more data.

When the QuadSPI module tries to pull data out of an empty TX Buffer the TX Buffer underrun is signaled by the QSPI_FR[TBUF] flag. The TX buffer underrun flag is also asserted when TX buffer contains less than 128 bits of data and QuadSPI module tries to pull out data from it. The current IP Command leading to the underrun condition is continued until the specified number of bytes has been sent to the serial flash device, in the underrun condition when QuadSPI module tries to pull out data of empty TX buffer, the data transferred is all F's i.e. once the underrun flag is set under this condition, it will return F's until the required number of bytes are not sent. This has been done to ensure that the software need not to erase whole sector after underrun, just reprogramming from failure point will serve the purpose. When this Sequence Command is finished, the QSPI_FR[TBFF] flag is asserted indicating that the Tx Buffer is ready to be written again.

The TX Buffer overflow isn't signaled explicitly, but the TX Buffer fill level can be monitored by the QSPI_TBSR[TRBFL] field.

Refer to [TX Buffer Status Register \(QuadSPI_TBSR\)](#) and [Flag Register \(QuadSPI_FR\)](#) for details about the TX Buffer related registers.

42.5.3.11 Address scheme

Earlier serial flash memories supported only 24-bit address space hence restricting the maximum memory size of the serial flash as 16 MB. The new memory specification supports two types of 32-bit addressing mode in addition to legacy 24-bit address mode.

- **Extended Address Mode**

In this mode, the legacy 24-bit commands are converted to accept 32-bit address commands. The flash memory needs to be configured for 32-bit address mode. Also, while programming the LUT sequence in QuadSPI for 32-bit mode, the ADDR and ADDR_DDR command should be programmed with 8'd32 as the operand value. By default, the QuadSPI is in 24-bit legacy address mode. Each of the memory vendors have a different way of enabling this mode (Refer to the memory specification from memory vendors). For example, the command B7h sent to Macronix flash will enable it for 32-bit address mode.

- **Extended Address register**

In this mode, the upper 8-bit of the 32-bit address is provided by the Extended address register in the memory itself. The memory provides a specific register which is updated according to the address to be accessed. This effectively converts the legacy 24-bit address command into 32-bit address commands. The memories greater in size than 16 MB, consists of banks of 16 MB. The 8-bit written in the extended address register effectively enables a bank. For example in Spansion memory, when the extended address register is updated with a value of 0x01 with the help of the command 17h, it will open Bank1 of the memory. The consequent 24-bit address commands will lead to Bank1. The extended address register needs to be update with the respective value for access to other banks. This effectively converts the legacy 24-bit address command into 32-bit address commands.

42.6 Initialization/Application Information

This section provides the initialization and application information of the QuadSPI module.

42.6.1 Power Up and Reset

Note that the serial flash devices connected to the QuadSPI module may require special voltage characteristics of their inputs during power up or reset. It is the responsibility of the application to ensure this.

42.6.2 Available Status/Flag Information

This paragraph gives an overview of the different status and flag information available and their interdependencies for different use cases. Related registers are QSPI_SR and QSPI_FR. Refer to the related descriptions how to set up the QuadSPI module appropriately.

42.6.2.1 IP Commands

Refer to [IP Configuration Register \(QuadSPI_IPCR\)](#) for additional details not explicitly covered in this paragraph.

- **IP Commands - Normal Operation**

Writing the QSPI_IPCR[SEQID] field triggers the execution of a new IP Command. Given that this is a legal command the QSPI_SR[IPACC] and the QSPI_SR[BUSY] bits are asserted simultaneously, immediately after the execution is started.

When the instruction on the serial flash device has been finished these bits are de-asserted and the QSPI_FR[TFF] flag is set.

- **IP Commands - Error Situations**

Refer to [Table 42-20](#) below.

42.6.2.2 AHB Commands

Refer to Section 1, Reading Serial Flash Data into the QuadSPI Module, in [Flash Read](#) for additional details not explicitly covered in this paragraph.

- **AHB Commands - Normal Operation**

Memory mapped read access to a serial flash address not contained in the AHB Buffer, triggers the execution of an AHB Command. Given that this is a legal command the QSPI_SR[AHBACC] and the QSPI_SR[BUSY] bits are asserted simultaneously immediately after the execution is started. When the instruction on the serial flash device has been finished these bits are de-asserted.

- **IP Commands - Error Situations**

Refer to [Table 42-20](#) below.

42.6.2.3 Overview of Error Flags

The following table gives an overview of the different error flags in the QSPI_FR register and additional error-related details.

Table 42-20. Overview of QSPI_FR Error Flags

Error Category	Error Flag in QSPI_FR	Command Execution on Serial Flash Device TFF Behavior (in case of IP commands only)	Description
AHB Error Flag	ABSEF	Flash transaction is aborted	AHB sequence contains <ul style="list-style-type: none"> • WRITE instruction • WRITE_DDR instruction
AHB Error Flag	ABOF	Flash transaction continues until it finishes	Set when the module tried to push data into the AHB buffer that exceeded the size of the AHB buffer. Only occurs due to wrong programming of the QSPI_BUFxCR[ADATSZ].
Miscellaneous Error Flag	DLFFF ¹	Flash transaction continues until it finishes	Set when DATA_LEARN instruction was encountered in a sequence but no sampling point was found for the data learning pattern.
Miscellaneous Error Flag	ILLINE	Flash transaction aborted	Illegal instruction Error Flag – Set when an illegal instruction is encountered by the controller in any of the sequences.
Command Arbitration Error	IPIEF	TFF not asserted in conjunction with that command	IP Command Error - caused when IP access is currently in progress (IP_ACC set) and <ul style="list-style-type: none"> • write attempt to QSPI_IPCR register. • write attempt to QSPI_SFAR register. • write attempt to QSPI_RBCT register.
Command Arbitration Error	IPAEF		<ul style="list-style-type: none"> • AHB Command already running, another IP Command could not be executed. • AHB Command already running, write attempt to QSPI_IPCR[SEQID] field.
Command Arbitration Error	IPGEF		<ul style="list-style-type: none"> • Exclusive access to the serial flash granted for AHB Commands, write attempt to QSPI_IPCR[SEQID] field.
IP Command Error	IUEF	—	<ul style="list-style-type: none"> • IP Command Usage Error

Table continues on the next page...

Table 42-20. Overview of QSPI_FR Error Flags (continued)

Error Category	Error Flag in QSPI_FR	Command Execution on Serial Flash Device TFF Behavior (in case of IP commands only)	Description
Buffer Related Error	RBOF	TFF is asserted on completion	<ul style="list-style-type: none"> RX Buffer Overrun
Buffer Related Error	TBUF		<ul style="list-style-type: none"> TX Buffer Underrun

1. Data learning is not implemented on this chip.

Note that only the buffer related errors are related to a transaction on the external serial flash. All the other errors do not trigger an actual transaction.

42.6.2.4 IP Bus and AHB Access Command Collisions

There are two flags related to this topic, the QSPI_FR[IPAEF] and QSPI_FR[PIEF]. Refer to sub-section "Reading Serial Flash Data into the QuadSPI Module" of [Flash Read](#) section, for a description of the flags and [Command Arbitration](#), for details about possible command collisions.

42.6.3 Exclusive Access to Serial Flash for AHB Commands

It is possible that several masters need to access the serial flash device connected to the QuadSPI module separately, one master by triggering IP Commands and reading the RX Buffer (via RBDR n register) and the other masters by triggering AHB Commands (via ARDB n Registers). These two set of buffer (RBDR and ARDB Buffer) points to the same physical buffer. Refer to [Figure 42-6](#) To avoid command collisions resulting in excessive latencies the QuadSPI module implements a request-handshake mechanism between the master triggering AHB Commands and the QuadSPI module allowing this specific master to request exclusive access to the serial flash device for AHB Commands. If this exclusive access is granted the execution of IP Commands is blocked. This resolves command collisions and excessive times where the AHB interface may be blocked.

If this capability is used in the device there is additional status and flag information available related to this mechanism. The QSPI_SR[AHBGNT] bit reflects the module-internal state that the exclusive access mentioned above is granted, any attempt to trigger an IP Command is rejected and results in the assertion of the QSPI_FR[IPGEF] flag. Refer to the descriptions of the related bit and flag for details.

It is within the responsibility of the application to set up the master using this mechanism appropriately, if used incorrectly no IP Commands at all can be triggered.

Two different cases can be distinguished:

42.6.3.1 RX Buffer Read via QSPI_ARDB Registers

In this case all masters share the AHB bus for RX Buffer as well as for AHB Buffer read. In this case the access to the AHB interface by the master triggering AHB Commands must be deferred until any pending IP Command has been finished **and** the RX Buffer readout has been finished as well. The QSPI ARDB Buffers access the Rx buffer i.e the data from the Rx Buffer is returned and no data from AHB Buffer is touched. This is the conservative use case, corresponding to the reset value 0 of the QSPI_RBCT[RXBRD] bit.

In this case the QSPI_SR[AHBGNT] bit is asserted not earlier than any running IP Command has been finished (QSPI_SR[IP_ACC] is 0), the RX Buffer has been read out completely (QSPI_RBSR[RDBFL] equal to 0) or no DMA read is pending (QSPI_SR[RXDMA] equal to 0 and Rx Buffer readout is via AHB(QSPI_RBCT[RXBRD]) equal to 1).

42.6.3.2 RX Buffer Read via QSPI_RBDR Registers

This is the preferred use case as an access to the AHB buffer (memory mapped flash) does not interfere with any IPS access to read the RBDR buffer. It is not possible that a pending AHB bus access triggered by an AHB Command stalls the AHB bus and blocks the RX Buffer readout since the RX Buffer is read via the IP bus based registers QSPI_RBDR0 to QSPI_RBDR31.

For this case it is recommended to program the QSPI_RBCT[RXBRD] bit to 1. The QSPI_SR[AHBGNT] bit is asserted immediately after any running IP Command has been finished (QSPI_SR[IP_ACC] is 0), the RX Buffer has been read out completely (QSPI_RBSR[RDBFL] equal to 0) or no DMA read is pending (QSPI_SR[RXDMA] equal to 0), allowing the master triggering AHB Commands to trigger AHB Commands as soon as possible without the need to wait for the RX Buffer readout to be finished.

42.6.4 Command Arbitration

In case of overlapping commands, the arbitration scheme is described in the following paragraphs under the assumption that the priority mechanism described in [Exclusive Access to Serial Flash for AHB Commands](#) is **not** used:

- During the execution of an IP Command, the running IP Command can't be terminated by issuing another IP Command or AHB Command. The QSPI_FR[IPIEF] flag is asserted when the host tries to write into the QSPI_IPCR register. When the host triggers an AHB Command (refer to sub-section "Reading Serial Flash Data into the QuadSPI Module" of [Flash Read](#) section, for details), this command is stalled until the currently running IP Command is finished.
- During the execution of an AHB Command, the running AHB Command can't be terminated by issuing an IP Command. The command is ignored and the QSPI_FR[IPAEF] flag is asserted. Refer to [Flag Register \(QuadSPI_FR\)](#) for the description of these flags.

When another AHB Command is triggered the address of the memory mapped access is considered. If the requested address is currently read from the serial flash device, the running command is continued. If this is not the case the currently running command is terminated and another AHB Command related to the requested address is executed. Refer to sub-section "Reading Serial Flash Data into the QuadSPI Module" of [Flash Read](#) section, for further details.

In case of coinciding commands the IP Command is triggered and the AHB Command is stalled until the IP Command has been finished (QSPI_SR[IP_ACC] has been deasserted).

The IP Commands ignored in case of command collision will not result in the assertion of the QSPI_FR[TFF] flag.

42.6.5 Flash Device Selection

Regardless of the SFM Command (IP or AHB) the access mode is selected by specifying the 32 bit address value for the following SFM Command.

For IP Commands the access mode is selected with the address programmed into the QSPI_SFAR register. Refer to [Serial Flash Address Register \(QuadSPI_SFAR\)](#) for details.

For AHB Commands the access mode is determined by the memory mapped address which is accessed Refer to [AMBA Bus Register Memory Map](#) for details.

42.6.6 DMA Usage

For the complete description of the DMA module refer to the related DMA Controller chapter. In this paragraph only the details specific to the DMA usage related to the QuadSPI module are given.

42.6.6.1 DMA Usage in Normal Mode

42.6.6.1.1 Bandwidth considerations

Careful consideration of the throughput rate of the entire chain (serial flash -> AHB bus / IP Bus -> DMA controller) involved in the read data process is essential for proper operation. Such analysis must take into account not only the data rate provided by the serial flash but also the data rate of the AHB bus and the performance of the DMA controller in reading data from the RX buffer.

Two figures must match for proper operation, that means that the data rate provided by the serial flash device must not exceed the average RX Buffer readout data rate. Otherwise, the longer this state persists, a RX Buffer overflow will result.

AHB Bus Side (data read):

The total number of bus cycles for each DMA Minor Loop completion is added from the following components:

- Overhead for each minor loop, given by DMA controller: Assume 10 cycles
- Overhead due to clock domain crossing: Assume 2 cycles
- Number of bus clock cycles required for 8 bytes (64 bit read size): Assume 2 cycles (read/write sequence of DMA controller)

Note that the size of the minor loop is determined by the size of the QSPI_RBCT[WMRK] field, therefore the overhead given above distributes among $(\text{QSPI_RBCT}[\text{WMRK}] + 1) / 2$ read accesses of 64 bit each.

The following table gives some examples for typical use cases:

Table 42-21. Access Duration Examples - Bus Clock Side

QSPI_RBCT[WMRK]	Number of Bytes per DMA Loop ¹	Number of Bus Clock cycles for DMA Minor Loop	Time Duration of DMA Minor Loop for 120Mhz Bus clock Frequency
0	4	12+2 = 14	~117ns

Table continues on the next page...

Table 42-21. Access Duration Examples - Bus Clock Side (continued)

QSPI_RBCT[WMRK]	Number of Bytes per DMA Loop ¹	Number of Bus Clock cycles for DMA Minor Loop	Time Duration of DMA Minor Loop for 120Mhz Bus clock Frequency
1	8	12+2 = 14	~117ns
3	16	12+4 = 16	~133ns
7	32	12+8 = 20	~167ns
11	48	12+12 = 24	~200ns

1. DMA Loop means one Minor Loop Completion which is equivalent to one.

NOTE

The table figure represents ideal scenario, actual performance will depend on how the system is integrated.

Serial Flash Device Side (data read):

The number of serial flash cycles can be determined in the following way:

- Number of serial flash clock cycles required to read 4 bytes, corresponding to one RX Buffer entry (setup of command and address not considered): 2 cycles for Quad DDR mode instructions in Parallel Flash Mode, 4 cycles for Quad (SDR) mode instruction in parallel flash mode or Dual IO DDR mode instruction in parallel flash mode, 8 cycles for Quad Mode (SDR) instructions in Individual Flash Mode etc.
- Overhead due to clock domain crossing : 1 cycle.

The following table lists the number of clock cycles required to read the data from the serial flash corresponding to the different settings of the QSPI_RBCT[WMRK] field:

Table 42-22. Access Duration Examples - Serial Flash side

QSPI_RBCT[WMRK] setting	Num Bytes per DMA Loop ¹	Num SCKFx for 60MHz SCKFx			Time duration of Flash data readout for 60MHz SCKFx (~16.6ns period)		
		IFM ² Quad	IFM Quad DDR	PFM ³ Quad DDR	IFM Quad	IFM Quad DDR	PFM Quad DDR
0	4	9	5	3	~150ns	~83ns	~50ns
1	8	17	9	5	~282ns	~150ns	~83ns
3	16	33	17	9	~548ns	~282ns	~150ns
7	32	65	33	17	~1079ns	~548ns	~282ns
11	48	97	49	25	~1610ns	~813ns	~415ns

1. DMA Loop means one Minor loop completion which is equivalent to one Major Loop iteration.
2. Individual flash mode.
3. Parallel flash mode.

From the examples given in the two tables above, it can be seen that depending on the relationship between the Bus clock and Serial flash clock frequencies, there are settings possible where the serial flash provides the read data faster than the AHB bus can read out the RX buffer. In the above tables, it is the case of PFM Quad DDR mode with Watermark up to 3 and other cases. In these cases, the RX buffer data keeps accumulating over time and will eventually overflow. To avoid RX Buffer overflow, the data transaction size should be small enough.

A complementary example would be when the watermark is set to be too high. In such a case, the time taken by the DMA to read out the RX buffer entries should be smaller than the time taken by the controller to push in the remaining entries in the buffer.

NOTE

The tables mentioned above are only examples which must be correlated with the DMA in the system.

42.6.7 Parallel mode

QuadSPI can access two flashes in parallel. This increases the throughput of the QuadSPI by two times. Only read operations are allowed in parallel mode. In case a write transaction is initiated in parallel mode, QSPI_FR[IUEF] is set. When dual die flashes are accessed in parallel mode, it is mandatory for flash A1 to be of the same size as B1 and A2 to be of the same size as B2. The following figure shows how QuadSPI maps the incoming addresses to the different flashes connected on board.

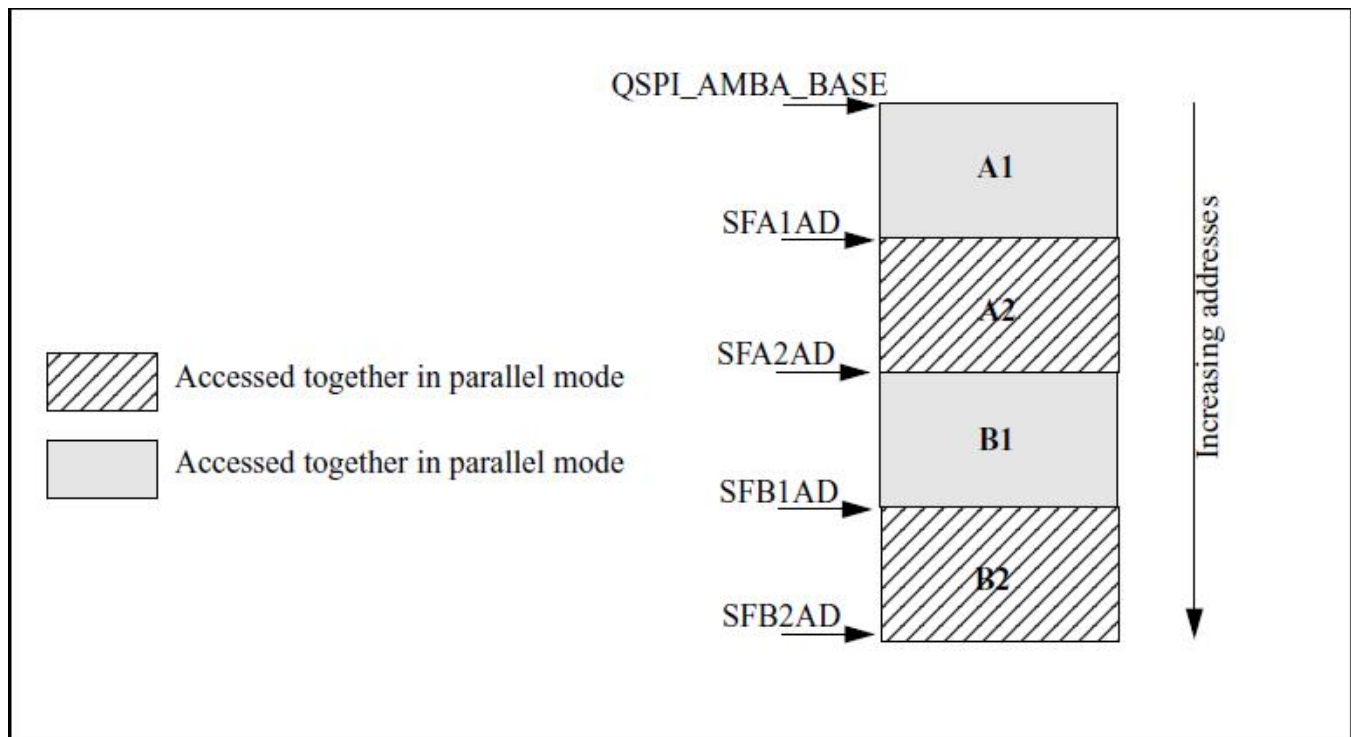

Figure 42-7. Flash addressing

An example programming for parallel mode access is given below (flash sizes are assumed to be 256MB):

- QSPI_AMBA_BASE - 0x10000000
- QSPI_SFA1AD[TPADA1] - 0x20000000
- QSPI_SFA2AD[TPADA2] - 0x30000000
- QSPI_SFB1AD[TPADB1] - 0x40000000
- QSPI_SFB2AD[TPADB2] - 0x50000000

In order to access the first location of A1/B1 pair, the incoming address should be 0x10000000. QSPI_AMBA_BASE is subtracted from this address and the result is divided by two. Therefore, address provided to flash A1 and B1

$$\text{Flash Address} = (\text{Memory mapped address} - \text{QSPI_AMBA_BASE})/2$$

For Memory Mapped address:

- 0x10000000, flash address: 0x0 (Or, the first address of flash A1 and B1)
- 0x10000004, flash address: 0x2
- 0x10000008, flash address: 0x4 etc.

Similarly, in order to access the first location of A2/B2 pair, the incoming address should be 0x30000000.

$$\text{Flash Address} = (\text{Memory mapped address} - \text{SFA2AD})/2$$

For Memory Mapped address:

- 0x30000000, flash address: 0x0 (Or, the first address of flash A2 and B2)
- 0x30000004, flash address: 0x2
- 0x30000008, flash address: 0x4 etc.

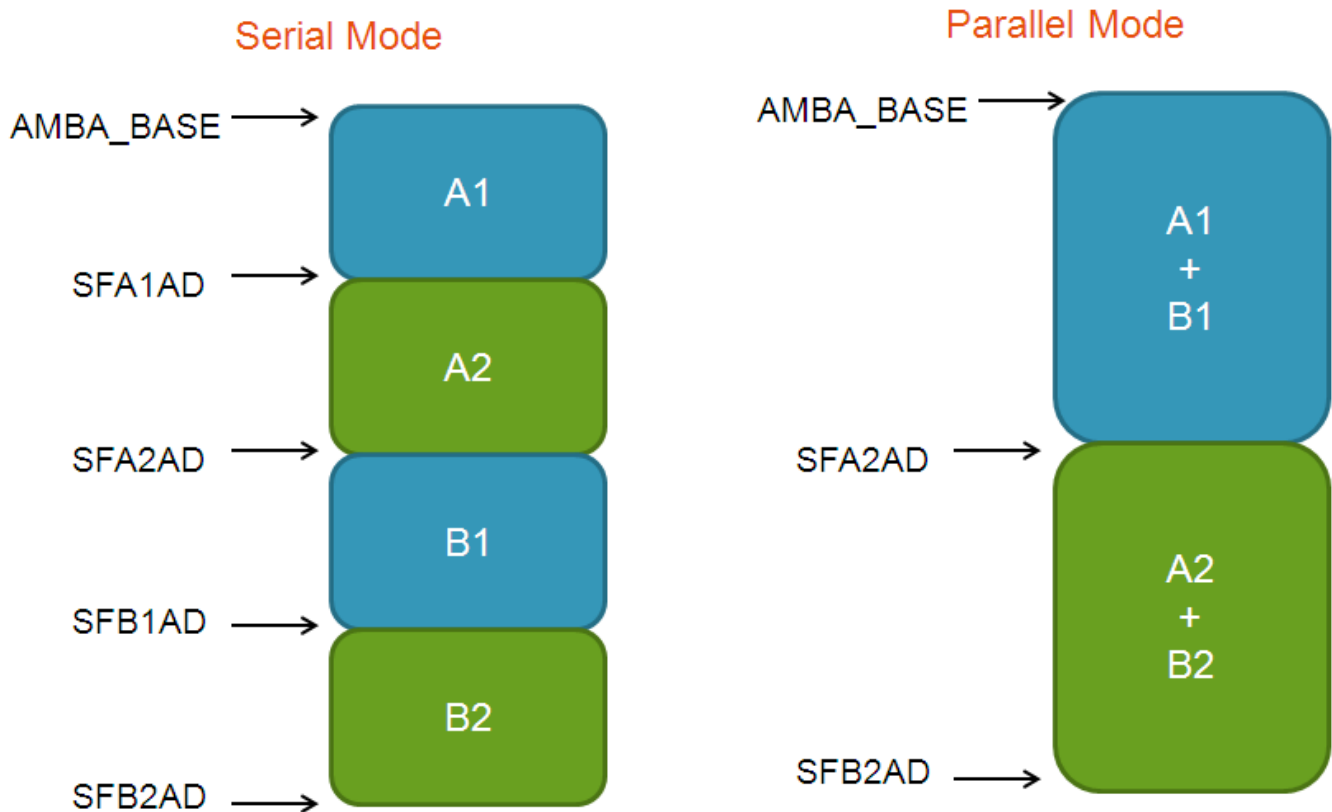

Figure 42-8. Memory map - Serial and Parallel

42.7 Byte Ordering - Endianness

QuadSPI provides support for swapping the flash read/write data based on the configuration of the QSPI_MCR[END_CFG]. By default the data is always returned in 64 bit LE format on the AHB bus and 32 bit LE format on the IPS interface when read via the RX buffer and written in 32 bit LE format when written via the TX buffer.

The table(QSPI_MCR[END_CFG]) below shows the complete bit ordering. BE signifies Big Endian which means the high order bits of the associated data vectors are associated with low order address positions. LE signifies Little Endian which means the lower order bits of the associated data vectors are associated with low order address positions. Refer to figure [Figure 42-6](#)

Table 42-23. QSPI_MCR[END_CFG]

00	64 bit BE
01	32 bit LE
10	32 bit BE
11	64 bit LE

The tables below (Byte ordering configuration in AHB) and (Byte ordering configuration in IPS) show how this configuration is implemented in QSPI AHB and IPS interfaces respectively. B in the table signifies Byte and the index 1-8 refers to the byte position i.e. 1 refer to bits[7:0], 8 refer to bits[63:56] and so on.

Table 42-24. Byte ordering configuration in AHB

64 bit BE	B1	B2	B3	B4	B5	B6	B7	B8
64 bit LE	B8	B7	B6	B5	B4	B3	B2	B1
32 bit BE	B5	B6	B7	B8	B1	B2	B3	B4
32 bit LE	B4	B3	B2	B1	B8	B7	B6	B5

Table 42-25. Byte ordering configuration in IPS

32BE	B1	B2	B3	B4
32LE	B4	B3	B2	B1

The examples below show the byte ordering in 64 bit BE configuration for AHB Buffer and 32 bit BE for TX/RX Buffer:

42.7.1 Programming Flash Data

CPU write instructions to the QSPI_TBDR register like

- Write QSPI_TBDR -> 0x01_02_03_04
- Write QSPI_TBDR -> 0x05_06_07_08

result in the following content of the TX Buffer:

Table 42-26. Example of QuadSPI TX Buffer

TX Buffer Entry	Content
0	32'h01_02_03_04
1	32'h05_06_07_08

Programming the TX Buffer into the external serial flash device results in the following byte order to be sent to the serial flash:

- 01...02...03...04...05...06...07...08

42.7.2 Reading Flash Data into the RX Buffer

Reading the content from the same address provides the following sequence of bytes, identical to the write case:

- 01...02...03...04...05...06...07...08

This results in the RX Buffer filled with:

Table 42-27. Resulting RX Buffer Content

RX Buffer Entry	Content
0	32'h01_02_03_04
1	32'h05_06_07_08

42.7.2.1 Readout of the RX Buffer via QSPI_RBDRn

The RX Buffer content appears at CPU read access via the Peripheral bus interface in the following order:

- Read QSPI_RBDR0 <- 0x01_02_03_04
- Read QSPI_RBDR1 <- 0x05_06_07_08

42.7.2.2 Readout of the RX Buffer via ARDBn

The RX Buffer content appears at read access on the AMBA AHB interface at the QuadSPI module boundary:

- (1a): 32 Bit Access: Read QSPI_ARDB0 <- 0x01_02_03_04
- (2a): 32 Bit Access: Read QSPI_ARDB1 <- 0x05_06_07_08
- (1b/2b): 64 Bit Access: Read QSPI_ARDB0 <- 0x01_02_03_04_05_06_07_08

42.7.3 Reading Flash Data into the AHB Buffer

Reading the content from the same address as it was written to provides the following sequence of bytes, identical to the write case:

- 01...02...03...04...05...06...07...08

This results in the AHB Buffer filled with:

Table 42-28. Resulting AHB Buffer Content

AHB Buffer Entry	Content
0	64'h01_02_03_04_05_06_07_08

42.7.3.1 Readout of the AHB Buffer via Memory Mapped Read

The AHB Buffer content appears at read access on the AMBA AHB interface at the QuadSPI module boundary:

- (1a): 32 Bit Read Access: <- 0x01_02_03_04
- (2a): 32 Bit Read Access: <- 0x05_06_07_08
- (1/2): 64 Bit Read Access: <- 0x01_02_03_04_05_06_07_08

42.8 Serial Flash Devices

Several different vendors make flash devices with a QuadSPI interface. At present there is no set standard for the QuadSPI instruction set. Most common commands currently have the same instruction code for all vendors, however some commands are unique to specific vendors. Some example sequences are provided below.

42.8.1 Example Sequences

This section provides the example sequences of the QuadSPI module.

Table 42-29. Exit 4 x I/O Read Enhance Performance Mode (XIP) (Macronix) and Read Status

INSTR	PAD	OPERAND	COMMENT
CMD	0x0	0xEB	4xIO Read Command
ADDR	0x2	0x18	24 Bit address to be send on 4 pads
MODE	0x2	0x00	2 mode cycles (exit XIP)
DUMMY	0x0	0x04	4 dummy cycles
READ	0x2	0x08	Read 64 bits
CMD	0x0	0x05	Read Status register
READ	0x0	0x01	Status register data
STOP	0x0	0x00	STOP, Instruction over

42.8.1.1 Fast Read Sequence (Macronix/Numonyx/Spansion/Winbond)

The following table shows the fast read sequence for Macronix/Numonyx/Spansion/Winbond flashes.

Table 42-30. Fast Read sequence

Instruction	Pad	Operand	Comment
CMD	0x0	0x0B	Fast Read command = 0x0B
ADDR	0x0	0x18	24 Addr bits to be sent on one pad
DUMMY	0x0	0x08	8 Dummy cycles
READ	0x0	0x04	Read 32 Bits on one pad
JMP_ON_CS	0x0	0x00	Jump to instruction 0 (CMD)

42.8.1.2 Fast Dual I/O DT Read Sequence (Macronix)

The following table shows the Fast Dual I/O DT read sequence for Macronix flashes.

Table 42-31. Fast Dual I/O DT Read sequence

Instruction	Pad	Operand	Comment
CMD	0x0	0xBD	Fast Dual I/O DT read command = 0xBD

Table continues on the next page...

Table 42-31. Fast Dual I/O DT Read sequence (continued)

Instruction	Pad	Operand	Comment
ADDR_DDR	0x1	0x18	24 Addr bits to be sent on 2 pads in DDR mode
MODE4_DDR	0x1	0x00	P2=P0 or P3=P1 is necessary. Refer to Macronix datasheet for details. One clock cycle for mode.
DUMMY	0x0	0x06	6 Dummy cycles
READ_DDR	0x1	0x04	Read 32 Bits on 2 pads in DDR mode
JMP_ON_CS	0x0	0x00	Jump to instruction 0 (CMD)

42.8.1.3 Fast Read Quad Output (Winbond)

The following table shows the Fast read quad output sequence for Winbond memories

Table 42-32. Fast Read Quad output sequence

Instruction	Pad	Operand	Comment
CMD	0x0	0x6B	Fast read quad output command = 0x6B
ADDR	0x0	0x18	24 Addr bits to be sent on 1 pad
DUMMY	0x0	0x08	8 Dummy cycles
READ	0x2	0x04	Read 32 Bits on 4 pads
JMP_ON_CS	0x0	0x00	Jump to instruction 0 (CMD)

42.8.1.4 4 x I/O Read Enhance Performance Mode (XIP) (Macronix)

The following table shows the 4 x I/O Read Enhance Performance Mode for Macronix flashes. The enhanced performance mode is also known as XIP mode.

Table 42-33. Fast Read Quad output sequence

Instruction	Pad	Operand	Comment
CMD	0x0	0xEB	4xI/O Read command = 0xEB
ADDR	0x2	0x18	24 Addr bits to be sent on 4 pads
MODE	0x2	0xA5	2 mode cycles
DUMMY	0x0	0x04	4 Dummy cycles
READ	0x2	0x04	Read 32 Bits on 4 pads
JMP_ON_CS	0x0	0x01	Jump to instruction 1 (ADDR)

When in XIP mode the software should ensure that all the flashes connected to the controller are in XIP mode. As a part of initializing the controller, all the flashes may be enabled with XIP by carrying out dummy reads.

42.8.1.5 Dual Command Page Program (Numonyx)

The following table shows the Dual command page program sequence for Numonyx flashes.

Table 42-34. Dual Command Page Program sequence

Instruction	Pad	Operand	Comment
CMD	0x1	0x02	Dual command page program = 0x02 on 2 pads
ADDR	0x1	0x18	24 Addr bits to be sent on 2 pads
WRITE	0x1	0x20	Write 32 Bytes on 2 pads
STOP	0x0	0x00	STOP, Instruction over

42.8.1.6 Sector Erase (Macronix/Spansion/Numonyx)

The following table shows the Sector erase sequence for Macronix/Spansion/Numonyx flashes

Table 42-35. Sector Erase sequence

Instruction	Pad	Operand	Comment
CMD	0x0	0xD8	Sector erase command = 0xD8
ADDR	0x0	0x18	24 Addr bits to be sent on 1 pad
STOP	0x0	0x00	STOP, Instruction over

42.8.1.7 Read Status Register (Macronix/Spansion/Numonyx/Winbond)

The following table shows the Read status register sequence for Macronix/Spansion/Numonyx/Winbond flashes.

Table 42-36. Read Status Register Sequence

Instruction	Pad	Operand	Comment
CMD	0x0	0x05	Read status register command = 0x05
READ	0x0	0x01	Read status register data
STOP	0x0	0x00	STOP, Instruction over

42.8.2 Dual Die Flashes

Certain serial flash vendors provide dual-die packages which are essentially two devices (dies) stacked within the same package to increase the memory capacity of a single package. These two devices within a package share the same data and clock pins, but have individual Chip Selects. QuadSPI controller provides support for two dual-die packages to be connected simultaneously. The figure below shows the two dual-die packages and the naming conventions used in this document. For simplicity, the data pins are shown to be unidirectional.

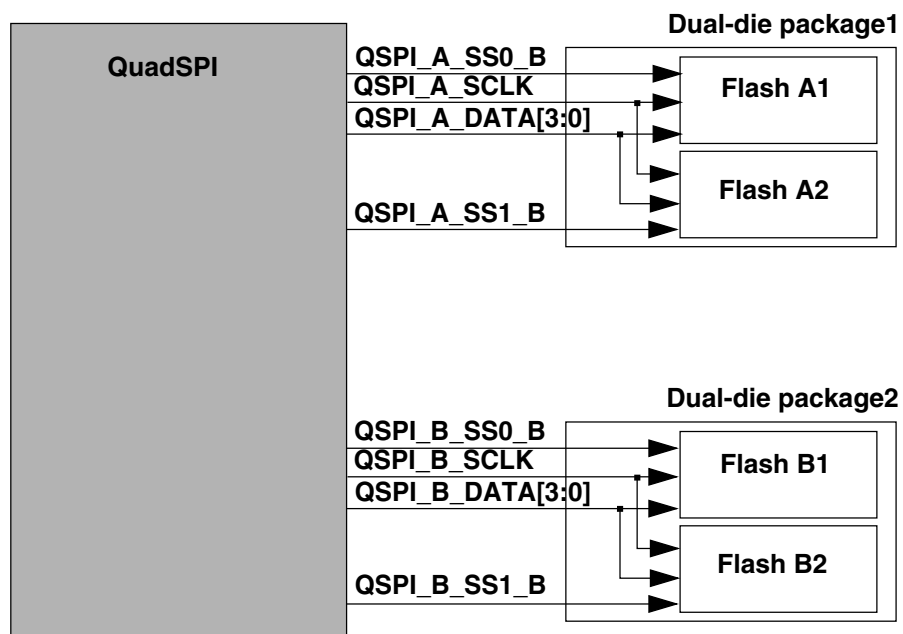

Figure 42-9. Dual-die support

Since the two devices within one package share the same i/o pads, they cannot function in parallel mode. Software should ensure that when QuadSPI is configured in parallel mode the two selected flash devices are from different dual-die packages.

42.8.3 Boot initialization sequence

The following are the recommended sequence of steps for booting from QuadSPI:

- System out of reset and flash available (300us)

- Clocks still at very low frequency. Clock tree configured, I/O pins configured. First request sent to QuadSPI for address 0x0 of flash.
- The reset command sequence in QuadSPI has 0x03 (basic read command) which is applicable to all flashes at < 50MHz serial flash clock
- The first few bytes of data is read from the flash which contains the following information:
 - The total sizes of all the flashes connected on board
 - Whether DDR mode supported
 - Frequency of DDR operation
 - Continuous mode entry sequence
 - 24bit or 32bit addressing (assuming 24bit for first accesses)
- All the serial flashes are configured
 - Quad Mode enabled
 - Dummy reads to enter into XIP
- QuadSPI is configured
 - Parallel enable set
 - LUT configured for highest performance reads
 - DDR mode enabled (if applicable)
 - Buffers configured
- Serial flash clock frequency increased.
- Boot reads happen in parallel, DDR enabled, quad output mode @66MHz.

42.9 Sampling of Serial Flash Input Data

42.9.1 Internal Sampling of Serial Flash Input Data

Depending from the actual implementation there is a delay between the internal clocking in the QuadSPI module and the external serial flash device. Refer to the following figure for an overview of this scheme.

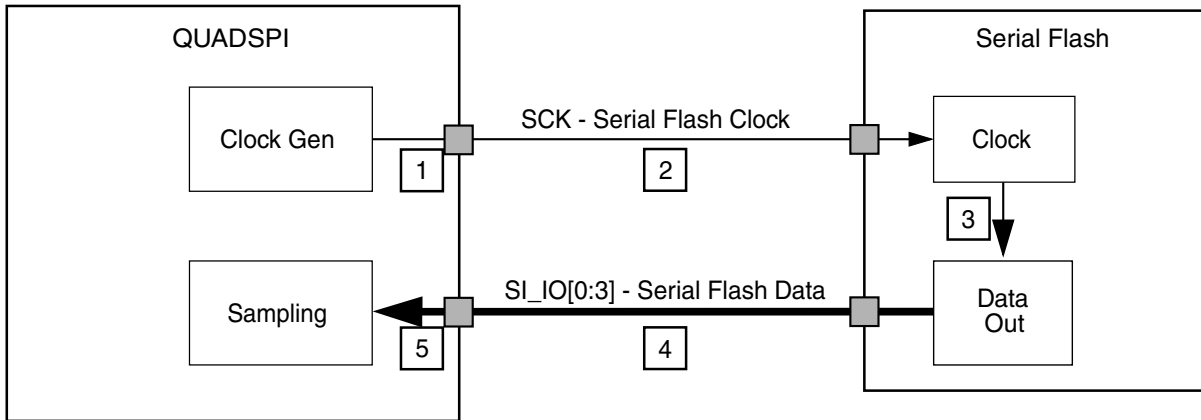

Figure 42-10. Serial Flash Sampling Clock Overview

Note

The arrival of the serial flash data in the sampling stage of the QuadSPI module are given in the following figure. Note that the amount of the total delay $t_{Del,total}$ is very specific to the characteristics of the actual implementation.

Note also that the serial flash device clock SCK is inverted with respect to the QuadSPI internal reference clock.

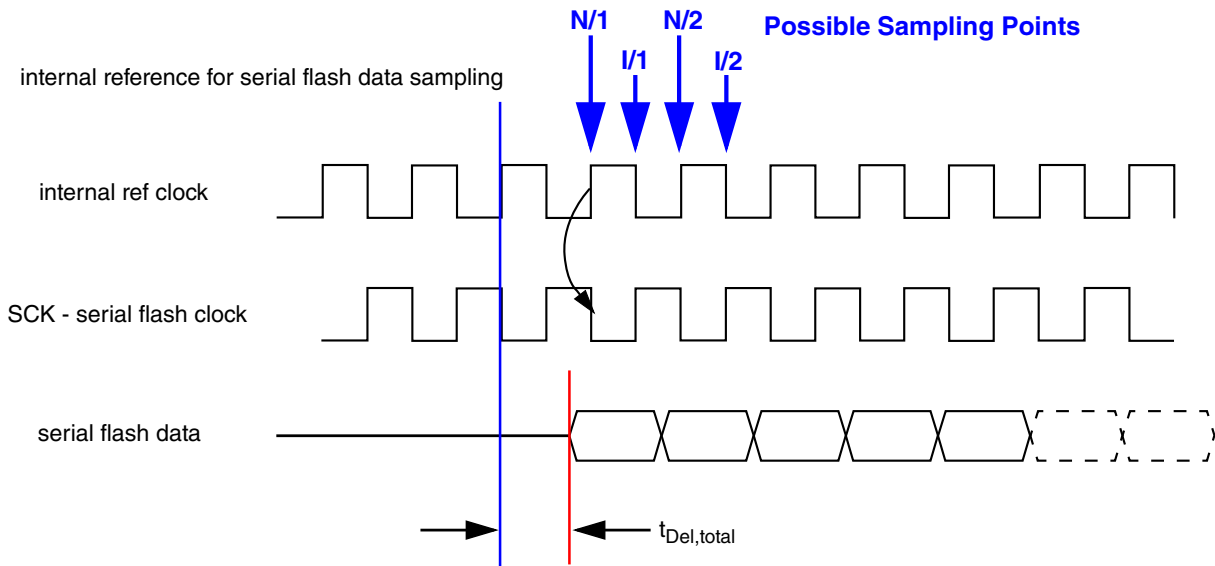

Figure 42-11. Serial Flash Sampling Clock Timing

The rising edge of the internal reference clock is taken as timing reference for the data output of the serial flash. After a time of $t_{Del,total}$ the data arrive at the internal sampling stage of the QuadSPI module.

According to the Serial Flash Sampling Clock Overview figure, the following parts of the delay chain contribute to $t_{Del,total}$:

1. Output delay of the serial flash clock output of the device containing the QuadSPI module
2. Wire delay of application/PCB from the device containing the QuadSPI module to the external serial flash device
3. Clock to data out delay of the external serial flash device, including input and output delays
4. Wire delay of application/PCB from the external serial flash device to the device containing the QuadSPI module
5. Input delay belonging to the data in input

The possible points in time for the sampling of the incoming data are denoted as N/1, I/1, N/2 and I/2 above. The sampling point relevant for the internal sampling is configured in the QSPI_SMPR register, refer to [Sampling Register \(QuadSPI_SMPR\)](#) for details. Note that the falling edges of the reference clock are not actually used, instead the inverted clock is used for sampling at these positions. The following table gives an overview of the available configurations for the commands running at regular (full) speed:

Table 42-37. Sampling Configuration

Sampling Point	Description	Delay [FSDLY] [HSDLY]	Phase [FSPHS] [HSPHS]	QSPI_SMPR for Full Speed Setting ¹
N/1	sampling with non-inverted clock, 1 sample delay	0	0	0x0000000x
I/1	sampling with inverted clock, 1 sample delay	0	1	0x0000002x
N/2	sampling with non-inverted clock, 2 samples delay	1	0	0x0000004x
I/2	sampling with inverted clock, 2 samples delay	1	1	0x0000006x

1. 'x' is not considered here

Depending from the actual delay and the serial flash clock frequency the appropriate sampling point can be chosen. The following remarks should be considered when selecting the appropriate setting:

- Theoretically there should be 2 settings possible to capture the correct data since the serial flash output is valid for 1 clock cycle, disregarding rise and fall times and timing uncertainties.
- Depending from the timing uncertainties it may turn out in actual applications that only one possible sample positions remains. This is subject to careful consideration depending from the actual implementation.

- The delay $t_{Del,total}$ is an absolute size to shift the point in time when the serial flash data get valid at the QuadSPI input.
- For decreasing frequency of the serial flash clock the distance between the edges increases. So for large differences in the frequency the required setting may change.
- For commands running at half of the regular serial flash clock (QSPI_SMPR[HSENA] bit set) the sampling point must be figured separately to allow for the compensation of the absolute shift in time with respect to the sample-relative setting in the QSPI_SMPR register.

42.9.2 DDR Mode

The increasing requirement of improved throughput has introduced the double data rate (DDR) mode. In DDR mode, the data is transferred on both the rising and falling edges of the serial flash clock. The DDR serial flashes sample as well as drive the data on both rising and falling edges of serial flash clock.

42.10 Serial Flash Data Input Timing

There are sampling modes for input flash data:

- Internal sampling - Input serial flash data is captured by internal serial clock. In SDR mode, serial data is sampled by serial clock 1x (ser_clk_1x) rise edge. In DDR mode, serial data is sampled by serial clock 4x (ser_clk_4x) rise edge.
- Loopback DQS sampling - Soc will output serial data strobe with internal serial clock. This serial data strobe would be loopback from pad and used to sample input serial data. In SDR mode, serial data is sampled by loopback DQS rise edge. In DDR mode, serial data is sampled by loopback DQS both edge

NOTE

DQS pad need to be set to force input for loopback.

- Flash DQS sampling - Some serial Flash device provide the data strobe output together with serial data. This strobe signal is used to sample input serial data directly. In SDR mode, serial data is sampled by Flash DQS rise edge. In DDR mode, serial data is sampled by Flash DQS both edge

Following table shows selection for sampling mode:

Sampling mode	DQS_EN	DQS_LOOPBACK_EN
Internal sampling	0	doesn't matter

Table continues on the next page...

Sampling mode	DQS_EN	DQS_LOOPBACK_EN
Loopback DQS sampling	1	1
Flash DQS sampling	1	0

Serial flash data and clock path for input timing is shown in the following figure.

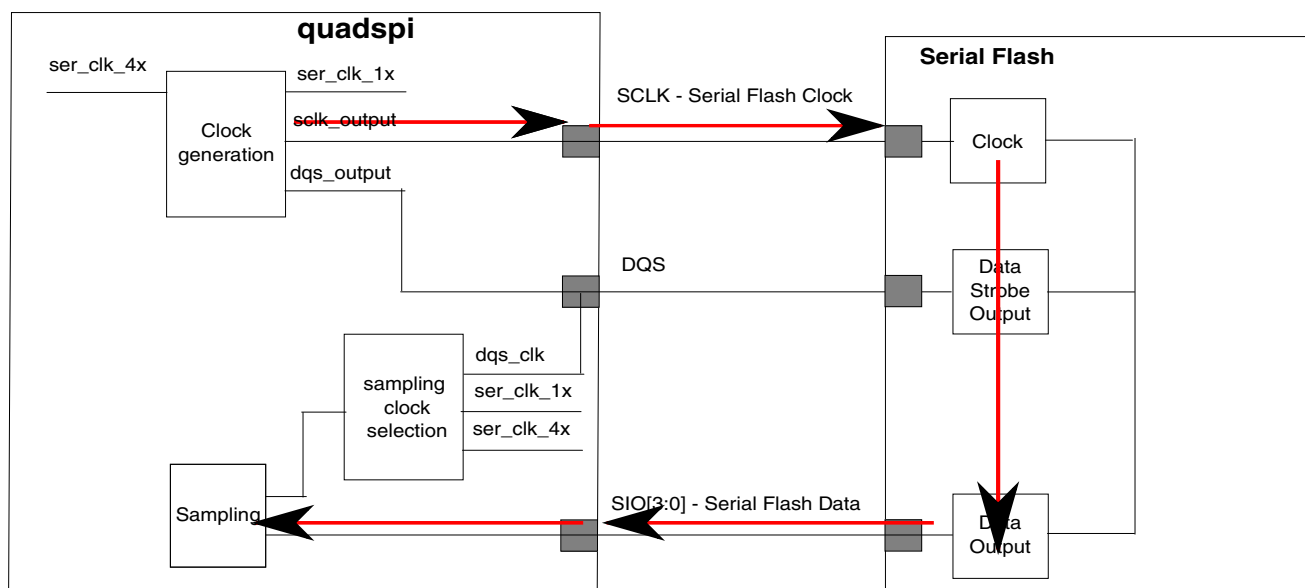

Figure 42-12. Serial flash data and clock path

NOTE

The red line is for data input path, the blue line is for DQS loopback path, and the purple line is for DQS input path from Serial Flash.

Total delay ($T_{total_delay_data}$) for serial flash data input is the sum of following delay:

1. Output delay of serial flash clock from internal serial clock to SCLK pad inside SOC
2. Wire delay of serial flash clock (SCLK) from SOC to external Serial Flash Device
3. Clock to Output Valid time of external Serial Flash Device
4. Wire delay of serial flash data (SIO) from external serial Flash Device to SOC
5. Input delay of serial flash data from SIO pad to internal sample register

Total delay ($T_{total_delay_loopback_dqs}$) for loopback DQS clock is the sum of following delay:

1. Output delay of DQS clock from internal serial clock to DQS pad inside SOC
2. Input delay of DQS clock from DQS pad to internal sample register

Total delay ($T_{total_delay_flash_dqs}$) for Flash DQS clock is the sum of following delay:

1. Output delay of serial flash clock from internal serial clock to SCLK pad inside SOC
2. Wire delay of serial flash clock (SCLK) from SOC to external Serial Flash Device

3. Clock to DQS Output time of external Serial Flash Device
4. Wire delay of serial flash data strobe (DQS) from external serial Flash Device to SOC
5. Input delay of DQS clock from DQS pad to internal sample register

42.10.1 Input timing in SDR mode with internal sampling

Input Timing diagram in SDR mode with internal sampling is show in the figure below.

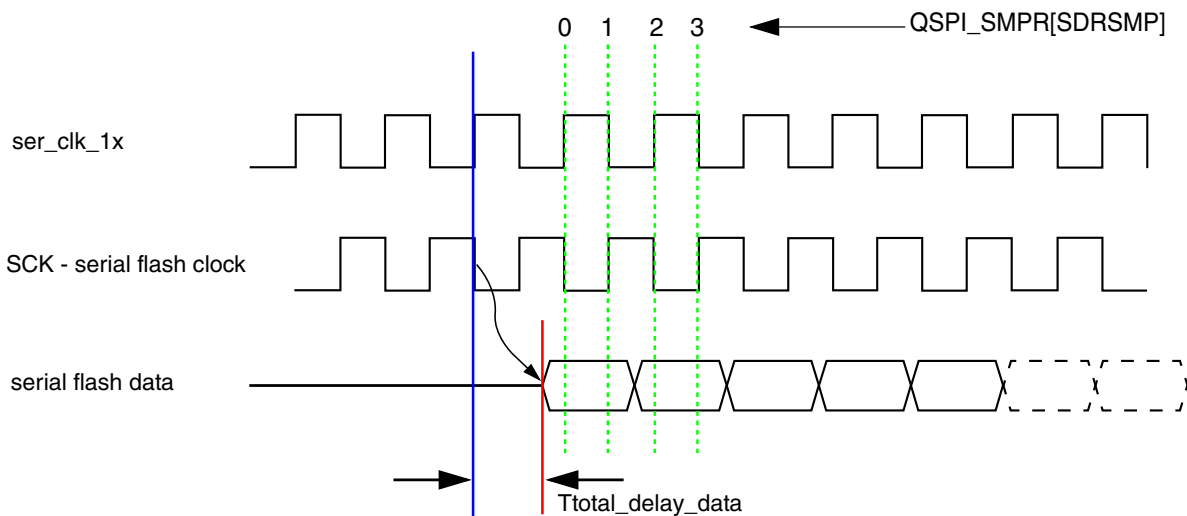

Figure 42-13. Internal sample SDR

There are four sample points for this sampling mode, which is determined by register field QSPI_SMPR.SDRSMP.

Sampling point need to be select correctly to meet both Setup and Hold timing for internal sample registers:

- For sample point N, Setup requirement is: $T_{cycle} * (N+2) / 2 > T_{total_delay_data,max}$
- For sample point N, Hold requirement is: $T_{total_delay_data,min} > T_{cycle} * N / 2$

NOTE

T_{cycle} is the cycle of ser_clk_1x . $T_{total_delay_data,max}$ is maximum delay of serial data input path. $T_{total_delay_data,min}$ is the minimum delay of serial data input path. $N=0,1,2,3$

42.10.2 Input timing in DDR mode with internal sampling

Input Timing diagram in SDR mode with internal sampling is show in the following figure.

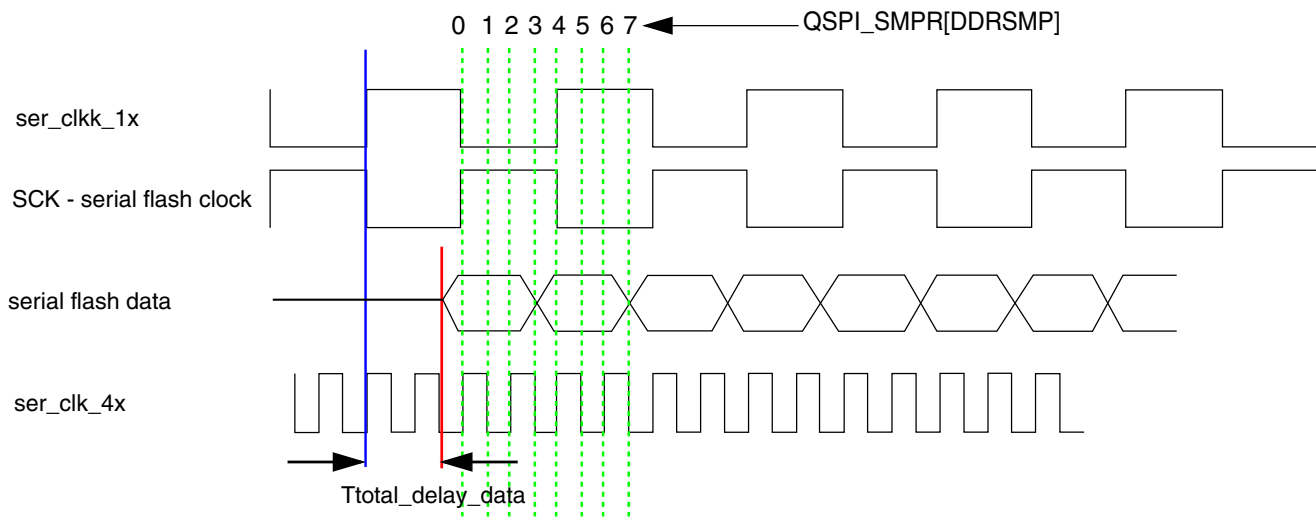

There are 8 sample points for this sampling mode, which is determined by register field DDRSMP.

Sampling point need to be select correctly to meet both Setup and Hold timing for internal sample registers:

- For sample point N, Setup requirement is: $T_{\text{cycle}} * (N+2)/8 > T_{\text{total_delay_data,max}}$
- For sample point N, Hold requirement is: $T_{\text{total_delay_data,min}} > T_{\text{cycle}} * N/8$

42.10.3 Input timing in SDR mode with loopback DQS sampling

Input Timing diagram in SDR mode with internal sampling is show in the following figure.

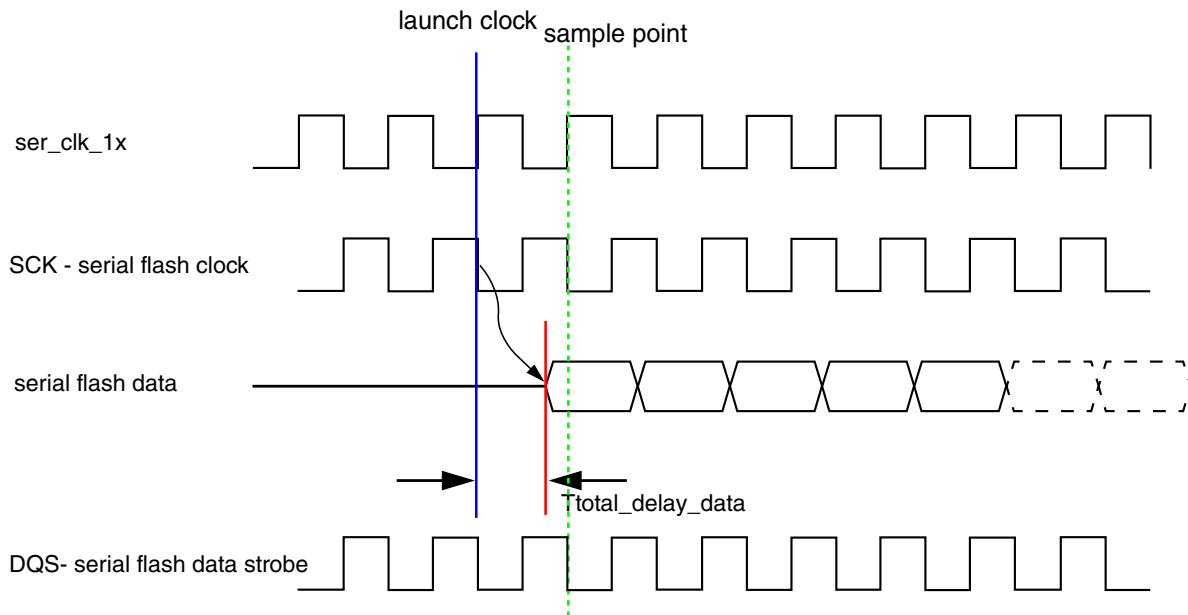

Figure 42-14. Input timing in SDR mode with loopback DQS sampling

In SDR mode and loopback sampling mode, DQS_PHASE_EN should be set 1.

For this sample point, the Setup requirement is: $T_{cycle} > \max(T_{total_delay_data} - T_{total_delay_loopback_dqs})$. The Hold requirement is: $\min(T_{total_delay_data} - T_{total_delay_loopback_dqs}) > 0$.

42.10.4 Input timing in DDR mode with loopback DQS sampling

Input Timing diagram in DDR mode with internal sampling is show in the following figure.

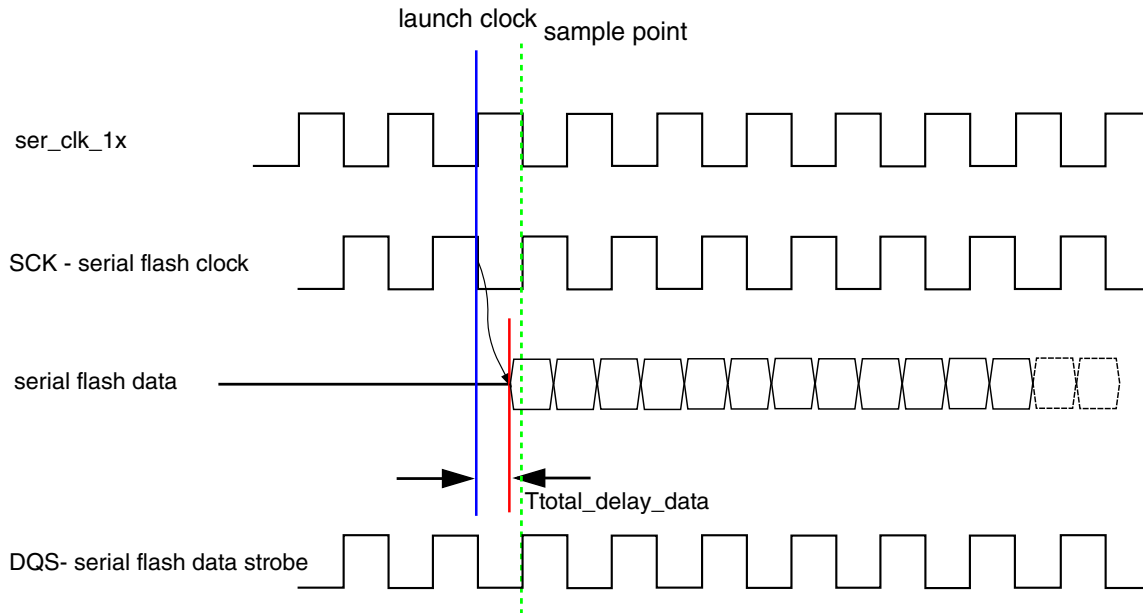

Figure 42-15. Input timing in DDR mode with loopback DQS sampling

In DDR mode and loopback sampling mode, `DQS_PHASE_EN` should be set 0.

For this sample point, the Setup requirement is: $T_{cycle} > \max(T_{total_delay_data} - T_{total_delay_loopback_dqs})$. The Hold requirement is: $\min(T_{total_delay_data} - T_{total_delay_loopback_dqs}) > 0$.

42.10.5 Input timing in SDR mode with flash DQS sampling

Input Timing diagram in SDR mode with internal sampling is show in the following figure.

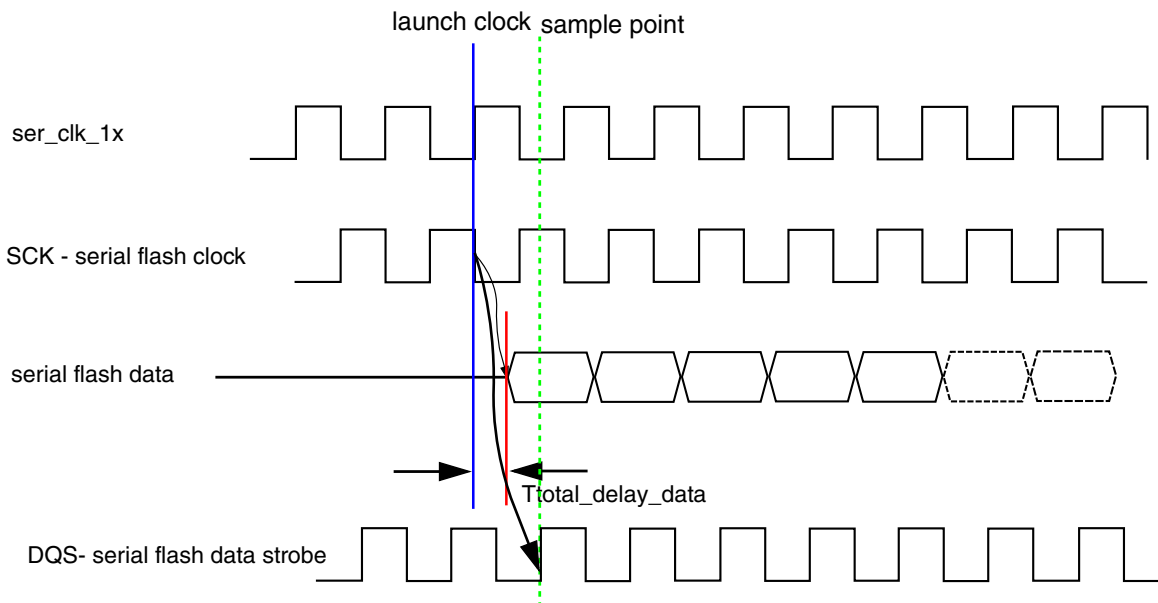

Figure 42-16. Input timing in SDR mode with flash DQS sampling

In this sampling mode, there will be a setup/hold requirement on Flash serial Data and Flash serial Data Strobe. This value will be specified in the data sheet.

42.10.6 Input timing in DDR mode with flash DQS sampling

Input Timing diagram in DDR mode with internal sampling is show in the following figure.

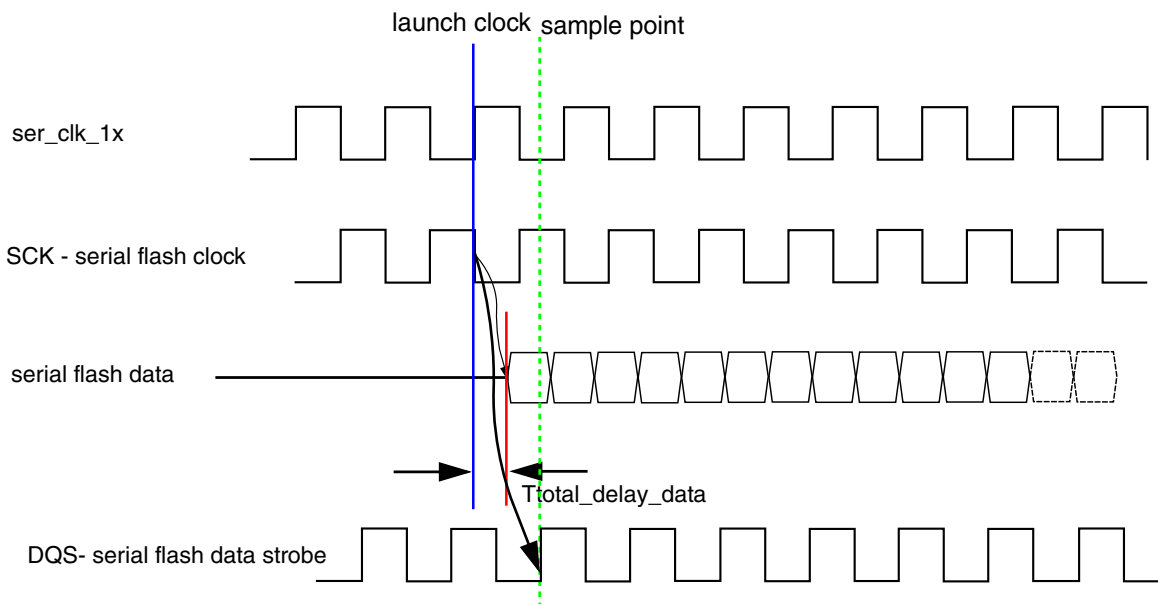

Figure 42-17. Input timing in DDR mode with flash DQS sampling

In this sampling mode, there will be a setup/hold requirement on Flash serial Data and Flash serial Data Strobe. This value will be specified in the data sheet.

42.10.7 Data Strobe Signal functionality

Some external serial flashes provide the data strobe (DQS/RDS) output which is fed directly to the QuadSPI module. The strobe (DQS/RDS) signal needs to be delayed to have the edges aligned to the data valid period. QuadSPI internally samples the incoming data at posedge of the strobe signal for SDR and on both the edges of the strobe signal for DDR. Refer to the figure for more detail.

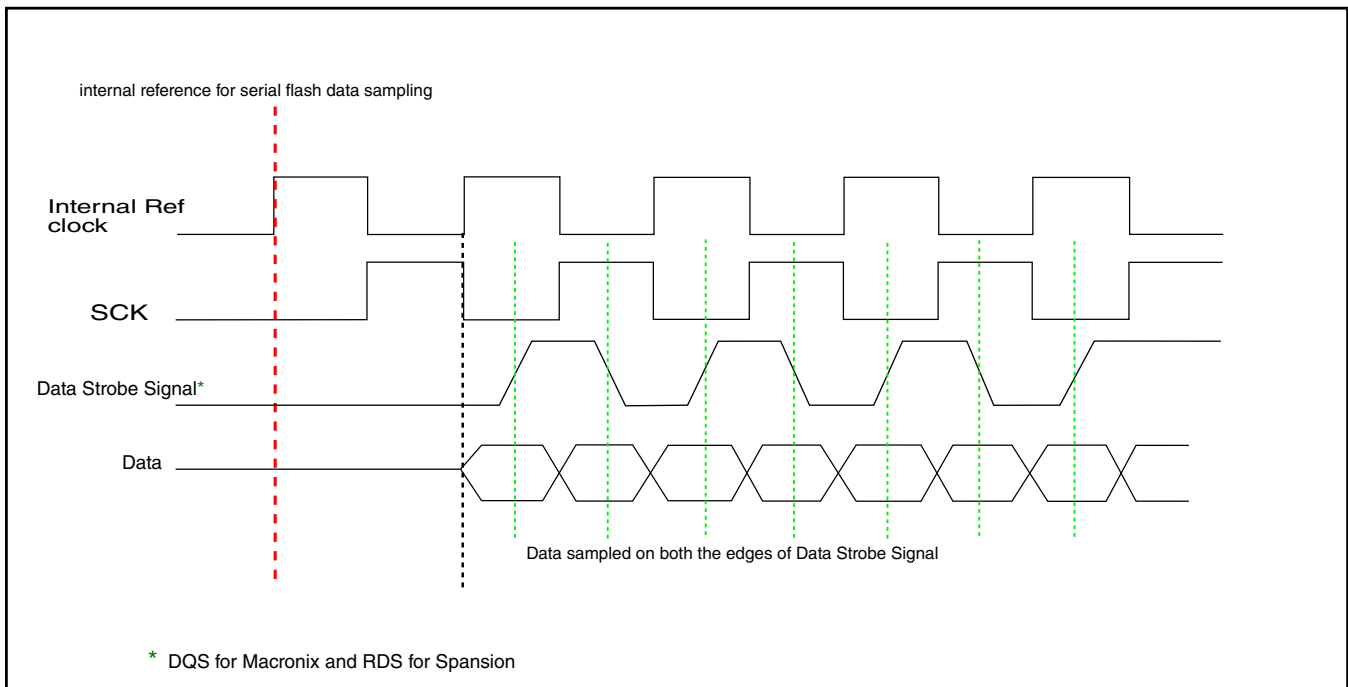

Figure 42-18. Data strobe signal functionality

42.11 Output timing in SDR mode

Output timing diagram in SDR mode is show in the following figure.

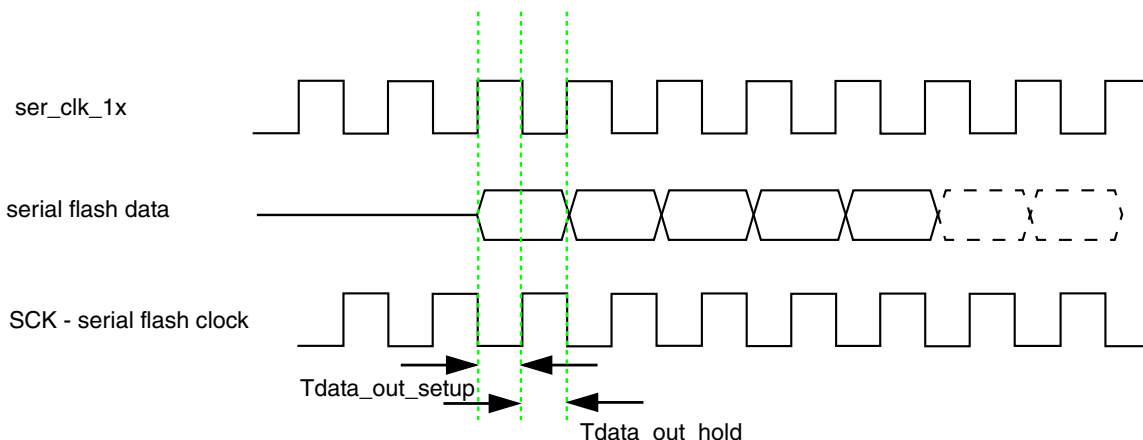

Figure 42-19. Output timing in SDR mode

In SDR mode, quadspi output serial data with internal serial clock rise edge 1x (ser_clk_1x). Flash Device has requirement on Data and Clock setup and hold timing.

42.12 Output timing in DDR mode

Output Timing diagram in DDR mode is show in the following figure.

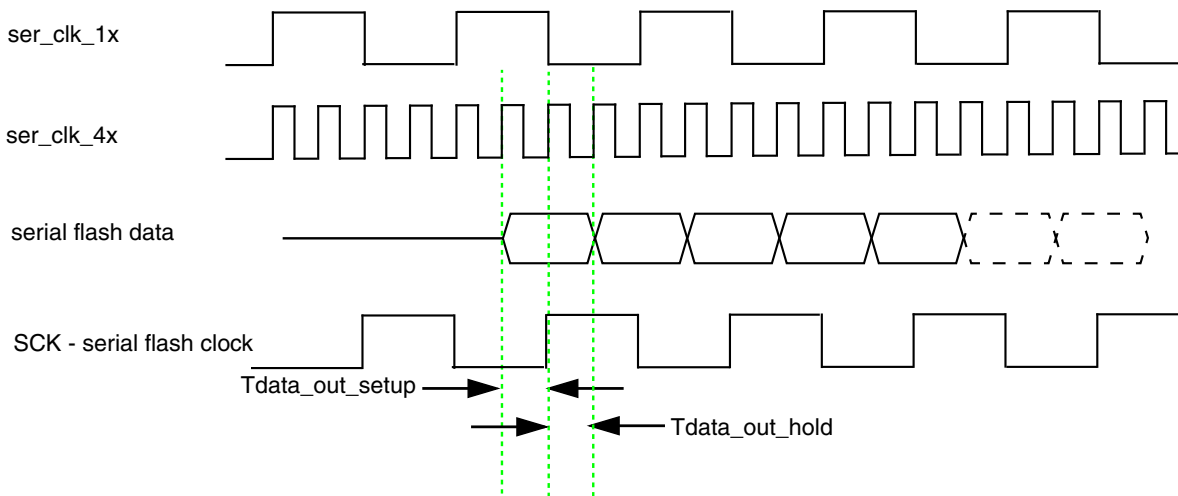

Figure 42-20. Output timing in DDR mode

In DDR mode, quadspi output serial data with internal serial clock both edge 1x (ser_clk_1x) and then delay one ser_clk_4x cycle for hold timing.

NOTE

TX_DDR_DELAY_EN should be set to 1 for DDR mode.

42.13 AHB RX Data Buffer (QSPI_ARDB0 to QSPI_ARDB31)**42.13.1 AHB RX Data Buffer (QSPI_ARDB0 to QSPI_ARDB31)****NOTE**

See the System Memory map in this document for the base address of the QSPI AHB RX Data Buffer.

memory map

Absolute address (hex)	Register name	Width (in bits)	Access	Reset value	Section/page
0	AHB RX Data Buffer register (ARDB0)	32	R/W	0000_0000h	42.13.1.1/3031
4	AHB RX Data Buffer register (ARDB1)	32	R/W	0000_0000h	42.13.1.1/3031
8	AHB RX Data Buffer register (ARDB2)	32	R/W	0000_0000h	42.13.1.1/3031
C	AHB RX Data Buffer register (ARDB3)	32	R/W	0000_0000h	42.13.1.1/3031
10	AHB RX Data Buffer register (ARDB4)	32	R/W	0000_0000h	42.13.1.1/3031
14	AHB RX Data Buffer register (ARDB5)	32	R/W	0000_0000h	42.13.1.1/3031
18	AHB RX Data Buffer register (ARDB6)	32	R/W	0000_0000h	42.13.1.1/3031
1C	AHB RX Data Buffer register (ARDB7)	32	R/W	0000_0000h	42.13.1.1/3031
20	AHB RX Data Buffer register (ARDB8)	32	R/W	0000_0000h	42.13.1.1/3031
24	AHB RX Data Buffer register (ARDB9)	32	R/W	0000_0000h	42.13.1.1/3031
28	AHB RX Data Buffer register (ARDB10)	32	R/W	0000_0000h	42.13.1.1/3031
2C	AHB RX Data Buffer register (ARDB11)	32	R/W	0000_0000h	42.13.1.1/3031
30	AHB RX Data Buffer register (ARDB12)	32	R/W	0000_0000h	42.13.1.1/3031

Table continues on the next page...

memory map (continued)

Absolute address (hex)	Register name	Width (in bits)	Access	Reset value	Section/page
34	AHB RX Data Buffer register (ARDB13)	32	R/W	0000_0000h	42.13.1.1/3031
38	AHB RX Data Buffer register (ARDB14)	32	R/W	0000_0000h	42.13.1.1/3031
3C	AHB RX Data Buffer register (ARDB15)	32	R/W	0000_0000h	42.13.1.1/3031
40	AHB RX Data Buffer register (ARDB16)	32	R/W	0000_0000h	42.13.1.1/3031
44	AHB RX Data Buffer register (ARDB17)	32	R/W	0000_0000h	42.13.1.1/3031
48	AHB RX Data Buffer register (ARDB18)	32	R/W	0000_0000h	42.13.1.1/3031
4C	AHB RX Data Buffer register (ARDB19)	32	R/W	0000_0000h	42.13.1.1/3031
50	AHB RX Data Buffer register (ARDB20)	32	R/W	0000_0000h	42.13.1.1/3031
54	AHB RX Data Buffer register (ARDB21)	32	R/W	0000_0000h	42.13.1.1/3031
58	AHB RX Data Buffer register (ARDB22)	32	R/W	0000_0000h	42.13.1.1/3031
5C	AHB RX Data Buffer register (ARDB23)	32	R/W	0000_0000h	42.13.1.1/3031
60	AHB RX Data Buffer register (ARDB24)	32	R/W	0000_0000h	42.13.1.1/3031
64	AHB RX Data Buffer register (ARDB25)	32	R/W	0000_0000h	42.13.1.1/3031
68	AHB RX Data Buffer register (ARDB26)	32	R/W	0000_0000h	42.13.1.1/3031
6C	AHB RX Data Buffer register (ARDB27)	32	R/W	0000_0000h	42.13.1.1/3031
70	AHB RX Data Buffer register (ARDB28)	32	R/W	0000_0000h	42.13.1.1/3031
74	AHB RX Data Buffer register (ARDB29)	32	R/W	0000_0000h	42.13.1.1/3031
78	AHB RX Data Buffer register (ARDB30)	32	R/W	0000_0000h	42.13.1.1/3031
7C	AHB RX Data Buffer register (ARDB31)	32	R/W	0000_0000h	42.13.1.1/3031

42.13.1.1 AHB RX Data Buffer register (ARDBn)

The AHB RX Data Buffer register 0 to 31 can be used to read the buffer content of the RX Buffer from successive addresses. QSPI_ARDB0 corresponds to the RX Buffer register entry corresponding to the current value of the read pointer with increasing order.

The increment of the read pointer depends from the access scheme (DMA or flag-driven). Refer to "Data Transfer from the QuadSPI Module Internal Buffers" section in [Flash Read](#) section, RX Buffer, data read via register interface and AHB read, for the description of successive accesses to the RX Buffer content. Refer also to [Byte Ordering of Serial Flash Read Data](#) for the byte ordering scheme.

Valid address range accessible in the QSPI_ARDBn range depends from the number of RX Buffer entries implemented and from the number of valid buffer entries available in the RX Buffer.

- Example 1, RX Buffer filled completely with 32 words: In this case the address range for valid read access extends from QSPI_ARDB0 to QSPI_ARDB31.
- Example 2, RX Buffer filled with 5 valid words, RX Buffer fill level QSPI_RBSR[RDBFL] is 5. In this case an access to QSPI_ARDB4 provides the last valid entry.

Address: 0h base + 0h offset + (4d × i), where i=0d to 31d

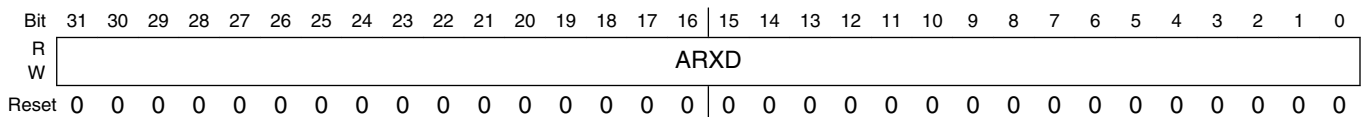

ARDBn field descriptions

Field	Description
ARXD	ARDB provided RX Buffer Data. Byte order (endianness) is identical to the RX Buffer Data Registers.

42.14 Peripheral Bus Register Descriptions

This section provides the peripheral bus register information of the QuadSPI module.

This section provides the memory map and register definitions of the QuadSPI module.

QuadSPI memory map

Absolute address (hex)	Register name	Width (in bits)	Access	Reset value	Section/page
21E_0000	Module Configuration Register (QuadSPI_MCR)	32	R/W	000F_4000h	42.14.1/3039
21E_0008	IP Configuration Register (QuadSPI_IPCR)	32	R/W	0000_0000h	42.14.2/3042
21E_000C	Flash Configuration Register (QuadSPI_FLSHCR)	32	R/W	0000_0303h	42.14.3/3043
21E_0010	Buffer0 Configuration Register (QuadSPI_BUF0CR)	32	R/W	0000_0000h	42.14.4/3043
21E_0014	Buffer1 Configuration Register (QuadSPI_BUF1CR)	32	R/W	0000_0000h	42.14.5/3044
21E_0018	Buffer2 Configuration Register (QuadSPI_BUF2CR)	32	R/W	0000_0000h	42.14.6/3045
21E_001C	Buffer3 Configuration Register (QuadSPI_BUF3CR)	32	R/W	See section	42.14.7/3046
21E_0020	Buffer Generic Configuration Register (QuadSPI_BFGENCR)	32	R/W	0000_0000h	42.14.8/3047
21E_0030	Buffer0 Top Index Register (QuadSPI_BUF0IND)	32	R/W	0000_0000h	42.14.9/3047
21E_0034	Buffer1 Top Index Register (QuadSPI_BUF1IND)	32	R/W	0000_0000h	42.14.10/3048
21E_0038	Buffer2 Top Index Register (QuadSPI_BUF2IND)	32	R/W	0000_0000h	42.14.11/3049
21E_0100	Serial Flash Address Register (QuadSPI_SFAR)	32	R/W	0000_0000h	42.14.12/3050
21E_0108	Sampling Register (QuadSPI_SMPR)	32	R/W	0000_0000h	42.14.13/3050
21E_010C	RX Buffer Status Register (QuadSPI_RBSR)	32	R	0000_0000h	42.14.14/3051
21E_0110	RX Buffer Control Register (QuadSPI_RBCT)	32	R/W	0000_0000h	42.14.15/3052
21E_0150	TX Buffer Status Register (QuadSPI_TBSTR)	32	R	0000_0000h	42.14.16/3053
21E_0154	TX Buffer Data Register (QuadSPI_TBDR)	32	R/W	0000_0000h	42.14.17/3053
21E_015C	Status Register (QuadSPI_SR)	32	R	0000_3800h	42.14.18/3055
21E_0160	Flag Register (QuadSPI_FR)	32	w1c	0800_0000h	42.14.19/3058
21E_0164	Interrupt and DMA Request Select and Enable Register (QuadSPI_RSER)	32	R/W	0000_0000h	42.14.20/3061
21E_0168	Sequence Suspend Status Register (QuadSPI_SPNDST)	32	R	0000_0000h	42.14.21/3064
21E_016C	Sequence Pointer Clear Register (QuadSPI_SPTRCLR)	32	R/W	0000_0000h	42.14.22/3066

Table continues on the next page...

QuadSPI memory map (continued)

Absolute address (hex)	Register name	Width (in bits)	Access	Reset value	Section/page
21E_0180	Serial Flash A1 Top Address (QuadSPI_SFA1AD)	32	R/W	0000_0000h	42.14.23/3066
21E_0184	Serial Flash A2 Top Address (QuadSPI_SFA2AD)	32	R/W	0000_0000h	42.14.24/3067
21E_0188	Serial Flash B1Top Address (QuadSPI_SFB1AD)	32	R/W	0000_0000h	42.14.25/3067
21E_018C	Serial Flash B2Top Address (QuadSPI_SFB2AD)	32	R/W	0000_0000h	42.14.26/3068
21E_0200	RX Buffer Data Register (QuadSPI_RBDR0)	32	R/W	0000_0000h	42.14.27/3068
21E_0204	RX Buffer Data Register (QuadSPI_RBDR1)	32	R/W	0000_0000h	42.14.27/3068
21E_0208	RX Buffer Data Register (QuadSPI_RBDR2)	32	R/W	0000_0000h	42.14.27/3068
21E_020C	RX Buffer Data Register (QuadSPI_RBDR3)	32	R/W	0000_0000h	42.14.27/3068
21E_0210	RX Buffer Data Register (QuadSPI_RBDR4)	32	R/W	0000_0000h	42.14.27/3068
21E_0214	RX Buffer Data Register (QuadSPI_RBDR5)	32	R/W	0000_0000h	42.14.27/3068
21E_0218	RX Buffer Data Register (QuadSPI_RBDR6)	32	R/W	0000_0000h	42.14.27/3068
21E_021C	RX Buffer Data Register (QuadSPI_RBDR7)	32	R/W	0000_0000h	42.14.27/3068
21E_0220	RX Buffer Data Register (QuadSPI_RBDR8)	32	R/W	0000_0000h	42.14.27/3068
21E_0224	RX Buffer Data Register (QuadSPI_RBDR9)	32	R/W	0000_0000h	42.14.27/3068
21E_0228	RX Buffer Data Register (QuadSPI_RBDR10)	32	R/W	0000_0000h	42.14.27/3068
21E_022C	RX Buffer Data Register (QuadSPI_RBDR11)	32	R/W	0000_0000h	42.14.27/3068
21E_0230	RX Buffer Data Register (QuadSPI_RBDR12)	32	R/W	0000_0000h	42.14.27/3068
21E_0234	RX Buffer Data Register (QuadSPI_RBDR13)	32	R/W	0000_0000h	42.14.27/3068
21E_0238	RX Buffer Data Register (QuadSPI_RBDR14)	32	R/W	0000_0000h	42.14.27/3068
21E_023C	RX Buffer Data Register (QuadSPI_RBDR15)	32	R/W	0000_0000h	42.14.27/3068
21E_0240	RX Buffer Data Register (QuadSPI_RBDR16)	32	R/W	0000_0000h	42.14.27/3068
21E_0244	RX Buffer Data Register (QuadSPI_RBDR17)	32	R/W	0000_0000h	42.14.27/3068

Table continues on the next page...

QuadSPI memory map (continued)

Absolute address (hex)	Register name	Width (in bits)	Access	Reset value	Section/page
21E_0248	RX Buffer Data Register (QuadSPI_RBDR18)	32	R/W	0000_0000h	42.14.27/3068
21E_024C	RX Buffer Data Register (QuadSPI_RBDR19)	32	R/W	0000_0000h	42.14.27/3068
21E_0250	RX Buffer Data Register (QuadSPI_RBDR20)	32	R/W	0000_0000h	42.14.27/3068
21E_0254	RX Buffer Data Register (QuadSPI_RBDR21)	32	R/W	0000_0000h	42.14.27/3068
21E_0258	RX Buffer Data Register (QuadSPI_RBDR22)	32	R/W	0000_0000h	42.14.27/3068
21E_025C	RX Buffer Data Register (QuadSPI_RBDR23)	32	R/W	0000_0000h	42.14.27/3068
21E_0260	RX Buffer Data Register (QuadSPI_RBDR24)	32	R/W	0000_0000h	42.14.27/3068
21E_0264	RX Buffer Data Register (QuadSPI_RBDR25)	32	R/W	0000_0000h	42.14.27/3068
21E_0268	RX Buffer Data Register (QuadSPI_RBDR26)	32	R/W	0000_0000h	42.14.27/3068
21E_026C	RX Buffer Data Register (QuadSPI_RBDR27)	32	R/W	0000_0000h	42.14.27/3068
21E_0270	RX Buffer Data Register (QuadSPI_RBDR28)	32	R/W	0000_0000h	42.14.27/3068
21E_0274	RX Buffer Data Register (QuadSPI_RBDR29)	32	R/W	0000_0000h	42.14.27/3068
21E_0278	RX Buffer Data Register (QuadSPI_RBDR30)	32	R/W	0000_0000h	42.14.27/3068
21E_027C	RX Buffer Data Register (QuadSPI_RBDR31)	32	R/W	0000_0000h	42.14.27/3068
21E_0300	LUT Key Register (QuadSPI_LUTKEY)	32	R/W	5AF0_5AF0h	42.14.28/3069
21E_0304	LUT Lock Configuration Register (QuadSPI_LCKCR)	32	R/W	0000_0002h	42.14.29/3070
21E_0310	Look-up Table register (QuadSPI_LUT0)	32	R/W	0818_0403h	42.14.30/3071
21E_0314	Look-up Table register (QuadSPI_LUT1)	32	R/W	2400_1C08h	42.14.31/3072
21E_0318	Look-up Table register (QuadSPI_LUT2)	32	R/W	0000_0000h	42.14.32/3073
21E_031C	Look-up Table register (QuadSPI_LUT3)	32	R/W	0000_0000h	42.14.32/3073
21E_0320	Look-up Table register (QuadSPI_LUT4)	32	R/W	0000_0000h	42.14.32/3073
21E_0324	Look-up Table register (QuadSPI_LUT5)	32	R/W	0000_0000h	42.14.32/3073

Table continues on the next page...

QuadSPI memory map (continued)

Absolute address (hex)	Register name	Width (in bits)	Access	Reset value	Section/page
21E_0328	Look-up Table register (QuadSPI_LUT6)	32	R/W	0000_0000h	42.14.32/3073
21E_032C	Look-up Table register (QuadSPI_LUT7)	32	R/W	0000_0000h	42.14.32/3073
21E_0330	Look-up Table register (QuadSPI_LUT8)	32	R/W	0000_0000h	42.14.32/3073
21E_0334	Look-up Table register (QuadSPI_LUT9)	32	R/W	0000_0000h	42.14.32/3073
21E_0338	Look-up Table register (QuadSPI_LUT10)	32	R/W	0000_0000h	42.14.32/3073
21E_033C	Look-up Table register (QuadSPI_LUT11)	32	R/W	0000_0000h	42.14.32/3073
21E_0340	Look-up Table register (QuadSPI_LUT12)	32	R/W	0000_0000h	42.14.32/3073
21E_0344	Look-up Table register (QuadSPI_LUT13)	32	R/W	0000_0000h	42.14.32/3073
21E_0348	Look-up Table register (QuadSPI_LUT14)	32	R/W	0000_0000h	42.14.32/3073
21E_034C	Look-up Table register (QuadSPI_LUT15)	32	R/W	0000_0000h	42.14.32/3073
21E_0350	Look-up Table register (QuadSPI_LUT16)	32	R/W	0000_0000h	42.14.32/3073
21E_0354	Look-up Table register (QuadSPI_LUT17)	32	R/W	0000_0000h	42.14.32/3073
21E_0358	Look-up Table register (QuadSPI_LUT18)	32	R/W	0000_0000h	42.14.32/3073
21E_035C	Look-up Table register (QuadSPI_LUT19)	32	R/W	0000_0000h	42.14.32/3073
21E_0360	Look-up Table register (QuadSPI_LUT20)	32	R/W	0000_0000h	42.14.32/3073
21E_0364	Look-up Table register (QuadSPI_LUT21)	32	R/W	0000_0000h	42.14.32/3073
21E_0368	Look-up Table register (QuadSPI_LUT22)	32	R/W	0000_0000h	42.14.32/3073
21E_036C	Look-up Table register (QuadSPI_LUT23)	32	R/W	0000_0000h	42.14.32/3073
21E_0370	Look-up Table register (QuadSPI_LUT24)	32	R/W	0000_0000h	42.14.32/3073
21E_0374	Look-up Table register (QuadSPI_LUT25)	32	R/W	0000_0000h	42.14.32/3073
21E_0378	Look-up Table register (QuadSPI_LUT26)	32	R/W	0000_0000h	42.14.32/3073
21E_037C	Look-up Table register (QuadSPI_LUT27)	32	R/W	0000_0000h	42.14.32/3073

Table continues on the next page...

QuadSPI memory map (continued)

Absolute address (hex)	Register name	Width (in bits)	Access	Reset value	Section/page
21E_0380	Look-up Table register (QuadSPI_LUT28)	32	R/W	0000_0000h	42.14.32/3073
21E_0384	Look-up Table register (QuadSPI_LUT29)	32	R/W	0000_0000h	42.14.32/3073
21E_0388	Look-up Table register (QuadSPI_LUT30)	32	R/W	0000_0000h	42.14.32/3073
21E_038C	Look-up Table register (QuadSPI_LUT31)	32	R/W	0000_0000h	42.14.32/3073
21E_0390	Look-up Table register (QuadSPI_LUT32)	32	R/W	0000_0000h	42.14.32/3073
21E_0394	Look-up Table register (QuadSPI_LUT33)	32	R/W	0000_0000h	42.14.32/3073
21E_0398	Look-up Table register (QuadSPI_LUT34)	32	R/W	0000_0000h	42.14.32/3073
21E_039C	Look-up Table register (QuadSPI_LUT35)	32	R/W	0000_0000h	42.14.32/3073
21E_03A0	Look-up Table register (QuadSPI_LUT36)	32	R/W	0000_0000h	42.14.32/3073
21E_03A4	Look-up Table register (QuadSPI_LUT37)	32	R/W	0000_0000h	42.14.32/3073
21E_03A8	Look-up Table register (QuadSPI_LUT38)	32	R/W	0000_0000h	42.14.32/3073
21E_03AC	Look-up Table register (QuadSPI_LUT39)	32	R/W	0000_0000h	42.14.32/3073
21E_03B0	Look-up Table register (QuadSPI_LUT40)	32	R/W	0000_0000h	42.14.32/3073
21E_03B4	Look-up Table register (QuadSPI_LUT41)	32	R/W	0000_0000h	42.14.32/3073
21E_03B8	Look-up Table register (QuadSPI_LUT42)	32	R/W	0000_0000h	42.14.32/3073
21E_03BC	Look-up Table register (QuadSPI_LUT43)	32	R/W	0000_0000h	42.14.32/3073
21E_03C0	Look-up Table register (QuadSPI_LUT44)	32	R/W	0000_0000h	42.14.32/3073
21E_03C4	Look-up Table register (QuadSPI_LUT45)	32	R/W	0000_0000h	42.14.32/3073
21E_03C8	Look-up Table register (QuadSPI_LUT46)	32	R/W	0000_0000h	42.14.32/3073
21E_03CC	Look-up Table register (QuadSPI_LUT47)	32	R/W	0000_0000h	42.14.32/3073
21E_03D0	Look-up Table register (QuadSPI_LUT48)	32	R/W	0000_0000h	42.14.32/3073
21E_03D4	Look-up Table register (QuadSPI_LUT49)	32	R/W	0000_0000h	42.14.32/3073

Table continues on the next page...

QuadSPI memory map (continued)

Absolute address (hex)	Register name	Width (in bits)	Access	Reset value	Section/page
21E_03D8	Look-up Table register (QuadSPI_LUT50)	32	R/W	0000_0000h	42.14.32/3073
21E_03DC	Look-up Table register (QuadSPI_LUT51)	32	R/W	0000_0000h	42.14.32/3073
21E_03E0	Look-up Table register (QuadSPI_LUT52)	32	R/W	0000_0000h	42.14.32/3073
21E_03E4	Look-up Table register (QuadSPI_LUT53)	32	R/W	0000_0000h	42.14.32/3073
21E_03E8	Look-up Table register (QuadSPI_LUT54)	32	R/W	0000_0000h	42.14.32/3073
21E_03EC	Look-up Table register (QuadSPI_LUT55)	32	R/W	0000_0000h	42.14.32/3073
21E_03F0	Look-up Table register (QuadSPI_LUT56)	32	R/W	0000_0000h	42.14.32/3073
21E_03F4	Look-up Table register (QuadSPI_LUT57)	32	R/W	0000_0000h	42.14.32/3073
21E_03F8	Look-up Table register (QuadSPI_LUT58)	32	R/W	0000_0000h	42.14.32/3073
21E_03FC	Look-up Table register (QuadSPI_LUT59)	32	R/W	0000_0000h	42.14.32/3073
21E_0400	Look-up Table register (QuadSPI_LUT60)	32	R/W	0000_0000h	42.14.32/3073
21E_0404	Look-up Table register (QuadSPI_LUT61)	32	R/W	0000_0000h	42.14.32/3073
21E_0408	Look-up Table register (QuadSPI_LUT62)	32	R/W	0000_0000h	42.14.32/3073
21E_040C	Look-up Table register (QuadSPI_LUT63)	32	R/W	0000_0000h	42.14.32/3073

42.14.1 Module Configuration Register (QuadSPI_MCR)

The QuadSPI_MCR holds configuration data associated with QuadSPI operation.

Write:

- *All other fields: Anytime*

Peripheral Bus Register Descriptions

Address: 21E_0000h base + 0h offset = 21E_0000h

Bit	31	30	29	28	27	26	25	24	23	22	21	20	19	18	17	16
R	Reserved	DQS_PHASE_EN	Reserved	Reserved				DQS_LOOPBACK_EN	Reserved				Reserved			
W	Reserved	DQS_PHASE_EN	Reserved	Reserved				DQS_LOOPBACK_EN	Reserved				Reserved			
Reset	0	0	0	0	0	0	0	0	0	0	0	0	1	1	1	1
Bit	15	14	13	12	11	10	9	8	7	6	5	4	3	2	1	0
R	Reserved	MDIS	Reserved	CLR_TXF	CLR_RXF	Reserved		DDR_EN	DQS_EN	Reserved			END_CFG		SWRSTHD	SWRSTSD
W	Reserved	MDIS	Reserved	CLR_TXF	CLR_RXF	Reserved		DDR_EN	DQS_EN	Reserved			END_CFG		SWRSTHD	SWRSTSD
Reset	0	1	0	0	0	0	0	0	0	0	0	0	0	0	0	0

QuadSPI_MCR field descriptions

Field	Description
31 Reserved	This field is reserved. This field should always be set to 0.
30 DQS_PHASE_EN	This bit controls internal DQS output phase. If DQS_EN and DQS_LOOPBACK_EN are both set to 1, this bit should be set in SDR mode, and cleared in DDR mode. If either DQS_EN or DQS_LOOPBACK_EN is set to 0, this bit is ignored.
29 Reserved	This field is reserved. This field should always be set to 0.
28–25 Reserved	This field is reserved. This field should always be set to 0.
24 DQS_LOOPBACK_EN	Quadspi will output serial data strobe signal which will be loopback from pad to sample input flash serial data. Please note pad should be force input for loopback. Quadspi will output serial data strobe signal which will be loopback from pad to sample input flash serial data. Please note pad should be force input for loopback. This bit is a don't care when DQS_EN is set to 0. 1'b1 DQS loopback sampling enabled 1'b0 DQS loopback sampling disabled
23–20 Reserved	This field is reserved.
19–16 Reserved	This field is reserved. This field is reserved and should always be set to 0xF.
15 Reserved	This field is reserved. This field is reserved.
14 MDIS	Module Disable. The MDIS bit allows the clock to the non-memory mapped logic in the QuadSPI to be stopped, putting the QuadSPI in a software controlled power-saving state. Please refer to , for more information.

Table continues on the next page...

QuadSPI_MCR field descriptions (continued)

Field	Description
	0 Enable QuadSPI clocks. 1 Allow external logic to disable QuadSPI clocks.
13–12 Reserved	This field is reserved.
11 CLR_TXF	Clear TX FIFO/Buffer. Invalidate the TX Buffer content. 0 No action. 1 Read and write pointers of the TX Buffer are reset to 0. QSPI_TBSR[TRCTR] is reset to 0.
10 CLR_RXF	Clear RX FIFO. Invalidate the RX Buffer. 0 No action. 1 Read and write pointers of the RX Buffer are reset to 0. QSPI_RBSR[RDBFL] is reset to 0.
9–8 Reserved	This field is reserved.
7 DDR_EN	DDR mode enable: 0 2x and 4x clocks are disabled for SDR instructions only 1 2x and 4x clocks are enabled supports both SDR and DDR instruction.
6 DQS_EN	DQS enable: This field is valid for both SDR and DDR mode. For more details Refer Data Strobe Signal Functionality 0 DQS disabled. 1 DQS enabled- When enabled, the incoming data is sampled on both the edges of DQS input when QSPI_MCR[DDR_EN] is set, else, on only one edge when QSPI_MCR[DDR_EN] is 0. The QSPI_SMPR[DDR_SMP] values are ignored.
5–4 Reserved	This field is reserved.
3–2 END_CFG	Defines the endianness of the QSPI module. For more details refer to Byte Ordering Endianness
1 SWRSTHD	Software reset for AHB domain NOTE: Please keep other fields value when write to SWRSTHD and SWRSTSD NOTE: These software reset don't reset register setting but only reset internal flip-flops in quadspi controller NOTE: To remove the reset, need to write 0 to SWRSTHD and SWRSTSD 0 No action 1 AHB domain flops are reset. Does not reset configuration registers. It is advisable to reset both the serial flash domain and AHB domain at the same time. Resetting only one domain might lead to side effects.
0 SWRSTSD	Software reset for Serial Flash domain NOTE: Please keep other fields value when write to SWRSTHD and SWRSTSD NOTE: These software reset don't reset register setting but only reset internal flip-flops in quadspi controller NOTE: To remove the reset, need to write 0 to SWRSTHD and SWRSTSD

Table continues on the next page...

QuadSPI_MCR field descriptions (continued)

Field	Description
0	No action
1	Serial Flash domain flops are reset. Does not reset configuration registers. It is advisable to reset both the serial flash domain and AHB domain at the same time. Resetting only one domain might lead to side effects.

42.14.2 IP Configuration Register (QuadSPI_IPCR)

The IP configuration register provides all the configuration required for an IP initiated command. An IP command can be triggered by writing in the SEQID field of this register. If the SEQID field is written successfully, a new command to the external serial flash is started as per the sequence pointed to by the SEQID field. Refer to [Normal Mode](#), for details about the command triggering and command execution.

Write:

- $QSPI_SR[IP_ACC]=0$

Address: 21E_0000h base + 8h offset = 21E_0008h

Bit	31	30	29	28	27	26	25	24	23	22	21	20	19	18	17	16
R	Reserved				SEQID				Reserved							PAR_EN
W	Reserved				SEQID				Reserved							PAR_EN
Reset	0	0	0	0	0	0	0	0	0	0	0	0	0	0	0	0
Bit	15	14	13	12	11	10	9	8	7	6	5	4	3	2	1	0
R	IDATSZ															
W	IDATSZ															
Reset	0	0	0	0	0	0	0	0	0	0	0	0	0	0	0	0

QuadSPI_IPCR field descriptions

Field	Description
31–28 Reserved	This field is reserved.
27–24 SEQID	Points to a sequence in the Look-up-table. The SEQID defines the bits [6:2] of the LUT index. The bits [1:0] are always assumed to be 0. Refer to Look-up Table for more details. A write to this bit -field triggers a transaction on the serial flash interface.
23–17 Reserved	This field is reserved.
16 PAR_EN	When set, a transaction to two serial flash devices is triggered in parallel mode. Refer to Parallel Flash Mode for more details.
IDATSZ	IP data transfer size: Defines the data transfer size in bytes of the IP command.

42.14.3 Flash Configuration Register (QuadSPI_FLSHCR)

The Flash configuration register contains the flash device specific timings that must be met by the QuadSPI controller for the device to function correctly.

Write:

- $QSPI_SR[AHB_ACC] = 0$
- $QSPI_SR[IP_ACC] = 0$

Address: 21E_0000h base + Ch offset = 21E_000Ch

Bit	31	30	29	28	27	26	25	24	23	22	21	20	19	18	17	16	15	14	13	12	11	10	9	8	7	6	5	4	3	2	1	0
R	Reserved																TCSH			Reserved			TCSS									
W	Reserved																TCSH			Reserved			TCSS									
Reset	0	0	0	0	0	0	0	0	0	0	0	0	0	0	0	0	0	0	0	0	0	0	1	1	0	0	0	0	0	0	1	1

QuadSPI_FLSHCR field descriptions

Field	Description
31–12 Reserved	This field is reserved. Reserved.
11–8 TCSH	Serial flash CS hold time in terms of serial flash clock cycles. NOTE: The actual delay between chip select assertion and clock fall edge is defined as: <ul style="list-style-type: none"> • 1 SCK cycle if TCSH is set 0 or 1 • N SCK cycle if TCSH is set N (N>1)
7–4 Reserved	This field is reserved. Reserved.
TCSS	Serial flash CS setup time in terms of serial flash clock cycles. NOTE: <ol style="list-style-type: none"> 1. The actual delay between chip select assertion and clock fall edge is defined as: <ul style="list-style-type: none"> • 0.5 SCK cycle if TCSS is set 0 or 1 • N+0.5 SCK cycle if TCSS is set N (N>1) 2. Any update to TCSS register bits is visible on the flash interface only from the second transaction following the update.

42.14.4 Buffer0 Configuration Register (QuadSPI_BUF0CR)

This register provides the configuration for any access to buffer0. An access is routed to buffer0 when the master port number of the incoming AHB request matches the MSTRID field of the BUF0CR. Any buffer "miss" leads to a serial flash transaction being triggered as per the sequence pointed to the SEQID field. Buffer0 may also be configured as a high priority buffer by setting the HP_EN field of this register.

Write:

- $QSPI_SR[AHB_ACC] = 0$

Peripheral Bus Register Descriptions

Address: 21E_0000h base + 10h offset = 21E_0010h

Bit	31	30	29	28	27	26	25	24	23	22	21	20	19	18	17	16
R																
W	HP_EN	Reserved														
Reset	0	0	0	0	0	0	0	0	0	0	0	0	0	0	0	0
Bit	15	14	13	12	11	10	9	8	7	6	5	4	3	2	1	0
R	ADATSZ								Reserved				MSTRID			
W																
Reset	0	0	0	0	0	0	0	0	0	0	0	0	0	0	0	0

QuadSPI_BUF0CR field descriptions

Field	Description
31 HP_EN	High Priority Enable: When set, the master associated with this buffer is assigned a priority higher than the rest of the masters. An access by a high priority master will suspend any ongoing prefetch by another AHB master and will be serviced on high priority. Refer to Flexible AHB Buffers for details.
30–16 Reserved	This field is reserved.
15–8 ADATSZ	AHB data transfer size: Defines the data transfer size in 8 bytes of an AHB triggered access to serial flash. For example, a value of 0x2 will set transfer size to 16bytes. When ADATSZ = 0, the data size mentioned the sequence pointed to by the SEQID field overrides this value. SW should ensure that this transfer size is not greater than the size of this buffer.
7–4 Reserved	This field is reserved. Reserved.
MSTRID	Master ID: The ID of the AHB master associated with BUFFER0. Any AHB access with this master port number is routed to this buffer.

42.14.5 Buffer1 Configuration Register (QuadSPI_BUF1CR)

This register provides the configuration for any access to buffer1. An access is routed to buffer1 when the master port number of the incoming AHB request matches the MSTRID field of the BUF1CR. Any buffer "miss" leads to the buffer being flushed and a serial flash transaction being triggered as per the sequence pointed to by the SEQID field.

Write:

- $QSPI_SR[AHB_ACC] = 0$

Address: 21E_0000h base + 14h offset = 21E_0014h

Bit	31	30	29	28	27	26	25	24	23	22	21	20	19	18	17	16	15	14	13	12	11	10	9	8	7	6	5	4	3	2	1	0
R																	ADATSZ				Reserved				MSTRID							
W	Reserved																															
Reset	0	0	0	0	0	0	0	0	0	0	0	0	0	0	0	0	0	0	0	0	0	0	0	0	0	0	0	0	0	0	0	0

QuadSPI_BUF1CR field descriptions

Field	Description
31–16 Reserved	This field is reserved.
15–8 ADATSZ	AHB data transfer size: Defines the data transfer size in 8 bytes of an AHB triggered access to serial flash. For example, a value of 0x2 will set transfer size to 16bytes. When ADATSZ = 0, the data size mentioned the sequence pointed to by the SEQID field overrides this value. SW should ensure that this transfer size is not greater than the size of this buffer.
7–4 Reserved	This field is reserved.
MSTRID	Master ID: The ID of the AHB master associated with BUFFER1. Any AHB access with this master port number is routed to this buffer.

42.14.6 Buffer2 Configuration Register (QuadSPI_BUF2CR)

This register provides the configuration for any access to buffer2. An access is routed to buffer2 when the master port number of the incoming AHB request matches the MSTRID field of the BUF2CR. Any buffer "miss" leads to the buffer being flushed and a serial flash transaction being triggered as per the sequence pointed to by the SEQID field.

Write:

- $QSPI_SR[AHB_ACC] = 0$

Address: 21E_0000h base + 18h offset = 21E_0018h

Bit	31	30	29	28	27	26	25	24	23	22	21	20	19	18	17	16	15	14	13	12	11	10	9	8	7	6	5	4	3	2	1	0
R	Reserved																ADATSZ						Reserved				MSTRID					
W	0																0						0				0					
Reset	0	0	0	0	0	0	0	0	0	0	0	0	0	0	0	0	0	0	0	0	0	0	0	0	0	0	0	0	0	0	0	

QuadSPI_BUF2CR field descriptions

Field	Description
31–16 Reserved	This field is reserved. Reserved.
15–8 ADATSZ	AHB data transfer size: Defines the data transfer size in 8 Bytes of an AHB triggered access to serial flash. For example, a value of 0x2 will set transfer size to 16bytes. When ADATSZ = 0, the data size mentioned the sequence pointed to by the SEQID field overrides this value. SW should ensure that this transfer size is not greater than the size of this buffer.
7–4 Reserved	This field is reserved. Reserved.
MSTRID	Master ID: The ID of the AHB master associated with BUFFER2. Any AHB access with this master port number is routed to this buffer.

42.14.7 Buffer3 Configuration Register (QuadSPI_BUF3CR)

This register provides the configuration for any access to buffer3. An access is routed to buffer3 when the master port number of the incoming AHB request matches the MSTRID field of the BUF3CR. Any buffer "miss" leads to the buffer being flushed a serial flash transaction being triggered as per the sequence pointed to by the SEQID field. If the ALLMST field is set, any transaction where the master port number does not match any of the buffer MSTRID fields will be routed to this buffer. In the case that the ALLMST field is not set, any such transaction (where master port number does not match any of the MSTRID fields) will be returned an ERROR response.

Write:

- $QSPI_SR[AHB_ACC] = 0$

Address: 21E_0000h base + 1Ch offset = 21E_001Ch

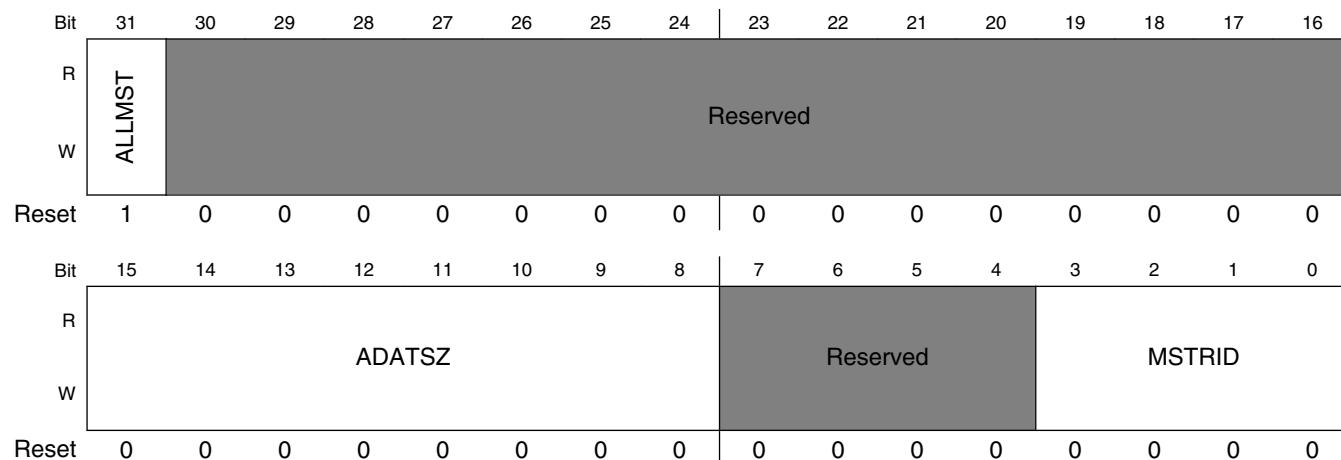

QuadSPI_BUF3CR field descriptions

Field	Description
31 ALLMST	All master enable: When set, buffer3 acts as an all-master buffer. Any AHB access with a master port number not matching with the master ID of buffer0 or buffer1 or buffer2 is routed to buffer3. When set, the MSTRID field of this register is ignored.
30–16 Reserved	This field is reserved. Reserved.
15–8 ADATSZ	AHB data transfer size: Defines the data transfer size in 8 Bytes of an AHB triggered access to serial flash. When ADATSZ = 0, the data size mentioned the sequence pointed to by the SEQID field overrides this value. SW should ensure that this transfer size is not greater than the size of this buffer.
7–4 Reserved	This field is reserved.
MSTRID	Master ID: The ID of the AHB master associated with BUFFER3. Any AHB access with this master port number is routed to this buffer.

42.14.8 Buffer Generic Configuration Register (QuadSPI_BFGENCR)

This register provides the generic configuration to any of the buffer accesses. Any buffer "miss" leads to the buffer being flushed and a serial flash transaction being triggered as per the sequence pointed to by the SEQID field. If the PAR_EN field is set, all the buffer accesses result in parallel accesses to the flashes.

Write:

- $QSPI_SR[AHB_ACC] = 0$

Address: 21E_0000h base + 20h offset = 21E_0020h

Bit	31	30	29	28	27	26	25	24	23	22	21	20	19	18	17	16
R	Reserved															PAR_EN
W																
Reset	0	0	0	0	0	0	0	0	0	0	0	0	0	0	0	0
Bit	15	14	13	12	11	10	9	8	7	6	5	4	3	2	1	0
R	SEQID				Reserved											
W																
Reset	0	0	0	0	0	0	0	0	0	0	0	0	0	0	0	0

QuadSPI_BFGENCR field descriptions

Field	Description
31–17 Reserved	This field is reserved.
16 PAR_EN	When set, a transaction to two serial flash devices is triggered in parallel mode. Refer to Parallel Flash Mode for more details.
15–12 SEQID	Points to a sequence in the Look-up-table. The SEQID defines the bits [6:2] of the LUT index. The bits [1:0] are always assumed to be 0. Refer to Look-up Table . NOTE: If the sequence pointer differs between the new and previous sequence then the user should reset this. See QSPI_SPTRCLR for more information.
Reserved	This field is reserved.

42.14.9 Buffer0 Top Index Register (QuadSPI_BUF0IND)

This register specifies the top index of buffer0, which defines its size. Note that that the 3 LSBs of this register are set to zero - this ensures that the buffer is 64bit aligned, as each buffer entry is 64bits long.

Peripheral Bus Register Descriptions

The register value should be set to the desired number of bytes less 8. For example, setting BUF0IND to 0 gives 8 bytes, 1 give 16bytes etc.

The size of buffer0 is the difference between the BUF0IND+8 and 0.

It is the responsibility of the software to ensure that BUF0IND value is not greater than the overall size of the buffer. The hardware does not provide any protection against illegal programming.

Write:

- $QSPI_SR[AHB_ACC] = 0$

Address: 21E_0000h base + 30h offset = 21E_0030h

Bit	31	30	29	28	27	26	25	24	23	22	21	20	19	18	17	16	15	14	13	12	11	10	9	8	7	6	5	4	3	2	1	0
R	TPINDX0																Reserved															
W	TPINDX0																Reserved															
Reset	0	0	0	0	0	0	0	0	0	0	0	0	0	0	0	0	0	0	0	0	0	0	0	0	0	0	0	0	0	0	0	0

QuadSPI_BUF0IND field descriptions

Field	Description
31–3 TPINDX0	Top index of buffer 0.
Reserved	This field is reserved. Reserved.

42.14.10 Buffer1 Top Index Register (QuadSPI_BUF1IND)

This register specifies the top index of buffer1, which defines its size. Note that the 3 LSBs of this register are set to zero - this ensures that the buffer is 64bit aligned as each buffer entry is 64bits long.

The register value should be set to the desired number of bytes less. The size of buffer1 is the difference between the BUF1IND and BUF0IND.

It is the responsibility of the software to ensure that BUF1IND value is not greater than the overall size of the buffer. The hardware does not provide any protection against illegal programming.

Write:

- $QSPI_SR[AHB_ACC] = 0$

Address: 21E_0000h base + 34h offset = 21E_0034h

Bit	31	30	29	28	27	26	25	24	23	22	21	20	19	18	17	16	15	14	13	12	11	10	9	8	7	6	5	4	3	2	1	0
R	TPINDX1																Reserved															
W	TPINDX1																Reserved															
Reset	0	0	0	0	0	0	0	0	0	0	0	0	0	0	0	0	0	0	0	0	0	0	0	0	0	0	0	0	0	0	0	0

QuadSPI_BUF1IND field descriptions

Field	Description
31–3 TPINDEX1	Top index of buffer 1.
Reserved	This field is reserved.

42.14.11 Buffer2 Top Index Register (QuadSPI_BUF2IND)

This register specifies the top index of buffer2, which defines its size. Note that the 3 LSBs of this register are set to zero - this ensures that the buffer is 64bit aligned as each buffer entry is 64bits long.

The register value should be set to the desired number of bytes less 8. The size of buffer2 is the difference between the BUF2IND and BUF1IND.

It is the responsibility of the software to ensure that BUF2IND value is not greater than the overall size of the buffer. The hardware does not provide any protection against illegal programming.

Write:

- $QSPI_SR[AHB_ACC] = 0$

Address: 21E_0000h base + 38h offset = 21E_0038h

Bit	31	30	29	28	27	26	25	24	23	22	21	20	19	18	17	16	15	14	13	12	11	10	9	8	7	6	5	4	3	2	1	0
R	TPINDEX2																Reserved															
W	TPINDEX2																Reserved															
Reset	0	0	0	0	0	0	0	0	0	0	0	0	0	0	0	0	0	0	0	0	0	0	0	0	0	0	0	0	0	0	0	

QuadSPI_BUF2IND field descriptions

Field	Description
31–3 TPINDEX2	Top index of buffer 2.
Reserved	This field is reserved.

42.14.12 Serial Flash Address Register (QuadSPI_SFAR)

The module automatically translates this address on the memory map to the address on the flash itself. When operating in 24bit mode, only bits 23-0 are sent to the flash, in 32bit mode, bits 27-0 are used with bits 31-28 driven to 0 Refer to [Table 42-5](#) for the mapping between the access mode and the QSPI_SFAR content and to [Normal Mode](#) for details about the command triggering and command execution. The software should ensure that the serial flash address provided in the QSPI_SFAR register lies in the valid flash address range as defined in [Table 42-5](#).

Write:

- $QSPI_SR[IP_ACC] = 0$

Address: 21E_0000h base + 100h offset = 21E_0100h

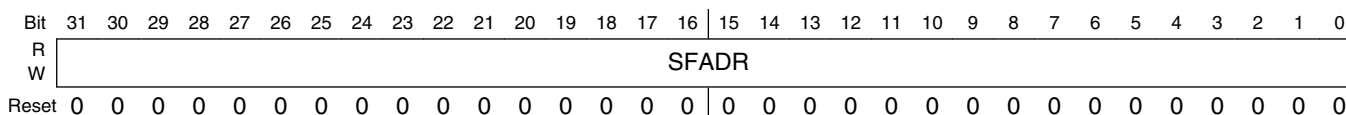

QuadSPI_SFAR field descriptions

Field	Description
SFADR	Serial Flash Address. The register content is used as byte address for all following IP Commands.

42.14.13 Sampling Register (QuadSPI_SMPR)

The Sampling Register allows configuration of how the incoming data from the external serial flash devices are sampled in the QuadSPI module.

Write:Disabled Mode

Address: 21E_0000h base + 108h offset = 21E_0108h

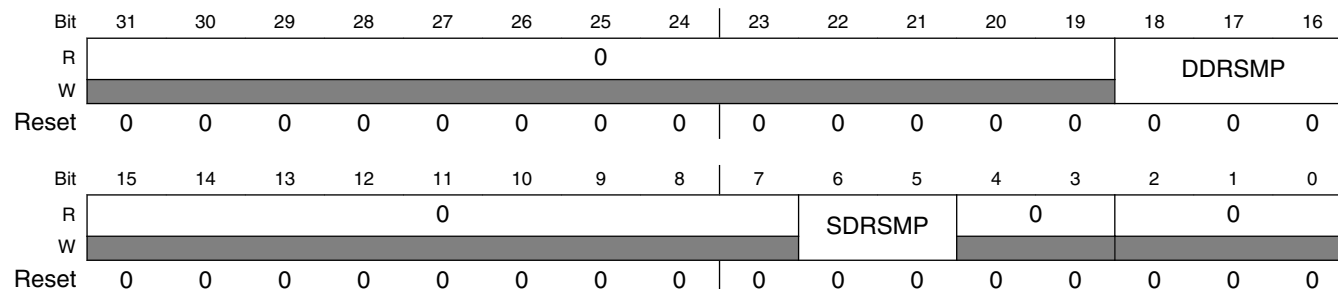

QuadSPI_SMPR field descriptions

Field	Description
31–19 Reserved	This field is reserved. This read-only field is reserved and always has the value 0.
18–16 DDRSMP	DDR Sampling point. Select the sampling point for incoming data when serial flash is executing a DDR instruction. Refer to Input timing in DDR mode with internal sampling , for details on the sampling points.
15–7 Reserved	This field is reserved. This read-only field is reserved and always has the value 0.
6–5 SDRSMP	SDR sampling point.
4–3 Reserved	This field is reserved. This read-only field is reserved and always has the value 0.
Reserved	This field is reserved. This read-only field is reserved and always has the value 0.

42.14.14 RX Buffer Status Register (QuadSPI_RBSR)

This register contains information related to the receive data buffer.

Address: 21E_0000h base + 10Ch offset = 21E_010Ch

Bit	31	30	29	28	27	26	25	24	23	22	21	20	19	18	17	16
R	RDCTR															
W	Reserved															
Reset	0	0	0	0	0	0	0	0	0	0	0	0	0	0	0	0
Bit	15	14	13	12	11	10	9	8	7	6	5	4	3	2	1	0
R	Reserved		RDBFL						Reserved							
W	Reserved															
Reset	0	0	0	0	0	0	0	0	0	0	0	0	0	0	0	0

QuadSPI_RBSR field descriptions

Field	Description
31–16 RDCTR	Read Counter, indicates how many entries of 4 bytes have been removed from the RX Buffer. For example a value of 0x2 would indicate 8bytes have been removed It is incremented by the number (QSPI_RBCT[WMRK] + 1) on RX Buffer POP event. The RX Buffer can be popped using DMA or pop flag QSPI_FR[RBDP]. The QSPI_RSER[RBDDE] defines which pop has to be done. For further details please refer to AHB RX Data Buffer (QSPI_ARDB0 to QSPI_ARDB31) and "Data Transfer from the QuadSPI Module Internal Buffers" section in Flash Read section.
15–14 Reserved	This field is reserved.
13–8 RDBFL	RX Buffer Fill Level, indicates how many entries of 4 bytes are still available in the RX Buffer. For example a value of 0x2 would indicate 8bytes are available.
Reserved	This field is reserved.

42.14.15 RX Buffer Control Register (QuadSPI_RBCT)

This register contains control data related to the receive data buffer.

Write:

- $QSPI_SR[IP_ACC] = 0$

Address: 21E_0000h base + 110h offset = 21E_0110h

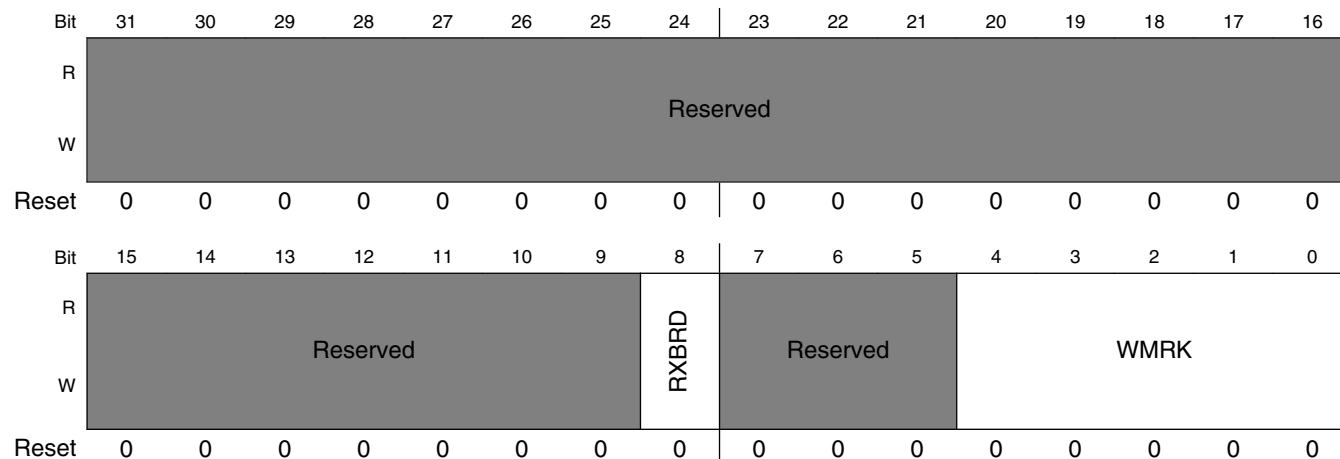

QuadSPI_RBCT field descriptions

Field	Description
31–9 Reserved	This field is reserved.
8 RXBRD	RX Buffer Readout: This bit specifies the access scheme for the RX Buffer readout. 0 RX Buffer content is read using the AHB Bus registers QSPI_ARDB0 to QSPI_ARDB31. For details, refer to Exclusive Access to Serial Flash for AHB Commands . 1 RX Buffer content is read using the IP Bus registers QSPI_RBDR0 to QSPI_RBDR31.
7–5 Reserved	This field is reserved.
WMRK	RX Buffer Watermark: This field determines when the readout action of the RX Buffer is triggered. When the number of valid entries in the RX Buffer is equal to or greater than the number given by (WMRK+1) the QSPI_SR[RXWE] flag is asserted. The value should be entered as the number of 4byte entries minus 1. For example a value of 0x0 would set the watermark to 4bytes, 1 to 8bytes, 2 to 12bytes etc. For details, refer to DMA Usage .

42.14.16 TX Buffer Status Register (QuadSPI_TBSR)

This register contains information related to the transmit data buffer.

Address: 21E_0000h base + 150h offset = 21E_0150h

Bit	31	30	29	28	27	26	25	24	23	22	21	20	19	18	17	16	15	14	13	12	11	10	9	8	7	6	5	4	3	2	1	0
R	TRCTR																Reserved			TRBFL				Reserved								
W	Reserved																Reserved			Reserved				Reserved								
Reset	0	0	0	0	0	0	0	0	0	0	0	0	0	0	0	0	0	0	0	0	0	0	0	0	0	0	0	0	0	0	0	0

QuadSPI_TBSR field descriptions

Field	Description
31–16 TRCTR	Transmit Counter. This field indicates how many entries of 4 bytes have been written into the TX Buffer by host accesses. It is reset to 0 when a 1 is written into the QSPI_MCR[CLR_TXF] bit. It is incremented on each write access to the QSPI_TBDR register when another word has been pushed onto the TX Buffer. When it is not cleared the TRCTR field wraps around to 0. Refer to TX Buffer Data Register (QuadSPI_TBDR) for details.
15–13 Reserved	This field is reserved.
12–8 TRBFL	TX Buffer Fill Level. The TRBFL field contains the number of entries of 4 bytes each available in the TX Buffer for the QuadSPI module to transmit to the serial flash device.
Reserved	This field is reserved.

42.14.17 TX Buffer Data Register (QuadSPI_TBDR)

The QSPI_TBDR register provides access to the circular TX Buffer of depth 128 bytes. This buffer provides the data written into it as write data for the page programming commands to the serial flash device. Refer to [Table 42-14](#) for the byte ordering scheme. A write transaction on the flash with data size of less than 32 bits will lead to the removal of four data entry from the TX buffer. The valid bits will be used and the rest of the bits will be discarded.

Write:

- $QSPI_SR[TXFULL] = 0$

32-bit write access required

NOTE

There is no limitation on Flash programming size. But the data size written to TX Buffer should be 64 Byte aligned. If flash programming size is not 64 bytes aligned, please write redundant data to TX Buffers. The redundant data will be ignored by QuadSPI controller.

Address: 21E_0000h base + 154h offset = 21E_0154h

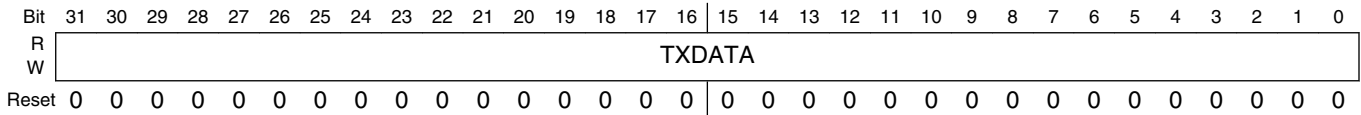

QuadSPI_TBDR field descriptions

Field	Description
TXDATA	<p>TX Data</p> <p>On write access the data is written into the next available entry of the TX Buffer and the QPSI_TBSR[TRBFL] field is updated accordingly.</p> <p>On a read access, the last data written to the register is returned.</p>

42.14.18 Status Register (QuadSPI_SR)

The QSPI_SR register provides all available status information about SFM command execution and arbitration, the RX Buffer and TX Buffer and the AHB Buffer.

Address: 21E_0000h base + 15Ch offset = 21E_015Ch

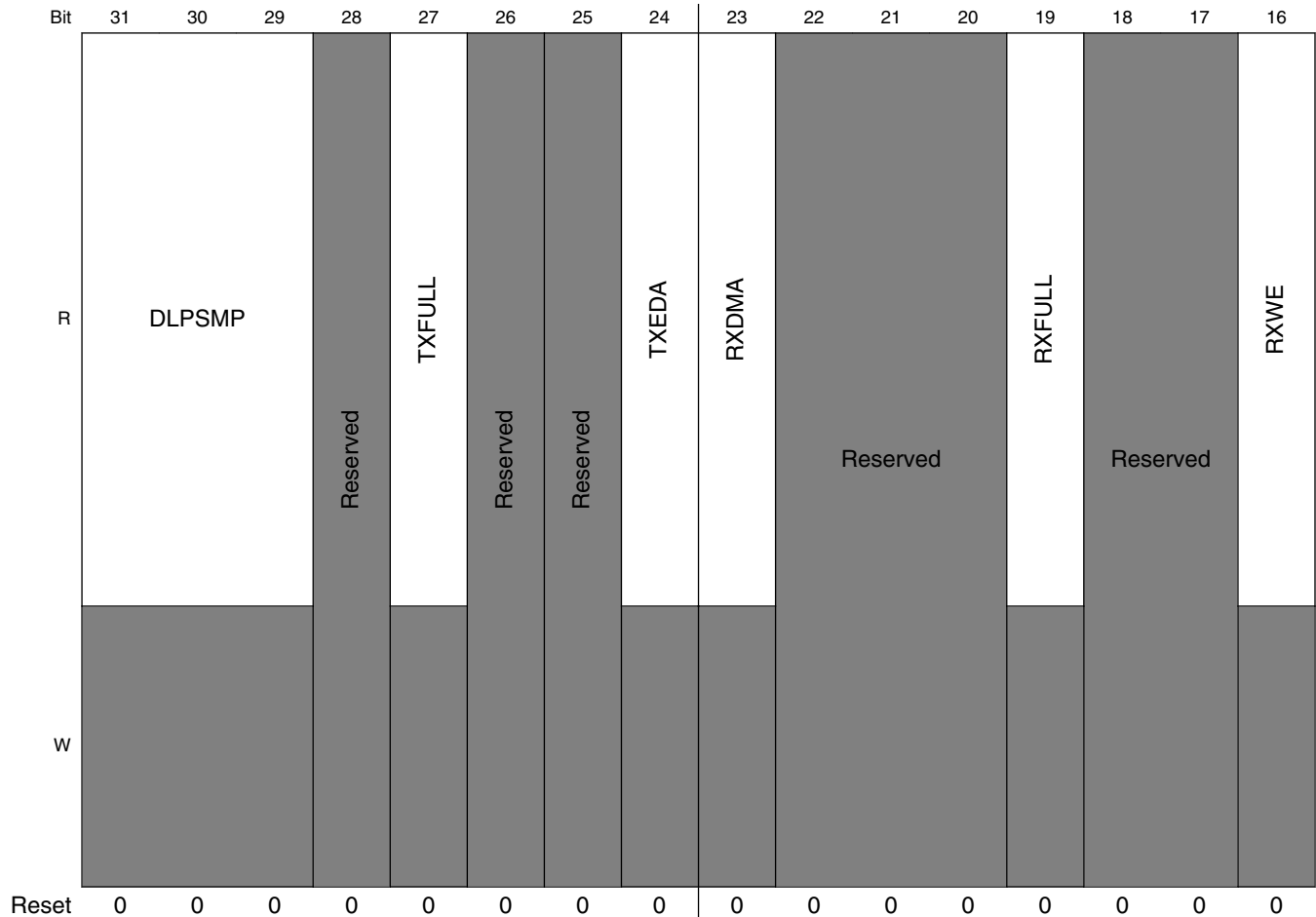

Peripheral Bus Register Descriptions

Bit	15	14	13	12	11	10	9	8	7	6	5	4	3	2	1	0
R	Reserved	AHB3FUL	AHB2FUL	AHB1FUL	AHB0FUL	AHB3NE	AHB2NE	AHB1NE	AHB0NE	AHBTRN	AHBGNT	Reserved	Reserved	AHB_ACC	IP_ACC	BUSY
W																
Reset	0	0	1	1	1	0	0	0	0	0	0	0	0	0	0	0

QuadSPI_SR field descriptions

Field	Description
31–29 DLPSMP	<p>NOTE: Data learning is not implemented on this chip. Data learning pattern sampling point: The sampling point found by the controller with the data learning pattern.</p> <ul style="list-style-type: none"> This is used for DDR only. If the learning fails, this field will return garbage and DLPFF bit will be set.
28 Reserved	This field is reserved.
27 TXFULL	TX Buffer Full: Asserted when no more data can be stored.
26 Reserved	This field is reserved.
25 Reserved	This field is reserved.
24 TXEDA	<p>Tx Buffer Enough Data Available</p> <p>Asserted when TX Buffer contains enough data for any pop operation to take place. There must be at least 128bit data available in TX FIFO for any pop operation otherwise QSPI_FR[TBUF] will be set.</p>

Table continues on the next page...

QuadSPI_SR field descriptions (continued)

Field	Description
23 RXDMA	RX Buffer DMA: Asserted when RX Buffer read out via DMA is active i.e DMA is requested or running.
22–20 Reserved	This field is reserved.
19 RXFULL	RX Buffer Full: Asserted when the RX Buffer is full, i.e. that QSPI_RBSR[RDBFL] field is equal to 32.
18–17 Reserved	This field is reserved.
16 RXWE	RX Buffer Watermark Exceeded: Asserted when the number of valid entries in the RX Buffer exceeds the number given in the QSPI_RBCT[WMRK] field.
15 Reserved	This field is reserved.
14 AHB3FUL	AHB 3 Buffer Full: Asserted when AHB 3 buffer is full.
13 AHB2FUL	AHB 2 Buffer Full: Asserted when AHB 2 buffer is full.
12 AHB1FUL	AHB 1 Buffer Full: Asserted when AHB 1 buffer is full.
11 AHB0FUL	AHB 0 Buffer Full: Asserted when AHB 0 buffer is full.
10 AHB3NE	AHB 3 Buffer Not Empty: Asserted when AHB 3 buffer contains data.
9 AHB2NE	AHB 2 Buffer Not Empty: Asserted when AHB 2 buffer contains data.
8 AHB1NE	AHB 1 Buffer Not Empty: Asserted when AHB 1 buffer contains data.
7 AHB0NE	AHB 0 Buffer Not Empty: Asserted when AHB 0 buffer contains data.
6 AHBTRN	AHB Access Transaction pending: Asserted when there is a pending request on the AHB interface. Refer to the AMBA specification for details.
5 AHBGNT	AHB Command priority Granted: Asserted when another module has been granted priority of AHB Commands against IP Commands. For details refer to Command Arbitration .
4 Reserved	This field is reserved.
3 RESERVED	This field is reserved.
2 AHB_ACC	AHB Access: Asserted when the transaction currently executed was initiated by AHB bus.
1 IP_ACC	IP Access: Asserted when transaction currently executed was initiated by IP bus.
0 BUSY	Module Busy: Asserted when module is currently busy handling a transaction to an external flash device.

42.14.19 Flag Register (QuadSPI_FR)

The QSPI_FR register provides all available flags about SFM command execution and arbitration which may serve as source for the generation of interrupt service requests. Note that the error flags in this register do not relate directly to the execution of the transaction in the serial flash device itself but only to the behavior and conditions visible in the QuadSPI module.

Write: Enabled Mode

Address: 21E_0000h base + 160h offset = 21E_0160h

Bit	31	30	29	28	27	26	25	24	23	22	21	20	19	18	17	16
R	DLPFF	Reserved	Reserved	Reserved	TBFF	TBUF	Reserved	Reserved	ILLINE	Reserved	Reserved	Reserved	Reserved	Reserved	RBOF	RBDF
W	w1c				w1c	w1c			w1c						w1c	w1c
Reset	0	0	0	0	1	0	0	0	0	0	0	0	0	0	0	0

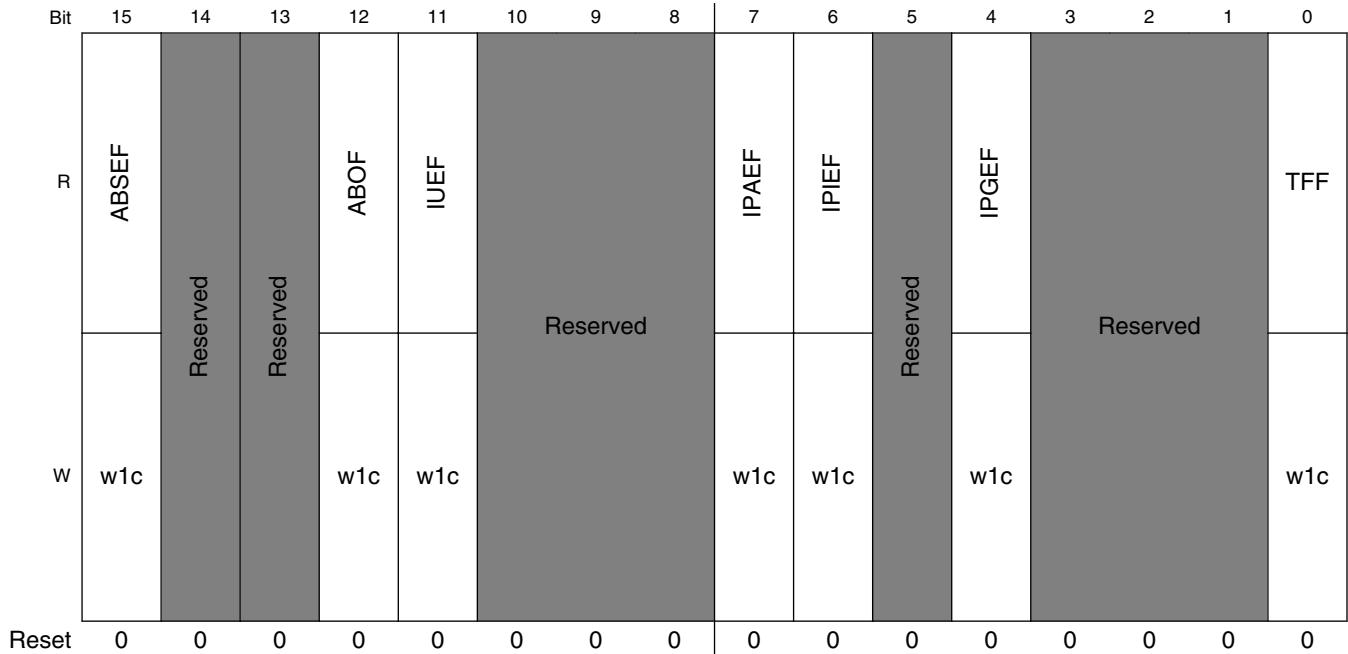

QuadSPI_FR field descriptions

Field	Description
31 DLFFF	NOTE: Data learning is not implemented on this chip. Data Learning Pattern Failure Flag: Set when DATA_LEARN instruction was encountered in a sequence but no sampling point was found for the data learning pattern The controller automatically starts sampling using the value in QSPI_SMPR[DDRSMP].
30 Reserved	This field is reserved.
29–28 Reserved	This field is reserved.
27 TBFF	TX Buffer Fill Flag: Before writing to the TX buffer, this bit should be cleared. Then this bit has to be read back. If the bit is set, the TX Buffer can take more data. If the bit remains cleared, the TX buffer is full. Refer to Tx Buffer Operation for details.
26 TBUF	TX Buffer Underrun Flag: Set when the module tried to pull data although TX Buffer was empty or the buffer contains less than 128bits of data. The application must ensure that the buffer never goes empty during a transaction expect for the last data fetch. The IP Command leading to the TX Buffer underrun is continued (data sent to the serial flash device is all F in case of valid tx underrun. The application must clear the TX Buffer in response to this event by writing a 1 into the QSPI_MCR[CLR_TXF] bit.
25–24 Reserved	This field is reserved.
23 ILLINE	Illegal Instruction Error Flag: Set when an illegal instruction is encountered by the controller in any of the sequences. Refer to Table 42-12 for a list of legal instructions.
22–18 Reserved	This field is reserved.
17 RBOF	RX Buffer Overflow Flag: Set when not all the data read from the serial flash device could be pushed into the RX Buffer. The IP Command leading to this condition is continued until the number of bytes according to the QSPI_IPCR[IDATSZ] field has been read from the serial flash device.

Table continues on the next page...

QuadSPI_FR field descriptions (continued)

Field	Description
	The content of the RX Buffer is not changed.
16 RBDF	<p>RX Buffer Drain Flag: Will be set if the QuadSPI_SR[RXWE] status bit is asserted.</p> <p>Writing 1 into this bit triggers one of the following actions:</p> <ul style="list-style-type: none"> • If the RX Buffer has up to QuadSPI_RBCT[WMRK] valid entries then the flag is cleared. • If the RX Buffer has more than QuadSPI_RBCT[WMRK] valid entries and the QuadSPI_RSER[RBDDE] bit is not set (flag driven mode) a RX Buffer POP event is triggered. <p>The flag remains set if the RX Buffer contains more than QuadSPI_RBCT[WMRK] valid entries after the RX Buffer POP event is finished.</p> <p>The flag is cleared if the RX Buffer contains less than or equal to QuadSPI_RBCT[WMRK] valid entries after the RX Buffer POP event is finished.</p> <p>Refer to "Receive Buffer Drain Interrupt or DMA Request" section in Normal Mode Interrupt and DMA Requests, for details.</p>
15 ABSEF	<p>AHB Sequence Error Flag: Set when the execution of an AHB Command is started with an WRITE or WRITE_DDR Command in the sequence pointed to by the QSPI_BUFxCR register</p> <p>Communication with the serial flash device is terminated before the execution of WRITE/WRITE_DDR command by the QuadSPI module.</p> <p>The AHB bus request which triggered this command is answered with an ERROR response.</p>
14 Reserved	<p>Reserved</p> <p>This field is reserved.</p>
13 Reserved	<p>Reserved</p> <p>This field is reserved.</p>
12 ABOF	<p>AHB Buffer Overflow Flag: Set when the size of the AHB access exceeds the size of the AHB buffer. This condition can occur only if the QSPI_BUFxCR[ADATSZ] field is programmed incorrectly.</p> <p>The AHB Command leading to this condition is continued until the number of entries according to the QSPI_BUFxCR[ADATSZ] field has been read from the serial flash device.</p> <p>The content of the AHB Buffer is not changed.</p>
11 IUEF	<p>IP Command Usage Error Flag: Set when in parallel flash mode the execution of an IP Command is started and the sequence pointed to by the sequence ID contains a WRITE or a WRITE_DDR command. Refer to Table 42-12 table for the related commands.</p> <p>Communication with the serial flash device is terminated before the execution of WRITE/WRITE_DDR command by the QuadSPI module.</p>
10–8 Reserved	This field is reserved.
7 IPAIEF	<p>IP Command Trigger during AHB Access Error Flag. Set when the following condition occurs:</p> <ul style="list-style-type: none"> • A write access occurs to the QSPI_IPCR[SEQID] field and the QSPI_SR[AHB_ACC] bit is set. Any command leading to the assertion of the IPAIEF flag is ignored.
6 IPIEF	<p>IP Command Trigger could not be executed Error Flag. Set when the QSPI_SR[IP_ACC] bit is set (i.e. an IP triggered command is currently executing) and any of the following conditions occurs:</p> <ul style="list-style-type: none"> • Write access to the QSPI_IPCR register. Any command leading to the assertion of the IPIEF flag is ignored • Write access to the QSPI_SFAR register. • Write access to the QSPI_RBCT register.
5 Reserved	This field is reserved.

Table continues on the next page...

QuadSPI_FR field descriptions (continued)

Field	Description
4 IPGEF	IP Command Trigger during AHB Grant Error Flag: Set when the following condition occurs: <ul style="list-style-type: none"> A write access occurs to the QSPI_IPCR[SEQID] field and the QSPI_SR[AHBGNT] bit is set. Any command leading to the assertion of the IPGEF flag is ignored.
3–1 Reserved	This field is reserved.
0 TFF	IP Command Transaction Finished Flag: Set when the QuadSPI module has finished a running IP Command. If an error occurred the related error flags are valid, at the latest, in the same clock cycle when the TFF flag is asserted.

1. QSPI_BUFxCR implies anyone of QSPI_BUF0CR/QSPI_BUF1CR/QSPI_BUF2CR/QSPI_BUF3CR

42.14.20 Interrupt and DMA Request Select and Enable Register (QuadSPI_RSER)

The QuadSPI_RSER register provides enables and selectors for the interrupts in the QuadSPI module.

NOTE

Each flag of the QuadSPI_FR register enabled as source for an interrupt prevents the QuadSPI module from entering Stop Mode or Module Disable Mode when this flag is set.

Write: Anytime

Address: 21E_0000h base + 164h offset = 21E_0164h

Bit	31	30	29	28	27	26	25	24	23	22	21	20	19	18	17	16
R																
W																
Reset	0	0	0	0	0	0	0	0	0	0	0	0	0	0	0	0

Peripheral Bus Register Descriptions

Bit	15	14	13	12	11	10	9	8	7	6	5	4	3	2	1	0
R		Reserved	Reserved	ABOIE	IUEIE	Reserved			IPAEIE	IPIEIE	Reserved	IPGEIE	Reserved			TFIE
W																
Reset	0	0	0	0	0	0	0	0	0	0	0	0	0	0	0	0

QuadSPI_RSER field descriptions

Field	Description
31 DLPFIE	<p>NOTE: Data learning is not implemented on this chip.</p> <p>Data Learning Pattern Failure Interrupt enable. Triggered by DLPFF flag in QSPI_FR register</p> <p>0 No DLPFF interrupt will be generated 1 DLPFF interrupt will be generated</p>
30 Reserved	This field is reserved.
29–28 RESERVED	This field is reserved.
27 TBFIE	<p>TX Buffer Fill Interrupt Enable</p> <p>0 No TBFF interrupt will be generated 1 TBFF interrupt will be generated</p>
26 TBUIE	<p>TX Buffer Underrun Interrupt Enable</p> <p>0 No TBUF interrupt will be generated 1 TBUF interrupt will be generated</p>
25 Reserved	This field is reserved.
24 Reserved	This field is reserved.
23 ILLINIE	<p>Illegal Instruction Error Interrupt Enable. Triggered by ILLINE flag in QSPI_FR</p> <p>0 No ILLINE interrupt will be generated 1 ILLINE interrupt will be generated</p>
22 Reserved	This field is reserved.
21 RBDDE	<p>RX Buffer Drain DMA Enable: Enables generation of DMA requests for RX Buffer Drain. When this bit is set DMA requests are generated as long as the QSPI_SR[RXWE] status bit is set.</p> <p>0 No DMA request will be generated 1 DMA request will be generated</p>
20–18 Reserved	This field is reserved.

Table continues on the next page...

QuadSPI_RSER field descriptions (continued)

Field	Description
17 RBOIE	RX Buffer Overflow Interrupt Enable 0 No RBOF interrupt will be generated 1 RBOF interrupt will be generated
16 RBDIE	RX Buffer Drain Interrupt Enable: Enables generation of IRQ requests for RX Buffer Drain. When this bit is set the interrupt is asserted as long as the QuadSPI_SR[RBDF] flag is set. 0 No RBDF interrupt will be generated 1 RBDF Interrupt will be generated
15 ABSEIE	AHB Sequence Error Interrupt Enable: Triggered by ABSEF flags of QSPI_FR 0 No ABSEF interrupt will be generated 1 ABSEF interrupt will be generated
14 Reserved	Reserved This field is reserved.
13 Reserved	Reserved This field is reserved.
12 ABOIE	AHB Buffer Overflow Interrupt Enable 0 No ABOF interrupt will be generated 1 ABOF interrupt will be generated
11 IUEIE	IP Command Usage Error Interrupt Enable 0 No IUEF interrupt will be generated 1 IUEF interrupt will be generated
10–8 Reserved	This field is reserved.
7 IPAEIE	IP Command Trigger during AHB Access Error Interrupt Enable 0 No IPAEF interrupt will be generated 1 IPAEF interrupt will be generated
6 IPIEIE	IP Command Trigger during IP Access Error Interrupt Enable 0 No IPIEF interrupt will be generated 0 IPIEF interrupt will be generated
5 Reserved	This field is reserved.
4 IPGEIE	IP Command Trigger during AHB Grant Error Interrupt Enable 0 No IPGEF interrupt will be generated 1 IPGEF interrupt will be generated
3–1 Reserved	This field is reserved. Reserved.
0 TFIE	Transaction Finished Interrupt Enable 0 No TFF interrupt will be generated 1 TFF interrupt will be generated

42.14.21 Sequence Suspend Status Register (QuadSPI_SPNDST)

The sequence suspend status register provides information specific to any suspended sequence. An AHB sequence may be suspended when a high priority AHB master makes an access before the AHB sequence completes the data transfer requested.

Address: 21E_0000h base + 168h offset = 21E_0168h

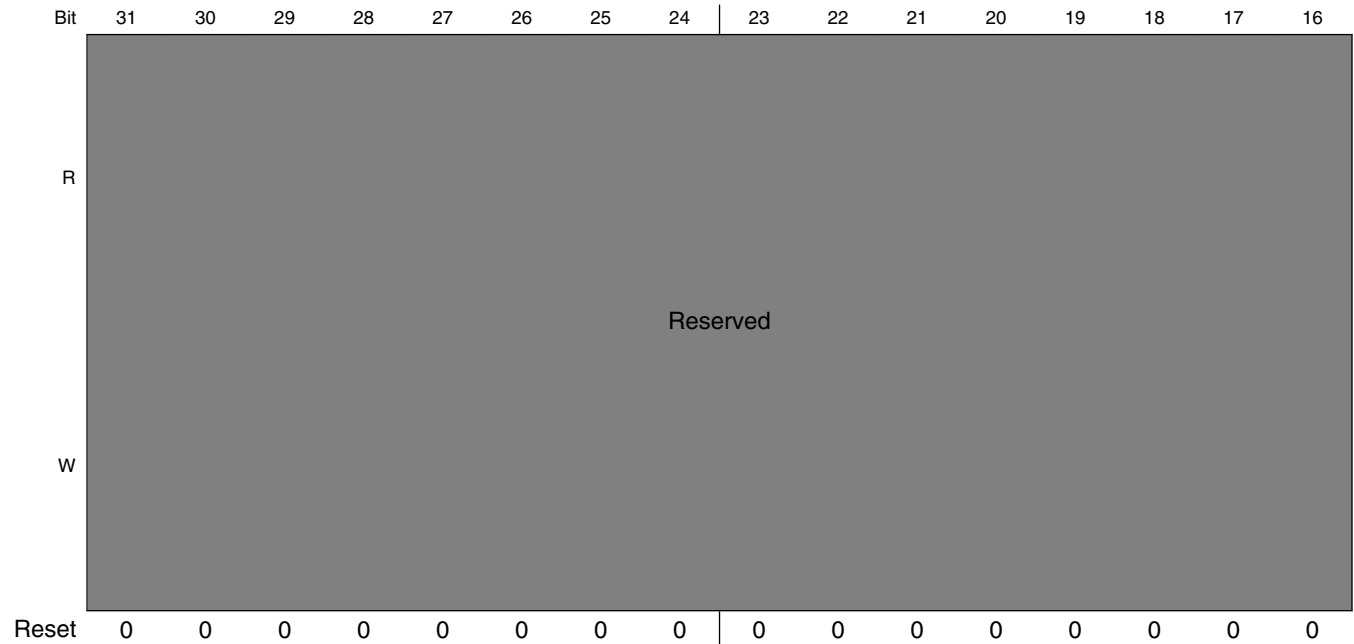

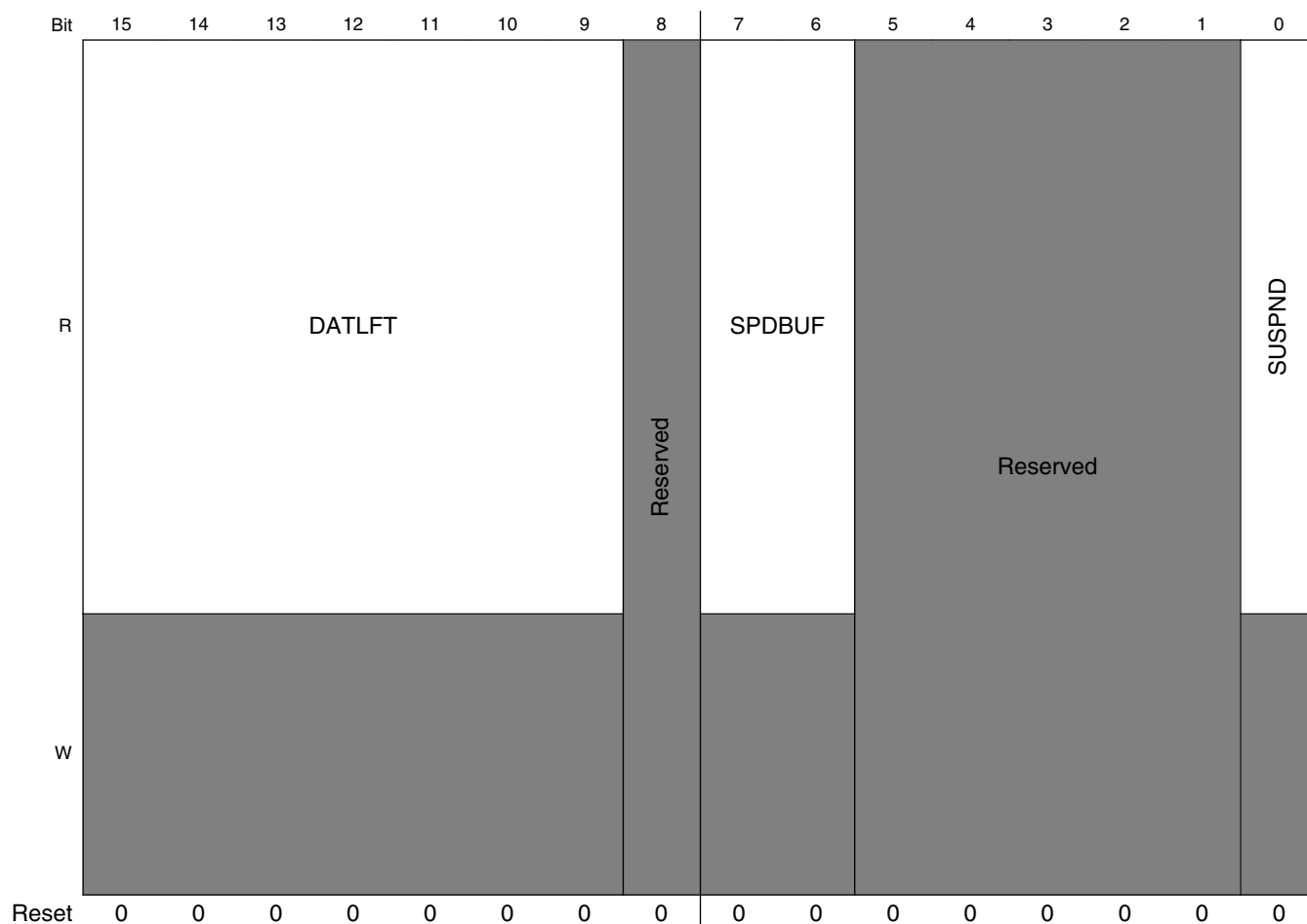

QuadSPI_SPNDST field descriptions

Field	Description
31–16 Reserved	This field is reserved.
15–9 DATLFT	Data left: Provides information about the amount of data left to be read in the suspended sequence. Valid only when SUSPND is set to 1'b1. Value in terms of 64 bits or 8 bytes
8 Reserved	This field is reserved.
7–6 SPDBUF	Suspended Buffer: Provides the suspended buffer number. Valid only when SUSPND is set to 1'b1
5–1 Reserved	This field is reserved.
0 SUSPND	When set, it signifies that a sequence is in suspended state

42.14.22 Sequence Pointer Clear Register (QuadSPI_SPTRCLR)

The sequence pointer clear register provides bits to reset the IP and Buffer sequence pointers. The sequence pointer contains the index of which instruction within the LUT entry is to be executed next. For example, if the LUT entry ends on a JMP_ON_CS value of 2, the index will be stored as 2.

The software should reset the sequence pointers whenever the sequence ID is changed by updating the SEQID field in QSPI_IPCR or QSPI_BFGENCR.

Address: 21E_0000h base + 16Ch offset = 21E_016Ch

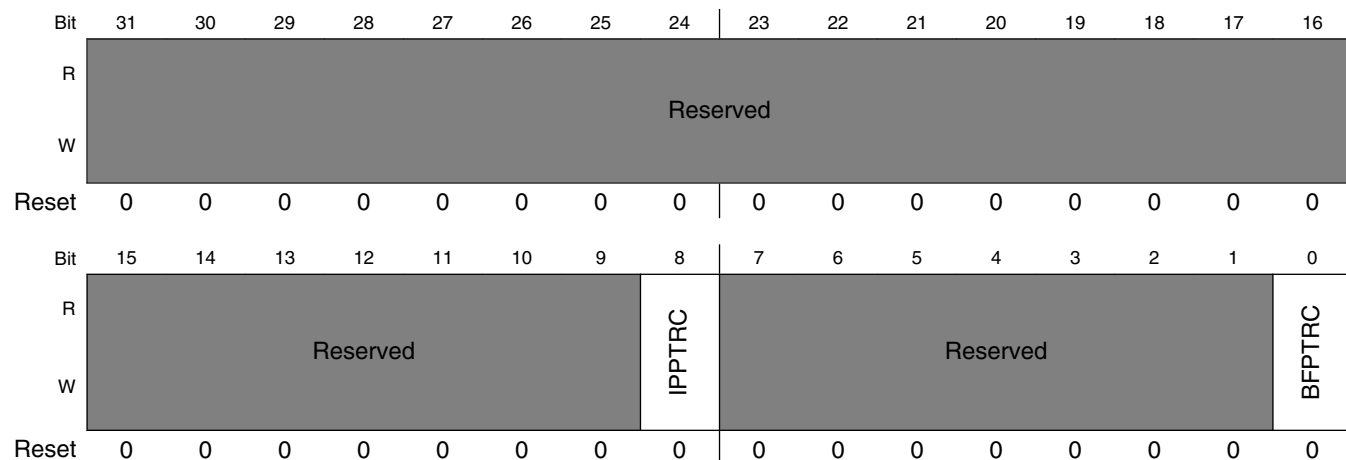

QuadSPI_SPTRCLR field descriptions

Field	Description
31–9 Reserved	This field is reserved.
8 IPTRC	IP Pointer Clear: 1: Clears the sequence pointer for IP accesses as defined in QuadSPI_IPCR
7–1 Reserved	This field is reserved. Reserved.
0 BPTRC	Buffer Pointer Clear: 1: Clears the sequence pointer for AHB accesses as defined in QuadSPI_BFGENCR.

42.14.23 Serial Flash A1 Top Address (QuadSPI_SFA1AD)

The QSPI_SFA1AD register provides the address mapping for the serial flash A1. The difference between QSPI_SFA1AD[TPADA1] and QSPI_AMBA_BASE defines the size of the memory map for serial flash A1.

Write:

- $QSPI_SR[IP_ACC] = 0$
- $QSPI_SR[AHB_ACC] = 0$

Address: 21E_0000h base + 180h offset = 21E_0180h

Bit	31	30	29	28	27	26	25	24	23	22	21	20	19	18	17	16	15	14	13	12	11	10	9	8	7	6	5	4	3	2	1	0
R	TPADA1																Reserved															
W	TPADA1																Reserved															
Reset	0	0	0	0	0	0	0	0	0	0	0	0	0	0	0	0	0	0	0	0	0	0	0	0	0	0	0	0	0	0	0	0

QuadSPI_SFA1AD field descriptions

Field	Description
31–10 TPADA1	Top address for Serial Flash A1. In effect, TPADxx is the first location of the next memory.
Reserved	This field is reserved.

42.14.24 Serial Flash A2 Top Address (QuadSPI_SFA2AD)

The QSPI_SFA2AD register provides the address mapping for the serial flash A2. The difference between QSPI_SFA2AD[TPADA2] and QSPI_SFA1AD[TPADA1] defines the size of the memory map for serial flash A2.

Write:

- $QSPI_SR[IP_ACC] = 0$
- $QSPI_SR[AHB_ACC] = 0$

Address: 21E_0000h base + 184h offset = 21E_0184h

Bit	31	30	29	28	27	26	25	24	23	22	21	20	19	18	17	16	15	14	13	12	11	10	9	8	7	6	5	4	3	2	1	0
R	TPADA2																Reserved															
W	TPADA2																Reserved															
Reset	0	0	0	0	0	0	0	0	0	0	0	0	0	0	0	0	0	0	0	0	0	0	0	0	0	0	0	0	0	0	0	0

QuadSPI_SFA2AD field descriptions

Field	Description
31–10 TPADA2	Top address for Serial Flash A2. In effect, TPxxAD is the first location of the next memory.
Reserved	This field is reserved.

42.14.25 Serial Flash B1 Top Address (QuadSPI_SFB1AD)

The QSPI_SFB1AD register provides the address mapping for the serial flash B1. The difference between QSPI_SFB1AD[TPADB1] and QSPI_SFA2AD[TPADA2] defines the size of the memory map for serial flash B1.

Write:

- $QSPI_SR[IP_ACC] = 0$
- $QSPI_SR[AHB_ACC] = 0$

Address: 21E_0000h base + 188h offset = 21E_0188h

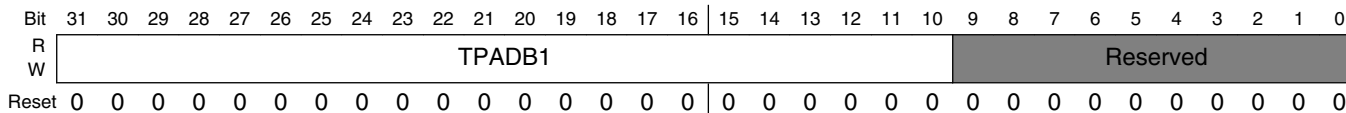

QuadSPI_SFB1AD field descriptions

Field	Description
31–10 TPADB1	Top address for Serial Flash B1. In effect, TPxxAD is the first location of the next memory.
Reserved	This field is reserved.

42.14.26 Serial Flash B2Top Address (QuadSPI_SFB2AD)

The QSPI_SFB2AD register provides the address mapping for the serial flash B2. The difference between QSPI_SFB2AD[TPADB2] and QSPI_SFB1AD[TPADB1] defines the size of the memory map for serial flash B2.

Write:

- $QSPI_SR[IP_ACC] = 0$
- $QSPI_SR[AHB_ACC] = 0$

Address: 21E_0000h base + 18Ch offset = 21E_018Ch

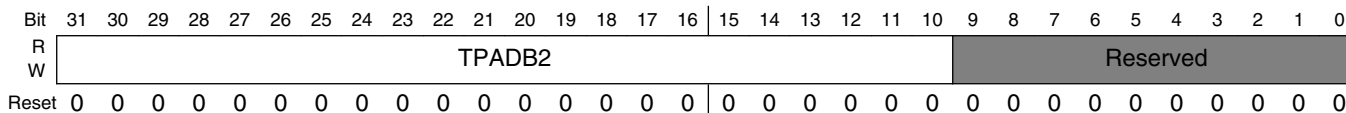

QuadSPI_SFB2AD field descriptions

Field	Description
31–10 TPADB2	Top address for Serial Flash B2. In effect, TPxxAD is the first location of the next memory.
Reserved	This field is reserved.

42.14.27 RX Buffer Data Register (QuadSPI_RBDRn)

The QuadSPI_RBDR registers provide access to the individual entries in the RX Buffer. Refer to [Table 42-14](#) for the byte ordering scheme.

QuadSPI_RBDR0 corresponds to the actual position of the read pointer within the RX Buffer. The number of valid entries available depends from the number of RX Buffer entries implemented and from the number of valid buffer entries available in the RX Buffer.

Example 1, RX Buffer filled completely with 32 words: In this case the address range for valid read access extends from QuadSPI_RBDR0 to QuadSPI_RBDR31.

Example 2, RX Buffer filled with 5 valid words: RX Buffer fill level QuadSPI_RBSR[RDBFL] is 5. In this case an access to QuadSPI_RBDR4 provides the last valid entry.

Any access beyond the range of valid RX Buffer entries provides undefined results.

Address: 21E_0000h base + 200h offset + (4d × i), where i=0d to 31d

Bit	31	30	29	28	27	26	25	24	23	22	21	20	19	18	17	16	15	14	13	12	11	10	9	8	7	6	5	4	3	2	1	0
R																																
W																																
Reset	0	0	0	0	0	0	0	0	0	0	0	0	0	0	0	0	0	0	0	0	0	0	0	0	0	0	0	0	0	0	0	0

QuadSPI_RBDRn field descriptions

Field	Description
RXDATA	RX Data. The RXDATA field contains the data associated with the related RX Buffer entry. Data format and byte ordering is given in Byte Ordering of Serial Flash Read Data .

42.14.28 LUT Key Register (QuadSPI_LUTKEY)

The LUT Key register contains the key to lock and unlock the Look-up-table. Refer to [Look-up Table](#) for details.

Write:Anytime

Address: 21E_0000h base + 300h offset = 21E_0300h

Bit	31	30	29	28	27	26	25	24	23	22	21	20	19	18	17	16	15	14	13	12	11	10	9	8	7	6	5	4	3	2	1	0
R																																
W																																
Reset	0	1	0	1	1	0	1	0	1	1	1	1	0	0	0	0	0	1	0	1	1	0	1	0	1	1	1	1	0	0	0	0

QuadSPI_LUTKEY field descriptions

Field	Description
KEY	The key to lock or unlock the LUT. The KEY is 0x5AF05AF0. The read value is always 0x5AF05AF0

42.14.29 LUT Lock Configuration Register (QuadSPI_LCKCR)

The LUT lock configuration register is used along with QSPI_LUTKEY register to lock or unlock the LUT. This register has to be written immediately after QSPI_LUTKEY register for the lock or unlock operation to be successful. Refer to [Look-up Table](#) for details. Setting both the LOCK and UNLOCK bits as "00" or "11" is not allowed.

Write: Just after writing the LUT Key Register

(QSPI_LUTKEY)

Address: 21E_0000h base + 304h offset = 21E_0304h

Bit	31	30	29	28	27	26	25	24	23	22	21	20	19	18	17	16
R	Reserved															
W	Reserved															
Reset	0	0	0	0	0	0	0	0	0	0	0	0	0	0	0	0
Bit	15	14	13	12	11	10	9	8	7	6	5	4	3	2	1	0
R	Reserved														UNLOCK	LOCK
W	Reserved														UNLOCK	LOCK
Reset	0	0	0	0	0	0	0	0	0	0	0	0	0	0	1	0

QuadSPI_LCKCR field descriptions

Field	Description
31–2 Reserved	This field is reserved.
1 UNLOCK	Unlocks the LUT when the following two conditions are met: <ol style="list-style-type: none"> 1. This register is written just after the LUT Key Register (QuadSPI_LUTKEY) 2. The LUT key register was written with 0x5AF05AF0 key
0 LOCK	Locks the LUT when the following condition is met: <ol style="list-style-type: none"> 1. This register is written just after the LUT Key Register (QuadSPI_LUTKEY) 2. The LUT key register was written with 0x5AF05AF0 key

42.14.30 Look-up Table register (QuadSPI_LUT0)

The LUT registers are a look-up-table for sequences of instructions. The programmable sequence engine executes the instructions in these sequences to generate a valid serial flash transaction. There are a total of 64 LUT registers. These 64 registers are divided into groups of 4 registers that make a valid sequence. Therefore, QSPI_LUT[0], QSPI_LUT[4], QSPI_LUT[8] QSPI_LUT[60] are the starting registers of a valid sequence. Each of these sets of 4 registers can have a maximum of 8 instructions. A maximum of 16 sequences can be defined at one time. [Look-up Table](#) describes the LUT registers in detail.

Write: Once the LUT is unlocked

Address: 21E_0000h base + 310h offset = 21E_0310h

Bit	31	30	29	28	27	26	25	24	23	22	21	20	19	18	17	16
R	INSTR1								PAD1		OPRND1					
W	INSTR1								PAD1		OPRND1					
Reset	0	0	0	0	1	0	0	0	0	0	0	1	1	0	0	0
Bit	15	14	13	12	11	10	9	8	7	6	5	4	3	2	1	0
R	INSTR0								PAD0		OPRND0					
W	INSTR0								PAD0		OPRND0					
Reset	0	0	0	0	0	1	0	0	0	0	0	0	0	0	1	1

QuadSPI_LUT0 field descriptions

Field	Description
31–26 INSTR1	Instruction 1
25–24 PAD1	Pad information for INSTR1. 00 1 Pad 01 2 Pads 10 4 Pads 11 NA
23–16 OPRND1	Operand for INSTR1.
15–10 INSTR0	Instruction 0
9–8 PAD0	Pad information for INSTR0. 00 1 Pad 01 2 Pads 10 4 Pads 11 NA
OPRND0	Operand for INSTR0.

42.14.31 Look-up Table register (QuadSPI_LUT1)

The LUT registers are a look-up-table for sequences of instructions. The programmable sequence engine executes the instructions in these sequences to generate a valid serial flash transaction. There are a total of 64 LUT registers. These 64 registers are divided into groups of 4 registers that make a valid sequence. Therefore, QSPI_LUT[0], QSPI_LUT[4], QSPI_LUT[8] QSPI_LUT[60] are the starting registers of a valid sequence. Each of these sets of 4 registers can have a maximum of 8 instructions. A maximum of 16 sequences can be defined at one time. [Look-up Table](#) describes the LUT registers in detail.

Write: Once the LUT is unlocked

Address: 21E_0000h base + 314h offset = 21E_0314h

Bit	31	30	29	28	27	26	25	24	23	22	21	20	19	18	17	16
R	INSTR1								PAD1				OPRND1			
W	INSTR1								PAD1				OPRND1			
Reset	0	0	1	0	0	1	0	0	0	0	0	0	0	0	0	0
Bit	15	14	13	12	11	10	9	8	7	6	5	4	3	2	1	0
R	INSTR0								PAD0				OPRND0			
W	INSTR0								PAD0				OPRND0			
Reset	0	0	0	1	1	1	0	0	0	0	0	0	1	0	0	0

QuadSPI_LUT1 field descriptions

Field	Description
31–26 INSTR1	Instruction 1
25–24 PAD1	Pad information for INSTR1. 00 1 Pad 01 2 Pads 10 4 Pads 11 NA
23–16 OPRND1	Operand for INSTR1.
15–10 INSTR0	Instruction 0
9–8 PAD0	Pad information for INSTR0. 00 1 Pad 01 2 Pads 10 4 Pads 11 NA
OPRND0	Operand for INSTR0.

42.14.32 Look-up Table register (QuadSPI_LUTn)

The LUT registers are a look-up-table for sequences of instructions. The programmable sequence engine executes the instructions in these sequences to generate a valid serial flash transaction. There are a total of 64 LUT registers. These 64 registers are divided into groups of 4 registers that make a valid sequence. Therefore, QSPI_LUT[0], QSPI_LUT[4], QSPI_LUT[8] QSPI_LUT[60] are the starting registers of a valid sequence. Each of these sets of 4 registers can have a maximum of 8 instructions. A maximum of 16 sequences can be defined at one time. [Look-up Table](#) describes the LUT registers in detail.

Write: Once the LUT is unlocked

Address: 21E_0000h base + 318h offset + (4d × i), where i=0d to 61d

Bit	31	30	29	28	27	26	25	24	23	22	21	20	19	18	17	16
R	INSTR1								PAD1				OPRND1			
W	INSTR1								PAD1				OPRND1			
Reset	0	0	0	0	0	0	0	0	0	0	0	0	0	0	0	0
Bit	15	14	13	12	11	10	9	8	7	6	5	4	3	2	1	0
R	INSTR0								PAD0				OPRND0			
W	INSTR0								PAD0				OPRND0			
Reset	0	0	0	0	0	0	0	0	0	0	0	0	0	0	0	0

QuadSPI_LUTn field descriptions

Field	Description
31–26 INSTR1	Instruction 1
25–24 PAD1	Pad information for INSTR1. 00 1 Pad 01 2 Pads 10 4 Pads 11 NA
23–16 OPRND1	Operand for INSTR1.
15–10 INSTR0	Instruction 0
9–8 PAD0	Pad information for INSTR0. 00 1 Pad 01 2 Pads 10 4 Pads 11 NA
OPRND0	Operand for INSTR0.

Chapter 43

ROM Controller with Patch (ROMC)

43.1 Overview

The Read Only Memory Controller with ROM Patch (ROMC) acts as an interface between the Arm advanced high-performance bus (AHB - Lite) and the Read Only Memory. The ROMC consists of a ROM Controller and a ROM Patch. The ROM Patch is used to either patch code routines or fix data tables in the ROM area. There is an IP Bus interface to access the ROM Patch Registers. The following figure depicts the main functional sub-blocks of the ROMC.

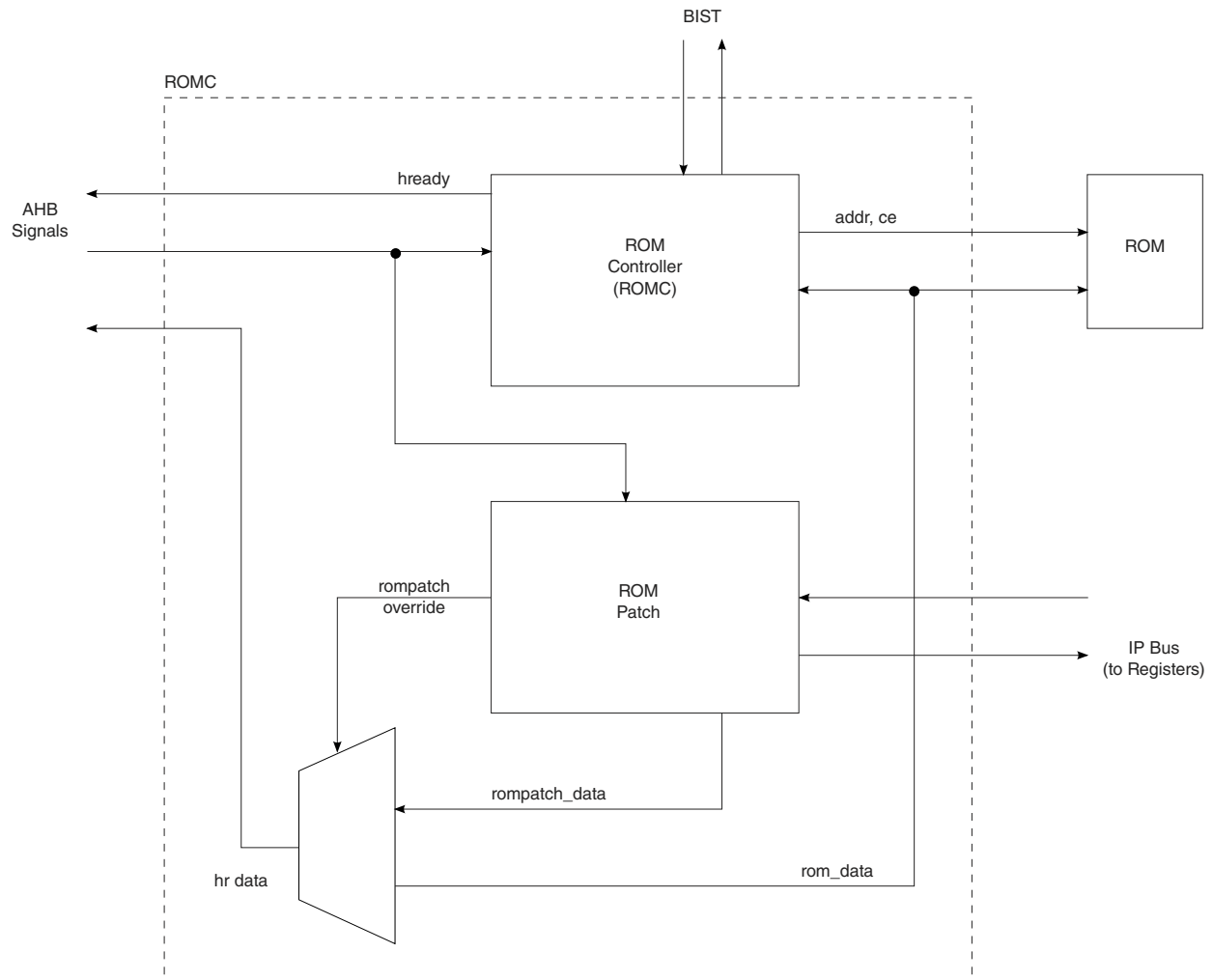

Figure 43-1. ROMC Block Diagram

43.1.1 Features

- Supports ROM size ranges from 16 Kbyte up to 4 Mbyte with increments of 1 Kbyte
- Supports opcode patching for a maximum of 16 different addresses in 4 Mbytes of ROM space
- Supports one-word data fixes for a max of 8 memory locations in 4 Mbytes of ROM space
- Supports patching of the Reset Vector (at 0x0000_0000) to allow external booting

43.1.2 Modes of Operation

There are two modes of operation: normal mode and BIST mode. In normal mode, the ROMC ensures correct reads from the ROM, assuming the memory complies with the characteristics and requirements for which the ROMC was designed.

43.1.2.1 Low Power Mode

There are two clock enables that are used to switch off parts of the ROMC logic when inactive. The first clock enable is used to disable the ROM Controller when the master connected to the AHB interface is not initiating a read to the ROM. The second clock enable is used to disable the registers used to program the ROM patch feature when the registers are not being accessed.

43.2 Clocks

The table found here describes the clock sources for ROMCP.

Please see [Clock Controller Module \(CCM\)](#) for clock setting, configuration and gating information.

Table 43-1. ROMCP Clocks

Clock name	Clock Root	Description
hclk	ahb_clk_root	System / bus clock
hclk_reg	ipg_clk_root	System access clock
96krom_CLK	ahb_clk_root	ROM clock

43.3 Memory Map

43.3.1 ROM Memory Map in detail

The ROMC supports ROM sizes with a range of 16 Kbyte to 4 Mbyte with an increment of 1 Kbyte. The 16 Kbyte lower limit was chosen because the minimum size of security code on an Arm platform is approximately 16 Kbyte of code, which is only accessible in supervisor mode. Note that it is the MMU that controls whether any region of memory is secure.

The exception vectors must be secured as well, and must be put in the same area as the security code. Since they must reside at address 0x0000_0000, the entire 16 Kbyte of ROM which can only be accessible in supervisor mode is located at the very beginning of the platform memory map.

If the user chooses not to use the security code, a memory size smaller than 16 Kbyte can be connected to the platform (minimum of 1 Kbyte). The MMU can be programmed to allow any kind of access into this memory. However, if the ROM size is less than 16 Kbyte, memory aliasing will occur for all invalid addresses greater than the memory size but within the 16 Kbyte of space.

For ROM sizes bigger than 16 Kbyte, the rest of its physical size resides at the address starting at 0x0040_4000 (4 M+16 Kbyte) going up to [0x0040_4000 + (mem. size - 16Kbyte)]. .

43.4 Functional Description

This section is divided up into the ROM Controller Functional Description and the ROMC functional description.

43.4.1 ROM Controller (ROMC) Functional Description

43.4.1.1 Functionality overview

The ROMC serves two main functions. First, as an interface between the AHB-Lite bus on an Arm platform and the ROM. Second, it drives and receives several signals for the BIST engine. In normal mode of operation, the ROMC monitors the AHB-Lite for memory access requests and performs the memory operation to the ROM.

The ROMC includes the option to wait state all accesses from either the Arm or non-Arm masters to ROM in the event that timing requirements will not allow single HCLK clock cycle reads. If a wait state is required, the static inputs `rom_wait_arm` or `rom_wait_alt_mstr` can be set to 1 and accesses will take two HCLK clock cycles. If wait states are not required, `rom_wait_arm` or `rom_wait_alt_mstr` can be set to 0 and accesses will take one HCLK clock cycle to complete.

43.4.2 ROMC Functional Description

43.4.2.1 ROMC Disabling

All the bits in the ROMC_ROMPATCHENL register are cleared on Reset, disabling all the address comparators. Once the comparators have been enabled, the ROMC functions of data fixing and opcode patching can be quickly disabled by setting the DIS bit in the ROMC_ROMPATCHCNTL register. This bit is used to enable secure operations in which patching functions need to be disabled. This bit is cleared on Reset.

43.4.2.2 ROMC Event Priority

The ROMC has a total of 16 address comparators. The first 8 (0 through 7) comparators can be programmed for the data fixing function (through the 8 data fix enable bits in the ROMC_ROMPATCHCNTL register) while the rest are for opcode patching by default. This allows for potential multiple matching events involving both data fixing and opcode patch types. In these cases the ROMC assigns the highest priority to a data fixing event.

For example, if the ROMC is set up to data fix a certain address with comparator 4 and also opcode patch the same address with comparator 7, it will let comparator 4 have higher priority in indicating a match, and data from ROMC_ROMPATCHD4 will be put on the rompatch_romc_hrdata bus as the override value.

If multiple address matches of the same type level occur concurrently, then the ROMC will choose the source number based on the one with the highest source number. For example, the ROMC is setup to data fix the same location with address comparators 4 and 7, then address comparator 7 will have higher priority in indicating a match, and the value from ROMC_ROMPATCHD7 will be put on the rompatch_romc_hrdata bus as the override value. The same priority applies for an opcode patch event, except the override data is in the form of an SWI instruction with the comment field set to the source number with the highest priority.

43.4.2.3 Data Fixing

The data fixing feature allows ROM data to be updated by direct replacement when it is being read. This data usually originates from data tables, but can include Arm instructions. To enable data fixing on a certain address, this address value is written in to one of the first eight (0 through 7) of ROMC_ROMPATCHAxx registers and the same numbered bit set in the ROMC_ROMPATCHENL and ROMC_ROMPATCHCNTL registers. The data to be used for replacement is placed in the corresponding ROMC_ROMPATCHDxx.

The ROMC looks for a read access to ROM (either code fetch or data load) by snooping the AHB interface for read transactions. The address is compared with the values stored in the ROMC_ROMPATCHAxx[22:2] registers. If a match occurs from one of the comparators, the ROMC places the value in the corresponding ROMC_ROMPATCHDxx register on the read data bus by overriding the read data coming from the actual ROM (see the mux in [Figure 43-1](#)). The value on the read data bus is maintained until hready is asserted to terminate the access. In data fixing, the entire word is replaced so if a byte or half-word access occurs on a "data fix" location, the entire data word is replaced. The word being replaced is word aligned. (The two LSBs of the matching ROMC_ROMPATCHAxx are ignored in the data fix operation.)

43.4.2.4 Opcode Patching

The opcode patch feature provides the Arm core a mechanism to fetch updated versions of code routines that were originally programmed in ROM. This patching mechanism makes use of the SWI (software interrupt instruction) and a table of function pointers residing in writable memory. The opcode being patched is replaced with a SWI instruction by the ROMC. Subsequent processing of the SWI reads from a function pointers table to obtain the address of the replacement code. Execution resumes with this code patch.

To enable opcode patching of a certain address, this address value is written into one of the ROMPATCHAxx registers and the corresponding bit set in the ROMPATCHENL to enable the associated comparator. The register's LSB (ROMC_ROMPATCHxx[0]) should be set if THUMB mode patching is in effect for this address. The ROMC identifies a ROM read access by snooping the AHB interface. The address is compared with the values stored in the ROMC_ROMPATCHAxx[22:2] registers. If a match occurs from one of the comparators, the ROMC generates the opcode of a software interrupt (SWI) instruction with the comment field containing the number of the matching address comparator. This opcode and comment is placed on the read data bus until hready is asserted by the ROM controller to terminate the read access.

The type of SWI generated, (that is, either Arm or THUMB), is determined by the LSB of the ROMC_ROMPATCHAxx register associated with the opcode patch. This bit is cleared for Arm mode (32 bits). The ROMC generates a 32-bit SWI (opcode field is 0xEF, occupying bits [31:24] of the word), with the least significant 5 bits of the 24-bit comment field (bits [23:0]) containing the number of the matching address comparator. The rest of the comment field is filled with zeros. This means that the ROMC will use 16 of the 16777216 possible software interrupts. The ROMC overrides the read data from the ROM.

If the LSB of the matching ROMC_ROMPATCHAxx register is set, the opcode patch is in THUMB mode (16 bits or half word). The ROMC generates a 16-bit SWI instruction (opcode field is 0xDF, occupying bits [15:8] of the half word) with the least significant 5 bits of the 8-bit comment field containing with the source number of the address comparator. The rest of the comments field is filled with zeros. This means that the ROMC will use 16 of the 256 possible software interrupts. The ROMC puts this 16 bit SWI instruction value on the proper half of the rompatch_romc_hrdata bus. The other half is zeroed out. Which half of the bus contains the SWI opcode and comment depends on the mode (Big Endian or Little Endian) and the bit 1 of the matching ROMC_ROMPATCHAxx register. In Little Endian mode, the lower half is bits {15:0} and the upper half is bits {31:16}. The order is reversed in Big Endian mode.

In Little Endian mode (bigend signal negated), if bit 1 of the matching ROMC_ROMPATCHAxx is cleared (lower half word selected) then the SWI instruction is put on the lower 16 bits of the read data bus and the upper 16 bits are zeroed out. Only the lower 16 bits of the read data bus is overwritten by the ROMC data. If ROMC_ROMPATCHAxx[1] is set (upper half word selected), the SWI instruction is put on the upper 16 bits of the read data bus and the lower 16 bits are zeroed out. Only the upper 16 bits of the read data bus is overwritten.

In Big Endian mode (bigend asserted), if bit 1 of the matching ROMC_ROMPATCHAxx is cleared (lower half word selected) then the SWI instruction is put on the upper 16 bits of the read data bus while the lower 16 bits are zeroed out. Only the upper 16 bits of the read data bus is overwritten. If ROMC_ROMPATCHAxx[1] is set (upper word selected), the SWI instruction is put on the lower 16 bits and the upper 16 bits are zeroed out. Only the lower 16 bits of the read data bus is overwritten.

The eventual execution of the SWI causes the Arm to save the CPSR in SPSR_SVC, the address of the next instruction after the SWI in R14_SVC, enter Supervisor mode, and fetch the SWI vector at 0x8, which then takes it to a handler for further processing as described in the next section.

43.4.2.4.1 Typical Software Response to Opcode Patch

When the SWI handler executes it needs to determine whether the SWI was generated by the ROMC. This is done by loading the SWI instruction and extracting its comment field. The state of the Arm core (Arm or THUMB) when the SWI was executed dictates whether to load the instruction word (Arm) or half word (THUMB). This state information can be determined by testing the T bit (bit 5) of the SPSR. If it's set, the execution was in THUMB mode.

By convention, if the comment field of the SWI is greater than 16, the software interrupt was initiated by software (i.e. an operating system call), and a branch is taken to the appropriate handler routine for further processing. If the comment field is less than 16, the SWI was generated by the ROMC performing a code patch operation. In this case, the software then reads from a table of function pointers, using the value in the SWI comment field as the index into the table. The value that is read is the address of the code patch. This value is loaded into the PC to begin the execution of the code patch. The following code segment illustrates a typical handling of the SWI.

```

stmfd      sp!, {r0-r1,lr}          @ push register onto SWI stack
mrs       r0, spsr                 @ get saved status register
tst       r0, #0x20                 @ check if call was in THUMB mode
ldrneh    r0, [lr,#-2]              @ yes: load opcode half-word and
bicne    r0, r0, #0xff00           @ yes: extract THUMB comment
ldreq     r0, [lr,#-4]              @ no: load opcode word and
biceq     r0, r0, #0xff000000       @ no: extract ARM comment
                                                @ now r0 has comment field
cmp       r0, #16                   @ compare to 16 (maximum for ROMC)
ldrlt     lr, =rompatch_tbl_ptr    @ < 16: get top of current ROMC
                                                @ table; global variable which is
                                                @ changeable per context
ldrlt     r1, [lr, r0, lsl #2]      @ < 16: read function pointer from
                                                @ table assumed an array of pointers
                                                @ patch functions
strlt     r1, [sp, #8]              @ < 16: store function pointer onto
                                                @ stack in position of link register
ldmpltfd  sp!, {r0-r1,pc}^         @ < 16: "fake" return from SWI, will
                                                @ vector core to appropriate patch
                                                @ function and set core back to previous
                                                @ mode of operating
ldr       r1, =swi_hdlr            @ >= 16: pointer to standard SWI
                                                @ handler
mov       lr, pc                    @ >= 16: set link register
bx       r1                          @ >= 16: jump to standard SWI
                                                @ handler
ldmfd     sp!, {r0-r1,pc}^         @ >= 16: pop registers from stack

```

43.4.2.5 External Boot Feature

Following a Reset event, the Arm issues an instruction fetch of the Reset Vector from address 0x0. This instruction, normally residing in ROM is usually a branch to a Reset handler or boot code which also normally resides in ROM. The ROMC external boot feature allows the bypassing of this code, using a different boot code residing perhaps in external memory.

This feature uses the data fix mechanism and works as follows: if the boot_int signal is negated when a Reset event occurred, the ROMC will perform a data fix of the Reset Vector at 0x0 with the following instruction (opcode 0xE59FF00C):

```

ldr       pc, [pc, #12]             @ read 0x0000_0014 for reset_vector

```

The value of PC when this instruction is executed is 8 so that a PC relative offset of 12 makes the source address 20 or 0x14. When this instruction executes, the Arm core reads from address 0x0000_0014, triggering a ROMC data fix operation which places the value

taken from the external boot address on the read data bus, with the two LSBs zeroed out. This value is returned to the Arm to be placed in the PC causing code fetch and execution to start from that address.

43.4.2.6 Alternate Masters and ROMC

The ROMC sits on the AHB bus of the internal ROM (ROMC). This means that the ROMC can modify values on the read data bus going to the master. Therefore, any master which reads an opcode patched or data patched location will read patched data.

43.5 ROMCP Memory Map/Register Definition

All registers are accessible through an IP Bus and can only be accessed in privileged mode. These registers can only be written with 32-bits stores and are clocked by hclk_reg.

ROMC memory map

Absolute address (hex)	Register name	Width (in bits)	Access	Reset value	Section/page
21A_C0D4	ROMC Data Registers (ROMC_ROMPATCH7D)	32	R/W	0000_0000h	43.5.1/3084
21A_C0D8	ROMC Data Registers (ROMC_ROMPATCH6D)	32	R/W	0000_0000h	43.5.1/3084
21A_C0DC	ROMC Data Registers (ROMC_ROMPATCH5D)	32	R/W	0000_0000h	43.5.1/3084
21A_C0E0	ROMC Data Registers (ROMC_ROMPATCH4D)	32	R/W	0000_0000h	43.5.1/3084
21A_C0E4	ROMC Data Registers (ROMC_ROMPATCH3D)	32	R/W	0000_0000h	43.5.1/3084
21A_C0E8	ROMC Data Registers (ROMC_ROMPATCH2D)	32	R/W	0000_0000h	43.5.1/3084
21A_C0EC	ROMC Data Registers (ROMC_ROMPATCH1D)	32	R/W	0000_0000h	43.5.1/3084
21A_C0F0	ROMC Data Registers (ROMC_ROMPATCH0D)	32	R/W	0000_0000h	43.5.1/3084
21A_C0F4	ROMC Control Register (ROMC_ROMPATCHCNTL)	32	R/W	0840_0000h	43.5.2/3085
21A_C0F8	ROMC Enable Register High (ROMC_ROMPATCHENH)	32	R	0000_0000h	43.5.3/3086
21A_C0FC	ROMC Enable Register Low (ROMC_ROMPATCHENL)	32	R/W	0000_0000h	43.5.4/3086
21A_C100	ROMC Address Registers (ROMC_ROMPATCH0A)	32	R/W	0000_0000h	43.5.5/3087
21A_C104	ROMC Address Registers (ROMC_ROMPATCH1A)	32	R/W	0000_0000h	43.5.5/3087
21A_C108	ROMC Address Registers (ROMC_ROMPATCH2A)	32	R/W	0000_0000h	43.5.5/3087
21A_C10C	ROMC Address Registers (ROMC_ROMPATCH3A)	32	R/W	0000_0000h	43.5.5/3087
21A_C110	ROMC Address Registers (ROMC_ROMPATCH4A)	32	R/W	0000_0000h	43.5.5/3087
21A_C114	ROMC Address Registers (ROMC_ROMPATCH5A)	32	R/W	0000_0000h	43.5.5/3087
21A_C118	ROMC Address Registers (ROMC_ROMPATCH6A)	32	R/W	0000_0000h	43.5.5/3087

Table continues on the next page...

ROMC memory map (continued)

Absolute address (hex)	Register name	Width (in bits)	Access	Reset value	Section/page
21A_C11C	ROMC Address Registers (ROMC_ROMPATCH7A)	32	R/W	0000_0000h	43.5.5/3087
21A_C120	ROMC Address Registers (ROMC_ROMPATCH8A)	32	R/W	0000_0000h	43.5.5/3087
21A_C124	ROMC Address Registers (ROMC_ROMPATCH9A)	32	R/W	0000_0000h	43.5.5/3087
21A_C128	ROMC Address Registers (ROMC_ROMPATCH10A)	32	R/W	0000_0000h	43.5.5/3087
21A_C12C	ROMC Address Registers (ROMC_ROMPATCH11A)	32	R/W	0000_0000h	43.5.5/3087
21A_C130	ROMC Address Registers (ROMC_ROMPATCH12A)	32	R/W	0000_0000h	43.5.5/3087
21A_C134	ROMC Address Registers (ROMC_ROMPATCH13A)	32	R/W	0000_0000h	43.5.5/3087
21A_C138	ROMC Address Registers (ROMC_ROMPATCH14A)	32	R/W	0000_0000h	43.5.5/3087
21A_C13C	ROMC Address Registers (ROMC_ROMPATCH15A)	32	R/W	0000_0000h	43.5.5/3087
21A_C208	ROMC Status Register (ROMC_ROMPATCHSR)	32	w1c	0000_0000h	43.5.6/3088

43.5.1 ROMC Data Registers (ROMC_ROMPATCHnD)

The ROMC data registers (ROMC_ROMPATCH 7D through ROMC_ROMPATCH 0D) store the data to use for the 8 1-word data fix events. Each register is associated with an address comparator (7 through 0). When a data fixing event occurs, the value in the data register corresponding to the comparator that has the address match is put on the romc_hrdata[31:0] bus until romc_hready is asserted by the ROM controller to terminate the access. A MUX external to the ROMC will select this data over that of romc_hrdata[31:0] in returning read data to the Arm core. The selection is done with the control bus rompatch_romc_hrdata_ovr[1:0] with both bits asserted by the ROMC.

If more than one address comparators match, the highest-numbered one takes precedence, and the value in corresponding data register is used for the patching event.

Address: 21A_C000h base + D4h offset + (4d × i), where i=0d to 7d

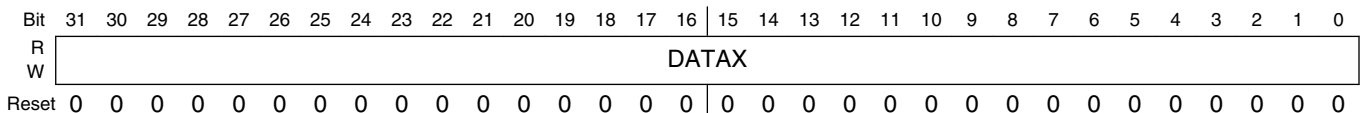

ROMC_ROMPATCHnD field descriptions

Field	Description
DATAx	Data Fix Registers - Stores the data used for 1-word data fix operations. The values stored within these registers do not affect the writes to the memory system. They are selected over the read data from ROM when a data fix event occurs. If any part of the 1-word data fix is read, then the entire word is replaced. Therefore, a byte or half-word read will cause the ROMC to replace the entire word. The word is word address aligned.

43.5.2 ROMC Control Register (ROMC_ROMPATCHCNTL)

The ROMC control register (ROMC_ROMPATCHCNTL) contains the block disable bit and the data fix enable bits. The block disable bit provides a means to disable the ROMC data fix and opcode patching functions, even when the address comparators are enabled. The External Boot feature is not affected by this bit. The eight data fix enable bits (0 through 7), when set, assign the associated address comparators to data fix operations

NOTE

Bits 27 and 22 always read as 1s.

Address: 21A_C000h base + F4h offset = 21A_C0F4h

Bit	31	30	29	28	27	26	25	24	23	22	21	20	19	18	17	16
R																
W	Reserved		DIS	Reserved				Reserved								
Reset	0	0	0	0	1	0	0	0	0	1	0	0	0	0	0	0
Bit	15	14	13	12	11	10	9	8	7	6	5	4	3	2	1	0
R	Reserved								DATAFIX							
W	Reserved								DATAFIX							
Reset	0	0	0	0	0	0	0	0	0	0	0	0	0	0	0	0

ROMC_ROMPATCHCNTL field descriptions

Field	Description
31–30 -	This field is reserved. Reserved
29 DIS	ROMC Disable -- This bit, when set, disables all ROMC operations. This bit is used to enable secure operations. 0 Does not affect any ROMC functions (default) 1 Disable all ROMC functions: data fixing, and opcode patching
28–8 -	This field is reserved. Reserved
DATAFIX	Data Fix Enable - Controls the use of the first 8 address comparators for 1-word data fix or for code patch routine. 0 Address comparator triggers a opcode patch 1 Address comparator triggers a data fix

43.5.3 ROMC Enable Register High (ROMC_ROMPATCHENH)

The ROMC enable register high (ROMC_ROMPATCHENH) and ROMC enable register low (ROMC_ROMPATCHENL) control whether or not the associated address comparator can trigger a opcode patch or data fix event. This implementation of the ROMC only has 16 comparators, therefore ROMC_ROMPATCHENH and the upper half of ROMC_ROMPATCHENL are read-only. ROMC_ROMPATCHENL[15:0] are associated with comparators 15 through 0. ROMC_ROMPATCHENLH[31:0] would have been associated with comparators 63 through 32.

Address: 21A_C000h base + F8h offset = 21A_C0F8h

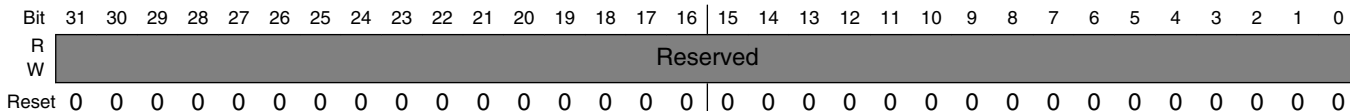

ROMC_ROMPATCHENH field descriptions

Field	Description
-	This field is reserved. Reserved

43.5.4 ROMC Enable Register Low (ROMC_ROMPATCHENL)

The ROMC enable register high (ROMC_ROMPATCHENH) and ROMC enable register low (ROMC_ROMPATCHENL) control whether or not the associated address comparator can trigger a opcode patch or data fix event. This implementation of the ROMC only has 16 comparators, therefore ROMC_ROMPATCHENH and the upper half of ROMC_ROMPATCHENL are read-only. ROMC_ROMPATCHENL[15:0] are associated with comparators 15 through 0. ROMC_ROMPATCHENLH[31:0] would have been associated with comparators 63 through 32.

Address: 21A_C000h base + FCh offset = 21A_C0FCh

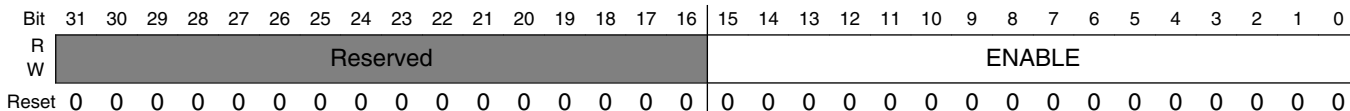

ROMC_ROMPATCHENL field descriptions

Field	Description
31–16 Reserved	This field is reserved.
ENABLE	<p>Enable Address Comparator - This bit enables the corresponding address comparator to trigger an event.</p> <p>0 Address comparator disabled</p> <p>1 Address comparator enabled, ROMC will trigger a opcode patch or data fix event upon matching of the associated address</p>

43.5.5 ROMC Address Registers (ROMC_ROMPATCHnA)

The ROMC address registers (ROMC_ROMPATCHA0 through ROMC_ROMPATCHA15) store the memory addresses where opcode patching begins and data fixing occurs. The address registers ROMC_ROMPATCHA0 through ROMC_ROMPATCHA15 are each 21 bits wide and dedicated to one 4 Mbyte memory space. Bits 21 through 2 are address bits, to be compared with romc_haddr[21:2] for a match; bit 1 is also an address bit used for half word selection. Bit 0 is the mode bit (set to 1 for THUMB mode). 1-word data fixing can only be used on the first 8 of the address comparators. ROMC_ROMPATCHA0 through ROMC_ROMPATCHA15 are associated each with address comparators 0 through 15.

Address: 21A_C000h base + 100h offset + (4d × i), where i=0d to 15d

Bit	31	30	29	28	27	26	25	24	23	22	21	20	19	18	17	16
R	Reserved								ADDRX							
W																
Reset	0	0	0	0	0	0	0	0	0	0	0	0	0	0	0	0
Bit	15	14	13	12	11	10	9	8	7	6	5	4	3	2	1	0
R	ADDRX															THUMBX
W																
Reset	0	0	0	0	0	0	0	0	0	0	0	0	0	0	0	0

ROMC_ROMPATCHnA field descriptions

Field	Description
31–23 -	This field is reserved. Reserved

Table continues on the next page...

ROMC_ROMPATCHnA field descriptions (continued)

Field	Description
22–1 ADDRX	Address Comparator Registers - Indicates the memory address to be watched. All 16 registers can be used for code patch address comparison. Only the first 8 registers can be used for a 1-word data fix address comparison. Bit 1 is ignored if data fix. Only used in code patch
0 THUMBX	THUMB Comparator Select - Indicates that this address will trigger a THUMB opcode patch or an Arm opcode patch. If this watchpoint is selected to be a data fix, then this bit is ignored as all data fixes are 1-word data fixes. 0 Arm patch 1 THUMB patch (ignore if data fix)

43.5.6 ROMC Status Register (ROMC_ROMPATCHSR)

The ROMC status register (ROMC_ROMPATCHSR) indicates the current state of the ROMC and the source number of the most recent address comparator event.

Address: 21A_C000h base + 208h offset = 21A_C208h

Bit	31	30	29	28	27	26	25	24	23	22	21	20	19	18	17	16
R	Reserved														SW	Reserv ed
W	Reserved														w1c	
Reset	0	0	0	0	0	0	0	0	0	0	0	0	0	0	0	0
Bit	15	14	13	12	11	10	9	8	7	6	5	4	3	2	1	0
R	Reserved										SOURCE					
W	Reserved										Reserved					
Reset	0	0	0	0	0	0	0	0	0	0	0	0	0	0	0	0

ROMC_ROMPATCHSR field descriptions

Field	Description
31–18 -	This field is reserved. Reserved
17 SW	ROMC AHB Multiple Address Comparator matches Indicator - Indicates that multiple address comparator matches occurred. Writing a 1 to this bit will clear this it. 0 no event or comparator collisions 1 a collision has occurred
16–6 -	This field is reserved. Reserved
SOURCE	ROMC Source Number - Binary encoding of the number of the address comparator which has an address match in the most recent patch event on ROMC AHB. If multiple matches occurred, the highest priority source number is used.

Table continues on the next page...

ROMC_ROMPATCHSR field descriptions (continued)

Field	Description
0	Address Comparator 0 matched
1	Address Comparator 1 matched
15	Address Comparator 15 matched

Chapter 44

Random Number Generator (RNGB)

44.1 Introduction

The purpose of the RNGB is to generate cryptographically strong random data.

It uses the True Random Number Generator (TRNG) and a Pseudo-Random Number Generator (PRNG) to achieve a true randomness and cryptographic strength. The RNGB generates random numbers for secret keys, per message secrets, random challenges, and other similar quantities used in the cryptographic algorithms.

This chapter describes the Random Number Generator (RNGB), including the programming model, functional description, and application information.

44.1.1 Block diagram

These figures show the RNGB's three main blocks: PRNG, TRNG, and XSEED generator.

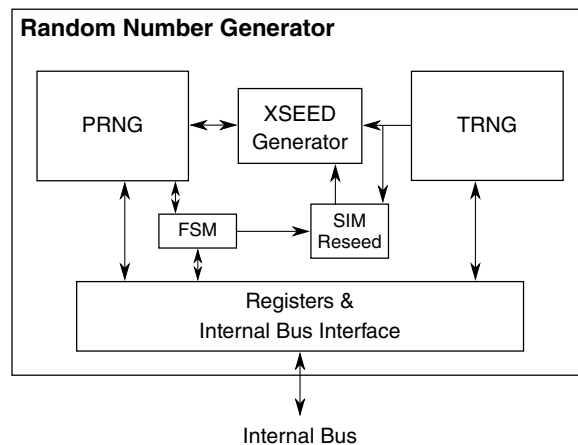

Figure 44-1. RNG block diagram

44.1.2 Features

The RNG includes these distinctive features:

- National Institute of Standards and Technology (NIST)-approved pseudo-random number generator
 - <http://csrc.nist.gov>
- Supports the key generation algorithm defined in the Digital Signature Standard
 - <http://www.itl.nist.gov/fipspubs/fip186.htm>
- Integrated entropy sources capable of providing the PRNG with the entropy for its seed.

44.2 Modes of operation

Operational modes of the RNGB can be found here.

44.2.1 Self-test mode

In this mode, the RNGB performs a self test of the statistical counters and the PRNG algorithm to verify that the hardware is functioning properly. The self test takes ~29,000 cycles to complete. When the self test completes, an interrupt can be generated if there are no outstanding commands in the command register. This mode is entered by setting the RNG_CMD[ST] bit. When the self-test mode completes, the RNGB remains idle until the seed mode is requested or the RNGB transitions to seed mode if the automatic seeding is enabled.

44.2.2 Seed-generation mode

During the seed generation, the RNGB adds the entropy generated in the TRNG to the 256-bit XKEY register. The PRNG algorithm executes 20,000 entropy samples from the TRNG to create an initial seed for the random number generation. At the same time, the TRNG runs simple statistical tests on its output.

When the seed generation is complete, the TRNG reports the pass/fail result of the tests through RNG_ESR. If the new seed passes the statistical tests, the RNG_SR[SDN] is set, signalling that the RNG is ready to compute the secure pseudo-random data. The RNG then transitions to the random number generation mode.

44.2.3 Random number generation mode

When the seed-generation mode completes and the output FIFO is empty, the RNG enters this mode automatically. The random number generation mode quickly creates the computationally-random data that is derived by the initial seed produced in the seed-generation mode.

During the random number generation, a new 160-bit random number is generated whenever the five-word output FIFO is empty. When the output FIFO contains data, the RNGB automatically enters the sleep mode, waiting for the data to be read. When the data is read, the RNGB generates a new 160-bit word and goes back to sleep.

After generating 2^{20} words of random data, the RNGB lets the user know that it requires reseeding through RNG_SR and continues to generate random data until it is directed to reseed. However, if the auto-seeding is selected, the RNGB automatically completes the seeding whenever it is needed.

44.3 Memory map/register definition

The following table shows the address map for the RNGB module. The detailed register descriptions are explained in the following sections.

RNGB memory map

Absolute address (hex)	Register name	Width (in bits)	Access	Reset value	Section/page
228_4000	RNGB version ID register (RNG_VER)	32	R	1000_0280h	44.3.1/3094
228_4004	RNGB command register (RNG_CMD)	32	R/W	0000_0000h	44.3.2/3094
228_4008	RNGB control register (RNG_CR)	32	R/W	0000_0000h	44.3.3/3096
228_400C	RNGB status register (RNG_SR)	32	R	0000_500Dh	44.3.4/3098
228_4010	RNGB error status register (RNG_ESR)	32	R	0000_0000h	44.3.5/3100
228_4014	RNGB Output FIFO (RNG_OUT)	32	R	0000_0000h	44.3.6/3102

44.3.1 RNGB version ID register (RNG_VER)

The read-only RNG_VER register contains the current version of the RNGB. It consists of the RNG type and the major and minor revision numbers.

Address: 228_4000h base + 0h offset = 228_4000h

Bit	31	30	29	28	27	26	25	24	23	22	21	20	19	18	17	16	15	14	13	12	11	10	9	8	7	6	5	4	3	2	1	0		
R	TYPE				0												MAJOR				MINOR													
W	[Shaded]																																	
Reset	0	0	0	1	0	0	0	0	0	0	0	0	0	0	0	0	0	0	0	0	0	0	0	0	1	0	1	0	0	0	0	0	0	0

RNG_VER field descriptions

Field	Description
31–28 TYPE	Random number generator type 0000 RNGA 0001 RNGB (This is the type used in this module.) 0010 RNGC Else Reserved
27–16 Reserved	This field is reserved. This read-only field is reserved and always has the value 0.
15–8 MAJOR	Major version number This field is always set to 0x02.
MINOR	Minor version number Subject to change

44.3.2 RNGB command register (RNG_CMD)

The RNG_CMD controls the RNG's operating modes and interrupt status.

Address: 228_4000h base + 4h offset = 228_4004h

Bit	31	30	29	28	27	26	25	24	23	22	21	20	19	18	17	16
R	0															
W	[Shaded]															
Reset	0	0	0	0	0	0	0	0	0	0	0	0	0	0	0	0
Bit	15	14	13	12	11	10	9	8	7	6	5	4	3	2	1	0
R	0								0	0	0	0			GS	ST
W	[Shaded]								SR	CE	CI	[Shaded]			GS	ST
Reset	0	0	0	0	0	0	0	0	0	0	0	0	0	0	0	0

RNG_CMD field descriptions

Field	Description
31–7 Reserved	This field is reserved. This read-only field is reserved and always has the value 0.
6 SR	Software reset Perform a software reset of the RNGB. This bit is self-clearing. 0 Do not perform a software reset. 1 Software reset
5 CE	Clear the error. Clear the errors in the RNG_ESR register and the RNGB interrupt. This bit is self-clearing. 0 Do not clear the errors and the interrupt. 1 Clear the errors and the interrupt.
4 CI	Clear the interrupt. Clear the RNGB interrupt if an error is not present. This bit is self-clearing. 0 Do not clear the interrupt. 1 Clear the interrupt.
3–2 Reserved	This field is reserved. This read-only field is reserved and always has the value 0.
1 GS	Generate the seed. Initiates the seed generation process. The seed generation starts. <ul style="list-style-type: none"> When the RNG_SR[BUSY] is cleared. If set simultaneously with the ST, after the self test. When the seed generation process completes, this bit automatically clears and an interrupt can be generated if all requested operations are complete. 0 Not in the seed generation mode 1 Generate the seed mode.
0 ST	Self test Initiates a self test of the RNGB's internal logic. The self test starts. <ul style="list-style-type: none"> When RNG_SR[BUSY] is cleared. If set simultaneously with the GS, the self test takes the precedence and is completed first. When the self test completes, this bit automatically clears and an interrupt may be generated if all requested operations are complete. 0 Not in the self-test mode 1 Self-test mode

44.3.3 RNGB control register (RNG_CR)

By using this register, the RNGB can be programmed to provide a slightly different functionality based on its desired use.

Address: 228_4000h base + 8h offset = 228_4008h

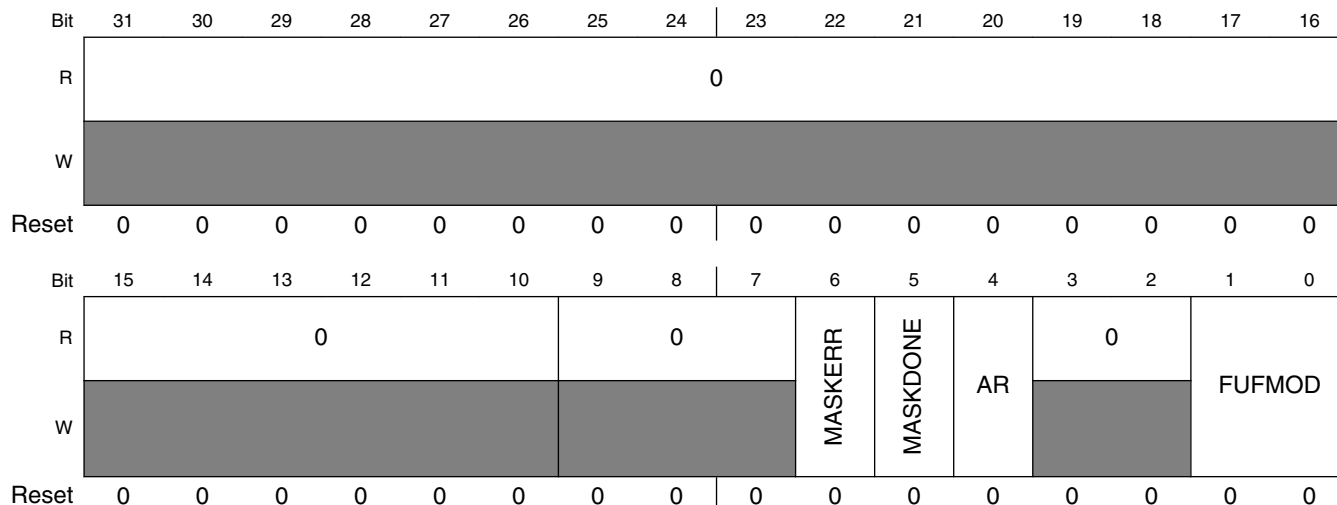

RNG_CR field descriptions

Field	Description
31–10 Reserved	This field is reserved. This read-only field is reserved and always has the value 0.
9–7 Reserved	This field is reserved. This read-only field is reserved and always has the value 0.
6 MASKERR	Mask the error interrupt. Masks the interrupts generated by errors in the RNGB. These errors can still be viewed in RNG_ESR. NOTE: Because the masked errors do not interrupt the operation of the RNGB and thus hide the potentially fatal errors or conditions that can result in corrupted results, it is strongly recommended to mask the errors while debugging. All errors are considered fatal, requiring the RNGB to be reset. Until the reset occurs, the RNGB does not service any random data. 0 No mask is applied. 1 The mask applied to the error interrupt
5 MASKDONE	Mask the interrupt done. Masks the interrupts generated upon the completion of the seed and self-test modes. The status of these jobs can be viewed by: <ul style="list-style-type: none"> • Reading the RNG_SR and viewing the seed done and the self-test done bits (RNG_SR[SDN, STDN]). • Viewing the RNG_CMD for the generate-seed or the self-test bits (RNG_CMD[GS,ST]) being set, indicating that the operation is still taking place.

Table continues on the next page...

RNG_CR field descriptions (continued)

Field	Description
	0 No mask is applied. 1 The mask is applied.
4 AR	Auto-reseed Setting this bit enables the RNGB to automatically generate a new seed whenever it is needed. This enables the software to never use the RNG_CMD[GS], although it is still possible. A new seed is needed whenever the RNG_SR[RS] is set. 0 Do not enable the automatic reseeding. 1 Enable the automatic reseeding.
3–2 Reserved	This field is reserved. This read-only field is reserved and always has the value 0.
FUFMOD	FIFO underflow response mode Controls the RNGB's response to a FIFO underflow condition. 00 Return all zeros and set the RNG_ESR[FUFE]. 01 Return all zeros and set the RNG_ESR[FUFE]. 10 Generate the bus transfer error 11 Generate the interrupt and return all zeros (overrides the RNG_CR[MASKERR]).

44.3.4 RNGB status register (RNG_SR)

The RNGBSR is a read-only register which reflects the internal status of the RNGB.

Address: 228_4000h base + Ch offset = 228_400Ch

Bit	31	30	29	28	27	26	25	24	23	22	21	20	19	18	17	16
R	STATPF								ST_PF			0				ERR
W																
Reset	0	0	0	0	0	0	0	0	0	0	0	0	0	0	0	0
Bit	15	14	13	12	11	10	9	8	7	6	5	4	3	2	1	0
R	FIFO_SIZE				FIFO_LVL				0	NSDN	SDN	STDN	RS	SLP	BUSY	1
W																
Reset	0	1	0	1	0	0	0	0	0	0	0	0	1	1	0	1

RNG_SR field descriptions

Field	Description
31–24 STATPF	<p>Statistics test pass failed.</p> <p>Indicates the pass or fail status of the various statistics tests on the last seed generated.</p> <ul style="list-style-type: none"> • Bit 31 - Long run test (>34) • Bit 30 - Length 6+ run test • Bit 29 - Length 5 run test • Bit 28 - Length 4 run test • Bit 27 - Length 3 run test • Bit 26 - Length 2 run test • Bit 25 - Length 1 run test • Bit 24 - Monobit test <p>0 Pass 1 Fail</p>
23–21 ST_PF	<p>Self-test pass fail</p> <p>Indicates the pass or fail status of the TRNG, PRNG, and RESEED self tests.</p> <ul style="list-style-type: none"> • Bit 23 - TRNG self test pass/fail

Table continues on the next page...

RNG_SR field descriptions (continued)

Field	Description
	<ul style="list-style-type: none"> • Bit 22 - PRNG self test pass/fail • Bit 21 - RESEED self test pass/fail 0 Pass 1 Fail
20–17 Reserved	This field is reserved. This read-only field is reserved and always has the value 0.
16 ERR	Error Indicates that an error was detected in the RNGB. Read the RNG_ESR register for details. 0 No error 1 Error detected
15–12 FIFO_SIZE	FIFO size Size of the FIFO, and the maximum possible FIFO level. The bits must be interpreted as an integer. This value is set to 5 on the default version of the RNGB.
11–8 FIFO_LVL	FIFO level Indicates the number of random words currently in the output FIFO. The bits must be interpreted as an integer.
7 Reserved	This field is reserved. This read-only field is reserved and always has the value 0.
6 NSDN	New seed done Indicates that a new seed is ready for use during the next seed-generation process.
5 SDN	Seed done Indicates that the RNG generated the first seed. 0 The seed-generation process is not complete. 1 Completed the seed generation since the last reset
4 STDN	Self test done Indicates that the self test is complete. This bit is cleared by the hardware reset or a new self test is initiated by setting the RNG_CMD[ST]. 0 Self test not completed 1 Completed a self test since the last reset
3 RS	Reseed needed Indicates that the RNGB needs to be reseeded. This is done by setting the RNG_CMD[GS], or automatically if the RNG_CR[AR] is set. 0 The RNGB does not need to be reseeded. 1 The RNGB needs to be reseeded.
2 SLP	Sleep Indicates whether the RNGB is in the sleep mode. When set, the RNGB is in the sleep mode and all internal clocks are disabled. While in this mode, access to the FIFO is allowed. Once the FIFO is empty, the RNGB fills the FIFO and then enters sleep mode again.

Table continues on the next page...

RNG_SR field descriptions (continued)

Field	Description
	0 The RNGB is not in the sleep mode. 1 The RNGB is in the sleep mode.
1 BUSY	Busy. Reflects the current state of the RNGB. If the RNGB is currently seeding, generating the next seed, creating a new random number, or performing a self test, this bit is set. 0 Not busy 1 Busy
0 Reserved	This field is reserved. This read-only field is reserved and always has the value 1.

44.3.5 RNGB error status register (RNG_ESR)

Address: 228_4000h base + 10h offset = 228_4010h

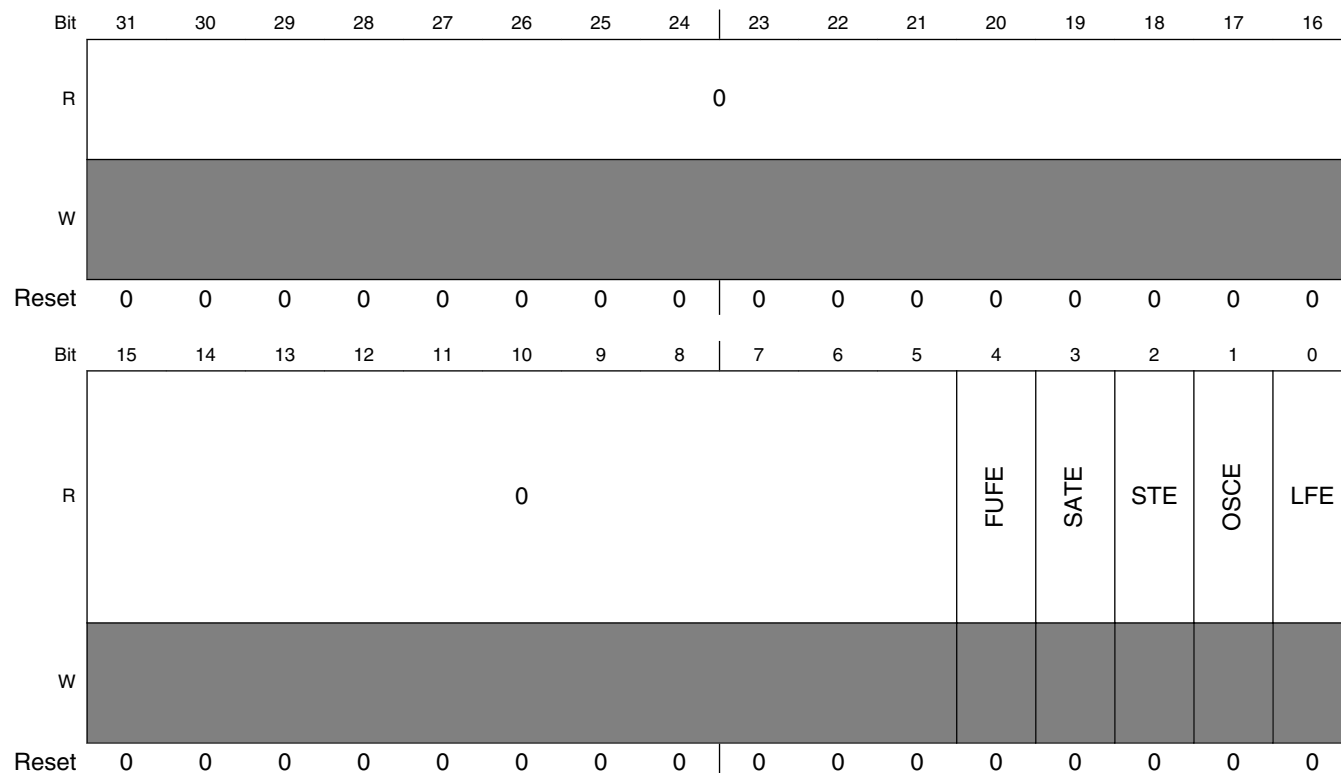

RNG_ESR field descriptions

Field	Description
31–5 Reserved	This field is reserved. This read-only field is reserved and always has the value 0.

Table continues on the next page...

RNG_ESR field descriptions (continued)

Field	Description
4 FUFE	<p>FIFO underflow error</p> <p>Indicates that the RNGB has experienced a FIFO underflow condition, resulting in the last random data read being unreliable. This bit can be masked by the RNG_CR[FUFMOD] and is cleared by a hardware or software reset or by writing 1 to the RNG_CMD[CE].</p> <p>0 FIFO underflow did not occur. 1 FIFO underflow occurred.</p>
3 SATE	<p>Statistical test error</p> <p>Indicates whether the RNGB failed the statistical tests for the last generated seed. This bit is sticky and is cleared by a hardware or software reset or by writing 1 to the RNG_CMD[CE].</p> <p>0 The RNGB did not fail the statistical tests. 1 The RNGB failed the statistical tests during the initialization.</p>
2 STE	<p>Self-test error</p> <p>Indicates that the RNGB failed the most recent self test. This bit is sticky and can only be reset by a hardware reset or by writing 1 to the RNG_CMD[CE].</p> <p>0 The RNGB did not fail the self test. 1 The RNGB failed the self test.</p>
1 OSCE	<p>Oscillator error</p> <p>Indicates that the oscillator in the RNG can be broken. This bit is sticky and can only be cleared by a software or hardware reset.</p> <p>0 The RNG oscillator is working properly. 1 A problem with the RNG oscillator was detected.</p>
0 LFE	<p>Linear feedback shift register (LFSR) error</p> <p>When this bit is set, the interrupt generated was caused by a failure of one of the LFSRs in one of the RNGB's three entropy sources. This bit is sticky and can only be cleared by a software or hardware reset.</p> <p>0 The LFSRs are working properly. 1 The LFSR failure occurred.</p>

44.3.6 RNGB Output FIFO (RNG_OUT)

The RNGBOUT provides a temporary storage for the random data generated by the RNGB. This enables the user to read multiple random longwords back-to-back. A read of this address when the FIFO is not empty returns 32 bits of random data. If the FIFO is read when empty, a FIFO underrun response is returned according to the RNG_CR[FUFMOD]. For optimal system performance, poll the RNG_SR[FIFO_LVL] to ensure that random values are present before reading the FIFO.

Address: 228_4000h base + 14h offset = 228_4014h

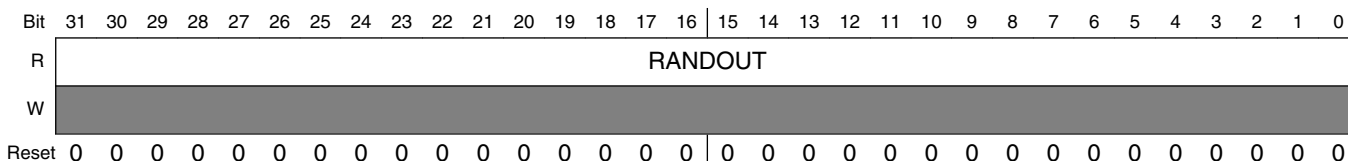

RNG_OUT field descriptions

Field	Description
RANDOUT	Random output

44.4 Functional description

The RNGB performs two functional operations: the seed generation and the random number generation.

These operations (described in [Modes of operation](#)) are performed in conjunction with the major functional blocks in the RNGB described below.

44.4.1 Pseudo-Random Number Generator (PRNG)

The PRNG implements the NIST-approved PRNG described in the *Digital Signature Standard*. The 160-bit output of the SHA-1 block are the next five words of random data. The PRNG is designed to generate 2²⁰ words of random data before requiring reseeding, using the TRNG only during the seeding/initialization process. The initial seed takes approximately two million clock cycles. After this, the RNGB can generate five 32-bit words every 112 clock cycles. The reseeding takes place transparently using the

simultaneous reseed LFSRs. The entropy stored in this 128-bit LFSR and the 128-bit shift register is added directly into the XKEY structure via the RNGB XSEED generator whenever the reseeding is required.

44.4.2 True Random Number Generator (TRNG)

The TRNG comprises of two entropy sources, with each providing a single bit of output. Concatenated together, these two output bits are expected to provide one bit of entropy every 100 clock cycles. In addition to generating the entropy, the TRNG also performs several statistical tests on its output. The pass/fail status of these tests is reflected in the RNG_ESR.

44.4.3 Resets

There are two ways to reset the RNGB: the power-on/hardware reset and the software reset. The software reset is functionally equivalent to the power-on/hardware reset. The power-on/hardware reset is asynchronous. The software reset is performed by setting the RNG_CMD[SR] bit. The resets are summarized in this table:

Table 44-1. Reset summary

Reset	Source	Characteristics	Internal resets	Effect on the external signal
Hardware	ipg_hard_async_reset_b	Active-low, asynchronous, minimum 1-cycle	Resets all interface registers and puts the RNGB into the IDLE state	—
Software	RNG_CMD[SR]	Active-high	Resets all interface registers and puts the RNGB into the IDLE state	—

44.4.3.1 Power-on/hardware reset

Asserting the ipg_hard_async_reset_b signal sets all interface registers to their default state and puts the state machine into the IDLE state.

44.4.3.2 Software reset

The software reset is functionally equivalent to the hardware reset, but enables the RNGB to be fully reset by writing to the SW_RST bit (bit-6) into the RNGB command register. This bit is self-resetting. The software reset can be performed at any time.

44.4.4 RNG interrupts

There is a single RNG interrupt, generated to the processor's interrupt controller. The source of the interrupt is determined by reading the RNG status register. If an error is the cause of the interrupt, further information is available by reading the RNG error status register. The interrupts can be masked by the RNG_CR[MASKDONE or MASKERR] bits.

It is strongly recommended to mask the error interrupt only while debugging because masking the error interrupt can hide the potentially fatal errors or conditions that can result in corrupted results. All errors are considered fatal, requiring the RNG to be reset. The RNG does not service any random data until a reset occurs.

The available interrupt sources are described in this table:

Table 44-2. RNG interrupt sources

Sources	Status bit field	RNG_CR mask bit field	Description
Seed generation done	RNG_SR[SDN]	MASKDONE	The first seed was generated
Self test done	RNG_SR[STDN]	MASKDONE	Self test finished
Error	RNG_SR[ERR]	MASKERR	Error detected—see RNG_ESR for details
Linear Feedback Shift Register (LFSR)	RNG_ESR[LSFRE]	MASKERR	Fault in one of the TRNG's LFSRs
Oscillator	RNG_ESR[OSCE]	MASKERR	TRNG ring oscillator may be malfunctioning
Self test	RNG_ESR[STE]	MASKERR	Self test failed
Statistical test	RNG_ESR[SATE]	MASKERR	Statistics test for the last seed generation failed
FIFO underflow	RNG_ESR[FUFE]	MASKERR	FIFO read while empty

44.5 Initialization/application information

The information located here describes the module initialization.

44.5.1 Manual seeding

The intended general operation of the RNGB is as follows:

1. Reset/initialize.
2. Write to the RNG_CR to setup the RNGB for the desired functionality.
3. Write to the RNG_CMD to run the self test or seed generation.
4. Wait for an interrupt to indicate the completion of the requested operation(s).
5. Repeat steps 3–4 if the seed generation is not complete.
6. Poll the RNG_SR for the FIFO level.
7. Read the available random data from the output FIFO.
8. Repeat steps 6 and 7 as needed, until 2^{20} words are generated.
9. Write to the RNG_CMD to run the seed mode.
10. Repeat steps 4–9.

44.5.2 Automatic seeding

The intended general operation of the RNGB with the automatic seeding enabled is as follows:

1. Reset/initialize.
2. Write to the RNG_CR to setup the RNGB for automatic seeding and the desired functionality.
3. Wait for an interrupt to indicate the completion of the first seed.
4. Poll the RNG_SR for the FIFO level.
5. Read the available random data from the output FIFO.
6. Repeat steps 4 and 5 as needed. The automatic seeding occurs when necessary and is transparent to the operation.

Chapter 45

Synchronous Audio Interface (SAI)

45.1 Overview

The synchronous audio interface (SAI) supports full-duplex serial interfaces with frame synchronization such as I²S, AC97, TDM, and codec/DSP interfaces.

45.1.1 Features

Note that some of the features are not supported across all SAI instances; see the chip-specific information in the first section of this chapter.

- Transmitter with independent bit clock and frame sync supporting 1 data line
- Receiver with independent bit clock and frame sync supporting 1 data line
- Maximum Frame Size of 32 words
- Word size of between 8-bits and 32-bits
- Word size configured separately for first word and remaining words in frame
- Asynchronous 32 × 32-bit FIFO for each transmit and receive channel
- Supports graceful restart after FIFO error

45.1.2 Block diagram

The following block diagram also shows the module clocks.

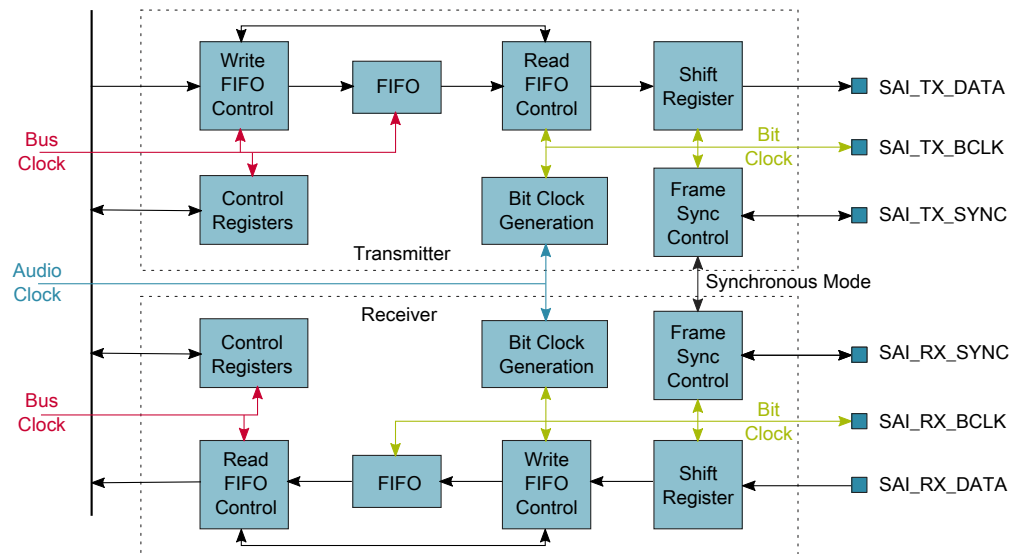

Figure 45-1. I²S/SAI block diagram

45.1.3 Modes of operation

Available power modes include: Run mode, Stop mode.

45.1.3.1 Run mode

In Run mode, the SAI transmitter and receiver operate normally.

45.1.3.2 Stop mode

In Stop mode, the transmitter is disabled after completing the current transmit frame, and, the receiver is disabled after completing the current receive frame. Entry into Stop mode is prevented—not acknowledged—while waiting for the transmitter and receiver to be disabled at the end of the current frame.

45.2 External Signals

The following table describes the external signals of SAI:

Table 45-1. SAI External Signals

Signal	Description	Pad	Mode	Direction
SAI1_MCLK	Audio Master Clock. The master clock is an input when externally generated and an output when internally generated.	CSI_DATA01	ALT6	IO
		LCD_DATA00	ALT8	
SAI1_RX_BCLK	Receive Bit Clock. The bit clock is an input when externally generated and an output when internally generated.	CSI_DATA03	ALT6	IO
SAI1_RX_DATA	Receive Data. The receive data is sampled synchronously by the bit clock.	CSI_DATA06	ALT6	I
		LCD_DATA03	ALT8	
SAI1_RX_SYNC	Receive Frame Sync. The frame sync is an input sampled synchronously by the bit clock when externally generated and an output generated synchronously by the bit clock when internally generated.	CSI_DATA02	ALT6	IO
SAI1_TX_BCLK	Transmit Bit Clock. The bit clock is an input when externally generated and an output when internally generated.	CSI_DATA05	ALT6	IO
		LCD_DATA02	ALT8	
SAI1_TX_DATA	Transmit Data. The transmit data is generated synchronously by the bit clock and is tristated whenever not transmitting a word.	CSI_DATA07	ALT6	O
		LCD_DATA04	ALT8	
SAI1_TX_SYNC	Transmit Frame Sync. The frame sync is an input sampled synchronously by the bit clock when externally generated and an output generated synchronously by the bit clock when internally generated.	CSI_DATA04	ALT6	IO
		LCD_DATA01	ALT8	
SAI2_MCLK	Audio Master Clock. The master clock is an input when externally generated and an output when internally generated.	JTAG_TMS	ALT2	IO
		SD1_CLK	ALT2	
SAI2_RX_BCLK	Receive Bit Clock. The bit clock is an input when externally generated and an output when internally generated.	NAND_DATA06	ALT2	IO
SAI2_RX_DATA	Receive Data. The receive data is sampled synchronously by the bit clock.	JTAG_TCK	ALT2	I
		SD1_DATA2	ALT2	
SAI2_RX_SYNC	Receive Frame Sync. The frame sync is an input sampled synchronously by the bit clock when externally generated and an output generated synchronously by the bit clock when internally generated.	SD1_CMD	ALT2	IO
SAI2_TX_BCLK	Transmit Bit Clock. The bit clock is an input when externally generated	JTAG_TDI	ALT2	IO
		SD1_DATA1	ALT2	

Table continues on the next page...

Table 45-1. SAI External Signals (continued)

Signal	Description	Pad	Mode	Direction
	and an output when internally generated.			
SAI2_TX_DATA	Transmit Data. The transmit data is generated synchronously by the bit clock and is tristated whenever not transmitting a word.	JTAG_TRST_B	ALT2	O
		SD1_DATA3	ALT2	
SAI2_TX_SYNC	Transmit Frame Sync. The frame sync is an input sampled synchronously by the bit clock when externally generated and an output generated synchronously by the bit clock when internally generated.	JTAG_TDO	ALT2	IO
		SD1_DATA0	ALT2	
SAI3_MCLK	Audio Master Clock. The master clock is an input when externally generated and an output when internally generated.	LCD_CLK	ALT3	IO
		LCD_DATA09	ALT1	
SAI3_RX_BCLK	Receive Bit Clock. The bit clock is an input when externally generated and an output when internally generated.	LCD_DATA11	ALT1	IO
SAI3_RX_DATA	Receive Data. The receive data is sampled synchronously by the bit clock.	LCD_DATA14	ALT1	I
SAI3_RX_SYNC		LCD_VSYNC	ALT3	IO
	Receive Frame Sync. The frame sync is an input sampled synchronously by the bit clock when externally generated and an output generated synchronously by the bit clock when internally generated.	LCD_DATA10	ALT1	
SAI3_TX_BCLK	Transmit Bit Clock. The bit clock is an input when externally generated and an output when internally generated.	LCD_DATA13	ALT1	IO
		LCD_HSYNC	ALT3	
SAI3_TX_DATA	Transmit Data. The transmit data is generated synchronously by the bit clock and is tristated whenever not transmitting a word.	LCD_DATA15	ALT1	O
		LCD_RESET	ALT3	
SAI3_TX_SYNC	Transmit Frame Sync. The frame sync is an input sampled synchronously by the bit clock when externally generated and an output generated synchronously by the bit clock when internally generated.	LCD_DATA12	ALT1	IO
		LCD_ENABLE	ALT3	

45.3 Functional description

This section provides a complete functional description of the block.

45.3.1 SAI clocking

The SAI clocks include:

- The audio master clock
- The bit clock
- The bus clock

45.3.1.1 Audio master clock

The audio master clock is used to generate the bit clock when the receiver or transmitter is configured for an internally generated bit clock. The transmitter and receiver can independently select between the bus clock and up to three audio master clocks to generate the bit clock.

Each SAI peripheral can control the input clock selection, pin direction and divide ratio of one audio master clock. The input clock selection and pin direction cannot be altered if an SAI module using that audio master clock has been enabled. The MCLK divide ratio can be altered while an SAI is using that master clock, although the change in the divide ratio takes several cycles. MCR[DUF] can be polled to determine when the divide ratio change has completed.

The audio master clock generation and selection is chip-specific. Refer to chip-specific clocking information about how the audio master clocks are generated. A typical implementation appears in the following figure.

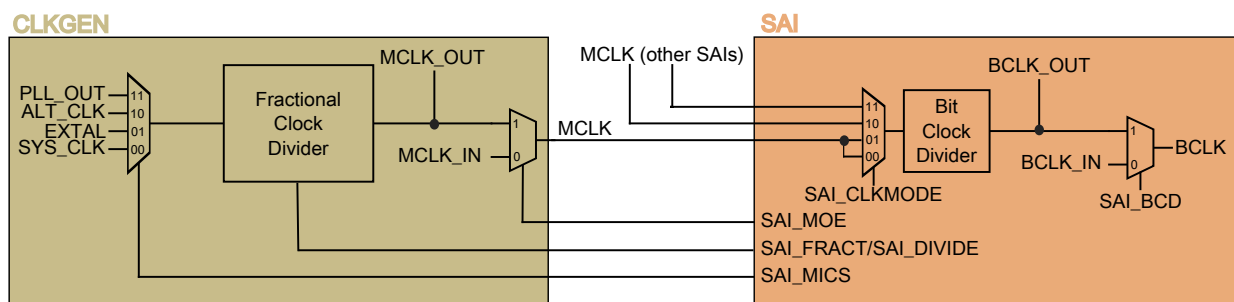

Figure 45-2. SAI master clock generation

The MCLK fractional clock divider uses both clock edges from the input clock to generate a divided down clock that will approximate the output frequency, but without creating any new clock edges. Configuring FRACT and DIVIDE to the same value will

result in a divide by 1 clock, while configuring FRACT higher than DIVIDE is not supported. The duty cycle can range from 66/33 when FRACT is set to one less than DIVIDE down to 50/50 for integer divide ratios, and will approach 50/50 for large non-integer divide ratios. There is no cycle to cycle jitter or duty cycle variance when the divide ratio is an integer or half integer, otherwise the divider output will oscillate between the two divided frequencies that are the closest integer or half integer divisors of the divider input clock frequency. The maximum jitter is therefore equal to half the divider input clock period, since both edges of the input clock are used in generating the divided clock.

45.3.1.2 Bit clock

The SAI transmitter and receiver support asynchronous free-running bit clocks that can be generated internally from an audio master clock or supplied externally. There is also the option for synchronous bit clock and frame sync operation between the receiver and transmitter or between multiple SAI peripherals.

- If both transmitter and receiver are configured for asynchronous operation, then the transmitter and receiver will each use *their own* bit clock and frame sync.
- If the *transmitter* is configured for asynchronous mode and the receiver is configured for synchronous mode, then both transmitter and receiver will use the *transmitter* bit clock and frame sync.
- If the *receiver* is configured for asynchronous mode and the transmitter is configured for synchronous mode, then both transmitter and receiver will use the *receiver* bit clock and frame sync.

Note that the software configures synchronous or asynchronous mode, and that choice selects the bit clock/frame sync used.

Externally generated bit clocks must be:

- Enabled before the SAI transmitter or receiver is enabled
- Disabled after the SAI transmitter or receiver is disabled and completes its current frames

If the SAI transmitter or receiver is using an externally generated bit clock in asynchronous mode and that bit clock is generated by an SAI that is disabled in stop mode, then the transmitter or receiver should be disabled by software before entering stop mode. This issue does not apply when the transmitter or receiver is in a synchronous mode because all synchronous SAIs are enabled and disabled simultaneously.

45.3.1.3 Bus clock

The bus clock is used by the control and configuration registers and to generate synchronous interrupts and DMA requests.

NOTE

Although there is no specific minimum bus clock frequency specified, the bus clock frequency must be fast enough (relative to the bit clock frequency) to ensure that the FIFOs can be serviced, without generating either a transmitter FIFO underrun or receiver FIFO overflow condition.

45.3.2 SAI resets

The SAI is asynchronously reset on system reset. The SAI has a software reset and a FIFO reset.

45.3.2.1 Software reset

The SAI transmitter includes a software reset that resets all transmitter internal logic, including the bit clock generation, status flags, and FIFO pointers. It does not reset the configuration registers. The software reset remains asserted until cleared by software.

The SAI receiver includes a software reset that resets all receiver internal logic, including the bit clock generation, status flags and FIFO pointers. It does not reset the configuration registers. The software reset remains asserted until cleared by software.

45.3.2.2 FIFO reset

The SAI transmitter includes a FIFO reset that synchronizes the FIFO write pointer to the same value as the FIFO read pointer. This empties the FIFO contents and is to be used after TCSR[FEF] is set, and before the FIFO is re-initialized and TCSR[FEF] is cleared. The FIFO reset is asserted for one cycle only.

The SAI receiver includes a FIFO reset that synchronizes the FIFO read pointer to the same value as the FIFO write pointer. This empties the FIFO contents and is to be used after the RCSR[FEF] is set and any remaining data has been read from the FIFO, and before the RCSR[FEF] is cleared. The FIFO reset is asserted for one cycle only.

45.3.3 Synchronous modes

The SAI transmitter and receiver can operate synchronously to each other.

45.3.3.1 Synchronous mode

The SAI transmitter and receiver can be configured to operate with synchronous bit clock and frame sync.

If the transmitter bit clock and frame sync are to be used by both the transmitter and receiver:

- The transmitter must be configured for asynchronous operation and the receiver for synchronous operation.
- In synchronous mode, the receiver is enabled only when both the transmitter and receiver are enabled.
- It is recommended that the transmitter is the last enabled and the first disabled.

If the receiver bit clock and frame sync are to be used by both the transmitter and receiver:

- The receiver must be configured for asynchronous operation and the transmitter for synchronous operation.
- In synchronous mode, the transmitter is enabled only when both the receiver and transmitter are both enabled.
- It is recommended that the receiver is the last enabled and the first disabled.

When operating in synchronous mode, only the bit clock, frame sync, and transmitter/receiver enable are shared. The transmitter and receiver otherwise operate independently, although configuration registers must be configured consistently across both the transmitter and receiver.

45.3.4 Frame sync configuration

When enabled, the SAI continuously transmits and/or receives frames of data. Each frame consists of a fixed number of words and each word consists of a fixed number of bits. Within each frame, any given word can be masked causing the receiver to ignore that word and the transmitter to tri-state for the duration of that word.

The frame sync signal is used to indicate the start of each frame. A valid frame sync requires a rising edge (if active high) or falling edge (if active low) to be detected and the transmitter or receiver cannot be busy with a previous frame. A valid frame sync is also ignored (slave mode) or not generated (master mode) for the first four bit clock cycles after enabling the transmitter or receiver.

The transmitter and receiver frame sync can be configured independently with any of the following options:

- Externally generated or internally generated
- Active high or active low
- Assert with the first bit in frame or asserts one bit early
- Assert for a duration between 1 bit clock and the first word length
- Frame length from 1 to 32 words per frame
- Word length to support 8 to 32 bits per word
 - First word length and remaining word lengths can be configured separately
- Words can be configured to transmit/receive MSB first or LSB first

These configuration options cannot be changed after the SAI transmitter or receiver is enabled.

45.3.5 Data FIFO

Each transmit and receive channel includes a FIFO of size 32×32 -bit. The FIFO data is accessed using the SAI Transmit/Receive Data Registers.

45.3.5.1 Data alignment

Data in the FIFO can be aligned anywhere within the 32-bit wide register through the use of the First Bit Shifted configuration field, which selects the bit index (between 31 and 0) of the first bit shifted.

Examples of supported data alignment and the required First Bit Shifted configuration are illustrated in [Figure 45-3](#) for LSB First configurations and [Figure 45-4](#) for MSB First configurations.

Functional description

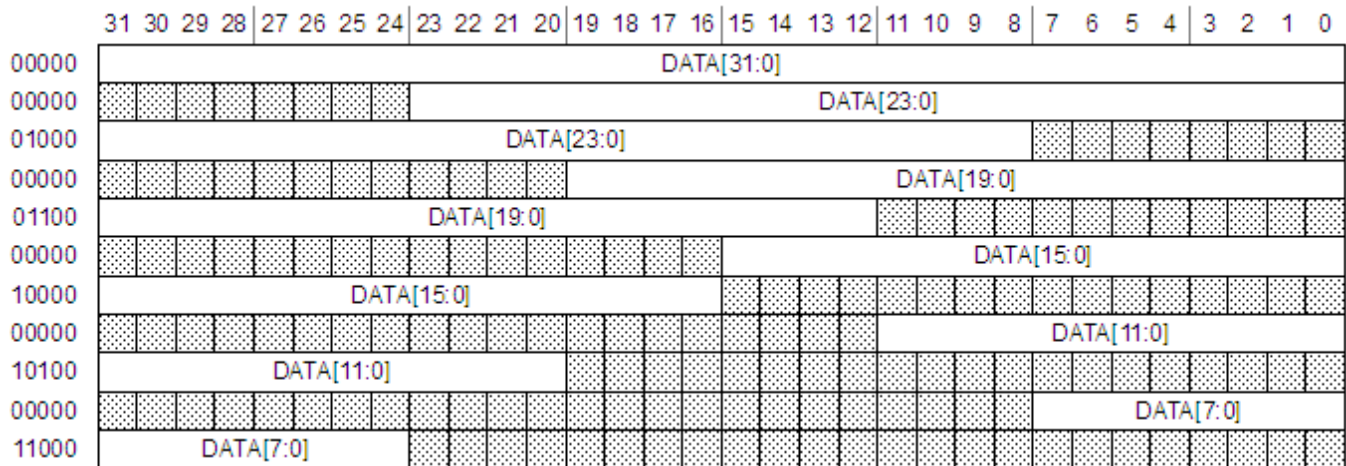

Figure 45-3. SAI first bit shifted, LSB first

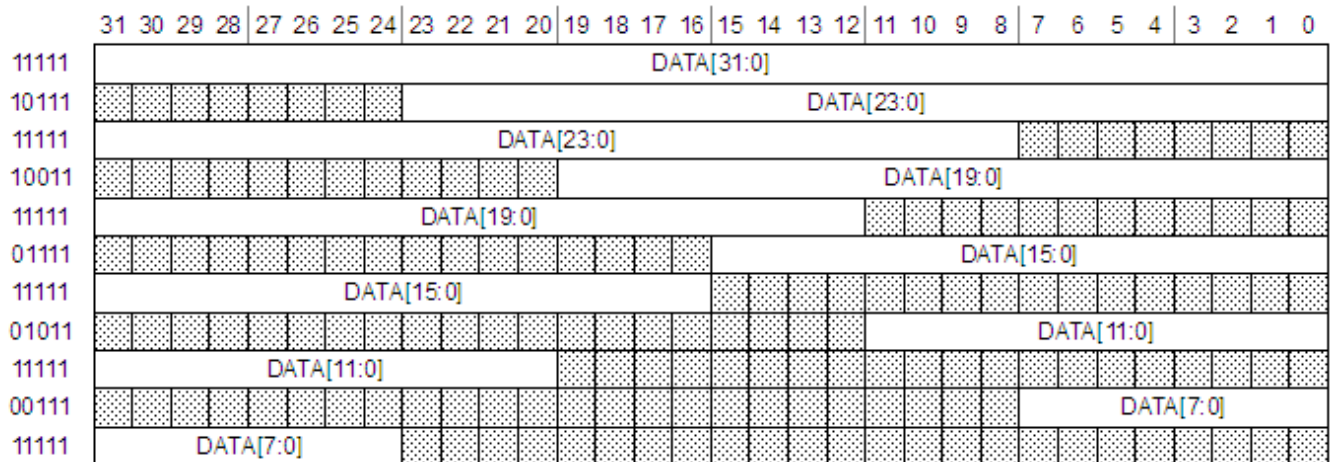

Figure 45-4. SAI first bit shifted, MSB first

45.3.5.2 FIFO pointers

When writing to a TDR, the WFP of the corresponding TFR increments after each valid write. The SAI supports 8-bit, 16-bit and 32-bit writes to the TDR and the FIFO pointer will increment after each individual write. Note that 8-bit writes should only be used when transmitting up to 8-bit data and 16-bit writes should only be used when transmitting up to 16-bit data.

Writes to a TDR are ignored if the corresponding bit of TCR3[TCE] is clear or if the FIFO is full. If the Transmit FIFO is empty, the TDR must be written at least three bit clocks before the start of the next unmasked word to avoid a FIFO underrun.

When reading an RDR, the RFP of the corresponding RFR increments after each valid read. The SAI supports 8-bit, 16-bit and 32-bit reads from the RDR and the FIFO pointer will increment after each individual read. Note that 8-bit reads should only be used when receiving up to 8-bit data and 16-bit reads should only be used when receiving up to 16-bit data.

Reads from an RDR are ignored if the corresponding bit of RCR3[RCE] is clear or if the FIFO is empty. If the Receive FIFO is full, the RDR must be read at least three bit clocks before the end of an unmasked word to avoid a FIFO overrun.

45.3.6 Word mask register

The SAI transmitter and receiver each contain a word mask register, namely TMR and RMR, that can be used to mask any word in the frame. Because the word mask register is double buffered, software can update it before the end of each frame to mask a particular word in the next frame.

The TMR causes the Transmit Data pin to be tri-stated for the length of each selected word and the transmit FIFO is not read for masked words.

The RMR causes the received data for each selected word to be discarded and not written to the receive FIFO.

45.3.7 Interrupts and DMA requests

The SAI transmitter and receiver generate separate interrupts and separate DMA requests, but support the same status flags.

45.3.7.1 FIFO request flag

The FIFO request flag is set based on the number of entries in the FIFO and the FIFO watermark configuration.

The transmit FIFO request flag is set when the number of entries in any of the enabled transmit FIFOs is less than or equal to the transmit FIFO watermark configuration and is cleared when the number of entries in each enabled transmit FIFO is greater than the transmit FIFO watermark configuration.

The receive FIFO request flag is set when the number of entries in any of the enabled receive FIFOs is greater than the receive FIFO watermark configuration and is cleared when the number of entries in each enabled receive FIFO is less than or equal to the receive FIFO watermark configuration.

The FIFO request flag can generate an interrupt or a DMA request.

45.3.7.2 FIFO warning flag

The FIFO warning flag is set based on the number of entries in the FIFO.

The transmit warning flag is set when the number of entries in any of the enabled transmit FIFOs is empty and is cleared when the number of entries in each enabled transmit FIFO is not empty.

The receive warning flag is set when the number of entries in any of the enabled receive FIFOs is full and is cleared when the number of entries in each enabled receive FIFO is not full.

The FIFO warning flag can generate an Interrupt or a DMA request.

45.3.7.3 FIFO error flag

The transmit FIFO error flag is set when the any of the enabled transmit FIFOs underflow. After it is set, all enabled transmit channels repeat the last valid word read from the transmit FIFO until TCSR[FEF] is cleared and the next transmit frame starts. All enabled transmit FIFOs must be reset and initialized with new data before TCSR[FEF] is cleared.

RCSR[FEF] is set when the any of the enabled receive FIFOs overflow. After it is set, all enabled receive channels discard received data until RCSR[FEF] is cleared and the next next receive frame starts. All enabled receive FIFOs should be emptied before RCSR[FEF] is cleared.

The FIFO error flag can generate only an interrupt.

45.3.7.4 Sync error flag

The sync error flag, TCSR[SEF] or RCSR[SEF], is set when configured for an externally generated frame sync and the external frame sync asserts when the transmitter or receiver is busy with the previous frame. The external frame sync assertion is ignored and the sync error flag is set. When the sync error flag is set, the transmitter or receiver continues checking for frame sync assertion when idle or at the end of each frame.

The sync error flag can generate an interrupt only.

45.3.7.5 Word start flag

The word start flag is set at the start of the second bit clock for the selected word, as configured by the Word Flag register field.

The word start flag can generate an interrupt only.

45.4 Memory map and register definition

A read or write access to an address from offset 0x108 and above will result in a bus error.

I2S memory map

Absolute address (hex)	Register name	Width (in bits)	Access	Reset value	Section/page
202_8000	SAI Transmit Control Register (I2S1_TCSR)	32	R/W	0000_0000h	45.4.1/3122
202_8004	SAI Transmit Configuration 1 Register (I2S1_TCR1)	32	R/W	0000_0000h	45.4.2/3125
202_8008	SAI Transmit Configuration 2 Register (I2S1_TCR2)	32	R/W	0000_0000h	45.4.3/3125
202_800C	SAI Transmit Configuration 3 Register (I2S1_TCR3)	32	R/W	0000_0000h	45.4.4/3127
202_8010	SAI Transmit Configuration 4 Register (I2S1_TCR4)	32	R/W	0000_0000h	45.4.5/3128
202_8014	SAI Transmit Configuration 5 Register (I2S1_TCR5)	32	R/W	0000_0000h	45.4.6/3129
202_8020	SAI Transmit Data Register (I2S1_TDR0)	32	W (always reads 0)	0000_0000h	45.4.7/3130
202_8040	SAI Transmit FIFO Register (I2S1_TFR0)	32	R	0000_0000h	45.4.8/3131
202_8060	SAI Transmit Mask Register (I2S1_TMR)	32	R/W	0000_0000h	45.4.9/3131
202_8080	SAI Receive Control Register (I2S1_RCSR)	32	R/W	0000_0000h	45.4.10/3132
202_8084	SAI Receive Configuration 1 Register (I2S1_RCR1)	32	R/W	0000_0000h	45.4.11/3135

Table continues on the next page...

I2S memory map (continued)

Absolute address (hex)	Register name	Width (in bits)	Access	Reset value	Section/page
202_8088	SAI Receive Configuration 2 Register (I2S1_RCR2)	32	R/W	0000_0000h	45.4.12/3136
202_808C	SAI Receive Configuration 3 Register (I2S1_RCR3)	32	R/W	0000_0000h	45.4.13/3137
202_8090	SAI Receive Configuration 4 Register (I2S1_RCR4)	32	R/W	0000_0000h	45.4.14/3138
202_8094	SAI Receive Configuration 5 Register (I2S1_RCR5)	32	R/W	0000_0000h	45.4.15/3140
202_80A0	SAI Receive Data Register (I2S1_RDR0)	32	R	0000_0000h	45.4.16/3140
202_80C0	SAI Receive FIFO Register (I2S1_RFR0)	32	R	0000_0000h	45.4.17/3141
202_80E0	SAI Receive Mask Register (I2S1_RMR)	32	R/W	0000_0000h	45.4.18/3141
202_8100	SAI MCLK Control Register (I2S1_MCR)	32	R/W	0000_0000h	45.4.19/3142
202_C000	SAI Transmit Control Register (I2S2_TCSR)	32	R/W	0000_0000h	45.4.1/3122
202_C004	SAI Transmit Configuration 1 Register (I2S2_TCR1)	32	R/W	0000_0000h	45.4.2/3125
202_C008	SAI Transmit Configuration 2 Register (I2S2_TCR2)	32	R/W	0000_0000h	45.4.3/3125
202_C00C	SAI Transmit Configuration 3 Register (I2S2_TCR3)	32	R/W	0000_0000h	45.4.4/3127
202_C010	SAI Transmit Configuration 4 Register (I2S2_TCR4)	32	R/W	0000_0000h	45.4.5/3128
202_C014	SAI Transmit Configuration 5 Register (I2S2_TCR5)	32	R/W	0000_0000h	45.4.6/3129
202_C020	SAI Transmit Data Register (I2S2_TDR0)	32	W (always reads 0)	0000_0000h	45.4.7/3130
202_C040	SAI Transmit FIFO Register (I2S2_TFR0)	32	R	0000_0000h	45.4.8/3131
202_C060	SAI Transmit Mask Register (I2S2_TMR)	32	R/W	0000_0000h	45.4.9/3131
202_C080	SAI Receive Control Register (I2S2_RCSR)	32	R/W	0000_0000h	45.4.10/3132
202_C084	SAI Receive Configuration 1 Register (I2S2_RCR1)	32	R/W	0000_0000h	45.4.11/3135
202_C088	SAI Receive Configuration 2 Register (I2S2_RCR2)	32	R/W	0000_0000h	45.4.12/3136
202_C08C	SAI Receive Configuration 3 Register (I2S2_RCR3)	32	R/W	0000_0000h	45.4.13/3137
202_C090	SAI Receive Configuration 4 Register (I2S2_RCR4)	32	R/W	0000_0000h	45.4.14/3138
202_C094	SAI Receive Configuration 5 Register (I2S2_RCR5)	32	R/W	0000_0000h	45.4.15/3140
202_C0A0	SAI Receive Data Register (I2S2_RDR0)	32	R	0000_0000h	45.4.16/3140
202_C0C0	SAI Receive FIFO Register (I2S2_RFR0)	32	R	0000_0000h	45.4.17/3141

Table continues on the next page...

I2S memory map (continued)

Absolute address (hex)	Register name	Width (in bits)	Access	Reset value	Section/page
202_C0E0	SAI Receive Mask Register (I2S2_RMR)	32	R/W	0000_0000h	45.4.18/3141
202_C100	SAI MCLK Control Register (I2S2_MCR)	32	R/W	0000_0000h	45.4.19/3142
203_0000	SAI Transmit Control Register (I2S3_TCSR)	32	R/W	0000_0000h	45.4.1/3122
203_0004	SAI Transmit Configuration 1 Register (I2S3_TCR1)	32	R/W	0000_0000h	45.4.2/3125
203_0008	SAI Transmit Configuration 2 Register (I2S3_TCR2)	32	R/W	0000_0000h	45.4.3/3125
203_000C	SAI Transmit Configuration 3 Register (I2S3_TCR3)	32	R/W	0000_0000h	45.4.4/3127
203_0010	SAI Transmit Configuration 4 Register (I2S3_TCR4)	32	R/W	0000_0000h	45.4.5/3128
203_0014	SAI Transmit Configuration 5 Register (I2S3_TCR5)	32	R/W	0000_0000h	45.4.6/3129
203_0020	SAI Transmit Data Register (I2S3_TDR0)	32	W (always reads 0)	0000_0000h	45.4.7/3130
203_0040	SAI Transmit FIFO Register (I2S3_TFR0)	32	R	0000_0000h	45.4.8/3131
203_0060	SAI Transmit Mask Register (I2S3_TMR)	32	R/W	0000_0000h	45.4.9/3131
203_0080	SAI Receive Control Register (I2S3_RCSR)	32	R/W	0000_0000h	45.4.10/3132
203_0084	SAI Receive Configuration 1 Register (I2S3_RCR1)	32	R/W	0000_0000h	45.4.11/3135
203_0088	SAI Receive Configuration 2 Register (I2S3_RCR2)	32	R/W	0000_0000h	45.4.12/3136
203_008C	SAI Receive Configuration 3 Register (I2S3_RCR3)	32	R/W	0000_0000h	45.4.13/3137
203_0090	SAI Receive Configuration 4 Register (I2S3_RCR4)	32	R/W	0000_0000h	45.4.14/3138
203_0094	SAI Receive Configuration 5 Register (I2S3_RCR5)	32	R/W	0000_0000h	45.4.15/3140
203_00A0	SAI Receive Data Register (I2S3_RDR0)	32	R	0000_0000h	45.4.16/3140
203_00C0	SAI Receive FIFO Register (I2S3_RFR0)	32	R	0000_0000h	45.4.17/3141
203_00E0	SAI Receive Mask Register (I2S3_RMR)	32	R/W	0000_0000h	45.4.18/3141
203_0100	SAI MCLK Control Register (I2S3_MCR)	32	R/W	0000_0000h	45.4.19/3142

45.4.1 SAI Transmit Control Register (I2Sx_TCSR)

Address: Base address + 0h offset

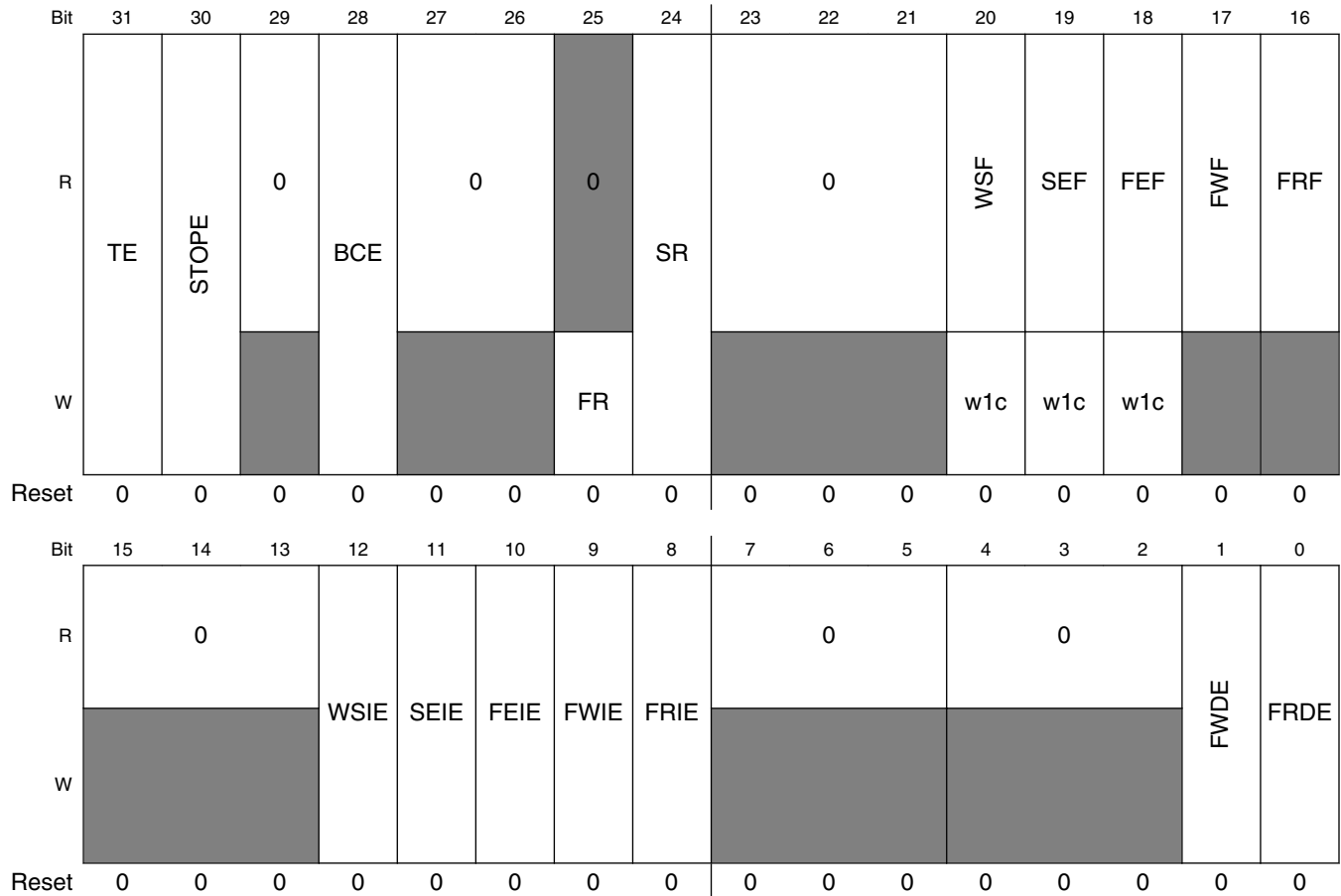

I2Sx_TCSR field descriptions

Field	Description
31 TE	<p>Transmitter Enable</p> <p>Enables/disables the transmitter. When software clears this field, the transmitter remains enabled, and this bit remains set, until the end of the current frame.</p> <p>0 Transmitter is disabled. 1 Transmitter is enabled, or transmitter has been disabled and has not yet reached end of frame.</p>
30 STOPE	<p>Stop Enable</p> <p>Configures transmitter operation in Stop mode. This field is ignored and the transmitter is disabled in all stop modes.</p> <p>0 Transmitter disabled in Stop mode. 1 Transmitter enabled in Stop mode.</p>
29 Reserved	<p>This field is reserved. This read-only field is reserved and always has the value 0.</p>

Table continues on the next page...

I2Sx_TCSR field descriptions (continued)

Field	Description
28 BCE	<p>Bit Clock Enable</p> <p>Enables the transmit bit clock, separately from the TE. This field is automatically set whenever TE is set. When software clears this field, the transmit bit clock remains enabled, and this bit remains set, until the end of the current frame.</p> <p>0 Transmit bit clock is disabled. 1 Transmit bit clock is enabled.</p>
27–26 Reserved	<p>This field is reserved. This read-only field is reserved and always has the value 0.</p>
25 FR	<p>FIFO Reset</p> <p>Resets the FIFO pointers. Reading this field will always return zero. FIFO pointers should only be reset when the transmitter is disabled or the FIFO error flag is set.</p> <p>0 No effect. 1 FIFO reset.</p>
24 SR	<p>Software Reset</p> <p>When set, resets the internal transmitter logic including the FIFO pointers. Software-visible registers are not affected, except for the status registers.</p> <p>0 No effect. 1 Software reset.</p>
23–21 Reserved	<p>This field is reserved. This read-only field is reserved and always has the value 0.</p>
20 WSF	<p>Word Start Flag</p> <p>Indicates that the start of the configured word has been detected. Write a logic 1 to this field to clear this flag.</p> <p>0 Start of word not detected. 1 Start of word detected.</p>
19 SEF	<p>Sync Error Flag</p> <p>Indicates that an error in the externally-generated frame sync has been detected. Write a logic 1 to this field to clear this flag.</p> <p>0 Sync error not detected. 1 Frame sync error detected.</p>
18 FEF	<p>FIFO Error Flag</p> <p>Indicates that an enabled transmit FIFO has underrun. Write a logic 1 to this field to clear this flag.</p> <p>0 Transmit underrun not detected. 1 Transmit underrun detected.</p>
17 FWF	<p>FIFO Warning Flag</p> <p>Indicates that an enabled transmit FIFO is empty.</p> <p>0 No enabled transmit FIFO is empty. 1 Enabled transmit FIFO is empty.</p>

Table continues on the next page...

I2Sx_TCSR field descriptions (continued)

Field	Description
16 FRF	FIFO Request Flag Indicates that the number of words in an enabled transmit channel FIFO is less than or equal to the transmit FIFO watermark. 0 Transmit FIFO watermark has not been reached. 1 Transmit FIFO watermark has been reached.
15–13 Reserved	This field is reserved. This read-only field is reserved and always has the value 0.
12 WSIE	Word Start Interrupt Enable Enables/disables word start interrupts. 0 Disables interrupt. 1 Enables interrupt.
11 SEIE	Sync Error Interrupt Enable Enables/disables sync error interrupts. 0 Disables interrupt. 1 Enables interrupt.
10 FEIE	FIFO Error Interrupt Enable Enables/disables FIFO error interrupts. 0 Disables the interrupt. 1 Enables the interrupt.
9 FWIE	FIFO Warning Interrupt Enable Enables/disables FIFO warning interrupts. 0 Disables the interrupt. 1 Enables the interrupt.
8 FRIE	FIFO Request Interrupt Enable Enables/disables FIFO request interrupts. 0 Disables the interrupt. 1 Enables the interrupt.
7–5 Reserved	This field is reserved. This read-only field is reserved and always has the value 0.
4–2 Reserved	This field is reserved. This read-only field is reserved and always has the value 0.
1 FWDE	FIFO Warning DMA Enable Enables/disables DMA requests. 0 Disables the DMA request. 1 Enables the DMA request.
0 FRDE	FIFO Request DMA Enable

Table continues on the next page...

I2Sx_TCSR field descriptions (continued)

Field	Description
	Enables/disables DMA requests.
0	Disables the DMA request.
1	Enables the DMA request.

45.4.2 SAI Transmit Configuration 1 Register (I2Sx_TCR1)

Address: Base address + 4h offset

Bit	31	30	29	28	27	26	25	24	23	22	21	20	19	18	17	16	15	14	13	12	11	10	9	8	7	6	5	4	3	2	1	0
R	0																TFW															
W	0																0															
Reset	0	0	0	0	0	0	0	0	0	0	0	0	0	0	0	0	0	0	0	0	0	0	0	0	0	0	0	0	0	0	0	

I2Sx_TCR1 field descriptions

Field	Description
31–5 Reserved	This field is reserved. This read-only field is reserved and always has the value 0.
TFW	Transmit FIFO Watermark Configures the watermark level for all enabled transmit channels.

45.4.3 SAI Transmit Configuration 2 Register (I2Sx_TCR2)

This register must not be altered when TCSR[TE] is set.

Address: Base address + 8h offset

Bit	31	30	29	28	27	26	25	24	23	22	21	20	19	18	17	16														
R	SYNC								BCS			BCI		MSEL		BCP		BCD		0										
W	0								0			0		0		0		0		0										
Reset	0	0	0	0	0	0	0	0	0	0	0	0	0	0	0	0	0	0	0	0	0	0	0	0	0	0	0	0	0	0
Bit	15	14	13	12	11	10	9	8	7	6	5	4	3	2	1	0														
R	0								DIV																					
W	0								0																					
Reset	0	0	0	0	0	0	0	0	0	0	0	0	0	0	0	0														

I2Sx_TCR2 field descriptions

Field	Description
31–30 SYNC	Synchronous Mode Configures between asynchronous and synchronous modes of operation. When configured for a synchronous mode of operation, the receiver must be configured for asynchronous operation.

Table continues on the next page...

I2Sx_TCR2 field descriptions (continued)

Field	Description
	00 Asynchronous mode. 01 Synchronous with receiver.
29 BCS	<p>Bit Clock Swap</p> <p>This field swaps the bit clock used by the transmitter. When the transmitter is configured in asynchronous mode and this bit is set, the transmitter is clocked by the receiver bit clock (SAI_RX_BCLK). This allows the transmitter and receiver to share the same bit clock, but the transmitter continues to use the transmit frame sync (SAI_TX_SYNC).</p> <p>When the transmitter is configured in synchronous mode, the transmitter BCS field and receiver BCS field must be set to the same value. When both are set, the transmitter and receiver are both clocked by the transmitter bit clock (SAI_TX_BCLK) but use the receiver frame sync (SAI_RX_SYNC).</p> <p>0 Use the normal bit clock source. 1 Swap the bit clock source.</p>
28 BCI	<p>Bit Clock Input</p> <p>When this field is set and using an internally generated bit clock in either synchronous or asynchronous mode, the bit clock actually used by the transmitter is delayed by the pad output delay (the transmitter is clocked by the pad input as if the clock was externally generated). This has the effect of decreasing the data input setup time, but increasing the data output valid time.</p> <p>The slave mode timing from the datasheet should be used for the transmitter when this bit is set. In synchronous mode, this bit allows the transmitter to use the slave mode timing from the datasheet, while the receiver uses the master mode timing. This field has no effect when configured for an externally generated bit clock .</p> <p>0 No effect. 1 Internal logic is clocked as if bit clock was externally generated.</p>
27–26 MSEL	<p>MCLK Select</p> <p>Selects the audio Master Clock option used to generate an internally generated bit clock. This field has no effect when configured for an externally generated bit clock.</p> <p>NOTE: Depending on the device, some Master Clock options might not be available. See the chip-specific information for the meaning of each option.</p> <p>00 Master Clock (MCLK) 1 option selected. 01 Master Clock (MCLK) 1 option selected. 10 Master Clock (MCLK) 2 option selected. 11 Master Clock (MCLK) 3 option selected.</p>
25 BCP	<p>Bit Clock Polarity</p> <p>Configures the polarity of the bit clock.</p> <p>0 Bit clock is active high with drive outputs on rising edge and sample inputs on falling edge. 1 Bit clock is active low with drive outputs on falling edge and sample inputs on rising edge.</p>
24 BCD	<p>Bit Clock Direction</p> <p>Configures the direction of the bit clock.</p> <p>0 Bit clock is generated externally in Slave mode. 1 Bit clock is generated internally in Master mode.</p>

Table continues on the next page...

I2Sx_TCR2 field descriptions (continued)

Field	Description
23–8 Reserved	This field is reserved. This read-only field is reserved and always has the value 0.
DIV	Bit Clock Divide Divides down the audio master clock to generate the bit clock when configured for an internal bit clock. The division value is $(DIV + 1) * 2$.

45.4.4 SAI Transmit Configuration 3 Register (I2Sx_TCR3)

This register must not be altered when TCSR[TE] is set.

Address: Base address + Ch offset

Bit	31	30	29	28	27	26	25	24	23	22	21	20	19	18	17	16	
R	0								0								TCE
W	[Shaded]																
Reset	0	0	0	0	0	0	0	0	0	0	0	0	0	0	0	0	0
Bit	15	14	13	12	11	10	9	8	7	6	5	4	3	2	1	0	
R	0								WDFL								
W	[Shaded]																
Reset	0	0	0	0	0	0	0	0	0	0	0	0	0	0	0	0	

I2Sx_TCR3 field descriptions

Field	Description
31–24 Reserved	This field is reserved. This read-only field is reserved and always has the value 0.
23–17 Reserved	This field is reserved. This read-only field is reserved and always has the value 0.
16 TCE	Transmit Channel Enable Enables the corresponding data channel for transmit operation. A channel must be enabled before its FIFO is accessed. The width of TCE field = the number of transmit channels (call it N). For example, if TCE field is 2 bits wide, then bit position 16 refers to transmit channel 1 and bit position 17 refers to transmit channel 2. Setting bit 16 enables transmit channel 1, and setting bit 17 enables transmit channel 2. Setting bit N will enable transmit channel N. 0 Transmit data channel N is disabled. 1 Transmit data channel N is enabled.
15–5 Reserved	This field is reserved. This read-only field is reserved and always has the value 0.
WDFL	Word Flag Configuration

Table continues on the next page...

I2Sx_TCR3 field descriptions (continued)

Field	Description
	Configures which word sets the start of word flag. The value written must be one less than the word number. For example, writing 0 configures the first word in the frame. When configured to a value greater than TCR4[FRSZ], then the start of word flag is never set.

45.4.5 SAI Transmit Configuration 4 Register (I2Sx_TCR4)

This register must not be altered when TCSR[TE] is set.

Address: Base address + 10h offset

Bit	31	30	29	28	27	26	25	24	23	22	21	20	19	18	17	16
R		0		0		0		0		0		FRSZ				
W																
Reset	0	0	0	0	0	0	0	0	0	0	0	0	0	0	0	0
Bit	15	14	13	12	11	10	9	8	7	6	5	4	3	2	1	0
R		0		SYWD						0		MF	FSE	0	FSP	FSD
W																
Reset	0	0	0	0	0	0	0	0	0	0	0	0	0	0	0	0

I2Sx_TCR4 field descriptions

Field	Description
31–29 Reserved	This field is reserved. This read-only field is reserved and always has the value 0.
28 Reserved	This field is reserved. This read-only field is reserved and always has the value 0.
27–26 Reserved	This field is reserved. This read-only field is reserved and always has the value 0.
25–24 Reserved	This field is reserved. This read-only field is reserved and always has the value 0.
23–21 Reserved	This field is reserved. This read-only field is reserved and always has the value 0.
20–16 FRSZ	Frame size Configures the number of words in each frame. The value written must be one less than the number of words in the frame. For example, write 0 for one word per frame. The maximum supported frame size is 32 words.
15–13 Reserved	This field is reserved. This read-only field is reserved and always has the value 0.
12–8 SYWD	Sync Width Configures the length of the frame sync in number of bit clocks. The value written must be one less than the number of bit clocks. For example, write 0 for the frame sync to assert for one bit clock only. The sync width cannot be configured longer than the first word of the frame.
7–5 Reserved	This field is reserved. This read-only field is reserved and always has the value 0.

Table continues on the next page...

I2Sx_TCR4 field descriptions (continued)

Field	Description
4 MF	MSB First Configures whether the LSB or the MSB is transmitted first. 0 LSB is transmitted first. 1 MSB is transmitted first.
3 FSE	Frame Sync Early 0 Frame sync asserts with the first bit of the frame. 1 Frame sync asserts one bit before the first bit of the frame.
2 Reserved	This field is reserved. This read-only field is reserved and always has the value 0.
1 FSP	Frame Sync Polarity Configures the polarity of the frame sync. 0 Frame sync is active high. 1 Frame sync is active low.
0 FSD	Frame Sync Direction Configures the direction of the frame sync. 0 Frame sync is generated externally in Slave mode. 1 Frame sync is generated internally in Master mode.

45.4.6 SAI Transmit Configuration 5 Register (I2Sx_TCR5)

This register must not be altered when TCSR[TE] is set.

Address: Base address + 14h offset

Bit	31	30	29	28	27	26	25	24	23	22	21	20	19	18	17	16	15	14	13	12	11	10	9	8	7	6	5	4	3	2	1	0
R	0																0															
W																																
Reset	0	0	0	0	0	0	0	0	0	0	0	0	0	0	0	0	0	0	0	0	0	0	0	0	0	0	0	0	0	0	0	

I2Sx_TCR5 field descriptions

Field	Description
31–29 Reserved	This field is reserved. This read-only field is reserved and always has the value 0.
28–24 WNW	Word N Width Configures the number of bits in each word, for each word except the first in the frame. The value written must be one less than the number of bits per word. Word width of less than 8 bits is not supported.
23–21 Reserved	This field is reserved. This read-only field is reserved and always has the value 0.

Table continues on the next page...

I2Sx_TCR5 field descriptions (continued)

Field	Description
20–16 WOW	Word 0 Width Configures the number of bits in the first word in each frame. The value written must be one less than the number of bits in the first word. Word width of less than 8 bits is not supported if there is only one word per frame.
15–13 Reserved	This field is reserved. This read-only field is reserved and always has the value 0.
12–8 FBT	First Bit Shifted Configures the bit index for the first bit transmitted for each word in the frame. If configured for MSB First, the index of the next bit transmitted is one less than the current bit transmitted. If configured for LSB First, the index of the next bit transmitted is one more than the current bit transmitted. The value written must be greater than or equal to the word width when configured for MSB First. The value written must be less than or equal to 31-word width when configured for LSB First.
Reserved	This field is reserved. This read-only field is reserved and always has the value 0.

45.4.7 SAI Transmit Data Register (I2Sx_TDRn)

Address: Base address + 20h offset + (4d × i), where i=0d to 0d

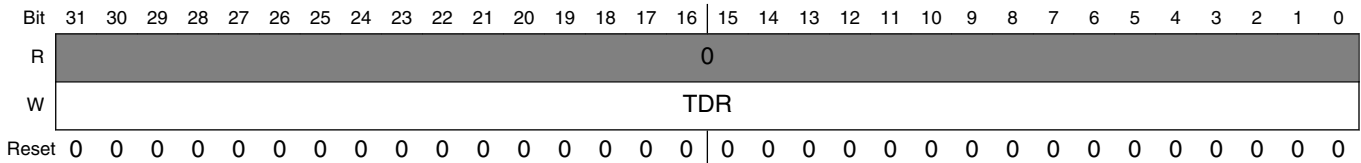

I2Sx_TDRn field descriptions

Field	Description
TDR	Transmit Data Register The corresponding TCR3[TCE] bit must be set before accessing the channel's transmit data register. Writes to this register when the transmit FIFO is not full will push the data written into the transmit data FIFO. Writes to this register when the transmit FIFO is full are ignored.

45.4.8 SAI Transmit FIFO Register (I2Sx_TFRn)

The MSB of the read and write pointers is used to distinguish between FIFO full and empty conditions. If the read and write pointers are identical, then the FIFO is empty. If the read and write pointers are identical except for the MSB, then the FIFO is full.

Address: Base address + 40h offset + (4d × i), where i=0d to 0d

Bit	31	30	29	28	27	26	25	24	23	22	21	20	19	18	17	16
R	0	0						WFP								
W	[Reserved]															
Reset	0	0	0	0	0	0	0	0	0	0	0	0	0	0	0	0
Bit	15	14	13	12	11	10	9	8	7	6	5	4	3	2	1	0
R	0								RFP							
W	[Reserved]															
Reset	0	0	0	0	0	0	0	0	0	0	0	0	0	0	0	0

I2Sx_TFRn field descriptions

Field	Description
31 Reserved	This field is reserved. This read-only field is reserved and always has the value 0.
30–22 Reserved	This field is reserved. This read-only field is reserved and always has the value 0.
21–16 WFP	Write FIFO Pointer FIFO write pointer for transmit data channel.
15–6 Reserved	This field is reserved. This read-only field is reserved and always has the value 0.
RFP	Read FIFO Pointer FIFO read pointer for transmit data channel.

45.4.9 SAI Transmit Mask Register (I2Sx_TMR)

This register is double-buffered and updates:

1. When TCSR[TE] is first set
2. At the end of each frame.

This allows the masked words in each frame to change from frame to frame.

Memory map and register definition

Address: Base address + 60h offset

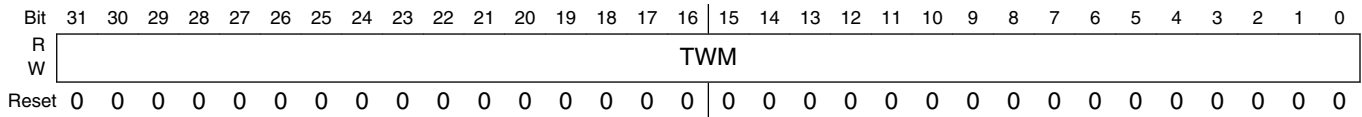

I2Sx_TMR field descriptions

Field	Description
TWM	<p>Transmit Word Mask</p> <p>Configures whether the transmit word is masked (transmit data pin tristated and transmit data not read from FIFO) for the corresponding word in the frame.</p> <p>0 Word N is enabled. 1 Word N is masked. The transmit data pins are tri-stated when masked.</p>

45.4.10 SAI Receive Control Register (I2Sx_RCSR)

Address: Base address + 80h offset

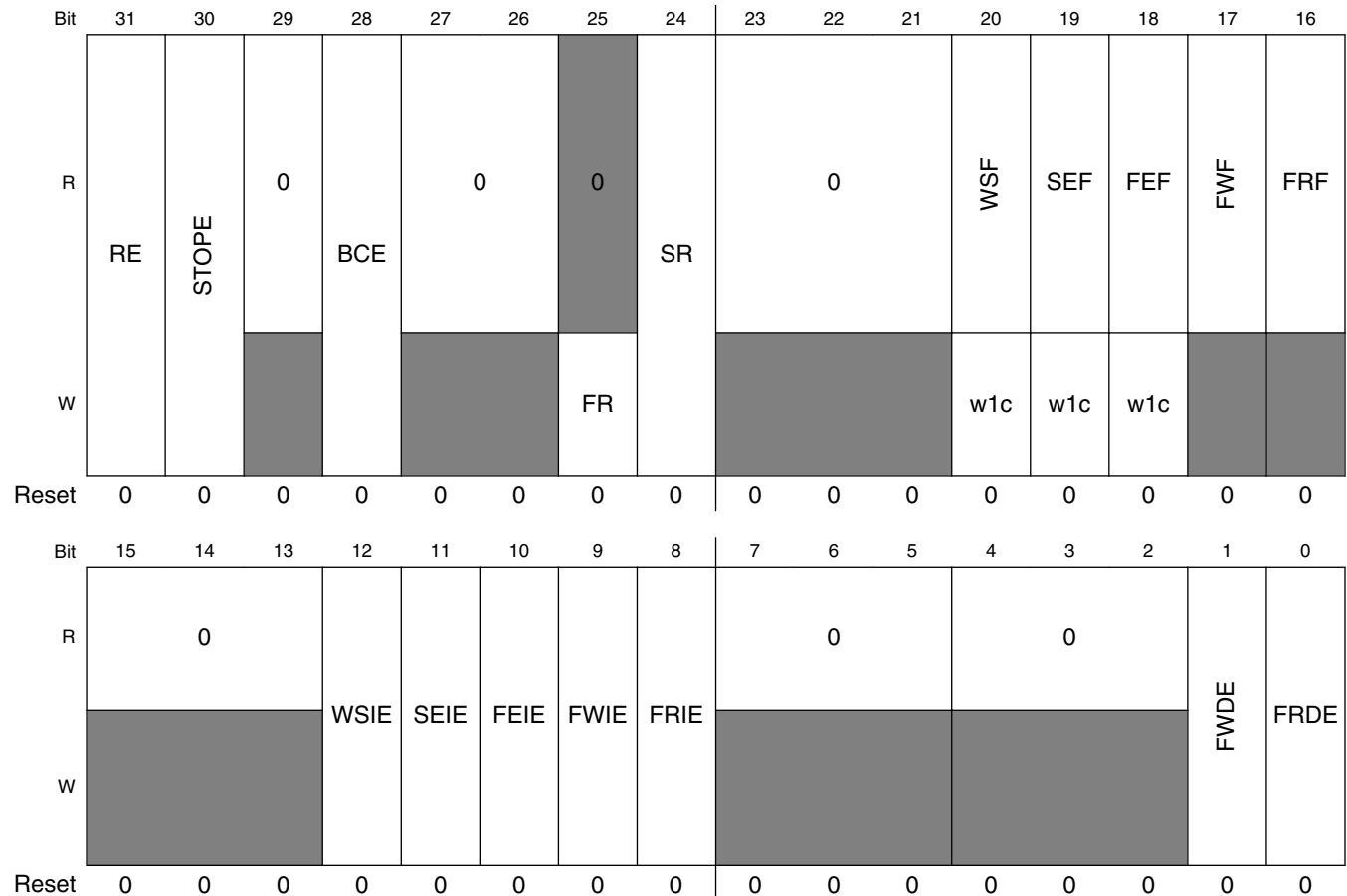

I2Sx_RCSR field descriptions

Field	Description
31 RE	<p>Receiver Enable</p> <p>Enables/disables the receiver. When software clears this field, the receiver remains enabled, and this bit remains set, until the end of the current frame.</p> <p>0 Receiver is disabled. 1 Receiver is enabled, or receiver has been disabled and has not yet reached end of frame.</p>
30 STOPE	<p>Stop Enable</p> <p>Configures receiver operation in Stop mode. This bit is ignored and the receiver is disabled in all stop modes.</p> <p>0 Receiver disabled in Stop mode. 1 Receiver enabled in Stop mode.</p>
29 Reserved	<p>This field is reserved. This read-only field is reserved and always has the value 0.</p>
28 BCE	<p>Bit Clock Enable</p> <p>Enables the receive bit clock, separately from RE. This field is automatically set whenever RE is set. When software clears this field, the receive bit clock remains enabled, and this field remains set, until the end of the current frame.</p> <p>0 Receive bit clock is disabled. 1 Receive bit clock is enabled.</p>
27–26 Reserved	<p>This field is reserved. This read-only field is reserved and always has the value 0.</p>
25 FR	<p>FIFO Reset</p> <p>Resets the FIFO pointers. Reading this field will always return zero. FIFO pointers should only be reset when the receiver is disabled or the FIFO error flag is set.</p> <p>0 No effect. 1 FIFO reset.</p>
24 SR	<p>Software Reset</p> <p>Resets the internal receiver logic including the FIFO pointers. Software-visible registers are not affected, except for the status registers.</p> <p>0 No effect. 1 Software reset.</p>
23–21 Reserved	<p>This field is reserved. This read-only field is reserved and always has the value 0.</p>
20 WSF	<p>Word Start Flag</p> <p>Indicates that the start of the configured word has been detected. Write a logic 1 to this field to clear this flag.</p> <p>0 Start of word not detected. 1 Start of word detected.</p>
19 SEF	<p>Sync Error Flag</p>

Table continues on the next page...

I2Sx_RCSR field descriptions (continued)

Field	Description
	Indicates that an error in the externally-generated frame sync has been detected. Write a logic 1 to this field to clear this flag. 0 Sync error not detected. 1 Frame sync error detected.
18 FEF	FIFO Error Flag Indicates that an enabled receive FIFO has overflowed. Write a logic 1 to this field to clear this flag. 0 Receive overflow not detected. 1 Receive overflow detected.
17 FWF	FIFO Warning Flag Indicates that an enabled receive FIFO is full. 0 No enabled receive FIFO is full. 1 Enabled receive FIFO is full.
16 FRF	FIFO Request Flag Indicates that the number of words in an enabled receive channel FIFO is greater than the receive FIFO watermark. 0 Receive FIFO watermark not reached. 1 Receive FIFO watermark has been reached.
15–13 Reserved	This field is reserved. This read-only field is reserved and always has the value 0.
12 WSIE	Word Start Interrupt Enable Enables/disables word start interrupts. 0 Disables interrupt. 1 Enables interrupt.
11 SEIE	Sync Error Interrupt Enable Enables/disables sync error interrupts. 0 Disables interrupt. 1 Enables interrupt.
10 FEIE	FIFO Error Interrupt Enable Enables/disables FIFO error interrupts. 0 Disables the interrupt. 1 Enables the interrupt.
9 FWIE	FIFO Warning Interrupt Enable Enables/disables FIFO warning interrupts. 0 Disables the interrupt. 1 Enables the interrupt.
8 FRIE	FIFO Request Interrupt Enable

Table continues on the next page...

I2Sx_RCSR field descriptions (continued)

Field	Description
	Enables/disables FIFO request interrupts. 0 Disables the interrupt. 1 Enables the interrupt.
7–5 Reserved	This field is reserved. This read-only field is reserved and always has the value 0.
4–2 Reserved	This field is reserved. This read-only field is reserved and always has the value 0.
1 FWDE	FIFO Warning DMA Enable Enables/disables DMA requests. 0 Disables the DMA request. 1 Enables the DMA request.
0 FRDE	FIFO Request DMA Enable Enables/disables DMA requests. 0 Disables the DMA request. 1 Enables the DMA request.

45.4.11 SAI Receive Configuration 1 Register (I2Sx_RCR1)

Address: Base address + 84h offset

Bit	31	30	29	28	27	26	25	24	23	22	21	20	19	18	17	16	15	14	13	12	11	10	9	8	7	6	5	4	3	2	1	0
R	0																R															
W	0																0															
Reset	0	0	0	0	0	0	0	0	0	0	0	0	0	0	0	0	0	0	0	0	0	0	0	0	0	0	0	0	0	0	0	

I2Sx_RCR1 field descriptions

Field	Description
31–5 Reserved	This field is reserved. This read-only field is reserved and always has the value 0.
RFW	Receive FIFO Watermark Configures the watermark level for all enabled receiver channels.

45.4.12 SAI Receive Configuration 2 Register (I2Sx_RCR2)

This register must not be altered when RCSR[RE] is set.

Address: Base address + 88h offset

Bit	31	30	29	28	27	26	25	24	23	22	21	20	19	18	17	16																																																
R	SYNC								BCS								BCI								MSEL								BCP								BCD								0															
W	0																0																																															
Reset	0	0	0	0	0	0	0	0	0	0	0	0	0	0	0	0	0	0	0	0	0	0	0	0	0	0	0	0																																				
Bit	15	14	13	12	11	10	9	8	7	6	5	4	3	2	1	0																																																
R	0								DIV																																																							
W	0																																																															
Reset	0	0	0	0	0	0	0	0	0	0	0	0	0	0	0	0																																																

I2Sx_RCR2 field descriptions

Field	Description
31–30 SYNC	<p>Synchronous Mode</p> <p>Configures between asynchronous and synchronous modes of operation. When configured for a synchronous mode of operation, the transmitter must be configured for asynchronous operation.</p> <p>00 Asynchronous mode. 01 Synchronous with transmitter.</p>
29 BCS	<p>Bit Clock Swap</p> <p>This field swaps the bit clock used by the receiver. When the receiver is configured in asynchronous mode and this bit is set, the receiver is clocked by the transmitter bit clock (SAI_TX_BCLK). This allows the transmitter and receiver to share the same bit clock, but the receiver continues to use the receiver frame sync (SAI_RX_SYNC).</p> <p>When the receiver is configured in synchronous mode, the transmitter BCS field and receiver BCS field must be set to the same value. When both are set, the transmitter and receiver are both clocked by the receiver bit clock (SAI_RX_BCLK) but use the transmitter frame sync (SAI_TX_SYNC).</p> <p>0 Use the normal bit clock source. 1 Swap the bit clock source.</p>
28 BCI	<p>Bit Clock Input</p> <p>When this field is set and using an internally generated bit clock in either synchronous or asynchronous mode, the bit clock actually used by the receiver is delayed by the pad output delay (the receiver is clocked by the pad input as if the clock was externally generated). This has the effect of decreasing the data input setup time, but increasing the data output valid time.</p> <p>The slave mode timing from the datasheet should be used for the receiver when this bit is set. In synchronous mode, this bit allows the receiver to use the slave mode timing from the datasheet, while the transmitter uses the master mode timing. This field has no effect when configured for an externally generated bit clock .</p> <p>0 No effect. 1 Internal logic is clocked as if bit clock was externally generated.</p>
27–26 MSEL	MCLK Select

Table continues on the next page...

I2Sx_RCR2 field descriptions (continued)

Field	Description
	<p>Selects the audio Master Clock option used to generate an internally generated bit clock. This field has no effect when configured for an externally generated bit clock.</p> <p>NOTE: Depending on the device, some Master Clock options might not be available. See the chip-specific information for the availability and chip-specific meaning of each option.</p> <p>00 Bus Clock selected. 01 Master Clock (MCLK) 1 option selected. 10 Master Clock (MCLK) 2 option selected. 11 Master Clock (MCLK) 3 option selected.</p>
25 BCP	<p>Bit Clock Polarity</p> <p>Configures the polarity of the bit clock.</p> <p>0 Bit Clock is active high with drive outputs on rising edge and sample inputs on falling edge. 1 Bit Clock is active low with drive outputs on falling edge and sample inputs on rising edge.</p>
24 BCD	<p>Bit Clock Direction</p> <p>Configures the direction of the bit clock.</p> <p>0 Bit clock is generated externally in Slave mode. 1 Bit clock is generated internally in Master mode.</p>
23–8 Reserved	<p>This field is reserved. This read-only field is reserved and always has the value 0.</p>
DIV	<p>Bit Clock Divide</p> <p>Divides down the audio master clock to generate the bit clock when configured for an internal bit clock. The division value is $(DIV + 1) * 2$.</p>

45.4.13 SAI Receive Configuration 3 Register (I2Sx_RCR3)

This register must not be altered when RCSR[RE] is set.

Address: Base address + 8Ch offset

Bit	31	30	29	28	27	26	25	24	23	22	21	20	19	18	17	16	
R	0								0								RCE
W																	
Reset	0	0	0	0	0	0	0	0	0	0	0	0	0	0	0	0	
Bit	15	14	13	12	11	10	9	8	7	6	5	4	3	2	1	0	
R	0								WDFL								
W																	
Reset	0	0	0	0	0	0	0	0	0	0	0	0	0	0	0	0	

I2Sx_RCR3 field descriptions

Field	Description
31–24 Reserved	This field is reserved. This read-only field is reserved and always has the value 0.
23–17 Reserved	This field is reserved. This read-only field is reserved and always has the value 0.
16 RCE	<p>Receive Channel Enable</p> <p>Enables the corresponding data channel for receive operation. A channel must be enabled before its FIFO is accessed.</p> <p>The width of RCE field = the number of receive channels (call it N). For example, if RCE field is 2 bits wide, then bit position 16 refers to receive channel 1 and bit position 17 refers to receive channel 2. Setting bit 16 enables receive channel 1, and setting bit 17 enables receive channel 2. Setting bit N will enable receive channel N.</p> <p>0 Receive data channel N is disabled. 1 Receive data channel N is enabled.</p>
15–5 Reserved	This field is reserved. This read-only field is reserved and always has the value 0.
WDFL	<p>Word Flag Configuration</p> <p>Configures which word the start of word flag is set. The value written should be one less than the word number (for example, write zero to configure for the first word in the frame). When configured to a value greater than the Frame Size field, then the start of word flag is never set.</p>

45.4.14 SAI Receive Configuration 4 Register (I2Sx_RCR4)

This register must not be altered when RCSR[RE] is set.

Address: Base address + 90h offset

Bit	31	30	29	28	27	26	25	24	23	22	21	20	19	18	17	16
R		0		0		0		0		0		FRSZ				
W	[Shaded]															
Reset	0	0	0	0	0	0	0	0	0	0	0	0	0	0	0	0
Bit	15	14	13	12	11	10	9	8	7	6	5	4	3	2	1	0
R	0			SYWD					0			MF	FSE	0	FSP	FSD
W	[Shaded]			[Shaded]					[Shaded]			[Shaded]	[Shaded]	[Shaded]	[Shaded]	[Shaded]
Reset	0	0	0	0	0	0	0	0	0	0	0	0	0	0	0	0

I2Sx_RCR4 field descriptions

Field	Description
31–29 Reserved	This field is reserved. This read-only field is reserved and always has the value 0.
28 Reserved	This field is reserved. This read-only field is reserved and always has the value 0.
27–26 Reserved	This field is reserved. This read-only field is reserved and always has the value 0.

Table continues on the next page...

I2Sx_RCR4 field descriptions (continued)

Field	Description
25–24 Reserved	This field is reserved. This read-only field is reserved and always has the value 0.
23–21 Reserved	This field is reserved. This read-only field is reserved and always has the value 0.
20–16 FRSZ	Frame Size Configures the number of words in each frame. The value written must be one less than the number of words in the frame. For example, write 0 for one word per frame. The maximum supported frame size is 32 words.
15–13 Reserved	This field is reserved. This read-only field is reserved and always has the value 0.
12–8 SYWD	Sync Width Configures the length of the frame sync in number of bit clocks. The value written must be one less than the number of bit clocks. For example, write 0 for the frame sync to assert for one bit clock only. The sync width cannot be configured longer than the first word of the frame.
7–5 Reserved	This field is reserved. This read-only field is reserved and always has the value 0.
4 MF	MSB First Configures whether the LSB or the MSB is received first. 0 LSB is received first. 1 MSB is received first.
3 FSE	Frame Sync Early 0 Frame sync asserts with the first bit of the frame. 1 Frame sync asserts one bit before the first bit of the frame.
2 Reserved	This field is reserved. This read-only field is reserved and always has the value 0.
1 FSP	Frame Sync Polarity Configures the polarity of the frame sync. 0 Frame sync is active high. 1 Frame sync is active low.
0 FSD	Frame Sync Direction Configures the direction of the frame sync. 0 Frame Sync is generated externally in Slave mode. 1 Frame Sync is generated internally in Master mode.

45.4.15 SAI Receive Configuration 5 Register (I2Sx_RCR5)

This register must not be altered when RCSR[RE] is set.

Address: Base address + 94h offset

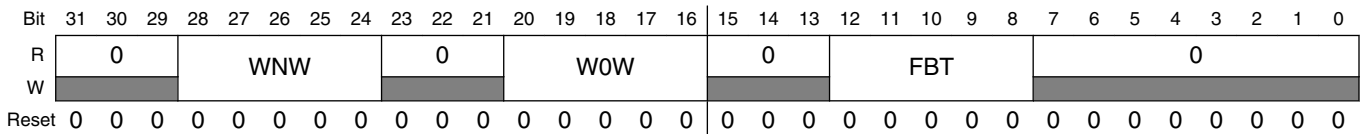

I2Sx_RCR5 field descriptions

Field	Description
31–29 Reserved	This field is reserved. This read-only field is reserved and always has the value 0.
28–24 WNW	Word N Width Configures the number of bits in each word, for each word except the first in the frame. The value written must be one less than the number of bits per word. Word width of less than 8 bits is not supported.
23–21 Reserved	This field is reserved. This read-only field is reserved and always has the value 0.
20–16 WOW	Word 0 Width Configures the number of bits in the first word in each frame. The value written must be one less than the number of bits in the first word. Word width of less than 8 bits is not supported if there is only one word per frame.
15–13 Reserved	This field is reserved. This read-only field is reserved and always has the value 0.
12–8 FBT	First Bit Shifted Configures the bit index for the first bit received for each word in the frame. If configured for MSB First, the index of the next bit received is one less than the current bit received. If configured for LSB First, the index of the next bit received is one more than the current bit received. The value written must be greater than or equal to the word width when configured for MSB First. The value written must be less than or equal to 31-word width when configured for LSB First.
Reserved	This field is reserved. This read-only field is reserved and always has the value 0.

45.4.16 SAI Receive Data Register (I2Sx_RDRn)

Reading this register introduces one additional peripheral clock wait state on each read.

Address: Base address + A0h offset + (4d × i), where i=0d to 0d

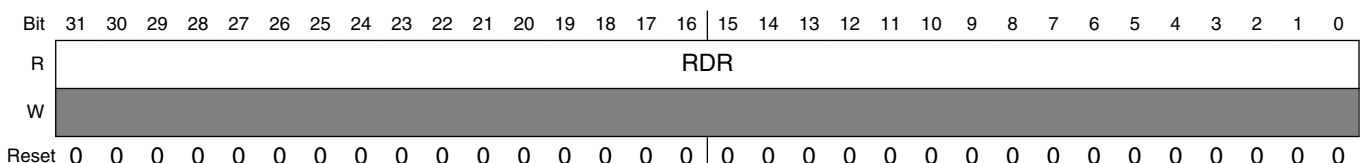

I2Sx_RDR_n field descriptions

Field	Description
RDR	Receive Data Register The corresponding RCR3[RCE] bit must be set before accessing the channel's receive data register. Reads from this register when the receive FIFO is not empty will return the data from the top of the receive FIFO. Reads from this register when the receive FIFO is empty are ignored.

45.4.17 SAI Receive FIFO Register (I2Sx_RFR_n)

The MSB of the read and write pointers is used to distinguish between FIFO full and empty conditions. If the read and write pointers are identical, then the FIFO is empty. If the read and write pointers are identical except for the MSB, then the FIFO is full.

Address: Base address + C0h offset + (4d × i), where i=0d to 0d

Bit	31	30	29	28	27	26	25	24	23	22	21	20	19	18	17	16
R	0								WFP							
W	[Shaded]															
Reset	0	0	0	0	0	0	0	0	0	0	0	0	0	0	0	0
Bit	15	14	13	12	11	10	9	8	7	6	5	4	3	2	1	0
R	0	0							RFP							
W	[Shaded]															
Reset	0	0	0	0	0	0	0	0	0	0	0	0	0	0	0	0

I2Sx_RFR_n field descriptions

Field	Description
31–22 Reserved	This field is reserved. This read-only field is reserved and always has the value 0.
21–16 WFP	Write FIFO Pointer FIFO write pointer for receive data channel.
15 Reserved	This field is reserved. This read-only field is reserved and always has the value 0.
14–6 Reserved	This field is reserved. This read-only field is reserved and always has the value 0.
RFP	Read FIFO Pointer FIFO read pointer for receive data channel.

45.4.18 SAI Receive Mask Register (I2Sx_RMR)

This register is double-buffered and updates:

Memory map and register definition

1. When RCSR[RE] is first set
2. At the end of each frame

This allows the masked words in each frame to change from frame to frame.

Address: Base address + E0h offset

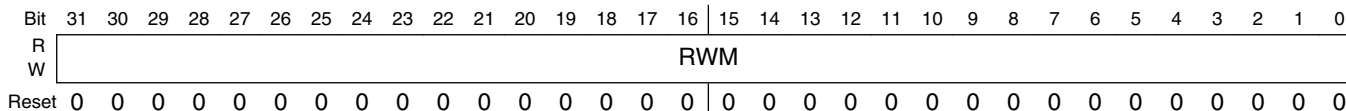

I2Sx_RMR field descriptions

Field	Description
RWM	<p>Receive Word Mask</p> <p>Configures whether the receive word is masked (received data ignored and not written to receive FIFO) for the corresponding word in the frame.</p> <p>0 Word N is enabled. 1 Word N is masked.</p>

45.4.19 SAI MCLK Control Register (I2Sx_MCR)

The MCLK Control Register (MCR) controls the clock source and direction of the audio master clock.

Address: Base address + 100h offset

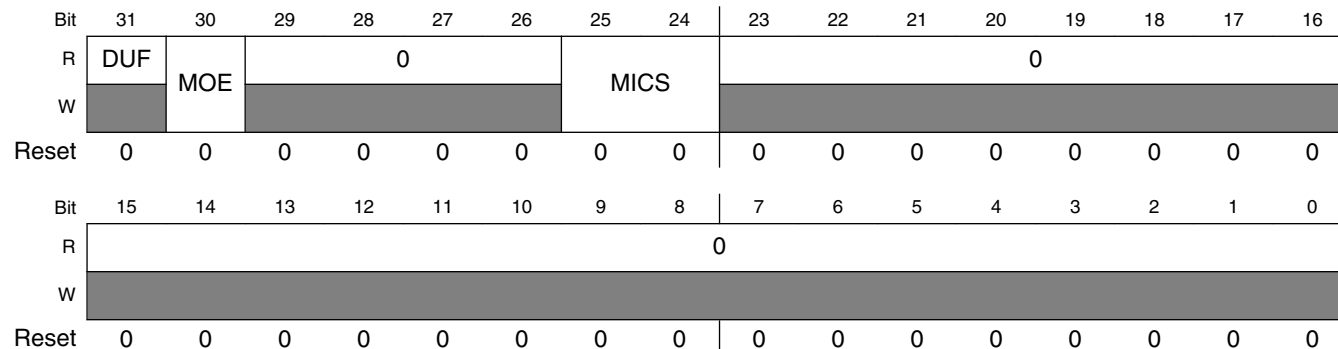

I2Sx_MCR field descriptions

Field	Description
31 DUF	<p>Divider Update Flag</p> <p>Provides the status of on-the-fly updates to the MCLK divider ratio.</p> <p>0 MCLK divider ratio is not being updated currently. 1 MCLK divider ratio is updating on-the-fly. Further updates to the MCLK divider ratio are blocked while this flag remains set.</p>

Table continues on the next page...

I2Sx_MCR field descriptions (continued)

Field	Description
30 MOE	<p>MCLK Output Enable</p> <p>Enables the MCLK divider and configures the MCLK signal pin as an output. When software clears this field, it remains set until the MCLK divider is fully disabled.</p> <p>0 MCLK signal pin is configured as an input that bypasses the MCLK divider. 1 MCLK signal pin is configured as an output from the MCLK divider and the MCLK divider is enabled.</p>
29–26 Reserved	<p>This field is reserved. This read-only field is reserved and always has the value 0.</p>
25–24 MICS	<p>MCLK Input Clock Select</p> <p>Selects the clock input to the MCLK divider. This field cannot be changed while the MCLK divider is enabled. See the chip-specific information for the connections to these inputs.</p> <p>00 MCLK divider input clock 0 is selected. 01 Reserved 10 MCLK divider input clock 2 is selected. 11 MCLK divider input clock 3 is selected.</p>
Reserved	<p>This field is reserved. This read-only field is reserved and always has the value 0.</p>

Chapter 46

Smart Direct Memory Access Controller (SDMA)

46.1 Overview

The Smart Direct Memory Access (SDMA) controller offers highly-competitive DMA features combined with software-based virtual-DMA flexibility. It enables data transfers between peripheral I/O devices and internal/external memories.

The SDMA controller helps maximize system performance by off-loading the Arm core in dynamic data routing.

46.1.1 Block Diagram

The figure below shows a block diagram of the SDMA controller. It includes the custom RISC core along with its RAM, ROM, DMA units, and the scheduler.

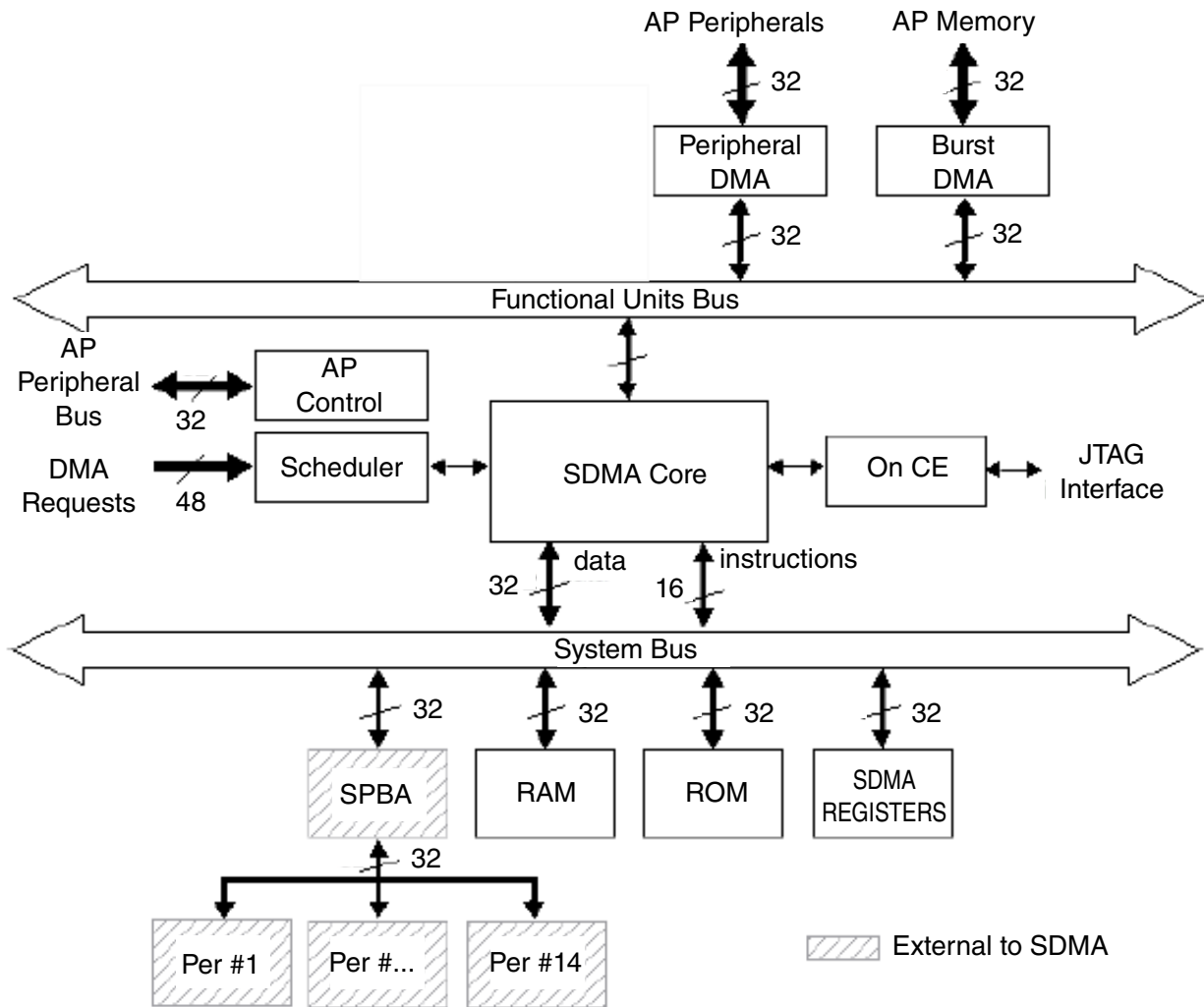

Figure 46-1. SDMA Block Diagram

The SDMA core executes short routines that perform DMA transfers; these routines are called *scripts*. The SDMA core interfaces to its own memory via the SDMA system bus. The SDMA system bus supports a 32-bit data path and a 16-bit address bus. The system bus datapath is used for both 16-bit instruction (program) memory access and 32-bit data access. DMA units interface to the core via the Functional Unit Bus and use dedicated registers to perform DMA transfers.

The SDMA memory contains a ROM and a RAM. The ROM contains startup scripts (for example, boot code) and other common utilities, which are referenced by the scripts that reside in the RAM. The internal RAM is divided into a context area and a script area (more details about this mapping are available in [Instruction Memory Map](#) and [Data Memory Map](#)).

Every transfer channel requires one context area to keep the contents of all the core and unit registers while inactive. Channel scripts are downloaded into the internal RAM by the SDMA using a dedicated channel that is started during the boot sequence. Downloads are invoked using commands and pointers provided by the Arm platform. Every channel contains a corresponding channel script located in RAM and/or ROM that can be reconfigured independently as-needed. Channel scripts can be stored in an external memory and downloaded when needed. The SDMA can be configured with any mixture of scripts to enable an endless combination of supported services.

The scheduler monitors and detects DMA requests, mapping them to channels, and mapping individual channels to a pre-configured priority. At any given point, the scheduler presents the highest priority channel that requires service to the SDMA core. A special SDMA core instruction is used to "conditionally yield" the current channel being executed to an eligible channel that requires service. If (and only if) there is an eligible channel pending, will the current channel execution be preempted.

There are two yield instructions that differently determine the eligible channels: In the first version, eligible channels are pending channels with a strictly higher priority than the current channel priority. In the second version (yieldge), eligible channels are pending channels with a priority that is greater or equal to the current channel priority. The scheduler detects devices that need service through its 48 DMA request inputs. After a request is detected, the scheduler determines the channel(s) that is (are) triggered by this request and marks it (them) as pending in the "Channel Pending (EP)" register. The priorities of all the pending channels are continuously evaluated in order to update the highest pending priority. The channel pending flag is cleared by the channel script when the transfer has completed.

The Arm platform control block contains the control registers used to configure the 32 individual channels. There are 48 Channel Enable registers, and every register maps one DMA request to any desired combination of channels. The 32 Priority registers are used to assign a programmable 1-of-7 level priority to every possible channel. This block also contains all other control registers that the Arm platform can access.

The 48 DMA requests that are connected to the scheduler come from a variety of sources. The "receive register full" and "transmit register empty" signals found in the UART and USB ports are typical examples of DMA requests that can be connected to the SDMA. These requests can be used to trigger a specific SDMA channel, or several channels.

There is an OnCE compatible debug port for product development. The OnCE includes support for setting breakpoints, single-step and trace, and register dump capability. In addition, all memory locations are accessible from the debug port.

46.1.2 Features

The following are the SDMA features:

- Multi-channel DMA supporting up to 32 time-division multiplexed DMA channels
- Hardware or software driven triggers for each channel
- 48 hardware driven triggers that can be mapped to any channel.
- Memory accesses including linear addressing, FIFO addressing and 2D addressing
- Fast context-switching with two-level, priority-based preemptive multi-tasking
- 16-bit instruction-set micro-RISC engine (the SDMA core)
- Two DMA units with some or all the following features:
 - Auto-flush and prefetch capability
 - Flexible address management (increment, decrement, and no address changes on source and destination address)
 - Misaligned data-transfer support
 - Uni-directional and bi-directional flows (copy mode)
 - Up to eight-word buffers for configurable burst transfers
- Support of byte-swapping
- An available API and library of scripts
- Little-Endian and Big-Endian modes
- Hardware handshakes for low-power entry sequence
- Security support to lock contents of the SDMA script RAM.
- 4-Kbyte ROM containing startup scripts (for example, boot code) and other common utilities that can be referenced by RAM-located scripts
- 8-Kbyte RAM area is divided into a processor context area and a code space area used to store channel scripts that are downloaded from the system memory
- Debug support, including a OnCE port, real-time monitors, and embedded cross-trigger events
- Supported clock frequencies in process:
 - Configurable clock options for the SDMA core and the Arm platform DMA units
 - 1:2 ratio with maximum of SDMA core running at Arm platform Peripheral Bus speed and DMA running at max DMA frequency.
 - 1:1 ratio when both SDMA core and Arm platform DMA clocks are set to the Arm platform Peripheral Bus speed.
- Peripheral bus interface for configuration register programming by the Arm platform
- The SDMA RISC engine (arithmetic and logic operations), which is referred to as the "SDMA core."
- An internal peripheral bus connected to the Shared Peripherals Bus Interface (SPBA) that enables access to up to 14 shared peripherals. SDMA supports 32-bit accesses to word peripherals and 16-bit accesses to half-word peripherals.

- The peripheral DMA unit that is hooked-up to the Arm platform Crossbar Switch to service Arm peripherals
- The burst DMA unit is able to perform burst accesses to the external memory
- All the DMA units are 32-bit AHB masters. They are connected to different buses, thus allowing concurrent accesses.

46.2 External Signals

The table found here describes the external signals of SDMA.

Table 46-1. SDMA External Signals

Signal	Description	Pad	Mode	Direction
SDMA_EVENT0	Event0 signal	GPIO1_IO02	ALT6	I
		JTAG_MOD	ALT6	
		SD1_CMD	ALT6	
SDMA_EVENT1	Event1 signal	JTAG_TMS	ALT6	I
		NAND_DQS	ALT6	

46.3 Clocks

The following table describes the clock sources for SDMA. Please see [Clock Controller Module \(CCM\)](#) for clock setting, configuration and gating information. For functional information regarding module clocks, see [SDMA Clocks and Low Power Modes](#).

Table 46-2. SDMA Clocks

Clock name	Clock Root	Description
events_sync_clk (clk)	ahb_clk_root	Arm peripheral / events clock
ips_hostctrl_clk	ipg_clk_root	Host control clock
ap_ahb_clk	ahb_clk_root	Arm platform bus clock
core_clk	ipg_clk_root	Module / Core clock
tck	-	JTAG access clock

46.4 Functional Description

The figure below shows the SDMA topology, and is composed of the following components:

Functional Description

- SDMA Core ([SDMA Core](#))
- SDMA Scheduler ([Scheduler](#))
- Functional Units:
 - Burst DMA ([Burst DMA Unit](#))
 - Peripheral DMA ([Peripheral DMA Unit](#))
- Arm platform Control for Arm control register access.
- Internal RAM and ROM Memory ([SDMA Programming Model](#))
- OnCE debug Port ([The OnCE Controller](#))

The functional unit bus provides access by the SDMA core to the DMA units. The system bus provides access to SDMA internal memory and also supports up to 14 peripherals.

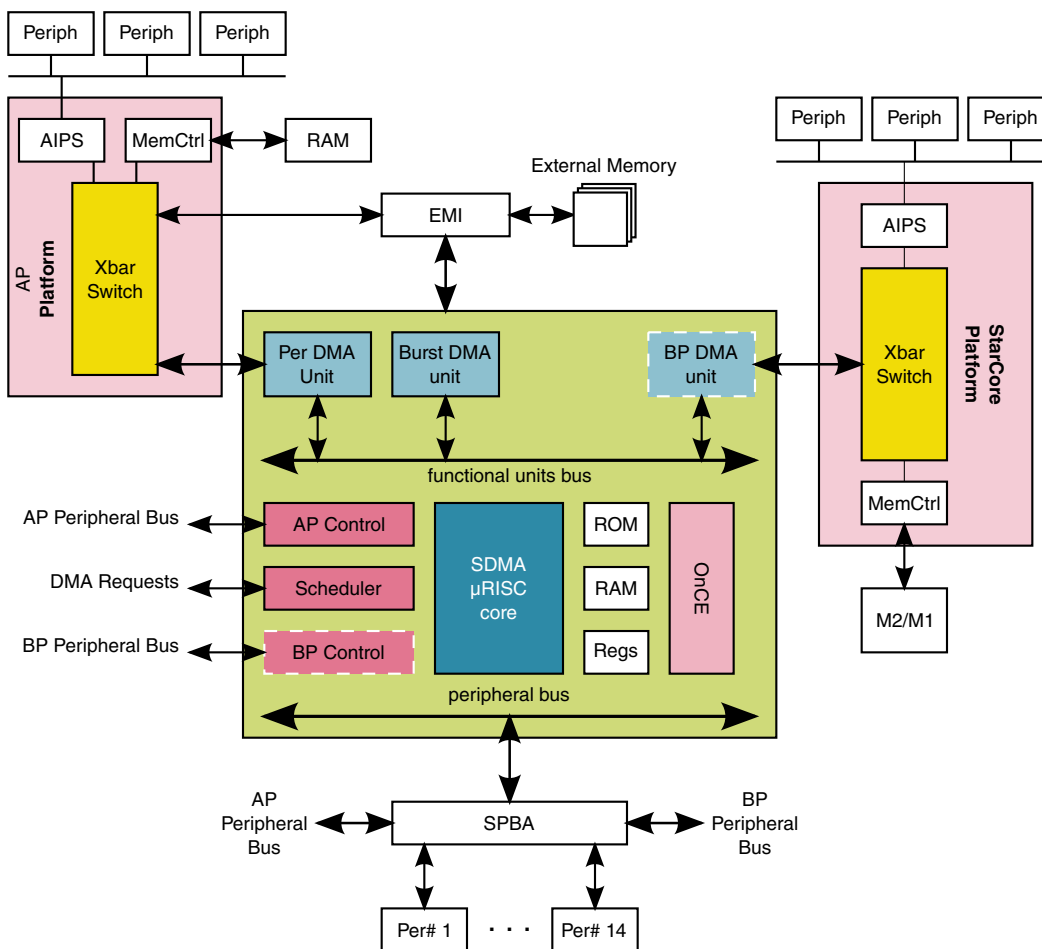

Figure 46-2. SDMA Connections

46.4.1 SDMA Core

The SDMA core is a customized RISC-like processor that is specifically developed to control DMA units and perform L1 tasks like byte-stuffing or framing.

The SDMA core incorporates on-chip debug capability using the OnCE.

The SDMA core is based on a 32-bit register architecture with 16-bit instructions. There are eight general purpose 32-bit registers, four flags (T, LM, SF, and DF), and four PCU registers (PC, RPC, SPC, and EPC) that can address 16,384 16-bit instructions.

46.4.1.1 SDMA Core Structure

The figure found here shows the structure of the SDMA core. It also shows the different registers, calculation resources, and possible data movements.

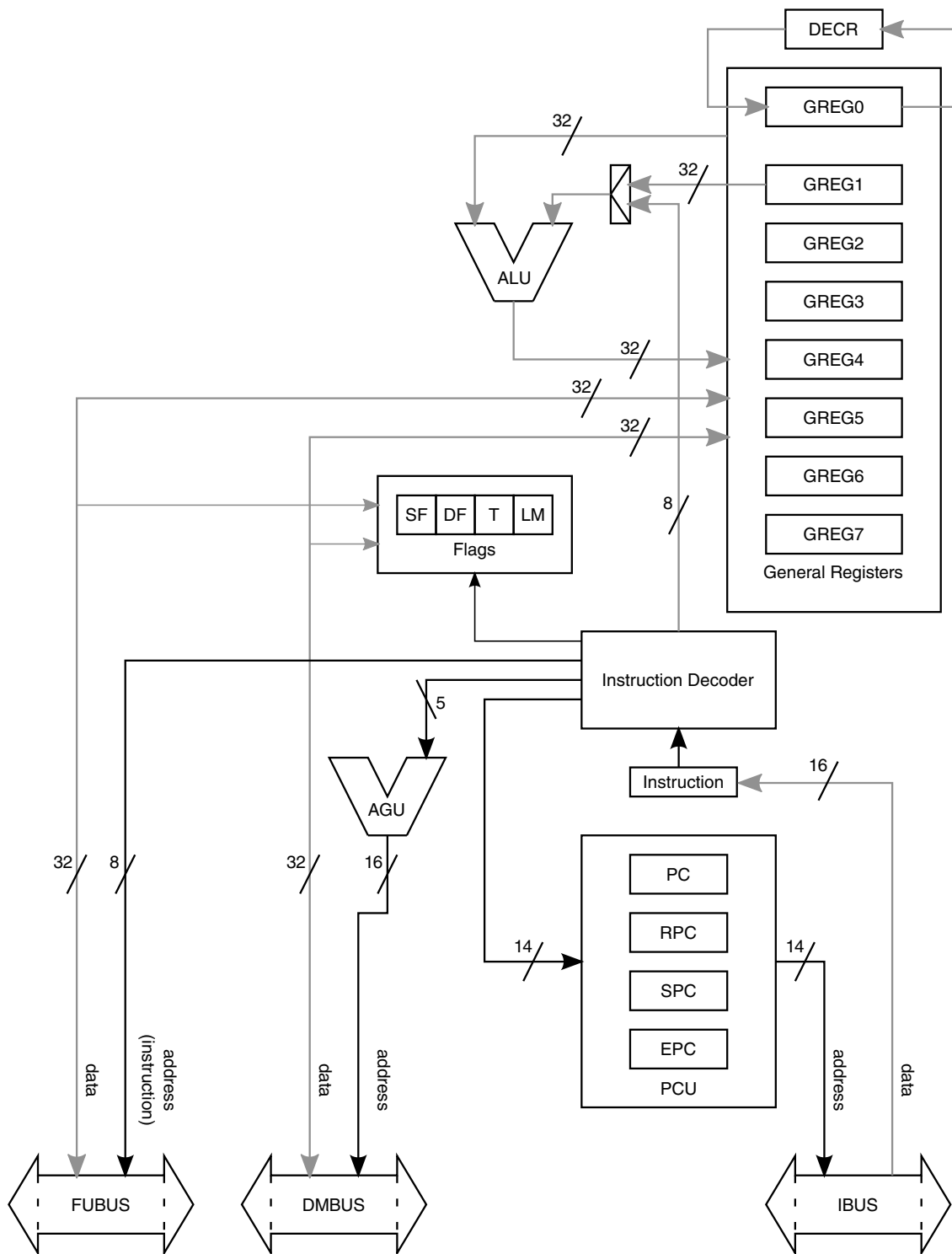

Figure 46-3. SDMA Core

- The Program Control Unit (PCU) is described in [Program Control Unit \(PCU\)](#). It handles the state of the core and generates the instruction fetch addresses. Instructions are retrieved from the Instruction Bus (IBUS) and stored in the SDMA

core instruction register prior to their decoding. The PCU contains the following registers:

- The Program Counter (PC) contains the address of the current instruction.
- The Return Program Counter (RPC) contains the address of the instruction that follows a jump to the subroutine.
- The Start Program Counter (SPC) contains the address of the first instruction of the current hardware loop.
- End Program Counter (EPC) contains the address of the last instruction of the current hardware loop.
- The other core registers are the general purpose registers (GREGn) and the flags.
 - The general purpose registers can be used to hold data and addresses. They can be loaded with immediate values (for example, 8-bit data that are encoded in the instruction), results of calculations that were performed with the ALU, 32-bit data that comes from the memory or peripherals via the Data Memory Bus (DMBUS), 32-bit data that comes from the DMAs via the Functional Units Bus (FUBUS) or another general purpose register. Their content can be the operands of the ALU, the data to send on either bus (DMBUS or FUBUS), or a pointer to memory (DMBUS address).
 - The general register 0 (GREG0) is also the hardware loop counter. In hardware loops, it cannot be used for any other purpose. This register uses a dedicated decrement unit (DECR) shown in [Figure 46-3](#).
 - The flags reflect the status of operations:
 - SF and DF are set when the last load or store on either bus (FUBUS or DMBUS) received an error response.
 - LM is set when the core is executing instructions inside a hardware loop.
 - T is set when the ALU operation result was 0 or the loop counter reaches 0 (the latter is preponderant when an ALU operation is the last instruction of a hardware loop).
- The ALU has two operands: any general register and either a second general register or an immediate value. The result is always stored into the first general register. A NOP function can be utilized by moving a register's contents into itself (For example, the instruction: mov R0,R0).
- The 16-bit instructions are fetched via the instruction bus (IBUS) whose address is driven by the PC. The SDMA RAM and ROM are visible to the core as 16-bit devices through this interface.
- The memory (RAM and ROM), memory mapped registers, and external peripherals are accessed via the DMBUS. The address is always taken from a general register whose content is added to a 5-bit immediate value. This is the only available addressing mode. The DMBUS is a 32-bit data bus. Except for the peripherals that

are external to the SDMA, the address accuracy is the 32-bit word (for example, adding 1 to an address points to the next word, not the next byte).

- The functional units are accessed via the FUBUS connection. The data is exchanged with any general register, but the address (which in fact is the instruction and the selector of the functional unit) comes from an 8-bit field of the corresponding load or store.

46.4.1.2 Program Control Unit (PCU)

This part of the SDMA core is dedicated to the control of the RISC engine, as implied by the instructions that are executed. Its behavior is determined by the instruction type and the inputs of the SDMA.

It contains the PC, RPC, SPC, and EPC registers that are described in [SDMA Core Structure](#).

46.4.1.2.1 Instruction Types

The state sequence and the delay of execution vary according to the type of the instruction. There are six possible categories of instructions, as follows:

1. Standard: Most of the instructions belong to this category, and always last 1 cycle.
2. ldf/stf: These are respectively the load and store instructions that access the functional units. They last $1+n$ cycles where n is the number of wait-states of the targeted functional unit.
3. ld/st: These are the load and store instructions that access the memory and peripherals. They last $1+n$ cycles where n is the number of wait-states of the targeted device (1 for the ROM, RAM, and memory mapped registers, 1 + the external peripheral wait-states). These instructions always last at least two cycles, but the core is able to handle them in one cycle. The first wait-state is inserted outside the core.
4. Branch: These are all the instructions that cause the Program Counter to point to another instruction other than the following one (for example, one that breaks the sequential flow). There are the absolute jumps, the conditional branches, the jump to the sub-routines, and the return from the sub-routine.
5. Loop, Modified Load or Store: The hardware loop instruction modifies the potential behavior of any load or store inside the loop (for example, when the LM flag is set). A jump may be implied after any such load or store if it received an error. The error causes an early exit of the loop, which means a jump to the instruction that follows the one that is pointed to by EPC. An additional cycle is required by the PCU to perform the jump (+1 to the ld/st/ldf/stf original execution delay). Although there is

usually an implicit jump after the last instruction of the loop when the PC goes back to SPC, this is performed at no cycle cost.

6. Done: The done, yield, or yieldg instructions are used to control channel switching. When no channel switching is performed, these instructions last a single cycle. When there is a change of channel or context switch, the delay is variable and depends on many factors (as detailed in [Context Switching](#)).

46.4.1.2.2 PCU States

The PCU state is visible through outputs of the SDMA (see [Real-Time Debug Outputs](#)) or the OnCE status register(see [OnCE Status Register \(OSTAT\)](#)).

The PCU state is a four-bit field that can take the values shown in the following table. [Figure 46-4](#) shows the possible state transitions and the corresponding conditions.

Table 46-3. PCU States

Value	State	Description
0	Program	This is the usual instruction cycle.
1	Data	This state is inserted when there are wait-states during a load or a store on the data bus (ld/st type).
2	Change of Flow	This is the second cycle of any instruction that breaks the sequence of instructions (branch and done types). This state lasts only a single cycle; it is always followed by the Program state.
3	Error in Loop	This state is used when an error causes a hardware loop exit (loop-modified load or store type). This state only lasts a single cycle; it is always followed by the Program state.
4	Debug	The SDMA is stopped in debug mode.
5	Functional Unit	This state is inserted when there are wait-states during a load or a store on the functional units bus (ldf/stf type).
6	Sleep	No script is running: The core is idle after saving the last channel context.
7	Save	The context switch FSM is saving the current channel.
8	Program in Sleep	Same as Program except there is no associated channel, this state is used when instructions are executed after entering debug mode, whereas the core was in either Sleep mode.
9	Data in Sleep	This is the same as Data except there is no associated channel.
10	Change of Flow in Sleep	This is the same as Change of Flow except there is no associated channel. This state only lasts a single cycle, and is always followed by the Program in Sleep state.
11	Error in Loop in Sleep	This is the same as Error in Loop except there is no associated. channel. This state only lasts a single cycle, and is always followed by the Program in Sleep state.
12	Debug in Sleep	This is the same as Debug except the core was put in debug mode when no channel was active.
13	Functional Unit in Sleep	This is the same as Functional Unit except there is no associated channel.

Table continues on the next page...

Table 46-3. PCU States (continued)

Value	State	Description
14	Sleep after Reset	This shows that no script is running, and the core is idle after a reset. When a channel becomes active, no context is restored but the core starts its boot program located at address 0 (or the address available in register in Channel 0 Boot Address (SDMAARM_CHN0ADDR)).
15	Restore	The context switch FSM is restoring the next channel context.

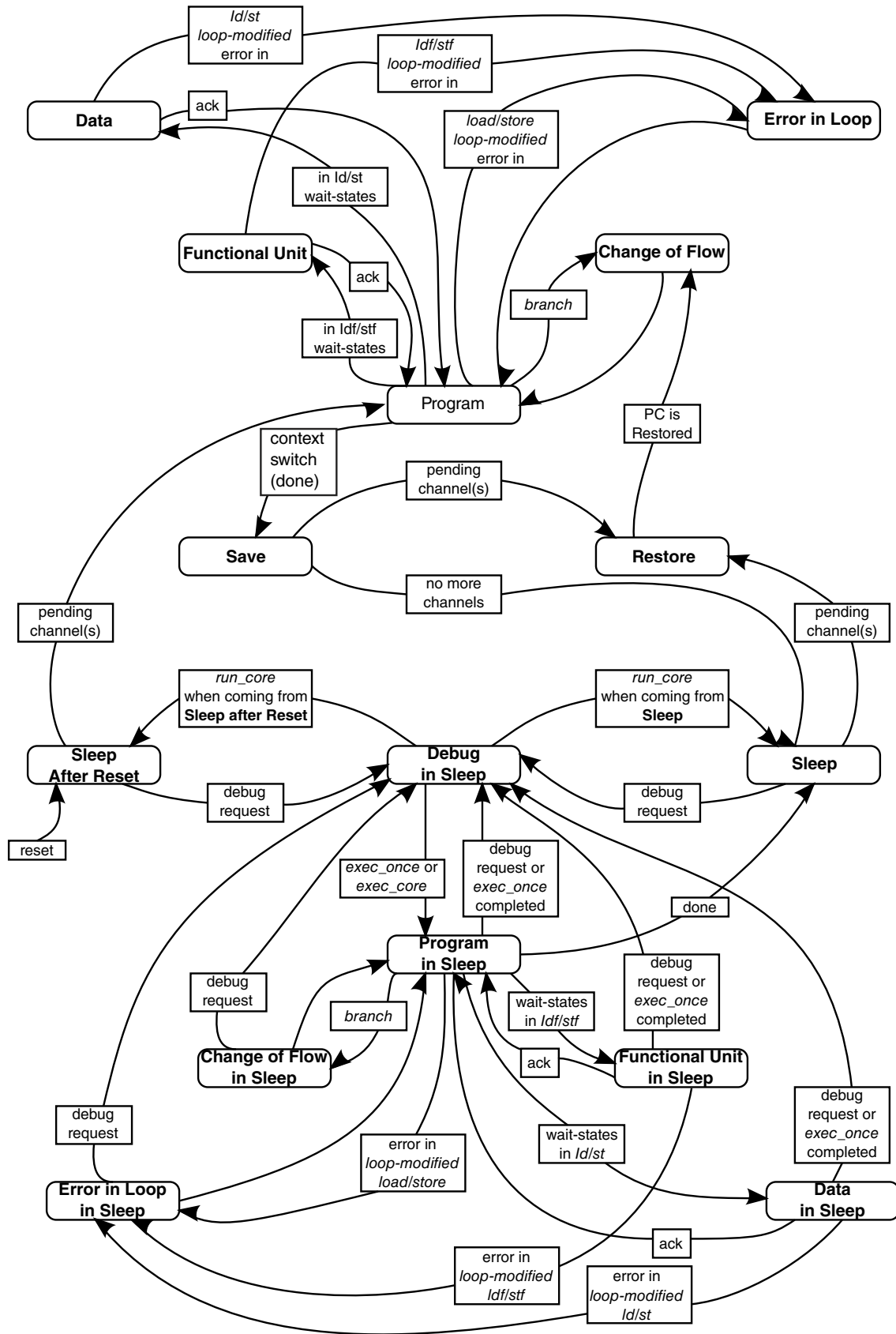

Figure 46-4. PCU State Diagram

46.4.1.3 SDMA Core Memory

The SDMA has two memory spaces: one for the instructions and one for the data. As both spaces share the same resources (ROM and RAM devices), the system bus manages possible conflicts when the core accesses the same resource for both an instruction read and a data read or write.

Program and data memory is further described in [Address Space](#).

Instructions of 16-bit width are stored in 32-bit wide devices and can be accessed as data. The mapping is Big Endian: an even instruction address (terminated by 0) accesses the most significant part of the 32-bit data (bits [31:16]), and an odd instruction address (terminated by 1) accesses the least significant part of the 32-bit data (bits [15:0]). Instructions can be fetched out of internal ROM or RAM.

Data can be read from ROM, RAM, memory mapped registers, and external peripherals, and written to the same devices (except the ROM).

The ROM contains bootload scripts, channel scripts, and common subroutines which may be referenced by channel scripts elsewhere in the ROM or RAM.

The RAM is divided into a context area and a code space area which may be used to store channel scripts. The RAM contains undefined values after a hardware reset. Channel scripts and initial context values are downloaded into RAM using channel 0 which is reserved for bootload functions.

46.4.2 Scheduler

All channel scheduling hardware is included in the Scheduler.

46.4.2.1 Primary Functions

The scheduler is a hardware-based design used to coordinate the timely execution of 32 virtual DMA channels by the SDMA core on the basis of channel status and priority.

The scheduler performs the following functions:

- Monitors, detects, and registers the occurrence of any one of the 48 DMA requests
- Links a specific request to a channel or group of channels (channel mapping)
- Ignores requests that are not mapped to a previously configured channel
- Maintains a list of all the channels that are requesting service

- Assigns a pre-programmed priority level (1 of 7) to every channel requesting service
- Detects and flags overrun/underrun conditions

46.4.2.2 Channels and DMA Requests

46.4.2.2.1 Channels

A Virtual Channel (hereafter simply called a channel) manages a flow of data through the SDMA. Flows are typically unidirectional.

The SDMA can have up to 32 simultaneously operating channels, numbered from 0 to 31. Channel 0 is usually dedicated to control the SDMA script downloading. All the channels can be assigned by the Arm platform software.

46.4.2.2.2 DMA Requests

A DMA request is caused by externally (for example, external to the SDMA) controlled conditions (for example, UART receive FIFO reaches a threshold). The SDMA currently supports up to 48 DMA requests.

46.4.2.2.3 Mapping from DMA Requests to Channels and Priorities

A channel can stall waiting on a single DMA request. A single DMA request can awake more than one channel (in fact, any request can awake any combination of channels).

The mapping between DMA requests and channels is program-controlled. There is a storage element assigned for each of the 48 requests that contains a bitmap table of the channels that are awakened by the event.

Every channel also has a three-bit register that indicates its priority.

46.4.2.3 Scheduler Functional Description

[Scheduler Overview](#) describes the behavior of the SDMA scheduler-from the channel enabling conditions to the highest priority pending channel selection.

46.4.2.3.1 Scheduler Overview

The scheduler algorithm is built in hardware. It is provided with possibilities for the Arm platform to control its behavior.

The scheduler processes incoming DMA requests, maps detected requests to 0, one, or several channels, maintains a list of channels that are requesting service (pending channels), identifies the top priority and its associated channel, and selects the next active channel when the current channel yields.

The following figure shows a functional overview.

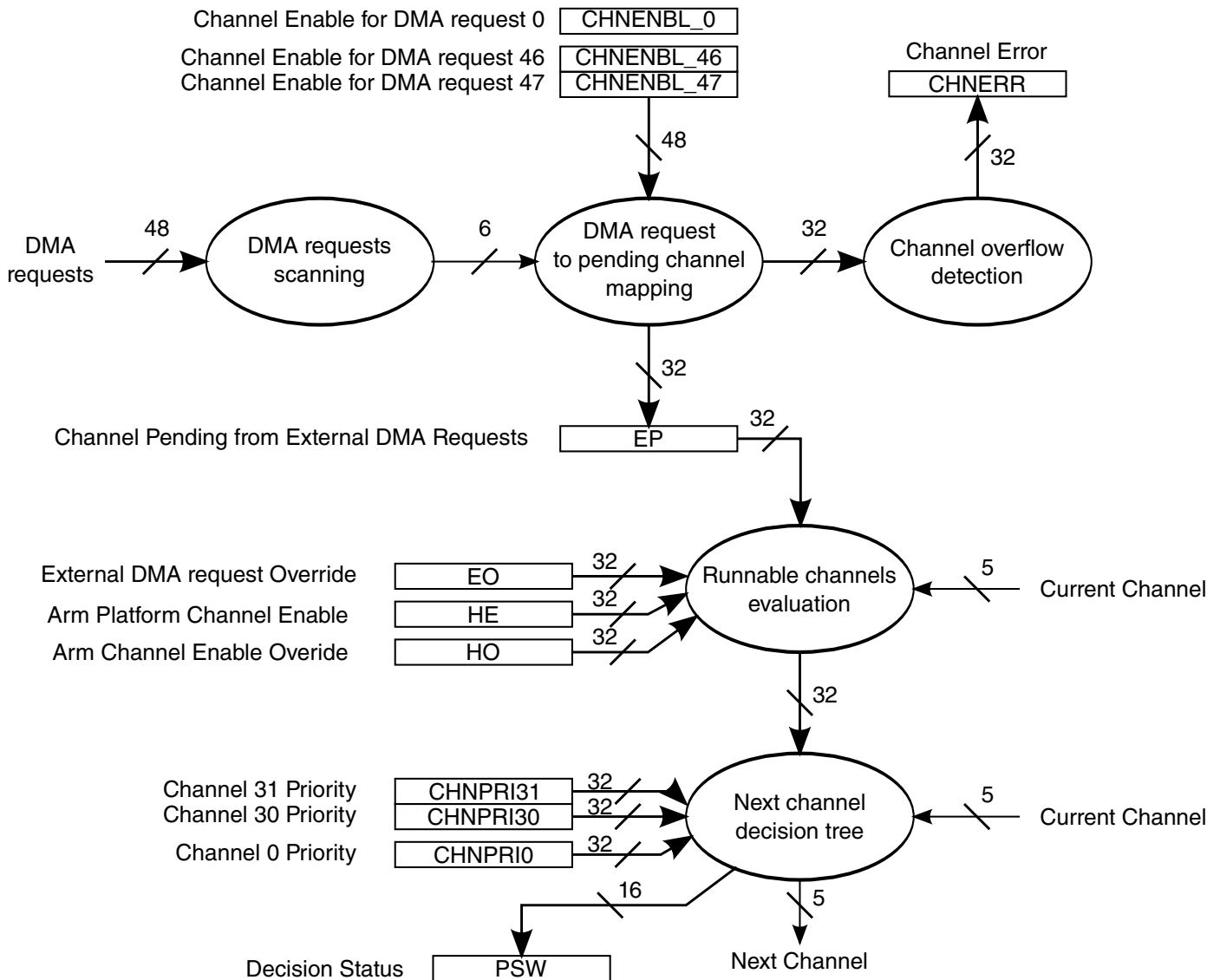

Figure 46-5. SDMA Hardware Scheduler

46.4.2.3.2 DMA Requests Scanning

The scheduler contains a 48-bit edge detection device that detects the rising edge of every DMA request and transmits the request number to the next stage.

The DMA requests are assumed to be generated on the same reference clock as the SDMA core clock; they are detected as soon as the signal goes from a 1-to-n-cycles low state to a 1-to-m-cycles high state.

This system is able to detect single-cycle pulses as well as level-based DMA requests such as a FIFO threshold crossing. In this case, the SDMA provides a memory mapped register that can be used by the channel script to monitor the DMA requests lines, and thus determines whether the data transfer is done or not done, and then continues with the transfer or closes the channel.

When several DMA requests are detected at the same time, they are forwarded to the next scheduler stage at the rate of one request per cycle. No request is lost.

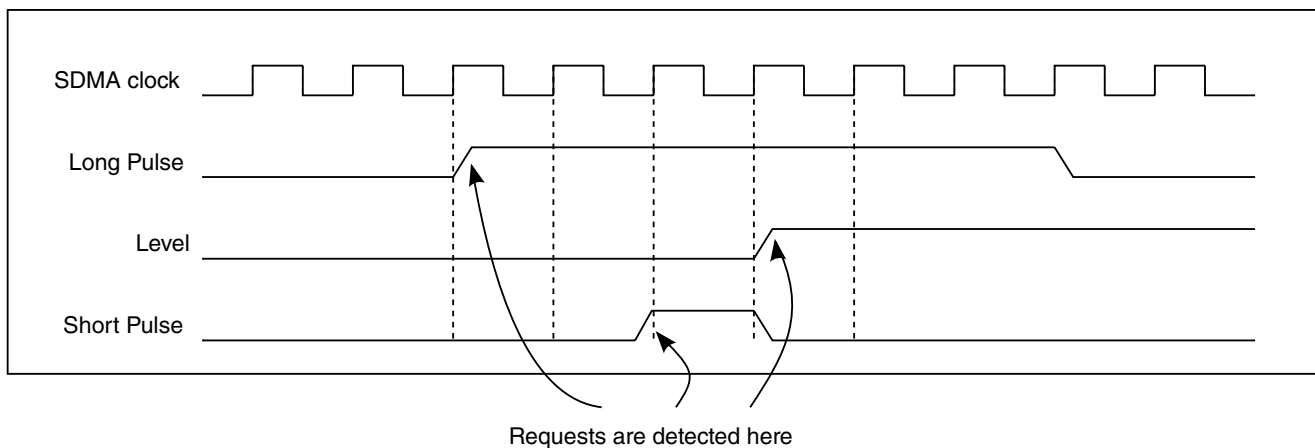

Figure 46-6. Examples of Valid DMA Requests

The DMA request inputs are connected to various sources that depend on the SoC. The exact list of DMA request inputs and their associated number is available in each respective project-specific chapter.

46.4.2.3.3 Mapping DMA Requests to Pending Channels

Whenever a DMA request is detected by the first stage, its number is used in the second stage to determine the channels that have to be activated.

This is performed with an array of 48 registers that are 32 bits wide: There are 48 Channel Enable Registers (CHNENBLn), one register per DMA request. The DMA request number selects the Channel Enable Registers, and every bit of this 32-bit register indicates that the corresponding channel must be activated when it is a 1.

Functional Description

This information is passed on the EP register. For every bit of the Channel Enable Register that is set, the corresponding bit of the EP register is also set, and the remaining bits of EP are left unchanged. The transformation of EP is summarized by the following equation:

$$EP = EP \text{ or } CHNENBLn$$

The EP register is used to know which channels require service because they received a DMA request.

Typical contents of the CHNENBLn registers are all 0s, except for a single bit set. For example, a DMA request triggers one channel, but all 0s or several 1s are possible. One DMA request could activate several channels, and the channel execution sequence can be controlled by the channel priorities and numbers, as explained in the next sections. The following table illustrates an example configuration.

NOTE

From the table, the DMA request 0 is programmed to simultaneously trigger channels 0, 1, and 31. Also, DMA requests 30-47 are not used in this example. The remaining channels 2 to 30, are configured to be triggered by DMA requests 29 to 1, respectively.

Table 46-4. Channel Enable RAM Programming Example

DMA Request Number	Channel																																							
	31																																							0
0	1	0	0	0	0	0	0	0	0	0	0	0	0	0	0	0	0	0	0	0	0	0	0	0	0	0	0	0	0	0	0	0	0	0	0	0	0	1	1	
1	0	1	0	0	0	0	0	0	0	0	0	0	0	0	0	0	0	0	0	0	0	0	0	0	0	0	0	0	0	0	0	0	0	0	0	0	0	0	0	0
2	0	0	1	0	0	0	0	0	0	0	0	0	0	0	0	0	0	0	0	0	0	0	0	0	0	0	0	0	0	0	0	0	0	0	0	0	0	0	0	0
3	0	0	0	1	0	0	0	0	0	0	0	0	0	0	0	0	0	0	0	0	0	0	0	0	0	0	0	0	0	0	0	0	0	0	0	0	0	0	0	0
4	0	0	0	0	1	0	0	0	0	0	0	0	0	0	0	0	0	0	0	0	0	0	0	0	0	0	0	0	0	0	0	0	0	0	0	0	0	0	0	0
5	0	0	0	0	0	1	0	0	0	0	0	0	0	0	0	0	0	0	0	0	0	0	0	0	0	0	0	0	0	0	0	0	0	0	0	0	0	0	0	0
6	0	0	0	0	0	0	1	0	0	0	0	0	0	0	0	0	0	0	0	0	0	0	0	0	0	0	0	0	0	0	0	0	0	0	0	0	0	0	0	0
7	0	0	0	0	0	0	0	1	0	0	0	0	0	0	0	0	0	0	0	0	0	0	0	0	0	0	0	0	0	0	0	0	0	0	0	0	0	0	0	0
8	0	0	0	0	0	0	0	0	1	0	0	0	0	0	0	0	0	0	0	0	0	0	0	0	0	0	0	0	0	0	0	0	0	0	0	0	0	0	0	0
9	0	0	0	0	0	0	0	0	0	1	0	0	0	0	0	0	0	0	0	0	0	0	0	0	0	0	0	0	0	0	0	0	0	0	0	0	0	0	0	0
10	0	0	0	0	0	0	0	0	0	0	1	0	0	0	0	0	0	0	0	0	0	0	0	0	0	0	0	0	0	0	0	0	0	0	0	0	0	0	0	0

Table continues on the next page...

Table 46-4. Channel Enable RAM Programming Example (continued)

DMA Request Number	Channel																																															
	3	1	0	0	0	0	0	0	0	0	0	0	0	0	0	0	0	0	0	0	0	0	0	0	0	0	0	0	0	0	0	0	0	0	0	0	0	0	0									
11	0	0	0	0	0	0	0	0	0	0	0	0	1	0	0	0	0	0	0	0	0	0	0	0	0	0	0	0	0	0	0	0	0	0	0	0	0	0	0	0								
12	0	0	0	0	0	0	0	0	0	0	0	0	0	1	0	0	0	0	0	0	0	0	0	0	0	0	0	0	0	0	0	0	0	0	0	0	0	0	0	0	0							
13	0	0	0	0	0	0	0	0	0	0	0	0	0	0	1	0	0	0	0	0	0	0	0	0	0	0	0	0	0	0	0	0	0	0	0	0	0	0	0	0	0							
14	0	0	0	0	0	0	0	0	0	0	0	0	0	0	0	1	0	0	0	0	0	0	0	0	0	0	0	0	0	0	0	0	0	0	0	0	0	0	0	0	0							
15	0	0	0	0	0	0	0	0	0	0	0	0	0	0	0	0	1	0	0	0	0	0	0	0	0	0	0	0	0	0	0	0	0	0	0	0	0	0	0	0	0							
16	0	0	0	0	0	0	0	0	0	0	0	0	0	0	0	0	0	1	0	0	0	0	0	0	0	0	0	0	0	0	0	0	0	0	0	0	0	0	0	0	0							
17	0	0	0	0	0	0	0	0	0	0	0	0	0	0	0	0	0	0	1	0	0	0	0	0	0	0	0	0	0	0	0	0	0	0	0	0	0	0	0	0	0							
18	0	0	0	0	0	0	0	0	0	0	0	0	0	0	0	0	0	0	0	0	1	0	0	0	0	0	0	0	0	0	0	0	0	0	0	0	0	0	0	0	0							
19	0	0	0	0	0	0	0	0	0	0	0	0	0	0	0	0	0	0	0	0	0	1	0	0	0	0	0	0	0	0	0	0	0	0	0	0	0	0	0	0	0							
20	0	0	0	0	0	0	0	0	0	0	0	0	0	0	0	0	0	0	0	0	0	0	1	0	0	0	0	0	0	0	0	0	0	0	0	0	0	0	0	0	0							
21	0	0	0	0	0	0	0	0	0	0	0	0	0	0	0	0	0	0	0	0	0	0	1	0	0	0	0	0	0	0	0	0	0	0	0	0	0	0	0	0	0							
22	0	0	0	0	0	0	0	0	0	0	0	0	0	0	0	0	0	0	0	0	0	0	0	1	0	0	0	0	0	0	0	0	0	0	0	0	0	0	0	0	0	0						
23	0	0	0	0	0	0	0	0	0	0	0	0	0	0	0	0	0	0	0	0	0	0	0	0	0	0	0	0	1	0	0	0	0	0	0	0	0	0	0	0	0	0						
24	0	0	0	0	0	0	0	0	0	0	0	0	0	0	0	0	0	0	0	0	0	0	0	0	0	0	0	0	0	0	0	1	0	0	0	0	0	0	0	0	0	0						
25	0	0	0	0	0	0	0	0	0	0	0	0	0	0	0	0	0	0	0	0	0	0	0	0	0	0	0	0	0	0	0	0	1	0	0	0	0	0	0	0	0	0						
26	0	0	0	0	0	0	0	0	0	0	0	0	0	0	0	0	0	0	0	0	0	0	0	0	0	0	0	0	0	0	0	0	0	1	0	0	0	0	0	0	0	0						
27	0	0	0	0	0	0	0	0	0	0	0	0	0	0	0	0	0	0	0	0	0	0	0	0	0	0	0	0	0	0	0	0	0	0	0	0	1	0	0	0	0	0						
28	0	0	0	0	0	0	0	0	0	0	0	0	0	0	0	0	0	0	0	0	0	0	0	0	0	0	0	0	0	0	0	0	0	0	0	0	0	0	0	1	0	0	0					
29	0	0	0	0	0	0	0	0	0	0	0	0	0	0	0	0	0	0	0	0	0	0	0	0	0	0	0	0	0	0	0	0	0	0	0	0	0	0	0	0	1	0	0	0				
30	0	0	0	0	0	0	0	0	0	0	0	0	0	0	0	0	0	0	0	0	0	0	0	0	0	0	0	0	0	0	0	0	0	0	0	0	0	0	0	0	0	0	0	0				
31	0	0	0	0	0	0	0	0	0	0	0	0	0	0	0	0	0	0	0	0	0	0	0	0	0	0	0	0	0	0	0	0	0	0	0	0	0	0	0	0	0	0	0	0				
32	0	0	0	0	0	0	0	0	0	0	0	0	0	0	0	0	0	0	0	0	0	0	0	0	0	0	0	0	0	0	0	0	0	0	0	0	0	0	0	0	0	0	0	0				
33	0	0	0	0	0	0	0	0	0	0	0	0	0	0	0	0	0	0	0	0	0	0	0	0	0	0	0	0	0	0	0	0	0	0	0	0	0	0	0	0	0	0	0	0	0			
34	0	0	0	0	0	0	0	0	0	0	0	0	0	0	0	0	0	0	0	0	0	0	0	0	0	0	0	0	0	0	0	0	0	0	0	0	0	0	0	0	0	0	0	0	0			
35	0	0	0	0	0	0	0	0	0	0	0	0	0	0	0	0	0	0	0	0	0	0	0	0	0	0	0	0	0	0	0	0	0	0	0	0	0	0	0	0	0	0	0	0	0	0		
36	0	0	0	0	0	0	0	0	0	0	0	0	0	0	0	0	0	0	0	0	0	0	0	0	0	0	0	0	0	0	0	0	0	0	0	0	0	0	0	0	0	0	0	0	0	0		
37	0	0	0	0	0	0	0	0	0	0	0	0	0	0	0	0	0	0	0	0	0	0	0	0	0	0	0	0	0	0	0	0	0	0	0	0	0	0	0	0	0	0	0	0	0	0		
38	0	0	0	0	0	0	0	0	0	0	0	0	0	0	0	0	0	0	0	0	0	0	0	0	0	0	0	0	0	0	0	0	0	0	0	0	0	0	0	0	0	0	0	0	0	0	0	
39	0	0	0	0	0	0	0	0	0	0	0	0	0	0	0	0	0	0	0	0	0	0	0	0	0	0	0	0	0	0	0	0	0	0	0	0	0	0	0	0	0	0	0	0	0	0	0	
40	0	0	0	0	0	0	0	0	0	0	0	0	0	0	0	0	0	0	0	0	0	0	0	0	0	0	0	0	0	0	0	0	0	0	0	0	0	0	0	0	0	0	0	0	0	0	0	
41	0	0	0	0	0	0	0	0	0	0	0	0	0	0	0	0	0	0	0	0	0	0	0	0	0	0	0	0	0	0	0	0	0	0	0	0	0	0	0	0	0	0	0	0	0	0	0	
42	0	0	0	0	0	0	0	0	0	0	0	0	0	0	0	0	0	0	0	0	0	0	0	0	0	0	0	0	0	0	0	0	0	0	0	0	0	0	0	0	0	0	0	0	0	0	0	0
43	0	0	0	0	0	0	0	0	0	0	0	0	0	0	0	0	0	0	0	0	0	0	0	0	0	0	0	0	0	0	0	0	0	0	0	0	0	0	0	0	0	0	0	0	0	0	0	0

Table continues on the next page...

Table 46-4. Channel Enable RAM Programming Example (continued)

DMA Request Number	Channel																																					
	3																															0						
44	0	0	0	0	0	0	0	0	0	0	0	0	0	0	0	0	0	0	0	0	0	0	0	0	0	0	0	0	0	0	0	0	0	0	0	0	0	
45	0	0	0	0	0	0	0	0	0	0	0	0	0	0	0	0	0	0	0	0	0	0	0	0	0	0	0	0	0	0	0	0	0	0	0	0	0	0
46	0	0	0	0	0	0	0	0	0	0	0	0	0	0	0	0	0	0	0	0	0	0	0	0	0	0	0	0	0	0	0	0	0	0	0	0	0	0
47	0	0	0	0	0	0	0	0	0	0	0	0	0	0	0	0	0	0	0	0	0	0	0	0	0	0	0	0	0	0	0	0	0	0	0	0	0	0

46.4.2.3.4 Channel Overflow

A channel overflow occurs when a DMA request requires service from channel *n* by setting bit *n* of the register EP, but this bit is already set, meaning channel *n* is already pending. This can come from an overrun/underrun condition.

This detection is possible only when the DMA requests are pulses, because a level-based DMA request stays high until it is serviced, even though an underrun or overrun condition occurs, thus preventing another edge detection of the DMA request.

The channel overflow information is saved in the 32-bit CHNERR register (1 bit per channel). You can configure the SDMA to trigger an interrupt to the Arm platform when there are 1s in CHNERR. Every bit of CHNERR is masked with the corresponding bit of INTRMASK and if it gives a 1, the corresponding bit of INTR is set, triggering the interrupt.

46.4.2.3.5 Runnable Channels Evaluation

The EP register is used in conjunction with several other 32-bit registers to determine the channels that are runnable.

Registers EO, DO, HO and HE, are controlled by the Arm platform. EP is controlled by the DMA requests and their mapping to channels.

Several channels may be runnable at any given time. The *i*th channel is runnable if (and only if) the condition below is true:

$$(HE[i] \text{ or } HO[i]) \text{ and } (DO[i]) \text{ and } (EP[i] \text{ or } EO[i])$$

After reset, the HE[i], HO[i], EP[i], and EO[i] bits are all cleared whereas the DO[i] bits are all set. The functions associated with DO are not available for this device. When DO[i] is set, the scheduler condition becomes:

(HE[i] or HO[i]) and (EP[i] or EO[i])

The registers in these equations are controlled as follows:

- Arm platform (host) channel enable flag HE[i] may be set or cleared by the Arm platform with the HSTART and STOP_STAT registers. It can also be cleared by the i^{th} channel script.

Typical usage is for the Arm platform to set this flag to activate the channel. The flag is cleared by the SDMA core when the transfer is done.

- Externally triggered channel pending flag EP[i] is set by the scheduler when the channel was activated by a DMA request. It can be cleared by the i^{th} channel script.
- The Arm platform channel override flag HO[i] may be set or cleared by the Arm platform. When set, it enables the i^{th} channel to run without the involvement of the Arm platform.

Typical usage is for the Arm platform to set this flag for channels that do not need Arm platform supervision such as channels that are controlled by DMA request events (EP).

- DO should always be set to 1 so that the runnable channel evaluation considers only HO, HE, EP, and EO.
- Externally triggered channel override flag EO[i] may be set or cleared by the Arm platform. When set, it prevents the i^{th} channel from stopping and stalling on incoming peripheral DMA requests. This is the case when the channel is not handling data transfers with peripherals (for example, a memory to memory transfer).

The SDMA can clear the HE[i], and EP[i] bits by means of a done or notify instruction. The done instruction causes a reschedule; thus, enabling another channel to preempt the current one, while the notify instruction does not. The done and notify instructions can clear either HE[i] or EP[i] (never more than one at a time).

Table 46-5. Runnable Channel Selection Control

Register	Set by	Cleared By
HO	Write to HOSTOVR register	Write to HOSTOVR register
HE	Write to HSTART register	Write to STOP_STAT register or by the channel script with the done or notify instructions.
DO	Write to DSPOVR register	Write to DSPOVR register
EO	Write to EVTOVER register	Write to EVTOVER register
EP	Set by external DMA request event input.	By the channel script with the done or notify instructions

46.4.2.3.6 Next Channel Decision Tree

The next channel number is computed from the runnable channels list, the current channel number, and their respective priorities.

It is re-evaluated every cycle, but is only used when the current channel yields or terminates by executing a yield, yieldge, or done instruction.

The decision tree is based on the selection of the runnable channel that has the highest priority.

The highest priority channel is selected according to the following rules:

- Runnable channels are sorted by priority.
- If one of the channels with the highest priority had been preempted by a channel with a higher priority, but did not want to yield to a channel of the same priority (for example, it executed a yield, not a yieldge), it is elected as the next channel.
- The channels that belong to the highest priority group are sorted by their number and the channel that has the highest number in this group becomes the next channel. For example, if priorities are the same, channel 31 will be selected before channel 30.

When the current channel requires a reschedule with a yield(ge) or a done instruction, the context switch decision is based on the instruction parameter, the current channel number and priority, and the next channel number and priority. The possible cases are all listed in the following table. The grayed cells correspond to unusual cases that should not occur with a typical usage of the SDMA.

Table 46-6. Channel Switching Decision with a yield, yield(ge), or done

Instruction	Current Channel	Next Channel	Priorities Comparison	New Running Channel/Comments
yield (done 0)	Runnable	Not runnable	none	Current
	Runnable	Runnable	Current > Next	Current
			Current = Next	Current
			Current < Next	Next ¹
	Not runnable	Not runnable	none	none ² (occurs when the channel was disabled by the Arm platform)
	Not runnable	Runnable	none	Next ¹ (occurs when the channel was disabled by the Arm platform)
yieldge (done 1)	Runnable	Not runnable	none	Current
	Runnable	Runnable	Current > Next	Current
			Current = Next	Next ¹
			Current < Next	Next ¹

Table continues on the next page...

Table 46-6. Channel Switching Decision with a yield, yield(ge), or done (continued)

Instruction	Current Channel	Next Channel	Priorities Comparison	New Running Channel/Comments
	Not runnable	Not runnable	none	none ² (occurs when the channel was disabled by the Arm platform)
	Not runnable	Runnable	none	Next ¹ (occurs when the channel was disabled by the Arm platform)
done (done>1)	Not runnable	Not runnable	none	none ²
	Runnable	Not runnable	none	Current ³ (occurs when the done instruction does not disable the channel runnable condition)
	Not runnable	Runnable	none	Next ¹
	Runnable	Runnable	none	Current ³ (occurs when the done instruction does not disable the channel runnable condition)

1. Current channel script execution is stopped, its context is saved; the next channel context is restored and its script execution resumes
2. Current channel context is saved and SDMA enters IDLE mode
3. Current channel context is saved, then restored, and the current channel script resumes execution

Finally, when the SDMA is in IDLE mode and a runnable channel is elected as the next channel, its context is immediately restored and the script execution resumes.

The *combinatorial-decision* tree supports dynamic modifications of the EP, EO, HE, HO, and DO flags as well as dynamic modifications of the channel priorities. The propagation times are detailed in [Scheduler Pipeline Timing Diagram](#).

The decision tree status is available in the PSW register, which is continuously updated. It contains the next channel priority, the next channel number, the current channel priority, and the current channel number. When a priority is read as 0, it means the channel is not runnable.

A few examples of decisions are presented below:

- Channel 31 is running with priority 5, channels 13 and 24 are pending with the same priority 5; channel 24 is eligible as the next channel since $24 > 13$.
- Channel 31 is running with priority 7, channels 13 and 24 are pending with priority 5; channel 31 is the next channel because its priority is greater than the other pending channels.
- Channels 7, 23, and 29 are pending with the same priority. Channel 7 is active and runs a yieldge; it is preempted by channel 29. After a period of time, channel 29 runs a yieldge, it is then preempted by channel 23 that is the selected channel since channel 29 is the current channel. Later, channel 23 runs a yieldge and is preempted

Functional Description

by channel 29. Channels 23 and 29 will go on switching after every yield until one of them terminates. It is only at that point that channel 7 becomes eligible again.

- Channel 11 is running with priority 3, and channel 15 is pending with priority 4. When the channel 31 script executes a yield instruction, it gets preempted by channel 15; then channels 6 and 18 with priority 3 become pending. Because channel 11 was preempted after executing a yield and there is no pending channel with a strictly greater priority, it is eligible as the next channel (although its number $11 < 18$).

46.4.2.3.7 Scheduler State Diagram

The [Figure 46-7](#) summarizes the behavior of the SDMA scheduler with details about the exact mechanism of the priority decision tree. It is important to understand the scheduler is a hardwired pipeline, which means all the stages are performed simultaneously every cycle, but a change on any given stage is reflected on the next stage after the delays presented in [Scheduler Pipeline Timing Diagram](#).

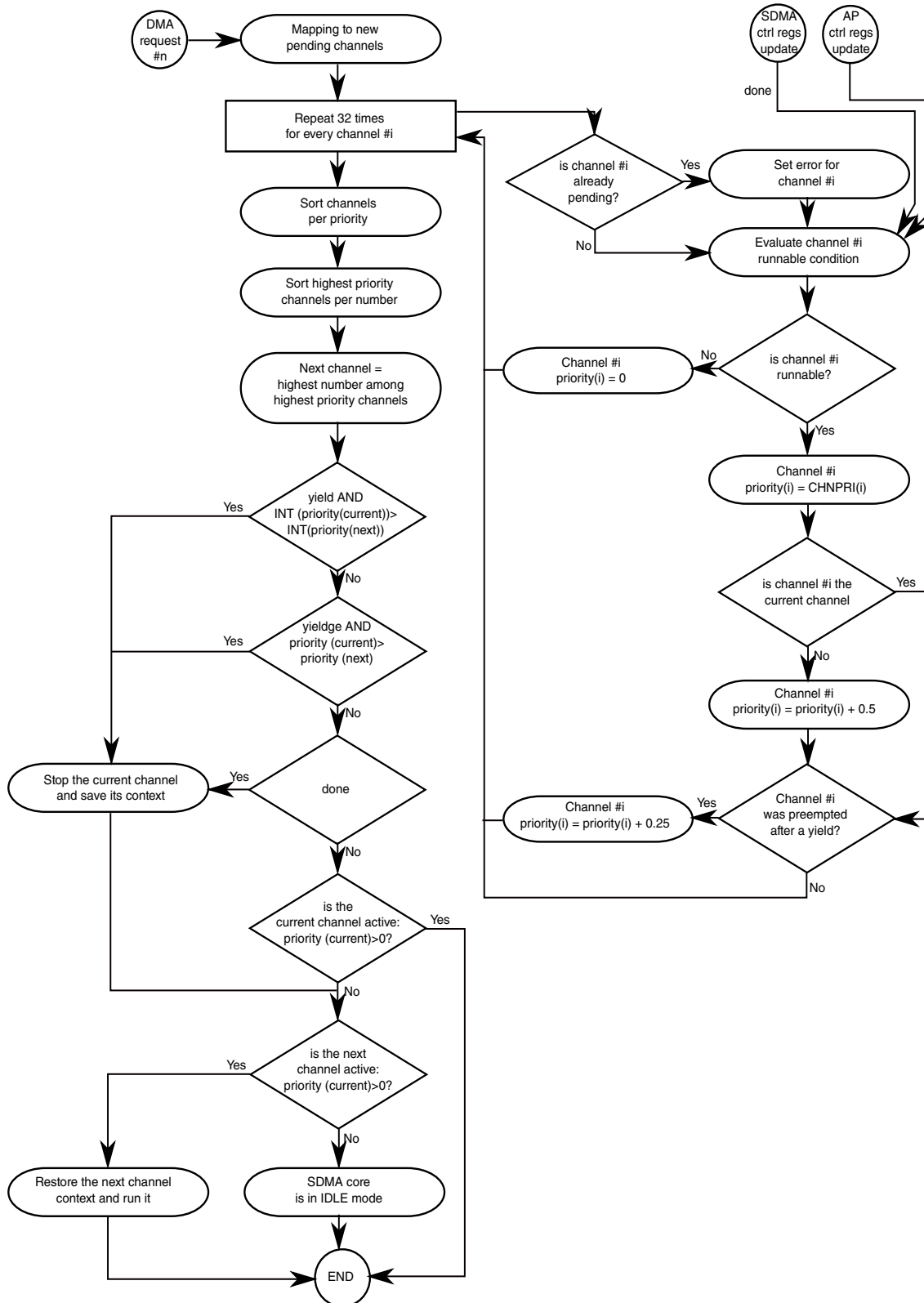

Figure 46-7. Scheduler State Diagram

46.4.2.3.8 Scheduler Pipeline Timing Diagram

The SDMA scheduler process of DMA-request and control-register modifications is not immediate.

The figure below shows the exact delays of all the tasks. The reference clock is the SDMA core clock.

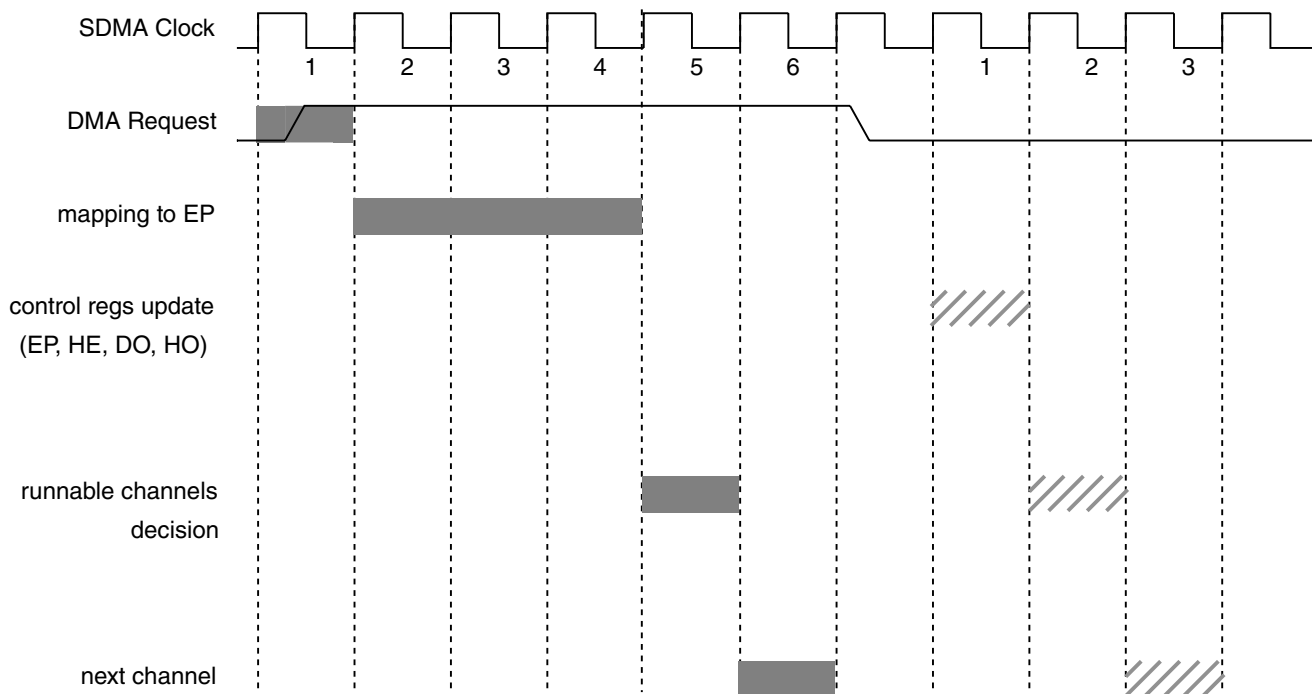

Figure 46-8. Scheduler Timing Diagram

Two numbers can be inferred from this timing diagram. First, it takes six SDMA core clock cycles to update the next channel from a DMA request. Second, it takes three SDMA core clock cycles to update the next channel from a direct modification of the condition registers (EP, DO, HE, or HO) by any processor. The processors that can modify these bits include SDMA with a done instruction or the Arm platform with a write access through the corresponding control port on their respective peripheral bus).

46.4.2.3.9 Channel-DMA Request Mapping

The 48 DMA request inputs to the SDMA scheduler are listed in project-specific chapters. Refer to the respective chapters for this information.

46.4.2.3.10 Examples: How to Start a Channel

A channel can be started when the following equation is true for channel *i*:

(HE[i] or HO[i]) and (DO[i]) and (EP[i] or EO[i])

Once this equation is true, the scheduler can start this channel according to the priority of all pending channels. Several examples of configuration are listed below:

1. To start a channel triggered by Arm platform software:
 - Initially, configure HO[i]=0, DO[i]=1, and EO[i]=1 using registers indicated in [Table 46-5](#).
 - Arm platform software triggers the channel by writing to the HSTART register to set HE[i]=1, thereby setting the above equation true.
2. To start a channel triggered by DMA request event.
 - Initially, configure HO[i]=1, DO[i]=1, and EO[i]=0 using registers indicated in [Table 46-5](#).
 - The DMA request is asserted to trigger the channel by setting EP[i]=1, which makes the above equation true.

46.4.2.4 Context Switching

On execution of a done or yield(ge) instruction, the current channel may be changed either because it has finished (which necessarily happens when the done instruction is executed), or it was preempted by a higher priority channel (which is possible but not systematic when the yield(ge) is executed).

Upon a channel change the SDMA goes through a context switch procedure.

When the current channel yields or ends, the context for that channel is saved into the context RAM locations for that channel. When the next channel starts running, its context is first restored from RAM.

Since context RAM is not yet initialized by reset, there will be no context restore at the beginning of the first channel (bootload channel) run after reset. It is expected that the bootload channel will be used to initialize the context for all other channels. When the bootload channel finishes running or yields, SDMA will enter its SAVE state and save that channel's context into RAM. Then, if the bootload channel is called again later, the context will be restored from RAM when the channel starts again.

The context structure for each channel is defined in [Context Switching-Programming](#) and [Table 46-11](#). There will be one context area reserved for each channel. When a channel ends or yields, the SDMA core registers are automatically saved into the context RAM and later restored from the context RAM when the channel is next run. The total RAM space reserved for 32-channel contexts is either 3K or 4K depending on whether the SMSZ bit is set in the CHN0ADDR register, which enables an additional 8 words of scratch RAM for each context.

46.4.2.4.1 Context Switch Modes

The exact procedure to save the context of the old channel, and to restore the context of the new channel depends on the context switch mode selected by the Arm platform in the CONFIG control register.

The following are the context switch modes:

- By default, the "dynamic" context switch is set. This mode provides the most efficient context switch for an average of eight cycles to stop the current channel, save its context, restore the next channel context, and resume its execution. It consists of saving modified registers of the current channel in the background (for example, during the channel execution)-which leaves very few registers to save when the switch is decided-resuming execution of the next channel as soon as possible (for example, when the minimal set of registers is restored), and continuing the restore phase during this execution.
- In "dynamic with no loop" mode, the same principle is followed except the modified registers are only saved in the background when the loop flag is not set. This mode offers almost the same effectiveness as the previous one, but it prevents the system from accessing the RAM during loops to save power. This is the recommended mode for an efficient context-switch when the loop bodies are short.
- In "dynamic power" mode, no background saving is performed, which reduces power consumption to the minimum. The modified registers are only saved when the context switch starts. The restore phase is the same as before. This is the mode that achieves the optimal power consumption at the cost of a slower context-switch.
- In a "static" context switch, all the registers are saved when a context switch is decided, and all the registers are restored before starting the execution of the new channel. This mode enables a predictable behavior of the context switch since all the registers are restored prior to the channel start and all registers are saved after the channel termination.

NOTE

Static context mode should be used for the first channel called after reset to ensure that the all context RAM for that channel is initialized during the context SAVE phase when the channel is done or yields. Subsequent calls to the same channel or different channels may use any of the dynamic context modes. This will ensure that all context locations for the bootloader channel are initialized, and prevent undefined values in context RAM from being loaded during the context restore if the channel is re-started later.

46.4.2.4.2 Context Switch Procedure

The Program Control Unit goes into the *save* state, the current context is spilled into memory, and the next channel context is restored according to the context-switch mode that was selected by the Arm platform.

The context switch procedure is as follows:

1. Load the current context's spill base address.
2. Spill the modified registers of the current channel to memory according to the selected context switch mode while the channel is running.

On a *done* or *yield(ge)* that causes the channel preemption, the PCU goes into the *save* state. In *static* mode, all the registers are saved; whereas, in either *dynamic* mode, the registers that were modified but not yet saved are then saved, and the PCU registers and flags are finally saved.

3. Put the SDMA core into *sleep* and wait for new channels to be serviced. This step is skipped if there are pending channels when the current channel is saved.

As soon as there is at least one pending channel, the PCU goes into its *restore* state to restore the context of the channel that was elected by the scheduler.

Once a channel is elected, it remains the current channel until its script requests a rescheduling operation with a *done* or *yield(ge)* instruction. That means the current channel cannot be modified by the Arm platform, even if it is no more runnable or if its priority is modified.

The Arm platform can however force a reschedule by writing the corresponding bit in the CONFIG register, which has the same effect as if the script had executed a *done* instruction. That feature should only be used to stop the SDMA in emergency cases.

4. Load the context base-address of the new channel.

In "static" mode, all the registers are restored. In either "dynamic" modes, only the PCU registers are restored.

The new channel is running. In "static" mode, no more activity regarding context restoring or saving is performed. In either "dynamic" modes, the registers are restored in the background every time an access to the context RAM is possible, and priority is given to restoring the registers that are required by the next instruction to be executed. When a register has not been restored and the next instruction needs it, this instruction gets stalled until the register was restored.

In "dynamic" and "dynamic with no loop" modes, background saving of dirty registers is performed every time an access to the context RAM is possible and allowed by the context switch mode.

NOTE

The contents of a channel context space in the context RAM depends on the selected context switch mode. In "dynamic" and "dynamic with no loop" modes, the contents of the context RAM tend to match the contents of the SDMA registers (except for the PCU registers and flags that are never saved in the background). In "dynamic power" and "static" modes, the contents of the context RAM remain unchanged until the channel terminates with a done or gets preempted.

46.4.2.4.3 Context Map in Memory

Refer to [Context Switching-Programming](#).

46.4.3 Functional Units

The functional units are small systems that are used by the SDMA core to handle data transfers between the core and a bus domain external to the SDMA.

The SDMA core is able to control and exchange data with these systems by sending instructions and reading or writing data from/to the functional units' registers via the FUBUS. This is done with the ldf and stf instructions.

The following sections provide introductions to the available functional units. [Functional Units Programming Model](#) provides descriptions the functional units' behaviors.

46.4.3.1 Burst DMA Unit

The burst DMA unit enables the SDMA core to perform data transfers to and from the Arm platform memory.

It is optimized for accessing SDRAM-like devices. It does not provide control to assign a privilege level to the DMA access. The burst DMA unit provides the SDMA with means to do the following:

- Perform up to 8-beat read and write bursts to the Arm platform memory, which optimizes throughput when accessing SDRAM-type devices because of an internal, 36-byte FIFO
- Access the Arm platform memory at once or twice the SDMA core frequency
- Copy data from one Arm platform memory location to another Arm platform memory location at the Arm platform bus speed, which provides a very high throughput
- Control the method for addressing the Arm platform memory (automatic increment of addresses or frozen addresses-the former aimed at accessing RAM-like memory and the latter aimed at accessing single-address FIFOs)
- Enable or disable automatic prefetch when reading data from the Arm platform memory. When the prefetch mode is selected, the burst DMA automatically triggers external bursts to fill its FIFO without waiting for the SDMA core to request the corresponding data, greatly improving throughput.
- Rely on the DMA to automatically flush its FIFO content when there is enough data to generate an 8-beat burst to the Arm platform memory. Or, it forces a flush when a data transfer must terminate.
- In the former case, the SDMA core may only be stalled when it tries writing data and there is not enough room left in the FIFO. In the latter case, the core is stalled until the data is effectively written to the Arm platform memory.

In automatic flush mode, the core receives an acknowledge that does not reflect the actual error status when the data is effectively written into the Arm platform memory. This error status is retrieved by a later access to the burst DMA.

Terminating a write data transfer with a forced flush command guarantees that any bus error to the Arm platform memory is caught.

- Handle address alignment issues between the Arm platform memory map and the SDMA core data. This enables the core to read or write 32-bit data from the burst DMA, whereas the corresponding Arm platform address is not 32-bit aligned. This drastically improves the SDMA scripts' efficiency since the same loop that transfers 32 bits at a time can be used regardless of the start and end addresses in the Arm platform memory space.

This unit structure and registers are described in [Burst DMA Structure](#) and [Burst DMA Registers](#).

46.4.3.1.1 Burst DMA Structure

The burst DMA is essentially made up of a 36-byte FIFO, address registers, and a controlling state-machine. The 36-byte FIFO enables eight-word buffering with address alignment, and the state-machine manages clock adaptation when required.

The burst DMA is depicted in the figure below.

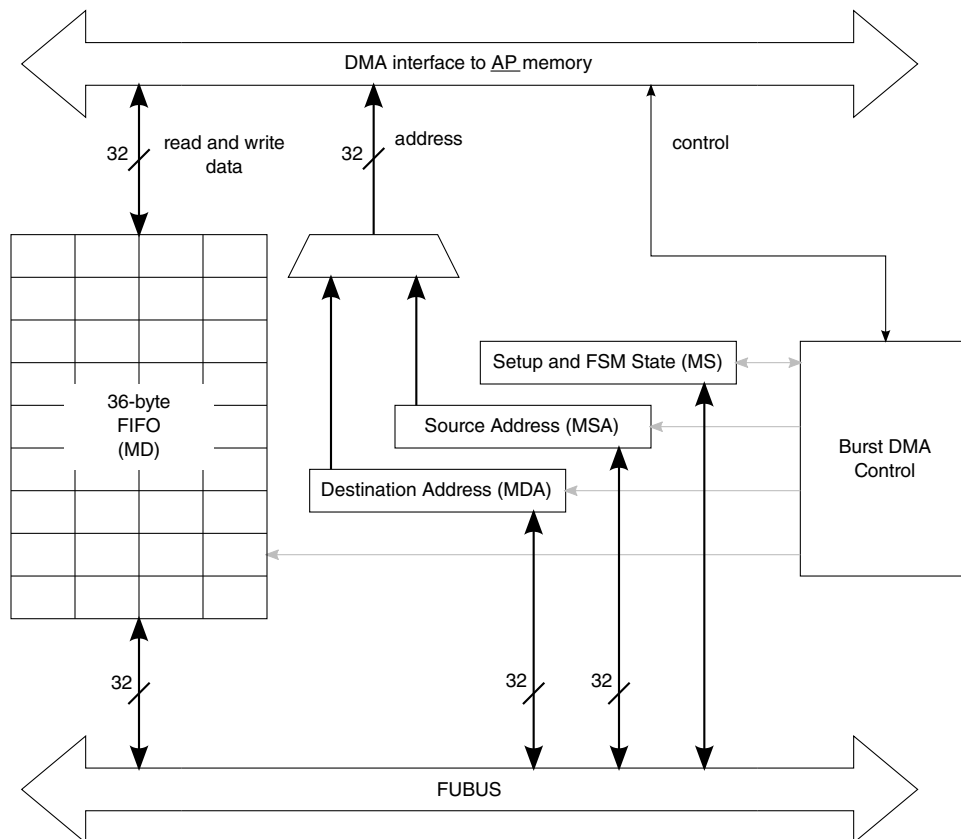

Figure 46-9. Burst DMA Structure

46.4.3.1.2 Burst DMA Registers

There are four registers, as follows, that may be accessed from the SDMA core:

- MSA (Memory Source Address) - Holds the source byte address in the Arm platform memory map for reading data from this location. This register is automatically modified every time the core reads new data from the FIFO.
- MDA (Memory Destination Address) - Holds the destination byte address in the Arm platform memory map for writing data to this location. This register is automatically modified every time the core writes new data into the FIFO.
- MD (Memory Data) - Labels the 36-byte FIFO access point: Reading a byte, halfword, or word from MD respectively retrieves the first 1, 2, or 4 bytes of the

FIFO (for example, the bytes that were stored first by the DMA state-machine when transferring data from the Arm platform memory).

- When the FIFO does not hold as many bytes as required by the SDMA core, the core is stalled until the missing bytes are read from the Arm platform memory. In the case of prefetch mode, the DMA controller decides when it should start a burst to Arm platform memory in order to reduce the risk to not have the required data for the future accesses of the core. When there is no prefetching, a burst is triggered when the required data is not available in the FIFO.

Writing a byte, halfword, or word to MD stores 1, 2, or 4 bytes, respectively, at the end of the FIFO (for example, these bytes are transmitted to the Arm platform memory after all the other bytes that were previously stored in the FIFO). When the FIFO does not have enough room left to hold the written data, the SDMA core is stalled until a sufficient amount of FIFO contents are flushed out to the Arm platform memory. Flushing is decided by the DMA controller when there are enough bytes in the FIFO to perform the largest allowed burst to Arm platform memory (the exact size depends on the burst start address and the AHB 1 Kbyte boundary rule).

However, the SDMA core has the ability to force the flushing operation at any time, for example, when at the end of the data transfer, prior to channel closure.

- MS (Memory Setup) - Contains the state of the burst DMA control, the two flags that define whether each address register is incremented after every access to the external memory, and another flag that is set when a bus error occurred.

46.4.3.1.3 Burst DMA Data Transfers

Three typical usages have been identified that involve the burst DMA: the data transfer startpoint, the endpoint, or both.

Every case requires a different procedure, as listed in the following sections:

46.4.3.1.3.1 Data Retrieval from the Arm platform Memory

The following steps retrieve data from Arm platform memory using the burst DMA unit:

- Set up the MS flags to reflect the mode for the source address (incremented or frozen according to the type of accessed device: memory or peripheral FIFO), then initialize the source address register itself (MSA).
- Read data from the FIFO using the *ldf MD* instruction as many times as needed. If an error occurred during the fetch from Arm platform memory, the DMA control tags the error status on the data and the SDMA core SF flag is set when reading this data from the FIFO.

46.4.3.1.3.2 Storing Data Into the Arm platform Memory

The following steps store data from Arm platform memory using the burst DMA unit:

- Set up the MS flags to reflect the mode for the destination address (incremented or frozen according to the type of accessed device: memory or peripheral FIFO), then initialize the destination address register itself (MDA).
- Store data into the FIFO using the *stf MD* instruction as many times as needed.
- When the transfer is finished and if the DMA worked in automatic flush mode, force the flush of the FIFO. This instruction is stalled until all the FIFO data is effectively sent to the Arm platform memory and the error status of the transfer is available in the DF flag.

46.4.3.1.3.3 Transferring Data Between Two Arm platform Memory Locations-Burst DMA Unit

The following steps copy data between two Arm platform memory locations using the burst DMA unit:

- Set up the MS flags to reflect the modes for the source and destination addresses (all the combinations are possible), then initialize the source address register (MSA) and the destination address register (MDA). Both addresses must be word-aligned.
- Use as many *stf MD* instructions with the *COPY* flag as needed. Every instruction triggers a burst read of a given number of words from the source address (this number is provided to the burst DMA via the SDMA core general purpose register, which is referenced in the *stf* instruction). Once all the data is loaded into the FIFO, the DMA empties it with a write burst of the same count to the destination address. The DMA acknowledges prior to instruction completion, which frees the SDMA core for other tasks at no delay cost.
- Once the transfer is done, there should be a final access to the burst DMA to check the error status.

46.4.3.2 Peripheral DMA Unit

The peripheral DMA unit is the second functional unit that connects the SDMA to the Arm platform memory.

Unlike the burst DMA, it does not support burst transfers and is optimized for accessing peripherals. It does not provide control to assign a privilege level to the DMA access. Its feature list comprises the following:

- Access to the Arm platform peripherals or memory at once or twice the SDMA core frequency

- Data copy from one Arm platform memory location to another Arm platform memory location at memory bus speed, improving throughput
- Control of the method for addressing the Arm platform memory (automatic increment or decrement of addresses or frozen addresses, the first ones aimed at accessing RAM-like memory and the last one aimed at accessing single-address FIFOs)
- Selectable automatic prefetch when reading data from the Arm platform memory. In prefetch mode, the peripheral DMA automatically fetches another data-without waiting for the SDMA core to request it-when its data register is empty, which improves the throughput
- Selectable automatic flush. In this mode, the SDMA core may only be stalled when it tries writing data and the previous write operation is not finished yet; whereas, in forced flush mode, the core is stalled until the data is effectively written to the Arm platform memory.
- In automatic flush mode, the core receives an acknowledge that does not reflect the actual error status when the data is effectively written into the Arm platform memory or the peripheral. This error status is retrieved by a later access to the peripheral DMA. Terminating a write data transfer with a forced flush command guarantees that any bus error to the Arm platform memory has been caught.

This unit structure and registers are described in [Peripheral DMA Structure](#) and [Peripheral DMA Registers](#).

46.4.3.2.1 Peripheral DMA Structure

The peripheral DMA is made up of a 32-bit data register, two address registers, and a controlling state-machine. The state-machine manages clock adaptation, when required.

It is shown in the following figure.

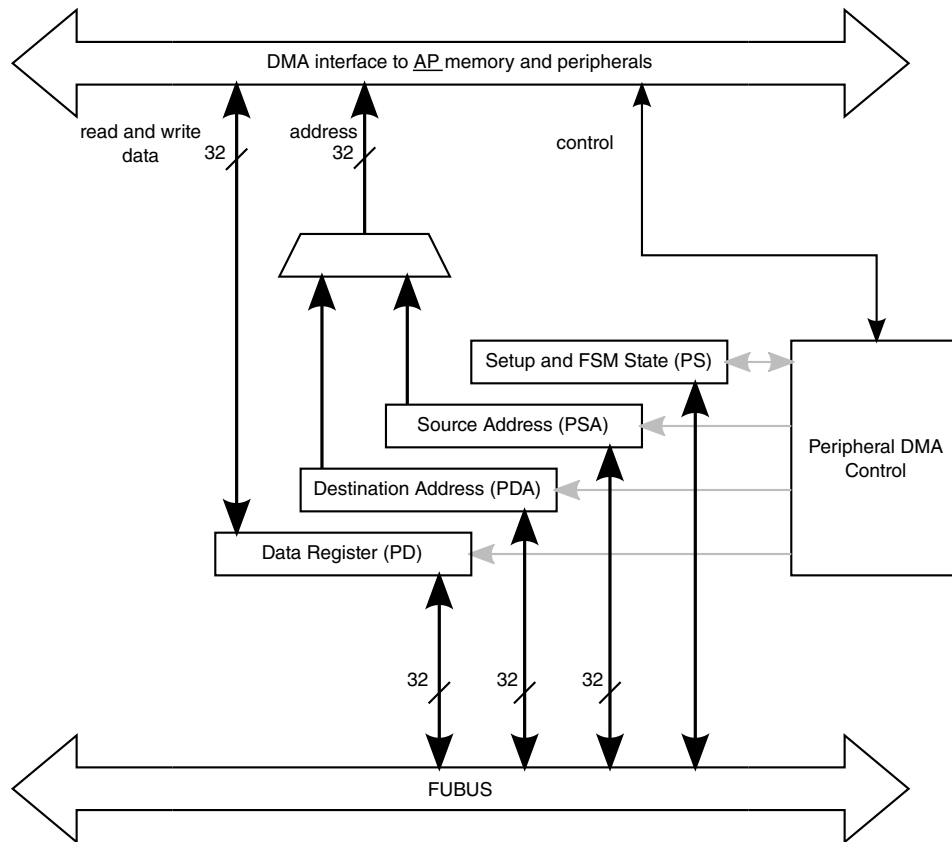

Figure 46-10. Peripheral DMA structure

46.4.3.2.2 Peripheral DMA Registers

According to Figure 46-10, the peripheral DMA has four registers that may be read or written by the SDMA core:

- *PD (Peripheral Data)* is the DMA 32-bit data register.
- *PSA (Peripheral Source Address)* holds the source byte address in the Arm platform memory map for reading data from this location. This register is automatically modified every time the core reads a new data from PD.

- *PDA (Peripheral Destination Address)* holds the destination byte address in the Arm platform memory map for writing data to this location. This register is automatically modified every time the core writes a new data into PD.
- *PS (Peripheral Setup)* contains the state of the peripheral DMA control, two configuration fields that define the way address registers are modified after every data access, two additional configuration fields that define the data size to access the source and destination devices, and another field that contains the latest transfer error status.

46.4.3.2.3 Peripheral DMA Data Transfers

There are three typical usages that involve the peripheral DMA, whether it is the data transfer start-point, endpoint, or both.

Every case requires a different procedure, as described in [Data Retrieval from the Arm platform Memory or Peripheral](#), [Storing Data into the Arm platform Memory or Peripheral](#), and [Transferring Data Between Two Arm platform Memory Locations-Peripheral DMA Unit](#).

46.4.3.2.3.1 Data Retrieval from the Arm platform Memory or Peripheral

The following steps retrieve data from Arm platform memory using the peripheral DMA unit:

- Set up the PS fields to reflect the mode and data size for the source (incremented, decremented, or frozen address register; 8-bit, 16-bit, or 32-bit data transfers), then initialize the source address register itself (PSA) with an address that is aligned to the programmed data size.
- Read data from PD using the ldf PD instruction as many times as needed. If an error occurs during the fetch from the Arm platform memory or peripheral, the DMA control tags the error status on the data and the SDMA core SF flag is set when reading this data from PD.

46.4.3.2.3.2 Storing Data into the Arm platform Memory or Peripheral

The following steps store data to Arm platform memory using the peripheral DMA unit:

- Set up the PS fields to reflect the mode and data size for the destination (incremented, decremented, or frozen address register; 8-bit, 16-bit, or 32-bit data transfers), then initialize the destination address register itself (PDA) with an address that is aligned to the programmed data size.

- Store data into PD using the *stf PD* instruction as many times as needed.
- When the transfer is finished and if the peripheral DMA worked in automatic flush mode, force the flush of PD. This instruction is stalled until PD contents are effectively sent to the Arm platform memory or peripheral, and the error status of the transfer is available in the DF flag.

46.4.3.2.3.3 Transferring Data Between Two Arm platform Memory Locations-Peripheral DMA Unit

The following steps copy data between two Arm platform memory locations using the peripheral DMA unit:

- Set up the PS fields to reflect the modes and data size for the source and destination addresses (all the combinations of addressing modes are possible, but both data sizes must be identical), then initialize the source address register (PSA) and the destination address register (PDA). Both addresses must be aligned with the programmed data size.
- Use as many *stf PD* instructions with the *COPY* flag as needed. Every instruction triggers a single read from the source address; a single write of the received data immediately follows. The DMA acknowledges prior to instruction completion, which frees the SDMA core for other tasks at no delay cost.
- Once the transfer is done, there should be a final access to the peripheral DMA to check the error status.

46.4.4 SDMA Security Support

The SDMA provides support to SDMA software to block unauthorized updates to the scripts in RAM.

SDMA supports the following Security modes:

- Open Mode: has full control to load scripts and context into SDMA RAM. This is the default mode.
- Locked Mode: The Arm platform loads scripts and channel contexts at startup when it is still executing known safe software. When finished, it locks the SDMA to prevent further updates to RAM and selected registers. More details described in [Locked Mode](#).

46.4.4.1 Locked Mode

The LOCK bit in the SDMA_LOCK register provides support for SDMA scripts to freeze RAM contents after the initial bootload routine to prevent future unauthorized updates to SDMA RAM.

After initial RAM contents are uploaded, Arm platform software can set the LOCK bit to secure the RAM contents to prevent future updates by an unauthorized. After the LOCK bit is written with a '1', the SDMA is "locked" until reset.

The LOCK bit can be read in the SDMA's internal memory map in the LOCK register (see Section [SDMA LOCK \(SDMAARM_SDMA_LOCK\)](#)). SDMA scripts which load information into RAM can check the value of the LOCK bit to determine if an upload to RAM is allowed. If not allowed, the script can refuse to allow the request to copy data into the RAM to continue. The exact use of the LOCK bit in SDMA scripts for security control will be described in SDMA software documentation (see [SDMA Scripts](#)).

While SDMA is locked, attempts to write to the SDMA_LOCK, CHN0ADR, ILLINSTADDR, and ONCE_ENB registers will be ignored. All registers remain readable. Writes to other registers are still allowed.

Once the SDMA is locked, the LOCK bit can only be cleared by a reset. A hardware reset will always clear the LOCK bit. A software reset initiated by writing to the RESET register will only clear the LOCK bit if the SRESET_LOCK_CLR bit in the SDMA_LOCK register is set. Since SDMA_LOCK register cannot be updated if SDMA is locked, the SRESET_LOCK_CLR bit must be configured before setting the LOCK bit. The SRESET_LOCK_CLR bit will also be cleared by resets that clear the LOCK bit.

The SDMA RISC core uses the ILLINST and CHN0ADDR registers as pointers to determine where to jump to after an illegal instruction or upon boot after a reset. The LOCK bit prevents updates to these registers to protect against unauthorized changes to these pointers.

While SDMA is locked, the ONCE_ENB register cannot be written to prevent the OnCE under Arm platform control from being used to gain access to SDMA internal memory. If Arm platform control of the OnCE is enabled before setting the LOCK bit, the Arm platform can use the ONCE for debug purpose after LOCK is set.

46.4.5 OnCE and PCU Debug States

The SDMA has two different debug modes in which the OnCE performs debug instructions.

Refer to [Figure 46-4](#) for an example of the PCU states in debug. The following are the two debug states:

- When a channel is running (that is, when CCR and CCPRI are different from 0, which can be read in the PSW register), SDMA can execute a SoftBkpt instruction from the channel script or receive a debug request. When either happens, the SDMA enters its "Classical" *Debug* state, which is described in [OnCE and Real-Time Debug](#).
- When a channel is not running, the SDMA can be in *Sleep* state or in *Sleep after Reset* state. If a debug request is sent to the core, it enters its *Debug in Sleep* state. This debug mode works similarly to the "Classical" *Debug* state, except it returns to the original state (*Sleep* or *Sleep after Reset*) when the debug mode is left via the `exec_core` instruction of the OnCE. From this *Debug in Sleep* state, the SDMA can execute a program whereas no channel is running. If a new debug request is sent to the core or if a SoftBkpt is executed, it comes back to this *Debug in Sleep* state.

The OnCE is provided with several instructions that can be executed when the core is in either debug state. The following table summarizes the behavior of these OnCE debug instructions. There exists other secondary OnCE instructions that are described in [OnCE and Real-Time Debug](#).

Table 46-7. SDMA in Debug Mode

Instruction	Debug	Debug in Sleep
<code>exec_once</code>	<p><code>exec_once <instruction></code></p> <p>SDMA executes the <instruction> and returns to the <i>Debug</i> state. The Program Counter (PC) is not incremented. This command must not be used with an instruction that modifies the PC value.</p>	<p><code>exec_once <instruction></code></p> <p>SDMA executes the <instruction> and returns to the <i>Debug in Sleep</i> state. The Program Counter (PC) is not incremented. This command must not be used with an instruction that modifies the PC value.</p>
<code>run_core</code>	<p><code>run_core <instruction></code></p> <p>SDMA executes the <instruction>, leaves the <i>Debug</i> state and continues executing the channel script from the position where it stopped. This command must not be used with an instruction that modifies the PC value.</p>	<p><code>run_core <instruction></code></p> <p>SDMA executes the <instruction> and returns to its <i>Sleep</i> or <i>Sleep after Reset</i> initial state. This command must not be used with an instruction that modifies the PC value.</p>
<code>exec_core</code>	<p><code>exec_core <instruction></code></p> <p>It is similar to <code>run_core</code> except it requires an instruction that changes the PC value (jump, branch...): the SDMA jumps to the new PC value, leaves the <i>Debug</i> state and starts executing instructions from this new PC value.</p>	<p><code>exec_core <instruction></code></p> <p>If the previous state was <i>Sleep after Reset</i>, the SDMA returns to this state, and <code>Chn0Addr</code> value overrides the PC value.</p> <p>Otherwise, the SDMA jumps to the new PC value and starts executing instructions from this new PC.</p>

NOTE

The feature `exec_core` in *Debug in Sleep* after *Sleep after Reset* was added for the Channel boot (channel 0) to allow the debugger to return to *Sleep after Reset* state with a new PC

value. The SDMA will be ready to boot at the Chn0Addr address.

46.4.6 SDMA Clocks and Low Power Modes

The SDMA receives several root clocks from the SoC clock controller block and performs adaptive clock gating to optimize its power consumption. From a user standpoint, clock gating and power mode selection are fully automatized inside the SDMA.

Root clock control is available from the SoC clock controller block.

There are numerous clock sources that are used in the SDMA. They belong to one of two possible clock domains listed in the following table, and have frequency constraints within each domain. Clocks are considered asynchronous between domains.

Within the Arm platform/SDMA clock domain, all clocks must come from the same DPLL. The Arm platform DMA interfaces (peripheral DMA and burst DMA) receive their clock from the Arm platform DMA clock source whose frequency can be once or twice the frequency of the SDMA core clock. The DMA interfaces are designed to work at the Arm platform DMA frequency, but the SDMA core is physically limited to a maximum 104 MHz frequency. Since this is lower than the maximum Arm platform DMA frequency, the SDMA core clock is tied to the Arm platform peripheral clock frequency.

The Arm platform Peripheral Bus Clock source must be an exact sub-frequency of the SDMA Core clock source (any integer value greater or equal to 1).

Table 46-8. Clocking Scheme

Clock Domain	Source Clock	Comments
Arm platform	SDMA core (SDMA main core)	Source clock for the core and all its operations; this clock is thus used by most of the SDMA sub-blocks.
	Arm platform DMA	DMA interface for the peripheral DMA and the burst DMA. It is balanced with the main clock source, and its frequency is either once or twice the main clock frequency.
	Arm platform peripheral	Connection to the Arm platform peripheral bus. It is a sub-frequency of the main clock frequency.
JTAG	TCK	Clock for JTAG access, limited to maximum of 1/8 of the SDMA core clock frequency.

The JTAG clock is sampled by the SDMA main clock to determine its rising edge. This simplifies design and clock management, but it also adds a ratio constraint between those two clocks. It is guaranteed the JTAG interface works properly when the frequency of TCK is lower than 1/8th of the frequency of the SDMA main clock (which is about 8 MHz when the SDMA core clock frequency is 66 MHz).

46.4.6.1 Clock Gating and Low Power Modes

The SDMA automatically performs power saving without requiring user involvement. It implements two levels of automatic clock gating.

46.4.6.1.1 Coarse Clock Gating

Every sub-block clock comes from one of the five available sources, and is gated with the sub-block specific enabling condition.

The following table displays the sub-block clocks and their source. It also indicates the relationships that may exist between different sub-blocks clock enables.

Table 46-9. Sub-blocks Clocks

Sub-block	Source Clocks	Enabling Condition and Comments	Related Enabling Conditions
Core	SDMA Main Core	The core sub-block clock is running when the core is not in one of its sleep states (Sleep or Sleep after Reset) or there is a pending channel. Typically, the core sub-block clock is stopped once all the channels are processed and the core enters its sleep state. A new pending channel awakes the core sub-block clock.	None
Memories	SDMA Main Core	The clock activation only occurs during a core access.	Disabled when Core sub-block clock is disabled or no memory access in progress
Scheduler	SDMA Main Core	Its clock only runs when scheduling is needed: for example, when there are pending channels, upon reception of a DMA request, and anytime the Arm platform modifies the channel running conditions.	None
Arm platform Control	SDMA Main Core & Arm platform peripheral	The Arm platform peripheral clock is solely used to determine the frequency ratio with the SDMA main clock. The control registers' clock is based on <i>SDMA main clock</i> ; it is active when the Arm platform or the SDMA modifies the contents of one of these registers.	None
Burst DMA	SDMA Main Core & Arm platform DMA	The burst DMA has two clocks: The first clock is derived from the SDMA main core clock and drives registers that are connected to the FUBUS. The second clock is derived from the Arm platform DMA clock and drives registers that are connected to the Arm platform DMA bus outside the SDMA. Both clocks are enabled	Disabled when Core sub-block clock is disabled

Table continues on the next page...

Table 46-9. Sub-blocks Clocks (continued)

Sub-block	Source Clocks	Enabling Condition and Comments	Related Enabling Conditions
		during active phases of data transfers (for example, these clocks are turned off when the burst DMA is not used by the running channel script).	
Peripheral DMA	SDMA Main Core & Arm platform DMA	The peripheral DMA has two clocks: The first clock is derived from SDMA main clock and drives registers that are connected to the FUBUS. The second clock is derived from the Arm platform DMA clock and drives registers that are connected to the Arm platform DMA bus outside the SDMA. Both clocks are enabled during active phases of data transfers (for example, these clocks are turned off when the peripheral DMA is not used by the running channel script).	Disabled when Core sub-block clock is disabled
OnCE	SDMA Main Core	The OnCE clock is derived from main source clock. It is disabled by default. In order to use the OnCE, its clock must be explicitly turned on, either by enabling the OnCE access from the Arm platform peripheral bus (register ONCE_ENB), or by driving the clk_gating_off input pin high. This is a SDMA input whose driver depends on the SoC implementation (typically a JTAG controller). The OnCE also receives the TCK input, which is the JTAG clock. It does not use it as a functional clock; the TCK input is sampled instead. Refer to Synchronization Implementation .	When enabled, all other clocks are systematically on (clock gating is off)

46.4.6.1.2 Refined Clock Gating

The SDMA implements a second level of clock gating on a register-per-register basis.

Unlike the first level that covers all the SDMA flip-flops, except the synchronizers (only five flip-flops are always running), the second level is only available for eligible registers, which amounts to about 90% of the SDMA flip-flops.

These gated registers are only clocked when the hardware logic detects a new data loading. This additional gating further reduces dynamic power consumption.

46.4.6.1.3 Low Power Modes and User Control

Power savings are automatically managed by the SDMA hardware without any user involvement; however, one can distinguish three different power modes: SLEEP, RUN, and DEBUG.

The following table describes these modes, and shows how to switch from one mode to another.

Table 46-10. Power Modes

Power Mode	Sub-blocks							Comments
	Core	Mem ories	Sche duler	Arm platf orm Control	Burs t DMA	Perip heral DMA	OnC E	
SLEEP	off ¹	off	wait ²	wait	off	off	off	Set when the PCU state is either <i>Sleep</i> or <i>Sleep after Reset</i> and the SDMA is not in DEBUG mode. This is the default mode after reset.
RUN	on ³	wait	wait	wait	wait	wait	off	Set for the other PCU states that are reachable out of debug: <i>Program, Data, Change of Flow, Error in Loop, Debug, Functional Unit, Save, or Restore.</i>
DEBUG	on	on	on	on	on	on	on	Set regardless of the PCU state when clock gating is turned off to use the OnCE features (either <i>clk_gating_off</i> pin high or ONCE_ENB[0] set).

1. *off*: no clock
2. *wait*: only clocked when accessed or stimulated
3. *on*: clock is always running

It is possible to control the SDMA power mode. The procedures to force the SDMA into either mode are described in [SLEEP Mode](#).

46.4.6.1.3.1 SLEEP Mode

This is the default mode after reset; therefore, resetting the SDMA forces this mode.

However, the common procedure is as follows:

- Ensure the *clk_gating_off* pin is low and ONCE_ENB[0] is cleared.
- Disable all channels (via the STOP_STAT control register, and the HO, DO, EO if necessary).
- Wait for the active channels to complete or force a reschedule via the reschedule bit in the RESET register.
- The SDMA is in SLEEP mode making it possible to completely shut off its clock from the chip level clock controller using the procedure described in [Stop Mode Response](#).

46.4.6.1.3.2 RUN Mode

This is the default mode when a channel is running:

- Ensure the *clk_gating_off* pin is low and ONCE_ENB[0] is cleared.
- Activate at least one channel (via the HSTART control registers, a DMA request, and/or the HO, DO, EO register bits).

46.4.6.1.3.3 DEBUG Mode

The DEBUG mode must be set when one needs to use the debugging facilities of the SDMA.

- Ensure the SDMA clocks are running from the CCM.
- Set the *clk_gating_off* pin high or use the SDMA to set ONCE_ENB[0].

46.4.6.1.4 Stop Mode Response

The SDMA receives a stop request from the chip level clock controller. This request may be asserted when the chip enters the stop low power mode.

If the SDMA is running when the request is received, then the SDMA will complete all pending channels before returning to the SLEEP state. The SDMA sends an acknowledgement to the clock controller when the SLEEP state is entered indicating that the SDMA's clocks can be turned off.

46.4.6.2 Reset

After reset (either received from the reset block or a software reset required by the Arm platform), the SDMA is in IDLE mode. It will start its boot code located at address 0 once a channel is activated.

Activating a channel can be done by the Arm platform after programming a positive priority and setting the channel bit in the EVTpend register.

There will not be a context RESTORE for the first channel (bootload channel) called after a reset because the context data in RAM has not been initialized. Static context mode should be used for the first channel called after reset to ensure that all context RAM for that channel is initialized. Subsequent calls to the same channel or different channels may use any of the dynamic context modes.

46.4.7 Software Interface

Appendix A fully describes the SDMA Application Programming Interface (API).

46.4.8 Initialization Information

This section discusses the following:

- [Hardware Reset](#)
- [Channel Script Execution](#)
- [Initialization and Script Execution Setup Sequence](#)

46.4.8.1 Hardware Reset

After reset, the program RAM, context RAM, data RAM, and RAM containing the channel enable registers (CHNENBLn) have unpredictable contents.

The active register set is assigned to channel 0 and the PC is initialized to all zeros. However, since the channel enable register is all zeros, there are no active channels and the SDMA is halted waiting for the boot channel to start.

The Arm platform will have to setup the SDMA in order to boot it. The CONFIG register must be initialized to determine the DMA/core clock ratio (1 or 2). Channel Enable Registers must also be initialized.

To start up the SDMA, the Arm platform first creates some channel control blocks (CCB) and buffer descriptors (BD) in Arm platform memory for the boot channel (channel 0) and then initializes the channel 0 pointer register (SDMA_MC0PTR) to the address of the first control block. [Data Structures for Boot Code and Channel Scripts](#) provides an overview of the data structure for the CCB and BD's. The SDMA_HSTART, SDMA_HOSTOVR and SDMA_EVTOVR registers are then configured according to [Runnable Channels Evaluation](#) to allow channel 0 to run.

Upon being enabled, the SDMA begins executing the script located at the address indicated by the Channel 0 Boot Address register (SDMA_CHN0ADDR) in the program memory. The reset value of SDMA_CHN0ADDR points to the default bootload script in ROM. This ROM script will read the channel 0 pointer register (SDMA_MC0PTR) to determine the location of the Channel Control Block (SDMA_CCB) in Arm platform memory. The script will then begin fetching by DMA the first channel control block which contains a pointer to the location channel 0 Buffer Descriptor chain which is also fetched via DMA. If the buffer descriptor contains a valid command, the script interprets the command in each buffer descriptor and proceeds to implement the command and move on to the next buffer descriptor control block. The buffer descriptor commands for

channel zero are typically set up to load SDMA's program RAM, Data RAM, and initial values for the channel contexts. Some channel scripts expect particular parameters to be passed

There are two ways to make the SDMA boot on a user-defined script. The OnCE (either via its JTAG interface or its Arm platform Control interface) can be used to download any code in the SDMA RAM and force the SDMA to boot on that code. Also, the SDMA_CHN0ADDR register in the Arm platform programming model can be modified to point to user code in RAM which would need to either have been loaded via the ONCE or default bootload routine (ex before a S/W reset).

46.4.8.2 Channel Script Execution

The execution of an SDMA script depends on both the instructions that make up the script, the data context upon which it operates, and commands or parameters allowed to the buffer. All these items must be initialized before the script is allowed to execute.

Each of the 32 channels has a separate context, but may share scripts and locations in data RAM.

Channels are initialized by the Arm platform by using channel 0 to download any required scripts and data values and the channels initial context. The context contains all the initial values of the SDMA core registers. This includes the Program Counter (PC) which is set to the start of the desired script in SDMA program memory.

The Arm platform selects which trigger conditions that must occur for the channel to start by configuring the SDMA_CHNENBL, SDMA_HOSTOVR and SDMA_EVT OVR registers. The trigger events include Arm platform setting HE (SDMA_HSTART) or a hardware DMA request asserts an event input to SDMA. The channel can become active according to its priority compared with other runnable channels when the selected trigger(s) cause the condition described in [Runnable Channels Evaluation](#) to evaluate as true.

The specific parameters to be passed to each script in the buffer descriptor or context are documented in the software documentation for each script. Please refer to [SDMA Scripts](#) for complete script documentation. [Buffer Descriptor Format](#) provides an overview of the buffer descriptor format.

46.4.8.3 Initialization and Script Execution Setup Sequence

To summarize, the following steps are minimally required to setup SDMA and run channel scripts.

- Perform Hardware Reset. The program RAM, context RAM, data RAM and SDMA_CHNENBLn registers have unpredictable contents after this reset.
- Initialize SDMA_CHNENBLn registers to map DMA request events to desired channels.
- Configure SDMA_CHNPRIn registers to select priority for runnable channels. A non-zero priority is required for the channel to run.
- Configure the SDMA_CONFIG register to select DMA to SDMA core clock ratio .
- Set up channel control blocks and buffer descriptors in Arm platform to specify the loading of SDMA program RAM and channel contexts for each SDMA channel to be used. Reference [Data Structures for Boot Code and Channel Scripts](#).
- Configure SDMA_MC0PTR register with base address of Arm platform Channel Control Block base address.
- Initialize SDMA_CHNENBLn registers to map DMA request events to associated channel. Reference [Mapping DMA Requests to Pending Channels](#).
- Configure SDMA_CHNPRIn registers to set priority for each channel to be run.
- For each channel to be run, configure SDMA_HOSTOVR (HO) and SDMA_EVTOVR (EO) registers to select which events (hardware and/or software trigger events) must occur for the channel to be runnable. Reference [Runnable Channels Evaluation](#).
- Set bit 0 of the SDMA_HSTART register to set HE[0] and allow Channel 0 to run (assumes EO[0] and DO[0] were both set in previous step). This will cause SDMA to load the program RAM and channel contexts configured previously.
- Wait for Channel 0 to finish running. This is indicated by HI[0]=1 in the SDMA_SDMA_INTR register, or by optional interrupt to the Arm platform.
- Set the LOCK bit in the SDMA_SDMA_LOCK register to prevent un-authorized uploads of data to SDMA RAM.
- Additional channel scripts can now be run by enabling the selected software or hardware trigger event according to [Runnable Channels Evaluation](#).

46.4.9 SDMA Programming Model

This section describes the programming model for the SDMA RISC engine, including its processor, memory, and internal control registers.

All addresses are related to the internal SDMA memory map, which is completely different from the Arm platform memory maps. The Arm platform processor has no access to any hardware resource described, except when those resources are described in Arm Platform Memory Map and Control Register Summary. .

46.4.9.1 State and Registers Per Channel

The SDMA can be seen as a set of 32 identical devices that are able to perform one data transfer channel each. Only one channel can work at a time, but every channel state is available at any time.

This chapter lists the components of every channel state.

46.4.9.2 General Purpose Registers

Each channel has eight general purpose registers of 32 bits for use by scripts. General register 0 has a dedicated function for the loop instruction, but otherwise can be used for any purpose.

46.4.9.3 Functional Unit State

Each channel context has some state that is part of the functional units.

The specific allocation of this state is part of the functional unit definition that is described in [Burst DMA Unit Programming](#), [Peripheral DMA Unit Programming](#) .

This state must be saved/restored on context switches.

46.4.9.3.1 Program Counter Register (PC)

The PC is 14 bits. Since instructions are 16 bits in width and all memory in the SDMA is 32 bits in width, the low order bit of the PC selects which half of the 32-bit word contains the current instruction.

A low order bit of zero selects the most significant half of the word.¹

46.4.9.3.2 Flags

Each channel has the following four flags:

- The T bit reflects the status of some arithmetic and test instructions. It is set when the result of an addition or a subtraction is zero and cleared otherwise. It is also the copy of the tested bits. Finally, it can also be set when the loop counter (GReg0) reaches zero. When the last instruction of the hardware loop is an operation that can modify the T flag, its effect on T is discarded and replaced by the GReg0 status.

1. For example, big-Endian.

- Two additional bits, SF and DF, are used to indicate error conditions resulting from loading data sources and storing to destinations, respectively. Access errors set these bits, and successful transactions clear them. They can also be cleared by specific instructions (CLRF and loop). The source fault (SF) is updated by the loads LD and LDF; the destination fault (DF) is updated by the stores ST and STF.
- Access errors are caused by several conditions including writing to the ROM, writing to a read-only memory mapped register, accessing an unmapped address, or any transfer error received by a peripheral when it is accessed.

The SF and DF flags have a major impact on the behavior of the hardware loop: If SF or DF is set when starting a hardware loop and it is not masked by the loop instruction, the loop body will not be executed. Inside the loop body, if a load or store sets the corresponding SF or DF flag, the loop exits immediately. Testing the status of the T flag at the end of the loop (as well as testing both SF and DF) tells if the loop exited abnormally as any anticipated exit prevents GReg0 from reaching the zero value and thus setting the T flag. This is also valid if the fault occurs at the last instruction of the last loop.

- The last flag is the loop mode flag, LM, which is composed of two bits. The most significant bit indicates when the processor is currently operating in loop mode. It is set by the loop instruction and is cleared after execution of the last instruction of the last loop. The least significant bit is set when the program counter points to the last instruction of a loop on the last path. It is used for a channel that is restored with this configuration to know that the next program counter is EPC. As with the dynamic context switch GReg0, which indicates when the program must get out of the loop, it can be restored only on the last instruction of the loop. This, however, is too late to fetch the next instruction after the loop.

46.4.9.3.3 Return Program Counter (RPC)

The RPC is 14 bits. It is set by the jump to the subroutine instructions and used by the return from the subroutine instructions.

Instructions are available to transfer its contents to and from a general register.

46.4.9.3.4 Loop Mode Start Program Counter (SPC)

The SPC is 14 bits. It is set by the loop instruction to the location immediately following it.

46.4.9.3.5 Loop Mode End Program Counter (EPC)

The EPC is 14 bits. It is set by the loop instruction to the location of the next instruction after the loop.

46.4.9.4 Context Switching-Programming

Each channel has a separate context consisting of the eight general purpose registers and additional registers representing the state of the functional units.

The active registers and functional units contain the context of the active channel. The context of inactive channels is stored in SDMA RAM, which is part of the SDMA address space.

In a function of the selected context switching mode ([Context Switching](#)), modified registers by the program can be saved in the channel RAM space while the program is going on. In every cycle, a write access to the RAM is possible.

On a done or yield(ge) instruction, SDMA goes into "real" context switching. In one of the dynamic modes, modified registers not previously saved, as well as the PC-Loop registers, are stored into the context area of the channel that will be closed. The new PC-Loop registers are loaded from the context area of the new channel. All other registers are restored while the program is executed, giving priority to registers used by the decoded instruction. Therefore, in the best case, only the PC and Loop registers should be saved and restored during this context-switching phase, which only requires five SDMA cycles.

In static mode, the context switch stores all registers in the old channel RAM space, and restores all registers from the new channel RAM space. It requires 26 SDMA cycles.

The address of the context memory for channel i is $CONTEXT_BASE + 24*i$ or $CONTEXT_BASE + 32*i$ where $CONTEXT_BASE$ equals 0x0800. The table below presents the layout of a channel context in memory:

Table 46-11. Layout of a Channel Context in Memory for SDMA

OFFSET	31	30	29-16	15	14	13-0
0	SF	-	RPC	T	-	PC
1	LM		EPC	DF	-	SPC
2	GR0					
3	GR1					
4	GR2					
5	GR3					
6	GR4					
7	GR5					

Table continues on the next page...

Table 46-11. Layout of a Channel Context in Memory for SDMA (continued)

8	GR6
9	GR7
10	MDA (burst DMA)
11	MSA (burst DMA)
12	MS (burst DMA)
13	MD (burst DMA)
14	PDA (peripheral DMA)
15	PSA (peripheral DMA)
16	PS (peripheral DMA)
17	PD (peripheral DMA)
18	
19	
20	Reserved ¹
21	Reserved ¹
22	Reserved ¹
23	Reserved ¹
24	Scratch RAM (optional)
25	Scratch RAM (optional)
26	Scratch RAM (optional)
27	Scratch RAM (optional)
28	Scratch RAM (optional)
29	Scratch RAM (optional)
30	Scratch RAM (optional)
31	Scratch RAM (optional)

46.4.9.5 Address Space

The SDMA has four internal buses which are listed here.

- The Instruction bus reads instructions from the memory. Its address map is described in [Instruction Memory Map](#).
- The Data bus (DMBUS) accesses the same memories as those visible on the Instruction bus, some memory-mapped registers (scheduler status and OnCE registers), and up to 14 peripherals. Its address map is described in [Data Memory Map](#).

- The Functional Units bus (FUBUS) accesses the , Burst DMA, Peripheral DMA . The addressing mechanism is further detailed in [Functional Units Programming Model](#).
- The Context Switch bus reads/writes registers into context-switch RAM space. It is a 64-bit bus dedicated for accessing this RAM space for updating the context of the running channel. While the program is going on, this bus has the lowest priority compared to the Instruction and Data buses, except for restoring a register needed for the decoded instruction to be executed. On the save part of a context switch (when the PCU is in its slave state), this is the only one used. On the restore part, the Instruction bus has the priority to read the next instruction at the restored PC and otherwise the Context Switch bus is used. It is not possible to control the actual data transfers that occur on this bus.

46.4.9.5.1 Instruction Memory Map

The instruction memory map is based on a 14-bit address bus and a 16-bit data (instruction) bus.

Instructions are fetched from either program ROM or program RAM. An SDMA script is able to change the contents of the program RAM, which is also visible from the data bus.

The first two instruction locations (at 0 and 1) are special. Location 0 is where the PC is set on reset. Location 1 is where the PC is set upon the execution of an illegal instruction. It is expected that both of these locations will contain a jmp to handle routines.

Table 46-12. SDMA Instruction Memory Space

Device	SDMA Address (Hex)	Base Address Label	Block Name	WS	Description
ROM	0x0000 ↓ 0x07FF	SDMA_IBUS_ROM_ADDR	-	0	4 Kbyte internal ROM with boot code and standard routines.
RAM	0x1000 ↓ 0x1FFF	SDMA_IBUS_RAM_ADDR	-	0	8 Kbyte internal RAM with channels context and user data/routines.

46.4.9.5.2 Data Memory Map

All of the data accessible to SDMA scripts make up the data memory space of the SDMA.

This address space has several components:

- ROM (also visible on the Instruction bus)
- RAM (also visible on the Instruction bus)

Functional Description

- Shared Peripherals Registers
- SDMA Internal Registers (scheduler, OnCE, and registers that are also accessible by the Arm platform)

SDMA scripts can read and write to the context RAM, data RAM, shared peripheral registers, and internal registers.

The address range is 16 bits and the data width is 32 bits. When accessing peripheral registers (USB and so on), the data width may be different. The exact address map for the peripherals depends on the project (as presented in each respective chapter).

Data access is performed with *ld* and *st* instructions that take the address from a general purpose register in the core (GRegn). The mapping between the general purpose register contents and the address bus is given in the following table:

Table 46-13. GRegn to DMBUS Address Mapping

31	30	29	28	27	26	25	24	23	22	21	20	19	18	17	16
15	14	13	12	11	10	9	8	7	6	5	4	3	2	1	0
sz	0	0	0	0	0	0	0	0	0	0	0	0	0	0	0
address															

Grayed bits are simply discarded but they must be cleared to ensure forward-script compatibility.

- sz (bit 31) indicates the peripheral data width: 0 is used for a 32-bit peripheral and 1 is used for a 16-bit peripheral.
- address (bits 15 down to 0) is the address of the accessed resource (internal memory, internal register, or shared peripheral).

Table 46-14. SDMA Data Memory Space

Device	SDMA Address (Hex)	Size	Description
ROM	0x0000 → 0x03FF	4 Kbyte	4 Kbyte internal ROM with boot code and standard routines
Reserved	0x0400 → 0x07FF	4 Kbyte	4 Kbyte Reserved
RAM	0x0800 → 0x0FFF	8 Kbyte	8 Kbyte internal RAM with channels contexts and user data/routines
per1	0x1000 → 0x1FFF	16 Kbyte	<i>peripheral 1</i> memory space (4 Kbyte peripheral's address space)
per2	0x2000 → 0x2FFF	16 Kbyte	<i>peripheral 2</i> memory space (4 Kbyte peripheral's address space)
per3	0x3000 → 0x3FFF	16 Kbyte	<i>peripheral 3</i> memory space (4 Kbyte peripheral's address space)
per4	0x4000 → 0x4FFF	16 Kbyte	<i>peripheral 4</i> memory space (4 Kbyte peripheral's address space)
per5	0x5000 → 0x5FFF	16 Kbyte	<i>peripheral 5</i> memory space (4 Kbyte peripheral's address space)
per6	0x6000 → 0x6FFF	16 Kbyte	<i>peripheral 6</i> memory space (4 Kbyte peripheral's address space)
Registers	0x7000 → 0x7FFF	16 Kbyte	Memory mapped registers
per7	0x8000 → 0x8FFF	16 Kbyte	<i>peripheral 7</i> memory space (4 Kbyte peripheral's address space)

Table continues on the next page...

Table 46-14. SDMA Data Memory Space (continued)

Device	SDMA Address (Hex)	Size	Description
per8	0x9000 → 0x9FFF	16 Kbyte	<i>peripheral 8</i> memory space (4 Kbyte peripheral's address space)
per9	0xA000 → 0xAFFF	16 Kbyte	<i>peripheral 9</i> memory space (4 Kbyte peripheral's address space)
per10	0xB000 → 0xBFFF	16 Kbyte	<i>peripheral 10</i> memory space (4 Kbyte peripheral's address space)
per11	0xC000 → 0xCFFF	16 Kbyte	<i>peripheral 11</i> memory space (4 Kbyte peripheral's address space)
per12	0xD000 → 0xDFFF	16 Kbyte	<i>peripheral 12</i> memory space (4 Kbyte peripheral's address space)
per13	0xE000 → 0xEFFF	16 Kbyte	<i>peripheral 13</i> memory space (4 Kbyte peripheral's address space)
per14	0xF000 → 0xFFFF	16 Kbyte	<i>peripheral 14</i> memory space (4 Kbyte peripheral's address space)

46.4.10 SDMA Initialization

Appendix A describes the setup of the SDMA . This section provides a quick description of several initialization procedures.

NOTE

There may be differences with the actual implementation in the API.

46.4.10.1 Hardware Reset-SDMA

After reset, the RAM that holds contexts, data, scripts, and the DMA request-channels matrix has unpredictable content.

The core registers are all reset to 0, including the PC; the PCU state is *Sleep after Reset*. No channel can be activated because all of the priorities are also reset to 0.

46.4.10.2 Standard Boot Sequence

The following is the standard boot sequence:

1. Initialize the CONFIG register-detailed in [Configuration Register \(SDMAARM_CONFIG\)](#)-to determine the Arm platform DMA/core clock ratio (1 or 2)
2. Initialize the DMA request-channels matrix (see [Channel Enable RAM \(SDMAARM_CHNENBL_n\)](#)).
3. Program the channel control registers-[Channel Event Override \(SDMAARM_EVTOVR\)](#), [Channel BP Override \(SDMAARM_DSPOVR\)](#), Channel

BP Override (SDMA_HOSTOVR), and [Channel Event Pending \(SDMAARM_EVTPEND\)](#)-according to the channel allocation.

4. Perform any necessary setup as required by the standard boot script in ROM (this is described in Appendix A).
5. Trigger channel 0 with the [Channel Start \(SDMAARM_HSTART\)](#) register, which starts the execution of the ROM script starting at address 0. This boot downloads channel scripts and contexts in RAM.

46.4.10.3 User-Defined Boot Sequence

The following is a user-defined boot sequence:

1. Initialize the [Configuration Register \(SDMAARM_CONFIG\)](#)[Channel Enable RAM \(SDMAARM_CHNENBL \$n\$ \)](#), [Channel Event Override \(SDMAARM_EVTOVR\)](#), [Channel BP Override \(SDMAARM_DSPOVR\)](#), [Channel Arm platform Override \(SDMAARM_HOSTOVR\)](#), and [Channel Event Pending \(SDMAARM_EVTPEND\)](#).
2. Use the OnCE (either via its JTAG interface or its Arm platform control registers) to download any code in the SDMA RAM. [Accessing the Memory](#) describes how to write data to the RAM via the OnCE.
3. Use the OnCE instructions to make the PC default value point to the new boot script start address, or rely on the ROM startup script, which first jumps to the address in [Channel 0 Boot Address \(SDMAARM_CHN0ADDR\)](#). (This register default address points to the standard boot script.)

46.4.10.4 Script Loading and Context Initialization

The execution of an SDMA script depends on both the instructions that make up the script and the data context upon which it operates. Both must be initialized before the script is allowed to execute.

Each of the 32 channels has a separate data context, but may share scripts and locations in the data RAM.

The Arm platform manages the space in program RAM and data RAM. It also manages the assignment of SDMA channels to the device drivers that need them. Channels are initialized by the Arm platform via the channel 0 boot script. The boot channel downloads any required scripts with their data and the channels' initial contexts. Every context contains all the initial values of the registers, including the PC. Then the Arm platform can enable any channel that becomes active and begins fetching and executing instructions from its script.

46.4.11 Instruction Description

The following sections introduce the instruction of the SDMA.

Instruction set details are available in [Instruction Set](#).

46.4.11.1 Scheduling Instructions

The following are scheduling instructions:

- **done**-The instruction causes certain scheduling or interrupt bits to be set or cleared, which may cause a change in the schedule-ability of the running channel. Then the instruction causes the SDMA to evaluate the current scheduling priorities and to choose the highest priority ready channel. If this channel is not the current channel, a context switch will take place. If there are no runnable channels, the SDMA will enter the stopped mode. The done 5 has a special usage reserved for debug, as explained in [Debug Instructions](#).
- **yield**-These instructions are special cases of the done instruction. They do not modify the scheduling bits, but allow the highest pending channel (if it exists) to preempt the current channel if the pending channel priority is strictly greater than the current channel priority.
- **yieldge**-These instructions are special cases of the done instruction. They do not modify the scheduling bits, but allow the highest pending channel (if it exists) to preempt the current channel if the pending channel priority is strictly greater or equal to the current channel priority.
- **notify**-The notify instruction affects the scheduling bits, but does not cause rescheduling.

46.4.11.2 Conditional Branch Instructions

The conditional branch instructions of an 8-bit displacement, which is sign-extended and added to the current PC (which points to the next instruction) if the condition is satisfied.

Otherwise, control passes to the next sequential instruction.

- **BF**-Branch if False. The branch is taken if the T bit in the processor status is zero (false).
- **BT**-Branch if True. The branch is taken if the T bit in the processor status is one (true).

- BSF-Branch if Source Fault. The branch is taken if the SF bit in the processor status is one.
- BDF-Branch if Destination Fault. The branch is taken if the DF bit in the processor status is one.

46.4.11.3 Unconditional Jump Instructions

There are two varieties of unconditional control transfers: an absolute transfer and a through-register transfer.

Absolute transfers have a 14-bit address field that replaces the current PC.

- JMP-Jump. Causes the processor to jump to an absolute address encoded in the instruction itself.
- JSR-Jump to Subroutine. Causes the processor to jump to a subroutine, the address of which is encoded in the instruction itself.
- JMPR-Jump through Register. Causes the processor to jump to an absolute address contained in a General register. This instruction is meant to be used when more than one level of subroutines are required.
- JSRR-Jump to Subroutine through Register. Causes the processor to jump to a subroutine, the address of which is contained in a General register. This instruction is meant to be used when more than one level of subroutines are required.

46.4.11.4 Subroutine Return Instructions

The following are subroutine return instructions:

- RET-Return from Subroutine. The RET restores the contents of RPC to PC.
- LDRPC-Load from RPC to Register. THE LDRPC instruction is meant to be used when more than one level of subroutines are required. It stores the contents of RPC in any General register.

46.4.11.5 Loop Instruction

The following is a loop instruction:

LOOP-Enters Loop Mode. Before entering loop mode, the loop instruction can optionally clear the fault flags (SF and/or DF) based on a 2-bit field in the instruction. This feature is linked to the fact that setting SF or DF in loop mode will cause an immediate exit of the loop.

46.4.11.6 Miscellaneous Instructions

The following are miscellaneous instructions:

- CLRF-Clear Fault Flags. This instruction clears any combination of SF and DF.
- MOV r,s-This moves data from GReg[s] to GReg[r].
- LDI r,immediate-This loads GReg[r] with a zero-extended immediate value.

46.4.11.7 Logic Instructions

The following are logic instructions:

- XORr,s-This performs an exclusive or between GReg[r] and GReg[s], and stores the result in GReg[r].
- XORIr,immediate-This performs an exclusive or between GReg[r] and a zero-extended immediate value, and stores the result in GReg[r].
- ORr,s-This performs an or between GReg[r] and GReg[s], and stores the result in GReg[r].
- ORIr,immediate-This performs an or between GReg[r] and a zero-extended immediate value and, stores the result in GReg[r].
- ANDNr,s-This performs an and between GReg[r] and the negated GReg[s], and stores the result in GReg[r].
- ANDNIr,immediate-This performs an and between GReg[r] and the negated zero-extended immediate value, and stores the result in GReg[r].
- ANDr,s-This performs an and between GReg[r] and GReg[s], and stores the result in GReg[r].
- ANDIr,immediate-This performs an and between GReg[r] and a zero-extended immediate value, and stores the result in GReg[r].

46.4.11.8 Arithmetic Instructions

Arithmetic instructions modify the T bit in the processor status according to the result of the operation. The T bit is set if the result is zero, otherwise it is cleared.

- ADD r,s-This performs the addition of GReg[r] and GReg[s], and stores the result in GReg[r].
- ADDI r,immediate-This performs the addition of GReg[r] and a zero-extended immediate value, and stores the result in GReg[r].

- SUB r,s-This performs the subtraction of GReg[s] from GReg[r], and stores the result in GReg[r].
- SUBIr,immediate-This performs the subtraction of a zero-extended immediate value from GReg[r], and stores the result in GReg[r].

46.4.11.9 Compare Instructions

Compare instructions modify the T bit in the processor status according to the result of the operation. The T bit is set if the comparison is true, otherwise it is cleared.

NOTE

Only one version of the immediate form is implemented. Non-equality comparisons to immediate values will require two instructions.

- CMPEQ r,s-This sets T when registers GReg[r] and GReg[s] are equal.
- CMPEQIr,immediate-This sets T when register GReg[r] and the zero-extended immediate value are equal.
- CMPLTr,s-This sets T when register GReg[r] is less than and not equal to GReg[s]. The comparison is signed.
- CMPHS r,s-This sets T when register GReg[r] is greater than or equal to GReg[s]. The comparison is signed.

46.4.11.10 Test Instructions

Test instructions modify the T bit in the processor status according to the result of the operation. The T bit is set if any bit in the result is one, otherwise it is cleared.

- TSTr,s-This performs an and between GReg[r] and GReg[s], and sets T if the result is not zero.
- TSTIr,immediate-This performs an and between GReg[r] and a zero-extended immediate value, and sets T if the result is not zero.

46.4.11.11 Byte Permutation Instructions

These instructions shuffle the bytes in a register. For the purpose of describing these instructions, have the bytes in a register be numbered from the most significant as b_3 , b_2 , b_1 , b_0 .

- RORBr-The rotate right byte. The result is b_0 , b_3 , b_2 , b_1 .

- REVB_r-The reverse bytes in word. The result is b_0, b_1, b_2, b_3 .
- REVBL_{Or}-The reverse, two low-order bytes. The result is b_3, b_2, b_0, b_1 .

46.4.11.12 Bit Shift Instructions

The following are bit shift instructions:

- ROR1_r-The rotate right 1 bit. This instruction does a circular right shift of 1 bit.
- LSR1_r-The logical shift right 1 bit. This instruction shifts all bits to the right by 1. The high order bit is replaced by a 0.
- ASR1_r-The arithmetic shift right 1 bit. This instruction shifts all bits to the right by 1. The high order bit is replaced by itself.
- LSL1_r-The logical shift left 1 bit. This instruction shifts all bits to the left by 1. The low order bit is replaced by zero.

46.4.11.13 Bit Manipulation Instructions

- BCLR_I_{r,n}-The bit clear is immediate; clears bit number i in register r .
- BSET_I_{r,n}-The bit set is immediate; sets bit number i in register r .
- BTST_I_{r,n}-The bit test is immediate; tests bit number i in register r (T becomes equal to the selected register bit).

46.4.11.14 SDMA Memory Access Instructions

All memory accesses are 32 bits.

Any memory location that is implemented with less than 32 bits (for example, peripheral registers) causes unimplemented bits to be read as 0s.

All memory accesses will cause either the SF or DF flags in the processor status to be set if they cause a fault.

What constitutes a fault, especially when accessing peripheral registers, is a property of the memory location.

- LDr,(b,d)-The load instruction creates an address by adding the displacement field (d) to the contents of the base register (b). The SDMA location at the resulting address is read and placed in the destination register (r).
- ST_r,(b,d)-The store instruction creates an address in the same manner as the load instruction. The register (r) is stored in the SDMA location at the resulting address.

46.4.11.15 Functional Unit Instructions

The functional unit instructions have an 8-bit field that is placed on the functional unit bus.

Some of these bits are used to select which functional unit should be involved in the transfer. The remaining bits are decoded by the selected functional unit so their specific use depends on the functional unit. See [Functional Units Programming Model](#).

There are two functional unit instructions, as follows:

- LDFr,fub-The 8-bit field is placed on the functional unit bus and a read is issued to the selected functional unit. As a result of this instruction, the SF may be set in the processor status.
- STFr,fub-The 8-bit field is placed on the functional unit bus and a write is issued to the selected functional unit. As a result of this instruction, the DF may be set in the processor status.

46.4.11.16 Illegal Instructions

All instruction encodings that are illegal cause the following actions:

- The current PC (which points to one beyond the offending instruction) is put in the EPC register.
- The loop mode bit is cleared.
- The PC is set to the value stored in the [Illegal Instruction Trap Address \(SDMAARM_ILLINSTADDR\)](#) register (the default value is 0x0001).

ILLEGAL-Although any instruction other than those indicated in the SDMA specification will trigger the illegal instruction mechanism, the ILLEGAL instruction code is preferred as it will always be kept as *illegal* in the possible future versions of the SDMA core.

46.4.11.17 Debug Instructions

The following are debug instructions:

- SOFTBKPT-The software breakpoint instruction causes the core to stop and enter debug mode. The core can then be accessed and started by the OnCE debug block only.

- done 5-This instruction is used for debugging, as it copies the contents of the PCU registers and flags to the context memory. Information on this instruction is described in [Saving the Context](#).
- CpShReg-This instruction copies the context memory into the PCU registers and flags. Modifying the corresponding memory location before executing this instruction enables you to have the channel continue from a new instruction address. This instruction is described in [Restoring the Context](#).

46.4.12 Functional Units Programming Model

The functional unit instructions cause an 8-bit code, found in the low eight bits of the instruction, to be asserted on the functional unit control bus.

Some of these bits are used to select one of several functional units. Functional units which can be selected include SDMA registers such as MSA and MSD which are not mapped in the SDMA memory map, and are accessible only through the functional unit bus. These Functional Unit Registers are listed in the following table. In order to establish a programming convention, assume the selection bits are some number of the most significant bits of the 8-bit code. Furthermore, some number of the least significant bits is decoded by a given functional unit to establish the type of operation to perform.

Table 46-15. Functional Unit Registers

Functional Unit	Register	Register Name	Section/Page
Burst DMA Unit Programming	SDMSA	Memory Source Address Register	Memory Source Address Register (MSA)
	MDA	Memory Destination Address Register	Memory Destination Address Register (MDA)
	MD	Memory Data Buffer Register	Memory Data Buffer Register (MD) (Write) Burst DMA Write (stf) (Read) Burst DMA Read (Idf)
	MS	Memory State Register	State Register (MS)
Peripheral DMA Unit Programming	PSA	Peripheral Source Address Register	Peripheral Source Address Register (PSA)
	PDA	Peripheral Destination Address Register	Peripheral Destination Address Register (PDA)
	PD	Peripheral Data Buffer Register	Peripheral Data Register (PD) (Write) Peripheral DMA Write (stf)-Write Mode

Table continues on the next page...

Table 46-15. Functional Unit Registers (continued)

Functional Unit	Register	Register Name	Section/Page
			(Read) Peripheral DMA Read (ldf)-Read Mode
	PS	Peripheral State Register	Peripheral State Register (PS)

More information regarding the functional units can be found in [Peripheral DMA Unit](#), and [Burst DMA Unit](#).

46.4.12.1 Burst DMA Unit Programming

The DMA instructions control the DMA state machine and may cause a DMA cycle on the associated memory bus.

There are four registers associated with the burst DMA unit: a Memory Source Address register (MSA), a Memory Destination Address register (MDA), a Memory Data buffer (MD), and a state register (MS). The burst DMA has two different uses:

- A data transfer between External Memory Interface and SDMA general register
- A data transfer in copy mode where blocks of data are transferred from the source address to the destination address

46.4.12.1.1 Memory Source Address Register (MSA)

The source address register contains the pointer into EXTMC memory associated with the next read data transfer. It has byte granularity.

Reading the register with the ldf instruction has no side effects, and gives the address value in the EXTMC memory of the next data that is read by the SDMA during an ldf MD instruction.

Writing the source address register has two side effects: If the prefetch bit is set, a DMA read cycle (8-word read access) is issued with the new address. Any data still located in the buffer is lost. If there is valid write data in the buffer, it is necessary to force the DMA to completely flush it out before modifying MSA to guarantee all the data is effectively written to memory.

The MSA register has two modes of programming:

- Frozen-In frozen mode, the MSA register is not modified after DMA accesses.
- Incremented (default mode)-In incremental mode, MSA is incremented by the number of bytes transferred during read cycles.

46.4.12.1.2 Memory Destination Address Register (MDA)

The destination address register contains the pointer into EXTMC memory associated with the next write data transfer. It has byte granularity.

Reading the MDA register with the `ldf` instruction has no side effects. It gives the address value in the EXTMC memory where the next SDMA data (`stf r,MD` instruction) is stored when MD FIFO is flushed.

Writing the destination address register has one side effect. Any data still located in the buffer is lost. If there is valid write data in the buffer, it is necessary to force the DMA to completely flush it out before modifying MDA to guarantee all the data is effectively written to memory.

The MDA register has two modes of programming:

- Frozen-In frozen mode, the MDA register is not modified after DMA accesses.
- Incremented (default mode)-The MDA register is incremented by the number of bytes transferred during write cycles.

46.4.12.1.3 Memory Data Buffer Register (MD)

The data buffer register consists of a bank of 36 bytes that behave like FIFO.

This FIFO stores the eight words received when a read burst is triggered by the DMA (DMA is in read mode).

The MD register is in write mode after a writing in MDA or after an `stf MD` instruction.

In that case, a burst write access is automatically triggered when there are more than eight words in MD. For bandwidth optimization, any transfers between DMA and the EXTMC controller are based on burst accesses.

An `ldf r,MD|SIZE` instruction that reads the data buffer may cause a DMA cycle, as follows:

- If there are less bytes in the FIFO than the size parameter of the instruction. For instance, if only two bytes are available in MD and a 4-byte read is requested, a burst read access is executed to complete the two bytes.
- If the prefetch bit is set, and after reading there is enough space in the FIFO to store a full burst, a burst read access is triggered.

An `stf r,MD|SIZE` instruction that writes to the data buffer may cause a DMA cycle if the number of written bytes in MD is higher than 32 (eight words) or if the flush bit is set.

Functional Description

When DMA is used for data transfer between SDMA and EXTMC (reading or writing), no immediate error is possible because the block manages a data misalignment issue; therefore, it is allowed to read/write a word to/from a half-word address. However, the addresses (source or destination) must belong to the EXTMC memory mapping. The only potential error, in this mode, would be the error sent back by the EXTMC controller when an access to a super-user page is detected. The whole transfer on the DMA associated bus will be considered successful when there are no errors seen on the bus during the transfer. In copy mode, an immediate error could be returned to SDMA as described in [Burst DMA Unit Error Management](#).

46.4.12.1.4 State Register (MS)

The state register contains the DMA state-machine value. It can be accessed in case of an error received during a transfer. MS is also accessed to set-up the conditional yielding feature.

The initialization value of this register is 0 and it consists of the following:

Table 46-16. SDMA_MS Structure

	31	30	29	28	27	26	25	24	23	22	21	20	19	18	17	16
	15	14	13	12	11	10	9	8	7	6	5	4	3	2	1	0
R	0	0	0	0	0	0	0	0	0	0	spriv	stype	0	0	dpriv	dtype
W																
R	0	0	0	0	y	d	e		0	0	n					
W																

Table 46-17. SDMA_MS Field Descriptions

Field	Description
31-22	Reserved
21 spriv	The spriv value is ignored for this device. 0 = valid value 1 = Reserved
20 stype	Source Mode. Indicates if MSA has to be incremented (or not) during accesses. 0 Frozen-MSA is not modified. 1 Incremented-MSA is incremented by the number of transferred bytes during read access.
19-18	Reserved
17 dpriv	The dpriv value is ignored for this device. 0 = valid value 1 = Reserved
16	Destination Mode. Indicates if MDA has to be incremented (or not) during accesses.

Table continues on the next page...

**Table 46-17. SDMA_MS Field Descriptions
(continued)**

Field	Description
dtype	0 Frozen-MDA is not modified. 1 Incremented-MDA is incremented by the number of transferred bytes during write access.
15-12	Reserved
11 y	Conditional Yielding selector. When selected, theyield/yieldge instructions will not switch channels if the Burst DMA is in Write Mode, and it has less than four bytes in its FIFO. This is aimed at reducing the number of inefficient FIFO flushes due to context switches. 0 Always yields 1 Yields conditionally (when there are less than four bytes in the FIFO in write mode)
10 d	Access Direction or DMA Mode. DMA is in write mode when data was written into MD by stf MD instructions, or if a previous DMA cycle on the external bus was a write access. Writing MDA or MSA changes the DMA mode to the respective value. DMA is in read mode when a previous DMA cycle was a read access, and DMA stays in read mode when data is read by SDMA with an ldf MD instruction. Reading MDA or MSA does not change the DMA mode. 0 Read Mode 1 Write Mode
9-8 e	Error. Indicates if the previous access was acknowledged with a bus error. 00 No error was received. 01 <i>reserved</i> 10 Error mode 11 error read burst
7-6	Reserved
5-0 n	Number of bytes in the MD FIFO.

46.4.12.1.5 Burst DMA Write (stf)

When received from a stf instruction, the function code bits are interpreted as follows, depending on the addressed register:

Table 46-18. STF Code Bits

Register	7	6	5	4	3	2	1	0
MSA	s		p	freeze	r			spriv
MDA								dpriv
MD			f	cpy				sz
MS								

Table 46-19. STF Code Bit Field Descriptions

Field	Description
7-6 s	Functional Unit selector 00 for Burst DMA
5 p (MSA)	Prefetch Flag 0 No prefetch 1 Prefetch required from new MSA
5 f (MD)	Forced Flush Flag 0 Automatic flush 1 FIFO contents are flushed (including the new written data).
4 freeze (MSA/MDA)	Address Freeze Mode 0 Address is normally incremented. 1 Address is frozen.
4 cpy (MD)	Copy Mode selection 0 Write Mode 1 Copy Mode
3-2 r	Register selection 00 MSA 01 MDA 10 MD 11 MS
1-0 sz (MD/MS)	Transfer Size 00 size 0 (no data stored in the FIFO) 01 byte (8 bits) 10 half-word (16 bits) 11 word (32 bits)
0 spriv (MSA)	The spriv value is ignored for this device. 0 = valid value 1 = Reserved
0 dpriv (MDA)	The dpriv value is ignored for this device. 0 = valid value 1 = Reserved

The possible write instructions are listed in the table below (unused bits should always be cleared).

Table 46-20. Burst DMA STF Instruction List

Binary	Assembly	Comments
00_0_0_00_00	stf r,MSA	Writes content of the SDMA general register (r) to the source address register. MSA is in incremented mode.

Table continues on the next page...

**Table 46-20. Burst DMA STF Instruction List
(continued)**

Binary	Assembly	Comments
00_0_1_00_00	stf r,MSAIFR	Writes content of the SDMA general register (r) to the source address register. MSA is in frozen mode.
00_1_0_00_00	stf r,MSAIPF	Writes content of the SDMA general register (r) to the source address register, and starts a read burst access. MSA is in incremented mode.
00_1_1_00_00	stf r,MSAIPFIFR	Writes content of the SDMA general register (r) to the source address register, and starts a read burst access.
00_0_0_01_00	stf r,MDA	Writes content of the SDMA general register (r) to the destination address register. MDA is in incremented mode.
00_0_1_01_00	stf r,MDAIFR	Writes content of the SDMA general register (r) to the destination address register. MDA is in frozen mode.
00_1_0_10_00	stf r,MDISZ0IFL	No data transfers between the SDMA and MD, but all valid written data of the MD is flushed to the memory. An acknowledge or error is sent back to the SDMA core on transfer completion.
00_0_0_10_01	stf r,MDISZ8	8-bit (byte) transfer to write buffer MD
00_1_0_10_01	stf r,MDISZ8IFL	8-bit (byte) transfer to write buffer MD and flush after transfer. All valid written data of the MD is flushed to memory.
00_0_0_10_10	stf r,MDISZ16	16-bit (half-word) transfer to write buffer MD
00_1_0_10_10	stf r,MDISZ16IFL	16-bit (half-word) transfer to write buffer MD and flush after transfer. All valid written data of the MD is flushed to memory.
00_0_0_10_11	stf r,MDISZ32	32-bit (word) transfer to write buffer MD
00_1_0_10_11	stf r,MDISZ32IFL	32-bit (word) transfer to write buffer MD and flush after transfer. All valid written data of MD is flushed to memory.
00_0_1_10_00	stf r,MDICPY	No data transfer between SDMA and MD but starts a copy transfer whose length is given by the 4 LSB of r register. (Maximum burst length is eight words.)
00_0_0_11_11	stf r,MS	32-bit (word) transfer to status register MS
00_0_0_11_00	stf r,MSISZ0	Clears the error flag (if set). Other MS bits are unchanged; this instruction is also known as clref MS.

NOTE

When a flush bit is set, the SDMA flushes the FIFO including the newly written data. An acknowledge is sent to the core before the flush completes (except if size 0 is used). The goal of this flush bit is to force a flush, but it is recommended to use it only when needed (for example, when finishing a row of pixels during 2D data transfers). Indeed, if this bit is omitted and if there are more than 32 bytes in the FIFO, a burst write access is automatically triggered.

Since all the stf r,MD instructions (including the copy mode) acknowledge the SDMA core before the store is effective (except if size 0 is used), it is recommended to perform an ldf

Functional Description

from MS before terminating a channel in order to check the final error status. (The ldf from MS will stall the core until all the data was flushed out and the transfer status is known.)

After every stf MD instruction, the MDA is incremented by the number of bytes that are written in MD, except when it is programmed in frozen mode.

46.4.12.1.6 Burst DMA Read (ldf)

When received from an ldf instruction, the function code bits are interpreted as follows, depending on the addressed register:

Table 46-21. LDF Code Bits

Register	7	6	5	4	3	2	1	0
MSA	s				r			
MDA								
MD		p					sz	
MS								

Table 46-22. LDF Code Bit Field Descriptions

Field	Description
7-6 s	Functional Unit selector 00 for Burst DMA
5 p (MD)	Prefetch Flag 0 no prefetch 1 automatic prefetch
3-2 r	Register selection 00 MSA 01 MDA 10 MD 11 MS
1-0 sz (MD)	Transfer Size 00 reserved 01 byte (8 bits) 10 half-word (16 bits) 11 word (32 bits)

The table below lists the possible write instructions (unused bits should always be cleared).

Table 46-23. Burst DMA LDF Instruction List

Binary	Assembly	Comments
00_0_0_00_00	ldf r,MSA	Copies the source address register value into an SDMA general register. It gives the memory address of the next data that will be read with an ldf MD instruction.
00_0_0_01_00	ldf r,MDA	Copies the destination address register value into an SDMA general register. It gives the memory address where the next incoming data will be flushed.
00_0_0_10_01	ldf r,MDISZ8	8-bit (byte) read
00_1_0_10_01	ldf r,MDISZ8IPF	8-bit (byte) read. If after this reading and the MD FIFO is empty, a burst read access at the MSA address is triggered.
00_0_0_10_10	ldf r,MDISZ16	16-bit (half-word) read
00_1_0_10_10	ldf r,MDISZ16IPF	16-bit (half-word) read. If after this reading, and the MD FIFO is empty, a burst read access at the MSA address is triggered.
00_0_0_10_11	ldf r,MDISZ32	32-bit (word) read
00_1_0_10_11	ldf r,MDISZ32IPF	32-bit (word) read. If after this reading and the MD FIFO is empty, a burst read access at the MSA address is triggered.
00_0_0_11_00	ldf r,MS	Copy the status register value into an SDMA general register.

NOTE

Read data is 0-extended before writing in the SDMA general registers. When reading the MD register, the DMA takes data from the FIFO if it is available. If part or whole data is not in the FIFO, an external burst read access is performed to provide the missing data. The SDMA is stalled as long as the required read data is not complete.

After every reading, MSA is incremented by the number of read bytes from MD FIFO, except when MSA is programmed in frozen mode.

46.4.12.1.7 Prefetch/Flush and Auto-Flush Management-Burst DMA Unit

The prefetch and auto-flush management enables the SDMA RISC machine to go on while a DMA access is performed.

When the RISC core requires a prefetch ($p = 1$) to the Burst DMA, it will receive an immediate transfer acknowledge before the DMA has finished the external access. This enables the RISC core to do other things like accessing another DMA machine.

The basic principle in prefetch mode is for the DMA to anticipate data reads from the SDMA RISC engine by fetching external bursts of data as soon as there is enough space in the DMA FIFO to store it. If ever the RISC engine required data that is not available in the FIFO, the read acknowledge is delayed until the data is available, but it does not have to wait until the burst completes.

The auto-flush basic principle is similar: An automatic flush is triggered every time there are eight words to be written in the FIFO. If the FIFO is full and the RISC engine requires another write, it is stalled until the burst has started and enough space was freed in the FIFO to store that new data. This means the SDMA RISC engine does not have to wait for the completion of a burst to receive its acknowledge and continue its processing.

In particular, an auto-flush is executed when DMA is in write mode and if the following is true:

- If the FIFO is empty and the first write is to a word-aligned address of any size (ex: the 2 LSB of MDA[1:0]= 0x0), the auto-flush is triggered immediately after the write of the 32'nd byte.
- If the FIFO is empty, and if MDA is an odd byte address (1, 3, 5, 7,...) and an stf MDISZ8 is executed, the byte is flushed to memory. Once MDA increments to a word aligned address, the auto-flush will be triggered every 32 bytes.
- If the FIFO is empty, and if MDA is a half-word address (2, 6, 0xA,...) and an stf MDISZ16 is executed, the two bytes of the incoming data are flushed to memory. Once MDA increments to a word aligned address, the auto-flush will be triggered every 32 bytes.
- If the FIFO is empty, and if MDA is not a word-aligned address (ex 1, 2, 3, 5, 6, 7, 9,...), and an stf MDISZ32 is executed, the first 1 to 3 bytes will be flushed up to the next word aligned address. Afterwards, an auto-flush will be triggered each time the FIFO receives 32-bytes.
- Therefore, if an stf MDISZ32 is executed with MDA equal to 0x1 and with an empty MD FIFO, the bytes located at addresses 1, 2, and 3 are flushed, and the byte located at address 4 remains in MD FIFO. This solves the misalignment issue. Additionally, the next write instructions (stf) complete the FIFO until it contains eight words; then a burst write is executed by the DMA to empty the FIFO. Protocol on the external bus does not support bursts of different data types (byte, half-word, or word).

For example, consider the case where data is written using a byte access, stf MDISZ8. The value of MDA during the very first byte write determines when the auto-flush will occur as follows:

- If MDA=0x0, the flush occurs following the write of byte 32
- If MDA=0x1, the flush occurs following the write of byte 1, byte 3 and byte 35.
- If MDA=0x2, the flush occurs following the write of byte 2 and byte 34.

- If MDA=0x3, the flush occurs following the write of byte 1 and byte 33.
- If MDA=0x4, the flush occurs following the write of byte 32

The flush command forces the DMA to flush all MD valid bytes to the EXTMC controller. An acknowledge is sent immediately to the SDMA, and any potential error is reported on a future access. It is thus essential to conclude a transfer with a last read from MS, which will stall the core until all data was flushed out and returned to the transfer status (acknowledge or error).

NOTE

During this kind of auto-flush (which occurs only at the beginning of a misaligned write transfer) no acknowledge is sent back to the SDMA, which is stalled until a flush is completed.

46.4.12.1.8 Data Alignment and Endianness-Burst DMA Unit

46.4.12.1.8.1 Burst DMA in Read Mode

For every read access to MD, the data returned to the SDMA core and the new FIFO state depends on the MSA status and the access size.

The FIFO is considered as a stack of 36 bytes: Data is fetched externally on a 32-bit bus, but the valid bytes only are stored in the FIFO and left-aligned (for a transfer of consecutive words, it is only the first word that may be truncated). The following table shows the FIFO byte alignment strategy and the corresponding MSA, the returned data, and the new FIFO state for any access size of an internal read from MD.

Table 46-24. FIFO Read Configuration

Before read		Internal read access size	Read data	After read	
MSA[1:0]	FIFO state			MSA[1:0]	FIFO state
00	x0 x1 x2 x3 y0 y1 y2 y3 z0 z1 z2 z3 and so on...	sz8	00 00 00 x0	01	x1 x2 x3 y0 y1 y2 y3 z0
		sz16	00 00 x0 x1	10	x2 x3 y0 y1 y2 y3 z0 z1
		sz32	x0 x1 x2 x3	00	y0 y1 y2 y3 z0 z1 z2 z3
01	x1 x2 x3 y0 y1 y2 y3 z0 z1 z2 z3 t0 and so on...	sz8	00 00 00 x1	10	x2 x3 y0 y1 y2 y3 z0 z1
		sz16	00 00 x1 x2	11	x3 y0 y1 y2 y3 z0 z1 z2
		sz32	x1 x2 x3 y0	01	y1 y2 y3 z0

Table continues on the next page...

Table 46-24. FIFO Read Configuration (continued)

Before read		Internal read access size	Read data	After read	
MSA[1:0]	FIFO state			MSA[1:0]	FIFO state
					z1 z2 z3 t0
10	x2 x3 y0 y1	sz8	00 00 00 x2	11	x3 y0 y1 y2
	y2 y3 z0 z1				y3 z0 z1 z2
	z2 z3 t0 t1 and so on...	sz16	00 00 x2 x3	00	y0 y1 y2 y3
		sz32	x2 x3 y0 y1	10	z0 z1 z2 z3
					y2 y3 z0 z1
					z2 z3 t0 t1
11	x3 y0 y1 y2	sz8	00 00 00 x3	00	y0 y1 y2 y3
	y3 z0 z1 z2				z0 z1 z2 z3
	z3 t0 t1 t2 and so on...	sz16	00 00 x3 y0	01	y1 y2 y3 z0
		sz32	x3 y0 y1 y2	11	z1 z2 z3 t0
					y3 z0 z1 z2
					z3 t0 t1 t2

46.4.12.1.8.2 Burst DMA in Write Mode

For every write access to the MD, the new FIFO state depends on the MDA status and the access size.

The FIFO is considered as a stack of 36 bytes: Data is stored in the FIFO according to the internal access size and the former MDA value. The following table shows the FIFO byte alignment strategy corresponding to MDA, as well as the new FIFO state for any access size of an internal write to MD.

Table 46-25. FIFO Write Configuration

Before write		Internal write access size	Written data	After write	
MDA[1:0]	FIFO state			MDA[1:0]	FIFO state
00	tt uu vv ww	sz8	?? ?? ?? x0	01	tt uu vv ww
	?? ?? ?? ??				x0 ?? ?? ??
	?? ?? ?? ?? and so on...	sz16	?? ?? x0 x1	10	?? ?? ?? ??
		sz32	x0 x1 x2 x3	00	tt uu vv ww
					x0 x1 ?? ??
					?? ?? ?? ??
					tt uu vv ww
					x0 x1 x2 x3
					?? ?? ?? ??
01	tt uu vv ww	sz8	?? ?? ?? x0	10	tt uu vv ww

Table continues on the next page...

Table 46-25. FIFO Write Configuration (continued)

Before write		Internal write access size	Written data	After write	
MDA[1:0]	FIFO state			MDA[1:0]	FIFO state
	xx ?? ?? ?? ?? ?? ?? ?? and so on...				xx x0 ?? ?? ?? ?? ?? ??
		sz16	?? ?? x0 x1	11	tt uu vv ww xx x0 x1 ?? ?? ?? ?? ??
		sz32	x0 x1 x2 x3	01	tt uu vv ww xx x0 x1 x2 x3 ?? ?? ??
10	tt uu vv ww xx yy ?? ?? ?? ?? ?? ?? and so on...	sz8	?? ?? ?? x0	11	tt uu vv ww xx yy x0 ?? ?? ?? ?? ??
		sz16	?? ?? x0 x1	00	tt uu vv ww xx yy x0 x1 ?? ?? ?? ??
		sz32	x0 x1 x2 x3	10	tt uu vv ww xx yy x0 x1 x2 x3 ?? ??
11	tt uu vv ww xx yy zz ?? ?? ?? ?? ?? and so on...	sz8	?? ?? ?? x0	00	tt uu vv ww xx yy zz x0 ?? ?? ?? ??
		sz16	?? ?? x0 x1	01	tt uu vv ww xx yy zz x0 x1 ?? ?? ??
		sz32	x0 x1 x2 x3	11	tt uu vv ww xx yy zz x0 x1 x2 x3 ??

NOTE

If the FIFO mode changes from a write to a read mode, all remaining written bytes in MD are lost but no error is returned. Typically, this happens if an ldf MD is executed after stf MD instructions. Before a mode change, it is recommended to force the flush of a potential remaining byte by a stfMD|SZ0|FL instruction. In the same way, if a FIFO mode changes from a read to a write mode, all prefetched data present in the FIFO is lost and no error is returned.

46.4.12.1.8.3 Endianness-Burst DMA Unit

Big and Little Endian are supported by the Burst DMA, but data is always stored in MD in Big Endian.

Byte manipulation is performed when data is exchanged with an Burst controller (for example, during read or write burst accesses).

46.4.12.1.9 Burst DMA Unit Copy Mode

A mechanism is available to perform fast Arm-to-Arm transfers.

Data does not flow through the SDMA core: It is kept in the DMA FIFO. This mechanism is selected when writing MD with a special option in the instruction code (copy flag).

It is possible to transfer up to eight words in one SDMA instruction (this does not mean in one cycle). In this mode, every time an stf MD|CPY is executed, a read burst is executed and directly followed by a write burst transfer. Burst transfers are limited to eight words. The size of the transfer (in words)-given by the SDMA general register (4 LSB)-is also limited to eight. The following SDMA code shows how 100 bytes could be copied from the MSA address to the MDA address. This is sample code only.

Burst DMA copy mode example

```

ldi r0,@src
stf r0,MSA // Source address setup
ldi r1,@dst
stf r1,MSA // Destination address setup
ldi r0,0x64 // data transfer counter
ldi r1,0x8

MAIN_XFER:
  cmphs r0,r1 // Is r0 >= 0x8
  bf LAST_XFER // If not, jump to last transfer label
  stf r1,MD|CPY // Copy 8 words from MSA to MDA address.
  subi r0,0x8 // Decrement counter
  jmp MAIN_XFER // return to main transfer loop

LAST_XFER:
  stf r0,MD|CPY

```

The main transfer loop is executed 12 times; then r0 equals 4 and the last transfer loop is run.

In this mode, an acknowledge is transmitted to the core as soon as the read burst can start; thus, a first copy instruction returns an immediate acknowledge and subsequent copy instructions will be acknowledged as soon as the previous copy has finished.

46.4.12.1.10 Burst DMA Unit Error Management

Another point to consider is the management of errors.

Because the DMA immediately sends an acknowledge to the RISC core (except for the stf MS|SZO|FLS instruction), it assumes no error will occur. If an error occurs, it is flagged (transfer error acknowledge) for the following DMA access.

This should not be a problem if the DMA is used properly. The MD accesses are meant to stall the SDMA as little as possible to optimize throughput and hide calculation time. Therefore, final access to MS should be performed before closing a channel. This access waits until any pending operation is finished in the burst DMA and gather any remaining error.

In copy mode, an error could be immediately returned to the SDMA on execution of the ldf copy or stf copy instruction. It happens when MSA or MDA are not word addresses (for example, 0[4]). This is because copy mode must only be used for transferring a large packet of aligned data.

When an error is received during a *read* transfer to the external bus, which may occur during the burst accesses, the MD FIFO contains the valid beats of the burst, and the error flag of MS is set to 2'b11 (error read burst). It is possible to read MS ("n" field) to know how much valid data remains in MD and when MD is empty (after ldf instructions). The next read MD instruction sets the MS error flag to 2'b10 (error mode), and an error is sent back to the SDMA core. In error mode, it is possible to read MSA, which gives the address of the error data. Any attempt to read or write MD, or to modify MDA or MSA in error mode, gives rise to an error; therefore, an error flag must be reset by clearing MS at the end of the SDMA code section responsible for error management.

In "error read burst" mode, writing MDA, MSA, or MD, or starting a copy transfer by a stf MDICOPY instruction will cancel the error mode. The following table shows when an immediate error is sent back according to the executed instruction.

Table 46-26. Possibilities in ERROR READ BURST Mode

DMA Instruction	Immediate Error	Comments
stf rn, MD stf rn, MSA (IU IPF) stf rn, MDA stf rn, MDICOPY	NO	Error mode is reset. MSA, MDA, or MD are updated and a DMA cycle may start. For the stf MDICOPY, a copy loop is executed.
stf rn, MS	NO	MS is updated.

Table continues on the next page...

Table 46-26. Possibilities in ERROR READ BURST Mode (continued)

DMA Instruction	Immediate Error	Comments
ldf rn, MS ldf rn, MSA ldf rn, MDA	NO	MS, MSA, and MDA could be read in ERROR READ mode without any side effects (for example, no DMA cycle is triggered).
ldf rn, MD	YES/NO	Immediate error if there is no more data available for read in the FIFO.

When an error is received during a *write* transfer, the error is reported to the next DMA access. In this case, an error is sent to the SDMA core and the DMA goes to its error mode. Reading MS gives the number of bytes that remain in MD; reading MDA gives the address of the error data. Any attempt to read or write MD, or to modify MDA or MSA in error mode, give rise to an error; therefore, an error flag must be reset by clearing MS at the end of the SDMA code section responsible for error management.

Table 46-27. Possibilities in ERROR Mode

DMA Instruction	Immediate Error	Comments
stf rn, MD stf rn, MSA stf rn, MDA	Yes	Any attempt to modify MD, MSA, MDA will raise an immediate error and burst DMA remains in error mode. When address registers are write-accessed, an error is returned.
stf rn, MS	No	This is the only way to exit error mode. MS[9:8] must be reset by an stf MSISZ0 instruction.
ldf rn, MS ldf rn, MSA ldf rn, MDA	No	MS, MSA, and MDA could be read in error mode without any side effects (for example, no DMA cycle is triggered).
ldf rn, MD	Yes	Whatever the DMA direction (read or write), an ldf rn triggers an immediate error.

46.4.12.1.11 Conditional Yielding-Burst DMA Unit

The standard SDMA transfer is based upon a hardware loop that has the following structure:

Hardware Loop

```

loop
load Rn,source           // can be ldf or ld
<computation>           // can be done through functional units
store Rn,dest            // can be st or stf
done 0                   // yield

```

This structure needs to be kept independent of the functional units' particularities regarding the context switch. However, there can be variations in the context switch's efficiency, which can depend on the number of data received up to that point, and on the data itself.

The DMA, with its 8-word burst capability, has a preferable context switch period when its address register is 8-word aligned: It is the only moment that occurs once every eight loops when the succession of bursts is not broken by the context switch. When this is not the case, a context switch requires the storing (or loading) of less than eight words, which requires separate accesses and is far less efficient. The rest of the 8-word packet is stored (or loaded) after the context restore, and this is done as separate accesses.

The proposed solution is a conditional yielding, which occurs only when the DMA is in an optimum state. It does not require any modification to the scripts. The condition is decided at the DMA level.

The DMA can be programmed in two modes-conditional or always-true-for every channel, which provides complete flexibility. By default, the DMA is not in conditional mode.

The DMA condition is computed from the FIFO fill level and the various modes, as follows:

- When copy mode is selected, regardless of the transfer direction ('read' or 'write'), the condition is always true.
- In read mode, the condition is always true.
- In write mode, the condition is true when there are four bytes or less in the FIFO; it is false when there are more than four bytes. The 4-byte limit comes from the possibility of saving those bytes as MD with absolutely no impact on the bus accesses.

The aim at conditional yielding is to avoid splitting bus accesses (especially bursts).

46.4.12.2 Peripheral DMA Unit Programming

The peripheral DMA unit is connected to the Multi-Layer DMA Crossbar Switch of the Arm platform.

Its goal is to perform data transfers between any blocks connected to the DMA bus of this platform. These blocks are either peripherals or memories. The peripheral DMA could be seen as the Arm platform DMA controller.

The DMA performs data transfers in three modes:

Functional Description

- Read mode, where data is read from peripherals or from memory connected to the Arm platform and copied in a SDMA general register.
- Write mode, where data of a general register has to be written in a peripheral or a memory.
- Copy mode, where data is read from a peripheral (or memory) at a source address (PSA) and automatically written to a peripheral (or memory) at a destination address (PDA).

In copy mode, no SDMA general register is involved as transferred data only goes through the data register of the DMA.

The peripheral DMA has three addressing modes: frozen, incremented, and decremented, as follows:

- Frozen mode-When source or destination addresses are frozen, their value is not modified after a transfer. This mode is typically used for addressing peripheral FIFOs located at a fixed address.
- Incremented mode-When source or destination addresses are in incremented mode, after every transfer they are incremented by the number of bytes transferred.
- Decrement mode-In decremented mode, addresses are decremented by the number of bytes transferred.

The peripheral DMA registers are as follows:

- Two, 32-bit address registers (PSA and PDA) that respectively contain the source address for a read access and the destination address for a write access
- A 32-bit status register (PS) that contains information on the peripheral DMA configuration, such as the number of valid bytes in the data register, the error flag, the source and destination address mode, and so on.
- A 32-bit data register (PD) that stores data involved in a data transfer

46.4.12.2.1 Peripheral Source Address Register (PSA)

The source address register contains a pointer to a source peripheral or a memory associated with the next read data transfer. It has byte granularity.

It is based on the following:

- A 32-bit register (PSA) to store the address value
- A 2-bit register (stype) to store the source address mode (frozen, incremented, or decremented)
- A 2-bit register (ssize) to store the source target data path size (byte, half-word, or word)

Reading the register with the `ldf` instruction has no side effects and gives the address value of the next data that will be read by the SDMA during an `ldf MD` instruction. Writing the source address register may have side effects. If there is valid write data in the data register and the source address is changed, the write data is discarded. If the prefetch bit is set, a DMA read cycle is issued with the new address.

When PSA is to be written, you must specify the source target address mode, providing its size (byte, half-word, or word). This enables omission of the size field in all `ldf MD` instructions. When DMA performs a read cycle, its size is given by the value of the PSA source size register (`ssize`). If source is a memory in incremented mode, first programmed in word mode (`stf PSA|SZ32I`), and if an SDMA script needs to read bytes from this memory, the size of the source target must be updated before executing new accesses. The source address mode and its size are given by labels added to the `stf PSA` instruction as described in the write section. The `ssize` and `stpe` registers are part of the DMA status register (`PS`).

Writing to PSA may issue an immediate error if the source size is not compatible with the value to be written into the PSA register. For instance, writing a 2 in PSA and specifying that it is memory-accessed in word mode creates an immediate error.

46.4.12.2.2 Peripheral Destination Address Register (PDA)

The destination address register contains a pointer to a source peripheral or a memory associated with the next write data transfer. It has byte granularity.

It is based on the following:

- A 32-bit register (`PDA`) to store the address value
- A 2-bit register (`dtype`) to store the destination address mode (frozen, incremented, or decremented)
- A 2-bit register (`dsize`) to store the destination target data path size (byte, half-word, or word)

Reading the register with the `ldf` instruction has no side effects, and gives the address value of the next data that will be written by SDMA during an `stfMD` instruction. Writing the destination register has no side effect. Similar to the PSA register, the destination address mode and source are specified in the `stf PDA` instruction and may also generate an error in case of incorrect programming.

46.4.12.2.3 Peripheral Data Register (PD)

The data register of the peripheral DMA is a 32-bit register. When the destination address is correctly set up, any writing to `PD` will automatically flush the new input data.

Functional Description

The number of SDMA bytes that will be transferred is given by the PDA size register. Unlike other SDMA DMAs, PD is not a FIFO: It is not used to accumulate bytes that from the SDMA and must be packed before being sent to external memories. In read mode, and if the source address is correctly set up, an ldf instruction will empty PD. If a prefetch is required along with the instruction, the DMA will initiate a new read transfer.

Reading PD in prefetch mode only stalls the SDMA when the prefetched data is not yet available. Writing PD only stalls the SDMA if the previous write operation was not completed. As soon as the previous operation is over, the acknowledge is sent back to the SDMA RISC engine.

An error flag-part of PS-is set when an external access fails. The error is thus reported to the next SDMA instruction that involves the peripheral DMA.

46.4.12.2.4 Peripheral State Register (PS)

The state register contains the DMA state-machine value. It can be accessed in case of an error received during a transfer.

Although all PS fields can be written by an stf instruction, it is recommended to access only the error bit (to reset it). Modifying other PS fields will provide an un-guaranteed DMA behavior.

The initialization value of PS is 0, and it consists of the following structure:

Table 46-28. PS Structure

	31	30	29	28	27	26	25	24	23	22	21	20	19	18	17	16
	15	14	13	12	11	10	9	8	7	6	5	4	3	2	1	0
R	0	0	0	0	0	0	0	0	ssize		stype		dsize		dtype	
W																
R	0	0	0	0	0	d	e		0	0	0	0	0	n		
W																

Table 46-29. PS Field Descriptions

Field	Description
31-24	Reserved
23-22 ssize	Source Target Size. Determines the size of the read transfers on the external bus. It should match the accessed device characteristics. 00 reserved 01 Byte (8 bits) 10 half-word (16 bits) 11 word (32 bits)

Table continues on the next page...

Table 46-29. PS Field Descriptions (continued)

Field	Description
21-20 stype	Source address Mode. Determines whether PSA is incremented, decremented, or kept unmodified after every read from the external bus. 00 Frozen Mode 01 Incremented Mode 10 Decrement Mode 11 <i>reserved</i>
19-18 dsize	Destination Target Size. Determines the size of the write transfers on the external bus. It should match the accessed device characteristics. 00 <i>reserved</i> 01 Byte (8 bits) 10 half-word (16 bits) 11 word (32 bits)
17-16 dtype	Destination address Mode. Determines whether PDA is incremented, decremented, or kept unmodified after every write on the external bus. 00 Frozen Mode 01 Incremented Mode 10 Decrement Mode 11 <i>reserved</i>
15-11	Reserved
10 d	Direction Flag or DMA Mode. DMA is in write mode when data was written into PD by stf PD instructions, or if a previous DMA cycle on the external bus was a write access. Writing PDA or PSA does not change the DMA mode. DMA is in read mode when a previous DMA cycle was a read access, and DMA stays in read mode when data is read by the SDMA with an ldf PD instruction. Reading PDA or PSA does not change the DMA mode. 0 Read Mode 1 Write Mode
9-8 e	Error. Indicates if the previous access was acknowledged with a bus error. 00 No error was received. 01 <i>reserved</i> 10 Error mode 11 Error read
7-3	Reserved
2-0 n	number of bytes in PD

NOTE

dtype, dsize, stype, and ssize are updated when PSA and PDA are written.

46.4.12.2.5 Peripheral DMA Write (stf)-Write Mode

When written by an stf instruction, the function code bits are interpreted as follows:

Table 46-30. STF Code Bits

Register	7	6	5	4	3	2	1	0	
PSA	s		p	ar	am		sz		
PDA									
PD			pdsel						
PS			pssel						

Table 46-31. STF Code Bits Field Descriptions

Field	Description
7-6 s	Functional Unit selector 11 for Peripheral DMA
5 p (PSA)	Prefetch Flag 0 no prefetch 1 automatic prefetch
4 ar (PSA/PDA)	Address Register Selector 0 PSA 1 PDA
3-2 am (PSA/PDA)	Address Mode. Determines how PSA or PDA is modified after every read or write access to the PD. 00 Frozen-Address registers are not modified after the transfer. 01 Incremented-Address registers are incremented by the number of transferred bytes. 10 Decrement-Address registers are decremented by the number of transferred bytes. 11 Updated-PSA and PDA are not modified. Either address mode is not modified, but the width of the data path is updated by the sz field.
1-0 sz	Transfer Size 00 <i>reserved</i> 01 byte (8 bits) 10 half-word (16 bits) 11 word (32 bits)
5-0 pdsel	PD access selector 001000 is the only valid option
5-0 pssel	PS access selector 111111 writes to PS 001100 only clears the error flag in PS

Due to the large number of possible stf instructions, the following table provides only a short list of all the possible write instructions:

Table 46-32. Peripheral DMA STF Instruction List

Binary	Assembly	Comments
11_00_00_01 11_00_00_10 11_00_00_11	stf Rn, PSAISZ8 IF stf Rn, PSAISZ16IF stf Rn, PSAISZ32IF	<ul style="list-style-type: none"> Source is a byte, half-word, or word target at the Rn address. Any further PD read instructions will trigger a byte, half-word, or word access to the source. Source address is frozen.
11_10_00_01 11_10_00_10 11_10_00_11	stf Rn, PSAISZ8 IFIPF stf Rn, PSAISZ16IFIPF stf Rn, PSAISZ32IFIPF	<ul style="list-style-type: none"> Source is a byte, half-word, or word target at the Rn address. Any further PD read instructions will trigger a byte, half-word, or word access to the source. 1, 2, or 4 bytes are <i>fetched</i> from the peripheral source. Source address is frozen.
11_00_01_01 11_00_01_10 11_00_01_11	stf Rn, PSAISZ8 I stf Rn, PSAISZ16I stf Rn, PSAISZ32I	<ul style="list-style-type: none"> Source is a byte, half-word, or word target at the Rn address. Any further PD read instructions will trigger a byte, half-word, or word access to the source. Source address is in incremented mode: PSA = PSA + 1, 2 or 4 after read PD.
11_10_01_01 11_10_01_10 11_10_01_11	stf Rn, PSAISZ8 IIPF stf Rn, PSAISZ16IIPF stf Rn, PSAISZ32IIPF	<ul style="list-style-type: none"> Source is a byte, half-word, or word target at the Rn address. Any further PD read instructions will trigger a byte, half-word, or word access to the source. Source address is in incremented mode: PSA = PSA + 1, 2, or 4 after read PD. 1, 2, or 4 bytes are <i>fetched</i> from the peripheral source.
11_00_10_01 11_00_10_10 11_00_10_11	stf Rn, PSAISZ8 ID stf Rn, PSAISZ16ID stf Rn, PSAISZ32ID	<ul style="list-style-type: none"> Source is a byte, half-word, or word target at the Rn address. Any further PD read instructions will trigger a byte, half-word, or word access to the source. Source address is in incremented mode: PSA = PSA-1, 2, or 4 after read PD.
11_10_10_01 11_10_10_10 11_10_10_11	stf Rn, PSAISZ8 IDIPF stf Rn, PSAISZ16IDIPF stf Rn, PSAISZ32IDIPF	<ul style="list-style-type: none"> Source is a byte, half-word, or word target at the Rn address. Any further PD read instructions will trigger a byte, half-word, or word access to the source. Source address is in incremented mode: PSA = PSA-1, 2, or 4 after read PD. 1, 2, or 4 bytes are <i>fetched</i> from the peripheral source.
11_00_11_01 11_00_11_10 11_00_11_11	stf Rn, PSAISZ8 IU stf Rn, PSAISZ16 IU stf Rn, PSAISZ32 IU	<ul style="list-style-type: none"> <i>Update</i> source pointer to memory, which becomes a pointer to a memory accessed in byte, half-word, or word. PSA value is not modified by Rn. Bytes present in PD are lost.
11_10_11_01 11_10_11_10 11_10_11_11	stf Rn, PSAISZ8 IPFIU stf Rn, PSAISZ16 IPFIU stf Rn, PSAISZ32 IPFIU	<ul style="list-style-type: none"> <i>Update</i> source pointer, which becomes a pointer to a target accessed in byte, half-word, or word. PSA value is not modified by Rn. Bytes present in PD are lost. 1, 2, or 4 bytes are <i>fetched</i> from the memory source.
11_01_00_01 11_01_00_10 11_01_00_11	stf Rn, PDAISZ8 IF stf Rn, PDAISZ16IF stf Rn, PDAISZ32IF	<ul style="list-style-type: none"> Destination is a byte, half-word, or word target at the Rn address, and any further PD write instructions will trigger byte, half-word, or word access to the destination. Destination address is frozen.
11_01_01_01 11_01_01_10 11_01_01_11	stf Rn, PDAISZ8 I stf Rn, PDAISZ16I stf Rn, PDAISZ32I	<ul style="list-style-type: none"> Destination is a byte, half-word, or word target at the Rn address, and any further PD write instructions will trigger byte, half-word, or word access to the destination. Destination address is in incremented mode: PDA = PDA + 1, 2, or 4 after write PD.

Table continues on the next page...

Table 46-32. Peripheral DMA STF Instruction List (continued)

Binary	Assembly	Comments
11_01_10_01 11_01_10_10 11_01_10_11	stf Rn, PDAISZ8 ID stf Rn, PDAISZ16ID stf Rn, PDAISZ32ID	<ul style="list-style-type: none"> Destination is a byte, half-word, or word target at the Rn address, and any further PD write instructions will trigger byte, half-word, or word access to the destination. Destination address is in incremented mode: PDA = PDA-1, 2, or 4 after write PD.
11_01_11_01 11_01_11_10 11_01_11_11	stf Rn, PDAISZ8 IU stf Rn, PDAISZ16 IU stf Rn, PDAISZ32 IU	<ul style="list-style-type: none"> Update destination pointer to memory, which becomes a pointer to a memory accessed in byte, half-word, or word. PDA value is not modified by Rn bytes present in PD are lost
11_00_10_00	stf Rn, PD	<ul style="list-style-type: none"> Write "dsize" bytes of Rn in PD and automatically flush to destination target
11_11_11_11	stf Rn, PS	<ul style="list-style-type: none"> Write status register
11_00_11_00	stf Rn, clrefPS	<ul style="list-style-type: none"> Clear error flag if set

NOTE

When writing PD, size information is not important: It is embedded in the dsize field of PDA register. If dsize is 1, 2, or 4, then one, two, or four bytes from Rn is written to the PD register, and automatically flushed out to the destination target.

46.4.12.2.6 Peripheral DMA Read (ldf)-Read Mode

When received from an ldf instruction, the function code bits are interpreted as follows.

Table 46-33. LDF Code Bits

Register	7	6	5	4	3	2	1	0
PSA	s			ar	a			
PDA								
PD			p	cpy				
PS			pssel					

Table 46-34. LDF Code Bits Descriptions

Field	Description
7-6 s	Functional Unit selector 11 for Peripheral DMA
5 p (PD)	Prefetch Flag 0 no prefetch 1 automatic prefetch
4 ar (PSA/PDA)	Address Register Selector 0 PSA

Table continues on the next page...

Table 46-34. LDF Code Bits Descriptions (continued)

Field	Description
	1 PDA
4 copy (PD)	Copy Mode 0 standard access 1 copy mode access
3 a	Register Set selection 0 PSA or PDA 1 PD or PS
5-0 pssel	PS access selector 111111 is the only valid option to read PS

Table 46-35. Peripheral DMA LDF Instruction List

Binary	Assembly	Comments
11_0_0_0_000	ldf Rn, PSA	Reads 32-bit of PSA value
11_0_1_0_000	ldf Rn, PDA	Reads 32-bit of PDA value
11_0_0_1_000	ldf Rn, PD	Reads programmed source size bytes of PD (0-extended)
11_1_0_1_000	ldf Rn, PDIPF	Reads programmed source size bytes of PD (0-extended), and starts a prefetch at PSA address.
11_0_1_1_000	ldf Rn, PDICOPY	Starts a copy transfer from the source target at the PSA address to the destination target at the PDA address. No data transmits through Rn, but Rn contents are lost (Rn is loaded with PD temporary contents that are <i>not</i> the copied data).
11_111111	ldf Rn, PS	Reads 32-bit of PS value

NOTE

When reading PD, size information is not important: It is embedded in the ssize field of the PSA register. If ssize is 1, 2, or 4, the one, two, or four bytes is transferred from PD to Rn. Read data is 0-extended.

46.4.12.2.7 Peripheral DMA Unit Copy Mode

Like burst DMA, the peripheral DMA unit has a copy mode that is used when data transfers do not involve SDMA general registers.

Data is read from the source target at a PSA address, stored in PD, and then automatically flushed to the destination target at the PDA address. Copy mode is only available for transfers that involve two targets of the same data path width.

Functional Description

Since copy mode is invoked with an ldf instruction, the *loaded* general purpose register loses its previous contents. (However, the new contents are unpredictable as they depend on temporary values that are seen on the external DMA bus.)

46.4.12.2.8 Error Management

Peripheral DMA generates two kinds of errors: the immediate error that sanctioned incorrect register programming; and the error triggered by the previous access and stored in the error flag of PS until a DMA instruction is executed.

46.4.12.2.8.1 Immediate Errors

The following table lists all incorrect DMA register setups.

Table 46-36. Immediate Errors with Peripheral DMA

Rn[1:0] values	DMA instruction	Comments
0x01 0x11	stf Rn, PSAISZ16IF stf Rn, PSAISZ16II stf Rn, PDAISZ16IF stf Rn, PDAISZ16II	If PSA points to a half-word peripheral or to a half-word address in memory, its value must be 0 modulo 2.
0x01 0x10 0x11	stf Rn, PSAISZ32IF stf Rn, PSAISZ32II stf Rn, PDAISZ32IF stf Rn, PDAISZ32II	If PSA points to a word peripheral or to a word address in memory, its value must be 0 modulo 4.
PSA[1:0]-PDA[1:0]	DMA instruction	Comments
0x01 0x10 0x11	stf Rn, PSAISZ32IU stf Rn, PDAISZ32IU	When PDA or PSA is updated and becomes a pointer to a word address in memory, its content must be 0 modulo 4.
0x01 0x11	stf Rn, PSAISZ16IU stf Rn, PDAISZ16IU	When PDA or PSA is updated and becomes a pointer to a half-word address in memory, its content must be 0 modulo 2.
Read/Write PD instruction	Comments	
stf Rn,PD ldf Rn,PD		If PDA size (dsize) has never been set up before an stf PD instruction (dsize=0) If PSA size (ssize) has never been set up before an ldf PD instruction (ssize=0)
ldf Rn,PDICPY		Copy mode is possible only between two targets whose data path width is identical. It is P8↔P8, P16↔P16, or P32↔P32 regardless of the way the address registers are incremented.

46.4.12.2.8.2 Data Transfer Errors

When PSA and PDA are correctly set up, the only error that may arise for an ldf PD or stf PD instruction would be the error of the previous DMA cycle.

Error handling is driven by a single consideration: When an error occurred during a data read on the DMA interface, this error should appear as a transfer error to the core when the core attempts to retrieve the data that was not successfully read from the accessed device (memory or peripheral).

When an error occurred during a write access to the DMA interface, the data is still available in PD and should not be destroyed by subsequent core accesses: The core must be warned about the error issue.

There are three error handling mechanisms for each case: [Read Error \(First Phase\)](#), [Write Error and Read Error \(Second Phase\)](#), and [Copy Mode Errors](#) handling.

46.4.12.2.8.3 Read Error (First Phase)

If an error occurred during a prefetch command, the peripheral DMA enters its ERROR READ mode (PS[9:8]=11). In this mode, the error is reported on the next ldf PD instruction and writing PSA, PDA, or PD will cancel the error flag.

The block returns no error mode and instructions are normally executed (a DMA cycle may be triggered). Similarly, initiating a copy transfer will reset the error flag and start a copy transfer. The following table details which instructions can be executed in this mode.

Table 46-37. Possibilities in ERROR READ Mode

DMA Instruction	Immediate Error	Comments
stf rn, PD stf rn, PSA (IU IPF) stf rn, PDA ldf rn, PDICOPY	NO	Error mode is reset, PSA or PDA are updated, or a write cycle is started. For the ldf PDICOPY, a copy loop is executed.
stf rn, PS	NO	PS is updated.
ldf rn, PS ldf rn, PSA ldf rn, PDA	NO	PS, PSA, and PDA could be read in ERROR READ mode without any side effects (for example, no DMA cycle is triggered).
ldf rn, PD	YES	Error of the previous read access is reported here and the peripheral DMA enters its ERROR mode.

46.4.12.2.8.4 Write Error and Read Error (Second Phase)

The peripheral DMA enters its ERROR mode (PS[9:8]=10) when the previous DMA write cycle failed, or, as explained in [Read Error \(First Phase\)](#), when an ldf PD is executed while the block is in ERROR READ mode. When a DMA cycle failed, address registers (PSA, PDA) are not modified and continue to point to the problematic address. In ERROR mode, stf instructions may raise an immediate error, and ldf instructions will not (as detailed in the table below).

Table 46-38. Possibilities in ERROR Mode

DMA Instruction	Immediate Error	Comments
stf rn, PD stf rn, PSA stf rn, PDA	YES	Any attempt to modify PD, PSA, or PDA will raise an immediate error, and the peripheral DMA stays in ERROR mode. When address registers are write accessed, an error is returned.
stf rn, PS	NO	This is the only way to exit the ERROR mode. PS[3] must be reset by an stf PS instruction.
ldf rn, PS ldf rn, PSA ldf rn, PDA	NO	PS, PSA, and PDA could be read in ERROR mode without any side effects (for example, no DMA cycle is triggered).
ldf rn, PD	YES	Whatever the DMA direction (read or write), an ldf rn, PD instruction will show an immediate error.

46.4.12.2.8.5 Copy Mode Errors

Because copy mode is a write access that follows a read access, there are two possible cases of bus error.

When the read access incurs a bus error, the peripheral DMA behaves exactly as described in [Read Error \(First Phase\)](#) and [Write Error and Read Error \(Second Phase\)](#) : It enters its ERROR READ mode, and so on.

When the error occurred during the write access of the copy transfer, the DMA enables the core to retrieve the data that was read because it is assumed the read from the peripheral removed the data from its source device. Therefore, the data to be flushed is still in PD. Any subsequent access to PD triggers an error to the core, which should execute its error handling procedure.

Once the ERROR mode is left (after writing to PS), it is possible for the core to retrieve the data in PD with an ldf instruction or try to flush PD contents once again (for example, when the error was due to a full FIFO and the script waited for the FIFO to be emptied) with another ldf instruction in copy mode. This latter instruction detects that there is valid data in PD, tries to flush it, and thus skips the read phase of the copy instruction. This is a different behavior from the usual stf PD instruction that overwrites PD with the selected General Purpose register contents. The same mechanism can be used any time PD holds data that is not written because of a bus error on the DMA interface; when the data was written via a copy instruction, or via the usual stf PD instruction.

46.4.12.2.8.6 Error Check Example

The following code illustrates an example checking for both immediate and data transfer errors on a store to the PD register. The first bdf instruction checks for an immediate error, but if a data transfer error occurred it is reported until the next instruction to access the Peripheral DMA. A second check of the error flags is done after the ldf PS

instruction. The value of PS here can be ignored. The act of reading any register in Peripheral DMA while it is in an error mode that returns the error to the core to set either the SF or DF flag. Any error returned on an ldf command sets the SF flag and any error returned on an stf instruction sets the DF flag. This can create a situation as shown in the example where a bus error during a DMA write which would normally be considered as a destination fault is reported as a source fault because the error was reported to the SDMA core during an ldf instruction.

Peripheral DMA Error Check

```

    clrf    0           // Clear SF and DF flags
    stf     R4, PD      // Write data to memory
    bdf     error_routine // Check for immediate error from write to PD.
    ldf     r3, PS      // Read PS (PS value in R3 can be ignored)
    bsf     error_routine // Check for bus error from "stf R4,PD"
                    // SF is set because it is a ldf instruction, even though
                    // the original error was a destination fault

```

46.4.12.2.9 Peripheral DMA Unit Prefetch/Flush Management

There is no flush bit because every time data is stored in PD by a stf PD instruction—assuming PDA is correctly programmed—it is automatically flushed to the destination.

An acknowledge is returned in the cycle of the DMA instruction, and the SDMA is only stalled by an instruction that addresses the peripheral DMA when the previous DMA access is not over.

46.4.12.3 OnCE and Real-Time Debug

The On-Chip Emulation block (OnCE) is the debug interface to the SDMA.

It supports the access to all core internal devices (registers, memory, and so on), and provides a set of mechanisms that control the core. The OnCE is accessed by JTAG ports at the chip's board level, or by the host via its peripheral bus.

To reduce the size of the hardware material involved, all tasks supported by the OnCE are performed on the SDMA core. The architecture of the SDMA OnCE is relatively simple and very flexible.

The commands supported by the SDMA OnCE are listed in the following sections.

46.4.12.3.1 Memory and Register Access

A set of mechanisms is provided to access SDMA memory and register locations. Both reading and writing are allowed. The access is supported if the processor is in debug mode.

Those registers can also be accessed through the Arm platform Control interface when the OnCE is controlled by the Arm platform, as described in the "Using BP" section.

46.4.12.3.2 Hardware Breakpoints

An event detection unit is implemented to support memory breakpoints. The unit watches the data exchanged between the SDMA memory bus and the core.

A debug request is sent to the core when matching conditions occur. The unit supports mixed conditions based on address range, access type, and data value. Event detection unit configuration registers are memory mapped in the SDMA space (see [Arm platform Channel 0 Pointer \(SDMAARM_MC0PTR\)](#)): You can modify them through a regular memory access or the Arm platform control interface.

46.4.12.3.3 Watchpoints

One output pin is provided to monitor matching trigger conditions that are defined in the event detection unit.

46.4.12.3.4 Software Breakpoints

The SDMA instruction set contains a software breakpoint. Upon executing a software breakpoint instruction, the core suspends normal execution and enters debug mode.

No hardware step execution mode is implemented in the OnCE, but this feature may be implemented at the software level with this instruction.

46.4.12.3.5 Core Control

Commands are provided to monitor and control processor activity. You can halt the core, rerun the core from another address location, and get processor status.

Any hardware breakpoint on the instruction bus is not supported, but this feature may be implemented by inserting a software breakpoints program.

46.4.13 The OnCE Controller

The OnCE controller receives commands from the Arm platform or from the JTAG controller. Each command is interpreted before being sent to the core.

46.4.13.1 OnCE Commands

A small set of commands supports the communication between the OnCE and the external world.

This command set enables you to perform any of the following tasks: control processor activity, save core context, and execute an SDMA instruction from the OnCE. Combined together, these tasks perform more complex commands.

A full OnCE command contains a 4-bit instruction (the OnCE command opcode) and a variable length data field (the OnCE data). During command execution, the OnCE data is transferred in a OnCE internal register before being exchanged with the SDMA. Some data values are also exported. This mechanism creates a link between the processor and the external world. Nine commands are defined: The following table presents their formats.

Table 46-39. OnCE Command Opcode Values

Instruction Opcode	Name	Action	Register	Data Field Size	Mode
0000	rstatus	Reads the OnCE status register	STATUS	16-bit	normal/debug
0001	dmov	Updates general register GReg1	GREG1	32-bit	debug
0010	exec_once	Runs the instruction from the SDMA instruction register	INSTRUCTION	16-bit	debug
0011	run_core	Returns to normal execution	BYPASS	1-bit	debug
0100	exec_core	Returns to normal execution via a jump instruction that specifies the new address	INSTRUCTION	16-bit	debug
0101	debug_rqst	Stops the core after execution of current instruction	BYPASS	1-bit	normal
0110	rbuffer	Reads the real time buffer	RTB	32-bit	normal/debug
0111-1110	reserved	Reserved	BYPASS	1-bit	normal/debug
1111	bypass	Bypasses TARM platform controller	BYPASS	1-bit	normal/debug

Each instruction corresponds to a specific action performed on the OnCE. The nature of the associated data field is clearly identified. The `dmov` command is followed by a 32-bit data value (which is a data value for the SDMA); the `exec_once` and the `exec_core` commands are followed by a 16-bit data value (which is an instruction for the SDMA); the `rstatus` command is followed by a 16-bit control value (which is the content of the OnCE status register); the `rbuffer` command is followed by a 32-bit data value. The

debug_rqst and the run_core commands are followed by a single bit data field (this is a bypass value). Finally, the bypass instruction enables the SDMA JTAG TAP controller to be daisy-chained with another JTAG TAP controller. This is a JTAG-only feature. The set of commands is simple, but enables you to perform any possible task on the SDMA during a debug process.

46.4.13.2 Sending Commands to the OnCE Controller

The JTAG access is the standard access to the OnCE, but sometimes the JTAG is not available to fix some bugs (if the chip is in production for instance), an additional access is then required. Therefore, one Arm platform access to the OnCE is provided.

46.4.13.2.1 Using the JTAG Interface

A serial access is performed through the five JTAG pins TCK, TRST, TMS, TDI, and TDO. A Test Access Port controller is provided to decode the TMS control signal.

It produces shift-enable signals (shift_ir and shift_dr), and updates enable signals (update_ir and update_dr). It is fully compliant with the IEEE 1149.1 testability (JTAG) standard.

During the shift_ir state, the command opcode is shifted into the OnCE controller (for example, the signal from the TDI pin is shifted into the command register and the TDO pin receives the signal shifted out). After transferring the four bits of the command, an update_ir signal is asserted and the command is decoded. The target data register is now clearly identified and the corresponding control signal is produced, as follows: bypass enable signal (bp_en), instruction enable signal (inst_en), data enable (data_en), and status enable signal (stat_en).

During the shift_dr state, the TDI signal is shifted into one of the following target registers: bypass register (1 bit), SDMA instruction register (16 bits), SDMA data register (32 bits), or OnCE status register (16 bits). The TDO pin is connected to the output of the selected register to receive the signals shifted out.

The JTAG access is disabled when the Arm platform access is enabled.

46.4.13.2.2 Using the Arm platform

The Arm platform access to the OnCE is not the standard access, but it is required if the JTAG is not available.

For example, if the SDMA ROM is out of use on a chip in production, and the Arm platform needs to download new code and restart the SDMA, the OnCE can easily perform this operation. This type of debug operation justifies the use of an Arm platform access to the OnCE.

To drive the OnCE, the Arm platform uses some registers contained in the Arm platform Control block of the SDMA. These registers are accessed through the Arm platform peripheral bus. Most of these registers are connected to another register in the OnCE controller. Thus, accessing one of these registers is equivalent to accessing the associated register in the OnCE controller.

The set of registers in the Arm platform Control block is listed below:

- **ONCE_ENB** register (1 bit, read/write)-This 1-bit register enables the Arm platform access to the OnCE. When this bit is set, the signals from the JTAG are ignored. When it is cleared, all writing operations to the following registers through the Host Control interface are ignored. This register is reset on a JTAG reset.
- **ONCE_CMD** register (4 bits, read/write)-This 4-bit register receives the command opcode. It is connected to the command register in the controller. A write access to this register causes the associated command to be executed on the OnCE. For example, after writing "0001" in this register, a `dmov` command is executed.

NOTE

On the Arm platform side, the `rstatus` and `bypass` commands are not supported. This register is reset on a JTAG reset.

- **ONCE_DATA** register (32 bits, read/write)-This 32-bit register is connected to the SDMA data register. This register is used when executing a `dmov` or `rbuffer` command.

NOTE

Before requesting a `dmov` command, the 32-bit data to transfer must be written in the **ONCE_DATA** register. At the end of the execution, the register is updated with `GReg1` former value. This register is reset on a JTAG reset.

- **ONCE_INSTR** register (16 bits, read/write)-This 16-bit register is connected to the SDMA instruction register. This register is used when executing an `exec_core` or an `exec_once` command.

NOTE

Before requesting an `exec_core` or an `exec_once` command, the appropriate instruction must be written in the **ONCE_INSTR** register. This register is reset on a JTAG reset.

- ONCE_STAT register (16 bits, read only)-A read access to the ONCE_STAT register returns the content of the OnCE status register (OSTAT). This register is read only.
- The bypass register is not useful when the Arm platform controls the OnCE, therefore no register is defined in the Arm platform Control block to access the bypass register.

46.4.13.2.3 Conflicts Between the JTAG and the Arm platform Accesses

When Arm platform access to the SDMA OnCE is enabled (that is, when the bit in the ONCE_ENB register is set), the JTAG access is disabled. This guarantees that the block is not accessed at the same time on both sides.

It is possible to check whether the JTAG access to the SDMA OnCE is enabled from the JTAG port. When the JTAG access is disabled, the SDMA TDO always returns 1. The check requires the following steps:

- Execute a dmov command from debug mode (with neither 0xffffffff nor 0x0 as dmov value: 0x5a5a5a5a is good).
- Execute another dmov command (the value here is not important).
- The returned value from the latter dmov command should be the original one if the JTAG access is enabled; if it is 0xffffffff instead of the original input value, this means the JTAG access is disabled.

46.4.13.3 Executing a Command from the OnCE

All the commands defined in [OnCE Commands](#) can be accessed through the JTAG. The Arm platform can access all these commands except the rstatus command.

On the Arm platform side, the OnCE status is directly accessed by reading the ONCE_STAT register.

46.4.13.3.1 Nature of the Commands

Two types of commands may be distinguished. First, there are two commands that do not interact with the core: rstatus and rbuffer. Those commands may be requested at any time: They do not depend on the core status.

NOTE

Each of these commands exports a data value or a status value from the SDMA.

There are also commands that interact with the core: `dmov`, `run_core`, `exec_core`, `exec_once`, and `debug_rqst`. These commands are core status dependent, as follows:

- During user mode only the `debug_rqst` is taken into account.
- During debug mode, all these commands are taken into account except the `debug_rqst`. For example, an `exec_once` command requested while not in debug mode has no effect.

46.4.13.3.2 Execution Request

The SDMA starts executing a task in debug mode when requested by the OnCE controller. The execution starting time depends on the type of access used to communicate with the OnCE.

If the JTAG is used, the request is sent after decoding the `update_dr` state in the TAP controller. Therefore, always cross this state when sending a command through the JTAG. If the OnCE is driven from the Arm platform side, the request is sent after detecting a write access to the `ONCE_CMD` register. All the registers involved in this operation must be loaded first.

The following is an example of an `exec_core` command execution from the Arm platform side: After writing '010' in the `ONCE_CMD` register, the OnCE controller asks the SDMA to execute the instruction contained in the `ONCE_INSTR` register. The instruction involved should be available in the `ONCE_INSTR` register before the beginning of the execution.

46.4.13.3.3 Command Execution

The following list shows the commands and details how each command is executed:

- `rstatus` command execution-The `rstatus` command exports the content of the OnCE status register (OSR). If the JTAG is used, the status information is captured in the OnCE status register during the `capture_dr` state, and shifted out after 16 TCK clock cycles in the `shift_dr` state. The `rstatus` command is not supported on the Arm platform side, but a status register is provided instead. The `rstatus` may be performed in both debug and user modes.
- `dmov` command execution-The `dmov` command accesses SDMA internal registers. Executing a `dmov` instruction exchanges the 32-bit data values between the SDMA data register and the general register `GReg[1]`.
- If the JTAG is used, the content of `GReg1` is captured in the SDMA data register during the `capture_dr` state, then it is shifted out after 32 TCK clock cycles in the `shift_dr` state. During the `update_dr` state, `GReg1` is updated with the new, shifted-in 32-bit data value. If the OnCE is driven from the Arm platform side, the data values

contained in GReg1 and the SDMA data register are exchanged after detecting a write access to the ONCE_CMD register. The ONCE_DATA register must therefore be loaded first.

- **exec_once** command execution-The **exec_once** command executes the instruction loaded in the SDMA instruction register. The command may only be requested from debug mode. The SDMA returns to debug mode at the end of the execution.
- Change of flow instructions as well as instructions that may cause a context switch are not supported: The comprehensive list comprises **done/yield/yiedge** (except **done 5**), **BF**, **BT**, **BSF**, **BDF**, **JMP**, **JSR**, **JMPR**, **JSRR**, **RET**, and **LOOP**, as well as all the illegal instructions.

No other command should be requested before the SDMA returns to debug mode. The SDMA status (for example, whether it is in debug mode or not) can be detected by polling with the **rstatus OnCE** command, monitoring the **debug_mode** pin, or checking the [OnCE Status Register \(SDMAARM_ONCE_STAT\)](#) register via the Arm platform control interface.

NOTE

Most of the instructions are single-cycle, which omits the step of polling the status. Loads and stores to DMA units are typical instructions that might require this polling.

If the JTAG is used, the 16-bit instruction is shifted in the SDMA instruction register after 16 TCK clock cycles in the **shift_dr** state. A request is sent to the core when the **update_dr** state is decoded in the TAP controller. If the OnCE is driven from the Arm platform side, the request is sent to the SDMA when detecting a write access to the ONCE_CMD register. The ONCE_INSTR register must be therefore be loaded first.

- **run_core** command execution-The **run_core** command leaves debug mode and resume normal program execution. The next instruction executed is the last instruction decoded before entering debug mode. Be sure to restore core context before re-running the core. This procedure is detailed in [Restoring the Context](#).
- If the JTAG is used, a 1-bit bypass value is shifted in the **bypass** register in the **shift_dr** state. The SDMA is rerun when the **update_dr** state is decoded in the TAP controller. If the OnCE is driven from the Arm platform side, the core is rerun when detecting a write access to the ONCE_CMD register.
- **exec_core** command execution-The **exec_core** command resumes program execution from any address. The 16-bit instruction provided with the **exec_core** overwrites the last instruction decoded before entering debug mode. This command is designed to support change of flow instructions, so that a program execution can be restarted from any address. After executing an **exec_core** command, the SDMA leaves debug mode. The **exec_core** command is usually used with a **jmp** instruction.

- If the JTAG is used, the 16-bit branch instruction is shifted in the SDMA instruction register after 16 TCK clock cycles in the shift_dr state. The SDMA is rerun when the update_dr state is decoded in the TAP controller. If the OnCE is driven from the Arm platform side, the SDMA reruns when detecting a write access to the ONCE_CMD register. The ONCE_INSTR register must therefore be loaded first. For example, to restart the SDMA from the program address 0x100, the instruction loaded should be a jump to address 0x100 instruction.
- debug_rqst command execution-The debug_rqst command puts the SDMA in debug mode. If the JTAG is used, a 1-bit bypass value is shifted in the bypass register during the shift_dr state. A debug request is sent to the SDMA when the update_dr state is decoded in the TAP controller. If the OnCE is driven from the Arm platform side, the debug request is sent when detecting a write access to the ONCE_CMD register. When the SDMA is already in debug mode, this command is simply ignored.
- rbuffer command execution-The rbuffer command exports the content of the real time buffer (RTB). If the JTAG is used, the content of the real time buffer (RTB) is captured in the SDMA data register during the capture_dr state. The register is completely shifted out after maintaining the shift_dr state during 32 TCK clock cycles. If the OnCE is driven from the Arm platform side, the content of the RTB is captured in the ONCE_DATA register after detecting a write access to the ONCE_CMD register.
- bypass command execution-This command is only available from the JTAG interface. It enables daisy-chaining of the SDMA JTAG TAP controller with other JTAG TAP controllers. This command does not change the SDMA state and can be executed in any mode (run, debug, or sleep). It selects the bypass register of the TAP controller.

46.4.13.4 Registers Descriptions

See [SDMACORE](#), and [SDMAARM](#), for detailed information on each register.

46.4.13.4.1 Event Cell Counter Register (ECOUNT)

The event cell counter register is a 16-bit register that contains the number of times minus one that an event detection occurs before generating a debug request.

This register should be written before attempting to use the event detection counter during an event detection process. The event cell counter register is cleared on a JTAG reset.

46.4.13.4.2 Event Cell Address Registers (EAA or EAB)

The event cell contains two address registers—the event cell address register (a), called EAA, and the event cell address register (b), called EAB. Every address register is a 16-bit register that stores a user-defined address value. This value computes one of the following address conditions: `addra_cond` or `addrb_cond`. Every address register is cleared on a JTAG reset.

46.4.13.4.3 Event Cell Address Mask Register (EAM)

The event cell address mask register is a 16-bit register that contains a user-defined address mask value. This mask is applied to the address value latched from the memory address bus before comparing addresses.

NOTE

There is a common address mask value for the two address comparators. If bit *i* of this register is set, then bit *i* of the address value latched from the memory bus does not influence the result of the address comparison. The event cell address mask register is cleared on a JTAG reset.

46.4.13.4.4 Event Cell Data Register (ED)

The event cell data register is a 32-bit register that contains a user-defined data value. This data value is an input for the data comparator, which generates the `data_cond` condition.

The event cell data register is cleared on a JTAG reset.

46.4.13.4.5 Event Cell Data Mask Register (EDM)

The event cell data mask register is a 32-bit register that contains a user-defined data mask value. This mask is applied to the data value latched from the memory bus before comparing data.

Setting bit *i* of the event cell data mask register means that bit *i* of the data value latched from the address bus does not influence the result of the data comparison. The event cell data mask register is cleared on a JTAG reset.

46.4.13.4.6 Real Time Buffer Register (RTB)

The real Time Buffer register is a 32-bit register that stores and retrieves run-time information without putting the SDMA in debug mode.

Refer to [Real Time Buffer](#) for more details.

46.4.13.4.7 Event Control Register (ECTL)

The event cell control register is a 16-bit register that defines cell event occurrence conditions.

The event cell control register is cleared on a JTAG reset. See also [OnCE Event Detection Unit](#) for more details.

46.4.13.4.8 Trace Buffer (TB)

The Trace Buffer register retrieves the information in the Trace Buffer.

See [Trace Buffer](#) for more details.

46.4.13.4.9 OnCE Status Register (OSTAT)

The OnCE status register is a 16-bit register that contains processor and event detection unit status. The OSTAT is a read-only register.

Refer to [OnCE Status Register \(SDMAARM_ONCE_STAT\)](#) for detailed description of the individual fields in the OSTAT register.

The following figure shows the OSTAT structure.

Table 46-40. OnCE Status Register (OnCE)

15	14	13	12	11	10	9	8	7	6	5	4	3	2	1	0
PST[3:0]				RCV	EDR	ODR	SWB	MST					ECCR[2:0]		

Where PST[3:0] is the SDMA core state, RCV is set when the real-time buffer (RTB) is modified. EDR, ODR, and SWB are set, respectively, when the SDMA has entered debug mode because of an external debug request, a OnCE debug_rqst command, or a software breakpoint. MST is set when the OnCE is controlled from the Arm platform control interface, and when ECCR is a three-flag set that shows the event cell condition(s) that put the core in debug mode. The OSTAT never provides more than one reason for entering debug mode.

There are two ways of accessing OSTAT content, as follows:

1. Send an rstatus command to the OnCE controller through the JTAG, or read the ONCE_STAT register through the Arm platform access. Executing the rstatus command through the JTAG can be performed in both user and debug modes.

2. Perform an SDMA read access to the location in the SDMA core memory map (OSTAT register) debug mode using the `exec_once` command. With this method of access, the SDMA state reflected by the PST (processor status bit) is always DATA.

The register may also be accessed by a running application.

46.4.13.5 JTAG Interface Requirements

Because the signals received from the JTAG (running on TCK) are transferred to the OnCE controller (running on the SDMA clock), a synchronization mechanism is required.

46.4.13.5.1 TCK Speed Limitation

In the JTAG top-level layer, the TDO signal is always captured on a TCK falling edge. To guarantee a stable TDO signal from the SDMA during this operation, a falling edge detection is performed on TCK.

Before being latched in the *I* flip-flop (see [Figure 46-11](#)) on TCK falling edge, the TDO signal must be stable at the input of the flip-flop. This condition is verified if the TCK period is superior to the following delay:

worst-case edge detection delay + negative-edge signal propagation delay + JTAG top-level logic propagation delay

The frequency relationship, $TCK < CLK/8$, limitation guarantees that all operations are performed as expected.

46.4.13.5.2 Synchronization Implementation

The figure found here shows the synchronization mechanism.

Flip-flops `tck0`, `tck1`, and `tck2` perform falling- and rising-edge detections on TCK. They generate the `posedge_detected` and `negedge_detected` nets that are used to sample the TDI and TMS inputs into the respective `tdi` and `tms` flip-flops, and update the `tdo` flip-flop to yield the TDO output. In the design, the only signal that might go metastable is the output of the `tck0` flip-flop. This signal is captured in the `tck1` flip-flop and no logical operation is performed on it to minimize a metastability propagation risk.

The TDI and TMS flip-flops also cannot go metastable: The propagation time of the rising-edge detection signal through `tck0`, `tck1`, and `tck2` guarantees that the TDI and TMS inputs are stable when captured in the TDI and TMS flip-flops.

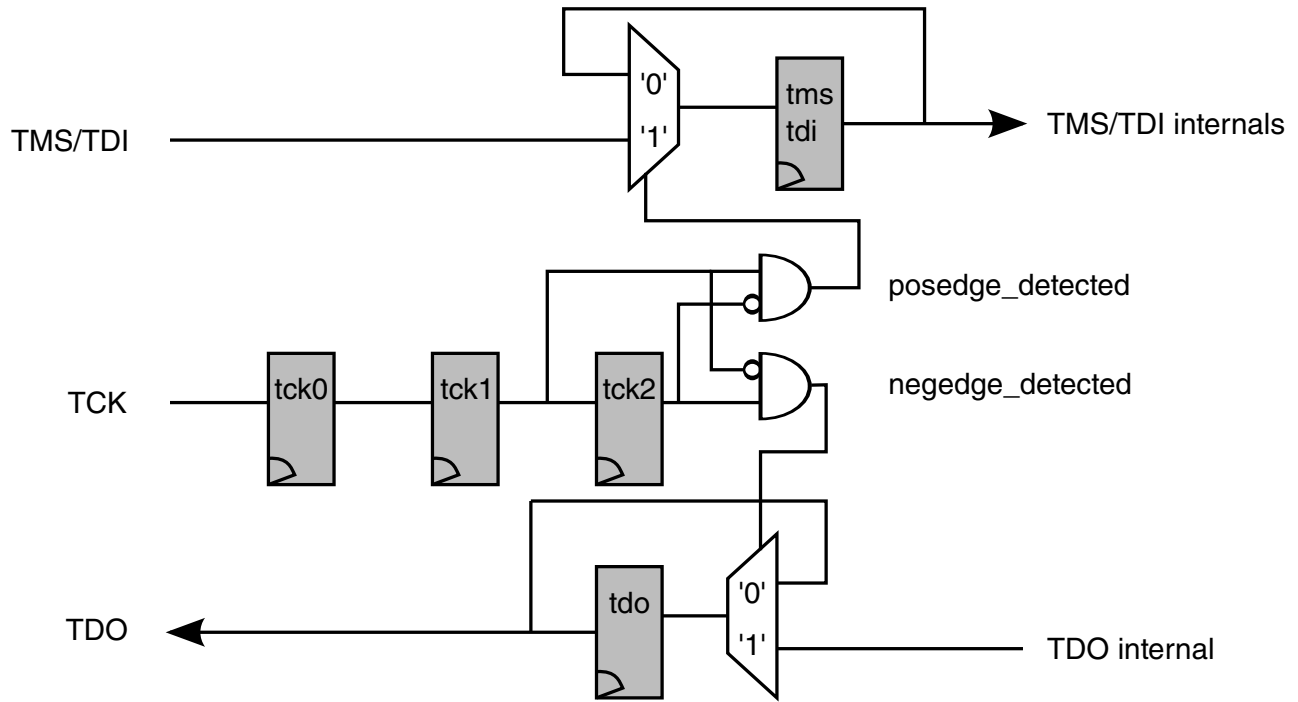

Figure 46-11. OnCE Synchronization Layer

The following figure shows synchronization timings. It takes three CLK clock cycles to synchronize TDI on the SDMA clock.

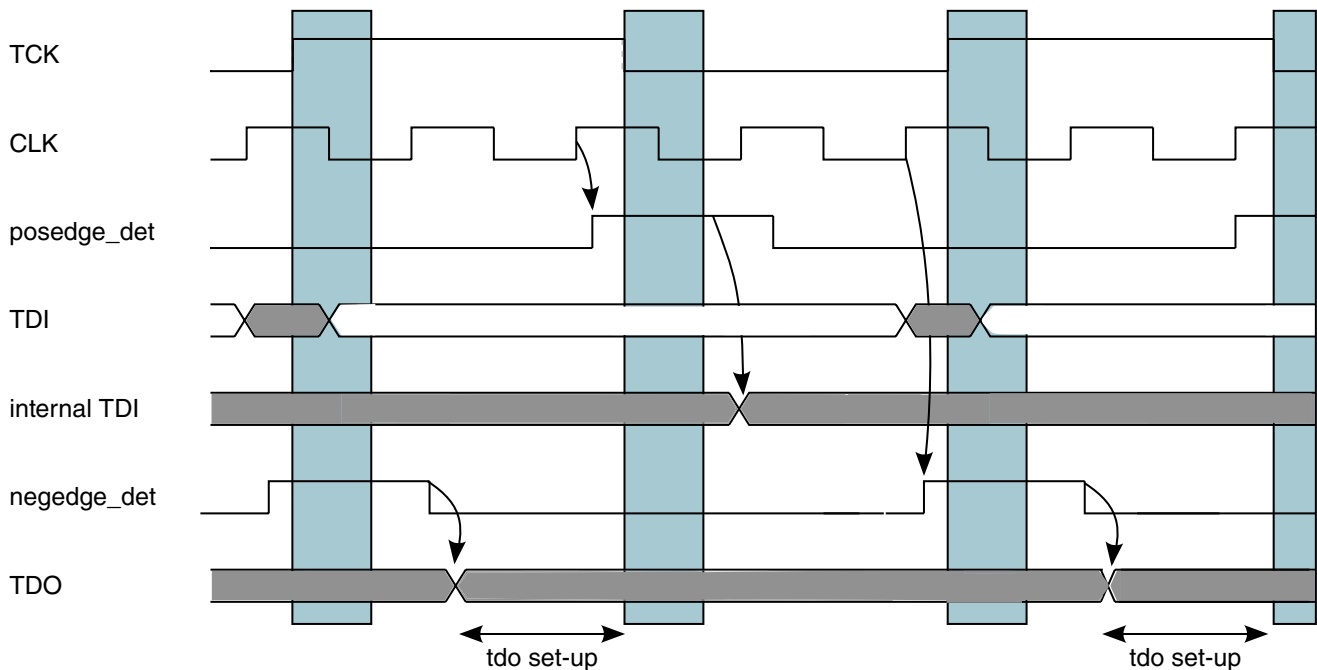

Figure 46-12. Synchronization Timings

46.4.13.5.3 JTAG Controller Start-Up Recommended Procedure

To ensure correct TAP controller initialization, it is recommended to use the following procedure:

1. Assert JTAG reset TRSTB (for example, set low).
2. Set TMS low.
3. Wait for 1 TCK clock.
4. Release JTAG reset TRSTB (for example, set high).
5. Wait for a minimum of five TCK cycles.

46.4.14 Using the OnCE

This section provides the elements necessary to run the OnCE during a debug process.

In addition to the basic set of commands described in [OnCE Commands](#), more complex commands can be built to meet users' requirements.

46.4.14.1 Activating Clocks in Debug Mode

For power consumption issues, some clocks in the SDMA are disabled when not needed.

This is the case for instances when the SDMA is in sleep mode. Clock gating management depends on the interface used to control the OnCE.

- For the JTAG access, the SDMA clock gating must be turned off via the `clk_gating_off` input.
- For the Arm platform access, the SDMA clock gating is automatically turned off when the Arm platform access is enabled (see [OnCE Enable \(SDMAARM_ONCE_ENB\)](#)).

46.4.14.2 Getting the Current Status

Most of the commands the OnCE supports have an impact on the status of the SDMA.

It is not permissible to request the execution of an instruction on the SDMA from the OnCE while the SDMA is not in debug mode. Such a violation may cause unpredictable behavior, and it might be necessary to reset the SDMA.

Therefore, the value of the PST bits provided in the OnCE status register should always be checked before sending any request to the SDMA.

46.4.14.3 Methods of Entering Debug Mode

A debug request may be asserted at any time, but it is not always taken into account immediately. Debug mode cannot be entered in the middle of an instruction, or during the save or restore states of a context switch.

The request is ignored when the core is already in debug mode. Refer to [Figure 46-4](#), which shows all possible transitions to the debug state, as there are several ways to enter debug mode.

46.4.14.3.1 External Debug Request During Reset

To enter debug mode after exiting reset, the external debug line has to be maintained high. This line is handled by the JTAG top-level block.

NOTE

The SDMA detects the debug requests only if the SDMA clock is running (see [Activating Clocks in Debug Mode](#)). The debug request line should be not be maintained high when the SDMA is in debug mode.

NOTE

The `debug_rqst` command (from the OnCE command set) is not supported during system reset.

46.4.14.3.2 Debug Request During Normal Activity

During normal activity, the SDMA enters debug mode when the following is true:

1. If the debug request line from the JTAG top-level is asserted, or
2. If the OnCE controller receives a `debug_rqst` command.

The `debug_rqst` command can be sent by the JTAG access or by an access on the Arm platform side (if the Arm platform access is enabled).

46.4.14.3.3 Software Breakpoint Instruction

The SDMA enters debug mode at the end of the execution of a software breakpoint instruction. This instruction must be inserted in program flow executed by the core.

46.4.14.3.4 Event Detection Unit Matching Condition

If the event detection is enabled, a debug request is sent to the core after detecting a matching condition on the SDMA memory bus.

See [OnCE Event Detection Unit](#) for more details.

46.4.14.4 Executing Instructions in Debug Mode

The OnCE supports a mechanism to execute instructions in debug mode. If the SDMA is in debug mode, then the `exec_once` command can be used to execute an SDMA instruction from the OnCE controller. The SDMA returns to debug mode at the end of each execution.

Some instructions are not supported by the `exec_once` command: `done/yield/yiedge` (except `done 5`), `BF`, `BT`, `BSF`, `BDF`, `JMP`, `JSR`, `JMPR`, `JSRR`, `RET`, and `LOOP`, as well as all the illegal instructions are not supported.

NOTE

While instructions are executed in debug mode from the OnCE, the program counter of the SDMA is not incremented.

46.4.14.5 Command Sequences Examples

This section provides examples of command sequences that run the SDMA in debug mode. These sequences are available for both the Arm platform and JTAG accesses.

The following presents the syntax used in this section. The data field provided with each command is put in parenthesis with the command name. A '-' is used if the data field provided is a *don't care* value.

```
my_command(data_field);           // executing my_command with a data field
my_command(-);                   // executing my_command with a don't care data field
```

The value returned by the command (if there is one) is referred by an assignment. In case the value returned by the command is not used, the assignment is omitted. For an Arm platform access, the value returned (it is always a data value) is obtained by reading back into the SDMA data register.

```
data_out = my_command(data_in); // returning a data value
```

To clarify the syntax, the instructions' opcodes are referred to by their names. In practice, use the corresponding 16-bit encoding.

46.4.14.5.1 Getting the SDMA Status

NOTE

Before executing any command that affects the SDMA (like `dmov` or `exec_once`), check that the SDMA is in debug mode.

Use the following snippet:

```
rstatus();           // read SDMA status until the SDMA is in debug mode
...
rstatus();
```

If the SDMA is not in debug mode, then a debug request must be generated. In this case, the SDMA enters debug mode at the end of the execution of the current instruction. Use this snippet:

```
debug_rqst(-);     // debug request
```

In the following sections, it is assumed that the SDMA was successfully put into debug mode.

46.4.14.5.2 Saving the Context

The first debug task is to save the SDMA context, which is the content of the eight general-purpose registers, the loop and PC-related registers, and the flags.

Use the general register `GReg[1]` as an intermediate register to export the entire context of the SDMA.

The following example shows how to save `GReg[0]`, `GReg[1]`, `GReg[2]` and `GReg[3]`. The sequence of commands used to export additional general registers is very similar to this.

Save `GReg[0]`, `GReg[1]`, `GReg[2]`, and `GReg[3]`

```
GReg1_data = dmov(-);           // the value exported is the content of
GReg[1]                                     // puts the content of GReg[0] into
exec_once("mov GReg1,GReg0");
GReg[1]
GReg0_data = dmov(-);           // the value exported is the content of
GReg[0]                                     // puts the content of GReg[2] into
exec_once("mov GReg1, GReg2");
GReg[1]
GReg2_data = dmov(-);           // the value exported is the content of
GReg[2]                                     // puts the content of GReg[3] into
exec_once("mov GReg1, GReg3");
GReg[1]
GReg3_data = dmov(-);           // the value exported is the content of
GReg[3]
```

Get the value of the internal flags (SF, DF, T, and LM), of the loop related registers (EPC and SPC), and of the PC-related registers (PC and RPC). Use a done 5, which is the formatting instruction dedicated to the debug. This instruction formats the flags and the values contained in the registers. It also writes the resulting values into the channel

Functional Description

context memory. It should not be used when entering debug from the IDLE state (for example, with no active channel script running on the SDMA), because it will update a channel context that may belong to any channel.

```
exec_once("done 5"); // formatting the value of flags and registers
```

At this point, the channel context should be up-to-date in memory, and debug operations should now be possible. However, the context can be exported with the following instructions:

Exporting the Context

```
dmov(ctx_base_addr); // loading GReg[1] with the channel
context_base_address
exec_once("ld GReg0, (GReg1,0)"); // get RPC-PC into GReg0
exec_once("ld GReg1, (GReg1,1)"); // get SPC-EPC into GReg1
Loop_data = dmov(-); // read back the value of Loop registers
exec_once("mov GReg1, GReg0"); // puts the PC info into GReg1
PC_data = dmov(-); // reads back the content of the PC registers
```

After this sequence of operations, the entire SDMA context is exported via the OnCE.

46.4.14.5.3 Restoring the Context

At this point in the operation, restore the context of the SDMA. It can be different from the original context located in memory, and the content previously saved into the debugging application via the OnCE.

The example found hereshows how it is possible to modify the current channel context.

Modifying the Current Channel Context

```
dmov(Loop_data); // put Loop former value into GReg[1]
exec_once("mov GReg0, GReg1"); // copy to GReg[0]
dmov(PC_data); // put PC former value into GReg[1]
exec_once("mov GReg2, GReg1"); // copy to GReg[2]
dmov(ctx_base_addr); // put channel context base address into
GReg[1]
exec_once("st GReg0, (GReg1,1)"); // restore Loop context
exec_once("st GReg2, (GReg1,0)"); // restore PC context
```

Once the context in memory is the desired context (with or without applying the previous instruction sequence), it can be restored to the *real* PC and loop registers in the SDMA core:

```
exec_once("cpShReg"); // restore flags and PC & loop related registers
```

After this command, the SDMA core PC, RPC, SPC, EPC registers, as well as the flags contain the same data as what is stored in the context RAM for the current channel.

The following example shows how to restore the context of general registers GReg[0], GReg[1], GReg[2] and GReg[3].

Restoring the General Register Context

```

dmov(GReg3_data); // put GReg[3] restore value in GReg[1]
exec_once("mov GReg3, GReg1"); // restore GReg[3]
dmov(GReg2_data); // put GReg[2] restore value in GReg[1]
exec_once("mov GReg2, GReg1"); // restore GReg[2]
dmov(GReg0_data); // put GReg[0] restore value in GReg[1]
exec_once("mov GReg0, GReg1"); // restore GReg[0]
dmov(GReg1_data); // restore GReg[1]

```

At this point, it is possible to restart the normal program execution.

NOTE

Every SDMA core general register value can be modified by a mov instruction, which makes modification of these registers easy during debug. Unfortunately, there is no such instruction as a mov to directly modify the contents of either PCU register or flag (PC, RPC, SPC, EPC, T, LM, SF, or DF). The cpShReg instruction is meant to provide a means for changing these register contents via the context memory.

46.4.14.5.4 Accessing the Memory

In the example shown here, it is assumed that the SDMA context is entirely saved. If true, it is permissible to modify the general purpose registers during debugging activity.

To perform a memory read access, the target address is stored via the OnCE in GReg[1], then the load instruction is executed on the SDMA (the data loaded from the memory overwrites the address contained in GReg[1]), and then the result value is read back via the OnCE.

```

macro READ:          dmov(target_addr); // put the target
address in GReg[1]  exec_once("ld GReg1, (GReg1,0)"); // execute the
load instruction    res_data = dmov(-); // exports the result
data value

```

For a memory write access, the target address is written in GReg[0], and the value to store is written in GReg[1]. Then the store instruction is executed on the SDMA.

```

macro WRITE:          dmov(target_addr); // puts the
target address in GReg[1]  exec_once("mov GReg0, GReg1"); // puts the target
address in GReg[0]  dmov(target_data); // puts the target
data in GReg[1]    exec_once("st GReg1, (GReg0,0)"); // performs the
store operation

```

This sequence is shown as an example; however, many other sequences are possible.

NOTE

This sequence of commands can also be applied to memory-mapped registers.

46.4.14.5.5 Resuming Program Execution

Before resuming program execution, it is assumed that the SDMA context is properly restored. There are two ways to restart the SDMA.

Start by executing the last instruction fetched before entering debug mode, as follows.

```
run_core(-); // resume execution from where we stopped before
```

If necessary, restart the execution from a different address. In this case, use the `exec_core` command. The data field provided with this command must be the encoding of a jump instruction.

```
exec_core("jmp start_addr"); // rerun the SDMA from another address
```

In these two examples, the SDMA exits debug mode and keeps executing the code fetched from the memory.

46.4.14.5.6 Single Stepping in RAM

To execute a program step-by-step from the RAM, insert software breakpoints in the program flow at appropriate places so that the SDMA only executes one instruction before returning to debug mode.

First, read the next instruction to execute in the RAM. Then, depending on the value of this instruction, compute the address where a software breakpoint instruction should be inserted. The instruction at the corresponding address must be saved, and, the software breakpoint instruction is inserted. After restarting the SDMA, there is only one instruction executed before meeting the software breakpoint.

The following example shows the macro functions `READ` and `WRITE`, which correspond to the sequence of commands (described above) used to access the memory.

NOTE

The data read from the memory are 32-bit values, while the instructions are 16-bit values only. This is why it is best to only use addresses divided by two when accessing the memory.

READ and WRITE Macro Functions

```
next_instr = READ(run_addr/2); // read the next instruction to execute
// the tool now has to compute the address where the breakpoint
// instruction should be inserted, this address is the "bkpt_addr"
instr_save = READ(bkpt_addr/2); // save the instruction before
overwriting // store the bkpt instruction
STORE("bkpt instruction",bkpt_addr/2);
in memory
exec_core("jmp run_addr"); // rerun the SDMA
rstatus(-); // wait for the SDMA to enter debug mode
...
rstatus(-);
```

```
STORE(instr_save,bpkt_addr/2);
overwritten
```

```
// restore the instruction
```

In case of branched conditional instructions, a breakpoint instruction should be written at the two possible target addresses.

46.4.14.5.7 Single Stepping in ROM

No single-step mechanism is supported in ROM. The program code can be loaded in the RAM, where the single-step mechanism can be executed.

46.4.14.6 OnCE Event Detection Unit

The event detection unit watches signals from the data memory bus (DMBUS), which the SDMA core uses to access its RAM, ROM, and memory mapped registers.

A debug request is sent to the OnCE controller when user-defined conditions on address and/or data values are true.

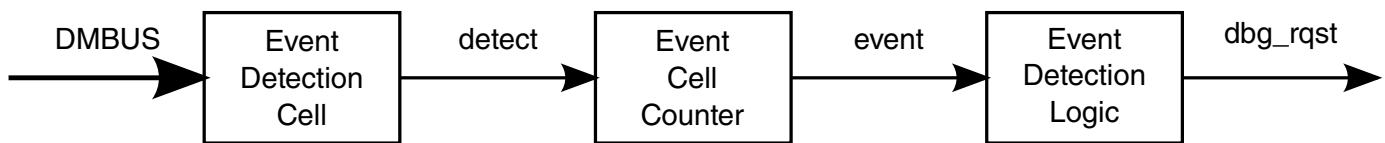

Figure 46-13. Event Detection Unit

A counter, provided with the detection cell, is decreased after an event detection. A debug request is sent to the core only when the counter reaches the value of 0. It is possible to disable the use of the counter if a debug request has to be generated after each event detection.

The event cell is the basic block that supports hardware breakpoints on an address value and/or data values coming from the SDMA memory bus. The trigger condition that generates the debug request is a mixed condition based on those values.

The following figure shows the event cell architecture. The event cell contains the address (stored in the memory address register) and the data (stored in the memory data register) used during the last memory access. There are some user-defined reference values located in memory mapped registers—the event cell addresses, the event cell address mask, the event cell data, and the event cell data mask. These registers are accessed by standard load/store instructions just like regular memory locations.

Functional Description

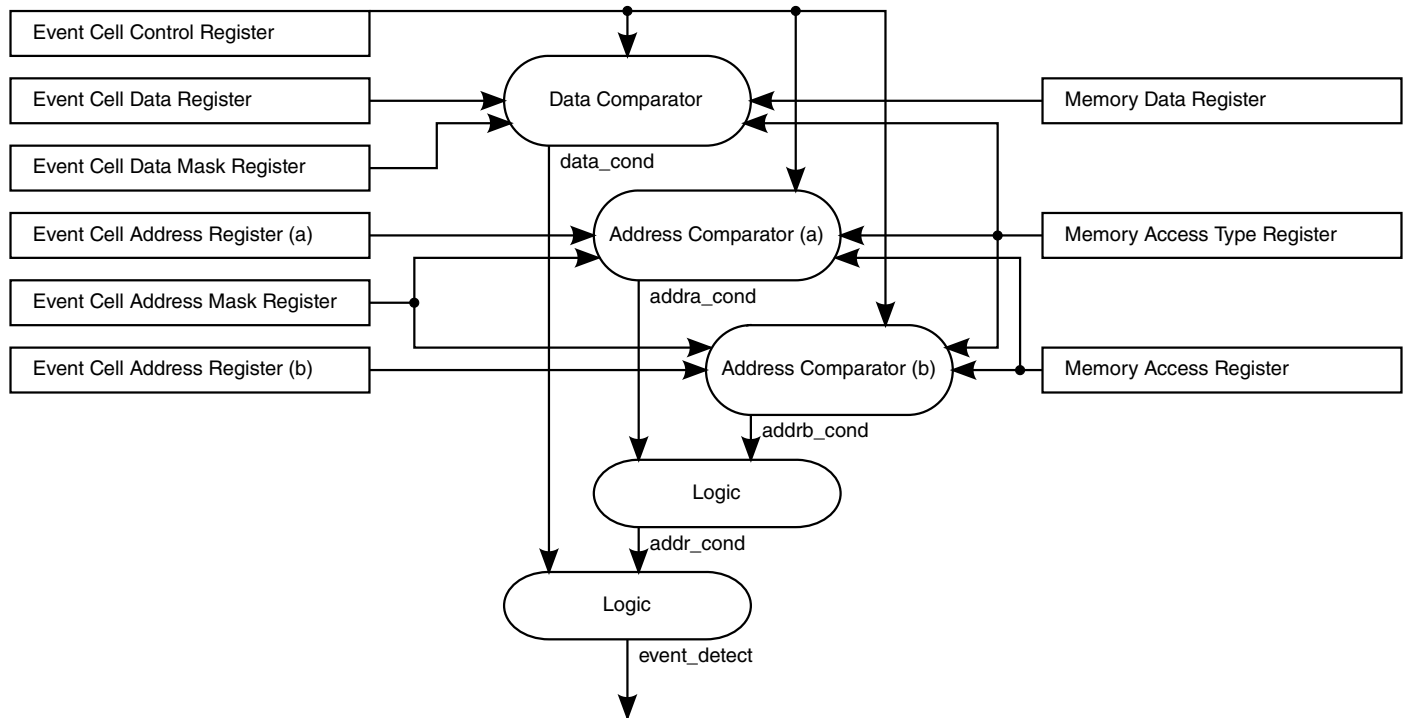

Figure 46-14. Event Cell Architecture

To define a memory breakpoint, three conditions are taken into account: The first two conditions are comparisons of the current memory address with user-defined reference addresses (these conditions are called addressA and addressB). The third condition consists of a comparison between the data received on the DMBUS and a user-defined reference data (this condition is called data). An intermediate address condition is set to express a dependency between addressA and addressB conditions.

46.4.14.7 Clock Gating and Reset

This section details how to use the clocks and handle the reset signals.

46.4.14.7.1 Clocks

Because the SDMA uses clock gating to save power, it is necessary to disable the clock gating and force the clocks to be enabled when using the OnCE.

When the OnCE is accessed through its JTAG interface, clock gating must be disabled outside the SDMA via a dedicated SDMA input port `clk_gating_off`. The reason why detection is not performed automatically by the SDMA internal hardware is that it would cost power to monitor activity on the JTAG interface.

When the OnCE is accessed through the Arm platform Control interface, clock gating is automatically turned off. This is done when bit 0 of the ONCE_ENB register (see [OnCE Enable \(SDMAARM_ONCE_ENB\)](#)) is set. A write access to this register is possible even when the OnCE clock is not running. If the Arm platform access is used, the bit in the ONCE_ENB register must be set before any attempt to access any other OnCE register.

46.4.14.7.2 Resets

The OnCE reset is different from the SDMA main reset.

Normally, activating the SDMA reset while keeping the OnCE reset inactive (when possible) enables you to reset the core without having to reprogram the OnCE.

46.4.14.8 Real Time Features

To rebuild the skeleton of a program execution, it is necessary to store the addresses of the program instructions where jumps are taken: A trace buffer is therefore provided. A real time buffer has also been added to receive data values written during a program execution.

The content of this register may be exported through JTAG ports without stopping the core.

46.4.14.8.1 Trace Buffer

The Trace Buffer is a 32-stage buffer that contains appropriate information to identify the 32 last changes of flow detected during a program execution.

The following figure shows an overview of the Trace Buffer.

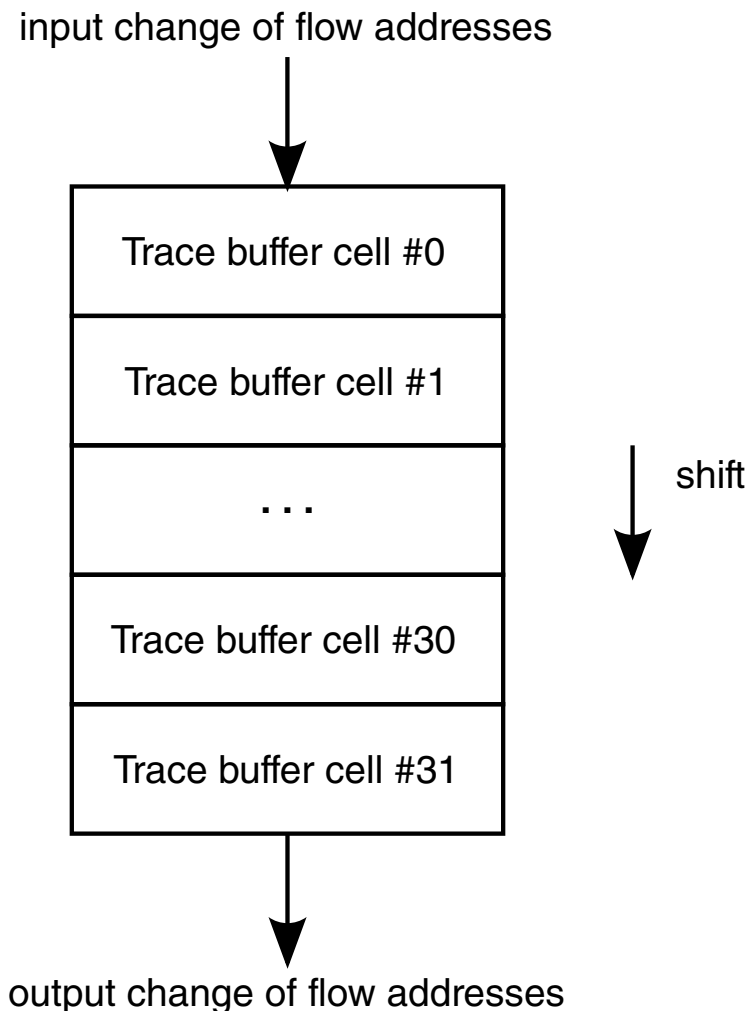

Figure 46-15. Trace Buffer

Each cell of the trace buffer contains two reference addresses and a flag. The flag is set when the addresses stored in the cell correspond to a valid change of flow; otherwise, the flag is cleared. The three most significant bits are unused.

After every change of flow detection, the address of current instruction and the address of the target instruction are stored at the top of the Trace Buffer (cell #0). The flag in the cell is set to indicate that a valid change of flow was detected. Former cell values are shifted one level down. The Trace Buffer contains the 32 last changes of flow. All the flags are reset on a software or a hardware reset, and after each transition from debug mode to user mode.

A memory mapped register of SDMA core, the Trace Buffer register (TB), is provided to read the content of the Trace Buffer. This operation should be done in debug mode. Performing a read access to the Trace Buffer register returns the content of the bottom of the Trace Buffer (cell #31). After every read access, the trace buffer is shifted one level down, and the flag at the top of the trace buffer is cleared.

A typical OnCE command sequence that retrieves the oldest change-of-flow information is as follows:

```
exec_once("mov r1, TB");           // stores the oldest change-of-flow in
GReg1
dmov(-);                          // retrieves GReg1 contents
```

This sequence requires the SDMA to be put in debug mode.

46.4.14.8.2 Real Time Buffer

The Real Time Buffer register (RTB) is a memory mapped register that can be accessed as a regular memory location by the SDMA core during program execution. This register is located in the OnCE.

Executing an `rbuffer` command (see [The OnCE Controller](#) for further details) exports the content of this register through JTAG ports.

When a write access is performed at the memory location corresponding to the RTB, the receive flag (for example, the RCV bit) is set in the OnCE Status Register (OSR). This flag is cleared at the end of the execution of a `rbuffer` command.

NOTE

Every write access to the RTB memory location updates the RTB register even if the RCV flag is set. The RTB is cleared on a JTAG reset.

46.4.14.8.3 Emulation Pin

The `debug_matched_event` emulation pin reflects the matching condition status detected by the Event Detection Unit.

Since it can be necessary to detect conditions without triggering debug requests, it is possible to disable the generation of debug requests by the Event Detection Unit and still have the matching condition available on the emulation pin. This can be done by clearing the EN flag in the ECTL register.

46.4.14.8.4 Real-Time Debug Outputs

The table found here shows the debug signals that are available at the SDMA boundaries. Their availability at chip boundaries depends on the project.

Table 46-41. Real-Time Debug Output Pins

Pin	Description
debug_core_state[3:0]	<p>The core_state bits reflect the state of the SDMA core.</p> <ul style="list-style-type: none"> • The "Program" state is the usual instruction execution cycle. • The "Data" state is inserted when there are wait-states during a load or a store on the data bus (ld or st). • The "Change of Flow" state is the second cycle of any instruction that breaks the sequence of instructions (jumps and channel switching instructions). • The "Change of Flow in Loop" state is used when an error causes a hardware loop exit. • The "Debug" state means the SDMA is in debug mode. • The "Functional Unit" state is inserted when there are wait-states during a load or a store on the functional units bus (ldf or stf). • In "Sleep" modes, no script is running (this is the core idle state); the "after Reset" is slightly different because no context restoring phase will happen when a channel is triggered: The script located at address 0 is executed (boot operation). • The "in Sleep" states are the same as above except they do not have any corresponding channel: they are used when entering debug mode after reset; the reason is that it is necessary to return to the "Sleep after Reset" state when leaving debug mode. <p>0 Program 1 Data 2 Change of Flow 3 Change of Flow in Loop 4 Debug 5 Functional Unit 6 Sleep 7 Context Switch Saving Channel 8 Program in Sleep 9 Data in Sleep 10 Change of Flow in Sleep 11 Change of Flow in Loop in Sleep 12 Debug in Sleep 13 Functional Unit in Sleep 14 Sleep after Reset 15 Context Switch Restoring Channel</p>
debug_yield	<p>Pulse that is active when a yield (done 0) or a yieldge (done 1) instruction is executed.</p> <p>0 - 1 yield/yieldge executed</p>
debug_core_run	<p>Active when the SDMA core is executing instructions.</p> <p>0 Debug or sleep mode</p>

Table continues on the next page...

Table 46-41. Real-Time Debug Output Pins (continued)

Pin	Description
	1 Run mode
debug_event_channel_sel	Indicates if debug_event_channel displays current channel or last received event 0- debug_event_channel[5:0] gives the number of the current channel 1- debug_event_channel[5:0] gives the number of the last received event
debug_event_channel[5:0]	Gives the number of any DMA request as soon as it is received or the number of the current channel. The value of debug_event_channel_sel indicates if debug_event_channel displays the current channel or last received event. The signal debug_event_channel_sel must be observed to determine what information is provided on debug_event_chanel at any given time.
debug_pc[13:0]	Program Counter value; it has a meaning when the core is in run mode.
debug_mode	Set when the core is in debug. 0 - 1 Core is in debug
debug_bus_error	Set when an error was received during a load or a store (ld, st, ldf, or stf instruction) and registered in SF or DF flag. 0 No error during last load/store 1 Error during last load/store
debug_bus_device[4:0]	Indicates the device or functional unit that is accessed by the current instruction. The debug_bus_device output is always valid when in sleep mode, debug mode, or executing any instruction that does not access the functional units or the memory mapped devices, "no access" is output. 0 No access 1 MSA 2 MDA 3 MD 4 MS 5 PSA 6 PDA 7 PD 8 PS 9 RESERVED 10 RESERVED 11 RESERVED 12 RESERVED 13 CA 14 CS 15 Reserved 16 Memory (RAM or ROM) 17 Memory mapped register

Table continues on the next page...

Table 46-41. Real-Time Debug Output Pins (continued)

Pin	Description
	18 Peripheral #1 19 Peripheral #2 20 Peripheral #3 21 Peripheral #4 22 Peripheral #5 23 Peripheral #6 24 Peripheral #7 25 Peripheral #8 26 Peripheral #9 27 Peripheral #10 28 Peripheral #11 29 Peripheral #12 30 Peripheral #13 31 Peripheral #14
debug_bus_rwb	Indicates the direction of the access given by debug_bus_device 0 Write access (st or stf) 1 Read access (ld or ldf)
debug_matched_dmbus	Pulse indicating the OnCE event detection unit has detected a match on the data bus during an access to memory (RAM or ROM), a memory mapped register or a peripheral that is hooked to the SDMA. 0 - 1 data bus match detected
debug_rtbuffer_write	Pulse indicating when the real-time buffer is written by the core. 0 - 1 RTB was modified
debug_evt_chn_lines[7:0]	Eight lines that generate short pulses when DMA requests are received or channels are (re)started. Every line is controlled through two parameters defined in registers Cross-Trigger Events Configuration Register 1 (SDMAARM_XTRIG_CONF1) (as described in SDMAARM). The following two parameters are available for every line: <ul style="list-style-type: none"> • CNF-Indicates what is monitored on the line: 0 for a channel start, 1 for a DMA request reception • NUM[5:0]-Gives the number of the DMA request or channel to monitor

The matched_event emulation pin reflects the matching condition status detected by the Event Detection Unit. Because it can be necessary to detect conditions without triggering debug requests, it is possible to disable the generation of debug requests by the Event Detection Unit and still have the matching condition available on the emulation pin. This can be done by clearing the EN flag in the ECTL register.

All real-time debug outputs are disabled by default (for example, they are stuck to 0) to avoid power consumption when they are not used. They are enabled when bit 11 (RTDOBS) of the [Configuration Register \(SDMAARM_CONFIG\)](#) is set. Signals provided to the system JTAG controller for SDMA debug mode status will also be enabled when the *clk_gating_off* input is asserted.

46.5 Instruction Set

46.5.1 Instruction Encoding

This section presents a short summary of the instruction codes. All context switch instructions are listed for information only; they cannot function properly out of the context switch routine.

```

x...x - don't care

rrr - destination/source general register

sss - additional source general register

bbb - general register used as address base register

dddd - address displacement

nnnnn - bit number
uuuuuuuu - function unit command bits

pppppppp - branch displacement (signed)

iiiiiii - 8-bit immediate

jjj - control bit to clear

ff - flag to clear
00000jjj00000000 - done (done,yield,wait)
00000jjj00000001 - notify
00000xxx00000010 - reserved
00000xxx00000011 - reserved
00000xxx00000100 - reserved
0000000000000101 - softBkpt
0000000100000101 - reserved
0000001000000101 - reserved
0000001100000101 - reserved
0000010000000101 - reserved
0000010100000101 - reserved
0000011000000101 - reserved
0000011100000101 - reserved
0000000000000110 - ret
0000000100000110 - reserved
0000001000000110 - reserved
0000001100000110 - reserved
0000010000000110 - reserved
0000010100000110 - reserved
0000011000000110 - reserved

```

Instruction Set

0000011100000110	- reserved
000000ff00000111	- clrf ff
0000010000000111	- reserved
0000010100000111	- reserved
0000011000000111	- reserved
0000011100000111	- illegal
00000rrr00001000	- jmp r
00000rrr00001001	- jsrr
00000rrr00001010	- ldrpc r
00000rrr00001011	- reserved
00000rrr000011xx	- reserved
00000rrr00010000	- revb
00000rrr00010001	- revblo
00000rrr00010010	- rorb
00000rrr00010011	- reserved
00000rrr00010100	- rorl
00000rrr00010101	- lsr1
00000rrr00010110	- asr1
00000rrr00010111	- lsl1
00000rrr001nnnnn	- bclri r,n
00000rrr010nnnnn	- bseti r,n
00000rrr011nnnnn	- btsti r,n
00000xxx10000xxx	- reserved
00000rrr10001sss	- mov
00000rrr10010sss	- xor
00000rrr10011sss	- add
00000rrr10100sss	- sub
00000rrr10101sss	- or
00000rrr10110sss	- andn
00000rrr10111sss	- and
00000rrr11000sss	- tst
00000rrr11001sss	- cmpeq
00000rrr11010sss	- cmplt
00000rrr11011sss	- cmphs
0000011011100000	- reserved
0000011011100001	- reserved
0000011011100010	- cpShReg
0000011011100011	- reserved
0000011011100100	- reserved
0000011011100101	- reserved
0000011011100110	- reserved
0000011011100111	- reserved
00000xxx11101xxx	- reserved
00000xxx11110xxx	- reserved
00000xxx11111xxx	- reserved
00001rrriiiiiiii	- ldi r,i
00010rrriiiiiiii	- xori r,i
00011rrriiiiiiii	- addi r,i
00100rrriiiiiiii	- subi r,i
00101rrriiiiiiii	- ori r,i
00110rrriiiiiiii	- andni r,i
00111rrriiiiiiii	- andi r,i
01000rrriiiiiiii	- tsti r,i
01001rrriiiiiiii	- cmpeqi r,i
01010rrrddddbbb	- ld r,(d,b)
01011rrrddddbbb	- st r,u
01100rrruuuuuuuu	- ldf r,u
01101rrruuuuuuuu	- stf r,u
011100xxxxxxxxxx	- reserved
011101xxxxxxxxxx	- reserved
011110ffnnnnnnnn	- Loop ff flags are reset
01111100pppppppp	- bf pc=pc+signed(pppppppp)+1
01111101pppppppp	- bt pc=pc+signed(pppppppp)+1
01111110pppppppp	- bsf pc=pc+signed(pppppppp)+1
01111111pppppppp	- bdf pc=pc+signed(pppppppp)+1
10aaaaaaaaaaaaaa	- jmp absolute
11aaaaaaaaaaaaaa	- jsr absolute

46.5.2 SDMA Instruction Set

This section describes all the useful instructions from the SDMA set.

Table 46-42. SDMA Instruction List

Instruction	Description	Page
ADD	Addition	ADD (Addition)
ADDI	Add with Immediate Value	ADDI (Add with Immediate Value)
AND	Logical AND	AND (Logical AND)
ANDI	Logical AND with Immediate Value	ANDI (Logical AND with Immediate Value)
ANDN	Logical AND NOT	ANDN (Logical AND NOT)
ANDNI	Logical AND with Negated Immediate Value	ANDNI (Logical AND with Negated Immediate Value)
ASR1	Arithmetic Shift Right by 1 Bit	ASR1 (Arithmetic Shift Right by 1 Bit)
BCLRI	Bit Clear Immediate	BCLRI1 (Bit Clear Immediate)
BDF	Conditional Branch if Destination Fault	BDF (Conditional Branch if Destination Fault)
BF	Conditional Branch if False	Functional Units Programming Model
BSETI	Bit Set Immediate	BSETI (Bit Set Immediate)
BSF	Conditional Branch if Source Fault	BSF (Conditional Branch if Source Fault)
BT	Conditional Branch if True	BT (Conditional Branch if True)
BTSTI	Bit Test immediate	BTSTI (Bit Test immediate)
CLRF	Clear Arm platform flags	CLRF (Clear Arm platform flags)
CMPEQ	Compare for Equal	CMPEQ (Compare for Equal)
CMPEQI	Compare with Immediate for Equal	CMPEQI (Compare with Immediate for Equal)
CMPHS	Compare for Higher or Same	CMPHS (Compare for Higher or Same)
CMPLT	Compare for Less Than	CMPLT (Compare for Less Than)
cpShReg	Update Context of PCU Registers and Flags	cpShReg (Update Context of PCU Registers and Flag)
DONE	DONE, Yield	DONE (DONE, Yield)
ILLEGAL	ILLEGAL Instruction	ILLEGAL (ILLEGAL Instruction)
JMP	Unconditional Jump Immediate	JMP (Unconditional Jump Immediate)
JMPR	Unconditional Jump	JMPR (Unconditional Jump)
JSR	Unconditional Jump to Subroutine Immediate	JSR (Unconditional Jump to Subroutine Immediate)
JSRR	Unconditional Jump to Subroutine	JSRR (Unconditional Jump to Subroutine)
LD	Load Register	LD (Load Register)
LDF	Load Register from Functional Unit	LDF (Load Register from Functional Unit)

Table continues on the next page...

**Table 46-42. SDMA Instruction List
(continued)**

Instruction	Description	Page
LDI	Load Register with Immediate Value	LDI (Load Register with Immediate Value)
LDRPC	Load from RPC to Register	LDRPC (Load from RPC to Register)
LOOP	Hardware Loop	LOOP (Hardware Loop)
LSL1	Logical Shift Left by 1 Bit	LSL1 (Logical Shift Left by 1 Bit)
LSR1	Logical Shift Right by 1 Bit	LSR1 (Logical Shift Right by 1 Bit)
MOV	Logical Move	MOV (Logical Move)
NOTIFY	Notify to Arm platform	NOTIFY (Notify to Arm platform)
OR	Logical OR	OR (Logical OR)
ORI	Logical OR with Immediate Value	ORI (Logical OR with Immediate Value)
RET	Return from Subroutine	RET (Return from Subroutine)
REVB	Reverse Byte Order	REVB (Reverse Byte Order)
REVBLO	Reverse Low Order Bytes	Reverse Low Order Bytes(REVBLO)
ROR1	Rotate Right by 1 Bit	ROR1 (Rotate Right by 1 Bit)
RORB	Rotate Right by 1 Byte	RORB (Rotate Right by 1 Byte)
SOFTBKPT	Software Breakpoint	SOFTBKPT (Software Breakpoint)
ST	Store Register	ST (Store Register)
STF	Store Register in Functional Unit	STF (Store Register in Functional Unit)
SUB	Subtract	SUB (Subtract)
SUBI	Subtract with Immediate	SUBI (Subtract with Immediate)
TST	Test with Zero	TST (Test with Zero)
TSTI	Test Immediate	TSTI (Test Immediate)
XOR	Logical Exclusive OR	XOR (Logical Exclusive OR)
XORI	Exclusive OR with Immediate	XORI (Exclusive OR with Immediate)

46.5.2.1 ADD (Addition)

Operation:

$$\text{GReg}[r] \leftarrow \text{GReg}[s] + \text{GReg}[r]$$

$$T \leftarrow (\text{GReg}[r] == 0)$$

Assembler:

Syntax: `add r,s`

Example: `add 0,3`

ADD GReg[3] and GReg[0] and store the result in GReg[0]

CPU Flags: T

Cycles: 1

Description: Performs the ADDition of the source general register *s* and the destination general register *r*, and stores the result in the destination general register *r*. The T flag is set if the result of the operation is 0. It is cleared if the result is not 0.

Instruction Format:

15	14	13	12	11	10	9	8	7	6	5	4	3	2	1	0
0	0	0	0	0	r	r	r	1	0	0	1	1	s	s	s

Instruction Fields:

rrr / sss - register field:

000 - GReg[0]

001 - GReg[1]

010 - GReg[2]

011 - GReg[3]

100 - GReg[4]

101 - GReg[5]

110 - GReg[6]

111 - GReg[7]

46.5.2.2 ADDI (Add with Immediate Value)

Operation:

$\text{GReg}[r] \leftarrow \text{GReg}[r] + \text{immediate}$

$T \leftarrow (\text{GReg}[r] == 0)$

Assembler:

Syntax: `addi r,immediate`

Example: `add 6,112`

ADD GReg[6] and decimal value 112 and store the result in GReg[6]

CPU Flags: T

Cycles: 1

Instruction Set

Description: Adds a 0-extended immediate value to a general register; stores the result in the general register. The flag T is set when the result of the operation is 0; otherwise, it is cleared. The immediate value is the low-order byte of the instruction and has a maximum value of 255 (0xFF).

Instruction Format

15	14	13	12	11	10	9	8	7	6	5	4	3	2	1	0
0	0	0	1	1	r	r	r	i	i	i	i	i	i	i	i

Instruction Fields:

rrr - register field:

000 - GReg[0]

001 - GReg[1]

010 - GReg[2]

011 - GReg[3]

100 - GReg[4]

101 - GReg[5]

110 - GReg[6]

111 - GReg[7]

iiiiiii - immediate value:

00000000 - 0

00000001 - 1

...

11111110 - 254

11111111 - 255

46.5.2.3 AND (Logical AND)

Operation:

$\text{GReg}[r] \leftarrow \text{GReg}[s] \ \& \ \text{GReg}[r]$

Assembler:

Syntax: `and r,s`

Example: `and 1,2`

AND GReg[1] and GReg[2] and store the result in GReg[1]

CPU Flags: Unaffected

Cycles: 1

Description: Performs the AND of the source general register *s* and the destination general register *r*, and stores the result in the destination general register *r*.

Instruction Format

15	14	13	12	11	10	9	8	7	6	5	4	3	2	1	0
0	0	0	0	0	r	r	r	1	0	1	1	1	s	s	s

Instruction Fields:

rrr / sss - register field:

000 - GReg[0]

001 - GReg[1]

010 - GReg[2]

011 - GReg[3]

100 - GReg[4]

101 - GReg[5]

110 - GReg[6]

111 - GReg[7]

46.5.2.4 ANDI (Logical AND with Immediate Value)

Operation:

$\text{GReg}[r] \leftarrow \text{GReg}[r] \ \& \ \text{immediate}$

Assembler:

Syntax: `andi r,immediate`

Example: `andi 7,45`

AND GReg[7] and decimal value 45 and store the result in GReg[7]

CPU Flags: unaffected

Cycles: 1

Description: Performs an AND between a 0-extended immediate value and a general register; stores the result in the general register. The immediate value is the low-order byte of the instruction and has a maximum value of 255 (0xFF).

Instruction Set

Instruction Format

15	14	13	12	11	10	9	8	7	6	5	4	3	2	1	0
0	0	1	1	1	r	r	r	i	i	i	i	i	i	i	i

Instruction Fields:

rrr - register field:

000 - GReg[0]

001 - GReg[1]

010 - GReg[2]

011 - GReg[3]

100 - GReg[4]

101 - GReg[5]

110 - GReg[6]

111 - GReg[7]

iiiiiii - immediate value:

00000000 - 0

00000001 - 1

...

11111110 - 254

11111111 - 255

46.5.2.5 ANDN (Logical AND NOT)

Operation:

$\text{GReg}[r] \leftarrow \sim\text{GReg}[s] \ \& \ \text{GReg}[r]$

Assembler:

Syntax: `andn r,s`

Example: `andn 3,4`

AND GReg[3] and NOT GReg[4] (bit inverted) and store the result in GReg[3]

CPU Flags: Unaffected

Cycles: 1

Description: Performs the AND of the negation of the source general register *s* and the destination general register *r*, and stores the result in the destination general register *r*.

Instruction Format:

Table 46-43. Instruction Format

15	14	13	12	11	10	9	8	7	6	5	4	3	2	1	0
0	0	0	0	0	r	r	r	1	0	1	1	0	s	s	s

Instruction Fields:

rrr /sss - destination register field:

000 - GReg[0]

001 - GReg[1]

010 - GReg[2]

011 - GReg[3]

100 - GReg[4]

101 - GReg[5]

110 - GReg[6]

111 - GReg[7]

46.5.2.6 ANDNI (Logical AND with Negated Immediate Value)

Operation:

$\text{GReg}[r] \leftarrow \text{GReg}[r] \& \sim\text{immediate}$

Assembler:

Syntax: `andni r,immediate`

Example: `andni 0,2`

AND GReg[0] and decimal value -3 (inverted 32-bit value 2) and store the result in GReg[0]

CPU Flags: unaffected

Cycles: 1

Description: Performs an AND between the negation of a 0-extended 8-bit immediate value and a general register; stores the result in the general register. The immediate value is the low-order byte of the instruction and has a maximum value of 255 (0xFF).

Instruction Set

Instruction Format

15	14	13	12	11	10	9	8	7	6	5	4	3	2	1	0
0	0	1	1	0	r	r	r	i	i	i	i	i	i	i	i

Instruction Fields:

rrr - register field:

000 - GReg[0]

001 - GReg[1]

010 - GReg[2]

011 - GReg[3]

100 - GReg[4]

101 - GReg[5]

110 - GReg[6]

111 - GReg[7]

iiiiiii - immediate value:

00000000 - 0

00000001 - 1

...

11111110 - 254

11111111 - 255

46.5.2.7 ASR1 (Arithmetic Shift Right by 1 Bit)

Operation:

$\text{GReg}[r] : \{b_{31}, b_{30}, \dots, b_1, b_0\} \leftarrow \text{GReg}[r] : \{b_{31}, b_{31}, b_{30}, \dots, b_1\}$

Assembler:

Syntax: `asr1 r`

Example: `asr1 3`

divide by 2 the signed value of GReg[3] and store the result in GReg[3]

CPU Flags: Unaffected

Cycles: 1

Description: Shift the bits of any general register to the right and keep the same sign: The left bit (bit 31) is kept untouched.

Instruction Format:

Table 46-44. Instruction Format

15	14	13	12	11	10	9	8	7	6	5	4	3	2	1	0
0	0	0	0	0	r	r	r	0	0	0	1	0	1	1	0

Instruction Fields:

rrr - register field:

000 - GReg[0]

001 - GReg[1]

010 - GReg[2]

011 - GReg[3]

100 - GReg[4]

101 - GReg[5]

110 - GReg[6]

111 - GReg[7]

46.5.2.8 BCLR11 (Bit Clear Immediate)

Operation:

$$\text{GReg}[r] : \{b_{31}, \dots, b_{(i+1)}, 0, b_{(i-1)}, \dots, b_0\} \leftarrow \text{GReg}[r] : \{b_{31}, \dots, b_{(i+1)}, b_{(i)}, b_{(i-1)}, \dots, b_0\}$$

Assembler:

Syntax: `bclri r,i`

Example: `bclri 1,12`

clear bit 12 in GReg[1]

CPU Flags: Unaffected

Cycles: 1

Description: Clear the bit of register r specified by the 5-bit immediate field

Instruction Format

15	14	13	12	11	10	9	8	7	6	5	4	3	2	1	0
----	----	----	----	----	----	---	---	---	---	---	---	---	---	---	---

Table continues on the next page...

Instruction Set

0	0	0	0	0	r	r	r	0	0	1	i	i	i	i	i
---	---	---	---	---	---	---	---	---	---	---	---	---	---	---	---

rrr - register field:

000 - GReg[0]

001 - GReg[1]

010 - GReg[2]

011 - GReg[3]

100 - GReg[4]

101 - GReg[5]

110 - GReg[6]

111 - GReg[7]

iiii - immediate value:

00000 - 0

00001 - 1

...

11110 - 30

11111 - 31

46.5.2.9 BDF (Conditional Branch if Destination Fault)

Operation:

if (DF == 1) PC ← PC + 1 + displacement else PC ← PC + 1

Assembler:

Syntax: bdf label

Example: bdf LLL

Jump to LLL if DF is set, or go to the next instruction if DF is cleared; the displacement value is calculated by the assembler.

CPU Flags: Unaffected

Cycles: 2 when the branch is done, 1 otherwise

Description: If flag DF is set, jump to the new address that is calculated by adding the sign-extended 8-bit displacement to the next PC address. If flag DF is cleared, no jump is performed: The next instruction is located at the next PC address.

Instruction Format

15	14	13	12	11	10	9	8	7	6	5	4	3	2	1	0
0	1	1	1	1	1	1	1	p	p	p	p	p	p	p	p

Instruction Fields:

pppppppp - signed displacement field:

```

00000000 - 0
00000001 - 1
...
01111110 - 126
01111111 - 127
10000000 - (-128)
10000001 - (-127)
...
11111110 - (-2)
11111111 - (-1)

```

46.5.2.10 BF (Conditional Branch if False)

Operation:

```

if (T == 0)
PC ← PC + 1 + displacement
else
PC ← PC + 1

```

Assembler:

```

Syntax: bf label
Example: bf LLL

```

Jump to LLL if T is cleared, or go to the next instruction if T is set. The displacement value is calculated by the assembler.

CPU Flags: Unaffected

Cycles: 2 when the branch is done, 1 otherwise

Instruction Set

Description: Conditional branch: If flag T is cleared, jump to the new address that is calculated by adding the sign-extended 8-bit displacement to the next PC address. If flag T is set, no jump is performed: The next instruction is located at the next PC address.

Instruction Format

15	14	13	12	11	10	9	8	7	6	5	4	3	2	1	0
0	1	1	1	1	1	0	0	p	p	p	p	p	p	p	p

Instruction Fields:

pppppppp - signed displacement field:

```
00000000 - 0
00000001 - 1
...
01111110 - 126
01111111 - 127
10000000 - (-128)
10000001 - (-127)
...
11111110 - (-2)
11111111 - (-1)
```

46.5.2.11 BSETI (Bit Set Immediate)

Operation:

$$GReg[r] : \{b31, \dots, b(i+1), 1, b(i-1), \dots, b0\} \leftarrow GReg[r] : \{b31, \dots, b(i+1), b(i), b(i-1), \dots, b0\}$$

Assembler:

Syntax: `bseti r,i`

Example: `bseti 6,5`

Set bit 5 in GReg[6]

CPU Flags: Unaffected

Cycles: 1

Description: Sets bit number *i* in the selected General Register.

Instruction Format

15	14	13	12	11	10	9	8	7	6	5	4	3	2	1	0
0	0	0	0	0	r	r	r	0	1	0	i	i	i	i	i

Instruction Fields:**rrr - register field:**

000 - GReg[0]

001 - GReg[1]

010 - GReg[2]

011 - GReg[3]

100 - GReg[4]

101 - GReg[5]

110 - GReg[6]

111 - GReg[7]

iiii - bit number field:

00000 - 0

00001 - 1

...

11110 - 30

11111 - 31

46.5.2.12 BSF (Conditional Branch if Source Fault)**Operation:**

```
if (SF == 1) PC ← PC + 1 + displacement else PC ← PC + 1
```

Assembler:Syntax: `bsf label`Example: `bsf LLL`

Jump to LLL if SF is set, or go to the next instruction if SF is cleared. The displacement value is calculated by the assembler.

CPU Flags: Unaffected

Cycles: 2 when the branch is done, 1 otherwise

Instruction Set

Description: Conditional branch: If flag SF is set, jump to the new address that is calculated by adding the sign-extended 8-bit displacement to the next PC address. If flag SF is cleared, no jump is performed: The next instruction is located at the next PC address.

Instruction Format

15	14	13	12	11	10	9	8	7	6	5	4	3	2	1	0
0	1	1	1	1	1	1	0	p	p	p	p	p	p	p	p

Instruction Fields:

pppppppp - signed displacement field:

```
00000000 - 0
00000001 - 1
...
01111110 - 126
01111111 - 127
10000000 - (-128)
10000001 - (-127)
...
11111110 - (-2)
11111111 - (-1)
```

46.5.2.13 BT (Conditional Branch if True)

Operation

```
if (T == 1)
PC ← PC + 1 + displacement
else
PC ← PC + 1
```

Assembler

```
Syntax: bt label

bt LLL
```

Jump to LLL if T is set, or go to the next instruction if T is cleared. The displacement value is calculated by the assembler.

CPU Flags: Unaffected

Cycles: 2 when the branch is done, 1 otherwise

Description: Conditional branch: If flag T is set, jump to the new address that is calculated by adding the sign-extended 8-bit displacement to the next PC address. If flag T is cleared, no jump is performed: The next instruction is located at the next PC address.

Instruction Format

15	14	13	12	11	10	9	8	7	6	5	4	3	2	1	0
0	1	1	1	1	1	0	1	p	p	p	p	p	p	p	p

pppppppp - signed displacement field:

```

00000000 - 0
00000001 - 1
...
01111110 - 126
01111111 - 127
10000000 - (-128)
10000001 - (-127)
...
11111110 - (-2)
11111111 - (-1)

```

46.5.2.14 BTSTI (Bit Test immediate)

Operation:

$T \leftarrow \text{GReg}[r] : b(i)$

Assembler:

Syntax: `btsti r,i`

Example: `btsti 2,29`

Test bit 29 in GReg[2] and copy its value in flag T

CPU flags: T

Cycles: 1

Description: T is loaded with the value of bit number i from the selected general register.

Instruction Set

Instruction Format:

Table 46-45. Instruction Format

15	14	13	12	11	10	9	8	7	6	5	4	3	2	1	0
0	0	0	0	0	r	r	r	0	1	1	i	i	i	i	i

Instruction Fields:

rrr - register field:

000 - GReg[0]

001 - GReg[1]

010 - GReg[2]

011 - GReg[3]

100 - GReg[4]

101 - GReg[5]

110 - GReg[6]

111 - GReg[7]

iiii - bit number field:

0000 - 0

0001 - 1

...

11110 - 30

11111 - 31

46.5.2.15 CLRF (Clear Arm platform flags)

Operation:

```
if (ff%2 == 0)
```

```
SF ← 0
```

```
if (ff/2 == 0)
```

```
DF ← 0
```

Assembler:

```
Syntax: clrf ff
```

```
Example: clrf 2
```

Clear flag SF and keep flag DF unchanged

CPU Flags: SF, DF

Cycles: 1

Description: Clears a selection of the Arm platform fault flags: SF, DF, both SF and DF or none can be cleared.

Instruction Format

15	14	13	12	11	10	9	8	7	6	5	4	3	2	1	0
0	0	0	0	0	0	f	f	0	0	0	0	0	1	1	1

Instruction Fields:

ff - flags field:

00 - clear SF and clear DF

01 - clear DF

10 - clear

SF 11 - no clear

46.5.2.16 CMPEQ (Compare for Equal)

Operation:

$T \leftarrow (GReg[s] == GReg[r])$

Assembler:

Syntax: `cmpeq r,s`

Example: `cmpeq 7,5`

Compare GReg[7] and GReg[5] and set flag T if they are equal

CPU flags: T

Cycles: 1

Description: Subtracts the destination general register *r* from the source general register *s*, and sets T if the result is 0, clears T if the result is not 0.

Instruction Format

15	14	13	12	11	10	9	8	7	6	5	4	3	2	1	0
0	0	0	0	0	r	r	r	1	1	0	0	1	s	s	s

Instruction Fields:

rrr / sss - register field:

- 000 - GReg[0]
- 001 - GReg[1]
- 010 - GReg[2]
- 011 - GReg[3]
- 100 - GReg[4]
- 101 - GReg[5]
- 110 - GReg[6]
- 111 - GReg[7]

46.5.2.17 CMPEQI (Compare with Immediate for Equal)

Operation:

$T \leftarrow (GReg[r] == \text{immediate})$

Assembler:

Syntax: `cmpeqi r,immediate`

Example: `cmpeqi 2,13`

Compare GReg[2] and decimal value 13 and set flag T if they are equal

CPU Flags: T

Cycles: 1

Description: Subtracts the 0-extended 8-bit immediate value from the general register, and sets T if the result is 0, clears T if the result is not 0. The immediate value is the low-order byte of the instruction.

Instruction Format

15	14	13	12	11	10	9	8	7	6	5	4	3	2	1	0
0	1	0	0	1	r	r	r	i	i	i	i	i	i	i	i

Instruction Fields:

rrr - destination register field:

- 000 - GReg[0]

001 - GReg[1]
 010 - GReg[2]
 011 - GReg[3]
 100 - GReg[4]
 101 - GReg[5]
 110 - GReg[6]
 111 - GReg[7]

iiiiiii - immediate value:

00000000 - 0
 00000001 - 1
 ...
 11111110 - 254
 11111111 - 255

46.5.2.18 CMPHS (Compare for Higher or Same)

Operation:

$T \leftarrow (GReg[r] \geq GReg[s])$

Assembler:

Syntax: `cmphs r,s`

Example: `cmphs 0,1`

Compare GReg[0] and GReg[1] and set flag T if GReg[0] is higher than or equal to GReg[1]

CPU Flags: T

Cycles: 1

Description: Compares the destination general register *r* and the source general register *s*, and sets T if the destination general register *r* is higher than or equal to the source general register *s*, clears T otherwise. The comparison is unsigned.

Instruction Format

15	14	13	12	11	10	9	8	7	6	5	4	3	2	1	0
0	0	0	0	0	r	r	r	1	1	0	1	1	s	s	s

Instruction Set

Instruction Fields:

rrr / sss - register field:

000 - GReg[0]
001 - GReg[1]
010 - GReg[2]
011 - GReg[3]
100 - GReg[4]
101 - GReg[5]
110 - GReg[6]
111 - GReg[7]

46.5.2.19 CMPLT (Compare for Less Than)

Operation:

$T \leftarrow (\text{GReg}[r] < \text{GReg}[s])$

Assembler:

Syntax: `cmplt r,s`

Example: `cmplt 7,4`

Compare GReg[7] and GReg[4] and set flag T if GReg[7] is lower than GReg[4]

CPU Flags: T

Cycles: 1

Description: Compares the destination general register *r* and the source general register *s*, and sets T if the destination general register *r* is lower than the source general register *s*, clears T otherwise. The comparison is signed.

Instruction Format

15	14	13	12	11	10	9	8	7	6	5	4	3	2	1	0
0	0	0	0	0	r	r	r	1	1	0	1	0	s	s	s

rrr / sss - register field:

000 - GReg[0]
001 - GReg[1]
010 - GReg[2]

011 - GReg [3]
 100 - GReg [4]
 101 - GReg [5]
 110 - GReg [6]
 111 - GReg [7]

46.5.2.20 cpShReg (Update Context of PCU Registers and Flag)

Assembler:

Syntax: cpShReg

CPU Flags: none

Cycles: 1

Description: SF, RPC, T, PC,LM, EPC, DF, and SPC registers are updated according to the value of their corresponding bits in the context memory. This instruction must only be used in debug mode via the OnCE. It reverses the done 5 operation.

Instruction Format

15	14	13	12	11	10	9	8	7	6	5	4	3	2	1	0
0	0	0	0	0	1	1	0	1	1	1	0	0	0	1	0

46.5.2.21 DONE (DONE, Yield)

Operation:

```
if (jjj&6 == 2) HE[CCR] ← 0
```

```
if (jjj == 3) HI[CCR] ← 1
```

```
if (jjj == 4) EP[CCR] ← 0
```

```
if ((jjj == 0) && (NCP > CCP)) CCR ← NCR
```

```
else if ((jjj == 1) && (NCP >= CCP))
```

```
CCR ← NCR
```

```
else
```

```
CCR ← NCR
```

(CCR stands for Current Channel Register; NCR stands for Next Channel Register)

Assembler:

Syntax: done jjj

Example: done 3

Clear HE bit for the current channel, send an interrupt to the Arm platform for the current channel and reschedule.

CPU Flags: Unaffected

Cycles: Variable if a context switch is done, 1 otherwise

Description: Clears one of the channel enabling bits (HE or EP for the corresponding channel number) if required. Sends an interrupt to the corresponding Arm platform by setting the appropriate flag, if required (HI for the corresponding channel number). Reschedules according to the mode and the NCP (Next Channel Priority) and CCP (Current Channel Priority) values. According to the scheduling decision, the NCR (Next Channel Register) is copied to the CCR (Current Channel Register) and channel contexts are switched. If several channels with the same highest priority are pending, they are ordered by their number from 31 down to 0. The higher number is selected (for example, channel 26 is selected if channels 3, 12, 14, and 26 with the same highest priority are pending). If no flag is modified, the reschedule can allow the replacement of the current channel by another channel with a priority strictly greater than the current channel priority (yield). Or, it can allow the replacement of the current channel by another channel with a priority greater than or equal to the current channel priority (yieldge). In the latter case, the selected channel will always be the first one with the same priority, starting from channel number 31 down to channel 0 (the current channel does not belong to the set of selectable channels).

Instruction Format

15	14	13	12	11	10	9	8	7	6	5	4	3	2	1	0
0	0	0	0	0	j	j	j	0	0	0	0	0	0	0	0

jjj - Channel Flags field:

000 - No channel flags affected: Reschedule only if the next channel priority is greater than current channel priority (yield)

001 - No channel flags affected: Reschedule only if the next channel priority is greater than or equal to the current channel priority (yieldge)

010 - Clear HE for the current channel and reschedule 011 - Clear HE, set HI for the current channel and reschedule 100 - Clear EP for the current channel and reschedule

101 - Reserved for debug to copy relevant registers into context memory

110 - RESERVED

111 - RESERVED

For the scheduling rules, refer to [Scheduler Functional Description](#). Every possible done instruction is further described as follows:

- done 0/yield is executed by a channel script when it accepts preemption by a higher priority channel;
- done 1/yieldge is executed by a channel script when it accepts preemption by a higher priority channel and it also accepts a roll-up with other channels that have the same priority;
- done 2 is executed by a channel script that was triggered by a Arm platform start via the [Channel Start \(SDMAARM_HSTART\)](#) register, when its task is completed and it requires termination;
- done 3 is executed by a channel script that was triggered by a Arm platform start via the [Channel Start \(SDMAARM_HSTART\)](#) register, when its task is completed, it requires termination and it needs to trigger an interrupt to the Arm platform upon closure;
- done 4 is executed by a channel script that was triggered by a DMA request, when its task is completed and it requires termination;
- done 5 is used in debug mode only; it copies the PCU registers and flags to the context memory of the current channel;

46.5.2.22 ILLEGAL (ILLEGAL Instruction)

Operation:

$PC \leftarrow 0001$

Assembler:

Syntax: `illegal`

CPU Flags: Unaffected

Cycles: 2

Description: Jumps to the Illegal instruction routine located at address 0001. All unauthorized instructions result in an Illegal instruction behavior; however, the ILLEGAL instruction must be used to guarantee software compatibility with future versions of the SDMA.

Instruction Format

Table 46-46. Instruction Format

15	14	13	12	11	10	9	8	7	6	5	4	3	2	1	0
0	0	0	0	0	1	1	1	0	0	0	0	0	1	1	1

46.5.2.23 JMP (Unconditional Jump Immediate)

Operation:

PC ← absolute_address

Assembler:

Syntax: jmp label

Example: jmp LLL

The assembler translates the label to the exact address

CPU Flags: Unaffected

Cycles: 2

Description: Jumps to the absolute address contained the lower 14 bits of the instruction (the PC is a 14-bit register).

Instruction Format

15	14	13	12	11	10	9	8	7	6	5	4	3	2	1	0
1	0	a	a	a	a	a	a	a	a	a	a	a	a	a	a

aaaaaaaaaaaaaaaa - address field:

00000000000000 - 0

000000000000001 - 1

...

111111111111110 - 16382

111111111111111 - 16383

46.5.2.24 JMPR (Unconditional Jump)

Operation:

PC ← GReg[r]

Assembler:

Syntax: `jmp r`

Example: `jmp 0`

Jump to address stored in GReg[0]

CPU Flags: Unaffected

Cycles: 2

Description: Jumps to the absolute address contained in a General Register.

Instruction Format

15	14	13	12	11	10	9	8	7	6	5	4	3	2	1	0
0	0	0	0	0	r	r	r	0	0	0	0	1	0	0	0

Instruction Fields:

rrr - register field:

000 - GReg[0]

001 - GReg[1]

010 - GReg[2]

011 - GReg[3]

100 - GReg[4]

101 - GReg[5]

110 - GReg[6]

111 - GReg[7]

46.5.2.25 JSR (Unconditional Jump to Subroutine Immediate)**Operation:**

$RPC \leftarrow PC + 1$

$PC \leftarrow \text{absolute_address}$

Assembler:

Syntax: `jsr r`

Example: `jsr LLL`

Jumps to subroutine starting at LLL; the assembler translates the label to exact address

Instruction Set

CPU Flags: Unaffected

Cycles: 2

Description: Jumps to the subroutine located at the absolute address contained the lower 14 bits of the instruction (the PC is a 14-bit register).

Instruction Format

15	14	13	12	11	10	9	8	7	6	5	4	3	2	1	0
1	1	a	a	a	a	a	a	a	a	a	a	a	a	a	a

aaaaaaaaaaaaaaaa - address field:

0000000000000000 - 0

0000000000000001 - 1

...

1111111111111110 - 16382

1111111111111111 - 16383

46.5.2.26 JSRR (Unconditional Jump to Subroutine)

Operation:

$RPC \leftarrow PC + 1$

$PC \leftarrow GReg[r]$

Assembler:

Syntax: `jsrr r`

Example: `jsrr 5`

Jumps to subroutine located at address stored in GReg[5]

CPU Flags: Unaffected

Cycles: 2

Description: Jumps to the subroutine at address contained in a General Register

Instruction Format

15	14	13	12	11	10	9	8	7	6	5	4	3	2	1	0
0	0	0	0	0	r	r	r	0	0	0	0	1	0	0	1

Instruction Fields:**rrr - register field:**

000 - GReg[0]
 001 - GReg[1]
 010 - GReg[2]
 011 - GReg[3]
 100 - GReg[4]
 101 - GReg[5]
 110 - GReg[6]
 111 - GReg[7]

46.5.2.27 LD (Load Register)**Operation:**

```
GReg[r] ← [GReg[b] + displacement]
if (transfer_error)
  SF ← 1
else
  SF ← 0
```

Assembler:

```
Syntax: ld r, (b, displacement)
Example: ld 1, (2, 23)
```

Loads data into GReg[1]; the data is located at address obtained by adding decimal value 23 to GReg[2]

CPU Flags: SF

Cycles: 2+n where n is 0 for ROM, RAM or memory mapped registers, and n is the number of wait-states of the peripheral for a peripheral access

Description: Adds a 5-bit 0-extended displacement to a base address in General Register b; the result is the address of the data to fetch on the DM bus. The data received from the bus is stored in the destination General Register r. If an error occurs during the transfer, the flag SF is set, else it is cleared.

Instruction Format

Instruction Set

15	14	13	12	11	10	9	8	7	6	5	4	3	2	1	0
0	1	0	1	0	r	r	r	d	d	d	d	d	b	b	b

rrr / bbb - register field:

000 - GReg[0]

001 - GReg[1]

...

111 - GReg[7]

dddd - displacement value:

00000 - 0

00001 - 1

...

11111 - 31

46.5.2.28 LDF (Load Register from Functional Unit)

Operation:

```
GReg[r] ← [fu_address]
```

```
if (transfer_error)
```

```
SF ← 1
```

```
else
```

```
SF ← 0
```

fu_address is an 8-bit field and depends on addressed functional unit

Assembler:

```
Syntax: ldf r, fu_address
```

```
Example: ldf 0, 13
```

Loads data coming from the Burst DMA register MD into GReg[0]; it is a 32-bit access with no prefetch

CPU Flags: SF

Cycles: 1+n where n is the number of wait-states that may be inserted by the functional unit

Description: Sends an 8-bit address on the Functional Unit Bus (FU bus) and stores the data received from the bus in the destination General Register r. If an error occurs during the transfer, the flag SF is set, else it is cleared.

Instruction Format

15	14	13	12	11	10	9	8	7	6	5	4	3	2	1	0
0	1	1	0	0	r	r	r	f	f	f	f	f	f	f	f

See the following sections for more details of the LDF instruction usage with each functional unit:

- [Burst DMA Read \(ldf\)](#) for Burst DMA
- [Peripheral DMA Read \(ldf\)-Read Mode](#) for Peripheral DMA

Instruction Fields:

rrr - register field:

000 - GReg[0]

001 - GReg[1]

010 - GReg[2]

011 - GReg[3]

100 - GReg[4]

101 - GReg[5]

110 - GReg[6]

111 - GReg[7]

ffffff - functional unit source register and action (unspecified values are reserved):

00000000 - MSA

00000100 - MDA

00001001 - MD byte

00001010 - MD halfword

00001011 - MD word

00001100 - MS

00101001 - MD byte - prefetch

00101010 - MD halfword - prefetch

00101011 - MD word - prefetch

01000000 - DSA

Instruction Set

11000000 - PSA
11001000 - PD
11010000 - PDA
11011000 - PD in copy mode (rrr contents are lost)
11101000 - PD - prefetch next data
11111111 - PS

46.5.2.29 LDI (Load Register with Immediate Value)

Operation:

GReg[r] ← immediate

Assembler:

Syntax: ldi r,immediate

Example: ldi 6,1

loads decimal value 1 into GReg[6]

CPU Flags: Unaffected

Cycles: 1

Description: Stores a 0-extended immediate value in a General Register. The immediate value is the low-order byte of the instruction and has a maximum value of 255 (0xFF).

Instruction Format

15	14	13	12	11	10	9	8	7	6	5	4	3	2	1	0
0	0	0	0	1	r	r	r	i	i	i	i	i	i	i	i

Instruction Fields:

rrr - register field:

000 - GReg[0]
001 - GReg[1]
010 - GReg[2]
011 - GReg[3]
100 - GReg[4]
101 - GReg[5]

110 - GReg[6]

111 - GReg[7]

iiiiiii - immediate value:

00000000 - 0

00000001 - 1

...

11111110 - 254

11111111 - 255

46.5.2.30 LDRPC (Load from RPC to Register)

Operation:

GReg[r] ← RPC

Assembler:

Syntax: ldrpc r

Example: ldrpc 3

copies RPC to GReg[3]

CPU Flags: Unaffected

Cycles: 1

Description: Stores the contents of the RPC in a General Register. That instruction may be used to have more than one level of subroutines.

Instruction Format

15	14	13	12	11	10	9	8	7	6	5	4	3	2	1	0
0	0	0	0	0	r	r	r	0	0	0	0	1	0	1	0

Instruction Fields:

rrr - register field:

000 - GReg[0]

001 - GReg[1]

010 - GReg[2]

011 - GReg[3]

100 - GReg[4]

Instruction Set

101 - GReg[5]

110 - GReg[6]

111 - GReg[7]

46.5.2.31 LOOP (Hardware Loop)

Operation:

```
if (ff%2 == 0)
    SF ← 0
if (ff/2 == 0)
    DF ← 0
if ((GReg[0] == 0) || (SF == 1) || (DF == 1))
    PC ← PC + loop_size + 1
else
    {
        SPC ← PC + 1
        EPC ← PC + loop_size + 1
        LM ← 1
        PC ← PC + 1
    }
```

during every instruction execution in the loop:

```
if ((SF == 1) || (DF == 1))
    {
        LM ← 0
        PC ← EPC
    }
else if ((PC + 1) == EPC)
    {
        GReg[0] ← GReg[0] - 1
        if (GReg[0] == 0)
            {
                LM ← 0
                PC ← EPC
            }
```

```

    }
else
    PC ← SPC
}
else
    PC ← nextPC(instruction)

```

after the execution of the last instruction of the loop body:

```

if (GReg[0] == 0)
    T ← 1
else
    T ← 0

```

Assembler:

Syntax: `loop n{,ff}`

Example: `loop 3,1`

Executes GReg[0] times the instructions comprised between PC+1 and PC+3 (included); ff=1 clears the DF flag before starting the loop. When omitted, the ff field is set to 0 (clearing both SF and DF).

CPU Flags: LM[1:0], T

Cycles: 2 when the loop count (GReg[0]) is 0 or SF or DF is set at loop start, 1+1 when the loop starts but exits abnormally (SF or DF set inside the loop which adds 1 cycle to the offending load or store to jump to EPC), 1 when the loop is executed normally

Description: The loop instruction executes a sequence of instructions several times. The number of times is given by the contents of GReg[0], the loop counter. SDMA will jump to the first instruction after the end of the loop if the value in GReg[0] is 0. Otherwise the SDMA enters loop mode. It sets the most significant bit of the LM flag that will only be reset once the last instruction of the last loop is executed. The instructions in the loop are executed GReg[0] times. The management of fault flags (SF and DF) is as follows. When entering the hardware loop, SF and DF can be cleared according to the ff field of the instruction. After that operation, if any flag is still set the loop will not be executed. The SDMA will jump to the first instruction after the end of the loop without entering loop mode. During the execution of the loop, if any fault flag is set by a LD, LDF, ST, or STF instruction, the SDMA will immediately exit loop mode and jump to the first instruction after the end of the loop. In that case, GReg0 is not decremented for that last piece of the loop body execution (even if the SF or DF flag is set at the last instruction of the loop body). The T flag reflects the state of GReg[0] after the end of the loop, which is an indicator of the complete execution of the loop. If the loop exited because of an error (SF

Instruction Set

or DF set), GReg[0] will not be 0 at the end of the loop, hence T will be cleared. If the loop executes without fault, GReg[0] will be 0 at the end of the loop, hence T will be set. The boundary case when a source or destination fault occurs at the last instruction of the last loop is considered as an anticipated exit of the loop, which causes the T flag to be cleared. If the last instruction executed before leaving the hardware loop also tries to modify the T flag, the flag is updated according to the value of GReg[0], NOT according to the result of the last executed instruction.

Limitations:

1. Jump instructions (JMP, JMPR, JSR, JSRR, BF, BT, BSF, BDF) are not allowed inside the hardware loop.
2. GReg[0] cannot be written to inside the hardware loop (it can be read).
3. The empty loop (0 instruction in the body) is forbidden.
4. If GReg[0] == 0 at the start of the loop, which causes a jump to EPC, the T flag is not updated.

Instruction Format

15	14	13	12	11	10	9	8	7	6	5	4	3	2	1	0
0	1	1	1	1	0	f	f	n	n	n	n	n	n	n	n

Instruction Fields:

ff - flags field:

00 - clear SF and clear DF

01 - clear DF

10 - clear SF

11 - no clear

nnnnnnnn - loop size

00000000 - empty loop: forbidden value

00000001 - 1 instruction in the loop

00000010 - 2 instructions in the loop

...

11111111 - 255 instructions in the loop

46.5.2.32 LSL1 (Logical Shift Left by 1 Bit)

Operation:

$$\text{GReg}[r] : \{b30, \dots, b1, b0, 0\} \leftarrow \text{GReg}[r] : \{b31, b30, \dots, b1, b0\}$$
Assembler:Syntax: `lsl1 r`Example: `lsl1 2`

multiplies by 2 the value in GReg[2]

CPU Flags: Unaffected

Cycles: 1

Description: Shift the bits of any General Register to the left. The right bit (bit 0) is set to 0. No overflow is detected by the hardware.

Instruction Format

15	14	13	12	11	10	9	8	7	6	5	4	3	2	1	0
0	0	0	0	0	r	r	r	0	0	0	1	0	1	1	1

Instruction Fields:**rrr - register field:**

000 - GReg[0]

001 - GReg[1]

010 - GReg[2]

011 - GReg[3]

100 - GReg[4]

101 - GReg[5]

110 - GReg[6]

111 - GReg[7]

46.5.2.33 LSR1 (Logical Shift Right by 1 Bit)**Operation:**

$$\text{GReg}[r] : \{0, b31, b30, \dots, b1\} \leftarrow \text{GReg}[r] : \{b31, b30, \dots, b1, b0\}$$
Assembler:Syntax: `lsr1 r`Example: `lsr1 4`

divides by 2 the unsigned value contained in GReg[4]

Instruction Set

CPU Flags: Unaffected

Cycles: 1

Description: Shift the bits of any General Register to the right. The left bit (bit 31) is set to 0.

Instruction Format

15	14	13	12	11	10	9	8	7	6	5	4	3	2	1	0
0	0	0	0	0	r	r	r	0	0	0	1	0	1	0	1

Instruction Fields:

rrr - destination register field:

000 - GReg[0]

001 - GReg[1]

010 - GReg[2]

011 - GReg[3]

100 - GReg[4]

101 - GReg[5]

110 - GReg[6]

111 - GReg[7]

46.5.2.34 MOV (Logical Move)

Operation:

$\text{GReg}[r] \leftarrow \text{GReg}[s]$

Assembler:

Syntax: `mov r,s`

Example: `mov 4,0`

copies GReg[0] to GReg[4]

CPU Flags: Unaffected

Cycles: 1

Description: Move the contents of the source General Register *s* to the destination General Register *r*.

Instruction Format

15	14	13	12	11	10	9	8	7	6	5	4	3	2	1	0
0	0	0	0	0	r	r	r	1	0	0	0	1	s	s	s

Instruction Fields:

rrr / sss - register field:

000 - GReg[0]

001 - GReg[1]

010 - GReg[2]

011 - GReg[3]

100 - GReg[4]

101 - GReg[5]

110 - GReg[6]

111 - GReg[7]

46.5.2.35 NOTIFY (Notify to Arm platform)

Operation:

```

if (jjj & 4 == 0)
{
    if (jjj&2 == 2)
        HE[CCR] ← 0
    if (jjj&1== 1)
        HI[CCR] ← 1
}
else if (jjj == 4)
    EP[CCR] ← 0
else

```

(CCR stands for Current Channel Register)

Assembler:

Syntax: notify jjj

Example: notify 3

Instruction Set

clears the HE bit for the current channel and sends an interrupt to the Host for the current channel

CPU Flags: Unaffected

Cycles: 1

Description: Clears one of the channel enabling bits (HE or EP for the corresponding channel number) if required, sends an interrupt to the corresponding Arm platform by setting the appropriate flag if required (HI for the corresponding channel number).

Instruction Format

15	14	13	12	11	10	9	8	7	6	5	4	3	2	1	0
0	0	0	0	0	j	j	j	0	0	0	0	0	0	0	1

jjj - Channel Flags field:

000 - unused

001 - set HI for the current channel

010 - clear HE for the current channel

011 - clear HE, set HI for the current channel

100 - clear EP for the current channel

101 - RESERVED

110 - RESERVED

111 - RESERVED

46.5.2.36 OR (Logical OR)

Operation:

$GReg[r] \leftarrow GReg[s] \mid GReg[r]$

Assembler:

Syntax: `or r,s`

Example: `or 3,6`

ORs GReg[3] and GReg[6] and stores the result in GReg[3]

CPU Flags: Unaffected

Cycles: 1

Description: Performs the OR of the source General Register *s* and the destination General Register *r*, and stores the result in the destination General Register *r*.

Instruction Format

15	14	13	12	11	10	9	8	7	6	5	4	3	2	1	0
0	0	0	0	0	r	r	r	1	0	1	0	1	s	s	s

Instruction Fields:

rrr / sss - register field:

000 - GReg[0]

001 - GReg[1]

010 - GReg[2]

011 - GReg[3]

100 - GReg[4]

101 - GReg[5]

110 - GReg[6]

111 - GReg[7]

46.5.2.37 ORI (Logical OR with Immediate Value)

Operation:

$\text{GReg}[r] \leftarrow \text{GReg}[r] \mid \text{immediate}$

Assembler:

Syntax: `ori r,immediate`

Example: `ori 1,56`

ORs GReg[1] and the decimal value 56 and stores the result in GReg[1]

CPU Flags: unaffected

Cycles: 1

Description: Performs an OR between a 0-extended 8-bit immediate value and a General Register; stores the result in the General Register. The immediate value is the low-order byte of the instruction and has a maximum value of 255 (0xFF).

Instruction Format

Instruction Set

15	14	13	12	11	10	9	8	7	6	5	4	3	2	1	0
0	0	1	0	1	r	r	r	i	i	i	i	i	i	i	i

Instruction Fields:

rrr - register field:

000 - GReg[0]

001 - GReg[1]

010 - GReg[2]

011 - GReg[3]

100 - GReg[4]

101 - GReg[5]

110 - GReg[6]

111 - GReg[7]

iiiiiii - immediate value:

00000000 - 0

00000001 - 1

...

11111110 - 254

11111111 - 255

46.5.2.38 RET (Return from Subroutine)

Operation:

PC ← RPC

Assembler:

Syntax: ret

CPU Flags: Unaffected

Cycles: 2

Description: Return from subroutine.

Instruction Format

15	14	13	12	11	10	9	8	7	6	5	4	3	2	1	0
0	0	0	0	0	0	0	0	0	0	0	0	0	1	1	0

46.5.2.39 REVB (Reverse Byte Order)

Operation:

$$GReg[r] : \{B3, B2, B1, B0\} \leftarrow GReg[r] : \{B0, B1, B2, B3\}$$

Assembler:

Syntax: `revb r`

Example: `revb 5`

reverses bytes order in GReg[5]

CPU Flags: Unaffected

Cycles: 1

Description: Reverse the byte order of any General Register.

Instruction Format

15	14	13	12	11	10	9	8	7	6	5	4	3	2	1	0
0	0	0	0	0	r	r	r	0	0	0	1	0	0	0	0

Instruction Fields:

rrr - register field:

000 - GReg[0]

001 - GReg[1]

010 - GReg[2]

011 - GReg[3]

100 - GReg[4]

101 - GReg[5]

110 - GReg[6]

111 - GReg[7]

46.5.2.40 Reverse Low Order Bytes(REVBLO)

Operation:

$$GReg[r] : \{B3, B2, B0, B1\} \leftarrow GReg[r] : \{B3, B2, B1, B0\}$$

Instruction Set

Assembler:

Syntax: revblo r

Example: revblo 0

reverses low order bytes in GReg[0]

CPU Flags: Unaffected

Cycles: 1

Description: Reverse both low order bytes of any General Register.

Instruction Format

15	14	13	12	11	10	9	8	7	6	5	4	3	2	1	0
0	0	0	0	0	r	r	r	0	0	0	1	0	0	0	1

Instruction Fields:

rrr - register field:

000 - GReg[0]

001 - GReg[1]

010 - GReg[2]

011 - GReg[3]

100 - GReg[4]

101 - GReg[5]

110 - GReg[6]

111 - GReg[7]

46.5.2.41 ROR1 (Rotate Right by 1 Bit)

Operation:

$\text{GReg}[r] : \{b_0, b_{31}, b_{30}, \dots, b_1\} \leftarrow \text{GReg}[r] : \{b_{31}, b_{30}, \dots, b_1, b_0\}$

Assembler:

Syntax: ror1 r

Example: ror1 3

rotates bits to the right in GReg[3]

CPU Flags: Unaffected

Cycles: 1

Description: Rotate the bits of any General Register to the right.

Instruction Format

15	14	13	12	11	10	9	8	7	6	5	4	3	2	1	0
0	0	0	0	0	r	r	r	0	0	0	1	0	1	0	0

Instruction Fields:

rrr - register field:

000 - GReg[0]

001 - GReg[1]

010 - GReg[2]

011 - GReg[3]

100 - GReg[4]

101 - GReg[5]

110 - GReg[6]

111 - GReg[7]

46.5.2.42 RORB (Rotate Right by 1 Byte)

Operation:

$\text{GReg}[r] : \{B0, B3, B2, B1\} \leftarrow \text{GReg}[r] : \{B3, B2, B1, B0\}$

Assembler:

Syntax: `rorb r`

Example: `rorb 2`

rotates bytes to the right in GReg[2]

CPU Flags: Unaffected

Cycles: 1

Description: Rotate the bytes of any General Register to the right.

Instruction Format

15	14	13	12	11	10	9	8	7	6	5	4	3	2	1	0
0	0	0	0	0	r	r	r	0	0	0	1	0	0	1	0

Instruction Fields:

rrr - register field:

- 000 - GReg[0]
- 001 - GReg[1]
- 010 - GReg[2]
- 011 - GReg[3]
- 100 - GReg[4]
- 101 - GReg[5]
- 110 - GReg[6]
- 111 - GReg[7]

46.5.2.43 SOFTBKPT (Software Breakpoint)

Operation:

Stops the current script and enters debug mode

Assembler:

softbkpt

CPU Flags: Unaffected

Description: When the core executes this instruction, it has the same effect as receiving a debug request from the OnCE or via the external debug request input: the script execution halts, the PCU enters its debug state and waits for the OnCE commands that are described in [OnCE and Real-Time Debug](#).

Instruction Format

15	14	13	12	11	10	9	8	7	6	5	4	3	2	1	0
0	0	0	0	0	0	0	0	0	0	0	0	0	1	0	1

46.5.2.44 ST (Store Register)

Operation:

[GReg[b] + displacement] ← GReg[r]

if (transfer_error)

```
DF ← 1
```

```
else
```

```
DF ← 0
```

Assembler:

Syntax: `st r, (b, displacement)`

Example: `st 7, (0,9)`

stores the value from GReg[7] into memory at address obtained by adding decimal value 9 to GReg[0]

CPU Flags: DF

Cycles: 2+n where n is 0 for ROM, RAM or memory mapped registers, and n is the number of wait-states of the peripheral for a peripheral access

Description: Adds a 5-bit 0-extended displacement to a base address in General Register b; the result is the address of the data to store on the DM bus. The data sent on the bus comes from the source General Register r. If an error occurs during the transfer, the flag DF is set, else it is cleared.

Instruction Format

15	14	13	12	11	10	9	8	7	6	5	4	3	2	1	0
0	1	0	1	1	r	r	r	d	d	d	d	d	b	b	b

Instruction Fields:

rrr / bbb - register field:

000 - GReg[0]

001 - GReg[1]

010 - GReg[2]

011 - GReg[3]

100 - GReg[4]

101 - GReg[5]

110 - GReg[6]

111 - GReg[7]

dddd - displacement value:

00000 - 0

00001 - 1

...
11111 - 31

46.5.2.45 STF (Store Register in Functional Unit)

Operation:

```
[fu_address] ← GReg[r] 0
if (transfer_error) 0
DF ← 1 0
else 0
DF ← 0
```

fu_address is an 8-bit field

Assembler:

Syntax: stf r, fu_address

Example: stf 3, 0x2B

stores the 32-bit contents of GReg[3] to the Burst DMA register MD; waits until the flush to external memory is completed

CPU Flags: DF

Cycles: 1+n where n is the number of wait-states that may be inserted by the functional unit

Description: Sends an 8-bit address on the Functional Unit Bus (FU bus) and sends the contents of the source General Register r on the bus. If an error occurs during the transfer, the flag DF is set, else it is cleared.

Table 46-47. Instruction Format

15	14	13	12	11	10	9	8	7	6	5	4	3	2	1	0
0	1	1	0	1	r	r	r	f	f	f	f	f	f	f	f

See the following sections for more details of the STF instruction usage with each functional unit:

- [Burst DMA Write \(stf\)](#) for Burst DMA
- [Peripheral DMA Write \(stf\)-Write Mode](#) for Peripheral DMA

Instruction Fields:

rrr - register field:

000 - GReg [0]

001 - GReg [1]

010 - GReg [2]

011 - GReg [3]

100 - GReg [4]

101 - GReg [5]

110 - GReg [6]

111 - GReg [7]

ffffff - functional unit destination register and action (unspecified values are reserved):

00000000 - MSA in incremented mode

00000100 - MDA in incremented mode

00001001 - MD byte

00001010 - MD halfword

00001011 - MD word

00001100 - clear MS error flag

00001111 - MS

00010000 - MSA in frozen mode

00010100 - MDA in frozen mode

00011000 - MD in copy mode - number of words in rrr

00100000 - MSA in incremented mode - start prefetch

00101000 - MD no data - flush

00101001 - MD byte - flush

00101010 - MD halfword - flush

00101011 - MD word - flush

00110000 - MSA in frozen mode - start prefetch

Instruction Set

11000001 - PSA in frozen mode - 8-bit data width
11000010 - PSA in frozen mode - 16-bit data width
11000011 - PSA in frozen mode - 32-bit data width
11000101 - PSA in incremented mode - 8-bit data width
11000110 - PSA in incremented mode - 16-bit data width
11000111 - PSA in incremented mode - 32-bit data width
11001000 - PD
11001001 - PSA in decremented mode - 8-bit data width
11001010 - PSA in decremented mode - 16-bit data width
11001011 - PSA in decremented mode - 32-bit data width
11001100 - clear PS error flag
11001101 - PSA data width becomes 8-bit
11001110 - PSA data width becomes 16-bit
11001111 - PSA data width becomes 32-bit
11010001 - PDA in frozen mode - 8-bit data width
11010010 - PDA in frozen mode - 16-bit data width
11010011 - PDA in frozen mode - 32-bit data width
11010101 - PDA in incremented mode - 8-bit data width
11010110 - PDA in incremented mode - 16-bit data width
11010111 - PDA in incremented mode - 32-bit data width
11011001 - PDA in decremented mode - 8-bit data width
11011010 - PDA in decremented mode - 16-bit data width
11011011 - PDA in decremented mode - 32-bit data width
11011101 - PDA data width becomes 8-bit
11011110 - PDA data width becomes 16-bit
11011111 - PDA data width becomes 32-bit
11100001 - PSA in frozen mode - 8-bit data width - prefetch data

11100010 - PSA in frozen mode - 16-bit data width - prefetch data
 11100011 - PSA in frozen mode - 32-bit data width - prefetch data
 11100101 - PSA in incremented mode - 8-bit data width - prefetch data
 11100110 - PSA in incremented mode - 16-bit data width - prefetch data
 11100111 - PSA in incremented mode - 32-bit data width - prefetch data
 11101001 - PSA in decremented mode - 8-bit data width - prefetch data
 11101010 - PSA in decremented mode - 16-bit data width - prefetch data
 11101011 - PSA in decremented mode - 32-bit data width - prefetch data
 11101101 - PSA data width becomes 8-bit - prefetch data
 11101110 - PSA data width becomes 16-bit - prefetch data
 11101111 - PSA data width becomes 32-bit - prefetch data
 11111111- PS

46.5.2.46 SUB (Subtract)

Operation:

$$\text{GReg}[r] \leftarrow \text{GReg}[r] - \text{GReg}[s]$$

$$T \leftarrow (\text{GReg}[r] == 0)$$

Assembler:

Syntax: `sub r,s`

Example: `sub 4,7`

SUBtracts GReg[7] from GReg[4] and stores the result in GReg[4]

CPU Flags: T

Cycles: 1

Description: Subtracts the source General Register *s* from the destination General Register *r*, and stores the result in the destination General Register *r*. The T flag is set if the result of the operation is 0; it is cleared if the result is not 0.

Instruction Format

15	14	13	12	11	10	9	8	7	6	5	4	3	2	1	0
0	0	0	0	0	r	r	r	1	0	1	0	0	s	s	s

Instruction Fields:

rrr / sss - register fields:

- 000 - GReg[0]
- 001 - GReg[1]
- 010 - GReg[2]
- 011 - GReg[3]
- 100 - GReg[4]
- 101 - GReg[5]
- 110 - GReg[6]
- 111 - GReg[7]

46.5.2.47 SUBI (Subtract with Immediate)

Operation:

GReg[r] ← GReg[r] - immediate
 T ← (GReg[r] == 0)

Assembler:

Syntax: sub r,immediate

Example: sub 1,255

SUBtracts decimal value 255 from GReg[1] and stores the result in GReg[1]

CPU Flags: T

Cycles: 1

Description: Subtracts a 0-extended 8-bit immediate value from a General Register; stores the result in the General Register. The flag T is set when the result of the operation is 0; otherwise, it is cleared. The immediate value is the low-order byte of the instruction and has a maximum value of 255 (0xFF).

Instruction Format

15	14	13	12	11	10	9	8	7	6	5	4	3	2	1	0
0	0	1	0	0	r	r	r	i	i	i	i	i	i	i	i

Instruction Fields:

rrr - register field:

000 - GReg[0]
 001 - GReg[1]
 010 - GReg[2]
 011 - GReg[3]
 100 - GReg[4]
 101 - GReg[5]
 110 - GReg[6]
 111 - GReg[7]

iiiiiii - immediate value:

00000000 - 0
 00000001 - 1
 ...
 11111110 - 254
 11111111 - 255

46.5.2.48 TST (Test with Zero)

Operation:

$$T \leftarrow ((\text{GReg}[s] \ \& \ \text{GReg}[r]) \neq 0)$$

Assembler:

Syntax: `tst r,s`

Example: `tst 2,3`

ANDs GReg[2] and GReg[3] and sets T if the result is non-null

CPU Flags: T

Cycles: 1

Description: Performs the AND of the source General Register *s* and the destination General Register *r*, and sets T if the result is not 0, clears T if the result is 0.

Instruction Format

15	14	13	12	11	10	9	8	7	6	5	4	3	2	1	0
0	0	0	0	0	r	r	r	1	1	0	0	0	s	s	s

Instruction Set

Instruction Fields:

rrr / sss - register field:

000 - GReg[0]

001 - GReg[1]

010 - GReg[2]

011 - GReg[3]

100 - GReg[4]

101 - GReg[5]

110 - GReg[6]

111 - GReg[7]

46.5.2.49 TSTI (Test Immediate)

Operation:

$T \leftarrow ((\text{GReg}[r] \ \& \ \text{immediate}) \neq 0)$

Assembler:

Syntax: `tsti r,immediate`

Example: `tsti 5,13`

ANDs GReg[5] and decimal value 13 and sets T if the result is non-null

CPU Flags: T

Cycles: 1

Description: Performs the AND of a 0-extended 8-bit immediate value and the destination General Register r, and sets T if the result is not 0, clears T if the result is 0. The immediate value is the low-order byte of the instruction and has a maximum value of 255 (0xFF).

Instruction Format

15	14	13	12	11	10	9	8	7	6	5	4	3	2	1	0
0	1	0	0	0	r	r	r	i	i	i	i	i	i	i	i

Instruction Fields:

rrr - destination register field:

000 - GReg[0]

001 - GReg[1]
 010 - GReg[2]
 011 - GReg[3]
 100 - GReg[4]
 101 - GReg[5]
 110 - GReg[6]
 111 - GReg[7]

iiiiiii - immediate value:

00000000 - 0
 00000001 - 1
 ...
 11111110 - 254
 11111111 - 255

46.5.2.50 XOR (Logical Exclusive OR)

Operation:

$\text{GReg}[r] \leftarrow \text{GReg}[s] \wedge \text{GReg}[r]$

Assembler:

Syntax: `xor r,s`

Example: `xor 0,3`

XORs GReg[0] and GReg[3] and stores the result in GReg[0]

CPU Flags: Unaffected

Cycles: 1

Description: Performs the eXclusive OR of the source General Register *s* and the destination General Register *r*, and stores the result in the destination General Register *r*.

Instruction Format

15	14	13	12	11	10	9	8	7	6	5	4	3	2	1	0
0	0	0	0	0	r	r	r	1	0	0	1	0	s	s	s

Instruction Fields:

rrr / sss - register field:

Instruction Set

000 - GReg [0]
001 - GReg [1]
010 - GReg [2]
011 - GReg [3]
100 - GReg [4]
101 - GReg [5]
110 - GReg [6]
111 - GReg [7]

46.5.2.51 XORI (Exclusive OR with Immediate)

Operation:

$\text{GReg}[r] \leftarrow \text{GReg}[r] \wedge \text{immediate}$

Assembler:

Syntax: `xori r,immediate`

Example: `xor 7,5`

XORs GReg[5] and decimal value 5 and stores the result in GReg[7]

CPU Flags: Unaffected

Cycles: 1

Description: Performs an eXclusive OR between a 0-extended 8-bit immediate value and a General Register; stores the result in the General Register. The immediate value is the low-order byte of the instruction and has a maximum value of 255 (0xFF).

Instruction Format

15	14	13	12	11	10	9	8	7	6	5	4	3	2	1	0
0	0	0	1	0	r	r	r	i	i	i	i	i	i	i	i

Instruction Fields:

rrr - register field:

000 - GReg [0]
001 - GReg [1]
010 - GReg [2]
011 - GReg [3]

100 - GReg [4]

101 - GReg [5]

110 - GReg [6]

111 - GReg [7]

iiiiiii - immediate value:

00000000 - 0

00000001 - 1

...

11111110 - 254

11111111 - 255

46.5.2.52 YIELD, YIELDGE (DONE, Yield)

By default, unsupported assembler syntax. Can be aliased to the corresponding done instructions (yield = done 0; yieldge = done 1). Refer to the done instruction description [DONE \(DONE, Yield\)](#).

46.6 Software Restrictions

46.6.1 Unsupported Burst DMA Access Sequence

The SDMA does not support triggering a pre-fetch followed by a flush of the Burst DMA without reading or writing any data. If the flush occurs while the background pre-fetch DMA operation is still in progress, it could result in un-defined behavior.

An example of the sequence which could result in undefined results is shown in the following example:

Instruction sequence not supported

```

stf r1, MSA|PF          ; Update source address, triggers data pre-fetch in the
                          ; background
mov R0,R0               ; Execute multiple assembly instructions, none of which
                          ; read
mov R0,R0               ; or write data to/from MD
stf MD|SZ0|FL          ; Flush FIFO without writing data. If the pre-fetch is still
                          ; in progress when this instruction is executed, there
                          ; could be undefined operation

```

A work-around to avoid any undesirable results is to first read MD to ensure the pre-fetch is complete before the flush is attempted.

Work-Around to previous example

```
stf r1, MSA|PF      ; Update source address, triggers data pre-fetch.
mov R0,R0           ; Execute multiple assembly instructions, none of which
                   ; read
mov R0,R0           ; or write data to/from MD
ldf r2, MD          ; dummy read of MD to ensure pre-fetch is complete
                   ; before the next instruction
stf MD|SZ0|FL      ; Flush FIFO without writing data
```

46.7 Application Notes

46.7.1 Data Structures for Boot Code and Channel Scripts

SDMA boot code downloads the different channel contexts and the scripts that will be executed on SDMA channels during the application.

The boot code is run after reset when channel 0 is started by the Arm platform. The boot code is also known as channel 0 script.

The boot code is based on the Channel Control Block (CCB) and Buffer Descriptor (BD) mechanisms that are data structures located into the Arm platform memory space. With these data structures, it is possible to instruct SDMA to download scripts and contexts but also to dump a context or a script to a destination data buffer. Channel scripts also use the CCB and BD data structures to pass instructions and/or pointers to data to be copied.

The format, processing, and field definition of the CCB and BD are defined and performed entirely by the software script rather than the SDMA hardware. An overview of the format and structure is provided here, but for complete details refer to the SDMA software documentation (see [SDMA Scripts](#)).

The CCB and BD data structures are accessed by SDMA using DMA and processed by the SDMA scripts. The ROM contains common sub-routines for processing these data structures which may be called by the bootload and channel scripts.

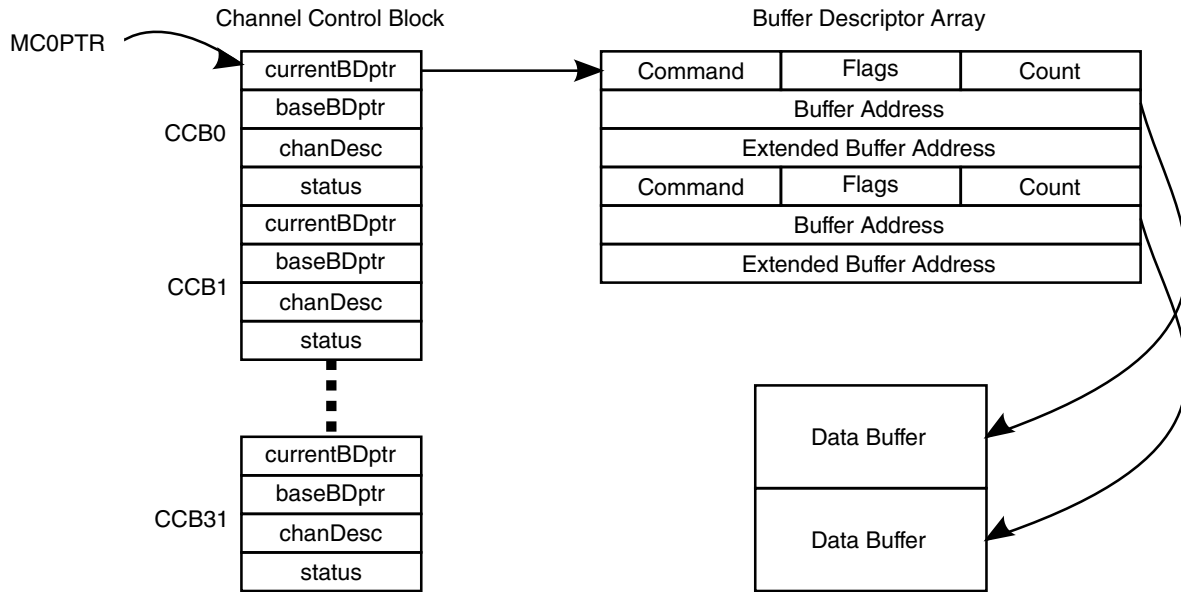

Figure 46-16. Data Structures Layout

The previous figure shows an example how these data structures are linked to pass command and pointers to data buffers. The SDMA's MC0PTR register holds the base address of the Channel 0 Control Block (CCB0). The Channel 0 control block holds a pointer to the array of buffer descriptors. The buffer descriptors are used to tell the channel 0 (boot channel) what to do as described [Buffer Descriptor Format](#).

46.7.1.1 Buffer Descriptor Format

Buffer descriptors are three longs (32-bit words) in size as, shown in the figure found here.

A buffer descriptor describes the properties of the data buffer it points to. The buffer descriptors can be used for linear or circular data buffers in the Arm platform processor memory. The CCB contains a pointer to the base BD as well as the current BD.

Table 46-48. Buffer Descriptor

31	30	29	28	27	26	25	24	23	22	21	20	19	18	17	16	15	14	13	12	11	10	9	8	7	6	5	4	3	2	1	0
Command								-	-	L	R	I	C	W	D	Count															
Buffer Address																															
Extended Buffer Address																															

Table 46-49. Buffer Descriptor Field Descriptions

Field	Description
31-24 Command	Command. The command field is used to differentiate operations performed within a script when the script accesses this particular buffer descriptor. The use of this field can be defined by the script. The command values defined for the bootload script are defined in Buffer Descriptor Commands for Bootload scripts . Refer to the individual script definition in script library documents in SDMA Scripts for command field definitions for other scripts.
23	Reserved
22	Reserved
21 L	Last Buffer Descriptor: This bit is set in SDMA IPC scripts to indicate to the receiving Core that the transfer has ended. Whenever the source finishes transferring the count it wanted to transfer, it sets LAST_BIT in the destination BD, to let the destination know that transfer is over. This bit also tells the destination software that when it processes the destination BDs, they need not process any BD after the BD with the LAST_BIT set. For example, when the DSP prepares a single buffer descriptor with count equals to 25 and Arm platform prepares a single buffer descriptor with count equals 100. When 25 bytes have been transferred from DSP to Arm platform, the DSP buffer descriptor is normally closed while the Arm platform buffer descriptor will have the L bit set and the byte count updated to 25.
20 R	erroR. Indicates an error occurred on the channel's buffer descriptor requested command. Some scripts may overwrite the command field with an error code indicating the source of the error. 0 No Error 1 Error
19 I	Interrupt. When SDMA has finished to process data transfer attached to this buffer descriptor, send an interrupt to the Arm platform. 0 No Interrupt 1 Interrupt the processor when BD is complete
18 C	Continuous. This buffer is allowed to receive multiple transmit buffers or is allowed to transmit to multiple receive buffers. The Continuous bit is decoded at the end of the processing of a BD to determine if the SDMA script must open a new BD to potentially continue the data transfer. 0 No further buffer descriptors 1 SDMA should move to the next Buffer descriptor after this one
17 W	Wrap. Indicates if this buffer descriptor is the last one for the channel control block. When encountering this bit set, the SDMA scripts updates the CurrentBD pointer to point to the first Buffer Descriptor of the array. This bit is set if the Arm platform wants to organize the array of BD in a circular way (like a ring). When all BD have been processed and if Wrap bit and CONTinuous bit are set in the last BD, the SDMA script will wrap around and it will try to re-open the first BD. 0 No Error 1 Wrap to first buffer descriptor after this one is processed.
16 D	D - "Done": bit 16: indicates the "ownership" of the buffer descriptor. When D=0 the host owns the buffer descriptor; when D=1 SDMA owns the buffer descriptor. In the case of the channel 0, D=1 indicates the SDMA has not yet processed this buffer, D=0 indicates the SDMA has processed this buffer. 0 Arm platform owns the buffer. 1 SDMA owns the buffer
15-0 Count	Count. the count field (bit 15-0) indicates the size of the data to be transmitted, the size of the data buffer pointed to by the buffer descriptor. The SDMA memory structure is different for program memory (16-bits shorts/half-words) and data memory (32-bits long). For channel 0 buffer descriptors, Count is expressed in 16-bit half-words when PM is addressed and in 32-bit words when DM is addressed. Count is typically expressed in bytes for other channel scripts, but the unit is dependant on the script.
31-0	Buffer address. Address pointer to the data buffer.
31-0	Extended buffer address. Additional pointer or other information required by some scripts.

The buffer descriptors form an array of programmable size. If the last buffer descriptor is marked by the Wrap flag-bit $W=1$, the array of buffer descriptor is treated as a ring with some logically continuous portion owned by the Arm platform with $D=0$, and the remainder owned by the SDMA with $D=1$. The count field of the buffer descriptor indicates how much data has been transmitted.

If Arm platform has prepared 3 buffers to be filled by the SDMA script, it has also prepared 3 BD, one for each buffer. The *Cont* and *Wrap* bits are used to organize the buffers in a circular way. For example, *CONTInous* bit is set to 1 in the 2 first BDs and *Wrap* is set in the 3rd BD. The SDMA script opens and processes BD#1. Since *CONTInous* bit is set for this BD, the SDMA will open the second BD and it will process it. Each time a BD is processed, its *Done* bit is reset by the SDMA. After the 3rd BD, if *CONTInous* is not set but if *Wrap* is set, the SDMA script stops here and the next time the channel will be triggered, the script will open the BD pointed by the currentBDptr pointer of the CCB and it will correspond to the first buffer descriptor.

If the *CONTInous* bit and *Wrap* bits are both set in the 3rd BD, the script will close it and it will try to open the first BD. An error may occur at this point if the BD#1 has already been processed and its *Done* bit is 0. The SDMA script cannot process a BD with a *Done* bit to 0. It means the BD is not ready to be processed. To avoid this situation, the *CONTInous* bit should not be set for the last BD if *Wrap* is set, and the Interrupt flag must set for the last BD. It will warn the owner of the BD that all the BDs have been processed and it has to re-set to 1 the *Done* bit of all the BD's if it desires the SDMA to fill them again. Basically, if the Arm platform expects the SDMA to fill up the buffers in a circular fashion, then it's the responsibility of the Arm platform to set the *Done* bit of a buffer descriptor at an appropriate time.

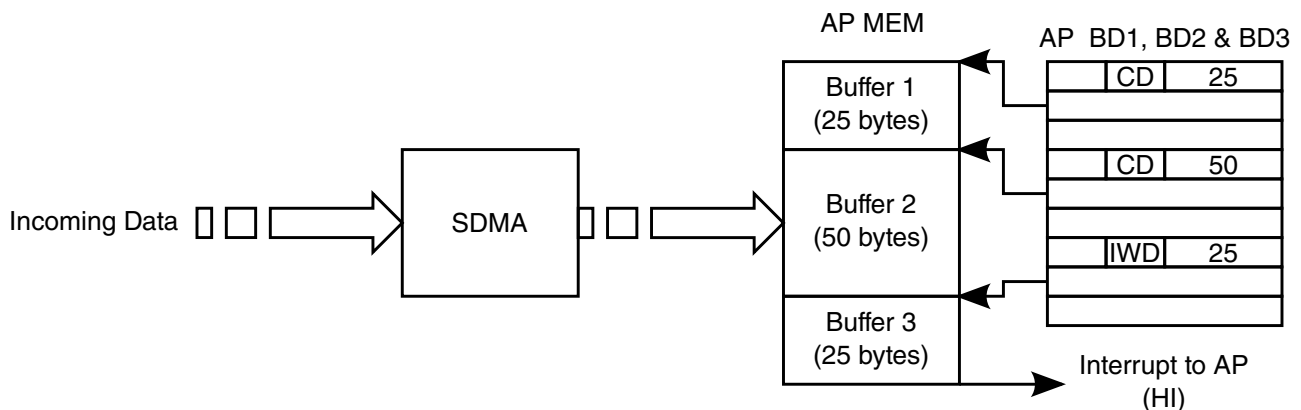

Figure 46-17. Buffer Descriptor Flow

The previous figure shows an example buffer descriptor flow. When the incoming data is stored and fills the first buffer of 25 bytes, the SDMA script opens the second BD because the CONTinuous bit was set. Then next incoming data is put in the second buffer. After receiving 50 bytes, the second buffer descriptor is also closed. The Done bit is reset and the third BD is opened. After receiving another 25 bytes, the third buffer is full and an interrupt is sent to the Arm platform because the Interrupt flag is set in the 3rd BD. The CONTinuous flag is not present the transfer is over. The next time the script will be triggered, the BD to be opened will be the first buffer descriptor since the Wrap flag was set in the 3rd BD. It is the Arm platform responsibility to set the Done bit of all the BD if it wants to use the same buffers.

46.7.1.2 Buffer Descriptor Commands for Bootload scripts

The command field of the buffer descriptor is defined separately for each script.

The following table lists the buffer descriptor commands defined for the channel 0 bootload script.

Table 46-50. Channel Zero Buffer Descriptor Commands

Command Field (binary)	Command	Description	Buffer Address	Extended Buffer Address
0000_0001 (0x01)	C0_SET_DM	Load SDMA data memory (RAM) from Arm platform memory buffer	Arm platform memory source address	SDMA memory destination address
0000_0010 (0x02)	C0_GET_DM	Copy SDMA data memory (RAM) to Arm platform memory buffer	Arm platform memory destination address	SDMA memory source address
0000_0100 (0x04)	C0_SET_PM	Load SDMA program memory (RAM) from Arm platform memory buffer	Arm platform memory source address	SDMA memory destination address
0000_0110 (0x06)	C0_GET_PM	Copy SDMA program memory (RAM) to Arm platform memory buffer	Arm platform memory destination address	SDMA memory source address
cccc_c111 (0x07 CHN)	C0_SETCTX	Load Context for channel cccc into SDMA RAM from Arm platform memory buffer	Arm Platform memory source address	-
cccc_c011 (0x03 CHN)	C0_GETCTXT	Copy Context for channel ccccc from SDMA RAM to Arm platform memory buffer	Arm platform memory destination address	-

The Channel 0 bootload commands are summarized as follows:

- **C0_SET_[PM-DM]**: load the buffer descriptor data in the SDMA local memory at the address pointed to by the "extended buffer address" field. The SDMA RAM can be seen as a Program Memory (PM, 16-bit address) or Data Memory (DM 32-bit address). When C0_SET_PM is used, the count field is expressed in "shorts" (16-bit

half words), this command can be used to download scripts. When C0_SET_DM is used, the count field is expressed in "long" (32-bit words), this command can be used to download channel contexts to the context channel area in RAM.

- C0_GET_[PM-DM]: write to the buffer descriptor's data buffer the content of the SDMA local memory from the address pointed to by the "extended buffer address" field for the length defined by the count in the buffer descriptor. C0_GET_PM is used to dump some part of the Program Memory (may be used to dump context of a channel), therefore count is expressed in "shorts"; while C0_GET_DM is used to dump to the buffer descriptor's data buffer, so the count field is in "longs."
- C0_SETCTX: load a context into the SDMA context page area. The handling script decodes the channel number from the 5 MSB of the command field of the buffer descriptor. Using the channel number the script computes the offset of the context data pointer for the channel relative to the context page base to use as the destination address in SDMA memory. Then the C0_SET_DM command explained above is invoked to load SDMA RAM from memory. The counter indicates the size in words of the context structure.
- Command value: (in binary) cccc c111, where cccc is the channel number (5 bits). For instance, 0x0F means set context for channel 1, 0xFF means set context for channel 31.
- C0_GETCTX: write to the buffer descriptor's data buffer the content of the SDMA context page area. The handling script decodes the channel number from the 5 MSB of the command field of the buffer descriptor. Using this channel number, the script computes the offset of the context data pointer for the channel relative to the context page base to use as the source address for the copy. Then the C0_GET_DM command explained above is invoked to copy the context to memory. The counter indicates the size in words of the context structure.
- Command value: (in binary): cccc c011, where cccc is the channel number (5 bits). For instance, 0x03 means get context of channel 1, 0xFB means get context of channel 31.

NOTE

To download channel context, C0_SETDM and C0_SETCTXT command can be used but the second one is easier because the channel number is embedded into the command field, whereas with the C0_SETDM, the pointer to the channel context area must be written into the extended buffer address field of the buffer descriptor.

46.7.1.3 Example of Buffer Descriptors for Channel 0.

Figure 46-19 illustrates the buffer descriptors that must be set in Arm platform memory space, before execution of boot code, to download contexts and scripts of channels 1, 4, and 10. After boot code execution, SDMA memory will be populated with the different contexts and scripts as presented in the following figure.

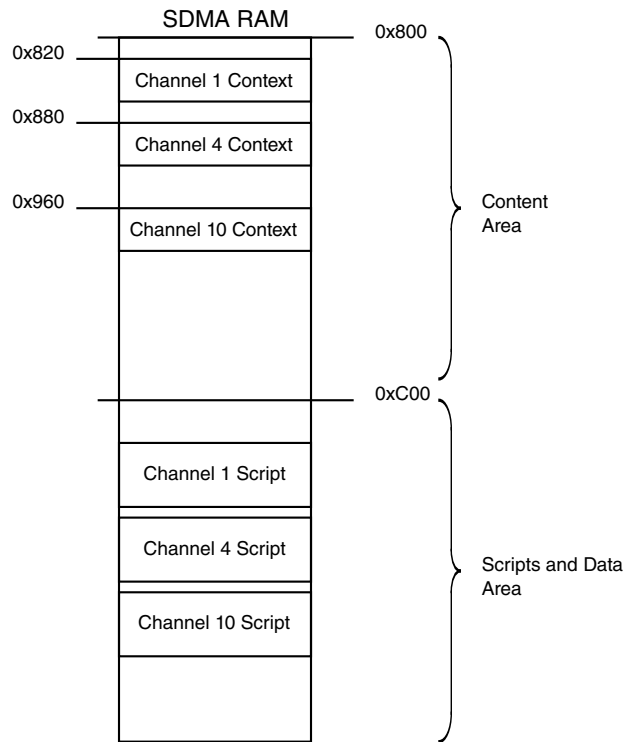
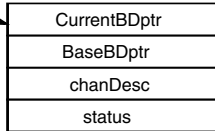

Figure 46-18. Example of SDMA RAM After Boot Session

SDMA Register



Channel Control Block



Channel 0 Buffer Descriptor Array

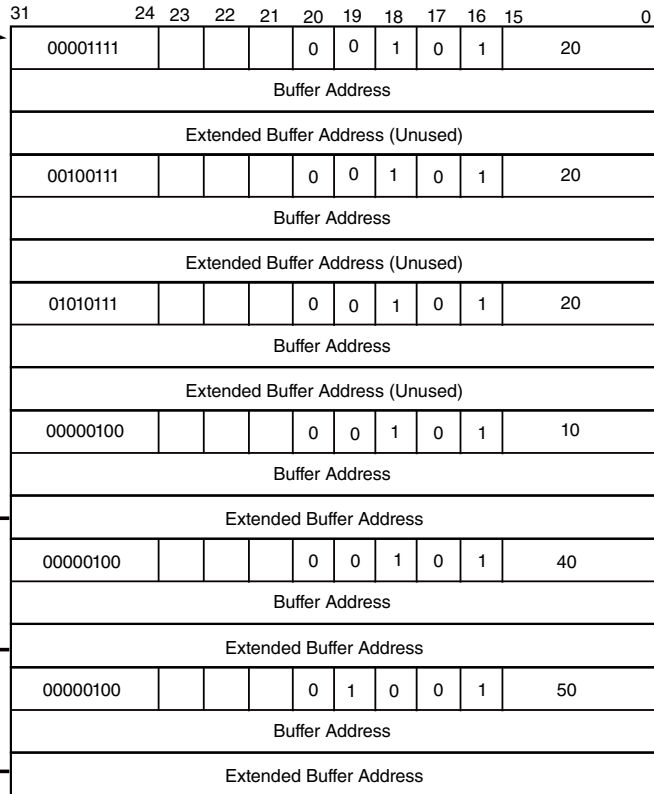

-
- BD1 - SET CONTEXT CH#1
Interrupt = 0,
Cont=1, Done = 1
-
- BD2 - SET CONTEXT CH#4
Interrupt = 0,
Cont=1, Done = 1
-
- BD3 - SET CONTEXT CH#10
Interrupt = 0,
Cont=1, Done = 1
-
- BD4 - SET_PM
Interrupt = 0,
Cont=1, Done = 1
-
- BD5 - SET_PM
Interrupt = 0,
Cont=1, Done = 1
-
- BD6 - SET_PM
Interrupt = 1,
Cont=0, Done = 1

SDMA RAM

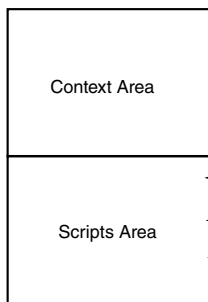

AP Memory Space

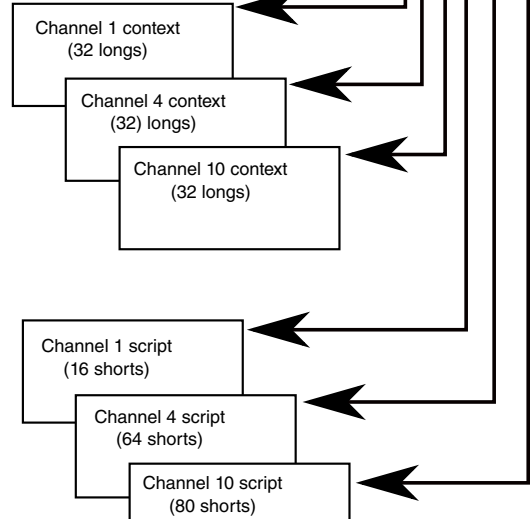

46.7.1.4 Channel Context

There are 32 channel context memory structures pointed to by the local save area pointer. These channel context memory structures are fixed.

The script in the SDMA computes the memory offset for a given channel based on the structure length and channel number. Figure below shows the structure of the channel context as it is saved in the SDMA local memory (RAM).

A channel context consists in 24 words, one per register. A total of 32 words are reserved for every channel. The additional 8 words are called scratch ram and they are dedicated to each channel. This memory area is commonly used for stack management.

The structure is divided in 4 areas:

- Channel status registers
- General purpose registers
- Functional units state registers reflecting the state of the Arm platform DMAs (Burst and Peripheral DMA).
- Scratch RAM

The details of the channel context status registers are described in the following figure.

The PC field of the first long register must point to the SDMA RAM address where the script that will be executed on the channel is located and this value equals the one stored in the extended buffer address of the buffer descriptor with C0_SETPM command.

	31	30	29		16	15	14	13		0
SF	-	RPC			T	-	PC			
LM		EPC			DF	-	SPC			

- SF: Source fault while loading data
- RPC: Return program counter
- T: Test bit: status of arithmetic and test instructions
- PC: Program counter
- LM: Loop mode
- EPC: Loop end program counter
- DF: Destination fault while storing data
- SPC: Loop Start program counter

Figure 46-20. SDMA State Registers (ShPC, ShLoop)

46.7.2 Typical Data Transfer Supported by SDMA DMA Units

This section presents a library of SDMA scripts that perform data transfers through the peripheral DMA and the burst DMA units.

The Arm platform memory and peripherals are devices that either the peripheral DMA or the burst DMA can access. The scripts are given for a peripheral DMA whose address registers are programmed in incremented mode when internal memory is involved. See the following table for the summary.

Table 46-51. Typical Data Transfers Summary

Data Transfer	Peripheral DMA	Burst DMA	Comments
Arm platform External Memory ↔ Arm platform External Memory		3	Copy mode Script example, see Burst DMA Unit Copy Mode and External Memory to External Memory .
Arm platform Peripheral ↔ Arm platform Peripheral	3		Copy mode if same data path width Script example, see Peripheral to Peripheral Transfer .
Arm platform External Memory ↔ Arm platform Peripheral	3	3	Data transit through SDMA Script example, see Transfer Between Peripheral and External Memory .
Arm platform External Memory ↔ Arm platform Internal Memory		3	Copy mode Script example, see Transfer Between External Memory and Internal Memory .
Arm platform Internal Memory ↔ Arm platform Internal Memory		3	Copy mode Script example, see Internal Memory to Internal Memory .
Arm platform Internal memory ↔ Arm platform Peripheral	3		Data transit through SDMA Script example, see Transfer Between Peripheral and Internal Memory .

NOTE

These scripts are provided as examples of how to use DMA blocks to perform required data transfers: They are not "official" programs.

46.7.2.1 External Memory to External Memory

This section describes the SDMA script that performs data moves in external memory.

For this particular data transfer, only the burst DMA is used. It is programmed in copy mode, so no data transmits through an SDMA general register.

Application Notes

The SDMA core only monitors data transfer status. It is assumed source and destination address values are already present in two SDMA general registers (r1 and r2). For this example, it is also assumed that a 32-bit word-to-move for source-to-destination address is present in r0 and equals 64.

Data Moves in External Memory

```
1      stf r1,MSA                // Source address setup
2      stf r2,MDA                // Destination address setup
3      ldi r0,0x64                // 64 words must be transferred from MSA to
MDA
4      ldi r1,0x8

MAIN_XFER:
5      cmphs r0,r1                // Is r0 >= 0x8
6      bf LAST_XFER              // If not, jump to last transfer label
7      stf r1,MD|CPY              // Copy 8 words from MSA to MDA address.
8      subi r0,0x8                // Decrement counter
9      jmp MAIN_XFER              // return to main transfer loop

LAST_XFER:
10     stf r0,MD|CPY              // perform last transfer
```

All instructions are performed in one cycle (jumps excepted). Instruction 7 triggers a copy transfer: A read burst access of 8-word starts, data is staged in MD and then a write burst of 8 words is executed. Instruction 8, 9, 5, and 6 are executed while the burst access is in progress. If this access is not complete when instruction 7 is executed a second time, SDMA stalls on this instruction as long as the previous copy transfer is not over. In this case, the instruction is no longer a one-cycle instruction.

During the main loop (MAIN_XFER), r1 always equals 8, so burst lengths are 8 words. On the last ldf |CPY instruction (10), r1 equals the remainder of r0 divided by 8; therefore, the length of bursts triggered in copy mode equal r1 value, which is between 1 and 7.

46.7.2.2 Peripheral to Peripheral Transfer

For this data transfer, only the peripheral DMA is used.

It is programmed in copy mode, so no data will transmit through the SDMA general register used in the ldf instruction, but the contents of the general register are lost. The SDMA core only monitors the transfer.

46.7.2.2.1 Source and Destination Target Have the Same Data Path Width

When the source and destination target have the same data path width, the following is true:

- Source target is a *half-word* (16-bit) peripheral located at address 0x1002.
- Destination is a *half-word* (16-bit) peripheral located at address 0x2006.

It is assumed the address values are already present in two SDMA general registers (r1, r2). The script for a transfer of 10 half-word is as follows:

Same Data Path Width for Source and Destination

```
//SETUP SECTION
1      stf r1, PSA|SZ16|F           //r1=0x1002 Source address register setup
2      stf r2, PDA|SZ16|F           //r2=0x2006 Destination address register
setup
3      bdf ERROR_ADDR_SETUP
4      ldi r0,0xa                   //loop counter is 10
//MAIN LOOP TRANSFER
copy_loop:
5      loop 2,0
6      ldf r7,PD|CPY                //Reads 1 half-word from src and writes to
dest.
7      yield
8      bdf ERROR_DURING_XFER
ERROR_ADDR_SETUP:
           //correction of PSA/PDA setup and jumps to main loop transfer
ERROR_DURING_XFER:
           //flag error is set,
           //PS can be read to know if error occurs during read or write access.
```

If a data transfer must occur between two word peripherals, only the setup section should be updated. The transfer itself is always performed by the hardware loop instruction.

All instructions are executed in one cycle (change of flow excepted). On instruction 6, a single read access is triggered, read data is staged in PD, and a write-to-destination is executed. When the transfers are in progress, the SDMA can execute the next instructions in parallel. If instruction 6, which performs the copy transfer, is executed while the previous access is not over, SDMA is stalled and instruction ldf is a multi-cycle instruction.

46.7.2.2.2 Source and Destination Target Have a Different Data Path Width

When the source and destination target have a different data path width, copy mode cannot be used, and any attempt to initiate a copy transfer immediately raises an error, which is stored in the SF flag.

The following example shows the SDMA code that could transfer 10 words from a *word* (32-bit) peripheral to a *half-word* peripheral whose addresses are preliminary and stored in r1 and r2.

Different Data Path Width for Source and Destination

```
//SETUP SECTION
1      stf r1, PSA|SZ32|F|PF           //r1=0x1000 and prefetch data
2      stf r2, PDA|SZ16|F             //r2=0x2006
3      bdf ERROR_ADDR_SETUP
4      ldi r0,0xa                      //loop counter is 10
//MAIN LOOP TRANSFER
main_loop_xfer_16_16:
5      loop 6,0
6      ldf r7,PD                       //copy 32-bit of PD in r7
7      stf r7,PD                       //store 16 LSB of r7 in PD and a flush is
executed
8      rorb r7
9      rorb r7                         //16 MSB --> 16 LSB
10     stf r7,PD                       //store 16 LSB of r6 in PD and a flush.
11     yield
```

On instruction 1, when the source address register is programmed and a data prefetch is required, a read access is executed. In parallel, the SDMA executes instructions 2 to 5. On instruction 6, the SDMA tries to read data that was fetched by instruction 1. If data is ready, the ldf will be a one cycle instruction; otherwise, the SDMA is stalled as long as the read access is not finished. Then, the 16 LSB of the read data is stored in PD and automatically flushed to the destination peripheral. In parallel, the SDMA executes the rotation instructions (8, 9), and stores the 16 MSB of the read data into PD. If a previous write access is finished, instruction 10 will be a one-cycle instruction.

The main loop transfer may appear inefficient, but due to wait states imposed to the peripheral DMA each time an external access is performed, a software pipeline is in place. During the time needed to flush PD, the SDMA executes the move and rotation operations. SDMA executes instructions in parallel with DMA accesses.

46.7.2.3 Transfer Between Peripheral and External Memory

46.7.2.3.1 Peripheral to External Memory Transfer

A transfer from a peripheral to the external memory controller involves the peripheral DMA and the burst DMA.

The code for transferring 100 word from word peripheral to the external memory would be as follows:

Peripheral to External Memory Transfer

```
//SETUP SECTION source and destination addresses are already in r1 and r2
1      stf r1, PSA|SZ16|F|PF           //r1=0x1000 and prefetch 32-bit data
2      stf r2, MDA                     //r2=0x2000, setup burst DMA destination
address
3      bdf ERROR_ADDR_SETUP
4      ldi r0,0x64                     //loop counter is 100
5
//MAIN LOOP TRANSFER
6      loop 3,0
```



```

7          ldf r1,PD|PF          // read 32 bits of PD and initiate a new read
access.
8          stf r1,MD|32          // store 32 bits of r1 in the MD fifo.
9          yield
10         ldf r1,PD             // last word data is read
11         stf r1,MD|32|FL      // to flush all remaining bytes of MD

```

On instruction 1, the source address register of the peripheral DMA is programmed and data is fetched. This data is stored in PD and the SDMA reads PD during instruction 7, which is a one-cycle instruction that is read-access finished. On the same instruction (7), a data prefetch is required and a read access to the source peripheral is executed. In parallel, the SDMA stored the previous read data into the data register of MD. When MD (which is an eight-word FIFO) is full, a burst write access is executed to empty the FIFO. As long as the next SDMA instructions do not access the burst DMA, they will be one-cycle instructions. The following figures show how the peripheral DMA and burst DMA work in parallel.

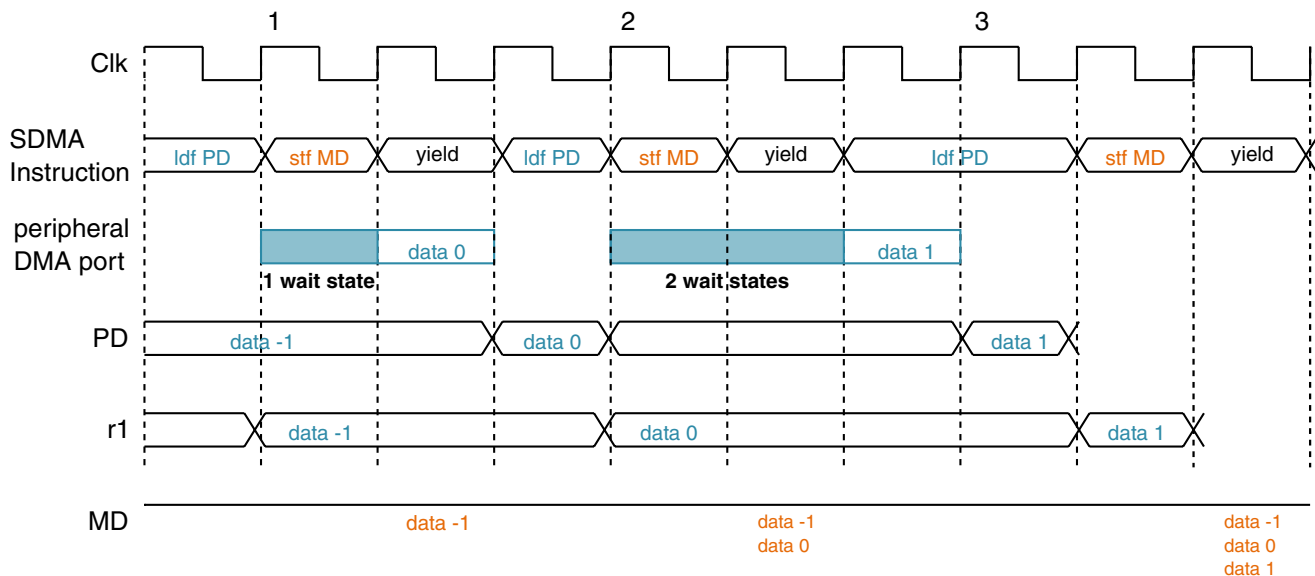

Figure 46-21. Peripheral to External Memory Example (1)

As seen in the figure above, the read access triggered by the ldf PD instruction is symbolized by the blue bar when in progress. After wait states, the read data (data 0, data 1) is stored in PD on the clk rising edge. On edge 2, data 0 is available in PD so it can be transferred to the SDMA general register r1, and then stored in MD FIFO. On edge 3, data 1 is not in PD; therefore, SDMA is stalled on the ldf instruction, which lasts two cycles. The figure below shows an example of when MD FIFO is full with data.

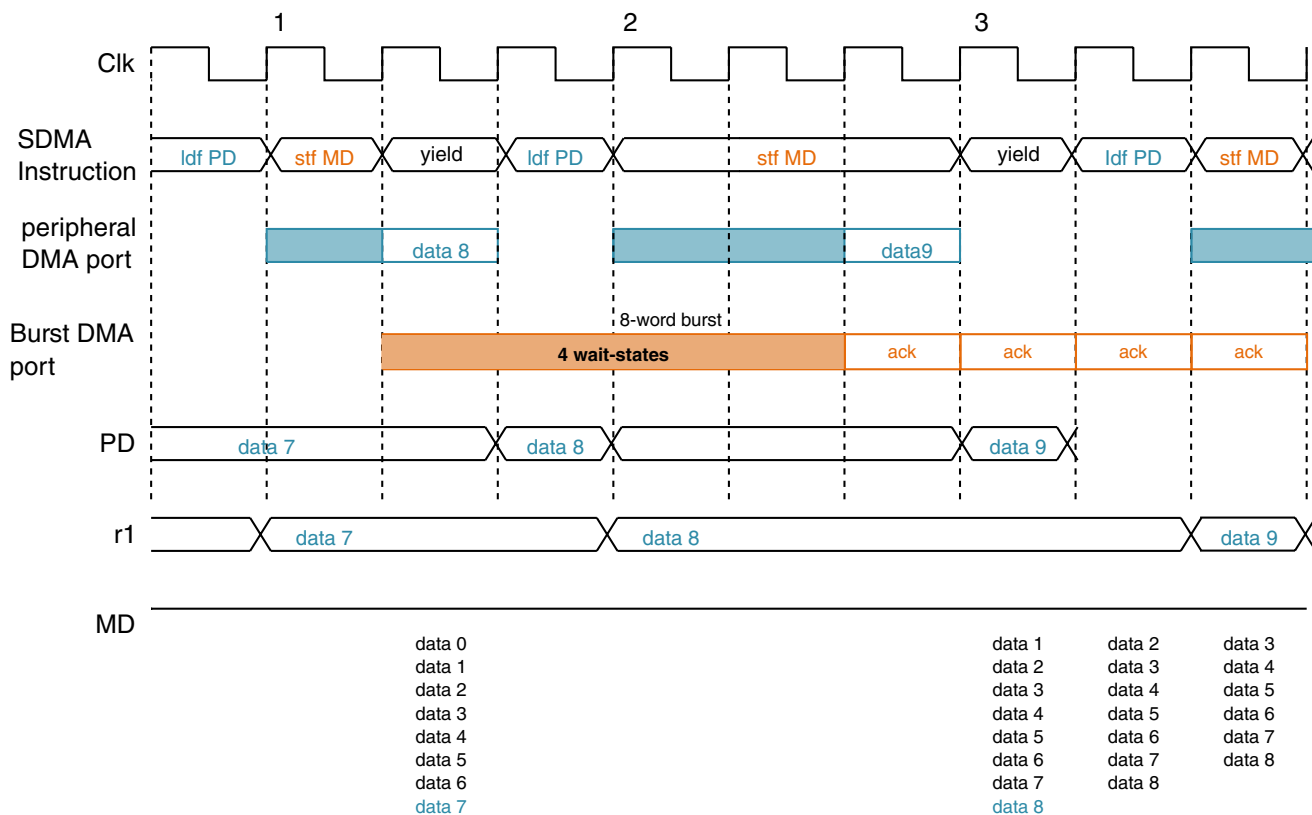

Figure 46-22. Peripheral to External Memory Example (2)

In the previous figure, the write bar means the burst DMA is performing a write burst access. The latency to have the first write acknowledge is four cycles. SDMA is stalled on instruction stf because no acknowledge was received, MD FIFO is full, and there is no empty slot to store data 9. When an acknowledge is sampled by the burst DMA, FIFO is shifted and data 8 is written. As long as there is at least one empty slot in MD FIFO, the stf MD instruction lasts one cycle.

46.7.2.3.2 External Memory to Peripheral Transfer

A transfer from the external memory to a peripheral involves the peripheral DMA and the burst DMA.

The code for transferring 100 word from external memory to a word peripheral would be as follows:

External Memory to Peripheral Transfer

```
//SETUP SECTION source and destination addresses are already in r1 and r2
1      stf r1, MSA|PF           //r1=0x1000 and starts a 8-word read burst
2      stf r2, PDA|SZ32|P      //r2=0x2010, setup peripheral DMA destination address
3      bdf ERROR_ADDR_SETUP
4      ldi r0,0x64             //loop counter is 100
//MAIN LOOP TRANSFER
6      loop 3,0
```

```

7      ldf r1,MD|32|PF          // read 32 bits of MD and initiate a new read access
                                     // if MD is empty after this reading.
8      stf r1,PD                // store 32 bits of r1 in the PD.
9      yield
10     ldf r1,MD|32            // last word data is read
11     stf r1,PD              // last write access

```

On instruction 1, a read burst of 8 words begins. Read data is staged into MD. On instruction 7 (and if data is available in MD), 32 bits are copied into r1. Then instruction 8 writes them into PD and an automatic flush is executed. The SDMA core, peripheral DMA, and burst DMA can work in parallel as long as no SDMA instruction tries to start a new write access on the peripheral DMA while the previous access is still in progress, or as long as there is data in MD when the SDMA tries to read it.

46.7.2.4 Transfer Between External Memory and Internal Memory

Since the internal memory (Arm platform RAM) is accessed via the peripheral DMA and the external memory is accessed via the burst DMA, the SDMA scripts that are described in [Transfer Between Peripheral and External Memory](#) can be reused. The exception is that the peripheral DMA address registers (PSA or PDA, depending on the script) should be programmed in incremented mode rather than frozen mode.

46.7.2.4.1 Internal Memory to Internal Memory

The internal memory can only be accessed via the peripheral DMA, so the script described in [Peripheral to Peripheral Transfer](#) can be reused with a different programming of the peripheral DMA address registers.

46.7.2.4.2 Transfer Between Peripheral and Internal Memory

For this transfer, the peripheral DMA is also used in copy mode.

The SDMA script is very similar to the one described in [Peripheral to Peripheral Transfer](#), except for the peripheral DMA address registers programming.

46.8 Arm Platform Memory Map and Control Register Definitions

The Arm platform controls the SDMA by means of several interface registers. Those registers are described in the current section.

All registers are clocked with the SDMA clock (which means the Arm platform must ensure that the SDMA clock is running when it wants to access any register).

SDMAARM memory map

Absolute address (hex)	Register name	Width (in bits)	Access	Reset value	Section/ page
20E_C000	Arm platform Channel 0 Pointer (SDMAARM_MC0PTR)	32	R/W	0000_0000h	46.8.1/3341
20E_C004	Channel Interrupts (SDMAARM_INTR)	32	w1c	0000_0000h	46.8.2/3341
20E_C008	Channel Stop/Channel Status (SDMAARM_STOP_STAT)	32	w1c	0000_0000h	46.8.3/3341
20E_C00C	Channel Start (SDMAARM_HSTART)	32	R/W	0000_0000h	46.8.4/3342
20E_C010	Channel Event Override (SDMAARM_EVTOVR)	32	R/W	0000_0000h	46.8.5/3342
20E_C014	Channel BP Override (SDMAARM_DSPOVR)	32	R/W	FFFF_FFFFh	46.8.6/3343
20E_C018	Channel Arm platform Override (SDMAARM_HOSTOVR)	32	R/W	0000_0000h	46.8.7/3343
20E_C01C	Channel Event Pending (SDMAARM_EVTPEND)	32	w1c	0000_0000h	46.8.8/3343
20E_C024	Reset Register (SDMAARM_RESET)	32	R	0000_0000h	46.8.9/3344
20E_C028	DMA Request Error Register (SDMAARM_EVTERR)	32	R	0000_0000h	46.8.10/3345
20E_C02C	Channel Arm platform Interrupt Mask (SDMAARM_INTRMASK)	32	R/W	0000_0000h	46.8.11/3345
20E_C030	Schedule Status (SDMAARM_PSW)	32	R	0000_0000h	46.8.12/3346
20E_C034	DMA Request Error Register (SDMAARM_EVTERRDBG)	32	R	0000_0000h	46.8.13/3346
20E_C038	Configuration Register (SDMAARM_CONFIG)	32	R/W	0000_0003h	46.8.14/3347
20E_C03C	SDMA LOCK (SDMAARM_SDMA_LOCK)	32	R/W	0000_0000h	46.8.15/3348
20E_C040	OnCE Enable (SDMAARM_ONCE_ENB)	32	R/W	0000_0000h	46.8.16/3349
20E_C044	OnCE Data Register (SDMAARM_ONCE_DATA)	32	R/W	0000_0000h	46.8.17/3350
20E_C048	OnCE Instruction Register (SDMAARM_ONCE_INSTR)	32	R/W	0000_0000h	46.8.18/3350
20E_C04C	OnCE Status Register (SDMAARM_ONCE_STAT)	32	R	0000_E000h	46.8.19/3350
20E_C050	OnCE Command Register (SDMAARM_ONCE_CMD)	32	R/W	0000_0000h	46.8.20/3352

Table continues on the next page...

SDMAARM memory map (continued)

Absolute address (hex)	Register name	Width (in bits)	Access	Reset value	Section/page
20E_C058	Illegal Instruction Trap Address (SDMAARM_ILLINSTADDR)	32	R/W	0000_0001h	46.8.21/3353
20E_C05C	Channel 0 Boot Address (SDMAARM_CHN0ADDR)	32	R/W	0000_0050h	46.8.22/3353
20E_C060	DMA Requests (SDMAARM_EVT_MIRROR)	32	R	0000_0000h	46.8.23/3354
20E_C064	DMA Requests 2 (SDMAARM_EVT_MIRROR2)	32	R	0000_0000h	46.8.24/3354
20E_C070	Cross-Trigger Events Configuration Register 1 (SDMAARM_XTRIG_CONF1)	32	R/W	0000_0000h	46.8.25/3355
20E_C074	Cross-Trigger Events Configuration Register 2 (SDMAARM_XTRIG_CONF2)	32	R/W	0000_0000h	46.8.26/3357
20E_C100	Channel Priority Registers (SDMAARM_SDMA_CHNPRI0)	32	R/W	0000_0000h	46.8.27/3358
20E_C104	Channel Priority Registers (SDMAARM_SDMA_CHNPRI1)	32	R/W	0000_0000h	46.8.27/3358
20E_C108	Channel Priority Registers (SDMAARM_SDMA_CHNPRI2)	32	R/W	0000_0000h	46.8.27/3358
20E_C10C	Channel Priority Registers (SDMAARM_SDMA_CHNPRI3)	32	R/W	0000_0000h	46.8.27/3358
20E_C110	Channel Priority Registers (SDMAARM_SDMA_CHNPRI4)	32	R/W	0000_0000h	46.8.27/3358
20E_C114	Channel Priority Registers (SDMAARM_SDMA_CHNPRI5)	32	R/W	0000_0000h	46.8.27/3358
20E_C118	Channel Priority Registers (SDMAARM_SDMA_CHNPRI6)	32	R/W	0000_0000h	46.8.27/3358
20E_C11C	Channel Priority Registers (SDMAARM_SDMA_CHNPRI7)	32	R/W	0000_0000h	46.8.27/3358
20E_C120	Channel Priority Registers (SDMAARM_SDMA_CHNPRI8)	32	R/W	0000_0000h	46.8.27/3358
20E_C124	Channel Priority Registers (SDMAARM_SDMA_CHNPRI9)	32	R/W	0000_0000h	46.8.27/3358
20E_C128	Channel Priority Registers (SDMAARM_SDMA_CHNPRI10)	32	R/W	0000_0000h	46.8.27/3358
20E_C12C	Channel Priority Registers (SDMAARM_SDMA_CHNPRI11)	32	R/W	0000_0000h	46.8.27/3358
20E_C130	Channel Priority Registers (SDMAARM_SDMA_CHNPRI12)	32	R/W	0000_0000h	46.8.27/3358
20E_C134	Channel Priority Registers (SDMAARM_SDMA_CHNPRI13)	32	R/W	0000_0000h	46.8.27/3358
20E_C138	Channel Priority Registers (SDMAARM_SDMA_CHNPRI14)	32	R/W	0000_0000h	46.8.27/3358
20E_C13C	Channel Priority Registers (SDMAARM_SDMA_CHNPRI15)	32	R/W	0000_0000h	46.8.27/3358

Table continues on the next page...

SDMAARM memory map (continued)

Absolute address (hex)	Register name	Width (in bits)	Access	Reset value	Section/page
20E_C140	Channel Priority Registers (SDMAARM_SDMA_CHNPRI16)	32	R/W	0000_0000h	46.8.27/3358
20E_C144	Channel Priority Registers (SDMAARM_SDMA_CHNPRI17)	32	R/W	0000_0000h	46.8.27/3358
20E_C148	Channel Priority Registers (SDMAARM_SDMA_CHNPRI18)	32	R/W	0000_0000h	46.8.27/3358
20E_C14C	Channel Priority Registers (SDMAARM_SDMA_CHNPRI19)	32	R/W	0000_0000h	46.8.27/3358
20E_C150	Channel Priority Registers (SDMAARM_SDMA_CHNPRI20)	32	R/W	0000_0000h	46.8.27/3358
20E_C154	Channel Priority Registers (SDMAARM_SDMA_CHNPRI21)	32	R/W	0000_0000h	46.8.27/3358
20E_C158	Channel Priority Registers (SDMAARM_SDMA_CHNPRI22)	32	R/W	0000_0000h	46.8.27/3358
20E_C15C	Channel Priority Registers (SDMAARM_SDMA_CHNPRI23)	32	R/W	0000_0000h	46.8.27/3358
20E_C160	Channel Priority Registers (SDMAARM_SDMA_CHNPRI24)	32	R/W	0000_0000h	46.8.27/3358
20E_C164	Channel Priority Registers (SDMAARM_SDMA_CHNPRI25)	32	R/W	0000_0000h	46.8.27/3358
20E_C168	Channel Priority Registers (SDMAARM_SDMA_CHNPRI26)	32	R/W	0000_0000h	46.8.27/3358
20E_C16C	Channel Priority Registers (SDMAARM_SDMA_CHNPRI27)	32	R/W	0000_0000h	46.8.27/3358
20E_C170	Channel Priority Registers (SDMAARM_SDMA_CHNPRI28)	32	R/W	0000_0000h	46.8.27/3358
20E_C174	Channel Priority Registers (SDMAARM_SDMA_CHNPRI29)	32	R/W	0000_0000h	46.8.27/3358
20E_C178	Channel Priority Registers (SDMAARM_SDMA_CHNPRI30)	32	R/W	0000_0000h	46.8.27/3358
20E_C17C	Channel Priority Registers (SDMAARM_SDMA_CHNPRI31)	32	R/W	0000_0000h	46.8.27/3358
20E_C200	Channel Enable RAM (SDMAARM_CHNENBL0)	32	R/W	0000_0000h	46.8.28/3358
20E_C204	Channel Enable RAM (SDMAARM_CHNENBL1)	32	R/W	0000_0000h	46.8.28/3358
20E_C208	Channel Enable RAM (SDMAARM_CHNENBL2)	32	R/W	0000_0000h	46.8.28/3358
20E_C20C	Channel Enable RAM (SDMAARM_CHNENBL3)	32	R/W	0000_0000h	46.8.28/3358
20E_C210	Channel Enable RAM (SDMAARM_CHNENBL4)	32	R/W	0000_0000h	46.8.28/3358
20E_C214	Channel Enable RAM (SDMAARM_CHNENBL5)	32	R/W	0000_0000h	46.8.28/3358

Table continues on the next page...

SDMAARM memory map (continued)

Absolute address (hex)	Register name	Width (in bits)	Access	Reset value	Section/page
20E_C218	Channel Enable RAM (SDMAARM_CHNENBL6)	32	R/W	0000_0000h	46.8.28/3358
20E_C21C	Channel Enable RAM (SDMAARM_CHNENBL7)	32	R/W	0000_0000h	46.8.28/3358
20E_C220	Channel Enable RAM (SDMAARM_CHNENBL8)	32	R/W	0000_0000h	46.8.28/3358
20E_C224	Channel Enable RAM (SDMAARM_CHNENBL9)	32	R/W	0000_0000h	46.8.28/3358
20E_C228	Channel Enable RAM (SDMAARM_CHNENBL10)	32	R/W	0000_0000h	46.8.28/3358
20E_C22C	Channel Enable RAM (SDMAARM_CHNENBL11)	32	R/W	0000_0000h	46.8.28/3358
20E_C230	Channel Enable RAM (SDMAARM_CHNENBL12)	32	R/W	0000_0000h	46.8.28/3358
20E_C234	Channel Enable RAM (SDMAARM_CHNENBL13)	32	R/W	0000_0000h	46.8.28/3358
20E_C238	Channel Enable RAM (SDMAARM_CHNENBL14)	32	R/W	0000_0000h	46.8.28/3358
20E_C23C	Channel Enable RAM (SDMAARM_CHNENBL15)	32	R/W	0000_0000h	46.8.28/3358
20E_C240	Channel Enable RAM (SDMAARM_CHNENBL16)	32	R/W	0000_0000h	46.8.28/3358
20E_C244	Channel Enable RAM (SDMAARM_CHNENBL17)	32	R/W	0000_0000h	46.8.28/3358
20E_C248	Channel Enable RAM (SDMAARM_CHNENBL18)	32	R/W	0000_0000h	46.8.28/3358
20E_C24C	Channel Enable RAM (SDMAARM_CHNENBL19)	32	R/W	0000_0000h	46.8.28/3358
20E_C250	Channel Enable RAM (SDMAARM_CHNENBL20)	32	R/W	0000_0000h	46.8.28/3358
20E_C254	Channel Enable RAM (SDMAARM_CHNENBL21)	32	R/W	0000_0000h	46.8.28/3358
20E_C258	Channel Enable RAM (SDMAARM_CHNENBL22)	32	R/W	0000_0000h	46.8.28/3358
20E_C25C	Channel Enable RAM (SDMAARM_CHNENBL23)	32	R/W	0000_0000h	46.8.28/3358
20E_C260	Channel Enable RAM (SDMAARM_CHNENBL24)	32	R/W	0000_0000h	46.8.28/3358
20E_C264	Channel Enable RAM (SDMAARM_CHNENBL25)	32	R/W	0000_0000h	46.8.28/3358
20E_C268	Channel Enable RAM (SDMAARM_CHNENBL26)	32	R/W	0000_0000h	46.8.28/3358
20E_C26C	Channel Enable RAM (SDMAARM_CHNENBL27)	32	R/W	0000_0000h	46.8.28/3358

Table continues on the next page...

SDMAARM memory map (continued)

Absolute address (hex)	Register name	Width (in bits)	Access	Reset value	Section/page
20E_C270	Channel Enable RAM (SDMAARM_CHNENBL28)	32	R/W	0000_0000h	46.8.28/3358
20E_C274	Channel Enable RAM (SDMAARM_CHNENBL29)	32	R/W	0000_0000h	46.8.28/3358
20E_C278	Channel Enable RAM (SDMAARM_CHNENBL30)	32	R/W	0000_0000h	46.8.28/3358
20E_C27C	Channel Enable RAM (SDMAARM_CHNENBL31)	32	R/W	0000_0000h	46.8.28/3358
20E_C280	Channel Enable RAM (SDMAARM_CHNENBL32)	32	R/W	0000_0000h	46.8.28/3358
20E_C284	Channel Enable RAM (SDMAARM_CHNENBL33)	32	R/W	0000_0000h	46.8.28/3358
20E_C288	Channel Enable RAM (SDMAARM_CHNENBL34)	32	R/W	0000_0000h	46.8.28/3358
20E_C28C	Channel Enable RAM (SDMAARM_CHNENBL35)	32	R/W	0000_0000h	46.8.28/3358
20E_C290	Channel Enable RAM (SDMAARM_CHNENBL36)	32	R/W	0000_0000h	46.8.28/3358
20E_C294	Channel Enable RAM (SDMAARM_CHNENBL37)	32	R/W	0000_0000h	46.8.28/3358
20E_C298	Channel Enable RAM (SDMAARM_CHNENBL38)	32	R/W	0000_0000h	46.8.28/3358
20E_C29C	Channel Enable RAM (SDMAARM_CHNENBL39)	32	R/W	0000_0000h	46.8.28/3358
20E_C2A0	Channel Enable RAM (SDMAARM_CHNENBL40)	32	R/W	0000_0000h	46.8.28/3358
20E_C2A4	Channel Enable RAM (SDMAARM_CHNENBL41)	32	R/W	0000_0000h	46.8.28/3358
20E_C2A8	Channel Enable RAM (SDMAARM_CHNENBL42)	32	R/W	0000_0000h	46.8.28/3358
20E_C2AC	Channel Enable RAM (SDMAARM_CHNENBL43)	32	R/W	0000_0000h	46.8.28/3358
20E_C2B0	Channel Enable RAM (SDMAARM_CHNENBL44)	32	R/W	0000_0000h	46.8.28/3358
20E_C2B4	Channel Enable RAM (SDMAARM_CHNENBL45)	32	R/W	0000_0000h	46.8.28/3358
20E_C2B8	Channel Enable RAM (SDMAARM_CHNENBL46)	32	R/W	0000_0000h	46.8.28/3358
20E_C2BC	Channel Enable RAM (SDMAARM_CHNENBL47)	32	R/W	0000_0000h	46.8.28/3358

46.8.1 Arm platform Channel 0 Pointer (SDMAARM_MC0PTR)

Address: 20E_C000h base + 0h offset = 20E_C000h

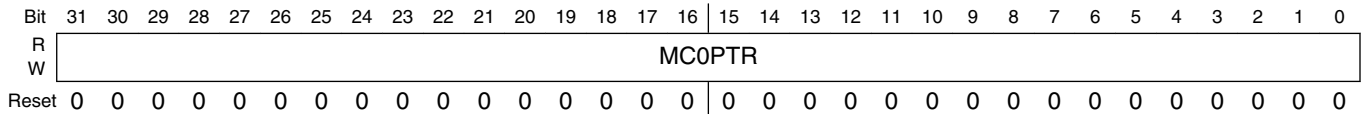

SDMAARM_MC0PTR field descriptions

Field	Description
MC0PTR	Channel 0 Pointer contains the 32-bit address, in Arm platform memory, of channel 0 control block (the boot channel). Appendix A fully describes the SDMA Application Programming Interface (API). The Arm platform has a read/write access and the SDMA has a read-only access.

46.8.2 Channel Interrupts (SDMAARM_INTR)

Address: 20E_C000h base + 4h offset = 20E_C004h

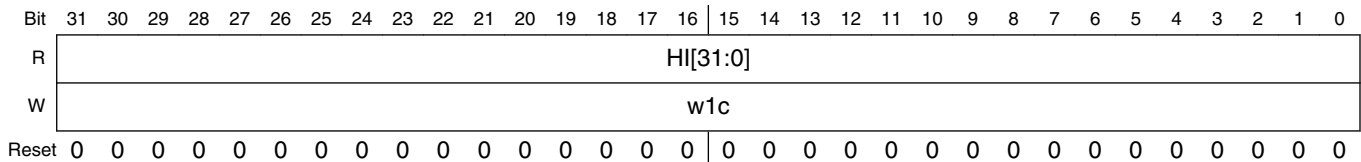

SDMAARM_INTR field descriptions

Field	Description
HI[31:0]	The Arm platform Interrupts register contains the 32 HI[i] bits. If any bit is set, it will cause an interrupt to the Arm platform. This register is a "write-ones" register to the Arm platform. When the Arm platform sets a bit in this register the corresponding HI[i] bit is cleared. The interrupt service routine should clear individual channel bits when their interrupts are serviced, failure to do so will cause continuous interrupts. The SDMA is responsible for setting the HI[i] bit corresponding to the current channel when the corresponding <code>done</code> instruction is executed.

46.8.3 Channel Stop/Channel Status (SDMAARM_STOP_STAT)

Address: 20E_C000h base + 8h offset = 20E_C008h

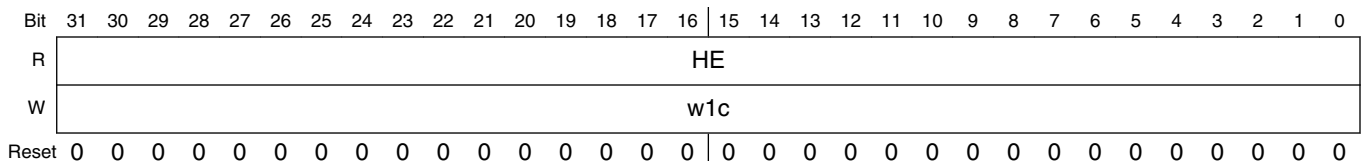

SDMAARM_STOP_STAT field descriptions

Field	Description
HE	This 32-bit register gives access to the Arm platform Enable bits. There is one bit for every channel. This register is a "write-ones" register to the Arm platform. When the Arm platform writes 1 in bit <i>i</i> of this register, it clears the HE[<i>i</i>] and HSTART[<i>i</i>] bits. Reading this register yields the current state of the HE[<i>i</i>] bits.

46.8.4 Channel Start (SDMAARM_HSTART)

Address: 20E_C000h base + Ch offset = 20E_C00Ch

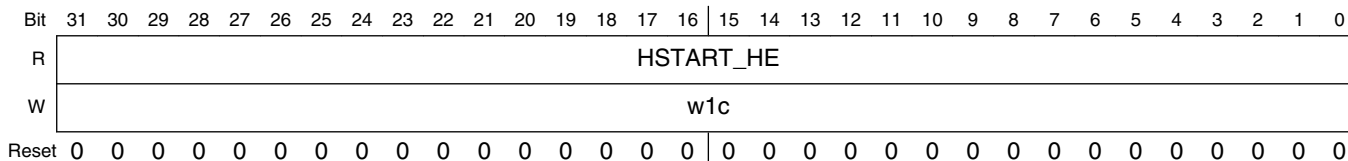

SDMAARM_HSTART field descriptions

Field	Description
HSTART_HE	<p>The HSTART_HE registers are 32 bits wide with one bit for every channel. When a bit is written to 1, it enables the corresponding channel. Two physical registers are accessed with that address (HSTART and HE), which enables the Arm platform to trigger a channel a second time before the first trigger is processed.</p> <ul style="list-style-type: none"> This register is a "write-ones" register to the Arm platform. Neither HSTART[<i>i</i>] bit can be set while the corresponding HE[<i>i</i>] bit is cleared. When the Arm platform tries to set the HSTART[<i>i</i>] bit by writing a one (if the corresponding HE[<i>i</i>] bit is clear), the bit in the HSTART[<i>i</i>] register will remain cleared and the HE[<i>i</i>] bit will be set. If the corresponding HE[<i>i</i>] bit was already set, the HSTART[<i>i</i>] bit will be set. The next time the SDMA channel <i>i</i> attempts to clear the HE[<i>i</i>] bit by means of a <code>done</code> instruction, the bit in the HSTART[<i>i</i>] register will be cleared and the HE[<i>i</i>] bit will take the old value of the HSTART[<i>i</i>] bit. Reading this register yields the current state of the HSTART[<i>i</i>] bits. This mechanism enables the Arm platform to pipeline two HSTART commands per channel.

46.8.5 Channel Event Override (SDMAARM_EVTOVR)

Address: 20E_C000h base + 10h offset = 20E_C010h

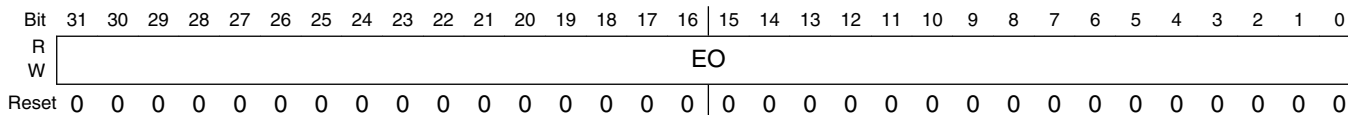

SDMAARM_EVTOVR field descriptions

Field	Description
EO	The Channel Event Override register contains the 32 EO[<i>i</i>] bits. A bit set in this register causes the SDMA to ignore DMA requests when scheduling the corresponding channel.

46.8.6 Channel BP Override (SDMAARM_DSPOVR)

Address: 20E_C000h base + 14h offset = 20E_C014h

Bit	31	30	29	28	27	26	25	24	23	22	21	20	19	18	17	16	15	14	13	12	11	10	9	8	7	6	5	4	3	2	1	0
R																																
W																																
Reset	1	1	1	1	1	1	1	1	1	1	1	1	1	1	1	1	1	1	1	1	1	1	1	1	1	1	1	1	1	1	1	1

SDMAARM_DSPOVR field descriptions

Field	Description
DO	This register is reserved. All DO bits should be set to the reset value of 1. A setting of 0 will prevent SDMA channels from starting according to the condition described in Runnable Channels Evaluation . 0 - Reserved 1 - Reset value.

46.8.7 Channel Arm platform Override (SDMAARM_HOSTOVR)

Address: 20E_C000h base + 18h offset = 20E_C018h

Bit	31	30	29	28	27	26	25	24	23	22	21	20	19	18	17	16	15	14	13	12	11	10	9	8	7	6	5	4	3	2	1	0
R																																
W																																
Reset	0	0	0	0	0	0	0	0	0	0	0	0	0	0	0	0	0	0	0	0	0	0	0	0	0	0	0	0	0	0	0	0

SDMAARM_HOSTOVR field descriptions

Field	Description
HO	The Channel Arm platform Override register contains the 32 HO[i] bits. A bit set in this register causes the SDMA to ignore the Arm platform enable bit (HE) when scheduling the corresponding channel.

46.8.8 Channel Event Pending (SDMAARM_EVTPEND)

Address: 20E_C000h base + 1Ch offset = 20E_C01Ch

Bit	31	30	29	28	27	26	25	24	23	22	21	20	19	18	17	16	15	14	13	12	11	10	9	8	7	6	5	4	3	2	1	0
R																																
W																																
Reset	0	0	0	0	0	0	0	0	0	0	0	0	0	0	0	0	0	0	0	0	0	0	0	0	0	0	0	0	0	0	0	0

SDMAARM_EVTPEND field descriptions

Field	Description
EP	<p>The Channel Event Pending register contains the 32 EP[i] bits. Reading this register enables the Arm platform to determine what channels are pending after the reception of a DMA request.</p> <ul style="list-style-type: none"> Setting a bit in this register causes the SDMA to reevaluate scheduling as if a DMA request mapped on this channel had occurred. This is useful for starting up channels, so that initialization is done before awaiting the first request. The scheduler can also set bits in the EVTpend register according to the received DMA requests. The EP[i] bit may be cleared by the <code>done</code> instruction when running the channel <i>i</i> script. This is a "write-ones" mechanism: Writing a '0' does not clear the corresponding bit.

46.8.9 Reset Register (SDMAARM_RESET)

Address: 20E_C000h base + 24h offset = 20E_C024h

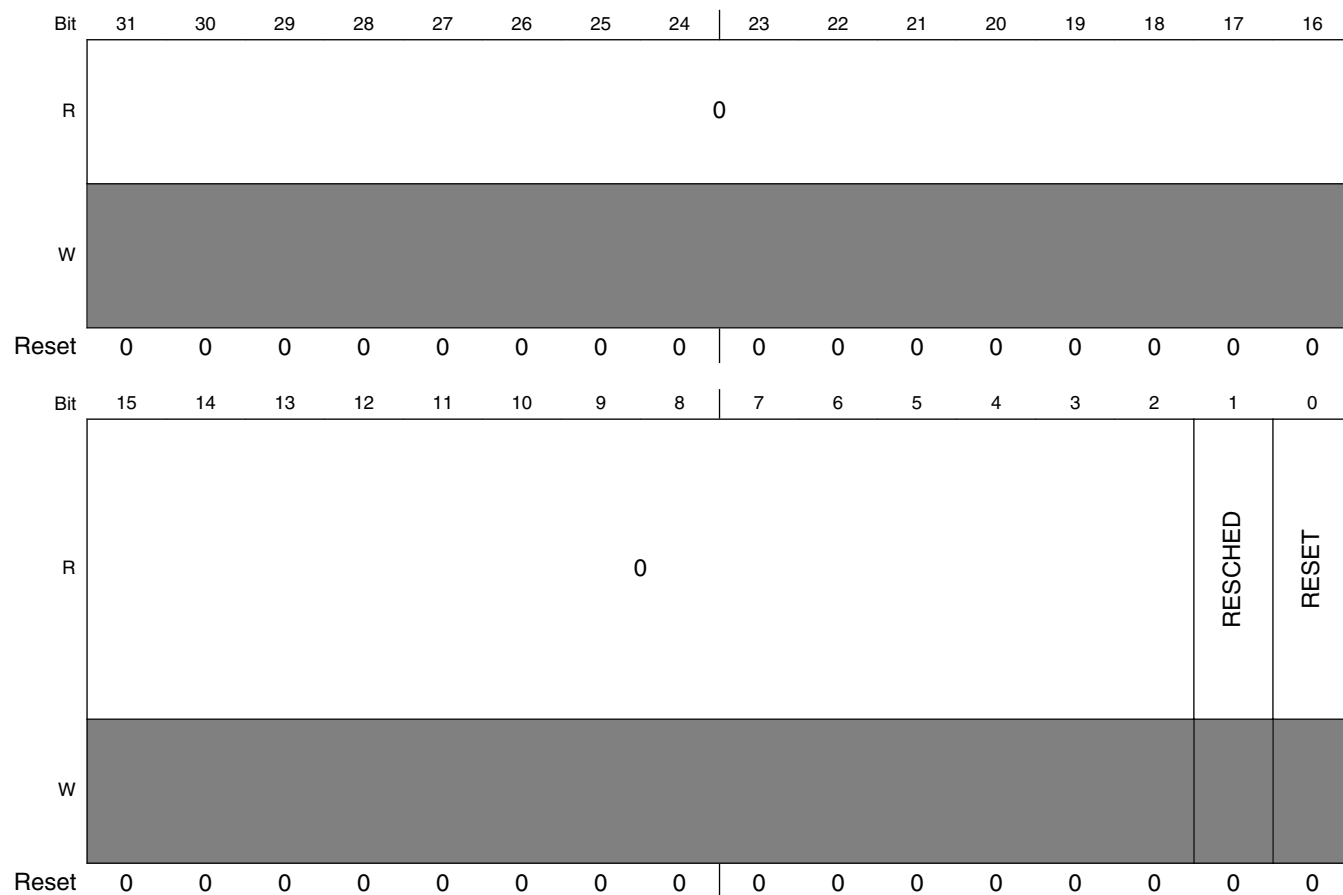

SDMAARM_RESET field descriptions

Field	Description
31–2 Reserved	This read-only field is reserved and always has the value 0.

Table continues on the next page...

SDMAARM_RESET field descriptions (continued)

Field	Description
1 RESCHED	When set, this bit forces the SDMA to reschedule as if a script had executed a <code>done</code> instruction. This enables the Arm platform to recover from a runaway script on a channel by clearing its HE[i] bit via the STOP register, and then forcing a reschedule via the RESCHED bit. The RESCHED bit is cleared when the context switch starts.
0 RESET	When set, this bit causes the SDMA to be held in a software reset. The internal reset signal is held low 16 cycles; the RESET bit is automatically cleared when the internal reset signal rises.

46.8.10 DMA Request Error Register (SDMAARM_EVTERR)

Address: 20E_C000h base + 28h offset = 20E_C028h

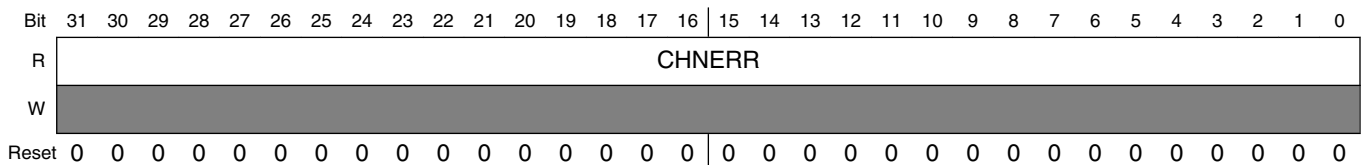

SDMAARM_EVTERR field descriptions

Field	Description
CHNERR	<p>This register is used by the SDMA to warn the Arm platform when an incoming DMA request was detected and it triggers a channel that is already pending or being serviced. This probably means there is an overflow of data for that channel.</p> <ul style="list-style-type: none"> An interrupt is sent to the Arm platform if the corresponding channel bit is set in the INTRMASK register. This is a "write-ones" register for the scheduler. It is only able to set the flags. The flags are cleared when the register is read by the Arm platform or during SDMA reset. The CHNERR[i] bit is set when a DMA request that triggers channel <i>i</i> is received through the corresponding input pins and the EP[i] bit is already set; the EVTERR[i] bit is unaffected if the Arm platform tries to set the EP[i] bit, whereas, that EP[i] bit is already set.

46.8.11 Channel Arm platform Interrupt Mask (SDMAARM_INTRMASK)

Address: 20E_C000h base + 2Ch offset = 20E_C02Ch

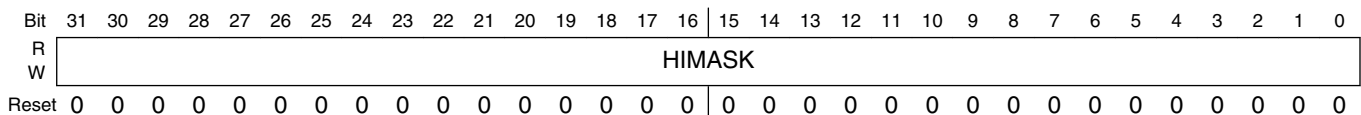

SDMAARM_INTRMASK field descriptions

Field	Description
HIMASK	The Interrupt Mask Register contains 32 interrupt generation mask bits. If bit HIMASK[i] is set, the HI[i] bit is set and an interrupt is sent to the Arm platform when a DMA request error is detected on channel <i>i</i> (for example, EVTERR[i] is set).

46.8.12 Schedule Status (SDMAARM_PSW)

Address: 20E_C000h base + 30h offset = 20E_C030h

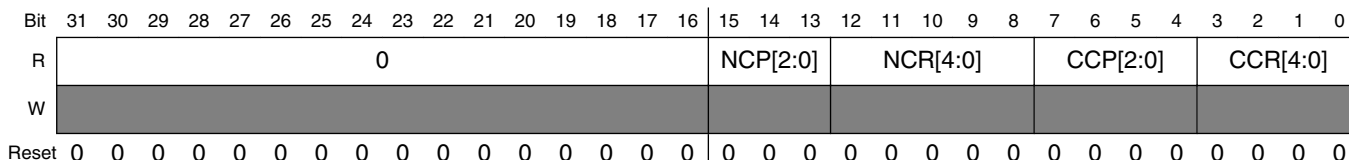

SDMAARM_PSW field descriptions

Field	Description
31–16 Reserved	This read-only field is reserved and always has the value 0.
15–13 NCP[2:0]	The Next Channel Priority gives the next pending channel priority. When the priority is 0, it means there is no pending channel and the NCR value has no meaning. 0 No running channel 1 Active channel priority
12–8 NCR[4:0]	The Next Channel Register indicates the number of the next scheduled pending channel with the highest priority.
7–4 CCP[2:0]	The Current Channel Priority indicates the priority of the current active channel. When the priority is 0, no channel is running: The SDMA is idle and the CCR value has no meaning. In the case that the SDMA has finished running the channel and has entered sleep state, CCP will indicate the priority of previous running channel. 0 No running channel 1 Active channel priority
CCR[4:0]	The Current Channel Register indicates the number of the channel that is being executed by the SDMA. SDMA. In the case that the SDMA has finished running the channel and has entered sleep state, CCR will indicate the previous running channel.

46.8.13 DMA Request Error Register (SDMAARM_EVTERRDBG)

Address: 20E_C000h base + 34h offset = 20E_C034h

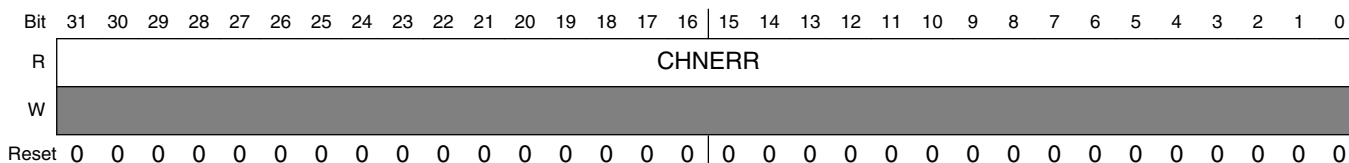

SDMAARM_EVERRDBG field descriptions

Field	Description
CHNERR	This register is the same as EVERR, except reading it does not clear its contents. This address is meant to be used in debug mode. The Arm platform OnCE may check this register value without modifying it.

46.8.14 Configuration Register (SDMAARM_CONFIG)

Address: 20E_C000h base + 38h offset = 20E_C038h

Bit	31	30	29	28	27	26	25	24	23	22	21	20	19	18	17	16
R	0															
W																
Reset	0	0	0	0	0	0	0	0	0	0	0	0	0	0	0	0
Bit	15	14	13	12	11	10	9	8	7	6	5	4	3	2	1	0
R	0			DSPDMA	RTDOBS	0						ACR	0		CSM	
W																
Reset	0	0	0	0	0	0	0	0	0	0	0	0	0	0	1	1

SDMAARM_CONFIG field descriptions

Field	Description
31–13 Reserved	This read-only field is reserved and always has the value 0.
12 DSPDMA	This bit's function is reserved and should be configured as zero. 0 - Reset Value 1 - Reserved
11 RTDOBS	Indicates if Real-Time Debug pins are used: They do not toggle by default in order to reduce power consumption. 0 RTD pins disabled 1 RTD pins enabled
10–5 Reserved	This read-only field is reserved and always has the value 0.
4 ACR	Arm platform DMA / SDMA Core Clock Ratio. Selects the clock ratio between Arm platform DMA interfaces (burst DMA and peripheral DMA) and the internal SDMA core clock. The frequency selection is determined separately by the chip clock controller. This bit has to match the configuration of the chip clock controller that generates the clocks used in the SDMA. 0 Arm platform DMA interface frequency equals twice core frequency 1 Arm platform DMA interface frequency equals core frequency
3–2 Reserved	This read-only field is reserved and always has the value 0.

Table continues on the next page...

SDMAARM_CONFIG field descriptions (continued)

Field	Description
CSM	<p>Selects the Context Switch Mode. The Arm platform has a read/write access. The SDMA cannot modify that register. The value at reset is 3, which selects the dynamic context switch by default. That register can be modified at anytime but the new context switch configuration will only be taken into account at the start of the next restore phase.</p> <p>NOTE: The first call to SDMA's channel 0 Bootload script after reset should use static context switch mode to ensure the context RAM for channel 0 is initialized in the channel SAVE Phase. After Channel 0 is run once, then any of the dynamic context modes can be used.</p> <p>0 static 1 dynamic low power 2 dynamic with no loop 3 dynamic</p>

46.8.15 SDMA LOCK (SDMAARM_SDMA_LOCK)

Address: 20E_C000h base + 3Ch offset = 20E_C03Ch

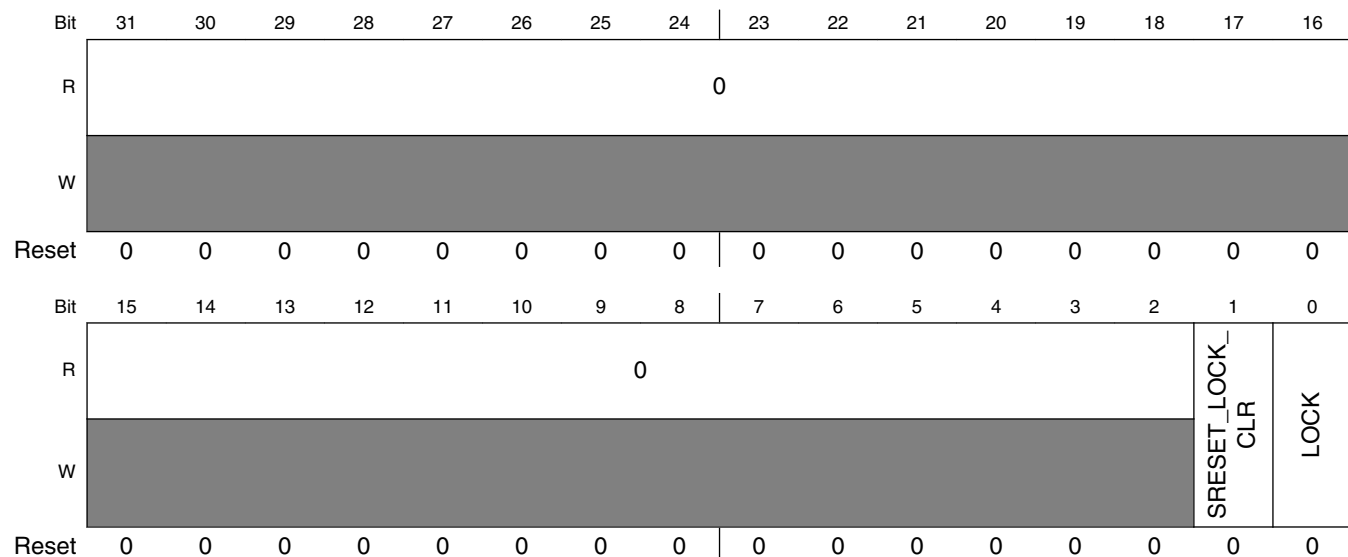

SDMAARM_SDMA_LOCK field descriptions

Field	Description
31–2 Reserved	This read-only field is reserved and always has the value 0.
1 SRESET_LOCK_CLR	<p>The SRESET_LOCK_CLR bit determine if the LOCK bit is cleared on a software reset triggered by writing to the RESET register. This bit cannot be changed if LOCK=1. SREST_LOCK_CLR is cleared by conditions that clear the LOCK bit.</p> <p>0 Software Reset does not clear the LOCK bit. 1 Software Reset clears the LOCK bit.</p>

Table continues on the next page...

SDMAARM_SDMA_LOCK field descriptions (continued)

Field	Description
0 LOCK	<p>The LOCK bit is used to restrict access to update SDMA script memory through ROM channel zero scripts and through the OnCE interface under Arm platform control.</p> <p>The LOCK bit is set:</p> <ul style="list-style-type: none"> • The SDMA_LOCK, ONCE_ENB, CH0ADDR, and ILLINSTADDR registers cannot be written. These registers can be read, but writes are ignored. • SDMA software executing out of ROM or RAM may check the LOCK bit in the LOCK register Lock Status Register (SDMACORE_SDMA_LOCK) to determine if certain operations are allowed, such as up-loading new scripts. <p>Once the LOCK bit is set to 1, only a reset can clear it. The LOCK bit is cleared by a hardware reset. LOCK is cleared by a software reset only if SRESET_LOCK_CLR is set.</p> <p>0 LOCK disengaged. 1 LOCK enabled.</p>

46.8.16 OnCE Enable (SDMAARM_ONCE_ENB)

Address: 20E_C000h base + 40h offset = 20E_C040h

Bit	31	30	29	28	27	26	25	24	23	22	21	20	19	18	17	16
R	0															
W																
Reset	0	0	0	0	0	0	0	0	0	0	0	0	0	0	0	0
Bit	15	14	13	12	11	10	9	8	7	6	5	4	3	2	1	0
R	0															
W																
Reset	0	0	0	0	0	0	0	0	0	0	0	0	0	0	0	0

SDMAARM_ONCE_ENB field descriptions

Field	Description
31–1 Reserved	This read-only field is reserved and always has the value 0.
0 ENB	<p>The OnCE Enable register selects the OnCE control source: When cleared (0), the OnCE registers are accessed through the JTAG interface; when set (1), the OnCE registers may be accessed by the Arm platform through the addresses described, as follows.</p> <ul style="list-style-type: none"> • After reset, the OnCE registers are accessed through the JTAG interface. • Writing a 1 to ENB enables the Arm platform to access the ONCE_* as any other SDMA control register. • When cleared (0), all the ONCE_xxx registers cannot be written. <p>The value of ENB cannot be changed if the LOCK bit in the SDMA_LOCK register is set.</p>

46.8.17 OnCE Data Register (SDMAARM_ONCE_DATA)

Address: 20E_C000h base + 44h offset = 20E_C044h

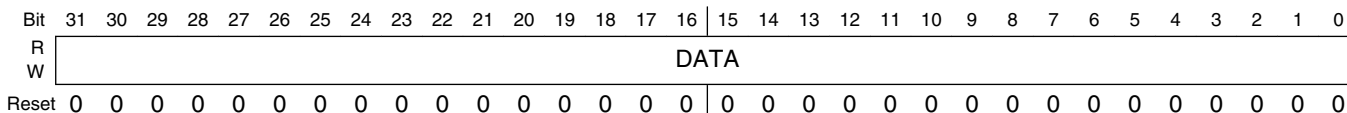

SDMAARM_ONCE_DATA field descriptions

Field	Description
DATA	Data register of the OnCE JTAG controller. Refer to OnCE and Real-Time Debug for information on this register.

46.8.18 OnCE Instruction Register (SDMAARM_ONCE_INSTR)

Address: 20E_C000h base + 48h offset = 20E_C048h

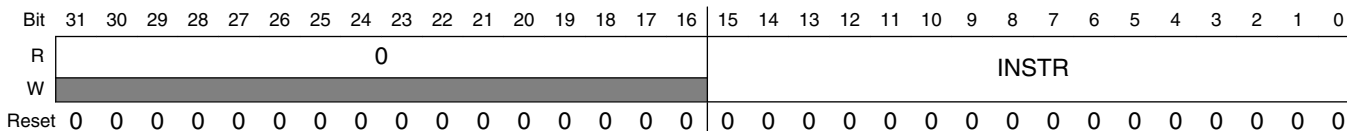

SDMAARM_ONCE_INSTR field descriptions

Field	Description
31–16 Reserved	This read-only field is reserved and always has the value 0.
INSTR	Instruction register of the OnCE JTAG controller. Refer to OnCE and Real-Time Debug for information on this register.

46.8.19 OnCE Status Register (SDMAARM_ONCE_STAT)

Address: 20E_C000h base + 4Ch offset = 20E_C04Ch

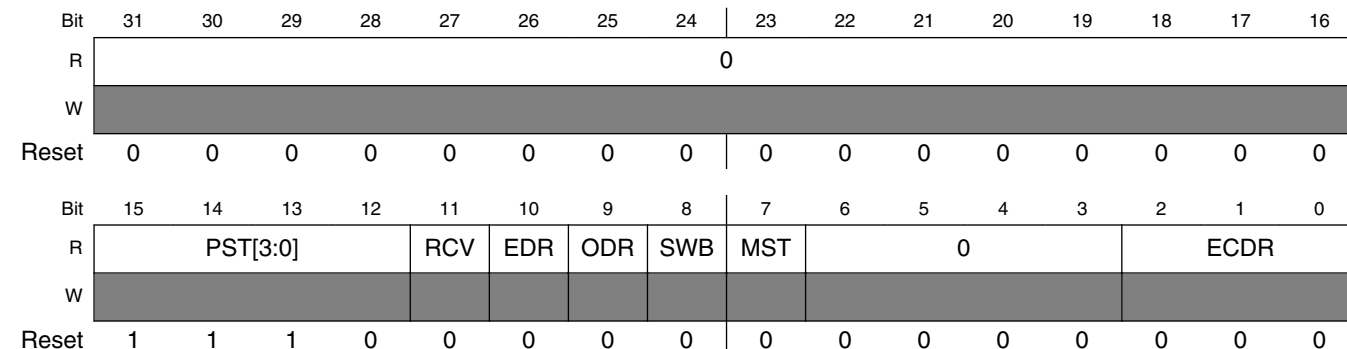

SDMAARM_ONCE_STAT field descriptions

Field	Description
31–16 Reserved	This read-only field is reserved and always has the value 0.
15–12 PST[3:0]	<p>The Processor Status bits reflect the state of the SDMA RISC engine. Its states are as follows:</p> <ul style="list-style-type: none"> • The "Program" state is the usual instruction execution cycle. • The "Data" state is inserted when there are wait-states during a load or a store on the data bus (ld or st). • The "Change of Flow" state is the second cycle of any instruction that breaks the sequence of instructions (jumps and channel switching instructions). • The "Change of Flow in Loop" state is used when an error causes a hardware loop exit. • The "Debug" state means the SDMA is in debug mode. • The "Functional Unit" state is inserted when there are wait-states during a load or a store on the functional units bus (ldf or stf). • In "Sleep" modes, no script is running (this is the RISC engine idle state). The "after Reset" is slightly different because no context restoring phase will happen when a channel is triggered: The script located at address 0 will be executed (boot operation). • The "in Sleep" states are the same as above except they do not have any corresponding channel: They are used when entering debug mode after reset. The reason is that it is necessary to return to the "Sleep after Reset" state when leaving debug mode. <p>0 Program 1 Data 2 Change of Flow 3 Change of Flow in Loop 4 Debug 5 Functional Unit 6 Sleep 7 Save 8 Program in Sleep 9 Data in Sleep 10 Change of Flow in Sleep 11 Change Flow in Loop in Sleep 12 Debug in Sleep 13 Functional Unit in Sleep 14 Sleep after Reset 15 Restore</p>
11 RCV	After each write access to the real time buffer (RTB), the RCV bit is set. This bit is cleared after execution of an <code>rbuffer</code> command and on a JTAG reset.
10 EDR	This flag is raised when the SDMA has entered debug mode after an external debug request.
9 ODR	This flag is raised when the SDMA has entered debug mode after a OnCE debug request.
8 SWB	This flag is raised when the SDMA has entered debug mode after a software breakpoint.
7 MST	<p>This flag is raised when the OnCE is controlled from the Arm platform peripheral interface.</p> <p>0 The JTAG interface controls the OnCE. 1 The Arm platform peripheral interface controls the OnCE.</p>
6–3 Reserved	This read-only field is reserved and always has the value 0.

Table continues on the next page...

SDMAARM_ONCE_STAT field descriptions (continued)

Field	Description
ECDR	<p>Event Cell Debug Request. If the debug request comes from the event cell, the reason for entering debug mode is given by the EDR bits. If all three bits of the EDR are reset, then it did not generate any debug request. If the cell did generate a debug request, then at least one of the EDR bits is set (the meaning of the encoding is given below). The encoding of the EDR bits is useful to find out more precisely why the debug request was generated. A debug request from an event cell is generated for a specific combination of the addra_cond, addrb_cond, and data_cond conditions. The value of those fields is given by the EDR bits.</p> <p>0 1 matched addra_cond 1 1 matched addrb_cond 2 1 matched data_cond</p>

46.8.20 OnCE Command Register (SDMAARM_ONCE_CMD)

Address: 20E_C000h base + 50h offset = 20E_C050h

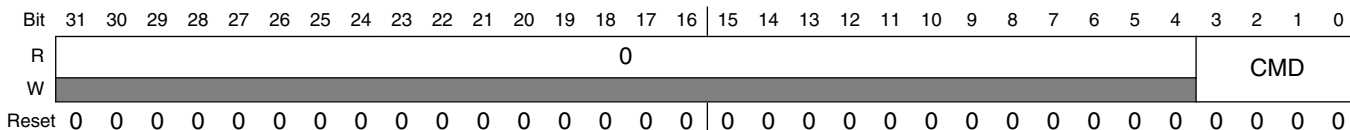

SDMAARM_ONCE_CMD field descriptions

Field	Description
31–4 Reserved	This read-only field is reserved and always has the value 0.
CMD	<p>Writing to this register will cause the OnCE to execute the command that is written. When needed, the ONCE_DATA and ONCE_INSTR registers should be loaded with the correct value before writing the command to that register. For a list of the OnCE commands and their usage, see OnCE and Real-Time Debug.</p> <p>NOTE: 7-15 reserved</p> <p>0 rstatus 1 dmov 2 exec_once 3 run_core 4 exec_core 5 debug_rqst 6 rbuffer</p>

46.8.21 Illegal Instruction Trap Address (SDMAARM_ILLINSTADDR)

Address: 20E_C000h base + 58h offset = 20E_C058h

Bit	31	30	29	28	27	26	25	24	23	22	21	20	19	18	17	16	15	14	13	12	11	10	9	8	7	6	5	4	3	2	1	0
R	0																ILLINSTADDR															
W	0																0															
Reset	0	0	0	0	0	0	0	0	0	0	0	0	0	0	0	0	0	0	0	0	0	0	0	0	0	0	0	0	0	0	0	1

SDMAARM_ILLINSTADDR field descriptions

Field	Description
31–14 Reserved	This read-only field is reserved and always has the value 0.
ILLINSTADDR	The Illegal Instruction Trap Address is the address where the SDMA jumps when an illegal instruction is executed. It is 0x0001 after reset. The value of ILLINSTADDR cannot be changed if the LOCK bit in the SDMA_LOCK register is set.

46.8.22 Channel 0 Boot Address (SDMAARM_CHN0ADDR)

Address: 20E_C000h base + 5Ch offset = 20E_C05Ch

Bit	31	30	29	28	27	26	25	24	23	22	21	20	19	18	17	16
R	0															
W	0															
Reset	0	0	0	0	0	0	0	0	0	0	0	0	0	0	0	0
Bit	15	14	13	12	11	10	9	8	7	6	5	4	3	2	1	0
R	0	SMSZ	CHN0ADDR													
W	0		0													
Reset	0	0	0	0	0	0	0	0	0	1	0	1	0	0	0	0

SDMAARM_CHN0ADDR field descriptions

Field	Description
31–15 Reserved	This read-only field is reserved and always has the value 0.
14 SMSZ	The bit 14 (Scratch Memory Size) determines if scratch memory must be available after every channel context. After reset, it is equal to 0, which defines a RAM space of 24 words for each channel. All of this area stores the channel context. By setting this bit, 32 words are reserved for every channel context,

Table continues on the next page...

SDMAARM_CHN0ADDR field descriptions (continued)

Field	Description
	<p>which gives eight additional words that can be used by the channel script to store any type of data. Those words are never erased by the context switching mechanism.</p> <p>The value of SMSZ cannot be changed if the LOCK bit in the SDMA_LOCK register is set.</p> <p>0 24 words per context 1 32 words per context</p>
CHN0ADDR	<p>This 14-bit register is used by the boot code of the SDMA. After reset, it points to the standard boot routine in ROM (channel 0 routine). By changing this address, you can perform a boot sequence with your own routine. The very first instructions of the boot code fetch the contents of this register (it is also mapped in the SDMA memory space) and jump to the given address. The reset value is 0x0050 (decimal 80).</p> <p>The value of CHN0ADDR cannot be changed if the LOCK bit in the SDMA_LOCK register is set.</p>

46.8.23 DMA Requests (SDMAARM_EVT_MIRROR)

Address: 20E_C000h base + 60h offset = 20E_C060h

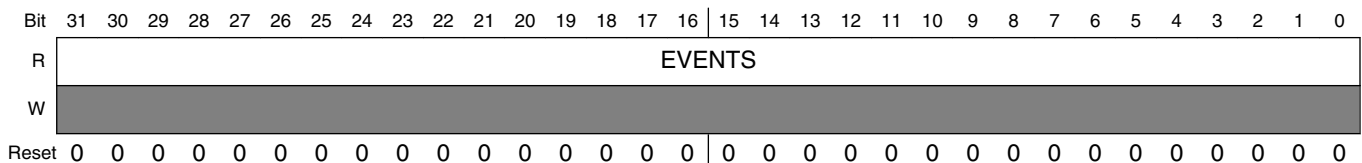

SDMAARM_EVT_MIRROR field descriptions

Field	Description
EVENTS	<p>This register reflects the DMA requests received by the SDMA for events 31-0. The Arm platform and the SDMA have a read-only access. There is one bit associated with each of 32 DMA request events. This information may be useful during debug of the blocks that generate the DMA requests. The EVT_MIRROR register is cleared following read access.</p> <p>0 DMA request event not pending 1 DMA request event pending</p>

46.8.24 DMA Requests 2 (SDMAARM_EVT_MIRROR2)

Address: 20E_C000h base + 64h offset = 20E_C064h

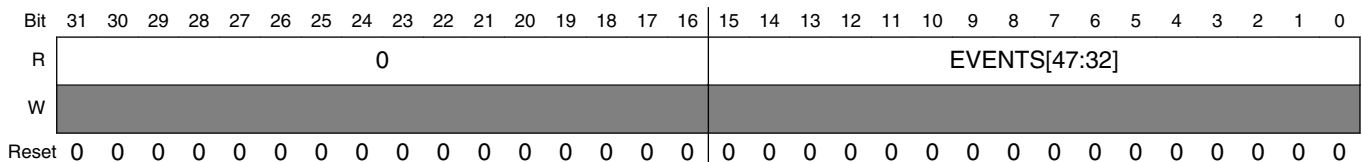

SDMAARM_EVT_MIRROR2 field descriptions

Field	Description
31–16 Reserved	This read-only field is reserved and always has the value 0.
EVENTS[47:32]	This register reflects the DMA requests received by the SDMA for events 47-32. The Arm platform and the SDMA have a read-only access. There is one bit associated with each of DMA request events. This information may be useful during debug of the blocks that generate the DMA requests. The EVT_MIRROR2 register is cleared following read access. 0 - DMA request event not pending 1- DMA request event pending

46.8.25 Cross-Trigger Events Configuration Register 1 (SDMAARM_XTRIG_CONF1)

Address: 20E_C000h base + 70h offset = 20E_C070h

Bit	31	30	29	28	27	26	25	24	23	22	21	20	19	18	17	16
R	0	CNF3	NUM3[5:0]					0	CNF2	NUM2[5:0]						
W																
Reset	0	0	0	0	0	0	0	0	0	0	0	0	0	0	0	0
Bit	15	14	13	12	11	10	9	8	7	6	5	4	3	2	1	0
R	0	CNF1	NUM1[5:0]					0	CNF0	NUM0[5:0]						
W																
Reset	0	0	0	0	0	0	0	0	0	0	0	0	0	0	0	0

SDMAARM_XTRIG_CONF1 field descriptions

Field	Description
31 Reserved	This read-only field is reserved and always has the value 0.
30 CNF3	Configuration of the SDMA event line number <i>i</i> that is connected to the cross-trigger. It determines whether the event line pulse is generated by the reception of a DMA request or by the starting of a channel script execution. 0 channel 1 DMA request
29–24 NUM3[5:0]	Contains the number of the DMA request or channel that triggers the pulse on the cross-trigger event line number <i>i</i> .
23 Reserved	This read-only field is reserved and always has the value 0.

Table continues on the next page...

SDMAARM_XTRIG_CONF1 field descriptions (continued)

Field	Description
22 CNF2	Configuration of the SDMA event line number <i>i</i> that is connected to the cross-trigger. It determines whether the event line pulse is generated by receiving a DMA request or by starting a channel script execution. 0 channel 1 DMA request
21–16 NUM2[5:0]	Contains the number of the DMA request or channel that triggers the pulse on the cross-trigger event line number <i>i</i> .
15 Reserved	This read-only field is reserved and always has the value 0.
14 CNF1	Configuration of the SDMA event line number <i>i</i> that is connected to the cross-trigger. It determines whether the event line pulse is generated by receiving a DMA request or by starting a channel script execution. 0 channel 1 DMA request
13–8 NUM1[5:0]	Contains the number of the DMA request or channel that triggers the pulse on the cross-trigger event line number <i>i</i> .
7 Reserved	This read-only field is reserved and always has the value 0.
6 CNF0	Configuration of the SDMA event line number <i>i</i> that is connected to the cross-trigger. It determines whether the event line pulse is generated by receiving a DMA request or by starting a channel script execution. 0 channel 1 DMA request
NUM0[5:0]	Contains the number of the DMA request or channel that triggers the pulse on the cross-trigger event line number <i>i</i> .

46.8.26 Cross-Trigger Events Configuration Register 2 (SDMAARM_XTRIG_CONF2)

Address: 20E_C000h base + 74h offset = 20E_C074h

Bit	31	30	29	28	27	26	25	24	23	22	21	20	19	18	17	16
R	0	CNF7	NUM7[5:0]						0	CNF6	NUM6[5:0]					
W																
Reset	0	0	0	0	0	0	0	0	0	0	0	0	0	0	0	0
Bit	15	14	13	12	11	10	9	8	7	6	5	4	3	2	1	0
R	0	CNF5	NUM5[5:0]						0	CNF4	NUM4[5:0]					
W																
Reset	0	0	0	0	0	0	0	0	0	0	0	0	0	0	0	0

SDMAARM_XTRIG_CONF2 field descriptions

Field	Description
31 Reserved	This read-only field is reserved and always has the value 0.
30 CNF7	Configuration of the SDMA event line number i that is connected to the cross-trigger. It determines whether the event line pulse is generated by receiving a DMA request or by starting a channel script execution. 0 channel 1 DMA request
29–24 NUM7[5:0]	Contains the number of the DMA request or channel that triggers the pulse on the cross-trigger event line number i .
23 Reserved	This read-only field is reserved and always has the value 0.
22 CNF6	Configuration of the SDMA event line number i that is connected to the cross-trigger. It determines whether the event line pulse is generated by receiving a DMA request or by starting a channel script execution. 0 channel 1 DMA request
21–16 NUM6[5:0]	Contains the number of the DMA request or channel that triggers the pulse on the cross-trigger event line number i .
15 Reserved	This read-only field is reserved and always has the value 0.
14 CNF5	Configuration of the SDMA event line number i that is connected to the cross-trigger. It determines whether the event line pulse is generated by receiving a DMA request or by starting a channel script execution

Table continues on the next page...

SDMAARM_XTRIG_CONF2 field descriptions (continued)

Field	Description
	0 channel 1 DMA request
13–8 NUM5[5:0]	Contains the number of the DMA request or channel that triggers the pulse on the cross-trigger event line number <i>i</i> .
7 Reserved	This read-only field is reserved and always has the value 0.
6 CNF4	Configuration of the SDMA event line number <i>i</i> that is connected to the cross-trigger. It determines whether the event line pulse is generated by receiving a DMA request or by starting a channel script execution. 0 channel 1 DMA request
NUM4[5:0]	Contains the number of the DMA request or channel that triggers the pulse on the cross-trigger event line number <i>i</i> .

46.8.27 Channel Priority Registers (SDMAARM_SDMA_CHNPRIn)

Address: 20E_C000h base + 100h offset + (4d × i), where i=0d to 31d

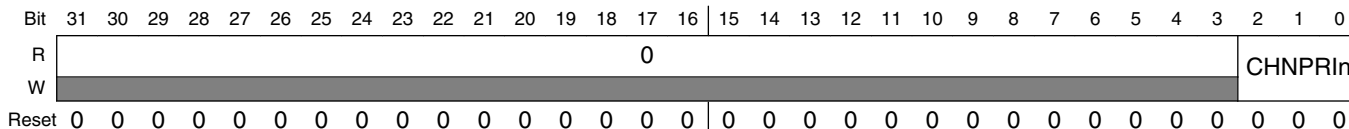

SDMAARM_SDMA_CHNPRIn field descriptions

Field	Description
31–3 Reserved	This read-only field is reserved and always has the value 0.
CHNPRIn	This contains the priority of channel number <i>n</i> . Useful values are between 1 and 7; 0 is reserved by the SDMA hardware to determine when there is no pending channel. Reset value is 0, which prevents the channels from starting.

46.8.28 Channel Enable RAM (SDMAARM_CHNENBLn)

Address: 20E_C000h base + 200h offset + (4d × i), where i=0d to 47d

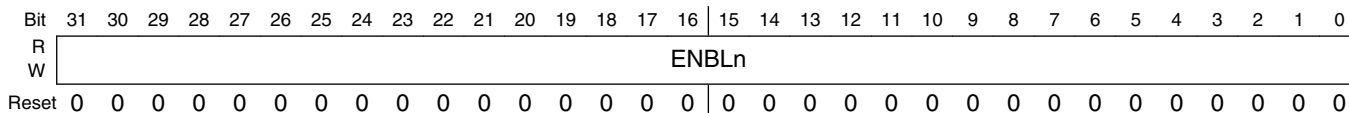

SDMAARM_CHNENBL n field descriptions

Field	Description
ENBL n	This 32-bit value selects the channels that are triggered by the DMA request number n . If ENBL n [i] is set to 1, bit EP[i] will be set when the DMA request n is received. These 48 32-bit registers are physically located in a RAM, with no known reset value. It is thus essential for the Arm platform to program them before any DMA request is triggered to the SDMA, otherwise an unpredictable combination of channels may be started.

46.9 BP Memory Map and Control Register Definitions

The following section describes SDMA control registers available to the BP.

NOTE

These registers are physically implemented in all platforms, but are not accessible when the SDMA BP control port is not connected. Reset values are calculated to allow the system to work when those registers cannot be accessed.

All registers are clocked with the SDMA clock (which means the SDMA clock must be running when the BP wants to access any register).

SDMABP memory map

Absolute address (hex)	Register name	Width (in bits)	Access	Reset value	Section/page
0	Channel 0 Pointer (SDMABP_DC0PTR)	32	R/W	0000_0000h	46.9.1/3359
4	Channel Interrupts (SDMABP_INTR)	32	w1c	0000_0000h	46.9.2/3360
8	Channel Stop/Channel Status (SDMABP_STOP_STAT)	32	R/W	0000_0000h	46.9.3/3360
C	Channel Start (SDMABP_DSTART)	32	R	0000_0000h	46.9.4/3361
28	DMA Request Error Register (SDMABP_EVTERR)	32	R	0000_0000h	46.9.5/3361
2C	Channel DSP Interrupt Mask (SDMABP_INTRMASK)	32	R/W	0000_0000h	46.9.6/3362
34	DMA Request Error Register (SDMABP_EVTERRDBG)	32	R	0000_0000h	46.9.7/3362

46.9.1 Channel 0 Pointer (SDMABP_DC0PTR)

Address: 0h base + 0h offset = 0h

Bit	31	30	29	28	27	26	25	24	23	22	21	20	19	18	17	16	15	14	13	12	11	10	9	8	7	6	5	4	3	2	1	0
R																																
W																																
Reset	0	0	0	0	0	0	0	0	0	0	0	0	0	0	0	0	0	0	0	0	0	0	0	0	0	0	0	0	0	0	0	0

SDMABP_DC0PTR field descriptions

Field	Description
DC0PTR	Channel 0 Pointer contains the 32-bit address, in BP memory, of the array of channel control blocks starting with the one for channel 0 (the control channel). This register should be initialized by the BP before it enables a channel (for example, channel 0). See the API document SDMA Scripts User Manual for the use of this register. The BP has a read/write access and the SDMA has a read-only access.

46.9.2 Channel Interrupts (SDMABP_INTR)

Address: 0h base + 4h offset = 4h

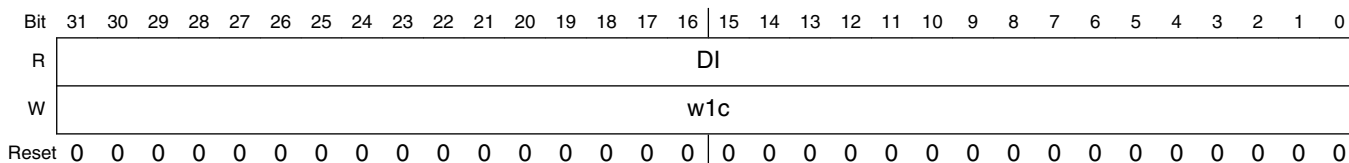

SDMABP_INTR field descriptions

Field	Description
DI	The BP Interrupts register contains the 32 DI[i] bits. If any bit is set, it will cause an interrupt to the BP. <ul style="list-style-type: none"> This register is a "write-ones" register to the BP. When the BP sets a bit in this register, the corresponding DI[i] bit is cleared. The interrupt service routine should clear individual channel bits when their interrupts are serviced; failure to do so will cause continuous interrupts. The SDMA is responsible for setting the DI[i] bit corresponding to the current channel when the corresponding <code>done</code> instruction is executed.

46.9.3 Channel Stop/Channel Status (SDMABP_STOP_STAT)

Address: 0h base + 8h offset = 8h

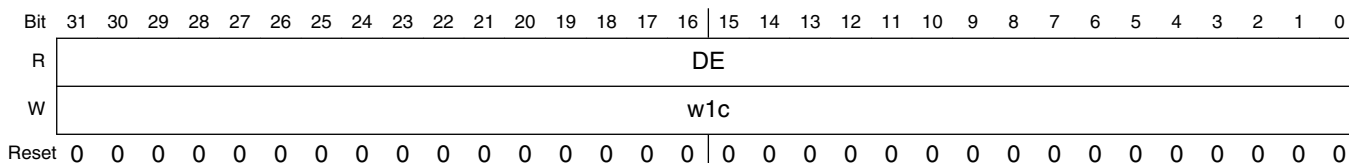

SDMABP_STOP_STAT field descriptions

Field	Description
DE	This 32-bit register gives access to the BP (DSP) Enable bits, DE. There is one bit for every channel. <ul style="list-style-type: none"> This register is a "write-ones" register to the BP. When the BP writes 1 in bit <i>i</i> of this register, it clears the DE[i] and DSTART[i] bits. Reading this register yields the current state of the DE[i] bits.

46.9.4 Channel Start (SDMABP_DSTART)

Address: 0h base + Ch offset = Ch

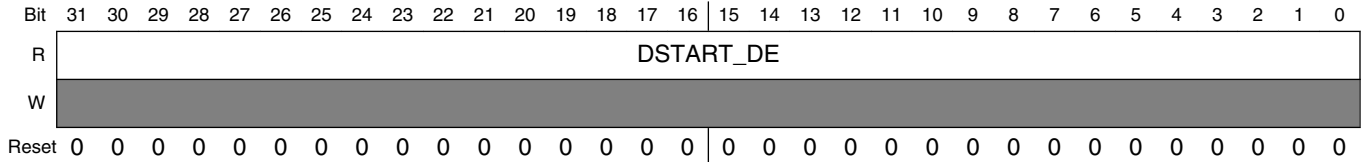

SDMABP_DSTART field descriptions

Field	Description
DSTART_DE	<p>The DSTART_DE registers are 32 bits wide with one bit for every channel.</p> <ul style="list-style-type: none"> When a bit is written to 1, it enables the corresponding channel. Two physical registers are accessed with that address (DSTART and DE), which enables the BP to trigger a channel a second time before the first trigger was processed. This register is a "write-ones" register to the BP. Neither DSTART[i] bit can be set while the corresponding DE[i] bit is cleared. When the BP tries to set the DSTART[i] bit by writing a one (if the corresponding DE[i] bit is clear), the bit in the DSTART[i] register will remain cleared and the DE[i] bit will be set. If the corresponding DE[i] bit was already set, the DSTART[i] bit will be set. The next time the SDMA channel <i>i</i> attempts to clear the DE[i] bit by means of a <code>done</code> instruction, the bit in the DSTART[i] register will be cleared and the DE[i] bit will take the old value of the DSTART[i] bit. Reading this register yields the current state of the DSTART[i] bits. This mechanism enables the BP to pipeline two DSTART commands per channel.

46.9.5 DMA Request Error Register (SDMABP_EVTERR)

Address: 0h base + 28h offset = 28h

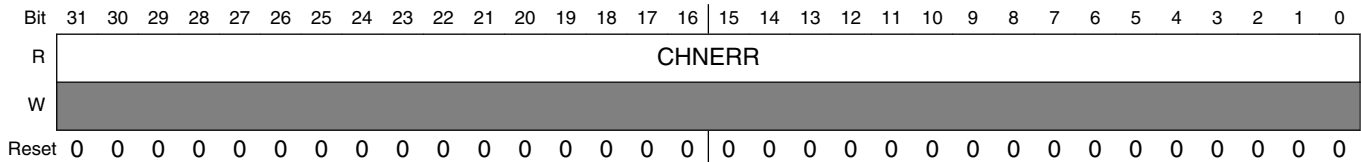

SDMABP_EVTERR field descriptions

Field	Description
CHNERR	<p>This register is used by the SDMA to warn the BP when an incoming DMA request was detected; it then triggers a channel that is already pending or being serviced, which may mean there is an overflow of data for that channel. An interrupt is sent to the BP if the corresponding channel bit is set in the INTRMASK register.</p> <ul style="list-style-type: none"> This is a "write-ones" register for the scheduler. It is only able to set the flags. The flags are cleared when the register is read by the BP or during an SDMA reset. The CHNERR[i] bit is set when a DMA request that triggers channel <i>i</i> is received through the corresponding input pins and the EP[i] bit is already set. The EVTERR[i] bit is unaffected if the BP tries to set the EP[i] bit when that EP[i] bit is already set.

46.9.6 Channel DSP Interrupt Mask (SDMABP_INTRMASK)

Address: 0h base + 2Ch offset = 2Ch

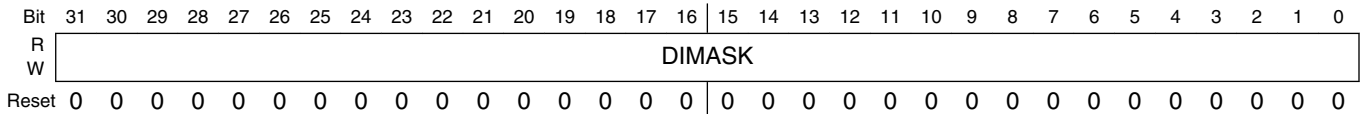

SDMABP_INTRMASK field descriptions

Field	Description
DIMASK	The Interrupt Mask Register contains 32 interrupt generation mask bits. If bit DIMASK[i] is set, the DI[i] bit is set and an interrupt is sent to the BP when a DMA request error is detected on channel <i>i</i> (for example, EVTERR[i] is set).

46.9.7 DMA Request Error Register (SDMABP_EVTERRDBG)

Address: 0h base + 34h offset = 34h

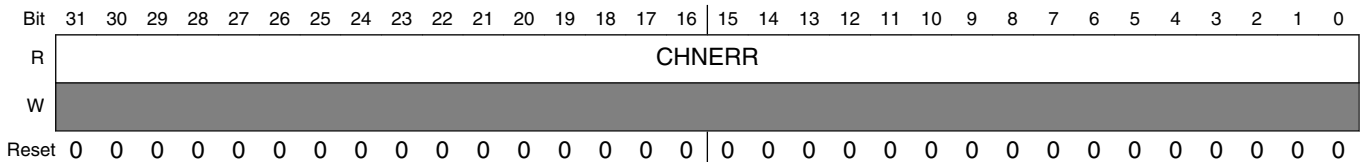

SDMABP_EVTERRDBG field descriptions

Field	Description
CHNERR	This register is the same as EVTERR except reading it does not clear its contents. This address is meant to be used in debug mode. The BP OnCE may check this register value without modifying it.

46.10 SDMA Internal (Core) Memory Map and Internal Register Definitions

The actual SDMA memory mapped registers are summarized in the following sections; for peripherals' memory maps, refer to the respective chapters.

The following definitions serve as a key for the SDMA internal register summary.

SDMACORE memory map

Absolute address (hex)	Register name	Width (in bits)	Access	Reset value	Section/page
201_C000	Arm platform Channel 0 Pointer (SDMACORE_MC0PTR)	32	R	0000_0000h	46.10.1/3364
201_C008	Current Channel Pointer (SDMACORE_CCPTTR)	32	R	0000_0000h	46.10.2/3364
201_C00C	Current Channel Register (SDMACORE_CCR)	32	R	0000_0000h	46.10.3/3364
201_C010	Highest Pending Channel Register (SDMACORE_NCR)	32	R	0000_0000h	46.10.4/3365
201_C014	External DMA Requests Mirror (SDMACORE_EVENTS)	32	R	0000_0000h	46.10.5/3366
201_C018	Current Channel Priority (SDMACORE_CCPRI)	32	R	0000_0000h	46.10.6/3367
201_C01C	Next Channel Priority (SDMACORE_NCPRI)	32	R	0000_0000h	46.10.7/3367
201_C020	OnCE Event Cell Counter (SDMACORE_ECOUNT)	32	R/W	0000_0000h	46.10.8/3368
201_C024	OnCE Event Cell Control Register (SDMACORE_ECTL)	32	R/W	0000_0000h	46.10.9/3368
201_C028	OnCE Event Address Register A (SDMACORE_EAA)	32	R/W	0000_0000h	46.10.10/3370
201_C02C	OnCE Event Cell Address Register B (SDMACORE_EAB)	32	R/W	0000_0000h	46.10.11/3370
201_C030	OnCE Event Cell Address Mask (SDMACORE_EAM)	32	R/W	0000_0000h	46.10.12/3370
201_C034	OnCE Event Cell Data Register (SDMACORE_ED)	32	R/W	0000_0000h	46.10.13/3371
201_C038	OnCE Event Cell Data Mask (SDMACORE_EDM)	32	R/W	0000_0000h	46.10.14/3371
201_C03C	OnCE Real-Time Buffer (SDMACORE_RTB)	32	R/W	0000_0000h	46.10.15/3372
201_C040	OnCE Trace Buffer (SDMACORE_TB)	32	R	0000_0000h	46.10.16/3372
201_C044	OnCE Status (SDMACORE_OSTAT)	32	R	0000_0000h	46.10.17/3373
201_C048	Channel 0 Boot Address (SDMACORE_MCHN0ADDR)	32	R	0000_0000h	46.10.18/3375
201_C04C	ENDIAN Status Register (SDMACORE_ENDIANNES)	32	R	0000_0001h	46.10.19/3376
201_C054	Lock Status Register (SDMACORE_SDMA_LOCK)	32	R	0000_0000h	46.10.20/3377
201_C058	External DMA Requests Mirror #2 (SDMACORE_EVENTS2)	32	R	0000_0000h	46.10.21/3378

46.10.1 Arm platform Channel 0 Pointer (SDMACORE_MC0PTR)

Address: 201_C000h base + 0h offset = 201_C000h

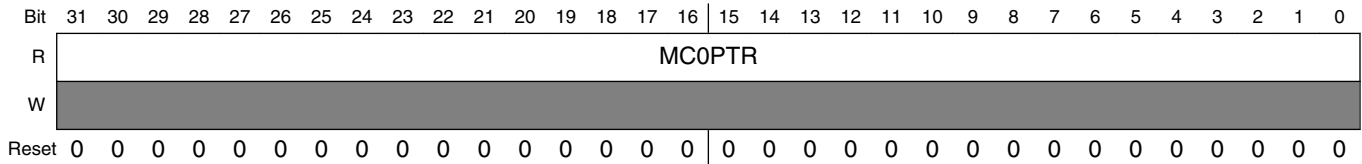

SDMACORE_MC0PTR field descriptions

Field	Description
MC0PTR	Contains the address-in the Arm platform memory space-of the initial SDMA context and scripts that are loaded by the SDMA boot script running on channel 0.

46.10.2 Current Channel Pointer (SDMACORE_CCPtr)

Address: 201_C000h base + 8h offset = 201_C008h

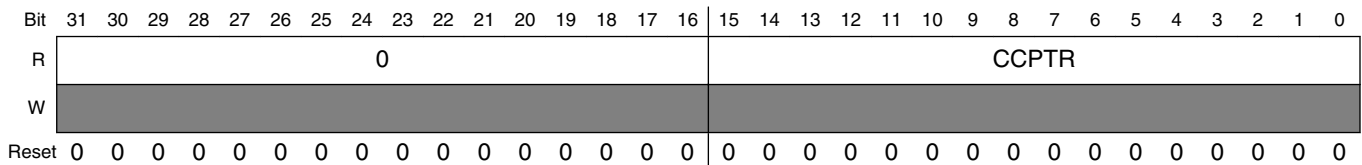

SDMACORE_CCPtr field descriptions

Field	Description
31–16 Reserved	This read-only field is reserved and always has the value 0.
CCPtr	Contains the start address of the context data for the current channel: Its value is <i>CONTEXT_BASE</i> + 24* <i>CCR</i> or <i>CONTEXT_BASE</i> + 32* <i>CCR</i> where <i>CONTEXT_BASE</i> = 0x0800. The value 24 or 32 is selected according to the programmed channel scratch RAM size in the register shown in Channel 0 Boot Address (SDMAARM_CHN0ADDR) .

46.10.3 Current Channel Register (SDMACORE_CCR)

Address: 201_C000h base + Ch offset = 201_C00Ch

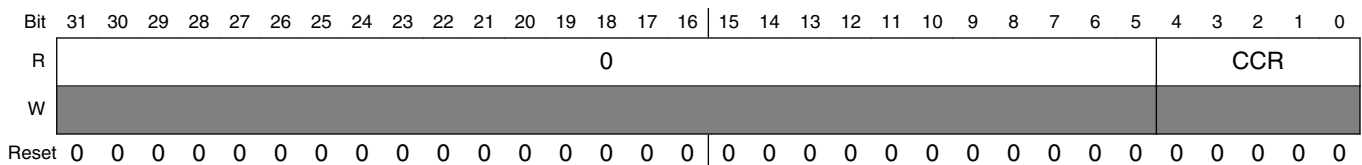

SDMACORE_CCR field descriptions

Field	Description
31–5 Reserved	This read-only field is reserved and always has the value 0.
CCR	Contains the number of the current running channel whose context is installed. In the case that the SDMA has finished running the channel and has entered sleep state, CCR will indicate the previous running channel. The PST bits in the OSTAT register indicate when the SDMA is in sleep state.

46.10.4 Highest Pending Channel Register (SDMACORE_NCR)

Address: 201_C000h base + 10h offset = 201_C010h

Bit	31	30	29	28	27	26	25	24	23	22	21	20	19	18	17	16	15	14	13	12	11	10	9	8	7	6	5	4	3	2	1	0
R	0																NCR															
W	[Shaded]																															
Reset	0	0	0	0	0	0	0	0	0	0	0	0	0	0	0	0	0	0	0	0	0	0	0	0	0	0	0	0	0	0	0	0

SDMACORE_NCR field descriptions

Field	Description
31–5 Reserved	This read-only field is reserved and always has the value 0.
NCR	Contains the number of the pending channel that the scheduler has selected to run next.

46.10.5 External DMA Requests Mirror (SDMACORE_EVENTS)

NOTE

This register is very useful in the case of DMA requests that are active when a peripheral FIFO level is above the programmed watermark. The activation of the DMA request (rising edge) is detected by the SDMA logic and it can enable one or several channels. One of the channels accesses the peripheral and reads or writes a number of data that matches the watermark level (for example, if the watermark is four words, the channel reads or writes four words).

If the channel is effectively executed long after the DMA request was received, reading or writing the watermark number of data may not be sufficient to reset the DMA request (for example, if the FIFO watermark is four and at the channel execution it already contains nine pieces of data). This means no new rising edge may be detected by the SDMA, although there still remains transfers to perform. Therefore, if the channel were terminated at that time, it would not be restarted, causing potential overrun or underrun of the peripheral.

The proposed mechanism is for the channel to check this register after it has performed the "watermark" number of accesses to the peripheral. If the bit for the DMA request that triggers this channel is set, it means there is still another watermark number of data to transfer. This goes on until the bit is cleared. The same script can be used for multiple channels that require this behavior. The script can determine its channel number from the CCR register and infer the corresponding DMA request bit to check. It needs a reference table that is coherent with the request-channel matrix that the Arm platform programmed.

Address: 201_C000h base + 14h offset = 201_C014h

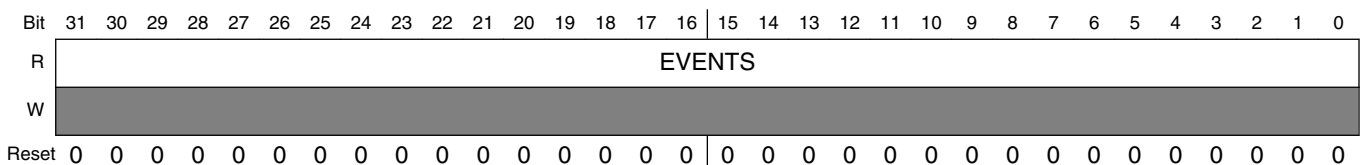

SDMACORE_EVENTS field descriptions

Field	Description
EVENTS	Reflects the status of the SDMA's external DMA requests. It is meant to allow any channel to monitor the states of these SDMA inputs. This register displays EVENTS 0-31. The EVENTS2 register displays events 32-47.

46.10.6 Current Channel Priority (SDMACORE_CCPRI)

Address: 201_C000h base + 18h offset = 201_C018h

Bit	31	30	29	28	27	26	25	24	23	22	21	20	19	18	17	16	15	14	13	12	11	10	9	8	7	6	5	4	3	2	1	0
R	0															CCPRI																
W																																
Reset	0	0	0	0	0	0	0	0	0	0	0	0	0	0	0	0	0	0	0	0	0	0	0	0	0	0	0	0	0	0	0	0

SDMACORE_CCPRI field descriptions

Field	Description
31–3 Reserved	This read-only field is reserved and always has the value 0.
CCPRI	Contains the 3-bit priority of the channel whose context is installed. It is 0 when no channel is running. NOTE: 1-7 current channel priority 0 no running channel

46.10.7 Next Channel Priority (SDMACORE_NCPRI)

Address: 201_C000h base + 1Ch offset = 201_C01Ch

Bit	31	30	29	28	27	26	25	24	23	22	21	20	19	18	17	16	15	14	13	12	11	10	9	8	7	6	5	4	3	2	1	0
R	0															NCPRI																
W																																
Reset	0	0	0	0	0	0	0	0	0	0	0	0	0	0	0	0	0	0	0	0	0	0	0	0	0	0	0	0	0	0	0	0

SDMACORE_NCPRI field descriptions

Field	Description
31–3 Reserved	This read-only field is reserved and always has the value 0.
NCPRI	Contains the 3-bit priority of the channel the scheduler has selected to run next. It is 0 when no other channel is pending.

46.10.8 OnCE Event Cell Counter (SDMACORE_ECOUNT)

Address: 201_C000h base + 20h offset = 201_C020h

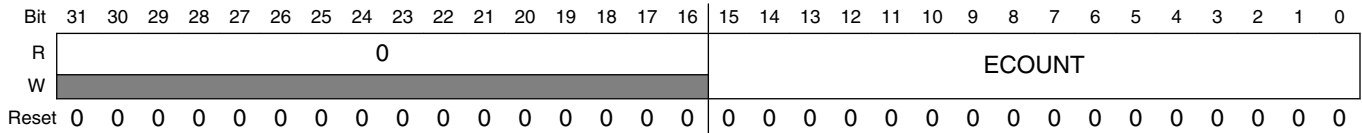

SDMACORE_ECOUNT field descriptions

Field	Description
31–16 Reserved	This read-only field is reserved and always has the value 0.
ECOUNT	The event cell counter contains the number of times minus one that an event detection must occur before generating a debug request. <ul style="list-style-type: none"> This register should be written before any attempt to use the event detection counter during an event detection process. The counter is cleared on a JTAG reset.

46.10.9 OnCE Event Cell Control Register (SDMACORE_ECTL)

Address: 201_C000h base + 24h offset = 201_C024h

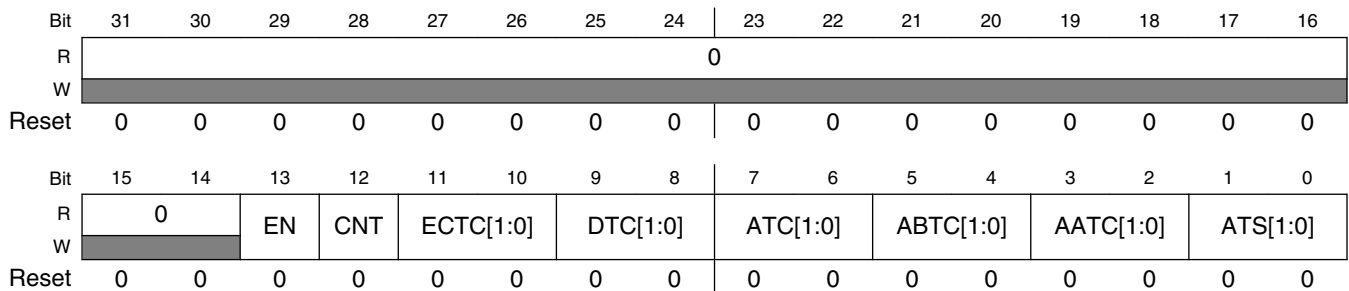

SDMACORE_ECTL field descriptions

Field	Description
31–14 Reserved	This read-only field is reserved and always has the value 0.
13 EN	Event Cell Enable. If the EN bit is set, the event cell is allowed to generate debug requests (the cell is awakened). If it is cleared, the event detection unit is disabled and no hardware breakpoint is generated, but matching conditions are still reflected on the emulation pin. 0 Cell is disabled. 1 Cell is enabled.
12 CNT	Event Counter Enable. The event counter enable bit determines if the cell counter is used during the event detection. In order to use the event counter during an event detection process, the event cell counter register should be loaded with a value equal to the number of times minus one that an event occurs before

Table continues on the next page...

SDMACORE_ECTL field descriptions (continued)

Field	Description
	<p>a debug request is sent. After every event detection, the counter is decreased. When the counter reaches the value 0, the event detection cell sends a debug request to the core. The event counter register should be written and the EN bit should be set before each new event detection process uses the event counter.</p> <p>0 Counter is disabled. 1 Counter is enabled.</p>
11–10 ECTC[1:0]	<p>The event cell trigger condition bits select the combination of address and data matching conditions that generate the final address/data condition. During program execution, if this event cell trigger condition goes to 1, a debug request is sent to the SDMA. The EN bit must be set to enable the debug request generation.</p> <p>00 address ONLY 01 data ONLY 10 address AND data 11 address OR data</p>
9–8 DTC[1:0]	<p>The data trigger condition bits define when data is considered matching after comparison with the data register of the event detection unit. The operations are performed on unsigned values.</p> <p>00 equal 01 not equal 10 greater than 11 less than</p>
7–6 ATC[1:0]	<p>The address trigger condition bits select how the two address conditions (addressA and addressB) are combined to define the global address matching condition. The supported combinations are described, as follows.</p> <p>00 addressA ONLY 01 addrA AND addrB 10 addrA OR addrB 11 reserved</p>
5–4 ABTC[1:0]	<p>The Address B Trigger Condition (ABTC) controls the operations performed by address comparator B. All operations are performed on unsigned values. This comparator B outputs the addressB condition.</p> <p>00 equal 01 not equal 10 greater than 11 less than</p>
3–2 AATC[1:0]	<p>The Address A Trigger Condition (AATC) controls the operations performed by address comparator A. All operations are performed on unsigned values. This comparator A outputs the addressA condition.</p> <p>00 equal 01 not equal 10 greater than 11 less than</p>
ATS[1:0]	<p>The access type select bits define the memory access type required on the SDMA memory bus.</p> <p>00 read ONLY 01 write ONLY 10 read or write 11 -</p>

46.10.10 OnCE Event Address Register A (SDMACORE_EAA)

Address: 201_C000h base + 28h offset = 201_C028h

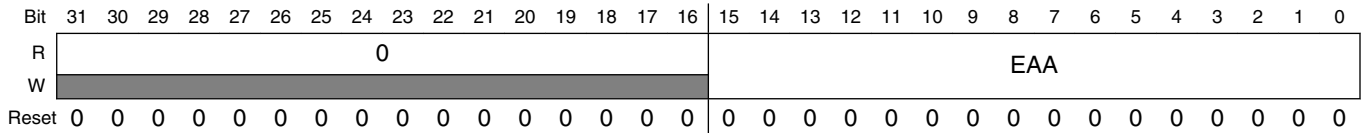

SDMACORE_EAA field descriptions

Field	Description
31–16 Reserved	This read-only field is reserved and always has the value 0.
EAA	Event Cell Address Register A computes an address A condition. It is cleared on a JTAG reset.

46.10.11 OnCE Event Cell Address Register B (SDMACORE_EAB)

Address: 201_C000h base + 2Ch offset = 201_C02Ch

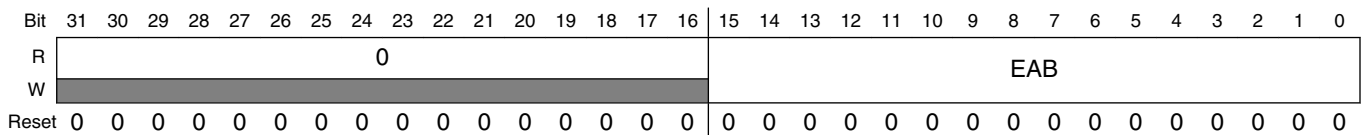

SDMACORE_EAB field descriptions

Field	Description
31–16 Reserved	This read-only field is reserved and always has the value 0.
EAB	Event Cell Address Register B computes an address B condition. It is cleared on a JTAG reset.

46.10.12 OnCE Event Cell Address Mask (SDMACORE_EAM)

Address: 201_C000h base + 30h offset = 201_C030h

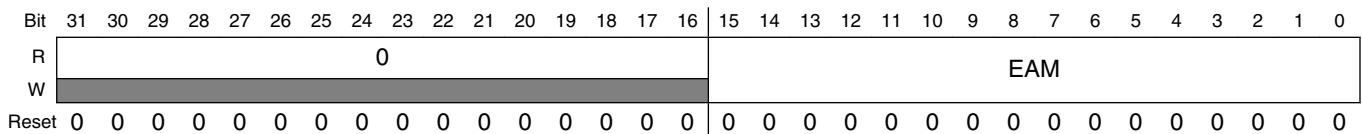

SDMACORE_EAM field descriptions

Field	Description
31–16 Reserved	This read-only field is reserved and always has the value 0.
EAM	The Event Cell Address Mask contains a user-defined address mask value. This mask is applied to the address value latched from the memory address bus before performing the address comparison. NOTE: There is a common address mask value for both address comparators. If bit <i>i</i> of this register is set, then bit <i>i</i> of the address value latched from the memory bus does not influence the result of the address comparison. The register is cleared on a JTAG reset.

46.10.13 OnCE Event Cell Data Register (SDMACORE_ED)

Address: 201_C000h base + 34h offset = 201_C034h

Bit	31	30	29	28	27	26	25	24	23	22	21	20	19	18	17	16	15	14	13	12	11	10	9	8	7	6	5	4	3	2	1	0
R																																
W																																
Reset	0	0	0	0	0	0	0	0	0	0	0	0	0	0	0	0	0	0	0	0	0	0	0	0	0	0	0	0	0	0	0	0

SDMACORE_ED field descriptions

Field	Description
ED	The event cell data register contains a user defined data value. This data value is an input for the data comparator which generates the data condition. It is cleared on a JTAG reset.

46.10.14 OnCE Event Cell Data Mask (SDMACORE_EDM)

Address: 201_C000h base + 38h offset = 201_C038h

Bit	31	30	29	28	27	26	25	24	23	22	21	20	19	18	17	16	15	14	13	12	11	10	9	8	7	6	5	4	3	2	1	0
R																																
W																																
Reset	0	0	0	0	0	0	0	0	0	0	0	0	0	0	0	0	0	0	0	0	0	0	0	0	0	0	0	0	0	0	0	0

SDMACORE_EDM field descriptions

Field	Description
EDM	The event cell data mask register contains the user-defined data mask value. <ul style="list-style-type: none"> This mask is applied to the data value latched from the memory bus before performing the data comparison. Setting bit <i>i</i> of the event cell data mask register means that bit <i>i</i> of the data value latched from the address bus does not influence the result of the data comparison. The data mask is cleared on a JTAG reset.

46.10.15 OnCE Real-Time Buffer (SDMACORE_RTB)

Address: 201_C000h base + 3Ch offset = 201_C03Ch

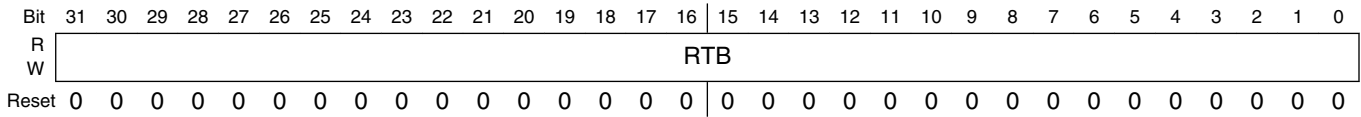

SDMACORE_RTB field descriptions

Field	Description
RTB	The Real Time Buffer register stores and retrieves run time information without putting the SDMA in debug mode. Writing to that register triggers a pulse on a specific real-time debug pin whose connection depends on the chip implementation. The RTB value can be accessed by the OnCE under Arm platform or JTAG control using the rbuffer command.

46.10.16 OnCE Trace Buffer (SDMACORE_TB)

Address: 201_C000h base + 40h offset = 201_C040h

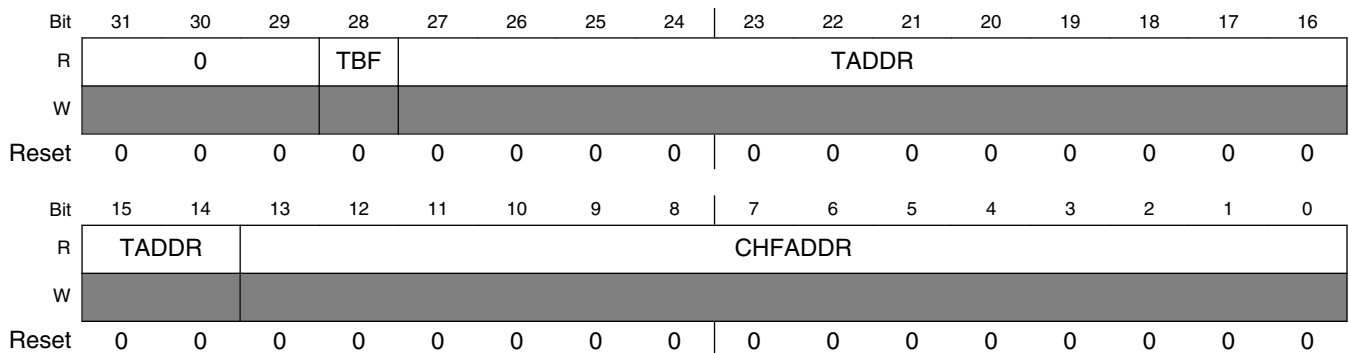

SDMACORE_TB field descriptions

Field	Description
31–29 Reserved	This read-only field is reserved and always has the value 0.
28 TBF	The Trace Buffer Flag is set when the buffer contains the addresses of a valid change of flow. The contents of the buffer should be ignored otherwise. 0 Invalid information 1 Valid information
27–14 TADDR	The target address is the address taken after the execution of the change of flow instruction.
CHFADDR	The change of flow address is the address where the change of flow is taken when executing a change of flow instruction.

46.10.17 OnCE Status (SDMACORE_OSTAT)

Address: 201_C000h base + 44h offset = 201_C044h

Bit	31	30	29	28	27	26	25	24		23	22	21	20	19	18	17	16
R	0																
W																	
Reset	0	0	0	0	0	0	0	0		0	0	0	0	0	0	0	0
Bit	15	14	13	12	11	10	9	8		7	6	5	4	3	2	1	0
R	PST[3:0]			RCV	EDR	ODR	SWB	MST	0			ECDR[2:0]					
W																	
Reset	0	0	0	0	0	0	0	0		0	0	0	0	0	0	0	0

SDMACORE_OSTAT field descriptions

Field	Description
31–16 Reserved	This read-only field is reserved and always has the value 0.
15–12 PST[3:0]	<p>The Processor Status bits reflect the state of the SDMA RISC engine.</p> <ul style="list-style-type: none"> The "Program" state is the usual instruction execution cycle. The "Data" state is inserted when there are wait-states during a load or a store on the data bus (ld or st). The "Change of Flow" state is the second cycle of any instruction that breaks the sequence of instructions (jumps and channel-switching instructions). The "Change of Flow in Loop" state is used when an error causes a hardware loop exit. The "Debug" state means the SDMA is in debug mode. The "Functional Unit" state is inserted when there are wait-states during a load or a store on the functional units bus (ldf or stf). In "Sleep" modes, no script is running (this is the RISC engine idle state). The "after Reset" is slightly different because no context restoring phase will happen when a channel is triggered: The script located at address 0 will be executed (boot operation). The "in Sleep" states are the same as above except they do not have any corresponding channel. They are used when entering debug mode after reset; the reason is that it is necessary to return to the "Sleep after Reset" state when leaving debug mode. <p>0 Program 1 Data 2 Change of Flow 3 Change of Flow in Loop 4 Debug 5 Functional Unit 6 Sleep 7 Save 8 Program in Sleep 9 Data in Sleep 10 Change of Flow in Sleep 11 Change Flow Loop Sleep 12 Debug in Sleep 13 Functional Unit in Sleep</p>

Table continues on the next page...

SDMACORE_OSTAT field descriptions (continued)

Field	Description
	14 Sleep after Reset 15 Restore
11 RCV	After each write access to the real time buffer (RTB), the RCV bit is set. This bit is cleared after execution of an <code>rbuffer</code> command and on a JTAG reset.
10 EDR	This flag is raised when the SDMA has entered debug mode after an external debug request.
9 ODR	This flag is raised when the SDMA has entered debug mode after a OnCE debug request.
8 SWB	This flag is raised when the SDMA has entered debug mode after a software breakpoint.
7 MST	This flag is raised when the OnCE is controlled from the Arm platform peripheral interface. 0 JTAG interface controls the OnCE. 1 Arm platform peripheral interface controls the OnCE.
6–3 Reserved	This read-only field is reserved and always has the value 0.
ECDR[2:0]	Event Cell Debug Request. If the debug request comes from the event cell, the reason for entering debug mode is given by the EDR bits. The encoding of the EDR bits is useful to find out more precisely why the debug request was generated. A debug request from an event cell is generated for a specific combination of the addressA, addressB, and data conditions; the value of those fields is given by the EDR bits. If all three bits of the EDR are reset, then it did not generate any debug request. If the cell did generate a debug request, then at least one EDR bit is set; the meaning of the encoding is as follows: 0 1 matched addressA condition 1 1 matched addressB condition 2 1 matched data condition

46.10.18 Channel 0 Boot Address (SDMACORE_MCHN0ADDR)

Address: 201_C000h base + 48h offset = 201_C048h

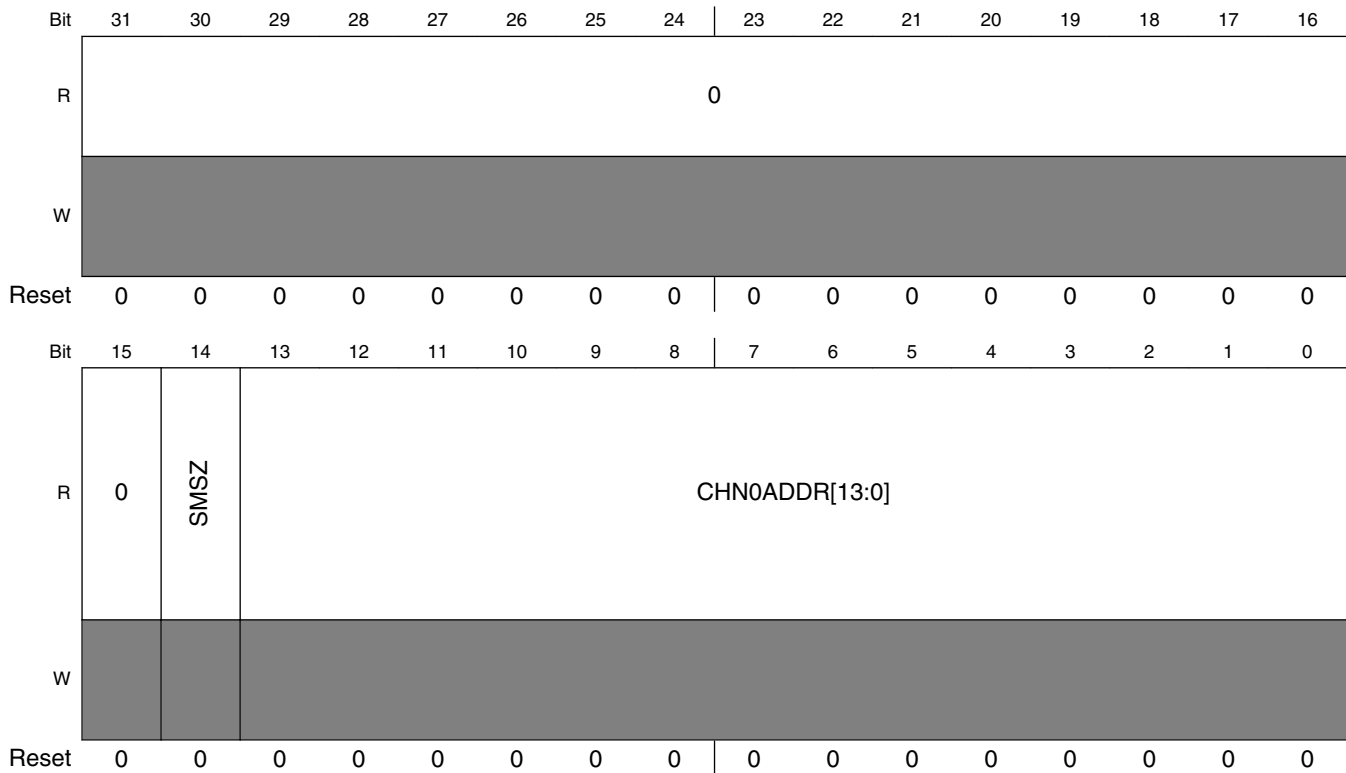

SDMACORE_MCHN0ADDR field descriptions

Field	Description
31–15 Reserved	This read-only field is reserved and always has the value 0.
14 SMSZ	The bit 14 (Scratch Memory Size) determines if scratch memory must be available after every channel context. After reset, it is equal to 0, which defines a RAM space of 24 words for each channel. All of this area stores the channel context. By setting this bit, 32 words are reserved for every channel context, which gives eight additional words that can be used by the channel script to store any type of data. Those words are never erased by the context switching mechanism. 0 24 words per context 1 32 words per context
CHN0ADDR[13:0]	Contains the address of the channel 0 routine programmed by the Arm platform; it is loaded into a general register at the very start of the boot and the SDMA jumps to the address it contains. By default, it points to the standard boot routine in ROM.

46.10.19 ENDIAN Status Register (SDMACORE_ENDIANNES)

Address: 201_C000h base + 4Ch offset = 201_C04Ch

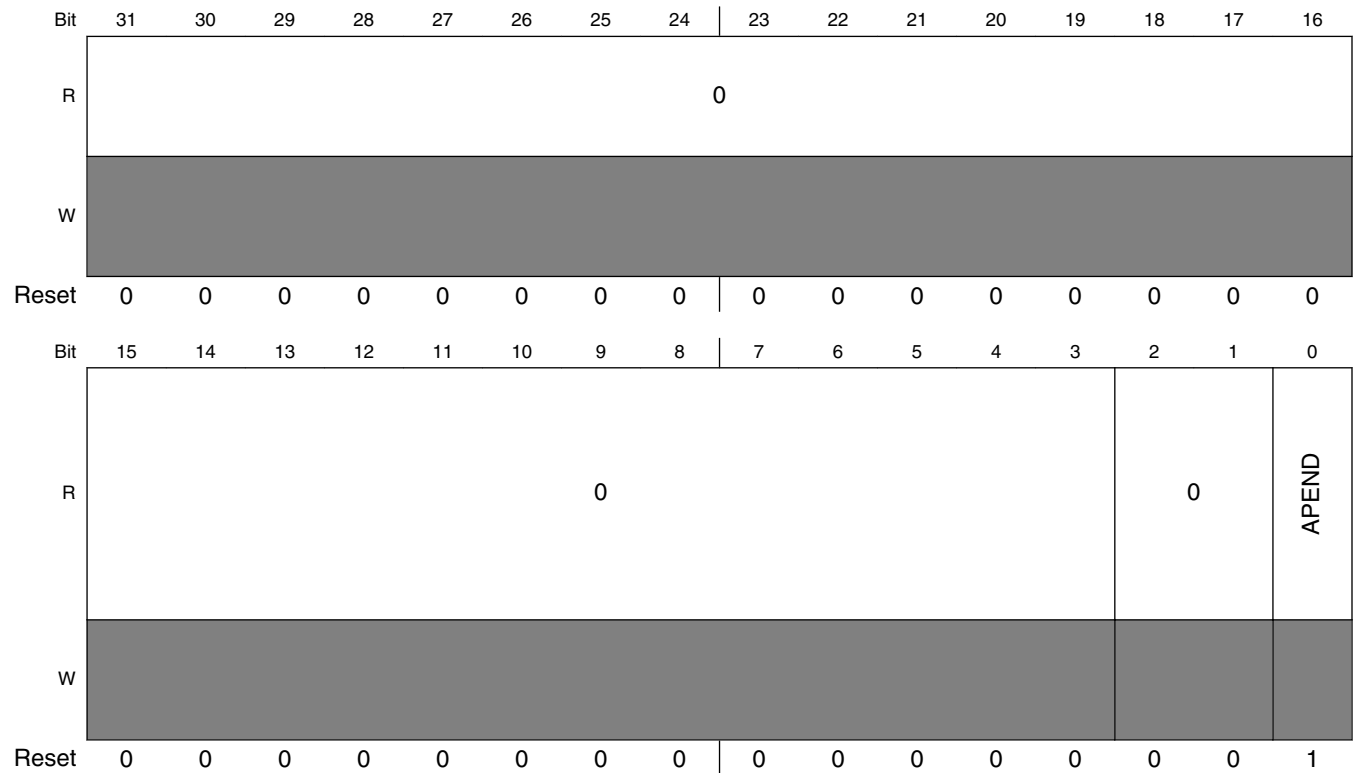

SDMACORE_ENDIANNES field descriptions

Field	Description
31–3 Reserved	This read-only field is reserved and always has the value 0.
2–1 Reserved	This read-only field is reserved and always has the value 0.
0 APEND	APEND indicates the endian mode of the Peripheral and Burst DMA interfaces. This bit is tied to logic '1' indicating little-endian mode. 0 - Arm platform is in big-endian mode 1 - Arm platform is in little-endian mode

46.10.20 Lock Status Register (SDMACORE_SDMA_LOCK)

Address: 201_C000h base + 54h offset = 201_C054h

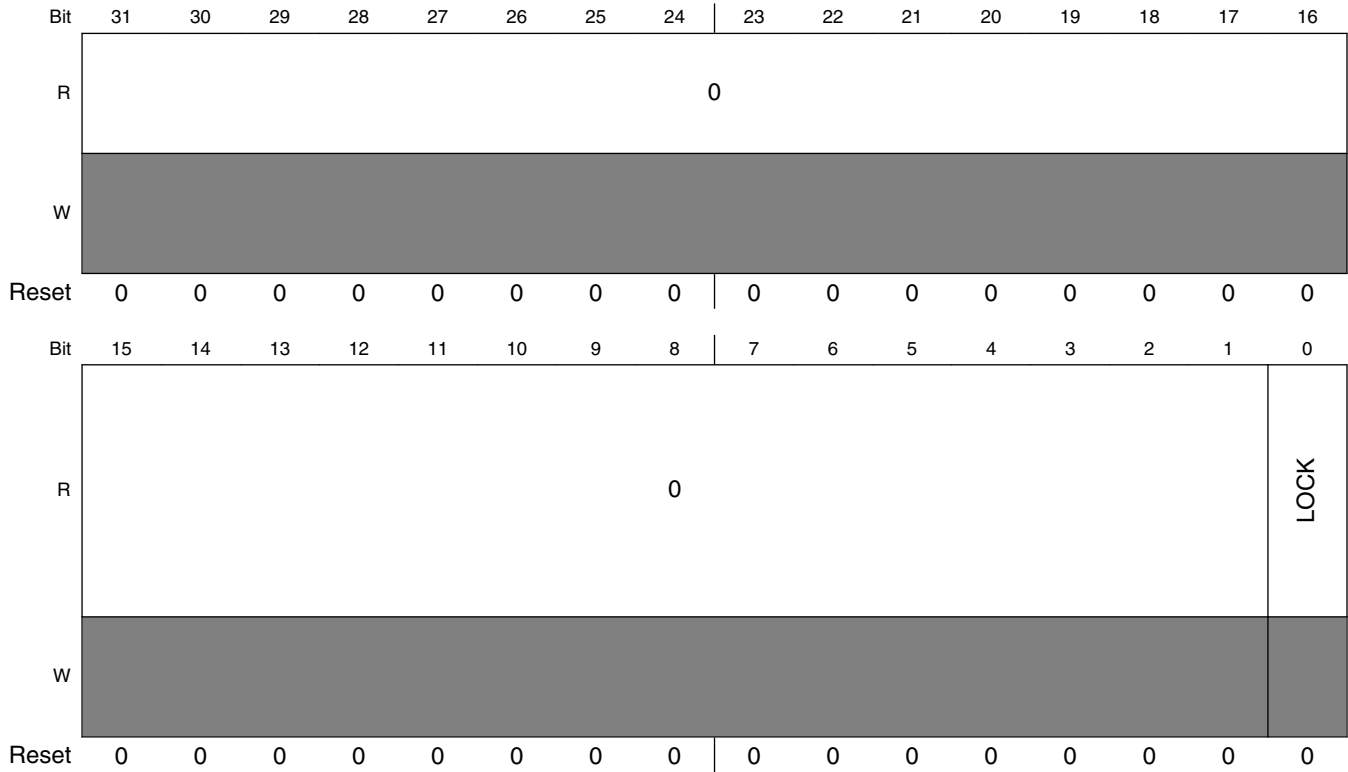

SDMACORE_SDMA_LOCK field descriptions

Field	Description
31–1 Reserved	This read-only field is reserved and always has the value 0.
0 LOCK	The LOCK bit reports the value of the LOCK bit in the SDMA_LOCK status register. SDMA software may use this value to determine if certain operations such as loading of new scripts is allowed. 0 - LOCK bit clear 1 - LOCK bit set

46.10.21 External DMA Requests Mirror #2 (SDMACORE_EVENTS2)

Address: 201_C000h base + 58h offset = 201_C058h

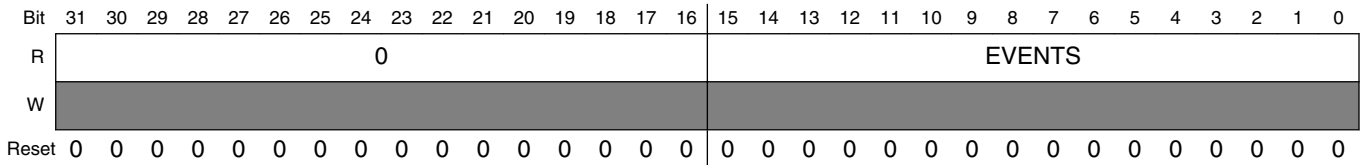

SDMACORE_EVENTS2 field descriptions

Field	Description
31–16 Reserved	This read-only field is reserved and always has the value 0.
EVENTS	Reflects the status of the SDMA's external DMA requests. It is meant to allow any channel to monitor the states of these SDMA inputs. This register displays EVENTS 32-47. The separate EVENTS register displays events 0-31.

46.11 SDMA Peripheral Registers

Refer to the respective peripherals' chapters for more information.

Chapter 47

System JTAG Controller (SJC)

47.1 Overview

The System JTAG Controller (SJC) provides debug and test control with the maximum security.

The test access port (TAP) is designed to support features compatible with the IEEE Standard 1149.1 v2001 (JTAG).

The figure below shows an overview of the JTAG architecture.

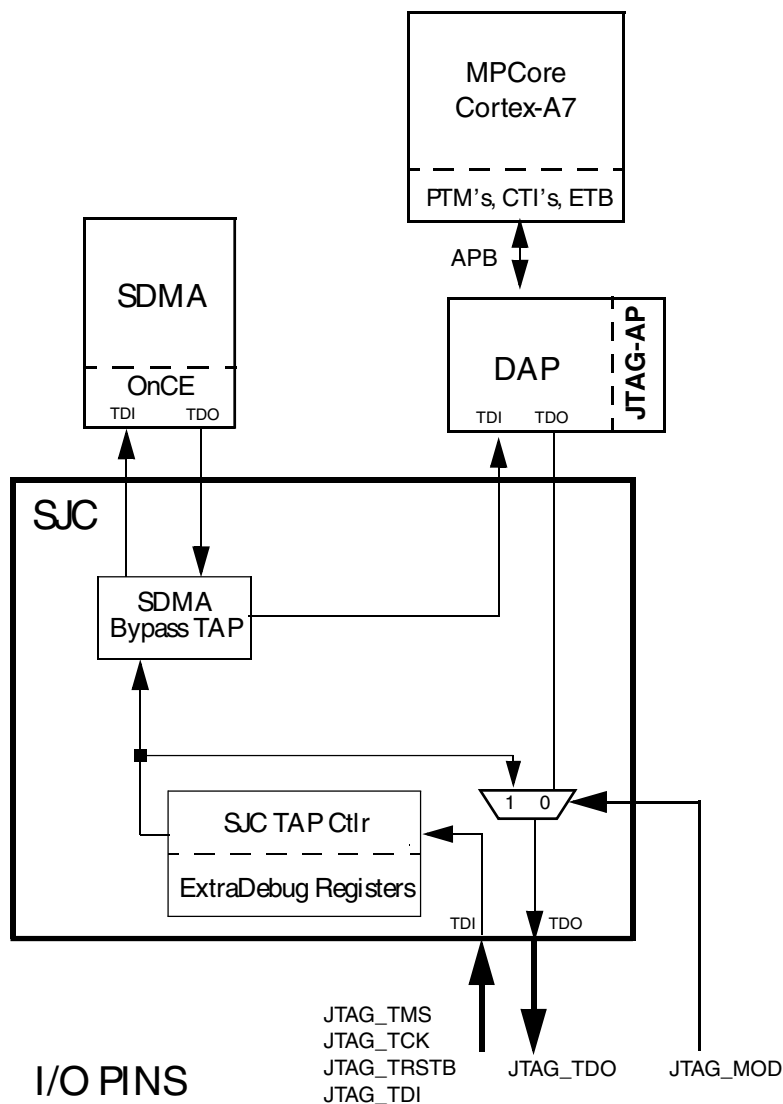

Figure 47-1. System JTAG Controller (SJC) Block Diagram

47.1.1 Features

The System JTAG Controller (SJC) provides the following capabilities:

- JTAG IEEE1149.1 mandatory instructions, see [EXTEST Instruction](#), [SAMPLE/PRELOAD Instruction](#), and [BYPASS Instruction](#).
- JTAG IEEE1149.1 optional instructions, see [ID_CODE Instruction \(IDCODE\)](#), and [HIGHZ Instruction](#).
- JTAG IEEE P1149.1 (standard JTAG) interface to off-chip test and development equipment including an SJC-only mode for true IEEE 1149.1 compliance, used primarily for board-level implementation of boundary scan.

- IEEE P1149.6 (JTAG) mandatory instructions, see [EXTEST_PULSE instruction](#) and [EXTEST_TRAIN instruction](#). These two instructions enable edge-detecting behavior on the signal path containing AC pins.
- Debug-related control and status, such as putting selected cores into reset and/or debug mode and the ability to monitor individual core status signals via JTAG.
- Provides means for accessing each OnCE/ICE TAP controller independently to control a target system (see [Modes of Operation](#)).
- ExtraDebug logic (see [ENABLE_ExtraDebug Instruction](#)).
- The maximum clock speed of the SJC is one-eighth of the lowest frequency of the accessed OnCE/ICE. For example in normal operation (no core in low-power mode), this frequency is one-eighth of the SDMA frequency if this core is present in the TDI-TDO chain (serially connected with other cores or standalone). The user must also consider the 25 MHz frequency limitation on the CE bus.
- Core compliant modes to support standalone core debuggers (see [Modes of Operation](#)).
- Multi-cores daisy chained mode (default one) to support multi-core debuggers (see [Modes of Operation](#)).

Detailed information about the SJC is provided in the Security Reference Manual. Contact your NXP representative for information about obtaining this document.

47.1.2 Modes of Operation

The SJC modes are controlled through both the TAP select register (SJC_TSR) and the MOD input port.

The MOD port (typically connected to pad of the same name) selects between two possible topologies of TAP connections, as seen at SoC level:

- Negating it (this should be the default state) selects all the TAPs (SJC, SDMA, DAP and Arm/ETM) to be connected in the TDI-TDO chain, which is referred to as "daisy chain" mode, throughout this chapter.
- Asserting it only selects the SJC TAP to be connected in the TDI-TDO chain.

IEEE1149.1 standard features are enabled by configuring the SJC input pin: MOD. Refer to the following table for MOD settings details:

Table 47-1. SJC Modes

MOD	Name	Description
0	Daisy chain ALL	For common SW debug (High speed and production)
1	SJC only	IEEE 1149.1 JTAG compliant mode

The following figure shows the SJC mode selection flow. The numbers shown in parenthesis below each block name indicates the TAP's IR length.

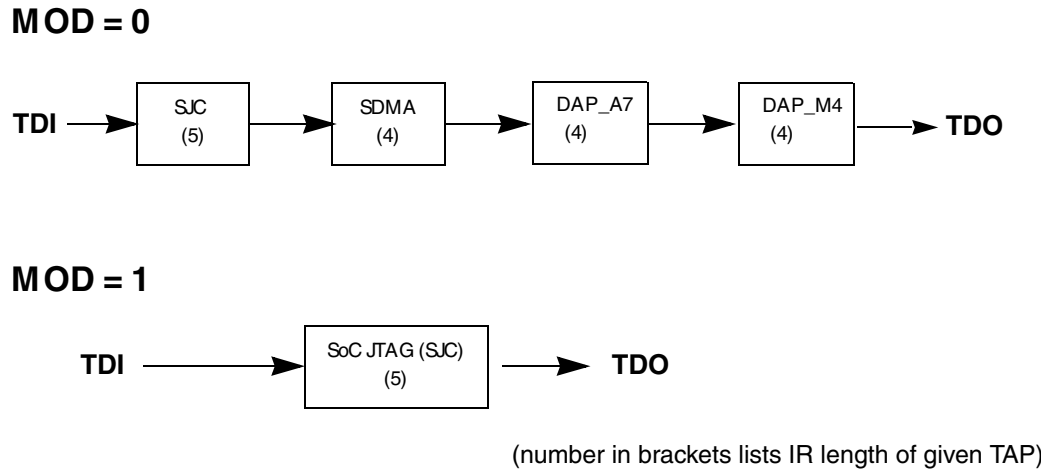

Figure 47-2. SJC Mode Selection Using MOD Pin Sampling

The Connect SDMA bit inside TAP select register controls the SDMA TAP bypass.

- When negated (should be the default state), the SDMA TAP is bypassed with a single D-FF (Flip-flop) during Shift-Dr path
- When asserted SDMA TAP is connected inside the chain
- When taking the SDMA into bypass or out of bypass (by writing to tapsel reg), additional cycle with TMS '0' should be given

The TAP selection block (TSB) provides a simple method of integrating various pieces of IP that have embedded TAPs.

- Provides a way to connect up multiple TAPs within a single SoC
- Identify the SJC TAP as the master TAP which controls the boundary chain (for IEEE 1149.1 standard compliance)
- Follow the state of SJC TAP, and when the Test-Logic-Reset (TLR) state is reached, reset all TAPs

The figure below shows the TAP Selection Block and SOC TAP Chain Scheme.

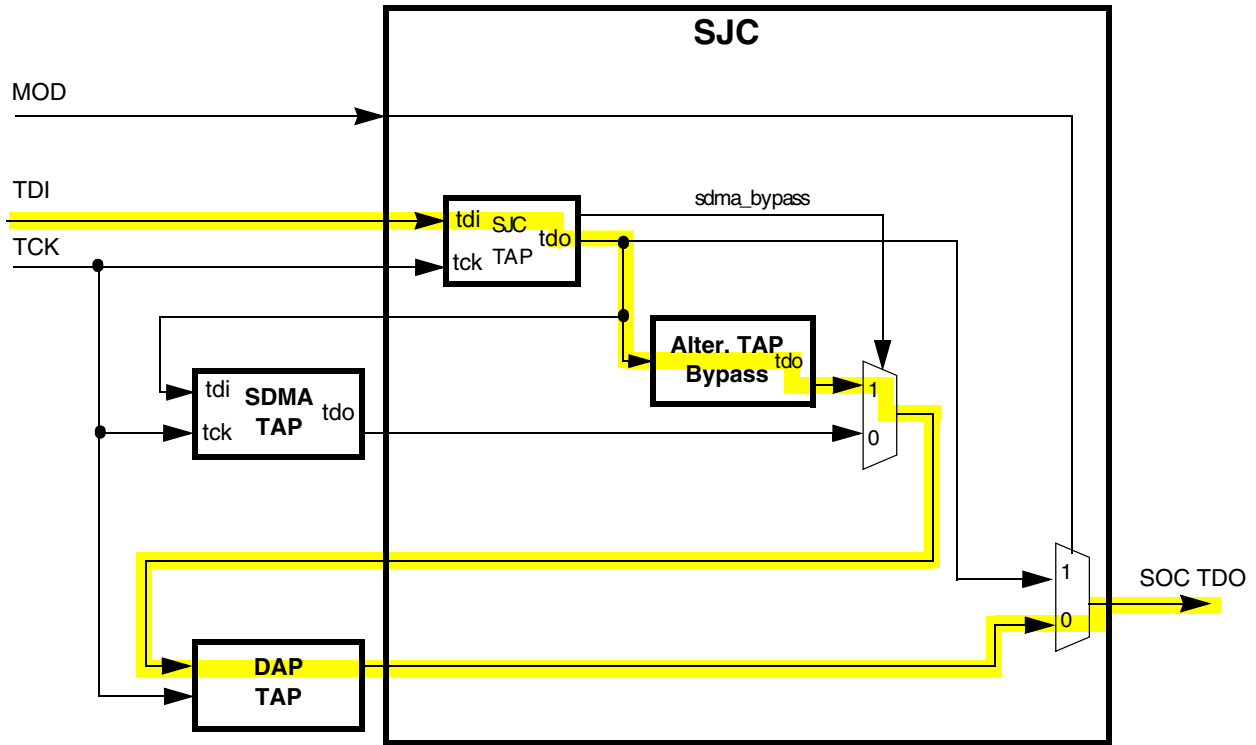

Note: The default daisy chain connectivity is highlighted in yellow

Figure 47-3. TAP Selection Block and SoC TAP Chain Scheme

NOTE

It is the responsibility of the user to ensure that in any configuration of the TAP controllers chosen, all of the TAPs in the chain comply with the demands of TCK clock frequency as well as the required ratio between TCK clock frequency and that of the core's to which the TAP refers.

47.2 External Signals

The table found here describes the external signals of SJC.

Table 47-2. SJC External Signals

Signal	Description	Pad	Mode	Direction
JTAG_DE_B	SoC debug request/acknowledge pin. The DE_IN_B pin is used to propagate an external debug request event to the core(s). This functionality must be enabled first, by set of DE_to_ARM /	UART2_CTS_B	ALT7	IO

Table continues on the next page...

**Table 47-2. SJC External Signals
(continued)**

Signal	Description	Pad	Mode	Direction
	DE_to_SDMA bits in SJC's DCR register. It is SoC implementation dependent, whether this pin can also be used to reflect the debug acknowledge event back from the cores (in the case where an Open-Drain scheme is used externally).			
JTAG_MOD	SJC mode selection. This pin is sampled at TRST reset to determine two possible modes for the TAP connection configuration.	JTAG_MOD	No muxing	I
JTAG_TCK	Test Clock (TCK). This is used to synchronize the test logic and includes an internal pull-up resistor	JTAG_TCK	ALT0	I
JTAG_TDI	Test Data Input (TDI). Serial test instruction and data are received through the test data input (TDI) pin. TDI is sampled on the rising edge of TCK and includes an internal pullup resistor	JTAG_TDI	ALT0	I
JTAG_TDO	Test Data Output (TDO). The serial output for test instructions and data. TDO is tri-statable and is actively driven in the shift-IR and shift-DR controller states. TDO changes on the falling edge of TCK	JTAG_TDO	ALT0	O
JTAG_TMS	Test Mode Select (TMS). This is used to sequence the test controller's state machine. TMS is sampled on the rising edge of TCK and includes an internal pullup resistor	JTAG_TMS	ALT0	I
JTAG_TRSTB	Test Reset (TRST). This is used to asynchronously initialize the test controller. The TRST pin has an internal pullup resistor	JTAG_TRST_B	ALT0	I

47.2.1 External Signal Overview

The SJC provides test and debug control with a minimum number of contacts.

The figure below shows SJC connections to external contacts and other chip blocks.

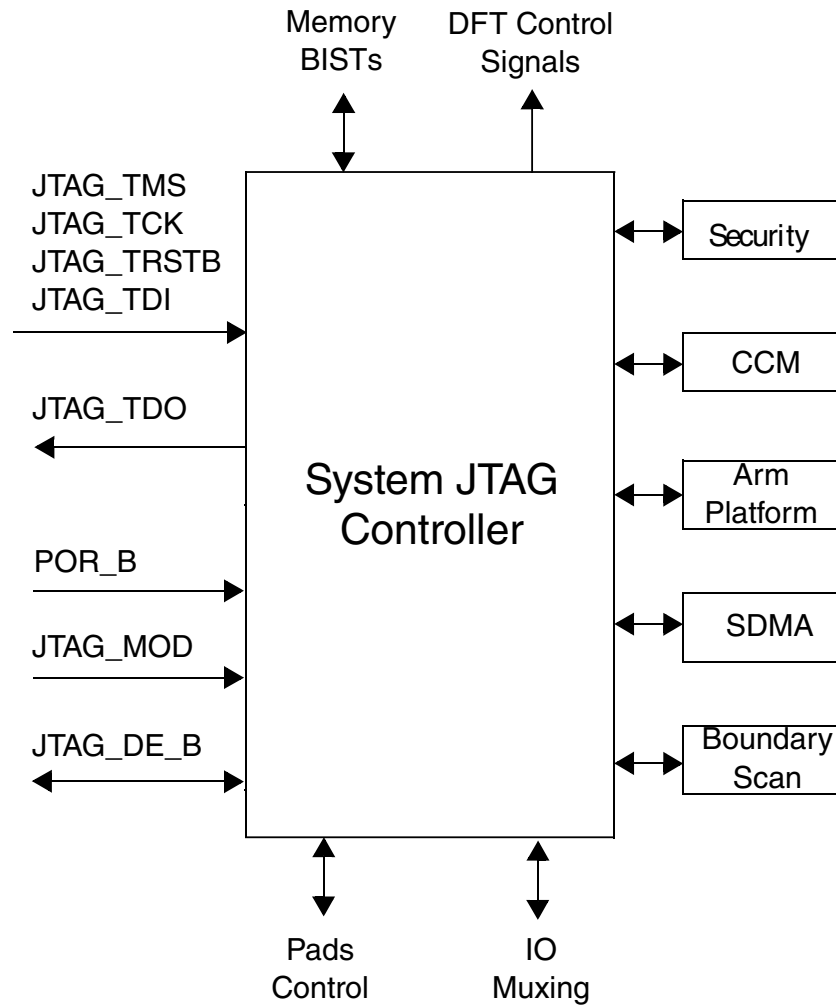

Figure 47-4. SJC Connections

47.2.2 TAP Controller

The TAP controller is responsible for interpreting the sequence of logical values on the TMS signal. It is a synchronous state machine that controls the operation of the JTAG logic. The value shown adjacent to each arc represents the value of the TMS signal sampled on the rising edge of TCK signal. For a description of the TAP controller states, refer to the appropriate IEEE 1149.1 document.

The state machine is shown in the following figure.

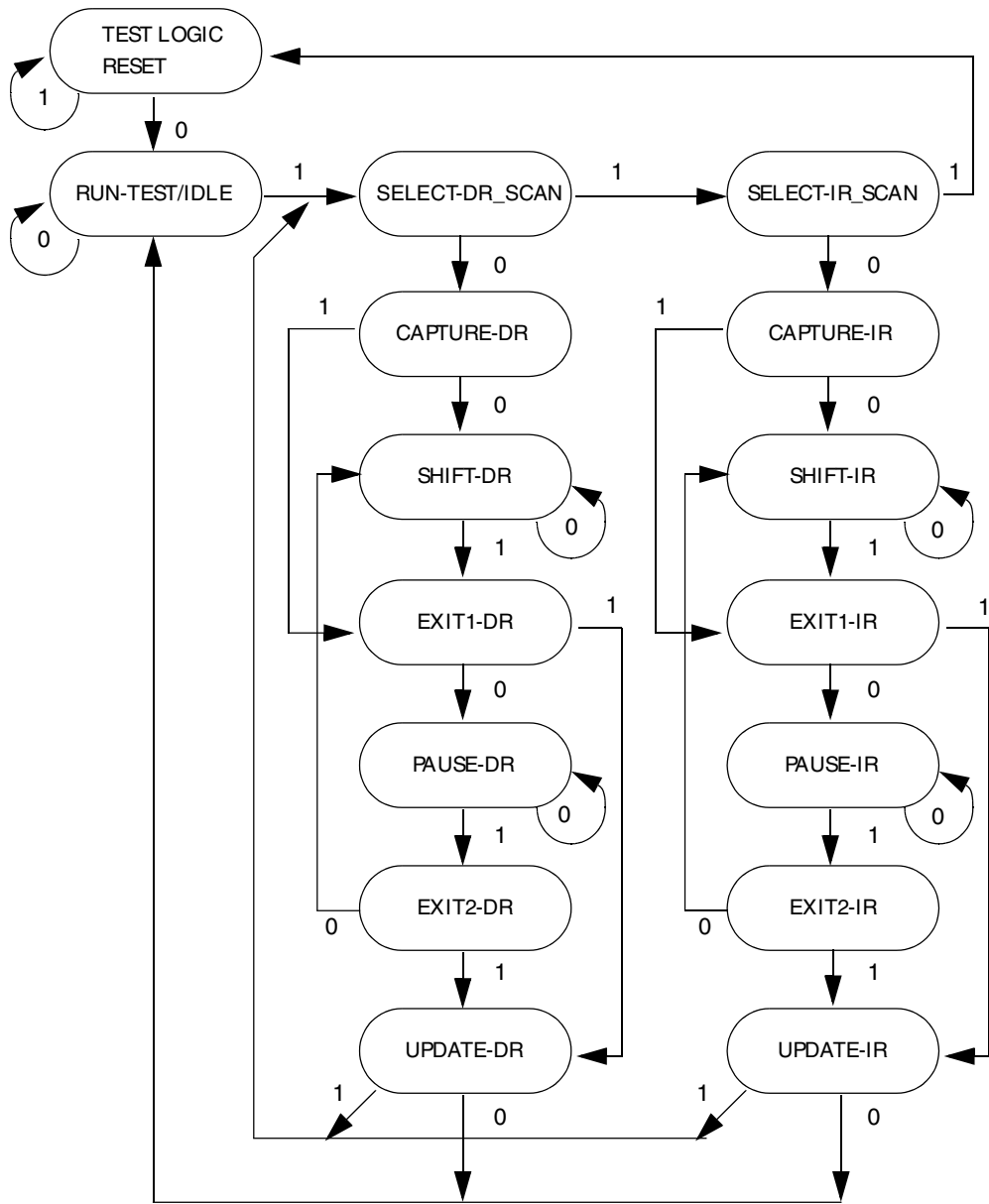

Figure 47-5. TAP Controller State Machine

The change of the JTAG state machine occurs on the rising edge of TCK. TMS and TDI change on the falling edge of TCK. TDO also changes on the falling edge of TCK following entry into the Shift_DR or Shift_IR states (TDO_EN is the enable of the tristate buffer driving the TDO output).

The figure below shows the timings of the SJC signals.

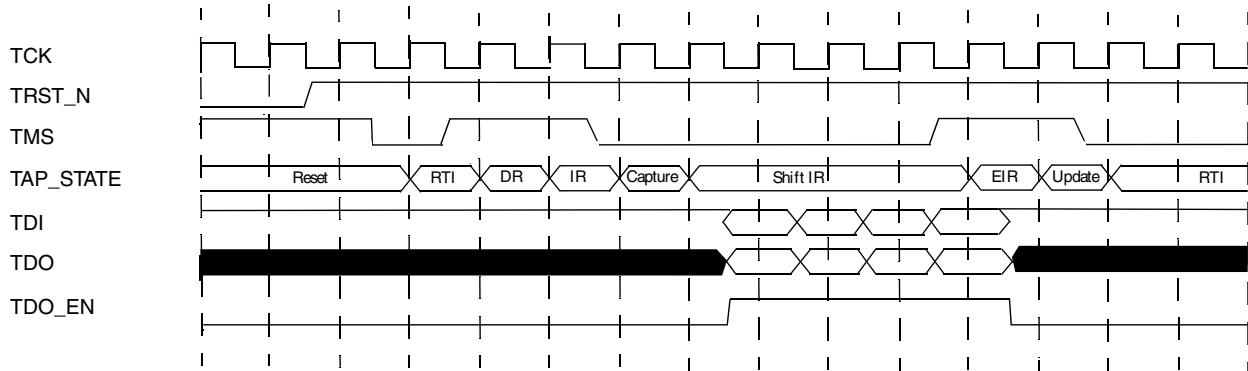

Figure 47-6. SJC Signals Timing Diagram

47.2.3 Accessing ExtraDebug Registers

Accessed through the Select-DR-Scan path, the ExtraDebug shift register consists of 38 bits (maximum) comprising a 32-bit data field (max length, see extradebug register description), a 5 bit address field and read/write bit.

The write actually takes place when the JTAG TAP controller enters the Update-DR state. On a read, the data field is ignored (the user should shift only 5 times to enter Read=1 and the address), the read takes place on the next path through DR at the Capture-DR state, the data is shifted-out during the Shift-DR state.

On the second path for a read access, simultaneous write access is not supported: command converter software shifts in zeros so the TAP decodes a write to the CSR (read-only register) which does not have any effect on the circuit.

The number of shift depends on the width of the accessed register as explained in the following diagrams.

First a write access (one path through Select-DR-Scan):

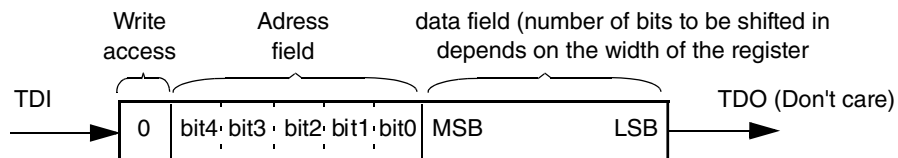
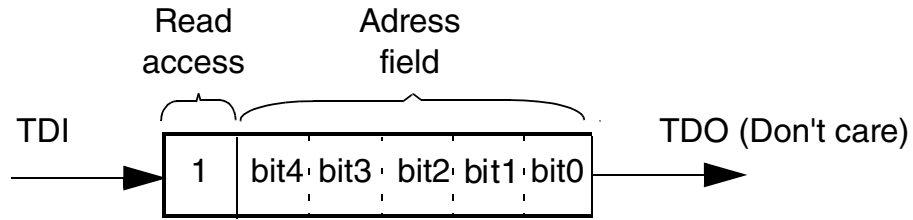

Figure 47-7. TDI/TDO on write access

Then a read access (requires two paths through Jtag DR Scan path):

First path



Second path

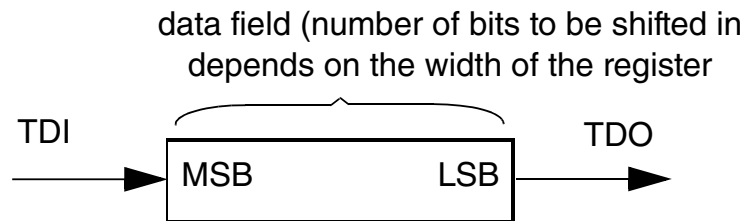

Figure 47-8. TDI/TDO on Read Access

For example, write value 0b1010_1100 to Debug Control Register (address = 0b00110).

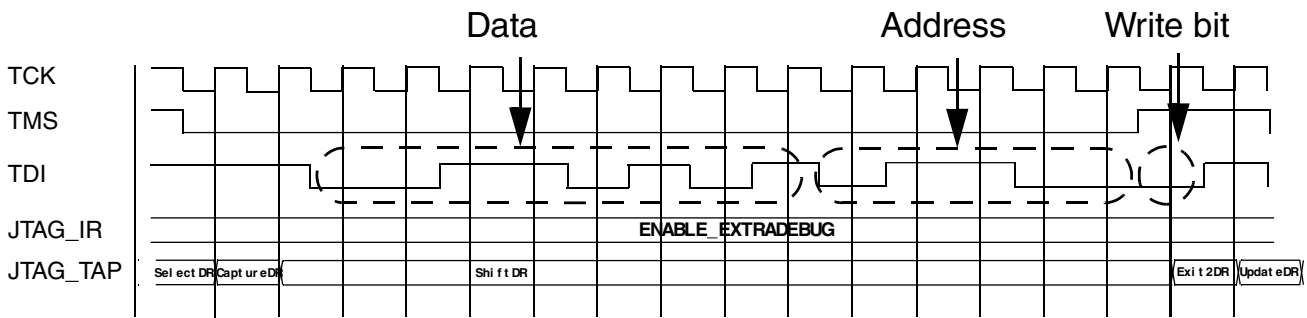

Figure 47-9. Example: Write Access to DCR

The SJC registers have different levels of security (Refer to [JTAG Security Modes](#)):

- Secured- accessible only in mode 2 (supposed correct response entered), mode 3 and mode 4.
- Unsecured- accessible in all modes

The level of security of each register is indicated in its name or description, in "Programmable Registers" section.

A single DE_B pin is dedicated for debug request input/output in bidirectional open drain functionality (including an internal pull-up device).

Bits 6:5 in DCR register serve as mask bits, controlling the propagation of external debug request to each recipients (Arm Platform, SDMA).

The bits 1:0 define the propagation enable of IR debug request to recipient cores.

For security reasons, bits for output and input propagation control are at their negated values after reset. A user cannot put the cores in debug mode through DE_B without any Jtag access.

The configuration after reset prevents propagation of debug requests / acknowledges to or from the cores.

47.3 TAP Selection Block (TSB)

As described in [Modes of Operation](#), the SJC can access cores in different modes selected through a TSB.

47.3.1 Select Mode Using Software

Conceptually, the SJC_TSR is a data register which is accessed through Access TSR IR instruction of SJC TAP.

The following figure shows the process of using reserved IR to access the SJC_TSR.

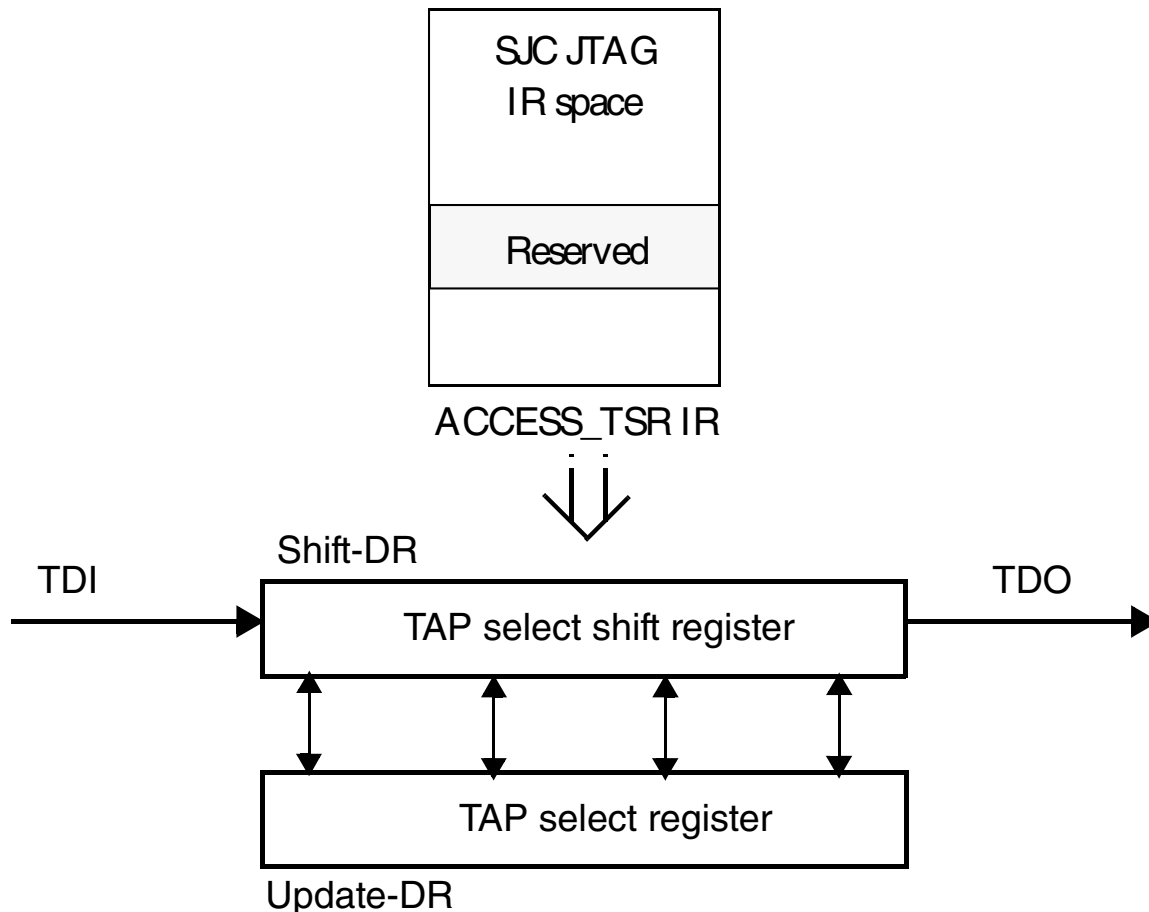

Figure 47-10. Using Reserved IR to Access the TAP Select Register (SJC_TSR)

The SJC_TSR can only be changed during the update-DR state of the TSB JTAG state machine. This is necessary to prevent a TAP that is being selected from losing synchronization with the TSB state machine when the TSB state machine returns to run-test-idle. Therefore, an associated shift register for the SJC_TSR is loaded into the SJC_TSR during the update-DR state (see the figure above). The shift register must also capture the state of the SJC_TSR when in the Capture-DR state for visibility of the contents of the SJC_TSR. See [TAP Select Instruction](#) , for more information.

47.4 Boundary Scan Register (BSR)

The Boundary Scan Register (BSR) in the JTAG implementation contains bits for all device signal and clock pins and associated control signals.

All SoC bidirectional pins have a single register bit in the boundary scan register for pin data, and are controlled by an associated control bit in the boundary scan register.

47.5 SoC JTAG Instruction Register (SJIR)

The SoC JTAG Instruction register is provided in the following table. The SoC JTAG Instruction register is 5 bits wide.

Table 47-3. SoC JTAG Instruction Register (SJIR)

Code					SJC IR
B4	B3	B2	B1	B0	
0	0	0	0	0	IDCODE
0	0	0	0	1	SAMPLE/PRELOAD
0	0	0	1	0	EXTEST
0	0	0	1	1	HI-Z
0	0	1	0	0	ENABLE_ExtraDebug
0	0	1	0	1	ENTER_DEBUG (secured)
0	0	1	1	0	Reserved
0	0	1	1	1	TAP select
0	1	0	0	0	EXTEST_PULSE
0	1	0	0	1	EXTEST_TRAIN
0	1	0	1	0	Reserved
0	1	0	1	1	Reserved
0	1	1	0	0	Security Output challenge
0	1	1	0	1	Security Enter response
-	-	-	-	-	Reserved
1	1	1	1	1	BYPASS

The instruction register is reset to 0b00000 in the test-logic-reset controller state which is equivalent to the IDCODE instruction.

During the capture-IR controller state, the parallel inputs to the instruction register are loaded with the code 01 in the least significant bits as required by the standard; the most significant bits are loaded with the values 00, leading to a capture value of 0b000001.

47.5.1 ID_CODE Instruction (IDCODE)

Selects the ID register, and the system logic controls the I/O pins. This instruction is provided as a public instruction to allow the manufacturer, part number and version of a component to be determined through the TAP.

The table below shows the ID register configuration.

Table 47-4. ID Configuration Register (IDCODE)

IDCODE				ID Configuration Register													
	BIT 31	30	29	28	27	26	25	24	23	22	21	20	19	18	17	BIT 16	
	Version Information[3:0]			Part Number (Bits 27-16)													
TYPE	r	r	r	r	r	r	r	r	r	r	r	r	r	r	r	r	
RESET	0	0	0	0	x	x	x	x	x	x	x	x	x	x	x	x	
Note:																	
	BIT 15	14	13	12	11	10	9	8	7	6	5	4	3	2	1	BIT 0	
	Part Number (Bits 15-12)				Manufacturer Identity											1	
TYPE	r	r	r	r	r	r	r	r	r	r	r	r	r	r	r	r	
RESET	x	x	x	x	0	0	0	0	0	0	0	1	1	1	0	1	
Note:																	

Table 47-5. ID Configuration Register Description (IDCODE)

Field	Description
31-28 Version Information	IC/SoC Version information number. Initial value: '0000' This number is subject to changes, for new IC/SoC (System On A Chip) revision releases.
27-12 Part Number	Customer Part Number The 16-bit Part Number value is unique for every NXP SoC / IC. See System Debug chapter for exact register value for a specific SoC.
11-1 Manufacturer Identity	Manufacturer Identity NXP Manufacturer Identity code. Bits [11:1] - 00000001110
0	Tied to logic 1.

One application of the ID register is to distinguish the manufacturer(s) of components on a board when multiple sourcing is used. As more components emerge which conform to the IEEE 1149.1 standard, it is desirable to allow for a system diagnostic controller unit to blindly interrogate a board design to determine the type of each component in each location. This information is also available for factory process monitoring and for failure mode analysis of assembled boards.

Once the IDCODE instruction is decoded, it selects the ID register which is a 32 Bit data register. Because the bypass register loads a logic 0 at the start of a scan cycle, whereas the ID register loads a logic 1 into its least significant bit, examination of the first bit of data shifted out of a component during a test data scan sequence immediate following exit from Test-Logic-Reset controller state shows whether such a register is included in the design. When the IDCODE instruction is selected, the operation of the test logic has no effect on the operation of the on-chip system logic as required by the IEEE 1149.1 standard.

47.5.2 SAMPLE/PRELOAD Instruction

Selects the boundary scan register and the system logic controls the I/O pins.

The SAMPLE/PRELOAD instruction provides two separate functions:

- First, it provides a means to obtain a snapshot of system data and control signals. The snapshot occurs on the rising edge of TCK in the capture-DR controller state. The data can be observed by shifting it transparently through the boundary scan register.
- The second function of SAMPLE/PRELOAD is to initialize the boundary scan register output cells prior to selection of EXTEST. This initialization ensures that known data appears on the outputs when entering the EXTEST instruction.

NOTE

Because there is no internal synchronization between the JTAG clock (TCK) and the system clock (CLK), the user must provide some form of external synchronization to achieve meaningful results.

For more details on the function and use of SAMPLE/PRELOAD, refer to the appropriate IEEE 1149.1 document.

47.5.3 EXTEST Instruction

Selects the boundary scan register, and the 1149.1 test logic has control of the I/O pins.

By using the TAP controller, the register is capable of:

- Scanning user-defined values into the output buffers,
- Capturing values presented to input pins
- Controlling the direction of bidirectional pins,
- Controlling the output drive of tri-statable output pins.

For more details on the function and use of EXTEST, refer to the appropriate IEEE 1149.1 document.

The EXTEST instruction also asserts internal reset for the cores (through CCM, refer to [Figure 47-13](#)) to force a predictable internal state while performing external boundary scan operations.

47.5.4 HIGHZ Instruction

All output drivers, including the two-state drivers, are turned off (that is, high impedance). The instruction selects the bypass register.

In this mode, all internal pullup resistors on all the pins (except for the TMS, TDI, TCK, TRSTB pins) are disabled. This disabling functionality is not built into SJC, but should be implemented by some logic in the SOC/IO Pads.

For more details on the function and use of HIGHZ, refer to the IEEE 1149.1 document.

The HIGHZ instruction also asserts internal reset for the cores (through CCM, refer to [Figure 47-13](#)) to force a predictable internal state while performing external boundary scan operations.

47.5.5 BYPASS Instruction

Selects the single Bit bypass register and the system logic controls the I/O pins.

This creates a shift-register path from TDI to the bypass register and, finally, to TDO, circumventing the boundary scan register. This instruction is used to enhance test efficiency when a component other than the SoC Core based device becomes the device under test.

When the bypass register is selected by the current instruction, the shift-register stage is set to a logic zero on the rising edge of TCK in the capture-DR controller state. Therefore, the first bit to be shifted out after selecting the bypass register is always a logic zero.

For more details on the function and use of BYPASS, refer to the appropriate IEEE 1149.1 document.

47.5.6 ENABLE_ExtraDebug Instruction

The TDI and TDO pins are connected directly to the ExtraDebug registers, the SJC TAP controller remaining connected to TDI and TMS.

The ExtraDebug shift register consists of 38 bits (maximum) comprising a 32-bits data field (maximum length, see [Accessing ExtraDebug Registers](#)), a 5 bits address field and read/write bit. On a register read, the data field does not need to be filled in. The particular ExtraDebug register connected between TDI and TDO at a given time is selected by the ExtraDebug controller depending on the ExtraDebug Address being currently decoded. All communication with the ExtraDebug controller is done through the Select-DR-Scan path of the JTAG TAP Controller.

47.5.7 ENTER_DEBUG instruction

The ENTER_DEBUG instruction is used to generate a debug request event to SDMA and the Arm Core Platform simultaneously (practically, inherited minimal skew is expected, due to difference in event signal propagation in the different modules).

The TDI and TDO are connected to the Instruction Register (IR). After the acknowledgment of the Debug Mode is received (can be checked by reading the Core Status Register part of the ExtraDebug logic), the user can perform system debug functions on the cores.

NOTE

The ENTER_DEBUG event issue to the cores, can be masked, by bits in DCR register.

NOTE

It is user's responsibility to shift-in another IR value (like IDCODE) before trying to bring the cores out of debug mode, as the debug request signals to the cores remains asserted as long as ENTER_DEBUG IR is in place.

NOTE

The user need to check that cores are in debug mode (watching debug acknowledge signal) before leaving ENTER_DEBUG instruction, otherwise debug request might not take affect.

47.5.8 TAP Select Instruction

By means of TAP select instruction a user can access TAP select register and by controlling its only bit SDMA Bypass, control whether SDMA TAP is bypassed or not.

Table 47-6. TAP Select Register (TSR)

	TAP Select Register
	BIT 0
	Connect SDMA
TYPE	rw
RESET	0
Note:	

Table 47-7. TAP Select Register Description

Field	Description
0 SDMA Bypass	Connect SDMA Control whether SDMA TAP is bypassed or not: <ul style="list-style-type: none"> • 0 - SDMA TAP is bypassed by the alternate TAP inside SJC (emulating 4-bit IR and 1-bit bypass path). • 1 - SDMA TAP is connected to the TDI-TDO chain. <p>NOTE: Additional cycle with TMS '0' should be inserted, after writing to this register, to allow the SDMA tap be sync before SDMA get into / out of bypass.</p>

47.5.9 EXTEST_PULSE instruction

The EXTEST_PULSE instruction implements test behaviors for AC pins and simultaneously behaves identically to IEEE Std 1149.1 EXTEST for DC pins.

47.5.10 EXTEST_TRAIN instruction

The EXTEST_TRAIN instruction implements test behaviors for AC pins and simultaneously behaves identically to IEEE Std 1149.1 EXTEST for DC pins.

47.6 Security

JTAG manipulation is one of the known hackers' ways of executing unauthorized program code, getting control over the OS and run code in privileged modes.

The SJC provides a debug access to several H/W blocks including the Arm processor and the system bus. This allows for program control and manipulation as well as visibility into system peripherals and memory. The ETM and NEXUS interfaces allow bus transactions to be traced. Together these tools provide the hacker all the access needed to completely comprise the system. Means must be provided to block any malicious JTAG access.

The SJC provides a way of regulating the JTAG access.

The following are the different JTAG security modes:

- **Mode #1: No Debug**-Maximum Security. All security sensitive JTAG features are permanently blocked.
- **Mode #2: Secure JTAG**-High security. JTAG use is regulated by secret key based authentication mechanism.
- **Mode #3: JTAG Enabled**-Low security. JTAG always enabled.

The JTAG security modes are configured using eFUSES which can be burned after packaging by applying electrical signals. The fuse burning is an irreversible process, once a fuse is burned (e-fuse or laser fuse) it is impossible to change the fuse back to the un-burned state.

47.6.1 JTAG Security Modes

JTAG can be in one of JTAG security modes which is selected by setting the SJC eFUSE configuration. The physical location of the fuses is not in the SJC.

47.6.1.1 Mode 1: No Debug - Maximum Security

No Debug JTAG security mode provides the highest security level.

In this mode, all JTAG features are disabled except for:

- ScanBoundary Scan
- MBIST, all modes except for debug modes which enable controlled memory contents output
- PLL BIST
- BIST monitor mode, allowing routing to external pins BIST pass/fail/invoke information
- PLL bypass- Bypass Arm or/and USB PLL.
- Visibility of the following status bits: power mode - normal, standby, stop, shutdown, and so on

These features do not reduce the security level of the product, and they allows to perform important tests and board connectivity checks.

47.6.1.2 Mode 2: Secure JTAG - High Security

The Secure JTAG mode limits the JTAG access by using challenge/response based authentication mechanism. Any access to JTAG port is being checked. Only authorized debug devices (that is, devices having the right response) can access the JTAG, unauthorized JTAG access attempts are denied.

The intent of this mode is to allow return field testing. When a secured JTAG device is being returned for debugging, this mode allows authorized re-activation of the JTAG.

47.6.1.2.1 Challenge/Response Mechanism in System JTAG Mode

When SJC is in Sysytem JTAG mode the authentication process is as follows:

1. Shift Output Challenge instruction to IR.
2. Passing through Capture-DR state of the SJC and by performing Shift-DR operations Challenge code can be accessed from TDO.
3. Shift Enter Response instruction to IR. By performing Shift-DR, operations enter Response code value through TDI. As Update-DR state is entered, Response code is compared with the correct one.

In Fixed challenge-response pair mode, each part has its individual challenge - response pair which is determined at manufacturing time, and does not change later on. The SJC compares the user's response to the expected response.

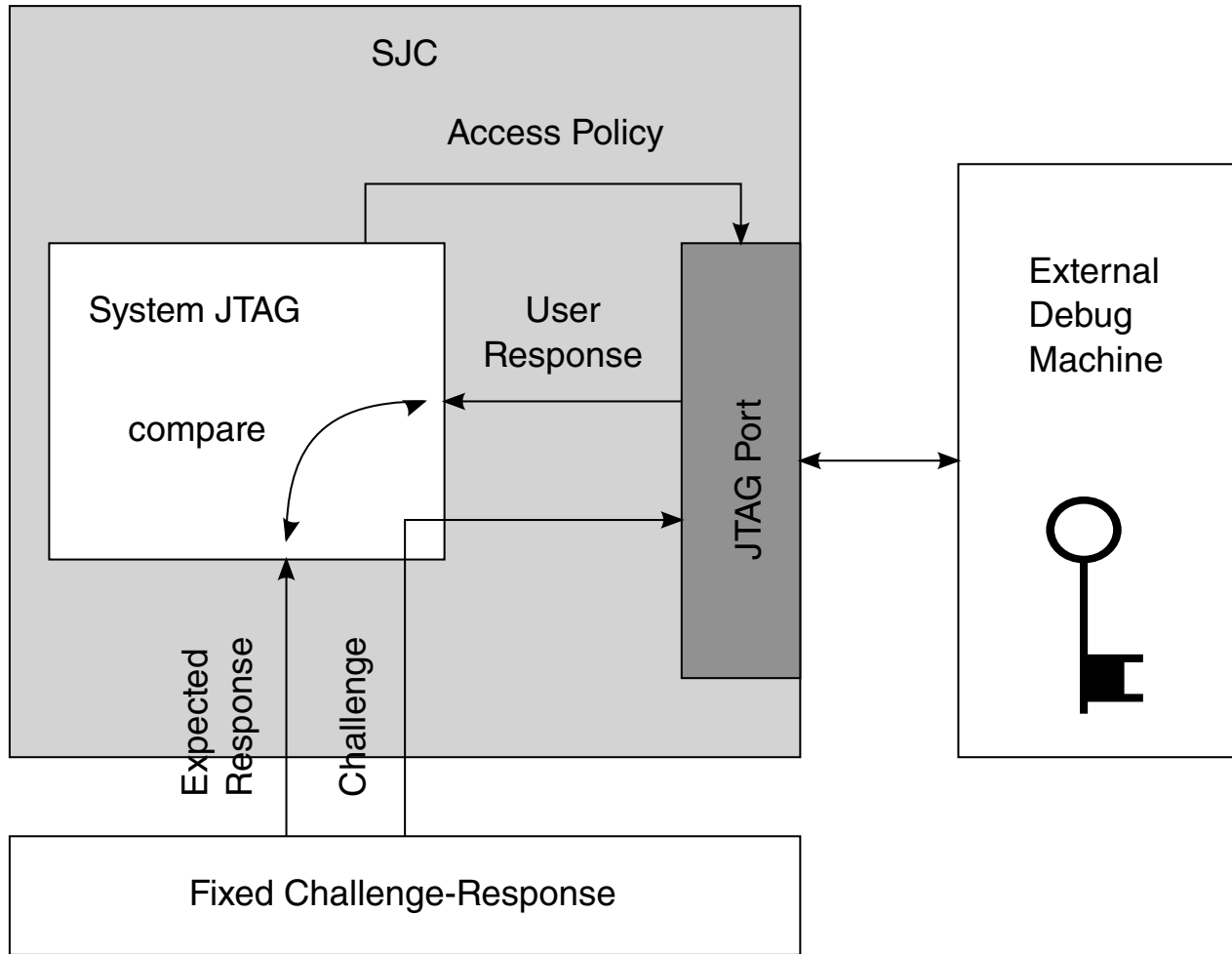

Figure 47-11. Mode #2 - Secure JTAG with Fixed Challenge-response Pair

47.6.1.3 Mode 3: JTAG Enabled - Low Security

In the JTAG Enabled JTAG security mode, all JTAG features are enabled.

47.6.2 Software Enabled JTAG

To increase the flexibility of the SJC, an option to enable the JTAG via software is added and is available only in Secure JTAG mode. By writing '1' to HAB_JDE (HAB JTAG DEBUG ENABLE) bit in the e-fuse controller module, the JTAG is opened, regardless of its security mode. It is the responsibility of software to assert or negate this bit.

Additionally, a corresponding lock bit is available (in the e-fuse control module) to ensure that only trusted software is able to set the JDE bit. When the LOCK bit is set, no future change of JDE is possible, until the next POR (power-on-reset) cycle.

The platform initialization software should set the LOCK bit for JDE bit before transferring control to the application code.

The S/W JTAG enable allows JTAG enabling without activating the challenge-Response mechanism (which requires JTAG access tool enhancement or special H/W). The JTAG S/W enable does not allow debug in case of boot or memory fault as it requires reset before entering debug.

This feature can be permanently blocked by burning the dedicated e-fuse.

NOTE

The S/W enabled JTAG feature reduces the overall security level of the system as it relies on S/W protections. If this feature is not required, it is strongly recommended to burn the JTAG_HEO e-fuse which disables this feature.

47.6.3 Kill Trace

The kill trace signal disables any output of the ETM block. The ETM can be accessed either via JTAG port and/or by direct software code. Blocking the JTAG port also yields assertion of the kill trace signal. This resulted in blocking of trace port. The intention of this action is to block any attempt to break into the system via software manipulation of the debug modules. The kill trace, when active, prevents trace output even in case where it can be activated via chip pin.

The kill trace feature needs to be activated by burning a dedicated e-fuse. If the fuse is left intact, kill trace is never activated as seen in [Figure 47-12](#).

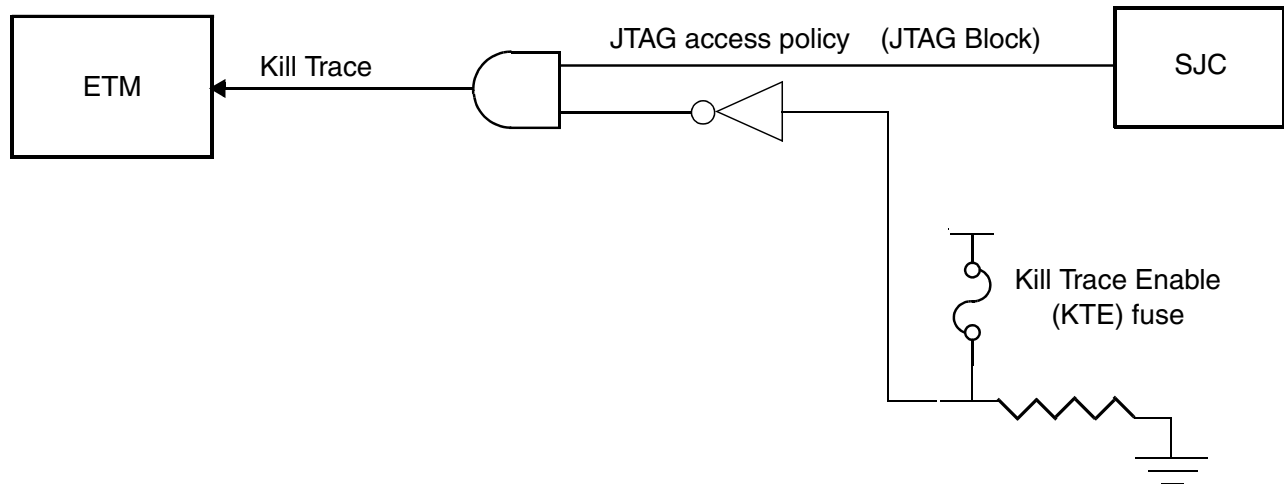

Figure 47-12. Kill Trace eFUSE

The kill trace is asserted when "kill trace enable" fuse is burned and "ipt_secur_block" signal in SJC is asserted, which happens when at least one of the following is true:

- Mode #2 (Secure JTAG) and no code has been entered
- Mode #2 (Secure JTAG) with burned Bypass and Re-enable fuses
- Mode #2 (Secure JTAG) with incorrect response entered
- Mode #1 (No debug)
- TRST_B signal is active
- POR has not ever been asserted

47.6.4 SJC Disable Fuse

In addition to the different JTAG security modes that are implemented internally in the System JTAG Controller (SJC), there is an option to disable the SJC functionality by eFUSE configuration. This creates additional JTAG mode that is, JTAG Disabled with highest level of JTAG protection. In this mode all JTAG features are disabled.

Specifically, the following debug features are disabled in addition to the features that were already disabled in No Debug JTAG mode:

- Memory BIST
- Boundary scan register (SJC_BSR)
- Non-Secure JTAG control registers (PLL configuration, Deterministic Reset, PLL bypass)
- Non-Secure JTAG status registers (Core status)
- Chip Identification Code (IDCODE)

47.7 Functional Description

This section provides a complete functional description of the block.

47.7.1 Static Core Debug

The SJC JTAG TAP controller is fully compatible with the IEEE 1149.1a-2001 Standard Test Access Port and Boundary Scan Architecture specifications.

The Arm platform has an integrated JTAG interface and a TAP controller to manage its own ICE. Also it can access an embedded trace ETM interface, see Arm core and ETM Technical reference guide for more information.

The SDMA has a TAP controller to manage its own OnCE, see SDMA OnCE specifications for more details.

The OnCE and ICE provide a mean of interacting with the cores and their peripherals non-intrusively so that a user may examine registers, memories to facilitate hardware and software development. Refer to [TAP Selection Block \(TSB\)](#), for more information.

47.7.2 Reset Mechanism

The following figure shows the SJC reset logic

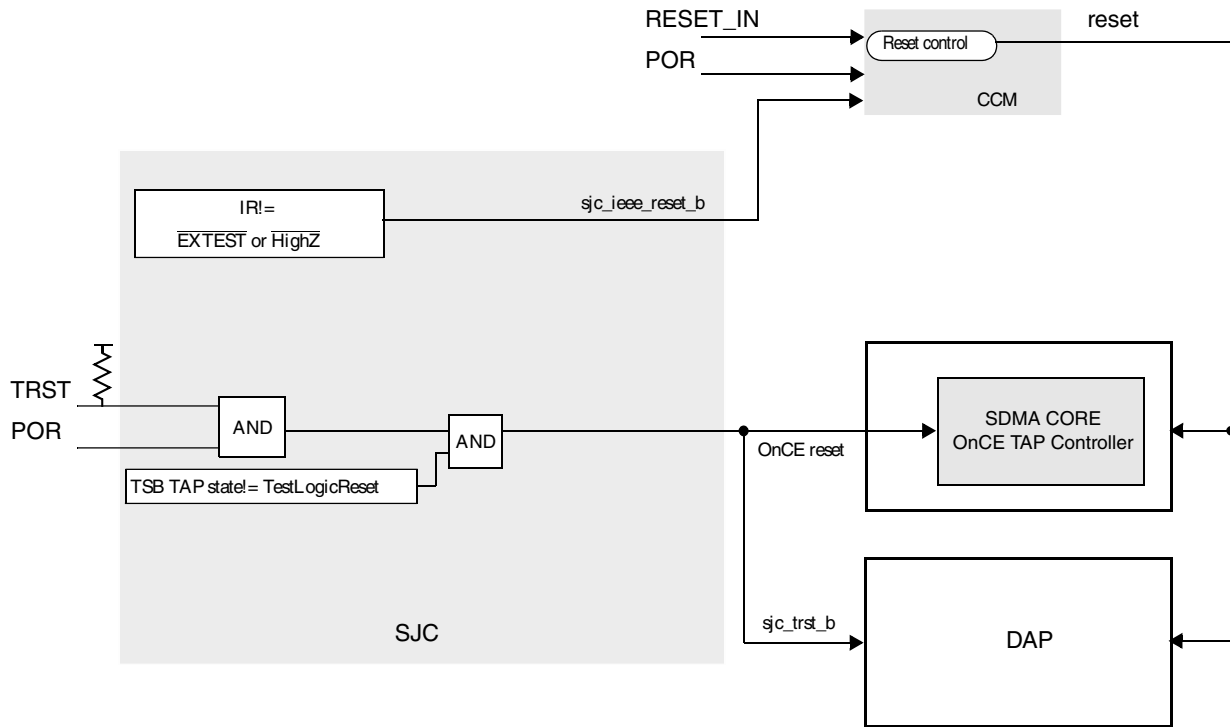

Figure 47-13. SJC Reset Logic

NOTE

- Asserting TRSTB in any scan mode resets the TCR losing the testmode configuration and selects default TAP.
- SJC generates an IEEE reset signal to the CCM when in one of the IEEE modes HIGHZ or EXTEST. This signal generates a system reset to the cores until exit from one of these modes.
- The TSB generates Once/ICE reset (either TRSTB if implemented or other) when its TAP state reaches Test-Logic-Reset (meaning that TAP accessed is also reaching Test-Logic-Reset).

47.8 Initialization/Application Information

The control afforded by the output enable signals using the boundary scan register and the EXTEST instruction requires a compatible circuit-board test environment to avoid device-destructive configurations. The user must avoid situations in which the SJC output drivers are enabled into actively driven networks.

There are two constraints related to the JTAG interface:

- Ensure that the JTAG test logic is kept transparent to the system logic by forcing TAP into the Test-Logic-Reset controller state. During power-up, SJC's internal TRSTB is asserted as IC's POR_B is asserted which forces the TAP controller into this state. After that, if TMS either remains unconnected or is connected to VCC, then the TAP controller cannot leave the Test-Logic-Reset state, regardless of the state of TCK.
- DE_B is an IO pin with pullup and care must be taken of the direction when driving this signal.

47.9 SJC Memory Map/Register Definition

In addition to the standard accessible JTAG registers (per IEEE1149.1 standard) listed in [SoC JTAG Instruction Register \(SJIR\)](#) , the chip contains the following registers accessed using the ExtraDebug mechanism, controlled via "ENABLE_ExtraDebug" IR instruction.

NOTE

SJC registers are only accessible by JTAG interface. They are not memory mapped to processor address space, so the absolute addresses provided by default in the SJC memory map are not valid.

This section assumes the JTAG controller is accessed in standalone mode or daisy chained (defined by TAP Selection Block) using the appropriate TSB configuration.

See "System Debug" chapter for more details about the general purpose register descriptions that are unique to this chip.

SJC memory map

Absolute address (hex)	Register name	Width (in bits)	Access	Reset value	Section/page
0	General Purpose Unsecured Status Register 1 (SJC_GPUSR1)	32	R	0000_0000h	47.9.1/3405
1	General Purpose Unsecured Status Register 2 (SJC_GPUSR2)	32	R	0000_0000h	47.9.2/3407
2	General Purpose Unsecured Status Register 3 (SJC_GPUSR3)	32	R	0000_0000h	47.9.3/3407
3	General Purpose Secured Status Register (SJC_GPSSR)	32	R	0000_0000h	47.9.4/3408
4	Debug Control Register (SJC_DCR)	32	R/W	1F9E_0000h	47.9.5/3409
5	Security Status Register (SJC_SSR)	32	R	See section	47.9.6/3411
7	General Purpose Clocks Control Register (SJC_GPCCR)	32	R/W	0C00_05A0h	47.9.7/3414

47.9.1 General Purpose Unsecured Status Register 1 (SJC_GPUSR1)

The General Purpose Unsecured Status Register 1 is a read only register used to check the status of the different Cores and of the PLL. The rest of its bits are for general purpose use.

Address: 0h base + 0h offset = 0h

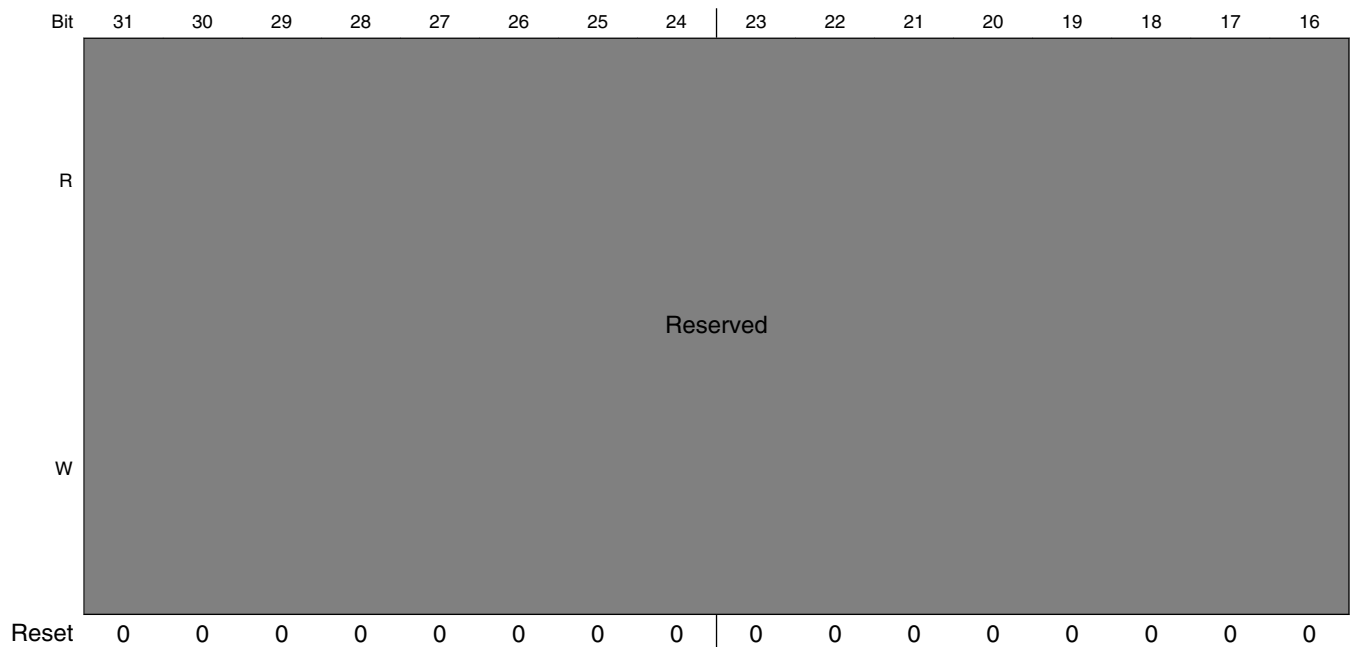

SJC Memory Map/Register Definition

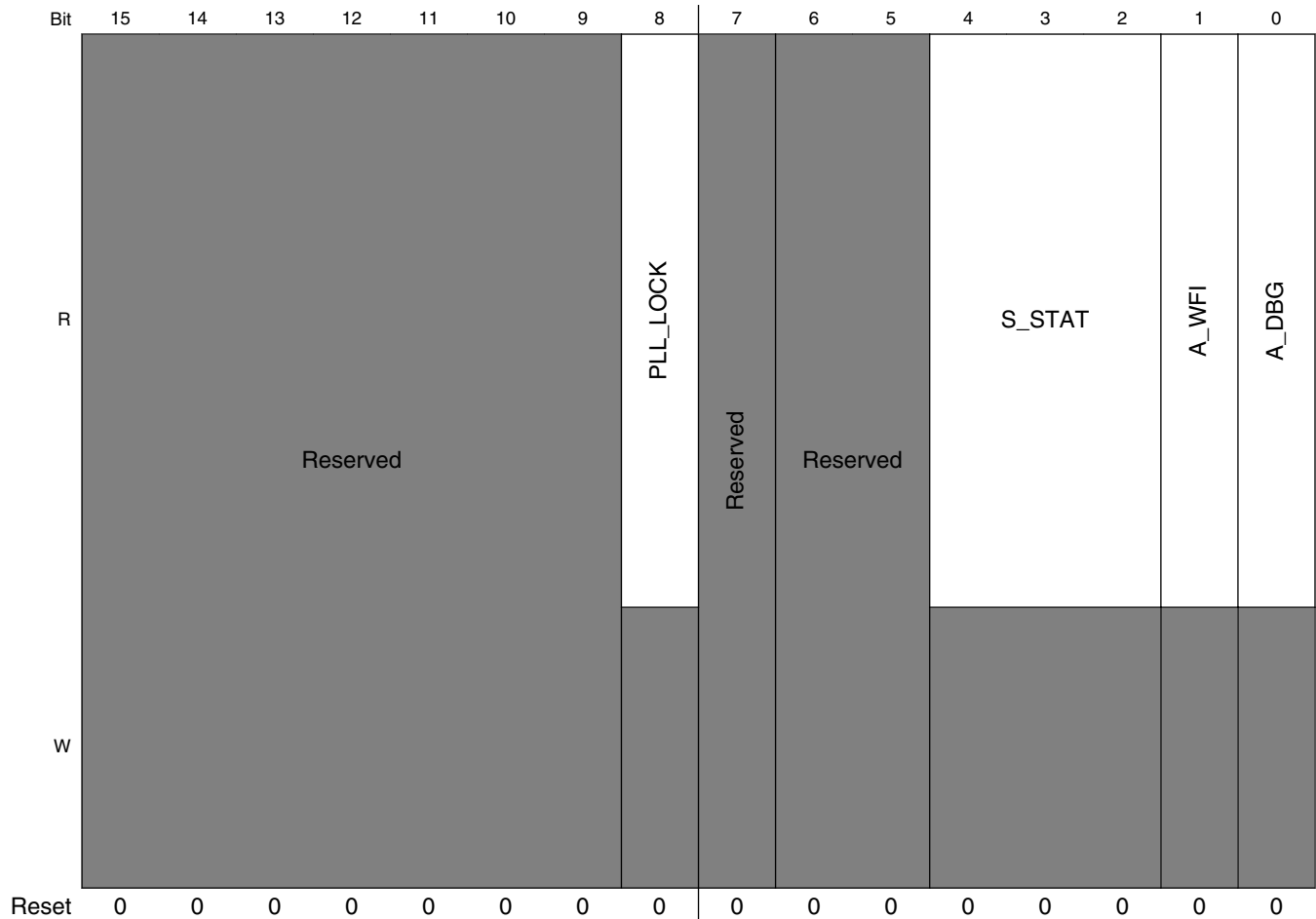

SJC_GPUSR1 field descriptions

Field	Description
31–9 -	This field is reserved. Reserved.
8 PLL_LOCK	PLL_LOCK A Combined PLL-Lock flag indicator, for all the PLL's.
7 -	This field is reserved. Reserved
6–5 -	This field is reserved. Reserved.
4–2 S_STAT	3 LSBits of SDMA core statusH.
1 A_WFI	Arm core wait-for interrupt bit Bit 1 is the Arm core standbywfi (stand by wait-for interrupt). When this bit is HIGH, Arm core is in wait for interrupt mode.
0 A_DBG	Arm core debug status bit Bit 0 is the Arm core DBGACK (debug acknowledge) DBGACK can be overwritten in the Arm core DCR to force a particular DBGACK value. Consequently interpretation of the DBGACK value is highly dependent on the debug sequence. When this bit is HIGH, Arm core is in debug.

47.9.2 General Purpose Unsecured Status Register 2 (SJC_GPUSR2)

Address: 0h base + 1h offset = 1h

Bit	31	30	29	28	27	26	25	24	23	22	21	20	19	18	17	16	15	14	13	12	11	10	9	8	7	6	5	4	3	2	1	0
R	Reserved																STBYWFE				S_STAT			STBYWFI								
W	Reserved																Reserved				Reserved			Reserved								
Reset	0	0	0	0	0	0	0	0	0	0	0	0	0	0	0	0	0	0	0	0	0	0	0	0	0	0	0	0	0	0	0	0

SJC_GPUSR2 field descriptions

Field	Description
31–12 -	This field is reserved. Reserved
11–8 STBYWFE	STBYWFE[3:0] Reflecting the "Standby Wait For Event" signals of all cores.
7–4 S_STAT	S_STAT[3:0] SDMA debug status bits: debug_core_state[3:0]
STBYWFI	STBYWFI[3:0] These bits provide status of "Standby Wait-For-Interrupt" state of all Arm cores.

47.9.3 General Purpose Unsecured Status Register 3 (SJC_GPUSR3)

Address: 0h base + 2h offset = 2h

Bit	31	30	29	28	27	26	25	24	23	22	21	20	19	18	17	16
R	Reserved															
W	Reserved															
Reset	0	0	0	0	0	0	0	0	0	0	0	0	0	0	0	0
Bit	15	14	13	12	11	10	9	8	7	6	5	4	3	2	1	0
R	Reserved													SYS_	IPG_	IPG_
W	Reserved													WAIT	STOP	WAIT
Reset	0	0	0	0	0	0	0	0	0	0	0	0	0	0	0	0

SJC_GPUSR3 field descriptions

Field	Description
31–3 -	This field is reserved. Reserved

Table continues on the next page...

SJC_GPUSR3 field descriptions (continued)

Field	Description
2 SYS_WAIT	System In wait Indication on System in wait mode (from CCM).
1 IPG_STOP	IPG_STOP CCM's "ipg_stop" signal indication
0 IPG_WAIT	IPG_WAIT CCM's "ipg_wait" signal indication

47.9.4 General Purpose Secured Status Register (SJC_GPSSR)

The General Purpose Secured Status Register is a read-only register used to check the status of the different critical information in the SoC. This register cannot be accessed in secure modes.

Address: 0h base + 3h offset = 3h

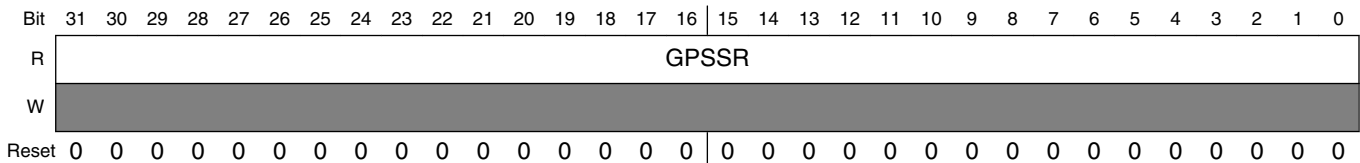

SJC_GPSSR field descriptions

Field	Description
GPSSR	General Purpose Secured Status Register Register is used for testing and debug.

47.9.5 Debug Control Register (SJC_DCR)

This register is used to control propagation of debug request from DE_B pad to the cores and debug signals from internal logic to the DE_B pad.

Address: 0h base + 4h offset = 4h

Bit	31	30	29	28	27	26	25	24	23	22	21	20	19	18	17	16						
R	Reserved																					
W																						
Reset	0	0	0	1	1	1	1	1	1	0	0	1	1	1	1	0						
Bit	15	14	13	12	11	10	9	8	7	6	5	4	3	2	1	0						
R	Reserved									DIRECT_ARM_REQ_EN		DIRECT_SDMA_REQ_EN		Reserved		DEBUG_OBS		Reserved		DE_TO_SDMA		DE_TO_ARM
W	Reserved									DIRECT_ARM_REQ_EN		DIRECT_SDMA_REQ_EN		Reserved		DEBUG_OBS		Reserved		DE_TO_SDMA		DE_TO_ARM
Reset	0	0	0	0	0	0	0	0	0	0	0	0	0	0	0	0						

SJC_DCR field descriptions

Field	Description
31–7 -	This field is reserved. Reserved
6 DIRECT_ARM_REQ_EN	Pass Debug Enable event from DE_B pin to Arm platform debug request signal(s). This bit controls the propagation of debug request DE_B to the Arm platform. 0 Disable propagation of system debug to (DE_B pin) to Arm platform. 1 Enable propagation of system debug to (DE_B pin) to Arm platform.
5 DIRECT_SDMA_REQ_EN	Debug enable of the sdma debug request This bit controls the propagation of debug request DE_B to the sdma. 0 Disable propagation of system debug to (DE_B pin) to sdma. 1 Enable propagation of system debug to (DE_B pin) to sdma.
4 -	This field is reserved. Reserved

Table continues on the next page...

SJC_DCR field descriptions (continued)

Field	Description
3 DEBUG_OBS	<p>Debug observability</p> <p>This bit controls the propagation of the "system debug" input to SJC (driven by the ECT logic), to the DE_B pad.</p> <p>(This logic can be used to pass debug acknowledge event from ECT out to the PAD, for example).</p> <p>The SJC's "system_debug" input is tied to logic HIGH value, therefore, set of "debug_obs" bit, will result in unconditional assertion of DE_B pad.</p> <p>0 Disable propagation of system debug to DE_B pin 1 Unconditional assertion of pad DE_B</p>
2 -	<p>This field is reserved. Reserved</p>
1 DE_TO_SDMA	<p>SDMA debug request input propagation</p> <p>This bit controls the propagation of debug request to SDMA, when the JTAG state machine is put in "ENTER_DEBUG" IR instruction..</p> <p>0 Disable propagation of debug request to SDMA 1 Enable propagation of debug request to SDMA</p>
0 DE_TO_ARM	<p>Arm platform debug request input propagation</p> <p>This bit controls the propagation of debug request to Arm platform ("dbgreq"), when the JTAG state machine is put in "ENTER_DEBUG" IR instruction.</p> <p>0 Disable propagation of debug request to Arm platform 1 Enable propagation of debug request to Arm platform</p>

47.9.6 Security Status Register (SJC_SSR)

Address: 0h base + 5h offset = 5h

Bit	31	30	29	28	27	26	25	24	23	22	21	20	19	18	17	16
R								-								
W																Reserved
Reset	0*	0*	0*	0*	0*	0*	0*	0*	0*	0*	0*	0*	0*	0*	0*	0*

SJC Memory Map/Register Definition

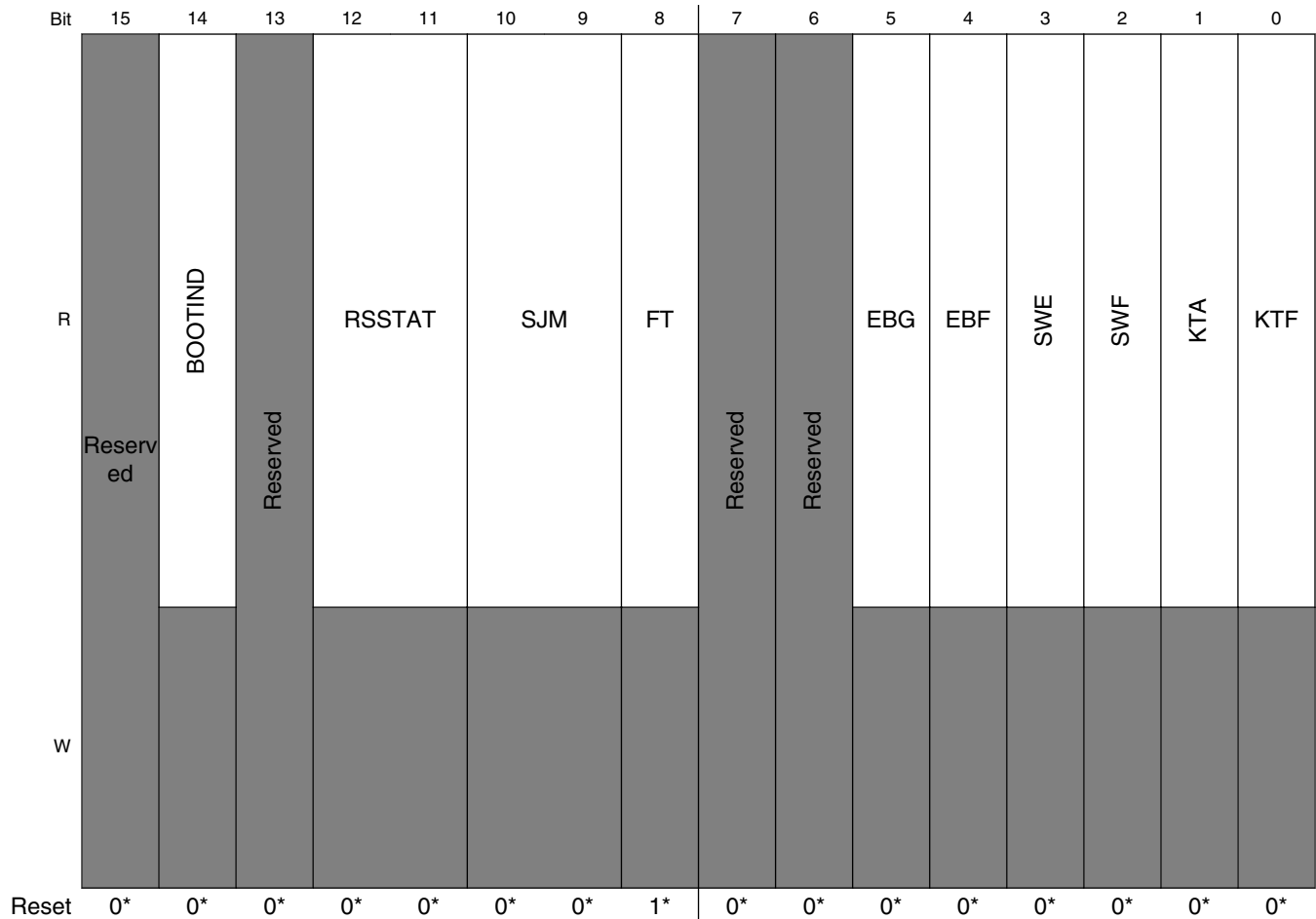

* Notes:

- The SJM reset value, reflects the JTAG security state, as defined by status of JTAG_SMODE[1:0] fuses. See the [SJM](#) bitfield description for details on valid values.

SJC_SSR field descriptions

Field	Description
31–17 -	Reserved.
16–15 -	This field is reserved. Reserved
14 BOOTIND	Boot Indication Inverted Internal Boot indication, i.e inverse of SRC: "src_int_boot" signal
13 -	This field is reserved. Reserved
12–11 RSSTAT	Response status Response status bits 00 Response wasn't entered 01 Response was entered but not verified

Table continues on the next page...

SJC_SSR field descriptions (continued)

Field	Description
	10 Response was entered and is incorrect 11 Response is correct
10–9 SJM	SJC Secure mode Secure JTAG mode, as set by external fuses. 00 No debug (#1) 01 Secure JTAG (#2) 10 Reserved 11 JTAG enabled (#3)
8 FT	Fuse type Fuse type bit - e-fuse or laser fuse 0 E-fuse technology 1 Laser fuse technology
7 -	This field is reserved. Reserved
6 -	This field is reserved. Reserved
5 EBG	External boot granted External boot enabled, requested and granted 1 granted 0 not granted
4 EBF	External Boot fuse Status of the external boot disable fuse 0 (intact) - external boot is allowed 1 (burned) - external boot is disabled
3 SWE	SW enable SW JTAG enable status 1 enabled 0 disabled
2 SWF	Software JTAG enable fuse Status of the no SW disable JTAG fuse 0 (intact) - SW enable possible 1 (intact) - no SW enable possible
1 KTA	Kill Trace is active 1 active 0 not active
0 KTF	Kill Trace Enable fuse value 0 (intact) - kill trace is never active 1 (burned) - kill trace functionality enabled

47.9.7 General Purpose Clocks Control Register (SJC_GPCCR)

This register is used to configure clock related modes in SOC, see System Configuration chapter for more information. Those bits are directly connected to JTAG outputs. Bit 0 of GPCCR controls SDMA clocks invocation. When out of reset, the SDMA is in sleep mode with no SDMA clock running. Unlike events, debug requests does not wake SDMA if it is in sleep mode. The debug request is recognized by the SDMA only when it exits sleep mode upon reception of an event. To be able to enter debug mode even if no event is triggered, the SDMA clock on bit needs to be set prior to sending the debug request (clear at reset).

Address: 0h base + 7h offset = 7h

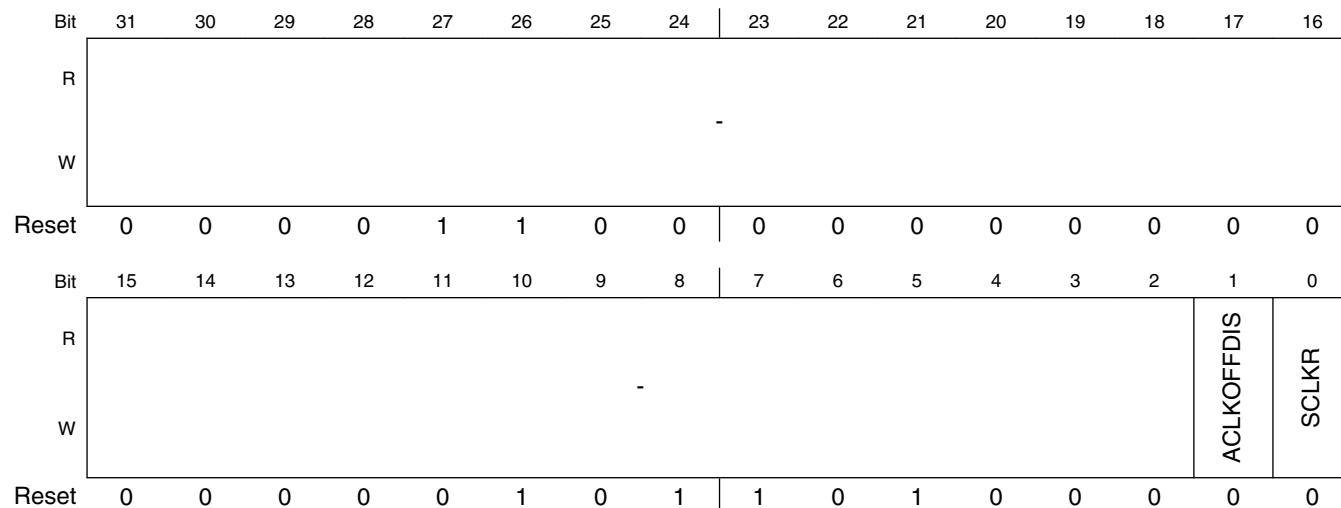

SJC_GPCCR field descriptions

Field	Description
31–2 -	Reserved
1 ACLKOFFDIS	Disable/prevent Arm platform clock/power shutdown
0 SCLKR	SDMA Clock ON Register - This bit forces the clock on of the SDMA

Chapter 48

Secure Non-Volatile Storage (SNVS)

48.1 SNVS overview

The low-power (battery-backed) section incorporates a secure real time counter, a monotonic counter, and a general-purpose register. The LP portion of the SNVS is powered by a battery that maintains the state of the SNVS_LP registers when the chip is powered off.

48.1.1 SNVS features

The following table summarizes the features:

Table 48-1. SNVS feature summary

Feature	What it does
(nonsecure) Real Time Counter (HP-RTC)	<ul style="list-style-type: none">• The counter is driven by a dedicated clock, which is off when the system power is down• Programmable time alarm interrupt• Periodic interrupt can be generated with different frequencies
Monotonic Counter (LP-MC)	<ul style="list-style-type: none">• The Monotonic Counter state is nonvolatile.• The counter can only increment.• The counter is a non-rollover counter• The counter value is invalidated in case of security violation.
General-Purpose Register	<ul style="list-style-type: none">• The general-purpose register state is nonvolatile.
Register access protection	<ul style="list-style-type: none">• Privileged software access policy• Registers can be programmed only when the system security monitor is in functional state.• Some registers/values can only be programmable once per boot cycle.

48.1.2 Modes of operation

The SNVS operates in either the system power-down or the system power-up mode of operation.

During system power-down, the SNVS_HP is powered down. The SNVS_LP is powered from the backup power supply and is electrically isolated from the rest of the chip. In this mode, the SNVS_LP retains the state of its registers .

During the system power-up, the SNVS_HP and SNVS_LP are both powered up and all SNVS functions are operational.

48.2 SNVS structure

The SNVS block is divided into two major submodules based on power supply: the high power domain (SNVS_HP) and the low power domain (SNVS_LP). They are powered as follows:

- SNVS_LP - dedicated always-powered-on domain
- SNVS_HP - system (chip) power domain

The following figure illustrates the low power and chip power domains of SNVS.

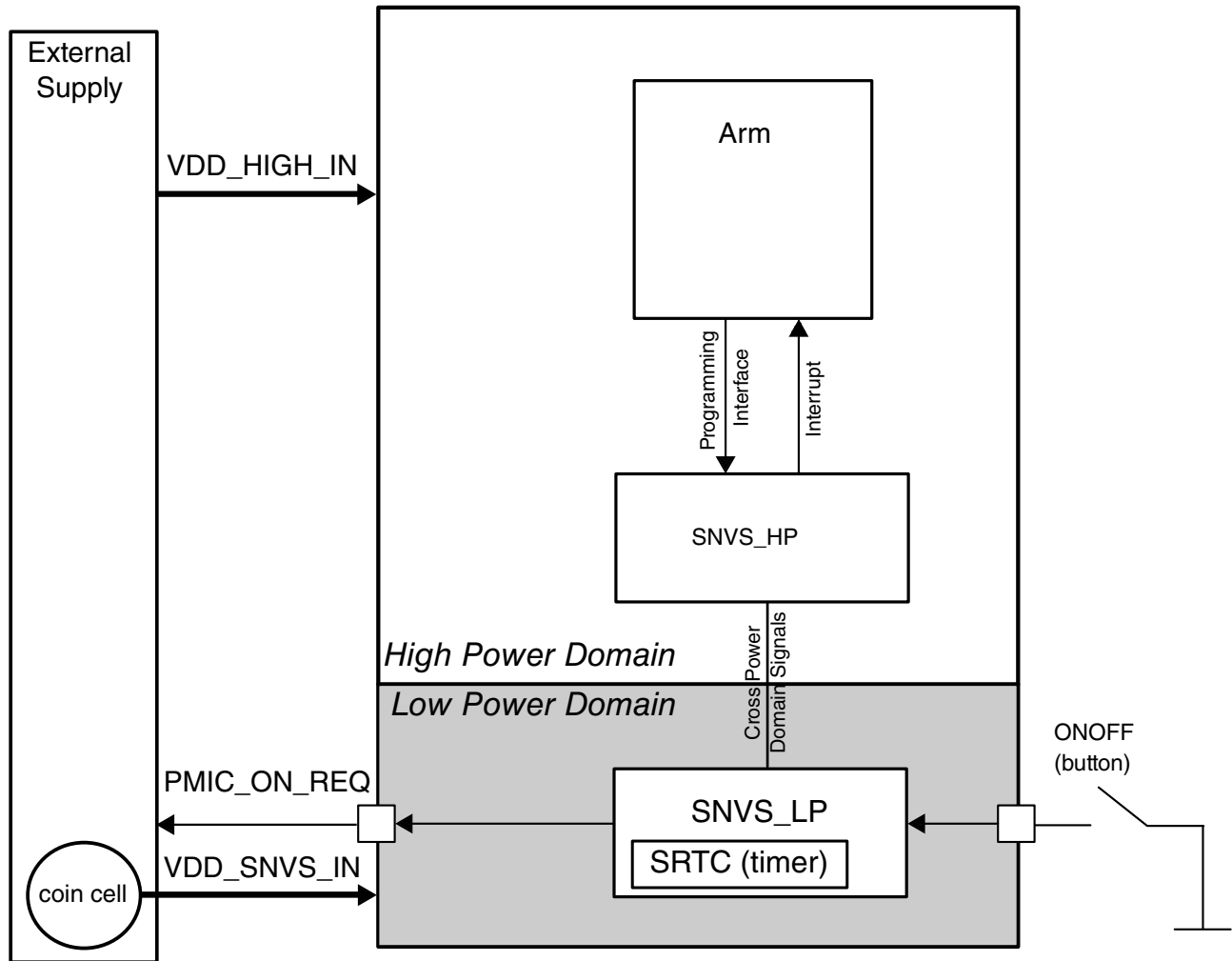

Figure 48-1. SNVS Power Domains

The SNVS_HP section implements all features that enable system communication and provisioning of the SNVS_LP section.

The SNVS_LP section provides hardware that enables secure storage and protection of sensitive data.

48.2.1 SNVS_HP (high-power domain)

The SNVS_HP is partitioned into these functional units:

- IP bus interface
- SNVS_LP interface
- Real-time counter with alarm
- Control and status registers

The SNVS_HP is in the chip's power-supply domain and thus receives the power along with the rest of the chip. The SNVS_HP provides an interface between the SNVS_LP and the rest of the system; there is no way to access the SNVS_LP registers except through the SNVS_HP. For access to the SNVS_LP registers, the SNVS_HP must be powered up. It uses a register access permission policy to determine whether the access to the particular registers is permitted.

48.2.2 Non-secure real-time counter

The SNVS_HP has an autonomous non-secure real-time counter. The counter is not active and is reset when the system is powered down. The HP RTC can be used by any application; it has no privileged software access restrictions. The counter can be synchronized with the SNVS_LP SRTC by writing to a specific bit in the SNVS_HP control register.

48.2.2.1 Calibrating the time counter

The RTC accuracy may suffer from a drift in the clock, which is used to increment the RTC register. To compensate for this drift, a clock calibration mechanism can adjust the RTC value. It is up to the system processor to decide whether the calibration is required or not. If the RTC correction is required, enable the mechanism and set the calibration value in the control register. The calibration value is a 5-bit value including the sign bit, which is implemented in the 2's complement.

If the calibration mechanism is enabled, the calibration value is added or subtracted from the RTC on a periodic basis, once per 32768 cycles of the RTC clock.

This table shows the available correction range:

Table 48-2. Time counter calibration settings

Calibration value setting	Correction in counts per 32768 cycles of the counter clock
01111	+15
:	:
00010	+2
00001	+1
00000	0
11111	-1
11110	-2
:	:
10001	-15
10000	-16

48.2.2.2 Time counter alarm

The SNVS_HP non-secure RTC has its own time-alarm register. Any application can update this register. The SNVS_HP time alarm can generate interrupts to alert the host processor and can wake up the host processor from one of its low-power modes. Note that this alarm can't wake up the entire system if it is powered off because this alarm would also be powered off.

48.2.2.3 Periodic interrupt

The SNVS_HP non-secure RTC incorporates a periodic interrupt. The periodic interrupt is generated when a zero-to-one or one-to-zero transition occurs on the selected bit of the RTC. The periodic interrupt source is chosen from the 16 bits of the HP RTC according to the PI_FREQ field setting in the HP control register. This bit selection also defines the frequency of the periodic interrupt.

This figure shows the SNVS_HP RTC and its interrupts:

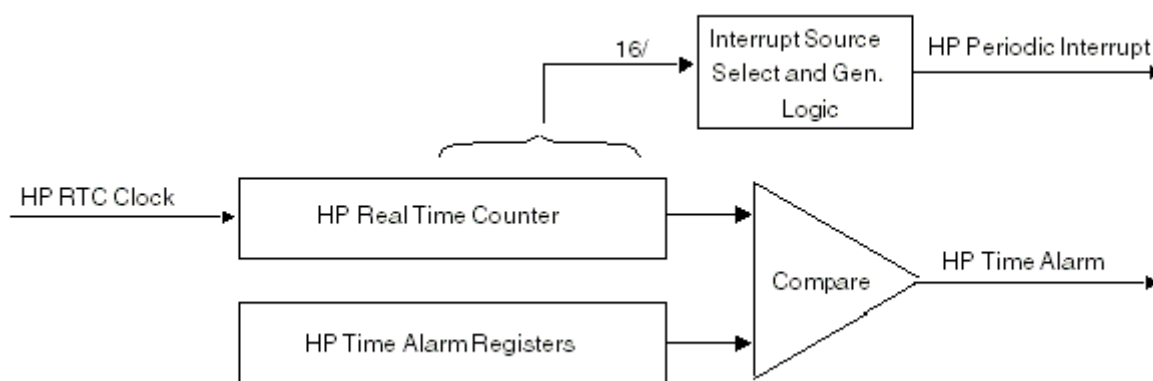

Figure 48-2. SNVS_HP RTC, alarm, and interrupts

48.3 SNVS_LP (low-power domain)

The SNVS_LP has these functional units:

- Non-rollover monotonic counter
- General-purpose register
- Control and status registers

The SNVS_LP is a data storage subsystem. Its purpose is to store and protect system data, regardless of the main system power state.

The SNVS_LP is in the always-powered-up domain, which is a separate power domain with its own power supply.

48.3.1 Behavior during system power down

When the chip power-supply domain loses power, the The SNVS_LP continues to operate normally and ignores all inputs from the SNVS_HP.

48.3.2 Monotonic Counter (MC)

This figure shows the MC and its rollover security violation:

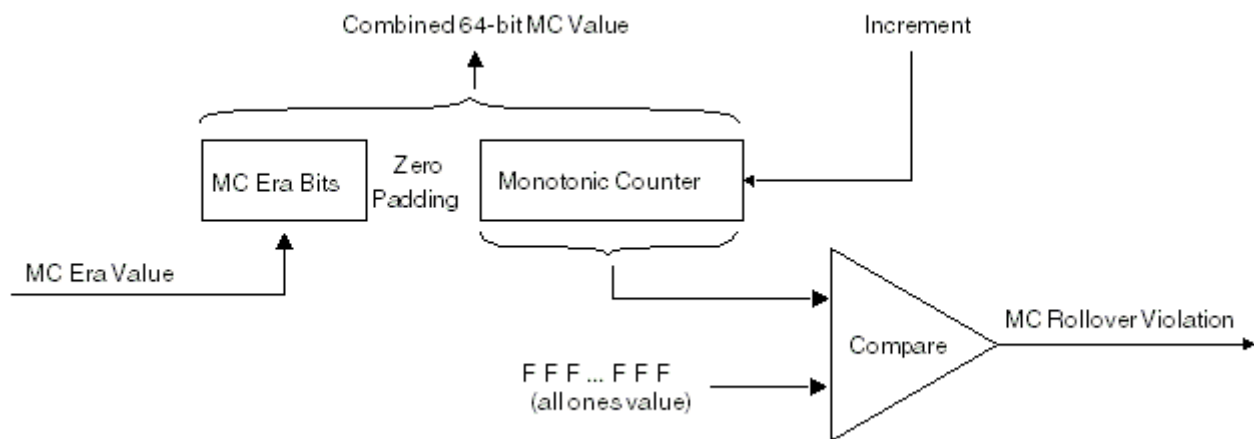

Figure 48-3. SNVS_LP monotonic counter

Some security applications require a Monotonic Counter (MC) that can't be exhausted or returned to any previous value during the product's lifetime. Because the MC should never repeat a number, it can't be reset or cycled back to its starting count. If it reaches its maximum value it does not rollover. Instead, a monotonic counter rollover indication is generated to the SNVS_LP tamper monitor. This generates an interrupt to the host processor.

The MON_COUNTER fields of the MC register are implemented in flip flops within the LP section. If LP power is lost, the MON_COUNTER value will be lost. To preserve monotonicity in this event, the most significant bits of MC (the MC_ERA_BITS field) are derived from fuses. This means that the MC_ERA_BITS value is preserved across LP section power failures. The next time that the chip powers up following an LP section

power failure, the chip's boot firmware will note that the monotonic counter value is invalid and will blow another of the fuses that drive the MC_ERA_bits field. This will result in a larger value in the MC_ERA MC field and since this field forms the most-significant bits of MC, this guarantees that the new value of MC is greater than any of its past values.

48.4 SNVS reset and system powerup

This table describes the reset actions for the SNVS.

Table 48-3. Reset summary

Reset	Source	Characteristics	Internally resets
HP hard	ipg_hard_async_reset_b	active-low, asynchronous	All SNVS_HPSNVS_LP registers and flops.
LP Power On Reset (POR)	lp_por_b	active-low, asynchronous	All SNVS_LP registers and flops.
LP software reset	software	active-high, synchronous, one cycle	All SNVS_LP registers and flops. The LP software reset can be asserted if not disabled.

48.4.1 PMIC interface

The on/off logic inside the SNVS_LP allows for connecting directly to a PMIC or other voltage-regulator device. The logic takes the button input signal and then outputs the PMIC "ON" request and the "Power Off" interrupt. The PMIC logic also supports the SNVS_LP tamper logic which allows to wake the system up when a tamper event has happened while in the OFF state. The logic has two different modes of operation (the dumb and smart modes).

Dumb PMIC mode:

The dumb PMIC mode uses the PMIC "ON" request to issue a level signal for the ON and OFF states. The dumb PMIC mode has many different configuration options which include debounce, off-to-on time, and maximum timeout.

- Debounce—the debounce configuration supports 0 ms, 50 ms, 100 ms, and 500 ms. The debounce is used to generate the set_pwr_off_irq interrupt. While it is in the ON state and the button is pressed longer than the debounce time, the set_pwr_off_irq is generated.

- Off-to-on time—the off-to-on configuration supports 0 ms, 50 ms, 100 ms, and 500 ms. This configuration supports the time it takes to request the power-on after the configured button press time is reached. When the button is pressed longer than the configuration time, the state machine transitions from the OFF to the ON state.
- Max timeout—the maximum timeout configuration supports 5 s, 10 s, 15 s, and disable. This configuration supports the time it takes to request the power down after the button is pressed for the defined time.

The dumb PMIC mode uses a 2-state state machine, as shown in the following figure. The output of the pmic_en_b is generated by the state of the state machine.

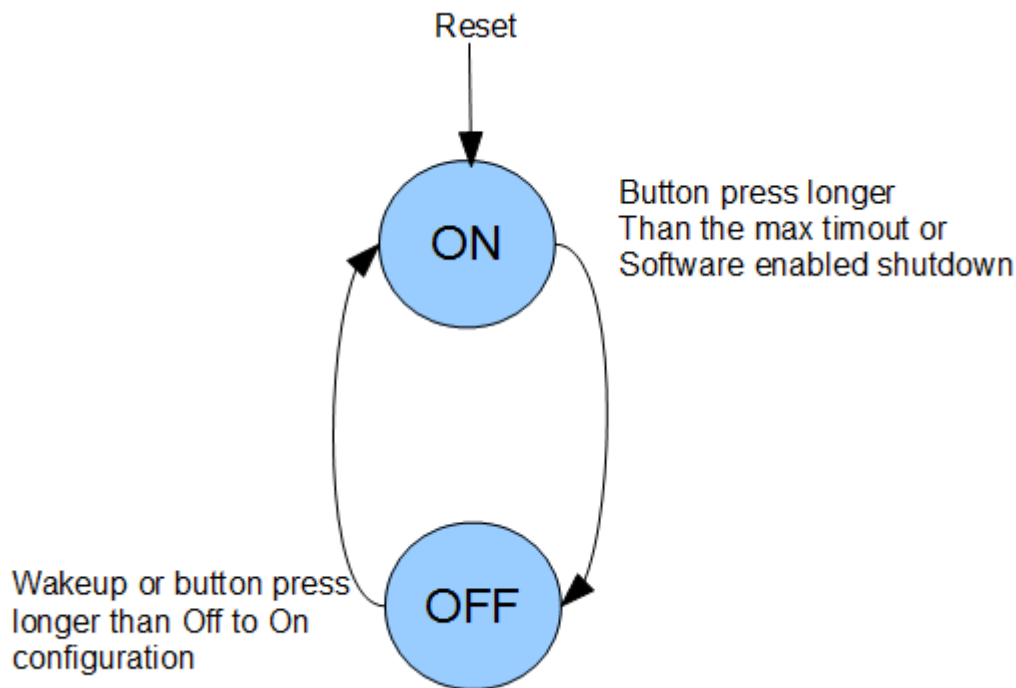

Smart PMIC mode:

The smart PMIC mode is meant to connect to another PMIC. The PMIC "ON" request signal issues a pulse instead of a level signal. The only configuration option available for this mode is the Debounce configuration that is used for the "Power Off" interrupt.

48.5 SNVS interrupts and alarms

SNVS provides these interrupt and alarm lines:

- Functional interrupt (active-low)

- Real-time clock period interrupt
- Power off (button) interrupt

This table summarizes all SNVS interrupts and alarm sources.

Table 48-4. Interrupts and alarms summary

Interrupt	Source	Default configuration ¹	Configuration options
SNVS functional interrupt	RTC time alarm	Disable	Enable/Disable
	RTC periodic interrupt	Disable	Enable/Disable
SNVS power off (button) interrupt	BTN input signal	50 ms debounce	Debounce time

1. Default behavior refers to the setting after the LP/HP reset.

48.6 Programming guidelines

This section provides the initialization and application information for the SNVS module.

48.6.1 RTC control bits setting

All SNVS registers are programmed from the register bus. Therefore, any changes are synchronized with the IP clock. Several registers can also change synchronously with the RTC clock after they are programmed. To avoid IP clock and RTC clock synchronization issues, these values can only be programmed when the corresponding function is disabled. This table presents the list of these values with the control bit setting required for programming:

Table 48-5. RTC synchronized values list

Function	Value/register	Control bit setting
HP section		
HP real-time counter	HPRTCMR and HPRTCLR registers	RTC_EN = 0—HPRTCMR/HPRTCLR can be programmed RTC_EN = 1—HPRTCMR/HPRTCLR can't be programmed
HP time alarm	HPTAMR and HPTALR registers	HPTA_EN = 0—HPTAMR/HPTALR can be programmed HPTA_EN = 1—HPTAMR/HPTALR can't be programmed
HP time calibration value	HPCALB_VAL value	HPCALB_EN = 0—HPCALB_VAL can be programmed HPCALB_EN = 1—HPCALB_VAL can't be programmed

Perform these steps to program the synchronized values:

1. Check the enable bit value. If it is set, clear it.

2. Verify that the enable bit is cleared.

There are two reasons to verify the enable bit's setting:

- The enable bit clearing does not happen immediately. It takes three IPclock cycles and two RTC clock cycles to change the enable bit's value.
- If the enable bit is locked for programming, it can't be cleared.

3. Program the desired value.

4. Set the enable bit. It takes three IP clock cycles and two RTC clock cycles for the bit to set.

NOTE

Incrementing the value programmed into the RTC registers by two compensates for the two RTC clock cycle delays that are required to enable the counter.

48.6.2 RTC value read

There are two scenarios when the software can read the corrupted values from the RTC (HPRTCMR and HPRTCLR) registers:

- The RTC counters are incremented by the slow 32-kHz clock, which is asynchronous to the system clock. The counter value is synchronized to the system clock before the software reads that. The synchronization register can capture the counter value in the middle of the counter update. In this case, it is not guaranteed that all bits are properly sampled by the synchronization register; the value read by the software can be wrong.
- The RTC value is longer than the single bus read transaction of 32 bits. Therefore, the software reads two registers with each holding a portion of the counter value. After reading one of these registers but before reading the second register, both registers can update their values. In this case, the value combined by the software is incorrect.

To avoid these issues, it is strongly recommended that the software performs two consecutive reads of the RTC value:

- If the two consecutive reads are similar, the value is correct.
- If the two consecutive reads are different, perform two more reads.

The worst-case scenario can require three sessions of two consecutive reads.

48.6.3 General initialization guidelines

Perform these steps to properly initialize the module:

1. Enable the interrupts in the SNVS control and configuration registers.
2. Program the SNVS general functions/configurations.
3. User-specific: Set the lock bits.

48.7 SNVS memory map/register definition

This section contains detailed register descriptions for the SNVS registers. Each description includes a standard register diagram and a register table. The register table provides detailed descriptions of the register bit and field functions in the bit order.

The SNVS registers consist of two types:

- Privileged read/write accessible
- Non-privileged read/write accessible

The privileged read/write accessible registers can only be accessed for read/write by the privileged software. Unauthorized write accesses are ignored, and unauthorized read accesses return zero. The non-privileged software can access privileged access registers when the non-privileged software access enable bit is set in the SNVS_HPcommand register.

- Non-secure
- Trusted
- Secure

The non-privileged read/write accessible registers are read/write accessible by any software.

The following table shows the SNVS memory map. The LP register values are set only on the LP POR and are unaffected by the system (HP) POR. The HP registers are set only on the system POR and are unaffected by the LP POR.

SNVS memory map

Offset address (hex)	Register name	Width (in bits)	Access	Reset value	Section/page
20C_C000	SNVS_HP Lock register (SNVS_HPLR)	32	R/W	0000_0000h	48.7.1/3427
20C_C004	SNVS_HP Command register (SNVS_HPCOMR)	32	R/W	0000_0000h	48.7.2/3429

Table continues on the next page...

SNVS memory map (continued)

Offset address (hex)	Register name	Width (in bits)	Access	Reset value	Section/page
20C_C008	SNVS_HP Control register (SNVS_HPCR)	32	R/W	0000_0000h	48.7.3/3431
20C_C014	SNVS_HP Status register (SNVS_HPSR)	32	R/W	8000_0000h	48.7.4/3434
20C_C024	SNVS_HP Real-Time Counter MSB Register (SNVS_HPRTCMBR)	32	R/W	0000_0000h	48.7.5/3436
20C_C028	SNVS_HP Real-Time Counter LSB Register (SNVS_HPRTCLR)	32	R/W	0000_0000h	48.7.6/3437
20C_C02C	SNVS_HP Time Alarm MSB Register (SNVS_HPTAMR)	32	R/W	0000_0000h	48.7.7/3437
20C_C030	SNVS_HP Time Alarm LSB Register (SNVS_HPTALR)	32	R/W	0000_0000h	48.7.8/3438
20C_C034	SNVS_LP Lock Register (SNVS_LPLR)	32	R/W	0000_0000h	48.7.9/3439
20C_C038	SNVS_LP Control Register (SNVS_LPCR)	32	R/W	0000_0020h	48.7.10/3441
20C_C04C	SNVS_LP Status Register (SNVS_LPSR)	32	R/W	0000_0008h	48.7.11/3444
20C_C05C	SNVS_LP Secure Monotonic Counter MSB Register (SNVS_LPSMCMR)	32	R/W	0000_0000h	48.7.12/3446
20C_C060	SNVS_LP Secure Monotonic Counter LSB Register (SNVS_LPSMCLR)	32	R/W	0000_0000h	48.7.13/3447
20C_C068	SNVS_LP General-Purpose Register (SNVS_LPGPR)	32	R/W	0000_0000h	48.7.14/3447
20C_CBF8	SNVS_HP Version ID Register 1 (SNVS_HPVIDR1)	32	R	003E_0300h	48.7.15/3448
20C_CBFC	SNVS_HP Version ID Register 2 (SNVS_HPVIDR2)	32	R	0300_0000h	48.7.16/3448

48.7.1 SNVS_HP Lock register (SNVS_HPLR)

The SNVS_HP lock register contains the lock bits for the SNVS registers. This is a privileged write register.

Address: 20C_C000h base + 0h offset = 20C_C000h

Bit	31	30	29	28	27	26	25	24	23	22	21	20	19	18	17	16
R	Reserved						Reserved						-	-	-	
W	Reserved						Reserved						-	-	-	
Reset	0	0	0	0	0	0	0	0	0	0	0	0	0	0	0	0
Bit	15	14	13	12	11	10	9	8	7	6	5	4	3	2	1	0
R	Reserved						-	-	Reserved	Reserved	GPR_SL	MC_SL	-	-	-	-
W	Reserved						-	-	Reserved	Reserved	GPR_SL	MC_SL	-	-	-	-
Reset	0	0	0	0	0	0	0	0	0	0	0	0	0	0	0	0

SNVS_HPLR field descriptions

Field	Description
31–29 -	This field is reserved.
28 -	This field is reserved.
27 -	This field is reserved.
26 -	This field is reserved.
25 -	This field is reserved.
24 -	This field is reserved.
23–19 -	This field is reserved.

Table continues on the next page...

SNVS_HPLR field descriptions (continued)

Field	Description
18 -	Security-related field
17 -	Security-related field
16 -	Security-related field
15–10 -	This field is reserved.
9 -	Security-related field
8 -	Security-related field
7 -	This field is reserved.
6 -	This field is reserved.
5 GPR_SL	<p>General-Purpose Register Soft Lock</p> <p>When set, it prevents any writes to the GPR. Once set, this bit can only be reset by the system reset.</p> <p>0 Write access is allowed. 1 Write access is not allowed.</p>
4 MC_SL	<p>Monotonic Counter Soft Lock</p> <p>When set, it prevents any writes (increments) to the MC registers and the MC_ENV bit. Once set, this bit can only be reset by the system reset.</p> <p>0 Write access (increment) is allowed. 1 Write access (increment) is not allowed.</p>
3 -	Security-related field
2 -	Security-related field
1 -	Security-related field
0 -	Security-related field.

48.7.2 SNVS_HP Command register (SNVS_HPCOMR)

The SNVS_HP command register contains the command, configuration, and control bits for the SNVS block. This is a privileged write register.

Address: 20C_C000h base + 4h offset = 20C_C004h

Bit	31	30	29	28	27	26	25	24	23	22	21	20	19	18	17	16		
R		Reserved													-	-	-	-
W	NPSWA_EN	Reserved																
Reset	0	0	0	0	0	0	0	0	0	0	0	0	0	0	0	0		
Bit	15	14	13	12	11	10	9	8	7	6	5	4	3	2	1	0		
R	Reserved		-	-	-	-	-	Reserved		LP_SWR_DIS		Reserved		-	-	-		
W	Reserved								Reserved		LP_SWR	Reserved						
Reset	0	0	0	0	0	0	0	0	0	0	0	0	0	0	0	0		

SNVS_HPCOMR field descriptions

Field	Description
31 NPSWA_EN	<p>Non-Privileged Software Access Enable</p> <p>When set, it allows non-privileged software to access all SNVS registers, including those that are privileged-software read/write access only.</p> <p>0—only the privileged software can access the privileged registers. 1—any software can access the privileged registers.</p>
30–20 -	This field is reserved.
19 -	Security-related field
18 -	Security-related field
17 -	Security-related field
16 -	Security-related field
15–14 -	This field is reserved.
13 -	Security-related field
12–11 -	Security-related field
10 -	Security-related field
9 -	Security-related field
8 -	Security-related field
7–6 -	This field is reserved.
5 LP_SWR_DIS	<p>LP Software Reset Disable</p> <p>When set, it disables the LP software reset. Once set, this bit can only be reset by the system reset.</p> <p>0 LP software reset is enabled. 1 LP software reset is disabled.</p>
4 LP_SWR	<p>LP Software Reset</p> <p>When set, it resets the SNVS_LP section. This bit can't be set when the LP_SWR_DIS bit is set. This self-clearing bit is always read as zero.</p> <p>0 No action 1 Reset LP section</p>
3 -	This field is reserved.
2 -	Security-related field
1 -	Security-related field

Table continues on the next page...

SNVS_HPCOMR field descriptions (continued)

Field	Description
0 -	Security-related field

48.7.3 SNVS_HP Control register (SNVS_HPCR)

The SNVS_HP control register contains various control bits of the HP section of the SNVS. .

Address: 20C_C000h base + 8h offset = 20C_C008h

Bit	31	30	29	28	27	26	25	24	23	22	21	20	19	18	17	16	
R	Reserved				BTN_MASK	BTN_CONFIG			Reserved							-	
W	Reserved					BTN_CONFIG			Reserved							-	
Reset	0	0	0	0	0	0	0	0	0	0	0	0	0	0	0	0	0
Bit	15	14	13	12	11	10	9	8	7	6	5	4	3	2	1	0	
R	Reserved	HPCALB_VAL						Reserved	HPCALB_EN	PI_FREQ				PI_EN	Reserved	HPTA_EN	RTC_EN
W		Reserved	HPCALB_VAL							HPCALB_EN	PI_FREQ						
Reset	0		0	0	0	0	0	0	0		0	0	0	0	0	0	0

SNVS_HPCR field descriptions

Field	Description
31–28 -	This field is reserved.
27 BTN_MASK	Button interrupt mask. This bit is used to mask the ipi_snvs_btn_int_b (button) interrupt request. 0—interrupt is disabled. 1—interrupt is enabled.
26–24 BTN_CONFIG	Button configuration. This field is used to configure which feature of the button (BTN) input signal constitutes "active".

Table continues on the next page...

SNVS_HPCR field descriptions (continued)

Field	Description
	<p>000—button signal is active-low.</p> <p>001—button signal is active-high.</p> <p>010—button signal is active on the rising edge.</p> <p>011—button signal is active on the falling edge.</p> <p>100—button signal is active on any edge.</p> <p>All other patterns are reserved.</p>
23–17 -	This field is reserved.
16 -	Security-related field
15 -	This field is reserved.
14–10 HPCALB_VAL	<p>HP Calibration Value</p> <p>Defines the signed calibration value for the HP real-time counter. This field can be programmed only when the RTC calibration is disabled (HPCALB_EN is not set). This is a 5-bit 2's complement value, hence the allowable calibration values are in the range from -16 to +15 counts per 32768 ticks of the counter.</p> <p>00000 +0 counts per each 32768 ticks of the counter</p> <p>00001 +1 counts per each 32768 ticks of the counter</p> <p>00010 +2 counts per each 32768 ticks of the counter</p> <p>01111 +15 counts per each 32768 ticks of the counter</p> <p>10000 -16 counts per each 32768 ticks of the counter</p> <p>10001 -15 counts per each 32768 ticks of the counter</p> <p>11110 -2 counts per each 32768 ticks of the counter</p> <p>11111 -1 counts per each 32768 ticks of the counter</p>
9 -	This field is reserved.
8 HPCALB_EN	<p>HP Real-Time Counter Calibration Enabled</p> <p>Indicates that the time-calibration mechanism is enabled.</p> <p>0 HP timer calibration is disabled.</p> <p>1 HP timer calibration is enabled.</p>
7–4 PI_FREQ	<p>Periodic Interrupt Frequency</p> <p>Defines the frequency of the periodic interrupt. The interrupt is generated when a zero-to-one or one-to-zero transition occurs on the selected bit of the HP real-time counter, and the real-time counter and the periodic interrupt are both enabled (RTC_EN and PI_EN are set). It is recommended to program this field when the periodic interrupt is disabled (PI_EN is not set). The possible frequencies are:</p> <p>0000 - Bit 0 of the RTC is selected as the source of the periodic interrupt.</p> <p>0001 - Bit 1 of the RTC is selected as the source of the periodic interrupt.</p> <p>0010 - Bit 2 of the RTC is selected as the source of the periodic interrupt.</p> <p>0011 - Bit 3 of the RTC is selected as the source of the periodic interrupt.</p> <p>0100 - Bit 4 of the RTC is selected as the source of the periodic interrupt.</p> <p>0101 - Bit 5 of the RTC is selected as the source of the periodic interrupt.</p> <p>0110 - Bit 6 of the RTC is selected as the source of the periodic interrupt.</p> <p>0111 - Bit 7 of the RTC is selected as the source of the periodic interrupt.</p>

Table continues on the next page...

SNVS_HPCR field descriptions (continued)

Field	Description
	1000 - Bit 8 of the RTC is selected as the source of the periodic interrupt. 1001 - Bit 9 of the RTC is selected as the source of the periodic interrupt. 1010 - Bit 10 of the RTC is selected as the source of the periodic interrupt. 1011 - Bit 11 of the RTC is selected as the source of the periodic interrupt. 1100 - Bit 12 of the RTC is selected as the source of the periodic interrupt. 1101 - Bit 13 of the RTC is selected as the source of the periodic interrupt. 1110 - Bit 14 of the RTC is selected as the source of the periodic interrupt. 1111 - Bit 15 of the RTC is selected as the source of the periodic interrupt.
3 PI_EN	HP Periodic Interrupt Enable The periodic interrupt can be generated only if the HP real-time counter is enabled. 0 HP periodic interrupt is disabled. 1 HP periodic interrupt is enabled.
2 -	This field is reserved.
1 HPTA_EN	HP Time Alarm Enable When set, the time alarm interrupt is generated if the value in the HP time alarm registers is equal to the value of the HP real-time counter. 0 HP time alarm interrupt is disabled. 1 HP time alarm interrupt is enabled.
0 RTC_EN	HP Real-Time Counter Enable 0 RTC is disabled. 1 RTC is enabled.

48.7.4 SNVS_HP Status register (SNVS_HPSR)

The SNVS_HP status register reflects the internal state of the SNVS.

Address: 20C_C000h base + 14h offset = 20C_C014h

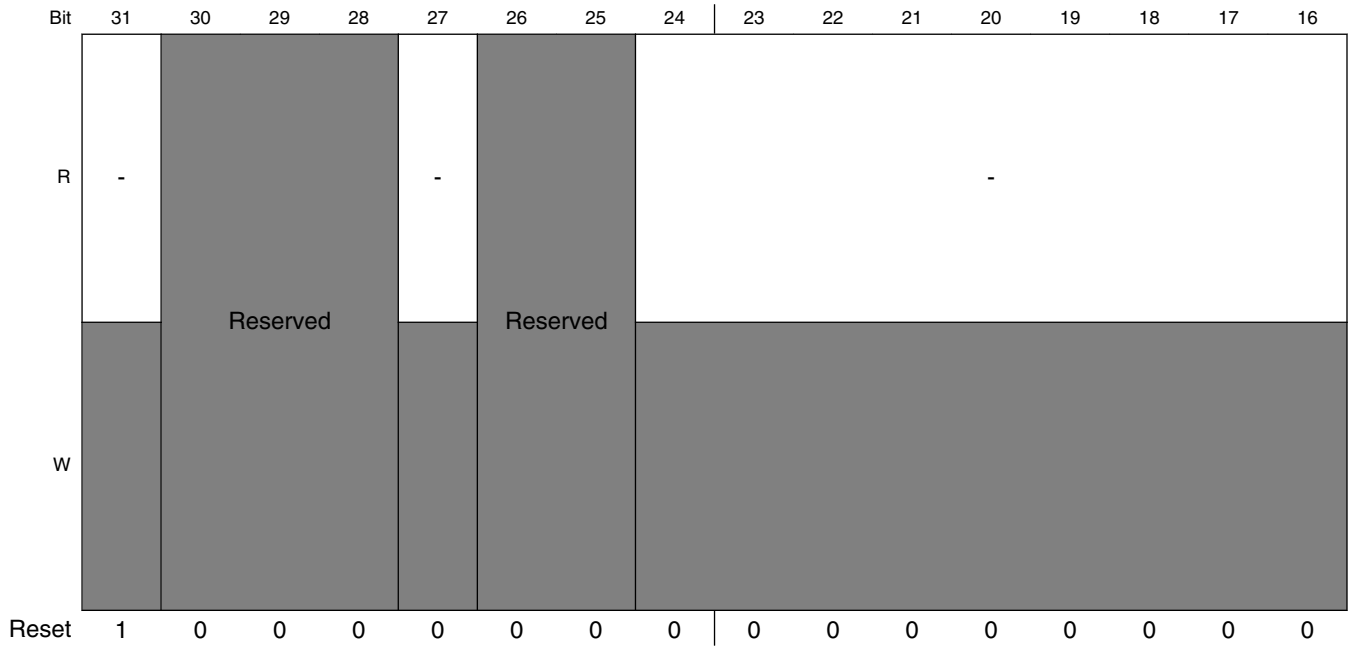

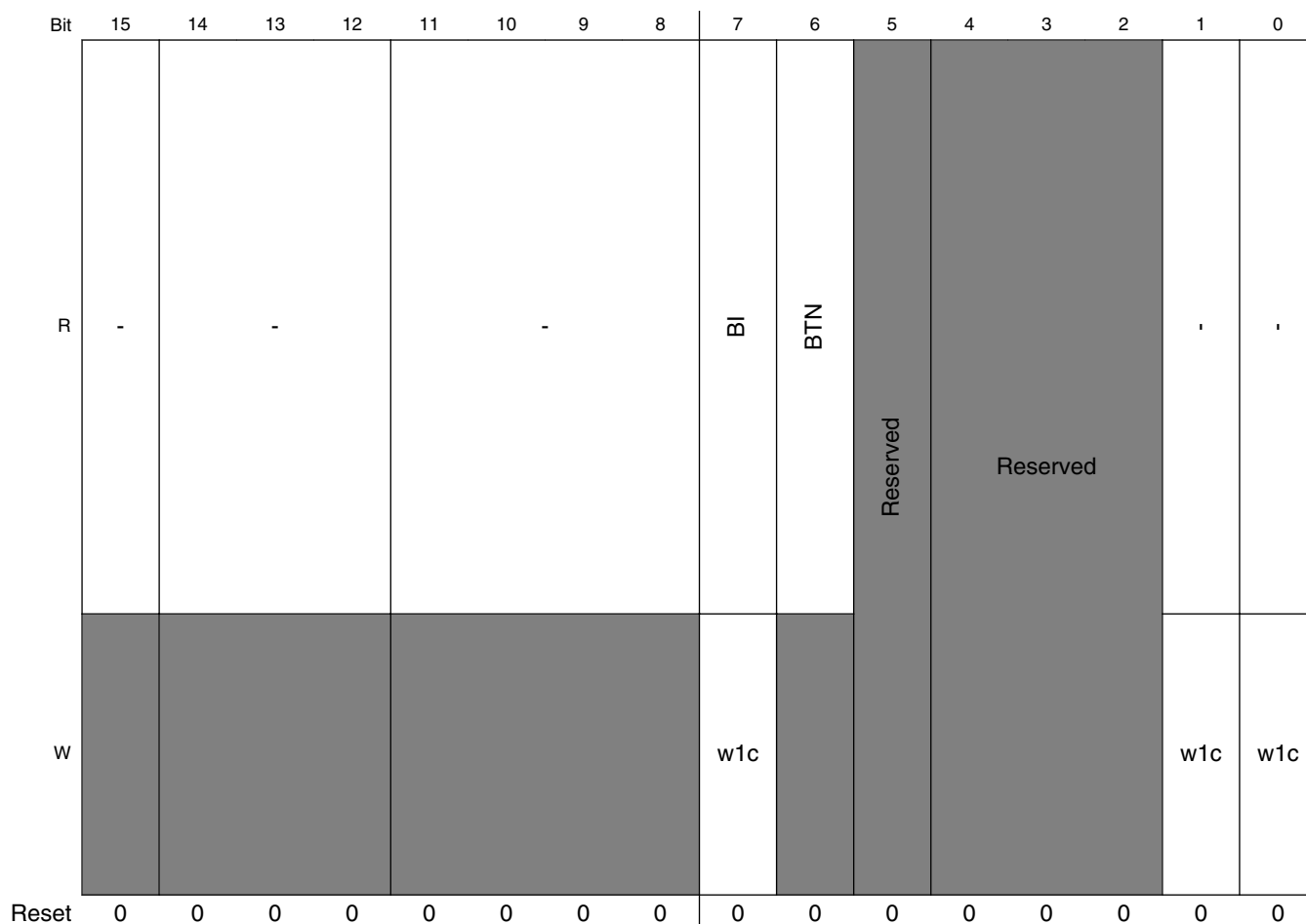

SNVS_HPSR field descriptions

Field	Description
31 -	Security-related field
30–28 -	This field is reserved.
27 -	Security-related field
26–25 -	This field is reserved.
24–16 -	Security-related field
15 -	Security-related field
14–12 -	Security-related field
11–8 -	Security-related field
7 BI	Button interrupt. The ipi_snvs_btn_int_b signal was asserted.

Table continues on the next page...

SNVS_HPSR field descriptions (continued)

Field	Description
6 BTN	Value of the BTN input. This is the external button used for the PMIC control. 0—BTN is not pressed. 1—BTN is pressed.
5 -	This field is reserved.
4–2 -	This field is reserved.
1 -	Security-related field
0 -	Security-related field

48.7.5 SNVS_HP Real-Time Counter MSB Register (SNVS_HPRTCMR)

The SNVS_HP real-time counter MSB register contains the most significant bits of the HP real-time counter.

Address: 20C_C000h base + 24h offset = 20C_C024h

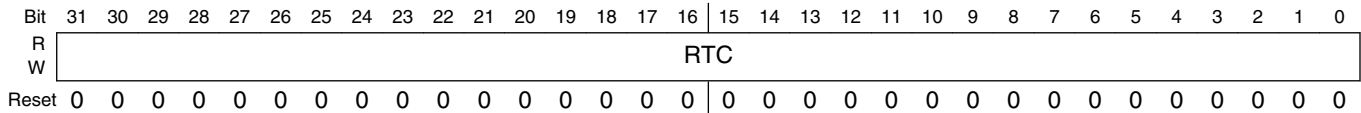

SNVS_HPRTCMR field descriptions

Field	Description
RTC	HP Real-Time Counter Most significant 32 bits. This register can be programmed only when the RTC is not active (the RTC_EN bit is not set).

48.7.6 SNVS_HP Real-Time Counter LSB Register (SNVS_HPRTCLR)

The SNVS_HP real-time counter LSB register contains the 32 least significant bits of the HP real-time counter.

Address: 20C_C000h base + 28h offset = 20C_C028h

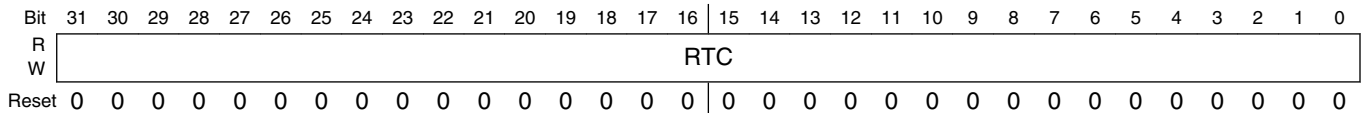

SNVS_HPRTCLR field descriptions

Field	Description
RTC	HP Real-Time Counter Least significant 32 bits. This register can be programmed only when the RTC is not active (the RTC_EN bit is not set).

48.7.7 SNVS_HP Time Alarm MSB Register (SNVS_HPTAMR)

The SNVS_HP time alarm MSB register contains the most significant bits of the SNVS_HP time alarm value.

Address: 20C_C000h base + 2Ch offset = 20C_C02Ch

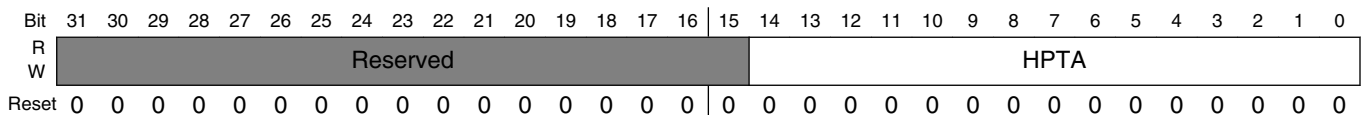

SNVS_HPTAMR field descriptions

Field	Description
31–15 -	This field is reserved.
HPTA	HP Time Alarm Most significant 15 bits. This register can be programmed only when the HP time alarm is disabled (the HPTA_EN bit is not set).

48.7.8 SNVS_HP Time Alarm LSB Register (SNVS_HPTALR)

The SNVS_HP time alarm LSB register contains the 32 least significant bits of the SNVS_HP time alarm value.

Address: 20C_C000h base + 30h offset = 20C_C030h

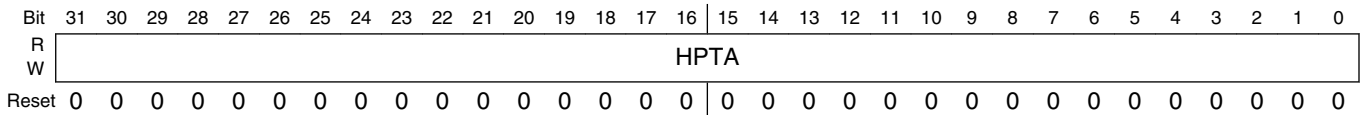

SNVS_HPTALR field descriptions

Field	Description
HPTA	HP Time Alarm The least significant bits. This register can be programmed only when the HP time alarm is disabled (the HPTA_EN bit is not set).

48.7.9 SNVS_LP Lock Register (SNVS_LPLR)

The SNVS_LP lock register contains the lock bits for the SNVS_LP registers.

Address: 20C_C000h base + 34h offset = 20C_C034h

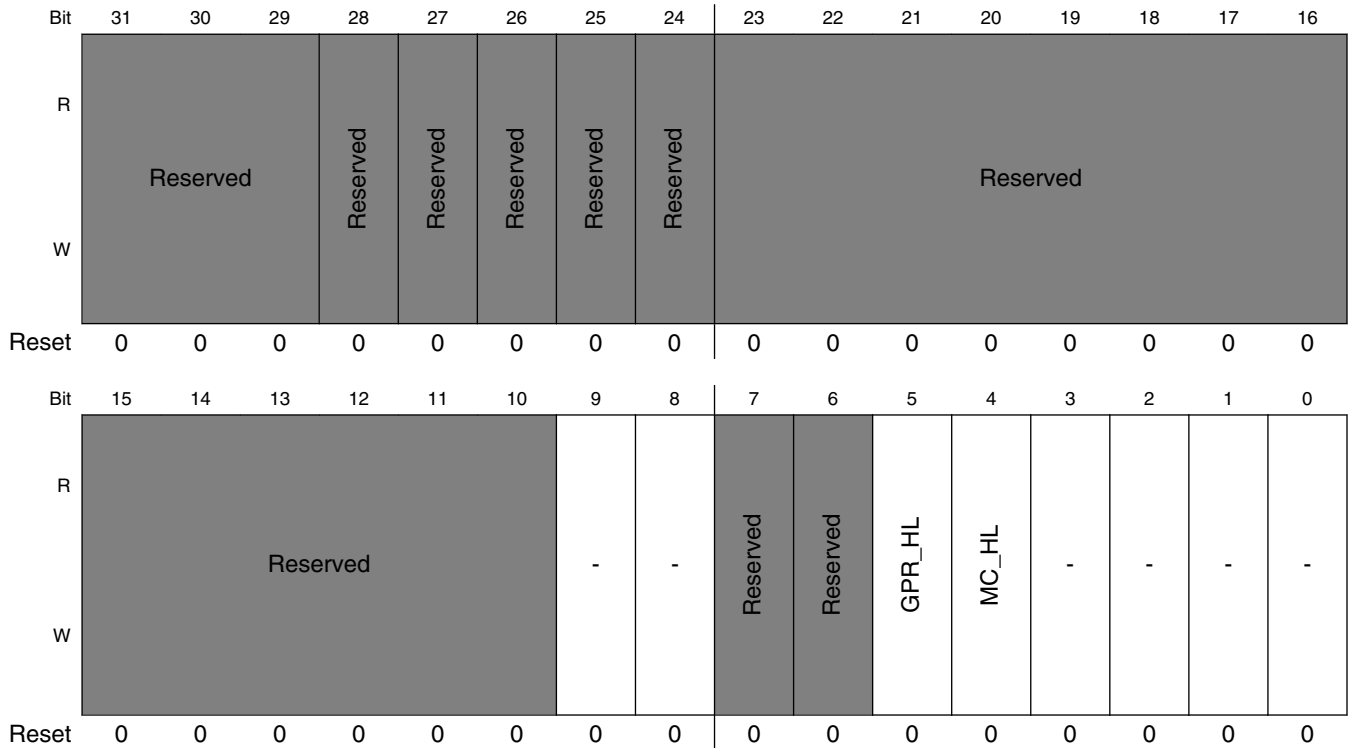

SNVS_LPLR field descriptions

Field	Description
31–29 -	This field is reserved.
28 -	This field is reserved.
27 -	This field is reserved.
26 -	This field is reserved.
25 -	This field is reserved.
24 -	This field is reserved.
23–10 -	This field is reserved.

Table continues on the next page...

SNVS_LPLR field descriptions (continued)

Field	Description
9 -	Security-related field
8 -	Security-related field
7 -	This field is reserved. >
6 -	This field is reserved.
5 GPR_HL	General-Purpose Register Hard Lock When set, it blocks any writes to the GPR. Once set, this bit can only be reset by the LP POR. 0 Write access is allowed. 1 Write access is not allowed.
4 MC_HL	Monotonic Counter Hard Lock When set, it blocks any writes (increments) to the MC registers and the MC_ENV bit. Once set, this bit can only be reset by the LP POR. 0 Write access (increment) is allowed. 1 Write access (increment) is not allowed.
3 -	Security-related field
2 -	Security-related field
1 -	Security-related field
0 -	Security-related field

48.7.10 SNVS_LP Control Register (SNVS_LPCR)

The SNVS_LP control register contains various control bits of the LP section of the SNVS.

Address: 20C_C000h base + 38h offset = 20C_C038h

Bit	31	30	29	28	27	26	25	24	23	22	21	20	19	18	17	16	
R	Reserved							Reserved	PK_OVERRIDE	PK_EN	ON_TIME	DEBOUNCE	BTN_PRESS_TIME				
W	Reserved							Reserved	PK_OVERRIDE	PK_EN	ON_TIME	DEBOUNCE	BTN_PRESS_TIME				
Reset	0	0	0	0	0	0	0	0	0	0	0	0	0	0	0	0	
Bit	15	14	13	12	11	10	9	8	7	6	5	4	3	2	1	0	
R	Reserved							Reserved	-	PWR_GLITCH_EN	TOP	DP_EN	-	-	MC_ENV	-	-
W	Reserved							Reserved	-	PWR_GLITCH_EN	TOP	DP_EN	-	-	MC_ENV	-	-
Reset	0	0	0	0	0	0	0	0	0	0	1	0	0	0	0	0	

SNVS_LPCR field descriptions

Field	Description
31–25 -	This field is reserved.
24 -	This field is reserved.
23 PK_OVERRIDE	PMIC On Request Override. The value written to the PK_OVERRIDE is asserted on the output signal snvs_lp_pk_override. This signal is used to override the IOMUX control for the PMIC I/O pad.
22 PK_EN	PMIC On Request Enable. The value written to the PK_EN is asserted on the output signal snvs_lp_pk_en. This signal is used to turn off the pullup/pulldown circuitry in the PMIC I/O pad.
21–20 ON_TIME	The ON_TIME field is used to configure the period of time after the BTN is asserted before the pmic_en_b is asserted to turn on the SoC power. 00: 500 ms off->on transition time 01: 50 ms off->on transition time 10: 100 ms off->on transition time

Table continues on the next page...

SNVS_LPCR field descriptions (continued)

Field	Description
	11: 0 ms off->on transition time
19–18 DEBOUNCE	This field configures the amount of debounce time for the BTN input signal. 00: 50 ms debounce 01: 100 ms debounce 10: 500 ms debounce 11: 0 ms debounce
17–16 BTN_PRESS_ TIME	Button press timeout values for the PMIC logic. 00 : 5 s 01 : 10 s 10 : 15 s 11 : long press is disabled (pmic_en_b is not asserted, regardless of how long the BTN is asserted)
15 -	This field is reserved.
14–10 -	Security-related field
9 -	This field is reserved.
8 -	Security-related field
7 PWR_GLITCH_ EN	By default, the detection of a power glitch does not cause the pmic_en_b signal to be asserted. Setting the power glitch enable bit to 1 enables the power-glitch event for the PMIC. 0—disabled 1—enabled
6 TOP	Turn off System Power Asserting this bit causes a signal to be sent to the power management IC to turn the system power off. This bit clears once the power is off. This bit is only valid when the dumb PMIC is enabled. 0 Leave the system power on. 1 Turn the system power off.
5 DP_EN	Dumb PMIC Enabled When set, the software can control the system power. When cleared, the system requires the smart PMIC to automatically turn the power off. 0 Smart PMIC is enabled. 1 Dumb PMIC is enabled.
4 -	Security-related field
3 -	Security-related field
2 MC_ENV	Monotonic Counter Enable and Valid When set, the MC can be incremented (by a write transaction to the LPSMCMR or LPSMCLR). This bit can't be changed once the MC_SL or MC_HL bits are set.

Table continues on the next page...

SNVS_LPCR field descriptions (continued)

Field	Description
	0 MC is disabled or invalid. 1 MC is enabled and valid.
1 -	Security-related field
0 -	Security-related field

48.7.11 SNVS_LP Status Register (SNVS_LPSR)

The SNVS_LP status register reflects the internal state and behavior of the SNVS_LP.

Address: 20C_C000h base + 4Ch offset = 20C_C04Ch

Bit	31	30	29	28	27	26	25	24	23	22	21	20	19	18	17	16	
R	-	-	Reserved										-	Reserved	SPO	EO	-
W	-	-	Reserved										-	Reserved	w1c	w1c	-
Reset	0	0	0	0	0	0	0	0	0	0	0	0	0	0	0	0	
Bit	15	14	13	12	11	10	9	8	7	6	5	4	3	2	1	0	
R	Reserved					-	-	-	-	-	-	-	-	MCR	-	-	
W	Reserved					-	-	-	-	-	-	-	-	w1c	-	-	
Reset	0	0	0	0	0	0	0	0	0	0	0	0	1	0	0	0	

SNVS_LPSR field descriptions

Field	Description
31 -	Security-related field
30 -	Security-related field
29–21 -	This field is reserved.
20 -	Security-related field.
19 -	This field is reserved.
18 SPO	<p>Set Power Off</p> <p>The SPO bit is set when the set_pwr_off_irq interrupt is triggered, which happens when the software writes a 1 to the TOP bit in the LPCR or when the power button is pressed longer than the configured debounce time. Writing to the SPO bit clears the set_pwr_off_irq interrupt.</p> <p>0 Emergency off is not detected. 1 Emergency off is detected.</p>
17 EO	<p>Emergency Off</p> <p>This bit is set when a power off is requested.</p> <p>0 Emergency off is not detected. 1 Emergency off is detected.</p>
16 -	Security-related field
15–11 -	This field is reserved.
10 -	Security-related field
9 -	Security-related field
8 -	Security-related field
7 -	Security-related field
6 -	Security-related field
5 -	Security-related field
4 -	Security-related field
3 -	Security-related field
2 MCR	<p>Monotonic Counter Rollover</p> <p>0 MC did not reach its maximum value. 1 MC reached its maximum value.</p>

Table continues on the next page...

SNVS_LPSR field descriptions (continued)

Field	Description
1 -	Security-related field
0 -	Security-related field

48.7.12 SNVS_LP Secure Monotonic Counter MSB Register (SNVS_LPSMCMR)

The SNVS_LP secure monotonic counter MSB register contains the monotonic counter era bits and the most-significant 16 bits of the monotonic counter. The monotonic counter is incremented by one if there is a write command to the LPSMCMR register or the LPSMCLR register.

Address: 20C_C000h base + 5Ch offset = 20C_C05Ch

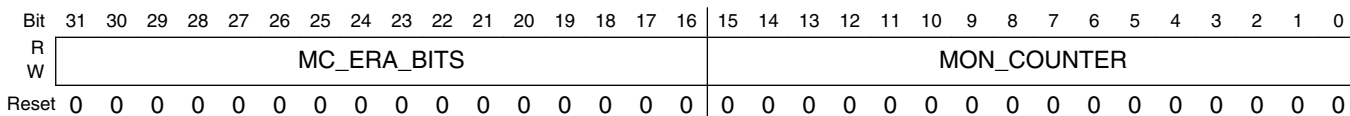

SNVS_LPSMCMR field descriptions

Field	Description
31–16 MC_ERA_BITS	Monotonic Counter Era Bits These bits are the inputs to the module and are typically connected to the fuses.
MON_COUNTER	Monotonic Counter Most-Significant 16 Bits The MC is incremented by one when: <ul style="list-style-type: none"> • A write transaction to the LPSMCMR register or the LPSMCLR register is detected. • The MC_ENV bit is set. • The MC_SL and MC_HL bits are not set.

48.7.13 SNVS_LP Secure Monotonic Counter LSB Register (SNVS_LPSMCLR)

The SNVS_LP secure monotonic counter LSB register contains the 32 least-significant bits of the monotonic counter. The MC is incremented by one if there is a write command to the LPSMCMR register or the LPSMCLR register.

Address: 20C_C000h base + 60h offset = 20C_C060h

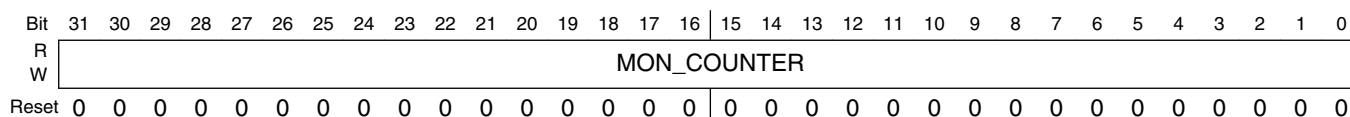

SNVS_LPSMCLR field descriptions

Field	Description
MON_COUNTER	Monotonic Counter bits The MC is incremented by one when: <ul style="list-style-type: none"> • A write transaction to the LPSMCMR register or the LPSMCLR register is detected. • The MC_ENV bit is set. • The MC_SL and MC_HL bits are not set.

48.7.14 SNVS_LP General-Purpose Register (SNVS_LPGPR)

The SNVS_LP general-purpose register is a 32-bit read/write register located in the low-power domain. Because the LPGPR is located in the battery-backed power domain, the LPGPR can be used by any application for retaining data during the SoC power-down mode. The LPGPR is automatically zeroized when a tamper event occurs, unless the GPR zeroization is disabled via the GPR_Z_DIS bit in the LP control register.

Address: 20C_C000h base + 68h offset = 20C_C068h

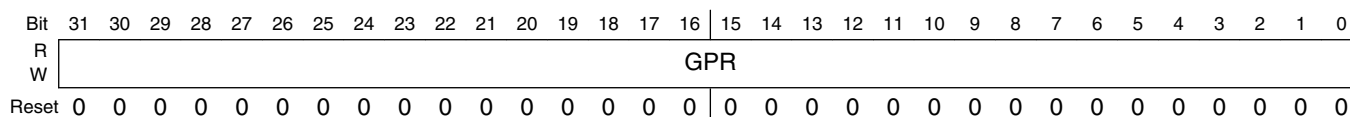

SNVS_LPGPR field descriptions

Field	Description
GPR	General-Purpose Register When the GPR_SL or GPR_HL bit is set, the register can't be programmed.

48.7.15 SNVS_HP Version ID Register 1 (SNVS_HPVIDR1)

The SNVS_HP Version ID Register 1 is a read-only register that contains the current version of the SNVS. The version consists of a module ID, a major version number, and a minor version number.

Address: 20C_C000h base + BF8h offset = 20C_CBF8h

Bit	31	30	29	28	27	26	25	24	23	22	21	20	19	18	17	16	15	14	13	12	11	10	9	8	7	6	5	4	3	2	1	0	
R	IP_ID																MAJOR_REV						MINOR_REV										
W	[Shaded]																																
Reset	0	0	0	0	0	0	0	0	0	0	0	1	1	1	1	1	0	0	0	0	0	0	0	1	1	0	0	0	0	0	0	0	0

SNVS_HPVIDR1 field descriptions

Field	Description
31–16 IP_ID	SNVS block ID
15–8 MAJOR_REV	SNVS block major version number
MINOR_REV	SNVS block minor version number

48.7.16 SNVS_HP Version ID Register 2 (SNVS_HPVIDR2)

The SNVS_HP version ID register 2 is a read-only register that indicates the current version of the SNVS. The version ID register 2 consists of these fields: integration options, ECO revision, and configuration options.

Address: 20C_C000h base + BFCh offset = 20C_CBFCh

Bit	31	30	29	28	27	26	25	24	23	22	21	20	19	18	17	16	15	14	13	12	11	10	9	8	7	6	5	4	3	2	1	0	
R	IP_ERA								INTG_OPT								ECO_REV				CONFIG_OPT												
W	[Shaded]																																
Reset	0	0	0	0	0	0	1	1	0	0	0	0	0	0	0	0	0	0	0	0	0	0	0	0	0	0	0	0	0	0	0	0	0

SNVS_HPVIDR2 field descriptions

Field	Description
31–24 IP_ERA	Era of the IP design 00h - Era 1 or 2 03h - Era 3

Table continues on the next page...

SNVS_HPVIDR2 field descriptions (continued)

Field	Description
	04h - Era 4 05h - Era 5
23–16 INTG_OPT	SNVS Integration Option
15–8 ECO_REV	SNVS ECO Revision
CONFIG_OPT	SNVS Configuration Option

Chapter 49

Shared Peripheral Bus Arbiter (SPBA)

49.1 Overview

The Shared Peripheral Bus Arbiter (SPBA) is a three-to-one IP Bus interface arbiter. Three masters arbitrate for shared peripheral access through the SPBA.

The SPBA has three primary functions:

- The IP Bus Line switches a master to one peripheral
- The Masters arbiter arbitrates between the three masters to solve concurrent access or restricted access to peripherals
- The Control Registers and Ownership Control includes a set of registers which are reachable through software and permit the access scheme to be defined for each peripheral (Resource Ownership and Access Control). It generates signals for the external steering logic of interrupts and DMA signals.

The figure below shows the SPBA block diagram

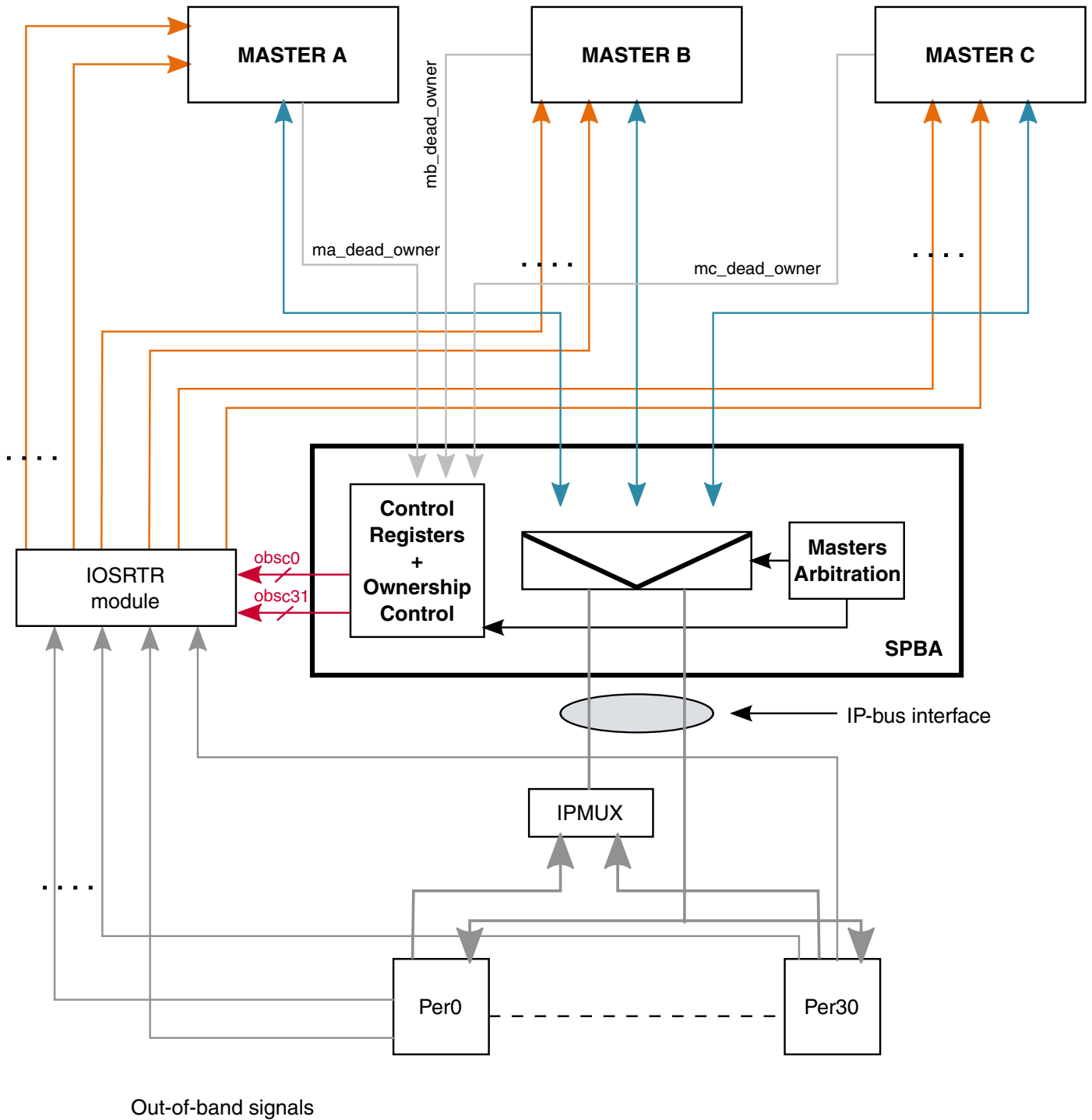

Figure 49-1. SPBA Block Diagram

49.1.1 Features

The SPBA includes the following features:

- Three IP Bus masters arbitration: Master A, B and C
- Support for DMA masters
- 32-bit data
- Supports up to 31 shared peripherals, each consuming 16 kilobytes of address space
- SPBA can be considered the 32nd peripheral, used for resource ownership and access control of the 31 peripherals
- Provides 31 sets of out of band steering control (OBSC) signals to the off-block steering logic
- Operating frequency up to 67 MHz
- Clocks: ipg_clk, ipg_clk_s

49.1.2 Modes of operation

SPBA behavior is transparent when accessing a peripheral, though it has these distinct modes of operation.

Reset/Abort

The SPBA has a hardware reset which initializes all registers, arbitration and peripherals rights registers (PRRs).

An abort signal input is provided allowing each master to abort its current access and release ownership (in case of master reset sequence).

Functional

Once a master request is granted, its IP Bus signals are steered to the requested peripheral.

Standby

No clock needed. The SPBA needs clocks only during access to the PRRs, arbitration, and abort phases. It generates two clock enable signals indicating when the clocks must be provided.

Configuration

During this phase, a master accesses the SPBA PRRs. The SPBA memory-mapped registers are seen as a shared peripheral.

49.2 Clocks

The table found here describes the clock sources for SPBA.

Please see [Clock Controller Module \(CCM\)](#) for clock setting, configuration and gating information.

Table 49-1. SPBA Clocks

Clock name	Clock Root	Description
ipg_clk	ipg_clk_root	Peripheral clock
ipg_clk_s	ipg_clk_root	Peripheral access clock

49.3 Functional description

49.3.1 Masters arbitration

The arbitration mechanism determines which port will control the master port, based on a simple round-robin arbitration scheme.

There are several use cases to consider.

- Only one master request per access. The master is switched to the shared peripheral bus, without arbitration. [Figure 49-2](#) shows the MB request on the global module enable signal, served without wait state.
- If two masters simultaneously access SPBA, the last granted master is held off using the <master>_ips_xfr_wait output signal (default value is high). When the master is granted sips_xfr_wait, shared IP Bus peripheral is connected to <master>_ips_xfr_wait outputs.
- If three masters simultaneously access SPBA, then the last two granted masters are held off using <master>_ips_xfr_wait. [Figure 49-3](#) shows a case in which the last two accesses granted are MA and MB. The requests are used even if they are in the same cycle.
- If after reset, at the first multiple access, no master has been granted, the priority is static: Master A (MA), Master B (MB) and last Master C (MC) port.
- No master request. No master switch to shared peripherals.

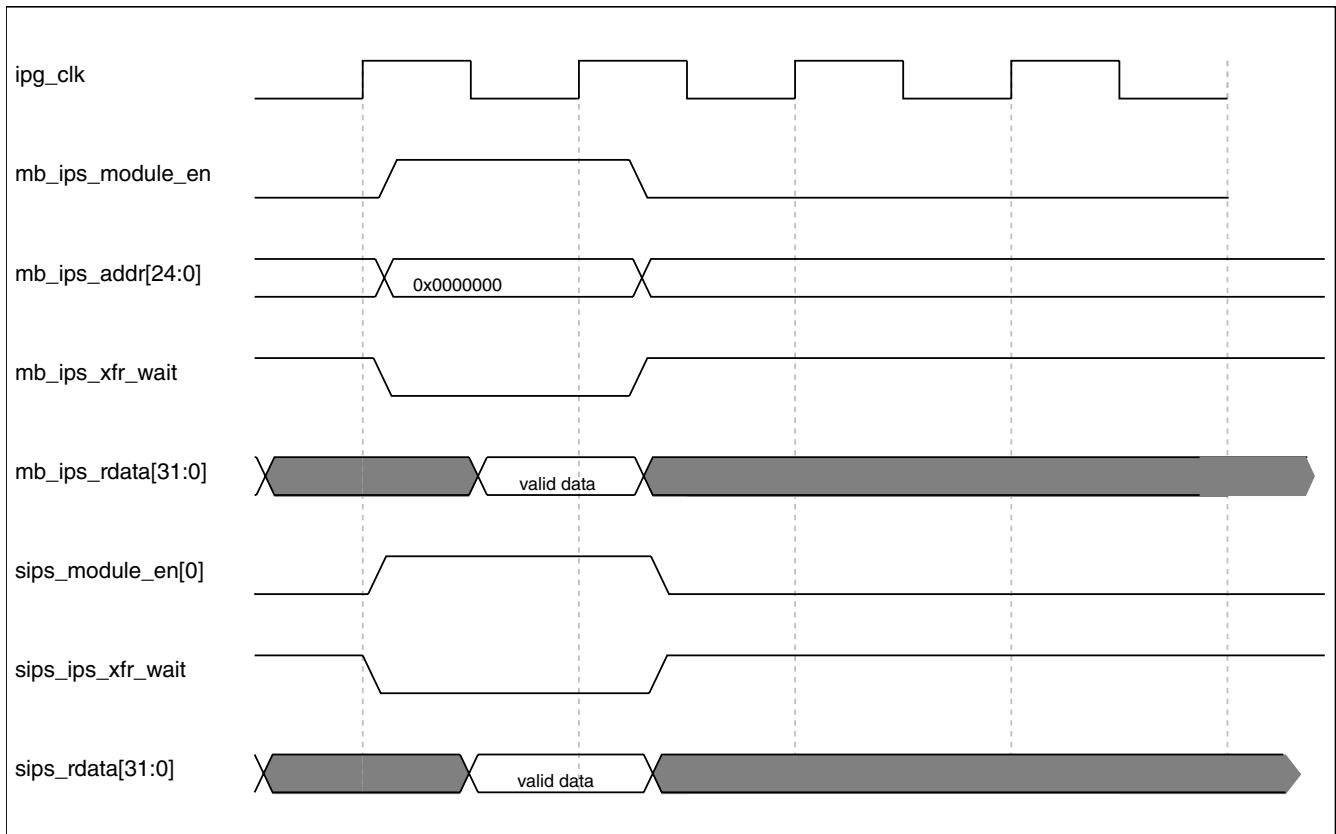

Figure 49-2. Example of one master request, no SPBA arbitration

The following figure assumes MA and MB have been the last two masters granted in the previous transfers (MA then MB).

Functional description

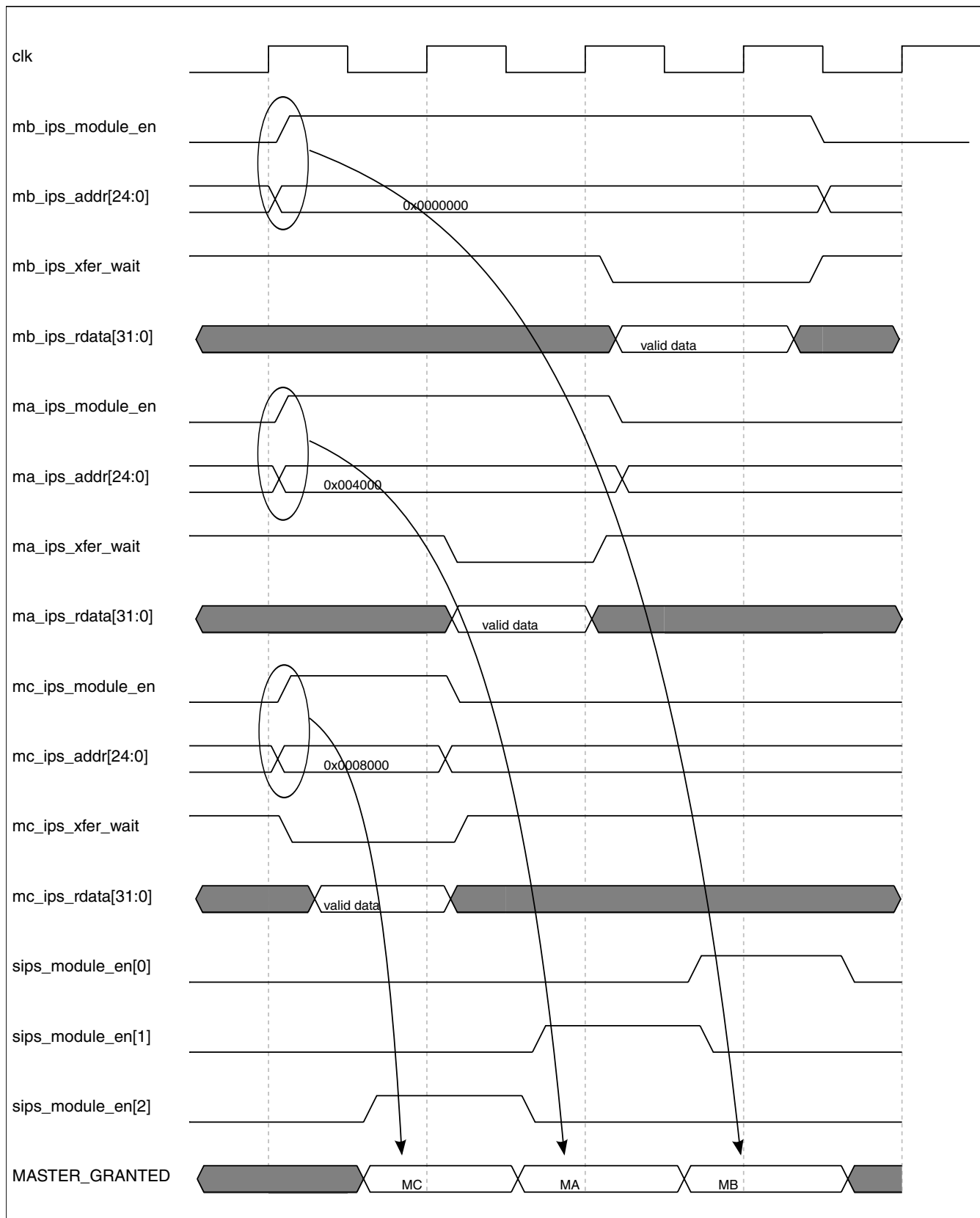

Figure 49-3. Example of three master requests: Masters already granted are "waited";

49.4 Resource ownership control

The resource ownership control regulates access to the shared peripherals and determines the steering of out-of-band signals.

49.4.1 Access control

49.4.1.1 Peripheral access

The peripheral access (resource access) of the requesting master is given by the corresponding RAR bit of the Peripheral Right Register. It determines if the master has access privilege to the resource.

Any attempt at access made by a requesting master whose access privilege bit is not set (in the PRR) is terminated with a bus error (<master>_ips_xfr_err is asserted by SPBA logic). The master that owns the resource can lock the peripheral for itself and/or grant other masters access to the peripheral by setting the appropriate bit(s) in the RAR field.

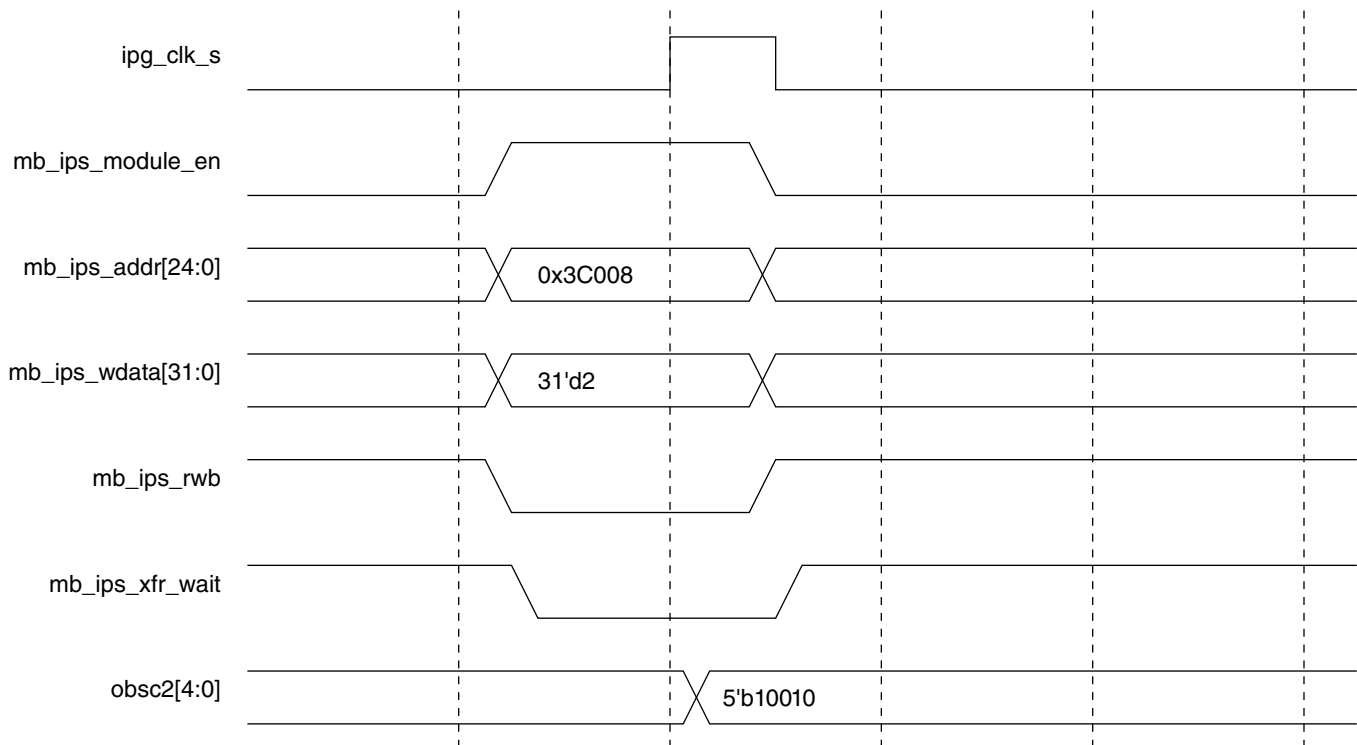

Master B is taking ownership of peripheral 2 by writing 3'b010 in the SPBA peripheral 2 right register (rarfield)
 This ownership can be checked on obsc2 output as roi2[1:0] = 2'b10 and rar2[2:0] = 3'b010
 (obsc[4:0] = {roi2[1], roi2[0], rar2[2], rar2[1], rar2[0]})

Figure 49-4. Example of one master B gaining ownership of peripheral 2

49.4.1.2 Peripheral Right Register access

The ROI bits of the Peripheral Right Register (PRR) determine which master is allowed to make write access to PRR. The identification of the requesting master is compared to the ROI bits of the PRR to determine if the master has ownership of the corresponding register.

Any attempted write access to a PRR already owned by another master will be ignored.

49.4.2 Owner election

When the peripheral is not owned by any master (ROI="00", after coming out of reset for instance), the first master to perform successfully a write to the RAR bits of the PRR is granted ownership of the peripheral and its associated PRR.

After writing to the PRR (RAR bit(s)), the master must read it back to make sure that it was granted ownership. If the RMO field is 2'b11, then the ownership claim is successful. If RMO is 2'b10, another master claimed ownership before this master was able to complete its write. This resolves the case in which two or more masters attempt to write the PRR at the same time; only the first master will be granted ownership. However all masters must read the PRR to determine if this case occurred, and if so, whether they were the first master which was granted ownership.

NOTE

A master that has been granted ownership of the PRR does not automatically have the right access to the peripheral; it must still set its own RAR bits in the PRR to access the peripheral.

49.4.3 Ending ownership

Ownership may be voluntarily ended by the owning master, or automatically upon assertion of a master-specific dead_owner signal.

The former is appropriate for software-controlled yielding of ownership. The latter is appropriate for automatic yielding of ownership when the owner has gone into reset.

When a master is reset, it clears the ROI bits of the PRRs owned by the corresponding master. When the owner is dead (in reset), all peripherals previously owned by that master must be changed to the un-owned state.

NOTE

It is the programmer's responsibility to make sure the peripherals are placed in an appropriate state before ending ownership.

49.4.3.1 Software Controlled Ownership Ending

The ROI bits will be automatically cleared when the master that owns the PRR access right clears (write) the RAR bits ([Table 2](#)).

It will then end the ownership of the PRR.

49.4.4 The Un-owned State

During the time when the peripheral is un-owned (i.e the ROI field contains all 0's), all masters have full access to it (RAR bits can then be modified by a master if ROI[1:0] = 2'b0).

In such cases it is necessary for software to ensure any necessary coherency in the resource, there is no hardware protection.

49.5 SPBA Memory Map/Register Definition

The SPBA control registers (Peripheral Right Registers) are mapped as a virtual shared peripheral.

SPBA can support up to 31 shared peripherals. Each of them has its own Peripheral Right Register (PRR) accessible within the SPBA memory-mapped registers, and consists of the Requesting Master Owner, the Resource Owner ID and the Resource Access Right fields.

SPBA memory map

Absolute address (hex)	Register name	Width (in bits)	Access	Reset value	Section/page
203_C000	Peripheral Rights Register (SPBA_PRR0)	32	R/W	0000_0007h	49.5.1/3462
203_C004	Peripheral Rights Register (SPBA_PRR1)	32	R/W	0000_0007h	49.5.1/3462
203_C008	Peripheral Rights Register (SPBA_PRR2)	32	R/W	0000_0007h	49.5.1/3462
203_C00C	Peripheral Rights Register (SPBA_PRR3)	32	R/W	0000_0007h	49.5.1/3462
203_C010	Peripheral Rights Register (SPBA_PRR4)	32	R/W	0000_0007h	49.5.1/3462
203_C014	Peripheral Rights Register (SPBA_PRR5)	32	R/W	0000_0007h	49.5.1/3462
203_C018	Peripheral Rights Register (SPBA_PRR6)	32	R/W	0000_0007h	49.5.1/3462
203_C01C	Peripheral Rights Register (SPBA_PRR7)	32	R/W	0000_0007h	49.5.1/3462
203_C020	Peripheral Rights Register (SPBA_PRR8)	32	R/W	0000_0007h	49.5.1/3462

Table continues on the next page...

SPBA memory map (continued)

Absolute address (hex)	Register name	Width (in bits)	Access	Reset value	Section/page
203_C024	Peripheral Rights Register (SPBA_PRR9)	32	R/W	0000_0007h	49.5.1/3462
203_C028	Peripheral Rights Register (SPBA_PRR10)	32	R/W	0000_0007h	49.5.1/3462
203_C02C	Peripheral Rights Register (SPBA_PRR11)	32	R/W	0000_0007h	49.5.1/3462
203_C030	Peripheral Rights Register (SPBA_PRR12)	32	R/W	0000_0007h	49.5.1/3462
203_C034	Peripheral Rights Register (SPBA_PRR13)	32	R/W	0000_0007h	49.5.1/3462
203_C038	Peripheral Rights Register (SPBA_PRR14)	32	R/W	0000_0007h	49.5.1/3462
203_C03C	Peripheral Rights Register (SPBA_PRR15)	32	R/W	0000_0007h	49.5.1/3462
203_C040	Peripheral Rights Register (SPBA_PRR16)	32	R/W	0000_0007h	49.5.1/3462
203_C044	Peripheral Rights Register (SPBA_PRR17)	32	R/W	0000_0007h	49.5.1/3462
203_C048	Peripheral Rights Register (SPBA_PRR18)	32	R/W	0000_0007h	49.5.1/3462
203_C04C	Peripheral Rights Register (SPBA_PRR19)	32	R/W	0000_0007h	49.5.1/3462
203_C050	Peripheral Rights Register (SPBA_PRR20)	32	R/W	0000_0007h	49.5.1/3462
203_C054	Peripheral Rights Register (SPBA_PRR21)	32	R/W	0000_0007h	49.5.1/3462
203_C058	Peripheral Rights Register (SPBA_PRR22)	32	R/W	0000_0007h	49.5.1/3462
203_C05C	Peripheral Rights Register (SPBA_PRR23)	32	R/W	0000_0007h	49.5.1/3462
203_C060	Peripheral Rights Register (SPBA_PRR24)	32	R/W	0000_0007h	49.5.1/3462
203_C064	Peripheral Rights Register (SPBA_PRR25)	32	R/W	0000_0007h	49.5.1/3462
203_C068	Peripheral Rights Register (SPBA_PRR26)	32	R/W	0000_0007h	49.5.1/3462
203_C06C	Peripheral Rights Register (SPBA_PRR27)	32	R/W	0000_0007h	49.5.1/3462
203_C070	Peripheral Rights Register (SPBA_PRR28)	32	R/W	0000_0007h	49.5.1/3462
203_C074	Peripheral Rights Register (SPBA_PRR29)	32	R/W	0000_0007h	49.5.1/3462
203_C078	Peripheral Rights Register (SPBA_PRR30)	32	R/W	0000_0007h	49.5.1/3462
203_C07C	Peripheral Rights Register (SPBA_PRR31)	32	R/W	0000_0007h	49.5.1/3462

49.5.1 Peripheral Rights Register (SPBA_PRRn)

This register controls master ownership and access for a peripheral.

Address: 203_C000h base + 0h offset + (4d × i), where i=0d to 31d

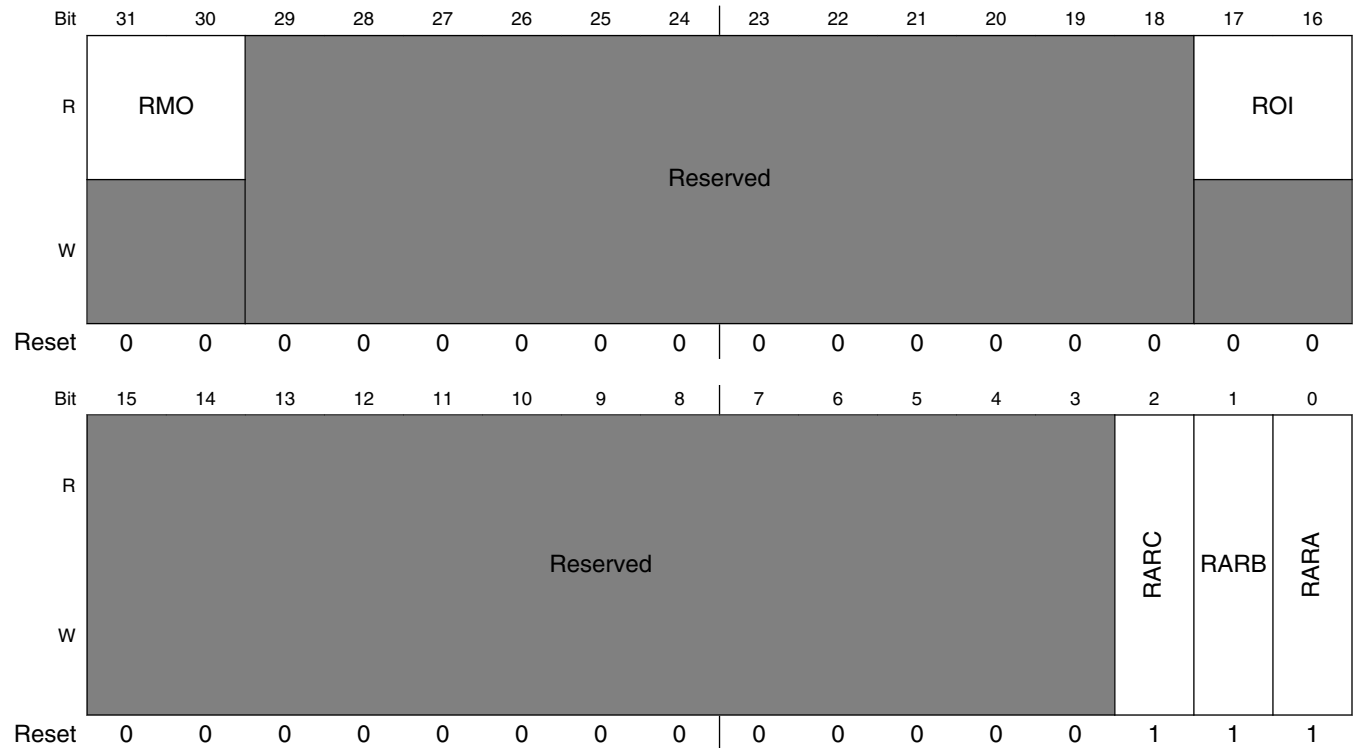

SPBA_PRRn field descriptions

Field	Description
31–30 RMO	Requesting Master Owner. This 2-bit register field indicates if the corresponding resource is owned by the requesting master or not. This register is reset to 2'b0 if ROI = 2'b0. 00 UNOWNED — The resource is unowned. 01 Reserved. 10 ANOTHER_MASTER — The resource is owned by another master. 11 REQUESTING_MASTER — The resource is owned by the requesting master.
29–18 -	This field is reserved. Reserved
17–16 ROI	Resource Owner ID. This field indicates which master (one at a time) can access to the PRR for rights modification. This is a read-only register. After reset, ROI bits are cleared ("00" -> un-owned resource).

Table continues on the next page...

SPBA_PRR_n field descriptions (continued)

Field	Description
	<p>A master performing a write access to the an un-owned PRR will get its ID automatically written into ROI, while modifying RARx bits. It can then read back the RMO, RAR, ROI bits to make sure RMO returns the right value, ROI bits contain its ID and RARx bits are correctly asserted. Then no other master (whom ID is different from the one stored in ROI) will be able to modify RAR fields.</p> <p>Owner master of a peripheral can assert its dead_owner signal, or write 1'b0 in the RARx to release the ownership (ROI[1:0] reset to 2'b0).</p> <p>00 UNOWNED — Unowned resource. 01 MASTER_A — The resource is owned by master A port. 10 MASTER_B — The resource is owned by master B port. 11 MASTER_C — The resource is owned by master C port.</p>
15–3 -	This field is reserved. Reserved
2 RARC	<p>Resource Access Right. Control and Status bit for master C.</p> <p>This field indicates whether master C can access the peripheral. From 0 up to 3 masters can have permission to access a resource (all the master can be granted on a peripheral, but only one access at a time will be granted by SPBA).</p> <p>0 PROHIBITED — Access to peripheral is not allowed. 1 ALLOWED — Access to peripheral is granted.</p>
1 RARB	<p>Resource Access Right. Control and Status bit for master B.</p> <p>This field indicates whether master B can access the peripheral. From 0 up to 3 masters can have permission to access a resource (all the master can be granted on a peripheral, but only one access at a time will be granted by SPBA).</p> <p>0 PROHIBITED — Access to peripheral is not allowed. 1 ALLOWED — Access to peripheral is granted.</p>
0 RARA	<p>Resource Access Right. Control and Status bit for master A.</p> <p>This field indicates whether master A can access the peripheral. From 0 up to 3 masters can have permission to access a resource (all the master can be granted on a peripheral, but only one access at a time will be granted by SPBA).</p> <p>0 PROHIBITED — Access to peripheral is not allowed. 1 ALLOWED — Access to peripheral is granted.</p>

Chapter 50

Sony/Philips Digital Interface (SPDIF)

50.1 Overview

The Sony/Philips Digital Interface (SPDIF) audio block is a stereo transceiver that allows the processor to receive and transmit digital audio.

The SPDIF transceiver allows the handling of both SPDIF channel status (CS) and User (U) data and includes a frequency measurement block that allows the precise measurement of an incoming sampling frequency.

A recovered clock is provided to drive both internal components in the system, such as SAI ports, and external components, such as A/Ds or D/As, with clocking control provided via related registers.

As the SPDIF internal data width is 24-bit, the eight most-significant bits of all registers return zeros.

The figure below shows a block diagram of the SPDIF transceiver data paths (receiver and transmitter) and its interface.

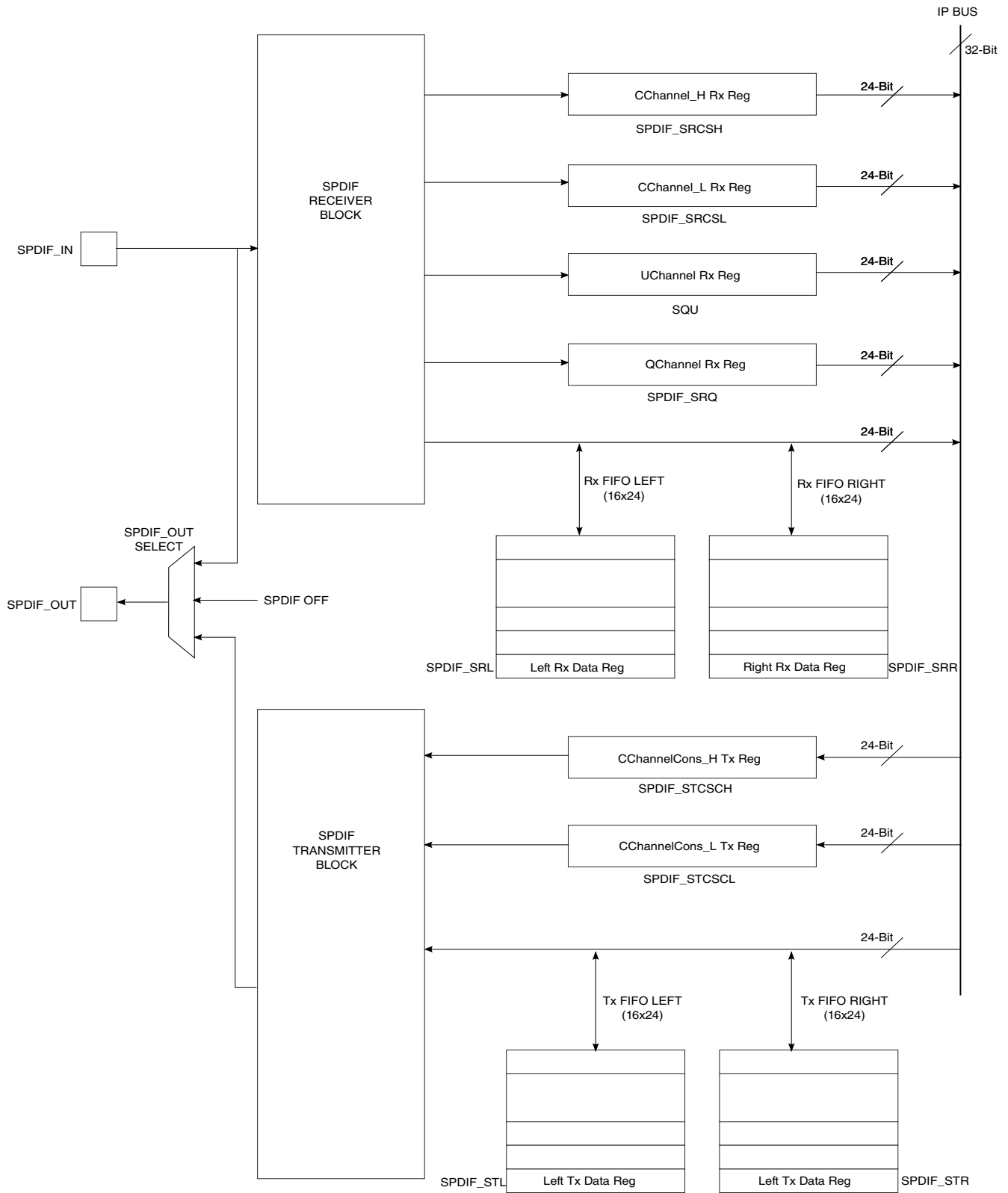

Figure 50-1. SPDIF Transceiver Data Interface Block Diagram

50.2 External Signals

The following table describes the external signals of SPDIF:

Table 50-1. SPDIF External Signals

Signal	Description	Pad	Mode	Direction
SPDIF_EXT_CLK	External clock signal	LCD_DATA07	ALT4	I
		NAND_DQS	ALT1	
SPDIF_IN	Input line	GPIO1_IO09	ALT2	I
		LCD_DATA08	ALT4	
		SD1_CLK	ALT1	
		UART1_RX_DATA	ALT6	
SPDIF_LOCK	Lock signal	LCD_DATA06	ALT4	O
SPDIF_OUT	Output line signal	GPIO1_IO08	ALT2	O
		JTAG_MOD	ALT4	
		LCD_DATA05	ALT1	
		SD1_CMD	ALT6	
		UART1_TX_DATA	ALT6	
SPDIF_SR_CLK	SR clock signal	LCD_DATA04	ALT4	O

50.3 Clocks

The table found here describes the clock sources for SPDIF.

Please see clock control block for clock setting, configuration and gating information.

Table 50-2. SPDIF Clocks

Clock name	Clock Root	Description
gclkw_t0	ipg_clk_root	Global clock
ipg_clk_s	ipg_clk_root	Peripheral access clock
tx_clk	spdif0_clk_root	Module Tx clock

50.4 Functional Description

The SPDIF is composed of two parts: SPDIF Receiver and SPDIF Transmitter.

Functional Description

The SPDIF receiver extracts the audio data from each SPDIF frame and places the data in the SPDIF Rx left and right FIFOs. The Channel Status and User Bits are also extracted from each frame and placed in the corresponding registers. The SPDIF receiver also provides a bypass option for direct transfer of the SPDIF input signal to the SPDIF transmitter.

For the SPDIF transmitter, the audio data is provided by the processor via the SPDIFTxLeft and SPDIFTxRight registers. The Channel Status bits are also provided via the corresponding registers. The SPDIF transmitter generates a SPDIF output bitstream in the biphas mark format (IEC60958), which consists of audio data, channel status and user bits.

In the SPDIF transmitter, the IEC60958 biphas bit stream is generated on both edges of the SPDIF Transmit clock. The SPDIF Transmit clock is generated by the SPDIF internal clock generate block and the sources are from outside of the SPDIF block. For the SPDIF receiver, it can recover the SPDIF Rx clock. [Figure 1](#) shows the clock structure of the SPDIF transceiver.

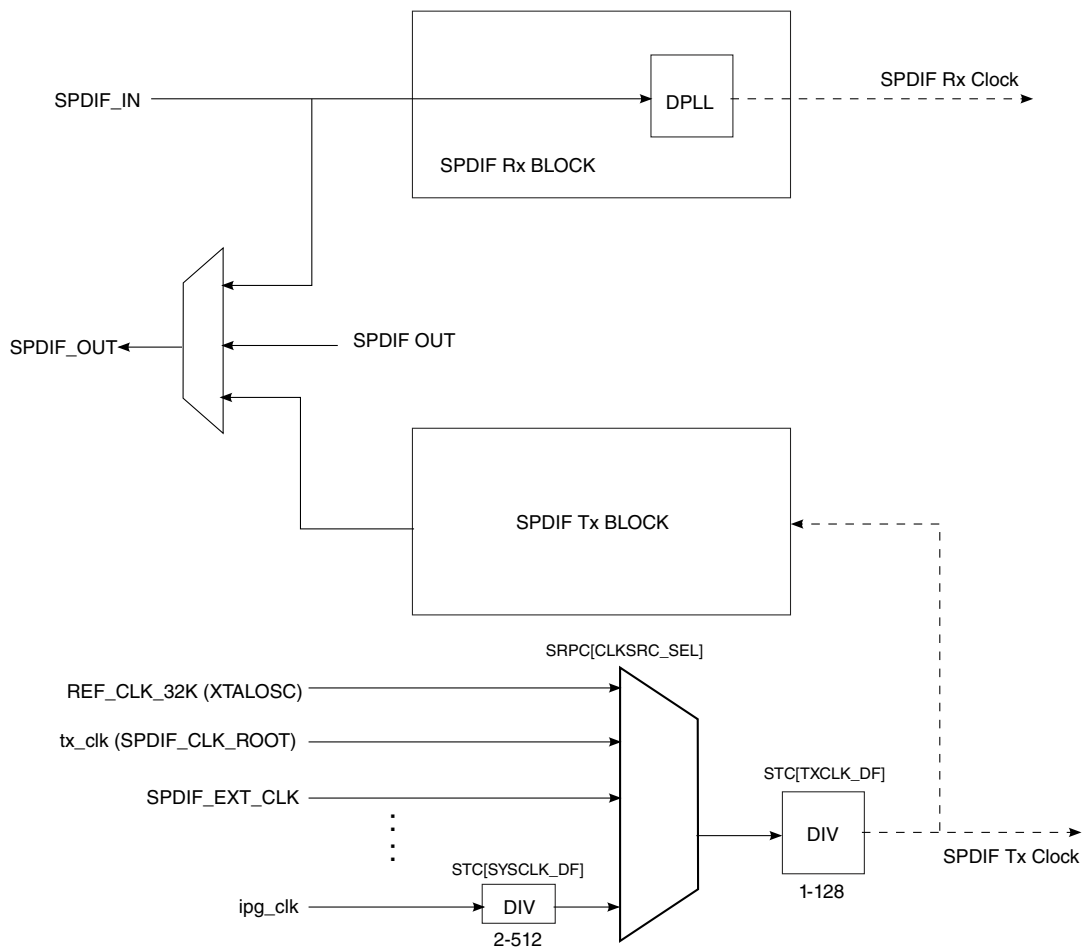

Figure 50-2. SPDIF Transceiver Clock Diagram

50.4.1 SPDIF Receiver

The SPDIF receiver extracts the audio data from each SPDIF frame and places the data in Rx left and right FIFOs.

The Tx left and right FIFOs are 16-deep and 24-bit-wide (equal to the audio data width). The Channel Status and User Bits are also extracted from each frame and placed in corresponding registers. The SPDIF receiver also provides a bypass option for direct transfer of the SPDIF input signal to the SPDIF transmitter.

The SPDIF receiver handles the main data audio stream and recovers the bit clock from the SPDIF input signal. The sample rate can be determined from the frequency measuring block. Additionally, the receiver supports the SPDIF C and U channels. The SPDIF C and U channel data is interfaced directly to memory-mapped registers.

All the data registers are controlled by the Interrupt Control Block and transferred to the memory-mapped IP bus.

The following functions are performed by the SPDIF receiver:

- Audio Data Reception see [Audio Data Reception](#)
- Channel Status bits Reception see [Channel Status Reception](#)
- U Channel bits Reception see [User Bit Reception](#)
- Validity Flag Reception see [Validity Flag Reception](#)
- SPDIF Receiver Exception support see [SPDIF Receiver](#)
- SPDIF Lock Detection

50.4.1.1 Audio Data Reception

The SPDIF Receiver block extracts the audio data from the IEC60958 stream, and outputs this via Rx left and right FIFOs to the memory-mapped registers SPDIFRxLeft and SPDIFRxRight.

Data from the SPDIF receiver is buffered in receive FIFO, and can be read by the processor from the memory-mapped registers.

- **SPDIF receiver data registers - Behavior on overrun, underrun**

The SPDIF Data Receive registers (SPDIFRxLeft and SPDIFRxRight) have individual FIFOs for left and right channel. As a result, there is always the possibility that left and right FIFOs may go out of sync due to FIFO underruns and FIFO overruns that affect

only one part (left or right) of any FIFOs. To prevent this from happening, hardware has been added to the device. Two mechanisms to prevent mismatch between the FIFOs are available.

If a SPDIF Data Rx FIFO overrun occurs on e.g. the right half of the FIFO, the sample that caused the overrun is not written to the right half (due to overrun). Special hardware will make sure the next sample is not written to the left half of the FIFO. If the overrun occurs on the left half of the FIFO, the next sample is not written to the right half of the FIFO.

- **SPDIF receiver data registers - Automatic resynchronization of FIFOs**

An automatic FIFO resynchronization feature is available. It can be enabled and disabled separately for every FIFO. If it is enabled, the hardware will check to see if the left and right FIFOs are in sync. If that is not the case, it will set the filling pointer of the right FIFO to be equal to the filling pointer of the left FIFO.

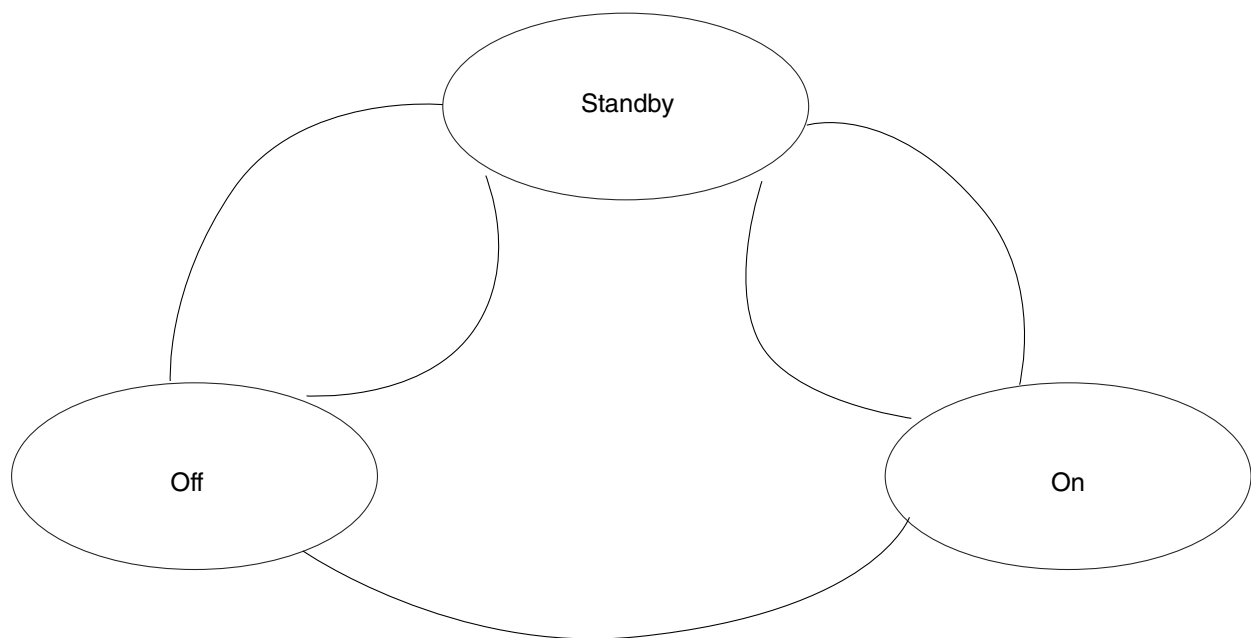

Figure 50-3. FIFO Auto-resync Controller State Machine

The operation is explained from the state diagram shown above. Every FIFO auto-resync controller has a state machine with 3 states: Off, StandBy and On. In the On state, the filling of the left FIFO is compared with the filling of right, and if they are not equal, right is made equal to left, and an interrupt is generated.

The controller will stay in Off state when the feature is disabled. When not disabled, the state machine will go to Off state on any processor read or write to the FIFO. It will go from On or Off to Standby on any left sample read from SPDIF Tx FIFOs, or on any left sample write to SPDIF Rx FIFOs. The controller will go from Standby to On on any right sample read from SPDIF Tx FIFO, or on any right sample write to SPDIF Rx FIFO. There is a control bit in the SPDIFConfig register to enable/disable the feature for the SPDIF Rx FIFO and SPDIF Tx FIFO.

50.4.1.1.1 Application Note

The automatic FIFO resynchronization can be switched on, and will avoid all mismatches between left and right FIFOs, if the software obeys the following rules: 1. When the left data is read or written to the left FIFO, in the same place of the program, data must be read or written to the right FIFO. Maximum time difference between left and right is 1/2 sample clock. (E.g. if sample frequency is 44 KHz, approximately 10 micro-seconds. For 88 KHz, approximately 5 micro-seconds.) 2. Write/read data to FIFO s at least 2 samples at the time. If there is a mismatch Left-Right, the resync logic may go on only 1 sample clock after last data is read/written to the FIFO. Also acceptable is polling the FIFO, if at least part of the time 2 samples will be read/written to it.

- **SPDIF receiver - Additional features**

There are three exceptions associated with the SPDIF Receivers FIFOs

- full
- under/overflow
- resync

When the "full" condition is set for processor data input registers, the processor should read data from the FIFO, before overflow occurs. When "full" is set, and the FIFO contains e.g. 6 samples, it is acceptable for the software to read first 6 samples from the LEFT address, followed by 6 samples from the RIGHT address, or 6 samples from the RIGHT address, followed by 6 samples from the LEFT address, or 1 sample LEFT, followed by 1 sample RIGHT repeated 6 times. There is no order specified.

The implementation for SPDIF Rx is a double FIFO, one for left and one for right. "full" is set when both FIFOs are full. "underrun, overflow" are set when one of the FIFOs do underrun or do overflow. The resync interrupt means hardware took special action to resynchronize left and right FIFOs.

The FIFO level at which the "full" interrupt is generated, is programmable via the Full Select field in the SPDIFConfigReg register.

Rx FIFO on and Rx FIFO reset.

Two additional control fields of the SPDIF Rx FIFO are the on/off select and FIFO reset fields.

If on/off select is set to off, all-zero will be read from the FIFO, irrespective of the data received over the SPDIF interface.

If FIFO reset is set, the FIFO is blocked at "1 sample in FIFO". In this, the full interrupt will be on if FullSelect is set to "00". If FullSelect is set to any other value, interrupt will be off. The other interrupts are always off.

50.4.1.2 Channel Status Reception

A total of 48 channel status bits are received in two registers. No interpretation is performed by the SPDIF receiver block.

Channel Status Bits are ordered first bit left. CS-channel MSB bit "0" is located in bit position 23 in the memory-mapped register SPDIFRxCChannel_h. CS-channel bit "23" is considered the LSB bit 0 in the register. C-channel bit 24 to 47 is seen as [23:0] bits of register SPDIFRxCChannel_l.

50.4.1.2.1 Channel Status Interrupt

When the value of a new SPDIF "CS" channel status frame is loaded in the register, an interrupt is generated. The interrupt is cleared when the processor writes the corresponding bit in the InterruptStat register.

50.4.1.3 User Bit Reception

There are two modes for U Channel reception, CD and non-CD. As is decided by USyncMode (bit 1 of CDText_Control register).

- **Behavior of U Channel receive interface on incoming CD U Channel Sub-code in SPDIF receiver.**

This mode is selected if UsyncMode, bit 1 in register CD Text control is set "1".

The CD sub-code stream embedded into the SPDIF U channel consists of a sequence of packets. Every packet is made up 98 "symbols". The first two symbols of every packet are "sync symbols", the other 96 symbols are "data symbols".

Any sequence found in the SPDIF U channel stream starting with a leading one, followed by 7 information bits, is recognized as a "data symbol". Subsequent data symbols are separated by "pauses". During the "pause", "zero bits" are seen on the SPDIF U channel.

Data symbols are coming in MSB first. The MSB is the leading one.

When a "long pause" is seen between 2 subsequent "data symbols", the SPDIF receiver will assume the reception of one or more "sync symbols". Table below gives details.

Table 50-3. Sync Control Bits

Number of U Channel zero bits	Corresponding number of sync symbols
0-1	Unpredictable, not allowed
2-10	0
11-22	1
23-34	2
35-46	3
>45	Unpredictable, not allowed

The recognition of the number of sync symbols derives from the fact that the U channel transmitter in the CD channel decoder will transmit one symbol on average every 12 SPDIF channel bits. On this average rate, there is a maximum tolerance of 5%.

The SPDIF receiver is tolerant of symbol errors. Due to the physical nature of the transmission of the data over the CD disc, not more than 1 out of any 5 consecutive user channel symbols may be in error. The error may cause a change in data value, which is not detected by this interface, or it may cause a data symbol to be seen as a sync symbol, or a sync symbol to be seen as a data symbol. However, not more than 1 out of any 5 consecutive user channel symbols should be affected in this way.

The SPDIF U channel circuitry recognizes the 98-symbol packet structure, and sends the 96 symbol payload to the processor application. The 96 symbol payload is transmitted to the processor via 2 registers:

- The SPDIFRxUChannel register. In this register, data is presented 3 symbols at the time to the processor. Every time 3 new valid symbols, received on the SPDIF U Channel are present, the UChannelRxFull interrupt is asserted. For one 98-symbol packet, 96 symbols are carried across SPDIFRxUChannel. To transfer all this data, 32 UChannelRxFull interrupts are generated.
- The QChannelReceive register. In this register, only the Q bit of the packet is accumulated. Operation is similar to UChannelReceive. Because only Q-bit is transferred, only 96 Q-bits are transferred for any 98-symbol packet. To transfer this data, 4 QChannelRxFull interrupts are generated. When QChannelRxFull occurs, it is coincident with UChannelRxFull. There is only one QChannelRxFull for every 8 UChannelRxFull. The convention is that most significant data is transmitted first, and is left-aligned in the registers.
- Timing regarding packet boundary is extracted by hardware. The last UChannelRxFull corresponding to a given packet should be coincident with the last

QChannelRxFull. In this last U, Q channel interrupt, symbols 95-98 are received, Q channel bits 67-98. The interrupts are coincident with UQSyncFound, flagging last symbols of the current frame.

- When the start of the new packet is found before the current packet is complete (less than 98 symbols in the packet), the UQFrameError interrupt is set. The application software should read out UChannelReceive and QchannelReceive registers, discard the value, and assume the start of a new packet.
 - As already said, packet sync extraction is tolerant for single-symbol errors. Packet sync detection is based on the recognition of the sequence data-sync-sync-data in the symbol stream, because this is the only syncing sequence that is not affected by single errors. If the sync symbols are not found 98 symbols after the previous occurrence, it is assumed to be destroyed by channel error, and a new sync symbols is interpolated.
 - Normally, only data bytes are passed to the application software. Every databyte will have its most significant bit set. If sync symbols are passed to the application software, they are seen as all-zero symbols. Sync symbols can only end up in the data stream due to channel error.
- **Behavior of U Channel receive interface on incoming non-CD data.**

This mode is selected if UsyncMode, bit 1 in register CD Text control is set '0'.

In non-CD mode, the SPDIF U channel stream is recognized as a sequence of "data symbols". No packet recognition is done.

Any sequence found in the SPDIF U channel stream starting with a leading one, followed by 7 information bits, is recognized as a "data symbol". Subsequent data symbols are separated by "pauses". During the "pause", "zero bits" are seen on the SPDIF U channel.

3 consecutive data symbols seen in the SPDIF U Channel stream are grouped together into the SPDIFRxUChannel register. First symbol is left, last symbol is right aligned. When SPDIFRxUChannel contains 3 new data symbols, UChannelRxFull is asserted.

In this mode, the operation of QchannelRx and associated interrupt QchannelRxFull is reserved, undefined. And the operation of UQFrameError and UQSyncFound is also reserved, undefined.

The U channel is extracted, and output by the SPDIF Rx on SPDIFRxUChannel-Stream.

When incoming SPDIF data parity error or bit error is detected, and if the next SPDIF word for that channel is error-free, the SPDIF word in error is replaced with the average of the previous word and next word. When incoming SPDIF data parity error or bit error is detected, and the next SPDIF word is in error, the previous SPDIF word is repeated.

50.4.1.4 Validity Flag Reception

An interrupt is associated with the Validity flag. (interrupt 16 - SPDIFValNoGood). This interrupt is set every time a frame is seen on the SPDIF interface with the validity bit set to "invalid".

50.4.1.5 SPDIF Receiver Interrupt Exception Definition

Several SPDIF exceptions can trigger an interrupt.

They are:

- Control Status channel change. Set when SPDIFRxCCChannel_1 register is updated. The register is updated for every new C-Channel received. The exception is reset on write to InterruptClear register.
- SPDIF Illegal Symbol. Set on reception of illegal symbol during SPDIF receive. Reset by writing register InterruptClear.¹
- SPDIF bit error. Set on reception of bit error. (Parity bit does not match). Reset on write to InterruptClear register.
- Receive data FIFO full. Set when SPDIF receive data FIFO is full.
- Receive data FIFO underrun/overrun. Set when there is a underrun/overrun on the SPDIF receive data FIFO.
- Receive data FIFO resynchronization. Set when a resynchronization event occurs on the SPDIF receive data FIFO.
- Receive U Channel buffer full. Set when next 24 bits of U channel code are available.
- Receive Q Channel buffer overrun. Set when Q channel buffer overrun.
- Receive U Channel buffer overrun. Set on U channel buffer overrun.
- Receive Q Channel buffer full. Set when next 24 bits of Q channel code are available.
- Receive UQ sync found. Set when UQ channel sync found.
- Receive UQ frame error. Set when UQ frame error found.

1. The SPDIF input is a biphas/mark modulated signal. The time between any two successive transitions of the SPDIF signal is always 1, 2 or 3 SPDIF symbol periods long. The SPDIF receiver will parse the stream, and split it in so-called symbols. It recognizes s1, s2 and s3 symbols, depending on the length of the symbols. Not all sequences of these symbols are allowed. To give an example, a sequence s2-s1-s1-s1-s2 cannot occur in a no-error SPDIF signal. If the receiver finds such an illegal sequence, the illegal symbol interrupt is set. No corrective action is undertaken. When the interrupt occurs, this means that(a) The SPDIF signal is destroyed by noise (b) The SPDIF frequency changed.

50.4.1.6 Standards Compliance

The SPDIF interface is compatible with the Tech 3250-E standard of the European Broadcasting Union, except clause 6.3.3 and the IEC60958-3 Ed2 for relevant topics.

Supported input frequency range is 12 KHz up to 96 KHz. (fully compliant) and 96 KHz up to 176 KHz (Can interface with compliant SPDIF transmitter within same cabinet, making reasonable assumptions on jitter added due to interconnecting wire.)

Tolerated jitter on SPDIF input signals are 0.25 bit peak-peak for high frequencies. There is no jitter limit for low frequencies. The user channel extraction in CD mode is capable of coping with single-symbol errors, and still retrieve U channel frames on correct boundaries. This capability is required for reliable reception of CD-Text from some Philips CD channel decoders. This capability was deemed more important than compliance with the IEC60958 annex A.3 standard, and for this reason user channel reception is not compliant with IEC60958 annex A.3. However, the interface is capable to receive U channel inserted by a typical CD channel decoder. Also, in this case, it is more robust and tolerant for channel error than what is required by IEC60958 annex A.3.

50.4.1.7 SPDIF PLOCK Detection and RxcIk Output

Using the high speed system clock, the internal DPLL can extract the bit clock (advanced pulse) from the input bitstream. When this internal DPLL is locked, the LOCK bit of PhaseConfig Register will be set, and the SPDIF Lock output pin SPDIF_LOCK will be asserted.

After DPLL has locked, the pulses are generated, and the average pulse rate is 128 x the sampling frequency. (For a 44.1 KHz input sampling frequency, the average pulse rate = 128 x 44.1 KHz.) The pulse signal is used in the FreqMeas circuit to generate the frequency measurement result.

50.4.1.8 Measuring Frequency of SPDIF_RxCIk

The internal DPLL can extract the bit clock (advanced plus) from the input bitstream. To do that, it is necessary to measure the frequency of the incoming signal in relationship with the system clock (BUS_CLK).

Associated with it are two registers, PhaseConfig and FreqMeas. The circuit will measure the frequency of the incoming clock as a function of the BUS_CLK. The circuit is a second-order filter. The output is a value represented by an unsigned number stored in the 24-bit FreqMeas register, giving the frequency of the source as a function of the BUS_CLK.

$\text{FreqMeas}[23:0] = \text{FreqMeas_CLK} / \text{BUS_CLK} * 2^{10} * \text{GAIN}$.

For example, if the GAIN is selected as $8 * (2^{**}10)$ ($\text{PhaseConfig}[5:3] = 3'b011$), the actual result

$\text{FreqMeas_CLK} / \text{BUS_CLK}$ is equal to $\text{FreqMeas}[23:0] / 2^{23}$.

50.4.2 SPDIF Transmitter

Audio data for the SPDIF transmitter is provided by processor via the SPDIFTxLeft and SPDIFTxRight registers.

Clocking for SPDIF transmitter is selected through a multiplexer from several clock sources (see [TxClk_Source](#) for clock source inputs). The SPDIF transmitter clock source can be divided down as needed using Txclk_DF. The SPDIF transmitter output can be chosen from either the SPDIF transmitter block, directly from the SPDIF receiver (via the output multiplexer), or disabled.

The SPDIF transmitter generates a SPDIF output bitstream in IEC60958 biphas mark format, consisting of audio data, channel status.

50.4.2.1 Audio Data Transmission

Audio data for the SPDIF transmitter is provided by the processor via SPDIFTxLeft and SPDIFTxRight registers. They send audio data to Tx left and right FIFOs. The Tx left and right FIFOs are also 16-deep and 24-width (equal to the audio data width).

- **SPDIF transmitter data registers - Behavior on overrun, underrun**

The SPDIF Data Transmit registers (SPDIFTxLeft and SPDIFTxRight) have individual FIFOs for left and right channel. As a result, there is always the possibility that left and right FIFOs may go out of sync due to FIFO underruns and FIFO overruns that affect only one part (left or right) of any FIFO. To prevent this from happening, hardware has been added on the device. Two mechanisms to prevent mismatch between the FIFOs are available.

If SPDIF Tx FIFO underruns on the right half of the FIFO, no sample leaves that FIFO (because it was already empty). Special hardware will make sure that the next sample read from the left FIFO will not leave the FIFO (no read strobe is generated). If the underrun occurs on the left half of the FIFO, next read strobe to the right FIFO is blocked.

- **SPDIF transmitter data registers - Automatic resynchronization of FIFOs**

See [Audio Data Reception](#).

- **SPDIFTxLeft, SPDIFTxRight details**

With SPDIF Tx FIFOs three exceptions are associated.

- empty
- under/overrun
- resync

When the empty condition is set for processor data output registers, the processor should write data to the FIFO, before underrun occurs. When empty is set and, for instance, 6 samples need to be written, it is acceptable for the software to write first 6 samples from the LEFT address, followed by 6 samples from the RIGHT address, or 1 sample LEFT, followed by 1 sample RIGHT repeated 6 times. Left should be written before right. The implementation of all data out FIFOs is a double FIFO, one for left and one for right. Empty is set when both FIFOs are empty. Underrun, overrun are set when one of the FIFOs do underrun or do overrun. Resync is set when the hardware resynchronizes left and right FIFOs.

On receiving underrun, overrun interrupt, synchronization between Left and Right words in the FIFOs may be lost. Synchronization will not be lost when the underrun or overrun comes from the IEC60958 side of the FIFO. If the processor reads or writes more data from, for example, left than from right, synchronization will be lost. If automatic resynchronization is enabled, and if the software obeys the rules to let this work, resynchronization will be automatic.

50.4.2.2 Channel Status Transmission

A total of 48 Consumer channel status bits are transmitted from two registers. Channel Status Bits are ordered first bit left.

CS-channel MSB bit "0" is located in bit position 23 in the memory-mapped register SPDIFTxCCchannelCons_h. CS-channel bit "23" is considered bit 0 in the register. C-channel bits 24-47 are seen as MSB-LSB bits of register SPDIFTxCCchannelCons_l.

50.4.2.3 Validity Flag Transmission

The validity bit setting is performed via bit 5 of the SPDIF_SCR register.

50.5 SPDIF Memory Map/Register Definition

SPDIF memory map

Absolute address (hex)	Register name	Width (in bits)	Access	Reset value	Section/page
200_4000	SPDIF Configuration Register (SPDIF_SCR)	32	R/W	0000_0400h	50.5.1/3480
200_4004	CDText Control Register (SPDIF_SRCD)	32	R/W	0000_0000h	50.5.2/3482
200_4008	PhaseConfig Register (SPDIF_SRPC)	32	R/W	0000_0000h	50.5.3/3483
200_400C	InterruptEn Register (SPDIF_SIE)	32	R/W	0000_0000h	50.5.4/3484
200_4010	InterruptStat Register (SPDIF_SIS)	32	R	0000_0002h	50.5.5/3486
200_4010	InterruptClear Register (SPDIF_SIC)	32	W	0000_0000h	50.5.6/3488
200_4014	SPDIFRxLeft Register (SPDIF_SRL)	32	R	0000_0000h	50.5.7/3489
200_4018	SPDIFRxRight Register (SPDIF_SRR)	32	R	0000_0000h	50.5.8/3490
200_401C	SPDIFRxCChannel_h Register (SPDIF_SRC SH)	32	R	0000_0000h	50.5.9/3490
200_4020	SPDIFRxCChannel_l Register (SPDIF_SRC SL)	32	R	0000_0000h	50.5.10/3491
200_4024	UchannelRx Register (SPDIF_SRU)	32	R	0000_0000h	50.5.11/3491
200_4028	QchannelRx Register (SPDIF_SRQ)	32	R	0000_0000h	50.5.12/3492
200_402C	SPDIFTxLeft Register (SPDIF_STL)	32	W	0000_0000h	50.5.13/3492
200_4030	SPDIFTxRight Register (SPDIF_STR)	32	W	0000_0000h	50.5.14/3493
200_4034	SPDIFTxCChannelCons_h Register (SPDIF_STC SCH)	32	R/W	0000_0000h	50.5.15/3493
200_4038	SPDIFTxCChannelCons_l Register (SPDIF_STC SCL)	32	R/W	0000_0000h	50.5.16/3494
200_4044	FreqMeas Register (SPDIF_SRFM)	32	R	0000_0000h	50.5.17/3494
200_4050	SPDIFTxCk Register (SPDIF_STC)	32	R/W	0002_0F00h	50.5.18/3495

50.5.1 SPDIF Configuration Register (SPDIF_SCR)

Address: 200_4000h base + 0h offset = 200_4000h

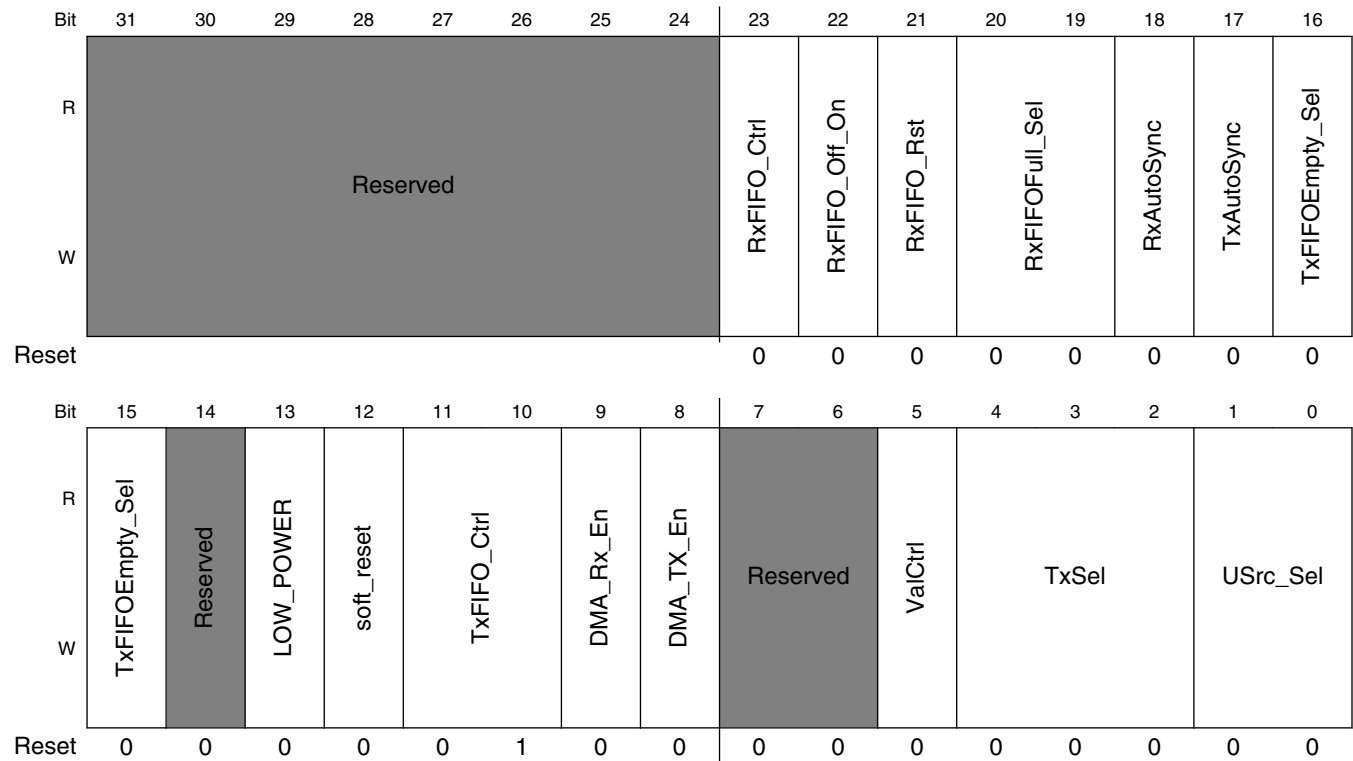

SPDIF_SCR field descriptions

Field	Description
31–24 [unimplemented]	This is a 24-bit register the upper byte is unimplemented. This field is reserved.
23 RxFIFO_Ctrl	0 Normal operation 1 Always read zero from Rx data register
22 RxFIFO_Off_On	0 SPDIF Rx FIFO is on 1 SPDIF Rx FIFO is off. Does not accept data from interface
21 RxFIFO_Rst	0 Normal operation 1 Reset register to 1 sample remaining
20–19 RxFIFOFull_Sel	00 Full interrupt if at least 1 sample in Rx left and right FIFOs 01 Full interrupt if at least 4 sample in Rx left and right FIFOs 10 Full interrupt if at least 8 sample in Rx left and right FIFOs 11 Full interrupt if at least 16 sample in Rx left and right FIFO
18 RxAutoSync	0 Rx FIFO auto sync off 1 RxFIFO auto sync on
17 TxAutoSync	0 Tx FIFO auto sync off 1 Tx FIFO auto sync on

Table continues on the next page...

SPDIF_SCR field descriptions (continued)

Field	Description
16–15 TxFIFOEmpty_Sel	00 Empty interrupt if 0 sample in Tx left and right FIFOs 01 Empty interrupt if at most 4 sample in Tx left and right FIFOs 10 Empty interrupt if at most 8 sample in Tx left and right FIFOs 11 Empty interrupt if at most 12 sample in Tx left and right FIFOs
14 -	This field is reserved. Reserved
13 LOW_POWER	When write 1 to this bit, it will cause SPDIF enter low-power mode. return 1 when SPDIF in Low-Power mode.
12 soft_reset	When write 1 to this bit, it will cause SPDIF software reset. The software reset will last 8 cycles. When in the reset process, return 1 when read. else return 0 when read.
11–10 TxFIFO_Ctrl	00 Send out digital zero on SPDIF Tx 01 Tx Normal operation 10 Reset to 1 sample remaining 11 Reserved
9 DMA_Rx_En	DMA Receive Request Enable (RX FIFO full)
8 DMA_TX_En	DMA Transmit Request Enable (Tx FIFO empty)
7–6 -	This field is reserved. Reserved
5 ValCtrl	0 Outgoing Validity always set 1 Outgoing Validity always clear
4–2 TxSel	000 Off and output 0 001 Feed-through SPDIFIN 101 Tx Normal operation Others Reserved
USrc_Sel	00 No embedded U channel 01 U channel from SPDIF receive block (CD mode) 10 Reserved 11 U channel from on chip transmitter

50.5.2 CDText Control Register (SPDIF_SRCD)

Address: 200_4000h base + 4h offset = 200_4004h

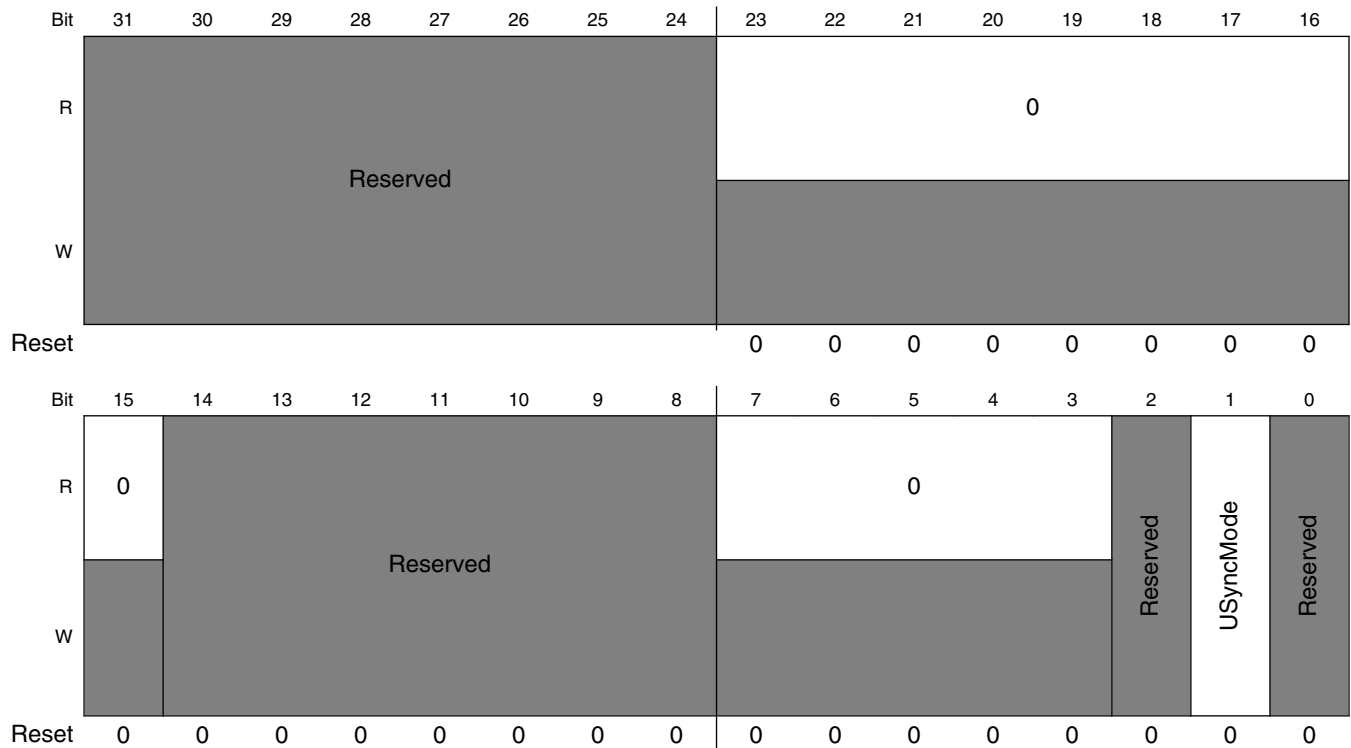

SPDIF_SRCD field descriptions

Field	Description
31–24 [unimplemented]	This is a 24-bit register the upper byte is unimplemented. This field is reserved.
23–15 Reserved	This read-only field is reserved and always has the value 0.
14–8 -	This field is reserved. Reserved. set to zero.
7–3 Reserved	This read-only field is reserved and always has the value 0.
2 -	This field is reserved. Reserved.
1 USyncMode	0 Non-CD data 1 CD user channel subcode
0 -	This field is reserved. Reserved.

50.5.3 PhaseConfig Register (SPDIF_SRPC)

Address: 200_4000h base + 8h offset = 200_4008h

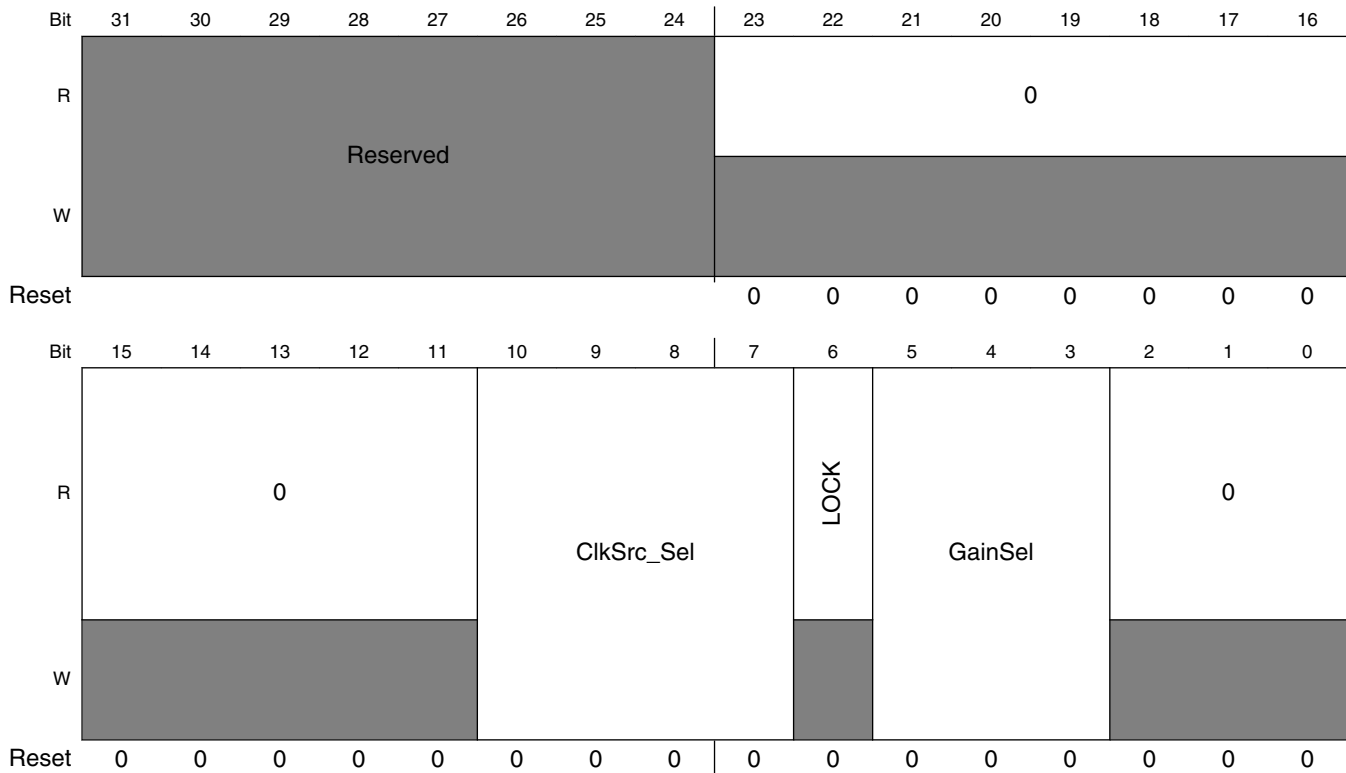

SPDIF_SRPC field descriptions

Field	Description
31–24 [unimplemented]	This is a 24-bit register the upper byte is unimplemented. This field is reserved.
23–11 Reserved	This read-only field is reserved and always has the value 0.
10–7 ClkSrc_Sel	Clock source selection, all other settings not shown are reserved: 0000 if (DPLL Locked) SPDIF_RxCk else REF_CLK_32K (XTALOSC) 0001 if (DPLL Locked) SPDIF_RxCk else tx_clk (SPDIF0_CLK_ROOT) 0011 if (DPLL Locked) SPDIF_RxCk else SPDIF_EXT_CLK 0101 REF_CLK_32K (XTALOSC) 0110 tx_clk (SPDIF0_CLK_ROOT) 1000 SPDIF_EXT_CLK
6 LOCK	LOCK bit to show that the internal DPLL is locked, read only
5–3 GainSel	Gain selection: 000 24*(2**10) 001 16*(2**10)

Table continues on the next page...

SPDIF_SRPC field descriptions (continued)

Field	Description
010	12*(2**10)
011	8*(2**10)
100	6*(2**10)
101	4*(2**10)
110	3*(2**10)
Reserved	This read-only field is reserved and always has the value 0.

50.5.4 InterruptEn Register (SPDIF_SIE)

The InterruptEn register (SPDIF_SIE) provides control over the enabling of interrupts.

Address: 200_4000h base + Ch offset = 200_400Ch

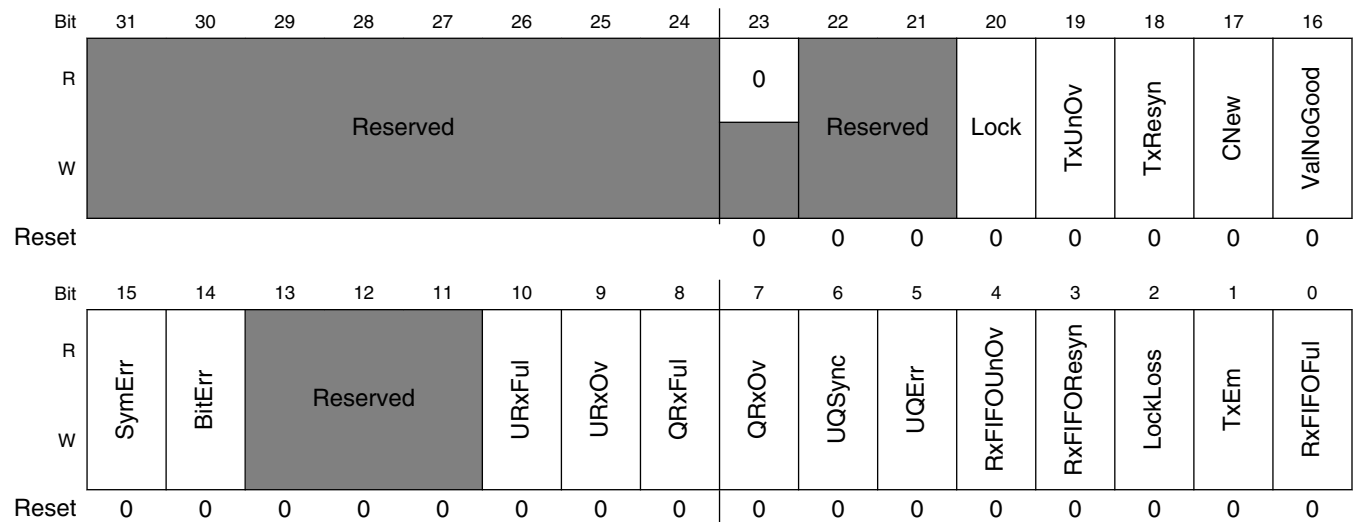

SPDIF_SIE field descriptions

Field	Description
31–24 [unimplemented]	This is a 24-bit register the upper byte is unimplemented. This field is reserved.
23 Reserved	This read-only field is reserved and always has the value 0.
22–21 -	This field is reserved. Reserved. set to zero.
20 Lock	SPDIF receiver's DPLL is locked
19 TxUnOv	SPDIF Tx FIFO under/overflow

Table continues on the next page...

SPDIF_SIE field descriptions (continued)

Field	Description
18 TxResyn	SPDIF Tx FIFO resync
17 CNew	SPDIF receive change in value of control channel
16 ValNoGood	SPDIF validity flag no good
15 SymErr	SPDIF receiver found illegal symbol
14 BitErr	SPDIF receiver found parity bit error
13–11 -	This field is reserved. Reserved. set to zero.
10 URxFul	U Channel receive register full, can't be cleared with reg. IntClear. To clear it, read from U Rx reg.
9 URxOv	U Channel receive register overrun
8 QRxFul	Q Channel receive register full, can't be cleared with reg. IntClear. To clear it, read from Q Rx reg.
7 QRxOv	Q Channel receive register overrun
6 UQSync	U/Q Channel sync found
5 UQErr	U/Q Channel framing error
4 RxFIFOUnOv	Rx FIFO underrun/overrun
3 RxFIFOResyn	Rx FIFO resync
2 LockLoss	SPDIF receiver loss of lock
1 TxEm	SPDIF Tx FIFO empty, can't be cleared with reg. IntClear. To clear it, write to Tx FIFO.
0 RxFIFOFull	SPDIF Rx FIFO full, can't be cleared with reg. IntClear. To clear it, read from Rx FIFO.

50.5.5 InterruptStat Register (SPDIF_SIS)

The InterruptStat (SPDIF_SIS) register is a read only register that provides the status on interrupt operations.

Address: 200_4000h base + 10h offset = 200_4010h

Bit	31	30	29	28	27	26	25	24	23	22	21	20	19	18	17	16
R	Reserved								0	Lock	TxUnOv	TxResyn	CNew	ValNoGood		
W	Reserved								Reserved	Reserved	Reserved	Reserved	Reserved	Reserved	Reserved	Reserved
Reset	0								0	0	0	0	0	0	0	0
Bit	15	14	13	12	11	10	9	8	7	6	5	4	3	2	1	0
R	SymErr	BitErr	0			URxFul	URxOv	QRxFul	QRxOv	UQSync	UQErr	RxFIFOUnOv	RxFIFOResyn	LockLoss	TxErm	RxFIFOFull
W	Reserved	Reserved	Reserved	Reserved	Reserved	Reserved	Reserved	Reserved	Reserved	Reserved	Reserved	Reserved	Reserved	Reserved	Reserved	
Reset	0	0	0	0	0	0	0	0	0	0	0	0	0	0	1	0

SPDIF_SIS field descriptions

Field	Description
31–24 [unimplemented]	This is a 24-bit register the upper byte is unimplemented. This field is reserved.
23–21 Reserved	This read-only field is reserved and always has the value 0.
20 Lock	SPDIF receiver's DPLL is locked
19 TxUnOv	SPDIF Tx FIFO under/overflow
18 TxResyn	SPDIF Tx FIFO resync
17 CNew	SPDIF receive change in value of control channel
16 ValNoGood	SPDIF validity flag no good
15 SymErr	SPDIF receiver found illegal symbol
14 BitErr	SPDIF receiver found parity bit error
13–11 Reserved	This read-only field is reserved and always has the value 0.
10 URxFul	U Channel receive register full, can't be cleared with reg. IntClear. To clear it, read from U Rx reg.
9 URxOv	U Channel receive register overrun
8 QRxFul	Q Channel receive register full, can't be cleared with reg. IntClear. To clear it, read from Q Rx reg.
7 QRxOv	Q Channel receive register overrun
6 UQSync	U/Q Channel sync found
5 UQErr	U/Q Channel framing error
4 RxFIFOUnOv	Rx FIFO underrun/overflow
3 RxFIFOResyn	Rx FIFO resync
2 LockLoss	SPDIF receiver loss of lock
1 TxEm	SPDIF Tx FIFO empty, can't be cleared with reg. IntClear. To clear it, write to Tx FIFO.
0 RxFIFOFull	SPDIF Rx FIFO full, can't be cleared with reg. IntClear. To clear it, read from Rx FIFO.

50.5.6 InterruptClear Register (SPDIF_SIC)

The InterruptClear (SPDIF_SIC) register is a write only register and is used to clear interrupts.

Address: 200_4000h base + 10h offset = 200_4010h

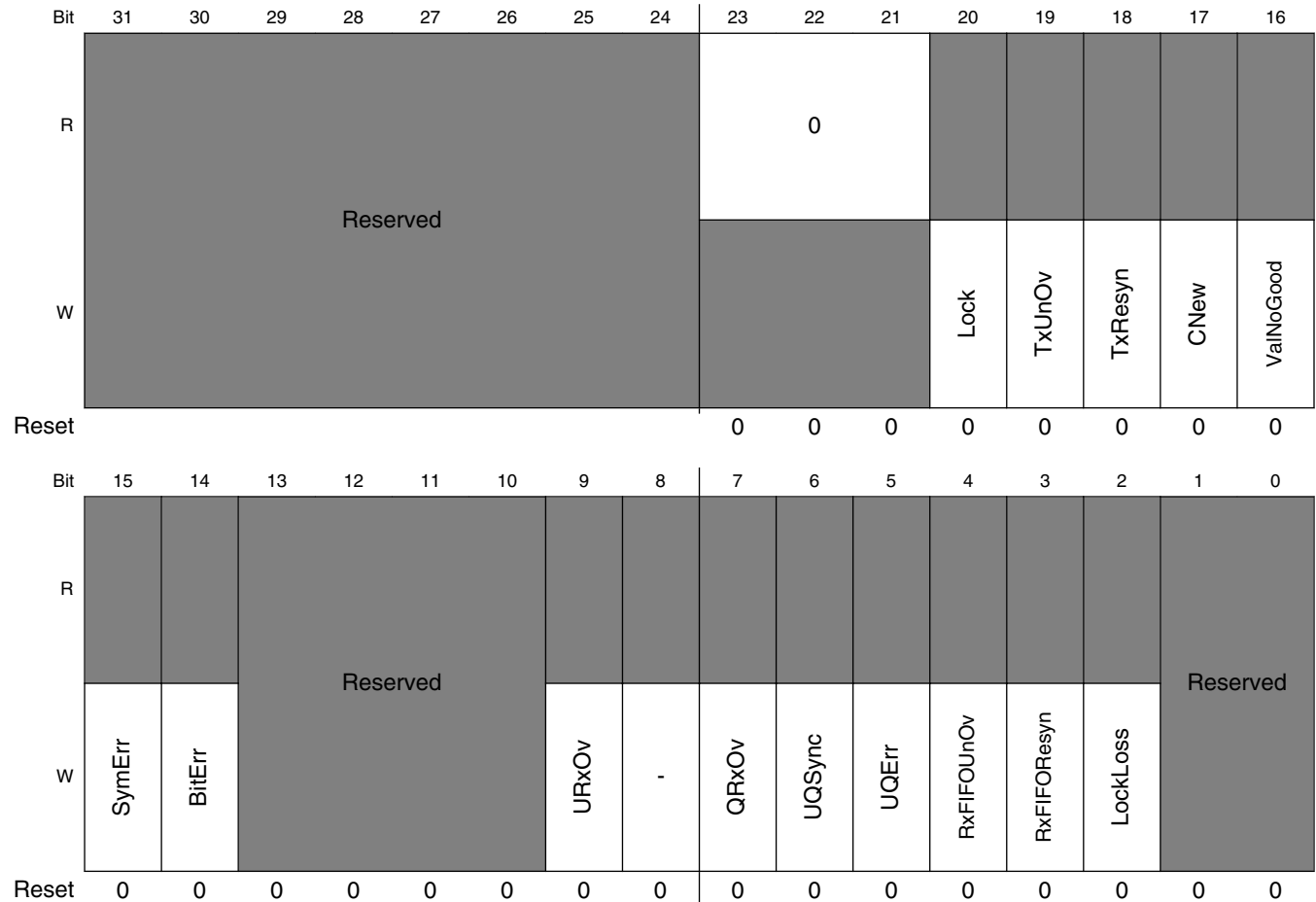

SPDIF_SIC field descriptions

Field	Description
31–24 [unimplemented]	This is a 24-bit register the upper byte is unimplemented. This field is reserved.
23–21 Reserved	This read-only field is reserved and always has the value 0.
20 Lock	SPDIF receiver's DPLL is locked
19 TxUnOv	SPDIF Tx FIFO under/overflow

Table continues on the next page...

SPDIF_SIC field descriptions (continued)

Field	Description
18 TxResyn	SPDIF Tx FIFO resync
17 CNew	SPDIF receive change in value of control channel
16 ValNoGood	SPDIF validity flag no good
15 SymErr	SPDIF receiver found illegal symbol
14 BitErr	SPDIF receiver found parity bit error
13–10 -	This field is reserved. Reserved.
9 URxOv	U Channel receive register overrun
8 -	Reserved
7 QRxOv	Q Channel receive register overrun
6 UQSync	U/Q Channel sync found
5 UQErr	U/Q Channel framing error
4 RxFIFOUnOv	Rx FIFO underrun/overrun
3 RxFIFOResyn	Rx FIFO resync
2 LockLoss	SPDIF receiver loss of lock
-	This field is reserved. Reserved.

50.5.7 SPDIFRxLeft Register (SPDIF_SRL)

SPDIFRxLeft register is an audio data reception register.

Address: 200_4000h base + 14h offset = 200_4014h

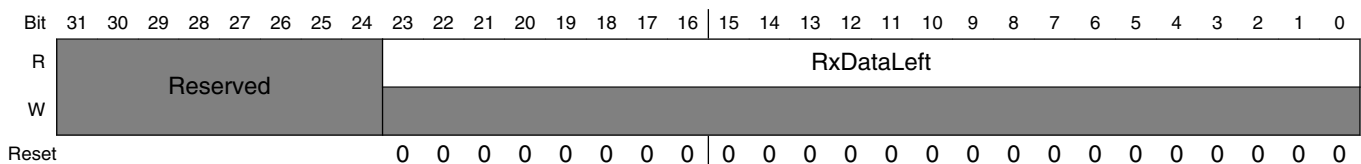

SPDIF_SRL field descriptions

Field	Description
31–24 [unimplemented]	This is a 24-bit register the upper byte is unimplemented. This field is reserved.
RxDataLeft	Processor receive SPDIF data left

50.5.8 SPDIFRxRight Register (SPDIF_SRR)

SPDIFRxRight register is an audio data reception register.

Address: 200_4000h base + 18h offset = 200_4018h

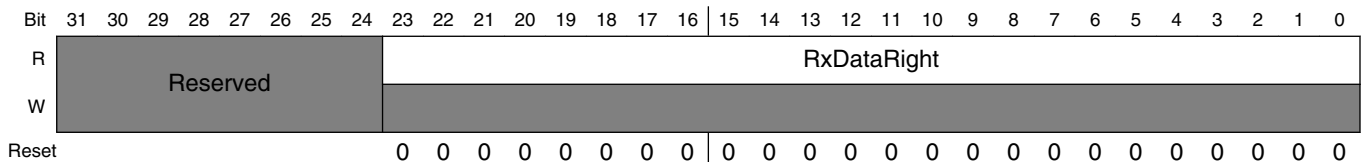

SPDIF_SRR field descriptions

Field	Description
31–24 [unimplemented]	This is a 24-bit register the upper byte is unimplemented. This field is reserved.
RxDataRight	Processor receive SPDIF data right

50.5.9 SPDIFRxChannel_h Register (SPDIF_SRC SH)

SPDIFRxChannel_h register is a channel status reception register.

Address: 200_4000h base + 1Ch offset = 200_401Ch

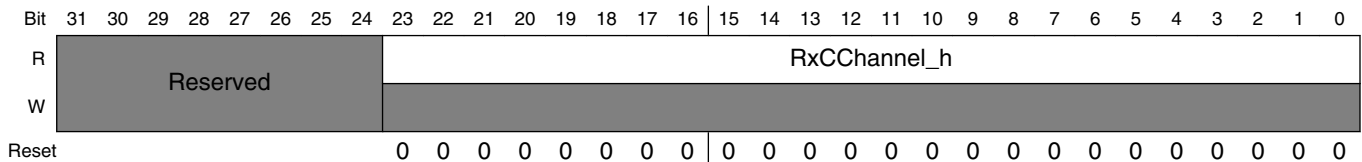

SPDIF_SRC SH field descriptions

Field	Description
31–24 [unimplemented]	This is a 24-bit register the upper byte is unimplemented. This field is reserved.
RxCChannel_h	SPDIF receive C channel register, contains first 24 bits of C channel without interpretation

50.5.10 SPDIFRxChannel_I Register (SPDIF_SRC SL)

SPDIFRxChannel_I register is a channel status reception register.

Address: 200_4000h base + 20h offset = 200_4020h

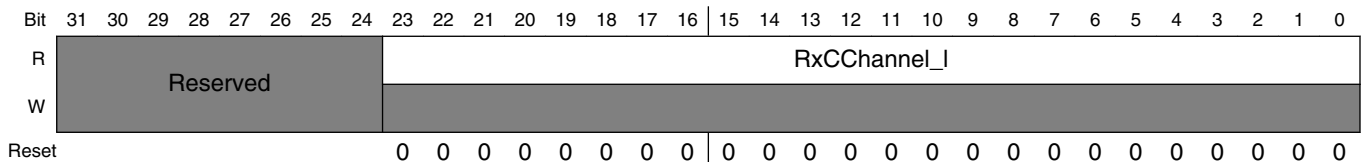

SPDIF_SRC SL field descriptions

Field	Description
31–24 [unimplemented]	This is a 24-bit register the upper byte is unimplemented. This field is reserved.
RxCChannel_I	SPDIF receive C channel register, contains next 24 bits of C channel without interpretation

50.5.11 UchannelRx Register (SPDIF_SR U)

UchannelRx register is a user bits reception register.

Address: 200_4000h base + 24h offset = 200_4024h

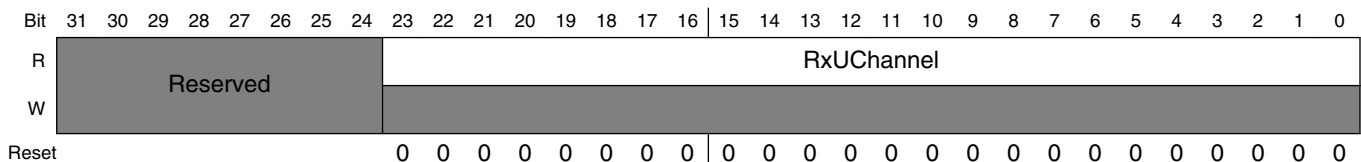

SPDIF_SRU field descriptions

Field	Description
31–24 [unimplemented]	This field is reserved. This is a 24-bit register the upper byte is unimplemented.
RxUChannel	SPDIF receive U channel register, contains next 3 U channel bytes

50.5.12 QchannelRx Register (SPDIF_SRQ)

QChannelRx register is a user bits reception register.

Address: 200_4000h base + 28h offset = 200_4028h

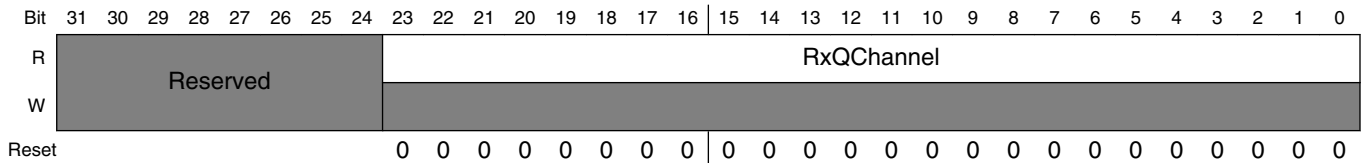

SPDIF_SRQ field descriptions

Field	Description
31–24 [unimplemented]	This is a 24-bit register the upper byte is unimplemented. This field is reserved.
RxQChannel	SPDIF receive Q channel register, contains next 3 Q channel bytes

50.5.13 SPDIFTxLeft Register (SPDIF_STL)

SPDIFTxLeft register is an audio data transmission register.

Address: 200_4000h base + 2Ch offset = 200_402Ch

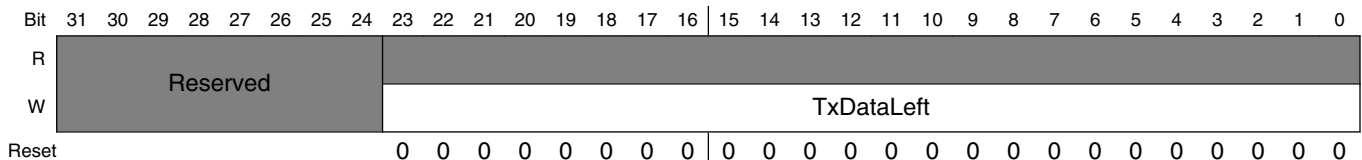

SPDIF_STL field descriptions

Field	Description
31–24 [unimplemented]	This field is reserved. This is a 24-bit register the upper byte is unimplemented.
TxDataLeft	SPDIF transmit left channel data. It is write-only, and always returns zeros when read

50.5.14 SPDIFTxRight Register (SPDIF_STR)

SPDIFTxRight register is an audio data transmission register.

Address: 200_4000h base + 30h offset = 200_4030h

Bit	31	30	29	28	27	26	25	24	23	22	21	20	19	18	17	16	15	14	13	12	11	10	9	8	7	6	5	4	3	2	1	0
R	Reserved																															
W	Reserved								TxDataRight																							
Reset	0								0																							

SPDIF_STR field descriptions

Field	Description
31–24 [unimplemented]	This field is reserved. This is a 24-bit register the upper byte is unimplemented.
TxDataRight	SPDIF transmit right channel data. It is write-only, and always returns zeros when read

50.5.15 SPDIFTxCChannelCons_h Register (SPDIF_STCSCH)

SPDIFTxCChannelCons_h register is a channel status transmission register.

Address: 200_4000h base + 34h offset = 200_4034h

Bit	31	30	29	28	27	26	25	24	23	22	21	20	19	18	17	16	15	14	13	12	11	10	9	8	7	6	5	4	3	2	1	0
R	Reserved								TxCChannelCons_h																							
W	Reserved								TxCChannelCons_h																							
Reset	0								0																							

SPDIF_STCSCH field descriptions

Field	Description
31–24 [unimplemented]	This is a 24-bit register the upper byte is unimplemented. This field is reserved.

Table continues on the next page...

SPDIF_STCSCH field descriptions (continued)

Field	Description
TxCChannelCons_h	SPDIF transmit Cons. C channel data, contains first 24 bits without interpretation. When read, it returns the latest data written by the processor

50.5.16 SPDIFTxChannelCons_I Register (SPDIF_STCSCL)

SPDIFTxChannelCons_I register is a channel status transmission register.

Address: 200_4000h base + 38h offset = 200_4038h

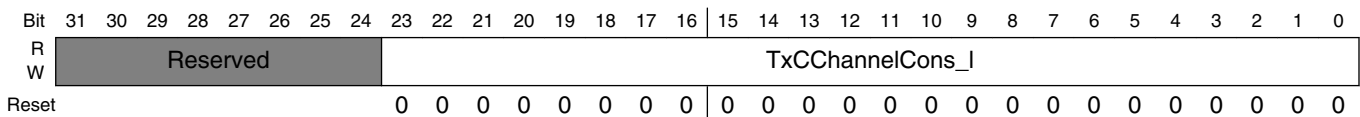

SPDIF_STCSCL field descriptions

Field	Description
31–24 [unimplemented]	This is a 24-bit register the upper byte is unimplemented. This field is reserved.
TxCChannelCons_I	SPDIF transmit Cons. C channel data, contains next 24 bits without interpretation. When read, it returns the latest data written by the processor

50.5.17 FreqMeas Register (SPDIF_SRFM)

Address: 200_4000h base + 44h offset = 200_4044h

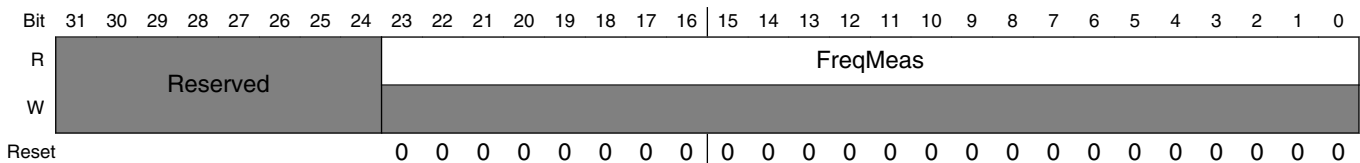

SPDIF_SRFM field descriptions

Field	Description
31–24 [unimplemented]	This is a 24-bit register the upper byte is unimplemented. This field is reserved.
FreqMeas	Frequency measurement data

50.5.18 SPDIFTxClk Register (SPDIF_STC)

The SPDIFTxClk Control register includes the means to select the transmit clock and frequency division.

Address: 200_4000h base + 50h offset = 200_4050h

Bit	31	30	29	28	27	26	25	24	23	22	21	20	19	18	17	16
R	Reserved								0				SYSCLK_DF			
W																
Reset									0	0	0	0	0	0	1	0
Bit	15	14	13	12	11	10	9	8	7	6	5	4	3	2	1	0
R	SYSCLK_DF				TxClk_Source				tx_all_clk_en	TxClk_DF						
W																
Reset	0	0	0	0	1	1	1	1	0	0	0	0	0	0	0	0

SPDIF_STC field descriptions

Field	Description
31–24 [unimplemented]	This is a 24-bit register the upper byte is unimplemented. This field is reserved.
23–20 Reserved	This read-only field is reserved and always has the value 0.
19–11 SYSCLK_DF	system clock divider factor, 2~512. 0 no clock signal 1 divider factor is 2 511 divider factor is 512
10–8 TxClk_Source	000 REF_CLK_32K input (XTALOSC 32 kHz clock) 001 tx_clk input (from SPDIF0_CLK_ROOT. See CCM.) 011 SPDIF_EXT_CLK, from pads 101 ipg_clk input (frequency divided)
7 tx_all_clk_en	Spdif transfer clock enable. When data is going to be transfered, this bit should be set to1. 0 disable transfer clock. 1 enable transfer clock.
TxClk_DF	Divider factor (1-128)

Table continues on the next page...

SPDIF_STC field descriptions (continued)

Field	Description
0	divider factor is 1
1	divider factor is 2
...	...
127	divider factor is 128

Chapter 51

System Reset Controller (SRC)

51.1 SRC Overview

The System Reset Controller (SRC) controls the reset and boot operation of the SoC.

It is responsible for the generation of all reset signals and boot decoding.

The reset controller determines the source and the type of reset, such as POR, WARM, COLD, and performs the necessary reset qualification and stretching sequences. Based on the type of reset, the reset logic generates the reset sequence for the entire IC. Whenever the chip is powered on, the reset is issued through SRC_ONOFF signal and the entire chip is reset.

51.1.1 Features

The SRC includes the following features.

- Receives and handles the resets from all the reset sources
- Resets the appropriate domains based upon the resets sources and the nature of the reset
- Latches the SRC_BOOT_MODE pins and common configuration signals from the internal fuse

51.2 External Signals

The following table describes the external signals of SRC.

Table 51-1. SRC External Signals

Signal	Description	Pad	Mode	Direction
SRC_BT_CFG0	Boot configuration signals	LCD_DATA00	ALT6	I
SRC_BT_CFG1		LCD_DATA01	ALT6	I
SRC_BT_CFG2		LCD_DATA02	ALT6	I
SRC_BT_CFG3		LCD_DATA03	ALT6	I
SRC_BT_CFG4		LCD_DATA04	ALT6	I
SRC_BT_CFG5		LCD_DATA05	ALT6	I
SRC_BT_CFG6		LCD_DATA06	ALT6	I
SRC_BT_CFG7		LCD_DATA07	ALT6	I
SRC_BT_CFG8		LCD_DATA08	ALT6	I
SRC_BT_CFG9		LCD_DATA09	ALT6	I
SRC_BT_CFG10		LCD_DATA10	ALT6	I
SRC_BT_CFG11		LCD_DATA11	ALT6	I
SRC_BT_CFG12		LCD_DATA12	ALT6	I
SRC_BT_CFG13		LCD_DATA13	ALT6	I
SRC_BT_CFG14		LCD_DATA14	ALT6	I
SRC_BT_CFG15		LCD_DATA15	ALT6	I
SRC_BT_CFG24		LCD_DATA16	ALT6	I
SRC_BT_CFG25		LCD_DATA17	ALT6	I
SRC_BT_CFG26		LCD_DATA18	ALT6	I
SRC_BT_CFG27		LCD_DATA19	ALT6	I
SRC_BT_CFG28		LCD_DATA20	ALT6	I
SRC_BT_CFG29		LCD_DATA21	ALT6	I
SRC_BT_CFG30		LCD_DATA22	ALT6	I
SRC_BT_CFG31	LCD_DATA23	ALT6	I	
SRC_POR_B	Power on reset signal	POR_B	No Muxing (ALT0)	I
SRC_ONOFF	ON/OFF signal	ONOFF	No Muxing (ALT0)	I
SRC_BOOT_MODE0	Boot mode signals	BOOT_MODE0	No Muxing	I
SRC_BOOT_MODE1		BOOT_MODE1	No Muxing	I

51.3 Clocks

The table found here describes the clock sources for SRC.

Please see [Clock Controller Module \(CCM\)](#) for clock setting, configuration and gating information.

Table 51-2. SRC Clocks

Clock name	Clock Root	Description
ipg_clk	ipg_clk_root	Peripheral clock
ipg_clk_s	ipg_clk_root	Peripheral access clock

51.4 Top-level resets, power-up sequence and external supply integration

Information found here defines chip resets, power-up sequence, and external supply integration.

51.4.1 Reset and Power-up Flow

The chip presumes the following reset and power-up flow:

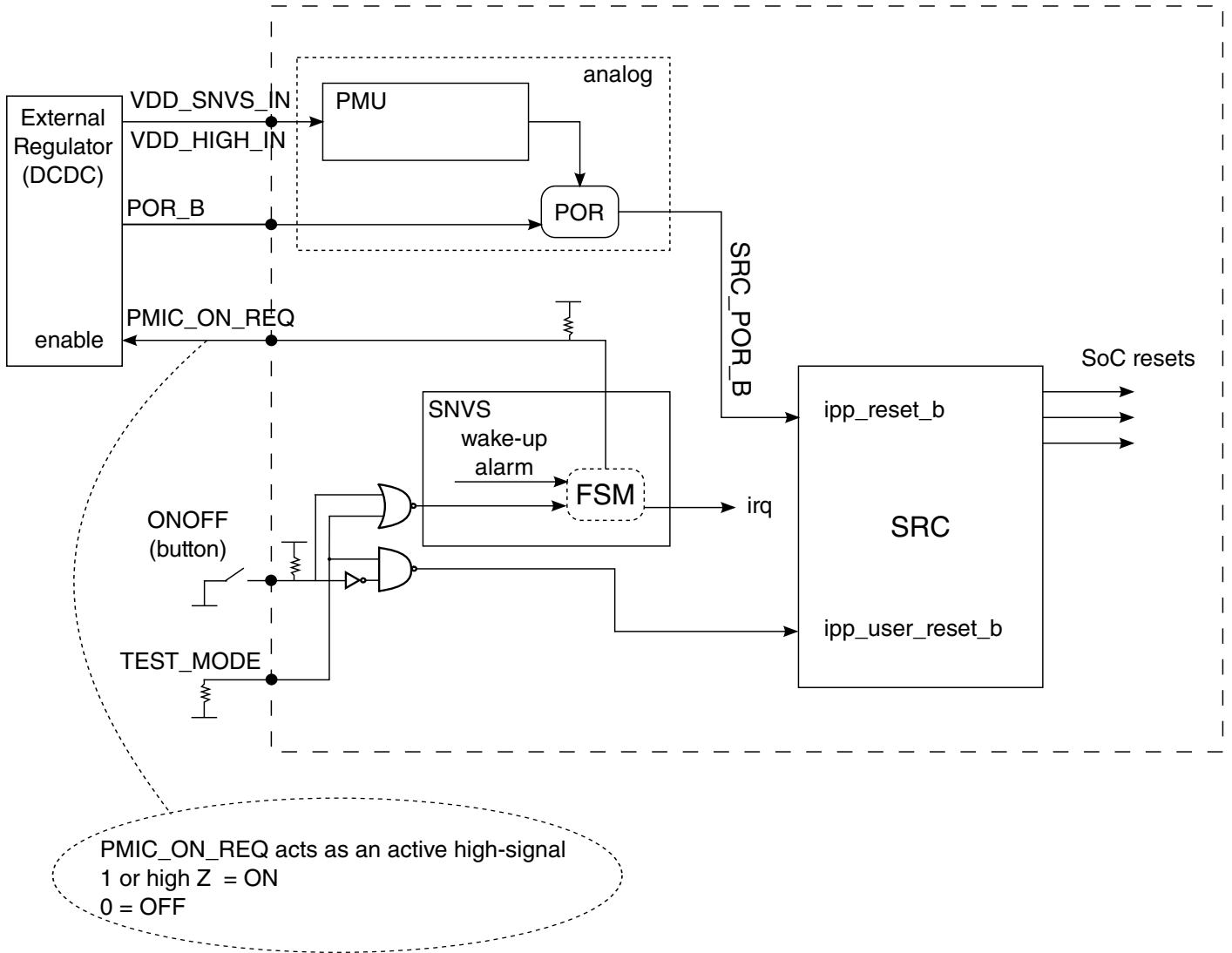

Figure 51-1. Chip reset scheme under PMU control

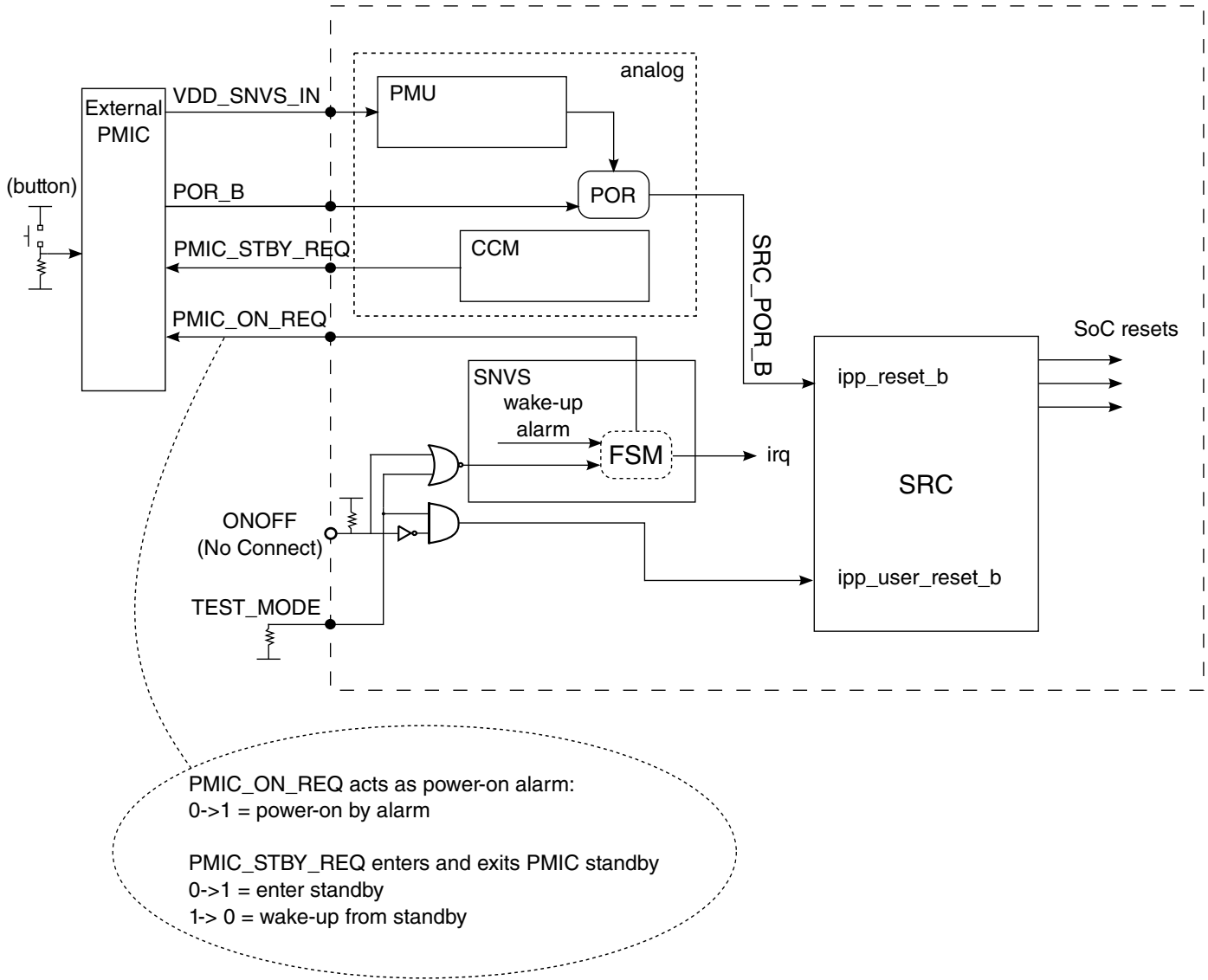

Figure 51-2. Chip reset scheme under external PMIC control

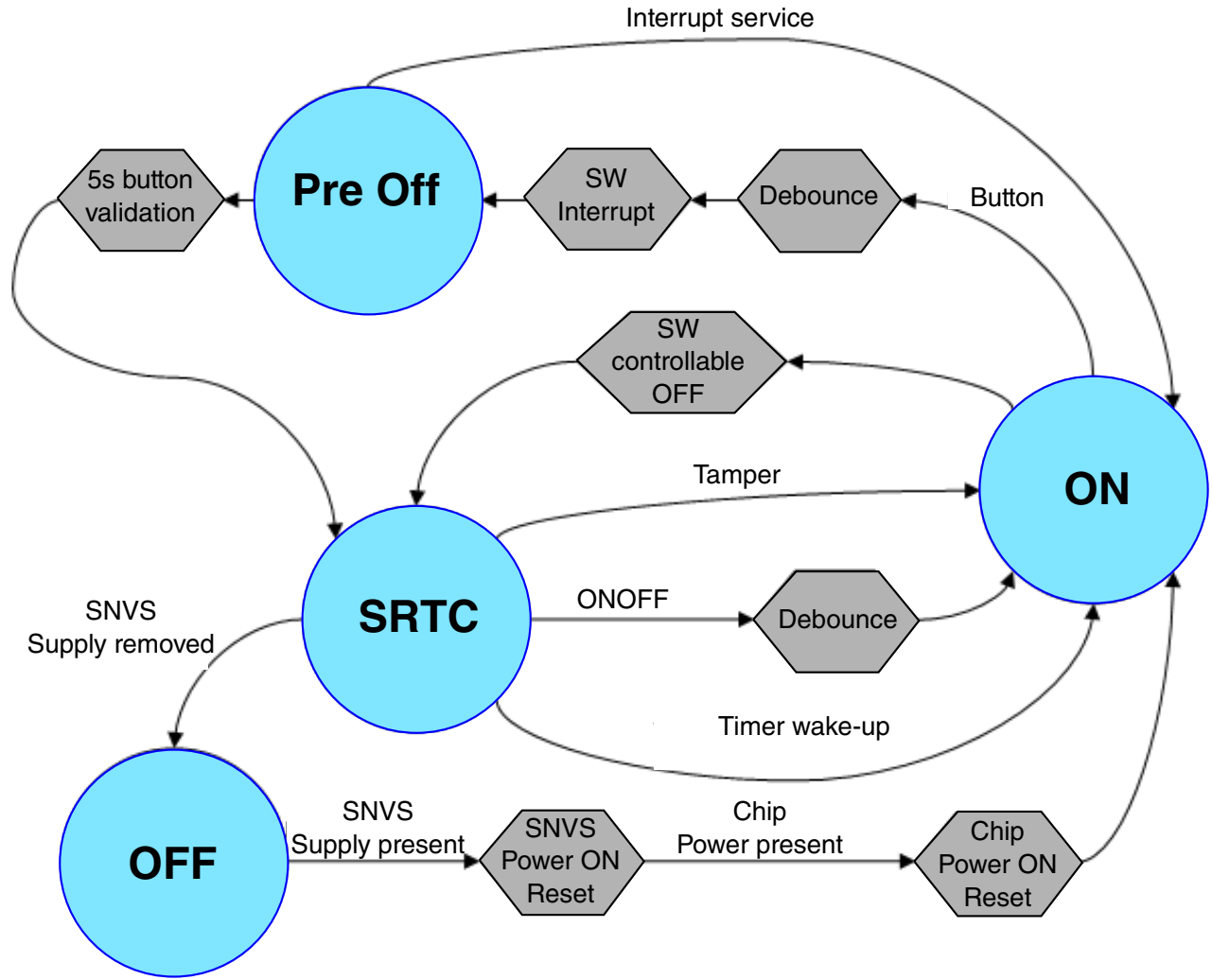

Figure 51-3. Chip on/off state flow diagram

51.4.2 Finite-State Machine (FSM)

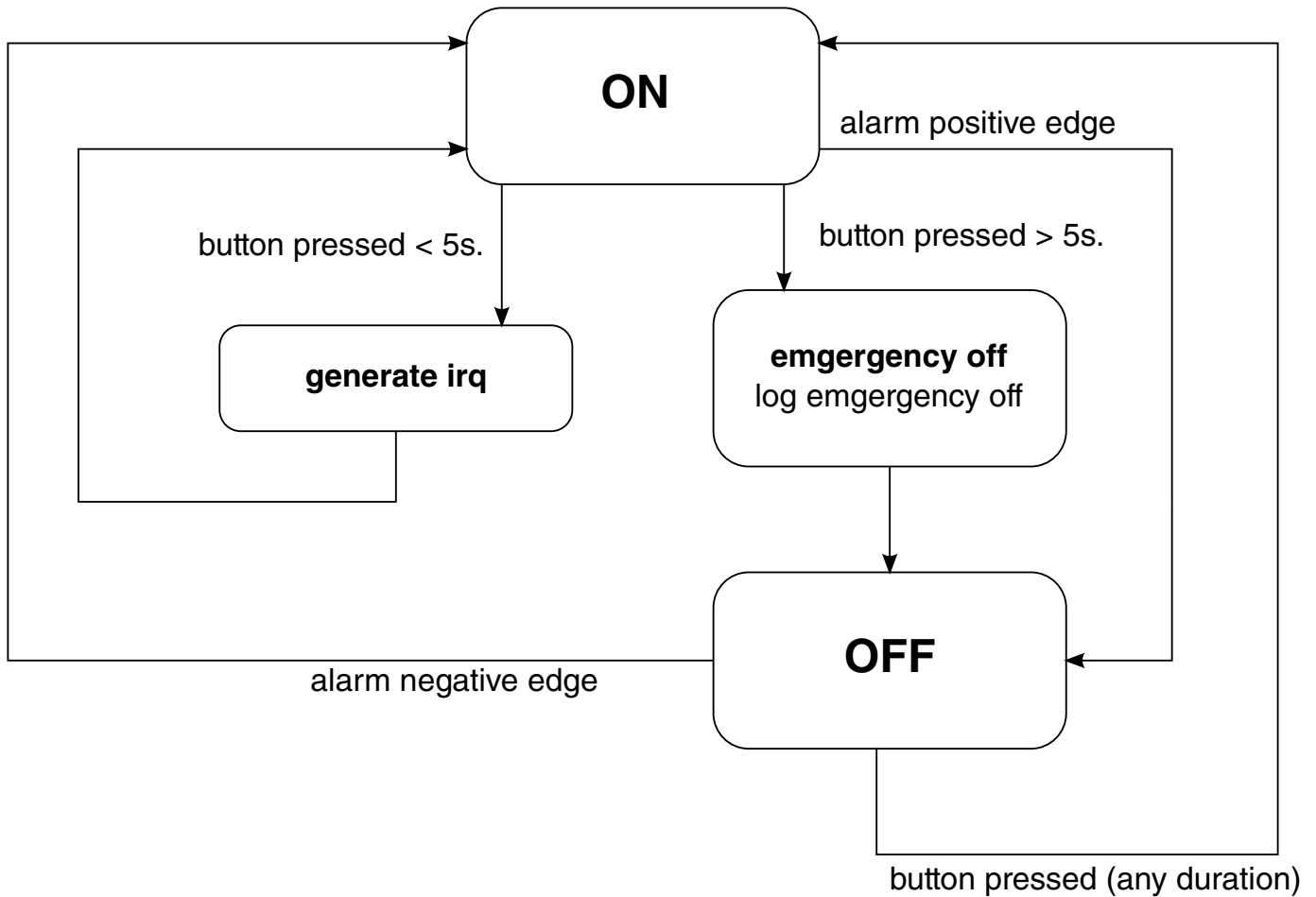

Figure 51-4. FSM

51.4.3 Power mode transitions

Table 51-3. Power mode transitions

Power mode	Configuration with external PMIC	Configuration with internal PMIC
ON, first time	<ol style="list-style-type: none"> 1. Either coin cell or SoC power supply is connected to SNVS. 2. When button is pressed, PMIC powers on. 	<ol style="list-style-type: none"> 1. Either coin cell or SoC power supply is connected to SNVS. 2. When button is pressed, 'state' goes ON, PMIC_ON_REQ goes '1'. 3. External regulator is enabled.
Normal ON to OFF, by button	<ol style="list-style-type: none"> 1. Button is pressed for a short duration on the external PMIC. 2. Interrupt request (irq) is sent to SoC from external PMIC. 	<ol style="list-style-type: none"> 1. SoC button is pressed for a short duration. 2. Interrupt request (irq) is sent to SoC from FSM. 3. Alarm timer is set up by software routine and started.

Table continues on the next page...

Table 51-3. Power mode transitions (continued)

Power mode	Configuration with external PMIC	Configuration with internal PMIC
	<ol style="list-style-type: none"> SoC is programming PMIC for power off when standby is asserted. In CCM STOP mode, Standby is asserted, PMIC gates SoC supplies. 	<ol style="list-style-type: none"> Upon alarm_in assertion to '1', PMIC_ON_REQ goes '0'. External regulator goes OFF.
Emergency ON to OFF, by button	<ol style="list-style-type: none"> Button is pressed for an extended time on the external PMIC. PMIC is powering off. 	<ol style="list-style-type: none"> Button is pressed for longer than 5 seconds on the SoC. FSM validates button pressed for 5 seconds. Emergency power off is logged, PMIC_ON_REQ goes '0', alarm_mask goes '1'. External regulator goes OFF.
OFF to ON, by button	<ol style="list-style-type: none"> Button is pressed on the external PMIC. PMIC powers ON. 	<ol style="list-style-type: none"> Button is pressed on the SoC. PMIC_ON_REQ goes '1', alarm_mask goes '0'. External regulator powers ON.
OFF to ON, by timer alarm	<ol style="list-style-type: none"> Timer alarm in SNVS is programmed by software before SoC goes OFF. SoC enters OFF mode. Upon timer limit, wake up alarm goes '0'. PMIC_ON_REQ goes '1'. PMIC receives assertion of PMIC_ON_REQ and wakes up. 	<ol style="list-style-type: none"> Timer alarm in SNVS is programmed by software before SoC goes OFF. SoC enters OFF mode. Upon timer limit, wake up alarm goes '0'. PMIC_ON_REQ goes '1'. External regulator is enabled by PMIC_ON_REQ = 1.

51.5 Power-On Reset and power sequencing

This module generates an internal POR_B signal that is logically AND'ed with any externally applied SRC_POR_B signal. The internal POR_B signal will be held low until all of the following conditions are met:

- 4ms after the external power supply VDDHIGH_IN is valid
- 1ms after the VDD_SOC_CAP supply is valid

The 4ms and 1ms delays are derived from counting the 32 kHz RTC clock cycles; the accuracy depends on the accuracy of the RTC. When the RTC crystal is either absent or in the process of powering up, an internal ring oscillator will be the source of RTC, which is not as accurate as the crystal.

51.5.1 External POR using SRC_POR_B

If the external SRC_POR_B signal is used to control the processor POR, SRC_POR_B must remain low (asserted) until the VDD_ARM_CAP and VDD_SOC_CAP supplies are stable.

51.5.2 Internal POR

If the external SRC_POR_B signal is not used (always held high or left unconnected), the processor defaults to the internal POR function (PMU controls generation of the POR based on the power supplies).

If the internal POR function is used, the following power supply requirements must be met:

- VDD_ARM_IN and VDD_SOC_IN may be supplied from the same source, or
- VDD_SOC_IN can be supplied before VDD_ARM_IN with a maximum delay of 1 ms.

51.6 Functional Description

51.6.1 Reset Control

This section details the reset control of this device.

51.6.1.1 Reset inputs and outputs

The reset control logic receives reset requests from all potential reset sources. All the immediate sources of reset are directly passed to the reset stretching block, whereas the resets requiring qualification are passed on to the reset qualification logic before they are sent to the reset stretching block.

All reset inputs and outputs are described in the following figure:

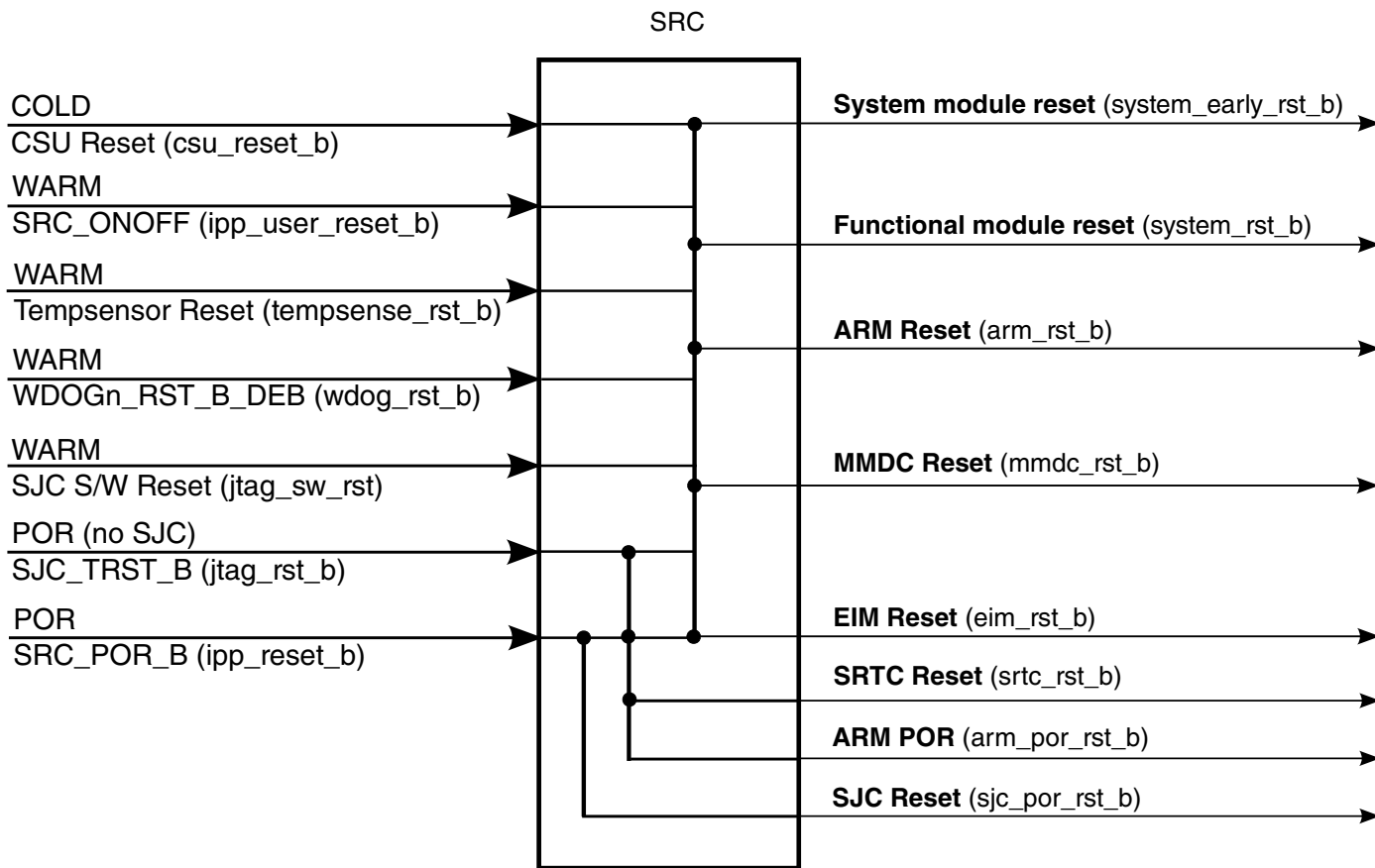

Figure 51-5. SRC inputs and outputs

The reset types and modules they affect are shown in [Table 51-4](#). As there is no chip POR, the POR_B is used to reset the entire chip including test logic and JTAG modules.

NOTE

All resets are expected to be active low except `jtag_sw_rst`.

Table 51-4. SRC reset functionality

SoC Modules	POR	COLD	WARM
System modules (PLLs, fuses, etc)	yes	yes	yes
Functional modules	yes	yes	yes
Arm	yes	yes	yes
Arm SoC	yes	yes	yes
MMDC	yes	yes	yes
Arm POR	yes	no	no
Arm debug	yes	no	no
SJC	yes	no	no
SRTC	yes	no	no

The reset priorities are POR (strongest), COLD and WARM (weakest). If a stronger reset is asserted during the sequence of a weaker reset, then the weaker sequence will be overridden, and the stronger reset sequence will commence. There is no priority within a reset type (POR, etc). If a reset is asserted during the reset sequence of the same type, the reset sequence will be interrupted and restarted.

The following lists the functionality of each of these reset outputs:

- `system_early_rst_b` - Resets the system modules that need to start first as CCM, OCOTP_CTRL, FUSEBOX, MMDC, etc.
- `system_rst_b` - Resets functional modules
- `arm_rst_b` - Resets Arm module (on regular system reset)
- `mmdc_rst_b` - Resets MMDC
- `arm_por_rst_b` - Resets Arm POR input
- `arm_soc_rst_b` - Reset for Arm SOC
- `arm_dbg_rst_b` - Reset debug logic of Arm
- `test_logic_rst_b` - Reset test logic (IOMUXC, DAP)
- `sjc_por_rst_b` - Reset to SJC
- `srtc_rst_b` - Resets SRTC

NOTE

It is assumed that each reset source will deassert after its assertion, either due to reset generated to the system from SRC, or by negation of the reset source (if it came from an external source to the chip). In the latter case, the reset source is assumed to be held for at least 2 XTALI clocks so it can be sampled by SRC.

51.6.1.2 Reset Handling

51.6.1.2.1 Reset Qualification

The reset qualification logic qualifies the reset source before sending it out to the chip as a valid reset. WARM resets are in this category. All remaining reset sources are immediate resets and are acknowledged by the reset circuitry the moment they are asserted.

WARM resets are not immediate resets. WARM resets do reset the CCM, the source of MMDC clock. So, if a WARM reset were to immediately reset the CCM, then the MMDC clock would be shut off and this may cause the MMDC data to be lost. During normal mode of operation of the chip, the protocol that is followed before shutting off the

MMDC clock is that an `mmdc_dvfs_req` signal is sent to MMDC and only after the MMDC sends an acknowledge signal, `mmdc_dvfs_ack`, is the clock to the MMDC gated off.

However, the implication here is that a valid WARM reset source condition will not be able to cause a chip reset until the MMDC sends the acknowledge signal (`mmdc_dvfs_ack`). For example, a JTAG reset event has occurred but the JTAG reset will not be serviced until the `mmdc_dvfs_ack` signal is received. So, essentially all WARM reset sources depend on the MMDC providing the `mmdc_dvfs_ack` acknowledge signal before the reset is performed. When the MMDC is not used, `mmdc_dvfs_ack` is defaulted high.

The occurrence of WARM reset results in the assertion of `warm_reset` signal before the system resets are asserted to indicate to the MMDC that the reset occurred is a WARM reset.

A reset source is updated in the Reset Status Register (`SRC_SRSR`) when it becomes valid, provided it is asserted for the minimum amount of time after asserting. So, all immediate resets are immediately updated in the Status Register (`SRC_SRSR`). WARM resets would be updated when the `mmdc_dvfs_ack` signal is received from the MMDC.

Once the reset is qualified, depending on the source of the reset, internal resets are asserted appropriately.

51.6.1.2.2 Reset Sequence and De-Assertion

The `SRC_ONOFF` will assert immediately after any reset source is recognized (except for the case of WARM reset when MMDC needs to answer `mmdc_dvfs_ack` first). After all of the reset sources are released, the SRC will start the following set of events depending on the type of reset that occurred.

51.6.1.2.3 POR (`SRC_POR_B`)

`SRC_POR_B` is an external reset signal. When the chip is powered up, the reset signal is passed through the `POR_B` pin indicating power-up sequence. The SRC resets the entire chip including the JTAG (SJC) module. All SRC registers will be reset during the POR sequence.

As soon as `SRC_POR_B` occurs, all resets are asserted and the entire chip is reset by SRC. The `SRC_POR_B` is stretched for 2 XTALI cycles and the stretching sequence takes place after 2 XTALI clocks of `POR_B` pin deassertion.

The `sjc_por_rst_b` and `srtc_rst_b` signals are deasserted together with `SRC_POR_B` signal. Those outputs are also deasserted after the stretching of `SRC_POR_B` has deasserted.

Once the above resets deassert, `system_early_rst_b` reset is deasserted after 2 XTALI clocks. The `system_early_rst_b` is used for the CCM and PLL-IPs to start generating PLL clock outputs and the system root clocks.

When the system root clocks are ready, the CCM will assert `system_clk_ready` signal. This signal is generated during the start sequence in the CCM and it involves the preparation of the PLLs to generate clock roots for functional operation.

SRC then enables `OCOTP_CTRL` and fusebox clocks, so that fuses can be loaded to `OCOTP_CTRL`.

- SRC will prepare the boot information and then deassert `mmdc_rst_b`.
- SRC will wait 8 ipg clock cycles, and then SRC will enable MMDC clocks.
- SRC will wait 8 XTALI clocks to allow MMDC to generate fixed external clock to external memory SDRAM.
- SRC will enable GPU clocks.
- After 8 ipg cycles, SRC will disable GPU clocks.
- After 8 ipg cycles, resets to all modules will be de-asserted (`system_rst_b`, `gpu_rst_b`).
- After 8 ipg cycles, system clocks will be enabled (`en_system_clk`).

51.6.1.2.4 COLD RESET

The sequence is similar to `SRC_POR_B` except the memory repair operation is not performed.

Once the reset source deasserts, `system_early_rst_b` reset is deasserted after at least 2 XTALI clocks. The `system_early_rst_b` is used for the CCM and PLL-IPs to start generating PLL clock outputs and the system root clocks.

Once the system root clocks are ready, the CCM will assert `system_clk_ready` signal. This signal is generated during the start sequence in the CCM and it involves the preparation of the PLLs to generate clock roots for functional operation. See CCM for more information.

Once `system_clk_ready` arrives at the SRC, it will enable `OCOTP_CTRL` and fusebox clocks, so that fuses can be loaded to `OCOTP_CTRL`. `OCOTP_CTRL` will notify with `iim_ready_flag` once the fusebox loading finishes.

- SRC will prepare the boot information and then deassert `mmdc_rst_b`.
- SRC will wait 8 ipg clock cycles, and then SRC will enable MMDC clocks.

Functional Description

- SRC will wait 8 XTALI clocks to allow MMDC to generate fixed external clock to external memory SDRAM.
- SRC will enable GPU clocks so that reset will penetrate this module.
- After 8 ipg cycles, SRC will disable GPU clocks.
- After 8 ipg cycles resets to all modules will be deasserted (system_rst_b, gpu_rst_b).
- After 8 ipg cycles, system clocks will be enabled (en_system_clk).

51.6.1.2.5 WARM RESET

WARM reset will be enabled only if SRC_SCR[warm_reset_enable] bit is programmed. Otherwise, all WARM reset sources will generate a COLD reset. This bit will be reset only by a POR.

A WARM reset is similar to a COLD reset except that before the reset is sent, a signal to MMDC is asserted mmdc_dvfs_req (generates DVFS assertion to MMDC) to request to prepare MMDC to a WARM reset, finishing the transactions placing MMDC in self-refresh. Another signal will be asserted to MMDC (warm_reset) that will wrap the WARM reset sequence and will notify MMDC that a WARM reset is in process.

One of the sources of the WARM reset is SRC_ONOFF. If this is the case, it is qualified for 4 XTALI edges. The WARM reset is initiated immediately after 4 XTALI edges. The system does not come out of reset until the SRC_ONOFF is released.

In case the handshake mechanism with MMDC is stuck, meaning that no mmdc_dvfs_ack is received, COLD reset will be generated after a number of XTALI clocks. The number of XTALI clocks is defined in register the SRC_SCR[warm_rst_bypass_count] bitfield (default of this bitfield is 16 XTALI counts.)

The following is a basic description of the WARM reset sequence:

1. ARM sets SRC_SCR[warm_reset_enable] bit to enable the WARM Reset functionality. If this bit is not set, all WARM reset sources will result in COLD reset.
2. Assertion of one of the WARM reset sources.
3. The reset source is qualified in the SRC.
4. If mmdc_dvfs_ack signal is low, then SRC triggers the MMDC to switch to self-refresh mode using mmdc_dvfs_req signal. This is done through the CCM to combine with the DVFS sent from the CCM in case of frequency change of MMDC.
5. Wait for mmdc_dvfs_ack signal from the MMDC. If no ack is received during warm_rst_bypass_count number of XTALI clocks, COLD reset will be generated.
6. Assert warm_reset signal to MMDC.
7. SRC asserts system resets

The deassertion sequence is exactly the same as in the Cold Reset except waiting for 8 XTALIs for MMDC to generate fixed external clock to external memory MMDC. This stage is not needed in WARM reset since MMDC is held in self-refresh in WARM reset and there is no need to reconfigure it when exiting WARM reset.

WARM BOOT

Software can save any needed information in the memory before initiating a WARM reset. In this case, software will set SRC_SRSR[warm_boot] bit before initiating WARM reset. After the system returns to run mode, the warm_boot bit will still be set, indicating the software that data was saved in memory and can be reused.

NOTE

mmdc_dvfs_req and acknowledge during WARM reset can be masked in the CCM by configuration of register CCCR[17:16].

51.6.2 Parallel Reset Requests

SRC will follow the following rules in the case of parallel reset requests:

1. The order of strength of resets is POR - strongest, cold - medium, warm - weakest.
2. If a stronger reset is asserted during weaker reset sequence, then the stronger reset will take over and the stronger reset process will commence. The following cases fall into this category:
 - POR reset request in the middle of cold or warm reset process - the cold or warm reset process will be stopped and the POR sequence will start.
 - COLD reset request in the middle of warm reset process - the warm reset process will be stopped and the cold sequence will start.
3. If a weaker reset is asserted during stronger reset sequence, then the stronger reset sequence will continue without interference. If at the end of the stronger reset process the weaker request is still asserted then the weaker sequence will commence. The following cases fall into this category:
 - COLD or WARM reset requests in the middle of POR reset process - the POR process will continue without interference.
 - WARM reset request in the middle of COLD reset process - the COLD process will continue without interference.
4. If a similar reset request is asserted during the process of reset handling, then the process of reset handling will start over (with the same process). The following cases fall into this category:

Functional Description

- POR reset request in the middle of POR reset process - the POR process will start over.
- COLD reset request in the middle of COLD reset process - the COLD process will start over.

There is one exception to this category: WARM reset request in the middle of WARM reset process. In this case, the new WARM reset process cannot restart because MMDC is reset and there can't be a handshake with MMDC if it is reset. In this case the first WARM reset will continue, and only if the second WARM reset is still asserted after the first one has finished, the WARM sequence will start again.

51.6.3 Boot Mode Control

51.6.3.1 BOOT_MODE Pin Latching

The exact boot sequence is controlled by the values of the BOOT_MODE pins on this device.

The value of the BOOT_MODE pins will be latched after the OCOTP_CTRL asserts the fuse read completion flag. After latching, the values of the BOOT_MODE pins are used to determine the booting options of the core as described in the SRC_SBMRx registers.

The boot mode general purpose bits can be provided to the SRC from either e-fuses or GPIO signals. The gpio_bt_sel e-fuse defines the source to be used to derive the boot information. When gpio_bt_sel is set, e-fuses are used. When cleared, GPIO signals are used.

The boot information is provided in SRC_SBMR1 register. The figure below shows the selection of boot mode information.

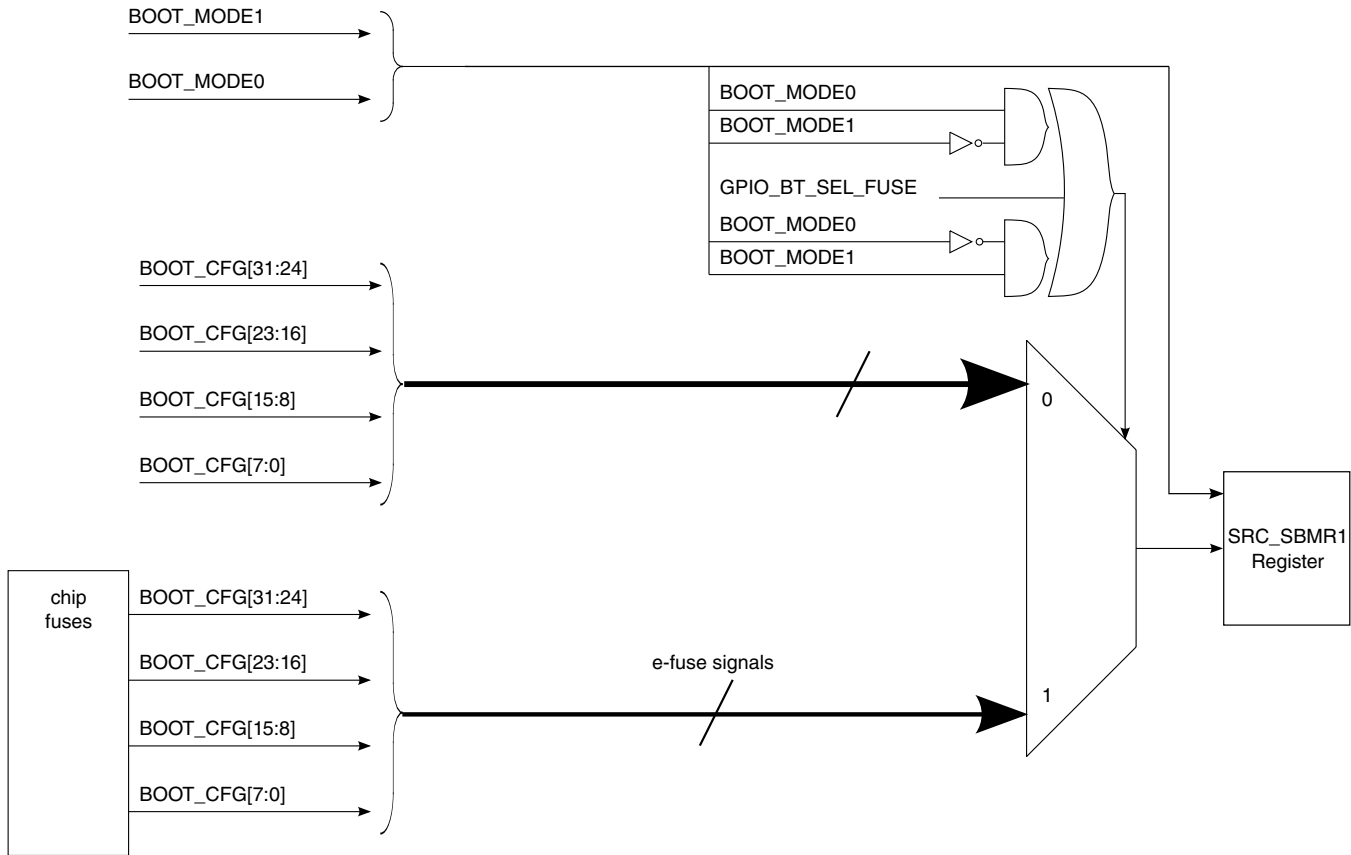

Figure 51-6. Boot mode information

51.7 SRC Memory Map/Register Definition

SRC memory map

Absolute address (hex)	Register name	Width (in bits)	Access	Reset value	Section/page
20D_8000	SRC Control Register (SRC_SCR)	32	R/W	0000_0521h	51.7.1/3514
20D_8004	SRC Boot Mode Register 1 (SRC_SBMR1)	32	R	0000_0000h	51.7.2/3517
20D_8008	SRC Reset Status Register (SRC_SRSR)	32	R/W	0000_0001h	51.7.3/3517
20D_8014	SRC Interrupt Status Register (SRC_SISR)	32	R	0000_0000h	51.7.4/3520
20D_801C	SRC Boot Mode Register 2 (SRC_SBMR2)	32	R	0000_0000h	51.7.5/3522
20D_8020	SRC General Purpose Register 1 (SRC_GPR1)	32	R/W	0000_0000h	51.7.6/3523
20D_8024	SRC General Purpose Register 2 (SRC_GPR2)	32	R/W	0000_0000h	51.7.7/3524
20D_8028	SRC General Purpose Register 3 (SRC_GPR3)	32	R/W	0000_0000h	51.7.8/3524
20D_802C	SRC General Purpose Register 4 (SRC_GPR4)	32	R/W	0000_0000h	51.7.9/3525

Table continues on the next page...

SRC memory map (continued)

Absolute address (hex)	Register name	Width (in bits)	Access	Reset value	Section/page
20D_8030	SRC General Purpose Register 5 (SRC_GPR5)	32	R/W	0000_0000h	51.7.10/ 3525
20D_8034	SRC General Purpose Register 6 (SRC_GPR6)	32	R/W	0000_0000h	51.7.11/ 3526
20D_8038	SRC General Purpose Register 7 (SRC_GPR7)	32	R/W	0000_0000h	51.7.12/ 3526
20D_803C	SRC General Purpose Register 8 (SRC_GPR8)	32	R/W	0000_0000h	51.7.13/ 3527
20D_8040	SRC General Purpose Register 9 (SRC_GPR9)	32	R/W	0000_0000h	51.7.14/ 3527
20D_8044	SRC General Purpose Register 10 (SRC_GPR10)	32	R/W	0000_0000h	51.7.15/ 3528

51.7.1 SRC Control Register (SRC_SCR)

The Reset control register (SCR), contains bits that control operation of the reset controller.

Address: 20D_8000h base + 0h offset = 20D_8000h

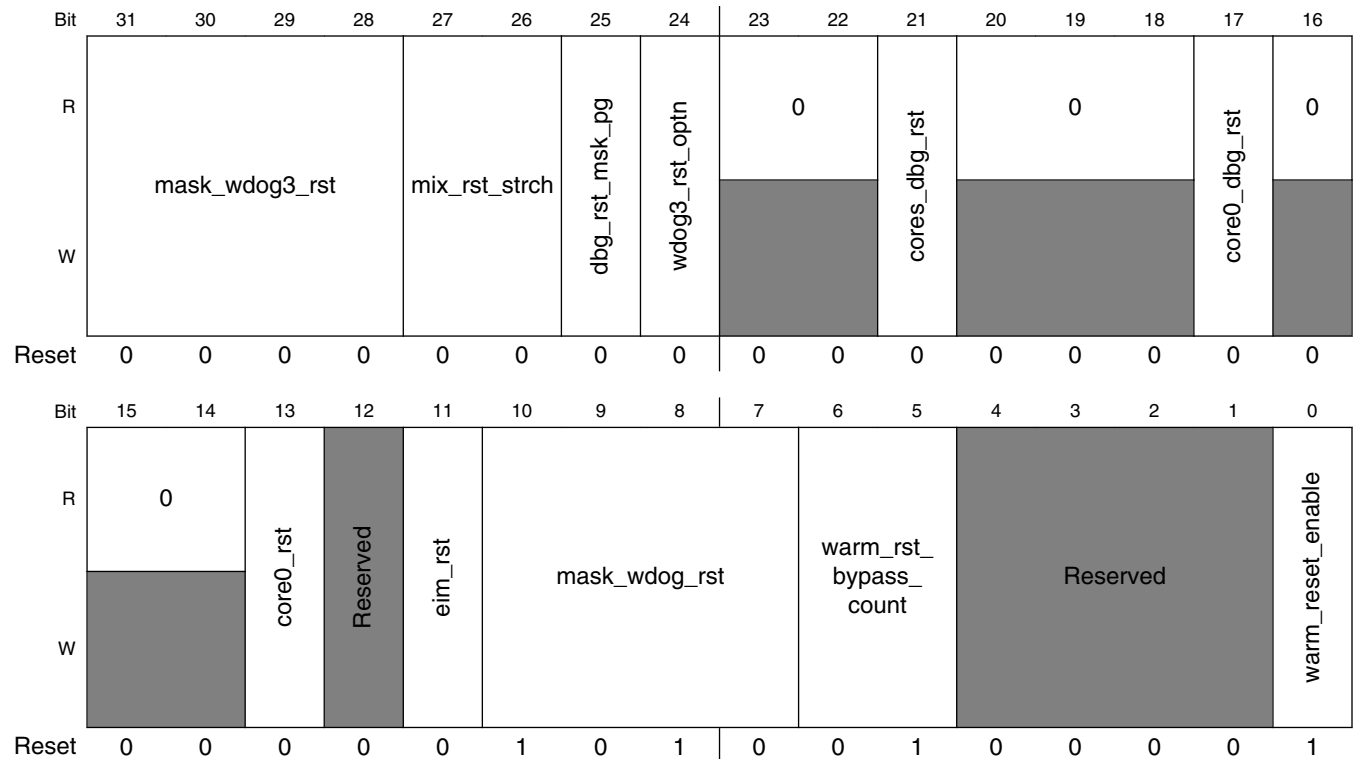

SRC_SCR field descriptions

Field	Description
31–28 mask_wdog3_rst	<p>Mask wdog3_rst_b source. If these 4 bits are coded from A to 5 then, the wdog3_rst_b input to SRC will be masked and the wdog3_rst_b will not create a reset to the chip.</p> <p>NOTE: During the time the WDOG3 event is masked using SRC logic, it is likely that the WDOG3 Reset Status Register (WRSR) bit 1 (which indicates a WDOG3 timeout event) will get asserted. Software / OS developer must prepare for this case. Re-enabling the WDOG3 is possible, by unmasking it in SRC, though it must be preceded by servicing the WDOG3. However, for the case that the event has been asserted, the status bit (WRSR bit-1) will remain asserted, regardless of servicing the WDOG3 module.</p> <p>NOTE: Hardware reset is the only way to cause the de-assertion of that bit. Any other code than 0101 will be coded to 1010 i.e. wdog3_rst_b is not masked</p> <p>0101 wdog3_rst_b is masked 1010 wdog3_rst_b is not masked</p>
27–26 mix_rst_strch	<p>SoC mix (Audio, ENET, uSDHC, EIM, QSPI, OCRAM, MMDC, etc) power up reset stretch mix reset width = (mix_rst_strch +1)* 88 ipg_clk cycles</p> <p>00 mix reset width is 88 ipg_cycle cycles 01 mix reset width is 2 * 88 ipg_cycle cycles 10 mix reset width is 3 * 88 ipg_cycle cycles 11 mix reset width is 4 * 88 ipg_cycle cycles</p>
25 dbg_rst_msk_pg	<p>Do not assert debug resets after power gating event of core</p> <p>0 do not mask core debug resets (debug resets will be asserted after power gating event) 1 mask core debug resets (debug resets won't be asserted after power gating event)</p>
24 wdog3_rst_optn	<p>Wdog3_rst_b option</p> <p>0 Wdog3_rst_b asserts M4 reset (default) 1 Wdog3_rst_b asserts global reset</p>
23–22 Reserved	This read-only field is reserved and always has the value 0.
21 cores_dbg_rst	<p>Software reset for debug of arm platform only.</p> <p>NOTE: This is a self clearing bit. Once it is set to 1, the reset process will begin, and once it finishes, this bit will be self cleared.</p> <p>0 do not assert arm platform debug reset 1 assert arm platform debug reset</p>
20–18 Reserved	This read-only field is reserved and always has the value 0.
17 core0_dbg_rst	<p>Software reset for core0 debug only.</p> <p>NOTE: This is a self clearing bit. Once it is set to 1, the reset process will begin, and once it finishes, this bit will be self cleared.</p> <p>0 do not assert core0 debug reset 1 assert core0 debug reset</p>
16–14 Reserved	This read-only field is reserved and always has the value 0.

Table continues on the next page...

SRC_SCR field descriptions (continued)

Field	Description
13 core0_rst	Software reset for core0 only. NOTE: This is a self clearing bit. Once it is set to 1, the reset process will begin, and once it finishes, this bit will be self cleared. 0 do not assert core0 reset 1 assert core0 reset
12 -	This field is reserved. Reserved
11 eim_rst	EIM reset is needed in order to reconfigure the eim chip select. The software reset bit must de-asserted. The eim chip select configuration should be updated. The software bit must be re-asserted since this is not self-refresh.
10–7 mask_wdog_rst	Mask wdog_rst_b source. If these 4 bits are coded from A to 5 then, the wdog_rst_b input to SRC will be masked and the wdog_rst_b will not create a reset to the chip. NOTE: During the time the WDOG event is masked using SRC logic, it is likely that the WDOG Reset Status Register (WRSR) bit 1 (which indicates a WDOG timeout event) will get asserted. software / OS developer must prepare for this case. Re-enabling the WDOG is possible, by unmasking it in SRC, though it must be preceded by servicing the WDOG. However, for the case that the event has been asserted, the status bit (WRSR bit-1) will remain asserted, regardless of servicing the WDOG module. (Hardware reset is the only way to cause the de-assertion of that bit). any other code will be coded to 1010 i.e. wdog_rst_b is not masked 0101 wdog_rst_b is masked 1010 wdog_rst_b is not masked (default)
6–5 warm_rst_ bypass_count	Defines the XTALI cycles to count before bypassing the MMDC acknowledge for WARM reset. If the MMDC acknowledge will not be asserted before this counter has elapsed, then a COLD reset will be initiated. 00 Counter not to be used - system will wait until MMDC acknowledge until it is asserted. 01 Wait 16 XTALI cycles before changing WARM reset to a COLD reset. 10 Wait 32 XTALI cycles before changing WARM reset to a COLD reset. 11 Wait 64 XTALI cycles before changing WARM reset to a COLD reset
4–1 -	This field is reserved. Reserved
0 warm_reset_ enable	WARM reset enable bit. WARM reset will be enabled only if warm_reset_enable bit is set. Otherwise all WARM reset sources will generate COLD reset. 0 WARM reset disabled 1 WARM reset enabled

51.7.2 SRC Boot Mode Register 1 (SRC_SBMR1)

The Boot Mode register (SBMR) contains bits that reflect the status of Boot Mode Pins of the chip. The reset value is configuration dependent (depending on boot/fuses/IO pads).

If SRC_GPR10[28] bit is set, this bit instructs the ROM code to use the SRC_GPR9 register as if it is SBMR1. This allows software to override the fuse bits and boot from an alternate boot source.

Address: 20D_8000h base + 4h offset = 20D_8004h

Bit	31	30	29	28	27	26	25	24	23	22	21	20	19	18	17	16	15	14	13	12	11	10	9	8	7	6	5	4	3	2	1	0																
R	BOOT_CFG4[7:0]								BOOT_CFG3[7:0]								BOOT_CFG2[7:0]								BOOT_CFG1[7:0]																							
W	[Shaded]																																															
Reset	0	0	0	0	0	0	0	0	0	0	0	0	0	0	0	0	0	0	0	0	0	0	0	0	0	0	0	0	0	0	0	0	0	0	0	0	0	0	0	0	0	0	0	0	0	0	0	0

SRC_SBMR1 field descriptions

Field	Description
31–24 BOOT_CFG4[7:0]	Refer to fusemap.
23–16 BOOT_CFG3[7:0]	Refer to fusemap.
15–8 BOOT_CFG2[7:0]	Refer to fusemap.
BOOT_CFG1[7:0]	Refer to fusemap.

51.7.3 SRC Reset Status Register (SRC_SRSR)

The SRSR is a write to one clear register which records the source of the reset events for the chip. The SRC reset status register will capture all the reset sources that have occurred. This register is reset on ipp_reset_b. This is a read-write register.

For bit[6-0] - writing zero does not have any effect. Writing one will clear the corresponding bit. The individual bits can be cleared by writing one to that bit. When the system comes out of reset, this register will have bits set corresponding to all the reset sources that occurred during system reset. Software has to take care to clear this register by writing one after every reset that occurs so that the register will contain the information of recently occurred reset.

SRC Memory Map/Register Definition

Address: 20D_8000h base + 8h offset = 20D_8008h

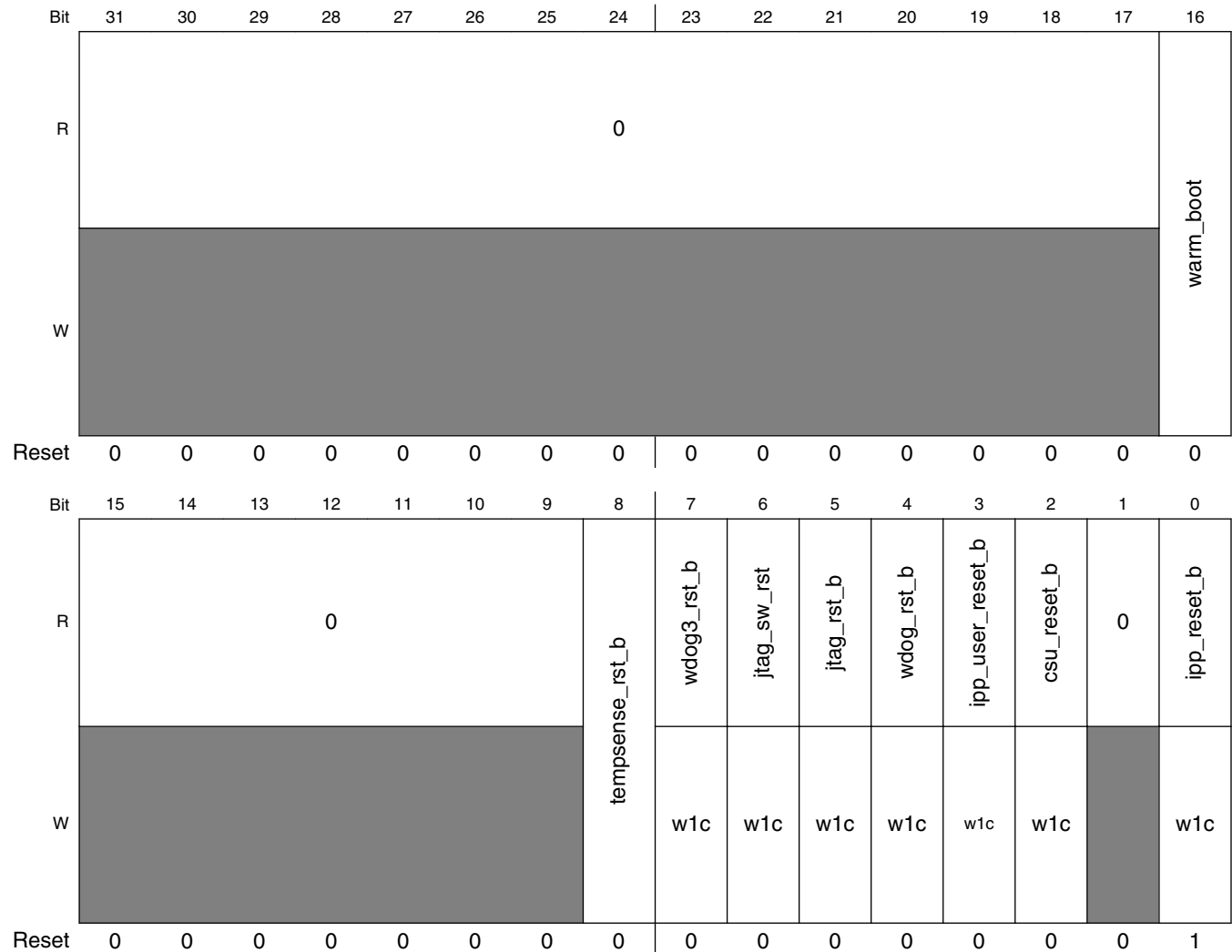

SRC_SRSR field descriptions

Field	Description
31–17 Reserved	This read-only field is reserved and always has the value 0.
16 warm_boot	<p>WARM boot indication shows that WARM boot was initiated by software. This indicates to the software that it saved the needed information in the memory before initiating the WARM reset. In this case, software will set this bit to '1', before initiating the WARM reset. The warm_boot bit should be used as indication only after a warm_reset sequence. Software should clear this bit after warm_reset to indicate that the next warm_reset is not performed with warm_boot. Please refer to Reset Sequence and De-Assertion for details on warm_reset.</p> <p>0 WARM boot process not initiated by software. 1 WARM boot initiated by software.</p>
15–9 Reserved	This read-only field is reserved and always has the value 0.
8 tempense_rst_b	Temper Sensor software reset. Indicates whether the reset was the result of software reset from on-chip Temperature Sensor.

Table continues on the next page...

SRC_SRSR field descriptions (continued)

Field	Description
	0 Reset is not a result of software reset from Temperature Sensor. 1 Reset is a result of software reset from Temperature Sensor.
7 wdog3_rst_b	IC Watchdog3 Time-out reset. Indicates whether the reset was the result of the watchdog3 time-out event. 0 Reset is not a result of the watchdog3 time-out event. 1 Reset is a result of the watchdog3 time-out event.
6 jtag_sw_rst	JTAG software reset. Indicates whether the reset was the result of software reset from JTAG. 0 Reset is not a result of software reset from JTAG. 1 Reset is a result of software reset from JTAG.
5 jtag_rst_b	HIGH - Z JTAG reset. Indicates whether the reset was the result of HIGH-Z reset from JTAG. 0 Reset is not a result of HIGH-Z reset from JTAG. 1 Reset is a result of HIGH-Z reset from JTAG.
4 wdog_rst_b	IC Watchdog Time-out reset. Indicates whether the reset was the result of the watchdog time-out event. 0 Reset is not a result of the watchdog time-out event. 1 Reset is a result of the watchdog time-out event.
3 ipp_user_reset_b	Indicates whether the reset was the result of the ipp_user_reset_b qualified reset. 0 Reset is not a result of the ipp_user_reset_b qualified as COLD reset event. 1 Reset is a result of the ipp_user_reset_b qualified as COLD reset event.
2 csu_reset_b	Indicates whether the reset was the result of the csu_reset_b input. NOTE: If case the csu_reset_b occurred during a WARM reset process, during the phase that ipg_clk is not available yet, then the occurrence of CSU reset will not be reflected in this bit. 0 Reset is not a result of the csu_reset_b event. 1 Reset is a result of the csu_reset_b event.
1 Reserved	This read-only field is reserved and always has the value 0.
0 ipp_reset_b	Indicates whether reset was the result of ipp_reset_b pin (Power-up sequence) 0 Reset is not a result of ipp_reset_b pin. 1 Reset is a result of ipp_reset_b pin.

51.7.4 SRC Interrupt Status Register (SRC_SISR)

Address: 20D_8000h base + 14h offset = 20D_8014h

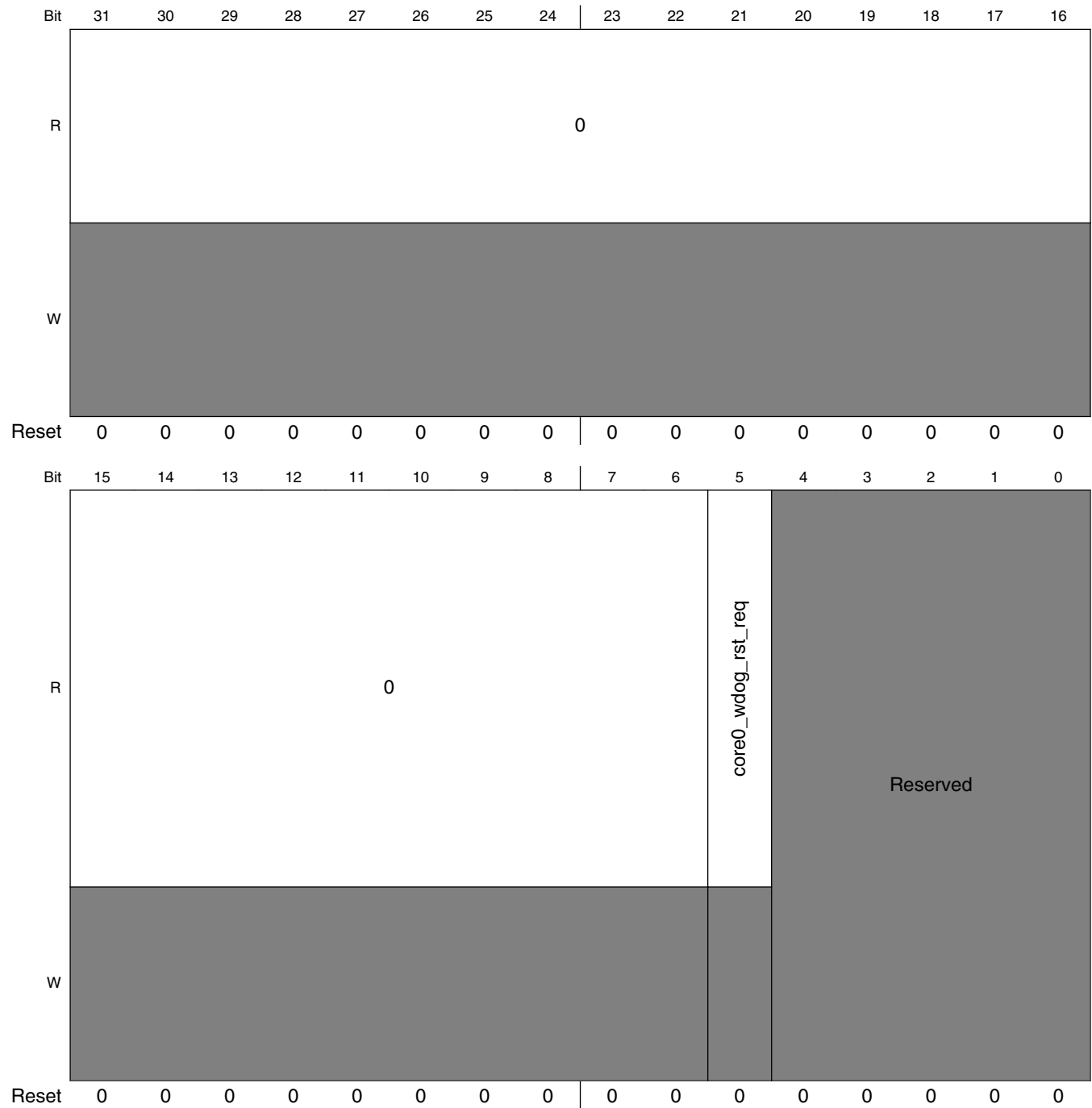

SRC_SISR field descriptions

Field	Description
31–6 Reserved	This read-only field is reserved and always has the value 0.
5 core0_wdog_rst_ req	WDOG reset request from core0. Read-only status bit.
-	This field is reserved. Reserved

51.7.5 SRC Boot Mode Register 2 (SRC_SBMR2)

The Boot Mode register (SBMR), contains bits that reflect the status of Boot Mode Pins of the chip. The default values for those bits depends on the values of pins/fuses during reset sequence, hence the question mark on their default value.

Address: 20D_8000h base + 1Ch offset = 20D_801Ch

Bit	31	30	29	28	27	26	25	24	23	22	21	20	19	18	17	16
R	0						BMOD[1:0]		0							
W	[Shaded]															
Reset	0	0	0	0	0	0	0	0	0	0	0	0	0	0	0	0
Bit	15	14	13	12	11	10	9	8	7	6	5	4	3	2	1	0
R	0										BT_FUSE_SEL	DIR_BT_DIS	0	SEC_CONFIG[1:0]		
W	[Shaded]															
Reset	0	0	0	0	0	0	0	0	0	0	0	0	0	0	0	0

SRC_SBMR2 field descriptions

Field	Description
31–26 Reserved	This read-only field is reserved and always has the value 0.
25–24 BMOD[1:0]	BMOD[1:0] shows the latched state of the BOOT_MODE1 and BOOT_MODE0 signals on the rising edge of POR_B. See the Boot mode pin settings section of System Boot.
23–5 Reserved	This read-only field is reserved and always has the value 0.
4 BT_FUSE_SEL	BT_FUSE_SEL (connected to gpio_bt_fuse_sel) shows the state of the BT_FUSE_SEL fuse. See Fusemap for additional information on this fuse.
3 DIR_BT_DIS	DIR_BT_DIS shows the state of the DIR_BT_DIS fuse. See Chapter 5, Fusemap for additional information on this fuse.
2 Reserved	This read-only field is reserved and always has the value 0.
SEC_CONFIG[1:0]	SECONFIG[1] shows the state of the SECONFIG[1] fuse. See Fusemap for additional information on this fuse. SECONFIG[0] shows the state of the SECONFIG[0] fuse. This fuse is shown as reserved in Fusemap (address 0x440[1]) because it does not have a user-relevant function.

51.7.6 SRC General Purpose Register 1 (SRC_GPR1)

NOTE

This register is used by the ROM code and should not be used by application software.

Address: 20D_8000h base + 20h offset = 20D_8020h

Bit	31	30	29	28	27	26	25	24	23	22	21	20	19	18	17	16	15	14	13	12	11	10	9	8	7	6	5	4	3	2	1	0
R																																
W																																
Reset	0	0	0	0	0	0	0	0	0	0	0	0	0	0	0	0	0	0	0	0	0	0	0	0	0	0	0	0	0	0	0	0

SRC_GPR1 field descriptions

Field	Description
PERSISTENT_ENTRY0	Holds entry function for core0 for waking-up from low power mode. The SRC ensures that the register value will persist across system resets.

51.7.7 SRC General Purpose Register 2 (SRC_GPR2)

NOTE

This register is used by the ROM code and should not be used by application software.

Address: 20D_8000h base + 24h offset = 20D_8024h

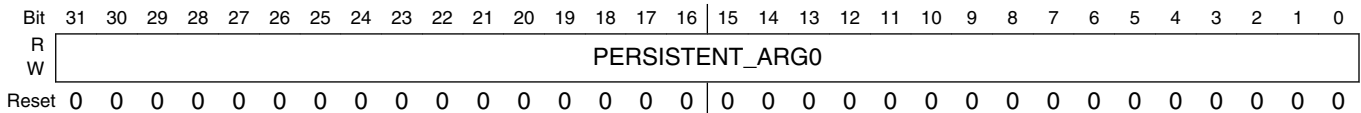

SRC_GPR2 field descriptions

Field	Description
PERSISTENT_ARG0	Holds argument of entry function for core0 for waking-up from low power mode. The SRC ensures that the register value will persist across system resets.

51.7.8 SRC General Purpose Register 3 (SRC_GPR3)

NOTE

This register is used by the ROM code and should not be used by application software.

Address: 20D_8000h base + 28h offset = 20D_8028h

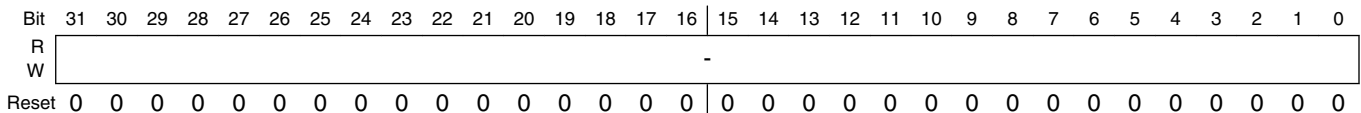

SRC_GPR3 field descriptions

Field	Description
-	Read/write general purpose bits used to store an arbitrary value.

51.7.9 SRC General Purpose Register 4 (SRC_GPR4)

NOTE

This register is used by the ROM code and should not be used by application software.

Address: 20D_8000h base + 2Ch offset = 20D_802Ch

Bit	31	30	29	28	27	26	25	24	23	22	21	20	19	18	17	16	15	14	13	12	11	10	9	8	7	6	5	4	3	2	1	0
R																																
W																																
Reset	0	0	0	0	0	0	0	0	0	0	0	0	0	0	0	0	0	0	0	0	0	0	0	0	0	0	0	0	0	0	0	0

SRC_GPR4 field descriptions

Field	Description
-	Read/write general purpose bits used to store an arbitrary value.

51.7.10 SRC General Purpose Register 5 (SRC_GPR5)

NOTE

This register is used by the ROM code and should not be used by application software.

Address: 20D_8000h base + 30h offset = 20D_8030h

Bit	31	30	29	28	27	26	25	24	23	22	21	20	19	18	17	16	15	14	13	12	11	10	9	8	7	6	5	4	3	2	1	0
R																																
W																																
Reset	0	0	0	0	0	0	0	0	0	0	0	0	0	0	0	0	0	0	0	0	0	0	0	0	0	0	0	0	0	0	0	0

SRC_GPR5 field descriptions

Field	Description
-	Read/write general purpose bits used to store an arbitrary value.

51.7.11 SRC General Purpose Register 6 (SRC_GPR6)

NOTE

This register is used by the ROM code and should not be used by application software.

Address: 20D_8000h base + 34h offset = 20D_8034h

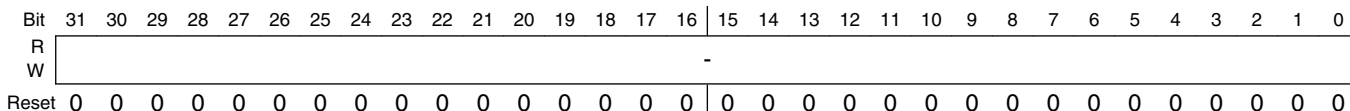

SRC_GPR6 field descriptions

Field	Description
-	Read/write general purpose bits used to store an arbitrary value.

51.7.12 SRC General Purpose Register 7 (SRC_GPR7)

NOTE

This register is used by the ROM code and should not be used by application software.

Address: 20D_8000h base + 38h offset = 20D_8038h

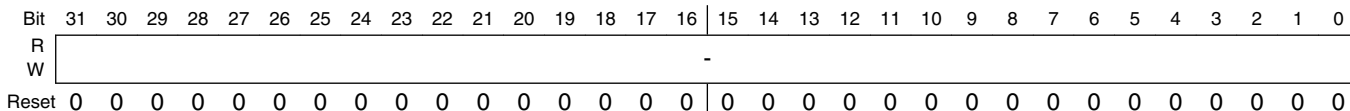

SRC_GPR7 field descriptions

Field	Description
-	Read/write general purpose bits used to store an arbitrary value.

51.7.13 SRC General Purpose Register 8 (SRC_GPR8)

NOTE

This register is used by the ROM code and should not be used by application software.

Address: 20D_8000h base + 3Ch offset = 20D_803Ch

Bit	31	30	29	28	27	26	25	24	23	22	21	20	19	18	17	16	15	14	13	12	11	10	9	8	7	6	5	4	3	2	1	0
R																																
W																																
Reset	0	0	0	0	0	0	0	0	0	0	0	0	0	0	0	0	0	0	0	0	0	0	0	0	0	0	0	0	0	0	0	0

SRC_GPR8 field descriptions

Field	Description
-	Read/write general purpose bits used to store an arbitrary value.

51.7.14 SRC General Purpose Register 9 (SRC_GPR9)

NOTE

This register is used by the ROM code and should not be used by application software.

Address: 20D_8000h base + 40h offset = 20D_8040h

Bit	31	30	29	28	27	26	25	24	23	22	21	20	19	18	17	16	15	14	13	12	11	10	9	8	7	6	5	4	3	2	1	0
R																	Reserved															
W																	Reserved															
Reset	0	0	0	0	0	0	0	0	0	0	0	0	0	0	0	0	0	0	0	0	0	0	0	0	0	0	0	0	0	0	0	0

SRC_GPR9 field descriptions

Field	Description
-	This field is reserved. Reserved.

51.7.15 SRC General Purpose Register 10 (SRC_GPR10)

NOTE

This register is used by the ROM code and should not be used by application software.

Address: 20D_8000h base + 44h offset = 20D_8044h

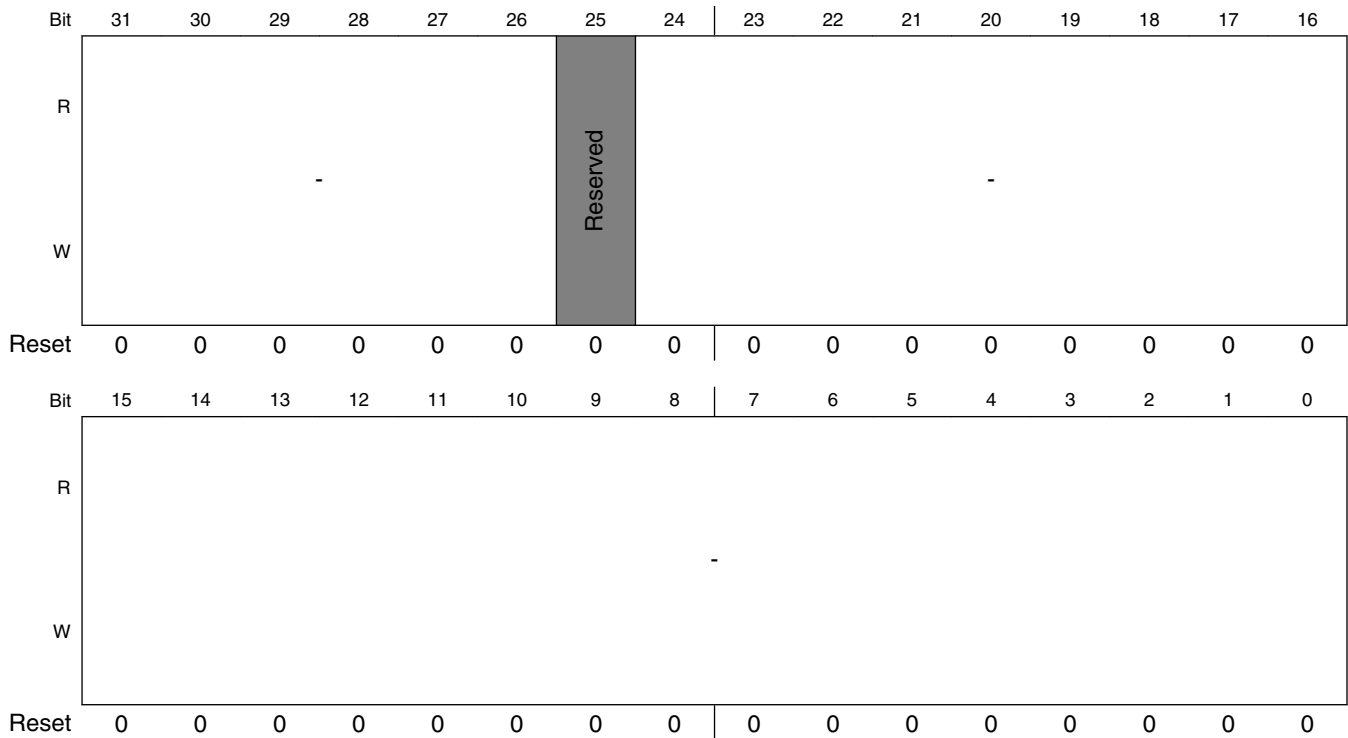

SRC_GPR10 field descriptions

Field	Description
31–26 -	Read/write bits, for general purpose NOTE: Reset only by POR
25 -	This field is reserved. Reserved.
-	Read/write bits, for general purpose NOTE: Reset only by POR

Chapter 52

Temperature Monitor (TEMPMON)

52.1 Overview

The temperature sensor module implements a temperature sensor/conversion function based on a temperature-dependent voltage to time conversion.

The module features alarm functions that can raise independent interrupt signals if the temperature is above two high-temperature thresholds and below a low temperature threshold. These temperature thresholds are programmable and designated as low, high and panic temperature. The panic threshold is a special programmable threshold in that if the temperature increases above this value and the temperature-panic-reset interrupt is enabled in the System Reset Controller, the hardware will assume that software no longer has control over the thermal situation and will initiate a reset of the chip.

In order to avoid false panic temperature initiated resets, the panic alarm will not fire until the temperature panic condition has been met for four consecutive conversion cycles. A self-repeating mode can also be programmed which executes a temperature sensing operation based on a programmed delay.

Since the high and low temperature thresholds are programmable, they form a sliding temperature bracket that can be tailored to the application's needs. For example, at start-up software can set the low temperature threshold to the minimum temperature code and the high temperature threshold to a maximum operating temperature for the system.

The system can then use this module to monitor the on-die temperature and take appropriate actions such as throttling back the core frequency when a the high temperature interrupt is set. Once the high temperature interrupt is set then the system can program the low temperature threshold to a desired cool down temperature. The system would then switch to monitoring the low temperature alarm and wait for its interrupt to be set. With this scheme, once the low temperature interrupt is set then software could be assured that the temperature has cooled down to a safe level and the process could be repeated.

The high-level implementation of the temperature sensor is shown in the figure below.

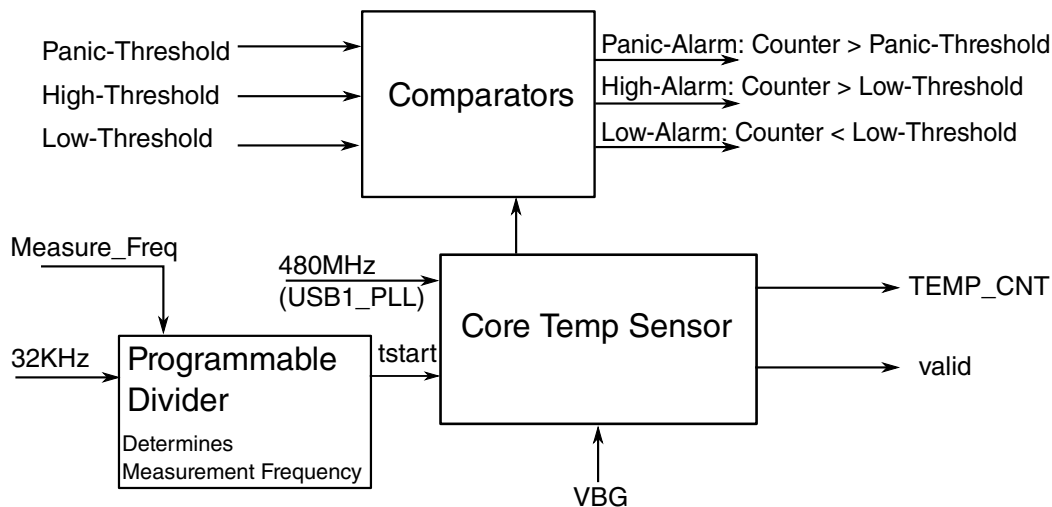

Figure 52-1. High Level Temp Sensor System Diagram

As shown in the figure above, the temperature sensor uses and assumes that the bandgap reference, 480MHz PLL and 32KHz RTC modules are properly programmed and fully settled for correct operation.

52.2 Software Usage Guidelines

During normal system operation software can use the temperature sensor counter output (TEMP_CNT) in conjunction with the fused temperature calibration data to determine the on-die operational temperature or to set an over-temperature interrupt alarm to within a couple of °C.

Based on calibration, two sets of temperature and counter values will be available via fuses on the device. These data points will correspond to the points (N₁, T₁) and (N₂, T₂) in the curve below.

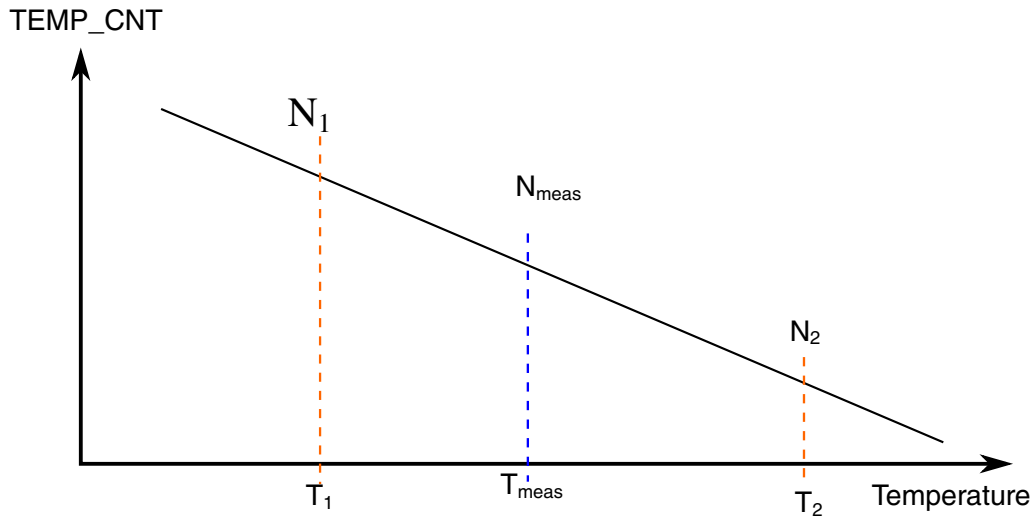

Figure 52-2. Temperature Measurement Cycle

After a temperature measurement cycle, software should use the calibration points in conjunction with the temperature code value in the `TEMPMON_TEMPSENSE0[TEMP_CNT]` bitfield to calculate the temperature for the device using the following equation:

$$T_{\text{meas}} = T_2 - (N_{\text{meas}} - N_2) * ((T_2 - T_1) / (N_1 - N_2))$$

Likewise, to determine the alarm counter value to be written in the `TEMPMON_TEMPSENSE0` register for a temperature based interrupt, the above equation can be solved for the N_{meas} value that should be used based on the desired temperature trigger.

The temperature calibration point fuse values are available in the `OCOTP_ANA1` register. The temperature calibration values are fused individually for each part in the product testing process. The fields of this register are described in the following table.

Table 52-1. OCOTP_ANA1 Temperature Sensor Calibration Data

Bit Range	Bit Mask	Name	Description
[31:20]	FFF0_0000h	ROOM_COUNT	Value of <code>TEMPMON_TEMPSENSE0[TEMP_VALUE]</code> after a measurement cycle at room temperature (25.0 °C).
[19:8]	000F_FF00h	HOT_COUNT	Value of <code>TEMPMON_TEMPSENSE0[TEMP_VALUE]</code> after a measurement cycle at the hot temperature, i.e. <code>HOT_TEMP</code> .
[7:0]	0000_00FFh	HOT_TEMP	The hot temperature test point. Each LSB equals 1 °C.

The points on the calibration curve are as follows.

- $(N_1, T_1) = (\text{ROOM_COUNT}, 25.0)$

TEMPMON Memory Map/Register Definition

- $(N_2, T_2) = (\text{HOT_COUNT}, \text{HOT_TEMP})$
- $(N_{\text{meas}}, T_{\text{meas}}) = (\text{TEMP_CNT}, T_{\text{meas}})$

Substituting the fields from OCOTP_ANA1 into the earlier equation results in the following:

$$T_{\text{meas}} = \text{HOT_TEMP} - (N_{\text{meas}} - \text{HOT_COUNT}) * ((\text{HOT_TEMP} - 25.0) / (\text{ROOM_COUNT} - \text{HOT_COUNT}))$$

52.3 TEMPMON Memory Map/Register Definition

TEMPMON memory map

Absolute address (hex)	Register name	Width (in bits)	Access	Reset value	Section/page
20C_8180	Tempsensor Control Register 0 (TEMPMON_TEMPSENSE0)	32	R/W	0000_0001h	52.3.1/3533
20C_8184	Tempsensor Control Register 0 (TEMPMON_TEMPSENSE0_SET)	32	R/W	0000_0001h	52.3.1/3533
20C_8188	Tempsensor Control Register 0 (TEMPMON_TEMPSENSE0_CLR)	32	R/W	0000_0001h	52.3.1/3533
20C_818C	Tempsensor Control Register 0 (TEMPMON_TEMPSENSE0_TOG)	32	R/W	0000_0001h	52.3.1/3533
20C_8190	Tempsensor Control Register 1 (TEMPMON_TEMPSENSE1)	32	R/W	0000_0001h	52.3.2/3535
20C_8194	Tempsensor Control Register 1 (TEMPMON_TEMPSENSE1_SET)	32	R/W	0000_0001h	52.3.2/3535
20C_8198	Tempsensor Control Register 1 (TEMPMON_TEMPSENSE1_CLR)	32	R/W	0000_0001h	52.3.2/3535
20C_819C	Tempsensor Control Register 1 (TEMPMON_TEMPSENSE1_TOG)	32	R/W	0000_0001h	52.3.2/3535
20C_8290	Tempsensor Control Register 2 (TEMPMON_TEMPSENSE2)	32	R/W	0000_0000h	52.3.3/3536
20C_8294	Tempsensor Control Register 2 (TEMPMON_TEMPSENSE2_SET)	32	R/W	0000_0000h	52.3.3/3536
20C_8298	Tempsensor Control Register 2 (TEMPMON_TEMPSENSE2_CLR)	32	R/W	0000_0000h	52.3.3/3536
20C_829C	Tempsensor Control Register 2 (TEMPMON_TEMPSENSE2_TOG)	32	R/W	0000_0000h	52.3.3/3536

52.3.1 Tempensor Control Register 0 (TEMPMON_TEMPSENSE0n)

This register defines the basic controls for the temperature sensor minus the frequency of automatic sampling which is defined in the tempsensor.

Address: 20C_8000h base + 180h offset + (4d × i), where i=0d to 3d

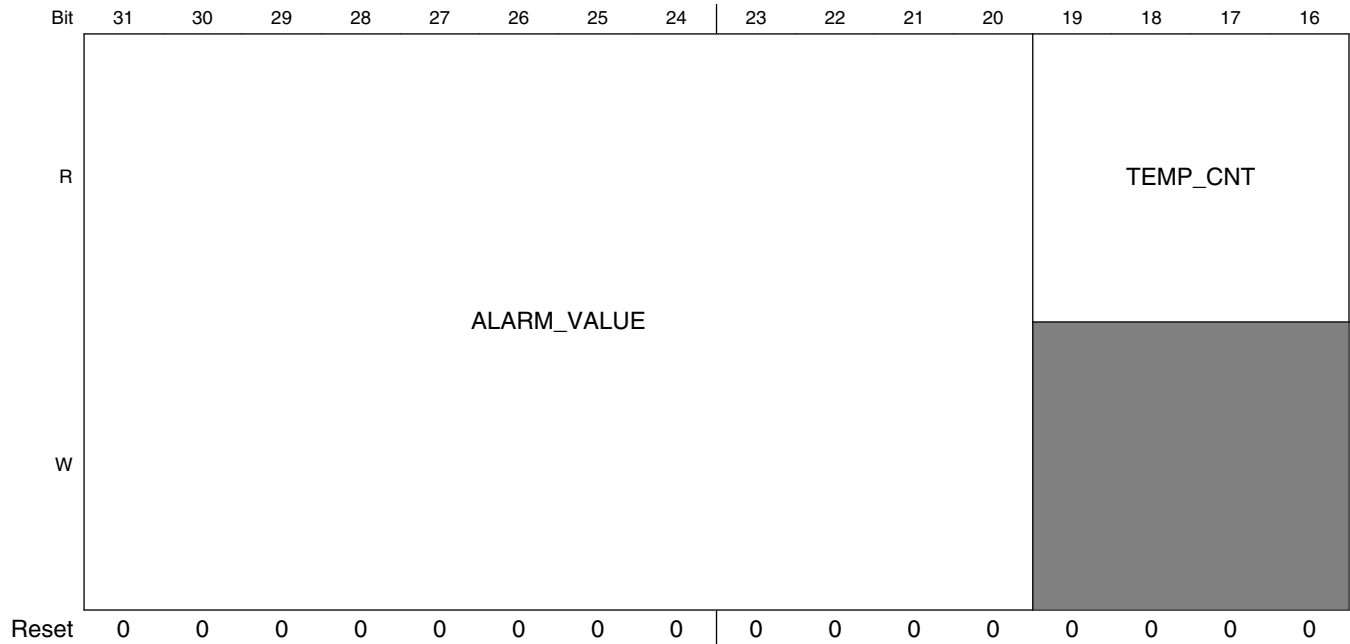

TEMPMON Memory Map/Register Definition

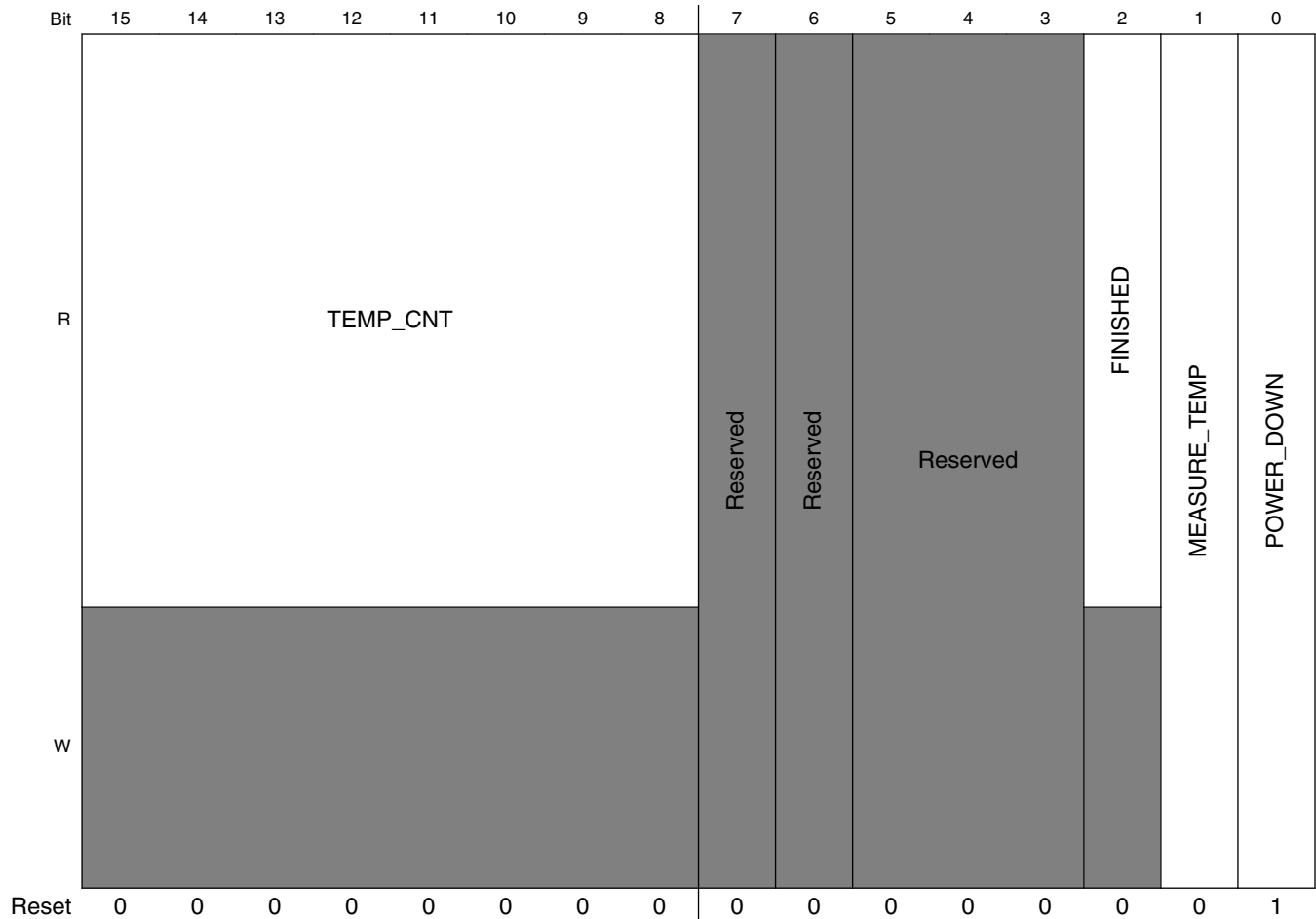

TEMPMON_TEMPSENSE0n field descriptions

Field	Description
31–20 ALARM_VALUE	This bit field contains the temperature count (raw sensor output) that will generate an alarm interrupt.
19–8 TEMP_CNT	This bit field contains the last measured temperature count.
7 -	This field is reserved. Reserved.
6 -	This field is reserved. Reserved.
5–3 -	This field is reserved. Reserved
2 FINISHED	Indicates that the latest temp is valid. This bit should be cleared by the sensor after the start of each measurement. 0 INVALID — Last measurement is not ready yet. 1 VALID — Last measurement is valid.
1 MEASURE_TEMP	Starts the measurement process. If the measurement frequency is zero in the TEMPSENSE1 register, this results in a single conversion.

Table continues on the next page...

TEMPMON_TEMPSENSE0n field descriptions (continued)

Field	Description
	0 STOP — Do not start the measurement process. 1 START — Start the measurement process.
0 POWER_DOWN	This bit powers down the temperature sensor. 0 POWER_UP — Enable power to the temperature sensor. 1 POWER_DOWN — Power down the temperature sensor.

52.3.2 Tempensor Control Register 1 (TEMPMON_TEMPSENSE1n)

This register defines the automatic repeat time of the temperature sensor.

Address: 20C_8000h base + 190h offset + (4d × i), where i=0d to 3d

Bit	31	30	29	28	27	26	25	24	23	22	21	20	19	18	17	16	15	14	13	12	11	10	9	8	7	6	5	4	3	2	1	0	
R	Reserved																MEASURE_FREQ																
W	Reserved																MEASURE_FREQ																
Reset	0	0	0	0	0	0	0	0	0	0	0	0	0	0	0	0	0	0	0	0	0	0	0	0	0	0	0	0	0	0	0	0	1

TEMPMON_TEMPSENSE1n field descriptions

Field	Description
31–16 -	This field is reserved. Reserved.
MEASURE_FREQ	This bits determines how many RTC clocks to wait before automatically repeating a temperature measurement. The pause time before remeasuring is the field value multiplied by the RTC period. 0x0000 Defines a single measurement with no repeat. 0x0001 Updates the temperature value at a RTC clock rate. 0x0002 Updates the temperature value at a RTC/2 clock rate. ... — 0xFFFF Determines a two second sample period with a 32.768KHz RTC clock. Exact timings depend on the accuracy of the RTC clock.

52.3.3 Tempensor Control Register 2 (TEMPMON_TEMPSENSE2n)

This register defines the automatic repeat time of the temperature sensor.

Address: 20C_8000h base + 290h offset + (4d × i), where i=0d to 3d

Bit	31	30	29	28	27	26	25	24	23	22	21	20	19	18	17	16	15	14	13	12	11	10	9	8	7	6	5	4	3	2	1	0
R																																
W																																
Reset	0	0	0	0	0	0	0	0	0	0	0	0	0	0	0	0	0	0	0	0	0	0	0	0	0	0	0	0	0	0	0	0

TEMPMON_TEMPSENSE2n field descriptions

Field	Description
31–28 -	This field is reserved. Reserved
27–16 PANIC_ALARM_VALUE	This bit field contains the temperature that will generate a panic interrupt when exceeded by the temperature measurement.
15–12 -	This field is reserved. Reserved.
LOW_ALARM_VALUE	This bit field contains the temperature that will generate a low alarm interrupt when the field is greater than the temperature measurement.

Chapter 53

Touch Screen Controller (TSC)

53.1 Overview

This block describes the Touch Screen Controller (TSC), which is used for ADC and touch screen analogue block.

TSC is responsible for providing control of ADC and touch screen analogue block to form a touch screen system, which achieves function of touch detection and touch location detection. The controller utilizes ADC hardware trigger function and control switches in touch screen analogue block. The controller only supports 4-wire or 5-wire screen touch modes.

Figure 53-1. TSC block diagram

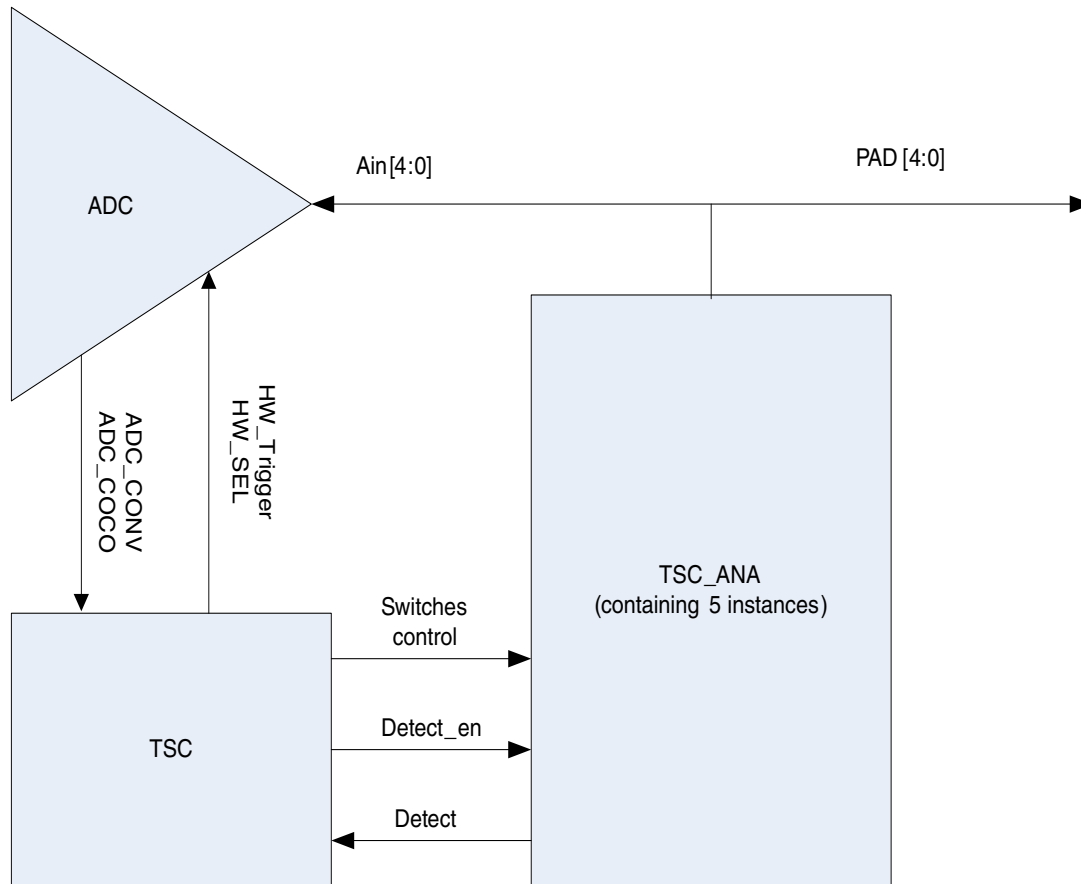

53.1.1 Features

The features of TSC controller are following.

- Configure registers: 32-bit, fully support sky-blue bus interface
- 4-wire or 5-wire mode of touch screen
- Low power wake up functions
- ADC average function and custom 8-bit, 10-bit, and 12-bit conversion result
- Custom pre-charge and de-glitch threshold time setting
- Total control five analogue groups of switches
- Fully asynchronous interface to ADC and analogue switches
- Easy software operation
- Software takes control of operation flow
- Strong debug functions—enable software recognize the IP as a transparent box and operation output directly
- Software reset function

53.2 Functional Description

This block works with ADC and TSC analogue to form a touch screen system. The system is responsible to detect touch on screen and measure the coordinate of the touch point. The touch screen controller, which is at the heart of the system, given control to TSC analogue and ADC. TSC analogue provides positive or negative voltage to the screen if the touch screen controller provides relevant signals. The ADC convert coordinates value if requested by touch screen controller.

53.2.1 Operating modes

The TSC can be worked in the following modes.

53.2.1.1 Idle

The TSC always stays at idle status if finish a coordinate measurement. The TSC only starts to detect a touch or starts to measure coordinate value if set the start_sen bit. The TSC returns to idle status after finish current task if disable bit is set by software.

53.2.1.2 Pre-charge

Pre-charge is a preparation for detection stage. Before detection stage, the upper layer of screen is required to charge to positive high. The time required for the pre-charge can be set in the pre-charge_timer.

53.2.1.3 Detection

Detection is a stage to sense touch detect on the screen. This stage is initialed a delay (set by pre-charge_timer) in order to wait enough time for the lower screen layer to achieve even-potential status. After the TSC send out detect enable signal to detect signal from analogue, once receiving the signal, TSC starts to measure coordinates or waiting for the instruction from software according to the value of auto_measure. If auto_measure is set then the TSC automatically measures coordinates after detect a touch. Otherwise TSC

waits for software order after detects a touch (and generates an interrupt). The software can choose to drop the measure (and return back to idle) by setting `drop_measure`, or start the measure by setting `start_measure`.

53.2.1.4 Measurement

During the measure stage, the TSC hardware gives control to TSC analogue and ADC. No software operation is needed. If requesting average function, do average configuration for ADC.

53.2.1.5 Data valid check

After measure the coordinate value, TSC do a touch detects again. If no touch has been detected, then previous measured coordinates' value is invalid. Otherwise, the measured coordinates' value is valid.

53.2.1.6 Interrupt

Each interrupt provides three software interface bits: interrupt enable, interrupt signal enable, and interrupt signal.

53.2.1.7 Reset

The TSC has two resets: `ipg_reset_b` and `sw_rst`. The `ipg_reset_b` reset is a hardware reset, which resets all registers in TSC block. While the `sw_rst` is a software reset, which resets every register except ips directly access ones.

53.2.1.8 Debug mode

The TSC provides fully software control signals. Once `debug_en` has been set, then all TSC outputs will be controlled by software. Software can also observe all TSC inputs through debug interface. Furthermore, the debug registers also provides current state machine states. Software can always check the current hardware state.

53.2.2 Configuration

53.2.2.1 TSC configurations

The following tables provide 4-wire and 5-wire screen touch modes.

Table 53-1. 4-wire screen touch mode

	wiper	ynlr	ypil	xnur	xpul
X measurement	OFF	OFF	OFF	LOW	HIGH
Y measurement	OFF	LOW	HIGH	OFF	OFF
Pre-charge	OFF	OFF	OFF	HIGH (200K, PULL UP)	HIGH (200K, PULL UP)
Intermediate	OFF	OFF	OFF	OFF	HIGH (200K)
Touch screen dection	OFF	LOW	LOW	OFF	HIGH (200K)

Table 53-2. 5-wire screen touch mode

	wiper	ynlr	ypil	xnur	xpul
X measurement	OFF	LOW	HIGH	LOW	HIGH
Y measurement	OFF	LOW	LOW	HIGH	HIGH
Pre-charge	HIGH (200K, PULL UP)	OFF	OFF	OFF	OFF
Intermediate¹	HIGH (200K)	OFF	OFF	OFF	OFF
Touch screen dection	HIGH (200K)	LOW	LOW	OFF	OFF

1. All other intermediate states switche to OFF.

53.2.2.2 TSC-ADC-TSC analogue configuration

The touch screen controller needs to co-work with ADC and TSC analogue.

The ADC is responsible for analogue value conversion. Following tables show the channels that the ADC used.

Table 53-3. 4-wire screen touch mode

X measurement	Channel 1	Connects to TSC ana YNLR
---------------	-----------	--------------------------

Table continues on the next page...

Table 53-3. 4-wire screen touch mode (continued)

Y measurement	Channel 3	Connects to TSC ana YNUR
---------------	-----------	--------------------------

Table 53-4. 5-wire screen touch mode

X measurement	Channel 0	Connects to TSC ana WIPER
Y measurement	Channel 0	Connects to TSC ana WIPER

53.2.2.3 TSC, TSC analogue and ADC connection

The following table describes the connections among the TSC, TSC analogue, and ADC.

Table 53-5. TSC, TSC analogue and ADC connection

TSC controller ports	TSC analogue IP ports	TSC analogue system integration instance Name	ADC Ain ports
wiper_pull_up	pu_en	1	Ain [0]
wiper_200k_pull_up	pull_up_200k_en		
wiper_pull_down	pd_en		
ynlr_pull_up	pu_en	2	Ain [1]
ynlr_200k_pull_up	pull_up_200k_en		
ynlr_pull_down	pd_en		
ypll_pull_up	pu_en	3	Ain [2]
ypll_200k_pull_up	pull_up_200k_en		
ypll_pull_down	pd_en		
xnur_pull_up	pu_en	4	Ain [3]
xnur_200k_pull_up	pull_up_200k_en		
xnur_pull_down	pd_en		
xpul_pull_up	pu_en	5	Ain [4]
xpul_200k_pull_up	pull_up_200k_en		
xpul_pull_down	pd_en		

53.2.2.4 TSC and GPIO

From TSC point of view, it does not care what kinds of PAD used. It can use digital pad or analogue pad.

Table 53-6. The ports used in TSC and GPIO

TSC function ports	TSC analogue instance	ADC Ain pin	GPIO ports
wiper	1	Ain [0]	GPIO1_IO00
ynlr	2	Ain [1]	GPIO1_IO01
ypil	3	Ain [2]	GPIO1_IO02
xnur	4	Ain [3]	GPIO1_IO03
xpul	5	Ain [4]	GPIO1_IO04

NOTE

For the PAD used for TSC, make sure the PAD behavior, such as a wire only connects to the Pin and TSC analogue switches.

For the PAD used for GPIO, for example, has a keeper to prevent the GPIO pad working from a wire only connects the Pin and TSC. In such condition, disable keeper when TSC working.

53.2.2.5 ADC-TSC co-working

The TSC is designed to work with the ADC. Two IP must work together to achieve the correct functions. The coordinate work includes two steps:

1. TSC starts ADC

TSC sends two signals: trigger and hardware trigger select signal: HWTS[4:0].

ADC regards triggers as clock to capture the select signal: HWTS. The details of information about trigger and HWTS is show in the ADC hardware trigger chapter. The TSC hardware makes sure that the HWTS signals ready one clock cycles before sending trigger signals. Make sure that the trigger delay is less than HWTS delay + one clock cycle.

The TSC send HWTS as in the following table:

	TSC 4-wire mode	TSC 5-wire mode
x-coordinate measure	HWTS = 5'b01000	HWTS = 5'b10000
y-coordinate measure	HWTS = 5'b00010	HWTS = 5'b10000

TSC HWTS[4:0] connects to the ADC HWTS[4:0]. The integration change will lead change in driver implementation. On ADC side, HWTS = 1 << x indicates the x logic channel is selected to start hardware ADC conversion. Configure ADC_HC_x to configure x logic channel and conversion will store in ADC_R_x.

Each ADC hardware trigger logic channel can be configured to one of many physical channels. The details of the ADC configuration, refer to the ADC hardware trigger chapter. Software driver configures the physical ADC. A sample configuration is shown in the following table.

	TSC 4-wire mode	TSC 5-wire mode
x-coordinate measure	ADC measures channel 1 or 2, so configure ADC_HC3[ADCH] to 1 or 2.	ADC measure channel 0, so configure ADC_HC[4] to 0.
y-coordinate measure	ADC measures channel3 or 4, so configure ADC_HC1[ADCH] to 3 or 4.	ADC measures channel 0, so configure ADC_HC[4] to 0.

Before TSC starts work, software driver configure ADC_HC_x. TSC hardware automatically sends trigger and HWTS at the correct time.

2. ADC sends back converted value and complete signals to TSC.

When ADC finishes conversion, the ADC would send a complete signal to TSC. A set of handshake signals between ADC and TSC makes sure that the TSC could receive complete signals, store correct ADC converted value, and clear ADC coco signals at correct order. All parts of this step are automatically done by hardware.

NOTE

For different ADC conversion modes, such 8-bit, 10-bit, 12-bit mode, average mode, please configure in ADC registers.

53.3 TSC Memory Map/Register Definition

The TSC Memory Map and Register Definition is described in the following section.

TSC memory map

Absolute address (hex)	Register name	Width (in bits)	Access	Reset value	Section/page
204_0000	PS Input Buffer Address (TSC_BASIC_SETTING)	32	R/W	0000_0000h	53.3.1/3545
204_0010	PS Input Buffer Address (TSC_PS_INPUT_BUFFER_ADDR)	32	R/W	0000_0000h	53.3.2/3546

Table continues on the next page...

TSC memory map (continued)

Absolute address (hex)	Register name	Width (in bits)	Access	Reset value	Section/page
204_0020	Flow Control (TSC_FLOW_CONTROL)	32	R/W	0000_0000h	53.3.3/3547
204_0030	Measure Value (TSC_MEASURE_VALUE)	32	R	0000_0000h	53.3.4/3548
204_0040	Interrupt Enable (TSC_INT_EN)	32	R/W	0000_0000h	53.3.5/3549
204_0050	Interrupt Signal Enable (TSC_INT_SIG_EN)	32	R/W	0000_0000h	53.3.6/3550
204_0060	Interrupt Status (TSC_INT_STATUS)	32	R/W	0000_0000h	53.3.7/3551
204_0070	TSC_DEBUG_MODE	32	R/W	0000_0000h	53.3.8/3553
204_0080	TSC_DEBUG_MODE2	32	R/W	0000_0000h	53.3.9/3555

53.3.1 PS Input Buffer Address (TSC_BASIC_SETTING)

Address: 204_0000h base + 0h offset = 204_0000h

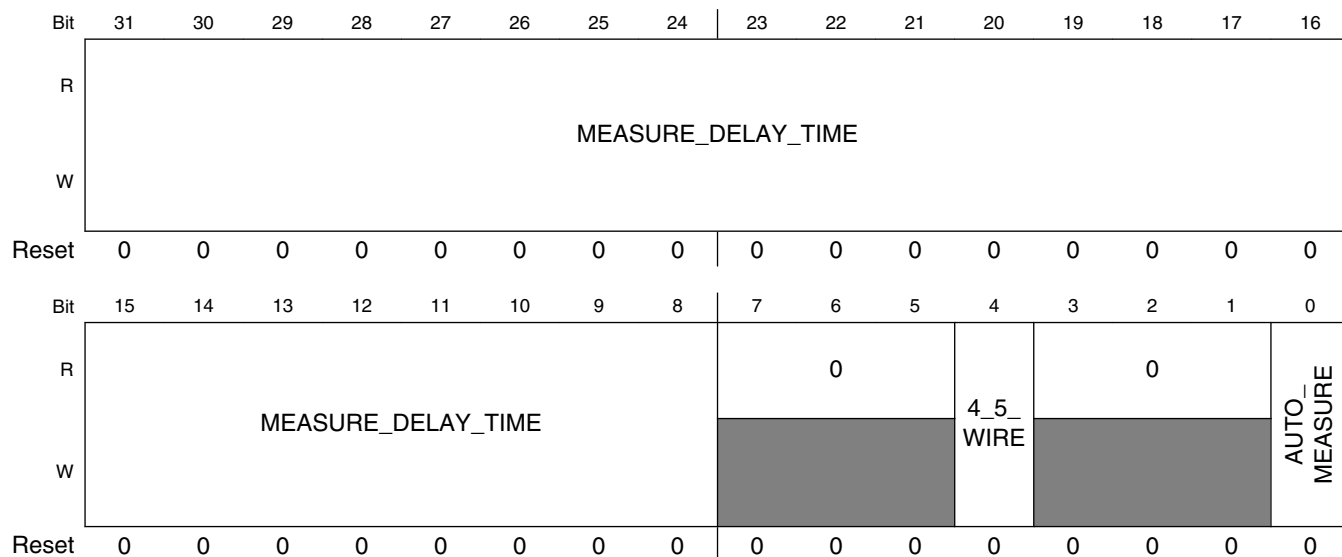

TSC_BASIC_SETTING field descriptions

Field	Description
31–8 MEASURE_DELAY_TIME	Measure Delay Time Before X-axis or Y-axis measurement, the screen need some time before even potential distribution ready.
7–5 Reserved	This read-only field is reserved and always has the value 0.
4 4_5_WIRE	4/5 Wire detection 4-Wire Detection Mode or 5-Wire Detection Mode 0 4-Wire Detection Mode 1 5-Wire Detection Mode

Table continues on the next page...

TSC_BASIC_SETTING field descriptions (continued)

Field	Description
3-1 Reserved	This read-only field is reserved and always has the value 0.
0 AUTO_MEASURE	Auto Measure This field indicates after detect touch, whether automatic start measurement. SW must make sure that the detect interrupt should be disable. This bit is not HW self-clear. 0 Disable Auto Measure 1 Auto Measure

53.3.2 PS Input Buffer Address (TSC_PS_INPUT_BUFFER_ADDR)

Address: 204_0000h base + 10h offset = 204_0010h

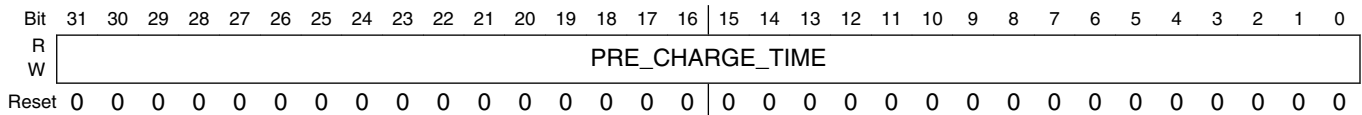

TSC_PS_INPUT_BUFFER_ADDR field descriptions

Field	Description
PRE_CHARGE_TIME	Auto Measure This field indicates after detect touch, whether automatic start measurement. SW must make sure that the detect interrupt should be disable. This bit is not HW self-clear. 0 Disable Auto Measure 1 Auto Measure

53.3.3 Flow Control (TSC_FLOW_CONTROL)

Address: 204_0000h base + 20h offset = 204_0020h

Bit	31	30	29	28	27	26	25	24	23	22	21	20	19	18	17	16
R	0															DISABLE
W																
Reset	0	0	0	0	0	0	0	0	0	0	0	0	0	0	0	0
Bit	15	14	13	12	11	10	9	8	7	6	5	4	3	2	1	0
R	0		START_SENSE	0				DROP_MEASURE	0			START_MEASURE	0			SW_RST
W																
Reset	0	0	0	0	0	0	0	0	0	0	0	0	0	0	0	0

TSC_FLOW_CONTROL field descriptions

Field	Description
31–17 Reserved	This read-only field is reserved and always has the value 0.
16 DISABLE	This bit is for SW disable registers. After set this bit, the hardware returns to idle status after finish the current state operation. SW must check the SW_IDLE bit to confirm that the controller has return to idle status. It's a HW self-clean bit. 0 Leave HW state machine control 1 SW set to idle status
15–13 Reserved	This read-only field is reserved and always has the value 0.
12 START_SENSE	Start Sense It's a HW self-clean bit. 0 Stay at idle status 1 Start sense detection and (if auto_measure set to 1) measure after detect a touch
11–9 Reserved	This read-only field is reserved and always has the value 0.
8 DROP_MEASURE	Drop Measure This field indicates whether start measure X/Y coordinate value after detect a touch It's a HW self-clean bit. 0 Do not drop measure for now 1 Drop the measure and controller return to idle status

Table continues on the next page...

TSC_FLOW_CONTROL field descriptions (continued)

Field	Description
7-5 Reserved	This read-only field is reserved and always has the value 0.
4 START_MEASURE	Start Measure This field indicates whether start measure X/Y coordinate value after detect a touch It's a self-clean bit. 0 Do not start measure for now 1 Start measure the X/Y coordinate value
3-1 Reserved	This read-only field is reserved and always has the value 0.
0 SW_RST	Soft Reset This is a synchronization reset, which reset all HW registers. NOTE: All SW accessible registers would keep as it original setting Software reset would be self-clear.

53.3.4 Measure Value (TSC_MEASEURE_VALUE)

Address: 204_0000h base + 30h offset = 204_0030h

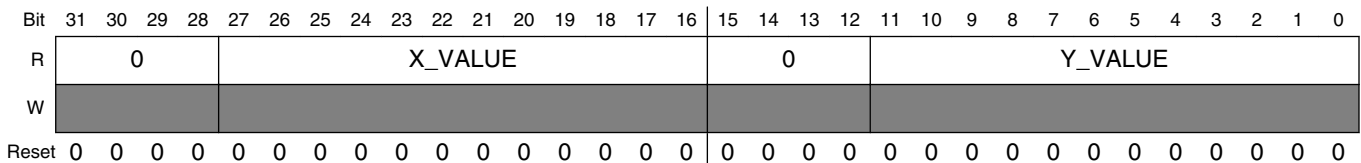

TSC_MEASEURE_VALUE field descriptions

Field	Description
31-28 Reserved	This read-only field is reserved and always has the value 0.
27-16 X_VALUE	X Value Coordinate value NOTE: It is an ADC conversion value, SW need to convert it to fit screen size.
15-12 Reserved	This read-only field is reserved and always has the value 0.
Y_VALUE	Y Value Y coordinate value, note, it is an ADC conversion value, SW need to convert it to fit screen size

53.3.5 Interrupt Enable (TSC_INT_EN)

Address: 204_0000h base + 40h offset = 204_0040h

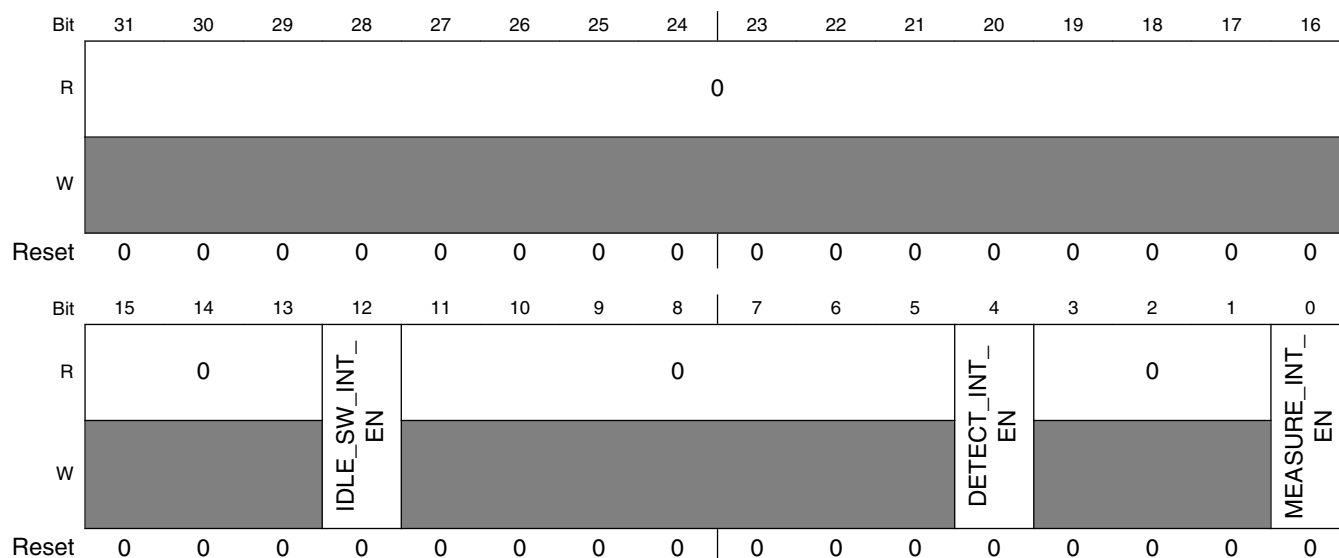

TSC_INT_EN field descriptions

Field	Description
31–13 Reserved	This read-only field is reserved and always has the value 0.
12 IDLE_SW_INT_EN	<p>Idle Software Interrupt Enable</p> <p>This field indicates whether enable the software return to idle status interrupt. This interrupt is generated if the controller has return to idle status. This bit is only valid if disable bit in flow control register set to 1'b1.</p> <p>0 Disable idle software interrupt 1 Enable idle software interrupt</p>
11–5 Reserved	<p>Reserved</p> <p>This read-only field is reserved and always has the value 0.</p>
4 DETECT_INT_EN	<p>Detect Interrupt Enable</p> <p>This field indicates whether enable the detect interrupt. This interrupt is generated if there is a touch detect after pre-charge ready.</p> <p>0 Disable detect interrupt 1 Enable detect interrupt</p>
3–1 Reserved	This read-only field is reserved and always has the value 0.
0 MEASURE_INT_EN	<p>Measure Interrupt Enable</p> <p>This field indicates whether enable the measure interrupt. This interrupt is generated after the touch detection which follows measurement.</p> <p>0 Disable measure</p>

53.3.6 Interrupt Signal Enable (TSC_INT_SIG_EN)

Address: 204_0000h base + 50h offset = 204_0050h

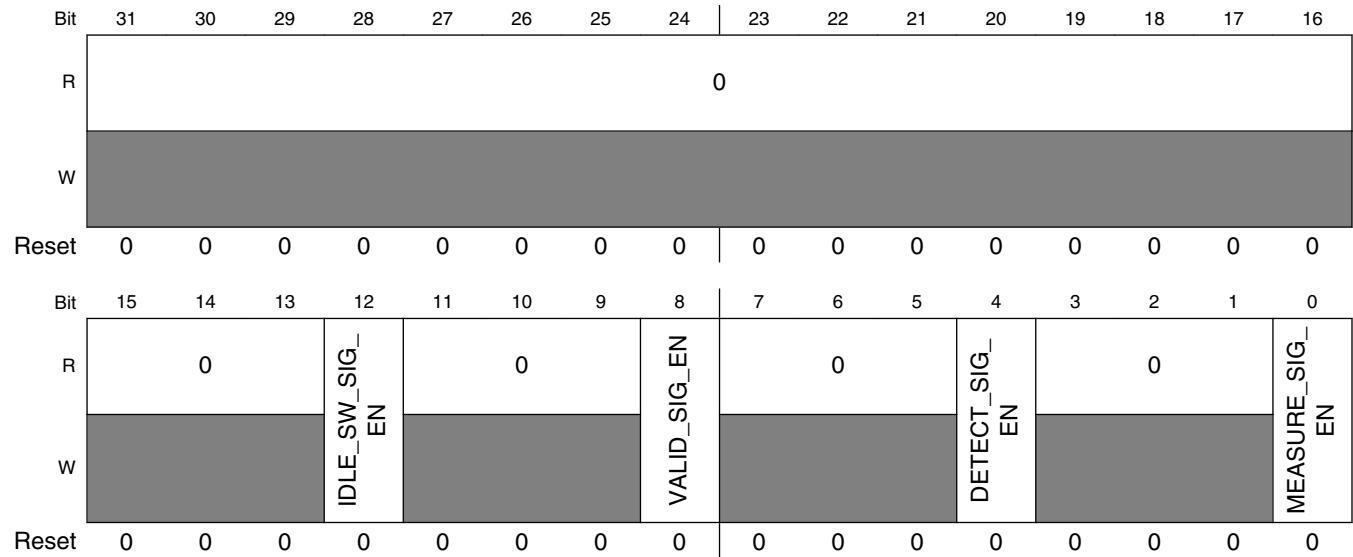

TSC_INT_SIG_EN field descriptions

Field	Description
31–13 Reserved	This read-only field is reserved and always has the value 0.
12 IDLE_SW_SIG_EN	<p>Idle Software Signal Enable</p> <p>This field indicates whether enable the software return to idle status. This signal is generated if the controller has return to idle status. This bit is only valid if disable bit in flow control register set to 1'b1.</p> <p>0 Disable idle software signal 1 Enable idle software signal</p>
11–9 Reserved	This read-only field is reserved and always has the value 0.
8 VALID_SIG_EN	<p>Valid Signal Enable</p> <p>This field indicates whether enable the valid signal. This field generated at the same time with MEASURE_SIG_EN.</p> <p>0 Disable valid signal 1 Enable valid signal</p>
7–5 Reserved	This read-only field is reserved and always has the value 0.
4 DETECT_SIG_EN	<p>Detect Signal Enable</p> <p>This field indicates whether enable the detect signal.</p> <p>0 Disable detect signal 1 Enable detect signal</p>

Table continues on the next page...

TSC_INT_SIG_EN field descriptions (continued)

Field	Description
3–1 Reserved	This read-only field is reserved and always has the value 0.
0 MEASURE_SIG_EN	Measure Signal Enable This field indicates whether enable the measure signal.

53.3.7 Interrupt Status (TSC_INT_STATUS)

Address: 204_0000h base + 60h offset = 204_0060h

Bit	31	30	29	28	27	26	25	24		23	22	21	20	19	18	17	16
R	0																
W	[Shaded]																
Reset	0	0	0	0	0	0	0	0		0	0	0	0	0	0	0	0
Bit	15	14	13	12	11	10	9	8		7	6	5	4	3	2	1	0
R	0			IDLE_SW	0				VALID	0			DETECT	0		MEASURE	
W	[Shaded]			[Shaded]	[Shaded]				[Shaded]	[Shaded]			[Shaded]	[Shaded]		[Shaded]	
Reset	0	0	0	0	0	0	0	0		0	0	0	0	0	0	0	0

TSC_INT_STATUS field descriptions

Field	Description
31–13 Reserved	This read-only field is reserved and always has the value 0.
12 IDLE_SW	Idle Software This field indicates whether the state machine return to idle status. This signal is generated if the controller has return to idle status. This bit is only valid if disable bit in flow control register set to 1'b1. 0 Haven't return to idle status 1 Already return to idle status
11–9 Reserved	This read-only field is reserved and always has the value 0.
8 VALID	Valid Signal This field indicates whether the measure value is valid. This field generated at the same time with MEASURE_SIG. 0 There is no touch detected after measurement, indicates that the measured value is not valid 1 There is touch detection after measurement, indicates that the measure is valid
7–5 Reserved	This read-only field is reserved and always has the value 0.

Table continues on the next page...

TSC_INT_STATUS field descriptions (continued)

Field	Description
4 DETECT	Detect Signal This field indicates whether there is a detect signal. 0 Does not exist a detect signal 1 Exist detect signal
3-1 Reserved	This read-only field is reserved and always has the value 0.
0 MEASURE	Measure Signal This field indicates whether there is a measure signal. 0 Does not exist a measure signal 1 Exist a measure signal

53.3.8 TSC_DEBUG_MODE

Address: 204_0000h base + 70h offset = 204_0070h

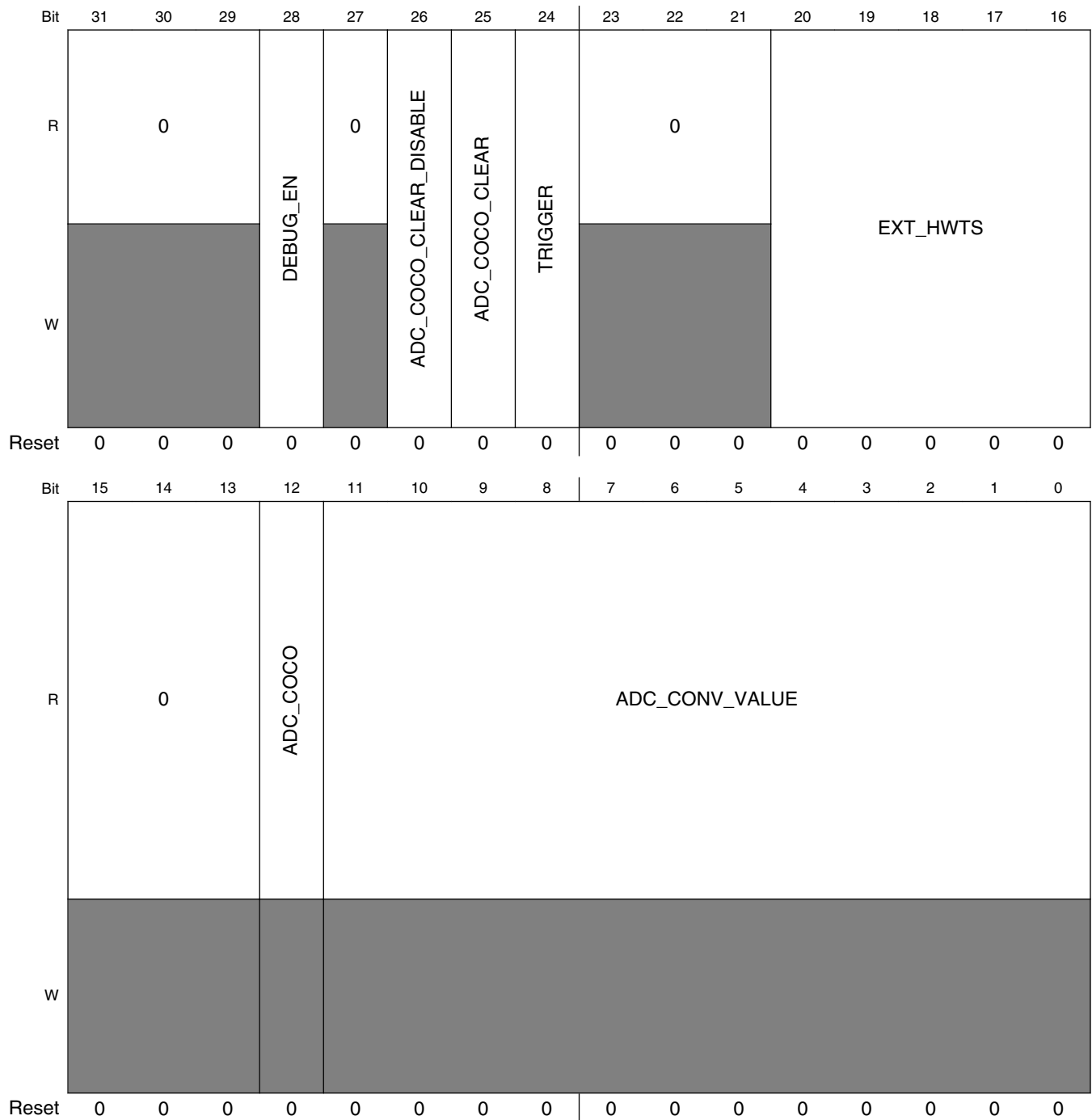

TSC_DEBUG_MODE field descriptions

Field	Description
31–29 Reserved	This read-only field is reserved and always has the value 0.
28 DEBUG_EN	<p>Debug Enable</p> <p>The RO registers in debug_mode and debug_mode2 always reflect the latest value and is not controlled by this bit. All RW SW bits are controlled by this bit.</p> <p>0 Enable debug mode 1 Disable debug mode</p>
27 Reserved	This read-only field is reserved and always has the value 0.
26 ADC_COCO_ CLEAR_ DISABLE	<p>ADC COCO Clear Disable</p> <p>This bit could prevent TSC HW generates an ADC COCO clear signal.</p> <p>NOTE: This bit does not effect ADC_COCO_CLEAR bit.</p> <p>0 Allow TSC hardware generates ADC COCO clear 1 Prevent TSC from generate ADC COCO clear signal — —</p>
25 ADC_COCO_ CLEAR	<p>ADC Coco Clear</p> <p>Original ADC coco only clear is system read conv result from IPS bus. However, TSC read conv result directly from ADC to lower SW load, so that ADC requires TSC generates a clear signal.</p> <p>0 No ADC COCO clear 1 Set ADC COCO clear</p>
24 TRIGGER	<p>Trigger</p> <p>Hardware trigger signal to ADC</p> <p>0 No hardware trigger signal 1 Hardware trigger signal, the signal must last at least 1 ips clock period</p>
23–21 Reserved	This read-only field is reserved and always has the value 0.
20–16 EXT_HWTS	<p>Hardware Trigger Select Signal</p> <p>Hardware trigger select signal, select which channel to start conversion.</p>
15–13 Reserved	This read-only field is reserved and always has the value 0.
12 ADC_COCO	<p>ADC COCO Signal</p> <p>This signal is generated by ADC.</p>
ADC_CONV_ VALUE	<p>ADC Conversion Value</p> <p>This signal is generated by ADC.</p>

53.3.9 TSC_DEBUG_MODE2

Address: 204_0000h base + 80h offset = 204_0080h

Bit	31	30	29	28	27	26	25	24	23	22	21	20	19	18	17	16
R	0	DE_GLITCH		DETECT_ENABLE_FIVE_WIRE	0			DETECT_ENABLE_FOUR_WIRE	INTERMEDIATE	STATE_MACHINE			0	DETECT_FIVE_WIRE	DETECT_FOUR_WIRE	
W	[Shaded]								[Shaded]							
Reset	0	0	0	0	0	0	0	0	0	0	0	0	0	0	0	0
Bit	15	14	13	12	11	10	9	8	7	6	5	4	3	2	1	0
R	0	[Shaded]														
W	[Shaded]															
Reset	0	0	0	0	0	0	0	0	0	0	0	0	0	0	0	0
		WIPER_200K_PULL_UP	WIPER_PULL_UP	WIPER_PULL_DOWN	YNLR_200K_PULL_UP	YNLR_PULL_UP	YNLR_PULL_DOWN	YPLL_200K_PULL_UP	YPLL_PULL_UP	YPLL_PULL_DOWN	XNUR_200K_PULL_UP	XNUR_PULL_UP	XNUR_PULL_DOWN	XPUL_200K_PULL_UP	XPUL_PULL_UP	XPUL_PULL_DOWN

TSC_DEBUG_MODE2 field descriptions

Field	Description
31 Reserved	This read-only field is reserved and always has the value 0.
30–29 DE_GLITCH	<p>This field indicates glitch threshold. The threshold is defined by number of clock cycles. A detect signal is only valid if it exist longer than threshold. Any signal transfer through detect and length is smaller than threshold is regards as a glitch.</p> <p>00</p> <ul style="list-style-type: none"> • Normal function: 0x1fff ipg clock cycles; • Low power mode: 0x9 low power clock cycles <p>01</p> <ul style="list-style-type: none"> • Normal function: 0xffff ipg clock cycles; • Low power mode: :0x7 low power clock cycles <p>10</p> <ul style="list-style-type: none"> • Normal function: 0x7ff ipg clock cycles; • Low power mode:0x5 low power clock cycles <p>11</p> <ul style="list-style-type: none"> • Normal function: 0x3 ipg clock cycles; • Low power mode:0x3 low power clock cycles
28 DETECT_ ENABLE_FIVE_ WIRE	<p>Detect Enable Five Wire</p> <p>0 Do not read five wire detect value, read default value from analogue</p> <p>1 Read five wire detect status from analogue</p>
27–25 Reserved	This read-only field is reserved and always has the value 0.
24 DETECT_ ENABLE_FOUR_ WIRE	<p>Detect Enable Four Wire</p> <p>0 Do not read four wire detect value, read default value from analogue</p> <p>1 Read four wire detect status from analogue</p>
23 INTERMEDIATE	<p>Intermediate State</p> <p>It's an intermediate state, between two state machine states, in order to provide better timing for analogue. It lasts for only once cycle. Intermediate state exists after pre-charge, detect, x- measure, y-measure, and 2nd-pre-charge, 2nd-detect. Note, the intermediate after pre-charge and 2nd-pre-charge is different.</p> <p>0 Not in intermedia</p> <p>1 Intermedia</p>
22–20 STATE_ MACHINE	<p>State Machine</p> <p>000 Idle</p> <p>001 Pre-charge</p> <p>010 Detect</p> <p>011 X-measure</p> <p>100 Y-measure</p> <p>101 Pre-charge</p> <p>110 Detect</p>
19–18 Reserved	This read-only field is reserved and always has the value 0.
17 DETECT_FIVE_ WIRE	<p>Detect Five Wire</p> <p>This field in only valid when the touch controller is under detect mode. That is not in idle.</p> <p>NOTE: It is in measure mode, not per-charge mode. This is an asynchronous signal.</p>

Table continues on the next page...

TSC_DEBUG_MODE2 field descriptions (continued)

Field	Description
	0 No detect signal 1 Yes, there is a detect on the touch screen.
16 DETECT_FOUR_WIRE	Detect Four Wire This field is only valid when the touch controller is under detect mode. That is not in idle. NOTE: It is in measure mode, not per-charge mode. This is an asynchronous signal. 0 No detect signal 1 Yes, there is a detect on the touch screen.
15 Reserved	This read-only field is reserved and always has the value 0.
14 WIPER_200K_PULL_UP	Wiper Wire 200K Pull Up Switch This is a control signal of this wiper wire 200k pull up switch. 0 Close the switch 1 Open up the switch
13 WIPER_PULL_UP	Wiper Wire Pull Up Switch This is a control signal of this switch. 0 Close the switch 1 Open up the switch
12 WIPER_PULL_DOWN	Wiper Wire Pull Down Switch This is a control signal of this wiper wire pull down switch. 0 Close the switch 1 Open up the switch
11 YNLR_200K_PULL_UP	YNLR Wire 200K Pull Up Switch This is a control signal of this YNLR wire 200K pull up switch. 0 Close the switch 1 Open up the switch
10 YNLR_PULL_UP	YNLR Wire Pull Up Switch This is a control signal of this YNLR wire pull up switch. 0 Close the switch 1 Open up the switch
9 YNLR_PULL_DOWN	YNLR Wire Pull Down Switch This is a control signal of this YNLR wire pull down switch. 0 Close the switch 1 Open up the switch
8 YPLL_200K_PULL_UP	YPLL Wire 200K Pull Up Switch This is a control signal of this YPLL wire 200k pull up switch.

Table continues on the next page...

TSC_DEBUG_MODE2 field descriptions (continued)

Field	Description
	0 Close the switch 1 Open up the switch
7 YPLL_PULL_UP	YPLL Wire Pull Up Switch This is a control signal of this YPLL wire pull up switch. 0 Close the switch 1 Open the switch
6 YPLL_PULL_DOWN	YPLL Wire Pull Down Switch This is a control signal of this YPLL wire pull down switch. 0 Close the switch 1 Open up the switch
5 XNUR_200K_PULL_UP	XNUR Wire 200K Pull Up Switch This is a control signal of this XNUR wire 200K pull up switch. 0 Close the switch 1 Open up the switch
4 XNUR_PULL_UP	XNUR Wire Pull Up Switch This is a control signal of this XNUR Wire Pull Up Switch. 0 Close the switch 1 Open up the switch
3 XNUR_PULL_DOWN	XNUR Wire Pull Down Switch This is a control signal of this XNUR Wire Pull Down Switch. 0 Close the switch 1 Open up the switch
2 XPUL_200K_PULL_UP	XPUL Wire 200K Pull Up Switch This is a control signal of this XPUL Wire 200K Pull Up Switch. 0 Close the switch 1 Open up the switch
1 XPUL_PULL_UP	XPUL Wire Pull Up Switch This is a control signal of this XPUL Wire Pull Up Switch. 0 Close the switch 1 Open up the switch
0 XPUL_PULL_DOWN	XPUL Wire Pull Down Switch This is a control signal of this XPUL wire pull down switch. 0 Close the switch 1 Open up the switch

Chapter 54

TrustZone Address Space Controller (TZASC)

54.1 Overview

The TrustZone Address Space Controller (TZASC) protects security-sensitive SW and data in a trusted execution environment against potentially compromised SW running on the platform.

The TZASC block diagram is shown in figure below.

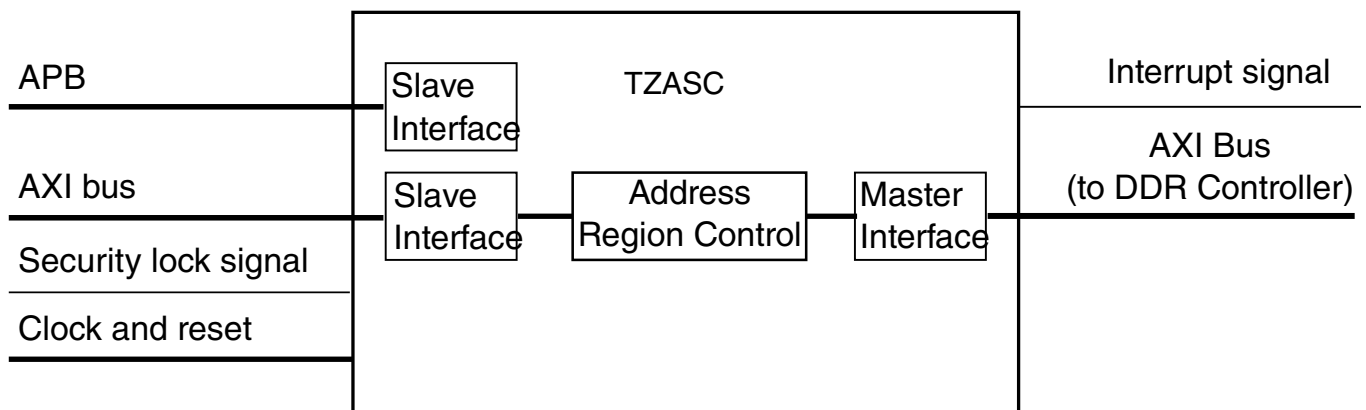

Figure 54-1. TZASC Block Diagram

The TZASC is an IP by Arm ("CoreLink™ TrustZone Address Space Controller TZC-380"), designed to provide configurable protection over program (SW) memory space.

The main features of TZASC are:

- Supports 16 independent address regions
- Access controls are independently programmable for each address region
- Sensitive registers may be locked
- Host interrupt may be programmed to signal attempted access control violations

- AXI master/slave interfaces for transactions
- APB slave interface for configuration and status reporting

54.2 Clocks

The table found here describes the clock sources for TZASC.

Please see [Clock Controller Module \(CCM\)](#) for clock setting, configuration and gating information.

Table 54-1. TZASC Clocks

Clock name	Clock Root	Description
acclk	mmdc_axi_clk_root	Module clock

54.3 Address Mapping in various memory mapping modes

The address configured to the TZASC controller(s) must match the "local addresses" as being passed on to the DDR controller(s).

Memory "aliasing" implications on TZASC settings - in systems which does not utilize the maximal supported DDR space the controller is designed for, the whole DDR memory map becomes "aliased" (replicated) by the size of the physical memory used. In such cases, the TZASC must be configured to protect all aliased regions as well (i.e. effectively reducing the number of available TZASC regions, since all aliased regions must be handled, for each "real" space needing protection).

For complete details on TZASC functionality and the programming model, see the Arm document, "CoreLink™ TrustZone Address Space Controller TZC-380 Technical Reference Manual, (Rev r0p1 or newer)", available at <http://infocenter.arm.com>.

Chapter 55

Universal Asynchronous Receiver/Transmitter (UART)

55.1 Overview

Universal Asynchronous Receiver/Transmitter (UART) provides serial communication capability with external devices through a level converter and an RS-232 cable or through use of external circuitry that converts infrared signals to electrical signals (for reception) or transforms electrical signals to signals that drive an infrared LED (for transmission) to provide low speed IrDA compatibility.

UART supports NRZ encoding format , RS485 compatible 9 bit data format and IrDA-compatible infrared slow data rate (SIR) format.

The following figure is the UART block diagram.

The "Module Clock" is the UART_CLK which comes from CCM. The "Peripheral Clock" is the IPG_CLK which comes from CCM.

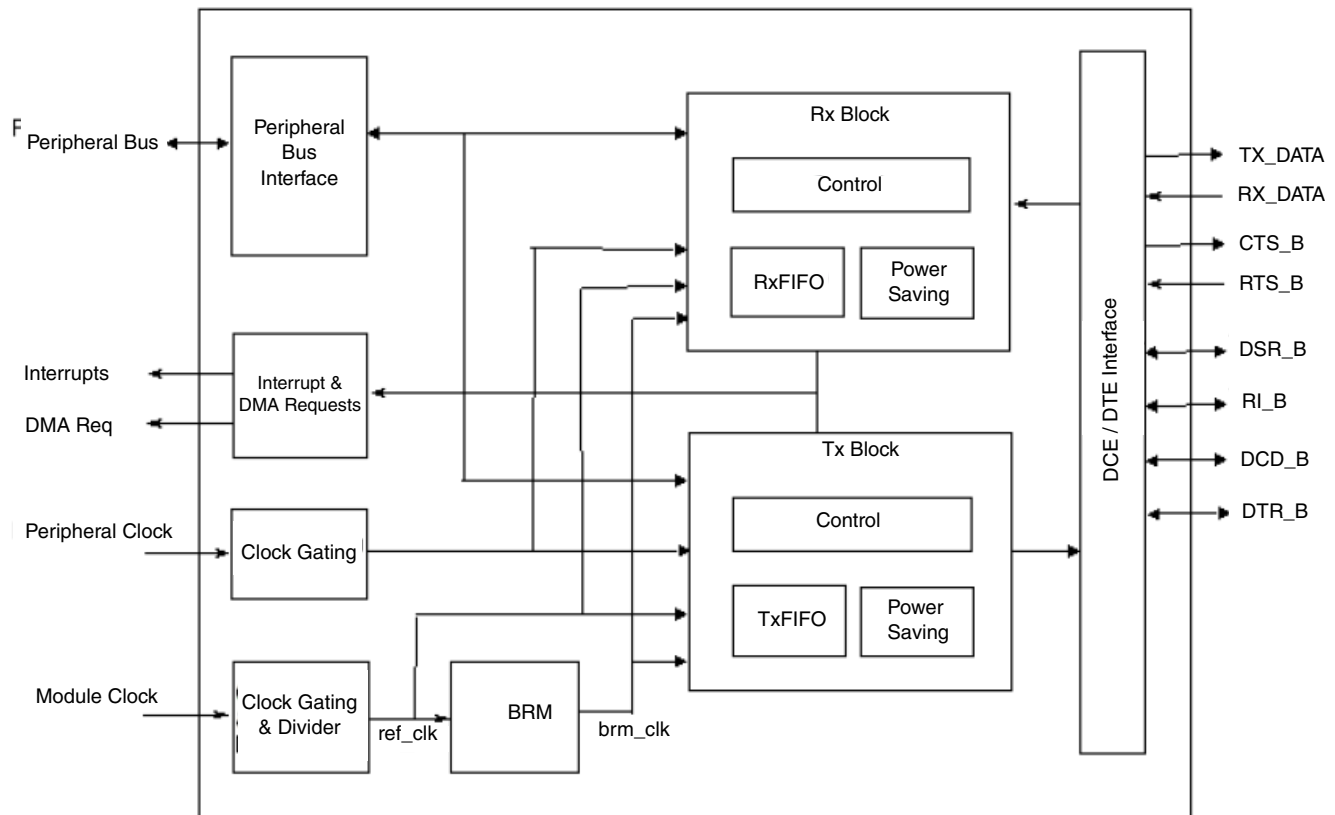

Figure 55-1. UART Block Diagram

55.1.1 Features

The UART includes the following features:

- High-speed TIA/EIA-232-F compatible, up to 5.0 Mbit/s
- Serial IR interface low-speed, IrDA-compatible (up to 115.2 Kbit/s)
- 9-bit or Multidrop mode (RS-485) support (automatic slave address detection)
- 7 or 8 data bits for RS-232 characters, or 9 bit RS-485 format
- 1 or 2 stop bits
- Programmable parity (even, odd, and no parity)
- Hardware flow control support for request to send (RTS_B) and clear to send (CTS_B) signals
- RS-485 driver direction control via CTS_B signal
- Edge-selectable RTS_B and edge-detect interrupts
- Status flags for various flow control and FIFO states
- Voting logic for improved noise immunity (16x oversampling)
- Transmitter FIFO empty interrupt suppression
- UART internal clocks enable/disable

- Auto baud rate detection (up to 115.2 Kbit/s)
- Receiver and transmitter enable/disable for power saving
- RX_DATA input and TX_DATA output can be inverted respectively in RS-232/RS-485 mode
- DCE/DTE capability
- RTS_B, IrDA asynchronous wake (AIRINT), receive asynchronous wake (AWAKE), RI_B (DTE only), DCD_B (DTE only), DTR_B (DCE only) and DSR_B (DTE only) interrupts wake the processor from STOP mode
- Maskable interrupts
- Two DMA Requests (TxFIFO DMA Request and Rx FIFO DMA Request)
- Escape character sequence detection
- Software reset (SRST_B)
- Two independent, 32-entry FIFOs for transmit and receive
- The peripheral clock can be totally asynchronous with the module clock. The module clock determines baud rate. This allows frequency scaling on peripheral clock (such as during DVFS mode) while remaining the module clock frequency and baud rate.

55.1.2 Modes of operation

- Serial RS-232NRZ mode
- 9-bit RS-485 mode
- IrDA mode

To set UART in different modes, see the table below.

Table 55-1. UART mode definition

MDEN (UMCR[0])	IREN (UCR1[7])	UART Mode	Description
0	0	RS-232	RXD/TXD data is serial RS-232 NRZ format
0	1	IrDA (Interface)	RXD/TXD data is IrDA-compatible infrared slow data rate (SIR) format
1	0	RS-485	RXD/TXD data is RS485 compatible 9 bit data format
1	1	Undefined	Undefined

55.2 External Signals

Tables that lists the conventions for representing signals and describing all UART signals that connect off-chip can be found here.

External Signals

The chip-level IOMUX modifies the direction and routing of the UART signals based on whether the UART is operating in DCE mode (UARTn_UFCR[DCEDTE]=0) or DTE mode (UARTn_UFCR[DCEDTE]=1). The routing of the external signals to the UART module is shown in the figure below.

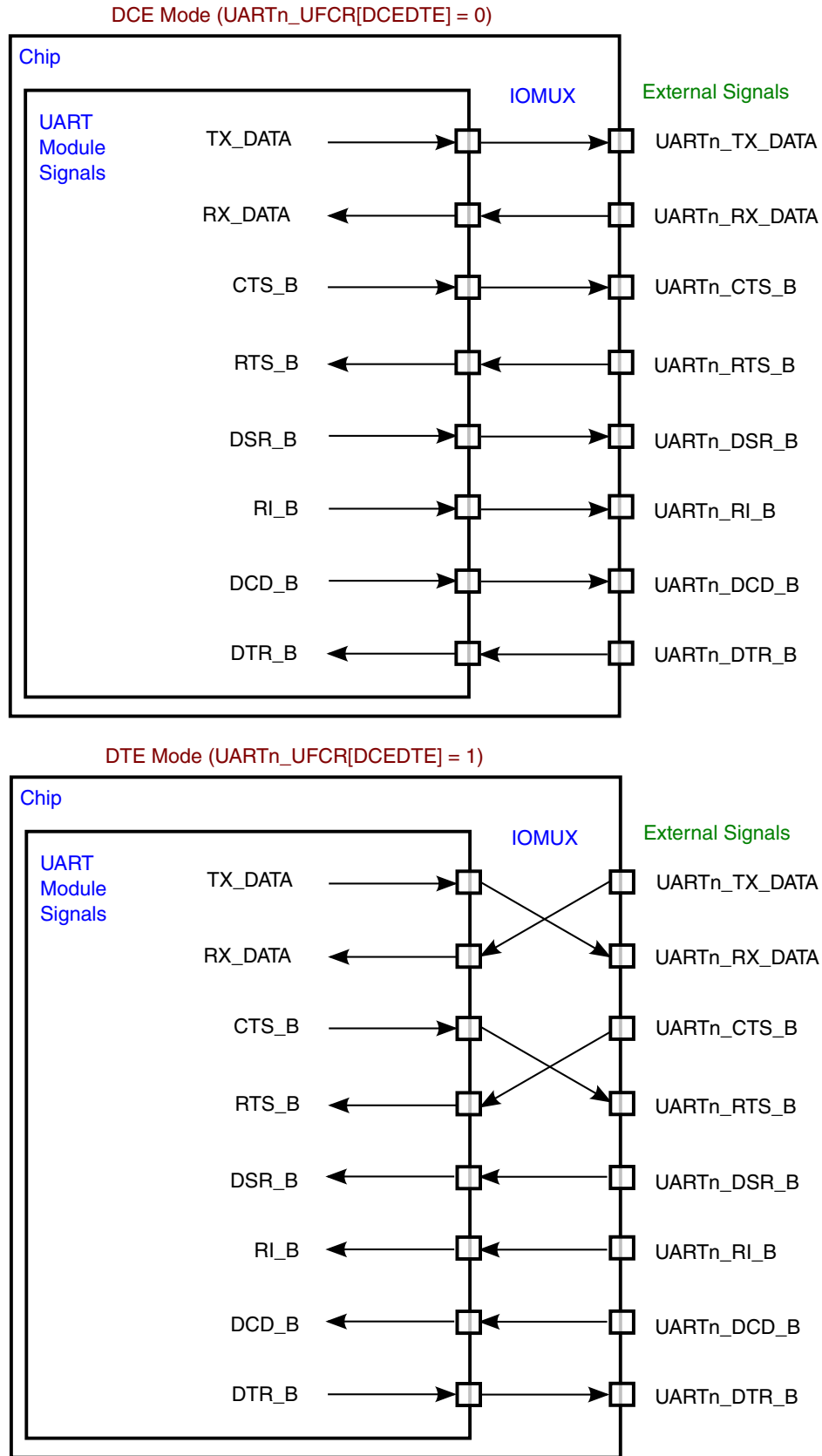

Figure 55-2. UART external signals to module signals routing with respect to DCE/DTE mode

External Signals

The following tables describes the external signals of UART:

Table 55-2. UART External Signals

Signal	Description	Pad	Mode	Direction
UART1_CTS_B	Clear to send	GPIO1_IO06	ALT8	I
		UART1_CTS_B	ALT0	
UART1_RTS_B	Request to send	GPIO1_IO07	ALT8	O
		UART1_RTS_B	ALT0	
UART1_RX_DATA	Serial / infrared data receive	GPIO1_IO03	ALT8	O
		UART1_RX_DATA	ALT0	
UART1_TX_DATA	Serial / infrared data transmit	GPIO1_IO02	ALT8	I
		UART1_TX_DATA	ALT0	
UART2_CTS_B	Clear to send	NAND_DATA06	ALT8	I
		UART2_CTS_B	ALT0	
		UART3_TX_DATA	ALT4	
UART2_RTS_B	Request to send	NAND_DATA07	ALT8	O
		UART2_RTS_B	ALT0	
		UART3_RX_DATA	ALT4	
UART2_RX_DATA	Serial / infrared data receive	NAND_DATA05	ALT8	O
		UART2_RX_DATA	ALT0	
UART2_TX_DATA	Serial / infrared data transmit	NAND_DATA04	ALT8	I
		UART2_TX_DATA	ALT0	
UART3_CTS_B	Clear to send	NAND_CE1_B	ALT8	I
		UART3_CTS_B	ALT0	
UART3_RTS_B	Request to send	NAND_CLE	ALT8	O
		UART3_RTS_B	ALT0	
UART3_RX_DATA	Serial / infrared data receive	NAND_CE0_B	ALT8	O
		UART3_RX_DATA	ALT0	
UART3_TX_DATA	Serial / infrared data transmit	NAND_READY_B	ALT8	I
		UART3_TX_DATA	ALT0	
UART4_CTS_B	Clear to send	ENET1_RX_DATA1	ALT1	I
		LCD_HSYNC	ALT2	
UART4_RTS_B	Request to send	ENET1_RX_DATA0	ALT1	O
		LCD_VSYNC	ALT2	
UART4_RX_DATA	Serial / infrared data receive	LCD_ENABLE	ALT2	O
		UART4_RX_DATA	ALT0	
UART4_TX_DATA	Serial / infrared data transmit	LCD_CLK	ALT2	I
		UART4_TX_DATA	ALT0	
UART5_CTS_B	Clear to send	CSI_DATA03	ALT8	I
		ENET1_TX_DATA0	ALT1	
		GPIO1_IO09	ALT8	
UART5_RTS_B	Request to send	CSI_DATA02	ALT8	O

Table continues on the next page...

Table 55-2. UART External Signals (continued)

Signal	Description	Pad	Mode	Direction
		ENET1_RX_EN	ALT1	
		GPIO1_IO08	ALT8	
UART5_RX_DATA	Serial / infrared data receive	CSI_DATA01	ALT8	O
		GPIO1_IO05	ALT8	
		UART5_RX_DATA	ALT0	
UART5_TX_DATA	Serial / infrared data transmit	CSI_DATA00	ALT8	I
		GPIO1_IO04	ALT8	
		UART5_TX_DATA	ALT0	
UART6_CTS_B	Clear to send	CSI_HSYNC	ALT8	I
		ENET1_TX_DATA1	ALT1	
UART6_RTS_B	Request to send	CSI_VSYNC	ALT8	O
		ENET1_TX_EN	ALT1	
UART6_RX_DATA	Serial / infrared data receive	CSI_PIXCLK	ALT8	O
		ENET2_RX_DATA1	ALT1	
UART6_TX_DATA	Serial / infrared data transmit	CSI_MCLK	ALT8	I
		ENET2_RX_DATA0	ALT1	
UART7_CTS_B	Clear to send	ENET1_TX_CLK	ALT1	I
		LCD_DATA06	ALT1	
UART7_RTS_B	Request to send	ENET1_RX_ER	ALT1	O
		LCD_DATA07	ALT1	
UART7_RX_DATA	Serial / infrared data receive	ENET2_TX_DATA0	ALT1	O
		LCD_DATA17	ALT1	
UART7_TX_DATA	Serial / infrared data transmit	ENET2_RX_EN	ALT1	I
		LCD_DATA16	ALT1	
UART8_CTS_B	Clear to send	ENET2_TX_CLK	ALT1	I
		LCD_DATA04	ALT1	
UART8_RTS_B	Request to send	ENET2_RX_ER	ALT1	O
		LCD_DATA05	ALT1	
UART8_RX_DATA	Serial / infrared data receive	ENET2_TX_EN	ALT1	O
		LCD_DATA21	ALT1	
UART8_TX_DATA	Serial / infrared data transmit	ENET2_TX_DATA1	ALT1	I
		LCD_DATA20	ALT1	

The user must configure the input path to the UART by properly configuring the DAISY bits in the IOMUXC_UARTn_RX_DATA_INPUT and the IOMUXC_UARTn_UART_RTS_B_SELECT_INPUT registers.

For IOMUXC_UARTn_UART_RTS_B_SELECT_INPUT[DAISY]:

- Configurations that select UARTn_RTS_B for the pad are only valid when UARTn_UFCR[DCEDTE]=0 (DCE mode)
- Configurations that select UARTn_CTS_B for the pad are only valid when UARTn_UFCR[DCEDTE]=1 (DTE mode)

For IOMUXC_UARTn_UART_RX_DATA_B_SELECT_INPUT[DAISY]:

- Configurations that select UARTn_RX_DATA for the pad are only valid when UARTn_UFCR[DCEDTE]=0 (DCE mode)
- Configurations that select UARTn_TX_DATA for the pad are only valid when UARTn_UFCR[DCEDTE]=1 (DTE mode)

55.2.1 Detailed Signal Descriptions

55.2.1.1 Interrupt Signals

55.2.1.1.1 *interrupt_uart* - UART Interrupt

Output interrupt request.

55.2.1.2 DMA Request Signals

55.2.1.2.1 *dma_req_rx* - Receiver DMA Request

Output DMA Request signal for receiver interface.

55.2.1.2.2 *dma_req_tx* - Transmitter DMA Request

Output DMA Request signal for transmitter interface. Set at 0 when TXDMAEN (UCR1[3]) is at 1 and TRDY (USR1[13]) is also at 1.

55.2.1.3 Special Signals

55.2.1.3.1 *stop_req* - Stop Mode

Input stop mode. Indicates to UART that Arm platform is going to enter in Stop Mode and clocks are going to stop running.

See [Low Power Modes](#) for more information about Stop Mode.

55.2.1.3.2 *doze_req* - Doze Mode

Input doze mode. Arm platform requests UART to switch in doze mode (power saving mode).

See [Low Power Modes](#) for more information about Doze Mode.

55.2.1.3.3 *debug_req* - Debug Mode

Input debug mode. Indicates UART it has to enter in debug mode.

See [UART Operation in System Debug State](#), for more information about Debug Mode.

55.3 Clocks

The table found here describes the clock sources for UART.

Please see [Clock Controller Module \(CCM\)](#) for clock setting, configuration and gating information.

Table 55-3. UART Clocks

Clock name	Clock Root	Description
ipg_clk	ipg_clk_root	Peripheral clock
ipg_clk_s	ipg_clk_root	Peripheral access clock
ipg_perclk	uart_clk_root	Module clock

55.4 Functional Description

This section provides a complete functional description of the block.

55.4.1 Interrupts and DMA Requests

See the following table for the lists of all interrupt and DMA signals and associated interrupt and DMA sources of the UART. See register description section for explanation of interrupt/DMA enable and status.

Table 55-4. Interrupts and DMA

Interrupt/DMA Output	Interrupt/DMA Enable	Enable Register Location	Interrupt/DMA Flag	Flag Register Location
<i>interrupt_uart</i>	RRDYEN	UCR1 (bit 9)	RRDY	USR1 (bit 9)
	IDEN	UCR1 (bit 12)	IDLE	USR2 (bit 12)
	DREN	UCR4 (bit 0)	RDR	USR2 (bit 0)
	RXDSEN	UCR3 (bit 6)	RXDS	USR1 (bit 6)
	ATEN	UCR2 (bit 3)	AGTIM	USR1 (bit 8)
<i>interrupt_uart</i>	TXMPTYEN	UCR1 (bit 6)	TXFE	USR2 (bit 14)
	TRDYEN	UCR1 (bit 13)	TRDY	USR1 (bit 13)
	TCEN	UCR4 (bit 3)	TXDC	USR2 (bit 3)
<i>interrupt_uart</i>	OREN	UCR4 (bit 1)	ORE	USR2 (bit 1)
	BKEN	UCR4 (bit 2)	BRCD	USR2 (bit 2)
	WKEN	UCR4 (bit 7)	WAKE	USR2 (bit 7)
	ADEN	UCR1 (bit 15)	ADET	USR2 (bit 15)
	ACIEN	UCR3 (bit 0)	ACST	USR2 (bit 11)
	ESCI	UCR2 (bit 15)	ESCF	USR1 (bit 11)
	ENIRI	UCR4 (bit 8)	IRINT	USR2 (bit 8)
	AIRINTEN	UCR3 (bit 5)	AIRINT	USR1 (bit 5)
	AWAKEN	UCR3 (bit 4)	AWAKE	USR1 (bit 4)
	FRAERREN	UCR3 (bit 11)	FRAERR	USR1 (bit 10)
	PARERREN	UCR3 (bit 12)	PARITYERR	USR1 (bit 15)
	RTSDEN	UCR1 (bit 5)	RTSD	USR1 (bit 12)
	RTSEN	UCR2 (bit 4)	RTSF	USR2 (bit 4)
	DTREN (DCE)	UCR3 (bit 13)	DTRF	USR2 (bit 13)
	RI (DTE)	UCR3 (bit 8)	RIDELT	USR2 (bit 10)
	DCD (DTE)	UCR3 (bit 9)	DCDDELT	USR2 (bit 6)
	DTRDEN	UCR3 (bit 3)	DTRD	USR1 (bit 7)
SADEN	UMCR (bit 3)	SAD	USR1 (bit 3)	
<i>dma_req_rx</i>	RXDMAEN	UCR1 (bit 8)	RRDY	USR1 (bit 9)
	ATDMAEN	UCR1 (bit 2)	AGTIM	USR1 (bit 8)
	IDDMAEN	UCR4 (bit 6)	IDLE	USR2 (bit 12)
<i>dma_req_tx</i>	TXDMAEN	UCR1 (bit 3)	TRDY	USR1 (bit 13)

55.4.2 Clocks

This section describes clocks and special clocking requirements of the UART.

55.4.2.1 Clock requirements

UART module receives 2 clocks, *peripheral_clock* and *module_clock*. The *peripheral_clock* is used as write clock of the TxFIFO, read clock of the RxFIFO and synchronization of the modem control input pins. It must always be running when UART is enabled. There is an exception in stop mode (see [Clocking in Low-Power Modes](#)).

The *module_clock* is for all the state machines, writing RxFIFO, reading TxFIFO, etc. It must always be running when UART is sending or receiving characters. This clock is used in order to allow frequency scaling on *peripheral_clock* without changing configuration of baud rate (*module_clock* staying at a fixed frequency).

The constraints on *peripheral_clock* and *module_clock* are as follows:

- *peripheral_clock* and *module_clock* can totally be asynchronous. They can also be synchronous.
- Due to the 16x oversampling of the incoming characters, *module_clock* frequency must always be greater or equal to 16x the maximum baud rate. For example, if max baud rate is 4 Mbit/s, *module_clock* must be greater or equal to $4 \text{ M} \times 16 = 64 \text{ MHz}$.

NOTE

The restriction that *peripheral_clock* frequency must be higher or equal to 16x baud rate has been removed. There is no limitation on *peripheral_clock* frequency to baud rate.

55.4.2.2 Maximum Baud Rate

The max baud rate the UART can support is determined by the max frequency of the *module_clock*.

For example, if the SoC can provide the fastest *module_clock* 66.5 MHz, the UART can transmit and receive serial data with the maximum baud rate $66.5\text{M}/16 = 4.15 \text{ Mbit/s}$.

The UART supports serial IR interface low speed. In the low speed IrDA mode, the max baud rate is 115.2 Kbit/s. To support the 115.2 Kbit/s, *module_clock* frequency must be higher or equal to 1.8432 MHz.

55.4.2.3 Clocking in Low-Power Modes

The UART supports 2 low-power modes: DOZE and STOP.

In STOP mode (input pin *stop_req* is at '1'), the UART doesn't need any clock. In this mode the UART can wake-up the Arm platform with the asynchronous interrupts (see [Low Power Modes](#)).

- If before entering in STOP mode the software has enabled RTSDEN interrupt, when RTS will change state (put at '0' by external device started to send), the asynchronous interrupt will wake-up the system, *peripheral_clock* and *module_clock* will be provided to the UART before first start bit, so that no data will be lost.
- If RTS doesn't change state (already at '0' before entering in STOP mode), then wake-up interrupt (AWAKE) will be sent at the arrival of first Start bit (on falling edge). In this case, the UART must receive the *peripheral_clock* and *module_clock* during the first half of start bit to correctly receive this character (for example, at 115.2 Kbit/s, UART must receive *peripheral_clock* and *module_clock* at maximum 4.3 microseconds after falling edge of Start bit). If the UART receives *peripheral_clock* and *module_clock* too late, first character will be lost, and so should be dropped. Also, if autobaud detection is enabled, the first character won't be correctly received and another autobaud detection will need to be initiated.

In Doze mode, UART behavior is programmable through DOZE bit (UCR1[1]). If DOZE bit is set to '1', then UART is disabled in Doze mode, and in consequence, UART clocks can be switched-off (after being sure UART is not transmitting nor receiving). On the contrary, if DOZE bit is set to '0', UART is enabled and it must receive *peripheral_clock* and *module_clock*.

55.4.3 General UART Definitions

Definitions of terms that occurs the following discussions are given in this section.

- Bit Time-The period of time required to serially transmit or receive 1 bit of data (1 cycle of the baud rate frequency).
- Start bit-The bit time of a logic 0 that indicates the beginning of a data frame. A start bit begins with a 1-to-0 transition, and is preceded by at least 1 bit time of logic 1.
- Stop bit-1 bit time of logic 1 that indicates the end of a data frame.
- BREAK-A frame in which all of the data bits, including the stop bit, are logic 0. This type of frame is usually sent to signal the end of a message or the beginning of a new message.
- Mark - When no data is being sent, the serial port's transmit pin's voltage is 1 and is said to be in a MARK state.
- Space - The serial port can also be forced to keep the transmit pin at a 0 and is said to be the SPACE or BREAK state.
- Frame-A start bit followed by a specified number of data or information bits and terminated by a stop bit. The number of data or information bits depends on the

format specified and must be the same for the transmitting device and the receiving device. The most common frame format is 1 start bit followed by 8 data bits (least significant bit first) and terminated by 1 stop bit. An additional stop bit and a parity bit also can be included.

- **Framing Error**-An error condition that occurs when the stop bit of a received frame is missing, usually when the frame boundaries in the received bit stream are not synchronized with the receiver bit counter. Framing errors can go undetected if a data bit in the expected stop bit time happens to be a logic 1. A framing error is always present on the receiver side when the transmitter is sending BREAKs. However, when the UART is programmed to expect 2 stop bits and only the first stop bit is received, this is not a framing error by definition.
- **Parity Error**-An error condition that occurs when the calculated parity of the received data bits in a frame does not match the parity bit received on the RX_DATA input. Parity error is calculated only after an entire frame is received.
- **Idle**-One in NRZ encoding format and selectable polarity in IrDA mode.
- **Overrun Error**-An error condition that occurs when the latest character received is ignored to prevent overwriting a character already present in the UART receive buffer (RxFIFO). An overrun error indicates that the software reading the buffer (RxFIFO) is not keeping up with the actual reception of characters on the RX_DATA input.

55.4.3.1 RTS_B - UART Request To Send

The UART Request To Send input controls the transmitter. The modem or other terminal equipment signals the UART when it is ready to receive by setting '0' on the RTS_B pin.

Normally, the transmitter waits until this signal is active (low) before transmitting a character, however when the Ignore RTS (IRTS) bit is set, the transmitter sends a character as soon as it is ready to transmit. An interrupt (RTSD) can be posted on any transition of this pin and can wake the Arm platform from STOP mode on its assertion. When RTS_B is set to '1' during a transmission, the UART transmitter finishes transmitting the current character and shuts off. The contents of the TxFIFO (characters to be transmitted) remain undisturbed. The operation of this input is the same regardless of whether the UART is in DTE or DCE mode.

55.4.3.2 RTS Edge Triggered Interrupt

The input to the RTS_B pin can be programmed to generate an interrupt on a selectable edge.

See the table below for summary of the operation of the RTS edge triggered interrupt (RTSF).

To enable the RTS_B pin to generate an interrupt, set the request to send interrupt enable (RTSEN) bit (UCR2[4]) to 1. Writing 1 to the RTS_B edge triggered interrupt flag (RTSF) bit (USR2[4]) clears the interrupt flag. The interrupt can occur on the rising edge, falling edge, or either edge of the RTS_B input. The request to send edge control (RTEC) field (UCR2[10:9]) programs the edge that generates the interrupt. When RTEC is set to 0x00 and RTSEN = 1, the interrupt occurs on the rising edge (default). When RTEC is set to 0x01 and RTSEN = 1, the interrupt occurs on the falling edge. When RTEC is set to 0x1X and RTSEN = 1, the interrupt occurs on either edge. This is a synchronous interrupt. The RTSF bit is cleared by writing 1 to it. Writing 0 to RTSF has no effect.

Table 55-5. RTS_B Edge Triggered Interrupt Truth Table

RTS_B	RTSEN	RTEC [1]	RTEC [0]	RTSF	Interrupt Occurs On...	interrupt_uart
X	0	X	X	0	Interrupt disabled	1
1->0	1	0	0	0	Rising edge	1
0->1	1	0	0	1	Rising edge	0
1->0	1	0	1	1	Falling edge	0
0->1	1	0	1	0	Falling edge	1
1->0	1	1	X	1	Either edge	0
0->1	1	1	X	1	Either edge	0

There is another RTS_B interrupt that is not programmable. The status bit RTSD asserts the *interrupt_uart* interrupt when the RTS_B delta interrupt enable = 1. This is an asynchronous interrupt. The RTSD bit is cleared by writing 1 to it. Writing 0 to the RTSD bit has no effect.

55.4.3.3 DTR_B - Data Terminal Ready

This signal indicates the general readiness of the Data Terminal Equipment (DTE). This signal is an input in DCE mode and an output in DTE mode. If the connection between the DCE and the DTE is established once, the DTR_B signal must remain active throughout the whole connection time.

In general the DTR_B and DSR_B signals are responsible for establishing the connection. RTS_B and CTS_B are responsible for the data transfer and the transfer direction in the case of a half-duplex configuration. The DTR_B signal is like a "main switch". If the DTR_B signal is inactive the RTS_B and CTS_B signals have no effect. In DCE mode, an interrupt (DTRD) can be posted on any transition of this pin and can wake the ARM platform from STOP mode on its assertion.

55.4.3.4 DSR_B - Data Set Ready

This signal indicates the general readiness of the DCE. This signal is an output in DCE mode and an input in DTE mode. The DCE uses this signal to inform the DTE that it is switched on, has completed all preparations and can communicate with the DTE.

In DTE mode, an interrupt (DTRD) can be posted on any transition of this pin and can wake the ARM platform from STOP mode on its assertion.

55.4.3.5 DTR_B/DSR_B Edge Triggered Interrupt

The DTR_B input pin (DCE mode) or DSR_B input pin (DTE mode) can be configured to cause an interrupt on a selectable edge.

See the table below for summary of the operation of the DTR/DSR edge triggered interrupt. To enable the interrupt, set the DTREN bit (UCR3[13]) to '1'. Write a "one" to the DTRF bit (USR2[13]) to clear the interrupt flag.

The interrupt can be configured to occur on either the rising, falling, or either edge of the DTR_B/DSR_B input. Write to the DPEC[1:0] bits (UCR3[15:14]) to program which edge will cause an interrupt. If the bits are set to 00b and DTREN = 1, the interrupt will occur on the rising edge (default). If the bits are set to 01b and DTREN = 1, the interrupt will occur on the falling edge. If the bits are set to 1Xb and DTREN = 1, the interrupt will occur on either edge.

Table 55-6. DTR/DSR_B Edge Triggered Interrupt Truth Table

DTR_B / DSR_B	DTREN	DPEC[1]	DPEC[0]	DTRF	Interrupt occurs on:	interrupt_uart
X	0	X	X	0	turned off	1
1->0	1	0	0	0	rising edge	1
0->1	1	0	0	1	rising edge	0
1->0	1	0	1	1	falling edge	0
0->1	1	0	1	0	falling edge	1
1->0	1	1	X	1	either edge	0
0->1	1	1	X	1	either edge	0

55.4.3.6 DCD_B - Data Carrier Detect

This signal is an output in DCE mode and an input in DTE mode. If used, the DCE device uses this signal to inform the DTE it has detected the carrier signal and the connection will be set up. This signal remains active while the connection remains established.

In DTE mode this input can trigger an interrupt on changing state. This is achieved by setting to '1' the interrupt enable bit (DCD, UCR3[9]). The change state is reflected in DCDELTA (USR2[6]). Also, the state of the Data Carrier Detect input is mirrored in the status register DCDIN (USR2[5]).

55.4.3.7 RI_B - Ring Indicator

This signal is an output in DCE mode and an input in DTE mode. If used, the DCE device uses this signal to inform the DTE that a ring just occurred.

In DTE mode this input can trigger an interrupt on changing state. This is achieved by setting to '1' the interrupt enable bit (RI, UCR3[8]). The change state is reflected in RIDELTA (USR2[10]). Also, the state of the Ring Indicator input is mirrored in the status register RIIN (USR2[9]).

55.4.3.8 CTS_B - Clear To Send

This output pin serves two purposes. Normally, the receiver indicates that it is ready to receive data by asserting this pin (low). When the CTS_B trigger level is programmed to trigger at 32 characters received and the receiver detects the valid start bit of the 33 character, it de-asserts this pin. The operation of this output is the same regardless of whether the UART is in DTE or DCE mode.

55.4.3.9 Programmable CTS_B Deassertion

The CTS_B output can also be programmed to deassert when the RxFIFO reaches a certain level. Setting the CTS trigger level (UCR4[15:10]) at any value less than 32 deasserts the CTS_B pin on detection of the valid start bit of the N + 1 character (where N is the trigger level setting). However, the receiver continues to receive characters until the RxFIFO is full.

55.4.3.10 TX_DATA - UART Transmit

This is the transmitter serial output. When operating in RS-232/RS-485 mode, NRZ encoded data is transmitted, and the data can be inverted (controlled by INVT (UCR3[1])) before transmitted. When operating in infrared mode, a 3/16 bit-period pulse is output for each 0 bit transmitted, and no pulse is output for each 1 bit transmitted.

For RS-232/RS-485 applications, this pin must be connected to an RS-232/RS-485 transmitter. The operation of this output is the same regardless of whether the UART is in DTE or DCE mode. See [Figure 55-3](#).

55.4.3.11 RX_DATA - UART Receive

This is the receiver serial input. When operating in RS-232/RS-485 mode, NRZ encoded data is expected, and the data can be inverted (controlled by INVR (UCR4[9])) before sampled. When operating in infrared mode, a narrow pulse is expected for each 0 bit received and no pulse is expected for each 1 bit received.

External circuitry must convert the IR signal to an electrical signal. RS-232/RS-485 applications require an external RS-232/RS-485 receiver to convert voltage levels. The operation of this input is the same regardless of whether the UART is in DTE or DCE mode. See the figure below.

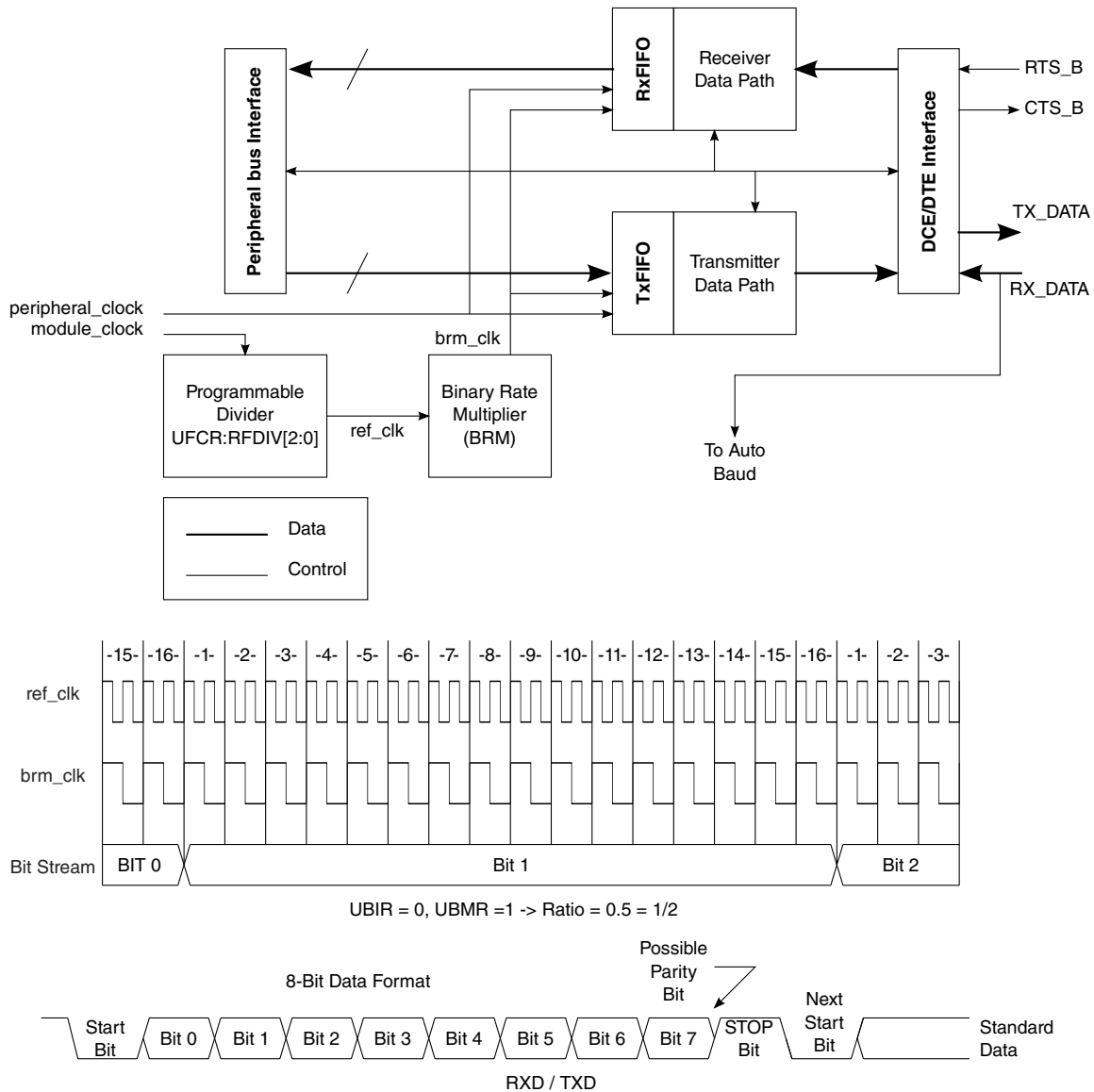

Figure 55-3. UART Simplified Block and Clock Generation Diagrams

55.4.4 Transmitter

The transmitter accepts a parallel character from the Arm platform and transmits it serially. The start, stop, and parity (when enabled) bits are added to the character.

When the ignore RTS bit (IRTS) is set, the transmitter sends a character as soon as it is ready to transmit. RTS_B can be used to provide flow-control of the serial data. When RTS_B is set to '1', the transmitter finishes sending the character in progress (if any), stops, and waits for RTS_B to be set to '0' again. Generation of BREAK characters and parity errors (for debugging purposes) is supported. The transmitter operates from the clock provided by the Binary Rate Multiplier(BRM). Normal NRZ encoded data is transmitted when the IR interface is disabled.

The transmitter FIFO (TxFIFO) contains 32 bytes. The data is written to TxFIFO by writing to the UTXD register with the byte data to the [7:0] bits. The data is written consecutively if the TxFIFO is not full. It is read (internally) consecutively if the TxFIFO is not empty. TXFULL bit (UTS[4]) can be used to control whether TxFIFO is full or not. The TxFIFO can be written regardless of the transmitter is disabled or enabled. If the UART is disabled, user can still write data into the TxFIFO correctly. But in this case the write access will yield to a transfer error.

55.4.4.1 Transmitter FIFO Empty Interrupt Suppression

The transmitter FIFO empty interrupt suppression logic suppresses the TXFE interrupt between writes to the TxFIFO.

When TxFIFO is empty, the software can either send one or several characters. If the software sends one character, it would write the character into the UTXD register, then that character is immediately transferred to the transmitter shift register, assuming the transmitter is already enabled. Without interrupt suppression logic, the TXFE interrupt flag would be set immediately. But, with this logic, the interrupt flag is set when the last bit of the character has been transmitted, for example, before the transmission of the parity bit (if exists) and the stop bit(s).

So, the suppression logic doesn't immediately send the TXFE interrupt flag. It allows the software to write another character to the TxFIFO before the interrupt flag is asserted.

When the transmitter shift register empties before another character is written to the TxFIFO, the interrupt flag is asserted. Writing data to the TxFIFO would release the interrupt flag. The interrupt flag is asserted on the following conditions:

- System Reset

Functional Description

- UART software reset
- When a single character has been written to Transmitter FIFO and then the Transmitter FIFO and the Transmitter Shift Register become empty until another character is written to the Transmitter FIFO
- The last character in the TxFIFO is transferred to the shift register, when TxFIFO contains two or more characters. See the figure below.

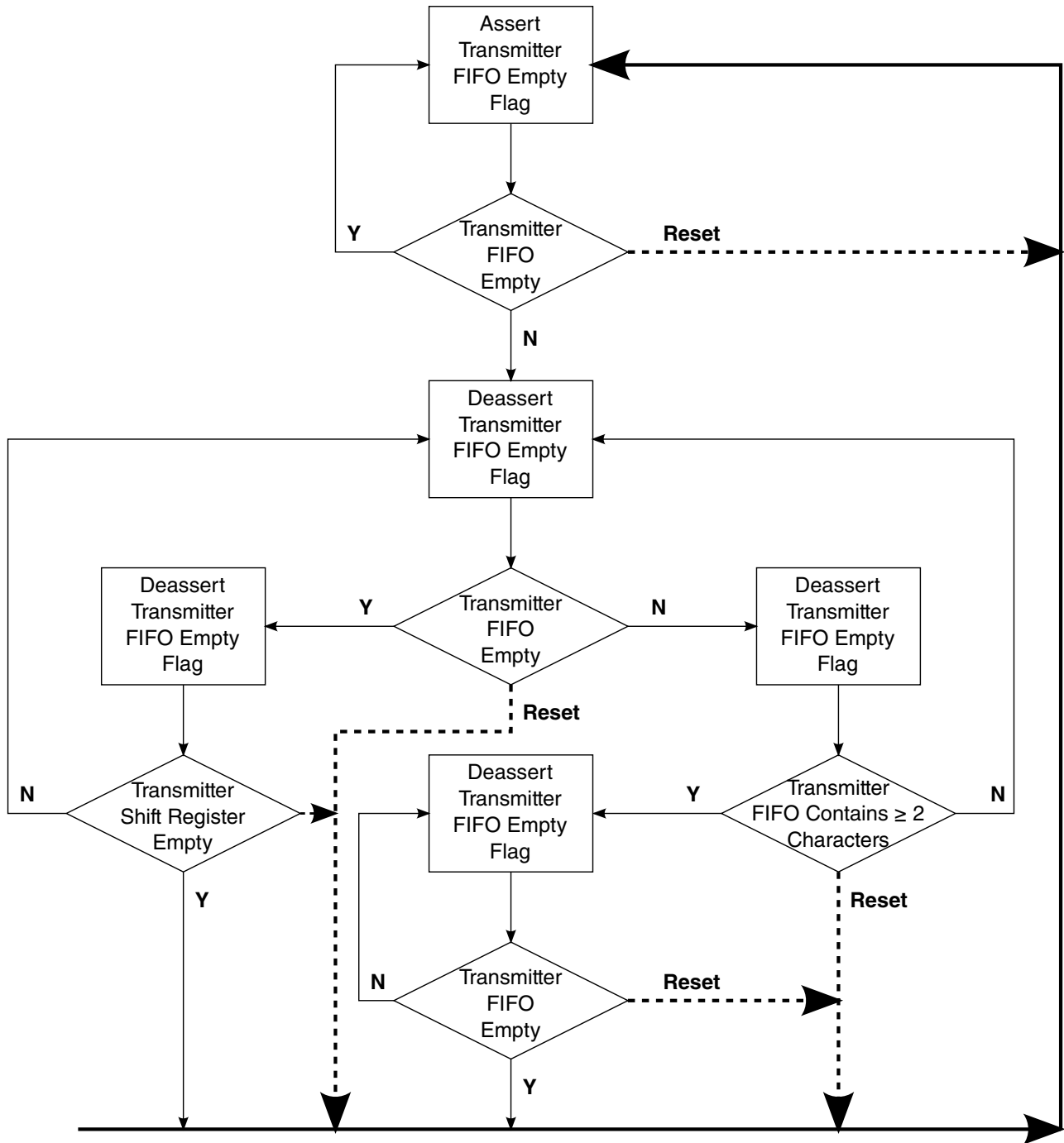

Figure 55-4. Transmitter FIFO Empty Interrupt Suppression Flow Chart

55.4.4.2 Transmitting a Break Condition

Asserting SNDBRK bit of the UCR1 Register forces the transmitter to send a break character (continuous zeros). The transmitter will finish sending the character in progress (if any) before sending break until this bit is reset.

The user is responsible to ensure that this bit is high for long enough to generate a valid BREAK. The transmitter samples SNDBRK after every bit is transmitted. Following completion of the BREAK transmission, the UART will transmit two mark bits. The user can continue to fill the FIFO and any character remaining will be transmitted when the break is terminated.

55.4.5 Receiver

See the figure below for the receiver flow chart.

The receiver accepts a serial data stream and converts it into parallel characters. When enabled, it searches for a start bit, qualifies it, and samples the following data bits at the bit-center.

Jitter tolerance and noise immunity are provided by sampling at a 16x rate and using voting techniques to clean up the samples. Once the start bit is found, the data bits, parity bit (if enabled), and stop bits (either 1 or 2 depending on user selection) are shifted in. Parity is checked and its status reported in the URXD register when parity is enabled. Frame errors and BREAKs are also checked and reported. When a new character is ready to be read by the Arm platform from the RxFIFO, the receive data ready (RDR = $USR2[0]$) bit is asserted and an interrupt is posted (if $DREN = UCR4[0] = 1$). If the receiver trigger level is set to 2 ($RXTL[5:0] = UFCR[5:0] = 2$), and 2 chars have been received into RxFIFO, the receiver ready interrupt flag ($RRDY = USR1[9]$) is asserted and an interrupt is posted if the receiver ready interrupt enable bit is set ($RRDYEN = UCR1[9] = 1$). If the UART Receiver Register (URXD) is read once, and in consequence there is only 1 character in the RxFIFO, the interrupt generated by the RDR bit is automatically cleared. The RRDY bit is cleared when the data in the RxFIFO falls below the programmed trigger level.

Normal NRZ encoded data is expected when the IR interface is disabled. The RxFIFO contains 32 half-word entries. Characters received are written consecutively into this FIFO. If the FIFO is full and a 33rd character is received, this character will be ignored and the $USR2[ORE]$ bit will be set.

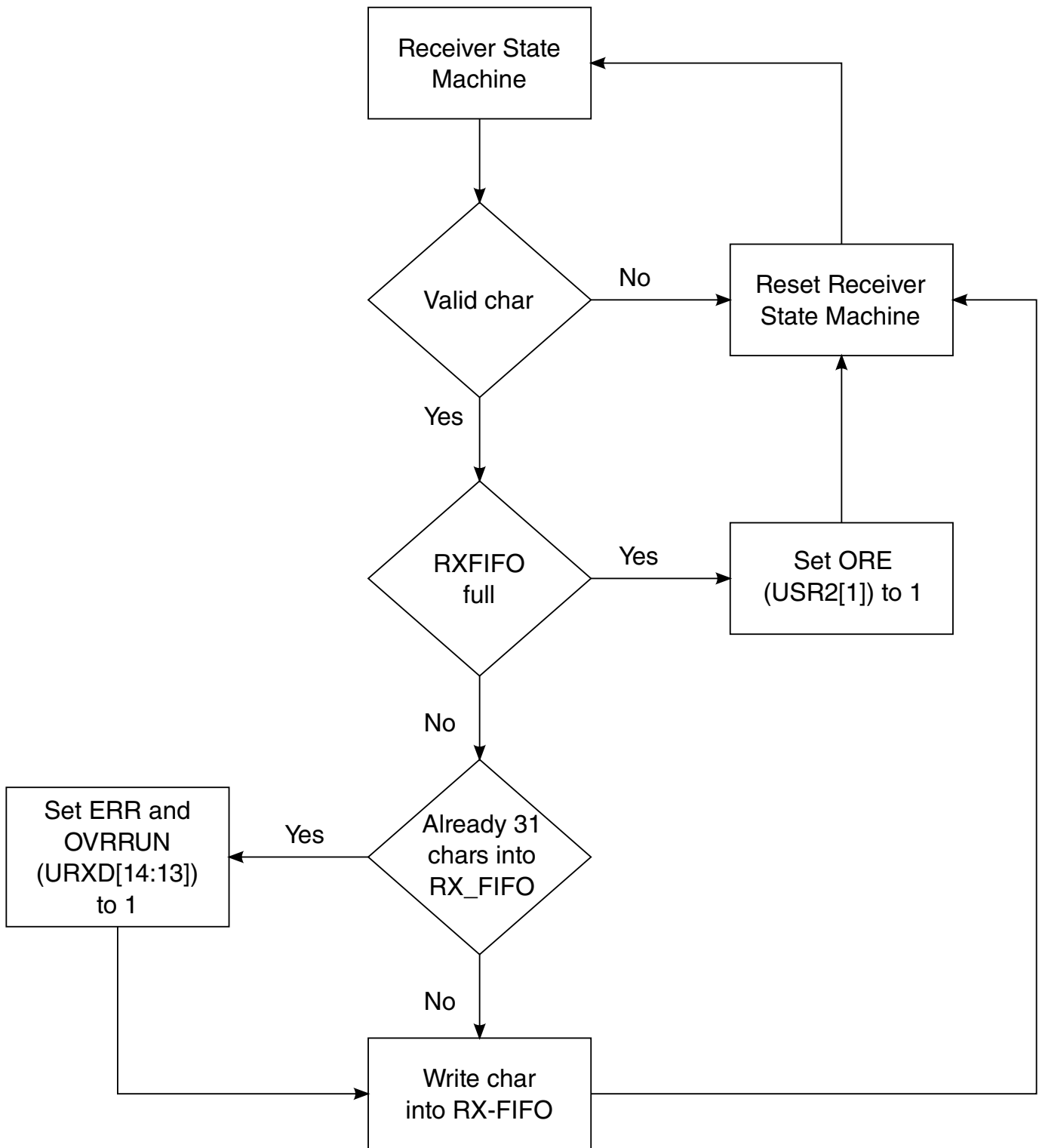

Figure 55-5. Receiver Flow Chart

55.4.5.1 Idle Line Detect

The receiver logic block includes the ability to detect an idle line. Idle lines indicate the end or the beginning of a message.

For an idle condition to occur:

- RxFIFO must be empty and
- RX_DATA pin must be idle for more than a configured number of frames (ICD[1:0] = UCR1[11:10]).

When the idle condition detected interrupt enable (IDEN = UCR1[12]) is set and the line is idle for 4 (default), 8, 16, or 32 (maximum) frames, the detection of an idle condition flags an interrupt (see the table below). When an idle condition is detected, the IDLE (USR2[12]) bit is set. Clear the IDLE bit by writing 1 to it. Writing 0 to the IDLE bit has no effect.

Table 55-7. Detection Truth Table

IDEN	ICD [1]	ICD [0]	IDLE	<i>interrupt_uart</i>
0	X	X	0	1
1	0	0	asserted after 4 idle frames	asserted after 4 idle frames
1	0	1	asserted after 8 idle frames	asserted after 8 idle frames
1	1	0	asserted after 16 idle frames	asserted after 16 idle frames
1	1	1	asserted after 32 idle frames	asserted after 32 idle frames

NOTE: This table assumes that no other interrupt is set at the same time this interrupt is set for the *interrupt_uart* signal. This table shows how this interrupt affects the *interrupt_uart* signal.

During a normal message there is no idle time between frames. When all of the information bits in a frame are logic 1s, the start bit ensures that at least one logic 0 bit time occurs for each frame so that the IDLE bit is not asserted.

55.4.5.2 Aging Character Detect

The receiver block also includes the possibility to detect when at least one character has been sitting into the RxFIFO for a time corresponding to 8 characters. This aging character capability allows the UART to inform the Arm platform that there is less character into the RxFIFO than the Rx trigger and, no new character has been detected on the RXD line.

The aging capability is a timer which starts to count as soon as the RxFIFO is not empty and its trigger level is not reached (RRDY=0). This counter is reset when either a RxFIFO read is performed or another character starts to present on the RXD line. If none of those two events occurs, the bit AGTIM (USR1[8]) is set when the counter has

measured a time corresponding to 8 characters. AGTIM is cleared by writing a 1 to it. AGTIM can flag an interrupt to Arm platform on *interrupt_uart* if ATEN (UCR2[3]) has been set.

To summarize, AGTIM is set when:

- There is at least one character into RxFIFO.
- No read has occurred on RxFIFO and RXD line has stayed high, for a time corresponding to 8 characters.
- The RxFIFO trigger is not reached (RRDY=0)

55.4.5.3 Receiver Wake

The WAKE bit (USR2[7]) is set when the receiver detects a qualified Start bit. For this, two conditions must be fulfilled, firstly a falling edge on RX_DATA line must be detected and secondly the RX_DATA line must stay at low level for more than a half-bit duration.

When the wake interrupt enable WKEN (UCR4[7]) bit is enabled, the receiver flags an interrupt (*interrupt_uart*) if the WAKE status bit is set. The WAKE bit is cleared by writing 1 to it. Writing 0 to the WAKE bit has no effect. The WAKE status bit can be asserted in either serial RS-232 mode or IR mode. The generation of the WAKE interrupt needs the clock *module_clock*.

When the asynchronous wake interrupt (AWAKE) is enabled (AWAKEN = UCR3[4] = 1), and the Arm platform is in STOP mode, and UART clocks have been shut-off, then a falling edge detected on the receive pin (RX_DATA) asserts the AWAKE bit (USR1[4]) and the *interrupt_uart* interrupt to wake the Arm platform from STOP mode. Re-enable UART clocks and clear the AWAKE bit by writing 1 to it. Writing 0 to the AWAKE bit has no effect. When IR interface is enabled (UCR1[7]=1), the AWAKE bit is always not asserted. The generation of the asynchronous AWAKE interrupt does not need any clocks.

In IR mode, if the asynchronous IR WAKE interrupt is enabled (AIRINTEN = UCR3[5] = 1), and if the Arm platform is in STOP mode (UART clocks are off when Arm platform in STOP mode), then the detection of a falling edge on the receive pin (RXD_IR), asserts the AIRINT bit (USR1[5]), and the *interrupt_uart* interrupt. This interrupt wakes the Arm platform from STOP mode. Software re-enables UART clocks and clear the AIRINT bit by writing 1 to it. Writing 0 to the AIRINT bit has no effect. When IR interface is disabled (UCR1[7]=0), the AIRINT bit is always not asserted. The generation of the asynchronous AIRINT interrupt does not need any clocks.

Recommended procedure for programming the asynchronous interrupts is to first clear them by writing 1 to the appropriate bit in the UART Status Register 1 (USR1). Poll or enable the interrupt for the Receiver IDLE Interrupt Flag (RXDS) in the USR1. When asserted, the RXDS bit indicates to the software that the receiver state machine is in the idle state, the next state is idle, and the RX_DATA pin is idle (high). After following this procedure, enable the asynchronous interrupt and enter STOP mode.

55.4.5.4 Receiving a BREAK Condition

A BREAK condition is received when the receiver detects all 0s (including a 0 during the bit time of the stop bit) in a frame. The BREAK condition asserts the BRCD bit (USR2[2]) and writes only the first BREAK character to the RxFIFO. Clear the BRCD bit by writing 1 to it. Writing 0 to the BRCD bit has no effect.

Asserting BRCD would generate an interrupt on *interrupt_uart*. The interrupt generation can be masked using the control bit BKEN (UCR4[2]). Receiving a break condition will also effect the following bits in the receiver register URXD:

URXD(11) = BRK. While high this bit indicates that the current char was detected as a break.

URXD(12) = FRMERR. The frame error bit will always be set when BRK is set.

URXD(10) = PRERR. If odd parity was selected the parity error bit will also be set when BRK is set.

URXD(14) = ERR. The error detect bit indicates that the character present in the rx data field has an error status. This can be asserted by a break.

55.4.5.5 Vote Logic

The vote logic block provides jitter tolerance and noise immunity by sampling with respect to a 16x clock (*brm_clk*) and using voting techniques to clean up the samples. The voting is implemented by sampling the incoming signal constantly on the rising edge of the *brm_clk*.

See [Figure 55-6](#). The receiver is provided with the majority vote value, which is 2 out of the 3 samples. For examples of the majority vote results of the vote logic, see the following table.

Table 55-8. Majority Vote Results

Samples	Vote
000	0
101	1
001	0
111	1

The vote logic captures a sample on every rising edge of *brm_clk*, however the receiver uses 16x oversampling to take its value in the middle of the sample character.

The receiver starts to count when the Start bit is set however it does not capture the contents of the RxFIFO at the time the Start bit is set. The start bit is validated when 0s are received for 7 consecutive 1/16 of bit times following the 1-to-0 transition. Once the counter reaches 0xF, it starts counting on the next bit and captures it in the middle of the sampling frame (see Table 55-8). All data bits are captured in the same manner. Once the stop bit is detected, the receiver shift register (SIPO_OUT) data is parallel shifted to the RxFIFO.

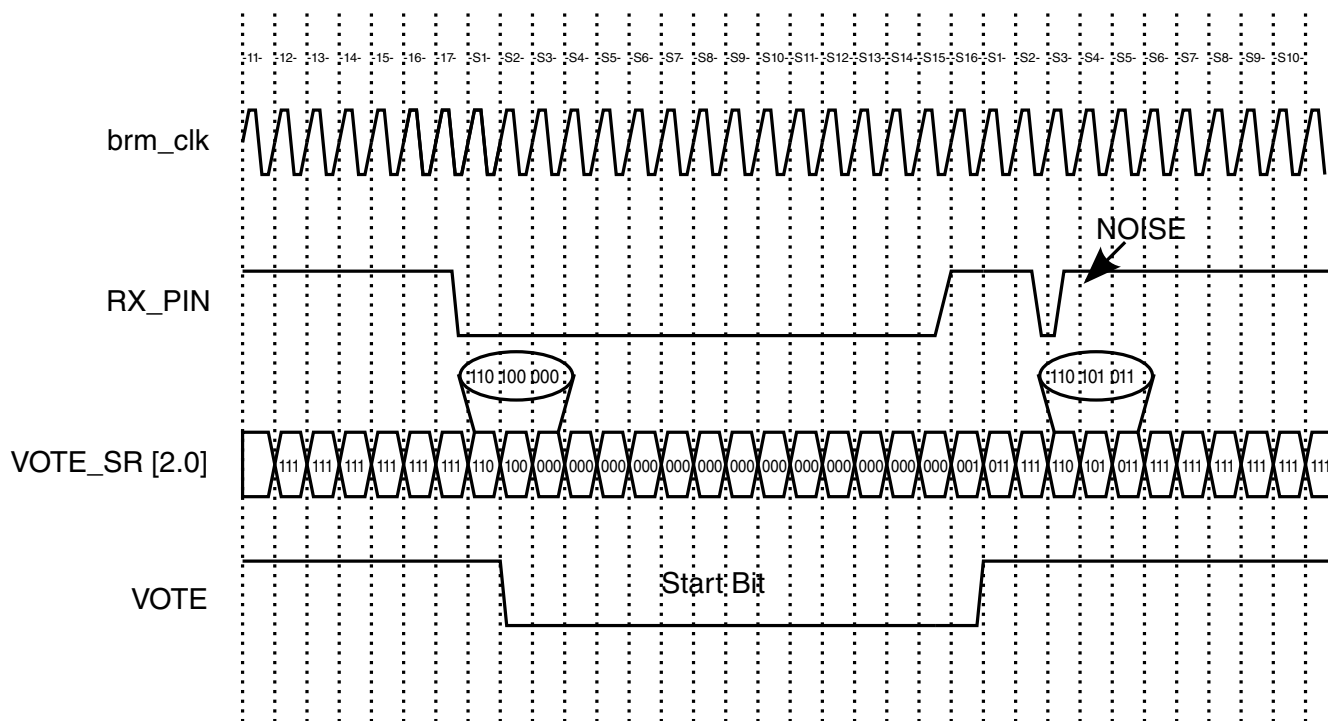

Figure 55-6. Majority Vote Results

A new feature has been recently implemented, it allows to re-synchronize the counter on each edge of RX_DATA line. This is automatic and allows to improve the immunity of UART against signal distortion.

There is a special case when the *brm_clk* frequency is too low and is unable to capture a 0 pulse in IrDA. In this case, the software must set the IRSC (UCR4[5]) bit so that the reference clock (after internal divider) is used for the voting logic. The pulse is validated by counting the length of the pulse.

Refer to [Infrared Interface](#) for more details.

55.4.5.6 Baud Rate Automatic Detection Logic

When the baud rate automatic detection logic is enabled, the UART locks onto the incoming baud rate. To enable this feature, set the automatic detection of baud rate bit (ADBR = UCR1[14] = 1) and write 1 to the ADET bit (USR2[15]) to clear it.

When ADET=0 and ADBR =1, the detection starts. Then, once the beginning of start bit (transition from 1-to-0 of RX_DATA) has been detected, UART starts a counter (UBRC) working at reference frequency. Once the end of start bit is detected (transition from 0-to-1 of RX_DATA), the value of UBRC - 1 is directly copied into UBMR register. UBIR register is filled with 0x000F.

So, at the end of start bit, registers gets following values:

```
UBRC = number of reference clock periods (after divider) during Start bit.
UBIR = 0x000F
UBMR = UBRC - 1
```

The updated values of the 3 registers can be read.

See [Table 55-9](#) for list of parameters for baud rate detection and [Figure 55-7](#) for baud rate detection protocol diagram.

If any of the UART BRM registers are simultaneously written by the baud rate automatic detection logic and by the peripheral data bus, the peripheral data bus would have lower priority.

Table 55-9. Baud Rate Automatic Detection

ADBR	ADET	Baud Rate Detection	<i>interrupt_uart</i>
0	X	Manual Configuration	1
1	0	Auto Detection Started	1
1	1	Auto Detection Complete	0

NOTE: This table assumes that no other interrupt is set at the same time this interrupt is set for the *interrupt_uart* signal.

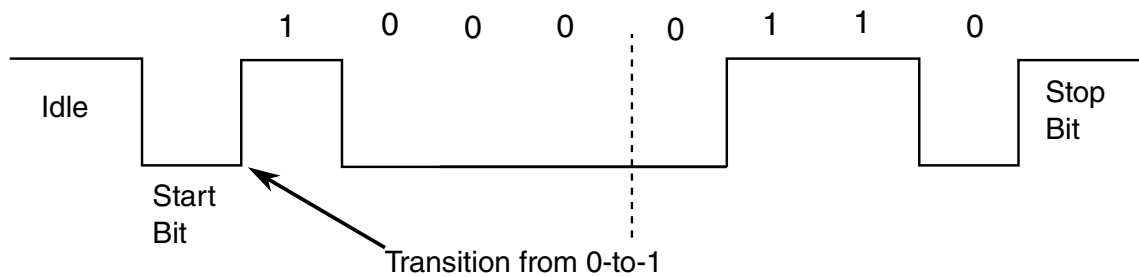

Note: LSB Transmitted first.

Figure 55-7. Baud Rate Detection Protocol Diagram

55.4.5.6.1 Baud Rate Automatic Detection Protocol

The receiver must receive an ASCII character "A" or "a" to verify proper detection of the incoming baud rate. When an ASCII character "A" (0x41) or "a" (0x61) is received and no error occurs, the Automatic Detect baud rate bit is set (ADET=1) and if the interrupt is enabled (ADEN=UCR1[15]=1), an interrupt *interrupt_uart* is generated.

When an ASCII character "A" or "a" is not received (because of a bit error or the reception of another character), the auto detection sequence restarts and waits for another 1-to-0 transition.

As long as ADET = 0 and ADBR = 1, the UART continues to try to lock onto the incoming baud rate. Once the ASCII character "A" or "a" is detected and the ADET bit is set, the receiver ignores the ADBR bit and continues normal operation with the calculated baud rate.

The UART interrupt is active (*interrupt_uart* = 0) as long as ADET = 1 and ADBR = 1. This can be disabled by clearing the automatic baud rate detection interrupt enable bit (ADEN = 0). Before starting an automatic baud rate detection sequence, set ADET = 0 and ADBR = 1.

The RxFIFO must contain the ASCII character "A" or "a" following the automatic baud rate detection interrupt.

The 16-bit UART Baud Rate Count Register (UBRC) is reset to 4 and stays at 0xFFFF when an overflow occurs. The UBRC register counts (measures) the duration of start bit. When the start bit is detected and counted, the UART Baud Rate Count Register retains its value until the next automatic baud rate detection sequence is initiated.

The Baud Rate Count Register counts only when auto detection is enabled.

55.4.5.6.2 New Baud Rate Determination

In order to fight against the problems caused by the distortion and the noise on the RX_DATA line, the duration of the baud rate measurement has been extended.

Previously, as described above, this determination was based on the measurement of the START bit duration. Now, this measurement is based on the duration of START bit + bit0. Bit0 is the first bit following the START bit. In fact, the counter which is started at the falling edge of START bit is no longer stopped at next rising edge (end of START bit), but it is stopped at the next falling edge (end of bit0). As the character sent is always a "A" (41h) or a "a" (61h), this second falling edge will always be present and it will indicate the end of bit0. Once this counter is stopped, the result is divided by 2 and used by the BRM to determine the incoming baud rate.

NOTE

UBRC register contains the result of this division by two, in consequence it reflects the measurement of the duration of one bit.

55.4.5.6.2.1 New Autobaud Counter Stopped bit and Interrupt

A new bit has been added in USR2 register: ACST (USR2[11]). This bit is set immediately after the determination of the baud rate.

So,

- if ADNIMP is not set (default), ACST is set to 1 after the end of bit0,
- If ADNIMP is set to 1, ACST is set to 1 at the end of START bit.

If ACIEN (UCR3[0]) is set to 1, ACST will flag an interrupt on *interrupt_uart* signal. This interrupt informs the Arm platform that the BRM has just been set with the result of the bit length measurement. If needed, the Arm platform can perform a read of UBMR (or UBRC) register and determine by itself the baud rate measured. Then the Arm platform has the possibility to correct the BRM registers with the nearest standardized baud rate.

NOTE

ACST is set only if ADBR is set to 1, for example, the UART is autobauding.

Clear the ACST bit by writing 1 to it. Writing 0 to the ACST bit has no effect.

55.4.6 Escape Sequence Detection

An escape sequence typically consists of 3 characters entered in rapid succession (such as +++). Because these are valid characters by themselves, the time between characters determines if it is a valid escape sequence.

Too much time between two of the "+" characters is interpreted as two "+" characters, and not part of an escape sequence.

The software chooses the escape character and writes its value to the UART Escape Character Register (UESC). The software must also enable escape detection feature by setting ESCEN (UCR2[11]) to 1. The hardware compares this value to incoming characters in the RxFIFO. When an escape character is detected, the internal escape timer starts to count. The software specifies a time-out value for the maximum allowable time between 2 successive escape characters (see the table below). The escape timer is programmable in intervals of 2 ms to a maximum interval of 8.192 seconds.

Table 55-10. Escape Timer Scaling

UTIM Register	Maximum Time Between Specified Escape Characters
0x000	2 ms
0x001	4 ms
0x002	6 ms
0x003	8 ms
0x004	10 ms
...	...
0F8	498 ms
0F9	500 ms
...	...
9C3	5 s
...	...
FFD	8.188 s
FFE	8.190 s
FFF	8.192 s
<p>NOTE: To calculate the time interval: $(UTIM_Value + 1) \times 0.002 = Time_Interval$ Example: $(09C3 + 1) \times 0.002 = 5\text{ s.}$</p>	

The escape sequence detection feature is available for all the reference frequencies. Before using Escape Sequence Detection, the user must fill the ONEMS register. This 24-bit register must contain the value of the UART internal frequency divided by 1000. The internal frequency is obtained after the UART internal divider which is applied on *module_clock* clock.

Example I:

- If the input clock *module_clock* frequency is 66.5 MHz.
- And if the input clock *module_clock* is divided by 2 with the internal divider:
UFCR[9:7] = 3'b100

$$\text{ONEMS} = \frac{66.5 \times 10^6}{2 \times 1000} = 33250 = 81E2\text{h}$$

Figure 55-8. Calculation of Frequency for ONEMS Register

Example II:

- If the input clock *module_clock* frequency is 66.5 MHz.
- And if the input clock *module_clock* is divided by 1 with the internal divider:
UFCR[9:7] = 3'b101

$$\text{ONEMS} = \frac{66.5 \times 10^6}{1000} = 66500 = 103C4\text{h}$$

Figure 55-9. Calculation of Frequency for ONEMS Register

The escape sequence detection interrupt is asserted when the escape sequence interrupt enable (ESCI) bit is set and an escape sequence is detected (ESCF set). Clear the ESCF bit by writing 1 to it. Writing 0 to the ESCF bit has no effect.

55.5 Binary Rate Multiplier (BRM)

The BRM sub-block receives *ref_clk* (*module_clock* clock after divider). From this clock, and with integer and non-integer division, BRM generates a 16x baud rate clock .

Binary Rate Multiplier (BRM)

The UART transmitter will shift data out based on this 16x baud rate clock. The UART receiver will sample the serial data line based on this 16x baud rate clock. The input and output frequency ratio is programmed in the UART BRM Incremental Register (UBIR) and UART BRM MOD Register (UBMR). The output frequency is divided by the input frequency to produce this ratio. For integer division, set the UBIR = 0x000F and write the divisor to the UBMR register. All values written to these registers must be one less than the actual value to eliminate division by 0 (undefined), and to increase the maximum range of the registers.

Updating the BRM registers requires writing to both registers. The UBIR register must be written before writing to the UBMR register. If only one register is written to by the software, the BRM continues to use the previous values.

The following examples show how to determine what values are to be programmed into UBIR and UBMR for a given reference frequency and desired baud rate. The following equation can be used to help determine these values:

$$\text{BaudRate} = \frac{\text{Ref Freq}}{\left(16 \times \frac{\text{UBMR} + 1}{\text{UBIR} + 1} \right)}$$

Figure 55-10. Frequency and Baud Rate for UBIR and UBMR

With:

Reference Frequency (Hz): UART Reference Frequency (*module_clock* after RFDIV divider)

Baud Rate (bit/s): Desired baud rate.

Integer Division ÷ 21

Reference Frequency = 19.44 MHz

UBIR = 0x000F

UBMR = 0x0014

Baud Rate = 925.7 kbit/s

NOTE

Observe that each value written to the registers is one less than the actual value.

Non-Integer Division

Reference Frequency = 16 MHz
 Desired Baud Rate = 920 Kbits/s

$$\frac{UBMR + 1}{UBIR + 1} = \frac{\text{RefFreq}}{16 \times \text{BaudRate}} = \frac{16 \times 10^6}{16 \times 920 \times 10^3} = 1.087$$

Ratio = 1.087 = 1087 / 1000
 UBIR = 999 (decimal) = 0x3E7
 UBMR = 1086 (decimal) = 0x43E
 Non-Integer Division
 Reference Frequency = 25 MHz
 Desired Baud Rate = 920 kbit/s
 Ratio = 1.69837 = 625 / 368
 UBIR = 367 (decimal) = 0x16F
 UBMR = 624 (decimal) = 0x270

Non-Integer Division

Reference Frequency: 30 MHz
 Desired Baud Rate = 115.2 kbit/s
 Ratio = 16.276043 = 65153 / 4003
 UBIR = 4002 (decimal) = 0x0FA2
 UBMR = 65152 (decimal) = 0xFE80

55.6 Infrared Interface

55.6.1 Generalities-Infrared

The Infrared interface is selected when IREN (UCR1[7]) is set to 1.

The Infrared Interface is compatible with IrDA Serial Infrared Physical Layer Specification. In this specification, a "zero" is represented by a positive pulse, and a "one" is represented by no pulse (line remains low).

In the UART:

In TX: For each "zero" to be transmitted, a narrow positive pulse which is 3/16 of a bit time is generated. For each "one" to be transmitted no pulse is generated (output is low). External circuitry has to be provided to drive an Infrared LED.

In RX: When receiving, a narrow negative pulse is expected for each "zero" transmitted while no pulse is expected for each "one" transmitted (input is high).

NOTE

Rx part of IR block expects to receive an inverted signal compared to IrDA specification. Circuitry external to the IC transforms the Infrared signal to an electrical signal.

The IR interface has an edge triggered interrupt (IRINT). This interrupt validates a zero bit being received. This interrupt is enabled by writing a "one" to ENIRI bit.

The behavior of Infrared Interface is determined by 3 bits INVT (UCR3[1]), INVR (UCR4[9]) and IRSC (UCR4[5]).

55.6.2 Inverted Transmission and Reception bits (INVT & INVR)

The values of INVT and INVR depend of the IrDA transceiver connected on the TXD_IR and RXD_IR pins of the UART. If this transceiver is not inverting on both paths Tx and Rx, a Zero is represented by a positive pulse and a One is represented by no pulse (line remains low). In this case, the bit INVT must be set to 0 and the bit INVR must be set to 1 (because Rx IR block expects an inverted signal).

On the contrary user must set INVT=1 and INVR=0 if both paths of the transceiver are inverting, that is, a Zero is represented as a negative pulse and a One is represented by no pulse (line remains high). The transceiver can also be inverting on only one path (Tx or Rx), in this case INVT and INVR must be together equal to 1 or to 0, depending on which path is inverted.

55.6.3 InfraRed Special Case (IRSC) Bit

The value to apply to IRSC bit is based on 2 parameters: the baud rate and the Minimum Pulse Duration (MPD) of the transceiver.

According to IrDA Standard Specification, for SIR (Serial IR) baud rates from 2.4 Kbit/s to 115.2 Kbit/s this nominal pulse duration is equal to 3/16 of a bit duration (at the selected baud rate). But, for all the baud rates a Minimum Pulse Duration is also specified. According to IrDA Standard, a Zero is represented by a light pulse, so the IrDA transceiver can't emit a light pulse shorter than the MPD. For SIR, the MPD is constant and equal to 1.41 μ s.

But user must take into account the electrical MPD associated with the transceiver on the receiver path. Typically this value is 2.0 μ s, but for some manufacturers MPD can go down to 1.0 μ s.

In order to understand the meaning of IRSC bit, one must understand how the RX path works in IrDA mode.

When the UART is in IrDA mode, a Zero is not only detected by the state of the RXD_IR line, but also with the duration of the pulse. This pulse duration can be measured with 2 different clocks. In this case, clock is selected with the IRSC bit.

- If IRSC = 0, the clock used is the BRM clock.
- If IRSC = 1, the clock used is the UART internal clock (UART clock after the divider (RFDIV)).

In normal operation, IRSC=0. This means that at any time, the user must ensure that the frequency of BRM_clock is high enough to measure the pulse. The pulse must last at least 2 BRM clock cycles. If this condition is not fulfilled, IRSC must be set to 1.

Let's examine two examples, for a Minimum Pulse Duration equal to the MPD from the IrDA SIR specification (i.e., 1.41 μ s).

1: Calculation of BRM Clock Period (Clock Period < 1.41 μ s)

The user wants to receive IrDA data at 115.2 Kbit/s. The UBIR and UBMR registers are set in order to create the BRM_clock with a frequency of $16 \times \text{baud rate} = 16 \times 115.2\text{K} = 1.843 \text{ MHz}$. But at the same time, in order to correctly detect the pulse, the user must be sure that $2 \times \text{BRM_clock period}$ is lower than 1.41 μ s. Lets check:

$$\text{BRM_clock period} = 1/1843000 = 542 \text{ ns}$$

So $2 \times \text{BRM_clock period} = 1.09 \mu\text{s} < 1.41 \mu\text{s}$. It is fine.

2: Calculation of BRM Clock Period (Clock Period > 1.41 μ s)

This time the user wants to receive at 19.2 Kbit/s. So, the BRM_clock is set to $16 \times 19200 = 307.2 \text{ kHz}$. Let's check if $2 \times \text{BRM_clock period} < 1.41 \mu\text{s}$:

1. $\text{BRM_clock period} = 1/307200 = 3.25 \mu\text{s}$

So $2 \times \text{BRM_clock period} = 6.50 \mu\text{s} \gg 1.41 \mu\text{s}$. It doesn't work.

So, in this case, the BRM clock can't be used to measure the pulse duration and the user must select the UART internal clock by setting IRSC =1.

NOTE

Like for Escape character detection, when IR Special Case is enabled (IRSC=1), the UART must measure a duration. In order to do that, the user must fill the ONEMS register. Refer to [Escape Sequence Detection](#).

55.6.4 IrDA interrupt

Serial infrared mode (SIR) uses an edge triggered interrupt flag IRINT (USR2[8]). When INVR =0, detection of a falling edge on the RXD pin asserts the IRINT bit. When INVR=1, detection of a rising edge on the RXD pin asserts the IRINT bit. When IRINT and ENIRI bits are both asserted, the *interrupt_uart* interrupt is asserted. Clear the IRINT bit by writing 1 to it. Writing 0 to the IRINT bit has no effect.

55.6.5 Conclusion about IrDA

Before using the UART in IrDA, the baud rate limit must be calculated. This baud rate limit will inform the user if IRSC bit has to be set or not.

Let's determine this limit:

As already described, if IRSC = 0, the following condition must always be fulfilled

$$2 \times \text{BRMClockPeriod} < \text{MinPulseDuration}$$

Figure 55-11. Calculation of Baud Rate

So,

$$\text{BRMClockFrequency} > \frac{2}{\text{MPD}}$$

So, knowing BRM_clock frequency = 16 * Baud Rate, we get:

$$\text{BaudRate} > \frac{1}{8 \times \text{MinPulseDuration}}$$

So, the user needs to set IRSC = 0 when:

- If Minimum Pulse Duration = 2.5 us and Baud Rate > 50 Kbit/s.
- If Minimum Pulse Duration = 2.0 us and Baud Rate > 62.5 Kbit/s.
- If Minimum Pulse Duration = 1.41 us and Baud Rate > 88.6 Kbit/s.

NOTE

For baud rates lower than the limit, IRSC must be set to 1.

55.6.6 Programming IrDA Interface

55.6.6.1 High Speed

As an example, the following sequence can be used to program the IrDA interface in order to send and receive characters at 115.2 Kbit/s.

Assumptions:

- Input UART clock = 90 MHz
- Internal clock divider = 3 (divide Input UART clock by 3)
- Baud rate = 115.2 Kbit/s
- IrDA transceiver is not inverting on both channels: for Tx and Rx, a Zero is represented by a positive pulse, and a One is represented by no pulse (line stays low).
- Interrupt: Sent to Arm platform when 1 char is received into the Rx FIFO (RDR)

Registers values and Programming orders:

```

UCR1 = 0x0085
UCR1[7] = IREN = 1: Enable IR interface
UCR1[0] = UARTEN = 1: Enable UART
UTS = 0x0000
UFCR = 0x0981
TXTL[5:0] = 0x02: Default value
RFDIV[2:0] = 0x3: Divide Input UART clock by 3 (resulting internal clock is 30 MHz)
RXTL[5:0] = 0x01: Default value
UBIR = 0x0202
UBMR = 0x20BE Baud rate = 115.2 kbit/s with internal clock = 30 MHz
UCR2 = 0x4027
UCR2[14] = IRTS = 1: Ignore level of RTS input signal
UCR2[5] = WS = 1: Characters are 8-bit length
UCR2[2] = TXEN = 1: Enable Rx path
UCR2[1] = RXEN = 1: Enable Tx path
UCR2[0] = SRST_B = 1: No software reset
UCR3 = 0x0000

UCR4 = 0x8201
CTSTL[5:0] = 0x20: Default value
UCR4[9] = INVR = 1: Inverted Infrared Reception (because IrDA transceiver is not inverting)
UCR4[1] = DREN = 1: To enable RDR interrupt (sent when one char is received)

```

The UART is ready to send a character as soon as there is a write into UTXD register. And an interrupt will be sent to Arm platform when a character is received.

55.6.6.2 Low Speed

This time, we keep the same assumptions but the speed is now 9.6 Kbit/s. So, this baud rate is below the limit (even with a Min. Pulse Duration of 2.5 us) and thus IRSC must be set to 1.

Assumptions:

- Input UART clock = 90 MHz
- Internal clock divider = 3 (divide Input UART clock by 3)
- Baud rate = 9.6 Kbit/s
- IrDA transceiver is not inverting on both channels: for Tx and Rx, a Zero is represented by a positive pulse, and a One is represented by no pulse (line stays low).
- Interrupt: Sent to Arm platform when 1 char is received into the Rx FIFO (RDR).

Registers values and Programming orders:

```

UCR1 = 0x0085
UCR1[7] = IREN = 1: Enable IR interface
UCR1[0] = UARTEN = 1: Enable UART
UFCR = 0x0981
UFCR[15:10] = TXTL[5:0] = 0x02: Default value
RFDIV[2:0] = 0x3: Divide Input UART clock by 3 (resulting internal clock is 30 MHz)
UFCR[5:0] = RXTL[5:0] = 0x01: Default value
UBIR = 0x00FF
UBMR = 0xC354 Baud rate = 9.6 kbit/s with internal clock = 30 MHz
UCR2 = 0x4027
UCR2[14] = IRTS = 1: Ignore level of RTS input signal
UCR2[5] = WS = 1: Characters are 8-bit length
UCR2[2] = TXEN = 1: Enable Rx path
UCR2 [1] = RXEN = 1: Enable Tx path
UCR2[0] = SRST_B = 1: No software reset
UCR3 = 0x0000
UCR3[1] = INVT = 0: Positive pulse represents 0.
UCR4 = 0x8221
UCR4[15:10] = CTSTL[5:0] = 0x20: Default value
UCR4[9] = INVR = 1: Inverted Infrared Reception (because IrDA transceiver is not inverting)
UCR4[5] = IRSC = 1: Because data rate is below the limit and thus the UART internal clock is
used to measure the pulse duration.
UCR4[1] = DREN = 1: To enable RDR interrupt (sent when one char is received)

```

The UART is now ready to send a character as soon as there is a write into UTXD register. An interrupt will be sent to Arm platform when a character is received.

55.7 9-bit RS-485 Mode

55.7.1 Generalities

The UART provides a 9-bit mode to facilitate multidrop (RS-485) network communication. To enable this mode, set MDEN bit in the UMCR register to 1. When 9-bit RS-485 mode is enabled, UART transmitter can transmit the ninth bit (9th bit) set by TXB8, and UART receiver can differentiate between data frames (9th bit = 0) and address frames (9th bit = 1).

The CTS_B pin can be used to control RS-485 output driver outside the chip.

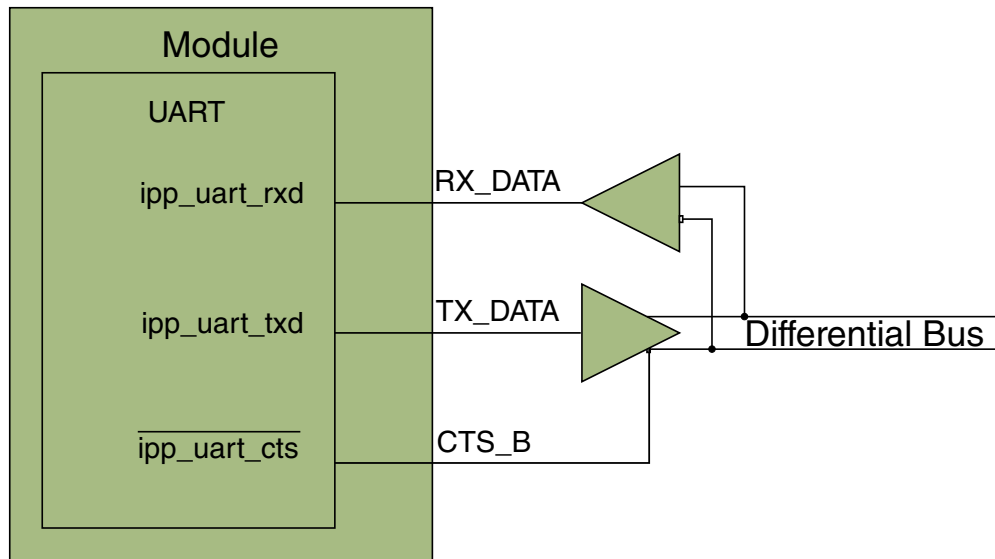

Figure 55-12. RS-485 driver connection (UART in DCE mode)

55.7.2 Transmit 9-bit RS-485 frames

To transmit 9-bit RS-485 frames, user need to enable parity (PREN=1) to enable trasmitting the ninth data bit, set 8-bit data word size (WS=1), and write TXB8 (UMCR[2]) as the 9th bit (bit [8]) to be transmitted (write '0' to TXB8 to transmit a data frame, write '1' to transmit a address frame). The other data bit [7:0] is written to TxFIFO by writing to the UTXD same as normal RS-232 operation.

55.7.3 Receive 9-bit RS-485 frames

To receive 9-bit RS-485 frames, user need to enable parity (PREN=1) to enable receiving the ninth data bit, set 8-bit data word size (WS=1). The receiver will save the 9-bit data to RxFIFO, and user should read the 9th databit (bit [8]) by reading the PRERR (URXD[10]) bit, and read data bit [7:0] by reading the RX_DATA (URXD[7:0]).

There are two slave address detect modes, normal detect mode and automatic detect mode, and can be selected by SLAM (UMCR[1]).

55.7.3.1 RS-485 Slave Address Normal Detect Mode

To enable Normal Detect mode, clear SLAM (UMCR[1] to 0). The receiver ignores all data frames (9th bit = 0) until an address frame is received (9th bit = 1). At that time, the slave address detected (SAD = USR1[3]) bit is asserted and the *interrupt_uart* interrupt is generated (if SADEN = UMCR[3] = 1). The address byte and subsequent bytes are all put into RxFIFO along with their 9th bit. The UART will also generate DMA request *dma_req_rx* when the RxFIFO reaches the selected threshold (controlled by RXTL) if receive ready DMA (RXDMAEN = UCR1[8]) request is enabled.

User should read the 9th databit (bit [8]) by reading the PRERR (URXD[10]) bit, and read data bit [7:0] by reading the RX_DATA (URXD[7:0]).

In this mode, once the UART has detected a 9th bit is equal to '1', it will always save the subsequent frames to RxFIFO. So the software must decide whether the address and data in RxFIFO are needed or not.

55.7.3.2 RS-485 Slave Address Automatic Detect Mode

To enable Automatic Detect Mode, set SLAM (UMCR[1]) to 1. The receiver tries to detect an address byte (frame 9th bit = 1) that matches the programmed SLADDR (UMCR[15:8]) character. If the received byte is a data or an address byte that does not match the programmed SLADDR character, the receiver will discard these data.

Once the UART receives a matching address byte, it will assert the slave address detected (SAD = USR1[3]) bit and the *interrupt_uart* interrupt will be generated (if SADEN = UMCR[3] = 1). The address byte and subsequent bytes are all put into RxFIFO along with their 9th bit. If receive ready DMA (RXDMAEN = UCR1[8]) request is enabled, the UART will also generate DMA request *dma_req_rx* when the RxFIFO reaches the selected threshold (controlled by RXTL).

If another address byte is received and this address byte does not match SLADDR character, the receiver will discard the address byte and subsequent data byte. If the address byte again matches SLADDR character, the receiver will put this address byte and subsequent data byte in the RxFIFO along with their 9th bit.

User should read the 9th databit (bit [8]) by reading the PRERR (URXD[10]) bit, and read data bit [7:0] by reading the RX_DATA (URXD[7:0]).

See [Initialization](#) for 9-bit RS-485 programming guide.

55.8 Low Power Modes

These modes are controlled by the signals *doze_req* and *stop_req*. The control/status/data registers won't change when getting in/out of low power modes.

Table 55-11. UART Low Power State Operation

	Normal State (<i>doze_req</i> = 1'b0 & <i>stop_req</i> = 1'b0)	Doze State (<i>doze_req</i> = 1'b1)		Stop State (<i>stop_req</i> = 1'b1)
		DOZE bit = 0	DOZE bit = 1	
UART-Clock	ON	ON	ON	OFF
UART Serial / IrDA	ON	ON	OFF	OFF

55.8.1 UART Operation in System Doze Mode

While in Doze State (when *doze_req* input pin is set to 1'b1), the UART behavior depends on the DOZE (UCR1[1]) control bit.

While the DOZE bit is negated, the UART serial interface is enabled. While the system is in the Doze State, and the DOZE bit is asserted, the UART is disabled. If the Doze State is entered with the DOZE bit asserted while the UART serial interface was receiving or transmitting data, it will complete the receive/transmit of the current character and signal to the far-end transmitter/receiver to stop sending/receiving.

55.8.2 UART Operation in System Stop Mode

The internal baud rate clocks of the transmitter and receiver are gated off if the *stop_req* signal to UART is asserted. Even though the clocks at the input of the UART continue to run during system Stop mode, the UART will not do any transmission or reception.

The following UART interrupts wake the Arm platform processor from STOP mode:

- RTS (RTSD)
- IrDA Asynchronous WAKE (AIRINT)
- Asynchronous WAKE (AWAKE)
- RI (RIDELT in DTE mode only)
- DCD (DCDDELTA in DTE mode only)
- DTR (DTRD in DCE mode only)
- DSR (DTRD in DTE mode only)

When an asynchronous WAKE (awake) interrupt exits the Arm platform from STOP mode, make sure that a dummy character is sent first because the first character may not be received correctly.

55.8.3 Power Saving Method in UART

The RXEN (UCR2[1]), TXEN (UCR2[2]) and UARTEN (UCR1[0]) bits are set by the user and provide software control of low-power modes.

Setting the UARTEN (UCR1[0]) bit to 0 shuts off the receiver and transmitter logic and the associated clocks.

If the UART is used only in transmit mode, UARTEN and TXEN must be set to 1. If the UART is used only in receive mode, UARTEN and RXEN must be set to 1. Setting TXEN or RXEN to 0 allows to save a lot of power.

55.9 UART Operation in System Debug State

The bit UTS [11] controls whether the UART will respond to the input signal *debug_req*, or whether it will continue to run as normal.

If the UART is programmed to respond to *debug_req*:

1. The UART will halt all operations upon detecting the *debug_req* input.
2. A transfer in progress, either to/from a core (using the IP Bus interface) or to/from an external device, will be completed before halting. This means a single byte/word transfer, not an entire FIFO. Reception of any further data from an external device will be disabled.
3. Internal registers will continue to be writable and readable using the IP Bus interface. A read will leave the contents unaffected.
4. The RX FIFO is affected in debug mode in the following way:
 - All writes into the RX FIFO are prevented.
 - The bit RXDBG (UTS[9]) is used to select the readability of the RX FIFO during debug mode:

RXDBG = 0: hold the read pointer at the location it had upon entering debug mode, and URXD register returns only the data value at that location, no matter how many reads attempted.

RXDBG = 1, selectable at any time: Allow to read the characters received in Rx FIFO. It will not be possible to re-read previously read locations, nor will it be possible to readjust the read pointer to the value it had prior to entering debug mode.

55.10 Reset

This section describes how to reset the block and explains special requirements related to reset.

55.10.1 Hardware reset

All of registers, FIFOs, state machines and sequential elements can be reset to their initial values by hardware reset or power on reset.

55.10.2 Software reset

The status registers USR1 and USR2, BRM registers UBIR and UBMR, TxFIFO and RxFIFO, and transmitter and receiver state machines can be reset by software reset. Internal logic will keep the software reset asserted for about 4 *module_clock* cycles.

Programmer can follow the following software reset sequence:

1. Clear the SRST_B bit (UCR2[0])
2. Wait for software reset complete: poll SOFTRST bit (UTS[0]) until it is 0.
3. Re-program baud rate registers: Re-write UBIR and UBMR.

55.11 Transfer Error

The UART can generate a transfer error on the peripheral bus in the following cases:

- Core is writing into a read-only register.
- Core is accessing (read or write) an unused location within the assigned address space reserved to UART.

Functional Timing

- Core is writing into UTXD register with transmit interface disabled (TXEN=0 or UARTEN=0)
- Core is reading URXD register with receive interface disabled (RXEN=0 or UARTEN=0)

55.12 Functional Timing

This section includes timing diagrams for functional signaling.

55.12.1 IrDA Mode

According to IrDA specification, the low speed (115.2Kbit/s and below) IR frame format is compatible with UART frame.

In this figure, an example data 0x65 is used.

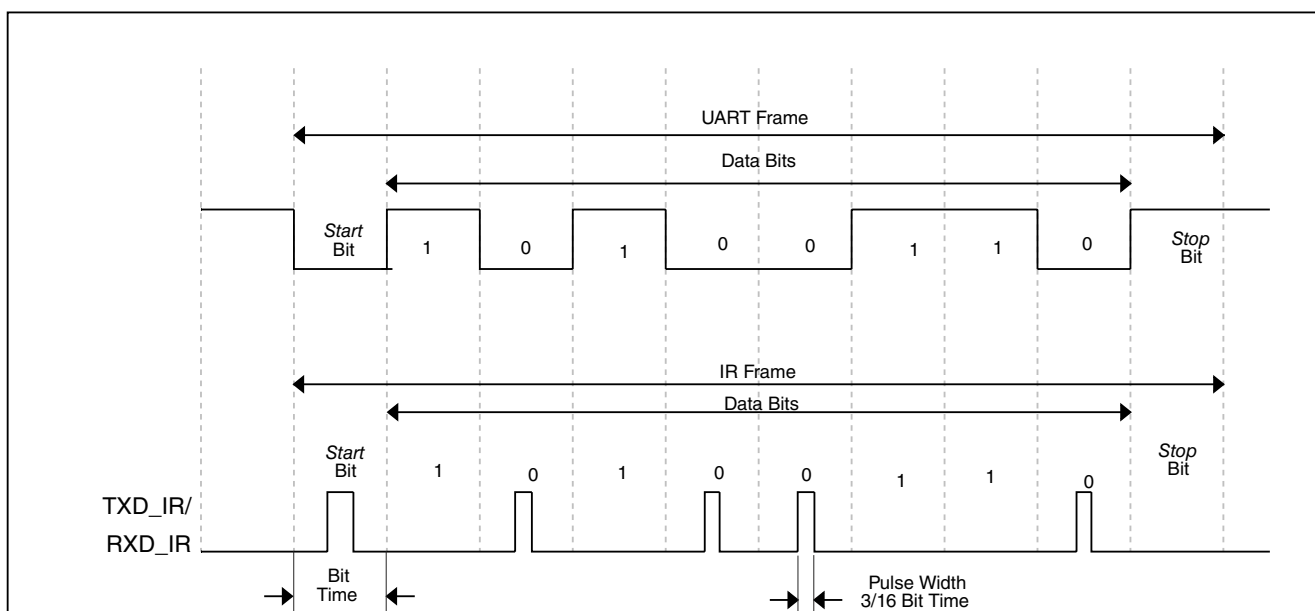

Figure 55-13. Timing diagram of Low Speed IR (<=115.2 Kbit/s) Data Line

55.13 Initialization

55.13.1 Programming the UART in RS-232 mode

As an example, the following sequence can be used to program the UART in order to send and receive characters in RS-232 mode.

Assumptions:

- Input uart clock = 100 MHz
- Baud rate = 921.6 Kbps
- Data bits = 8 bits
- Parity = Even
- Stop bits = 1 bit
- Flow control = Hardware

Main program:

1. UCR1 = 0x0001

Enable the UART.

2. UCR2 = 0x2127

Set hardware flow control, data format and enable transmitter and receiver.

3. UCR3 = 0x0704

Set UCR3[RXDMUXSEL] = 1.

4. UCR4 = 0x7C00

Set CTS trigger level to 31,

5. UFCR = 0x089E

Set internal clock divider = 5 (divide input uart clock by 5). So the reference clock is $100 \text{ MHz}/5 = 20 \text{ MHz}$.

Set TXTL = 2 and RXTL = 30.

6. UBIR = 0x08FF

7. UBMR = 0x0C34

In the above two steps, set baud rate to 921.6Kbps based on the 20MHz reference clock.

8. UCR1 = 0x2201

Enable the TRDY and RRDY interrupts.

9. UMCR = 0x0000

UMCR stay at default value 0x0000

Interrupt service routine for the transmitter:

- Write characters into UTXD

The TRDY interrupt will be automatically de-asserted when the data level of the TxFIFO exceeds the TXCTL=2. Note: For the first time the interrupt may be de-asserted after 4 characters are written into the TxFIFO because of the shift register.

Interrupt service routine for the receiver:

- Read characters from URXD

The RRDY interrupt will be automatically de-asserted when the data level of the RxFIFO is below the RXCTL=30.

55.13.2 Programming the UART in 9-bit RS-485 mode

As an example, the following sequence can be used to program the UART in order to send and receive frames in RS-485 mode.

Assumptions:

- Input uart clock = 100 MHz
- Baud rate = 5 Mbps

Main program:

1. UCR1 = 0x0001

Enable the UART.

2. UCR2 = 0x4127

Set software flow control ($\overline{\text{CTS}}$ pin is controlled by UCR2[12]), enable parity(enable 9th bit rxd/txd), 8-bit word size , and enable transmitter and receiver.

3. UCR4 = 0x7C00

Set CTS trigger level to 31,

4. UFCR = 0x0A9E

Set RFDIV = 5 (divide input uart clock by 1), so the reference clock is 100 MHz. Set UART in DCE mode (RS-485 driver connection outside the chip is the same as [Figure 55-12](#))

Set TXTL = 2 and RXTL = 30.

5. UBIR = 0x0003
6. UBMR = 0x0004

In the above two steps, set baud rate to 5 Mbps based on the 100 MHz reference clock.

7. UCR1 = 0x2001 when UART as a master ,
or UCR1 = 0x0201 (or 0x0101) when UART as a slave.

Enable TRDY interrupt when UART as a master, enable RRDY interrupt or DMA request when UART as a slave.

8. UMCR = 0xA50B

Enable 9-bit RS-485 mode, enable SAD interrupt, set automatic slave address detect mode, set slave address is 0xA5.

Interrupt service routine for the transmitter:

- Transmit data: write its ninth bit (bit[8]) to UMCR[2], write its bit [7:0] into UTXD[7:0]

The TRDY interrupt will be automatically de-asserted when the data level of the Tx FIFO exceeds the TXTL=2.

Note: For the first time the interrupt may be de-asserted after 4 characters are written into the Tx FIFO because of the shift register.

Interrupt service routine for the receiver:

- Receive data: read its ninth bit (bit[8]) from URXD[10] , read its bit [7:0] from URXD[7:0].

Note: in RS-485 mode, URXD[10] bit is not the parity error, instead it holds the ninth bit (bit[8]) of the received data.

The SAD interrupt can not de-assert automatically, it needs MCU write 1 to USR1[3] to clear it . The RRDY interrupt or DMA request will be automatically de-asserted when the data level of the Rx FIFO is below the RXTL=30.

55.14 References

- EIA/TIA-232-F Interface Standard

<http://www.eia.org>, <http://www.tiaonline.org/standards>

- IrDA Standard

<http://www.irda.org>

55.15 UART Memory Map/Register Definition

UART supports 8-bit, 16-bit and 32-bit accesses to 32-bit memory-mapped addresses. Any access to unmapped memory location will yield a transfer error.

All registers except the ONEMS described in this section are 16-bit registers. The ONEMS register is a 24-bit register.

- For 32-bit write accesses, the upper two bytes will not be taken into account.
- For 32-bit read accesses the upper two bytes will return 0.

The ONEMS register is expanded from 16 bits to 24 bits in order to support the high frequency of the BRM internal clock *ref_clk* (*module_clock* after divider). The ONEMS register can be accessed as 8 bits, 16 bits or 32 bits.

- For 32-bit write accesses, the most significant byte of the ONEMS will be discarded.
- For 32-bit read accesses, the most significant byte of the ONEMS will be read as 0.

UART memory map

Absolute address (hex)	Register name	Width (in bits)	Access	Reset value	Section/page
201_8000	UART Receiver Register (UART7_URXD)	32	R	0000_0000h	55.15.1/3615
201_8040	UART Transmitter Register (UART7_UTXD)	32	W	0000_0000h	55.15.2/3617
201_8080	UART Control Register 1 (UART7_UCR1)	32	R/W	0000_0000h	55.15.3/3618
201_8084	UART Control Register 2 (UART7_UCR2)	32	R/W	0000_0001h	55.15.4/3620
201_8088	UART Control Register 3 (UART7_UCR3)	32	R/W	0000_0700h	55.15.5/3623
201_808C	UART Control Register 4 (UART7_UCR4)	32	R/W	0000_8000h	55.15.6/3625
201_8090	UART FIFO Control Register (UART7_UFCR)	32	R/W	0000_0801h	55.15.7/3627

Table continues on the next page...

UART memory map (continued)

Absolute address (hex)	Register name	Width (in bits)	Access	Reset value	Section/page
201_8094	UART Status Register 1 (UART7_USR1)	32	R/W	0000_2040h	55.15.8/3629
201_8098	UART Status Register 2 (UART7_USR2)	32	R/W	0000_4028h	55.15.9/3632
201_809C	UART Escape Character Register (UART7_UESC)	32	R/W	0000_002Bh	55.15.10/3634
201_80A0	UART Escape Timer Register (UART7_UTIM)	32	R/W	0000_0000h	55.15.11/3635
201_80A4	UART BRM Incremental Register (UART7_UBIR)	32	R/W	0000_0000h	55.15.12/3635
201_80A8	UART BRM Modulator Register (UART7_UBMR)	32	R/W	0000_0000h	55.15.13/3636
201_80AC	UART Baud Rate Count Register (UART7_UBRC)	32	R	0000_0004h	55.15.14/3636
201_80B0	UART One Millisecond Register (UART7_ONEMS)	32	R/W	0000_0000h	55.15.15/3637
201_80B4	UART Test Register (UART7_UTS)	32	R/W	0000_0060h	55.15.16/3638
201_80B8	UART RS-485 Mode Control Register (UART7_UMCR)	32	R/W	0000_0000h	55.15.17/3639
202_0000	UART Receiver Register (UART1_URXD)	32	R	0000_0000h	55.15.1/3615
202_0040	UART Transmitter Register (UART1_UTXD)	32	W	0000_0000h	55.15.2/3617
202_0080	UART Control Register 1 (UART1_UCR1)	32	R/W	0000_0000h	55.15.3/3618
202_0084	UART Control Register 2 (UART1_UCR2)	32	R/W	0000_0001h	55.15.4/3620
202_0088	UART Control Register 3 (UART1_UCR3)	32	R/W	0000_0700h	55.15.5/3623
202_008C	UART Control Register 4 (UART1_UCR4)	32	R/W	0000_8000h	55.15.6/3625
202_0090	UART FIFO Control Register (UART1_UFCR)	32	R/W	0000_0801h	55.15.7/3627
202_0094	UART Status Register 1 (UART1_USR1)	32	R/W	0000_2040h	55.15.8/3629
202_0098	UART Status Register 2 (UART1_USR2)	32	R/W	0000_4028h	55.15.9/3632
202_009C	UART Escape Character Register (UART1_UESC)	32	R/W	0000_002Bh	55.15.10/3634
202_00A0	UART Escape Timer Register (UART1_UTIM)	32	R/W	0000_0000h	55.15.11/3635
202_00A4	UART BRM Incremental Register (UART1_UBIR)	32	R/W	0000_0000h	55.15.12/3635

Table continues on the next page...

UART memory map (continued)

Absolute address (hex)	Register name	Width (in bits)	Access	Reset value	Section/page
202_00A8	UART BRM Modulator Register (UART1_UBMR)	32	R/W	0000_0000h	55.15.13/3636
202_00AC	UART Baud Rate Count Register (UART1_UBRC)	32	R	0000_0004h	55.15.14/3636
202_00B0	UART One Millisecond Register (UART1_ONEMS)	32	R/W	0000_0000h	55.15.15/3637
202_00B4	UART Test Register (UART1_UTS)	32	R/W	0000_0060h	55.15.16/3638
202_00B8	UART RS-485 Mode Control Register (UART1_UMCR)	32	R/W	0000_0000h	55.15.17/3639
21E_8000	UART Receiver Register (UART2_URXD)	32	R	0000_0000h	55.15.1/3615
21E_8040	UART Transmitter Register (UART2_UTXD)	32	W	0000_0000h	55.15.2/3617
21E_8080	UART Control Register 1 (UART2_UCR1)	32	R/W	0000_0000h	55.15.3/3618
21E_8084	UART Control Register 2 (UART2_UCR2)	32	R/W	0000_0001h	55.15.4/3620
21E_8088	UART Control Register 3 (UART2_UCR3)	32	R/W	0000_0700h	55.15.5/3623
21E_808C	UART Control Register 4 (UART2_UCR4)	32	R/W	0000_8000h	55.15.6/3625
21E_8090	UART FIFO Control Register (UART2_UFCR)	32	R/W	0000_0801h	55.15.7/3627
21E_8094	UART Status Register 1 (UART2_USR1)	32	R/W	0000_2040h	55.15.8/3629
21E_8098	UART Status Register 2 (UART2_USR2)	32	R/W	0000_4028h	55.15.9/3632
21E_809C	UART Escape Character Register (UART2_UESC)	32	R/W	0000_002Bh	55.15.10/3634
21E_80A0	UART Escape Timer Register (UART2_UTIM)	32	R/W	0000_0000h	55.15.11/3635
21E_80A4	UART BRM Incremental Register (UART2_UBIR)	32	R/W	0000_0000h	55.15.12/3635
21E_80A8	UART BRM Modulator Register (UART2_UBMR)	32	R/W	0000_0000h	55.15.13/3636
21E_80AC	UART Baud Rate Count Register (UART2_UBRC)	32	R	0000_0004h	55.15.14/3636
21E_80B0	UART One Millisecond Register (UART2_ONEMS)	32	R/W	0000_0000h	55.15.15/3637
21E_80B4	UART Test Register (UART2_UTS)	32	R/W	0000_0060h	55.15.16/3638
21E_80B8	UART RS-485 Mode Control Register (UART2_UMCR)	32	R/W	0000_0000h	55.15.17/3639

UART memory map (continued)

Absolute address (hex)	Register name	Width (in bits)	Access	Reset value	Section/page
21E_C000	UART Receiver Register (UART3_URXD)	32	R	0000_0000h	55.15.1/3615
21E_C040	UART Transmitter Register (UART3_UTXD)	32	W	0000_0000h	55.15.2/3617
21E_C080	UART Control Register 1 (UART3_UCR1)	32	R/W	0000_0000h	55.15.3/3618
21E_C084	UART Control Register 2 (UART3_UCR2)	32	R/W	0000_0001h	55.15.4/3620
21E_C088	UART Control Register 3 (UART3_UCR3)	32	R/W	0000_0700h	55.15.5/3623
21E_C08C	UART Control Register 4 (UART3_UCR4)	32	R/W	0000_8000h	55.15.6/3625
21E_C090	UART FIFO Control Register (UART3_UFCR)	32	R/W	0000_0801h	55.15.7/3627
21E_C094	UART Status Register 1 (UART3_USR1)	32	R/W	0000_2040h	55.15.8/3629
21E_C098	UART Status Register 2 (UART3_USR2)	32	R/W	0000_4028h	55.15.9/3632
21E_C09C	UART Escape Character Register (UART3_UESC)	32	R/W	0000_002Bh	55.15.10/3634
21E_C0A0	UART Escape Timer Register (UART3_UTIM)	32	R/W	0000_0000h	55.15.11/3635
21E_C0A4	UART BRM Incremental Register (UART3_UBIR)	32	R/W	0000_0000h	55.15.12/3635
21E_C0A8	UART BRM Modulator Register (UART3_UBMR)	32	R/W	0000_0000h	55.15.13/3636
21E_C0AC	UART Baud Rate Count Register (UART3_UBRC)	32	R	0000_0004h	55.15.14/3636
21E_C0B0	UART One Millisecond Register (UART3_ONEMS)	32	R/W	0000_0000h	55.15.15/3637
21E_C0B4	UART Test Register (UART3_UTS)	32	R/W	0000_0060h	55.15.16/3638
21E_C0B8	UART RS-485 Mode Control Register (UART3_UMCR)	32	R/W	0000_0000h	55.15.17/3639
21F_0000	UART Receiver Register (UART4_URXD)	32	R	0000_0000h	55.15.1/3615
21F_0040	UART Transmitter Register (UART4_UTXD)	32	W	0000_0000h	55.15.2/3617
21F_0080	UART Control Register 1 (UART4_UCR1)	32	R/W	0000_0000h	55.15.3/3618
21F_0084	UART Control Register 2 (UART4_UCR2)	32	R/W	0000_0001h	55.15.4/3620
21F_0088	UART Control Register 3 (UART4_UCR3)	32	R/W	0000_0700h	55.15.5/3623

Table continues on the next page...

UART memory map (continued)

Absolute address (hex)	Register name	Width (in bits)	Access	Reset value	Section/page
21F_008C	UART Control Register 4 (UART4_UCR4)	32	R/W	0000_8000h	55.15.6/3625
21F_0090	UART FIFO Control Register (UART4_UFCR)	32	R/W	0000_0801h	55.15.7/3627
21F_0094	UART Status Register 1 (UART4_USR1)	32	R/W	0000_2040h	55.15.8/3629
21F_0098	UART Status Register 2 (UART4_USR2)	32	R/W	0000_4028h	55.15.9/3632
21F_009C	UART Escape Character Register (UART4_UESC)	32	R/W	0000_002Bh	55.15.10/3634
21F_00A0	UART Escape Timer Register (UART4_UTIM)	32	R/W	0000_0000h	55.15.11/3635
21F_00A4	UART BRM Incremental Register (UART4_UBIR)	32	R/W	0000_0000h	55.15.12/3635
21F_00A8	UART BRM Modulator Register (UART4_UBMR)	32	R/W	0000_0000h	55.15.13/3636
21F_00AC	UART Baud Rate Count Register (UART4_UBRC)	32	R	0000_0004h	55.15.14/3636
21F_00B0	UART One Millisecond Register (UART4_ONEMS)	32	R/W	0000_0000h	55.15.15/3637
21F_00B4	UART Test Register (UART4_UTS)	32	R/W	0000_0060h	55.15.16/3638
21F_00B8	UART RS-485 Mode Control Register (UART4_UMCR)	32	R/W	0000_0000h	55.15.17/3639
21F_4000	UART Receiver Register (UART5_URXD)	32	R	0000_0000h	55.15.1/3615
21F_4040	UART Transmitter Register (UART5_UTXD)	32	W	0000_0000h	55.15.2/3617
21F_4080	UART Control Register 1 (UART5_UCR1)	32	R/W	0000_0000h	55.15.3/3618
21F_4084	UART Control Register 2 (UART5_UCR2)	32	R/W	0000_0001h	55.15.4/3620
21F_4088	UART Control Register 3 (UART5_UCR3)	32	R/W	0000_0700h	55.15.5/3623
21F_408C	UART Control Register 4 (UART5_UCR4)	32	R/W	0000_8000h	55.15.6/3625
21F_4090	UART FIFO Control Register (UART5_UFCR)	32	R/W	0000_0801h	55.15.7/3627
21F_4094	UART Status Register 1 (UART5_USR1)	32	R/W	0000_2040h	55.15.8/3629
21F_4098	UART Status Register 2 (UART5_USR2)	32	R/W	0000_4028h	55.15.9/3632
21F_409C	UART Escape Character Register (UART5_UESC)	32	R/W	0000_002Bh	55.15.10/3634

Table continues on the next page...

UART memory map (continued)

Absolute address (hex)	Register name	Width (in bits)	Access	Reset value	Section/page
21F_40A0	UART Escape Timer Register (UART5_UTIM)	32	R/W	0000_0000h	55.15.11/ 3635
21F_40A4	UART BRM Incremental Register (UART5_UBIR)	32	R/W	0000_0000h	55.15.12/ 3635
21F_40A8	UART BRM Modulator Register (UART5_UBMR)	32	R/W	0000_0000h	55.15.13/ 3636
21F_40AC	UART Baud Rate Count Register (UART5_UBRC)	32	R	0000_0004h	55.15.14/ 3636
21F_40B0	UART One Millisecond Register (UART5_ONEMS)	32	R/W	0000_0000h	55.15.15/ 3637
21F_40B4	UART Test Register (UART5_UTS)	32	R/W	0000_0060h	55.15.16/ 3638
21F_40B8	UART RS-485 Mode Control Register (UART5_UMCR)	32	R/W	0000_0000h	55.15.17/ 3639
21F_C000	UART Receiver Register (UART6_URXD)	32	R	0000_0000h	55.15.1/ 3615
21F_C040	UART Transmitter Register (UART6_UTXD)	32	W	0000_0000h	55.15.2/ 3617
21F_C080	UART Control Register 1 (UART6_UCR1)	32	R/W	0000_0000h	55.15.3/ 3618
21F_C084	UART Control Register 2 (UART6_UCR2)	32	R/W	0000_0001h	55.15.4/ 3620
21F_C088	UART Control Register 3 (UART6_UCR3)	32	R/W	0000_0700h	55.15.5/ 3623
21F_C08C	UART Control Register 4 (UART6_UCR4)	32	R/W	0000_8000h	55.15.6/ 3625
21F_C090	UART FIFO Control Register (UART6_UFCR)	32	R/W	0000_0801h	55.15.7/ 3627
21F_C094	UART Status Register 1 (UART6_USR1)	32	R/W	0000_2040h	55.15.8/ 3629
21F_C098	UART Status Register 2 (UART6_USR2)	32	R/W	0000_4028h	55.15.9/ 3632
21F_C09C	UART Escape Character Register (UART6_UESC)	32	R/W	0000_002Bh	55.15.10/ 3634
21F_C0A0	UART Escape Timer Register (UART6_UTIM)	32	R/W	0000_0000h	55.15.11/ 3635
21F_C0A4	UART BRM Incremental Register (UART6_UBIR)	32	R/W	0000_0000h	55.15.12/ 3635
21F_C0A8	UART BRM Modulator Register (UART6_UBMR)	32	R/W	0000_0000h	55.15.13/ 3636
21F_C0AC	UART Baud Rate Count Register (UART6_UBRC)	32	R	0000_0004h	55.15.14/ 3636
21F_C0B0	UART One Millisecond Register (UART6_ONEMS)	32	R/W	0000_0000h	55.15.15/ 3637

Table continues on the next page...

UART memory map (continued)

Absolute address (hex)	Register name	Width (in bits)	Access	Reset value	Section/page
21F_C0B4	UART Test Register (UART6_UTS)	32	R/W	0000_0060h	55.15.16/3638
21F_C0B8	UART RS-485 Mode Control Register (UART6_UMCR)	32	R/W	0000_0000h	55.15.17/3639
228_8000	UART Receiver Register (UART8_URXD)	32	R	0000_0000h	55.15.1/3615
228_8040	UART Transmitter Register (UART8_UTXD)	32	W	0000_0000h	55.15.2/3617
228_8080	UART Control Register 1 (UART8_UCR1)	32	R/W	0000_0000h	55.15.3/3618
228_8084	UART Control Register 2 (UART8_UCR2)	32	R/W	0000_0001h	55.15.4/3620
228_8088	UART Control Register 3 (UART8_UCR3)	32	R/W	0000_0700h	55.15.5/3623
228_808C	UART Control Register 4 (UART8_UCR4)	32	R/W	0000_8000h	55.15.6/3625
228_8090	UART FIFO Control Register (UART8_UFCR)	32	R/W	0000_0801h	55.15.7/3627
228_8094	UART Status Register 1 (UART8_USR1)	32	R/W	0000_2040h	55.15.8/3629
228_8098	UART Status Register 2 (UART8_USR2)	32	R/W	0000_4028h	55.15.9/3632
228_809C	UART Escape Character Register (UART8_UESC)	32	R/W	0000_002Bh	55.15.10/3634
228_80A0	UART Escape Timer Register (UART8_UTIM)	32	R/W	0000_0000h	55.15.11/3635
228_80A4	UART BRM Incremental Register (UART8_UBIR)	32	R/W	0000_0000h	55.15.12/3635
228_80A8	UART BRM Modulator Register (UART8_UBMR)	32	R/W	0000_0000h	55.15.13/3636
228_80AC	UART Baud Rate Count Register (UART8_UBRC)	32	R	0000_0004h	55.15.14/3636
228_80B0	UART One Millisecond Register (UART8_ONEMS)	32	R/W	0000_0000h	55.15.15/3637
228_80B4	UART Test Register (UART8_UTS)	32	R/W	0000_0060h	55.15.16/3638
228_80B8	UART RS-485 Mode Control Register (UART8_UMCR)	32	R/W	0000_0000h	55.15.17/3639

55.15.1 UART Receiver Register (UARTx_URXD)

NOTE

The UART will yield a transfer error on the peripheral bus when core is reading URXD register with receive interface disabled (RXEN=0 or UARTEN=0).

Address: Base address + 0h offset

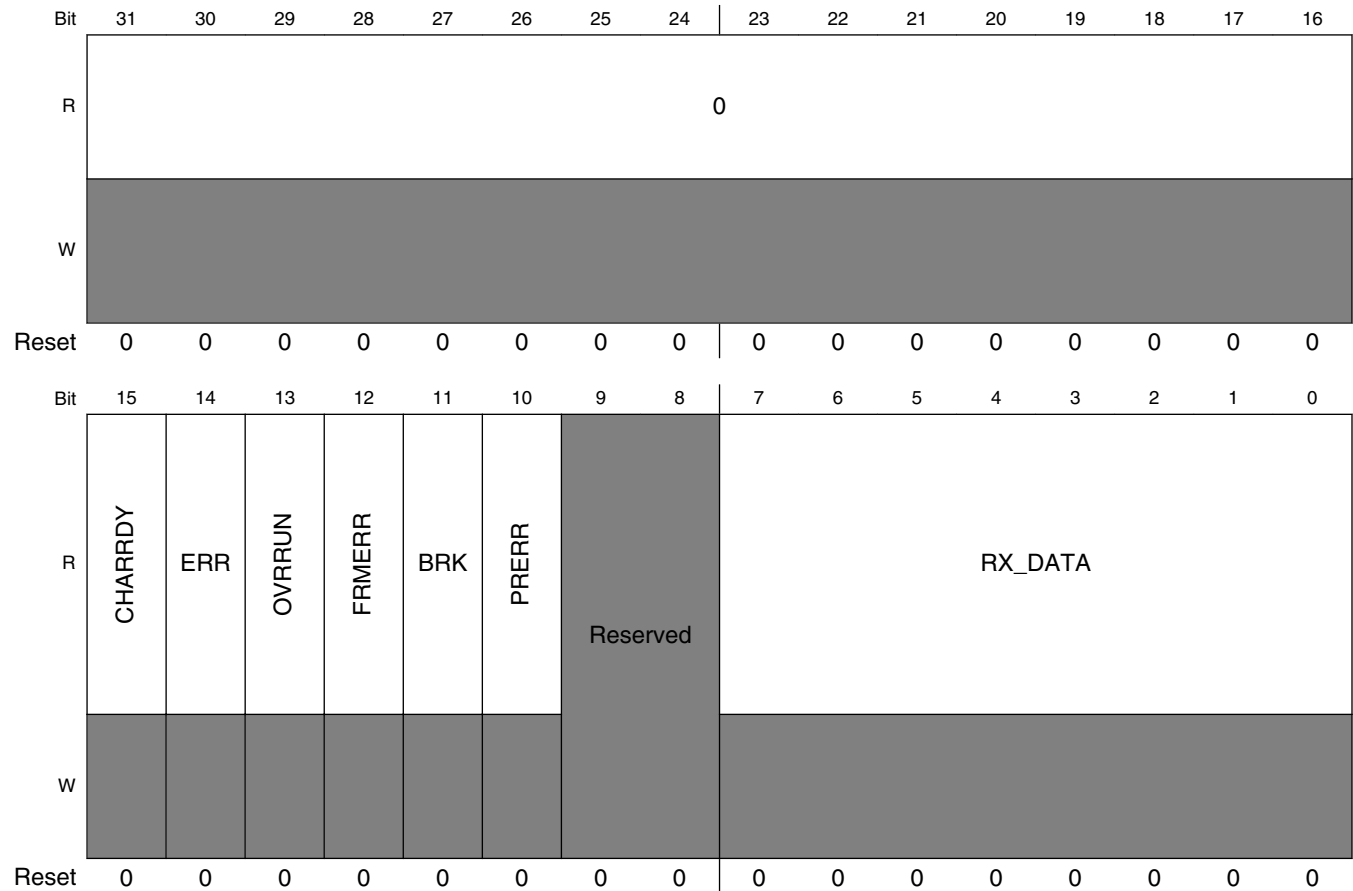

UARTx_URXD field descriptions

Field	Description
31–16 Reserved	This read-only field is reserved and always has the value 0.
15 CHARRDY	Character Ready. This read-only bit indicates an invalid read when the FIFO becomes empty and software tries to read the same old data. This bit should not be used for polling for data written to the RX FIFO. 0 Character in RX_DATA field and associated flags are invalid. 1 Character in RX_DATA field and associated flags valid and ready for reading.

Table continues on the next page...

UARTx_URXD field descriptions (continued)

Field	Description
14 ERR	<p>Error Detect. Indicates whether the character present in the RX_DATA field has an error (OVRRUN, FRMERR, BRK or PRERR) status. The ERR bit is updated and valid for each received character.</p> <p>0 No error status was detected 1 An error status was detected</p>
13 OVRRUN	<p>Receiver Overrun. This read-only bit, when HIGH, indicates that the corresponding character was stored in the last position (32nd) of the Rx FIFO. Even if a 33rd character has not been detected, this bit will be set to '1' for the 32nd character.</p> <p>0 No RxFIFO overrun was detected 1 A RxFIFO overrun was detected</p>
12 FRMERR	<p>Frame Error. Indicates whether the current character had a framing error (a missing stop bit) and is possibly corrupted. FRMERR is updated for each character read from the RxFIFO.</p> <p>0 The current character has no framing error 1 The current character has a framing error</p>
11 BRK	<p>BREAK Detect. Indicates whether the current character was detected as a BREAK character. The data bits and the stop bit are all 0. The FRMERR bit is set when BRK is set. When odd parity is selected, PRERR is also set when BRK is set. BRK is valid for each character read from the RxFIFO.</p> <p>0 The current character is not a BREAK character 1 The current character is a BREAK character</p>
10 PRERR	<p>In RS-485 mode, it holds the ninth data bit (bit [8]) of received 9-bit RS-485 data</p> <p>In RS232/IrDA mode, it is the Parity Error flag. Indicates whether the current character was detected with a parity error and is possibly corrupted. PRERR is updated for each character read from the RxFIFO. When parity is disabled, PRERR always reads as 0.</p> <p>0 = No parity error was detected for data in the RX_DATA field 1 = A parity error was detected for data in the RX_DATA field</p>
9-8 -	<p>This field is reserved. Reserved</p>
RX_DATA	<p>Received Data. Holds the received character. In 7-bit mode, the most significant bit (MSB) is forced to 0. In 8-bit mode, all bits are active.</p>

55.15.2 UART Transmitter Register (UARTx_UTXD)

NOTE

The UART will yield a transfer error on the peripheral bus when core is writing into UART_URXD register with transmit interface disabled (TXEN=0 or UARTEN=0).

Memory space between UART_URXD and UART_UTXD registers is reserved. Any read or write access to this space will be considered as an invalid access and yield a transfer error.

Address: Base address + 40h offset

Bit	31	30	29	28	27	26	25	24	23	22	21	20	19	18	17	16	15	14	13	12	11	10	9	8	7	6	5	4	3	2	1	0
R	0																0															
W																								TX_DATA								
Reset	0	0	0	0	0	0	0	0	0	0	0	0	0	0	0	0	0	0	0	0	0	0	0	0	0	0	0	0	0	0	0	0

UARTx_UTXD field descriptions

Field	Description
31–16 Reserved	This read-only field is reserved and always has the value 0.
15–8 Reserved	This read-only field is reserved and always has the value 0.
TX_DATA	Transmit Data. Holds the parallel transmit data inputs. In 7-bit mode, D7 is ignored. In 8-bit mode, all bits are used. Data is transmitted least significant bit (LSB) first. A new character is transmitted when the TX_DATA field is written. The TX_DATA field must be written only when the TRDY bit is high to ensure that corrupted data is not sent.

55.15.3 UART Control Register 1 (UARTx_UCR1)

Address: Base address + 80h offset

Bit	31	30	29	28	27	26	25	24	23	22	21	20	19	18	17	16
R	0															
W																
Reset	0	0	0	0	0	0	0	0	0	0	0	0	0	0	0	0
Bit	15	14	13	12	11	10	9	8	7	6	5	4	3	2	1	0
R	ADEN	ADBR	TRDYEN	IDEN	ICD	RRDYEN	RXDMAEN	IREN	TXEMPTYEN	RTSDEN	SNDBRK	TXDMAEN	ATDMAEN	DOZE	UARTEN	
W	ADEN	ADBR	TRDYEN	IDEN	ICD	RRDYEN	RXDMAEN	IREN	TXEMPTYEN	RTSDEN	SNDBRK	TXDMAEN	ATDMAEN	DOZE	UARTEN	
Reset	0	0	0	0	0	0	0	0	0	0	0	0	0	0	0	0

UARTx_UCR1 field descriptions

Field	Description
31–16 Reserved	This read-only field is reserved and always has the value 0.
15 ADEN	Automatic Baud Rate Detection Interrupt Enable. Enables/Disables the automatic baud rate detect complete (ADET) bit to generate an interrupt (<i>interrupt_uart</i> = 0). 0 Disable the automatic baud rate detection interrupt 1 Enable the automatic baud rate detection interrupt
14 ADBR	Automatic Detection of Baud Rate. Enables/Disables automatic baud rate detection. When the ADBR bit is set and the ADET bit is cleared, the receiver detects the incoming baud rate automatically. The ADET flag is set when the receiver verifies that the incoming baud rate is detected properly by detecting an ASCII character "A" or "a" (0x41 or 0x61). 0 Disable automatic detection of baud rate 1 Enable automatic detection of baud rate
13 TRDYEN	Transmitter Ready Interrupt Enable. Enables/Disables the transmitter Ready Interrupt (TRDY) when the transmitter has one or more slots available in the TxFIFO. The fill level in the TxFIFO at which an interrupt is generated is controlled by TxTL bits. When TRDYEN is negated, the transmitter ready interrupt is disabled. NOTE: An interrupt will be issued as long as TRDYEN and TRDY are high even if the transmitter is not enabled. In general, user should enable the transmitter before enabling the TRDY interrupt. 0 Disable the transmitter ready interrupt 1 Enable the transmitter ready interrupt
12 IDEN	Idle Condition Detected Interrupt Enable. Enables/Disables the IDLE bit to generate an interrupt (<i>interrupt_uart</i> = 0). 0 Disable the IDLE interrupt 1 Enable the IDLE interrupt

Table continues on the next page...

UARTx_UCR1 field descriptions (continued)

Field	Description
11–10 ICD	<p>Idle Condition Detect. Controls the number of frames RXD is allowed to be idle before an idle condition is reported.</p> <p>00 Idle for more than 4 frames 01 Idle for more than 8 frames 10 Idle for more than 16 frames 11 Idle for more than 32 frames</p>
9 RRDYEN	<p>Receiver Ready Interrupt Enable. Enables/Disables the RRDY interrupt when the RxFIFO contains data. The fill level in the RxFIFO at which an interrupt is generated is controlled by the RXTL bits. When RRDYEN is negated, the receiver ready interrupt is disabled.</p> <p>0 Disables the RRDY interrupt 1 Enables the RRDY interrupt</p>
8 RXDMAEN	<p>Receive Ready DMA Enable. Enables/Disables the receive DMA request <i>dma_req_rx</i> when the receiver has data in the RxFIFO. The fill level in the RxFIFO at which a DMA request is generated is controlled by the RXTL bits. When negated, the receive DMA request is disabled.</p> <p>0 Disable DMA request 1 Enable DMA request</p>
7 IREN	<p>Infrared Interface Enable. Enables/Disables the IR interface. See the IR interface description in Infrared Interface, for more information.</p> <p>Note: MDEN(UMCR[0]) must be cleared to 0 when using IrDA interface. See Table 55-1</p> <p>0 Disable the IR interface 1 Enable the IR interface</p>
6 TXMPTYEN	<p>Transmitter Empty Interrupt Enable. Enables/Disables the transmitter FIFO empty (TXFE) interrupt. <i>interrupt_uart</i>. When negated, the TXFE interrupt is disabled.</p> <p>NOTE: An interrupt will be issued as long as TXMPTYEN and TXFE are high even if the transmitter is not enabled. In general, user should enable the transmitter before enabling the TXFE interrupt.</p> <p>0 Disable the transmitter FIFO empty interrupt 1 Enable the transmitter FIFO empty interrupt</p>
5 RTSDEN	<p>RTS Delta Interrupt Enable. Enables/Disables the RTSD interrupt. The current status of the RTS_B pin is read in the RTSS bit.</p> <p>0 Disable RTSD interrupt 1 Enable RTSD interrupt</p>
4 SNDBRK	<p>Send BREAK. Forces the transmitter to send a BREAK character. The transmitter finishes sending the character in progress (if any) and sends BREAK characters until SNDBRK is reset. Because the transmitter samples SNDBRK after every bit is transmitted, it is important that SNDBRK is asserted high for a sufficient period of time to generate a valid BREAK. After the BREAK transmission completes, the UART transmits 2 mark bits. The user can continue to fill the TxFIFO and any characters remaining are transmitted when the BREAK is terminated.</p> <p>0 Do not send a BREAK character 1 Send a BREAK character (continuous 0s)</p>
3 TXDMAEN	<p>Transmitter Ready DMA Enable. Enables/Disables the transmit DMA request <i>dma_req_tx</i> when the transmitter has one or more slots available in the TxFIFO. The fill level in the TxFIFO that generates the <i>dma_req_tx</i> is controlled by the TXTL bits.</p>

Table continues on the next page...

UARTx_UCR1 field descriptions (continued)

Field	Description
	<p>NOTE: A DMA request will be issued as long as TXDMAEN and TRDY are high even if the transmitter is not enabled. In general, user should enable the transmitter before enabling the transmit DMA request.</p> <p>0 Disable transmit DMA request 1 Enable transmit DMA request</p>
2 ATDMAEN	<p>Aging DMA Timer Enable. Enables/Disables the receive DMA request <i>dma_req_rx</i> for the aging timer interrupt (triggered with AGTIM flag in USR1[8]).</p> <p>0 Disable AGTIM DMA request 1 Enable AGTIM DMA request</p>
1 DOZE	<p>DOZE. Determines the UART enable condition in the DOZE state. When <i>doze_req</i> input pin is at '1', (the Arm Platform executes a doze instruction and the system is placed in the Doze State), the DOZE bit affects operation of the UART. While in the Doze State, if this bit is asserted, the UART is disabled. See the description in Low Power Modes.</p> <p>0 The UART is enabled when in DOZE state 1 The UART is disabled when in DOZE state</p>
0 UARTEN	<p>UART Enable. Enables/Disables the UART. If UARTEN is negated in the middle of a transmission, the transmitter stops and pulls the TXD line to a logic 1. UARTEN must be set to 1 before any access to UTXD and URXD registers, otherwise a transfer error is returned.</p> <p>This bit can be set to 1 along with other bits in this register. There is no restriction to the sequence of programing this bit and other control registers.</p> <p>0 Disable the UART 1 Enable the UART</p>

55.15.4 UART Control Register 2 (UARTx_UCR2)

Address: Base address + 84h offset

Bit	31	30	29	28	27	26	25	24	23	22	21	20	19	18	17	16
R	0															
W	[Shaded]															
Reset	0	0	0	0	0	0	0	0	0	0	0	0	0	0	0	0
Bit	15	14	13	12	11	10	9	8	7	6	5	4	3	2	1	0
R																
W	ESCI	IRTS	CTSC	CTS	ESCBEN	RTEC	PREN	PRO E	STPB	WS	RTSEN	ATEN	TXEN	RXEN	SRST	
Reset	0	0	0	0	0	0	0	0	0	0	0	0	0	0	0	1

UARTx_UCR2 field descriptions

Field	Description
31–16 Reserved	This read-only field is reserved and always has the value 0.
15 ESCI	Escape Sequence Interrupt Enable. Enables/Disables the ESCF bit to generate an interrupt. 0 Disable the escape sequence interrupt 1 Enable the escape sequence interrupt
14 IRTS	Ignore RTS Pin. Forces the RTS input signal presented to the transmitter to always be asserted (set to low), effectively ignoring the external pin. When in this mode, the RTS pin serves as a general purpose input. 0 Transmit only when the RTS pin is asserted 1 Ignore the RTS pin
13 CTSC	CTS Pin Control. Controls the operation of the CTS_B module output. When CTSC is asserted, the CTS_B module output is controlled by the receiver. When the RxFIFO is filled to the level of the programmed trigger level and the start bit of the overflowing character (TRIGGER LEVEL + 1) is validated, the CTS_B module output is negated to indicate to the far-end transmitter to stop transmitting. When the trigger level is programmed for less than 32, the receiver continues to receive data until the RxFIFO is full. When the CTSC bit is negated, the CTS_B module output is controlled by the CTS bit. On reset, because CTSC is cleared to 0, the CTS_B pin is controlled by the CTS bit, which again is cleared to 0 on reset. This means that on reset the CTS_B signal is negated. 0 The CTS_B pin is controlled by the CTS bit 1 The CTS_B pin is controlled by the receiver
12 CTS	Clear to Send. Controls the CTS_B pin when the CTSC bit is negated. CTS has no function when CTSC is asserted. 0 The CTS_B pin is high (inactive) 1 The CTS_B pin is low (active)
11 ESSEN	Escape Enable. Enables/Disables the escape sequence detection logic. 0 Disable escape sequence detection 1 Enable escape sequence detection
10–9 RTEC	Request to Send Edge Control. Selects the edge that triggers the RTS interrupt. This has no effect on the RTS delta interrupt. RTEC has an effect only when RTSEN = 1 (see Table 55-5). 00 Trigger interrupt on a rising edge 01 Trigger interrupt on a falling edge 1X Trigger interrupt on any edge
8 PREN	Parity Enable. Enables/Disables the parity generator in the transmitter and parity checker in the receiver. When PREN is asserted, the parity generator and checker are enabled, and disabled when PREN is negated. 0 Disable parity generator and checker 1 Enable parity generator and checker
7 PROE	Parity Odd/Even. Controls the sense of the parity generator and checker. When PROE is high, odd parity is generated and expected. When PROE is low, even parity is generated and expected. PROE has no function if PREN is low. 0 Even parity 1 Odd parity

Table continues on the next page...

UARTx_UCR2 field descriptions (continued)

Field	Description
6 STPB	<p>Stop. Controls the number of stop bits after a character. When STPB is low, 1 stop bit is sent. When STPB is high, 2 stop bits are sent. STPB also affects the receiver.</p> <p>0 The transmitter sends 1 stop bit. The receiver expects 1 or more stop bits. 1 The transmitter sends 2 stop bits. The receiver expects 2 or more stop bits.</p>
5 WS	<p>Word Size. Controls the character length. When WS is high, the transmitter and receiver are in 8-bit mode. When WS is low, they are in 7-bit mode. The transmitter ignores bit 7 and the receiver sets bit 7 to 0. WS can be changed in-between transmission (reception) of characters, however not when a transmission (reception) is in progress, in which case the length of the current character being transmitted (received) is unpredictable.</p> <p>0 7-bit transmit and receive character length (not including START, STOP or PARITY bits) 1 8-bit transmit and receive character length (not including START, STOP or PARITY bits)</p>
4 RTSEN	<p>Request to Send Interrupt Enable. Controls the RTS edge sensitive interrupt. When RTSEN is asserted and the programmed edge is detected on the RTS_B pin (the RTSF bit is asserted), an interrupt will be generated on the <i>interrupt_uart</i> pin. (See Table 55-5.)</p> <p>0 Disable request to send interrupt 1 Enable request to send interrupt</p>
3 ATEN	<p>Aging Timer Enable. This bit is used to enable the aging timer interrupt (triggered with AGTIM)</p> <p>0 AGTIM interrupt disabled 1 AGTIM interrupt enabled</p>
2 TXEN	<p>Transmitter Enable. Enables/Disables the transmitter. When TXEN is negated the transmitter is disabled and idle. When the UARTEN and TXEN bits are set the transmitter is enabled. If TXEN is negated in the middle of a transmission, the UART disables the transmitter immediately, and starts marking 1s. The transmitter FIFO cannot be written when this bit is cleared.</p> <p>0 Disable the transmitter 1 Enable the transmitter</p>
1 RXEN	<p>Receiver Enable. Enables/Disables the receiver. When the receiver is enabled, if the RXD input is already low, the receiver does not recognize BREAK characters, because it requires a valid 1-to-0 transition before it can accept any character.</p> <p>0 Disable the receiver 1 Enable the receiver</p>
0 SRST	<p>Software Reset. Once the software writes 0 to SRST_B, the software reset remains active for 4 <i>module_clock</i> cycles before the hardware deasserts SRST_B. The software can only write 0 to SRST_B. Writing 1 to SRST_B is ignored.</p> <p>0 Reset the transmit and receive state machines, all FIFOs and register USR1, USR2, UBIR, UBMR, UBRC, URXD, UTXD and UTS[6-3]. 1 No reset</p>

55.15.5 UART Control Register 3 (UARTx_UCR3)

Address: Base address + 88h offset

Bit	31	30	29	28	27	26	25	24	23	22	21	20	19	18	17	16
R	0															
W																
Reset	0	0	0	0	0	0	0	0	0	0	0	0	0	0	0	0
Bit	15	14	13	12	11	10	9	8	7	6	5	4	3	2	1	0
R	DPEC		DTREN	PARERREN	FRAERREN	DSR	DCD	RI	ADNIMP	RXDSEN	AIRINTEN	AWAKEN	DTRDEN	FXDMUXSEL	INVT	ACIEN
W																
Reset	0	0	0	0	0	1	1	1	0	0	0	0	0	0	0	0

UARTx_UCR3 field descriptions

Field	Description
31–16 Reserved	This read-only field is reserved and always has the value 0.
15–14 DPEC	DTR/DSR Interrupt Edge Control. These bits control the edge of DTR_B (DCE) or DSR_B (DTE) on which an interrupt will be generated. An interrupt will only be generated if the DTREN bit is set. 00 interrupt generated on rising edge 01 interrupt generated on falling edge 1X interrupt generated on either edge
13 DTREN	Data Terminal Ready Interrupt Enable. When this bit is set, it will enable the status bit DTRF (USR2 [13]) (DTR/DSR edge sensitive interrupt) to cause an interrupt. 0 Data Terminal Ready Interrupt Disabled 1 Data Terminal Ready Interrupt Enabled
12 PARERREN	Parity Error Interrupt Enable. Enables/Disables the interrupt. When asserted, PARERREN causes the PARITYERR bit to generate an interrupt. 0 Disable the parity error interrupt 1 Enable the parity error interrupt
11 FRAERREN	Frame Error Interrupt Enable. Enables/Disables the interrupt. When asserted, FRAERREN causes the FRAMERR bit to generate an interrupt. 0 Disable the frame error interrupt 1 Enable the frame error interrupt
10 DSR	Data Set Ready. This bit is used by software to control the DSR/DTR module output for the modem interface. In DCE mode it applies to DSR_B and in DTE mode it applies to DTR_B. 0 DSR/ DTR pin is logic zero 1 DSR/ DTR pin is logic one

Table continues on the next page...

UARTx_UCR3 field descriptions (continued)

Field	Description
9 DCD	<p>Data Carrier Detect. In DCE mode this bit is used by software to control the DCD_B module output for the modem interface. In DTE mode, when this bit is set, it will enable the status bit DCDELT (USR2 (6)) to cause an interrupt.</p> <p>0 DCD_B pin is logic zero (DCE mode) 1 DCD_B pin is logic one (DCE mode) 0 DCDELT interrupt disabled (DTE mode) 1 DCDELT interrupt enabled (DTE mode)</p>
8 RI	<p>Ring Indicator. In DCE mode this bit is used by software to control the RI_B module output for the modem interface. In DTE mode, when this bit is set, it will enable the status bit RIDELT (USR2 (10)) to cause an interrupt.</p> <p>0 RI_B pin is logic zero (DCE mode) 1 RI_B pin is logic one (DCE mode) 0 RIDELT interrupt disabled (DTE mode) 1 RIDELT interrupt enabled (DTE mode)</p>
7 ADNIMP	<p>Autobaud Detection Not Improved-. Disables new features of autobaud detection (See Baud Rate Automatic Detection Protocol, for more details).</p> <p>0 Autobaud detection new features selected 1 Keep old autobaud detection mechanism</p>
6 RXDSEN	<p>Receive Status Interrupt Enable. Controls the receive status interrupt (<i>interrupt_uart</i>). When this bit is enabled and RXDS status bit is set, the interrupt <i>interrupt_uart</i> will be generated.</p> <p>0 Disable the RXDS interrupt 1 Enable the RXDS interrupt</p>
5 AIRINTEN	<p>Asynchronous IR WAKE Interrupt Enable. Controls the asynchronous IR WAKE interrupt. An interrupt is generated when AIRINTEN is asserted and a pulse is detected on the RXD pin.</p> <p>0 Disable the AIRINT interrupt 1 Enable the AIRINT interrupt</p>
4 AWAKEN	<p>Asynchronous WAKE Interrupt Enable. Controls the asynchronous WAKE interrupt. An interrupt is generated when AWAKEN is asserted and a falling edge is detected on the RXD pin.</p> <p>0 Disable the AWAKE interrupt 1 Enable the AWAKE interrupt</p>
3 DTRDEN	<p>Data Terminal Ready Delta Enable. Enables / Disables the asynchronous DTRD interrupt. When DTRDEN is asserted and an edge (rising or falling) is detected on DTR_B (in DCE mode) or on DSR_B (in DTE mode), then an interrupt is generated.</p> <p>0 Disable DTRD interrupt 1 Enable DTRD interrupt</p>
2 RXDMUXSEL	<p>RXD Muxed Input Selected. Selects proper input pins for serial and Infrared input signal.</p> <p>NOTE: In this chip, UARTs are used in MUXED mode, so that this bit should always be set.</p>
1 INVT	<p>Invert TXD output in RS-232/RS-485 mode, set TXD active level in IrDA mode.</p> <p>In RS232/RS-485 mode(UMCR[0] = 1), if this bit is set to 1, the TXD output is inverted before transmitted.</p> <p>In IrDA mode, when INVT is cleared, the infrared logic block transmits a positive IR 3/16 pulse for all 0s and 0s are transmitted for 1s. When INVT is set (INVT = 1), the infrared logic block transmits an active low or negative infrared 3/16 pulse for all 0s and 1s are transmitted for 1s.</p>

Table continues on the next page...

UARTx_UCR3 field descriptions (continued)

Field	Description
	0 TXD is not inverted 1 TXD is inverted 0 TXD Active low transmission 1 TXD Active high transmission
0 ACIEN	Autobaud Counter Interrupt Enable. This bit is used to enable the autobaud counter stopped interrupt (triggered with ACST (USR2[11]). 0 ACST interrupt disabled 1 ACST interrupt enabled

55.15.6 UART Control Register 4 (UARTx_UCR4)

Address: Base address + 8Ch offset

Bit	31	30	29	28	27	26	25	24	23	22	21	20	19	18	17	16
R	0															
W																
Reset	0	0	0	0	0	0	0	0	0	0	0	0	0	0	0	0
Bit	15	14	13	12	11	10	9	8	7	6	5	4	3	2	1	0
R	<div style="display: flex; justify-content: space-between;"> CTSTL INVR ENIRI WKEN IDDMAEN IRSC LPBYP TCEN BKEN OREN DREN </div>															
W																
Reset	1	0	0	0	0	0	0	0	0	0	0	0	0	0	0	0

UARTx_UCR4 field descriptions

Field	Description
31–16 Reserved	This read-only field is reserved and always has the value 0.
15–10 CTSTL	CTS Trigger Level. Controls the threshold at which the CTS_B pin is deasserted by the RxFIFO. After the trigger level is reached and the CTS_B pin is deasserted, the RxFIFO continues to receive data until it is full. The CTSTL bits are encoded as shown in the Settings column. Settings 0 to 32 are in use. All other settings are Reserved. 000000 0 characters received 000001 1 characters in the RxFIFO ... — ... — 100000 32 characters in the RxFIFO (maximum)
9 INVR	Invert RXD input in RS-232/RS-485 Mode, determine RXD input logic level being sampled in In IrDA mode.

Table continues on the next page...

UARTx_UCR4 field descriptions (continued)

Field	Description
	<p>In RS232/RS-485 Mode(UMCR[0] = 1), if this bit is set to 1, the RXD input is inverted before sampled.</p> <p>In IrDA mode,when cleared, the infrared logic block expects an active low or negative IR 3/16 pulse for 0s and 1s are expected for 1s. When INVR is set (INVR 1), the infrared logic block expects an active high or positive IR 3/16 pulse for 0s and 0s are expected for 1s.</p> <p>0 RXD input is not inverted 1 RXD input is inverted</p> <p>0 RXD active low detection 1 RXD active high detection</p>
8 ENIRI	<p>Serial Infrared Interrupt Enable. Enables/Disables the serial infrared interrupt.</p> <p>0 Serial infrared Interrupt disabled 1 Serial infrared Interrupt enabled</p>
7 WKEN	<p>WAKE Interrupt Enable. Enables/Disables the WAKE bit to generate an interrupt. The WAKE bit is set at the detection of a start bit by the receiver.</p> <p>0 Disable the WAKE interrupt 1 Enable the WAKE interrupt</p>
6 IDDMAEN	<p>DMA IDLE Condition Detected Interrupt Enable Enables/Disables the receive DMA request <i>dma_req_rx</i> for the IDLE interrupt (triggered with IDLE flag in USR2[12]).</p> <p>0 DMA IDLE interrupt disabled 1 DMA IDLE interrupt enabled</p>
5 IRSC	<p>IR Special Case. Selects the clock for the vote logic. When set, IRSC switches the vote logic clock from the sampling clock to the UART reference clock. The IR pulses are counted a predetermined amount of time depending on the reference frequency. See InfraRed Special Case (IRSC) Bit.</p> <p>0 The vote logic uses the sampling clock (16x baud rate) for normal operation 1 The vote logic uses the UART reference clock</p>
4 LPBYP	<p>Low Power Bypass. Allows to bypass the low power new features in UART. To use during debug phase.</p> <p>0 Low power features enabled 1 Low power features disabled</p>
3 TCEN	<p>TransmitComplete Interrupt Enable. Enables/Disables the TXDC bit to generate an interrupt (<i>interrupt_uart</i> = 0)</p> <p>NOTE: An interrupt will be issued as long as TCEN and TXDC are high even if the transmitter is not enabled. In general, user should enable the transmitter before enabling the TXDC interrupt.</p> <p>0 Disable TXDC interrupt 1 Enable TXDC interrupt</p>
2 BKEN	<p>BREAK Condition Detected Interrupt Enable. Enables/Disables the BRCD bit to generate an interrupt.</p> <p>0 Disable the BRCD interrupt 1 Enable the BRCD interrupt</p>
1 OREN	<p>Receiver Overrun Interrupt Enable. Enables/Disables the ORE bit to generate an interrupt.</p> <p>0 Disable ORE interrupt 1 Enable ORE interrupt</p>

Table continues on the next page...

UARTx_UCR4 field descriptions (continued)

Field	Description
0 DREN	Receive Data Ready Interrupt Enable. Enables/Disables the RDR bit to generate an interrupt. 0 Disable RDR interrupt 1 Enable RDR interrupt

55.15.7 UART FIFO Control Register (UARTx_UFCR)

Address: Base address + 90h offset

Bit	31	30	29	28	27	26	25	24	23	22	21	20	19	18	17	16
R	0															
W																
Reset	0	0	0	0	0	0	0	0	0	0	0	0	0	0	0	0
Bit	15	14	13	12	11	10	9	8	7	6	5	4	3	2	1	0
R	TXTL				RFDIV				DCEDTE	RXTL						
W																
Reset	0	0	0	0	1	0	0	0	0	0	0	0	0	0	0	1

UARTx_UFCR field descriptions

Field	Description
31–16 Reserved	This read-only field is reserved and always has the value 0.
15–10 TXTL	Transmitter Trigger Level. Controls the threshold at which a maskable interrupt is generated by the TxFIFO. A maskable interrupt is generated whenever the data level in the TxFIFO falls below the selected threshold. The bits are encoded as shown in the Settings column. Settings 0 to 32 are in use. All other settings are Reserved. 000000 Reserved 000001 Reserved 000010 TxFIFO has 2 or fewer characters ... — ... — 011111 TxFIFO has 31 or fewer characters 100000 TxFIFO has 32 characters (maximum)
9–7 RFDIV	Reference Frequency Divider. Controls the divide ratio for the reference clock. The input clock is <i>module_clock</i> . The output from the divider is <i>ref_clk</i> which is used by BRM to create the 16x baud rate oversampling clock (<i>brm_clk</i>). 000 Divide input clock by 6 001 Divide input clock by 5

Table continues on the next page...

UARTx_UFCR field descriptions (continued)

Field	Description
	010 Divide input clock by 4 011 Divide input clock by 3 100 Divide input clock by 2 101 Divide input clock by 1 110 Divide input clock by 7 111 Reserved
6 DCEDTE	<p>DCE/DTE mode select. Select UART as data communication equipment (DCE mode) or as data terminal equipment (DTE mode).</p> 0 DCE mode selected 1 DTE mode selected
RXTL	<p>Receiver Trigger Level. Controls the threshold at which a maskable interrupt is generated by the RxFIFO. A maskable interrupt is generated whenever the data level in the RxFIFO reaches the selected threshold. The RXTL bits are encoded as shown in the Settings column.</p> <p>Setting 0 to 32 are in use. All other settings are Reserved.</p> 000000 0 characters received 000001 RxFIFO has 1 character ... — ... — 011111 RxFIFO has 31 characters 100000 RxFIFO has 32 characters (maximum)

55.15.8 UART Status Register 1 (UARTx_USR1)

Address: Base address + 94h offset

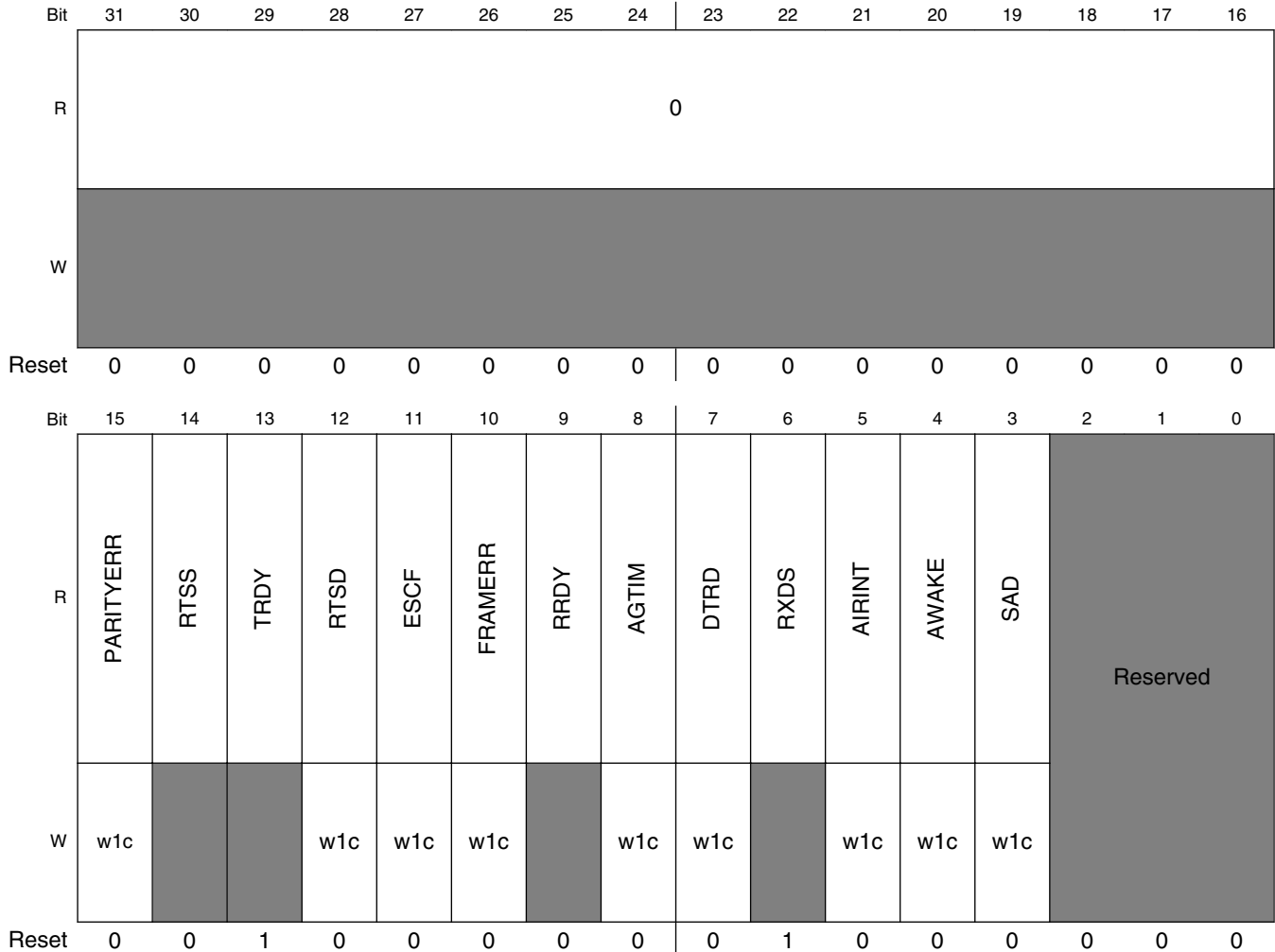

UARTx_USR1 field descriptions

Field	Description
31–16 Reserved	This read-only field is reserved and always has the value 0.
15 PARITYERR	Parity Error Interrupt Flag. Indicates a parity error is detected. PARITYERR is cleared by writing 1 to it. Writing 0 to PARITYERR has no effect. When parity is disabled, PARITYERR always reads 0. At reset, PARITYERR is set to 0. 0 No parity error detected 1 Parity error detected (write 1 to clear)
14 RTSS	RTS_B Pin Status. Indicates the current status of the RTS_B pin. A "snapshot" of RTS_B is taken immediately before RTSS is presented to the data bus. RTSS cannot be cleared because all writes to RTSS are ignored. At reset, RTSS is set to 0.

Table continues on the next page...

UARTx_USR1 field descriptions (continued)

Field	Description
	0 The RTS_B module input is high (inactive) 1 The RTS_B module input is low (active)
13 TRDY	Transmitter Ready Interrupt / DMA Flag. Indicates that the TxFIFO emptied below its target threshold and requires data. TRDY is automatically cleared when the data level in the TxFIFO exceeds the threshold set by TXTL bits. At reset, TRDY is set to 1. 0 The transmitter does not require data 1 The transmitter requires data (interrupt posted)
12 RTSD	RTS Delta. Indicates whether the RTS_B pin changed state. It (RTSD) generates a maskable interrupt. When in STOP mode, RTS assertion sets RTSD and can be used to wake the processor. The current state of the RTS_B pin is available on the RTSS bit. Clear RTSD by writing 1 to it. Writing 0 to RTSD has no effect. At reset, RTSD is set to 0. 0 RTS_B pin did not change state since last cleared 1 RTS_B pin changed state (write 1 to clear)
11 ESCF	Escape Sequence Interrupt Flag. Indicates if an escape sequence was detected. ESCF is asserted when the ESCEN bit is set and an escape sequence is detected in the RxFIFO. Clear ESCF by writing 1 to it. Writing 0 to ESCF has no effect. 0 No escape sequence detected 1 Escape sequence detected (write 1 to clear).
10 FRAMERR	Frame Error Interrupt Flag. Indicates that a frame error is detected. The <i>interrupt_uart</i> interrupt will be generated if a frame error is detected and the interrupt is enabled. Clear FRAMERR by writing 1 to it. Writing 0 to FRAMERR has no effect. 0 No frame error detected 1 Frame error detected (write 1 to clear)
9 RRDY	Receiver Ready Interrupt / DMA Flag. Indicates that the RxFIFO data level is above the threshold set by the RXTL bits. (See the RXTL bits description in UART FIFO Control Register (UART_UFCR) for setting the interrupt threshold.) When asserted, RRDY generates a maskable interrupt or DMA request. RRDY is automatically cleared when data level in the RxFIFO goes below the set threshold level. At reset, RRDY is set to 0. 0 No character ready 1 Character(s) ready (interrupt posted)
8 AGTIM	Ageing Timer Interrupt Flag. Indicates that data in the RxFIFO has been idle for a time of 8 character lengths (where a character length consists of 7 or 8 bits, depending on the setting of the WS bit in UCR2, with the bit time corresponding to the baud rate setting) and FIFO data level is less than RxFIFO threshold level (RXTL in the UFCR). Clear by writing a 1 to it. 0 AGTIM is not active 1 AGTIM is active (write 1 to clear)
7 DTRD	DTR Delta. Indicates whether DTR_B (in DCE mode) or DSR_B (in DTE mode) pins changed state. DTRD generates a maskable interrupt if DTRDEN (UCR3[3]) is set. Clear DTRD by writing 1 to it. Writing 0 to DTRD has no effect. 0 DTR_B (DCE) or DSR_B (DTE) pin did not change state since last cleared 1 DTR_B (DCE) or DSR_B (DTE) pin changed state (write 1 to clear)
6 RXDS	Receiver IDLE Interrupt Flag. Indicates that the receiver state machine is in an IDLE state, the next state is IDLE, and the receive pin is high. RXDS is automatically cleared when a character is received. RXDS is active only when the receiver is enabled.

Table continues on the next page...

UARTx_USR1 field descriptions (continued)

Field	Description
	0 Receive in progress 1 Receiver is IDLE
5 AIRINT	Asynchronous IR WAKE Interrupt Flag. Indicates that the IR WAKE pulse was detected on the RXD pin. Clear AIRINT by writing 1 to it. Writing 0 to AIRINT has no effect. 0 No pulse was detected on the RXD IrDA pin 1 A pulse was detected on the RXD IrDA pin
4 AWAKE	Asynchronous WAKE Interrupt Flag. Indicates that a falling edge was detected on the RXD pin. Clear AWAKE by writing 1 to it. Writing 0 to AWAKE has no effect. 0 No falling edge was detected on the RXD Serial pin 1 A falling edge was detected on the RXD Serial pin
3 SAD	RS-485 Slave Address Detected Interrupt Flag. Indicates if RS-485 Slave Address was detected . SAD was asserted in RS-485 mode when the SADEN bit is set and Slave Address is detected in RxFIFO (in Nomal Address Detect Mode, the 9 th data bit = 1; in Automatic Address Detect Mode, the received charater matches the programmed SLADDR). 0 No slave address detected 1 Slave address detected
-	This field is reserved. Reserved

55.15.9 UART Status Register 2 (UARTx_USR2)

Address: Base address + 98h offset

Bit	31	30	29	28	27	26	25	24	23	22	21	20	19	18	17	16
R	0															
W																
Reset	0	0	0	0	0	0	0	0	0	0	0	0	0	0	0	0
Bit	15	14	13	12	11	10	9	8	7	6	5	4	3	2	1	0
R	ADET	TXFE	DTRF	IDLE	ACST	RIDELT	RIIN	IRINT	WAKE	DCDDEL	DCDIN	RTSF	TXDC	BRCD	ORE	RDR
W	w1c		w1c	w1c	w1c	w1c		w1c	w1c	w1c		w1c		w1c	w1c	
Reset	0	1	0	0	0	0	0	0	0	0	1	0	1	0	0	0

UARTx_USR2 field descriptions

Field	Description
31–16 Reserved	This read-only field is reserved and always has the value 0.
15 ADET	Automatic Baud Rate Detect Complete. Indicates that an "A" or "a" was received and that the receiver detected and verified the incoming baud rate. Clear ADET by writing 1 to it. Writing 0 to ADET has no effect. 0 ASCII "A" or "a" was not received 1 ASCII "A" or "a" was received (write 1 to clear)
14 TXFE	Transmit Buffer FIFO Empty. Indicates that the transmit buffer (TxFIFO) is empty. TXFE is cleared automatically when data is written to the TxFIFO. Even though TXFE is high, the transmission might still be in progress. 0 The transmit buffer (TxFIFO) is not empty 1 The transmit buffer (TxFIFO) is empty

Table continues on the next page...

UARTx_USR2 field descriptions (continued)

Field	Description
13 DTRF	DTR edge triggered interrupt flag. This bit is asserted, when the programmed edge is detected on the DTR_B pin (DCE mode) or on DSR_B (DTE mode). This flag can cause an interrupt if DTREN (UCR3[13]) is enabled. 0 Programmed edge not detected on DTR/DSR 1 Programmed edge detected on DTR/DSR (write 1 to clear)
12 IDLE	Idle Condition. Indicates that an idle condition has existed for more than a programmed amount frame (see Idle Line Detect). An interrupt can be generated by this IDLE bit if IDEN (UCR1[12]) is enabled. IDLE is cleared by writing 1 to it. Writing 0 to IDLE has no effect. 0 No idle condition detected 1 Idle condition detected (write 1 to clear)
11 ACST	Autobaud Counter Stopped. In autobaud detection (ADBR=1), indicates the counter which determines the baud rate was running and is now stopped. This means either START bit is finished (if ADNIMP=1), or Bit 0 is finished (if ADNIMP=0). See New Autobaud Counter Stopped bit and Interrupt , for more details. An interrupt can be flagged on <i>interrupt_uart</i> if ACIEN=1. 0 Measurement of bit length not finished (in autobaud) 1 Measurement of bit length finished (in autobaud). (write 1 to clear)
10 RIDELT	Ring Indicator Delta. This bit is used in DTE mode to indicate that the Ring Indicator input (RI_B) has changed state. This flag can generate an interrupt if RI (UCR3[8]) is enabled. RIDELT is cleared by writing 1 to it. Writing 0 to RIDELT has no effect. 0 Ring Indicator input has not changed state 1 Ring Indicator input has changed state (write 1 to clear)
9 RIIN	Ring Indicator Input. This bit is used in DTE mode to reflect the status if the Ring Indicator input (RI_B). The Ring Indicator input is used to indicate that a ring has occurred. In DCE mode this bit is always zero. 0 Ring Detected 1 No Ring Detected
8 IRINT	Serial Infrared Interrupt Flag. When an edge is detected on the RXD pin during SIR Mode, this flag will be asserted. This flag can cause an interrupt which can be masked using the control bit ENIRI: UCR4 [8]. 0 no edge detected 1 valid edge detected (write 1 to clear)
7 WAKE	Wake. Indicates the start bit is detected. WAKE can generate an interrupt that can be masked using the WKEN bit. Clear WAKE by writing 1 to it. Writing 0 to WAKE has no effect. 0 start bit not detected 1 start bit detected (write 1 to clear)
6 DCDDELTA	Data Carrier Detect Delta. This bit is used in DTE mode to indicate that the Data Carrier Detect input (DCD_B) has changed state. This flag can cause an interrupt if DCD (UCR3[9]) is enabled. When in STOP mode, this bit can be used to wake the processor. In DCE mode this bit is always zero. 0 Data Carrier Detect input has not changed state 1 Data Carrier Detect input has changed state (write 1 to clear)
5 DCDIN	Data Carrier Detect Input. This bit is used in DTE mode reflect the status of the Data Carrier Detect input (DCD_B). The Data Carrier Detect input is used to indicate that a carrier signal has been detected. In DCE mode this bit is always zero.

Table continues on the next page...

UARTx_USR2 field descriptions (continued)

Field	Description
	0 Carrier signal Detected 1 No Carrier signal Detected
4 RTSF	RTS Edge Triggered Interrupt Flag. Indicates if a programmed edge is detected on the RTS_B pin. The RTEC bits select the edge that generates an interrupt (see Table 55-5). RTSF can generate an interrupt that can be masked using the RTSSEN bit. Clear RTSF by writing 1 to it. Writing 0 to RTSF has no effect. 0 Programmed edge not detected on RTS_B 1 Programmed edge detected on RTS_B (write 1 to clear)
3 TXDC	Transmitter Complete. Indicates that the transmit buffer (TxFIFO) and Shift Register is empty; therefore the transmission is complete. TXDC is cleared automatically when data is written to the TxFIFO. 0 Transmit is incomplete 1 Transmit is complete
2 BRCD	BREAK Condition Detected. Indicates that a BREAK condition was detected by the receiver. Clear BRCD by writing 1 to it. Writing 0 to BRCD has no effect. 0 No BREAK condition was detected 1 A BREAK condition was detected (write 1 to clear)
1 ORE	Overrun Error. When set to 1, ORE indicates that the receive buffer (RxFIFO) was full (32 chars inside), and a 33rd character has been fully received. This 33rd character has been discarded. Clear ORE by writing 1 to it. Writing 0 to ORE has no effect. 0 No overrun error 1 Overrun error (write 1 to clear)
0 RDR	Receive Data Ready- Indicates that at least 1 character is received and written to the RxFIFO. If the URXD register is read and there is only 1 character in the RxFIFO, RDR is automatically cleared. 0 No receive data ready 1 Receive data ready

55.15.10 UART Escape Character Register (UARTx_UESC)

Address: Base address + 9Ch offset

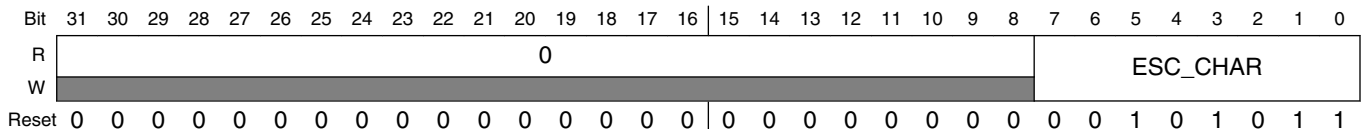

UARTx_UESC field descriptions

Field	Description
31–8 Reserved	This read-only field is reserved and always has the value 0.
ESC_CHAR	UART Escape Character. Holds the selected escape character that all received characters are compared against to detect an escape sequence.

55.15.11 UART Escape Timer Register (UARTx_UTIM)

Address: Base address + A0h offset

Bit	31	30	29	28	27	26	25	24	23	22	21	20	19	18	17	16	15	14	13	12	11	10	9	8	7	6	5	4	3	2	1	0
R	0																TIM															
W	0																0															
Reset	0	0	0	0	0	0	0	0	0	0	0	0	0	0	0	0	0	0	0	0	0	0	0	0	0	0	0	0	0	0	0	0

UARTx_UTIM field descriptions

Field	Description
31–12 Reserved	This read-only field is reserved and always has the value 0.
TIM	UART Escape Timer. Holds the maximum time interval (in ms) allowed between escape characters. The escape timer register is programmable in intervals of 2 ms. See Escape Sequence Detection and Table 55-10 for more information on the UART escape sequence detection. Reset value 0x000 = 2 ms up to 0xFFFF = 8.192 s.

55.15.12 UART BRM Incremental Register (UARTx_UBIR)

This register can be written by both software and hardware. When enabling the automatic baud rate detection feature hardware can write 0x000F value into the UBIR after finishing detecting baud rate. Hardware has higher priority when both software and hardware try to write it at the same cycle³.

Please note software reset will reset the register to its reset value.

Address: Base address + A4h offset

Bit	31	30	29	28	27	26	25	24	23	22	21	20	19	18	17	16	15	14	13	12	11	10	9	8	7	6	5	4	3	2	1	0
R	0																INC															
W	0																0															
Reset	0	0	0	0	0	0	0	0	0	0	0	0	0	0	0	0	0	0	0	0	0	0	0	0	0	0	0	0	0	0	0	0

UARTx_UBIR field descriptions

Field	Description
31–16 Reserved	This read-only field is reserved and always has the value 0.
INC	Incremental Numerator. Holds the numerator value minus one of the BRM ratio (see Binary Rate Multiplier (BRM)). The UBIR register MUST be updated before the UBMR register for the baud rate to be updated correctly. If only one register is written to by software, the BRM will ignore this data until the other register is written to by software. Updating this field using byte accesses is not recommended and is undefined.

3. Note: The write priority in the new design is not same as the original UART. In the original design, software has higher priority than hardware when writing this register at the same time.

55.15.13 UART BRM Modulator Register (UARTx_UBMR)

This register can be written by both software and hardware. When enabling the automatic baud rate detection feature hardware can write a proper value into the UBMR based on detected baud rate. Hardware has higher priority when both software and hardware try to write it at the same cycle⁴.

Please note software reset will reset the register to its reset value.

Address: Base address + A8h offset

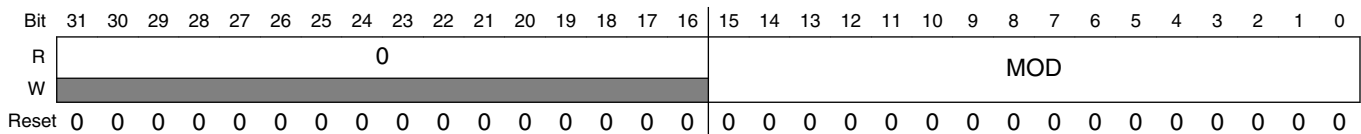

UARTx_UBMR field descriptions

Field	Description
31–16 Reserved	This read-only field is reserved and always has the value 0.
MOD	Modulator Denominator. Holds the value of the denominator minus one of the BRM ratio (see Binary Rate Multiplier (BRM)). The UBIR register MUST be updated before the UBMR register for the baud rate to be updated correctly. If only one register is written to by software, the BRM will ignore this data until the other register is written to by software. Updating this register using byte accesses is not recommended and undefined.

55.15.14 UART Baud Rate Count Register (UARTx_UBRC)

Address: Base address + ACh offset

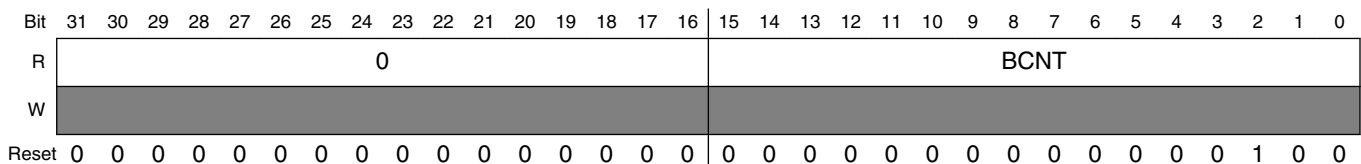

UARTx_UBRC field descriptions

Field	Description
31–16 Reserved	This read-only field is reserved and always has the value 0.
BCNT	Baud Rate Count Register. This read only register is used to count the start bit of the incoming baud rate (if ADNIMP=1), or start bit + bit0 (if ADNIMP=0). When the measurement is done, the Baud Rate Count Register contains the number of UART internal clock cycles (clock after divider) present in an incoming bit. BCNT retains its value until the next Automatic Baud Rate Detection sequence has been initiated. The 16 bit Baud Rate Count register is reset to 4 and stays at hex FFFF in the case of an overflow.

4. Note: The write priority in the new design is not same as the original UART. In the original design, software has higher priority than hardware when writing this register at the same time.

55.15.15 UART One Millisecond Register (UARTx_ONEMS)

NOTE

This register has been expanded from 16 bits to 24 bits. In previous versions, the 16-bit ONEMS can only support the maximum 65.535MHz (0xFFFFx1000) *ref_clk*. To support 4Mbps Bluetooth application with 66.5MHz *module_clock*, the value 0x103C4 (66.5M/1000) should be written into this register. In this case, the 16 bits are not enough to contain the 0x103C4. So this register was expanded to 24 bits to support high frequency of the *ref_clk*.

Address: Base address + B0h offset

Bit	31	30	29	28	27	26	25	24	23	22	21	20	19	18	17	16	15	14	13	12	11	10	9	8	7	6	5	4	3	2	1	0
R	0								ONEMS																							
W	0								0																							
Reset	0	0	0	0	0	0	0	0	0	0	0	0	0	0	0	0	0	0	0	0	0	0	0	0	0	0	0	0	0	0	0	

UARTx_ONEMS field descriptions

Field	Description
31–24 Reserved	This read-only field is reserved and always has the value 0.
ONEMS	<p>One Millisecond Register. This 24-bit register must contain the value of the UART internal frequency (<i>ref_clk</i> in Figure 55-1) divided by 1000. The internal frequency is obtained after the UART BRM internal divider ($F(\text{ref_clk}) = F(\text{module_clock}) / \text{RFDIV}$).</p> <p>In fact this register contains the value corresponding to the number of UART BRM internal clock cycles present in one millisecond.</p> <p>The ONEMS (and UTIM) registers value are used in the escape character detection feature (Escape Sequence Detection) to count the number of clock cycles left between two escape characters. The ONEMS register is also used in infrared special case mode (IRSC = UCR4[5] = 1'b1), see InfraRed Special Case (IRSC) Bit.</p>

55.15.16 UART Test Register (UARTx_UTS)

Address: Base address + B4h offset

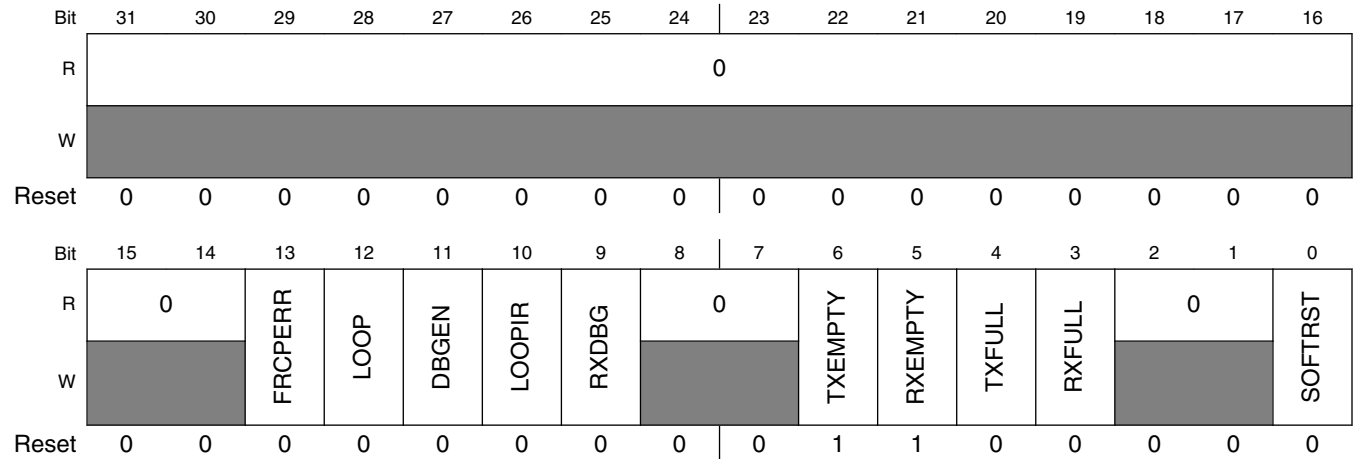

UARTx_UTS field descriptions

Field	Description
31–14 Reserved	This read-only field is reserved and always has the value 0.
13 FRCPERR	Force Parity Error. Forces the transmitter to generate a parity error if parity is enabled. FRCPERR is provided for system debugging. 0 Generate normal parity 1 Generate inverted parity (error)
12 LOOP	Loop TX and RX for Test. Controls loopback for test purposes. When LOOP is high, the receiver input is internally connected to the transmitter and ignores the RXD pin. The transmitter is unaffected by LOOP. If RXDMUXSEL (UCR3[2]) is set to 1, the loopback is applied on serial and IrDA signals. If RXDMUXSEL is set to 0, the loopback is only applied on serial signals. 0 Normal receiver operation 1 Internally connect the transmitter output to the receiver input
11 DBGEN	debug_enable_B. This bit controls whether to respond to the <i>debug_req</i> input signal. 0 UART will go into debug mode when <i>debug_req</i> is HIGH 1 UART will not go into debug mode even if <i>debug_req</i> is HIGH
10 LOOPIR	Loop TX and RX for IR Test (LOOPIR). This bit controls loopback from transmitter to receiver in the InfraRed interface. 0 No IR loop 1 Connect IR transmitter to IR receiver
9 RXDBG	RX_fifo_debug_mode. This bit controls the operation of the RX fifo read counter when in debug mode. 0 rx fifo read pointer does not increment 1 rx_fifo read pointer increments as normal

Table continues on the next page...

UARTx_UTS field descriptions (continued)

Field	Description
8–7 Reserved	This read-only field is reserved and always has the value 0.
6 TXEMPTY	TxFIFO Empty. Indicates that the TxFIFO is empty. 0 The TxFIFO is not empty 1 The TxFIFO is empty
5 RXEMPTY	RxFIFO Empty. Indicates the RxFIFO is empty. 0 The RxFIFO is not empty 1 The RxFIFO is empty
4 TXFULL	TxFIFO FULL. Indicates the TxFIFO is full. 0 The TxFIFO is not full 1 The TxFIFO is full
3 RXFULL	RxFIFO FULL. Indicates the RxFIFO is full. 0 The RxFIFO is not full 1 The RxFIFO is full
2–1 Reserved	This read-only field is reserved and always has the value 0.
0 SOFTTRST	Software Reset. Indicates the status of the software reset (SRST_B bit of UCR2). 0 Software reset inactive 1 Software reset active

55.15.17 UART RS-485 Mode Control Register (UARTx_UMCR)

Address: Base address + B8h offset

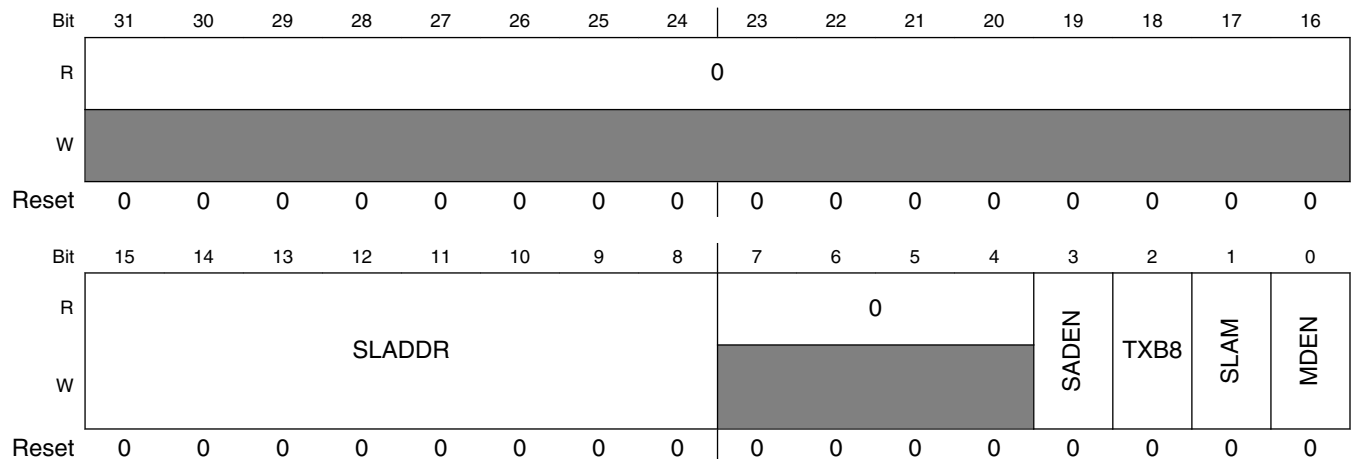

UARTx_UMCR field descriptions

Field	Description
31–16 Reserved	This read-only field is reserved and always has the value 0.
15–8 SLADDR	RS-485 Slave Address Character. Holds the selected slave address character that the receiver will try to detect.
7–4 Reserved	This read-only field is reserved and always has the value 0.
3 SADEN	RS-485 Slave Address Detected Interrupt Enable. 0 Disable RS-485 Slave Address Detected Interrupt 1 Enable RS-485 Slave Address Detected Interrupt
2 TXB8	Transmit RS-485 bit 8 (the ninth bit or 9 th bit). In RS-485 mode, software writes TXB8 bit as the 9 th data bit to be transmitted. 0 0 will be transmitted as the RS485 9 th data bit 1 1 will be transmitted as the RS485 9 th data bit
1 SLAM	RS-485 Slave Address Detect Mode Selection. 0 Select Normal Address Detect mode 1 Select Automatic Address Detect mode
0 MDEN	9-bit data or Multidrop Mode (RS-485) Enable. 0 Normal RS-232 or IrDA mode, see Table 55-1 for detail. 1 Enable RS-485 mode, see Table 55-1 for detail

Chapter 56

Universal Serial Bus Controller (USB)

56.1 Overview

The USB controller block provides high performance USB functionality that conforms to the *Universal Serial Bus Specification*, Rev. 2.0 (Compaq, Hewlett-Packard, Intel, Lucent, Microsoft, NEC, Philips; 2000), and the *On-The-Go and Embedded Host Supplement to the USB Revision 2.0 Specification* (Hewlett-Packard Company, Intel Corporation, LSI Corporation, Microsoft Corporation, Renesas Electronics Corporation, ST-Ericsson; 2012).

The USB controller consists of independent USB controller cores: two On-The-Go (OTG) controller cores. Each controller core supports UTMI interface. See [Features](#) for more details. controller cores are single-port cores. For the OTG cores, there is only one port. The port can be used as either a downstream or an upstream port.

The following figure is a block diagram of USB.

56.1.1 Features

There are USB 2.0 controller cores in this chip:

- Controller Core 0 is also named 'OTG1 Core'; its connected port is named 'OTG1 port'.
- Controller Core 1 is also named 'OTG2 Core'; its connected port is named 'OTG2 port'.

The following list provides features of each of the controller cores.

- USB 2.0 Controller Core 0
 - High-Speed/Full-Speed/Low-Speed OTG core
 - HS/FS/LS UTMI compliant interface

- High Speed, Full Speed and Low Speed operation in Host mode (with UTMI transceiver)
- High Speed, and Full Speed operation in Peripheral mode (with UTMI transceiver)
- Hardware support for OTG signaling, session request protocol, and host negotiation protocol
- Up to 8 bidirectional endpoints
- Support charger detection
- USB 2.0 Controller Core 1
 - High-Speed/Full-Speed/Low-Speed OTG core
 - HS/FS/LS UTMI compliant interface
 - High Speed, Full Speed and Low Speed operation in Host mode (with UTMI transceiver)
 - High Speed, and Full Speed operation in Peripheral mode (with UTMI transceiver)
 - Hardware support for OTG signaling, session request protocol, and host negotiation protocol
 - Up to 8 bidirectional endpoints
- Low-power mode with local and remote wake-up capability
- Serial PHY interfaces configurable for bidirectional/unidirectional and differential/single ended
- Embedded DMA controller in each core

56.1.2 Modes of Operation

The USB has two main modes of operation: normal mode and low power mode.

Each USB OTG controller core can operate in High Speed operation (480 Mbps), Full Speed operation (12 Mbps) and Low Speed operation (1.5 Mbps).

This chapter explains the operation modes.

56.1.2.1 Normal Mode

The OTG controller core can operate in Host mode and Device (Peripheral) mode. The Host-only controller core can operate in Host mode only.

Each USB controller core has its corresponding port, which can work in one or more interface modes.

NOTE

Each controller supports only the interface type listed below. Selecting a different interface type in the PORTSC.PTS field results in unpredictable behavior and may cause the system to hang.

- OTG1 port
 - This port supports on-chip UTMI transceiver only.
- OTG2 port
 - This port supports on-chip UTMI transceiver only.

NOTE

HSIC is an inter-chip interface that is optimized for circuit board layouts.

56.1.2.2 Low-Power Mode

Each USB controller core has a low-power mode (Suspend mode) to save power consumption.

As described in the USB 2.0 specification, the device can go into the Suspend state after it sees a constant Idle state on the upstream facing port. The OTG controller core enters Suspend mode after 3 ms of inactivity on the port when it is in Device Operation mode. Host controllers, including the OTG controller in Host mode, do not suspend automatically but can be placed in Suspend mode by software.

Either the local ARM platform or the remote USB Host/Peripheral can initiate a wake-up sequence to resume USB communication. For details about Suspend/Resume, see [USB Power Control](#).

56.2 External Signals

The table found here describes the external signals of USB.

Table 56-1. USB External Signals

Signal	Description	Pad	Mode	Direction
USB_OTG1_ID	ID signal	GPIO1_IO00	ALT2	I
		SD1_DATA0	ALT8	
		UART3_TX_DATA	ALT8	
USB_OTG1_OC	OTG External input for VBUS overcurrent detection	ENET2_RX_DATA1	ALT8	I

Table continues on the next page...

**Table 56-1. USB External Signals
(continued)**

Signal	Description	Pad	Mode	Direction
		GPIO1_IO01	ALT2	
		SD1_CLK	ALT8	
USB_OTG1_PWR	To control PMIC to supply VBUS voltage	ENET2_RX_DATA0	ALT8	O
		GPIO1_IO04	ALT2	
		SD1_CMD	ALT8	
USB_OTG2_ID	ID signal	ENET2_TX_CLK	ALT8	I
		GPIO1_IO05	ALT2	
		SD1_DATA3	ALT8	
USB_OTG2_OC	OTG External input for VBUS overcurrent detection	ENET2_TX_EN	ALT8	I
		GPIO1_IO03	ALT2	
		SD1_DATA2	ALT8	
USB_OTG2_PWR	To control PMIC to supply VBUS voltage	ENET2_TX_DATA1	ALT8	O
		GPIO1_IO02	ALT2	
		SD1_DATA1	ALT8	

56.3 Functional Description

These sections describe the functionality of the various building blocks of the USB.

56.3.1 USB 2.0 Controller Core 0

The USB 2.0 Controller 0 is an instantiation of an EHCI-compatible core which supports high-, full-, and low-speed operation.

In Host mode, this controller core supports high-, full-, and low-speed operation. In Device mode, it supports high- and full-speed operation.

56.3.1.1 Host Mode

The controller supports direct connection of .

Although there is no separate Transaction Translator block in the system, the transaction translator function normally associated with a USB 2.0 high speed hub has been implemented within the DMA and protocol engine blocks to support connection to full and low speed devices.

56.3.1.2 Peripheral (Device) Mode

- Up to eight bidirectional endpoints
- High/full-speed operation
- Support of HNP and SRP
- Remote wake-up capability

56.3.2 USB 2.0 Controller Core 1

USB 2.0 Controller Core 1 is an instantiation of EHCI-compatible core which supports High Speed / Full Speed / Low Speed operation with ULPI interface. It also supports High Speed operation with HSIC interface.

This USB core's signals connect directly to I/O pins (HSIC interface).

56.3.3 USB Power Control

The USB controller supports suspend and wake-up functionality.

The power control block allows for placing the transceiver in USB low power mode when USB bus is IDLE, and supports local and remote wake-up to bring the transceiver out of USB low power mode when needed. Additionally, the power control block can wake-up the Arm platform from core sleep mode by generating an interrupt.

56.3.3.1 Entering Low Power Suspend Mode

In Host operation mode, low power suspend mode is entered as follows:

1. Clear the ASE and PSE bits in USB_USBCMD, and wait until the AS and PS bits in USB_USBSTS become "0".
2. Set the "SUSPEND" bit in USB_PORTSC1
3. Set the "PHCD" bit in USB_PORTSC1
4. Set all PWD bits in USBPHYx_PWD
5. Set CLKGATE in USBPHYx_CTRL

NOTE

Step 3,4,5 shall be done in atomic operation. That is, interrupt should be disabled during these three steps.

For device operation mode, low power suspend mode is entered as follows:

Functional Description

1. After Host drive is IDLE for 3ms, an SLI interrupt is issued (the "DCSUSPEND" or "SLI" bit in USB_USBSTS)
2. Set the "PHCD" bit on USB_PORTSC1
3. Set all PWD bits in USBPHYx_PWD
4. Set CLKGATE in USBPHYx_CTRL

NOTE

Step 2,3,4 shall be done in atomic operation. That is, interrupt should be disabled during these three steps.

56.3.3.2 Wake-Up Events

The power control block monitors the USB bus when the USB core is in the USB suspend state.

Depending on whether the core is on Host or Device mode, a number of wake-up conditions are monitored. Upon detection of a wake-up condition, an interrupt (asynchronous) will be generated to Arm platform if the related wake-up interrupt enable bit is set.

USB wake-up interrupt also re-activates the Arm platform clocks if they were stopped during the suspend.

56.3.3.2.1 Host Mode Events

The host controller wakes up on the following events:

- Remote Wake-up Request

A peripheral can request the host to reactivate the bus by driving wake-up signaling on the DM/DP lines. The power control block sends a wake-up request to the USB core when a J-K transition on DM/DP line is detected.

- Wake-Up On Overcurrent

If Wake-Up On Overcurrent is enabled (WKOC bit in the USB core register PORTSC1 is set '1'), the power control block sends a wake-up request to the USB core when an overcurrent event is detected.

- Wake-Up On Disconnect

If Wake-Up On Disconnect is enabled (WKDC bit in the USB core register PORTSC1 is set '1'), the power control block sends a wake-up request to the USB core when a disconnection event is detected (J-SE0/K-SE0 transition on DM/DP line).

- Wake-Up On Connect

If a Wake-Up On Connect is enabled (WKCN bit in the USB core register PORTSC1 is set '1'), the power control sub-block sends a wake-up request to the USB core when the connection event is detected (SE0-J/SE0-K transition on DM/DP line).

For a detailed description of register bits WKOC, WKDC, WKCN, please see [Port Status & Control \(USB_nPORTSC1\)](#).

56.3.4 Interrupts

56.3.4.1 USB Core Interrupts

Each USB core uses one dedicated vector in the Interrupt Table. The vector numbers associated with each of the cores can be found in the Interrupt section.

With the exception of the wake-up interrupts, all of the interrupt sources are controlled in the USB Cores. Refer to the [Interrupt Enable Register \(USB_nUSBINTR\)](#) for details.

56.3.4.2 USB Wake-Up Interrupts

Each USB Core has an associated wake-up interrupt. The wake-up interrupts are generated outside of the USB controller cores, but using the same vector as the corresponding USB controller cores interrupt.

These interrupts are generated by the Power Control blocks which run on the 32 KHz standby clock. The wake-up interrupt is designed to work even when the USB and Arm platform clocks are disabled, such that a wake-up condition on the USB bus can re-activate the Arm platform clocks.

Because the wake-up interrupt is generated and cleared on a 32 KHz clock, this interrupt request responds very slowly to clear actions. For this reason, the software must disable the wake-up interrupt to clear the request flag. Disabling the interrupt masks the request instantaneously as this is clocked by the Arm platform clock. The software should wait for at least three 32 KHz clock cycles before re-enabling this interrupt to allow sufficient time for the request flag to clear. Because this interrupt is only used during low power modes of the USB, it is sufficient to enable the wake-up interrupt just prior to entering the USB suspend mode.

56.4 USB Operation Model

This section describes the detailed application knowledge for OTG1 and OTG2 ports.

56.4.1 Register Interface

Configuration, control and status registers are divided into three categories, identification, capability and operational registers.

NOTE

USB controller registers support only DWORD (32-bit) access.

- Identification registers are used to declare the slave interface presence along with the complete set of the hardware configuration parameters.
- Static, read only capability registers define the software limits, restrictions, and capabilities of the host/device controller.
- Operational registers are dynamic control or status registers that may be read only, read/write, or read/write-to-clear. The following sections define the use of these registers.

EHCI registers are listed alongside device registers to show the complementary nature of host and device control.

The following table describes the Interface register sets.

Table 56-2. Interface Register Sets

Offset	Register Set	Explanation
000h-07Ch	Identification Registers	Identification registers are used to declare the slave interface presence and include a table of the hardware configuration parameters.
100h-124h	Capability Registers	Capability registers specify the limits, restrictions, and capabilities of a host/device controller implementation. These values are used as parameters to the host/device controller driver.
080h-0FCh 140h-1FCh	Operational Registers	Operational registers are used by the system software to control and monitor the operational state of the host/device controller.

56.4.1.1 Configuration, Control and Status Register Set

The following table describes the Device/Host capability registers.

NOTE

Depending on implementation, "x" can have the following values: UOG1, UOG2.

Table 56-3. Device/Host Capability Registers

Offset	Size (Bytes)	Mnemonic	Register Name	Device Mode	Host Mode
000h	4	USB_x_ID	Identification Register	O	O
004h	4	USB_x_HWGENERAL	General Hardware Parameters	O	O
008h	4	USB_x_HWHOST	Host Hardware Parameters	X	O
00Ch	4	USB_x_HWDEVICE	Device Hardware Parameters	O	X
010h	4	USB_x_HWTXBUF	TX Buffer Hardware Parameters	O	O
014h	4	USB_x_HWRXBUF	RX Buffer Hardware Parameters	O	O
018-07Fh		-	Reserved		
080h	4	USB_x_GPTIMER0LD	General Purpose Timer #0 Load Register	O	O
084h	4	USB_x_GPTIMER0CTRL	General Purpose Timer #0 Control Register	O	O
088h	4	USB_x_GPTIMER1LD	General Purpose Timer #1 Load Register	O	O
08Ch	4	USB_x_GPTIMER1CTRL	General Purpose Timer #1 Control Register	O	O
090h	4	USB_x_SBUSCFG	System Bus Interface Configuration Register	O	O
094-09Fh		-	Reserved		
100h	1	USB_x_CAPLENGTH	Capability Register Length	O	O
101h		-	Reserved		
102h	2	USB_x_HCVERSION	Host Controller Interface Version Number	X	O
104h	4	USB_x_HCSPARAMS	Host Controller Structural Parameters	X	O
108h	4	USB_x_HCCPARAMS	Host Controller Capability Parameters	X	O
10C-11Fh		-	Reserved		
120h	2	USB_x_DCVERSION	Device Controller Interface Version Number	O	X
122h	2	-	Reserved		
124h	4	USB_x_DCCPARAMS	Device Controller Capability Parameters	O	X
128-13Fh		-	Reserved		
140h	4	USB_x_USBCMD	USB Command Register	O	O
144h	4	USB_x_USBSTS	USB Status Register	O	O
148h	4	USB_x_USBINTR	USB Interrupt Enable Register	O	O
14Ch	4	USB_x_FRINDEX	USB Frame Index	O	O
150h	4	-	Reserved		
154h	4	USB_x_PERIODICLISTBASE	Frame List Base Address	X	O
		USB_x_DEVICEADDR	USB Device Address	O	X
158h	4	USB_x_ASYNC_LIST_ADDR	Next Asynchronous List Address	X	O
		USB_x_ENDPOINT_LIST_ADDR	Address at Endpoint list in memory	O	X
15Ch	4	-	Reserved		

Table continues on the next page...

Table 56-3. Device/Host Capability Registers (continued)

Offset	Size (Bytes)	Mnemonic	Register Name	Device Mode	Host Mode
160h	4	USB_X_BURSTSIZE	Programmable Burst Size	O	O
164h	4	USB_X_TXFILLTUNING	Host Transmit Pre-Buffer Packet Tuning	X	O
168h	4	-	Reserved		
170h	4	-	Reserved		
178h	4	USB_X_ENDPTNAK	Endpoint NAK register	O	X
17Ch	4	USB_X_ENDPTNAKEN	Endpoint NAK Enable register	O	X
180h	4	USB_X_CONFIGFLAG	Configured Flag Register	X	O
184h	4	USB_X_PORTSC1	Port Status/Control Register 1	O	O
188-1A3h		-	Reserved		
1A4h	4	USB_X_OTGSC	On-The-Go Status/Control Register (OTG only)	O	O
1A8h	4	USB_X_USBMODE	USB Controller Operating Mode	O	O
1ACh	4	USB_X_ENDPTSETUPS TAT	Endpoint Setup Status	O	X
1B0h	4	USB_X_ENDPTPRIME	Endpoint Initialization	O	X
1B4h	4	USB_X_ENDPTFLUSH	Endpoint De-Initialization	O	X
1B8h	4	USB_X_ENDPTSTATUS	Endpoint Status	O	X
1BCh	4	USB_X_ENDPTCOMPLE TE	Endpoint Complete	O	X
1C0 1C4 ... 1DCh	64	USB_X_ENDPTCTRL0 USB_X_ENDPTCTRL1 USB_X_ENDPTCTRL7	Endpoint Control Register 0-7	O	X

NOTE

"O" means the register is available in host/device operation mode;

"X" means the register is reserved in host/device operation mode

56.4.1.2 Identification Registers

Identification registers are used to declare the slave interface presence and include a table of the hardware configuration parameters.

56.4.1.3 OTG Operations

56.4.1.3.1 Register Bits

In the previous section, the Register interface has behaviors described for device mode and behaviors described for host mode. However, for OTG operations it is necessary to perform tasks independent of the controller mode.

NOTE

The only way to transit the controller mode out of host or device mode is with the controller reset bit. Therefore, it is also necessary for the OTG tasks to be performed independent of a controller reset as well as independent of the controller mode.

The following figure shows the controller mode.

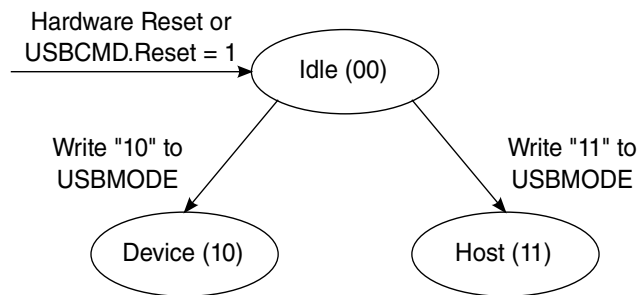

Figure 56-1. Controller Mode

To this end, listed below are the register bits that are used for OTG operations, which are independent of the controller mode and are also not affected by a write to the reset bit in the USBCMD register:

All Identification Registers

All Device/Host Capability Registers

OTGSC: All bits

PORTSC1:

Physical Interface Select

Physical Interface Serial Select

Physical Interface Data Width

Physical Interface Low Power

Physical Interface Wake Signals

Port Indicators

56.4.2 Host Data Structures

This section defines the interface data structures used to communicate control, status, and data between HCD (software) and the Enhanced Host Controller (hardware).

The data structure definitions in this chapter support a 32-bit memory buffer address space. The interface consists of a Periodic Schedule, Periodic Frame List, Asynchronous Schedule, Isochronous Transaction Descriptors, Split-transaction Isochronous Transfer Descriptors, Queue Heads, and Queue Element Transfer Descriptors.

The periodic frame list is the root of all periodic (isochronous and interrupt transfer type) transfers for the host controller. The asynchronous list is the root for all the bulk and control transfers. Isochronous data streams are managed using Isochronous Transaction Descriptors. Isochronous split-transaction data streams are managed with Split-transaction Isochronous Transfer Descriptors. All Interrupt, Control, and Bulk data streams are managed via queue heads and Queue Element Transfer Descriptors. These data structures are optimized to reduce the total memory footprint of the schedule and to reduce (on average) the number of memory accesses needed to execute a USB transaction.

Note that software must ensure that no interface data structure reachable by the EHCI host controller spans a 4 K-page boundary.

The data structures defined in this section are (from the host controller's perspective) a mix of read-only and read/writeable fields. The host controller must preserve the read-only fields on all data structure writes.

56.4.2.1 Periodic Frame List

This schedule is for all periodic transfers (isochronous and interrupt). The periodic schedule is referenced from the operational registers space using the USB_PERIODICLISTBASE address register and the USB_FRINDEX register.

The periodic schedule is based on an array of pointers called the Periodic Frame List.

The USB_PERIODICLISTBASE address register is combined with the USB_FRINDEX register to produce a memory pointer into the frame list. The Periodic Frame List implements a sliding window of work over time.

The following figure shows the organization of periodic schedule.

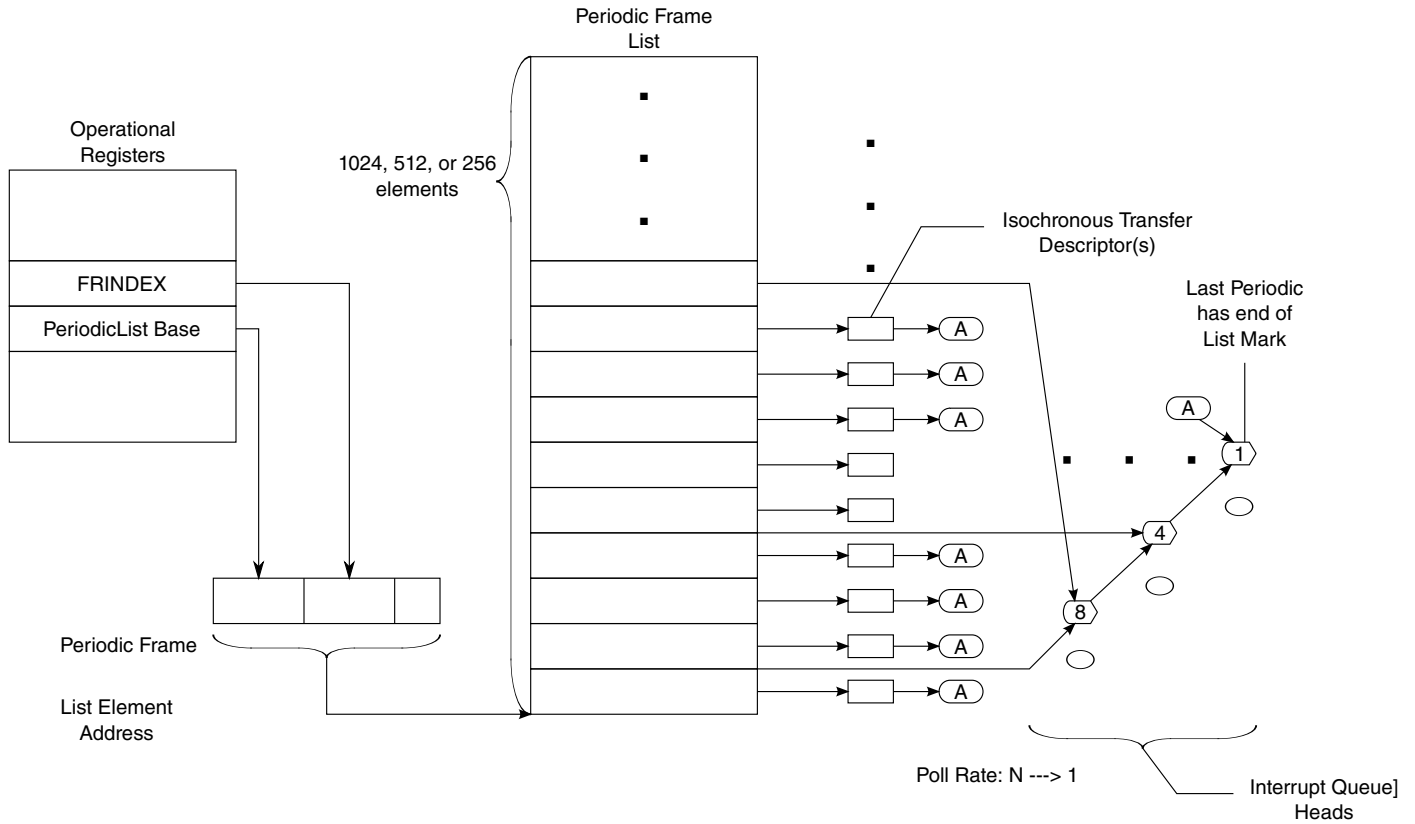

Figure 56-2. Periodic Schedule Organization

Split transaction Interrupt, Bulk and Control are also managed using queue heads and queue element transfer descriptors.

The periodic frame list is a 4 K-page aligned array of Frame List Link pointers. The length of the frame list may be programmable. The programmability of the periodic frame list is exported to system software via the USB_HCCPARAMS register. If non-programmable, the length is 1024 elements. If programmable, the length can be selected by system software as one of 256, 512, or 1024 elements. An implementation must support all three sizes. Programming the size (that is, the number of elements) is accomplished by system software writing the appropriate value into Frame List Size field in the USB_USBCMD register.

Frame List Link pointers direct the host controller to the first work item in the frame's periodic schedule for the current micro-frame. The link pointers are aligned on DWord boundaries within the Frame List.

The table below illustrates the format of the Frame list element pointer.

Table 56-4. Format of Frame List Element Pointer

31	30	29	28	27	26	25	24	23	22	21	20	19	18	17	16	15	14	13	12	11	10	9	8	7	6	5	4	3	2	1	0	
----	----	----	----	----	----	----	----	----	----	----	----	----	----	----	----	----	----	----	----	----	----	---	---	---	---	---	---	---	---	---	---	--

Table continues on the next page...

Table 56-4. Format of Frame List Element Pointer (continued)

Frame List Link Pointer	0	Typ	03-00H
-------------------------	---	-----	--------

Frame List Link pointers always reference memory objects that are 32-byte aligned. The referenced object may be an isochronous transfer descriptor for high-speed devices, a split-transaction isochronous transfer descriptor (for full-speed isochronous endpoints), or a queue head (used to support high-, full- and low-speed interrupt). System software should not place non-periodic schedule items into the periodic schedule. The least significant bits in a frame list pointer are used to key the host controller as to the type of object the pointer is referencing.

The least significant bit is the T-Bit (bit 0). When this bit is set to a one, the host controller never uses the value of the frame list pointer as a physical memory pointer. The Typ field is used to indicate the exact type of data structure being referenced by this pointer. The value encodings are.

Table 56-5. Typ Field Value Definitions

Value	Meaning
00b	Isochronous Transfer Descriptor
01b	Queue Head
10b	Split Transaction Isochronous Transfer Descriptor.
11b	Frame Span Traversal Node.

56.4.2.2 Asynchronous List Queue Head Pointer

The Asynchronous Transfer List (based at the USB_ASYNC_LIST_ADDR register) is where all of the control and bulk transfers are managed.

Host controllers use this list only when it reaches the end of the periodic list, the periodic list is disabled, or the periodic list is empty.

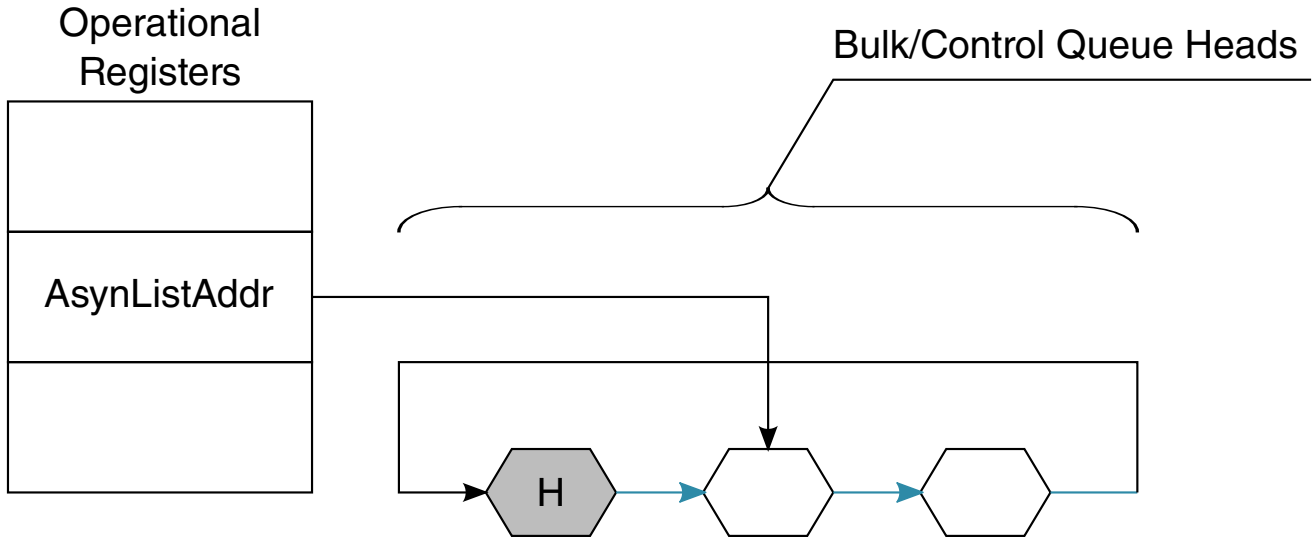

Figure 56-3. Asynchronous Schedule Organization

The Asynchronous list is a simple circular list of queue heads. The USB_ASYNCLISTADDR register is simply a pointer to the next queue head. This implements a pure round-robin service for all queue heads linked into the asynchronous list.

56.4.2.3 Isochronous (High-Speed) Transfer Descriptor (iTDD)

The format of an isochronous transfer descriptor is shown in the table below.

This structure is used only for high-speed isochronous endpoints. All other transfer types should use queue structures. Isochronous TDs must be aligned on a 32-byte boundary.

Table 56-6. Isochronous Transaction Descriptor (iTDD)

31	30	29	28	27	26	25	24	23	22	21	20	19	18	17	16	15	14	13	12	11	10	9	8	7	6	5	4	3	2	1	0	
Next Link Pointer																											0	Typ	T	03-00H		
Status		Transaction 0 Length														IO C	PG*	Transaction 0 Offset*										07-04H				
Status		Transaction 1 Length														IO C	PG*	Transaction 1 Offset*										0B-08H				
Status		Transaction 2 Length														IO C	PG*	Transaction 2 Offset*										0F-0CH				
Status		Transaction 3 Length														IO C	PG*	Transaction 3 Offset*										13-10H				

Table continues on the next page...

Table 56-6. Isochronous Transaction Descriptor (iTID) (continued)

Status	Transaction 4 Length	IO C	PG*	Transaction 4 Offset*	17-14 H		
Status	Transaction 5 Length	IO C	PG*	Transaction 5 Offset*	1B-1 8H		
Status	Transaction 6 Length	IO C	PG*	Transaction 6 Offset*	1F-1 CH		
Status	Transaction 7 Length	IO C	PG*	Transaction 7 Offset*	23-20 H		
Buffer Pointer (Page 0)				EndPt	R	Device Address	27-24 H
Buffer Pointer (Page 1)				I/ O	Maximum Packet Size		2B-2 8H
Buffer Pointer (Page 2)				-		Mult	2F-2 CH
Buffer Pointer (Page 3)				-			33-30 H
Buffer Pointer (Page 4)				-			37-34 H
Buffer Pointer (Page 5)				-			3B-3 8H
Buffer Pointer (Page 6)				-			3F-3 CH



Host Controller Read/Write

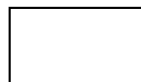

Host Controller Read Only

These fields may be modified by the host controller if the I/O field indicates an OUT.

56.4.2.3.1 Next Link Pointer

The first DWord of an iTD is a pointer to the next schedule data structure.

The following table describes the Next Schedule Element pointer field.

Table 56-7. Next Schedule Element Pointer

Bit	Description
31-5 Link Pointer (LP)	These bits correspond to memory address signals [31:5], respectively. This field points to another Isochronous Transaction Descriptor (iTID/siTID) or Queue Head (QH).
4-3	These bits are reserved and their value has no effect on operation. Software should initialize this field to zero.

Table continues on the next page...

Table 56-7. Next Schedule Element Pointer (continued)

Reserved	
2-1 QH/(s)iTD Select (Typ)	This field indicates to the Host Controller whether the item referenced is an iTD, siTD or a QH. This allows the Host Controller to perform the proper type of processing on the item after it is fetched. Value encodings are: Value Meaning 00b iTD (isochronous transfer descriptor) 01b QH (queue head) 10b siTD (split transaction isochronous transfer descriptor) 11b FSTN (frame span traversal node)
0 Terminate (T)	1= Link Pointer field is not valid. 0= Link Pointer field is valid.

56.4.2.3.2 iTD Transaction Status and Control List

DWords 1 through 8 are eight slots of transaction control and status.

Each transaction description includes:

- Status results field
- Transaction length (bytes to send for OUT transactions and bytes received for IN transactions).
- Buffer offset. The PG and Transaction X Offset fields are used with the buffer pointer list to construct the starting buffer address for the transaction.

The host controller uses the information in each transaction description plus the endpoint information contained in the first three DWords of the Buffer Page Pointer list, to execute a transaction on the USB.

The following table describes iTD Transaction Status and Control fields.

Table 56-8. iTD Transaction Status and Control

Bit	Description
31-28 Status	This field records the status of the transaction executed by the host controller for this slot. This field is a bit vector with the following encoding:
Bit	Definition
31	Active. Set to one by software to enable the execution of an isochronous transaction by the Host Controller. When the transaction associated with this descriptor is completed, the Host Controller sets this bit to zero indicating that a transaction for this element should not be executed when it is next encountered in the schedule.
30	Data Buffer Error. Set to a one by the Host Controller during status update to indicate that the Host Controller is unable to keep up with the reception of incoming data (overrun) or is unable to supply data fast enough during transmission (under run). If an overrun condition occurs, no action is necessary.
29	Babble Detected. Set to one by the Host Controller during status update when "babble" is detected during the transaction generated by this descriptor.

Table continues on the next page...

Table 56-8. iTD Transaction Status and Control (continued)

Bit	Description
28	Transaction Error (XactErr). Set to one by the Host Controller during status update in the case where the host did not receive a valid response from the device (Timeout, CRC, Bad PID, etc.). This bit may only be set for isochronous IN transactions.
27-16 Transaction X Length	For an OUT, this field is the number of data bytes the host controller sends during the transaction. The host controller is not required to update this field to reflect the actual number of bytes transferred during the transfer. For an IN, the initial value of the endpoint to deliver. During the status update, the host controller writes back the field is the number of bytes the host expects the number of bytes successfully received. The value in this register is the actual byte count (0±zero length data, 1±one byte, 2±two bytes, etc.). The maximum value this field may contain is 0xC00 (3072).
15 Interrupt On Complete (IOC)	If this bit is set to one, it specifies that when this transaction completes, the Host Controller should issue an interrupt at the next interrupt threshold.
14-12 Page Select (PG)	These bits are set by software to indicate which of the buffer page pointers the offset field in this slot should be concatenated to produce the starting memory address for this transaction. The valid range of values for this field is 0 to 6.
11-0 Transaction X Offset	This field is a value that is an offset, expressed in bytes, from the beginning of a buffer. This field is concatenated onto the buffer page pointer indicated in the adjacent PG field to produce the starting buffer address for this transaction.

56.4.2.3.3 iTD Buffer Page Pointer List (Plus)

DWords 9-15 of an isochronous transaction descriptor are nominally page pointers (4 K aligned) to the data buffer for this transfer descriptor. This data structure requires the associated data buffer to be contiguous (relative to virtual memory), but allows the physical memory pages to be non-contiguous.

Seven page pointers are provided to support the expression of eight isochronous transfers. The seven pointers allow for 3 (transactions) * 1024 (maximum packet size) * 8 (transaction records) (24576 bytes) to be moved with this data structure, regardless of the alignment offset of the first page.

Because each pointer is a 4 K aligned page pointer, the least significant 12 bits in several of the page pointers are used for other purposes.

The tables below illustrate the field descriptions.

Table 56-9. iTD Buffer Pointer Page 0 (Plus)

Bit	Description
31-12 Buffer Pointer (Page 0)	This is a 4 K aligned pointer to physical memory. Corresponds to memory address bits [31:12].
11-8 Endpoint Number (Endpt)	This 4-bit field selects the particular endpoint number on the device serving as the data source or sink.

Table continues on the next page...

Table 56-9. iTD Buffer Pointer Page 0 (Plus) (continued)

Bit	Description
7 Reserved	Bit reserved for future use and should be initialized by software to zero.
6-0 Device Address	This field selects the specific device serving as the data source or sink.

Table 56-10. iTD Buffer Pointer Page 1 (Plus)

Bit	Description
31-12 Buffer Pointer (Page 1)	This is a 4K aligned pointer to physical memory. Corresponds to memory address bits [31:12].
11 Direction (I/O)	0 = OUT; 1 = IN. This field encodes whether the high-speed transaction should use an IN or OUT PID.
10-0 Maximum Packet Size	This directly corresponds to the maximum packet size of the associated endpoint (<i>wMaxPacketSize</i>). This field is used for high-bandwidth endpoints where more than one transaction is issued per transaction description (per micro-frame). This field is used with the <i>Multi</i> field to support high-bandwidth pipes. This field is also used for all IN transfers to detect packet babble. Software should not set a value larger than 1024 (400h). Any value larger yields undefined results.

Table 56-11. iTD Buffer Pointer Page 2 (Plus)

Bit	Description
31-12 Buffer Pointer	This is a 4K aligned pointer to physical memory. Corresponds to memory address bits [31:12].
11-2 Reserved	This bit reserved for future use and should be set to zero.
1-0 Multi	This field is used to indicate to the host controller the number of transactions that should be executed per transaction description (per micro-frame). The valid values are: Value Meaning 00b Reserved. A zero in this field yields undefined results. 01b One transaction to be issued for this endpoint per micro- frame. 10b Two transactions to be issued for this endpoint per micro- frame. 11b Three transactions to be issued for this endpoint per micro- frame.

Table 56-12. iTD Buffer Pointer Page 3-6

Bit	Description
31-12 Buffer Pointer	This is a 4 K aligned pointer to physical memory. Corresponds to memory address bits [31:12].
11-0 Reserved	These bits reserved for future use and should be set to zero.

56.4.2.4 Split Transaction Isochronous Transfer Descriptor (siTD)

All Full-speed isochronous transfers through the internal transaction translator are managed using the siTD data structure. This data structure satisfies the operational requirements for managing the split transaction protocol.

The following table shows the Split Transaction Isochronous Transfer Descriptor (siTD).

Table 56-13. Split Transaction Isochronous Transfer Descriptor

31	30	29	28	27	26	25	24	23	22	21	20	19	18	17	16	15	14	13	12	11	10	9	8	7	6	5	4	3	2	1	0	Addr
Next Link Pointer																								0	Typ	T	03-00					
I/O	Port Number						-	Hub Addr						Reserved				EndPt				-	Device Address						07-04 ¹			
Reserved												µFrame C-mask						µFrame S-mask						0B-08 ¹								
io	P	Reserved				Total Bytes to Transfer						µFrame C-prog-mask						Status				0F-0C ²										
Buffer Pointer (Page 0)												Current Offset												13-10 ²								
Buffer Pointer (Page 1)												Reserved						TP	T-count				17-14 ²									
Back Pointer																								0		T	1B-18					

- 1. 04-0B: Static Endpoint State
- 2. 0C-13: Transfer results



Host Controller Read/Write



Host Controller Read Only

56.4.2.4.1 Next Link Pointer

DWord0 of a siTD is a pointer to the next schedule data structure.

The following table describes the Next Link Pointer fields.

Table 56-14. Next Link Pointer

Bit	Description
31-5	Next Link Pointer (LP). This field contains the address of the next data object to be processed in the periodic list and corresponds to memory address signals [31:5], respectively.

Table continues on the next page...

Table 56-14. Next Link Pointer (continued)

Bit	Description
4-3	Reserved. These bits must be written as zeros.
2-1	QH/(s)iTD Select (Typ). This field indicates to the Host Controller whether the item referenced is an iTD/siTD or a QH. This allows the Host Controller to perform the proper type of processing on the item after it is fetched. Value encodings are: Value Meaning 00b iTD (isochronous transfer descriptor) 01b QH (queue head) 10b siTD (split transaction isochronous transfer descriptor) 11b FSTN (frame span traversal node)
0	Terminate (T). 1 = Link Pointer field is not valid. 0 = Link Pointer is valid.

56.4.2.4.2 siTD Endpoint Capabilities/Characteristics

DWords 1 and 2 specify static information about the full-speed endpoint, the addressing of the parent Companion Controller, and micro-frame scheduling control.

The tables below describe the Endpoint and transaction translator characteristics and micro-frame schedule control fields.

Table 56-15. Endpoint and Transaction Translator Characteristics

Bit	Description
31	Direction (I/O). 0 = OUT; 1 = IN. This field encodes whether the full-speed transaction should be an IN or OUT.
30-24	Port Number. This field is the port number of the recipient Transaction Translator.
23	Reserved. Bit reserved and should be set to zero.
22-16	Hub Address. This field holds the device address of the Companion Controllers' hub.
15-12	Reserved. Field reserved and should be set to zero.
11-8	Endpoint Number (Endpt). This 4-bit field selects the particular endpoint number on the device serving as the data source or sink.
7	Reserved. Bit is reserved for future use. It should be set to zero.
6-0	Device Address. This field selects the specific device serving as the data source or sink.

Table 56-16. Micro-frame Schedule Control

Bit	Description
31-16	Reserved. This field reserved for future use. It should be set to zero.
15-8	Split Completion Mask (mFrame C-Mask). This field (along with the <i>Active</i> and <i>SplitX-state</i> fields in the <i>Status</i> byte) is used to determine during which micro-frames the host controller should execute complete-split transactions. When the criteria for using this field is met, an all zeros value has undefined behavior. The host

Table continues on the next page...

Table 56-16. Micro-frame Schedule Control (continued)

Bit	Description
	controller uses the value of the three low-order bits of the FRINDEX register to index into this bit field. If the FRINDEX register value indexes to a position where the <i>mFrame C-Mask</i> field is a one, then this siTD is a candidate for transaction execution. There may be more than one bit in this mask set.
7-0	Split Start Mask (<i>mFrame S-mask</i>). This field (along with the <i>Active</i> and <i>SplitX-state</i> fields in the <i>Status</i> byte) is used to determine during which micro-frames the host controller should execute start-split transactions. The host controller uses the value of the three low-order bits of the FRINDEX register to index into this bit field. If the FRINDEX register value indexes to a position where the <i>mFrame S-mask</i> field is a one, then this siTD is a candidate for transaction execution. An all zeros value in this field, in combination with existing periodic frame list has undefined results.

56.4.2.4.3 siTD Transfer State

DWords 3-6 are used to manage the state of the transfer.

The following table describes siTD transfer state fields.

Table 56-17. siTD Transfer Status and Control

Bit	Description
31	Interrupt On Complete (<i>ioc</i>). 0 = Do not interrupt when transaction is complete. 1 = Do interrupt when transaction is complete. When the host controller determines that the split transaction has completed it asserts a hardware interrupt at the next interrupt threshold.
30	Page Select (<i>P</i>). Used to indicate which data page pointer should be concatenated with the <i>CurrentOffset</i> field to construct a data buffer pointer (0 selects <i>Page 0</i> pointer and 1 selects <i>Page 1</i>). The host controller is not required to write this field back when the siTD is retired (<i>Active</i> bit transitioned from a one to a zero).
29-26	Reserved. This field reserved for future use and should be set to zero.
25-16	Total Bytes To Transfer. This field is initialized by software to the total number of bytes expected in this transfer. Maximum value is 1023 (3FFh)
15-8	μ Frame Complete-split Progress Mask (<i>C-prog-Mask</i>). This field is used by the host controller to record which split-completes has been executed.
7-0: Status—This field records the status of the transaction executed by the host controller for this slot. It is a bit vector with the encoding shown in the following rows.	
7	Active. Set to one by software to enable the execution of an isochronous split transaction by the Host Controller.
6	ERR. Set to a one by the Host Controller when an ERR response is received from the Companion Controller.
5	Data Buffer Error. Set to a one by the Host Controller during status update to indicate that the Host Controller is unable to keep up with the reception of incoming data (overrun) or is unable to supply data fast enough during transmission (under run). In the case of an under run, the Host Controller transmits an incorrect CRC (thus invalidating the data at the endpoint). If an overrun condition occurs, no action is necessary.
4	Babble Detected. Set to a one by the Host Controller during status update when "babble" is detected during the transaction generated by this descriptor.
3	Transaction Error (<i>XactErr</i>). Set to a one by the Host Controller during status update in the case where the host did not receive a valid response from the device (Timeout, CRC, Bad PID, etc.). This bit is set only for IN transactions.
2	Missed Micro-Frame. The host controller detected that a host-induced hold-off caused the host controller to miss a required complete-split transaction.

Table continues on the next page...

Table 56-17. siTD Transfer Status and Control (continued)

Bit	Description
1	<p>Split Transaction State (SplitXstate). The bit encodings are:</p> <p>Value Meaning</p> <p>00b Do Start Split.</p> <p>This value directs the host controller to issue a Start split transaction to the endpoint when a match is encountered in the S-mask.</p> <p>01b Do Complete Split.</p> <p>This value directs the host controller to issue a Complete split transaction to the endpoint when a match is encountered in the C-mask.</p>
0	Reserved. Bit reserved for future use and should be set to zero.

56.4.2.4.4 siTD Buffer Pointer List (plus)

DWords 4 and 5 are the data buffer page pointers for the transfer. This structure supports one physical page cross. The most significant 20 bits of each DWord in this section are the 4 K (page) aligned buffer pointers.

The least significant 12 bits of each DWord are used as additional transfer state. The following table describes the siTD buffer pointer fields.

Table 56-18. Buffer Page Pointer List (plus)

Bit	Description
31-12	Buffer Pointer List. Bits [31:12] of DWords 4 and 5 are 4 K page aligned physical memory addresses. These bits correspond to physical address bits [31:12] respectively. The lower 12 bits in each pointer are defined and used as specified below. The field <i>P</i> (see siTD Transfer State) specifies the <i>current</i> active pointer.
Bits 11-0 (Page 0)	Current Offset—The 12 least significant bits of the Page 0 pointer are the current byte offset for the current page pointer (as selected with the page indicator bit (<i>P</i> field)). The host controller is not required to write this field back when the siTD is retired (<i>Active</i> bit transitioned from a one to a zero).
Bits 11-0 (Page 1)—The least significant bits of the Page 1 pointer are split into three subfields as shown in the following rows.	
11-5 (Page 1)	Reserved
4-3 (Page 1)	<p>Transaction position (TP). This field is used with T-count to determine whether to send <i>all</i>, <i>first</i>, <i>middle</i>, or <i>last</i> with each outbound transaction payload. System software must initialize this field with the appropriate starting value. The host controller must correctly manage this state during the lifetime of the transfer. The bit encodings are:</p> <p>Value Meaning</p> <p>00b All. The entire full-speed transaction data payload is in this transaction (that is, less than or equal to 188 bytes).</p> <p>01b Begin. This is the first data payload for a full-speed that is greater than 188 bytes.</p> <p>10B Mid. This is the <i>middle</i> payload for a full-speed OUT transaction that is larger than 188 bytes.</p>

Table continues on the next page...

Table 56-18. Buffer Page Pointer List (plus) (continued)

Bit	Description
	11b End. This is the <i>last</i> payload for a full-speed OUT transaction that was larger than 188 bytes.
2-0 (Page 1)	Transaction count (T-Count). Software initializes this field with the number of OUT start-splits this transfer requires. Any value larger than 6 is undefined.

56.4.2.4.5 siTD Back Link Pointer

DWord 6 of a siTD is simply another schedule link pointer. This pointer is always zero, or references a siTD, and it cannot reference any other schedule data structure.

The following table describes the siTD back link pointer fields.

Table 56-19. siTD Back Link Pointer

Bit	Description
31-5	siTD Back Pointer. This field is a physical memory pointer to a siTD.
4-1	Reserved. This field is reserved for future use. It should be set to zero.
0	Terminate (T). 1 = siTD Back Pointer field is not valid. 0 = siTD Back Pointer field is valid.

56.4.2.5 Queue element transfer descriptor (qTD)

This data structure is only used with a queue head. It describes one or more USB transactions to transfer up to 20480 (5*4096) bytes.

The structure contains two structure pointers used for queue advancement, a DWord of transfer state, and a five-element array of data buffer pointers.

It is 32 bytes and must be physically contiguous.

The buffer associated with this transfer must be virtually contiguous. The buffer may start on any byte boundary; however, for optimal utilization of on-chip busses it is recommended to align the buffers on a 32-byte boundary. A separate buffer pointer list element must be used for each physical page in the buffer, regardless of whether the buffer is physically contiguous.

Host controller updates (host controller writes) to stand-alone qTDs only occur during transfer retirement. References in the following bit field definitions of updates to the qTD are to the qTD portion of a queue head.

The following table shows the queue element transfer descriptor data structure.

Table 56-20. Queue element transfer descriptor data structure

31	30	29	28	27	26	25	24	23	22	21	20	19	18	17	16	15	14	13	12	11	10	9	8	7	6	5	4	3	2	1	0	Addr
Next qTD Pointer																												0	T	03-00		
Alternate Next qTD Pointer																												0	T	07-04		
dt	Total Bytes to Transfer															io c	C_Page	C_err	PID Code	Status						0B-08 ¹						
Buffer Pointer (page 0)														Current Offset												0F-0C ¹						
Buffer Pointer (page 1)														Reserved												13-10						
Buffer Pointer (page 2)														Reserved												17-14						
Buffer Pointer (page 3)														Reserved												1B-18						
Buffer Pointer (page 4)														Reserved												1F-1C						

1. 08-0F: Transfer Results



Host Controller Read/Write



Host Controller Read Only

Queue Element Transfer Descriptors must be aligned on 32-byte boundaries.

56.4.2.5.1 Next qTD Pointer

The first DWord of an element transfer descriptor is a pointer to another transfer element descriptor.

The following table describes Next qTD pointer fields.

Table 56-21. qTD Next Element Transfer Pointer (DWord 0)

Bit	Description
31-5	Next Transfer Element Pointer. This field contains the physical memory address of the next qTD to be processed. The field corresponds to memory address signals[31:5], respectively.
4-1	Reserved

Table continues on the next page...

Table 56-21. qTD Next Element Transfer Pointer (DWord 0) (continued)

0	Terminate (T). 1= pointer is invalid. 0=Pointer is valid (points to a valid Transfer Element Descriptor). This bit indicates to the Host Controller that there are no more valid entries in the queue.
---	--

56.4.2.5.2 Alternate Next qTD Pointer

The second DWord of a queue element transfer descriptor is used to support hardware-only advance of the data stream to the next transfer descriptor on short packet. To be more explicit the host controller always uses this pointer when the current qTD is retired due to short packet.

The following table describes the TD Alternate Next Element Transfer Pointer field descriptions.

Table 56-22. TD Alternate Next Element Transfer Pointer (DWord 1)

Bit	Description
31-5	Alternate Next Transfer Element Pointer. This field contains the physical memory address of the next qTD to be processed in the event that the current qTD execution encounters a short packet (for an IN transaction). The field corresponds to memory address signals [31:5], respectively.
4-1	Reserved
0	Terminate (T). 1= pointer is invalid. 0=Pointer is valid (points to a valid Transfer Element Descriptor). This bit indicates to the Host Controller that there are no more valid entries in the queue.

56.4.2.5.3 qTD Token

The third DWord of a queue element transfer descriptor contains most of the information the host controller requires to execute a USB transaction (the remaining endpoint-addressing information is specified in the queue head).

NOTE

The field descriptions forward reference fields defined in the queue head. Where necessary, these forward references are preceded with a QH notation.

The following table describes the TD Token fields.

Table 56-23. TD Token (DWord 2)

Bit	Description
31 Data Toggle	This is the data toggle sequence bit. The use of this bit depends on the setting of the <i>Data Toggle Control</i> bit in the queue head.

Table continues on the next page...

Table 56-23. TD Token (DWord 2) (continued)

Bit	Description						
30-16 Total Bytes to Transfer	<p>This field specifies the total number of bytes to be moved with this transfer descriptor. This field is decremented by the number of bytes actually moved during the transaction, only on the successful completion of the transaction. The maximum value software may store in this field is 5 * 4K (5000H). This is the maximum number of bytes 5 page pointers can access. If the value of this field is zero when the host controller fetches this transfer descriptor (and the active bit is set), the host controller executes a zero-length transaction and retires the transfer descriptor. It is not a requirement for OUT transfers that <i>Total Bytes To Transfer</i> be an even multiple of QHD.Maximum Packet Length. If software builds such a transfer descriptor for an OUT transfer, the last transaction is always less than QHD.Maximum Packet Length.</p> <p>Although it is possible to create a transfer up to 20K this assumes the 1st offset into the first page is 0. When the offset cannot be predetermined, crossing past the 5th page can be guaranteed by limiting the total bytes to 16K**. Therefore, the maximum recommended transfer is 16 K(4000H).</p>						
15 Interrupt On Complete (IOC)	If this bit is set to a one, it specifies that when this qTD is completed, the Host Controller should issue an interrupt at the next interrupt threshold.						
14-12 Current Page (C_Page)	This field is used as an index into the qTD buffer pointer list. Valid values are in the range 0H to 4H. The host controller is not required to write this field back when the qTD is retired.						
11-10 Error Counter (CERR)	<p>This field is a 2-bit down counter that keeps track of the number of consecutive Errors detected while executing this qTD. If this field is programmed with a non-zero value during set-up, the Host Controller decrements the count and writes it back to the qTD if the transaction fails. If the counter counts from one to zero, the Host Controller marks the qTD inactive, sets the <i>Halted</i> bit to a one, and error status bit for the error that caused <i>CERR</i> to decrement to zero. An interrupt is generated if the <i>USB Error Interrupt Enable</i> bit in the USBINTR register is set to a one. If HCD programs this field to zero during set-up, the Host Controller does not count errors for this qTD and there is no limit on the retries of this qTD. Note that write-backs of intermediate execution state are to the queue head overlay area, not the qTD.</p> <p>Transaction Error - Decrement Data Buffer Error - No Decrement³ Stalled - No Decrement¹ Babble Detected - No Decrement¹ No Error - No Decrement²</p>						
	<table border="1"> <thead> <tr> <th data-bbox="475 1334 610 1375">Error</th> <th data-bbox="610 1334 1472 1375">Decrement Counter</th> </tr> </thead> <tbody> <tr> <td data-bbox="475 1375 610 1448">1</td> <td data-bbox="610 1375 1472 1448">Detection of Babble or Stall automatically halts the queue head. Thus, count is not decremented</td> </tr> <tr> <td data-bbox="475 1448 610 1821">2</td> <td data-bbox="610 1448 1472 1821"> <p>If the EPS field indicates a HS device or the queue head is in the Asynchronous Schedule (and <i>PIDCode</i> indicates an IN or OUT) and a bus transaction completes and the host controller does not detect a transaction error, then the host controller should reset <i>CERR</i> to extend the total number of errors for this transaction. For example, <i>CERR</i> should be reset with maximum value (3) on each successful completion of a transaction. The host controller must never reset this field if the value at the start of the transaction is 00b.</p> <p>See Split Transaction Interrupt for CERR adjustment rules when the EPS field indicates a FS or LS device and the queue head is in the Periodic Schedule. See Asynchronous - Do Complete Split for CERR adjustment rules when the EPS field indicates a FS or LS device, the queue head is in the Asynchronous schedule and the <i>PIDCode</i> indicates a SETUP.</p> </td> </tr> </tbody> </table>	Error	Decrement Counter	1	Detection of Babble or Stall automatically halts the queue head. Thus, count is not decremented	2	<p>If the EPS field indicates a HS device or the queue head is in the Asynchronous Schedule (and <i>PIDCode</i> indicates an IN or OUT) and a bus transaction completes and the host controller does not detect a transaction error, then the host controller should reset <i>CERR</i> to extend the total number of errors for this transaction. For example, <i>CERR</i> should be reset with maximum value (3) on each successful completion of a transaction. The host controller must never reset this field if the value at the start of the transaction is 00b.</p> <p>See Split Transaction Interrupt for CERR adjustment rules when the EPS field indicates a FS or LS device and the queue head is in the Periodic Schedule. See Asynchronous - Do Complete Split for CERR adjustment rules when the EPS field indicates a FS or LS device, the queue head is in the Asynchronous schedule and the <i>PIDCode</i> indicates a SETUP.</p>
Error	Decrement Counter						
1	Detection of Babble or Stall automatically halts the queue head. Thus, count is not decremented						
2	<p>If the EPS field indicates a HS device or the queue head is in the Asynchronous Schedule (and <i>PIDCode</i> indicates an IN or OUT) and a bus transaction completes and the host controller does not detect a transaction error, then the host controller should reset <i>CERR</i> to extend the total number of errors for this transaction. For example, <i>CERR</i> should be reset with maximum value (3) on each successful completion of a transaction. The host controller must never reset this field if the value at the start of the transaction is 00b.</p> <p>See Split Transaction Interrupt for CERR adjustment rules when the EPS field indicates a FS or LS device and the queue head is in the Periodic Schedule. See Asynchronous - Do Complete Split for CERR adjustment rules when the EPS field indicates a FS or LS device, the queue head is in the Asynchronous schedule and the <i>PIDCode</i> indicates a SETUP.</p>						

Table continues on the next page...

Table 56-23. TD Token (DWord 2) (continued)

Bit	Description
3	Data buffer errors are host problems. They don't count against the device's retries. NOTE: Software must not program CERR to a value of zero when the EPS field is programmed with a value indicating a Full- or Low-speed device. This combination could result in undefined behavior.
9-8 PID Code	This field is an encoding of the token, which should be used for transactions associated with this transfer descriptor. Encodings are:
00b	OUT Token generates token (E1H)
01b	IN Token generates token (69H)
10b	SETUP Token generates token (2DH) (undefined if endpoint is an interrupt, the queue head is non-zero) transfer type, for example, μ Frame S-mask field in.
11b	Reserved
7-0 Status	This field is used by the Host Controller to communicate individual command execution states back to HCD. This field contains the status of the last transaction performed on this qTD. The bit encodings are:
Bit	Status Field Description
7	Active. Set to one by software to enable the execution of transactions by the Host Controller.
6	Halted. Set to one by the Host Controller during status updates to indicate that a serious error has occurred at the device/endpoint addressed by this qTD. This can be caused by babble, the error counter counting down to zero, or reception of the STALL handshake from the device during a transaction. Any time that a transaction results in the Halted bit being set to a one, the Active bit is also set to zero.
5	Data Buffer Error. Set to a one by the Host Controller during status update to indicate that the Host Controller is unable to keep up with the reception of incoming data (overflow) or is unable to supply data fast enough during transmission (under run). If an overflow condition occurs, the Host Controller forces a timeout condition on the USB, invalidating the transaction at the source. If the host controller sets this bit to a one, then it remains a one for the duration of the transfer.
4	Babble Detected. Set to a one by the Host Controller during status update when "babble" is detected during the transaction. In addition to setting this bit, the Host Controller also sets the <i>Halted</i> bit to a one. Because "babble" is considered a fatal error for the transfer, setting the Halted bit to a one insures that no more transactions occur because of this descriptor.
3	Transaction Error (XactErr). Set to a one by the Host Controller during status update in the case where the host did not receive a valid response from the device (Timeout, CRC, Bad PID, etc.). If the host controller sets this bit to a one, then it remains a one for the duration of the transfer.
2	Missed Micro-Frame. This bit is ignored unless the <i>QH.EPS</i> field indicates a full- or low-speed endpoint and the queue head is in the periodic list. This bit is set when the host controller detected that a host-induced hold-off caused the host controller to miss a required complete-split transaction. If the host controller sets this bit to a one, then it remains a one for the duration of the transfer.
1	Split Transaction State (SplitXstate). This bit is ignored by the host controller unless the <i>QH.EPS</i> field indicates a full- or low-speed endpoint. When a Full- or Low-speed device, the host controller uses this bit to track the state of the split-

Table continues on the next page...

Table 56-23. TD Token (DWord 2) (continued)

Bit	Description
	<p>transaction. The functional requirements of the host controller for managing this state bit and the split transaction protocol depends on whether the endpoint is in the periodic or asynchronous schedule. The bit encodings are:</p> <p>Value Meaning</p> <p>0b Do Start Split. This value directs the host controller to issue a Start split transaction to the endpoint.</p> <p>1b Do Complete Split. This value directs the host controller to issue a Complete split transaction to the endpoint.</p>
0	<p>Ping State (P)/ERR. If the <i>QH.EPS</i> field indicates a High-speed device and the <i>PID_Code</i> indicates an OUT endpoint, then this is the state bit for the Ping protocol. The bit encodings are:</p> <p>Value Meaning</p> <p>0b Do OUT. This value directs the host controller to issue an OUT PID to the endpoint.</p> <p>1b Do Ping. This value directs the host controller to issue a PING PID to the endpoint.</p> <p>If the <i>QH.EPS</i> field does not indicate a High-speed device, then this field is used as an error indicator bit. It is set to a one by the host controller whenever a periodic split-transaction receives an ERR handshake.</p>

56.4.2.5.4 qTD Buffer Page Pointer List

The last five DWords of a queue element transfer descriptor is an array of physical memory address pointers. These pointers reference the individual pages of a data buffer.

System software initializes Current Offset field to the starting offset into the current page, where current page is selected through the value in the *C_Page* field.

The following table describes the qTD Buffer Pointer(s) (DWords 3-7) fields.

Table 56-24. qTD Buffer Pointer(s) (DWords 3-7)

Bit	Description
31-12	<p>Buffer Pointer List. Each element in the list is a 4 K page aligned physical memory address. The lower 12 bits in each pointer are reserved (except for the first one), as each memory pointer must reference the start of a 4 K page. The field <i>C_Page</i> specifies the current active pointer. When the transfer element descriptor is fetched, the starting buffer address is selected using <i>C_Page</i> (similar to an array index to select an array element). If a transaction spans a 4K buffer boundary, the host controller must detect the page-span boundary in the data stream, increment <i>C_Page</i> and advance to the next buffer pointer in the list, and conclude the transaction through the new buffer pointer.</p>
11-0	<p>Current Offset (Reserved). This field is reserved in all pointers except the first one (for example Page 0). The host controller should ignore all reserved bits. For the page 0 current offset interpretation, this field is the byte offset into the current page (as selected by <i>C_Page</i>). The host controller is not required to write this field back when the qTD is retired. Software should ensure the Reserved fields are initialized to zero.</p>

56.4.2.6 Queue Head

The table located in this section shows the Queue Head structure layout.

The following table shows the queue head structure layout.

Table 56-25. Queue Head Structure Layout

31	30	29	28	27	26	25	24	23	22	21	20	19	18	17	16	15	14	13	12	11	10	9	8	7	6	5	4	3	2	1	0	Addr
Queue Head Horizontal Link Pointer																								0	Typ	T	03-00					
RL			C	Maximum Packet Length										H	dt	EP	EndPt		I	Device Address					07-04 ¹							
Mult		Port Number ²					Hub Addr ²					μFrame C-mask ²					μFrame S-mask					0B-08 ¹										
Current qTD Pointer																								0			0F-0C					
Next qTD Pointer																								0		T	13-10 ³					
Alternate Next qTD pointer																								NakCnt		T	17-14 ⁴					
dt	Total Bytes to Transfer										io	C_Page	Cerr	PID Code	Status			1B-18														
Buffer Pointer (Page 0)												Current Offset					1F-1C															
Buffer Pointer (Page 1)												Reserved		C-prog-mask ²					23-20													
Buffer Pointer (Page 2)												S-bytes ²					FrameTag ²		27-24 ⁴													
Buffer Pointer (Page 3)												Reserved					2B-28															
Buffer Pointer (Page 4)												Reserved					2F-2C ³															

1. 04-0B: Static endpoint state.
2. These fields are used exclusively to support split transactions to USB 2.0 hubs
3. 10-2F: Transfer overlay.
4. 14-27: Transfer results.



Host Controller Read/Write



Host Controller Read Only

56.4.2.6.1 Queue Head Horizontal Link Pointer

The first DWord of a Queue Head contains a link pointer to the next data object to be processed after any required processing in this queue has been completed, as well as the control bits defined below.

This pointer may reference a queue head or one of the isochronous transfer descriptors. It must not reference a queue element transfer descriptor.

The following table describes the Queue head DWord 0 fields.

Table 56-26. Queue Head DWord 0

Bit	Description
31-5	Queue Head Horizontal Link Pointer (QHLP). This field contains the address of the next data object to be processed in the horizontal list and corresponds to memory address signals [31:5], respectively.
4-3	Reserved
2-1	QH/(s)iTD Select (Typ). This field indicates to the hardware whether the item referenced by the link pointer is an iTD, siTD or a QH. This allows the Host Controller to perform the proper type of processing on the item after it is fetched. Value encodings are: Value Meaning 00b iTD (isochronous transfer descriptor) 01b QH (queue head) 10b siTD (split transaction isochronous transfer descriptor) 11b FSTN (frame span traversal node)
0	Terminate (T). 1=Last QH (pointer is invalid). 0=Pointer is valid. If the queue head is in the context of the periodic list, a one bit in this field indicates to the host controller that this is the end of the periodic list. This bit is ignored by the host controller when the queue head is in the Asynchronous schedule. Software must ensure that queue heads reachable by the host controller always have valid horizontal link pointers.

56.4.2.6.2 Queue Head Endpoint Capabilities/Characteristics

The second and third DWords of a Queue Head specifies static information about the endpoint. This information does not change over the lifetime of the endpoint.

There are three types of information in this region:

- **Endpoint Characteristics.** These are the USB endpoint characteristics including addressing, maximum packet size, and endpoint speed.
- **Endpoint Capabilities.** These are adjustable parameters of the endpoint. They effect how the endpoint data stream is managed by the host controller.
- **Split Transaction Characteristics.** This data structure is used to manage full- and low-speed data streams for bulk, control, and interrupt via split transactions to USB2.0 Hub Transaction Translator. There are additional fields used for addressing the hub and scheduling the protocol transactions (for periodic).

The host controller must not modify the bits in this region.

The following table describes the Endpoint characteristics: Queue head DWord 1 fields.

Table 56-27. Endpoint Characteristics: Queue Head DWord 1

Bit	Description	
31-28	Nak Count Reload (RL). This field contains a value, which is used by the host controller to reload the Nak Counter field.	
27	Control Endpoint Flag (C). If the <i>QH.EPS</i> field indicates the endpoint is not a high-speed device, and the endpoint is a control endpoint, then software must set this bit to a one. Otherwise, it should always set this bit to zero.	
26-16	Maximum Packet Length. This directly corresponds to the maximum packet size of the associated endpoint (<i>wMaxPacketSize</i>). The maximum value this field may contain is 0x400 (1024).	
15	Head of Reclamation List Flag (H). This bit is set by System Software to mark a queue head as being the head of the reclamation list.	
14	Data Toggle Control (DTC). This bit specifies where the host controller should get the initial data toggle on an overlay transition. 0b Ignore DT bit from incoming qTD. Host controller preserves DT bit in the queue head. 1b Initial data toggle comes from incoming qTD DT bit. Host controller replaces DT bit in the queue head from the DT bit in the qTD.	
13-12	Endpoint Speed (EPS). This is the speed of the associated endpoint. Bit combinations are:	
	Value	Meaning
	00b	Full-Speed (12 Mbits/sec)
	01b	Low-Speed (1.5 Mbits/sec)
	10b	High-Speed (480 Mbits/sec)
	11b	Reserved
This field must not be modified by the host controller.		
11-8	Endpoint Number (Endpt). This 4-bit field selects the particular endpoint number on the device serving as the data source or sink.	
7	Inactivate on Next Transaction (I). This bit is used by system software to request that the host controller set the Active bit to zero. See Rebalancing the periodic schedule , for full operational details. This field is only valid when the queue head is in the Periodic Schedule and the <i>EPS</i> field indicates a Full or Low-speed endpoint. Setting this bit to one when the queue head is in the Asynchronous Schedule or the <i>EPS</i> field indicates a high-speed device yields undefined results.	
6-0	Device Address. This field selects the specific device serving as the data source or sink.	

The table below describes the Endpoint capabilities: Queue head DWord 2 field descriptions.

Table 56-28. Endpoint Capabilities: Queue Head DWord 2

Bit	Description
31-30	High-Bandwidth Pipe Multiplier (Mult). This field is a multiplier used to key the host controller as the number of successive packets the host controller may submit to the endpoint in the current execution. The host controller makes the simplifying assumption that software properly initializes this field (regardless of location of queue head in the schedules or other run time parameters). The valid values are: Value Meaning

Table continues on the next page...

Table 56-28. Endpoint Capabilities: Queue Head DWord 2 (continued)

	<p>00b Reserved. A zero in this field yields undefined results.</p> <p>01b One transaction to be issued for this endpoint per micro-frame.</p> <p>10b Two transactions to be issued for this endpoint per micro-frame.</p> <p>11b Three transactions to be issued for this endpoint per micro-frame.</p>
29-23	Port Number. This field is ignored by the host controller unless the <i>EPS</i> field indicates a full- or low-speed device. The value is the port number identifier on the USB 2.0 Hub (for hub at device address <i>Hub Addr</i> below), below which the full- or low-speed device associated with this endpoint is attached. This information is used in the split-transaction protocol.
22-16	Hub Addr. This field is ignored by the host controller unless the <i>EPS</i> field indicates a full- or low-speed device. The value is the USB device address of the USB 2.0 Hub below which the full- or low-speed device associated with this endpoint is attached. This field is used in the split-transaction protocol.
15-8	Split Completion Mask (μ Frame C-Mask). This field is ignored by the host controller unless the <i>EPS</i> field indicates this device is a low- or full-speed device and this queue head is in the periodic list. This field (along with the <i>Active</i> and <i>SplitX-state</i> fields) is used to determine during which micro-frames the host controller should execute a complete-split transaction. When the criteria for using this field are met, a zero value in this field has undefined behavior. This field is used by the host controller to match against the three low-order bits of the FRINDEX register. If the FRINDEX register bits decode to a position where the μ Frame C- Mask field is a one, then this queue head is a candidate for transaction execution. There may be more than one bit in this mask set.
7-0	Interrupt Schedule Mask (μ Frame S-mask). This field is used for all endpoint speeds. Software should set this field to a zero when the queue head is on the asynchronous schedule. A non-zero value in this field indicates an interrupt endpoint. The host controller uses the value of the three low-order bits of the FRINDEX register as an index into a bit position in this bit vector. If the μ Frame S-mask field has a one at the indexed bit position then this queue head is a candidate for transaction execution. If the <i>EPS</i> field indicates the endpoint is a high-speed endpoint, then the transaction executed is determined by the <i>PID_Code</i> field contained in the execution area. This field is also used to support split transaction types: Interrupt (IN/OUT). This condition is true when this field is non-zero and the <i>EPS</i> field indicates this is either a full- or low-speed device. A zero value in this field, in combination with existing in the periodic frame list has undefined results.

56.4.2.6.3 Transfer Overlay-Queue Head

The nine DWords in this area represent a transaction working space for the host controller. The general operational model is that the host controller can detect whether the overlay area contains a description of an active transfer. If it does not contain an active transfer, then it follows the Queue Head Horizontal Link Pointer to the next queue head. The host controller will never follow the Next Transfer Queue Element or Alternate Queue Element pointers unless it is actively attempting to advance the queue. For the duration of the transfer, the host controller keeps the incremental status of the transfer in the overlay area. When the transfer is complete, the results are written back to the original queue element.

The DWord3 of a Queue Head contains a pointer to the source qTD currently associated with the overlay. The host controller uses this pointer to write back the overlay area into the source qTD after the transfer is complete.

The following table describes the current qTD link pointer field descriptions.

Table 56-29. Current qTD Link Pointer

Bit	Description
31-5	Current Element Transaction Descriptor Link Pointer. This field contains the address Of the current transaction being processed in this queue and corresponds to memory address signals [31:5], respectively.
4-0	Reserved (R). These bits are ignored by the host controller when using the value as an address to write data. The actual value may vary depending on the usage.

The DWords 4-11 of a queue head are the transaction overlay area. This area has the same base structure as a Queue Element Transfer Descriptor. The queue head utilizes the reserved fields of the page pointers to implement tracking the state of split transactions.

This area is characterized as an overlay because when the queue is advanced to the next queue element, the source queue element is merged onto this area. This area serves as execution cache for the transfer.

The table below describes the Host-controller rules for bits in overlay.

Table 56-30. Host-Controller Rules for Bits in Overlay (DWords 5, 6, 8 and 9)

DWord	Bit	Description
5	4-1	Nak Counter (NakCnt) μ RW. This field is a counter the host controller decrements whenever a transaction for the endpoint associated with this queue head results in a Nak or Nyet response. This counter is reloaded from <i>RL</i> before a transaction is executed during the first pass of the reclamation list (relative to an Asynchronous List Restart condition). It is also loaded from <i>RL</i> during an overlay.
6	31	Data Toggle. The <i>Data Toggle Control</i> controls whether the host controller preserves this bit when an overlay operation is performed.
6	15	Interrupt On Complete (IOC). The IOC control bit is always inherited from the source qTD when the overlay operation is performed.
6	11-10	Error Counter (C_ERR). This two-bit field is copied from the qTD during the overlay and written back during queue advancement.
6	0	Ping State (P)/ERR. If the <i>EPS</i> field indicates a high-speed endpoint, then this field should be preserved during the overlay operation.
8	7-0	Split-transaction Complete-split Progress (C-prog-mask). This field is initialized to zero during any overlay. This field is used to track the progress of an interrupt split-transaction.
9	4-0	Split-transaction Frame Tag (Frame Tag). This field is initialized to zero during any overlay. This field is used to track the progress of an interrupt split-transaction.
9	11-5	S-bytes. Software must ensure that the <i>S-bytes</i> field in a <i>qTD</i> is zero before activating the <i>qTD</i> . This field is used to keep track of the number of bytes sent or received during an IN or OUT split transaction.

56.4.2.7 Periodic Frame Span Traversal Node (FSTN)

This data structure is to be used only for managing Full- and Low-speed transactions that span a Host-frame boundary.

See [Host Controller Operational Model for FSTNs](#) for full operational details. Software must not use an FSTN in the Asynchronous Schedule. An FSTN in the Asynchronous schedule results in undefined behavior. Software must not use the FSTN feature with a host controller whose USB_HCIVERSION register indicates a revision implementation below 0096h. FSTNs are not defined for implementations before 0.96 and their use yields undefined results.

Table 56-31. Frame Span Traversal Node Structure Layout

31	30	29	28	27	26	25	24	23	22	21	20	19	18	17	16	15	14	13	12	11	10	9	8	7	6	5	4	3	2	1	0	Addr
Normal Path Link Pointer																											0	Typ	T	03-00		
Back Path Link Pointer																											0	Typ ¹	T	07-04		

1. Must be set to indicate a queue head



Host Controller Read/Write

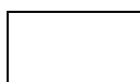

Host Controller Read Only

56.4.2.7.1 FSTN Normal Path Pointer

The first DWord of an FSTN contains a link pointer to the next schedule object. This object can be of any valid periodic schedule data type.

The following table describes the FSTN normal path pointer fields.

Table 56-32. FSTN Normal Path Pointer Field Descriptions

Bit	Description
31-5	Normal Path Link Pointer (NPLP). This field contains the address of the next data object to be processed in the periodic list and corresponds to memory address signals [31:5], respectively.
4-3	Reserved
2-1	QH/(s)iTD/FSTN Select (Typ). This field indicates to the Host Controller whether the item referenced is a iTD/siTD, a QH or an FSTN. This allows the Host Controller to perform the proper type of processing on the item after it is fetched. Value encodings are: Value Meaning 00b iTD (isochronous transfer descriptor) 01b QH (queue head) 10b siTD (split transaction isochronous transfer descriptor) 11b FSTN (Frame Span Traversal Node)
0	Terminate (T). 1 = Link Pointer field is not valid. 0 = Link Pointer is valid.

56.4.2.7.2 FSTN Back Path Link Pointer

The second DWord of an FSTN node contains a link pointer to a queue head.

If the T-bit in this pointer is zero, then this FSTN is a Save-Place indicator. Its Typ field must be set by software to indicate the target data structure is a queue head. If the T-bit in this pointer is set to one, then this FSTN is the Restore indicator. When the T-bit is one, the host controller ignores the Typ field.

The following table describes the FSTN back path link pointer fields.

Table 56-33. FSTN Back Path Link Pointer Field Descriptions

Bit	Description
31-5	Back Path Link Pointer (BPLP). This field contains the address of a Queue Head. This field corresponds to memory address signals [31:5], respectively.
4-3	Reserved
2-1	Typ. Software must ensure this field is set to indicate the target data structure is a Queue Head. Any other value in this field yields undefined results.
0	Terminate (T). 1=Link Pointer field is not valid (that is the host controller must not use bits [31:5] as a valid memory address). This value also indicates that this FSTN is a Restore indicator. 0=Link Pointer is valid (that is the host controller may use bits [31:5] (in combination with the CTRLDSSEGMENT register if applicable) as a valid memory address). This value also indicates that this FSTN is a Save-Place indicator.

56.4.3 Host Operational Model

The general operational model is for the enhanced interface host controller hardware and enhanced interface host controller driver (generally referred to as system software).

Each significant operational feature of the EHCI host controller is discussed in a separate section. Each section presents the operational model requirements for the host controller hardware. Where appropriate, recommended system software operational models for features are also presented.

56.4.3.1 Host Controller Initialization

After initial power-on or HCRreset (hardware or through HCRreset bit in the USB_USBCMD register), all of the operational registers are at their default values. After a hardware reset, only the operational registers not contained in the Auxiliary power well are at their default values.

The following table describes the default values of operational registers.

Table 56-34. Default Values of Operational Register Space

Operational Register	Default Value (after Reset)
USB_USBCMD	00080000h (00080B00h, if <i>Asynchronous Schedule Park Capability is one</i>)
USB_USBSTS	00001000h
USB_USBINTR	00000000h
USB_FRINDEX	00000000h
USB_CTRLDSSEGMENT	00000000h
USB_PERIODICLISTBASE	Undefined
USB_ASYNCLISTADDR	Undefined
USB_CONFIGFLAG	00000000h
USB_PORTSC1	00002000h (w/PPC set to one); 00003000h (w/PPC set to zero)

To initialize the host controller, software should perform the following steps:

- Write the appropriate value to the USB_USBINTR register to enable the appropriate interrupts.
- Write the base address of the Periodic Frame List to the USB_PERIODICLIST BASE register. If no work items are in the periodic schedule, all elements of the Periodic Frame List should have their T-Bits set to one.
- Write the USB_USBCMD register to set the desired interrupt threshold, frame list size (if applicable) and turn the host controller ON through setting the Run/Stop bit.

At this point, the host controller is up and running and the port registers begin reporting device connects, and so on. System software can enumerate a port through the reset process (where the port is in the enabled state). At this point, the port is active with SOFs occurring down the enabled ports, but the schedules have not enabled. To communicate with devices through the asynchronous schedule, system software must write the USB_ASYNCLISTADDR register with the address of a control or bulk queue head. Software must then enable the asynchronous schedule by writing one to the Asynchronous Schedule Enable bit in the USB_USBCMD register. To communicate with devices through the periodic schedule, system software must enable the periodic schedule by writing one to the Periodic Schedule Enable bit in the USB_USBCMD register.

NOTE

The schedules can be turned on before the first port is reset (and enabled).

When the USB_USBCMD register is written, system software must ensure the appropriate bits are preserved, depending on the intended operation.

56.4.3.2 Port Routing and Control

The EHCI specification defines that a USB 2.0 Host controller is comprised of one high-speed host controller, which implements the EHCI programming interface and 0 to N USB 1.1 companion host controllers.

Companion host controllers (cHCs) may be implementations of either Universal or Open host controller specifications. This configuration is used to deliver the required full USB 2.0-defined port capability; for example, Low-, Full-, and High-speed capability for every port.

NOTE

The USB controllers do not require nor support companion controllers to support Full and Low Speed device. Full and Low Speed devices are supported within the USB controller by emulating the functionality of a high-speed HUB. Therefore, no port routing is present in the controller. Please refer to [Embedded Transaction Translator Function](#) for details.

The following figure illustrates a simple block diagram of the port routing logic and its relationship to the high-speed and companion host controllers within a USB 2.0 host controller.

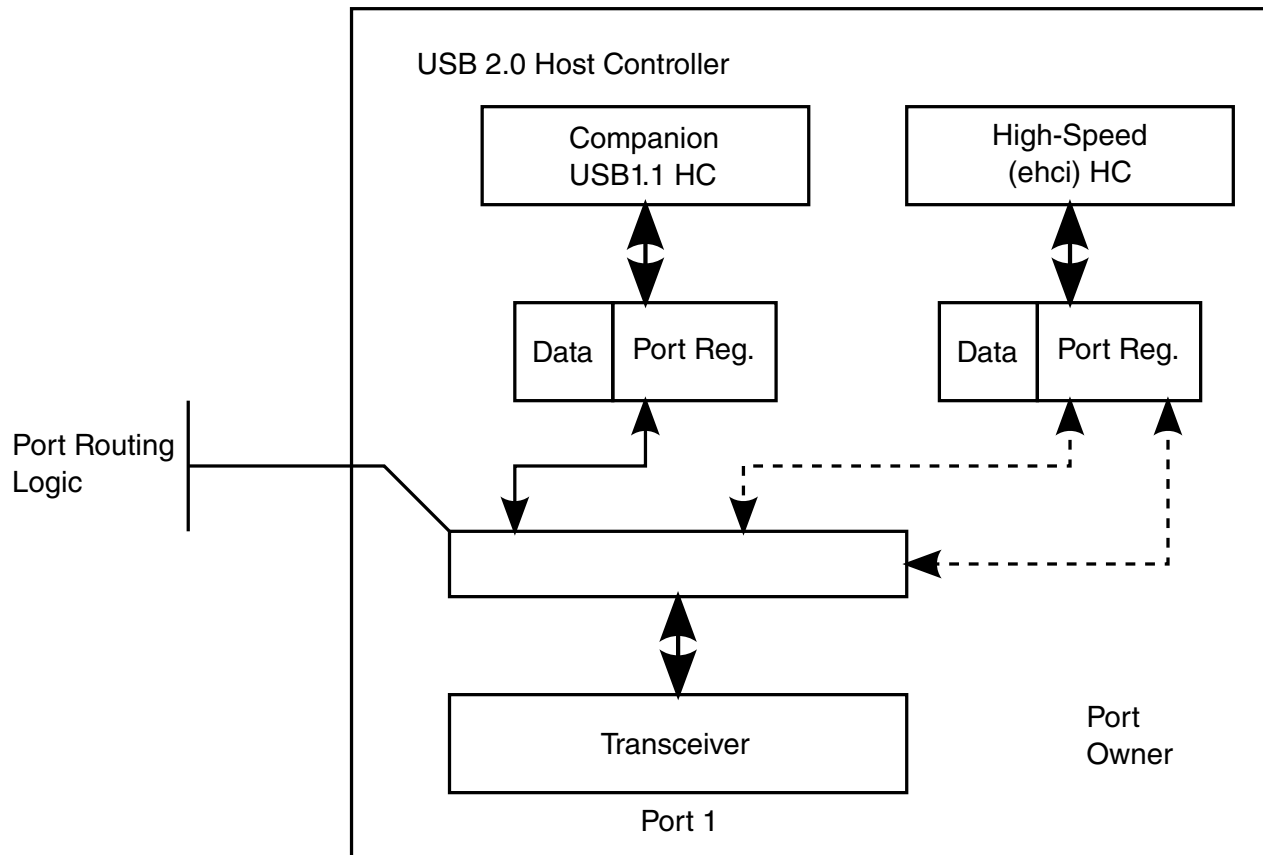

Figure 56-4. Example USB 2.0 Host Controller Port Routing Block Diagram

There exists one transceiver per physical port and each host controller block has its own port status and control registers. The EHCI controller has port status and control registers for every port. Each companion host controller has only the port control and status registers it is required to operate. Either the EHCI host controller or one companion host controller controls each transceiver. Routing logic lies between the transceiver, the port status and control registers.¹

The port routing logic is controlled from signals originating in the EHCI host controller. The EHCI host controller has a global routing policy control field and per-port ownership control fields. The Configured Flag (CF) bit is the global routing policy control. At power-on or reset, the default routing policy is to the companion controllers (if they exist). If the system does not include a driver for the EHCI host controller and the host controller includes Companion Controllers, then the ports still work in Full- and Low-speed mode (assuming the system includes a driver for the companion controllers). In general, when the EHCI owns the ports, the companion host controllers' port registers do not see a connect indication from the transceiver. Similarly, when a companion host controller owns a port, the EHCI controller's port registers do not see a connect indication

1. The routing logic should not be implemented in the 480 MHz clock domain of the transceiver.

from the transceiver. The details on the rules for the port routing logic are described in the following sections. The USB 2.0 host controller must be implemented as a multi-function PCI device if the implementation includes companion controllers. The companion host controllers' function numbers must be less than the EHCI host controller function number. The EHCI host controller must be a larger function number with respect to the companion host controllers associated with this EHCI host controller. If a PCI device implementation contains only an EHCI controller (that is no companion controllers or other PCI functions), then the EHCI host controller must be function zero, in accordance with the PCI Specification. The N_CC field in the Structural Parameter register (HCSPARAMS) indicates whether the controller implementation includes companion host controllers. When N_CC has a non-zero value there exists companion host controllers. If N_CC has a value of zero, then the host controller implementation does not include companion host controllers. If the host controller root ports are exposed to attachment of full- or low-speed devices, the ports always fails the high-speed chirp during reset and the ports are not enabled. System software can notify the user of the illegal condition. This type of implementation requires a USB 2.0 hub be connected to a root port to provide full and low-speed device connectivity.

System software uses information in the host controller capability registers to determine how the ports are routed to the companion host controllers. See [Host Controller Structural Parameters \(USB_nHCSPARAMS\)](#)

56.4.3.2.1 Port Routing Control through EHCI Configured (CF) Bit

Each port in the USB 2.0 host controller are routed either to a single companion host controller or to the EHCI host controller.

The port routing logic is controlled by two mechanisms in the EHCI HC: a host controller global flag and per-port control. The Configured Flag (CF) bit, is used to globally set the policy of the routing logic. Each port register has a Port Owner control bit which allows the EHCI Driver to explicitly control the routing of individual ports. Whenever the CF bit transitions from zero to one (this transition is only available under program control) the port routing unconditionally routes all of the port registers to the EHCI HC (all Port Owner bits go to zero). While the CF-bit is one, the EHCI Driver controls individual ports' routing through the Port Owner control bit. Likewise, whenever the CF bit transitions from one to zero (as a result of Aux power application, HCRESET, or software writing zero to CF-bit), the port routing unconditionally routes all of the port registers to the appropriate companion HC. The default value for the EHCI HC's CF bit (after Aux power application or HCRESET) is zero.

The *view* of the port depends on the current owner. A Universal or Open companion host controller will see port register bits consistent with the appropriate specification. Port bit definitions that are required for EHCI host controllers are not visible to companion host controllers.

The following table summarizes the default routing for all the ports, based on the value of the EHCI HC's CF bit.

Table 56-35. Default Port Routing Depending on EHCI HC CF Bit

HS CF Bit	Default Port Ownership	Explanation
0B	Companion HCs	The companion host controllers own the ports and only Full- and Low-speed devices are supported in the system. The exact port assignments are implementation dependent. The ports behave only as Full- and Low-speed ports in this configuration
1B	EHCI HC	The EHCI host controller has default ownership over all of the ports. The routing logic inhibits device connect events from reaching the companion HCs' port status and control registers when the port owner is the EHCI HC. The EHCI HC has access to the additional port status and control bits defined in this specification (see Port Status & Control (USB_nPORTSC1)). The EHCI HC can temporarily release control of the port to a companion HC by setting the <i>PortOwner</i> bit in the PORTSC1 register to one.

56.4.3.2.2 Port Routing Control through PortOwner and Disconnect Event

Manipulating the port routing through the CF-bit is an extreme process and not intended to be used during normal operation.

The normal mode of port ownership transferal is on the granularity of individual ports using the Port Owner bit in the EHCI HC's USB_PORTSC1 register (for hand-offs from EHCI to companion host controllers). Individual port ownership is returned to the EHCI controller when the port registers a device disconnect. When the disconnect is detected, the port routing logic immediately returns the port ownership to the EHCI controller. The companion host controller port register detects the device disconnect and operates normally.

Under normal operating conditions (assuming all HC drivers loaded and operational and the EHCI *CF-bit* is set to one), the typical port enumeration sequence proceeds as illustrated below:

- Initial condition is that EHCI is port owner. A device is connected causing the port to detect a connect, set the port connect change bit and issue a port-change interrupt (if enabled).
- EHCI Driver identifies the port with the new connect change bit asserted and sends a change report to the hub driver. Hub driver issues a GetPortStatus() request and

identifies the connect change. It then issues a request to clear the connect change, followed by a request to reset and enable the port.

- When the EHCI Driver receives the request to reset and enable the port, it first checks the value reported by the LineStatus bits in the USB_PORTSC1 register. If they indicate the attached device is a full-speed device (for example, D+ is asserted), then the EHCI Driver sets the PortReset control bit to one (and sets the PortEnable bit to zero) which begins the reset-process. Software times the duration of the reset, then terminates reset signaling by writing zero to the port reset bit. The reset process is actually complete when software reads zero in the PortReset bit. The EHCI Driver checks the PortOwner bit in the USB_PORTSC1 register. If set to one, the connected device is a high-speed device and EHCI Driver (root hub emulator) issues a change report to the hub driver and the hub driver continues to enumerate the attached device.
- At the time the EHCI Driver receives the port reset and enable request the LineStatus bits might indicate a low-speed device. Additionally, when the port reset process is complete, the PortEnable field may indicate that a full-speed device is attached. In either case the EHCI driver sets the PortOwner bit in the USB_PORTSC1 register to one to release port ownership to a companion host controller.
- When the EHCI Driver sets PortOwner bit to one, the port routing logic makes the connection state of the transceiver available to the companion host controller port register and removes the connection state from the EHCI HC port. The EHCI USB_PORTSC1 register observes and reports a disconnect event through the disconnect change bit. The EHCI Driver detects the connection status change (either by polling or by port change interrupt) and then sends a change report to the hub driver. When the hub driver requests that port-state, the EHCI Driver responds with a reset complete change set to one, a connect change set to one and a connect status set to zero. This information is derived directly from the EHCI port register. This allows the hub driver to assume the device was disconnected during reset. It acknowledges the change bits and wait for the next change event. While the EHCI controller does not own the port, it simply remains in a state where the port reports no device connected. The device-connect evaluation circuitry of the companion HC activates and detects the device, the companion Driver detects the connection and enumerates the port.

When a port is routed to a companion HC, it remains under the control of the companion HC until the device is disconnected from the root port (ignoring for now the scenario where EHCI's CF-bit transitions from 1b to 0b). When a disconnect occurs, the disconnect event is detected by both the companion HC port control and the EHCI port ownership control. On the event, the port ownership is returned immediately to the EHCI controller. The companion HC stack detects the disconnect and acknowledges as it would in an ordinary standalone implementation. Subsequent connects is detected by the EHCI port register and the process repeats.

56.4.3.2.3 Example Port Routing State Machine

The following figure illustrates an example of how the port ownership should be managed. The following sections describe the entry conditions to each state.

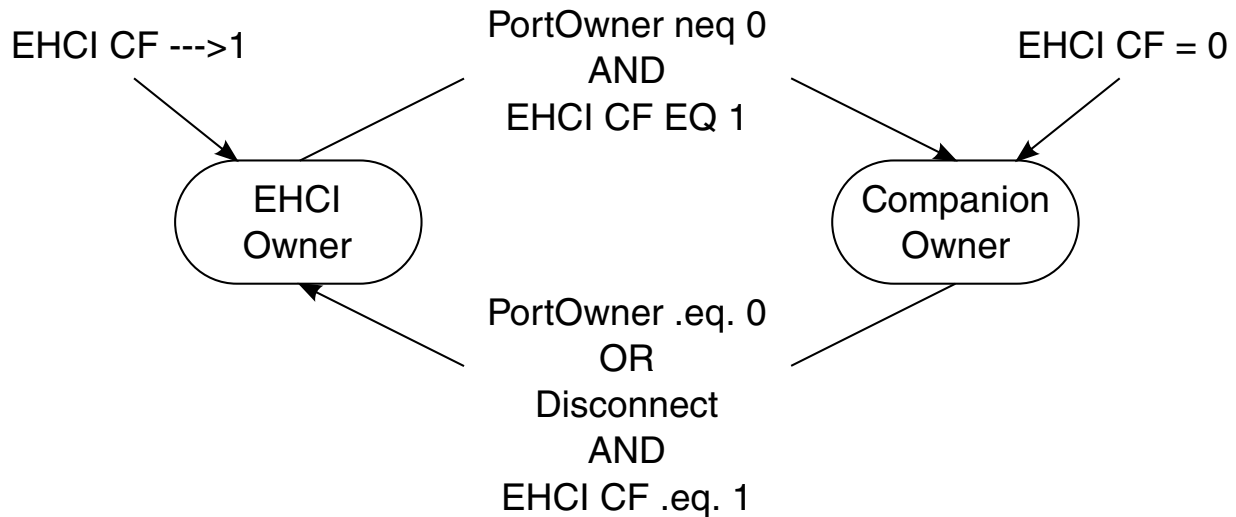

Figure 56-5. Port Owner Handoff State Machine

56.4.3.2.3.1 EHCI HC Owner

Entry to this state occurs when one of the following events occur:

- When the EHCI HC's Configure Flag (CF) bit in the USB_CONFIGFLAG register transitions from zero to one. This signals the fact that the system has a host controller driver for the EHCI HC and that all ports in the USB 2.0 host controller must default route to the EHCI controller.
- When the port is owned by a companion HC and the device is disconnected from the port. The EHCI port routing control logic is notified of the disconnect, and returns port routing to the EHCI controller. The connection state of the companion HC goes immediately to the disconnected state (with appropriate side effect to connect change, enable and enable change). The companion HC driver acknowledges the disconnect by setting the connect status change bit to zero. This allows the companion HC's driver to interact with the port completely through the disconnect process.
- When system software writes zero to the PortOwner bit in the USB_PORTSC1 register. This allows software to take ownership of a port from a companion host controller. When this occurs, the routing logic to the companion HC effectively signals a disconnect to the companion HC's port status and control register.

56.4.3.2.3.2 Companion HC Owner

Entry to this state occurs whenever one of the following events occur:

- When the PortOwner field transitions from zero to one.
- When the HS-mode HC's Configure Flag (CF) is equal to zero.

On entry to this state, the routing logic allows the companion HC port register to detect a device connect. Normal port enumeration proceeds.

56.4.3.2.4 Port Power

The Port Power Control (PPC) bit in the USB_HCSPARAMS register indicates whether the USB 2.0 host controller has port power control (see [Host Controller Structural Parameters \(USB_nHCSPARAMS\)](#)).

When this bit is zero, then the host controller does not support software control of port power switches. When in this configuration, the port power is always available and the companion host controllers must implement functionality consistent with port power always on. When the *PPC* bit is one, then the host controller implementation includes port power switches. Each available switch has an output enable, which is referred to in this discussion as PortPowerOutputEnable (PPE). PPE is controlled based on the state of the combination bits PPC bit, EHCI Configured (CF)-bit and individual Port Power (PP) bits.

The following table describes the summary behavioral model.

Table 56-36. Port Power Enable Control Rules

CF	CHC ¹ (PP)	EHC ² (PP)	Owner	PPE ³	Description
0	0	X	CHC	0	When the EHCI controller is not configured, the port is owned by the companion host controller. When the companion HC's port power select is off, then the port power is off.
0	1	X	CHC	1	Similar to previous entry. When the companion HC's port power select is on, then the port power is on.
1	0	0	CHC	0	Port owner has port power turned off, the power to port is off.
1	0	0	EHC	0	Port owner has port power turned off, the power to port is off.
1	0	1	EHC	1	Port owner has port power on, so power to port is on.
1	0	1	CHC	1	If either HC has port power turned on, the power to the port is on.

Table continues on the next page...

Table 56-36. Port Power Enable Control Rules (continued)

1	1	0	EHC	1	If either HC has port power turned on, the power to the port is on.
1	1	0	CHC	1	Port owner has port power on, so power to port is on.
1	1	1	CHC	1	Port owner has port power on, so power to port is on.
1	1	1	EHC	1	Port owner has port power on, so power to port is on.

1. CHC (Companion Host Controller).
2. EHC (EHCI Host Controller).
3. PPE (Port Power Enable). This bit actually turns on the port power switch (if one exists).

56.4.3.2.5 Port Reporting Over-Current

Host controllers are by definition power providers on USB. Whether the ports are considered high- or low-powered is a platform implementation issue. Each EHCI USB_PORTSC1 register has an over-current status and over-current change bit.

The functionality of these bits are specified in the USB Specification Revision 2.0.

The over current detection and limiting logic usually resides outside the host controller logic. This logic may be associated with one or more ports. When this logic detects an over-current condition it is made available to both the companion and EHCI ports. The effect of an over-current status on a companion host controller port is beyond the scope of this document.

The over-current condition effects the following bits in the USB_PORTSC1 register on the EHCI port:

- Over-current Active bits are set to one. When the over-current condition goes away, the Over-current Active bit transitions from one to zero.
- Over-current Change bits are set to one. On every transition of the Over-current Active bit the host controller sets the Over-current Change bit to one. Software sets the Over-current Change bit to zero by writing one to this bit.
- Port Enabled/Disabled bit is set to zero. When this change bit gets set to one, then the Port Change Detect bit in the USB_USBSTS register is set to one.
- Port Power (PP) bits may optionally be set to zero. There is no requirement in USB that a power provider shut off power in an over current condition. It is sufficient to limit the current and leave power applied. When the Over-current Change bit transitions from zero to one, the host controller also sets the Port Change Detect bit in the USB_USBSTS register to one. In addition, if the Port Change Interrupt Enable bit in the USB_USBINTR register is one, then the host controller issues an interrupt to the system. Refer to [Table 56-37](#) for summary behavior for over-current detection

when the host controller is halted (suspended from a device component point of view).

56.4.3.3 Suspend/Resume-Host Operational Model

The EHCI host controller provides an equivalent suspend and resume model as that defined for individual ports in a USB 2.0 Hub.

Control mechanisms are provided to allow system software to suspend and resume individual ports. The mechanisms allow the individual ports to be resumed completely through software initiation. Other control mechanisms are provided to parameterize the host controller's response (or sensitivity) to external resume events. In this discussion, host-initiated, or software initiated resumes are called Resume Events/Actions. Bus-initiated resume events are called wake-up events. The classes of wake-up events are:

- Remote-wake-up enabled device asserts resume signaling. In similar kind to USB 2.0 Hubs, EHCI controllers must always respond to explicit device resume signaling and wake-up the system (if necessary).
- Port connect and disconnect and over-current events. Sensitivity to these events can be turned on or off by using the per-port control bits in the USB_PORTSC1 registers.

Selective suspend is a feature supported by every USB_PORTSC1 register. It is used to place specific ports into a suspend mode. This feature is used as a functional component for implementing the appropriate power management policy implemented in a particular operating system. When system software intends to suspend the entire bus, it should selectively suspend all enabled ports, then shut off the host controller by setting the Run/Stop bit in the USB_USBCMD register to zero. The EHCI sub-block can then be placed into a lower device state through the PCI power management interface (see Appendix A, Enhanced Host Controller Interface Specification for Universal Serial Bus, Revision 0.95, November 2000, Intel Corporation. <http://www.intel.com>).

When a wake event occurs, the system resumes operation and system software eventually set the Run/Stop bit to one and resume the suspended ports. Software must not set the Run/Stop bit to one until it is confirmed that the clock to the host controller is stable. This is usually confirmed in a system implementation in that all of the clocks in the system are stable before the Arm platform is restarted. So, by definition, if software is running, clocks in the system are stable and the Run/Stop bit in the USB_USBCMD register can be set to one. Minimum system software delays are also defined in the PCI Power Management Specification. Refer to PCI Power Management Specification for more information.

56.4.3.3.1 Port Suspend/Resume

System software places individual ports into suspend mode by writing one into the appropriate USB_PORTSC1 Suspend bit. Software must only set the Suspend bit when the port is in the enabled state (Port Enabled bit is one) and the EHCI is the port owner (PortOwner bit is zero).

The host controller may evaluate the Suspend bit immediately or wait until a micro-frame or frame boundary occurs. If evaluated immediately, the port is not suspended until the current transaction (if one is executing) completes. Therefore, there may be several micro-frames of activity on the port until the host controller evaluates the Suspend bit. The host controller must evaluate the Suspend bit at least every frame boundary.

System software can initiate a resume on a selectively suspended port by writing one to the Force Port Resume bit. Software should not attempt to resume a port unless the port reports that it is in the suspended state (see [Port Status & Control \(USB_nPORTSC1\)](#)). If system software sets Force Port Resume bit to one when the port is not in the suspended state, the resulting behavior is undefined. In order to assure proper USB device operation, software must wait for at least 10 ms after a port indicates that it is suspended (Suspend bit is one) before initiating a port resume through the Force Port Resume bit. When Force Port Resume bit is one, the host controller sends resume signaling down the port. System software times the duration of the resume (nominally 20 ms) then sets the Force Port Resume bit to zero. When the host controller receives the write to transition Force Port Resume to zero, it completes the resume sequence as defined in the USB specification, and sets both the Force Port Resume and Suspend bits to zero. Software-initiated port resumes do not affect the Port Change Detect bit in the USB_USBSTS register nor do they cause an interrupt if the Port Change Interrupt Enable bit in the USB_USBINTR register is one. An external USB event may also initiate a resume. The wake events are defined above. When a wake event occurs on a suspended port, the resume signaling is detected by the port and the resume is reflected downstream within 100 μ sec. The port's Force Port Resume bit is set to one and the Port Change Detect bit in the USB_USBSTS register is set to one. If the Port Change Interrupt Enable bit in the USB_USBINTR register is one the host controller issues a hardware interrupt.

System software observes the resume event on the port, delays a port resume time (nominally 20 ms), then terminates the resume sequence by writing zero to the Force Port Resume bit in the port. The host controller receives the write of zero to Force Port Resume, terminates the resume sequence and sets Force Port Resume and Suspend port bits to zero. Software can determine that the port is enabled (not suspended) by sampling the USB_PORTSC1 register and observing that the Suspend and Force Port Resume bits are zero. Software must ensure that the host controller is running (that is HCHalted bit in the USB_USBSTS register is zero), before terminating a resume by writing zero to a

port's Force Port Resume bit. If HCHalted is one when Force Port Resume is set to zero, then SOFs do not occur down the enabled port and the device returns to suspend mode in a maximum of 10 msec.

The table below summarizes the wake-up events. Whenever a resume event is detected, the Port Change Detect bit in the USB_USBSTS register is set to one. If the Port Change Interrupt Enable bit is one in the USB_USBINTR register, the host controller generates an interrupt on the resume event. Software acknowledges the resume event interrupt by clearing the Port Change Detect status bit in the USB_USBSTS register.

Table 56-37. Behavior During Wake-up Events

Port Status and Signaling Type	Signaled Port Response	Device State	
		D0	Not D0
Port disabled, resume K-State received	No Effect	N/A	N/A
Port suspended, resume K-State received	Resume reflected downstream on signaled port. Force Port Resume status bit in USB_PORTSC1 register is set to one. Port Change Detect bit in USB_USBSTS register set to one.	[1], [2]	[2]
Port is enabled, disabled or suspended, and the port's WKDSCNNT_E bit is one. A disconnect is detected.	Depending in the initial port state, the USB_PORTSC1 Connected Enable status bits are set to zero, and the Connect Change status bit is set to one. Port Change Detect bit in the USB_USBSTS register is set to one.	[1], [2]	[2]
Port is enabled, disabled or suspended, and the port's WKDSCNNT_E bit is zero. A disconnect is detected.	Depending on the initial port state, the USB_PORTSC1 Connect and Enable status bits are set to zero, and the Connect Change status bit is set to one. Port Change Detect bit in the USB_USBSTS register is set to one.	[1], [3]	[3]
Port is not connected and the port's WKCNTNT_E bit is one. A connect is detected.	USB_PORTSC1 Connect Status and Connect Status Change bits are set to one. Port Change Detect bit in the USB_USBSTS register is set to one.	[1], [2]	[2]
Port is not connected and the port's WKCNTNT_E bit is zero. A connect is detected.	USB_PORTSC1 Connect Status and Connect Status Change bits are set to one. Port Change Detect bit in the USB_USBSTS register is set to one.	[1], [3]	[3]
Port is connected and the port's WKOC_E bit is one. An over-current condition occurs.	USB_PORTSC1 Over-current Active, Over-current Change bits are set to one. If Port Enable/Disable bit is one, it is set to zero. Port Change Detect bit in the USB_USBSTS register is set to one	[1], [2]	[2]
Port is connected and the port's WKOC_E bit is zero. An over-current condition occurs.	USB_PORTSC1 Over-current Active, Over-current Change bits are set to one. If Port Enable/Disable bit is one, it is set to zero. Port Change Detect bit in the USB_USBSTS register is set to one.	[1], [3]	[3]

[1] Hardware interrupt issued if Port Change Interrupt Enable bit in the USB_USBINTR register is one.

[2] PME# asserted if enabled (Note: PME Status must always be set to one).

[3] PME# not asserted.

56.4.3.4 Schedule Traversal Rules

The host controller executes transactions for devices using a simple, shared-memory schedule.

The schedule is comprised of a few data structures, organized into two distinct lists. The data structures are designed to provide the maximum flexibility required by USB, minimize memory traffic and hardware / software complexity.

System software maintains two schedules for the host controller: a periodic schedule and an asynchronous schedule. The root of the periodic schedule is the USB_PERIODICLISTBASE register (see [Frame List Base Address \(USB_nPERIODICLISTBASE\)](#))/ [Device Address \(USB_nDEVICEADDR\)](#). The USB_PERIODICLISTBASE register is the physical memory base address of the periodic frame list. The periodic frame list is an array of physical memory pointers. The objects referenced from the frame list must be valid schedule data structures as defined in [Host Data Structures](#). In each micro-frame, if the periodic schedule is enabled (see [Periodic scheduling threshold](#)) then the host controller must execute from the periodic schedule before executing from the asynchronous schedule. It only executes from the asynchronous schedule after it encounters the end of the periodic schedule. The host controller traverses the periodic schedule by constructing an array offset reference from the USB_PERIODICLISTBASE and the USB_FRINDEX registers (see the following figure). It fetches the element and begins traversing the graph of linked schedule data structures.

The end of the periodic schedule is identified by a next link pointer of a schedule data structure having its T-bit set to one. When the host controller encounters a T-Bit set to one during a horizontal traversal of the periodic list, it interprets this as an End-Of-Periodic-List mark. This causes the host controller to cease working on the periodic schedule and transitions immediately to traversing the asynchronous schedule. After the transition, the host controller executes from the asynchronous schedule until the end of the micro-frame.

The following figure illustrates the derivation of pointer into frame list array.

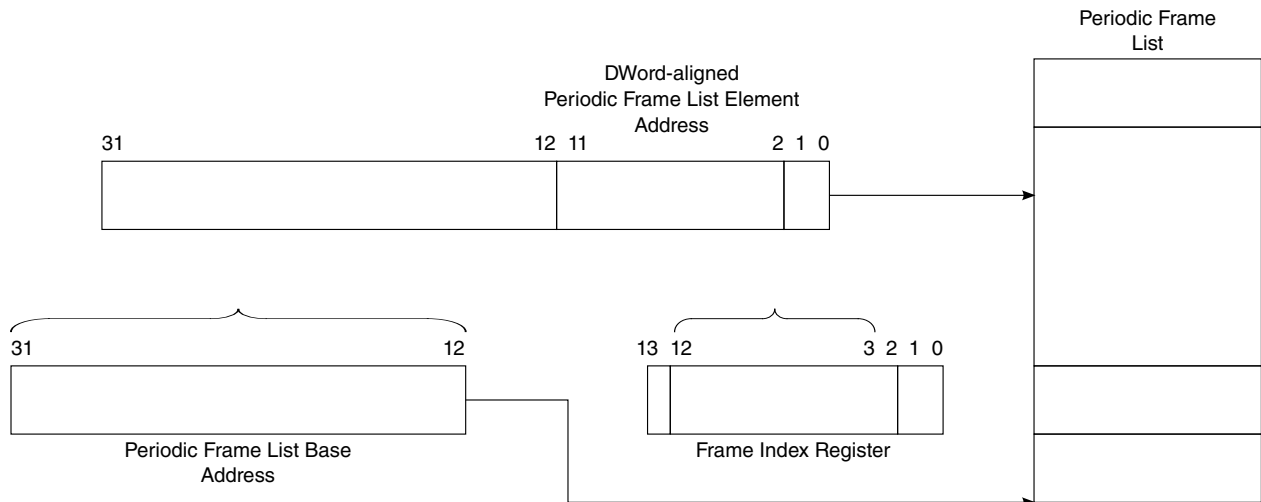

Figure 56-6. Derivation of Pointer into Frame List Array

When the host controller determines that it is the time to execute from the asynchronous list, it uses the operational register USB_ASYNC_LIST_ADDR to access the asynchronous schedule, see the figure below.

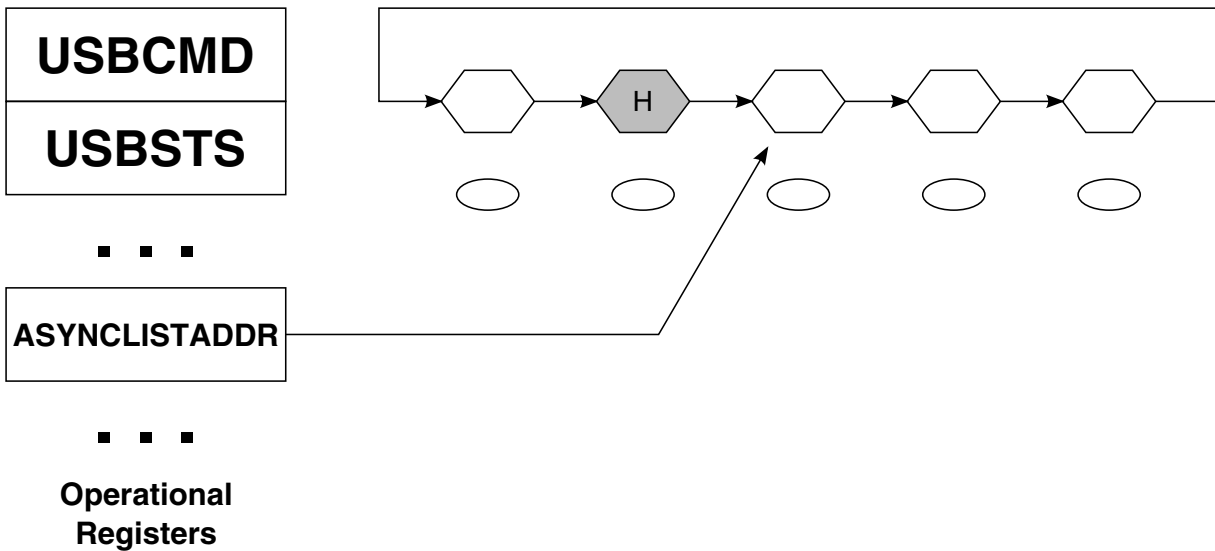

Figure 56-7. General Format of Asynchronous Schedule List

The USB_ASYNC_LIST_ADDR register contains a physical memory pointer to the next queue head. When the host controller makes a transition to executing the asynchronous schedule, it begins by reading the queue head referenced by the USB_ASYNC_LIST_ADDR register. Software must set queue head horizontal pointer T-bits to zero for queue heads in the asynchronous schedule. See [Asynchronous Schedule](#) for complete operational details.

56.4.3.4.1 Example - Preserving Micro-Frame Integrity

One of the requirements of a USB host controller is to maintain Frame Integrity. This means that the HC must preserve the micro-frame boundaries.

For example, SOF packets must be generated on time (within the specified allowable jitter), and High-speed EOF1,2 thresholds must be enforced. The end of micro-frame timing points EOF1 and EOF2 are clearly defined in the USB Specification Revision 2.0. One implication of this responsibility is that the HC must ensure that it does not start transactions that do not complete before the end of the micro-frame. More precisely, no transactions should be started by the host controller, which do not complete in their entirety before the EOF1 point. In order to enforce this rule, the host controller must check each transaction before it starts to ensure that it completes before the end of the micro-frame.

So, what exactly needs to be involved in this check? Fundamentally, the transaction data payload, plus bit stuffing, plus transaction overhead must be taken into consideration. It is possible to be extremely accurate on how much time the next transaction takes. Take OUTs for an example. The host controller must fetch all of the OUT data from memory in order to send it onto the USB bus. A host controller implementation could pre-fetch all of the OUT data, and pre-compute the actual number of bits in the token and data packets. In addition, the system knows the depth of the target endpoint, so it could closely estimate turnaround time for handshake. In addition, the host controller knows the size of a handshake packet. Pre-computing effects of bit stuffing and summing up the other overhead numbers can allow the host controller to know exactly whether there is enough bus time, before EOF1 to complete the OUT transaction. To accomplish this particular approach takes an inordinate amount of time and hardware complexity.

The alternative is to make a reasonable guess whether the next transaction can be started. An example approximation algorithm is described below. This example algorithm relies on the EHCI policy that periodic transactions are scheduled first in the micro-frame. It is a reasonable assumption that software never over-commits the micro-frame to periodic transactions greater than the specification allowable 80%. In the available remaining 20% bandwidth, the host controller has some ability (in this example) to decide whether or not to execute a transaction. The result of this algorithm is that sometimes, under some circumstances a transaction is not executed that could have been executed. However, under all circumstances, a transaction is never started unless there is enough time in the frame to complete the transaction.

56.4.3.4.1.1 Transaction Fit - A Best-Fit Approximation Algorithm

A curve is calculated which represents the latest start time for every packet size, at which software schedules the start of a periodic transaction.

This curve is the 80% bandwidth curve. Another curve is calculated which is the absolute, latest permitted start time for every packet size. This curve represents the absolute latest time, that a transaction of each packet size can be started and completed, in the micro-frame. A plot of these two curves are illustrated in Figure 56-8. The plot Y-axis represents the number of byte-times left in a frame.

The space between the 80% and the Last Start plots is bandwidth reclamation area. In this algorithm the host controller may skip transactions during this time if it is prudent.

The Best-Fit Approximation method plots a function ($f(x)$) between the 80% and Last Start curves. The function $f(x)$ adds a constant to every transaction's maximum packet size and the result compared with the number of bytes left in the frame. The constant represents an approximation of the effects of bit stuffing and protocol overhead. The host controller starts transactions whose results land above the function curve. The host controller will not start transactions whose results land below the function curve.

The following figure illustrates the Best-Fit Approximation.

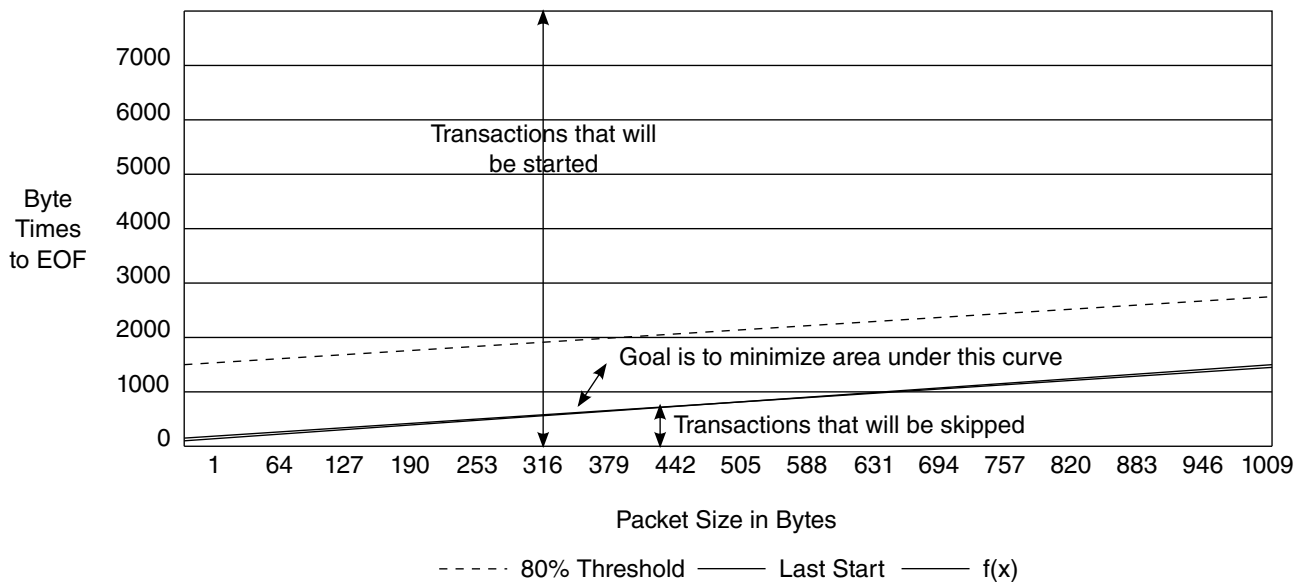

Figure 56-8. Best Fit Approximation

The LastStart line was calculated in this example to assume the absolute worst-case bus overhead per transaction. The particular transaction used is a start-split, zero-length OUT transaction with a handshake. Summaries of the component parts are listed in the table below. The component times were derived from the protocol timings defined in the USB Specification Revision 2.0.

Table 56-38. Example Worse-case Transaction Timing Components

Component	Bit time	Byte Time	Explanation
-----------	----------	-----------	-------------

Table continues on the next page...

Table 56-38. Example Worse-case Transaction Timing Components (continued)

Split Token	76	9.5	Split token as defined in USB core specification. Includes sync, token, eop, and so on.
Host 2 Host IPG	88	11	Number of bit times required between consecutive host packets.
Token	67	8.375	Token as defined in USB core specification. Includes sync, token, eop, and so on.
Host 2 Host IPG	88	11	Token as defined in USB core specification. Includes sync, token, eop, and so on.
Data Packet (0 data bytes)	66.7	8.34	Zero-length data packet. Includes sync, PID, crc16, eop, and so on.
Turnaround time	721	90.125	Time for packet initiator (Host) to see the beginning of a response to a transmitted packet.
Handshake packet	48	6	Handshake packet as defined in USB core specification. Includes sync, PID, eop, and so on.
		144	Total

The exact details of the function ($f(x)$) are up to the particular implementation. However, it should be obvious that the goal is to minimize the area under the curve between the approximation function and the Last Start curve, without dipping below the LastStart line, while at the same time keeping the check as simple as possible for hardware implementation. The $f(x)$ in [Figure 56-8](#) was constructed using the following pseudo-code test on each transaction size data point. This algorithm assumes that the host controller keeps track of the remaining bits in the frame.

```

Algorithm CheckTransactionWillFit (MaximumPacketSize, HC_BytesLeftInFrame)
Begin
Local Temp = MaximumPacketSize + 192
Local rvalue = TRUE
If MaximumPacketSize >= 128 then
    Temp += 128
End If
If Temp > HC_BytesLeftInFrame then
    Rvalue = FALSE
End If
Return rvalue
End

```

This algorithm takes two inputs, the current maximum packet size of the transaction and the hardware counter of the number of bytes left in the current micro-frame. It unconditionally adds a simple constant of 192 to the maximum packet size to account for a first-order effect of transaction overhead and bit stuffing. If the transaction size is greater than or equal to 128 bytes, then an additional constant of 128 is added to the running sum to account for the additional worst-case bit stuffing of payloads larger than 128. An inflection point was inserted at 128 because the $f(x)$ plot was getting close to the LastStart line.

56.4.3.5 Periodic Schedule Frame Boundaries vs Bus Frame Boundaries

The USB Specification Revision 2.0 requires that the frame boundaries (SOF frame number changes) of the high-speed bus and the full- and low-speed bus(s) below USB 2.0 Hubs be strictly aligned.

Super-imposed on this requirement is that USB 2.0 Hubs manage full- and low-speed transactions through a micro-frame pipeline (see start- (SS) and complete- (CS) splits illustrated in the following figure). A simple, direct projection of the frame boundary model into the host controller interface schedule architecture creates tension (complexity for both hardware and software) between the frame boundaries and the scheduling mechanisms required to service the full- and low-speed transaction translator periodic pipelines.

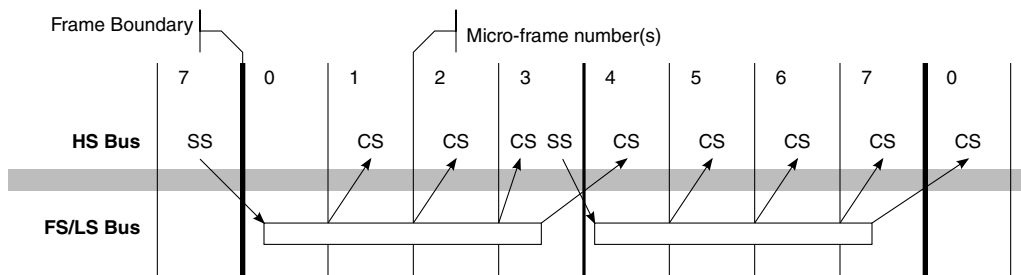

Figure 56-9. Frame Boundary Relationship between HS bus and FS/LS Bus

The simple projection, as the above figure illustrates, introduces frame-boundary wrap conditions for scheduling on both the beginning and end of a frame. In order to reduce the complexity for hardware and software, the host controller is required to implement one micro-frame phase shift for its view of frame boundaries. The phase shift eliminates the beginning of frame and frame-wrap scheduling boundary conditions.

The implementation of this phase shift requires that the host controller use one register value for accessing the periodic frame list and another value for the frame number value included in the SOF token. These two values are separate, but tightly coupled. The periodic frame list is accessed through the Frame List Index Register (USB_FRINDEX) documented in [USB Frame Index \(USB_nFRINDEX\)](#) and initially illustrated in [Schedule Traversal Rules](#). Bits FRINDEX[2:0], represent the micro-frame number. The SOF value is coupled to the value of FRINDEX[13:3]. Both FRINDEX[13:3] and the SOF value are increment based on FRINDEX[2:0]. It is required that the SOF value be delayed from the FRINDEX value by one micro-frame. The one micro-frame delay yields host controller periodic schedule and bus frame boundary relationship as illustrated in the following figure. This adjustment allows software to trivially schedule the periodic start and

complete-split transactions for full-and low-speed periodic endpoints, using the natural alignment of the periodic schedule interface. The reasons for selecting this phase-shift are beyond the scope of this specification.

The following figure illustrates how periodic schedule data structures relate to schedule frame boundaries and bus frame boundaries. To aid the presentation, two terms are defined: The host controller's view of the 1 msec boundaries is called H-Frames. The high-speed bus's view of the 1 msec boundaries is called B-Frames.

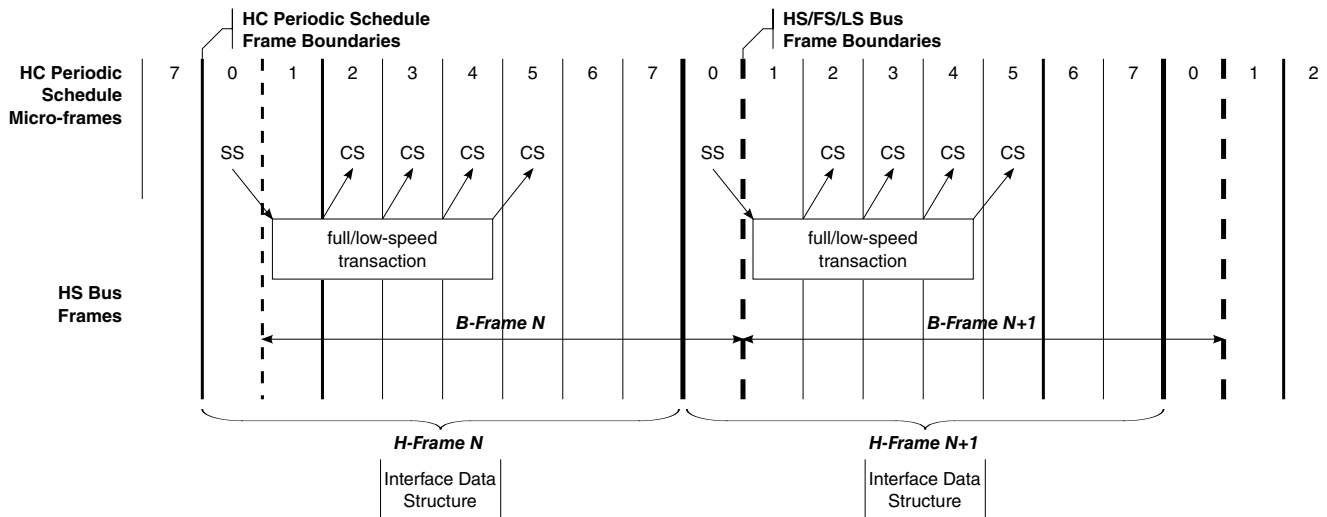

Figure 56-10. Relationship of Periodic Schedule Frame Boundaries to Bus Frame Boundaries

H-Frame boundaries for the host controller correspond to increments of $FRINDEX[13:3]$. Micro-frame numbers for the H-Frame are tracked by $FRINDEX[2:0]$. B-Frame boundaries are visible on the high-speed bus through changes in the SOF token's frame number. Micro-frame numbers on the high-speed bus are only derived from the SOF token's frame number (that is the high-speed bus sees eight SOFs with the same frame number value). H-Frames and B-Frames have the fixed relationship (that is B-Frames lag H-Frames by one micro-frame time) illustrated in the figure above. The host controller's periodic schedule is naturally aligned to H-Frames. Software schedules transactions for full- and low-speed periodic endpoints relative the H-Frames. The result is these transactions execute on the high-speed bus at exactly the right time for the USB 2.0 Hub periodic pipeline. As described in [USB Frame Index \(\$USB_nFRINDEX\$ \)](#), the SOF Value can be implemented as a shadow register (in this example, called SOFV), which lags the $FRINDEX$ register bits $[13:3]$ by one micro-frame count. This lag behavior can be accomplished by incrementing $FRINDEX[13:3]$ based on carry-out on the 7 to 0 increment of $FRINDEX[2:0]$ and incrementing SOFV based on the transition of 0 to 1 of $FRINDEX[2:0]$.

Software is allowed to write to FRINDEX. [USB Frame Index \(USB_nFRINDEX\)](#) provides the requirements that software should adhere when writing a new value in FRINDEX.

The table below illustrates the required relationship between the value of FRINDEX and the value of SOFV.

Table 56-39. Operation of FRINDEX and SOFV (SOF Value Register)

Current			Next		
FRINDEX[F]	SOFV	FRINDEX[mF]	FRINDEX[F]	SOFV	FRINDEX[mF]
N	N	111b	N+1	N	000b
N+1	N	000b	N+1	N+1	001b
N+1	N+1	001b	N+1	N+1	010b
N+1	N+1	010b	N+1	N+1	011b
N+1	N+1	011b	N+1	N+1	100b
N+1	N+1	100b	N+1	N+1	101b
N+1	N+1	101b	N+1	N+1	110b
N+1	N+1	110b	N+1	N+1	111b

NOTE

Where [F] = [13:3]; [μF] = [2:0]

56.4.3.6 Periodic Schedule

The periodic schedule traversal is enabled or disabled through the Periodic Schedule Enable bit in the USB_USBCMD register. If the Periodic Schedule Enable bit is set to zero, then the host controller simply does not try to access the periodic frame list through the USB_PERIODICLISTBASE register. Likewise, when the Periodic Schedule Enable bit is one, then the host controller does use the USB_PERIODICLISTBASE register to traverse the periodic schedule.

The host controller will not react to modifications to the Periodic Schedule Enable immediately. In order to eliminate conflicts with split transactions, the host controller evaluates the Periodic Schedule Enable bit only when FRINDEX[2:0] is zero. System software must not disable the periodic schedule if the schedule contains an active split transaction work item that spans the 000b micro-frame. These work items must be removed from the schedule before the Periodic Schedule Enable bit is written to zero.

The Periodic Schedule Status bit in the USB_USBSTS register indicates status of the periodic schedule. System software enables (or disables) the periodic schedule by writing one (or zero) to the Periodic Schedule Enable bit in the USB_USBCMD register. Software then can poll the Periodic Schedule Status bit to determine when the periodic

schedule has made the desired transition. Software must not modify the Periodic Schedule Enable bit unless the value of the Periodic Schedule Enable bit equals that of the Periodic Schedule Status bit.

The periodic schedule is used to manage all isochronous and interrupt transfer streams. The base of the periodic schedule is the periodic frame list. Software links schedule data structures to the periodic frame list to produce a graph of scheduled data structures. The graph represents an appropriate sequence of transactions.

The following figure illustrates isochronous transfers (using iTDs and siTDs) with a period of one are linked directly to the periodic frame list. Interrupt transfers (are managed with queue heads) and isochronous streams with periods other than one are linked following the period-one iTD/siTDs. Interrupt queue heads are linked into the frame list ordered by poll rate. Longer poll rates are linked first (for example, closest to the periodic frame list), followed by shorter poll rates, with queue heads with a poll rate of one, on the very end.

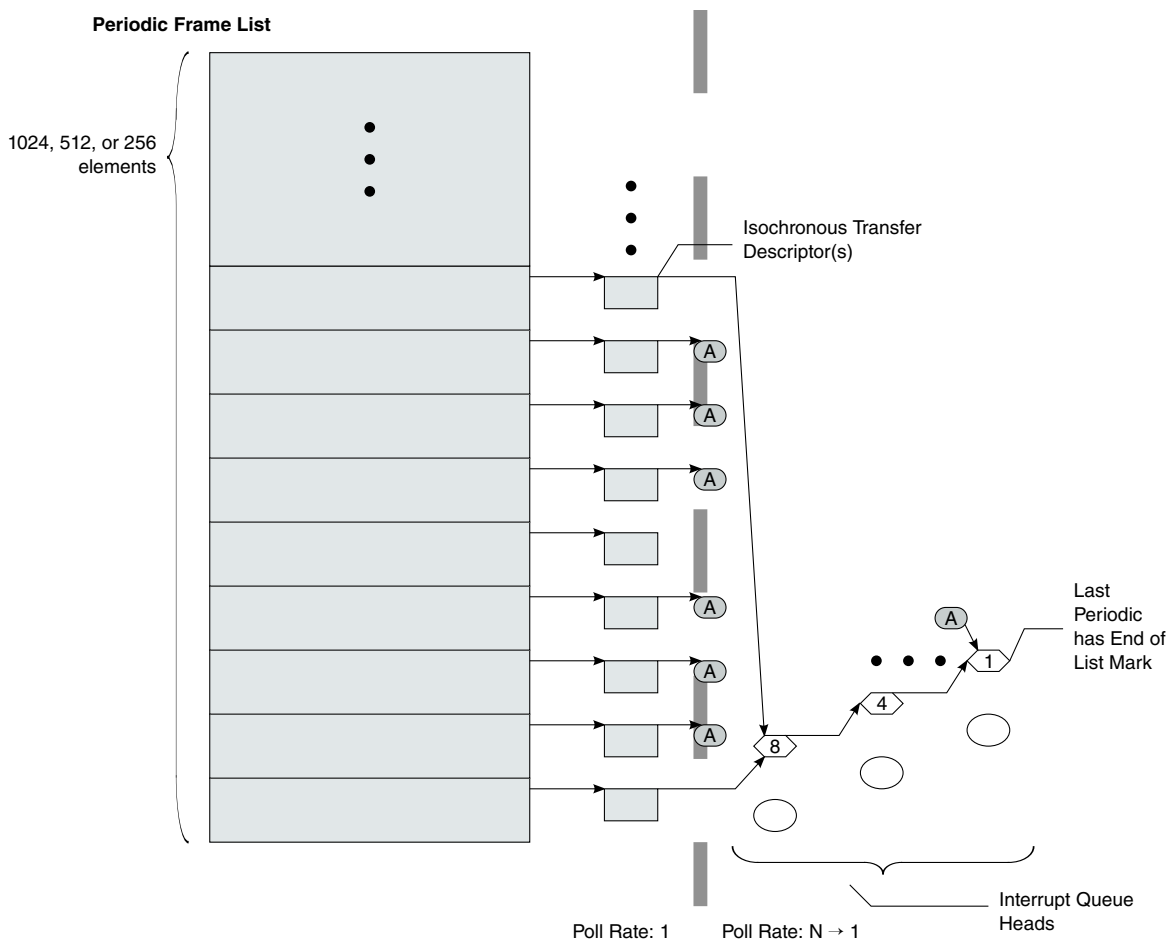

Figure 56-11. Example Periodic Schedule

56.4.3.7 Managing Isochronous Transfers Using iTDs

The structure of an iTD is presented in [Isochronous \(High-Speed\) Transfer Descriptor \(iTD\)](#). The four distinct sections to an iTD:

- The first field is the Next Link Pointer. This field is for schedule linkage purposes only.
- Transaction description array. This area is an eight-element array. Each element represents control and status information for one micro-frame's worth of transactions for a single high-speed isochronous endpoint.
- The buffer page pointer array is a 7-element array of physical memory pointers to data buffers. These are 4 K aligned pointers to physical memory.
- Endpoint capabilities. This area utilizes the unused low-order 12 bits of the buffer page pointer array. The fields in this area are used across all transactions executed for this iTD, including endpoint addressing, transfer direction, maximum packet size and high-bandwidth multiplier.

56.4.3.7.1 Host Controller Operational Model for iTDs

The host controller uses FRINDEX register bits [12:3] to index into the periodic frame list. This means that the host controller visits each frame list element eight consecutive times before incrementing to the next periodic frame list element. Each iTD contains eight transaction descriptions, which map directly to FRINDEX register bits [2:0]. Therefore, each transaction descriptor corresponds to one micro-frame. Each iTD can span 8 micro-frames worth of transactions.

When the host controller fetches an iTD, it uses FRINDEX register bits [2:0] to index into the transaction description array.

If the active bit in the Status field of the indexed transaction description is set to zero, the host controller ignores the iTD and follows the Next pointer to the next schedule data structure.

When the indexed active bit is one, the host controller continues to parse the iTD. It stores the indexed transaction description and the general endpoint information (device address, endpoint number, maximum packet size, and so on.). It also uses the Page Select (PG) field to index the buffer pointer array, storing the selected buffer pointer and the next sequential buffer pointer. For example, if PG field is 0, then the host controller stores Page 0 and Page 1.

The host controller constructs a physical data buffer address by concatenating the current buffer pointer (as selected using the current transaction description's PG field) and the transaction description's Transaction Offset field. The host controller uses the endpoint addressing information and I/O-bit to execute a transaction to the appropriate endpoint. When the transaction is complete, the host controller clears the active bit and writes back any additional status information to the Status field in the currently selected transaction description.

The data buffer associated with the iTD must be virtually contiguous memory. Seven page pointers are provided to support eight high-bandwidth transactions regardless of the starting packet's offset alignment into the first page. A starting buffer pointer (physical memory address) is constructed by concatenating the page pointer (for example, page 0 pointer) selected by the active transaction descriptions' PG (for example, value: 00B) field with the transaction offset field. As the transaction moves data, the host controller must detect when an increment of the current buffer pointer crosses a page boundary. When this occurs the host controller simply replaces the current buffer pointer's page portion with the next page pointer (for example, page 1 pointer) and continues to move data. The size of each bus transaction is determined by the value in the Maximum Packet Size field. An iTD supports high-bandwidth pipes through the Mult (multiplier) field. When the Mult field is 1, 2, or 3, the host controller executes the specified number of Maximum Packet sized bus transactions for the endpoint in the current micro-frame. In other words, the Mult field represents a transaction count for the endpoint in the current micro-frame. If the Mult field is zero, the operation of the host controller is undefined. The transfer description is used to service all transactions indicated by the Mult field.

For OUT transfers, the value of the Transaction X Length field represents the total bytes to be sent during the micro-frame. The Mult field must be set by software to be consistent with Transaction X Length and Maximum Packet Size. The host controller sends the bytes in Maximum Packet Size'd portions. After each transaction, the host controller decrements its local copy of Transaction X Length by Maximum Packet Size. The number of bytes the host controller sends is always Maximum Packet Size or Transaction X Length, whichever is less. The host controller advances the transfer state in the transfer description, updates the appropriate record in the iTD and moves to the next schedule data structure. The maximum sized transaction supported is 3 x 1024 bytes.

For IN transfers, the host controller issues Mult transactions. It is assumed that software has properly initialized the iTD to accommodate all of the possible data. During each IN transaction, the host controller must use Maximum Packet Size to detect packet babble errors. The host controller keeps the sum of bytes received in the Transaction X Length field. After all transactions for the endpoint have completed for the micro-frame, Transaction X Length contains the total bytes received. If the final value of Transaction X Length is less than the value of Maximum Packet Size, then less data than was allowed for was received from the associated endpoint. This short packet condition does not set

the USBINT bit in the USB_USBSTS register to one. The host controller will not detect this condition. If the device sends more than Transaction X Length or Maximum Packet Size bytes (whichever is less), then the host controller sets the Babble Detected bit to one and set the Active bit to zero. Note, that the host controller is not required to update the iTD field Transaction X Length in this error scenario. If the Mult field is greater than one, then the host controller automatically executes the value of Mult transactions. The host controller will not execute all Mult transactions if:

- The endpoint is an OUT and Transaction X Length goes to zero before all the Mult transactions have executed (ran out of data), or
- The endpoint is an IN and the endpoint delivers a short packet, or an error occurs on a transaction before Mult transactions have been executed. The end of micro-frame may occur before all of the transaction opportunities have been executed. When this happens, the transfer state of the transfer description is advanced to reflect the progress that was made, the result written back to the iTD and the host controller proceeds to processing the next micro-frame. Refer to Appendix D for a table summary of the host controller required behavior for all the high-bandwidth transaction cases.

56.4.3.7.2 Software Operational Model for iTDs

A client buffer request to an isochronous endpoint may span 1 to N micro-frames. When N is larger than one, system software may have to use multiple iTDs to read or write data with the buffer (if N is larger than eight, it must use more than one iTD).

The following figure illustrates the simple model of how a client buffer is mapped by system software to the periodic schedule (that is the periodic frame list and a set of iTDs). On the right is the client description of its request. The description includes a buffer base address plus additional annotations to identify which portions of the buffer should be used with each bus transaction. In the middle is the iTD data structures used by the system software to service the client request. Each iTD can be initialized to service up to 24 transactions, organized into eight groups of up to three transactions each. Each group maps to one micro-frame's worth of transactions. The EHCI controller does not provide per-transaction results within a micro-frame. It treats the per-micro-frame transactions as a single logical transfer. On the left is the host controller's frame list. System software establishes references from the appropriate locations in the frame list to each of the appropriate iTDs. If the buffer is large, then system software can use a small set of iTDs to service the entire buffer. System software can activate the transaction description records (contained in each iTD) in any pattern required for the particular data stream.

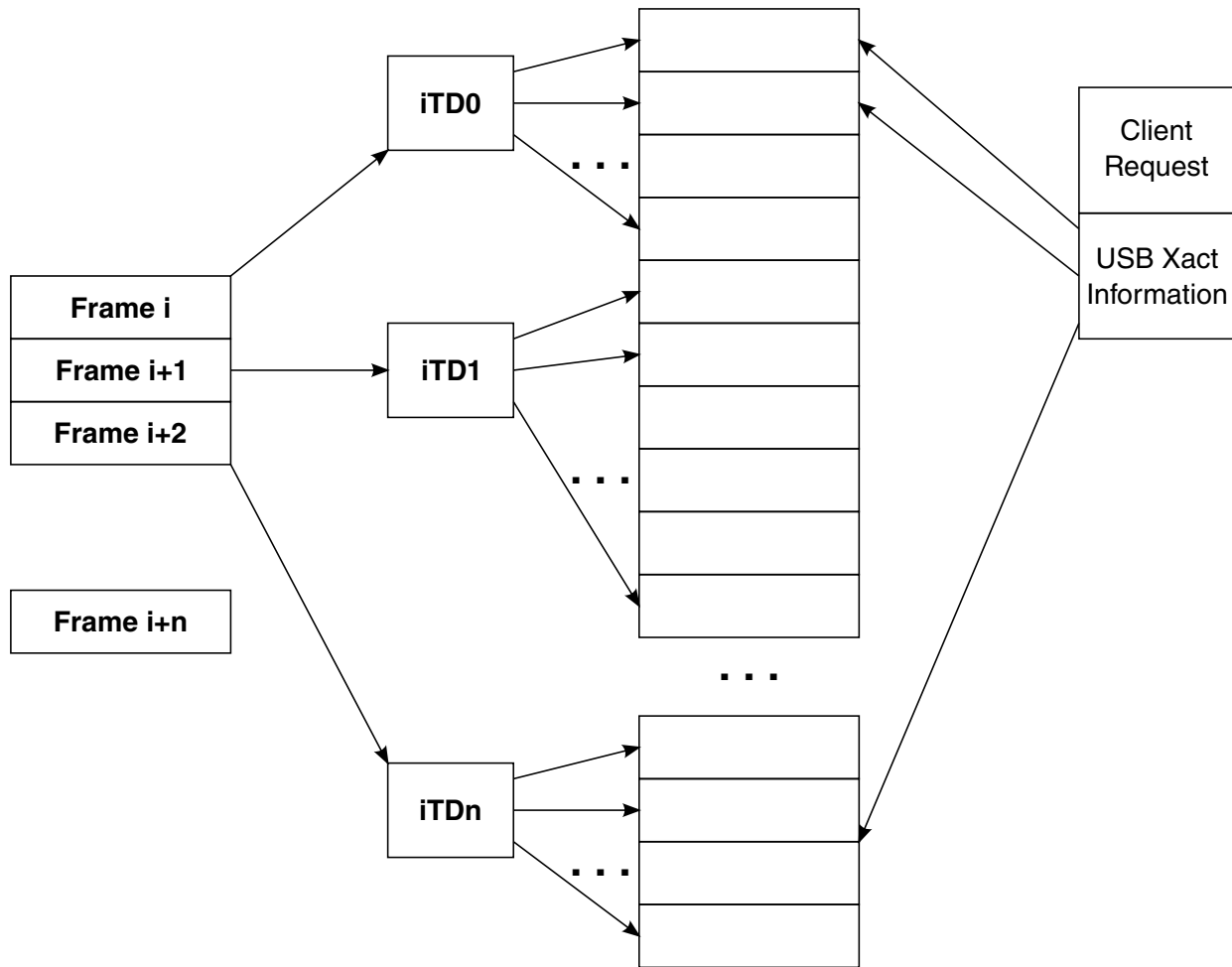

Figure 56-12. Example Association of iTDs to Client Request Buffer

As noted above, the client request includes a pointer to the base of the buffer and offsets into the buffer to annotate which buffer sections are to be used on each bus transaction that occurs on this endpoint. System software must initialize each transaction description in an iTD to ensure it uses the correct portion of the client buffer. For example, for each transaction description, the PG field is set to index the correct physical buffer page pointer and the Transaction Offset field is set relative to the correct buffer pointer page (for example, the same one referenced by the PG field). When the host controller executes a transaction it selects a transaction description record based on FRINDEX[2:0]. It then uses the current Page Buffer Pointer (as selected by the PG field) and concatenates to the transaction offset field. The result is a starting buffer address for the transaction. As the host controller moves data for the transaction, it must watch for a page wrap condition and properly advance to the next available Page Buffer Pointer. System software must not use the Page 6 buffer pointer in a transaction description where the length of the transfer wraps a page boundary. Doing so yields undefined behavior. The host controller hardware is not required to 'alias' the page selector to Page zero. USB 2.0 isochronous

endpoints can specify a period greater than one. Software can achieve the appropriate scheduling by linking iTDs into the appropriate frames (relative to the frame list) and by setting appropriate transaction description elements active bits to one.

56.4.3.7.2.1 Periodic scheduling threshold

The Isochronous Scheduling Threshold field in the USB_HCCPARAMS capability register is an indicator to system software as to how the host controller pre-fetches and effectively caches schedule data structures.

It is used by system software when adding isochronous work items to the periodic schedule. The value of this field indicates to system software the minimum distance it can update isochronous data (relative to the current location of the host controller execution in the periodic list) and still have the host controller process them.

The iTD and siTD data structures each describe 8 micro-frames worth of transactions. The host controller is allowed to cache one (or more) of these data structures in order to reduce memory traffic. Three basic caching models that account for the fact the isochronous data structures span 8 micro-frames. The three caching models are: no caching, micro-frame caching and frame caching.

When software is adding new isochronous transactions to the schedule, it always performs a read of the USB_FRINDEX register to determine the current frame and micro-frame the host controller is currently executing. Of course, there is no information about where in the micro-frame the host controller is, so a constant uncertainty-factor of one micro-frame has to be assumed. Combining the knowledge of where the host controller is executing with the knowledge of the caching model allows the definition of simple algorithms for how closely software can reliably work to the executing host controller.

No caching is indicated with a value of zero in the Isochronous Scheduling Threshold field. The host controller may pre-fetch data structures during a periodic schedule traversal (per micro-frame) but always dumps any accumulated schedule state at the end of the micro-frame. At the appropriate time relative to the beginning of every micro-frame, the host controller always begins schedule traversal from the frame list. Software can use the value of the USB_FRINDEX register (plus the constant 1 uncertainty-factor) to determine the approximate position of the executing host controller. When no caching is selected, software can add an isochronous transaction as near as 2 micro-frames in front of the current executing position of the host controller.

Frame caching is indicated with a non-zero value in bit [7] of the Isochronous Scheduling Threshold field. In the frame-caching model, system software assumes that the host controller caches one (or more) isochronous data structures for an entire frame (8 micro-frames). Software uses the value of the USB_FRINDEX register (plus the constant 1

uncertainty) to determine the current micro-frame/frame (assume modulo 8 arithmetic in adding the constant 1 to the micro-frame number). For any current frame N, if the current micro-frame is 0 to 6, then software can safely add isochronous transactions to Frame N + 1. If the current micro-frame is 7, then software can add isochronous transactions to Frame N + 2.

Micro-frame caching is indicated with a non-zero value in the least-significant 3 bits of the Isochronous Scheduling Threshold field. System software assumes the host controller caches one or more periodic data structures for the number of micro-frames indicated in the Isochronous Scheduling Threshold field. For example, if the count value were 2, then the host controller keeps a window of 2 micro-frames worth of state (current micro-frame, plus the next) on-chip. On each micro-frame boundary, the host controller releases the current micro-frame state and begins accumulating the next micro-frame state.

56.4.3.8 Asynchronous Schedule

The Asynchronous schedule traversal is enabled or disabled through the Asynchronous Schedule Enable bit in the USB_USBCMD register.

If the Asynchronous Schedule Enable bit is set to zero, then the host controller simply does not try to access the asynchronous schedule through the USB_ASYNCLISTADDR register. Likewise, when the Asynchronous Schedule Enable bit is one, then the host controller does use the USB_ASYNCLISTADDR register to traverse the asynchronous schedule. Modifications to the Asynchronous Schedule Enable bit are not necessarily immediate. Rather the new value of the bit is taken into consideration the next time the host controller needs to use the value of the USB_ASYNCLISTADDR register to get the next queue head.

The Asynchronous Schedule Status bit in the USB_USBSTS register indicates status of the asynchronous schedule. System software enables (or disables) the asynchronous schedule by writing one (or zero) to the Asynchronous Schedule Enable bit in the USB_USBCMD register. Software then can poll the Asynchronous Schedule Status bit to determine when the asynchronous schedule has made the desired transition. Software must not modify the Asynchronous Schedule Enable bit unless the value of the Asynchronous Schedule Enable bit equals that of the Asynchronous Schedule Status bit.

The asynchronous schedule is used to manage all Control and Bulk transfers. Control and Bulk transfers are managed using queue head data structures. The asynchronous schedule is based at the USB_ASYNCLISTADDR register. The default value of the USB_ASYNCLISTADDR register after reset is undefined and the schedule is disabled when the Asynchronous Schedule Enable bit is zero.

Software may only write this register with defined results when the schedule is disabled. For example, Asynchronous Schedule Enable bit in the USB_USBCMD and the Asynchronous Schedule Status bit in the USB_USBSTS register are zero. System software enables execution from the asynchronous schedule by writing a valid memory address (of a queue head) into this register. Then software enables the asynchronous schedule by setting the Asynchronous Schedule Enable bit to one. The asynchronous schedule is actually enabled when the Asynchronous Schedule Status bit is one.

When the host controller begins servicing the asynchronous schedule, it begins by using the value of the USB_ASYNCLISTADDR register. It reads the first referenced data structure and begins executing transactions and traversing the linked list as appropriate. When the host controller completes processing the asynchronous schedule, it retains the value of the last accessed queue head's horizontal pointer in the USB_ASYNCLISTADDR register. Next time the asynchronous schedule is accessed, this is the first data structure that is serviced. This provides round-robin fairness for processing the asynchronous schedule.

A host controller completes processing the asynchronous schedule when one of the following events occur:

- The end of a micro-frame occurs.
- The host controller detects an empty list condition (see [Empty Asynchronous Schedule Detection](#))
- The schedule has been disabled through the Asynchronous Schedule Enable bit in the USB_USBCMD register.

The queue heads in the asynchronous list are linked into a simple circular list as shown in [Figure 56-7](#). Queue head data structures are the only valid data structures that may be linked into the asynchronous schedule. An isochronous transfer descriptor (iTDD or siTD) in the asynchronous schedule yields undefined results.

The maximum packet size field in a queue head is sized to accommodate the use of this data structure for all non-isochronous transfer types. The USB Specification, Revision 2.0 specifies the maximum packet sizes for all transfer types and transfer speeds. System software should always parameterize the queue head data structures according to the core specification requirements.

56.4.3.8.1 Adding Queue Heads to Asynchronous Schedule

This is a software requirement section.

There are two independent events for adding queue heads to the asynchronous schedule. The first is the initial activation of the asynchronous list. The second is inserting a new queue head into an activated asynchronous list.

Activation of the list is simple. System software writes the physical memory address of a queue head into the USB_ASYNC_LIST_ADDR register, then enables the list by setting the Asynchronous Schedule Enable bit in the USB_USBCMD register to one.

When inserting a queue head into an active list, software must ensure that the schedule is always coherent from the host controllers' point of view. This means that the system software must ensure that all queue head pointer fields are valid. For example, qTD pointers have T-Bits set to one or reference valid qTDs and the Horizontal Pointer references a valid queue head data structure. The following algorithm represents the functional requirements:

```

InsertQueueHead (pQHeadCurrent, pQueueHeadNew)
--
-- Requirement: all inputs must be properly initialized.
--
-- pQHeadCurrent is a pointer to a queue head that is
-- already in the active list
-- pQHeadNew is a pointer to the queue head to be added
--
-- This algorithm links a new queue head into a existing
-- list
--
pQueueHeadNew.HorizontalPointer = pQueueHeadCurrent.HorizontalPointer
pQueueHeadCurrent.HorizontalPointer = physicalAddressOf (pQueueHeadNew)
End InsertQueueHead

```

56.4.3.8.2 Removing Queue Heads from Asynchronous Schedule

This is a software requirement section.

There are two independent events for removing queue heads from the asynchronous schedule. The first is shutting down (deactivating) the asynchronous list. The second is extracting a single queue head from an activated list.

Software deactivates the asynchronous schedule by setting the Asynchronous Schedule Enable bit in the USB_USBCMD register to zero. Software can determine when the list is idle when the Asynchronous Schedule Status bit in the USB_USBSTS register is zero. The normal mode of operation is that software removes queue heads from the asynchronous schedule without shutting it down. Software must not remove an active queue head from the schedule. Software should first deactivate all active qTDs, wait for the queue head to go inactive, then remove the queue head from the asynchronous list. Software removes a queue head from the asynchronous list through the following algorithm. As illustrated, the unlinking is quite easy. Software merely must ensure all of the link pointers reachable by the host controller are kept consistent.

```

UnlinkQueueHead (pQHeadPrevious, pQueueHeadToUnlink, pQHeadNext)
--
-- Requirement: all inputs must be properly initialized.
--
-- pQHeadPrevious is a pointer to a queue head that
-- references the queue head to remove
-- pQHeadToUnlink is a pointer to the queue head to be

```

USB Operation Model

```
-- removed
-- pQheadNext is a pointer to a queue head still in the
-- schedule. Software provides this pointer with the
-- following strict rules:
--     if the host software is one queue head, then
--     pQHeadNext must be the same as
--     QueueheadToUnlink.HorizontalPointer. If the host
--     software is unlinking a consecutive series of
--     queue heads, QHeadNext must be set by software to
--     the queue head remaining in the schedule.
--
-- This algorithm unlinks a queue head from a circular list
--
pQueueHeadPrevious.HorizontalPointer = pQueueHeadToUnlink.HorizontalPointer
pQueueHeadToUnlink.HorizontalPointer = pQHeadNext
```

End UnlinkQueueHead

If software removes the queue head with the H-bit set to one, it must select another queue head still linked into the schedule and set its H-bit to one. This should be completed before removing the queue head. The requirement is that software keep one queue head in the asynchronous schedule, with its H-bit set to one. At the point software has removed one or more queue heads from the asynchronous schedule, it is unknown whether the host controller has a cached pointer to them. Similarly, it is unknown how long the host controller might retain the cached information, as it is implementation dependent and may be affected by the actual dynamics of the schedule load. Therefore, once software has removed a queue head from the asynchronous list, it must retain the coherency of the queue head (link pointers, and so on). It cannot disturb the removed queue heads until it knows that the host controller does not have a local copy of a pointer to any of the removed data structures.

The method software uses to determine when it is safe to modify a removed queue head is to handshake with the host controller. The handshake mechanism allows software to remove items from the asynchronous schedule, then execute a simple, lightweight handshake that is used by software as a key that it can free (or reuse) the memory associated the data structures it has removed from the asynchronous schedule.

The handshake is implemented with three bits in the host controller. The first bit is a command bit (Interrupt on Async Advance Doorbell bit in the USB_USBCMD register) that allows software to inform the host controller that something has been removed from its asynchronous schedule. The second bit is a status bit (Interrupt on Async Advance bit in the USB_USBSTS register) that the host controller sets after it has released all on-chip state that may potentially reference one of the data structures just removed. When the host controller sets this status bit to one, it also sets the command bit to zero. The third bit is an interrupt enable (Interrupt on Async Advance bit in the USB_USBINTR register) that is matched with the status bit. If the status bit is one and the interrupt enable bit is one, then the host controller asserts a hardware interrupt.

The figure below illustrates a general example. In this example, consecutive queue heads (B and C) are unlinked from the schedule using the algorithm above. Before the unlink operation, the host controller has a copy of queue head A.

The unlink algorithm requires that as software unlinks each queue head, the unlinked queue head is loaded with the address of a queue head that remains in the asynchronous schedule.

When the host controller observes that doorbell bit being set to one, it makes a note of the local reachable schedule information. In this example, the local reachable schedule information includes both queue heads (A and B). It is sufficient that the host controller can set the status bit (and clear the doorbell bit) as soon as it has traversed beyond current reachable schedule information (that is traversed beyond queue head (B) in this example). The following figure illustrates the generic queue head unlink scenario.

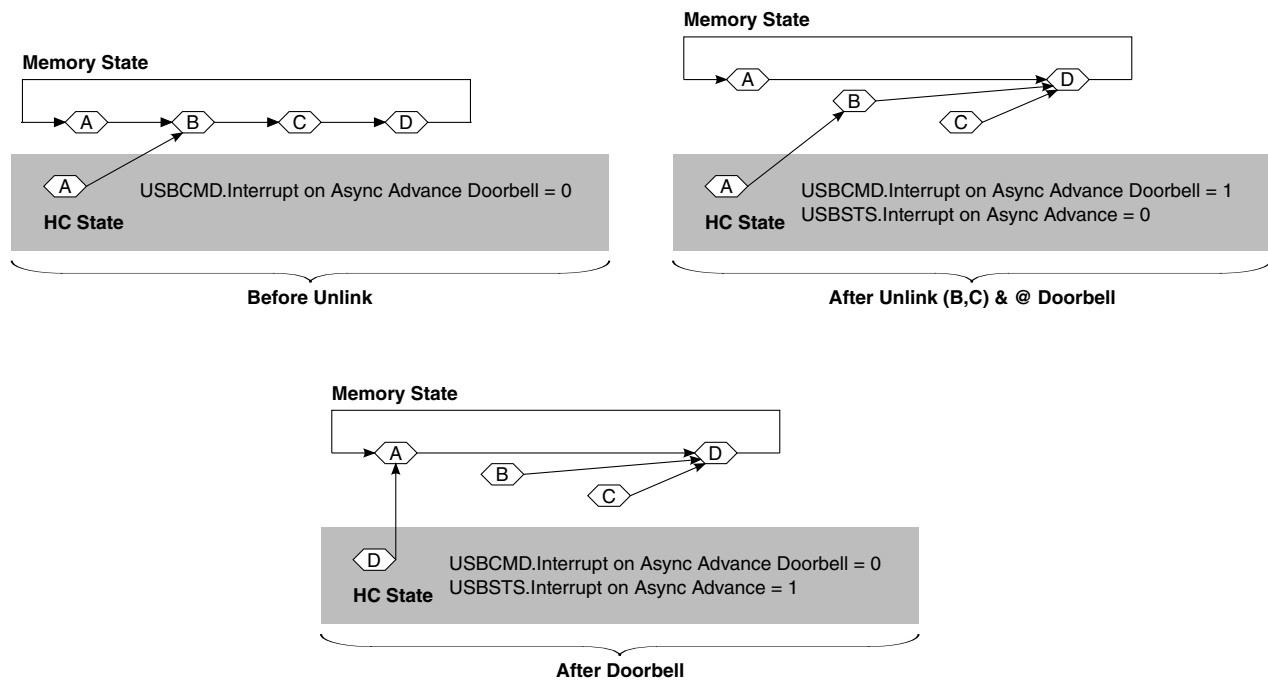

Figure 56-13. Generic Queue Head Unlink Scenario

Alternatively, a host controller implementation is allowed to traverse the entire asynchronous schedule list (for example, observed the head of the queue (twice)) before setting the Advance on Async status bit to one.

Software may re-use the memory associated with the removed queue heads after it observes the Interrupt on Async Advance status bit is set to one, following assertion of the doorbell. Software should acknowledge the Interrupt on Async Advance status as indicated in the USB_USBSTS register, before using the doorbell handshake again.

56.4.3.8.3 Empty Asynchronous Schedule Detection

The Enhanced Host Controller Interface uses two bits to detect when the asynchronous schedule is empty.

The queue head data structure (see [Table 56-25](#)) defines an *H-bit* in the queue head, which allows software to mark a queue head as being the *head* of the reclaim list. The Enhanced Host Controller Interface also keeps a 1-bit flag in the USB_USBSTS register (*Reclamation*) that is set to zero when the Enhanced Interface Host Controller observes a queue head with the H-bit set to one. The reclamation flag in the status register is set to one when any USB transaction from the asynchronous schedule is executed (or whenever the asynchronous schedule starts, see [Asynchronous schedule traversal: Start Event](#)).

If the Enhanced Host Controller Interface ever encounters an *H-bit* of one and a *Reclamation* bit of zero, the EHCI controller simply stops traversal of the asynchronous schedule.

An example illustrating the H-bit in a schedule is shown in the following figure.

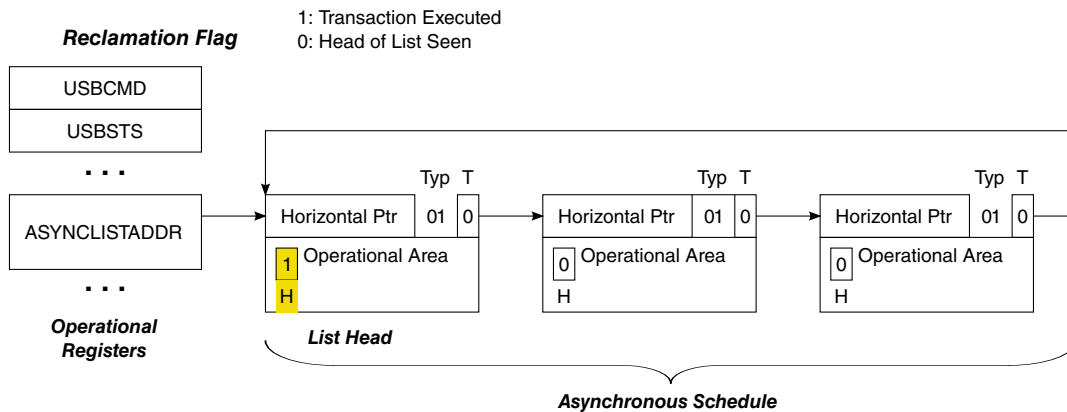

Figure 56-14. Asynchronous Schedule List w/Annotation to Mark Head of List

Software must ensure there is at most one queue head with the *H-bit* set to one, and that it is always coherent with respect to the schedule.

56.4.3.8.4 Restarting Asynchronous Schedule Before EOF

There are many situations where the host controller will detect an empty list *long* before the end of the micro-frame.

It is important to remember that under many circumstances the schedule traversal has stopped due to Nak/Nyet responses from all endpoints.

An example of particular interest is when a start-split for a bulk endpoint occurs early in the micro-frame. Given the EHCI simple traversal rules, the complete-split for that transaction may Nak/Nyet out very quickly. If it is the only item in the schedule, then the host controller ceases traversal of the Asynchronous schedule very early in the micro-frame. In order to provide reasonable service to this endpoint, the host controller should issue the complete-split before the end of the current micro-frame, instead of waiting

until the next micro-frame. When the reason for host controller idling asynchronous schedule traversal is because of empty list detection, it is mandatory the host controller implement a 'waking' method to resume traversal of the asynchronous schedule. An example method is described below.

56.4.3.8.4.1 Example Method for Restarting Asynchronous Schedule Traversal

The reason for idling the host controller when the list is empty is to keep the host controller from unnecessarily occupying too much memory bandwidth. The question is: *how long should the host controller stay idle before restarting?*

The answer in this example is based on deriving a manifest constant, which is the amount of time the host controller will stay idle before restarting traversal. In this example, the manifest constant is called *AsyncSchedSleepTime*, and has a value of 10 μ sec. The value is derived based on the analysis in [Example Derivation for AsyncSchedSleepTime](#), The traversal algorithm is simple:

- Traverse the Asynchronous schedule until the either an End-Of-micro-Frame event occurs, or an empty list is detected. If the event is an End-of-micro-Frame, go attempt to traverse the Periodic schedule. If the event is an empty list, then set a sleep timer and go to a *schedule sleep* state.
- When the sleep timer expires, set working context to the Asynchronous Schedule start condition and go to *schedule active* state. The start context allows the HC to reload *Nakcnt* fields, and so on. So the HC has a chance to run for more than one iteration through the schedule.

This process simply repeats itself each micro-frame. The figure below illustrates a sample state machine to manage the active and sleep states of the Asynchronous Schedule traversal policy. There are three states: Actively traversing the Asynchronous schedule, Sleeping, and Not Active. The last two are similar in terms of interaction with the Asynchronous schedule, but the Not Active state means that the host controller is busy with the Periodic schedule or the Asynchronous schedule is not enabled. The Sleeping state is specifically a special state where the host controller is just waiting for a period of time before resuming execution of the Asynchronous schedule.

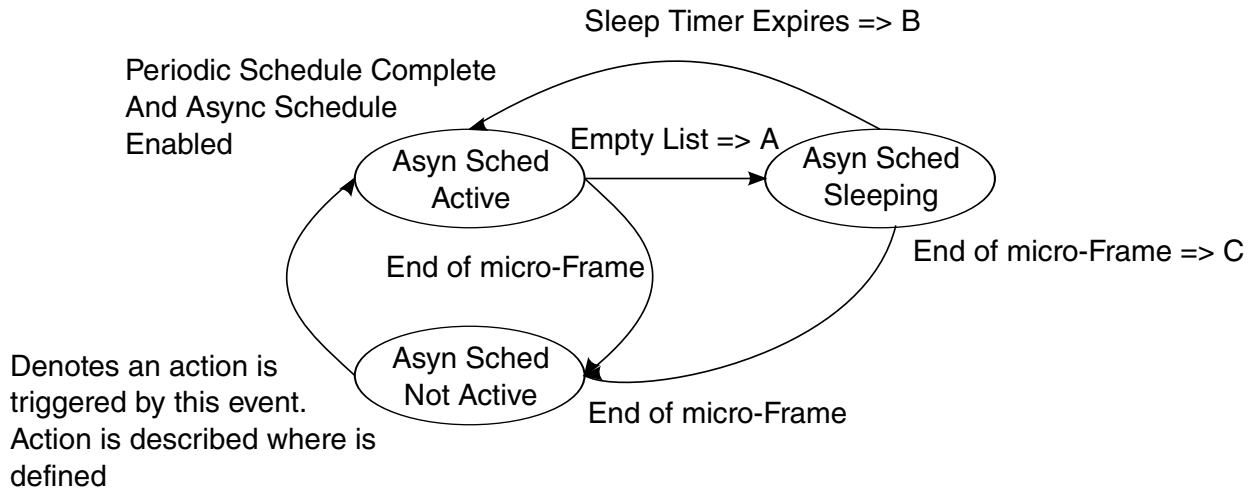

Figure 56-15. Example State Machine for Managing Asynchronous Schedule Traversal

The actions referred to in the figure above are defined in the following table.

Table 56-40. Asynchronous Schedule SM Transition Actions

Action	Action Description Label
A	On detection of the empty list, the host controller sets the <i>AsynchronousTraversalSleepTimer</i> to <i>AsynSchedSleepTime</i> .
B	When the <i>AsynchronousTraversalSleepTimer</i> expires, the host controller sets the <i>Reclamation</i> bit in the USBSTS register to one and moves the Nak Counter reload state machine to <i>WaitForListHead</i> (see Nak Count Reload Control).
C	The host controller cancels the sleep timer (<i>AsynchronousTraversalSleepTimer</i>).

56.4.3.8.4.2 Async Sched Not Active

This is the initial state of the traversal state machine after a host controller reset. The traversal state machine does not leave this state when the *Asynchronous Schedule Enable* bit in the USB_USBCMD register is zero.

This state is entered from Async Sched Active or Async Sched Sleeping states when the end-of-micro-frame event is detected.

56.4.3.8.4.3 Async Sched Active

This state is entered from the Async Sched Not Active state when the periodic schedule is not active. It is also entered from the Async Sched Sleeping states when the *AsynchrhonousTraversalSleepTimer* expires. On every transition into this state, the host controller sets the *Reclamation* bit in the USB_USBSTS register to one.

While in this state, the host controller continually traverses the asynchronous schedule until either the end of micro-frame or an empty list condition is detected.

56.4.3.8.4.4 Async Sched Sleeping

The state is entered from the Async Sched Active state when a schedule empty condition is detected. On entry to this state, the host controller sets the *AsynchronousTraversalSleepTimer* to *AsyncSchedSleepTime*.

56.4.3.8.4.5 Example Derivation for AsyncSchedSleepTime

The derivation is based on analysis of what work the host controller could be doing next.

It assumes the host controller does not keep any state about what work is possibly pending in the asynchronous schedule. The schedule could contain any mix of the possible combinations of high- full- or low-speed control and bulk requests.

The table below summarizes some of the typical 'next transactions' that could be in the schedule, and the amount of time (for example *footprint*, or *wall clock*) the transaction takes to complete.

Table 56-41. Typical Low-/Full-speed Transaction Times

Transaction Attributes		Footprint (time)	Description
Speed	HS	11.9 ms	Maximum foot print for a worst-case, full-sized bulk data transaction.
Size	512	9.45 ms	Maximum footprint for an approximate best-case, full-sized bulk data transaction.
Type	Bulk		
Speed	FS	~50 ms	Approximate typical for full-sized bulk data. An 8-byte low-speed is about 2x, or between 90 and 100 ms.
Size	64		
Type	Bulk		
Speed	FS	~12 ms	Approximate typical for 8-byte bulk/control (that is setup)
Size	8		
Type	Cntrl		

A *AsyncSchedSleepTime* value of 10 μ s provides a reasonable relaxation of the system memory load and still provides a good level of service for the various transfer types and payload sizes. For example, say we detect an empty list after issuing a start-split for a 64-byte full-speed bulk request. Assuming this is the only thing in the list, the host controller gets the results of the full-speed transaction from the hub during the fifth complete-split request. If the full-speed transaction was an IN and it nak'd, the 10 μ s sleep period would allow the host controller to get the NAK results on the first complete-split.

56.4.3.8.5 Asynchronous schedule traversal: *Start Event*

Once the HC has *idled* itself through the empty schedule detection (Section 0), it will naturally *activate* and begin processing from the Periodic Schedule at the beginning of each micro-frame.

In addition, it may have idled itself early in a micro-frame. When this occurs (idles early in the micro-frame) the HC must occasionally *re-activate* during the micro-frame and traverse the asynchronous schedule to determine whether any progress can be made. The requirements and method for this restart are described in [Restarting Asynchronous Schedule Before EOF](#). Asynchronous schedule *Start Events* are defined to be:

- Whenever the host controller transitions from the periodic schedule to the asynchronous schedule. If the periodic schedule is disabled and the asynchronous schedule is enabled, then the beginning of the micro-frame is equivalent to the transition from the periodic schedule, or
- The asynchronous schedule traversal restarts from a sleeping state (see [Restarting Asynchronous Schedule Before EOF](#)).

56.4.3.8.6 Reclamation Status Bit (USBSTS Register)

The operation of the empty asynchronous schedule detection feature (see [Empty Asynchronous Schedule Detection](#)) depends on the proper management of the *Reclamation* bit in the USB_USBSTS register. The host controller tests for an empty schedule just after it fetches a new queue head while traversing the asynchronous schedule (see [Fetch Queue Head](#)).

The host controller is required to set the *Reclamation* bit to one whenever an asynchronous schedule traversal *Start Event*, as documented in [Asynchronous schedule traversal: *Start Event*](#), occurs. The *Reclamation* bit is also set to one whenever the host controller executes a transaction while traversing the asynchronous schedule (see [Execute Transaction](#)). The host controller sets the *Reclamation* bit to zero whenever it finds a queue head with its *H-bit* set to one. Software should only set a queue head's *H-bit* if the queue head is in the asynchronous schedule. If software sets the *H-bit* in an interrupt queue head to one, the resulting behavior is undefined. The host controller may set the *Reclamation* bit to zero when executing from the periodic schedule.

56.4.3.9 Operational Model for Nak Counter

This section describes the operational model for the *NakCnt* field defined in a queue head.

See [Queue Head Initialization](#) for more information. Software should not use this feature for interrupt queue heads. This rule is not required to be enforced by the host controller.

USB protocol has built-in flow control through the Nak response by a device. There are several scenarios, beyond the Ping feature, where an endpoint may naturally Nak or Nyet the majority of the time. An example is the host controller management of the split transaction protocol for control and bulk endpoints. All bulk endpoints (High- or Full-speed) are serviced through the same asynchronous schedule. The time between the *Start-split* transaction and the first *Complete-split* transaction could be very short (that is like when the endpoint is the only one in the asynchronous schedule). The hub NYETs (effectively Naks) the *Complete-split* transaction until the classic transaction is complete. This could result in the host controller thrashing memory, repeatedly fetching the queue head and executing the transaction to the Hub, which does not complete until after the transaction on the classic bus completes.

The two component fields in a queue head to support the throttling feature: a counter field (*NakCnt*), and a counter reload field (*RL*). *NakCnt* is used by the host controller as one of the criteria to determine whether or not to execute a transaction to the endpoint. The two operational modes associated with this counter:

- Not Used- This mode is set when the *RL* field is zero. The host controller ignores the *NakCnt* field for any execution of transactions through a queue head with an *RL* field of zero. Software must use this selection for interrupt endpoints.
- Nak Throttle Mode- This mode is selected when the *RL* field is non-zero. In this mode, the value in the *NakCnt* field represents the maximum number of Nak or Nyet responses the host controller tolerates on each endpoint. In this mode, the HC decrements the *NakCnt* field based on the token/handshake criteria listed in the table below. The host controller must reload *NakCnt* when the endpoint successfully moves data (for example, policy to reward device for moving data).

The following table describes the *NakCnt* field adjustment rules.

Table 56-42. NakCnt Field Adjustment Rules

Token	Handshake	
	Handshake NAK	NYET
IN/PING	decrement <i>NakCnt</i>	N/A (protocol error)
OUT	decrement <i>NakCnt</i>	No Action ¹ Start
Split	decrement <i>NakCnt</i>	N/A (protocol error)
Complete Split	No Action	Decrement <i>NakCnt</i>

1. Recommended behavior on this response is to reload *NakCnt*

In summary, system software enables the counter by setting the reload field (*RL*) to a non-zero value. The host controller may execute a transaction if *NakCnt* is non-zero. The host controller does not execute a transaction if *NakCnt* is zero. The reload mechanism is described in detail in [Nak Count Reload Control](#) .

NOTE

When all queue heads in the Asynchronous Schedule either exhausts all transfers or all *NakCnt*'s go to zero, then the host controller detects an empty Asynchronous Schedule and idle schedule traversal (see [Empty Asynchronous Schedule Detection](#)).

Any time the host controller begins a new traversal of the Asynchronous Schedule, a *Start Event* is assumed, see [Asynchronous schedule traversal: Start Event](#). Every time a Start-Event occurs, the Nak Count reload procedure is enabled.

56.4.3.9.1 Nak Count Reload Control

When the host controller reaches the *Execute Transaction* state for a queue head (meaning that it has an active operational state), it checks to determine whether the *NakCnt* field should be reloaded from *RL* (see [Execute Transaction](#)). If the answer is yes, then *RL* is copied into *NakCnt*. After the reload or if the reload is not active, the host controller evaluates whether to execute the transaction.

The host controller must reload nak counters (*NakCnt* see [Table 56-25](#)) in queue heads during the first pass through the reclamation list after an asynchronous schedule Start Event (see [Asynchronous schedule traversal: Start Event](#) for the definition of the Start Event). The Asynchronous Schedule should have at most one queue head marked as the head (see [Figure 56-14](#)).

The following figure illustrates an example state machine that satisfies the operational requirements of the host controller detecting the first pass through the Asynchronous Schedule. This state machine is maintained internal to the host controller and is only used to gate reloading of the nak counter during the queue head traversal state: *Execute Transaction* (see the figure below). The host controller does not perform the nak counter reload operation if the *RL* field (see [Table 56-25](#)) is set to zero.

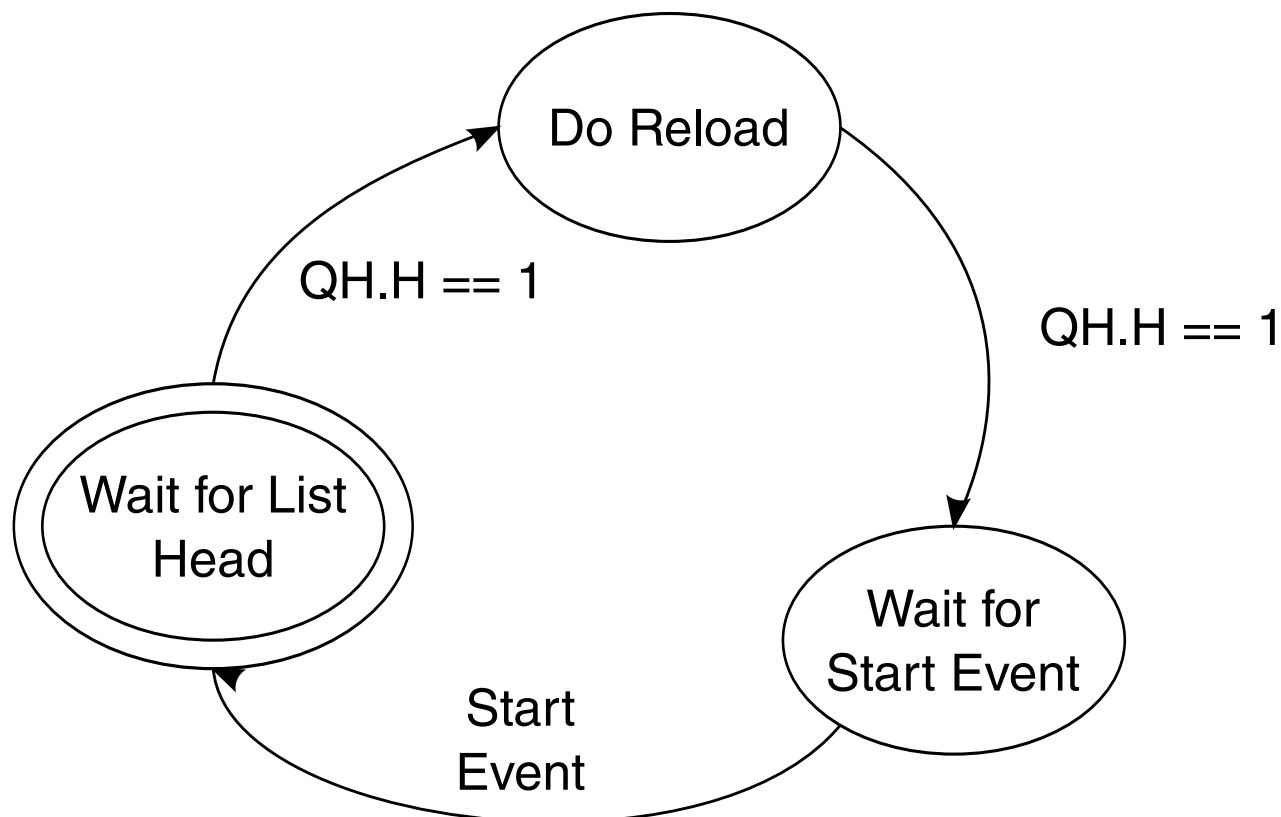

Figure 56-16. Example HC State Machine for Controlling Nak Counter Reloads

56.4.3.9.1.1 Wait for List Head

This is the initial state.

The state machine enters this state from Wait for Start Event when a start event as defined in [Asynchronous schedule traversal: Start Event](#) occurs.

The purpose of this state is to wait for the first observation of the head of the Asynchronous Schedule.

This occurs when the host controller fetches a queue head whose *H-bit* is set to one.

56.4.3.9.1.2 Do Reload

This state is entered from the Wait for List Head state when the host controller fetches a queue head with the *H-bit* set to one. While in this state, the host controller performs nak counter reloads for every queue head visited that has a non-zero nak reload value (*RL*) field.

56.4.3.9.1.3 Wait for Start Event

This state is entered from the *Do Reload* state when a queue head with the *H-bit* set to one is fetched. While in this state, the host controller does not perform nak counter reloads.

56.4.3.10 Managing Control/Bulk/Interrupt Transfers through Queue Heads

This section presents an overview of how the host controller interacts with queuing data structures.

Queue heads use the Queue Element Transfer Descriptor (qTD) structure. One queue head is used to manage the data stream for one endpoint. The queue head structure contains static endpoint characteristics and capabilities. It also contains a working area from where individual bus transactions for an endpoint are executed (see Overlay area defined in [Table 56-25](#)). Each qTD represents one or more bus transactions, which is defined in the context of this specification as a *transfer*.

The general processing model for the host controller's use of a queue head is simple:

- read a queue head,
- execute a transaction from the overlay area,
- write back the results of the transaction to the overlay area,
- move to the next queue head.

If the host controller encounters errors during a transaction, the host controller sets one (or more) of the error reporting bits in the queue head's *Status* field. The *Status* field accumulates all errors encountered during the execution of a qTD (for example, the error bits in the queue head *Status* field are 'sticky' until the transfer (qTD) has completed). This state is always written back to the source qTD when the transfer is complete. On transfer (for example, buffer or halt conditions) boundaries, the host controller must auto-advance (without software intervention) to the next qTD. Additionally, the hardware must be able to halt the queue so no additional bus transactions occurs for the endpoint and the host controller does not advance the queue.

An example host controller operational state machine of a queue head traversal is illustrated in the following figure. This state machine is a model for how a host controller should traverse a queue head. The host controller must be able to advance the queue from the *Fetch QH* state in order to avoid all hardware/software race conditions. This simple mechanism allows software to simply link qTDs to the queue head and *activate* them, then the host controller always *find* them if/when they are reachable. The figure below illustrates the Host Controller Queue Head Traversal State Machine.

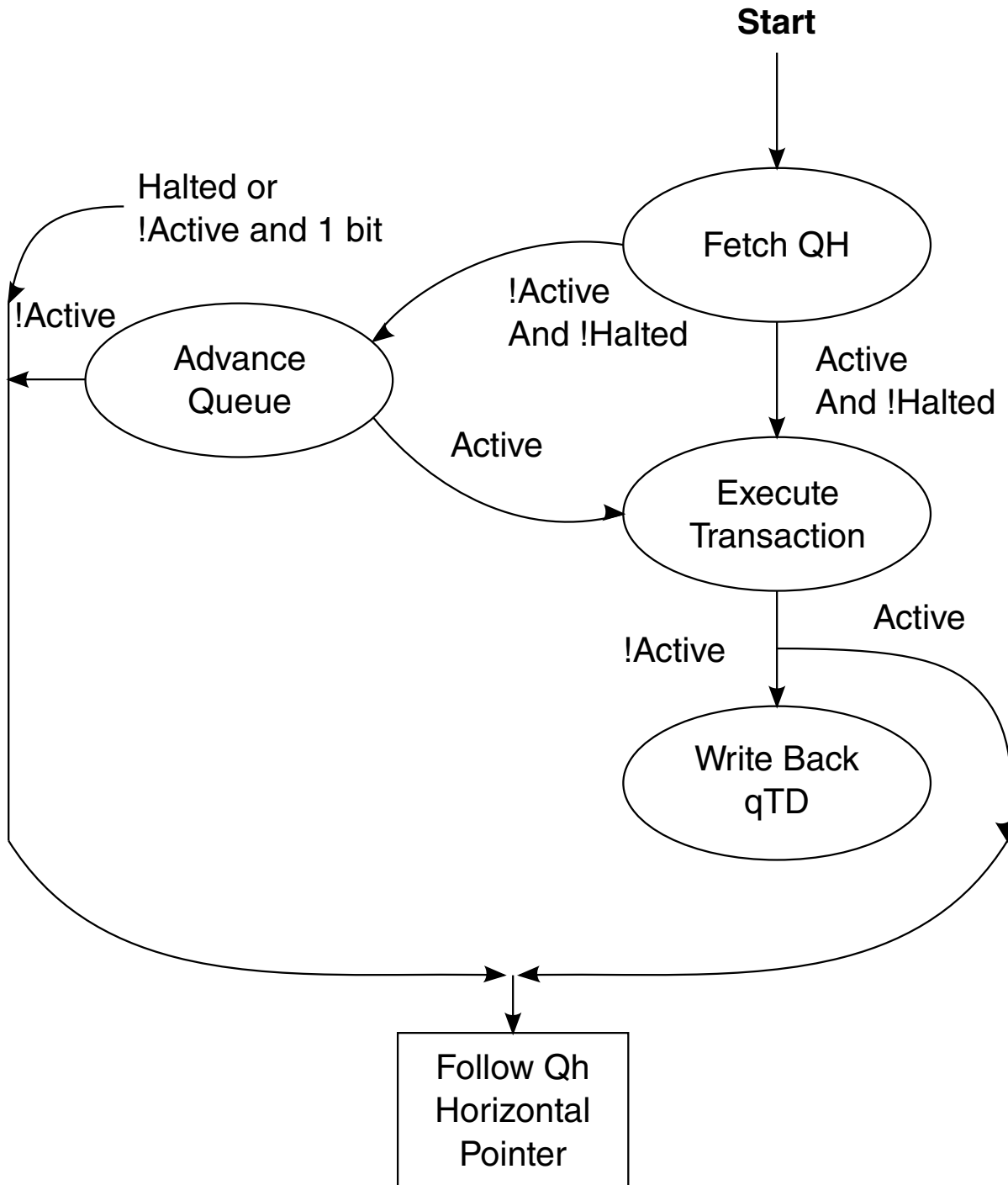

Figure 56-17. Host Controller Queue Head Traversal State Machine

This traversal state machine applies to all queue heads, regardless of transfer type or whether split transactions are required. The following sections describe each state. Each state description describes the entry criteria. The Execute Transaction state (see [Execute](#)

[Transaction](#)) describes the basic requirements for all endpoints. [Split Transactions for Asynchronous Transfers](#) and [Split Transaction Interrupt](#) describe details of the required extensions to the Execute Transaction state for endpoints requiring split transactions.

NOTE

Prior to software placing a queue head into either the periodic or asynchronous list, software must ensure the queue head is properly initialized. Minimally, the queue head should be initialized to the following (see Section Queue Head for layout of a queue head):

Valid static endpoint state.

- For the very first use of a queue head, software may zero-out the queue head transfer overlay, then set the *Next qTD Pointer* field value to reference a valid qTD.

56.4.3.10.1 Fetch Queue Head

A queue head can be referenced from the physical address stored in the ASYNCLISTADDR Register (see [Next Asynch. Address \(USB_nASYNCLISTADDR\)](#))/ [Endpoint List Address \(USB_nENDPTLISTADDR\)](#) Additionally, it may be referenced from the *Next LinkPointer* field of an iTD, siTD, FSTN or another Queue Head. If the referencing link pointer has the *Typ* field set to indicate a queue head, it is assumed to reference a queue head structure as defined in [Table 56-25](#).

While in this state, the host controller performs operations to implement empty schedule detection (see [Empty Asynchronous Schedule Detection](#)) and Nak Counter reloads (see [Operational Model for Nak Counter](#)). After the queue head has been fetched, the host controller conducts the following queries for empty schedule detection:

- If queue head is not an interrupt queue head (that is *S-mask* is zero), and
- The *H-bit* is one, and
- The *Reclamation* bit in the USBSTS register is zero.

When these criteria are met, the host controller stops traversing the asynchronous list (as described in [Empty Asynchronous Schedule Detection](#)). When the criteria are not met, the host controller continues schedule traversal. If the queue head is not an interrupt and the *H-bit* is one and the *Reclamation* bit is one, then the host controller sets the *Reclamation* bit in the USBSTS register to zero before completing this state. The operations for reloading of the Nak Counter are described in detail in [Operational Model for Nak Counter](#).

This state is complete when the queue head has been read on-chip.

56.4.3.10.2 Advance Queue

To advance the queue, the host controller must find the next qTD, adjust pointers, perform the overlay and write back the results to the queue head.

This state is entered from the FetchQHD state if the overlay *Active* and *Halt* bits are set to zero. On entry to this state, the host controller determines which next pointer to use to fetch a qTD, fetches a qTD and determines whether or not to perform an overlay.

NOTE

If the *I-bit* is one and the *Active* bit is zero, the host controller immediately skips processing of this queue head, exits this state and uses the horizontal pointer to the next schedule data structure. If the field *Bytes to Transfer* is not zero and the *T-bit* in the *Alternate Next qTD Pointer* is set to zero, then the host controller uses the *Alternate Next qTD Pointer*. Otherwise, the host controller uses the *NextqTD Pointer*. If *NextqTD Pointer's T-bit* is set to one, then the host controller exits this state and uses the horizontal pointer to the next schedule data structure.

Using the selected pointer the host controller fetches the referenced qTD. If the fetched qTD has its *Active* bit set to one, the host controller moves the pointer value used to reach the qTD (*Next* or *Alternate Next*) to the *Current qTD Pointer* field, then performs the overlay. If the fetched qTD has its *Active* bit set to zero, the host controller aborts the queue advance and follows the queue head's horizontal pointer to the next schedule data structure.

The host controller performs the overlay based on the following rules:

- The value of the data toggle (*dt*) field in the overlay area depends on the value of the *data toggle control (dtc)* bit (see [Table 56-27](#)).
- If the *EPS* field indicates the endpoint is a high-speed endpoint, the *Ping* state field is preserved by the host controller. The value of this field is not changed as a result of the overlay.
- *C-prog-mask* field is set to zero (field from incoming qTD is ignored, as is the current contents of the overlay area).
- *Frame Tag* field is set to zero (field from incoming qTD is ignored, as is the current contents of the overlay area).
- *NakCnt* field in the overlay area is loaded from the *RL* field in the queue head's Static Endpoint State.
- All other areas of the overlay are set by the incoming qTD.

The host controller exits this state when it has committed the write to the queue head.

56.4.3.10.3 Execute Transaction

The host controller enters this state from the Fetch Queue Head state only if the *Active* bit in *Status* field of the queue head is set to one.

On entry to this state, the host controller executes a few pre-operations, then checks some pre-condition criteria before committing to executing a transaction for the queue head.

The pre-operations performed and the pre-condition criteria depend on whether the queue head is an interrupt endpoint. The host controller can determine that a queue head is an interrupt queue head when the queue head's *S-mask* field contains a non-zero value. It is the responsibility of software to ensure the *S-mask* field is appropriately initialized based on the transfer type. There are other criteria that must be met if the *EPS* field indicates that the endpoint is a low- or full-speed endpoint, see [Split Transactions for Asynchronous Transfers](#) and [Split Transaction Interrupt](#).

56.4.3.10.3.1 Interrupt Transfer Pre-condition Criteria

If the queue head is for an interrupt endpoint (for example, non-zero *S-mask* field), then the FRINDEX[2:0] field must identify a bit in the *S-mask* field that has one in it.

For example, an *S-mask* value of 00100000b would evaluate to true only when FRINDEX[2:0] is equal to 101b. If this condition is met then the host controller considers this queue head for a transaction.

56.4.3.10.3.2 Asynchronous Transfer Pre-operations and Pre-condition Criteria

If the queue head is not for an interrupt endpoint (for example, zero *S-mask* field), then the host controller performs one pre-operation and then evaluates one pre-condition criteria.

The pre-operation is:

Checks the Nak counter reload state ([Operational Model for Nak Counter](#)). It may be necessary for the host controller to reload the Nak Counter field. The reload is performed at this time.

The pre-condition evaluated is:

- Whether or not the *NakCnt* field has been reloaded, the host controller checks the value of the *NakCnt* field in the queue head. If *NakCnt* is non-zero, or if the *Reload Nak Counter* field is zero, then the host controller considers this queue head for a transaction.

56.4.3.10.3.3 Transfer Type Independent Pre-operations

Regardless of the transfer type, the host controller always performs at least one pre-operation and evaluates one pre-condition. The pre-operation is:

- A host controller internal transaction (down) counter *qHTransactionCounter* is loaded from the queue head's *Mult* field. A host controller implementation is allowed to ignore this for queue heads on the asynchronous list. It is mandatory for interrupt queue heads. Software should ensure that the *Mult* field is set appropriately for the transfer type.

The pre-conditions evaluated are:

- The host controller determines whether there is enough time in the micro-frame to complete this transaction (see [Transaction Fit - A Best-Fit Approximation Algorithm](#) for an example evaluation method). If there is not enough time to complete the transaction, the host controller exits this state.
- If the value of *qHTransactionCounter* for an interrupt endpoint is zero, then the host controller exits this state.

When the pre-operations are complete and pre-conditions are met, the host controller sets the *Reclamation* bit in the USBSTS register to one and then begins executing one or more transactions using the endpoint information in the queue head. The host controller iterates *qHTransactionCounter* times in this state executing transactions. After each transaction is executed, *qHTransactionCounter* is decremented by one. The host controller exits this state when one of the following events occurs:

- The *qHTransactionCounter* decrements to zero, or
- The endpoint responds to the transaction with any handshake other than an ACK,⁴ or
- The transaction experiences a transaction error, or
- The *Active* bit in the queue head goes to zero, or
- There is not enough time in the micro-frame left to execute the next transaction(see [Transaction Fit - A Best-Fit Approximation Algorithm](#)) for example method for implementing the frame boundary test).

NOTE

For a high-bandwidth interrupt OUT endpoint, the host controller may optionally immediately retry the transaction if it fails.

The results of each transaction is recorded in the on-chip overlay area. If data was successfully moved during the transaction, the transfer state in the overlay area is advanced. To advance queue head's transfer state, the *Total Bytes to Transfer* field is decremented by the number of bytes moved in the transaction, the data toggle bit (*dt*) is toggled, the current page offset is advanced to the next appropriate value (for example,

advanced by the number of bytes successfully moved), and the *C_Page* field is updated to the appropriate value (if necessary). See [Buffer Pointer List Use for Data Streaming with qTDs](#) .

NOTE

The *Total Bytes To Transfer* field may be zero when all the other criteria for executing a transaction are met. When this occurs, the host controller executes zero-length transaction to the endpoint. If the *PID_Code* field indicates an IN transaction and the device delivers data, the host controller detects a packet babble condition, set the *babble* and *halted* bits in the *Status* field, set the *Active* bit to zero, write back the results to the source qTD, then exit this state.

In the event an IN token receives a data PID mismatch response, the host controller must ignore the received data (for example not advance the transfer state for the bytes received). Additionally, if the endpoint is an interrupt IN, then the host controller must record that the transaction occurred (for example, decrement *qHTransactionCounter*). It is recommended (but not required) the host controller continue executing transactions for this endpoint if the resultant value of *qHTransactionCounter* is greater than one.

If the response to the IN bus transaction is a Nak (or Nyet) and *RL* is non-zero, *NakCnt* is decremented by one. If *RL* is zero, then no write-back by the host controller is required (for a transaction receiving a Nak or Nyet response and the value of *CErr* did not change). Software should set the *RL* field to zero if the queue head is an interrupt endpoint. Host controller hardware is not required to enforce this rule or operation.

After the transaction has finished and the host controller has completed the post processing of the results (advancing the transfer state and possibly *NakCnt*, the host controller writes back the results of the transaction to the queue head's overlay area in main memory).

The number of bytes moved during an IN transaction depends on how much data the device endpoint delivers. The maximum number of bytes a device can send is *MaximumPacket Size*. The number of bytes moved during an OUT transaction is either *Maximum Packet Length* bytes or *Total Bytes to Transfer*, whichever is less.

If there was a transaction error during the transaction, the transfer state (as defined above) is not advanced by the host controller. The *CErr* field is decremented by one and the status field is updated to reflect the type of error observed. Transaction errors are summarized in [Transaction Error](#) .

The following events causes the host controller to clear the *Active* bit in the queue head's overlay status field. When the *Active* bit transitions from one to zero, the transfer in the overlay is considered complete. The reason for the transfer completion (clearing the *Active* bit) determines the next state.

- *CErr* field decrements to zero. When this occurs the *Halted* bit is set to one and *Active* is set to zero. This results in the hardware not advancing the queue and the pipe halts. Software must intercede to recover.
- The device responds to the transaction with a STALL PID. When this occurs, the *Halted* bit is set to one and the *Active* bit is set to zero. This results in the hardware not advancing the queue and the pipe halts. Software must intercede to recover.
- The *Total Bytes to Transfer* field is zero after the transaction completes.
 - For a zero length transaction, it was zero before the transaction was started. When this condition occurs, the *Active* bit is set to zero.
- The PID code is an IN, and the number of bytes moved during the transaction is less than the *Maximum Packet Length*. When this occurs, the *Active* bit is set to zero and a short packet condition exists. The short-packet condition is detected during the Advance Queue state. Refer to [Split Transactions](#) for additional rules for managing low- and full-speed transactions.

With the exception of a NAK response (when *RL* field is zero), the host controller always writes the results of the transaction back to the overlay area in main memory. This includes when the transfer completes. For a high-speed endpoint, the queue head information written back includes minimally the following fields: The *PID Code* field indicates an IN and the device sends more than the expected number of bytes (for example *Maximum Packet Length* or *Total Bytes to Transfer* bytes, whichever is less) (for example a packet babble). This results in the host controller setting the *Halted* bit to one.

- NakCnt, dt, Total Bytes to Transfer, C_Page, Status, CERR, and Current Offset

For a low- or full-speed device the queue head information written back also includes the fields:

- C-prog-mask, FrameTag and S-bytes.

The duration of this state depends on the time it takes to complete the transaction(s) and the status write to the overlay is committed.

56.4.3.10.3.4 Halting a Queue Head

A halted endpoint is defined only for the transfer types that are managed through queue heads (control, bulk and interrupt).

The following events indicate that the endpoint has reached a condition where no more activity can occur without intervention from the driver:

- An endpoint may return a STALL handshake during a transaction,
- A transaction had three consecutive error conditions, or
- A Packet Babble error occurs on the endpoint.

When any of these events occur (for a queue head) the Host Controller halts the queue head and set the USBERRINT status bit in the USB_n_USBSTS register to one. To halt the queue head, the *Active* bit is set to zero and the *Halted* bit is set to one. There may be other error status bits that are set when a queue is halted. The host controller always writes back the overlay area to the source qTD when the transfer is complete, regardless of the reason (normal completion, short packet or halt). The host controller does not advance the transfer state on a transaction that results in a *Halt* condition (for example no updates necessary for *Total Bytes to Transfer*, *C_Page*, *Current Offset*, and *dt*). The host controller must update *CErr* as appropriate. When a queue head is halted, the *USB Error Interrupt* bit in the USB_n_USBSTS register is set to one. If the *USB Error Interrupt Enable* bit in the USB_n_USBINTR register is set to one, a hardware interrupt is generated at the next interrupt threshold.

56.4.3.10.3.5 Asynchronous Schedule Park Mode

Asynchronous Schedule Park mode is a special execution mode that can be enabled by system software, where the host controller is permitted to execute more than one bus transaction from a high-speed queue head in the Asynchronous schedule before continuing horizontal traversal of the Asynchronous schedule.

This feature has no effect on queue heads or other data structures in the Periodic schedule. This feature is similar in intent as the *Mult* feature that is used in the Periodic schedule. Where-as the *Mult* feature is a characteristic that is tunable for each endpoint; park-mode is a policy that is applied to all high-speed queue heads in the asynchronous schedule. It is essentially the specification of an iterator for consecutive bus transactions to the same endpoint. All of the rules for managing bus transactions and the results of those as defined in [Execute Transaction](#) apply. This feature merely specifies how many consecutive times the host controller is permitted to execute from the same queue head before moving to the next queue head in the Asynchronous List. This feature should allow the host controller to attain better bus utilization for those devices that are capable of moving data at maximum rate, while at the same time providing a fair service to all endpoints.

A host controller exports its capability to support this feature to system software by setting the *Asynchronous Schedule Park Capability* bit in the USB_n_HCCPARAMs register to one. This information keys system software that the *Asynchronous Schedule Park Mode Enable* and *Asynchronous Schedule Park Mode Count* fields in the USB_n_USBCMD register are modifiable. System software enables the feature by writing a one to the *Asynchronous Schedule Park Mode Enable* bit.

When park-mode is not enabled (for example *Asynchronous Schedule Park Mode Enable* bit in the USB_n_USBCMD register is zero), the host controller must not execute more than one bus transaction per high-speed queue head, per traversal of the asynchronous schedule. When park-mode is enabled, the host controller must not apply the feature to a queue head whose *EPS* field indicates a Low/Full-speed device (for example only one bus transaction is allowed from each Low/Full-speed queue head per traversal of the asynchronous schedule). Park-mode may only be applied to queue heads in the Asynchronous schedule whose *EPS* field indicates that it is a high-speed device.

The host controller must apply park mode to queue heads whose *EPS* field indicates a high-speed endpoint. The maximum number of consecutive bus transactions a host controller may execute on a high-speed queue head is determined by the value in the *Asynchronous Schedule Park Mode Count* field in the USB_n_USBCMD register. Software must not set *Asynchronous Schedule Park Mode Enable* bit to one and also set *Asynchronous Schedule Park Mode Count* field to zero. The resulting behavior is not defined. An example behavioral example describes the operational requirements for the host controller implementing park-mode. This feature does not affect how the host controller handles the bus transaction as defined in [Execute Transaction](#). It only effects how many consecutive bus transactions for the current queue head can be executed. All boundary conditions, error detection and reporting applies as usual. This feature is similar in concept to the use of the *Mult* field for high-bandwidth Interrupt for queue heads in the Periodic Schedule.

The host controller effectively loads an internal down-counter *PM-Count* from *Asynchronous Schedule Park Mode Count* when *Asynchronous Schedule Park Mode Enable* bit is one, and a high-speed queue head is first fetched and meets all the criteria for executing a bus transaction. After the bus transaction, *PM-Count* is decremented. The host controller may continue to execute bus transactions from the current queue head until *PM-Count* goes to zero, an error is detected, the buffer for the current transfer is exhausted or the endpoint responds with a flow-control or STALL handshake.

The following table summarizes the responses that effect whether the host controller continues with another bus transaction for the current queue head.

Table 56-43. Actions for Park Mode, based on Endpoint Response and Residual Transfer State

PID	Endpoint Response	Transfer State after Transaction		Action
		PM-Count	Bytes to Transfer	
IN	DATA[0,1] w/Maximum Packet sized data	Not zero	Not Zero	Allowed to perform another bus transaction. ^{1, 2}
		Not zero	Zero	Retire qTD and move to next QH
		Zero	Don't care	Move to next QH.

Table continues on the next page...

Table 56-43. Actions for Park Mode, based on Endpoint Response and Residual Transfer State (continued)

	DATA[0,1] w/short packet	Don't care	Don't care	Retire qTD and move to next QH.
	NAK	Don't care	Don't care	Move to next QH.
	STALL, XactErr	Don't care	Don't care	Move to next QH.
OUT	ACK	Not zero	Not Zero	Allowed to perform another bus transaction. ²
		Not zero	Zero	Retire qTD and move to next QH
		Zero	Don't care	Move to next QH.
	NYET, NAK	Don't care	Don't care	Move to next QH.
	STALL, XactErr	Don't care	Don't care	Move to next QH
PING	ACK	Not Zero	Not Zero	Allowed to perform another bus transaction. ²
	NAK	Don't care	Don't care	Move to next QH
	STALL, XactErr	Don't care	Don't care	Move to next QH

1. The host controller may continue to execute bus transactions from the current high-speed queue head (if *PM-Count* is not equal to zero), if a PID mismatch is detected (for example expected DATA1 and received DATA0, or visa-versa).
2. This specification does not *require* that the host controller execute another bus transaction when *PM-Count* is non-zero. Implementations are encouraged to make appropriate complexity and performance trade-offs.

56.4.3.10.4 Write Back qTD

This state is entered from the Execute Transaction state when the *Active* bit is set to zero.

The source data for the write-back is the transfer results area of the queue head overlay area (see [Table 56-43](#)).

The host controller uses the *Current qTD Pointer* field as the target address for the qTD.

The queue head transfer result area is written back to the transfer result area of the target qTD. This state is also referred to as: qTD retirement. The fields that must be written back to the source qTD include *Total Bytes to Transfer*, *Cerr*, and *Status*.

The duration of this state depends on when the qTD write-back is committed.

56.4.3.10.5 Follow Queue Head Horizontal Pointer

The host controller must use the horizontal pointer in the queue head to the next schedule data structure when any of the following conditions exist:

- If the *Active* bit is one on exit from the Execute Transaction state, or
- When the host controller exits the Write Back qTD state, or
- If the Advance Queue state fails to advance the queue because the target qTD is not active, or
- If the *Halted* bit is one on exit from the Fetch QH state.

There is no functional requirement that the host controller wait until the current transaction is complete before using the horizontal pointer to read the next linked data structure. However, it must wait until the current transaction is complete before executing the next data structure.

56.4.3.10.6 Buffer Pointer List Use for Data Streaming with qTDs

A qTD has an array of buffer pointers, which is used to reference the data buffer for a transfer. This specification requires that the buffer associated with the transfer be *virtually contiguous*.

This means: if the buffer spans more than one physical page, it must obey the following rules (the figure below illustrates an example):

- The first portion of the buffer must begin at some offset in a page and extend through the end of the page.
- The remaining buffer cannot be allocated in small chunks scattered around memory. For each 4 K chunk beyond the first page, each buffer portion matches to a full 4 K page. The final portion, which may only be large enough to occupy a portion of a page, must start at the top of the page and be contiguous within that page.

The buffer pointer list in the qTD is long enough to support a maximum transfer size of 20 K bytes. This case occurs when all five buffer pointers are used and the first offset is zero. A qTD handles a 16 Kbyte buffer with any starting buffer alignment.

The host controller uses the field *C_Page* field as an index value to determine which buffer pointer in the list should be used to start the current transaction. The host controller uses a different buffer pointer for each physical page of the buffer. This is always true, even if the buffer is physically contiguous.

The host controller must detect when the current transaction spans a page boundary and automatically move to the next available buffer pointer in the page pointer list. The next available pointer is reached by incrementing *C_Page* and pulling the next page pointer from the list. Software must ensure there are sufficient buffer pointers to move the amount of data specified in the *Bytes to Transfer* field.

The following figure illustrates a nominal example of how System software would initialize the buffer pointers list and the *C_Page* field for a transfer size of 16383 bytes. *C_Page* is set to zero. The upper 20-bits of Page 0 references the start of the physical page. *Current Offset* (the lower 12-bits of queue head Dword 7) holds the offset in the page for example 2049 (for example 4096-2047). The remaining page pointers are set to reference the beginning of each subsequent 4 K page.

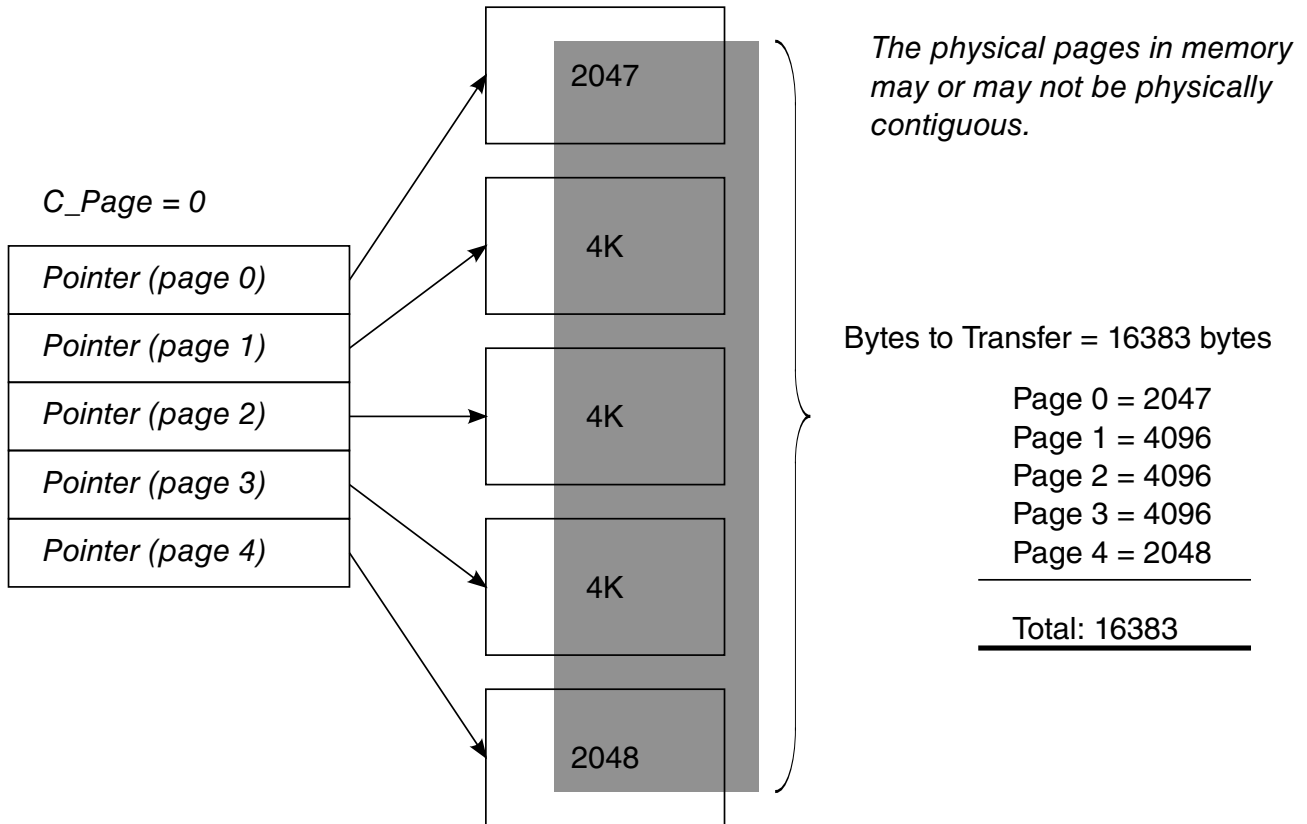

Figure 56-18. Example Mapping of qTD Buffer Pointers to Buffer Pages

For the first transaction on the qTD (assuming a 512-byte transaction), the host controller uses the first buffer pointer (page 0 because *C_Page* is set to zero) and concatenates the *Current Offset* field. The 512 bytes are moved during the transaction, the *Current Offset* and *Total Bytes to Transfer* are adjusted by 512 and written back to the queue head working area.

During the 4th transaction, the host controller needs 511 bytes in page 0 and one byte in page 1. The host controller increments *C_Page* (to 1) and use the page 1 pointer to move the final byte of the transaction. After the 4th transaction, the active page pointer is the page 1 pointer and *Current Offset* has rolled to one, and both are written back to the overlay area. The transactions continue for the rest of the buffer, with the host controller automatically moving to the next page pointer (that is *C_Page*) when necessary. The three conditions for how the host controller handles *C_Page*:

- The current transaction does not span a page boundary. The value of *C_Page* is not adjusted by the host controller.

- The current transaction does span a page boundary. The host controller must detect the page cross condition and advance to the next buffer while streaming data to/from the USB.
- The current transaction completes on a page boundary (that is the last byte moved for the current transaction is the last byte in the page for the current page pointer). The host controller must increment *C_Page* before writing back status for the transaction.

NOTE

The only valid adjustment the host controller may make to *C_Page* is to increment by one.

56.4.3.10.7 Adding Interrupt Queue Heads to the Periodic Schedule

The link path(s) from the periodic frame list to a queue head establishes in which frames a transaction can be executed for the queue head. Queue heads are linked into the periodic schedule so they are polled at the appropriate rate.

System software sets a bit in a queue head's *S-Mask* to indicate which micro-frame within 1 msec period a transaction should be executed for the queue head. Software must ensure that all queue heads in the periodic schedule have *S-Mask* set to a non-zero value. An *S-mask* with zero value in the context of the periodic schedule yields undefined results.

If the desired poll rate is greater than one frame, system software can use a combination of queue head linking and *S-Mask* values to spread interrupts of equal poll rates through the schedule so that the periodic bandwidth is allocated and managed in the most efficient manner possible. Some examples are illustrated in the following table.

Table 56-44. Example Periodic Reference Patterns for Interrupt Transfers with 2ms Poll Rate

Frame # Reference Sequence	Description
0, 2, 4, 6, 8, and so on <i>S-Mask</i> = 01h	A queue head for the <i>bInterval</i> of 2 msec (16 micro-frames) is linked into the periodic schedule so that it is reachable from the periodic frame list locations indicated in the previous column. In addition, the <i>S-Mask</i> field in the queue head is set to 01h, indicating that the transaction for the endpoint should be executed on the bus during micro-frame 0 of the frame.
0, 2, 4, 6, 8, and so on <i>S-Mask</i> = 02h	Another example of a queue head with a <i>bInterval</i> of 2 msec is linked into the periodic frame list at exactly the same interval as the previous example. However, the <i>S-Mask</i> is set to 02h indicating that the transaction for the endpoint should be executed on the bus during micro-frame 1 of the frame.

56.4.3.10.8 Managing Transfer Complete Interrupts from Queue Heads

The host controller sets an interrupt to be signaled at the next interrupt threshold when the completed transfer (qTD) has an *Interrupt on Complete (IOC)* bit set to one, or whenever a transfer (qTD) completes with a short packet.

If system software needs multiple qTDs to complete a client request (that is like a control transfer) the intermediate qTDs do not require interrupts. System software may only need a single interrupt to notify it that the complete buffer has been transferred. System software may set IOC's to occur more frequently. A motivation for this may be that it wants early notification so that interface data structures can be re-used in a timely manner.

56.4.3.11 Ping Control

USB 2.0 defines an addition to the protocol for high-speed devices called Ping. Ping is required for all USB 2.0 High-speed bulk and control endpoints.

Ping is not allowed for a split-transaction stream. This extension to the protocol eliminates the bad side-effects of Naking OUT endpoints. The *Status* field has a *Ping State* bit, which the host controller uses to determine the *next* actual PID it uses in the next transaction to the endpoint (see the table below).

The Ping State bit is only managed by the host controller for queue heads that meet the following criteria:

- Queue head is not an interrupt and
- *EPS* field equals High-Speed and
- *PIDCode* field equals OUT

The following table illustrates the state transition table for the host controller's responsibility for maintaining the PING protocol. Refer to Chapter 8 in the USB Specification Revision 2.0 for detailed description on the Ping protocol.

Table 56-45. Ping Control State Transition Table

Event	Host	Device	Next
Current	Host	Device	Next
Do Ping	PING	Nak	Do Ping
Do Ping	PING	Ack	Do OUT
Do Ping	PING	XactErr ¹	Do Ping
Do Ping	PING	Stall	N/C ² Do
OUT	OUT	Nak	Do Ping
Do OUT	OUT	Nyet	Do Ping

Table continues on the next page...

Table 56-45. Ping Control State Transition Table (continued)

Do OUT	OUT	Ack	Do OUT
Do OUT	OUT	XactErr ¹	Do Ping
Do OUT	OUT	Stall	N/C ²

1. Transaction Error (XactErr) is any time the host misses the handshake.
2. No transition change required for the Ping State bit. The Stall handshake results in the endpoint being halted (for example Active set to zero and Halt set to one). Software intervention is required to restart queue. 3 A Nyet response to an OUT means that the device has accepted the data, but cannot receive any more at this time. Host must advance the transfer state and additionally, transition the Ping State bit to Do Ping. The Ping State bit has the following encoding:

Table 56-46. Ping State bit Encoding

Value	Meaning
0B	Do OUT The host controller uses an OUT PID during the next bus transaction to this endpoint.
1B	Do Ping The host controller uses a PING PID during the next bus transaction to this endpoint.

The defined ping protocol (see USB 2.0 Specification, Chapter 8) allows the host to be *imprecise* on the initialization of the ping protocol (that is start in *Do OUT* when we don't know whether there is space on the device or not). The host controller manages the *Ping State* bit. System software sets the initial value in the queue head when it initializes a queue head. The host controller preserves the *Ping State* bit across all queue advancements. This means that when a new qTD is written into the queue head overlay area, the previous value of the *Ping State* bit is preserved.

56.4.3.12 Split Transactions

USB 2.0 defines extensions to the bus protocol for managing USB 1.x data streams through USB 2.0 Hubs.

This section describes how the host controller uses the interface data structures to manage data streams with full- and low-speed devices, connected below USB 2.0 hub, utilizing the split transaction protocol.

Refer to USB 2.0 Specification for the complete definition of the split transaction protocol. Full- and Low-speed devices are enumerated identically as high-speed devices, but the transactions to the Full- and Low-speed endpoints use the split-transaction protocol on the high-speed bus. The split transaction protocol is an encapsulation of (or wrapper around) the Full- or Low-speed transaction. The high-speed wrapper portion of the protocol is addressed to the USB 2.0 Hub and Transaction Translator below which the Full- or Low-speed device is attached.

The EHCI interface uses dedicated data structures for managing full-speed isochronous data streams (see [Split Transaction Isochronous Transfer Descriptor \(siTD\)](#)). Control, Bulk and Interrupt are managed using the queuing data structures (see [Queue Head](#)). The interface data structures need to be programmed with the device address and the Transaction Translator number of the USB 2.0 Hub operating as the Low-/Full-speed host controller for this link. The following sections describe the details of how the host controller must process and manage the split transaction protocol.

56.4.3.12.1 Split Transactions for Asynchronous Transfers

A queue head in the asynchronous schedule with an *EPS* field indicating a full-or low-speed device indicates to the host controller that it must use split transactions to stream data for this queue head.

All full-speed bulk and full-, low-speed control are managed through queue heads in the asynchronous schedule.

Software must initialize the queue head with the appropriate device address and port number for the transaction translator that is serving as the full/low-speed host controller for the links connecting the endpoint. Software must also initialize the split transaction state bit (*SplitXState*) to Do-Start-Split. Finally, if the endpoint is a control endpoint, then system software must set the *Control Transfer Type (C)* bit in the queue head to one. If this is not a control transfer type endpoint, the *C* bit must be initialized by software to be zero. This information is used by the host controller to properly set the Endpoint Type (ET) field in the split transaction bus token. When the *C* bit is zero, the split transaction token's ET field is set to indicate a bulk endpoint. When the *C* bit is one, the split transaction token's ET field is set to indicate a control endpoint. Refer to Chapter 8 of USB Specification Revision 2.0 for details.

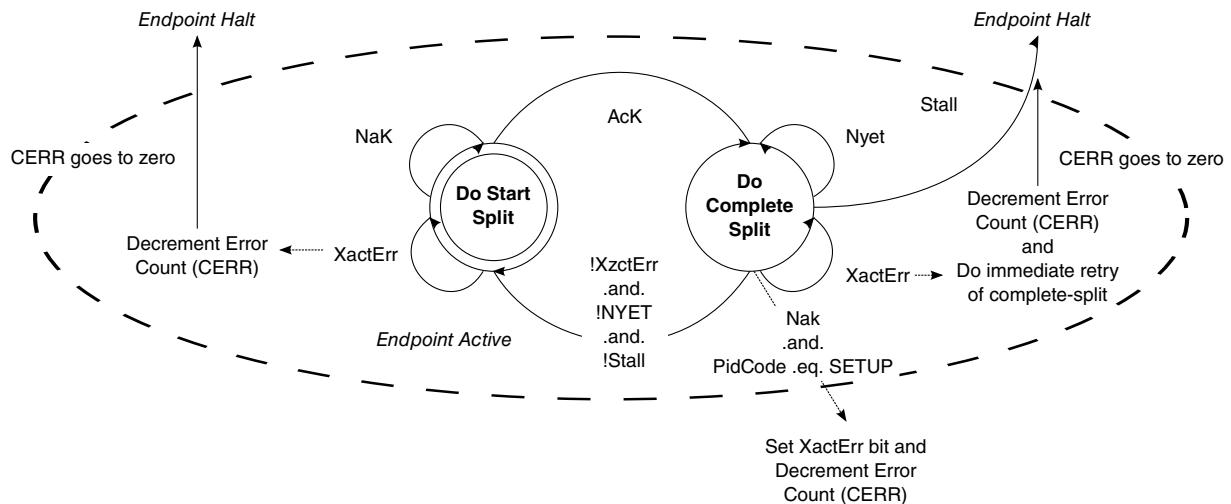

Figure 56-19. Host Controller Asynchronous Schedule Split-Transaction State Machine

56.4.3.12.1.1 Asynchronous - Do Start Split

This is the state which software must initialize a full- or low-speed asynchronous queue head. This state is entered from the Do Complete Split state only after a complete-split transaction receives a valid response from the transaction translator that is not a Nyet handshake.

For queue heads in this state, the host controller executes a start-split transaction to the appropriate transaction translator. If the bus transaction completes without an error and *PidCode* indicates an IN or OUT transaction, then the host controller reloads the error counter (*CErr*). If it is a successful bus transaction and the *PidCode* indicates a SETUP, the host controller does not reload the error counter. If the transaction translator responds with a Nak, the queue head is left in this state, and the host controller proceeds to the next queue head in the asynchronous schedule.

If the host controller times out the transaction (no response, or bad response) the host controller decrements *Cerr* and proceeds to the next queue head in the asynchronous schedule.

56.4.3.12.1.2 Asynchronous - Do Complete Split

This state is entered from the Do Start Split state only after a start-split transaction receives an Ack handshake from the transaction translator.

For queue heads in this state, the host controller executes a complete-split transaction to the appropriate transaction translator. If the transaction translator responds with a Nyet handshake, the queue head is left in this state, the error counter is reset and the host controller proceeds to the next queue head in the asynchronous schedule. When a Nyet handshake is received for a bus transaction where the queue head's *PidCode* indicates an IN or OUT, the host controller reloads the error counter (*CErr*). When a Nyet handshake is received for a complete-split bus transaction where the queue head's *PidCode* indicates a SETUP, the host controller must not adjust the value of *CErr*.

Independent of *PIDCode*, the following responses have the effects:

- Transaction Error (XactErr). Timeout or data CRC failure, and so on. The error counter (*Cerr*) is decremented by one and the complete split transaction is *immediately* retried (if possible). If there is not enough time in the micro-frame to execute the retry, the host controller **MUST** ensure that the next time the host controller begins executing from the Asynchronous schedule, it must begin executing from this queue head. If another start-split (for some other endpoint) is sent to the transaction translator before the complete-split is really completed, the transaction translator could dump the results (which were never delivered to the host). This is why the core specification states the retries must be immediate. A method to

accomplish this behavior is to not advance the asynchronous schedule. When the host controller returns to the asynchronous schedule in the next micro-frame, the first transaction from the schedule is the retry for this endpoint.

If *Cerr* went to zero, the host controller must halt the queue.

- **NAK.** The target endpoint Nak'd the full- or low-speed transaction. The state of the transfer is not advanced and the state is exited. If the *PidCode* is a SETUP, then the Nak response is a protocol error. The *XactErr* status bit is set to one and the *CErr* field is decremented.
- **STALL.** The target endpoint responded with a STALL handshake. The host controller sets the *halt* bit in the status byte, retires the qTD but does not attempt to advance the queue.

If the *PidCode* indicates an IN, then any of following responses are expected:

- **DATA0/1.** On reception of data, the host controller ensures the PID matches the expected data toggle and checks CRC. If the packet is *good*, the host controller advances the state of the transfer, for example move the data pointer by the number of bytes received, decrement *BytesToTransfer* field by the number of bytes received, and toggle the *dt* bit. The host controller then exit this state. The response and advancement of transfer may trigger other processing events, such as retirement of the qTD and advancement of the queue.

If the data sequence PID does not match the expected, the data is ignored, the transfer state is not advanced and this state is exited. If the *PidCode* indicates an OUT/SETUP, then any of following responses are expected:

- **ACK.** The target endpoint accepted the data, so the host controller must advance the state of the transfer. The *Current Offset* field is incremented by *Maximum Packet Length* or *Bytes to Transfer*, whichever is less. The field *Bytes To Transfer* is decremented by the same amount and the data toggle bit (*dt*) is toggled. The host controller then exit this state.
- Advancing the transfer state may cause other processing events such as retirement of the qTD and advancement of the queue (see [Managing Control/Bulk/Interrupt Transfers through Queue Heads](#)).

56.4.3.12.2 Split Transaction Interrupt

Split-transaction Interrupt-IN/OUT endpoints are managed through the same data structures used for high-speed interrupt endpoints. They both co-exist in the periodic schedule.

Queue heads/qTDs offer the set of features required for reliable data delivery, which is characteristic to interrupt transfer types. The split-transaction protocol is managed completely within this defined functional transfer framework. For example, for a high-speed endpoint, the host controller visits a queue head, execute a high-speed transaction (if criteria are met) and advance the transfer state (or not) depending on the results of the entire transaction. For low- and full-speed endpoints, the details of the *execution* phase are different (that is takes more than one bus transaction to complete), but the remainder of the operational framework is intact. This means that the transfer advancement, and so on, occurs as defined in [Managing Control/Bulk/Interrupt Transfers through Queue Heads](#), but only occurs on the completion of a split transaction.

56.4.3.12.2.1 Split Transaction Scheduling Mechanisms for Interrupt

Full- and low-speed Interrupt queue heads have an *EPS* field indicating full- or low-speed and have a non-zero *S-mask* field.

The host controller can detect this combination of parameters and assume the endpoint is a periodic endpoint. Low- and full-speed interrupt queue heads require the use of the split transaction protocol. The host controller sets the Endpoint Type (ET) field in the split token to indicate the transaction is an interrupt. These transactions are managed through a transaction translator's periodic pipeline. Software should not set these fields to indicate the queue head is an interrupt unless the queue head is used in the periodic schedule.

System software manages the per/transaction translator periodic pipeline by budgeting and scheduling exactly during which micro-frames the start-splits and complete-splits for each endpoint occurs. The characteristics of the transaction translator are such that the high-speed transaction protocol must execute during explicit micro-frames, or the data or response information in the pipeline is lost.

The following figure illustrates the general scheduling boundary conditions that are supported by the EHCI periodic schedule and queue head data structure. The S and ^CX labels indicate micro-frames where software can schedule start-splits and complete splits (respectively).

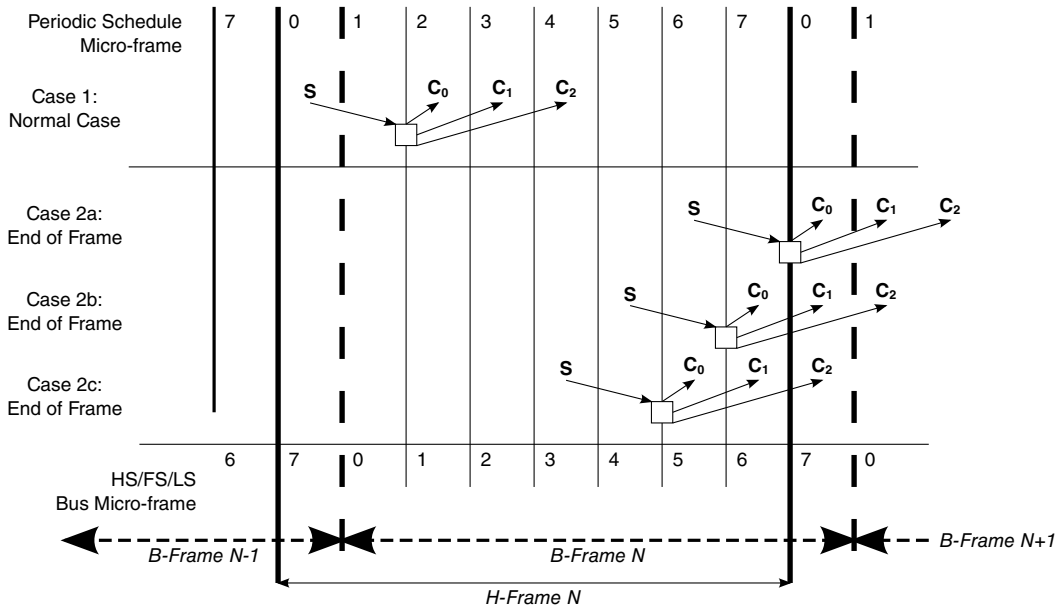

Figure 56-20. Split Transaction, Interrupt Scheduling Boundary Conditions

The scheduling cases are:

- Case 1: The normal scheduling case is where the entire split transaction is completely bounded by a frame (*H-Frame* in this case).
- Case 2a through Case 2c: The USB 2.0 Hub pipeline rules states clearly, when and how many complete-splits must be scheduled to account for earliest to latest execution on the full/low-speed link. The complete-splits may span the *H-Frame* boundary when the start-split is in micro-frame 4 or later. When this occurs, the *H-Frame* to *B-Frame* alignment requires that the queue head be reachable from consecutive periodic frame list locations. System software cannot build an efficient schedule that satisfies this requirement unless it uses FSTNs.

The figure below illustrates the general layout of the periodic schedule.

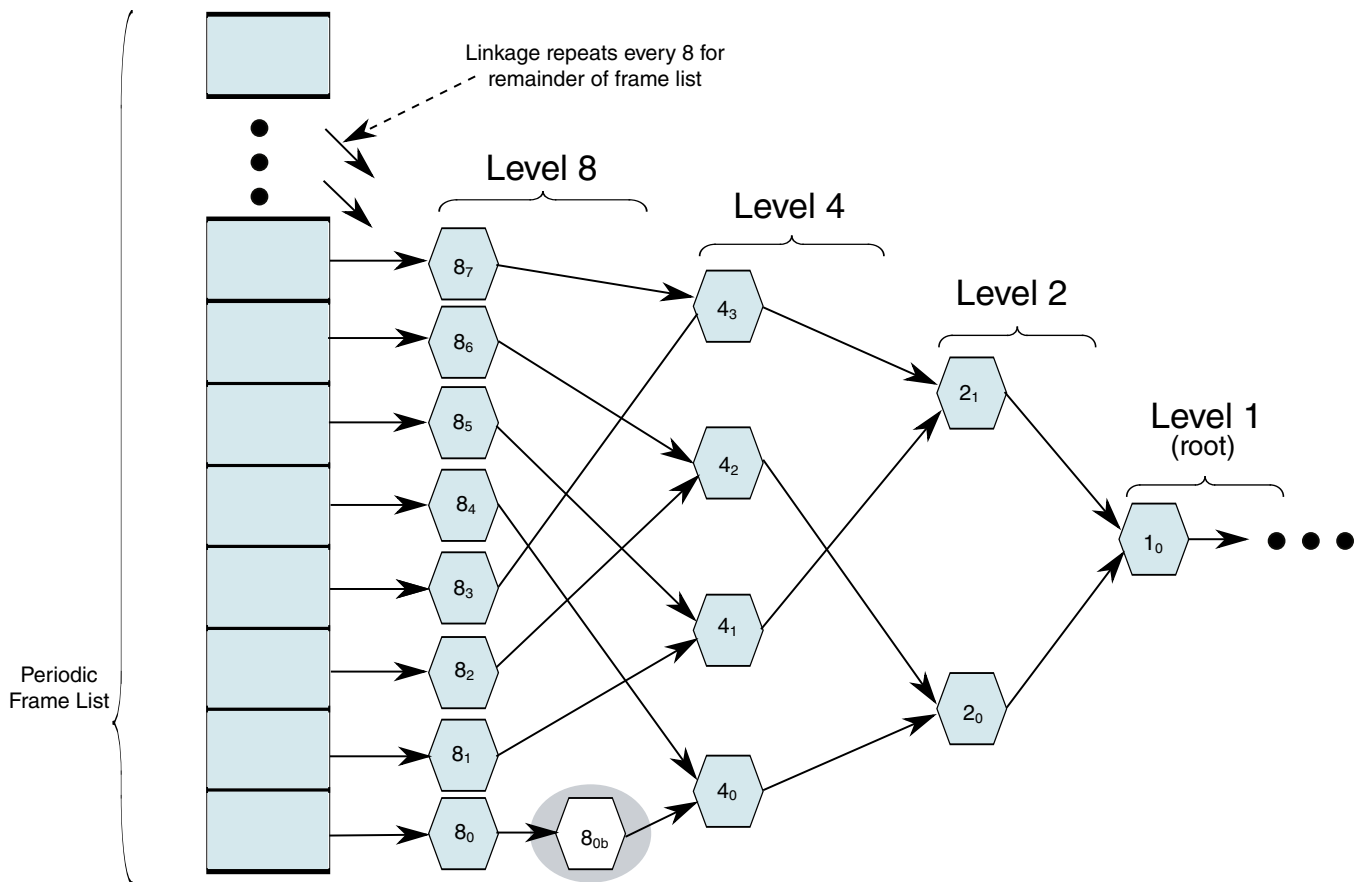

Figure 56-21. General Structure of EHCI Periodic Schedule Utilizing Interrupt Spreading

The periodic frame list is effectively the leaf level a binary tree, which is always traversed leaf to root. Each level in the tree corresponds to a 2^N poll rate. Software can efficiently manage periodic bandwidth on the USB by *spreading* interrupt queue heads that have the same poll rate requirement across all the available paths from the frame list. For example, system software can schedule eight poll rate 8 queue heads and account for them once in the high-speed bus bandwidth allocation.

When an endpoint is allocated an execution footprint that spans a frame boundary, the queue head for the endpoint must be reachable from consecutive locations in the frame list. An example would be if 8_{0b} where such an endpoint. Without additional support on the interface, to get 8_{0b} reachable at the correct time, software would have to link 8_1 to 8_{0b} . It would then have to move 4_1 and everything linked after into the same path as 4_0 . This upsets the integrity of the binary tree and disallows the use of the spreading technique.

FSTN data structures are used to preserve the integrity of the binary-tree structure and enable the use of the spreading technique. [Host Controller Operational Model for FSTNs](#) defines the hardware and software operational model requirements for using FSTNs.

The following queue head fields are initialized by system software to instruct the host controller when to execute portions of the split-transaction protocol:

- *SplitXState*. This is single bit residing in the *Status* field of a queue head (see [Table 56-23](#)). This bit is used to track the current state of the split transaction.
- *Frame S-mask*. This is a bit-field where-in system software sets a bit corresponding to the micro-frame (within an *H-Frame*) that the host controller should execute a start-split transaction. This is always qualified by the value of the *SplitXState* bit in the *Status* field of the queue head. For example, referring to [Figure 56-20](#), case one, the *S-mask* would have a value of 00000001b indicating that if the queue head is traversed by the host controller, and the *SplitXState* indicates Do_Start, and the current micro-frame as indicated by FRINDEX[2:0] is 0, then execute a start-split transaction.
- *Frame C-mask*. This is a bit-field where system software sets one or more bits corresponding to the micro-frames (within an *H-Frame*) that the host controller should execute complete-split transactions. The interpretation of this field is always qualified by the value of the *SplitXState* bit in the *Status* field of the queue head. For example, referring to [Figure 56-20](#), case one, the *C-mask* would have a value of 00011100b indicating that if the queue head is traversed by the host controller, and the *SplitXState* indicates Do_Complete, and the current micro-frame as indicated by FRINDEX[2:0] is 2, 3, or 4, then execute a complete-split transaction. It is software's responsibility to ensure that the translation between *H-Frames* and *B-Frames* is correctly performed when setting bits in *S-mask* and *C-mask*

56.4.3.12.2.2 Host Controller Operational Model for FSTNs

The FSTN data structure is used to manage Low/Full-speed interrupt queue heads that need to be reached from consecutive frame list locations (that is boundary cases 2a through 2c).

An FSTN is essentially a *back pointer*, similar in intent to the back pointer field in the siTD data structure (see [siTD Back Link Pointer](#)).

This feature provides software a simple primitive to save a schedule position, redirect the host controller to traverse the necessary queue heads in the previous frame, then restore the original schedule position and complete normal traversal.

The four components to the use of FSTNs:

- FSTN data structure.
- A *Save Place* indicator. This is always an FSTN with its *Back Path Link Pointer.T-bit* set to zero.

- A *Restore* indicator. This is always an FSTN with its *Back Path Link Pointer.T-bit* set to one.
- Host controller FSTN traversal rules.

When the host controller encounters an FSTN during micro-frames 2 through 7 it simply follows the node's *Normal Path Link Pointer* to access the next schedule data structure.

NOTE

The FSTN's *Normal Path Link Pointer.T-bit* may set to one, which the host controller must interpret as the end of periodic list mark.

When the host controller encounters a *Save-Place* FSTN in micro-frames 0 or 1, it saves the value of the *Normal Path Link Pointer* and set an internal flag indicating that it is executing in *Recovery Path* mode. *Recovery Path* mode modifies the host controller's rules for how it traverses the schedule and limits which data structures is considered for execution of bus transactions. The host controller continues executing in *Recovery Path* mode until it encounters a *Restore* FSTN or it determines that it has reached the end of the micro-frame (see details in the list below).

The rules for schedule traversal and limited execution while in *Recovery Path* mode are:

- Always follow the *Normal Path Link Pointer* when it encounters an FSTN that is a *Save-Place* indicator. The host controller must not recursively follow *Save-Place* FSTNs. Therefore, while executing in *Recovery Path* mode, it must never follow an FSTN's *Back Path Link Pointer*.
- Do not process an siTD or, iTD data structure. Simply follow its *Next Link Pointer*.
- Do not process a QH (Queue Head) whose *EPS* field indicates a high-speed device. Simply follow its *Horizontal Link Pointer*.
- When a QH's *EPS* field indicates a Full/Low-speed device, the host controller considers only it for execution if its *SplitXState* is DoComplete (note: this applies whether the *PID Code* indicates an IN or an OUT). See [Execute Transaction](#) and [Tracking Split Transaction Progress for Interrupt Transfers](#) for a complete list of additional conditions that must be met in general for the host controller to issue a bus transaction.
 - The host controller must not execute a Start-split transaction while executing in *Recovery Path* mode. See [Periodic Isochronous - Do Complete Split](#) for special handling when in *Recovery Path* mode.
- Stop traversing the *recovery path* when it encounters an FSTN that is a *Restore* indicator. The host controller unconditionally uses the saved value of the *Save-Place* FSTN's *Normal Path Link Pointer* when returning to the normal path traversal. The

host controller must clear the context of executing a *Recovery Path* when it restores schedule traversal to the *Save-Place* FSTN's *Normal Path Link Pointer*.

- If the host controller determines that there is not enough time left in the micro-frame to complete processing of the periodic schedule, it abandons traversal of the recovery path, and clears the context of executing a recovery path. The result is that at the start of the next consecutive micro-frame, the host controller starts traversal at the frame list.

An example traversal of a periodic schedule that includes FSTNs is illustrated in the following figure.

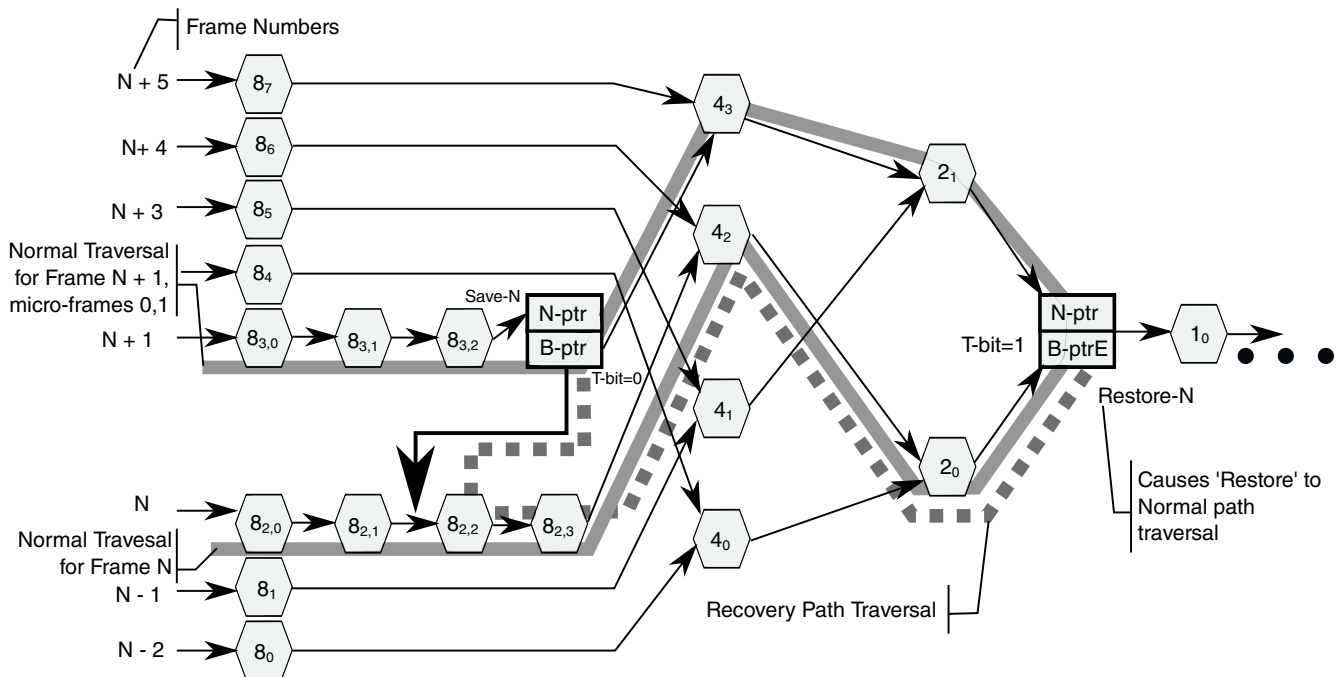

Figure 56-22. Example Host Controller Traversal of Recovery Path via FSTNs

In frame N+1 (micro-frames 0 and 1), when the host controller encounters Save-Path FSTN (Save-N), it observes that Save-N.Back Path Link Pointer.T-bit is zero (definition of a Save-Path indicator). The host controller saves the value of Save-N.Normal Path Link Pointer and follows Save-N.Back Path Link Pointer. At the same time, it sets an internal flag indicating that it is now in *Recovery Path* mode (the recovery path is annotated in the figure above with a large dashed line). The host controller continues traversing data structures on the recovery path and executing only those bus transactions as noted above, on the recovery path until it reaches Restore FSTN (Restore-N). Restore-N.Back Path Link Pointer.T-bit is set to one (definition of a Restore indicator), so the host controller exits *Recovery Path* mode by clearing the internal *Recovery Path* mode flag and commences (restores) schedule traversal using the saved value of the *Save-Place* FSTN's *Normal Path Link Pointer* (for example Save-N.Normal Path Link Pointer). The nodes traversed during these micro-frames include: {83,0, 83,1, 83,2, Save-A, 82,2, 82,3, 42,

2_0 , Restore-N, 4_3 , 2_1 , Restore-N, $1_0 \dots$ }. The nodes on the recovery-path are in bold. In frame N (micro-frames 0-7), for this example, the host controller traverses all of the schedule data structures utilizing the *Normal Path Link Pointers* in any FSTNs it encounters. This is because the host controller has not yet encountered a *Save-Place* FSTN so it not executing in *Recovery Path* mode. When it encounters the *Restore* FSTN, (Restore-N), during micro-frames 0 and 1, it uses Restore-N.Normal Path Link Pointer to traverse to the next data structure (that is normal schedule traversal). This is because the host controller must use a Restore FSTN's *Normal Path Link Pointer* when not executing in a *Recovery-Path* mode. The nodes traversed during frame N include: $\{8_{2,0}$, $8_{2,1}$, $8_{2,2}$, $8_{2,3}$, 4_2 , 2_0 , Restore-N, $1_0 \dots$ }.

In frame N+1 (micro-frames 2-7), when the host controller encounters Save-Path FSTN Save-N, it unconditionally follows Save-N.Normal Path Link Pointer. The nodes traversed during these micro-frames include: $\{8_{3,0}$, $8_{3,1}$, $8_{3,2}$, Save-A, 4_3 , 2_1 , Restore-N, $1_0 \dots$ }.

56.4.3.12.2.3 Software Operational Model for FSTNs

Software must create a consistent, coherent schedule for the host controller to traverse.

When using FSTNs, system software must adhere to the following rules:

- Each *Save-Place* indicator requires a matching *Restore* indicator.
 - The *Save-Place* indicator is an FSTN with a valid *Back Path Link Pointer* and *T-bit* equal to zero.
 - *Back Path Link Pointer.Type* field must be set to indicate the referenced data structure is a queue head. The *Restore* indicator is an FSTN with its *Back Path Link Pointer.T-bit* set to one.
 - A *Restore* FSTN may be matched to one or more *Save-Place* FSTNs. For example, if the schedule includes a poll-rate 1 level, then system software only needs to place a *Restore* FSTN at the beginning of this list in order to match all possible *Save-Place* FSTNs.
- If the schedule does not have elements linked at a poll-rate level of one, and one or more *Save-Place* FSTNs are used, then System Software must ensure the *Restore* FSTN's *Normal Path Link Pointer's T-bit* is set to one, as this is used to mark the end of the periodic list.
- When the schedule does have elements linked at a poll rate level of one, a *Restore* FSTN must be the first data structure on the poll rate one list. All traversal paths from the frame list converge on the poll-rate one list. System software must ensure that *Recovery Path* mode is exited before the host controller is allowed to traverse the poll rate level one list.
- A *Save-Place* FSTN's *Back Path Link Pointer* must reference a queue head data structure. The referenced queue head must be reachable from the previous frame list

location. In other words, if the *Save-Place* FSTN is reachable from frame list offset N, then the FSTN's *Back Path Link Pointer* must reference a queue head that is reachable from frame list offset N-1.

Software should make the schedule as efficient as possible. What this means in this context is that software should have no more than one *Save-Place* FSTN reachable in any single frame. Note there is times when two (or more, depending on the implementation) could exist as full/low-speed footprints change with bandwidth adjustments. This could occur, for example when a bandwidth re-balance causes system software to move the *Save-Place* FSTN from one poll rate level to another. During the transition, software must preserve the integrity of the previous schedule until the new schedule is in place.

56.4.3.12.2.4 Tracking Split Transaction Progress for Interrupt Transfers

To correctly maintain the data stream, the host controller must be able to detect and report errors where data is lost.

For interrupt-IN transfers, data is lost when it makes it into the USB 2.0 hub, but the USB 2.0 host system is unable to get it from the USB 2.0 Hub and into the system before it expires from the transaction translator pipeline.

When a lost data condition is detected, the queue must be halted, thus signaling system software to recover from the error. A data-loss condition exists whenever a start-split is issued, accepted and successfully executed by the USB 2.0 Hub, but the complete-splits get unrecoverable errors on the high-speed link, or the complete-splits do not occur at the correct times. One reason complete-splits might not occur at the right time would be due to host-induced system hold-offs that cause the host controller to miss bus transactions because it cannot get timely access to the schedule in system memory.

The same condition can occur for an interrupt-OUT, but the result is not an endpoint halt condition, but rather effects only the progress of the transfer. The queue head has the following fields to track the progress of each split transaction. These fields are used to keep incremental state about which (and when) portions have been executed.

- *C-prog-mask*. This is an eight-bit bit-vector where the host controller keeps track of which complete-splits have been executed. Due to the nature of the Transaction Translator periodic pipeline, the complete-splits need to be executed in-order. The host controller needs to detect when the complete-splits have not been executed in order. This can only occur due to system hold-offs where the host controller cannot get to the memory-based schedule. *C-prog-mask* is a simple bit-vector that the host controller sets one of the *C-prog-mask* bits for each complete-split executed. The bit position is determined by the micro-frame number in which the complete-split was executed. The host controller always checks *C-prog-mask* before executing a

complete-split transaction. If the previous complete-splits have not been executed then it means one (or more) have been skipped and data has potentially been lost.

- *FrameTag*. This field is used by the host controller during the complete-split portion of the split transaction to tag the queue head with the frame number (*H-Frame* number) when the next complete split must be executed.
- *S-bytes*. This field can be used to store the number of data payload bytes sent during the start-split (if the transaction was an OUT). The *S-bytes* field must be used to accumulate the data payload bytes received during the complete-splits (for an IN).

56.4.3.12.2.5 Split Transaction Execution State Machine for Interrupt

In the following presentation, all references to micro-frame are in the context of a micro-frame within an *H-Frame*.

As with asynchronous Full- and Low-speed endpoints, a split-transaction state machine is used to manage the split transaction sequence.

Aside from the fields defined in the queue head for scheduling and tracking the split transaction, the host controller calculates one internal mechanism that is also used to manage the split transaction. The internal calculated mechanism is:

- *cMicroFrameBit* is a single-bit encoding of the current micro-frame number. It is an eight-bit value calculated by the host controller at the beginning of every micro-frame. It is calculated from the three least significant bits of the *FRINDEX* register (that is, $cMicroFrameBit = (1 \text{ shifted-left}(FRINDEX[2:0]))$). The *cMicroFrameBit* has at most one bit asserted, which always corresponds to the current micro-frame number. For example, if the current micro-frame is 0, then *cMicroFrameBit* will equal 00000001b. The variable *cMicroFrameBit* is used to compare against the *S-mask* and *C-mask* fields to determine whether the queue head is marked for a start- or complete-split transaction for the current micro-frame.

The following figure illustrates the state machine for managing a complete interrupt split transaction. There are two phases to each split transaction. The first is a single start-split transaction, which occurs when the *SplitXState* is at *Do_Start* and the single bit in *cMicroFrameBit* has a corresponding bit active in *QH.S-mask*. The transaction translator does not acknowledge the receipt of the periodic start-split, so the host controller unconditionally transitions the state to *Do_Complete*. Due to the available jitter in the transaction translator pipeline, there will be more than one complete-split transaction scheduled by software for the *Do_Complete* state. This translates simply to the fact that there are multiple bits set to a one in the *QH.C-mask* field.

The host controller keeps the queue head in the *Do_Complete* state until the split transaction is complete (see definition below), or an error condition triggers the *three-strikes-rule* (for example, after the host tries the same transaction three times, and each

encounters an error, the host controller will stop retrying the bus transaction and halt the endpoint, thus requiring system software to detect the condition and perform system-dependent recovery).

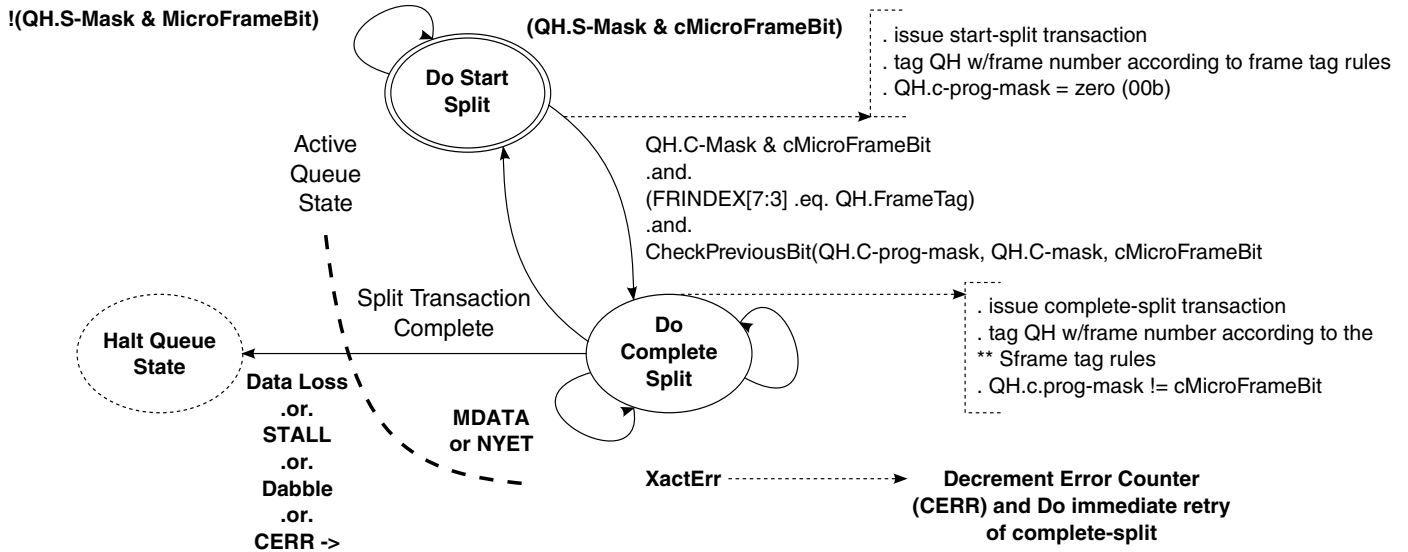

Figure 56-23. Split Transaction State Machine for Interrupt

See Previous Section for the frame tag management rules.

Periodic Interrupt - Do Start Split

This is the state software must initialize a full- or low-speed interrupt queue head *StartXState* bit. This state is entered from the Do_Complete Split state only after the split transaction is complete. This occurs when one of the following events occur: The transaction translator responds to a complete-split transaction with one of the following:

- NAK. A NAK response is a propagation of the full- or low-speed endpoint's NAK response.
- ACK. An ACK response is a propagation of the full- or low-speed endpoint's ACK response. Only occurs on an OUT endpoint.
- DATA 0/1. Only occurs for INs. Indicates that this is the last of the data from the endpoint for this split transaction.
- ERR. The transaction on the low-/full-speed link below the transaction translator had a failure (for example, timeout, bad CRC, etc.).
- NYET (and Last). The host controller issued the last complete-split and the transaction translator responded with a NYET handshake. This means that the start-split was not correctly received by the transaction translator, so it never executed a transaction to the full- or low-speed endpoint, see Section [Periodic Isochronous - Do Complete Split](#) for the definition of 'Last'.

Each time the host controller visits a queue head in this state (once within the Execute Transaction state), it performs the following test to determine whether to execute a start-split.

- *QH.S-mask* is bit-wise anded with *cMicroFrameBit*.

If the result is non-zero, then the host controller will issue a start-split transaction. If the *PIDCode* field indicates an IN transaction, the host controller must zero-out the *QH.S-bytes* field. After the split-transaction has been executed, the host controller sets up state in the queue head to track the progress of the complete-split phase of the split transaction. Specifically, it records the expected frame number into *QH.FrameTag* field (see Section), set *C-prog-mask* to zero (00h), and exits this state. Note that the host controller must not adjust the value of *CErr* as a result of completion of a start-split transaction.

Periodic Interrupt - Do Complete Split

This state is entered unconditionally from the Do Start Split state after a start-split transaction is executed on the bus. Each time the host controller visits a queue head in this state (once within the Execute Transaction state), it checks to determine whether a complete-split transaction should be executed now.

There are four tests to determine whether a complete-split transaction should be executed.

- Test A. *cMicroFrameBit* is bit-wise anded with *QH.C-mask* field. A non-zero result indicates that software scheduled a complete-split for this endpoint, during this micro-frame.
- Test B. *QH.FrameTag* is compared with the current contents of *FRINDEX[7:3]*. An equal indicates a match.
- Test C. The complete-split progress bit vector is checked to determine whether the previous bit is set, indicating that the previous complete-split was appropriately executed. An example algorithm for this test is provided below:

```
Algorithm Boolean CheckPreviousBit(QH.C-prog-mask, QH.C-mask, cMicroFrameBit)
Begin
-- Return values:
-- TRUE - no error
-- FALSE - error
--
Boolean rvalue = TRUE;
previousBit = cMicroframeBit logical-rotate-right(1)
-- Bit-wise anding previousBit with C-mask indicates
-- whether there was an intent
-- to send a complete split in the previous micro-frame. So,
-- if the
-- 'previous bit' is set in C-mask, check C-prog-mask to
-- make sure it
-- happened.
If (previousBit bitAND QH.C-mask) then
    If not(previousBit bitAND QH.C-prog-mask) then
        rvalue = FALSE;
    End if
End If
-- If the C-prog-mask already has a one in this bit position,
```

USB Operation Model

```
-- then an aliasing
-- error has occurred. It will probably get caught by the
-- FrameTag Test, but
-- at any rate it is an error condition that as detectable here
-- should not allow
-- a transaction to be executed.
If (cMicroFrameBit bitAND QH.C-prog-mask) then
  rvalue = FALSE;
End if
return (rvalue)
End Algorithm
```

- Test D. Check to see if a start-split should be executed in this micro-frame. Note this is the same test performed in the Do Start Split state (see Section [Periodic Isochronous - Do Start Split](#)). Whenever it evaluates to TRUE and the controller is NOT processing in the context of a *Recovery Path* mode, it means a start-split should occur in this micro-frame. Test D and Test A evaluating to TRUE at the same time is a system software error. Behavior is undefined.

If (A .and. B .and. C .and. not(D)) then the host controller will execute a complete-split transaction. When the host controller commits to executing the complete-split transaction, it updates *QH.C-prog-mask* by bit-ORing with *cMicroFrameBit*. On completion of the complete-split transaction, the host controller records the result of the transaction in the queue head and sets *QH.FrameTag* to the expected *H-Frame* number (see Section). The effect to the state of the queue head and thus the state of the transfer depends on the response by the transaction translator to the complete-split transaction. The following responses have the effects (note that any responses that result in decrementing of the *CErr* will result in the queue head being halted by the host controller if the result of the decrement is zero):

- NYET (and Last). On each NYET response, the host controller checks to determine whether this is the last complete-split for this split transaction. Last is defined in this context as the condition where all of the scheduled complete-splits have been executed. If it is the last complete-split (with a NYET response), then the transfer state of the queue head is not advanced (never received any data) and this state exited. The transaction translator must have responded to all the complete-splits with NYETs, meaning that the start-split issued by the host controller was not received. The start-split should be retried at the next poll period.
- The test for whether this is the Last complete split can be performed by XOR *QH.C-mask* with *QH.C-prog-mask*. If the result is all zeros then all complete-splits have been executed. When this condition occurs, the *XactErr* status bit is set to a one and the *CErr* field is decremented.
- NYET (and not Last). See above description for testing for Last. The complete-split transaction received a NYET response from the transaction translator. Do not update any transfer state (except for *C-prog-mask* and *FrameTag*) and stay in this state. The host controller must not adjust *CErr* on this response.

- Transaction Error (XactErr). Timeout, data CRC failure, etc. The *CErr* field is decremented and the *XactErr* bit in the *Status* field is set to a one. The complete split transaction is *immediately* retried (if *CErr* is non-zero). If there is not enough time in the micro-frame to complete the retry and the endpoint is an IN, or *CErr* is decremented to a zero from a one, the queue is halted. If there is not enough time in the micro-frame to complete the retry and the endpoint is an OUT and *CErr* is not zero, then this state is exited (that is, return to Do Start Split). This results in a retry of the entire OUT split transaction, at the next poll period. Refer to Chapter 11 Hubs (specifically the section full- and low-speed Interrupts) in the USB Specification Revision 2.0 for detailed requirements on why these errors must be immediately retried.
- ACK. This can only occur if the target endpoint is an OUT. The target endpoint ACK'd the data and this response is a propagation of the endpoint ACK up to the host controller. The host controller must advance the state of the transfer. The *Current Offset* field is incremented by *Maximum Packet Length* or *Bytes to Transfer*, whichever is less. The field *Bytes To Transfer* is decremented by the same amount. And the data toggle bit (*dt*) is toggled. The host controller will then exit this state for this queue head. The host controller must reload *CErr* with maximum value on this response. Advancing the transfer state may cause other process events such as retirement of the qTD and advancement of the queue (see Section [Managing Control/Bulk/Interrupt Transfers through Queue Heads](#)).
- MDATA. This response will only occur for an IN endpoint. The transaction translator responded with zero or more bytes of data and an MDATA PID. The incremental number of bytes received is accumulated in *QH.S-bytes*. The host controller must not adjust *CErr* on this response.
- DATA0/1. This response may only occur for an IN endpoint. The number of bytes received is added to the accumulated byte count in *QH.S-bytes*. The state of the transfer is advanced by the result and the host controller will exit this state for this queue head.
- Advancing the transfer state may cause other processing events such as retirement of the qTD and advancement of the queue (see Section [Managing Control/Bulk/Interrupt Transfers through Queue Heads](#)).
- If the data sequence PID does not match the expected, the entirety of the data received in this split transaction is ignored, the transfer state is not advanced and this state is exited.
- NAK. The target endpoint Nak'd the full- or low-speed transaction. The state of the transfer is not advanced, and this state is exited. The host controller must reload *CErr* with maximum value on this response.

- **ERR.** There was an error during the full- or low-speed transaction. The ERR status bit is set to a one, *Cerr* is decremented, the state of the transfer is not advanced, and this state is exited.
- **STALL.** The queue is halted (an exit condition of the Execute Transaction state). The status field bits: *Active* bit is set to zero and the *Halted* bit is set to a one and the qTD is retired. Responses which are not enumerated in the list or which are received out of sequence are illegal and may result in undefined host controller behavior. The other possible combinations of tests A, B, C, and D may indicate that data or response was lost. The table below lists the possible combinations and the appropriate action.

Table 56-47. Interrupt IN/OUT Do Complete Split State Execution Criteria

Condition	Action	Description
not(A) not(D)	Ignore QHD	Neither a start nor complete-split is scheduled for the current micro-frame. Host controller should continue walking the schedule.
A not(C)	If <i>PIDCode</i> = IN Halt QHD If <i>PIDCode</i> = OUT Retry start-split	Progress bit check failed. These means a complete-split has been missed. There is the possibility of lost data. If <i>PIDCode</i> is an IN, then the Queue head must be halted. If <i>PIDCode</i> is an OUT, then the transfer state is not advanced and the state exited (for example, start-split is retried). This is a host-induced error and does not effect <i>CERR</i> . In either case, set the <i>Missed Micro-frame</i> bit in the status field to a one.
A not(B) C	If <i>PIDCode</i> = IN Halt QHD If <i>PIDCode</i> = OUT Retry start-split	<i>QH.FrameTag</i> test failed. This means that exactly one or more <i>H-Frames</i> have been skipped. This means complete-splits and have missed. There is the possibility of lost data. If <i>PIDCode</i> is an IN, then the Queue head must be halted. If <i>PIDCode</i> is an OUT, then the transfer state is not advanced and the state exited (for example, start-split is retried). This is a host-induced error and does not effect <i>CERR</i> . In either case, set the <i>Missed Micro-frame</i> bit in the status field to a one.
A B C not(D)	Execute complete-split	This is the non-error case where the host controller executes a complete-split transaction.
D	If <i>PIDCode</i> = IN Halt QHD If <i>PIDCode</i> = OUT Retry start-split	This is a degenerate case where the start-split was issued, but all of the complete-splits were skipped and all possible intervening opportunities to detect the missed data failed to fire. If <i>PIDCode</i> is an IN, then the Queue head must be halted. If <i>PIDCode</i> is an OUT, then the transfer state is not advanced and the state exited (for example, start-split is retried). This is a host-induced error and does not effect <i>CERR</i> . In either case, set the <i>Missed Micro-frame</i> bit in the status field to a one. Note: When executing in the context of a <i>Recovery Path</i> mode, the host controller is allowed to process the queue head and take the actions indicated above, or it may wait until the queue head is visited in the

Table 56-47. Interrupt IN/OUT Do Complete Split State Execution Criteria

		normal processing mode. Regardless, the host controller must not execute a start-split in the context of a executing in a <i>Recovery Path</i> mode.
--	--	--

Managing QH.FrameTag Field

The *QH.FrameTag* field in a queue head is completely managed by the host controller. The rules for setting *QH.FrameTag* are simple:

- Rule 1: If transitioning from Do Start Split to Do Complete Split and the current value of *FRINDEX*[2:0] is 6 *QH.FrameTag* is set to *FRINDEX*[7:3] + 1. This accommodates split transactions whose start-split and complete-splits are in different *H-Frames* (case 2a, see [Figure 56-20](#)).
- Rule 2: If the current value of *FRINDEX*[2:0] is 7, *QH.FrameTag* is set to *FRINDEX*[7:3] + 1. This accommodates staying in Do Complete Split for cases 2a, 2b, and 2c ([Figure 56-20](#)).
- Rule 3: If transitioning from Do_Start Split to Do Complete Split and the current value of *FRINDEX*[2:0] is not 6, or currently in Do Complete Split and the current value of (*FRINDEX*[2:0]) is not 7, *FrameTag* is set to *FRINDEX*[7:3]. This accommodates all other cases ([Figure 56-20](#)).

56.4.3.12.2.6 Rebalancing the periodic schedule

System software must occasionally adjust a periodic queue head's S-mask and C-mask fields during operation.

This need occurs when adjustments to the periodic schedule create a new bandwidth budget and one or more queue head's are assigned new execution footprints (that is, new S-mask and C-mask values).

It is imperative that System software must not update these masks to new values in the midst of a split transaction. In order to avoid any race conditions with the update, the EHCI host controller provides a simple assist to system software. System software sets the *Inactivate-on-next-Transaction* (*I*) bit to a one to signal the host controller that it intends to update the S-mask and C-mask on this queue head. System software will then wait for the host controller to observe the *I-bit* is a one and transition the *Active* bit to a zero. The rules for how and when the host controller sets the *Active* bit to zero are enumerated below:

- If the *Active* bit is a zero, no action is taken. The host controller does not attempt to advance the queue when the *I-bit* is a one.
- If the *Active* bit is a one and the *SplitXState* is DoStart (regardless of the value of *S-mask*), the host controller will simply set *Active* bit to a zero. The host controller is

not required to write the transfer state back to the *current* qTD. Note that if the *S-mask* indicates that a start-split is scheduled for the current micro-frame, the host controller must not issue the start-split bus transaction. It must set the *Active* bit to zero.

System software must save transfer state before setting the *I-bit* to a one. This is required so that it can correctly determine what transfer progress (if any) occurred after the *I-bit* was set to a one and the host controller executed its final bus-transaction and set *Active* to a zero.

After system software has updated the S-mask and C-mask, it must then reactivate the queue head. Because the *Active* bit and the *I-bit* cannot be updated with the same write, system software needs to use the following algorithm to coherently re-activate a queue head that has been stopped via the *I-bit*.

1. Set the *Halted* bit to a one, then
2. Set the *I-bit* to a zero, then
3. Set the *Active* bit to a one and the *Halted* bit to a zero in the same write.

Setting the *Halted* bit to a one inhibits the host controller from attempting to advance the queue between the time the *I-bit* goes to a zero and the *Active* bit goes to a one.

56.4.3.12.3 Split Transaction Isochronous

Full-speed isochronous transfers are managed using the split-transaction protocol through a USB 2.0 transaction translator in a USB2.0 Hub. The EHCI controller utilizes siTD data structure to support the special requirements of isochronous split-transactions.

This data structure uses the scheduling model of isochronous TDs (iTd, Section [Isochronous \(High-Speed\) Transfer Descriptor \(iTd\)](#)) (see Section [Managing Isochronous Transfers Using iTDs](#) for the operational model of iTDs) with the contiguous data feature provided by queue heads. This simple arrangement allows a single isochronous scheduling model and adds the additional feature that all data received from the endpoint (per split transaction) must land into a contiguous buffer.

56.4.3.12.3.1 Split Transaction Scheduling Mechanisms for Isochronous

Full-speed isochronous transactions are managed through a transaction translator's periodic pipeline. As with full- and low-speed interrupt, system software manages each transaction translator's periodic pipeline by budgeting and scheduling exactly during which micro-frames the start-splits and complete-splits for each full-speed isochronous endpoint occur.

The requirements described in Section [Split Transaction Scheduling Mechanisms for Interrupt](#) apply. The following figure illustrates the general scheduling boundary conditions that are supported by the EHCI periodic schedule. The ^SX and ^CX labels indicate micro-frames where software can schedule start- and complete-splits (respectively). The *H-Frame* boundaries are marked with a large, solid bold vertical line. The *B-Frame* boundaries are marked with a large, bold, dashed line. The bottom of the figure illustrates the relationship of an siTD to the *H-Frame*.

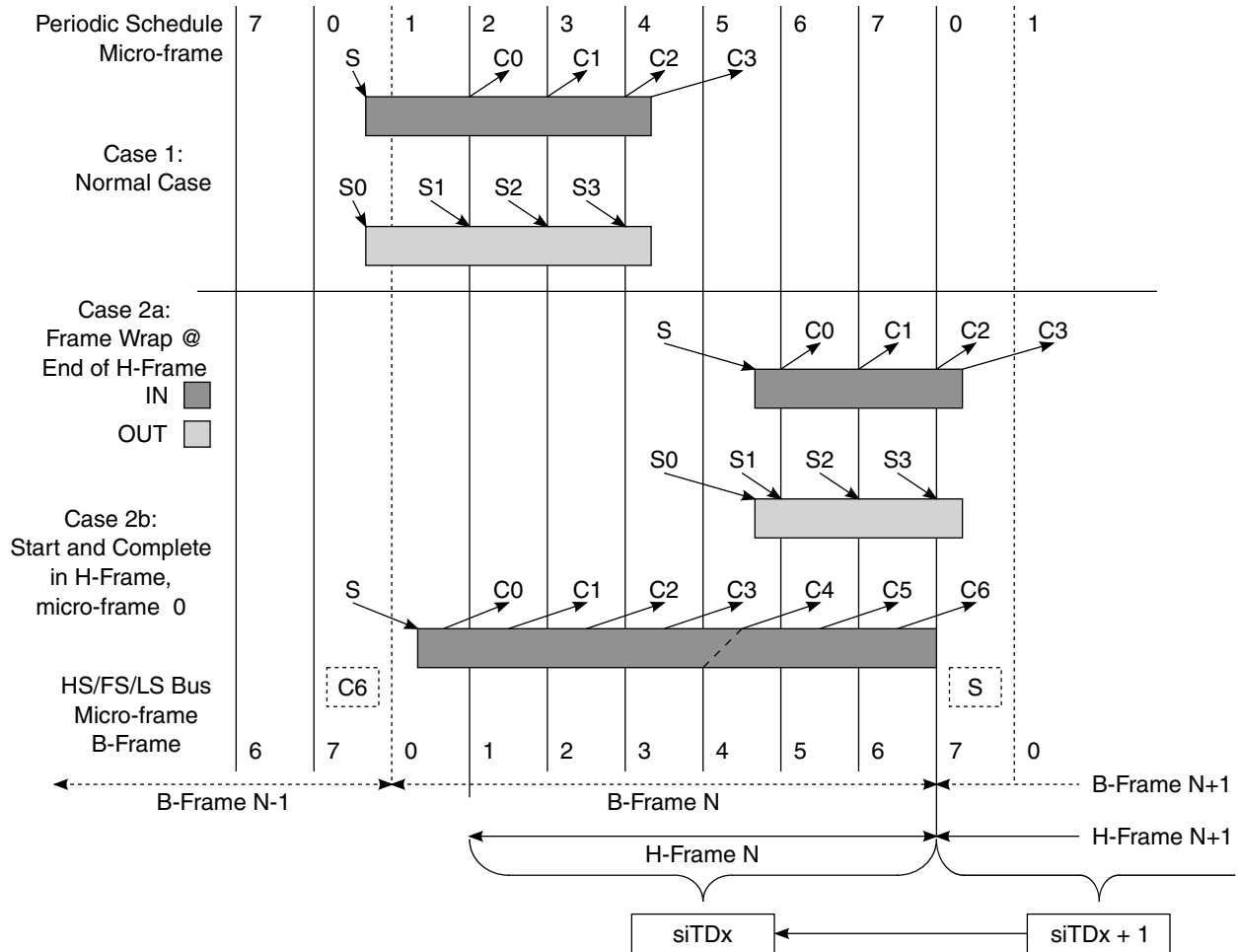

Figure 56-24. Split Transaction, Isochronous Scheduling Boundary Conditions

When the endpoint is an isochronous OUT, there are only start-splits, and no complete-splits. When the endpoint is an isochronous IN, there is at most one start-split and one to *N* complete-splits. The scheduling boundary cases are:

- *Case 1*: The entire split transaction is completely bounded by an *H-Frame*. For example: the start-splits and complete-splits are all scheduled to occur in the same *H-Frame*.

- *Case 2a*: This boundary case is where one or more (at most two) complete-splits of a split transaction IN are scheduled across an *H-Frame* boundary. This can only occur when the split transaction has the possibility of moving data in *B-Frame*, micro-frames 6 or 7 (*H-Frame* micro-frame 7 or 0). When an *H-Frame* boundary wrap condition occurs, the scheduling of the split transaction spans more than one location in the periodic list. (For example, it takes two siTDs in adjacent periodic frame list locations to fully describe the scheduling for the split transaction.)
- Although the scheduling of the split transaction may take two data structures, all of the complete-splits for each full-speed IN isochronous transaction must use only one data pointer. For this reason, siTDs contain a back pointer, the use of which is described below.
- Software must never schedule full-speed isochronous OUTs across an *H-Frame* boundary.
- *Case 2b*: This case can only occur for a very large isochronous IN. It is the only allowed scenario where a start-split and complete-split for the same endpoint can occur in the same micro-frame. Software must enforce this rule by scheduling the large transaction first. Large is defined to be anything larger than 579 byte maximum packet size.

A subset of the same mechanisms employed by full- and low-speed interrupt queue heads are employed in siTDs to schedule and track the portions of isochronous split transactions. The following fields are initialized by system software to instruct the host controller when to execute portions of the split transaction protocol.

- *SplitXState*. This is a single bit residing in the *Status* field of an siTD (see [Figure 56-25](#)). This bit is used to track the current state of the split transaction. The rules for managing this bit are described in [Section Split Transaction Execution State Machine for Interrupt](#).
- *Frame S-mask*. This is a bit-field where-in system software sets a bit corresponding to the micro-frame (within an *H-Frame*) that the host controller should execute a start-split transaction. This is always qualified by the value of the *SplitXState* bit. For example, referring to the IN example in [Figure 56-24](#), case one, the *S-mask* would have a value of 00000001b indicating that if the siTD is traversed by the host controller, and the *SplitXState* indicates Do Start Split, and the current micro-frame as indicated by `USB_n_FRINDEX[2:0]` is 0, then execute a start-split transaction.
- *Frame C-mask*. This is a bit-field where system software sets one or more bits corresponding to the micro-frames (within an *H-Frame*) that the host controller should execute complete-split transactions. The interpretation of this field is always qualified by the value of the *SplitXState* bit. For example, referring to the IN example in [Figure 56-24](#), case one, the *C-mask* would have a value of 00111100b indicating that if the siTD is traversed by the host controller, and the *SplitXState* indicates Do

Complete Split, and the current micro-frame as indicated by *USB_n_FRINDEX*[2:0] is 2, 3, 4, or 5, then execute a complete-split transaction.

- *Back Pointer*. This field in a siTD is used to complete an IN split-transaction using the previous *H-Frame*'s siTD. This is only used when the scheduling of the complete-splits span an *H-Frame* boundary.

There exists a one-to-one relationship between a high-speed isochronous split transaction (including all start- and complete-splits) and one full-speed isochronous transaction. An siTD contains (amongst other things) buffer state and split transaction scheduling information. An siTD's buffer state always maps to one full-speed isochronous data payload. This means that for any full-speed transaction payload, a single siTD's data buffer must be used. This rule applies to both IN and OUTs. An siTD's scheduling information usually also maps to one high-speed isochronous split transaction. The exception to this rule is the *H-Frame* boundary wrap cases mentioned above.

The siTD data structure describes at most, one frame's worth of high-speed transactions and that description is strictly bounded within a frame boundary. The figure below illustrates some examples. On the top are examples of the full-speed transaction footprints for the boundary scheduling cases described above. In the middle are time-frame references for both the *B-Frames* (HS/FS/LS Bus) and the *H-Frames*. On the bottom is illustrated the relationship between the scope of an siTD description and the time references. Each *H-Frame* corresponds to a single location in the periodic frame list. The implication is that each siTD is reachable from a single periodic frame list location at a time.

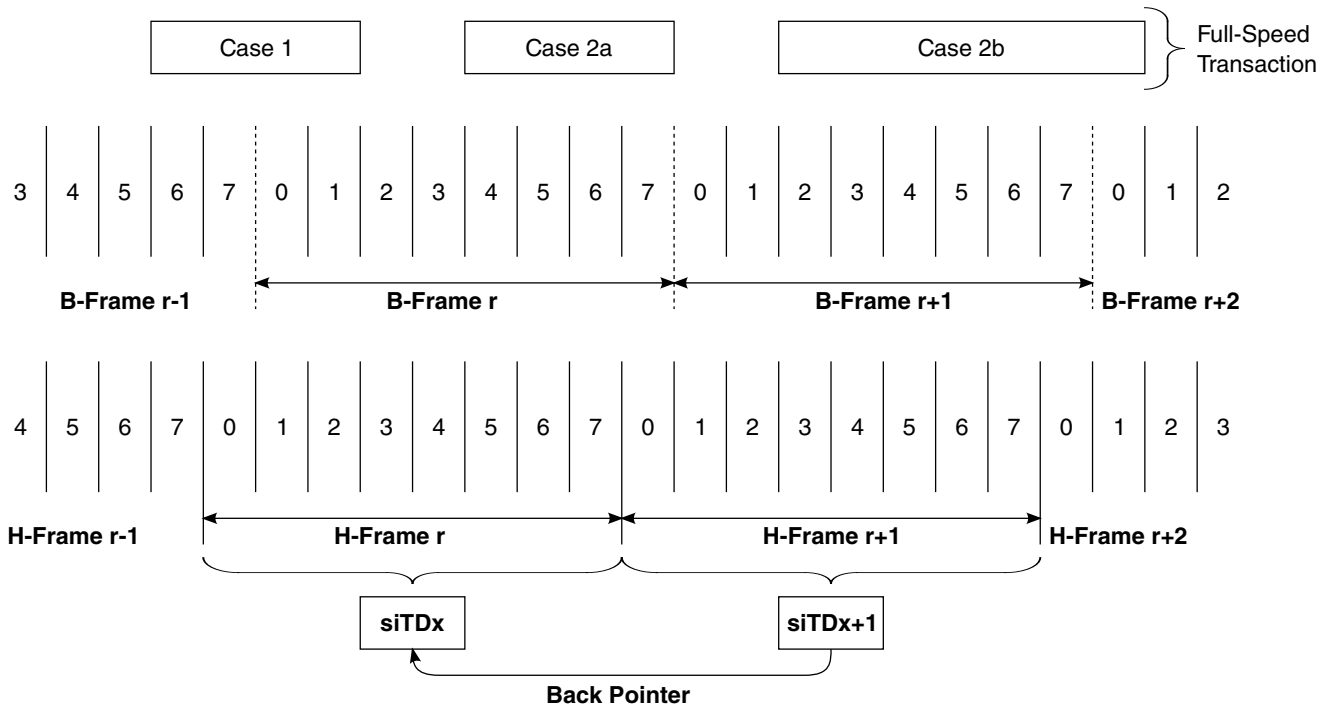

Figure 56-25. siTD Scheduling Boundary Examples

Each case is described below:

- *Case 1:* One siTD is sufficient to describe and complete the isochronous split transaction because the whole isochronous split transaction is tightly contained within a single *H-Frame*.
- *Case 2a, 2b:* Although both INs and OUTs can have these footprints, OUTs always take only one siTD to schedule. However, INs (for these boundary cases) require two siTDs to complete the scheduling of the isochronous split transaction siTD_x is used to always issue the start-split and the first *N* complete-splits. The full-speed transaction (for these cases) can deliver data on the full-speed bus segment during micro-frame 7 of *H-Frame*_{Y+1}, or micro-frame 0 of *H-Frame*_{Y+2}. The complete splits are scheduled using siTD_{X+2} (not shown). The complete-splits to extract this data must use the buffer pointer from siTD_{X+1}. The only way for the host controller to reach siTD_{X+1} from *H-Frame*_{Y+2} is to use siTD_{X+2}'s back pointer. The host controller rules for when to use the back pointer are described in Section [Periodic Isochronous - Do Complete Split](#).

Software must apply the following rules when calculating the schedule and linking the schedule data structures into the periodic schedule:

- Software must ensure that an isochronous split-transaction is started so that it will complete before the end of the *B-Frame*.
- Software must ensure that for a single full-speed isochronous endpoint, there is never a start-split and complete-split in *H-Frame, micro-frame 1*. This is mandated as a rule so that case 2a and case 2b can be discriminated. According to the core USB specification, the long isochronous transaction illustrated in Case 2b, could be scheduled so that the start-split was in micro-frame 1 of *H-Frame N* and the last complete-split would need to occur in micro-frame 1 of *H-Frame N+1*. However, it is impossible to discriminate between cases 2a and case 2b, which has significant impact on the complexity of the host controller.

56.4.3.12.3.2 Tracking Split Transaction Progress for Isochronous Transfers

To correctly maintain the data stream, the host controller must be able to detect and report errors where device to host data is lost. Isochronous endpoints do not employ the concept of a halt on error, however the host is required to identify and report per-packet errors observed in the data stream. This includes schedule traversal problems (skipped micro-frames), timeouts and corrupted data received.

In similar kind to interrupt split-transactions, the portions of the split transaction protocol must execute in the micro-frames they are scheduled. The queue head data structure used to manage full- and low-speed interrupt has several mechanisms for tracking when portions of a transaction have occurred. Isochronous transfers use siTDs, for their transfers, and the data structures are only reachable via the schedule in the exact micro-frame in which they are required (so all the mechanism employed for tracking in queue heads is not required for siTDs). Software has the option of reusing siTD several times in the complete periodic schedule. However, it must ensure that the results of split transaction *N* are consumed and the siTD reinitialized (activated) before the host controller gets back to the siTD (in a future micro-frame).

Split-transaction isochronous OUTs utilize a low-level protocol to indicate which portions of the split transaction data have arrived. Control over the low-level protocol is exposed in an siTD via the fields *Transaction Position (TP)* and *Transaction Count (T-count)*. If the entire data payload for the OUT split transaction is larger than 188 bytes, there will be more than one start-split transaction, each of which require proper annotation. If host hold-offs occur, then the sequence of annotations received from the host will not be complete, which is detected and handled by the transaction translator. See Section [Periodic Isochronous - Do Start Split](#) for a description on how these fields are used during a sequence of start-split transactions.

The fields *siTD.T-Count* and *siTD.TP* are used by the host controller to drive and sequence the transaction position annotations. It is the responsibility of system software to properly initialize these fields in each siTD. Once the budget for a split-transaction

isochronous endpoint is established, *S-mask*, *T-Count*, and *TP* initialization values for all the siTD associated with the endpoint are constant. They remain constant until the budget for the endpoint is recalculated by software and the periodic schedule adjusted.

For IN-endpoints, the transaction translator simply annotates the response data packets with enough information to allow the host controller to identify the last data. As with split transaction Interrupt, it is the host controller's responsibility to detect when it has missed an opportunity to execute a complete-split. The following field in the siTD is used to track and detect errors in the execution of a split transaction for an IN isochronous endpoint.

- *C-prog-mask*. This is an eight-bit bit-vector where the host controller keeps track of which complete-splits have been executed. Due to the nature of the Transaction Translator periodic pipeline, the complete-splits need to be executed in-order. The host controller needs to detect when the complete-splits have not been executed in order. This can only occur due to system hold-offs where the host controller cannot get to the memory-based schedule. *C-prog-mask* is a simple bit-vector that the host controller sets a bit for each complete-split executed. The bit position is determined by the micro-frame (`USB_n_FRINDEX[2:0]`) number in which the complete-split was executed. The host controller always checks *C-prog-mask* before executing a complete-split transaction. If the previous complete-splits have not been executed, then it means one (or more) have been skipped and data has potentially been lost. System software is required to initialize this field to zero before setting an siTD's *Active* bit to a one.

If a transaction translator returns with the final data before all of the complete-splits have been executed, the state of the transfer is advanced so that the remaining complete-splits are not executed. Refer to Section [Asynchronous - Do Complete Split](#) for a description on how the state of the transfer is advanced. It is important to note that an IN siTD is retired based solely on the responses from the Transaction Translator to the complete-split transactions. This means, for example, that it is possible for a transaction translator to respond to a complete-split with an MDATA PID. The number of bytes in the MDATA's data payload could cause the siTD field *Total Bytes to Transfer* to decrement to zero. This response can occur, before all of the scheduled complete-splits have been executed. In other interface, data structures (for example, high-speed data streams through queue heads), the transition of *Total Bytes to Transfer* to zero signals the end of the transfer and results in setting of the *Active* bit to zero. However, in this case, the result has not been delivered by the Transaction Translator and the host must continue with the next complete-split transaction to extract the residual transaction state. This scenario occurs because of the pipeline rules for a Transaction Translator (see Chapter 11 of the Universal Serial Bus Revision 2.0). In summary the periodic pipeline rules require that on a micro-frame boundary, the Transaction Translator will hold the final two bytes received (if it has not seen an End Of Packet (EOP)) in the full-speed bus pipe stage and give the

remaining bytes to the high-speed pipeline stage. At the micro-frame boundary, the Transaction Translator could have received the entire packet (including both CRC bytes) but not received the packet EOP. In the next micro-frame, the Transaction Translator will respond with an MDATA and send all of the data bytes (with the two CRC bytes being held in the full-speed pipeline stage). This could cause the siTD to decrement its *Total Bytes to Transfer* field to zero, indicating it has received all expected data. The host must still execute one more (scheduled) complete-split transaction in order to extract the results of the full-speed transaction from the Transaction Translator (for example, the Transaction Translator may have detected a CRC failure, and this result must be forwarded to the host).

If the host experiences hold-offs that cause the host controller to skip one or more (but not all) scheduled split transactions for an isochronous OUT, then the protocol to the transaction translator will not be consistent and the transaction translator will detect and react to the problem. Likewise, for host hold-offs that cause the host controller to skip one or more (but not all) scheduled split transactions for an isochronous IN, the *C-prog-mask* is used by the host controller to detect errors. However, if the host experiences a hold-off that causes it to skip all of an siTD, or an siTD expires during a host hold off (for example, a hold-off occurs and the siTD is no longer reachable by the host controller in order for it to report the hold-off event), then system software must detect that the siTDs have not been processed by the host controller (that is, state not advanced) and report the appropriate error to the client driver.

56.4.3.12.3.3 Split Transaction Execution State Machine for Isochronous

In the following presentation, all references to micro-frame are in the context of a micro-frame within an *H-Frame*.

If the *Active* bit in the *Status* byte is a zero, the host controller will ignore the siTD and continue traversing the periodic schedule. Otherwise the host controller will process the siTD as specified below. A split transaction state machine is used to manage the split-transaction protocol sequence. The host controller uses the fields defined in Section [Tracking Split Transaction Progress for Interrupt Transfers](#), plus the variable *cMicroFrameBit* defined in Section [Split Transaction Execution State Machine for Interrupt](#) to track the progress of an isochronous split transaction. The figure below illustrates the state machine for managing an siTD through an isochronous split transaction. Bold, dotted circles denote the state of the *Active* bit in the *Status* field of a siTD. The Bold, dotted arcs denote the transitions between these states. Solid circles denote the states of the split transaction state machine and the solid arcs denote the transitions between these states. Dotted arcs and boxes reference actions that take place either as a result of a transition or from being in a state.

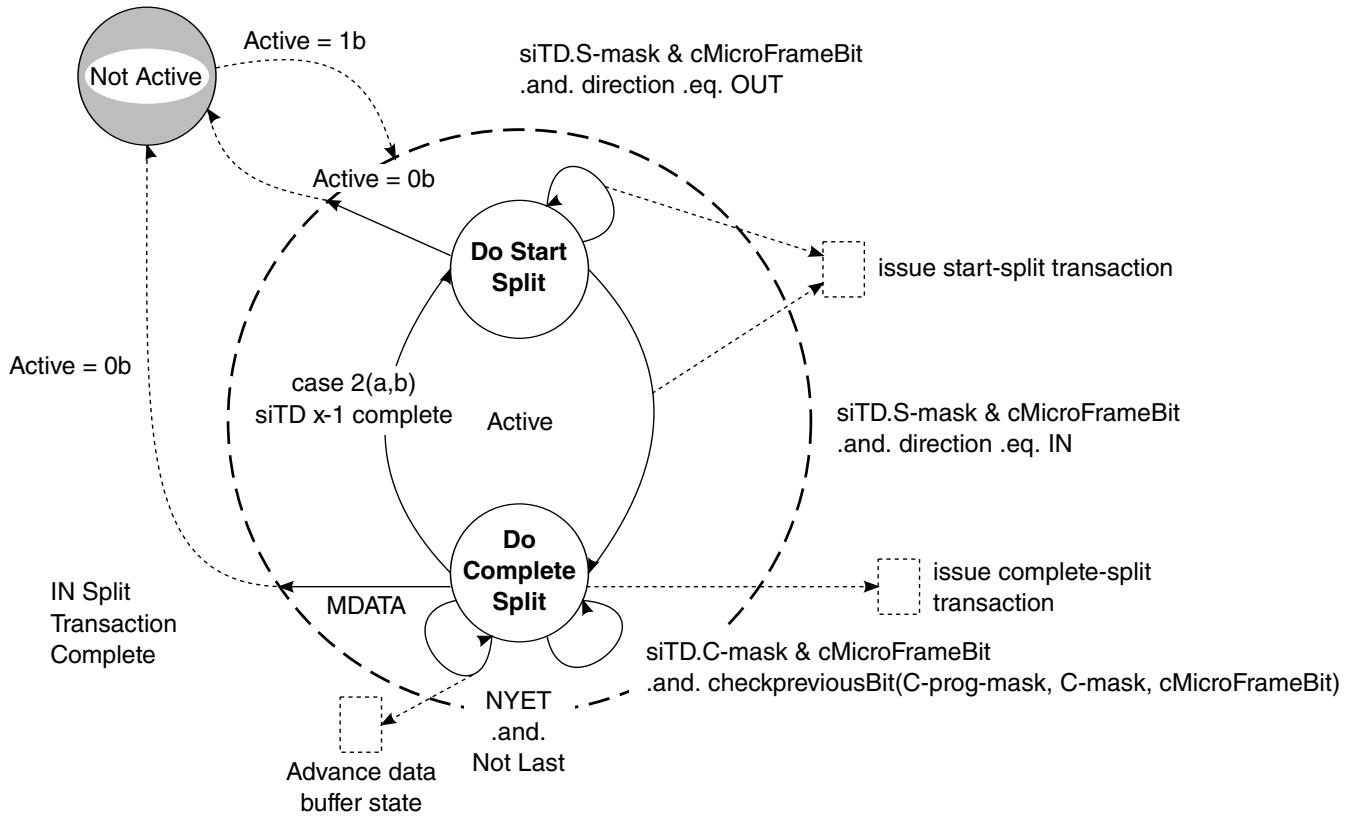

Figure 56-26. Split Transaction State Machine for Isochronous

56.4.3.12.3.4 Periodic Isochronous - Do Start Split

Isochronous split transaction OUTs use only this state.

An siTD for a split-transaction isochronous IN is either initialized to this state, or the siTD transitions to this state from Do Complete Split when a case 2a (IN) or 2b scheduling boundary isochronous split-transaction completes.

Each time the host controller reaches an active siTD in this state, it checks the *siTD.S-mask* against *cMicroFrameBit*. If there is a one in the appropriate position, the siTD will execute a start-split transaction. By definition, the host controller cannot *reach* an siTD at the wrong time. If the *I/O* field indicates an IN, then the start-split transaction includes only the extended token plus the full-speed token. Software must initialize the *siTD.Total Bytes To Transfer* field to the number of bytes expected. This is usually the maximum packet size for the full-speed endpoint. The host controller exits this state when the start-split transaction is complete.

The remainder of this section is specific to an isochronous OUT endpoint (that is, the *I/O* field indicates an OUT). When the host controller executes a start-split transaction for an isochronous OUT it includes a data payload in the start-split transaction. The memory

buffer address for the data payload is constructed by concatenating *siTD.Current Offset* with the page pointer indicated by the page selector field (*siTD.P*). A zero in this field selects Page 0 and a 1 selects Page 1. During the start-split for an OUT, if the data transfer crosses a page boundary during the transaction, the host controller must detect the page cross, update the *siTD.P*-bit from a zero to a one, and begin using the *siTD.Page 1* with *siTD.Current Offset* as the memory address pointer. The field *siTD.TP* is used to annotate each start-split transaction with the indication of which part of the split-transaction data the current payload represents (ALL, BEGIN, MID, END). In all cases the host controller simply uses the value in *siTD.TP* to mark the start-split with the correct transaction position code.

T-Count is always initialized to the number of start-splits for the current frame. *TP* is always initialized to the first required transaction position identifier. The scheduling boundary case (see [Figure 56-25](#)) is used to determine the initial value of *TP*. The initial cases are summarized in the following table.

Table 56-48. Initial Conditions for OUT siTD's TP and T-count Fields

Case	T-count	TP	Description
1, 2a	=1	ALL	When the OUT data payload is less than (or equal to) 188 bytes, only one start-split is required to move the data. The one start-split must be marked with an ALL.
1, 2a	!=1	BEGIN	When the OUT data payload is greater than 188 bytes more than one start-split must be used to move the data. The initial start-split must be marked with a BEGIN.

After each start-split transaction is complete, the host controller updates *T-Count* and *TP* appropriately so that the next start-split is correctly annotated.

The table below illustrates all of the *TP* and *T-count* transitions, which must be accomplished by the host controller.

Table 56-49. Transaction Position (TP)/Transaction Count (T-Count) Transition Table

TP	T-count next	TP next	Description
ALL	0	N/A	Transition from ALL, to done.
BEGIN	1	END	Transition from BEGIN to END. Occurs when <i>T-count</i> starts at 2.
BEGIN	!=1	MID	Transition from BEGIN to MID. Occurs when <i>T-count</i> starts at greater than 2.
MID	!=1	MID	<i>TP</i> stays at MID while <i>T-count</i> is not equal to 1 (that is, greater than 1). This case can occur for any of the scheduling boundary cases where the <i>T-count</i> starts greater than 3.
MID	1	END	Transition from MID to END. This case can occur for any of the scheduling boundary cases where the <i>T-count</i> starts greater than 2.

The start-split transactions do not receive a handshake from the transaction translator, so the host controller always advances the transfer state in the siTD after the bus transaction is complete. To advance the transfer state the following operations take place:

- The *siTD.Total Bytes To Transfer* and the *siTD.Current Offset* fields are adjusted to reflect the number of bytes transferred.
- The *siTD.P* (page selector) bit is updated appropriately.
- The *siTD.TP* and *siTD.T-count* fields are updated appropriately as defined in [Table 56-49](#).

These fields are then written back to the memory based siTD. The *S-mask* is fixed for the life of the current budget. As mentioned above, *TP* and *T-count* are set specifically in each siTD to reflect the data to be sent from this siTD. Therefore, regardless of the value of *S-mask*, the actual number of start-split transactions depends on *T-count* (or equivalently, *Total Bytes to Transfer*). The host controller must set the *Active* bit to a zero when it detects that all of the schedule data has been sent to the bus. The preferred method is to detect when *T-Count* decrements to zero as a result of a start-split bus transaction. Equivalently, the host controller can detect when *Total Bytes to Transfer* decrements to zero. Either implementation must ensure that if the initial condition is *Total Bytes to Transfer* equal to zero and *T-count* is equal to a one, then the host controller will issue a single start-split, with a zero-length data payload. Software must ensure that *TP*, *T-count* and *Total Bytes to Transfer* are set to deliver the appropriate number of bus transactions from each siTD. An inconsistent combination will yield undefined behavior.

If the host experiences hold-offs that cause the host controller to skip start-split transactions for an OUT transfer, the state of the transfer will not progress appropriately. The transaction translator will observe protocol violations in the arrival of the start-splits for the OUT endpoint (that is, the transaction position annotation will be incorrect as received by the transaction translator).

Example scenarios are described in Section [Split Transaction for Isochronous - Processing Examples](#).

A host controller implementation can optionally track the progress of an OUT split transaction by setting appropriate bits in the *siTD.C-prog-mask* as it executes each scheduled start-split. The *checkPreviousBit()* algorithm defined in [Periodic Isochronous - Do Complete Split](#) can be used prior to executing each start-split to determine whether start-splits were skipped. The host controller can use this mechanism to detect missed micro-frames. It can then set the siTD's *Active* bit to zero and stop execution of this siTD. This saves on both memory and high-speed bus bandwidth.

56.4.3.12.3.5 Periodic Isochronous - Do Complete Split

This state is only used by a split-transaction isochronous IN endpoint.

This state is entered unconditionally from the Do Start State after a start-split transaction is executed for an IN endpoint. Each time the host controller visits an siTD in this state, it conducts a number of tests to determine whether it should execute a complete-split transaction. The individual tests are listed below. The sequence they are applied depends on which micro-frame the host controller is currently executing which means that the tests might not be applied until after the siTD referenced from the back pointer has been fetched.

- Test A. *cMicroFrameBit* is bit-wise anded with *siTD.C-mask* field. A non-zero result indicates that software scheduled a complete-split for this endpoint, during this micro-frame. This test is always applied to a newly fetched siTD that is in this state.
- Test B. The *siTD.C-prog-mask* bit vector is checked to determine whether the previous complete splits have been executed. An example algorithm is below (this is slightly different than the algorithm used in Section [Periodic Isochronous - Do Complete Split](#)). The sequence in which this test is applied depends on the current value of *USB_n_FRINDEX[2:0]*. If *USB_n_FRINDEX[2:0]* is 0 or 1, it is not applied until the back pointer has been used. Otherwise it is applied immediately.

Algorithm Boolean CheckPreviousBit(*siTD.C-prog-mask*, *siTD.C-mask*, *cMicroFrameBit*)

Begin

```

Boolean rvalue = TRUE;
previousBit = cMicroFrameBit rotate-right(1)
-- Bit-wise anding previousBit with C-mask indicates whether there was an intent
-- to send a complete split in the previous micro-frame. So, if the
-- 'previous bit' is set in C-mask, check C-prog-mask to make sure it
-- happened.
if previousBit bitAND siTD.C-mask then
    if not (previousBit bitAND siTD.C-prog-mask) then
        rvalue = FALSE
    End if
End if
Return rvalue

```

End Algorithm

If Test A is true and *USB_n_FRINDEX[2:0]* is zero or one, then this is a case 2a or 2b scheduling boundary (see [Figure 56-24](#)). See Section [Periodic Isochronous - Do Complete Split](#) for details in handling this condition.

If Test A and Test B evaluate to true, then the host controller will execute a complete-split transaction using the transfer state of the current siTD. When the host controller commits to executing the complete-split transaction, it updates *QH.C-prog-mask* by bit-ORing with *cMicroFrameBit*. The transfer state is advanced based on the completion status of the complete-split transaction. To advance the transfer state of an IN siTD, the host controller must:

- Decrement the number of bytes received from *siTD.Total Bytes To Transfer*,
- Adjust *siTD.Current Offset* by the number of bytes received,

- Adjust *siTD.P* (page selector) field if the transfer caused the host controller to use the next page pointer, and
- Set any appropriate bits in the *siTD.Status* field, depending on the results of the transaction.

Note that if the host controller encounters a condition where *siTD.Total Bytes To Transfer* is zero, and it receives more data, the host controller must not write the additional data to memory. The *siTD.Status.Active* bit must be set to zero and the *siTD.Status.Babble Detected* bit must be set to a one. The fields *siTD.Total Bytes To Transfer*, *siTD.Current Offset*, and *siTD.P* (page selector) are not required to be updated as a result of this transaction attempt.

The host controller must accept (assuming good data packet CRC and sufficient room in the buffer as indicated by the value of *siTD.Total Bytes To Transfer*) MDATA and DATA0/1 data payloads up to and including 192 bytes. A host controller implementation may optionally set *siTD.Status Active* to a zero and *siTD.Status.Babble Detected* to a one when it receives MDATA or DATA0/1 with a data payload of more than 192 bytes. The following responses have the noted effects:

- ERR. The full-speed transaction completed with a time-out or bad CRC and this is a reflection of that error to the host. The host controller sets the *ERR* bit in the *siTD.Status* field and sets the *Active* bit to a zero.
- Transaction Error (XactErr). The complete-split transaction encounters a Timeout, CRC16 failure, etc. The *siTD.Status* field *XactErr* field is set to a one and the complete-split transaction must be retried immediately. The host controller must use an internal error counter to count the number of retries as a counter field is not provided in the siTD data structure. The host controller will not retry more than two times. If the host controller exhausts the retries or the end of the micro-frame occurs, the *Active* bit is set to zero.
- DATAx (0 or 1). This response signals that the final data for the split transaction has arrived. The transfer state of the siTD is advanced and the *Active* bit is set to a zero. If the *Bytes To Transfer* field has not decremented to zero (including the reception of the data payload in the DATAx response), then less data than was expected, or allowed for was actually received. This *short packet* event does not set the USBINT status bit in the USBSTS register to a one. The host controller will not detect this condition.
- NYET (and Last). On each NYET response, the host controller also checks to determine whether this is the last complete-split for this split transaction. Last was defined in Section [Periodic Isochronous - Do Complete Split](#) . If it is the last complete-split (with a NYET response), then the transfer state of the siTD is not advanced (never received any data) and the *Active* bit is set to a zero. No bits are set in the *Status* field because this is essentially a skipped transaction. The transaction translator must have responded to all the scheduled complete-splits with NYETs,

meaning that the start-split issued by the host controller was not received. This result should be interpreted by system software as if the transaction was completely skipped. The test for whether this is the last complete split can be performed by XORing *C-mask* with *C-prog-mask*. A zero result indicates that all complete-splits have been executed.

- **MDATA (and Last).** See above description for testing for Last. This can only occur when there is an error condition. Either there has been a babble condition on the full-speed link, which delayed the completion of the full-speed transaction, or software set up the *S-mask* and/or *C-masks* incorrectly. The host controller must set *XactErr* bit to a one and the *Active* bit is set to a zero.
- **NYET (and not Last).** See above description for testing for Last. The complete-split transaction received a NYET response from the transaction translator. Do not update any transfer state (except for *C-prog-mask*) and stay in this state.
- **MDATA (and not Last).** The transaction translator responds with an MDATA when it has partial data for the split transaction. For example, the full-speed transaction data payload spans from micro-frame *X* to *X+1* and during micro-frame *X*, the transaction translator will respond with an MDATA and the data accumulated up to the end of micro-frame *X*. The host controller advances the transfer state to reflect the number of bytes received.

If Test A succeeds, but Test B fails, it means that one or more of the complete-splits have been skipped. The host controller sets the *Missed Micro-Frame* status bit and sets the *Active* bit to a zero.

56.4.3.12.3.6 Complete-Split for Scheduling Boundary Cases 2a, 2b

Boundary cases 2a and 2b (INs only) (see [Figure 56-24](#)) require that the host controller use the transaction state context of the previous siTD to finish the split transaction. The table below enumerates the transaction state fields.

Table 56-50. Summary siTD Split Transaction State

Buffer State	Status	Execution Progress
Total Bytes To Transfer	All bits in the status field	C-prog-mask
P (page select)		
Current Offset		
TP (transaction position)		
T-count (transaction count)		

NOTE

TP and *T-count* are used only for Host to Device (OUT) endpoints.

If software has budgeted the schedule of this data stream with a frame wrap case, then it must initialize the *siTD.Back Pointer* field to reference a valid siTD and will have the *siTD.Back Pointer.T-bit* in the *siTD.Back Pointer*

field set to a zero. Otherwise, software must set the *siTD.Back Pointer.T-bit* in the *siTD.Back Pointer* field to a one. The host controller's rules for interpreting when to use the *siTD.Back Pointer* field are listed below. These rules apply only when the siTD's *Active* bit is a one and the *SplitXState* is Do Complete Split.

- When *cMicroFrameBit* is a 1h and the *siTDX.Back Pointer.T-bit* is a zero, or
- If *cMicroFrameBit* is a 2h and *siTDX.S-mask[0]* is a zero

When either of these conditions apply, then the host controller must use the transaction state from *siTD_{X-1}*.

In order to access *siTD_{X-1}*, the host controller reads on-chip the siTD referenced from *siTD_X.Back Pointer*.

The host controller must save the entire state from *siTD_X* while processing *siTD_{X-1}*. This is to accommodate for case 2b processing. The host controller must not recursively walk the list of *siTD.Back Pointers*.

If *siTD_{X-1}* is active (*Active* bit is a one and *SplitXStat* is Do Complete Split), then both Test A and Test B are applied as described above. If these criteria to execute a complete-split are met, the host controller executes the complete split and evaluates the results as described above. The transaction state (see [Table 56-50](#)) of *siTD_{X-1}* is appropriately advanced based on the results and written back to memory. If the resultant state of *siTD_{X-1}*'s *Active* bit is a one, then the host controller returns to the context of *siTD_X*, and follows its next pointer to the next schedule item. No updates to *siTD_X* are necessary.

If *siTD_{X-1}* is active (*Active* bit is a one and *SplitXStat* is Do Start Split), then the host controller must set *Active* bit to a zero and *Missed Micro-Frame* status bit to a one and the resultant status written back to memory.

If *siTD_{X-1}*'s *Active* bit is a zero, (because it was zero when the host controller first visited *siTD_{X-1}* via *siTD_X*'s back pointer, it transitioned to zero as a result of a detected error, or the results of *siTD_{X-1}*'s complete-split transaction transitioned it to zero), then the host controller returns to the context of *siTD_X* and transitions its *SplitXState* to Do Start Split. The host controller then determines whether the case 2b start split boundary condition exists (that is, if *cMicroframeBit* is a 1b and *siTD_X.S-mask[0]* is a 1b). If this criterion is met the host controller immediately executes a start-split transaction and appropriately advances the transaction state of *siTD_X*, then follows *siTD_X.Next Pointer* to the next schedule item. If the criterion is not met, the host controller simply follows *siTD_X.Next Pointer* to the next schedule item. Note that in the case of a 2b boundary case, the split-transaction of *siTD_{X-1}* will have its *Active* bit set to zero when the host controller returns

to the context of $siTD_x$. Also, note that software should not initialize an siTD with *C-mask* bits 0 and 1 set to a one and an *S-mask* with bit zero set to a one. This scheduling combination is not supported and the behavior of the host controller is undefined.

56.4.3.12.3.7 Split Transaction for Isochronous - Processing Examples

There is an important difference between how the hardware/software manages the isochronous split transaction state machine and how it manages the asynchronous and interrupt split transaction state machines.

The asynchronous and interrupt split transaction state machines are encapsulated within a single queue head. The progress of the data stream depends on the progress of each split transaction. In some respects, the split-transaction state machine is sequenced via the Execute Transaction queue head traversal state machine (see [Figure 56-17](#)).

Isochronous is a pure time-oriented transaction/data stream. The interface data structures are optimized to efficiently describe transactions that need to occur at specific times. The isochronous split-transaction state machine must be managed across these time-oriented data structures. This means that system software must correctly describe the scheduling of split-transactions across more than one data structure.

Then the host controller must make the appropriate state transitions at the appropriate times, in the correct data structures.

For example, the table below illustrates a couple of frames worth of scheduling required to schedule a case 2a full-speed isochronous data stream.

Table 56-51. Example Case 2a - Software Scheduling siTDs for an IN Endpoint

siTDx		Micro-Frames								Initial
#	Masks	0	1	2	3	4	5	6	7	SplitXState
X	S-Mask	-	-	-	-	1	-	-	-	Do Start Split
	C-Mask	1	1	-	-	-	-	1	1	
X+1	S-Mask	-	-	-	-	1	-	-	-	Do Complete Split
	C-Mask	1	1					1	1	
X+2	S-Mask	-	-	-	-	1	-	-	-	Do Complete Split
	C-Mask	1	1					1	1	
X+3	S-Mask	Repeats previous pattern								Do Complete Split
	C-Mask									

This example shows the first three siTDs for the transaction stream. Because this is the case-2a frame-wrap case, *S-masks* of all siTDs for this endpoint have a value of 10h (a one bit in micro-frame 4) and *C-mask* value of C3h (one-bits in micro-frames 0,1, 6 and 7). Additionally, software ensures that the *Back Pointer* field of each siTD references the appropriate siTD data structure (and the *Back PointerT-bits* are set to zero).

The initial *SplitXState* of the first siTD is Do Start Split. The host controller will visit the first siTD eight times during frame X. The C-mask bits in micro-frames 0 and 1 are ignored because the state is Do Start Split. During micro-frame 4, the host controller determines that it can run a start-split (and does) and changes *SplitXState* to Do Complete Split. During micro-frames 6 and 7, the host controller executes complete-splits. Notice the siTD for frame X+1 has its *SplitXState* initialized to Do Complete Split. As the host controller continues to traverse the schedule during *H-Frame* X+1, it will visit the second siTD eight times. During micro-frames 0 and 1 it will detect that it must execute complete-splits.

During *H-Frame* X+1, micro-frame 0, the host controller detects that siTD_{X+1}'s *Back Pointer.T-bit* is a zero, saves the state of siTD_{X+1} and fetches siTD_X. It executes the complete split transaction using the transaction state of siTD_X. If the siTD_X split transaction is complete, siTD's *Active* bit is set to zero and results written back to siTD_X. The host controller retains the fact that siTD_X is retired and transitions the *SplitXState* in the siTD_{X+1} to Do Start Split. At this point, the host controller is prepared to execute the start-split for siTD_{X+1} when it reaches micro-frame 4. If the split-transaction completes early (transaction-complete is defined in Section [Periodic Isochronous - Do Complete Split](#)), that is, before all the scheduled complete-splits have been executed, the host controller will transition *siTD_X.SplitXState* to Do Start Split early and naturally skip the remaining scheduled complete-split transactions. For this example, siTD_{X+1} does not receive a DATA0 response until *H-Frame* X+2, micro-frame 1.

During *H-Frame* X+2, micro-frame 0, the host controller detects that siTD_{X+2}'s *Back Pointer.T-bit* is a zero, saves the state of siTD_{X+2} and fetches siTD_{X+1}. As described above, it executes another split transaction, receives an MDATA response, updates the transfer state, but does not modify the *Active* bit. The host controller returns to the context of siTD_{X+2}, and traverses its next pointer without any state change updates to siTD_{X+2}. S

During *H-Frame* X+2, micro-frame 1, the host controller detects siTD_{X+2}'s *S-mask[0]* is a zero, saves the state of siTD_{X+2} and fetches siTD_{X+1}. It executes another complete-split transaction, receives a DATA0 response, updates the transfer state and sets the *Active* bit to a zero. It returns to the state of siTD_{X+2} and changes its *SplitXState* to Do Start Split. At this point, the host controller is prepared to execute start-splits for siTD_{X+2} when it reaches micro-frame 4.

56.4.3.13 Host Controller Pause

When the host controller's *HCHalted* bit in the USBSTS register is a zero, the host controller is sending SOF (Start OF Frame) packets down all enabled ports.

When the schedules are enabled, the EHCI host controller will access the schedules in main memory each micro-frame. This constant pinging of main memory is known to create Arm platform power management problems for mobile systems. Specifically, mobile systems aggressively manage the state of the Arm platform, based on recent history usage. In the more aggressive power saving modes, the Arm platform can disable its caches. Current PC architectures assume that bus-master accesses to main memory must be cache-coherent. So, when bus masters are busy touching memory, the Arm platform power management software can detect this activity over time and inhibit the transition of the Arm platform into its lowest power savings mode. USB controllers are bus-masters and the frequency at which they access their memory-based schedules keeps the Arm platform power management software from placing the Arm platform into its lowest power savings state.

USB Host controllers don't access main memory when they are suspended. However, there are a variety of reasons why placing the USB controllers into suspend won't work, but they are beyond the scope of this document. The base requirement is that the USB controller needs to be kept out of main memory, while at the same time, the USB bus is kept from going into suspend.

EHCI controllers provide a large-grained mechanism that can be manipulated by system software to change the memory access pattern of the host controller. System software can manipulate the schedule enable bits in the USBCMD register to turn on/off the scheduling traversal. A software heuristic can be applied to implement an on/off duty cycle that allows the USB to make reasonable progress and allow the Arm platform power management to get the Arm platform into its lowest power state. This method is not intended to be applied at all times to throttle USB, but should only be applied in very specific configurations and usage loads. For example, when only a keyboard or mouse is attached to the USB, the heuristic could detect times when the USB is attempting to move data only very infrequently and can adjust the duty cycle to allow the Arm platform to reach its low power state for longer periods of time. Similarly, it could detect increases in the USB load and adjust the duty cycle appropriately, even to the point where the schedules are never disabled. The assumption here is that the USB is moving data and the Arm platform will be required to process the data streams.

It is suggested that in order to provide a complete solution for the system, the companion host controllers should also provide a similar method to allow system software to inhibit the companion host controller from accessing its shared memory based data structures (schedule lists or otherwise).

56.4.3.14 Port Test Modes -Host Operational Model

EHCI host controllers must implement the port test modes Test J_State, Test K_State, Test_Packet, Test Force_Enable, and Test SE0_NAK as described in the USB Specification Revision 2.0.

The system is only allowed to test ports that are owned by the EHCI controller (for example, *CF-bit* is a one and *PortOwner* bit is a zero). System software is allowed to have at most one port in test mode at a time. Placing more than one port in test mode will yield undefined results. The required, per port test sequence is (assuming the *CF-bit* in the USB_n_CONFIGFLAG register is a one):

- Disable the periodic and asynchronous schedules by setting the *Asynchronous Schedule Enable* and *Periodic Schedule Enable* bits in the USBCMD register to a zero.
- Place all enabled root ports into the suspended state by setting the *Suspend* bit in each appropriate USB_n_PORTSC register to a one.
- Set the *Run/Stop* bit in the USBCMD register to a zero and wait for the *HCHalted* bit in the USBSTS register, to transition to a one. Note that an EHCI host controller implementation may optionally allow port testing with the *Run/Stop* bit set to a one. However, all host controllers must support port testing with *Run/Stop* set to a zero and *HCHalted* set to a one.
- Set the *Port Test Control* field in the port under test PORTSC register to the value corresponding to the desired test mode. If the selected test is Test_Force_Enable, then the *Run/Stop* bit in the USBCMD register must then be transitioned back to one, in order to enable transmission of SOFs out of the port under test.
- When the test is complete, system software must ensure the host controller is halted (*HCHalted* bit is a one) then it terminates and exits test mode by setting *HCRreset* to a one.

56.4.3.15 Interrupts-Host Operational Model

The EHCI Host Controller hardware provides interrupt capability based on a number of sources.

There are several general groups of interrupt sources:

- Interrupts as a result of executing transactions from the schedule (success and error conditions),
- Host controller events (Port change events, etc.), and
- Host Controller error events

All transaction-based sources are maskable through the Host Controller's Interrupt Enable register (USBINTR, see Section [Interrupt Enable Register \(USB_nUSBINTR\)](#)).

Additionally, individual transfer descriptors can be marked to generate an interrupt on completion. This section describes each interrupt source and the processing that occurs in response to the interrupt.

During normal operation, interrupts may be immediate or deferred until the next interrupt threshold occurs. The interrupt threshold is a tunable parameter via the *Interrupt Threshold Control* field in the USBCMD register. The value of this register controls when the host controller will generate an interrupt on behalf of normal transaction execution. When a transaction completes during an interrupt interval period, the interrupt signaling the completion of the transfer will not occur until the interrupt threshold occurs. For example, the default value is eight micro-frames. This means that the host controller will not generate interrupts any more frequently than once every eight micro-frames.

Section [Host System Error](#) details effects of a host system error.

If an interrupt has been scheduled to be generated for the current interrupt threshold interval, the interrupt is not signaled until after the status for the last complete transaction in the interval has been written back to host memory. This may sometimes result in the interrupt not being signaled until the next interrupt threshold.

Initial interrupt processing is the same, regardless of the reason for the interrupt. When an interrupt is signaled by the hardware, Arm platform control is transferred to host controller's USB interrupt handler. The precise mechanism to accomplish the transfer is OS specific. For this discussion it is just assumed that control is received. When the interrupt handler receives control, its first action is to read the USBSTS (USB Status Register). It then acknowledges the interrupt by clearing all of the interrupt status bits by writing ones to these bit positions. The handler then determines whether the interrupt is due to schedule processing or some other event. After acknowledging the interrupt, the handler (via an OS-specific mechanism), schedules a deferred procedure call (DPC) which will execute later. The DPC routine processes the results of the schedule execution. The precise mechanisms used are beyond the scope of this document.

Note: the host controller is not required to de-assert a currently active interrupt condition when software sets the interrupt enables (in the USBINR register, see Section [Interrupt Enable Register \(USB_nUSBINTR\)](#)) to a zero. The only reliable method software should use for acknowledging an interrupt is by transitioning the appropriate status bits in the USBSTS register (Section [USB Status Register \(USB_nUSBSTS\)](#)) from a one to a zero.

56.4.3.15.1 Transfer/Transaction Based Interrupts

These interrupt sources are associated with transfer and transaction progress. They are all dependent on the next interrupt threshold.

56.4.3.15.1.1 Transaction Error

A transaction error is any error that caused the host controller to think that the transfer did not complete successfully.

The table below lists the events/responses that the host can observe as a result of a transaction. The effects of the error counter and interrupt status are summarized in the following paragraphs. Most of these errors set the *XactErr* status bit in the appropriate interface data structure.

There is a small set of protocol errors that relate only when executing a queue head and fit under the umbrella of a WRONG PID error that are significant to explicitly identify. When these errors occur, the *XactErr* status bit in the queue head is set and the *CErr* field is decremented. When the *PIDCode* indicates a SETUP, the following responses are protocol errors and result in *XactErr* bit being set to a one and the *CErr* field being decremented.

- *EPS* field indicates a high-speed device and it returns a Nak handshake to a SETUP.
- *EPS* field indicates a high-speed device and it returns a Nyet handshake to a SETUP.
- *EPS* field indicates a low- or full-speed device and the complete-split receives a Nak handshake.

Table 56-52. Summary of Transaction Errors

Event / Result	Queue Head/qTD/iTD/siTD Side-effects		USB Status Register (USBSTS)
	Cerr	Status Field	USBERRINT
CRC	-1	XactErr set to a one.	1 ¹
Timeout	-1	XactErr set to a one.	1 ¹
Bad PID ²	-1	XactErr set to a one.	1 ¹
Babble	N/A	Section Serial Bus Babble	1
Buffer Error	N/A	Section Data Buffer Error	

1. If occurs in a queue head, then *USBERRINT* is asserted only when *CErr* counts down from a one to a zero. In addition the queue is halted, see [Halting a Queue Head](#).
2. The host controller received a response from the device, but it could not recognize the PID as a valid PID.

56.4.3.15.1.2 Serial Bus Babble

When a device transmits more data on the USB than the host controller is expecting for this transaction, it is defined to be babbling. In general, this is called a *Packet Babble*.

When a device sends more data than the *Maximum Length* number of bytes, the host controller sets the *Babble Detected* bit to a one and halts the endpoint if it is using a queue head (see [Halting a Queue Head](#)). *Maximum Length* is defined as the minimum of *Total Bytes to Transfer* and *Maximum Packet Size*. The *CErr* field is not decremented for a packet babble condition (only applies to queue heads). A babble condition also exists if IN transaction is in progress at High-speed EOF2 point. This is called a frame babble. A frame babble condition is recorded into the appropriate schedule data structure. In addition, the host controller must disable the port to which the frame babble is detected.

The *USBERRINT* bit in the *USB_n_USBSTS* register is set to a one and if the *USB Error Interrupt Enable* bit in the *USB_n_USBINTR* register is a one, then a hardware interrupt is signaled to the system at the next interrupt threshold. The host controller must never start an OUT transaction that will babble across a micro-frame EOF.

NOTE

When a host controller detects a data PID mismatch, it must either: disable the packet babble checking for the duration of the bus transaction or do packet babble checking based solely on *Maximum Packet Size*. The USB core specification defines the requirements on a data receiver when it receives a data PID mismatch (for example, expects a DATA0 and gets a DATA1 or visa-versa). In summary, it must ignore the received data and respond with an ACK handshake, in order to advance the transmitter's data sequence.

The EHCI interface allows System software to provide buffers for a Control, Bulk or Interrupt IN endpoint that are not an even multiple of the maximum packet size specified by the device. Whenever a device misses an ACK for an IN endpoint, the host and device are out of synchronization with respect to the progress of the data transfer. The host controller may have advanced the transfer to a buffer that is less than maximum packet size. The device will re-send its maximum packet size data packet, with the original data PID, in response to the next IN token. In order to properly manage the bus protocol, the host controller must disable the packet babble check when it observes the data PID mismatch.

56.4.3.15.1.3 Data Buffer Error

This event indicates that an overrun of incoming data or a underrun of outgoing data has occurred for this transaction.

This would generally be caused by the host controller not being able to access required data buffers in memory within necessary latency requirements. These conditions are not considered transaction errors, and do not effect the error count in the queue head. When these errors do occur, the host controller records the fact the error occurred by setting the *Data Buffer Error* bit in the queue head, iTD or siTD.

If the data buffer error occurs on a non-isochronous IN, the host controller will not issue a handshake to the endpoint. This will force the endpoint to resend the same data (and data toggle) in response to the next IN to the endpoint.

If the data buffer error occurs on an OUT, the host controller must corrupt the end of the packet so that it cannot be interpreted by the device as a good data packet. Simply truncating the packet is not considered acceptable. An acceptable implementation option is to 1's complement the CRC bytes and send them. There are other options suggested in the Transaction Translator section of the USB Specification Revision 2.0.

56.4.3.15.1.4 USB Interrupt (Interrupt on Completion (IOC))

Transfer Descriptors (iTDS, siTDs, and queue heads (qTDs)) contain a bit that can be set to cause an interrupt on their completion. The completion of the transfer associated with that schedule item causes the USB Interrupt (USBINT) bit in the USB_n_USBSTS register to be set to a one.

In addition, if a short packet is encountered on an IN transaction associated with a queue head, then this event also causes USBINT to be set to a one. If the USB Interrupt Enable bit in the USB_n_USBINTR register is set to a one, a hardware interrupt is signaled to the system at the next interrupt threshold. If the completion is because of errors, the *USBERRINT* bit in the USB_n_USBSTS register is also set to a one.

56.4.3.15.1.5 Short Packet

Reception of a data packet that is less than the endpoint's Max Packet size during Control, Bulk or Interrupt transfers signals the completion of the transfer. Whenever a short packet completion occurs during a queue head execution, the *USBINT* bit in the USB_n_USBSTS register is set to a one.

If the *USB Interrupt Enable* bit is set in the USB_n_USBINTR register, a hardware interrupt is signaled to the system at the next interrupt threshold.

56.4.3.15.2 Host Controller Event Interrupts

These interrupt sources are independent of the interrupt threshold (with the one exception being the Interrupt on Async Advance, see Section [Interrupt on Async Advance](#)).

56.4.3.15.2.1 Port Change Events

Port registers contain status and status change bits. When the status change bits are set to a one, the host controller sets the *Port Change Detect* bit in the USBSTS register to a one.

If the *Port Change Interrupt Enable* bit in the USB_n_USBINTR register is a one, then the host controller will issue a hardware interrupt. The port status change bits include:

- Connect Status Change
- Port Enable/Disable Change
- Over-current Change
- Force Port Resume

56.4.3.15.2.2 Frame List Rollover

This event indicates that the host controller has wrapped the frame list. The current programmed size of the frame list effects how often this interrupt occurs.

If the frame list size is 1024, then the interrupt will occur every 1024 milliseconds, if it is 512, then it will occur every 512 milliseconds, etc. When a frame list rollover is detected, the host controller sets the *Frame List Rollover* bit in the USB.USBSTS register to a one. If the *Frame List Rollover Enable* bit in the USB.USBINTR register is set to a one, the host controller issues a hardware interrupt. This interrupt is not delayed to the next interrupt threshold.

56.4.3.15.2.3 Interrupt on Async Advance

This event is used for deterministic removal of queue heads from the asynchronous schedule. Whenever the host controller advances the on-chip context of the asynchronous schedule, it evaluates the value of the *Interrupt on Async Advance Doorbell* bit in the USB.USBCMD register.

If it is a one, it sets the *Interrupt on Async Advance* bit in the USB.USBSTS register to a one. If the *Interrupt on Async Advance Enable* bit in the USB.USBINTR register is a one, the host controller issues a hardware interrupt at the next interrupt threshold. A detailed explanation of this feature is described in Section [Removing Queue Heads from Asynchronous Schedule](#) .

56.4.3.15.2.4 Host System Error

The host controller is a bus master and any interaction between the host controller and the system may experience errors.

The type of host error may be catastrophic to the host controller (such as a Master Abort) making it impossible for the host controller to continue in a coherent fashion. In the presence of non-catastrophic host errors, such as parity errors, the host controller could potentially continue operation. The recommended behavior for these types of errors is to escalate it to a catastrophic error and halt the host controller. Host-based error must result in the following actions:

- The *Run/Stop* bit in the USB.USBCMD register is set to a zero.
- The following bits in the USB.USBSTS register are set:
 - *Host System Error* bit is to a one.
 - *HCHalted* bit is set to a one.
- If the *Host System Error Enable* bit in the USB.USBINTR register is a one, then the host controller will issue a hardware interrupt. This interrupt is not delayed to the next interrupt threshold. The following table summarizes the required actions taken on the various host errors.

Table 56-53. Summary Behavior of EHCI Host Controller on Host System Errors

Cycle Type	Master Abort	Target Abort	Data Phase Parity
Frame list pointer fetch (read)	Fatal	Fatal	Fatal [o]
siTD fetch (read)	Fatal	Fatal	Fatal [o]
siTD status write-back (write)	Fatal [o]	Fatal [o]	Fatal [o]
iTD fetch (read)	Fatal	Fatal	Fatal [o]
iTD status write-back (write)	Fatal [o]	Fatal [o]	Fatal [o]
qTD fetch (read)	Fatal	Fatal	Fatal [o]
qHD status write-back (write)	Fatal [o]	Fatal [o]	Fatal [o]
Data write	Fatal [o]	Fatal [o]	Fatal [o]
Data read	Fatal	Fatal	Fatal [o]

Potentially, a host controller implementation could continue operation without a halt. However, the recommended behavior is to halt the host controller.

NOTE

After a *Host System Error*, Software must reset the host controller through *HCRreset* in the USB.USBCMD register before re-initializing and restarting the host controller.

56.4.4 EHCI Deviation

For the purposes a dual-role Host/Device controller with support for On-The-Go applications, it is necessary to deviate from the EHCI specification. Enhanced Host Controller Interface Specification for Universal Serial Bus, Revision 0.95, November 2000, Intel Corporation. <http://www.intel.com>. Device operation & On-The-Go operation is not specified in the EHCI and thus the implementation supported in this core is proprietary.

The host mode operation of the core is near EHCI compatible with few minor differences documented in this section.

The particulars of the deviations occur in the areas summarized here:

- Embedded Transaction Translator - Allows direct attachment of FS and LS devices in host mode without the need for a companion controller.
- Device operation - In host mode the device operational registers are generally disabled and thus device mode is mostly transparent when in host mode. However, there are a couple exceptions documented in the following sections.
- Embedded design interface - This core does not have a PCI Interface and therefore the PCI configuration registers described in the EHCI specification are not applicable.
- On-The-Go Operation - This design includes an On-The-Go controller for Port #1.

56.4.4.1 Embedded Transaction Translator Function

The OTG controller supports directly connected full and low speed devices without requiring a companion controller by including the capabilities of a USB 2.0 high speed hub transaction translator.

Although there is no separate Transaction Translator block in the system, the transaction translator function normally associated with a high speed hub has been implemented within the DMA and Protocol engine blocks. The embedded transaction translator function is an extension to EHCI interface, but makes use of the standard data structures and operational models that exist in the EHCI specification to support full and low speed devices.

56.4.4.1.1 Capability Registers

The following additions have been added to the capability registers to support the embedded Transaction Translator Function:

- N_TT added to USB.HCSPARAMS - Host Control Structural Parameters
- N_PTT added to USB.HCSPARAMS - Host Control Structural Parameters

56.4.4.1.2 Operational Registers

The following additions have been added to the operational registers to support the embedded TT:

- Addition of two-bit Port Speed (PSPD) to the [Port Status & Control \(USB_nPORTSC1\)](#) register.

56.4.4.1.3 Discovery-EHCI Deviation

In a standard EHCI controller design, the EHCI host controller driver detects a Full speed (FS) or Low speed (LS) device by noting if the port enable bit is set after the port reset operation.

The port enable will only be set in a standard EHCI controller implementation after the port reset operation and when the host and device negotiate a High-Speed connection (that is, Chirp completes successfully).

Because this controller has an embedded Transaction Translator, the port enable will always be set after the port reset operation regardless of the result of the host device chirp result and the resulting port speed will be indicated by the PSPD field in USB.PORTSCx.

Therefore, the standard EHCI host controller driver requires an alteration to handle directly connected Full and Low speed devices or hubs.

The change is a fundamental one in that is summarized in the following table.

Table 56-54. Summary of EHCI

Standard EHCI	EHCI with embedded Transaction Translator
After port enable bit is set following a connection and reset sequence, the device/hub is assumed to be HS.	After port enable bit is set following a connection and reset sequence, the device/hub speed is noted from USB.PORTSCx.
FS and LS devices are assumed to be downstream from a HS hub thus, all port-level control is performed through the Hub Class to the nearest Hub.	FS and LS device can be either downstream from a HS hub or directly attached. When the FS/LS device is downstream from a HS hub, then port-level control is done using the Hub Class through the nearest Hub. When a FS/LS device is directly attached, then port-level control is accomplished using USB.PORTSCx.
FS and LS devices are assumed to be downstream from a HS hub with HubAddr=X. [where HubAddr > 0 and HubAddr is the address of the Hub where the bus transitions from HS to FS/LS (ie. Split target hub)]	FS and LS device can be either downstream from a HS hub with HubAddr = X [HubAddr > 0] or directly attached [where HubAddr = 0 and HubAddr is the address of the Root Hub where the bus transitions from HS to FS/LS (ie. Split target hub is the root hub)]

56.4.4.1.4 Data Structures

The same data structures used for FS/LS transactions through a HS hub are also used for transactions through the Root Hub with sm embedded Transaction Translator.

Here it is demonstrated how the Hub Address and Endpoint Speed fields should be set for directly attached FS/LS devices and hubs:

1. QH (for direct attach FS/LS) - Async. (Bulk/Control Endpoints) Periodic (Interrupt)
 - Hub Address = 0
 - Transactions to direct attached device/hub.
 - QH.EPS = Port Speed
 - Transactions to a device downstream from direct attached FS hub.
 - QH.EPS = Downstream Device Speed

NOTE

When QH.EPS = 01 (LS) and PORTSCx.PSPD = 00 (FS), a LS-pre-pid will be sent before the transmitting LS traffic.

Maximum Packet Size must be less than or equal 64 or undefined behaviour may result.

2. siTD (for direct attach FS) - Periodic (ISO Endpoint)
 - All FS ISO transactions:
 - Hub Address = 0
 - siTD.EPS = 00 (full speed)
 - Maximum Packet Size must less than or equal to 1023 or undefined behaviour may result.

56.4.4.1.5 Operational Model

The operational models are well defined for the behavior of the Transaction Translator (see USB 2.0 specification. Universal Serial Bus Specification, Revision 2.0, April 2000, Compaq, Hewlett-Packard, Intel, Lucent, Microsoft, NEC, Philips. <http://www.usb.org>) and for the EHCI controller moving packets between system memory and a USB-HS hub. Because the embedded Transaction Translator exists within the host controller there is no physical bus between EHCI host controller driver and the USB FS/LS bus. These sections will briefly discuss the operational model for how the EHCI and Transaction Translator operational models are combined without the physical bus between. The following sections assume the reader is familiar with both the EHCI and USB 2.0 Transaction Translator operational models.

56.4.4.1.5.1 Micro- frame Pipeline

The EHCI operational model uses the concept of H-frames and B-frames to describe the pipeline between the Host (H) and the Bus (B). The embedded Transaction Translator shall use the same pipeline algorithms specified in the USB 2.0 specification for a Hub-based Transaction Translator.

All periodic transfers always begin at B-frame 0 (after SOF) and continue until the stored periodic transfers are complete. As an example of the micro-frame pipeline implemented in the embedded Transaction Translator, all periodic transfers that are tagged in EHCI to execute in H-frame 0 will be ready to execute on the bus in B-frame 0.

It is important to note that when programming the S-mask and C-masks in the EHCI data structures to schedule periodic transfers for the embedded Transaction Translator, the EHCI host controller driver must follow the same rules specified in EHCI for programming the S-mask and C-mask for downstream Hub-based Transaction Translators.

Once periodic transfers are exhausted, any stored asynchronous transfer will be moved. Asynchronous transfers are opportunistic in that they shall execute whenever possible and their operation is not tied to H-frame and B-frame boundaries with the exception that an asynchronous transfer can not babble through the SOF (start of B-frame 0.)

56.4.4.1.5.2 Split State Machines

The start and complete split operational model differs from EHCI slightly because there is no bus medium between the EHCI controller and the embedded Transaction Translator.

Where a start or complete-split operation would occur by requesting the split to the HS hub, the start/complete split operation is simple an internal operation to the embedded Transaction Translator. The following table summarizes the conditions where handshakes are emulated from internal state instead of actual handshakes to HS split bus traffic.

Table 56-55. Summary of the Conditions of Handshakes¹

Condition	Emulate TT Response
Start-Split: All asynchronous buffers full.	NAK
Start-Split: All periodic buffers full.	ERR
Start-Split: Success for start of Async. Transaction.	ACK
Start-Split: Start Periodic Transaction.	No Handshake (Ok)
Complete-Split: Failed to find transaction in queue.	Bus Time Out
Complete-Split: Transaction in Queue is Busy.	NYET
Complete-Split: Transaction in Queue is Complete.	[Actual Handshake from LS/FS device]

1. The un-shaded cells represent Start-Splits and the shaded cells represent Complete-Splits

56.4.4.1.5.3 Asynchronous Transaction Scheduling and Buffer Management

The following USB 2.0 specification items are implemented in the embedded Transaction Translator:

- Sequencing is provided & a packet length estimator ensures no full-speed/low-speed packet babbles into SOF time.
- Transaction tracking for 2 data pipes.

56.4.4.1.5.3.1 USB 2.0 - 11.17.3

- Sequencing is provided & a packet length estimator ensures no full-speed/low-speed packet babbles into SOF time.

56.4.4.1.5.3.2 USB 2.0 - 11.17.4

- Transaction tracking for 2 data pipes.

56.4.4.1.5.4 Periodic Transaction Scheduling and Buffer Management

The following USB 2.0 specification items are implemented in the embedded Transaction Translator:

- Abort of pending start-splits
 - EOF (and not started in micro-frames 6)
 - Idle for more than 4 micro-frames
- Abort of pending complete-splits
 - EOF
 - Idle for more than 4 micro-frames
- Transaction tracking for up to 16 data pipes.
- Complete-split transaction searching.

NOTE

There is no data schedule mechanism for these transactions other than the micro-frame pipeline. The embedded TT assumes the number of packets scheduled in a frame does not exceed the frame duration (1 ms) or else undefined behavior may result.

56.4.4.1.5.4.1 USB 2.0 - 11.18.6.[1-2]

- Abort of pending start-splits
 - EOF (and not started in micro-frames 6)
 - Idle for more than 4 micro-frames
- Abort of pending complete-splits

- EOF
- Idle for more than 4 micro-frames

56.4.4.1.5.4.2 USB 2.0 - 11.18.[7-8]

- Transaction tracking for up to 16 data pipes.
- Complete-split transaction searching.

NOTE

There is no data schedule mechanism for these transactions other than the micro-frame pipeline. The embedded TT assumes the number of packets scheduled in a frame does not exceed the frame duration (1 ms) or else undefined behavior may result.

56.4.4.1.5.5 Multiple Transaction Translators

The maximum number of embedded Transaction Translators that is currently supported is one as indicated by the N_TT field in the [Host Controller Structural Parameters \(USB_nHCSPARAMS\)](#) register.

56.4.4.2 Device Operation

The co-existence of a device operational controller within the host controller has little effect on EHCI compatibility for host operation except as noted in this section.

56.4.4.2.1 USB_USBMODE Register

Given that the dual-role controller is initialized in neither host nor device mode, the [USB Device Mode \(USB_nUSBMODE\)](#) register must be programmed for host operation before the EHCI host controller driver can begin EHCI host operations.

56.4.4.2.2 Non-Zero Fields the Register File

Some of the reserved fields and reserved addresses in the capability registers and operational register have use in device mode, the following must be adhered to:

- Write operations to all EHCI reserved fields (some of which are device fields) with the operation registers should always be written to zero. This is an EHCI requirement of the device controller driver that must be adhered to.
- Read operations by the host controller must properly mask EHCI reserved fields (some of which are device fields) because fields that are used exclusive for device are undefined in host mode .

56.4.4.2.3 SOF Interrupt

This SOF Interrupt used for device mode is shared as a free running 125us interrupt for host mode.

EHCI does not specify this interrupt but it has been added for convenience and as a potential software time base. See [USB Status Register \(USB_nUSBSTS\)](#) and [Interrupt Enable Register \(USB_nUSBINTR\)](#) registers.

56.4.4.3 Embedded Design Interface

This is an Embedded USB Host Controller as defined by the EHCI specification and thus does not implement the PCI configuration registers.

56.4.4.3.1 Frame Adjust Register

Given that the optional PCI configuration registers are not included in this implementation, there is no corresponding bit level timing adjustments like is provided by the Frame Adjust register in the PCI configuration registers. Starts of micro-frames are timed precisely to 125 us using the transceiver clock as a reference clock. That is, a 60 Mhz transceiver clock for 8-bit physical interfaces & full-speed serial interfaces or 30 Mhz transceiver clock for 16-bit physical interfaces.

56.4.4.4 Miscellaneous variations from EHCI

56.4.4.4.1 Programmable Physical Interface Behaviour

This design supports multiple Physical interfaces which can operate in differing modes when the core is configured with software programmable Physical Interface Modes. Software programmability allows the selection of the Physical interface part during the board design phase instead of during the chip design phase. The control bits for selecting the Physical Interface operating mode have been added to the [Port Status & Control \(USB_nPORTSC1\)](#) register providing a capability that is not defined by EHCI.

56.4.4.4.2 Discovery

56.4.4.4.2.1 Port Reset

The port connect methods specified by EHCI require setting the port reset bit in the [Port Status & Control \(USB_nPORTSC1\)](#) register for a duration of 10ms. Due to the complexity required to support the attachment of devices that are not high speed there are counter already present in the design that can count the 10ms reset pulse to alleviate the requirement of the software to measure this duration. Therefore, the basic connection is then summarized as the following:

- [Port Change Interrupt] Port connect change occurs to notify the host controller driver that a device has attached.
- Software shall write a '1' to reset the device.
- Software shall write a '0' to reset the device after 10 ms.
 - This step, which is necessary in a standard EHCI design, may be omitted with this implementation. Should the EHCI host controller driver attempt to write a '0' to the reset bit while a reset is in progress, the write will simple be ignored and the reset will continue until completion.
- [Port Change Interrupt] Port enable change occurs to notify the host controller that the device is now operational and at this point the port speed has been determined.

56.4.4.4.2.2 Port Speed Detection

After the port change interrupt indicates that a port is enabled, the EHCI stack should determine the port speed. Unlike the EHCI implementation, which will re-assign the port owner for any device that does not connect at High-Speed, this host controller supports direct attach of non High-Speed devices.

Therefore, the following differences are important regarding port speed detection:

- Port Owner is read-only and always reads 0.
- A 2-bit Port Speed indicator has been added to PORTSC to provide the current operating speed of the port to the host controller driver.
- A 1-bit High Speed indicator has been added to PORTSC to signify that the port is in High-Speed vs. Full/Low Speed - *This information is redundant with the 2-bit Port Speed indicator above.*

56.4.4.4.3 Port Test Mode

Port Test Control mode behaves fully as described in EHCI. An alternate host controller driver procedure is not necessary or supported.

56.4.5 Device Data Structures

This section defines the interface data structures used to communicate control, status, and data between Device Controller Driver (DCD) Software and the Device Controller.

The data structure definitions in this chapter support a 32-bit memory buffer address space. The interface consists of device Queue Heads and Transfer Descriptors.

NOTE

Software must ensure that no interface data structure reachable by the Device Controller spans a 4K-page boundary.

The data structures defined in the chapter are (from the device controller's perspective) a mix of read-only and read/ writable fields. The device controller must preserve the read-only fields on all data structure writes.

The figure below shows the organization of the EndPoint Queue Head.

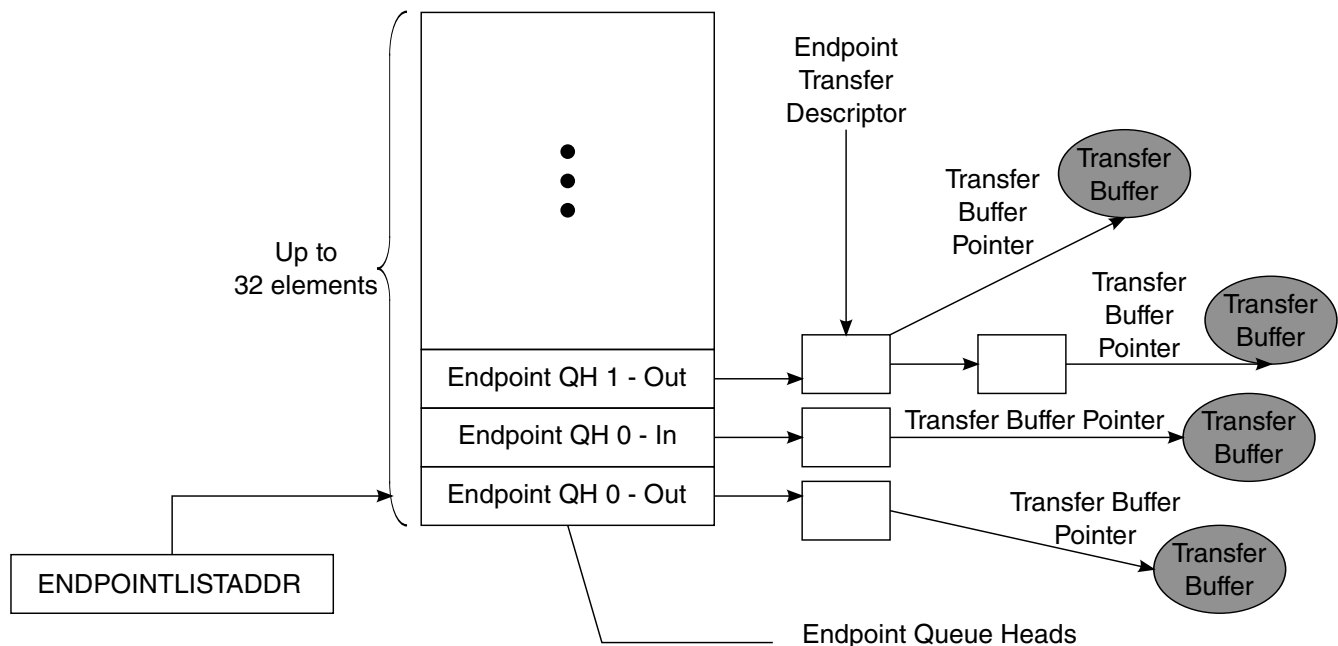

Figure 56-27. EndPoint Queue Head Organization

Endpoint queue heads are arranged in an array in a continuous area of memory pointed to by the USB.ENDPOINTLISTADDR pointer. The even -numbered device queue heads in the list support receive endpoints (OUT/SETUP) and the odd-numbered queue heads in the list are used for transmit endpoints (IN/INTERRUPT). The device controller will index into this array based upon the endpoint number received from the USB bus. All information necessary to respond to transactions for all primed transfers is contained in this list so the Device Controller can readily respond to incoming requests without having to traverse a linked list.

NOTE

The Endpoint Queue Head List must be aligned to a 2k boundary.

56.4.5.1 Endpoint Queue Head (dQH)

The device Endpoint Queue Head (dQH) is where all transfers for a given endpoint are managed. The dQH is a 48-byte data structure, but must be aligned on 64-byte boundaries.

During priming of an endpoint, the dTD (device transfer descriptor) is copied into the overlay area of the dQH, which starts at the nextTD pointer DWord and continues through the end of the buffer pointers DWords. After a transfer is complete, the dTD status DWord is updated in the dTD pointed to by the currentTD pointer. While a packet is in progress, the overlay area of the dQH is used as a staging area for the dTD so that the Device Controller can access needed information with little minimal latency.

Table 56-56. Endpoint Queue Head (dQH)

31	30	29	28	27	26	25	24	23	22	21	20	19	18	17	16	15	14	13	12	11	10	9	8	7	6	5	4	3	2	1	0		
Mult		zlt		0		Maximum Packet Length										ios		0															
Current dTD Pointer																												0					
Next dTD Pointer																												0		T ¹			
0		Total Bytes														ioc		0		MultO		0		Status									
Buffer Pointer (Page 0)														Current Offset																			
Buffer Pointer (Page 1)														Reserved																			
Buffer Pointer (Page 2)														Reserved																			
Buffer Pointer (Page 3)														Reserved																			
Buffer Pointer (Page 4) ¹														Reserved																			
Reserved																																	
Set-up Buffer Bytes 3...0																																	
Set-up Buffer Bytes 7...4																																	

1. Transfer overlay starts at T and continues through Buffer Pointer (Page 4).



Host Controller Read/Write

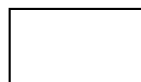

Host Controller Read Only

56.4.5.1.1 Endpoint Capabilities/Characteristics

This DWord specifies static information about the endpoint, in other words, this information does not change over the lifetime of the endpoint. Device Controller software should not attempt to modify this information while the corresponding endpoint is enabled.

Table 56-57 describes the endpoint capabilities.

Table 56-57. Endpoint Capabilities/Characteristics

Bit	Description
31-30	Mult. This field is used to indicate the number of packets executed per transaction description as given by the following: 00 - Execute N Transactions as demonstrated by the USB variable length packet protocol where N is computed using the Maximum Packet Length (dQH) and the Total Bytes field (dTD) 01 Execute 1 Transaction. 10 Execute 2 Transactions. 11 Execute 3 Transactions. NOTE: Non-ISO endpoints must set Mult="00". ISO endpoints must set Mult="01", "10", or "11" as needed.
29	Zero Length Termination Select. This bit is used to indicate when a zero length packet is used to terminate transfers where the total transfer length is a multiple of the Maximum Packet Length. This bit is not relevant for Isochronous 0 - Enable zero length packet to terminate transfers equal to a multiple of the Maximum Packet Length. (default). 1 - Disable the zero length packet on transfers that are equal in length to a multiple Maximum Packet Length.
28-27	Reserved. These bits reserved for future use and should be set to zero.
26-16	Maximum Packet Length. This directly corresponds to the maximum packet size of the associated endpoint (wMaxPacketSize). The maximum value this field may contain is 0x400 (1024).
15	Interrupt On Setup (IOS). This bit is used on control type endpoints to indicate if USBINT is set in response to a setup being received.
14-0	Reserved. Bits reserved for future use and should be set to zero.

56.4.5.1.2 Transfer Overlay-Endpoint Queue Head

The seven DWords in the overlay area represent a transaction working space for the device controller.

The general operational model is that the device controller can detect whether the overlay area contains a description of an active transfer. If it does not contain an active transfer, then it will not read the associated endpoint.

After an endpoint is readied, the dTD will be copied into this queue head overlay area by the device controller. Until a transfer is expired, software must not write the queue head overlay area or the associated transfer descriptor. When the transfer is complete, the device controller will write the results back to the original transfer descriptor and advance the queue.

See dTD for a description of the overlay fields.

56.4.5.1.3 Current dTD Pointer

The current dTD pointer is used by the device controller to locate the transfer in progress. This word is for Device Controller (hardware) use only and should not be modified by DCD software.

The following table describes the dTD Pointer.

Table 56-58. Next dTD Pointer

Bit	Description
31-5	Current dTD. This field is a pointer to the dTD that is represented in the transfer overlay area. This field will be modified by the Device Controller to next dTD pointer during endpoint priming or queue advance.
4-0	Reserved. Bit reserved for future use and should be set to zero.

56.4.5.1.4 Set-up Buffer

The set-up buffer is dedicated storage for the 8-byte data that follows a set-up PID.

NOTE

Each endpoint has a TX and an RX dQH associated with it, and only the RX queue head is used for receiving setup data packets.

The following table describes the Multiple Mode Control.

Table 56-59. Multiple Mode Control (HCCPARAMS)

DWord	Bits	Description
1	31-0	Setup Buffer 0. This buffer contains bytes 3 to 0 of an incoming setup buffer packet and is written by the device controller to be read by software.
2	31-0	Setup Buffer 1. This buffer contains bytes 7 to 4 of an incoming setup buffer packet and is written by the device controller to be read by software.

56.4.5.2 Endpoint Transfer Descriptor (dTD)

The dTD describes to the device controller the location and quantity of data to be sent/received for a given transfer.

The DCD should not attempt to modify any field in an active dTD except the Next Like Pointer, which should only be modified as described in section [Managing Transfers with Transfer Descriptors](#).

Table below shows the Endpoint Transfer Descriptor (dTD).

Table 56-60. Endpoint Transfer Descriptor (dTD)

31	30	29	28	27	26	25	24	23	22	21	20	19	18	17	16	15	14	13	12	11	10	9	8	7	6	5	4	3	2	1	0
Next Link Pointer																												0	T		
0	Total Bytes															ioc	0	MultO	0	Status											
Buffer Pointer (Page 0)														Current Offset																	
Buffer Pointer (Page 1)														0	Frame Number																
Buffer Pointer (Page 2)														Reserved																	
Buffer Pointer (Page 3)														Reserved																	
Buffer Pointer (Page 4)														Reserved																	



Host Controller Read/Write

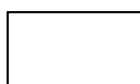

Host Controller Read Only

The following table describes the dTD Pointer.

Table 56-61. Next dTD Pointer

Bit	Description
31-5	Next Transfer Element Pointer. This field contains the physical memory address of the next dTD to be processed. The field corresponds to memory address signals [31:5], respectively.
4-1	Reserved. Bits reserved for future use and should be set to zero.
0	Terminate (T). 1=pointer is invalid. 0=Pointer is valid (points to a valid Transfer Element Descriptor). This bit indicates to the Device Controller that there are no more valid entries in the queue.

The following table describes the dTD Token.

Table 56-62. dTD Token

Bit	Description
31	Reserved. Bit reserved for future use and should be set to zero.
30-16	<p>Total Bytes. This field specifies the total number of bytes to be moved with this transfer descriptor. This field is decremented by the number of bytes actually moved during the transaction and only on the successful completion of the transaction.</p> <p>The maximum value software may store in the field is 5*4K (5000H). This is the maximum number of bytes 5 page pointers can access. Although it is possible to create a transfer up to 20K this assumes the 1st offset into the first page is 0. When the offset cannot be predetermined, crossing past the 5th page can be guaranteed by limiting the total bytes to 16K**. Therefore, the maximum recommended transfer is 16K (4000H).</p> <p>If the value of the field is zero when the host controller fetches this transfer descriptor (and the active bit is set), the device controller executes a zero-length transaction and retires the transfer descriptor.</p>

Table continues on the next page...

Table 56-62. dTD Token (continued)

	It is not a requirement for IN transfers that Total Bytes To Transfer be an even multiple of <i>Maximum Packet Length</i> . If software builds such a transfer descriptor for an IN transfer, the last transaction will always be less than <i>Maximum Packet Length</i> .
15	Interrupt On Complete (IOC). This bit is used to indicate if USBINT is to be set in response to device controller being finished with this dTD.
14-12	Reserved. Bits reserved for future use and should be set to zero.
11-10	Multiplier Override (MultiO). This field can be used for transmit ISO's (ie. ISO-IN) to override the multiplier in the QH. This field must be zero for all packet types that are not transmit-ISO. Example: if QH.multiplier = 3; Maximum packet size = 8; Total Bytes = 15; MultiO = 0 [default] Three packets are sent: {Data2(8); Data1(7); Data0(0)} if QH.multiplier = 3; Maximum packet size = 8; Total Bytes = 15; MultiO = 2 Two packets are sent: {Data1(8); Data0(7)} For maximal efficiency, software should compute MultiO = greatest integer of (Total Bytes / Max. Packet Size) except for the case when Total Bytes = 0; then MultiO should be 1. Note: Non-ISO and Non-TX endpoints must set MultiO = "00".
9-8	Reserved. Bits reserved for future use and should be set to zero.
7-0	Status. This field is used by the Device Controller to communicate individual command execution states back to the Device Controller software. This field contains the status of the last transaction performed on this qTD. The bit encodings are: Bit Status Field Description 7 Active. 6 Halted. 5 Data Buffer Error. 3 Transaction Error. 4, 2, 0 Reserved.

The table below describes the dTD Buffer Page Pointer List.

Table 56-63. dTD Buffer Page Pointer List

Bit	Description
31-12	Buffer Pointer. Selects the page offset in memory for the packet buffer. Non virtual memory systems will typically set the buffer pointers to a series of incrementing integers.
0,11-0	Current Offset. Offset into the 4kb buffer where the packet is to begin.
1,10-0	Frame Number. Written by the device controller to indicate the frame number in which a packet finishes. This is typically be used to correlate relative completion times of packets on an ISO endpoint.

56.4.6 Device Operational Model

The function of the device operation is to transfer a request in the memory image to and from the Universal Serial Bus.

Using a set of linked list transfer descriptors, pointed to by a queue head, the device controller will perform the data transfers. The following sections explain the use of the device controller from the device controller driver (DCD) point-of-view and further describe how specific USB bus events relate to status changes in the device controller programmer's interface.

56.4.6.1 Device Controller Initialization

After hardware reset, the device is disabled until the Run/Stop bit is set to a '1'. In the disabled state, the pull-up on the USB D+ is not active which prevents an attach event from occurring. At a minimum, it is necessary to have the queue heads setup for endpoint zero before the device attach occurs.

Shortly after the device is enabled, a USB reset will occur followed by setup packet arriving at endpoint 0. A Queue head must be prepared so that the device controller can store the incoming setup packet.

In order to initialize a device, the software should perform the following steps:

- Set Controller Mode in the USB.USBMODE register to device mode.

NOTE

Transitioning from host mode to device mode requires a device controller reset before modifying USB.USBMODE.

- Allocate and Initialize device queue heads in system memory.
 - Minimum: Initialize device queue heads 0 Tx & 0 Rx.

NOTE

All device queue heads for control endpoints must be initialized before the endpoint is enabled. Non-Control device queue heads before the endpoint can be used.

- For information on device queue heads, refer to section [Device Data Structures](#).
- Configure USB.ENDPOINTLISTADDR Pointer.
 - For additional information on USB.ENDPOINTLISTADDR, refer to the register table.
- Enable the microprocessor interrupt associated with the USB core.
 - Recommended: enable all device interrupts including: USBINT, USBERRINT, Port Change Detect, USB Reset Received, DCSuspend.
 - For a list of available interrupts refer to the [Interrupt Enable Register \(USB_nUSBINTR\)](#) and the [USB Status Register \(USB_nUSBSTS\)](#) register tables.
- Set Run/Stop bit to Run Mode.

- After the Run bit is set and the device is connected to a host, a Bus Reset will be issued by host downstream port. The DCD must monitor the reset event and adjust the software state as described in the Bus Reset section of the Port State and Control section below.

NOTE

Endpoint 0 is designed as a control endpoint only and does not need to be configured using `ENDPTCTRL0` register.

It is also not necessary to prime Endpoint 0 initially because the first packet received will always be a setup packet. The contents of the first setup packet will require a response in accordance with USB device framework (Chapter 9) command set.

56.4.6.2 Port State and Control

From a chip or system reset, the device controller enters the *powered* state. A transition from the *powered* state to the *attach* state occurs when the Run/Stop bit is set to a '1'.

After receiving a reset on the bus, the port will enter the *defaultFS* or *defaultHS* state in accordance with the reset protocol described in Appendix C.2 of the USB Specification Rev. 2.0.

The following state diagram depicts the state of a USB 2.0 device.

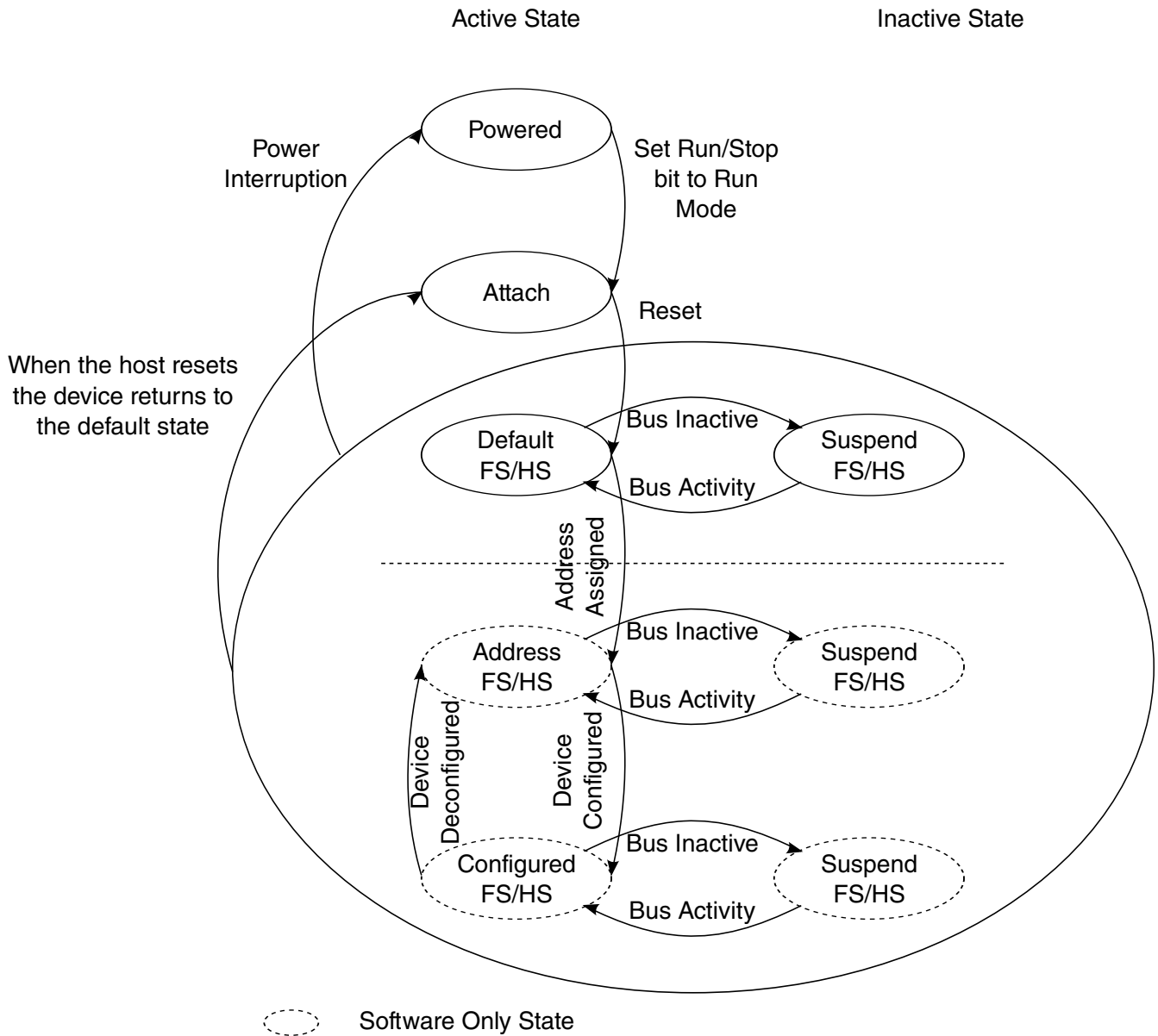

Figure 56-28. Device State Diagram

States *powered*, *attach*, *defaultFS/HS*, *suspendFS/HS* are implemented in the device controller and are communicated to the DCD using the following status bits:

The following table describes the Device Controller State Information Bits.

Table 56-64. Device Controller State Information Bits

Bit	Register
DCSuspend	USB Status Register (USB_nUSBSTS)
USB Reset Received	USB Status Register (USB_nUSBSTS)
Port Change Detect	USB Status Register (USB_nUSBSTS)
High-Speed Port	Port Status & Control (USB_nPORTSC1)

It is the responsibility of the DCD to maintain a state variable to differentiate between the *DefaultFS/HS* state and the *Address/Configured* states. Change of state from *Default* to *Address* and the *Configured* states is part of the enumeration process described in the device framework section of the USB 2.0 Specification.

As a result of entering the *Address* state, the device address register (DEVICEADDR) must be programmed by the DCD.

Entry into the *Configured* indicates that all endpoints to be used in the operation of the device have been properly initialized by programming the USB_UOG_ENDPTCTRLx registers and initializing the associated queue heads.

56.4.6.2.1 Bus Reset

A bus reset is used by the host to initialize downstream devices.

When a bus reset is detected, the device controller will renegotiate its attachment speed, reset the device address to 0, and notify the DCD by interrupt (assuming the USB Reset Interrupt Enable is set). After a reset is received, all endpoints (except endpoint 0) are disabled and any primed transactions will be cancelled by the device controller. The concept of priming will be clarified below, but the DCD must perform the following tasks when a reset is received:

Clear all setup token semaphores by reading the [Endpoint Status \(USB_nENDPTSTAT\)](#) register and writing the same value back to the [Endpoint Status \(USB_nENDPTSTAT\)](#) register.

Clear all the endpoint complete status bits by reading the [Endpoint Complete \(USB_nENDPTCOMPLETE\)](#) register and writing the same value back to the [Endpoint Complete \(USB_nENDPTCOMPLETE\)](#) register.

Cancel all primed status by waiting until all bits in the [Endpoint Prime \(USB_nENDPTPRIME\)](#) are 0 and then writing 0xFFFFFFFF to [Endpoint Flush \(USB_nENDPTFLUSH\)](#).

Read the reset bit in the [Port Status & Control \(USB_nPORTSC1\)](#) register and make sure that it is still active. A USB reset will occur for a minimum of 3 ms and the DCD must reach this point in the reset cleanup before end of the reset occurs, otherwise a hardware reset of the device controller is recommended (rare.)

- A hardware reset can be performed by writing a one to the device controller reset bit in the USBCMD reset. Note: a hardware reset will cause the device to detach from the bus by clearing the Run/Stop bit. Thus, the DCD must completely re-initialize the device controller after a hardware reset.

Free all allocated dTDs because they will no longer be executed by the device controller. If this is the first time the DCD is processing a USB reset event, then it is likely that no dTDs have been allocated.

At this time, the DCD may release control back to the OS because no further changes to the device controller are permitted until a Port Change Detect is indicated.

After a Port Change Detect, the device has reached the default state and the DCD can read the [Port Status & Control \(USB_nPORTSC1\)](#) to determine if the device is operating in FS or HS mode. At this time, the device controller has reached normal operating mode and DCD can begin enumeration according to the USB Chapter 9 - Device Framework.

NOTE

The device DCD may use the FS/HS mode information to determine the bandwidth mode of the device

In some applications, it may not be possible to enable one or more pipes while in FS mode. *Beyond the data rate issue, there is no difference in DCD operation between FS and HS modes.*

56.4.6.2.2 Suspend/Resume

The details of suspend and resume are explained in these sections.

56.4.6.2.2.1 Suspend

Suspend Description

In order to conserve power, USB devices automatically enter the suspended state when the device has observed no bus traffic for a specified period. When suspended, the USB device maintains any internal status, including its address and configuration. Attached devices must be prepared to suspend at any time they are powered, regardless of if they have been assigned a non-default address, are configured, or neither. Bus activity may cease due to the host entering a suspend mode of its own. In addition, a USB device shall also enter the suspended state when the hub port it is attached to is disabled.

A USB device exits suspend mode when there is bus activity. A USB device may also request the host to exit suspend mode or selective suspend by using electrical signaling to indicate remote wakeup. The ability of a device to signal remote wakeup is optional. If the USB device is capable of remote wakeup signaling, the device must support the ability of the host to enable and disable this capability. When the device is reset, remote wakeup signaling must be disabled.

Suspend Operational Model

The device controller moves into the suspend state when suspend signaling is detected or activity is missing on the upstream port for more than a specific period. After the device controller enters the suspend state, the DCD is notified by an interrupt (assuming *DC Suspend Interrupt* is enabled). When the *DCSuspend* bit in the [Port Status & Control \(USB_nPORTSC1\)](#) is set to a '1', the device controller is suspended.

DCD response when the device controller is suspended is application specific and may involve switching to low power operation.

Information on the bus power limits in suspend state can be found in USB 2.0 specification.

NOTE

Review system level clocking issues defined in section (Ref: Signals-Clocking) for the clocking requirements of a suspended device controller.

56.4.6.2.2 Resume

If the device controller is suspended, its operation is resumed when any non-idle signaling is received on its upstream facing port. In addition, the device can signal the system to resume operation by forcing resume signaling to the upstream port.

Resume signaling is sent upstream by writing a '1' to the Resume bit in the in the [Port Status & Control \(USB_nPORTSC1\)](#) while the device is in suspend state. Sending resume signal to an upstream port should cause the host to issue resume signaling and bring the suspended bus segment (one more devices) back to the active condition.

NOTE

Before resume signaling can be used, the host must enable it by using the Set Feature command defined in device framework (chapter 9) of the USB 2.0 Specification.

56.4.6.3 Managing Endpoints

The USB 2.0 specification defines an endpoint, also called a device endpoint or an address endpoint as a uniquely addressable portion of a USB device that can source or sink data in a communications channel between the host and the device.

The endpoint address is specified by the combination of the endpoint number and the endpoint direction.

The channel between the host and an endpoint at a specific device represents a data pipe. Endpoint 0 for a device is always a *control* type data channel used for device discovery and enumeration. Other types of endpoints support by USB include *bulk*, *interrupt*, and *isochronous*. Each endpoint type has specific behavior related to packet response and error handling. More detail on endpoint operation can be found in the USB 2.0 specification.

The USB OTG device controller hardware supports up to 8 endpoint numbers.

Each endpoint direction is essentially independent and can be configured with differing behavior in each direction. For example, the DCD can configure endpoint 1-IN to be a bulk endpoint and endpoint 1-OUT to be an isochronous endpoint. This helps to conserve the total number of endpoints required for device operation. The only exception is that control endpoints must use both directions on a single endpoint number to function as a control endpoint. Endpoint 0 is, for example, is always a control endpoint and uses the pair of directions.

Each endpoint direction requires a *queue head* allocated in memory. To support the 8 endpoint numbers, 16 *queue heads* are required. The operation of an endpoint and use of *queue heads* are described later in this document.

56.4.6.3.1 Endpoint Initialization

After hardware reset, all endpoints except endpoint zero are uninitialized and disabled. The DCD must configure and enable each endpoint by writing to configuration bit in the USB_UOG_ENDPTCTRLx register.

Each 32-bit USB_UOG_ENDPTCTRLx is split into an upper and lower half. The lower half of USB_UOG_ENDPTCTRLx is used to configure the receive or OUT endpoint and the upper half is likewise used to configure the corresponding transmit or IN endpoint. Control endpoints must be configured the same in both the upper and lower half of the USB_UOG_ENDPTCTRLx register otherwise the behavior is undefined. The following table shows how to construct a configuration word for endpoint initialization. The following table shows the fields and values for the Device Controller Endpoint initialization.

Table 56-65. Device Controller Endpoint Initialization

Field	Value
Data Toggle Reset	1
Data Toggle Inhibit	0
Endpoint Type	00 Control 01 Isochronous 10 Bulk

Table continues on the next page...

Table 56-65. Device Controller Endpoint Initialization (continued)

	11 Interrupt
Endpoint Stall	0

56.4.6.3.2 Stalling

There are two occasions where the device controller may need to return to the host a STALL.

The first occasion is the functional stall, which is a condition set by the DCD as described in the USB 2.0 device framework. A functional stall is only used on non-control endpoints and can be enabled in the device controller by setting the endpoint stall bit in the USB_UOG_ENDPTCTRLx register associated with the given endpoint and the given direction. In a functional stall condition, the device controller will continue to return STALL responses to all transactions occurring on the respective endpoint and direction until the endpoint stall bit is cleared by the DCD.

A protocol stall, unlike a function stall, is used on control endpoints is automatically cleared by the device controller at the start of a new control transaction (setup phase). When enabling a protocol stall, the DCD should enable the stall bits (both directions) as a pair. A single write to the USB_UOG_ENDPTCTRLx register can ensure that both stall bits are set at the same instant.

NOTE

Any write to the USB_UOG_ENDPTCTRLx register during operational mode must preserve the endpoint type field (that is, perform a read-modify-write).

The following table shows the response matrix for the Device Controller Stall.

Table 56-66. Device Controller Stall Response Matrix

USB Packet	Endpoint Stall Bit.	Effect on STALL bit.	USB Response
SETUP packet received by a non-control endpoint.	N/A	None.	STALL
IN/OUT/PING packet received by a non-control endpoint.	'1'	None.	STALL
IN/OUT/PING packet received by a non-control endpoint.	'0'	None.	ACK/ NAK/ NYET
SETUP packet received by a control endpoint.	N/A	Cleared	ACK
IN/OUT/PING packet received by a control endpoint	'1'	None	STALL

Table continues on the next page...

Table 56-66. Device Controller Stall Response Matrix (continued)

IN/OUT/PING packet received by a control endpoint.	'0'	None.	ACK/ NAK/ NYET
--	-----	-------	----------------------

56.4.6.3.3 Data Toggle

Data toggle is a mechanism to maintain data coherency between host and device for any given data pipe.

For more information on data toggle, refer to the USB 2.0 specification.

56.4.6.3.3.1 Data Toggle Reset

The DCD may reset the data toggle state bit and cause the data toggle sequence to reset in the device controller by writing a '1' to the data toggle reset bit in the USB_UOG_ENDPTCTRLx register.

This should only be necessary when configuring/initializing an endpoint or returning from a STALL condition.

56.4.6.3.3.2 Data Toggle Inhibit

NOTE

This feature is for test purposes only and should never be used during normal device controller operation.

Setting the *data toggle Inhibit bit* active ('1') causes the device controller to ignore the data toggle pattern that is normally sent and accept all incoming data packets regardless of the data toggle state.

In normal operation, the device controller checks the DATA0/DATA1 bit against the data toggle to determine if the packet is valid. If Data PID does not match the data toggle state bit maintained by the device controller for that endpoint, the Data toggle is considered not valid. If the data toggle is not valid, the device controller assumes the packet was already received and discards the packet (not reporting it to the DCD). To prevent the host controller from re-sending the same packet, the device controller will respond to the error packet by acknowledging it with either an ACK or NYET response.

56.4.6.3.3.3 Priming Transmit Endpoints

Priming a transmit endpoint will cause the device controller to fetch the device transfer descriptor (dTd) for the transaction pointed to by the device queue head (dQH).

After the dTD is fetched, it will be stored in the dQH until the device controller completes the transfer described by the dTD. Storing the dTD in the dQH allows the device controller to fetch the operating context needed to handle a request from the host without the need to follow the linked list, starting at the dQH when the host request is received.

After the device has loaded the dTD, the leading data in the packet is stored in a FIFO in the device controller. This FIFO is split into virtual channels so that the leading data can be stored for any endpoint up to the maximum number of endpoints configured at device synthesis time.

After a priming request is complete, an endpoint state of primed is indicated in the USB_UOG_ENDPTSTATUS register. For a primed transmit endpoint, the device controller can respond to an IN request from the host and meet the stringent bus turnaround time of High Speed USB.

Because only the leading data is stored in the device controller FIFO, it is necessary for the device controller to begin filling in behind leading data after the transaction starts. The FIFO must be sized to account for the maximum latency that can be incurred by the system memory bus. More information about FIFO sizing is presented in section .

56.4.6.3.3.4 Priming Receive Endpoints

Priming receive endpoints is identical to priming of transmit endpoints from the point of view of the DCD. At the device controller the major difference in the operational model is that there is no data movement of the leading packet data simply because the data is to be received from the host.

Note as part of the architecture, the FIFO for the receive endpoints is not partitioned into multiple channels like the transmit FIFO. Thus, the size of the RX FIFO does not scale with the number of endpoints.

56.4.6.4 Operational Model For Packet Transfers

All transactions on the USB bus are initiated by the host and in turn, the device must respond to any request from the host within the turnaround time stated in the USB 2.0 Specification.

At USB 1.1 Full or Low Speed rates, this turnaround time was significant and the USB 1.1 device controllers were architected so that the device controller could access main memory or interrupt a host protocol processor in order to respond to the USB 1.1

transaction. The architecture of the USB 2.0 device controller must be different because same methods will not meet USB 2.0 High-speed turnaround time requirements by simply increasing clock rate.

A USB host will send requests to the device controller in an order that can not be precisely predicted as a single pipeline, so it is not possible to prepare a single packet for the device controller to execute. However, the order of packet requests is predictable when the endpoint number and direction is considered. For example, if endpoint 3 (transmit direction) is configured as a bulk pipe, then we can expect the host will send IN requests to that endpoint. This device controller is architected in such a way that it can prepare packets for each endpoint/direction in anticipation of the host request. The process of preparing the device controller to send or receive data in response to host initiated transaction on the bus is referred to as "priming" the endpoint. This term will be used throughout the following documentation to describe the device controller operation so the DCD can be architected properly use priming. Further, note that the term "flushing" is used to describe the action of clearing a packet that was queued for execution.

56.4.6.4.1 Interrupt/Bulk Endpoint Operational Model

The behaviors of the device controller for interrupt and bulk endpoints are identical.

All valid IN and OUT transactions to bulk pipes will handshake with a NAK unless the endpoint had been primed. Once the endpoint has been primed, data delivery will commence.

A dTD will be retired by the device controller when the packets described in the transfer descriptor have been completed. Each dTD describes N packets to be transferred according to the USB Variable Length transfer protocol. The formula and table on the following page describe how the device controller computes the number and length of the packets to be sent/received by the USB vary according to the total number of bytes and maximum packet length.

With Zero Length Termination (ZLT) = 0

$$N = \text{INT}(\text{Number Of Bytes}/\text{Max. Packet Length}) + 1$$

With Zero Length Termination (ZLT) = 1

$$N = \text{MAXINT}(\text{Number Of Bytes}/\text{Max. Packet Length})$$

Table 56-67. Variable Length Transfer Protocol Example (ZLT = 0)

Bytes (dTD)	Max. Packet Length (dQH)	N	P1	P2	P3
511	256	2	256	255	

Table continues on the next page...

Table 56-67. Variable Length Transfer Protocol Example (ZLT = 0) (continued)

512	256	3	256	256	0
512	512	2	512	0	

Table 56-68. Variable Length Transfer Protocol Example (ZLT = 1)

Bytes (dTD)	Max. Packet Length (dQH)	N	P1	P2	P3
511	256	2	256	255	
512	256	2	256	256	
512	512	1	512		

NOTE

The MULT field in the dQH must be set to "00" for bulk, interrupt, and control endpoints.

TX-dTD is complete when:

- All packets described dTD were successfully transmitted. *** Total bytes in dTD will equal zero when this occurs.

RX-dTD is complete when:

- All packets described in dTD were successfully received. *** Total bytes in dTD will equal zero when this occurs.
- A short packet (number of bytes < maximum packet length) was received. *** This is a successful transfer completion; DCD must check Total Bytes in dTD to determine the number of bytes that are remaining. From the total bytes remaining in the dTD, the DCD can compute the actual bytes received.
- A long packet was received (number of bytes > maximum packet size) OR (total bytes received > total bytes specified). *** This is an error condition. The device controller will discard the remaining packet, and set the Buffer Error bit in the dTD. In addition, the endpoint will be flushed and the USBERR interrupt will become active.

On the successful completion of the packet(s) described by the dTD, the active bit in the dTD will be cleared and the next pointer will be followed when the Terminate bit is clear. When the Terminate bit is set, the device controller will flush the endpoint/direction and cease operations for that endpoint/direction.

On the unsuccessful completion of a packet (see long packet above), the dQH will be left pointing to the dTD that was in error. In order to recover from this error condition, the DCD must properly reinitialize the dQH by clearing the active bit and update the nextTD pointer before attempting to re-prime the endpoint.

NOTE

All packet level errors such as a missing handshake or CRC error will be retried automatically by the device controller.

There is no required interaction with the DCD for handling such errors.

56.4.6.4.1.1 Interrupt/Bulk Endpoint Bus Response Matrix

The table below shows the response matrix for Interrupt/Bulk Endpoint Bus.

Table 56-69. Interrupt/Bulk Endpoint Bus Response Matrix

	Stall	Not Primed	Primed	Underflow	Overflow
Setup	Ignore	Ignore	Ignore	N/A	N/A
In	STALL	NAK	Transmit	BS Error	N/A
Out	STALL	NAK	Receive + NYET/ACK	N/A	NAK
Ping	STALL	NAK	ACK	N/A	N/A
Invalid	Ignore	Ignore	Ignore	Ignore	Ignore

NOTE

BS Error = Force Bit Stuff Error

NYET/ACK - NYET unless the Transfer Descriptor has packets remaining according to the USB variable length protocol then ACK.

SYSERR - System error should never occur when the latency FIFOs are correctly sized and the DCD is responsive.

56.4.6.4.2 Control Endpoint Operation Model

This section details the setup phase, data phase, status phase, and the control endpoint bus response matrix.

56.4.6.4.2.1 Setup Phase

All requests to a control endpoint begin with a setup phase followed by an optional data phase and a required status phase. The device controller will always accept the setup phase unless the setup lockout is engaged.

The setup lockout will engage so that future setup packets are ignored. Lockout of setup packets ensures that while software is reading the setup packet stored in the queue head, that data is not written as it is being read potentially causing an invalid setup packet.

The setup lockout mechanism can be disabled and a new tripwire type semaphore will ensure that the setup packet payload is extracted from the queue head without being corrupted by an incoming setup packet. This is the preferred behavior because ignoring repeated setup packets due to long software interrupt latency would be a compliance issue.

- Disable Setup Lockout by writing 1 to Setup Lockout Mode (SLOM) in [USB Device Mode \(USB_nUSBMODE\)](#). (once at initialization). Setup lockout is not necessary when using the tripwire as described below.

NOTE

Leaving the Setup Lockout Mode As 0 will result in pre-2.3 hardware behavior.

- After receiving an interrupt and inspecting [Endpoint Setup Status \(USB_nENDPTSETUPSTAT\)](#) to determine that a setup packet was received on a particular pipe:
 - a. Write 1 to clear corresponding bit [Endpoint Setup Status \(USB_nENDPTSETUPSTAT\)](#).
 - b. Write 1 to Setup Tripwire (SUTW) in [USB Command Register \(USB_nUSBCMD\)](#) register.
 - c. Duplicate contents of dQH.SetupBuffer into local software byte array.
 - d. Read Setup TripWire (SUTW) in [USB Command Register \(USB_nUSBCMD\)](#) register. (if set - continue; if cleared - goto 2)
 - e. Write 0 to clear Setup Tripwire (SUTW) in [USB Command Register \(USB_nUSBCMD\)](#) register.
 - f. Process setup packet using local software byte array copy and execute status/handshake phases.

NOTE

After receiving a new setup packet the status and/or handshake phases may still be pending from a previous control sequence. These should be flushed & deallocated before linking a new status and/or handshake dTD for the most recent setup packet.

56.4.6.4.2.2 Data Phase

Following the setup phase, the DCD must create a device transfer descriptor for the data phase and prime the transfer.

After priming the packet, the DCD must verify a new setup packet has not been received by reading the USB.ENDPTSETUPSTAT register immediately verifying that the prime had completed. A prime will complete when the associated bit in the [Endpoint Prime \(USB_nENDPTPRIME\)](#) register is zero and the associated bit in the [Endpoint Status](#)

(USB_nENDPTSTAT) register is a one. If a prime fails, ie. The **Endpoint Prime (USB_nENDPTPRIME)** bit goes to zero and the **Endpoint Status (USB_nENDPTSTAT)** bit is not set, then the prime has failed. This can only be due to improper setup of the dQH, dTD or a setup arriving during the prime operation. If a new setup packet is indicated after the ENDPTPRIME bit is cleared, then the transfer descriptor can be freed and the DCD must reinterpret the setup packet.

Should a setup arrive after the data stage is primed, the device controller will automatically clear the prime status (**Endpoint Status (USB_nENDPTSTAT)**) to enforce data coherency with the setup packet.

NOTE

- The MULT field in the dQH must be set to "00" for bulk, interrupt, and control endpoints.
- Error handling of data phase packets is the same as bulk packets described previously.

56.4.6.4.2.3 Status Phase

Similar to the data phase, the DCD must create a transfer descriptor (with byte length equal zero) and prime the endpoint for the status phase.

The DCD must also perform the same checks of the USB.ENDPTSETUPSTAT as described above in the data phase.

NOTE

- The MULT field in the dQH must be set to 00 for bulk, interrupt, and control endpoints.
- Error handling of data phase packets is the same as bulk packets described previously.

56.4.6.4.2.4 Control Endpoint Bus Response Matrix

Shown in the following table is the device controller response to packets on a control endpoint according to the device controller state.

The table below shows the response matrix for the Control Endpoint Bus.

Table 56-70. Control Endpoint Bus Response Matrix

Token Type	Endpoint State					Setup Lockout
	Stall	Not Primed	Primed	Underflow	Overflow	
Setup	ACK	ACK	ACK	N/A	SYSEERR	
In	STALL	NAK	Transmit	BS Error	N/A	N/A

Table continues on the next page...

Table 56-70. Control Endpoint Bus Response Matrix (continued)

Out	STALL	NAK	Receive + NYET/ACK	N/A	NAK	N/A
Ping	STALL	NAK	ACK	N/A	N/A	N/A
Invalid	Ignore	Ignore	Ignore	Ignore	Ignore	Ignore

BS Error = Force Bit Stuff Error

NYET/ACK - NYET unless the Transfer Descriptor has packets remaining according to the USB variable length protocol then ACK.

SYSERR - System error should never occur when the latency FIFOs are correctly sized and the DCD is responsive.

56.4.6.4.3 Isochronous Endpoint Operational Model

Isochronous endpoints are used for real-time scheduled delivery of data and their operational model is significantly different than the host throttled Bulk, Interrupt, and Control data pipes.

Real time delivery by the device controller will be accomplished by the following:

- Exactly MULT Packets per (micro) Frame are transmitted/received. Note: MULT is a two-bit field in the device Queue Head. The variable length packet protocol is not used on isochronous endpoints.
- NAK responses are not used. Instead, zero length packets are sent in response to an IN request to an unprimed endpoints. For unprimed RX endpoints, the response to an OUT transaction is to ignore the packet within the device controller.
- Prime requests always schedule the transfer described in the dTD for the next (micro) frame. If the ISO-dTD is still active after that frame, then the ISO-dTD will be held ready until executed or canceled by the DCD.

An EHCI compatible host controller uses the periodic frame list to schedule data exchanges to Isochronous endpoints. The operational model for device mode does not use such a data structure. Instead, the same dTD used for Control/Bulk/Interrupt endpoints is also used for isochronous endpoints. The difference is in the handling of the dTD.

The first difference between bulk and ISO-endpoints is that priming an ISO-endpoint is a delayed operation such that an endpoint will become primed only after a SOF is received. After the DCD writes the prime bit, the prime bit will be cleared as usual to indicate to software that the device controller completed a priming the dTD for transfer. Internal to the design, the device controller hardware masks that prime start until the next frame boundary. This behavior is hidden from the DCD but occurs so that the device controller can match the dTD to a specific (micro)frame.

Another difference with isochronous endpoints is that the transaction must wholly complete in a (micro)frame. Once an ISO transaction is started in a (micro)frame it will retire the corresponding dTD when MULT transactions occur or the device controller finds a fulfillment condition.

The transaction error bit set in the status field indicates a fulfillment error condition. When a fulfillment error occurs, the frame after the transfer failed to complete wholly, the device controller will force retire the ISO-dTD and move to the next ISO-dTD.

It is important to note that fulfillment errors are only caused due to partially completed packets. If no activity occurs to a primed ISO-dTD, the transaction will stay primed indefinitely. This means it is up to software discard transmit ISO-dTDs that pile up from a failure of the host to move the data.

Finally, the last difference with ISO packets is in the data level error handling. When a CRC error occurs on a received packet, the packet is not retried similar to bulk and control endpoints. Instead, the CRC is noted by setting the *Transaction Error* bit and the data is stored as usual for the application software to sort out.

- TX Packet Retired
 - MULT counter reaches zero.
 - Fulfillment Error [*Transaction Error* bit is set]
 - # Packets Occurred > 0 AND # Packets Occurred < MULT

NOTE

For TX-ISO, MULT Counter can be loaded with a lesser value in the dTD Multiplier Override field in hardware versions 2.3 and later. If the Multiplier Override is zero, the MULT Counter is initialized to the Multiplier in the QH.

- RX Packet Retired:
 - MULT counter reaches zero.
 - Non-MDATA Data PID is received**
 - ** Exit criteria only valid in hardware version 2.3 or later. Previous to hardware version 2.3, any PID sequence that did not match the MULT field exactly would be flagged as a transaction error due to PID mismatch or fulfillment error.
 - Overflow Error:
 - Packet received is > maximum packet length. [*Buffer Error* bit is set]
 - Packet received exceeds total bytes allocated in dTD. [*Buffer Error* bit is set]
 - Fulfillment Error [*Transaction Error* bit is set]
 - # Packets Occurred > 0 AND # Packets Occurred < MULT
 - CRC Error [*Transaction Error* bit is set]

NOTE

For ISO, when a dTD is retired, the next dTD is primed for the next frame. For continuous (micro)frame to (micro)frame operation the DCD should ensure that the dTD linked-list is out ahead of the device controller by at least two (micro)frames.

56.4.6.4.3.1 Isochronous Pipe Synchronization

When it is necessary to synchronize an isochronous data pipe to the host, the (micro) frame number (USB_UOG_FRINDEX register) can be used as a marker.

To cause a packet transfer to occur at a specific (micro) frame number [N], the DCD should interrupt on SOF during frame N-1. When the USB_UOG_FRINDEX=N-1, the DCD must write the prime bit. The device controller will prime the isochronous endpoint in (micro) frame N-1 so that the device controller will execute delivery during (micro) frame N.

NOTE

Priming an endpoint towards the end of (micro) frame N-1 will not guarantee delivery in (micro) frame N. The delivery may actually occur in (micro) frame N+1 if device controller does not have enough time to complete the prime before the SOF for packet N is received.

56.4.6.4.3.2 Isochronous Endpoint Bus Response Matrix

The following table shows the response matrix for the Isochronous Endpoint Bus.

Table 56-71. Isochronous Endpoint Bus Response Matrix

	Stall	Not Primed	Primed	Underflow	Overflow
Setup	STALL	STALL	STALL	N/A	N/A
In	NULL Packet	NULL Packet	Transmit	BS Error	N/A
Out	Ignore	Ignore	Receive	N/A	Drop Packet
Ping	Ignore	Ignore	Ignore	Ignore	Ignore
Invalid	Ignore	Ignore	Ignore	Ignore	Ignore

1. BS Error = Force Bit Stuff Error

NULL Packet = Zero Length Packet

56.4.6.5 Managing Queue Heads

The following figure shows the End Point Queue Head.

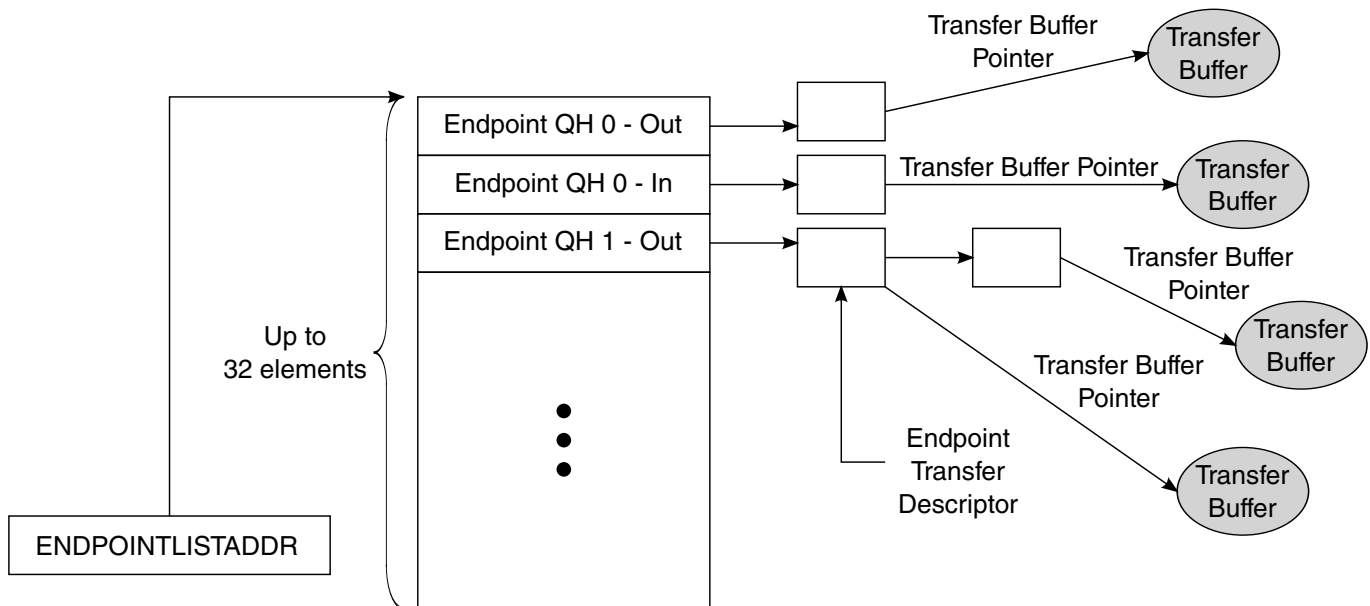

Figure 56-29. End Point Queue Head Diagram

The device queue head (dQH) points to the linked list of transfer tasks, each depicted by the device Transfer Descriptor (dTDT). An area of memory pointed to by `USB.ENDPOINTLISTADDR` contains a group of all dQH's in a sequential list as shown in [Figure 56-29](#). The even elements in the list of dQH's are used for receive endpoints (OUT/SETUP) and the odd elements are used for transmit endpoints (IN/INTERRUPT). Device transfer descriptors are linked head to tail starting at the queue head and ending at a terminate bit. Once the dTD has been retired, it will no longer be part of the linked list from the queue head. Therefore, software is required to track all transfer descriptors because pointers will no longer exist within the queue head once the dTD is retired (see section [Software Link Pointers](#)).

In addition to the current and next pointers and the dTD overlay examined in section [Operational Model For Packet Transfers](#), the dQH also contains the following parameters for the associated endpoint: Multiplier, Maximum Packet Length, Interrupt On Setup. The complete initialization of the dQH including these fields is demonstrated in the next section.

56.4.6.5.1 Queue Head Initialization

One device queue head must be initialized for each active endpoint.

To initialize a device queue head:

- Write the wMaxPacketSize field as required by the USB Chapter 9 or application specific protocol.
- Write the multiplier field to 0 for control, bulk, and interrupt endpoints. For ISO endpoints, set the multiplier to 1,2, or 3 as required bandwidth and in conjunction with the USB Chapter 9 protocol.

NOTE

In FS mode, the multiplier field can only be 1 for ISO endpoints.

- Write the next dTD Terminate bit field to 1.
- Write the Active bit in the status field to 0.
- Write the Halt bit in the status field to 0.

NOTE

The DCD must only modify dQH if the associated endpoint is not primed and there are no outstanding dTD's.

56.4.6.5.2 Operational Model For Setup Transfers

As discussed in section [Control Endpoint Operation Model](#), setup transfer requires special treatment by the DCD. A setup transfer does not use a dTD but instead stores the incoming data from a setup packet in an 8-byte buffer within the dQH.

Upon receiving notification of the setup packet, the DCD should handle the setup transfer as demonstrated here:

1. Copy setup buffer contents from dQH - RX to software buffer.
2. Acknowledge setup backup by writing a "1" to the corresponding bit in ENDPTSETUPSTAT.

NOTE

- The acknowledge must occur before continuing to process the setup packet.
 - After the acknowledge has occurred, the DCD must not attempt to access the setup buffer in the dQH - RX. Only the local software copy should be examined.
3. Check for pending data or status dTD's from previous control transfers and flush if any exist as discussed in section [Flushing/De-priming an Endpoint](#).
 4. Decode setup packet and prepare data phase [optional] and status phase transfer as required by the USB Chapter 9 or application specific protocol.

NOTE

It is possible for the device controller to receive setup packets before previous control transfers complete. Existing control packets in progress must be flushed and the new control packet completed.

56.4.6.6 Managing Transfers with Transfer Descriptors**56.4.6.6.1 Software Link Pointers**

It is necessary for the DCD software to maintain head and tail pointers to the for the linked list of dTDs for each respective queue head.

This is necessary because the dQH only maintains pointers to the current working dTD and the next dTD to be executed. The operations described in next section for managing dTD will assume the DCD can use reference the head and tail of the dTD linked list. The following figure shows the Software Link Pointers.

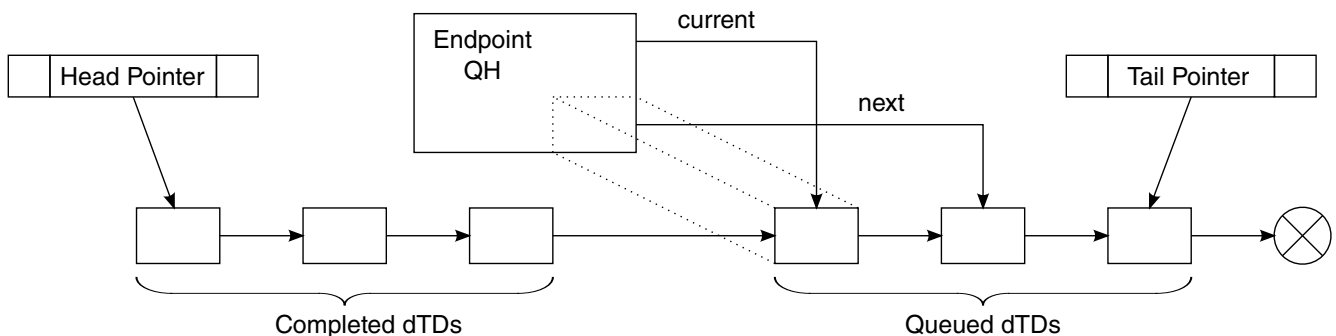

Figure 56-30. Software Link Pointers

NOTE

To conserve memory, the reserved fields at the end of the dQH can be used to store the Head & Tail pointers, but it still remains the responsibility of the DCD to maintain the pointers.

56.4.6.6.2 Building a Transfer Descriptor

Before a transfer can be executed from the linked list, a dTD must be built to describe the transfer.

Use the following procedure for building dTDs.

Allocate 8-DWord dTD block of memory aligned to 8-DWord boundaries. Example: bit address 4:0 would be equal to "00000"

Write the following fields:

1. Initialize first 7 DWords to 0.
2. Set the terminate bit to 1.
3. Fill in total bytes with transfer size.
4. Set the interrupt on complete if desired.
5. Initialize the status field with the active bit set to 1 and all remaining status bits set to 0.
6. Fill in buffer pointer page 0 and the current offset to point to the start of the data buffer.
7. Initialize buffer pointer page 1 through page 4 to be one greater than each of the previous buffer pointer.

56.4.6.6.3 Executing A Transfer Descriptor

To safely add a dTD, the DCD must follow this procedure which will handle the event where the device controller reaches the end of the dTD list at the same time a new dTD is being added to the end of the list.

Determine whether the link list is empty: Check DCD driver to see if pipe is empty (internal representation of linked-list should indicate if any packets are outstanding).

- Case 1: Link list is empty
 - a. Write dQH next pointer AND dQH terminate bit to 0 as a single DWord operation.
 - b. Clear active & halt bit in dQH (in case set from a previous error).
 - c. Prime endpoint by writing 1 to correct bit position in [Endpoint Prime \(USB_nENDPTPRIME\)](#).
- Case 2: Link list is not empty
 - a. Add dTD to end of linked list.
 - b. Read correct prime bit in [Endpoint Prime \(USB_nENDPTPRIME\)](#)- if 1 DONE.
 - c. Set ATDTW bit in USBCMD register to 1.
 - d. Read correct status bit in [Endpoint Status \(USB_nENDPTSTAT\)](#). (store in tmp. variable for later)
 - e. Read ATDTW bit in USBCMD register.
 - If 0 goto 3.
 - If 1 continue to 6.
 - f. Write ATDTW bit in USBCMD register to 0.
 - g. If status bit read in (3) is 1 DONE.

h. If status bit read in (3) is 0 then Goto Case 1: Step 1.

56.4.6.6.4 Transfer Completion

After a dTD has been initialized and the associated endpoint primed the device controller will execute the transfer upon the host-initiated request. The DCD will be notified with a USB interrupt if the Interrupt On Complete bit was set or alternately, the DCD can poll the endpoint complete register to find when the dTD had been executed. After a dTD has been executed, DCD can check the status bits to determine success or failure.

NOTE

Multiple dTD can be completed in a single endpoint complete notification. After clearing the notification, DCD must search the dTD linked list and retire all dTDs that have finished (Active bit cleared).

By reading the status fields of the completed dTDs, the DCD can determine if the transfers completed successfully. Success is determined with the following combination of status bits:

- Active = 0
- Halted = 0
- Transaction Error = 0
- Data Buffer Error = 0

Should any combination other than the one shown above exist, the DCD must take proper action. Transfer failure mechanisms are indicated in the [Device Error Matrix](#).

In addition to checking the status bit the DCD must read the Transfer Bytes field to determine the actual bytes transferred. When a transfer is complete, the Total Bytes transferred is by decremented by the actual bytes transferred. For Transmit packets, a packet is only complete after the actual bytes reaches zero, but for receive packets, the host may send fewer bytes in the transfer according the USB variable length packet protocol.

56.4.6.6.5 Flushing/De-priming an Endpoint

It is necessary for the DCD to flush to de-prime one more endpoints on a USB device reset or during a broken control transfer.

There may also be application specific requirements to stop transfers in progress. The following procedure can be used by the DCD to stop a transfer in progress:

1. Write a '1' to the corresponding bit(s) in [Endpoint Flush \(USB_nENDPTFLUSH\)](#).
2. Wait until all bits in [Endpoint Flush \(USB_nENDPTFLUSH\)](#) are '0'.

- Software note: this operation may take a large amount of time depending on the USB bus activity. It is not desirable to have this wait loop within an interrupt service routine.
3. Read [Endpoint Status \(USB_nENDPTSTAT\)](#) to ensure that for all endpoints commanded to be flushed, that the corresponding bits are now '0'. If the corresponding bits are '1' after step #2 has finished, then the flush failed as described in the following:
- Explanation: In very rare cases, a packet is in progress to the particular endpoint when commanded flush using [Endpoint Flush \(USB_nENDPTFLUSH\)](#). A safeguard is in place to refuse the flush to ensure that the packet in progress completes successfully. The DCD may need to repeatedly flush any endpoints that fail to flush by repeating steps 1-3 until each endpoint is successfully flushed.

56.4.6.6.6 Device Error Matrix

The following table summarizes packet errors that are not automatically handled by the Device Controller.

Table 56-72. Device Error Matrix

Error	Direction	Packet Type	Data Buffer Error Bit	Transaction Error Bit
Overflow **	RX	Any	1	0
ISO Packet Error	RX	ISO	0	1
ISO Fulfillment Error	Both	ISO	0	1

Notice that the device controller handles all errors on Bulk/Control/Interrupt Endpoints except for a data buffer overflow. However, for ISO endpoints, errors packets are not retried and errors are tagged as indicated. The table below describes the errors.

Table 56-73. Error Descriptions

Error	Description
Overflow	Number of bytes received exceeded max. packet size or total buffer length. ** This error will also set the Halt bit in the dQH and if there are dTDs remaining in the linked list for the endpoint, then those will not be executed.
ISO Packet Error	CRC Error on received ISO packet. Contents not guaranteed to be correct.
ISO Fulfillment Error	Host failed to complete the number of packets defined in the dQH mult field within the given (micro)frame. For scheduled data delivery the DCD may need to readjust the data queue because a fulfillment error will cause Device Controller to cease data transfers on the pipe for one (micro)frame. During the "dead" (micro)frame, the Device Controller reports error on the pipe and primes for the following frame.

56.4.6.7 Servicing Interrupts

The interrupt service routine must consider that there are high-frequency, low-frequency operations, and error operations and order accordingly.

56.4.6.7.1 High-Frequency Interrupts

High frequency interrupts in particular should be handled in the order below. The most important of these is listed first because the DCD must acknowledge a setup buffer in the timeliest manner possible.

The table below describes the High frequency interrupt events.

Table 56-74. High Frequency Interrupt Events

Execution Order	Interrupt	Action
1a	USB Interrupt - USB.ENDPTSETUPSTATUS	Copy contents of setup buffer and acknowledge setup packet (as indicated in Figure 56-29 shows the End Point Queue Head). Process setup packet according to USB 2.0 Chapter 9 or application specific protocol.
1b	USB Interrupt ¹ - USB.ENDPTCOMPLETE	Handle completion of dTD as indicated in Figure 56-29 shows the End Point Queue Head.
2	SOF Interrupt	Action as deemed necessary by application. This interrupt may not have a use in all applications.

1. It is likely that multiple interrupts to stack up on any call to the Interrupt Service Routine AND during the Interrupt Service Routine.

56.4.6.7.2 Low-Frequency Interrupts

The low frequency interrupts can be handled in any order because they do not occur often in comparison to the high-frequency interrupts.

The table below shows the Low frequency interrupt events.

Table 56-75. Low Frequency Interrupt Events

Interrupt	Action
Port Change	Change software state information.
Sleep Enable (Suspend)	Change software state information. Low power handling as necessary.
Reset Received	Change software state information. Abort pending transfers.

56.4.6.7.3 Error Interrupts

Error interrupts will be least frequent and should be placed last in the interrupt service routine.

The following table shows the error interrupt events.

Table 56-76. Error Interrupt Events

Interrupt	Action
USB Error Interrupt	This error is redundant because it combines USB Interrupt and an error status in the dTD. The DCD will more aptly handle packet-level errors by checking dTD status field upon receipt of USB Interrupt (w/ USB.ENDPTCOMPLETE).
System Error	Unrecoverable error. Immediate Reset of core; free transfers buffers in progress and restart the DCD.

56.5 USB Non-Core Memory Map/Register Definition

There are two kinds of registers in the USB module: USB core registers and USB non-core registers.

USB core registers are used to control USB core functions, and more independent of USB features. Each USB controller core has its own core registers.

USB non-core registers are additional to USB core registers, and more dependent on USB features. i.MX series products vary in non-core registers.

This section describes only the USB non-core registers. For detailed descriptions of USB core registers, please refer to [Register Interface](#).

NOTE

- For reserved bits, please preserve the value when writing (read its reset value, then write this value back)
- "USB_UOG1_", "USB_UOG2_" prefix in register name indicates it is a core register for OTG1/OTG2 controller core respectively.
- USBNC_USB_" prefix in register name indicates it is a USB non-core register.

USBNC memory map

Absolute address (hex)	Register name	Width (in bits)	Access	Reset value	Section/page
218_4800	USB OTG1 Control Register (USBNC_USB_OTG1_CTRL)	32	R/W	3000_1000h	56.5.1/3816
218_4804	USB OTG2 Control Register (USBNC_USB_OTG2_CTRL)	32	R/W	3000_1000h	56.5.2/3819
218_4818	OTG1 UTMI PHY Control 0 Register (USBNC_USB_OTG1_PHY_CTRL_0)	32	R/W	8000_0000h	56.5.3/3822
218_481C	OTG2 UTMI PHY Control 0 Register (USBNC_USB_OTG2_PHY_CTRL_0)	32	R/W	8000_0098h	56.5.4/3823

56.5.1 USB OTG1 Control Register (USBNC_USB_OTG1_CTRL)

The USB OTG1 control register controls the integration specific features of the USB OTG1 module. These features are not directly related to the USB functionality, but control special features, interfacing on the USB ports, as well as power control and wake-up functionality.

Address: 218_4000h base + 800h offset = 218_4800h

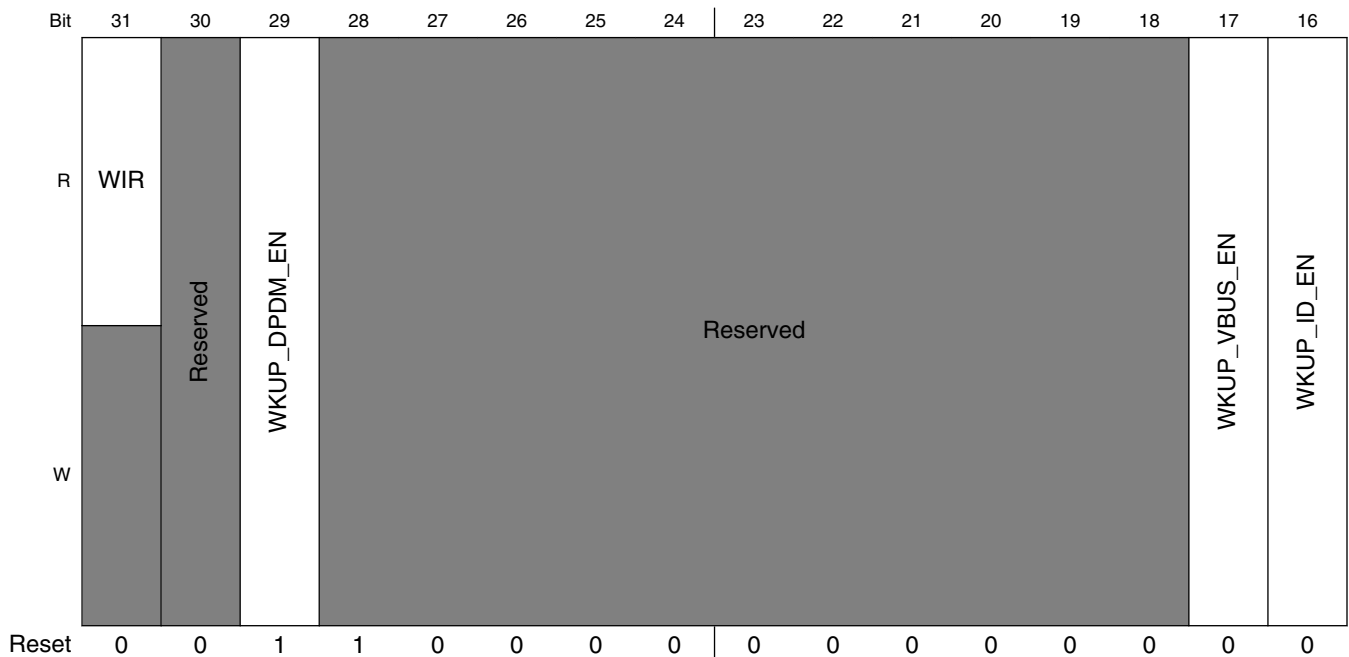

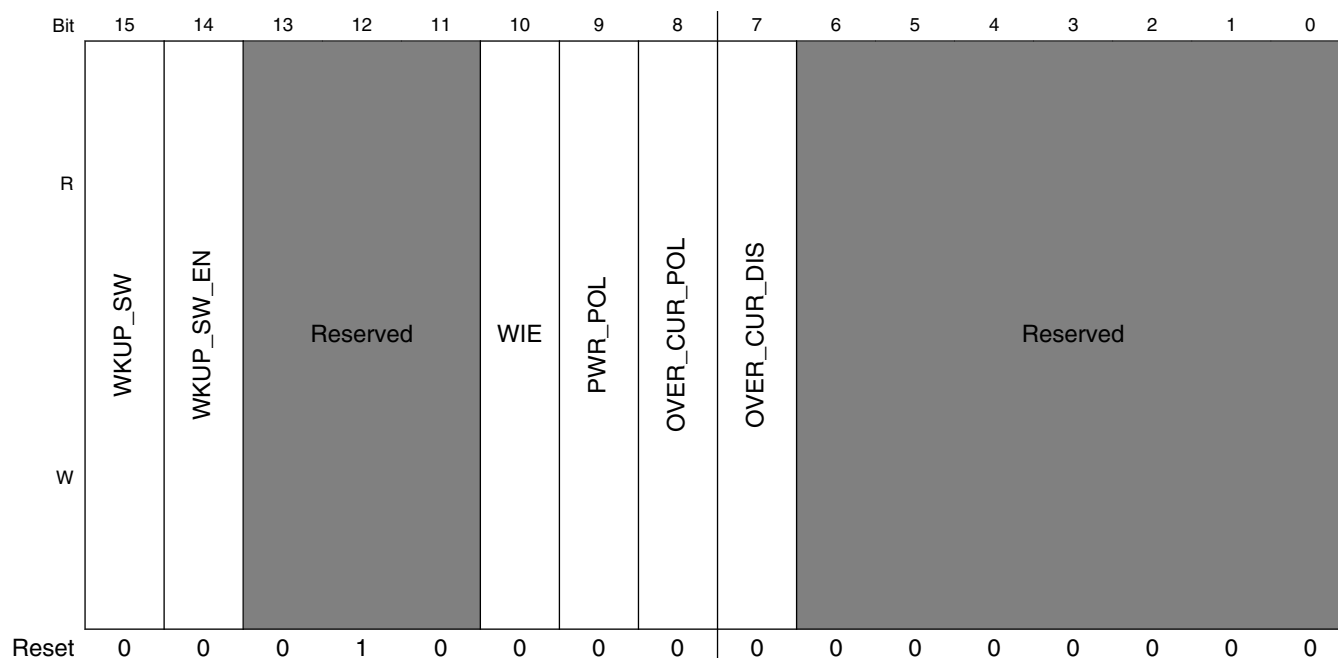

USBNC_USB_OTG1_CTRL field descriptions

Field	Description
31 WIR	OTG1 Wake-up Interrupt Request This bit indicates that a wake-up interrupt request is received on the OTG1 port. This bit is cleared by disabling the wake-up interrupt (clearing bit "OWIE"). 1 Wake-up Interrupt Request received 0 No wake-up interrupt request received
30 -	This field is reserved. Reserved
29 WKUP_DPDM_EN	Wake-up on DPDM change enable 1 (Default) DPDM changes wake-up to be enabled, it is for device only. 0 DPDM changes wake-up to be disabled only when VBUS is 0.
28–18 -	This field is reserved. Reserved
17 WKUP_VBUS_EN	OTG1 wake-up on VBUS change enable 1 Enable 0 Disable
16 WKUP_ID_EN	OTG1 Wake-up on ID change enable 1 Enable 0 Disable
15 WKUP_SW	OTG1 Software Wake-up 1 Force wake-up 0 Inactive

Table continues on the next page...

USBNC_USB_OTG1_CTRL field descriptions (continued)

Field	Description
14 WKUP_SW_EN	OTG1 Software Wake-up Enable 1 Enable 0 Disable
13–11 -	This field is reserved. Reserved
10 WIE	OTG1 Wake-up Interrupt Enable This bit enables or disables the OTG1 wake-up interrupt. Disabling the interrupt also clears the Interrupt request bit. Wake-up interrupt enable should be turned off after receiving a wake-up interrupt and turned on again prior to going in suspend mode 1 Interrupt Enabled 0 Interrupt Disabled
9 PWR_POL	OTG1 Power Polarity This bit should be set according to PMIC Power Pin polarity. 1 PMIC Power Pin is High active. 0 PMIC Power Pin is Low active.
8 OVER_CUR_POL	OTG1 Polarity of Overcurrent The polarity of OTG1 port overcurrent event 1 Low active (low on this signal represents an overcurrent condition) 0 High active (high on this signal represents an overcurrent condition)
7 OVER_CUR_DIS	Disable OTG1 Overcurrent Detection 1 Disables overcurrent detection 0 Enables overcurrent detection
-	This field is reserved. Reserved

56.5.2 USB OTG2 Control Register (USBNC_USB_OTG2_CTRL)

The USB OTG2 control register controls the integration specific features of the USB OTG2 module. These features are not directly related to the USB functionality, but control special features, interfacing on the USB ports, as well as power control and wake-up functionality.

Address: 218_4000h base + 804h offset = 218_4804h

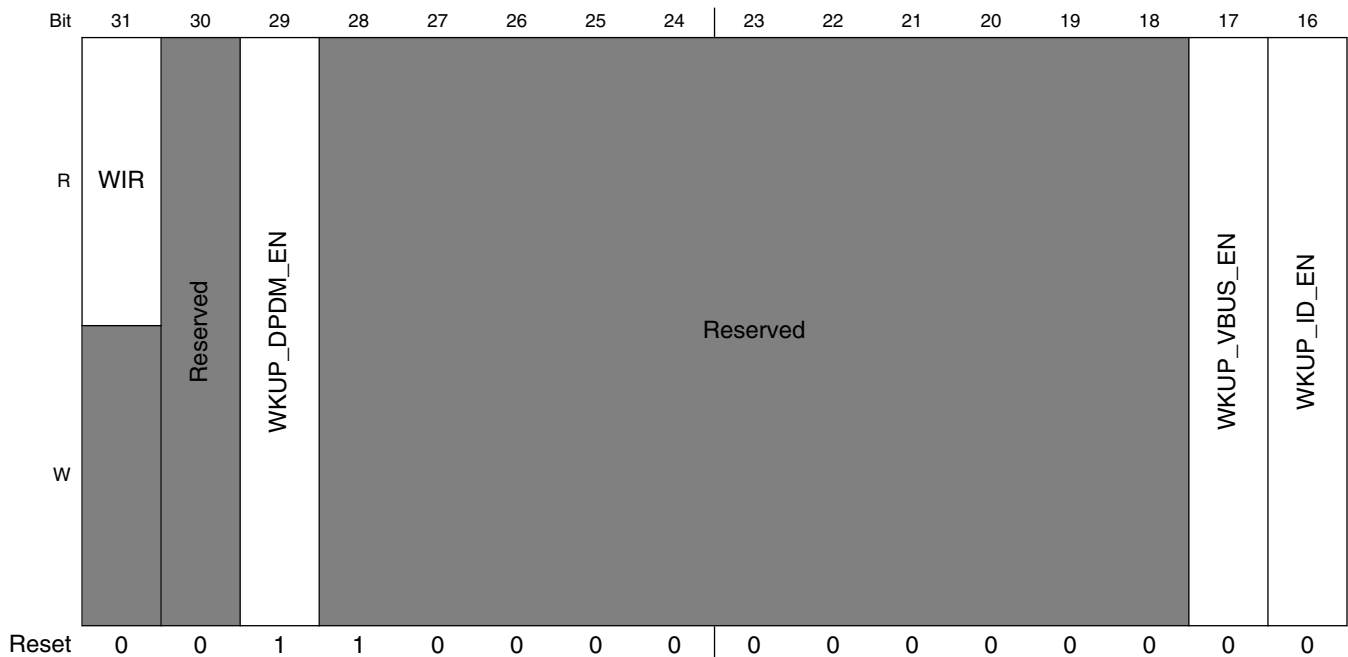

USB Non-Core Memory Map/Register Definition

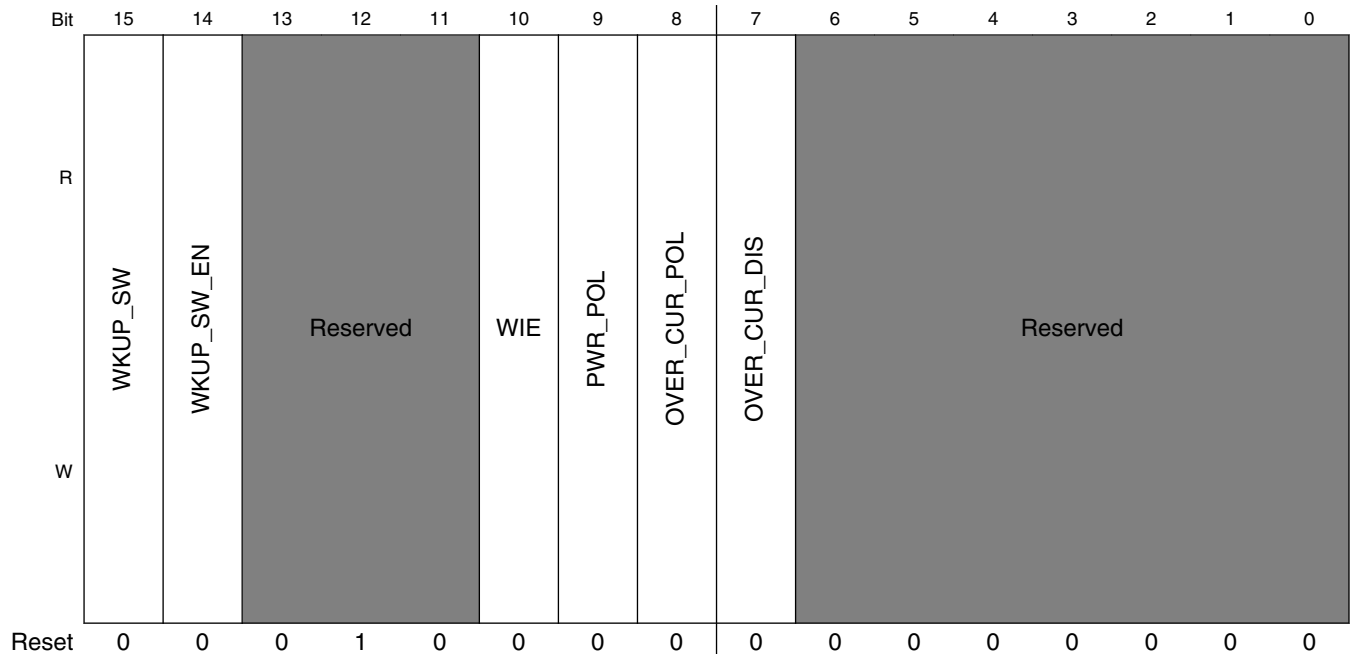

USBNC_USB_OTG2_CTRL field descriptions

Field	Description
31 WIR	OTG2 Wake-up Interrupt Request This bit indicates that a wake-up interrupt request is received on the OTG port. This bit is cleared by disabling the wake-up interrupt (clearing bit "OWIE"). 1 Wake-up Interrupt Request received 0 No wake-up interrupt request received
30 -	This field is reserved. Reserved
29 WKUP_DPDM_EN	Wake-up on DPDM change enable 1 (Default) DPDM changes wake-up to be enabled, it is for device only. 0 DPDM changes wake-up to be disabled only when VBUS is 0.
28–18 -	This field is reserved. Reserved
17 WKUP_VBUS_EN	OTG2 wake-up on VBUS change enable 1 Enable 0 Disable
16 WKUP_ID_EN	OTG2 Wake-up on ID change enable 1 Enable 0 Disable
15 WKUP_SW	OTG2 Software Wake-up 1 Force wake-up 0 Inactive

Table continues on the next page...

USBNC_USB_OTG2_CTRL field descriptions (continued)

Field	Description
14 WKUP_SW_EN	OTG2 Software Wake-up Enable 1 Enable 0 Disable
13–11 -	This field is reserved. Reserved
10 WIE	OTG2 Wake-up Interrupt Enable This bit enables or disables the OTG2 wake-up interrupt. Disabling the interrupt also clears the Interrupt request bit. Wake-up interrupt enable should be turned off after receiving a wake-up interrupt and turned on again prior to going in suspend mode 1 Interrupt Enabled 0 Interrupt Disabled
9 PWR_POL	OTG2 Power Polarity This bit should be set according to PMIC Power Pin polarity. 1 PMIC Power Pin is High active. 0 PMIC Power Pin is Low active.
8 OVER_CUR_POL	OTG2 Polarity of Overcurrent The polarity of OTG2 port overcurrent event 1 Low active (low on this signal represents an overcurrent condition) 0 High active (high on this signal represents an overcurrent condition)
7 OVER_CUR_DIS	Disable OTG2 Overcurrent Detection 1 Disables overcurrent detection 0 Enables overcurrent detection
-	This field is reserved. Reserved

56.5.3 OTG1 UTMI PHY Control 0 Register (USBNC_USB_OTG1_PHY_CTRL_0)

USB OTG1 UTMI PHY control register 0 is used to control the on-chip OTG1 UTMI PHY.

Address: 218_4000h base + 818h offset = 218_4818h

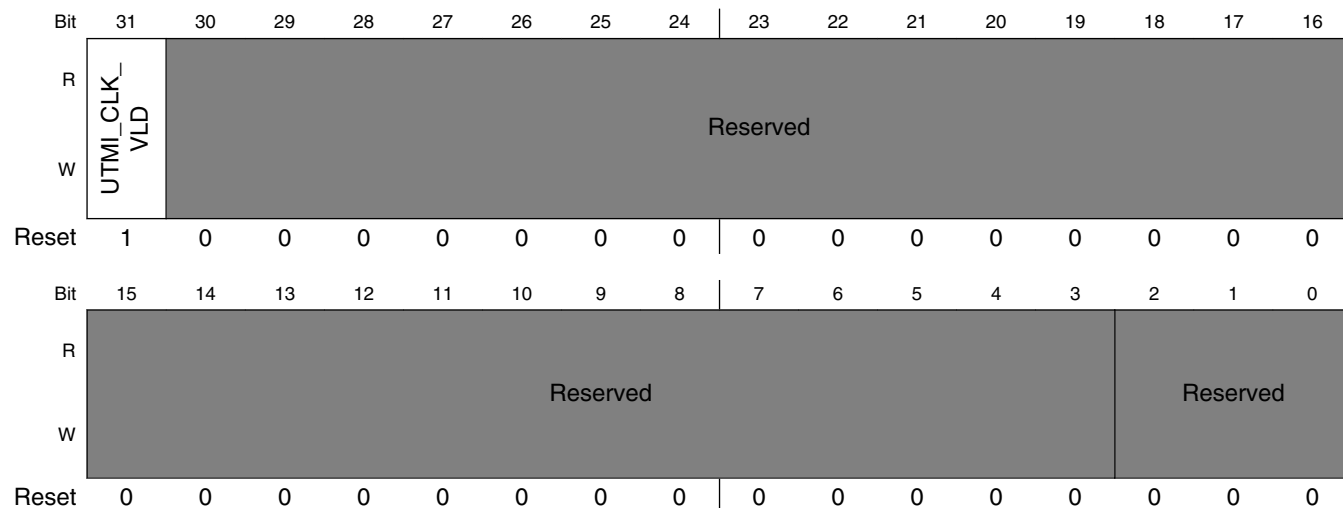

USBNC_USB_OTG1_PHY_CTRL_0 field descriptions

Field	Description
31 UTMI_CLK_VLD	Indicating whether OTG1 UTMI PHY clock is valid 1 Valid 0 Invalid
30-3 -	This field is reserved. Reserved
-	This field is reserved. Reserved

56.5.4 OTG2 UTMI PHY Control 0 Register (USBNC_USB_OTG2_PHY_CTRL_0)

USB OTG2 UTMI PHY Control Register 0 are used to control the on-chip OTG2 UTMI PHY.

Address: 218_4000h base + 81Ch offset = 218_481Ch

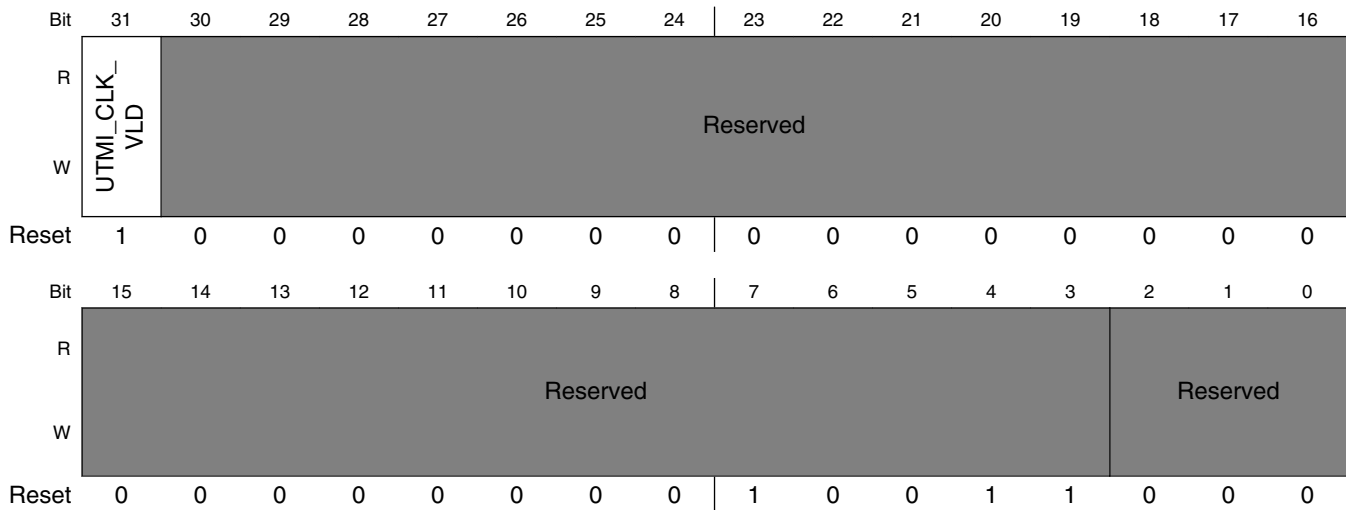

USBNC_USB_OTG2_PHY_CTRL_0 field descriptions

Field	Description
31 UTMI_CLK_VLD	Indicating whether OTG2 UTMI PHY clock is valid 1 Valid 0 Invalid
30-3 -	This field is reserved. Reserved
-	This field is reserved. Reserved

56.6 USB Core Memory Map/Register Definition

USB memory map

Absolute address (hex)	Register name	Width (in bits)	Access	Reset value	Section/page
218_4000	Identification register (USB_UOG1_ID)	32	R	E4A1_FA05h	56.6.1/3828

Table continues on the next page...

USB memory map (continued)

Absolute address (hex)	Register name	Width (in bits)	Access	Reset value	Section/page
218_4004	Hardware General (USB_UOG1_HWGGENERAL)	32	R	0000_0035h	56.6.2/3828
218_4008	Host Hardware Parameters (USB_UOG1_HWHOST)	32	R	1002_0001h	56.6.3/3830
218_400C	Device Hardware Parameters (USB_UOG1_HWDEVICE)	32	R	0000_0011h	56.6.4/3831
218_4010	TX Buffer Hardware Parameters (USB_UOG1_HWTXBUF)	32	R	8008_0B08h	56.6.5/3831
218_4014	RX Buffer Hardware Parameters (USB_UOG1_HWRXBUF)	32	R	0000_0808h	56.6.6/3832
218_4080	General Purpose Timer #0 Load (USB_UOG1_GPTIMER0LD)	32	R/W	0000_0000h	56.6.7/3833
218_4084	General Purpose Timer #0 Controller (USB_UOG1_GPTIMER0CTRL)	32	R/W	0000_0000h	56.6.8/3833
218_4088	General Purpose Timer #1 Load (USB_UOG1_GPTIMER1LD)	32	R/W	0000_0000h	56.6.9/3835
218_408C	General Purpose Timer #1 Controller (USB_UOG1_GPTIMER1CTRL)	32	R/W	0000_0000h	56.6.10/3835
218_4090	System Bus Config (USB_UOG1_SBUSCFG)	32	R/W	0000_0002h	56.6.11/3836
218_4100	Capability Registers Length (USB_UOG1_CAPLENGTH)	8	R	40h	56.6.12/3837
218_4102	Host Controller Interface Version (USB_UOG1_HCVERSION)	16	R	0100h	56.6.13/3838
218_4104	Host Controller Structural Parameters (USB_UOG1_HCSPARAMS)	32	R	0001_0011h	56.6.14/3838
218_4108	Host Controller Capability Parameters (USB_UOG1_HCCPARAMS)	32	R	0000_0006h	56.6.15/3840
218_4120	Device Controller Interface Version (USB_UOG1_DCVERSION)	16	R	0001h	56.6.16/3842
218_4124	Device Controller Capability Parameters (USB_UOG1_DCCPARAMS)	32	R	0000_0188h	56.6.17/3843
218_4140	USB Command Register (USB_UOG1_USBCMD)	32	R/W	0008_0000h	56.6.18/3844
218_4144	USB Status Register (USB_UOG1_USBSTS)	32	R/W	0000_0000h	56.6.19/3848
218_4148	Interrupt Enable Register (USB_UOG1_USBINTR)	32	R/W	0000_0000h	56.6.20/3852
218_414C	USB Frame Index (USB_UOG1_FRINDEX)	32	R/W	0000_0000h	56.6.21/3854
218_4154	Frame List Base Address (USB_UOG1_PERIODICLISTBASE)	32	R/W	0000_0000h	56.6.22/3855
218_4154	Device Address (USB_UOG1_DEVICEADDR)	32	R/W	0000_0000h	56.6.23/3855
218_4158	Next Asynch. Address (USB_UOG1_ASYNCLISTADDR)	32	R/W	0000_0000h	56.6.24/3856
218_4158	Endpoint List Address (USB_UOG1_ENDPTLISTADDR)	32	R/W	0000_0000h	56.6.25/3857

Table continues on the next page...

USB memory map (continued)

Absolute address (hex)	Register name	Width (in bits)	Access	Reset value	Section/page
218_4160	Programmable Burst Size (USB_UOG1_BURSTSIZE)	32	R/W	0000_0808h	56.6.26/3857
218_4164	TX FIFO Fill Tuning (USB_UOG1_TXFILLTUNING)	32	R/W	000A_0000h	56.6.27/3858
218_4178	Endpoint NAK (USB_UOG1_ENDPTNAK)	32	R/W	0000_0000h	56.6.28/3860
218_417C	Endpoint NAK Enable (USB_UOG1_ENDPTNAKEN)	32	R/W	0000_0000h	56.6.29/3860
218_4180	Configure Flag Register (USB_UOG1_CONFIGFLAG)	32	R/W	0000_0001h	56.6.30/3861
218_4184	Port Status & Control (USB_UOG1_PORTSC1)	32	R/W	1000_0000h	56.6.31/3861
218_41A4	On-The-Go Status & control (USB_UOG1_OTGSC)	32	R/W	0000_1120h	56.6.32/3868
218_41A8	USB Device Mode (USB_UOG1_USBMODE)	32	R/W	0000_5000h	56.6.33/3872
218_41AC	Endpoint Setup Status (USB_UOG1_ENDPTSETUPSTAT)	32	R/W	0000_0000h	56.6.34/3873
218_41B0	Endpoint Prime (USB_UOG1_ENDPTPRIME)	32	R/W	0000_0000h	56.6.35/3874
218_41B4	Endpoint Flush (USB_UOG1_ENDPTFLUSH)	32	R/W	0000_0000h	56.6.36/3875
218_41B8	Endpoint Status (USB_UOG1_ENDPTSTAT)	32	R	0000_0000h	56.6.37/3875
218_41BC	Endpoint Complete (USB_UOG1_ENDPTCOMPLETE)	32	R/W	0000_0000h	56.6.38/3876
218_41C0	Endpoint Control0 (USB_UOG1_ENDPTCTRL0)	32	R/W	0080_0080h	56.6.39/3877
218_41C4	Endpoint Control 1 (USB_UOG1_ENDPTCTRL1)	32	R/W	0000_0000h	56.6.40/3879
218_41C8	Endpoint Control 2 (USB_UOG1_ENDPTCTRL2)	32	R/W	0000_0000h	56.6.41/3882
218_41CC	Endpoint Control 3 (USB_UOG1_ENDPTCTRL3)	32	R/W	0000_0000h	56.6.42/3884
218_41D0	Endpoint Control 4 (USB_UOG1_ENDPTCTRL4)	32	R/W	0000_0000h	56.6.43/3887
218_41D4	Endpoint Control 5 (USB_UOG1_ENDPTCTRL5)	32	R/W	0000_0000h	56.6.44/3890
218_41D8	Endpoint Control 6 (USB_UOG1_ENDPTCTRL6)	32	R/W	0000_0000h	56.6.45/3893
218_41DC	Endpoint Control 7 (USB_UOG1_ENDPTCTRL7)	32	R/W	0000_0000h	56.6.46/3896
218_4200	Identification register (USB_UOG2_ID)	32	R	E4A1_FA05h	56.6.1/3828
218_4204	Hardware General (USB_UOG2_HWGENERAL)	32	R	0000_0035h	56.6.2/3828

Table continues on the next page...

USB memory map (continued)

Absolute address (hex)	Register name	Width (in bits)	Access	Reset value	Section/page
218_4208	Host Hardware Parameters (USB_UOG2_HWHOST)	32	R	1002_0001h	56.6.3/3830
218_420C	Device Hardware Parameters (USB_UOG2_HWDEVICE)	32	R	0000_0011h	56.6.4/3831
218_4210	TX Buffer Hardware Parameters (USB_UOG2_HWTXBUF)	32	R	8008_0B08h	56.6.5/3831
218_4214	RX Buffer Hardware Parameters (USB_UOG2_HWRXBUF)	32	R	0000_0808h	56.6.6/3832
218_4280	General Purpose Timer #0 Load (USB_UOG2_GPTIMER0LD)	32	R/W	0000_0000h	56.6.7/3833
218_4284	General Purpose Timer #0 Controller (USB_UOG2_GPTIMER0CTRL)	32	R/W	0000_0000h	56.6.8/3833
218_4288	General Purpose Timer #1 Load (USB_UOG2_GPTIMER1LD)	32	R/W	0000_0000h	56.6.9/3835
218_428C	General Purpose Timer #1 Controller (USB_UOG2_GPTIMER1CTRL)	32	R/W	0000_0000h	56.6.10/3835
218_4290	System Bus Config (USB_UOG2_SBUSCFG)	32	R/W	0000_0002h	56.6.11/3836
218_4300	Capability Registers Length (USB_UOG2_CAPLENGTH)	8	R	40h	56.6.12/3837
218_4302	Host Controller Interface Version (USB_UOG2_HCIVERSION)	16	R	0100h	56.6.13/3838
218_4304	Host Controller Structural Parameters (USB_UOG2_HCCPARAMS)	32	R	0001_0011h	56.6.14/3838
218_4308	Host Controller Capability Parameters (USB_UOG2_HCCPARAMS)	32	R	0000_0006h	56.6.15/3840
218_4320	Device Controller Interface Version (USB_UOG2_DCIVERSION)	16	R	0001h	56.6.16/3842
218_4324	Device Controller Capability Parameters (USB_UOG2_DCCPARAMS)	32	R	0000_0188h	56.6.17/3843
218_4340	USB Command Register (USB_UOG2_USBCMD)	32	R/W	0008_0000h	56.6.18/3844
218_4344	USB Status Register (USB_UOG2_USBSTS)	32	R/W	0000_0000h	56.6.19/3848
218_4348	Interrupt Enable Register (USB_UOG2_USBINTR)	32	R/W	0000_0000h	56.6.20/3852
218_434C	USB Frame Index (USB_UOG2_FRINDEX)	32	R/W	0000_0000h	56.6.21/3854
218_4354	Frame List Base Address (USB_UOG2_PERIODICLISTBASE)	32	R/W	0000_0000h	56.6.22/3855
218_4354	Device Address (USB_UOG2_DEVICEADDR)	32	R/W	0000_0000h	56.6.23/3855
218_4358	Next Asynch. Address (USB_UOG2_ASYNCLISTADDR)	32	R/W	0000_0000h	56.6.24/3856
218_4358	Endpoint List Address (USB_UOG2_ENDPTLISTADDR)	32	R/W	0000_0000h	56.6.25/3857
218_4360	Programmable Burst Size (USB_UOG2_BURSTSIZE)	32	R/W	0000_0808h	56.6.26/3857

Table continues on the next page...

USB memory map (continued)

Absolute address (hex)	Register name	Width (in bits)	Access	Reset value	Section/page
218_4364	TX FIFO Fill Tuning (USB_UOG2_TXFILLTUNING)	32	R/W	000A_0000h	56.6.27/3858
218_4378	Endpoint NAK (USB_UOG2_ENDPTNAK)	32	R/W	0000_0000h	56.6.28/3860
218_437C	Endpoint NAK Enable (USB_UOG2_ENDPTNAKEN)	32	R/W	0000_0000h	56.6.29/3860
218_4380	Configure Flag Register (USB_UOG2_CONFIGFLAG)	32	R/W	0000_0001h	56.6.30/3861
218_4384	Port Status & Control (USB_UOG2_PORTSC1)	32	R/W	1000_0000h	56.6.31/3861
218_43A4	On-The-Go Status & control (USB_UOG2_OTGSC)	32	R/W	0000_1120h	56.6.32/3868
218_43A8	USB Device Mode (USB_UOG2_USBMODE)	32	R/W	0000_5000h	56.6.33/3872
218_43AC	Endpoint Setup Status (USB_UOG2_ENDPTSETUPSTAT)	32	R/W	0000_0000h	56.6.34/3873
218_43B0	Endpoint Prime (USB_UOG2_ENDPTPRIME)	32	R/W	0000_0000h	56.6.35/3874
218_43B4	Endpoint Flush (USB_UOG2_ENDPTFLUSH)	32	R/W	0000_0000h	56.6.36/3875
218_43B8	Endpoint Status (USB_UOG2_ENDPTSTAT)	32	R	0000_0000h	56.6.37/3875
218_43BC	Endpoint Complete (USB_UOG2_ENDPTCOMPLETE)	32	R/W	0000_0000h	56.6.38/3876
218_43C0	Endpoint Control0 (USB_UOG2_ENDPTCTRL0)	32	R/W	0080_0080h	56.6.39/3877
218_43C4	Endpoint Control 1 (USB_UOG2_ENDPTCTRL1)	32	R/W	0000_0000h	56.6.40/3879
218_43C8	Endpoint Control 2 (USB_UOG2_ENDPTCTRL2)	32	R/W	0000_0000h	56.6.41/3882
218_43CC	Endpoint Control 3 (USB_UOG2_ENDPTCTRL3)	32	R/W	0000_0000h	56.6.42/3884
218_43D0	Endpoint Control 4 (USB_UOG2_ENDPTCTRL4)	32	R/W	0000_0000h	56.6.43/3887
218_43D4	Endpoint Control 5 (USB_UOG2_ENDPTCTRL5)	32	R/W	0000_0000h	56.6.44/3890
218_43D8	Endpoint Control 6 (USB_UOG2_ENDPTCTRL6)	32	R/W	0000_0000h	56.6.45/3893
218_43DC	Endpoint Control 7 (USB_UOG2_ENDPTCTRL7)	32	R/W	0000_0000h	56.6.46/3896

56.6.1 Identification register (USB_nID)

The ID register identifies the USB 2.0 High-Speed core and its revision.

Address: 218_4000h base + 0h offset + (512d × i), where i=0d to 1d

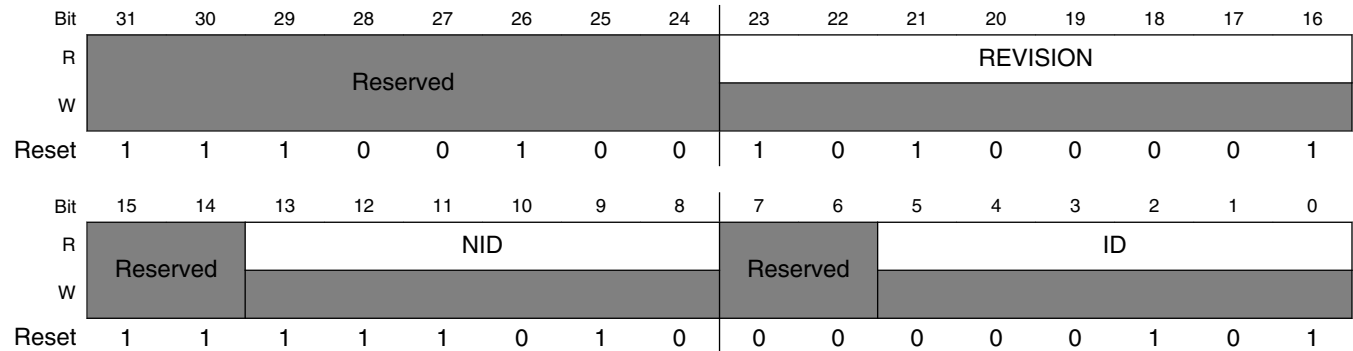

USB_nID field descriptions

Field	Description
31–24 -	This field is reserved. Reserved
23–16 REVISION	Revision number of the controller core.
15–14 -	This field is reserved. Reserved
13–8 NID	Complement version of ID
7–6 -	This field is reserved. Reserved
ID	Configuration number. This number is set to 0x05 and indicates that the peripheral is USB 2.0 High-Speed core.

56.6.2 Hardware General (USB_nHWGENERAL)

General hardware parameters as defined in System Level Issues and Core Configuration.

NOTE

The reset value could vary from instance to instance. Please see the detail in bit field description and ignore reset value in summary table in this case!

Address: 218_4000h base + 4h offset + (512d × i), where i=0d to 1d

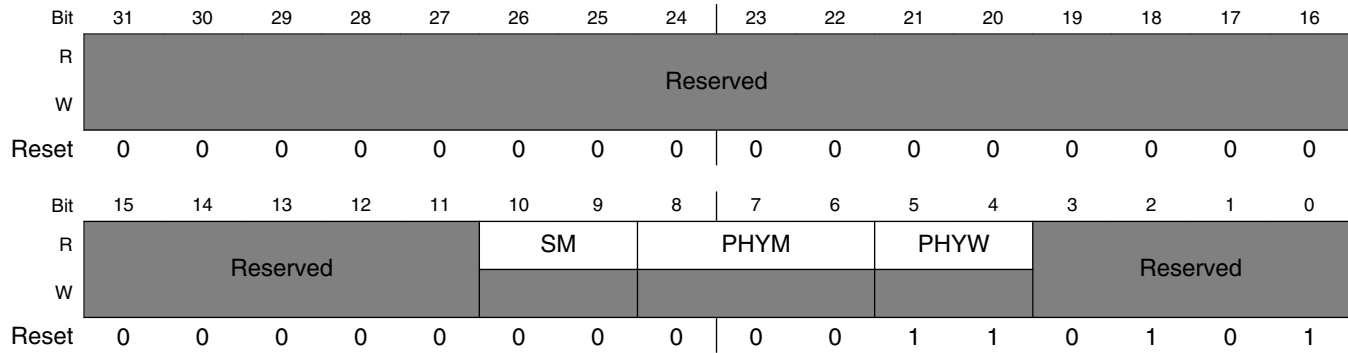

USB_nHWGENERAL field descriptions

Field	Description
31–11 -	This field is reserved. Reserved
10–9 SM	Serial interface mode capability 00 No Serial Engine, always use parallel signalling. 01 Serial Engine present, always use serial signalling for FS/LS. 10 Software programmable - Reset to use parallel signalling for FS/LS 11 Software programmable - Reset to use serial signalling for FS/LS
8–6 PHYM	Transceiver type 000 UTMI/UMTI+ 001 ULPI DDR 010 ULPI 011 Serial Only 100 Software programmable - reset to UTMI/UTMI+ 101 Software programmable - reset to ULPI DDR 110 Software programmable - reset to ULPI 111 Software programmable - reset to Serial 1000 IC-USB 1001 Software programmable - reset to IC-USB 1010 HSIC 1011 Software programmable - reset to HSIC
5–4 PHYW	Data width of the transceiver connected to the controller core. PHYW bit reset value is 00 8 bit wide data bus Software non-programmable 01 16 bit wide data bus Software non-programmable 10 Reset to 8 bit wide data bus Software programmable 11 Reset to 16 bit wide data bus Software programmable

Table continues on the next page...

USB_nHWGENERAL field descriptions (continued)

Field	Description
-	This field is reserved. Reserved

56.6.3 Host Hardware Parameters (USB_nHWHOST)

Address: 218_4000h base + 8h offset + (512d × i), where i=0d to 1d

Bit	31	30	29	28	27	26	25	24	23	22	21	20	19	18	17	16
R	Reserved															
W	Reserved															
Reset	0	0	0	1	0	0	0	0	0	0	0	0	0	0	1	0
Bit	15	14	13	12	11	10	9	8	7	6	5	4	3	2	1	0
R	Reserved												NPORT		HC	
W	Reserved												Reserved		Reserved	
Reset	0	0	0	0	0	0	0	0	0	0	0	0	0	0	0	1

USB_nHWHOST field descriptions

Field	Description
31–4 -	This field is reserved. Reserved
3–1 NPORT	The Number of downstream ports supported by the host controller is (NPORT+1). NOTE: When these bits value is '000', it indicates a single-port host controller.
0 HC	Host Capable. Indicating whether host operation mode is supported or not. 1 Supported 0 Not supported

56.6.4 Device Hardware Parameters (USB_nHWDEVICE)

Address: 218_4000h base + Ch offset + (512d × i), where i=0d to 1d

Bit	31	30	29	28	27	26	25	24	23	22	21	20	19	18	17	16
R	Reserved															
W	Reserved															
Reset	0	0	0	0	0	0	0	0	0	0	0	0	0	0	0	0
Bit	15	14	13	12	11	10	9	8	7	6	5	4	3	2	1	0
R	Reserved										DEVEP				DC	
W	Reserved										Reserved				Reserved	
Reset	0	0	0	0	0	0	0	0	0	0	0	1	0	0	0	1

USB_nHWDEVICE field descriptions

Field	Description
31–6 -	This field is reserved. Reserved
5–1 DEVEP	Device Endpoint Number
0 DC	Device Capable. Indicating whether device operation mode is supported or not. 1 Supported 0 Not supported

56.6.5 TX Buffer Hardware Parameters (USB_nHWTXBUF)

Address: 218_4000h base + 10h offset + (512d × i), where i=0d to 1d

Bit	31	30	29	28	27	26	25	24	23	22	21	20	19	18	17	16	15	14	13	12	11	10	9	8	7	6	5	4	3	2	1	0
R	Reserved								TXCHANADD								Reserved								TXBURST							
W	Reserved								Reserved								Reserved								Reserved							
Reset	1	0	0	0	0	0	0	0	0	0	0	0	1	0	0	0	0	0	0	0	1	0	1	1	0	0	0	0	1	0	0	0

USB_nHWTXBUF field descriptions

Field	Description
31–24 -	This field is reserved. Reserved
23–16 TXCHANADD	TX FIFO Buffer size is: (2 ^{TXCHANADD}) * 4 Bytes. These bits are set to '08h', so buffer size is 256*4 Bytes. For the OTG controller operating in device mode, this is the FIFO buffer size per endpoint. As the OTG controller has 8 TX endpoint, there are 8 of these buffers.

Table continues on the next page...

USB_nHWTXBUF field descriptions (continued)

Field	Description
	For the OTG controller operating in host mode, or for Host-only controller, the entire buffer memory is used as a single TX buffer. Therefore, there is only 1 of this buffer
15–8 -	This field is reserved. Reserved
TXBURST	Default burst size for memory to TX buffer transfer. This is reset value of TXPBURST bits in USB core regsiter USB_n_BURSTSIZE. Please see Programmable Burst Size (USB_nBURSTSIZE) .

56.6.6 RX Buffer Hardware Parameters (USB_nHWRXBUF)

Address: 218_4000h base + 14h offset + (512d × i), where i=0d to 1d

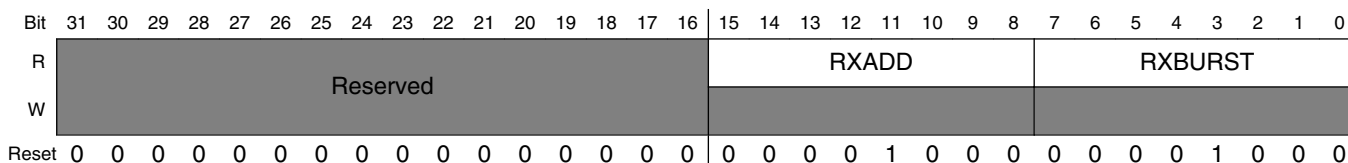

USB_nHWRXBUF field descriptions

Field	Description
31–16 -	This field is reserved. Reserved
15–8 RXADD	Buffer total size for all receive endpoints is (2^RXADD). RX Buffer size is: (2^RXADD) * 4 Bytes. These bits are set to '08h', so buffer size is 256*4 Bytes. There is a single Receive FIFO buffer in the USB controller. The buffer is shared for all endpoints for the OTG controller in device mode.
RXBURST	Default burst size for memory to RX buffer transfer. This is reset value of RXPBURST bits in USB core regsiter USB_n_BURSTSIZE. Please see Programmable Burst Size (USB_nBURSTSIZE) .

56.6.7 General Purpose Timer #0 Load (USB_nGPTIMER0LD)

This register controls load value of the count timer in register n_GPTIMER0CTRL. Please see [General Purpose Timer #0 Controller \(USB_nGPTIMER0CTRL\)](#) .

Address: 218_4000h base + 80h offset + (512d × i), where i=0d to 1d

Bit	31	30	29	28	27	26	25	24	23	22	21	20	19	18	17	16	15	14	13	12	11	10	9	8	7	6	5	4	3	2	1	0
R	Reserved								GPTLD																							
W	Reserved								GPTLD																							
Reset	0	0	0	0	0	0	0	0	0	0	0	0	0	0	0	0	0	0	0	0	0	0	0	0	0	0	0	0	0	0	0	0

USB_nGPTIMER0LD field descriptions

Field	Description
31–24 -	This field is reserved. Reserved
GPTLD	General Purpose Timer Load Value These bit fields are loaded to GPTCNT bits when GPTRST bit is set '1b'. This value represents the time in microseconds minus 1 for the timer duration. Example: for a one millisecond timer, load 1000-1=999 or 0x0003E7. NOTE: Max value is 0xFFFFF or 16.777215 seconds.

56.6.8 General Purpose Timer #0 Controller (USB_nGPTIMER0CTRL)

This register contains the control for this countdown timer and a data field can be queried to determine the running count value. This timer has granularity on 1 us and can be programmed to a little over 16 seconds. There are two counter modes which are described in the register table below. When the timer counter value transitions to zero, an interrupt could be generated if enable.

Interrupt status bit is TI0 bit in n_USBSTS register (See [USB Status Register \(USB_nUSBSTS\)](#)), interrupt enable bit is TIE0 bit in n_USBINTR register. (See [Interrupt Enable Register \(USB_nUSBINTR\)](#) .)

USB Core Memory Map/Register Definition

Address: 218_4000h base + 84h offset + (512d × i), where i=0d to 1d

Bit	31	30	29	28	27	26	25	24	23	22	21	20	19	18	17	16
R	GPTRUN	GPTRST	Reserved					GPTMODE	GPTCNT							
W																
Reset	0	0	0	0	0	0	0	0	0	0	0	0	0	0	0	0
Bit	15	14	13	12	11	10	9	8	7	6	5	4	3	2	1	0
R	GPTCNT															
W																
Reset	0	0	0	0	0	0	0	0	0	0	0	0	0	0	0	0

USB_nGPTIMER0CTRL field descriptions

Field	Description
31 GPTRUN	General Purpose Timer Run GPTCNT bits are not effected when setting or clearing this bit. 0 Stop counting 1 Run
30 GPTRST	General Purpose Timer Reset 0 No action 1 Load counter value from GPTLD bits in n_GPTIMEROLD
29–25 -	This field is reserved. Reserved
24 GPTMODE	General Purpose Timer Mode In one shot mode, the timer will count down to zero, generate an interrupt, and stop until the counter is reset by software; In repeat mode, the timer will count down to zero, generate an interrupt and automatically reload the counter value from GPTLD bits to start again. 0 One Shot Mode 1 Repeat Mode
GPTCNT	General Purpose Timer Counter. This field is the count value of the countdown timer.

56.6.9 General Purpose Timer #1 Load (USB_nGPTIMER1LD)

This register controls load value of the count timer in register n_GPTIMER1CTRL. Please see [General Purpose Timer #1 Controller \(USB_nGPTIMER1CTRL\)](#).

Address: 218_4000h base + 88h offset + (512d × i), where i=0d to 1d

Bit	31	30	29	28	27	26	25	24	23	22	21	20	19	18	17	16	15	14	13	12	11	10	9	8	7	6	5	4	3	2	1	0
R	Reserved								GPTLD																							
W	0								0																							
Reset	0								0																							

USB_nGPTIMER1LD field descriptions

Field	Description
31–24 -	This field is reserved. Reserved
GPTLD	<p>General Purpose Timer Load Value</p> <p>These bit fields are loaded to GPTCNT bits when GPTRST bit is set '1b'.</p> <p>This value represents the time in microseconds minus 1 for the timer duration.</p> <p>Example: for a one millisecond timer, load 1000-1=999 or 0x0003E7.</p> <p>NOTE: Max value is 0xFFFFF or 16.777215 seconds.</p>

56.6.10 General Purpose Timer #1 Controller (USB_nGPTIMER1CTRL)

This register contains the control for this countdown timer and a data field can be queried to determine the running count value. This timer has granularity on 1 us and can be programmed to a little over 16 seconds. There are two counter modes which are described in the register table below. When the timer counter value transitions to zero, an interrupt could be generated if enable.

Interrupt status bit is TI1 bit in USB_n_USBSTS register (See [USB Status Register \(USB_n_USBSTS\)](#)), interrupt enable bit is TIE1 bit in n_USBINTR register (See [Interrupt Enable Register \(USB_n_USBINTR\)](#)).

USB Core Memory Map/Register Definition

Address: 218_4000h base + 8Ch offset + (512d × i), where i=0d to 1d

Bit	31	30	29	28	27	26	25	24	23	22	21	20	19	18	17	16	
R	GPTRUN		GPTRST		Reserved				GPTMODE	GPTCNT							
W	GPTRUN		GPTRST		Reserved				GPTMODE	GPTCNT							
Reset	0	0	0	0	0	0	0	0	0	0	0	0	0	0	0	0	
Bit	15	14	13	12	11	10	9	8	7	6	5	4	3	2	1	0	
R	GPTCNT																
W	GPTCNT																
Reset	0	0	0	0	0	0	0	0	0	0	0	0	0	0	0	0	

USB_nGPTIMER1CTRL field descriptions

Field	Description
31 GPTRUN	General Purpose Timer Run GPTCNT bits are not effected when setting or clearing this bit. 0 Stop counting 1 Run
30 GPTRST	General Purpose Timer Reset 0 No action 1 Load counter value from GPTLD bits in USB_n_GPTIMER0LD
29–25 -	This field is reserved. Reserved
24 GPTMODE	General Purpose Timer Mode In one shot mode, the timer will count down to zero, generate an interrupt, and stop until the counter is reset by software. In repeat mode, the timer will count down to zero, generate an interrupt and automatically reload the counter value from GPTLD bits to start again. 0 One Shot Mode 1 Repeat Mode
GPTCNT	General Purpose Timer Counter. This field is the count value of the countdown timer.

56.6.11 System Bus Config (USB_nSBUSCFG)

Address: 218_4000h base + 90h offset + (512d × i), where i=0d to 1d

Bit	31	30	29	28	27	26	25	24	23	22	21	20	19	18	17	16	15	14	13	12	11	10	9	8	7	6	5	4	3	2	1	0
R	Reserved																AHBBRS															
W	Reserved																T															
Reset	0	0	0	0	0	0	0	0	0	0	0	0	0	0	0	0	0	0	0	0	0	0	0	0	0	0	0	0	0	0	1	0

USB_nSBUSCFG field descriptions

Field	Description
31–3 -	This field is reserved. Reserved
AHBBRST	<p>AHB master interface Burst configuration</p> <p>These bits control AHB master transfer type sequence (or priority).</p> <p>NOTE: This register overrides n_BURSTSIZE register when its value is not zero.</p> <p>000 Incremental burst of unspecified length only 001 INCR4 burst, then single transfer 010 INCR8 burst, INCR4 burst, then single transfer 011 INCR16 burst, INCR8 burst, INCR4 burst, then single transfer 100 Reserved, don't use 101 INCR4 burst, then incremental burst of unspecified length 110 INCR8 burst, INCR4 burst, then incremental burst of unspecified length 111 INCR16 burst, INCR8 burst, INCR4 burst, then incremental burst of unspecified length</p>

56.6.12 Capability Registers Length (USB_nCAPLENGTH)

The Capability Registers Length register contains the address offset to the Operational registers relative to the CAPLENGTH register.

Address: 218_4000h base + 100h offset + (512d × i), where i=0d to 1d

Bit	7	6	5	4	3	2	1	0
Read	CAPLENGTH							
Write								
Reset	0	1	0	0	0	0	0	0

USB_nCAPLENGTH field descriptions

Field	Description
CAPLENGTH	These bits are used as an offset to add to register base to find the beginning of the Operational Register. Default value is '40h'.

56.6.13 Host Controller Interface Version (USB_nHCIVERSION)

This is a 2-byte register containing a BCD encoding of the EHCI revision number supported by this host controller. The most significant byte of this register represents a major revision and the least significant byte is the minor revision.

Address: 218_4000h base + 102h offset + (512d × i), where i=0d to 1d

Bit	15	14	13	12	11	10	9	8	7	6	5	4	3	2	1	0
Read	HCIVERSION															
Write	[Reserved]															
Reset	0	0	0	0	0	0	0	1	0	0	0	0	0	0	0	0

USB_nHCIVERSION field descriptions

Field	Description
HCIVERSION	Host Controller Interface Version Number Default value is '10h', which means EHCI rev1.0.

56.6.14 Host Controller Structural Parameters (USB_nHCSPARAMS)

The following figure shows the port steering logic capabilities of Host Control Structural Parameters (n_HCSPARAMS).

Address: 218_4000h base + 104h offset + (512d × i), where i=0d to 1d

Bit	31	30	29	28	27	26	25	24	23	22	21	20	19	18	17	16
R	Reserved				N_TT				N_PTT				Reserved			PI
W	[Reserved]				[Reserved]				[Reserved]				[Reserved]			[Reserved]
Reset	0	0	0	0	0	0	0	0	0	0	0	0	0	0	0	1
Bit	15	14	13	12	11	10	9	8	7	6	5	4	3	2	1	0
R	N_CC				N_PCC				Reserved			PPC	N_PORTS			
W	[Reserved]				[Reserved]				[Reserved]			[Reserved]	[Reserved]			
Reset	0	0	0	0	0	0	0	0	0	0	0	1	0	0	0	1

USB_nHCSPARAMS field descriptions

Field	Description
31–28 -	This field is reserved. Reserved
27–24 N_TT	Number of Transaction Translators (N_TT). Default value '0000b' This field indicates the number of embedded transaction translators associated with the USB2.0 host controller. These bits would be set to '0001b' for Multi-Port Host, and '0000b' for Single-Port Host.
23–20 N_PTT	Number of Ports per Transaction Translator (N_PTT). Default value '0000b' This field indicates the number of ports assigned to each transaction translator within the USB2.0 host controller. These bits would be set to equal N_PORTS for Multi-Port Host, and '0000b' for Single-Port Host.
19–17 -	This field is reserved. Reserved
16 PI	Port Indicators (P INDICATOR) This bit indicates whether the ports support port indicator control. When set to one, the port status and control registers include a read/writeable field for controlling the state of the port indicator This bit is "1b" in all controller core.
15–12 N_CC	Number of Companion Controller (N_CC). This field indicates the number of companion controllers associated with this USB2.0 host controller. These bits are '0000b' in all controller core. 0 There is no internal Companion Controller and port-ownership hand-off is not supported. 1 There are internal companion controller(s) and port-ownership hand-offs is supported.
11–8 N_PCC	Number of Ports per Companion Controller This field indicates the number of ports supported per internal Companion Controller. It is used to indicate the port routing configuration to the system software. For example, if N_PORTS has a value of 6 and N_CC has a value of 2 then N_PCC could have a value of 3. The convention is that the first N_PCC ports are assumed to be routed to companion controller 1, the next N_PCC ports to companion controller 2, etc. In the previous example, the N_PCC could have been 4, where the first 4 are routed to companion controller 1 and the last two are routed to companion controller 2. The number in this field must be consistent with N_PORTS and N_CC. These bits are '0000b' in all controller core.
7–5 -	This field is reserved. Reserved
4 PPC	Port Power Control This field indicates whether the host controller implementation includes port power control. A one indicates the ports have port power switches. A zero indicates the ports do not have port power switches. The value of this field affects the functionality of the Port Power field in each port status and control register
N_PORTS	Number of downstream ports. This field specifies the number of physical downstream ports implemented on this host controller. The value of this field determines how many port registers are addressable in the Operational Register. Valid values are in the range of 1h to Fh. A zero in this field is undefined. These bits are always set to '0001b' because all controller cores are Single-Port Host.

56.6.15 Host Controller Capability Parameters (USB_nHCCPARAMS)

This register identifies multiple mode control (time-base bit functionality), addressing capability.

Address: 218_4000h base + 108h offset + (512d × i), where i=0d to 1d

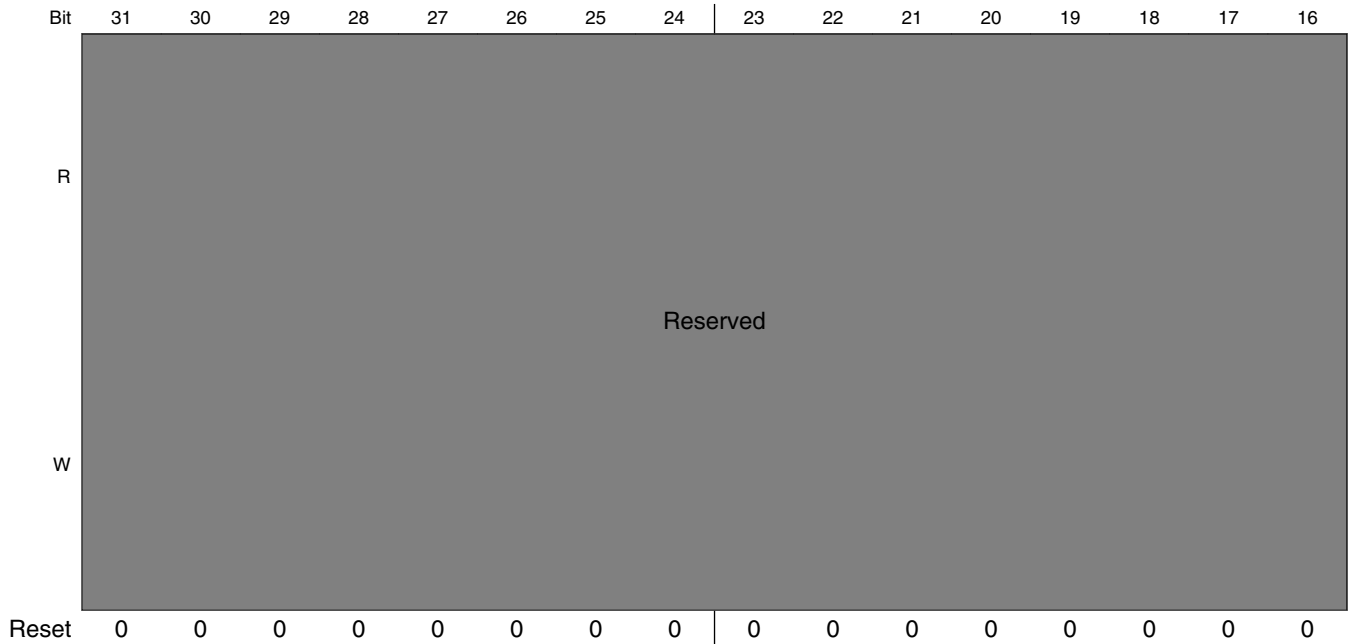

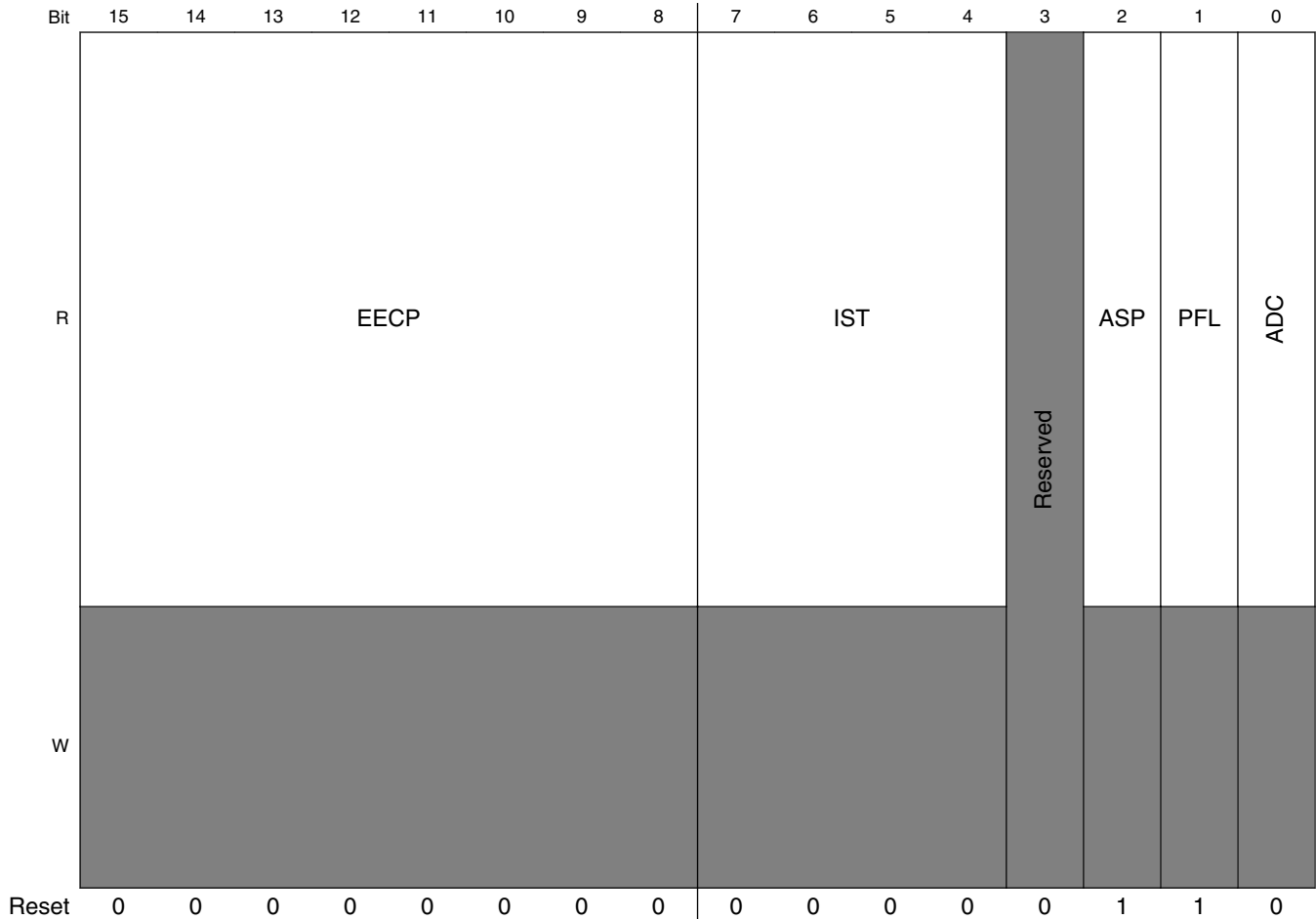

USB_nHCCPARAMS field descriptions

Field	Description
31–16 -	This field is reserved. Reserved
15–8 EECP	EHCI Extended Capabilities Pointer. This field indicates the existence of a capabilities list. A value of 00h indicates no extended capabilities are implemented. A non-zero value in this register indicates the offset in PCI configuration space of the first EHCI extended capability. The pointer value must be 40h or greater if implemented to maintain the consistency of the PCI header defined for this class of device. NOTE: These bits are set '00h' in all controller core.
7–4 IST	Isochronous Scheduling Threshold. This field indicates, relative to the current position of the executing host controller, where software can reliably update the isochronous schedule. When bit [7] is zero, the value of the least significant 3 bits indicates the number of micro-frames a host controller can hold a set of isochronous data structures (one or more) before flushing the state. When bit [7] is a one, then host software assumes the host controller may cache an isochronous data structure for an entire frame. These bits are set '00h' in all controller core.
3 -	This field is reserved. Reserved

Table continues on the next page...

USB_nHCCPARAMS field descriptions (continued)

Field	Description
2 ASP	<p>Asynchronous Schedule Park Capability</p> <p>If this bit is set to a one, then the host controller supports the park feature for high-speed queue heads in the Asynchronous Schedule. The feature can be disabled or enabled and set to a specific level by using the <i>Asynchronous Schedule Park Mode Enable</i> and <i>Asynchronous Schedule Park Mode Count</i> fields in the USBCMD register.</p> <p>NOTE: ASP bit reset value: '00b' for OTG controller core, '11b' for Host-only controller core.</p>
1 PFL	<p>Programmable Frame List Flag</p> <p>If this bit is set to zero, then the system software must use a frame list length of 1024 elements with this host controller. The USBCMD register Frame List Size field is a read-only register and must be set to zero.</p> <p>If set to a one, then the system software can specify and use a smaller frame list and configure the host controller via the USBCMD register Frame List Size field. The frame list must always be aligned on a 4K-page boundary. This requirement ensures that the frame list is always physically contiguous.</p> <p>This bit is set '1b' in all controller core.</p>
0 ADC	<p>64-bit Addressing Capability</p> <p>This bit is set '0b' in all controller core, no 64-bit addressing capability is supported.</p>

56.6.16 Device Controller Interface Version (USB_nDCIVERSION)

This register indicates the two-byte BCD encoding of the device controller interface version number.

Address: 218_4000h base + 120h offset + (512d × i), where i=0d to 1d

Bit	15	14	13	12	11	10	9	8	7	6	5	4	3	2	1	0
Read	DCIVERSION															
Write																
Reset	0	0	0	0	0	0	0	0	0	0	0	0	0	0	0	1

USB_nDCIVERSION field descriptions

Field	Description
DCIVERSION	<p>Device Controller Interface Version Number</p> <p>Default value is '01h', which means rev0.1.</p>

56.6.17 Device Controller Capability Parameters (USB_nDCCPARAMS)

These fields describe the overall device capability of the controller.

Address: 218_4000h base + 124h offset + (512d × i), where i=0d to 1d

Bit	31	30	29	28	27	26	25	24	23	22	21	20	19	18	17	16	
R	Reserved																
W	Reserved																
Reset	0	0	0	0	0	0	0	0	0	0	0	0	0	0	0	0	
Bit	15	14	13	12	11	10	9	8	7	6	5	4	3	2	1	0	
R	Reserved								HC	DC	Reserved			DEN			
W	Reserved										Reserved						
Reset	0	0	0	0	0	0	0	0	1	1	0	0	0	1	0	0	0

USB_nDCCPARAMS field descriptions

Field	Description
31–9 -	This field is reserved. Reserved
8 HC	Host Capable When this bit is 1, this controller is capable of operating as an EHCI compatible USB 2.0 host controller.
7 DC	Device Capable When this bit is 1, this controller is capable of operating as a USB 2.0 device.
6–5 -	This field is reserved. Reserved
DEN	Device Endpoint Number This field indicates the number of endpoints built into the device controller. If this controller is not device capable, then this field will be zero. Valid values are 0 - 15.

56.6.18 USB Command Register (USB_nUSBCMD)

The Command Register indicates the command to be executed by the serial bus host/device controller. Writing to the register causes a command to be executed.

Address: 218_4000h base + 140h offset + (512d × i), where i=0d to 1d

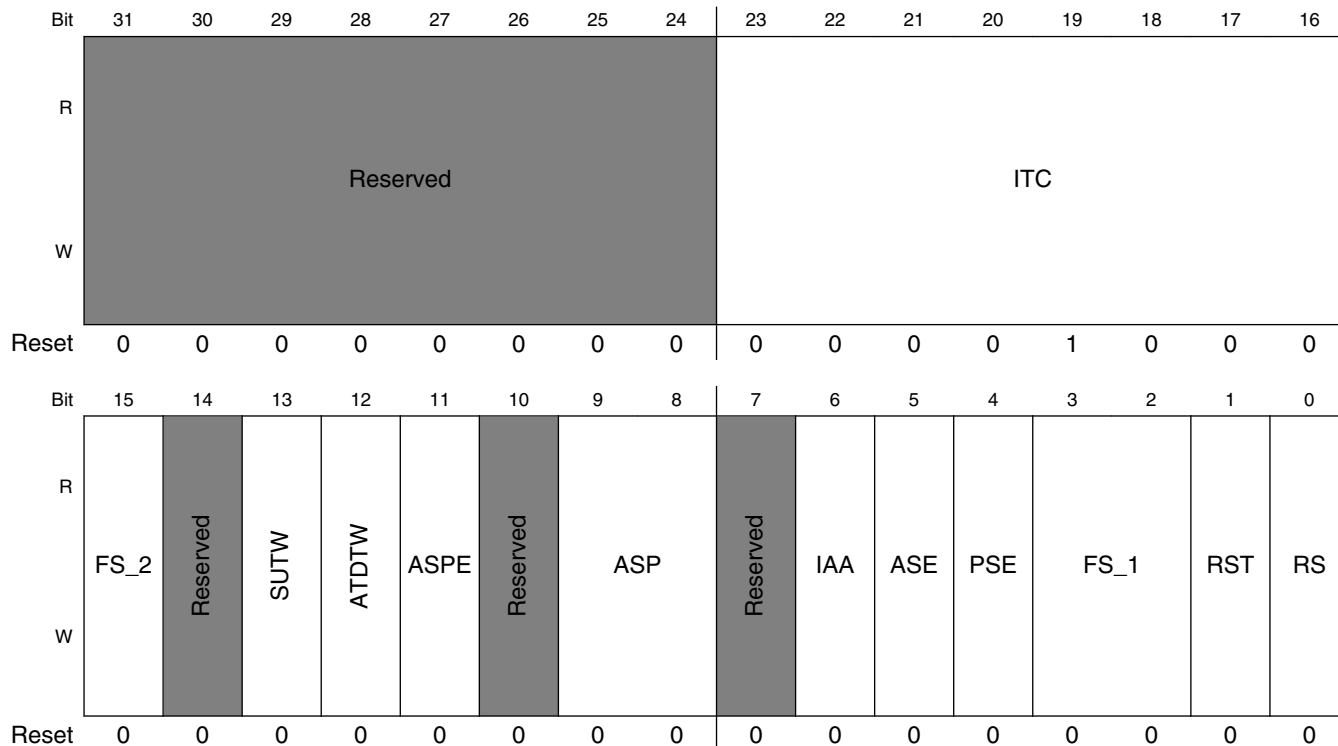

USB_nUSBCMD field descriptions

Field	Description
31–24 -	This field is reserved. Reserved
23–16 ITC	Interrupt Threshold Control -Read/Write. The system software uses this field to set the maximum rate at which the host/device controller will issue interrupts. ITC contains the maximum interrupt interval measured in micro-frames. Valid values are shown below. Value Maximum Interrupt Interval 0x00 Immediate (no threshold) 0x01 1 micro-frame 0x02 2 micro-frames 0x04 4 micro-frames 0x08 8 micro-frames 0x10 16 micro-frames

Table continues on the next page...

USB_nUSBCMD field descriptions (continued)

Field	Description
	0x20 32 micro-frames 0x40 64 micro-frames
15 FS_2	See also bits 3-2 Frame List Size - (Read/Write or Read Only). [host mode only] This field is Read/Write only if Programmable Frame List Flag in the HCCPARAMS registers is set to one. This field specifies the size of the frame list that controls which bits in the Frame Index Register should be used for the Frame List Current index. NOTE: This field is made up from USBCMD bits 15, 3 and 2. Value Meaning 000 1024 elements (4096 bytes) Default value 001 512 elements (2048 bytes) 010 256 elements (1024 bytes) 011 128 elements (512 bytes) 100 64 elements (256 bytes) 101 32 elements (128 bytes) 110 16 elements (64 bytes) 111 8 elements (32 bytes)
14 -	This field is reserved. Reserved
13 SUTW	Setup TripWire - Read/Write. [device mode only] This bit is used as a semaphore to ensure that the setup data payload of 8 bytes is extracted from a QH by the DCD without being corrupted. If the setup lockout mode is off (SLOM bit in USB core register n_USBMODE, see USB Device Mode (USB_nUSBMODE)) then there is a hazard when new setup data arrives while the DCD is copying the setup data payload from the QH for a previous setup packet. This bit is set and cleared by software. This bit would also be cleared by hardware when a hazard detected.
12 ATDTW	Add dTD TripWire - Read/Write. [device mode only] This bit is used as a semaphore to ensure proper addition of a new dTD to an active (primed) endpoint's linked list. This bit is set and cleared by software. This bit would also be cleared by hardware when state machine is hazard region for which adding a dTD to a primed endpoint may go unrecognized.
11 ASPE	Asynchronous Schedule Park Mode Enable - Read/Write. If the <i>Asynchronous Park Capability</i> bit in the HCCPARAMS register is a one, then this bit defaults to a 1h and is R/W. Otherwise the bit must be a zero and is RO. Software uses this bit to enable or disable Park mode. When this bit is one, Park mode is enabled. When this bit is a zero, Park mode is disabled. NOTE: ASPE bit reset value: '0b' for OTG controller .
10 -	This field is reserved. Reserved
9–8 ASP	Asynchronous Schedule Park Mode Count - Read/Write. If the <i>Asynchronous Park Capability</i> bit in the HCCPARAMS register is a one, then this field defaults to 3h and is R/W. Otherwise it defaults to zero and is Read-Only. It contains a count of the number of successive transactions the host controller is allowed to execute from a high-speed queue head on the

Table continues on the next page...

USB_nUSBCMD field descriptions (continued)

Field	Description
	Asynchronous schedule before continuing traversal of the Asynchronous schedule. Valid values are 1h to 3h. Software must not write a zero to this bit when <i>Park Mode Enable</i> is a one as this will result in undefined behavior. This field is set to 3h in all controller core.
7 -	This field is reserved. Reserved
6 IAA	Interrupt on Async Advance Doorbell - Read/Write. This bit is used as a doorbell by software to tell the host controller to issue an interrupt the next time it advances asynchronous schedule. Software must write a 1 to this bit to ring the doorbell. When the host controller has evicted all appropriate cached schedule states, it sets the Interrupt on Async Advance status bit in the USBSTS register. If the Interrupt on Sync Advance Enable bit in the USBINTR register is one, then the host controller will assert an interrupt at the next interrupt threshold. The host controller sets this bit to zero after it has set the Interrupt on Sync Advance status bit in the USBSTS register to one. Software should not write a one to this bit when the asynchronous schedule is inactive. Doing so will yield undefined results. This bit is only used in host mode. Writing a one to this bit when device mode is selected will have undefined results.
5 ASE	Asynchronous Schedule Enable - Read/Write. Default 0b. This bit controls whether the host controller skips processing the Asynchronous Schedule. Only the host controller uses this bit. Values Meaning 0 Do not process the Asynchronous Schedule. 1 Use the ASYNCLISTADDR register to access the Asynchronous Schedule.
4 PSE	Periodic Schedule Enable- Read/Write. Default 0b. This bit controls whether the host controller skips processing the Periodic Schedule. Only the host controller uses this bit. Values Meaning 0 Do not process the Periodic Schedule 1 Use the PERIODICLISTBASE register to access the Periodic Schedule.
3-2 FS_1	See description at bit 15
1 RST	Controller Reset (RESET) - Read/Write. Software uses this bit to reset the controller. This bit is set to zero by the Host/Device Controller when the reset process is complete. Software cannot terminate the reset process early by writing a zero to this register. Host operation mode: When software writes a one to this bit, the Controller resets its internal pipelines, timers, counters, state machines etc. to their initial value. Any transaction currently in progress on USB is immediately terminated. A USB reset is not driven on downstream ports. Software should not set this bit to a one when the HCHalted bit in the USBSTS register is a zero. Attempting to reset an actively running host controller will result in undefined behavior. Device operation mode:

Table continues on the next page...

USB_nUSBCMD field descriptions (continued)

Field	Description
	<p>When software writes a one to this bit, the Controller resets its internal pipelines, timers, counters, state machines etc. to their initial value. Writing a one to this bit when the device is in the attached state is not recommended, because the effect on an attached host is undefined. In order to ensure that the device is not in an attached state before initiating a device controller reset, all primed endpoints should be flushed and the USBCMD Run/Stop bit should be set to 0.</p>
<p>0 RS</p>	<p>Run/Stop (RS) - Read/Write. Default 0b. 1=Run. 0=Stop.</p> <p>Host operation mode:</p> <p>When set to '1b', the Controller proceeds with the execution of the schedule. The Controller continues execution as long as this bit is set to a one. When this bit is set to 0, the Host Controller completes the current transaction on the USB and then halts. The HC Halted bit in the status register indicates when the Controller has finished the transaction and has entered the stopped state. Software should not write a one to this field unless the controller is in the Halted state (that is, HCHalted in the USBSTS register is a one).</p> <p>Device operation mode:</p> <p>Writing a one to this bit will cause the controller to enable a pull-up on D+ and initiate an attach event. This control bit is not directly connected to the pull-up enable, as the pull-up will become disabled upon transitioning into high-speed mode. Software should use this bit to prevent an attach event before the controller has been properly initialized. Writing a 0 to this will cause a detach event.</p>

56.6.19 USB Status Register (USB_nUSBSTS)

This register indicates various states of the Host/Device Controller and any pending interrupts. This register does not indicate status resulting from a transaction on the serial bus.

Address: 218_4000h base + 144h offset + (512d × i), where i=0d to 1d

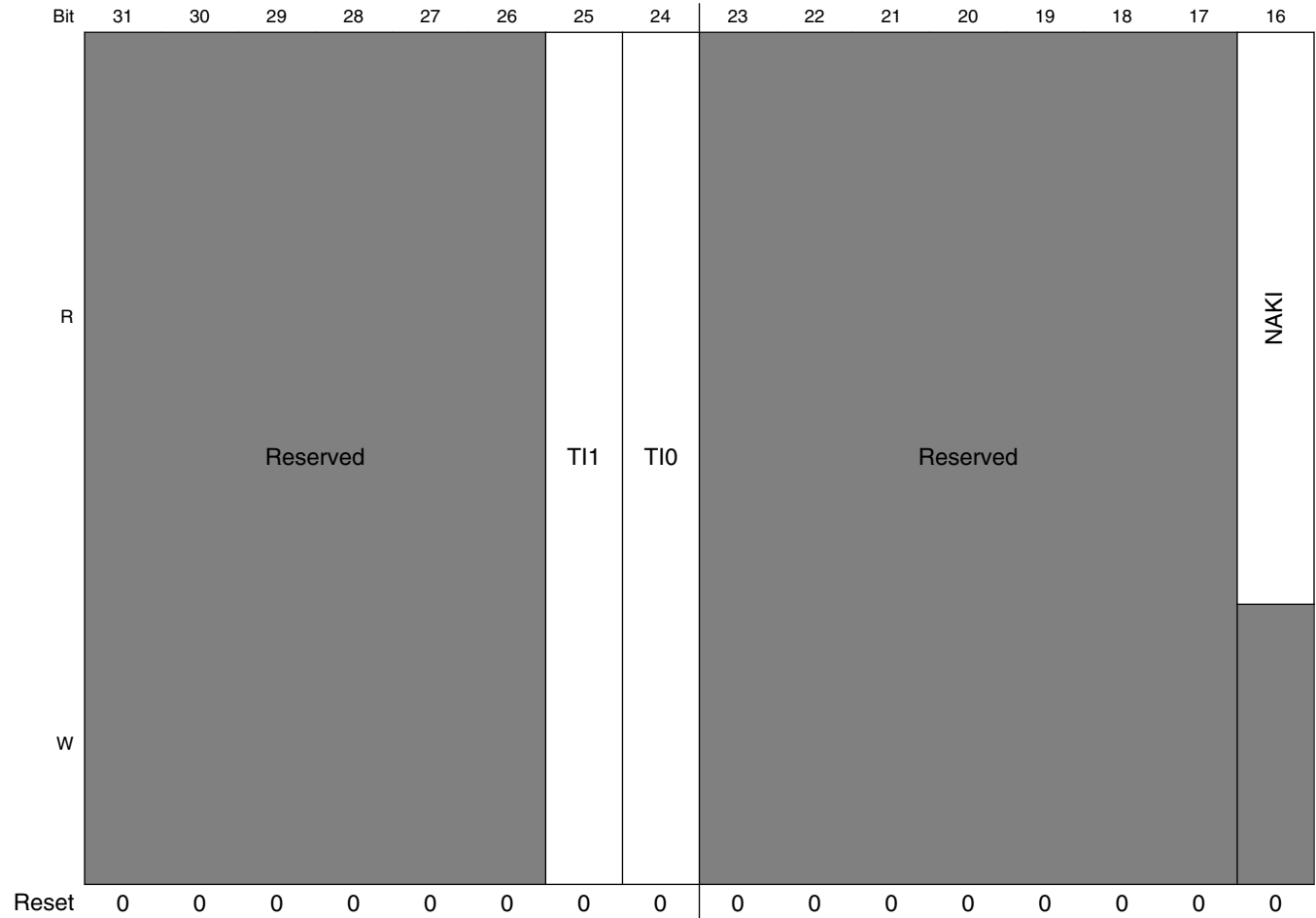

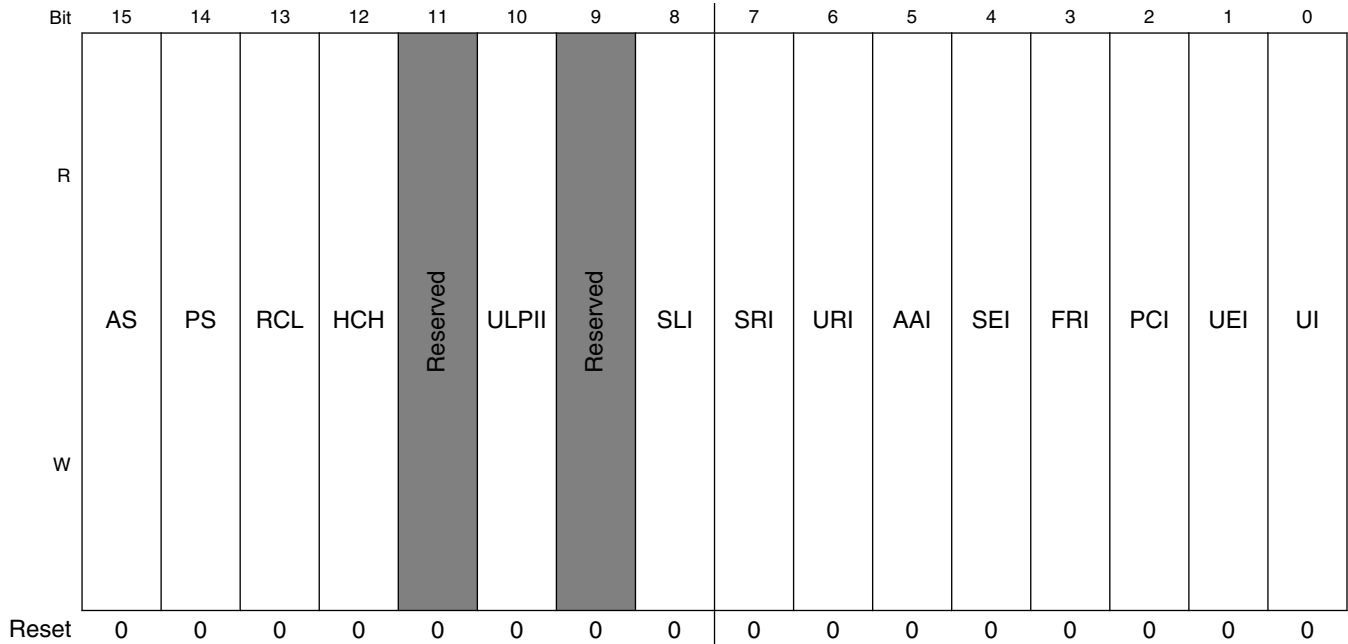

USB_nUSBSTS field descriptions

Field	Description
31–26 -	This field is reserved. Reserved
25 TI1	General Purpose Timer Interrupt 1(GPTINT1)--R/WC. This bit is set when the counter in the GPTIMER1CTRL register transitions to zero, writing a one to this bit will clear it.
24 TI0	General Purpose Timer Interrupt 0(GPTINT0)--R/WC. This bit is set when the counter in the GPTIMER0CTRL register transitions to zero, writing a one to this bit clears it.
23–17 -	This field is reserved. Reserved
16 NAKI	NAK Interrupt Bit--RO. This bit is set by hardware when for a particular endpoint both the TX/RX Endpoint NAK bit and corresponding TX/RX Endpoint NAK Enable bit are set. This bit is automatically cleared by hardware when all Enabled TX/RX Endpoint NAK bits are cleared.
15 AS	Asynchronous Schedule Status - Read Only. This bit reports the current real status of the Asynchronous Schedule. When set to zero the asynchronous schedule status is disabled and if set to one the status is enabled. The Host Controller is not required to immediately disable or enable the Asynchronous Schedule when software transitions the Asynchronous Schedule Enable bit in the USBCMD register. When this bit and the Asynchronous Schedule Enable bit are the same value, the Asynchronous Schedule is either enabled (1) or disabled (0). Only used in the host operation mode.
14 PS	Periodic Schedule Status - Read Only.

Table continues on the next page...

USB_nUSBSTS field descriptions (continued)

Field	Description
	<p>This bit reports the current real status of the Periodic Schedule. When set to zero the periodic schedule is disabled, and if set to one the status is enabled. The Host Controller is not required to immediately disable or enable the Periodic Schedule when software transitions the Periodic Schedule Enable bit in the USBCMD register. When this bit and the Periodic Schedule Enable bit are the same value, the Periodic Schedule is either enabled (1) or disabled (0).</p> <p>Only used in the host operation mode.</p>
13 RCL	<p>Reclamation - Read Only.</p> <p>This is a read-only status bit used to detect an empty asynchronous schedule.</p> <p>Only used in the host operation mode.</p>
12 HCH	<p>HCHalted - Read Only.</p> <p>This bit is a zero whenever the Run/Stop bit is a one. The Controller sets this bit to one after it has stopped executing because of the Run/Stop bit being set to 0, either by software or by the Controller hardware (for example, an internal error).</p> <p>Only used in the host operation mode.</p> <p>Default value is '0b' for OTG core.</p> <p>This is because OTG core is not operating as host in default. Please see CM bit in USB_n_USBMODE register.</p> <p>NOTE: HCH bit reset value: '0b' for OTG controller core.</p>
11 -	<p>This field is reserved.</p> <p>Reserved</p>
10 ULPII	<p>ULPI Interrupt - R/WC.</p> <p>This bit will be set '1b' by hardware when there is an event completion in ULPI viewport.</p> <p>This bit is usable only if the controller support UPLI interface mode.</p>
9 -	<p>This field is reserved.</p> <p>Reserved</p>
8 SLI	<p>DCSuspend - R/WC.</p> <p>When a controller enters a suspend state from an active state, this bit will be set to a one. The device controller clears the bit upon exiting from a suspend state.</p> <p>Only used in device operation mode.</p>
7 SRI	<p>SOF Received - R/WC.</p> <p>When the device controller detects a Start Of (micro) Frame, this bit will be set to a one. When a SOF is extremely late, the device controller will automatically set this bit to indicate that an SOF was expected. Therefore, this bit will be set roughly every 1ms in device FS mode and every 125ms in HS mode and will be synchronized to the actual SOF that is received.</p> <p>Because the device controller is initialized to FS before connect, this bit will be set at an interval of 1ms during the prelude to connect and chirp.</p> <p>In host mode, this bit will be set every 125us and can be used by host controller driver as a time base.</p> <p>Software writes a 1 to this bit to clear it.</p>
6 URI	<p>USB Reset Received - R/WC.</p> <p>When the device controller detects a USB Reset and enters the default state, this bit will be set to a one. Software can write a 1 to this bit to clear the USB Reset Received status bit.</p> <p>Only used in device operation mode.</p>

Table continues on the next page...

USB_nUSBSTS field descriptions (continued)

Field	Description
5 AAI	<p>Interrupt on Async Advance - R/WC.</p> <p>System software can force the host controller to issue an interrupt the next time the host controller advances the asynchronous schedule by writing a one to the Interrupt on Async Advance Doorbell bit in the n_USBCMD register. This status bit indicates the assertion of that interrupt source.</p> <p>Only used in host operation mode.</p>
4 SEI	<p>System Error- R/WC.</p> <p>This bit is will be set to '1b' when an Error response is seen to a read on the system interface.</p>
3 FRI	<p>Frame List Rollover - R/WC.</p> <p>The Host Controller sets this bit to a one when the Frame List Index rolls over from its maximum value to zero. The exact value at which the rollover occurs depends on the frame list size. For example. If the frame list size (as programmed in the Frame List Size field of the USB_n_USBCMD register) is 1024, the Frame Index Register rolls over every time FRINDEX [13] toggles. Similarly, if the size is 512, the Host Controller sets this bit to a one every time FHINDEX [12] toggles.</p> <p>Only used in host operation mode.</p>
2 PCI	<p>Port Change Detect - R/WC.</p> <p>The Host Controller sets this bit to a one when on any port a Connect Status occurs, a Port Enable/Disable Change occurs, or the Force Port Resume bit is set as the result of a J-K transition on the suspended port.</p> <p>The Device Controller sets this bit to a one when the port controller enters the full or high-speed operational state. When the port controller exits the full or high-speed operation states due to Reset or Suspend events, the notification mechanisms are the USB Reset Received bit and the DCSuspend bits respectively.</p>
1 UEI	<p>USB Error Interrupt (USBERRINT) - R/WC.</p> <p>When completion of a USB transaction results in an error condition, this bit is set by the Host/Device Controller. This bit is set along with the USBINT bit, if the TD on which the error interrupt occurred also had its interrupt on complete (IOC) bit set.</p> <p>The device controller detects resume signaling only.</p>
0 UI	<p>USB Interrupt (USBINT) - R/WC.</p> <p>This bit is set by the Host/Device Controller when the cause of an interrupt is a completion of a USB transaction where the Transfer Descriptor (TD) has an interrupt on complete (IOC) bit set.</p> <p>This bit is also set by the Host/Device Controller when a short packet is detected. A short packet is when the actual number of bytes received was less than the expected number of bytes.</p>

56.6.20 Interrupt Enable Register (USB_nUSBINTR)

The interrupts to software are enabled with this register. An interrupt is generated when a bit is set and the corresponding interrupt source is active. The USB Status register (n_USBSTS) still shows interrupt sources even if they are disabled by the n_USBINTR register, allowing polling of interrupt events by the software.

Address: 218_4000h base + 148h offset + (512d × i), where i=0d to 1d

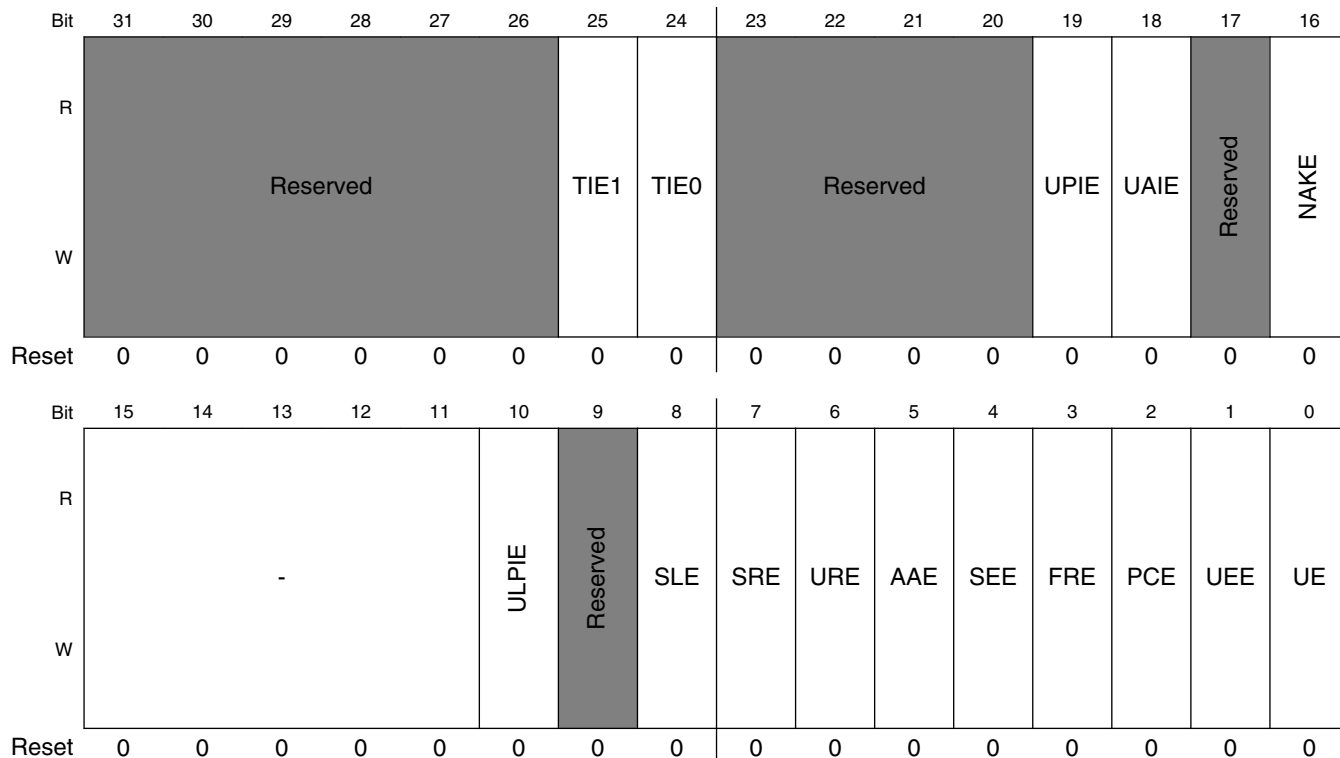

USB_nUSBINTR field descriptions

Field	Description
31–26 -	This field is reserved. Reserved
25 TIE1	General Purpose Timer #1 Interrupt Enable When this bit is one and the TI1 bit in n_USBSTS register is a one the controller will issue an interrupt.
24 TIE0	General Purpose Timer #0 Interrupt Enable When this bit is one and the TI0 bit in n_USBSTS register is a one the controller will issue an interrupt.
23–20 -	This field is reserved. Reserved
19 UPIE	USB Host Periodic Interrupt Enable

Table continues on the next page...

USB_nUSBINTR field descriptions (continued)

Field	Description
	When this bit is one, and the UPI bit in the n_USBSTS register is one, host controller will issue an interrupt at the next interrupt threshold.
18 UAIE	USB Host Asynchronous Interrupt Enable When this bit is one, and the UAI bit in the n_USBSTS register is one, host controller will issue an interrupt at the next interrupt threshold.
17 -	This field is reserved. Reserved
16 NAKE	NAK Interrupt Enable When this bit is one and the NAKI bit in n_USBSTS register is a one the controller will issue an interrupt.
15–11 -	These bits are reserved and should be set to zero.
10 ULPIE	ULPI Interrupt Enable When this bit is one and the UPLI bit in n_USBSTS register is a one the controller will issue an interrupt. This bit is usable only if the controller support UPLI interface mode.
9 -	This field is reserved. Reserved
8 SLE	Sleep Interrupt Enable When this bit is one and the SLI bit in n_n_USBSTS register is a one the controller will issue an interrupt. Only used in device operation mode.
7 SRE	SOF Received Interrupt Enable When this bit is one and the SRI bit in n_USBSTS register is a one the controller will issue an interrupt.
6 URE	USB Reset Interrupt Enable When this bit is one and the URI bit in n_USBSTS register is a one the controller will issue an interrupt. Only used in device operation mode.
5 AAE	Async Advance Interrupt Enable When this bit is one and the AAI bit in n_USBSTS register is a one the controller will issue an interrupt. Only used in host operation mode.
4 SEE	System Error Interrupt Enable When this bit is one and the SEI bit in n_USBSTS register is a one the controller will issue an interrupt. Only used in host operation mode.
3 FRE	Frame List Rollover Interrupt Enable When this bit is one and the FRI bit in n_USBSTS register is a one the controller will issue an interrupt. Only used in host operation mode.
2 PCE	Port Change Detect Interrupt Enable When this bit is one and the PCI bit in n_USBSTS register is a one the controller will issue an interrupt.
1 UEE	USB Error Interrupt Enable When this bit is one and the UEI bit in n_USBSTS register is a one the controller will issue an interrupt.
0 UE	USB Interrupt Enable When this bit is one and the UI bit in n_USBSTS register is a one the controller will issue an interrupt.

56.6.21 USB Frame Index (USB_nFRINDEX)

This register is used by the host controller to index the periodic frame list. The register updates every 125 microseconds (once each micro-frame). Bits [N: 3] are used to select a particular entry in the Periodic Frame List during periodic schedule execution. The number of bits used for the index depends on the size of the frame list as set by system software in the Frame List Size field in the n_USBCMD register.

This register must be written as a DWord. Byte writes produce undefined results. This register cannot be written unless the Host Controller is in the 'Halted' state as indicated by the HCHalted bit. A write to this register while the Run/Stop hit is set to a one produces undefined results. Writes to this register also affect the SOF value.

In device mode this register is read only and, the device controller updates the FRINDEX [13:3] register from the frame number indicated by the SOF marker. Whenever a SOF is received by the USB bus, FRINDEX [13:3] will be checked against the SOF marker. If FRINDEX [13:3] is different from the SOF marker, FRINDEX [13:3] will be set to the SOF value and FRINDEX [2:0] will be set to zero (that is, SOF for 1 ms frame). If FRINDEX [13:3] is equal to the SOF value, FRINDEX [2:0] will be increment (that is, SOF for 125 us micro-frame.).

Address: 218_4000h base + 14Ch offset + (512d × i), where i=0d to 1d

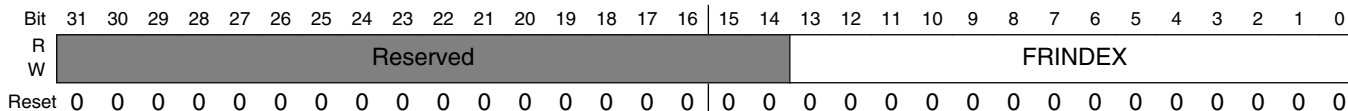

USB_nFRINDEX field descriptions

Field	Description
31–14 -	This field is reserved. Reserved
FRINDEX	<p>Frame Index.</p> <p>The value, in this register, increments at the end of each time frame (micro-frame). Bits [N: 3] are used for the Frame List current index. This means that each location of the frame list is accessed 8 times (frames or micro-frames) before moving to the next index.</p> <p>The following illustrates values of N based on the value of the Frame List Size field in the USBCMD register, when used in host mode.</p> <p>USBCMD [Frame List Size] Number Elements N</p> <p>In device mode the value is the current frame number of the last frame transmitted. It is not used as an index.</p> <p>In either mode bits 2:0 indicate the current microframe.</p> <p>000 (1024) 12 001 (512) 11</p>

Table continues on the next page...

USB_nFRINDEX field descriptions (continued)

Field	Description
010	(256) 10
011	(128) 9
100	(64) 8
101	(32) 7
110	(16) 6
111	(8) 5

56.6.22 Frame List Base Address (USB_nPERIODICLISTBASE)

Host Controller only

This 32-bit register contains the beginning address of the Periodic Frame List in the system memory. HCD loads this register prior to starting the schedule execution by the Host Controller. The memory structure referenced by this physical memory pointer is assumed to be 4-Kbyte aligned. The contents of this register are combined with the Frame Index Register (USB_n_FRINDEX) to enable the Host Controller to step through the Periodic Frame List in sequence.

Address: 218_4000h base + 154h offset + (512d × i), where i=0d to 1d

Bit	31	30	29	28	27	26	25	24	23	22	21	20	19	18	17	16	15	14	13	12	11	10	9	8	7	6	5	4	3	2	1	0
R																																
W	BASEADR																Reserved															
Reset	0	0	0	0	0	0	0	0	0	0	0	0	0	0	0	0	0	0	0	0	0	0	0	0	0	0	0	0	0	0	0	0

USB_nPERIODICLISTBASE field descriptions

Field	Description
31–12 BASEADR	Base Address (Low). These bits correspond to memory address signals [31:12], respectively. Only used by the host controller.
-	This field is reserved. Reserved

56.6.23 Device Address (USB_nDEVICEADDR)

Device Controller only

The upper seven bits of this register represent the device address. After any controller reset or a USB reset, the device address is set to the default address (0). The default address will match all incoming addresses. Software shall reprogram the address after receiving a SET_ADDRESS descriptor.

USB Core Memory Map/Register Definition

Address: 218_4000h base + 154h offset + (512d × i), where i=0d to 1d

Bit	31	30	29	28	27	26	25	24	23	22	21	20	19	18	17	16	
R	USBADR							USBADRA	Reserved								
W																	
Reset	0	0	0	0	0	0	0	0	0	0	0	0	0	0	0	0	
Bit	15	14	13	12	11	10	9	8	7	6	5	4	3	2	1	0	
R	Reserved																
W																	
Reset	0	0	0	0	0	0	0	0	0	0	0	0	0	0	0	0	

USB_nDEVICEADDR field descriptions

Field	Description
31–25 USBADR	Device Address. These bits correspond to the USB device address
24 USBADRA	Device Address Advance. Default=0. When this bit is '0', any writes to USBADR are instantaneous. When this bit is written to a '1' at the same time or before USBADR is written, the write to the USBADR field is staged and held in a hidden register. After an IN occurs on endpoint 0 and is ACKed, USBADR will be loaded from the holding register. Hardware will automatically clear this bit on the following conditions: 1) IN is ACKed to endpoint 0. (USBADR is updated from staging register). 2) OUT/SETUP occur to endpoint 0. (USBADR is not updated). 3) Device Reset occurs (USBADR is reset to 0). NOTE: After the status phase of the SET_ADDRESS descriptor, the DCD has 2 ms to program the USBADR field. This mechanism will ensure this specification is met when the DCD can not write of the device address within 2ms from the SET_ADDRESS status phase. If the DCD writes the USBADR with USBADRA=1 after the SET_ADDRESS data phase (before the prime of the status phase), the USBADR will be programmed instantly at the correct time and meet the 2ms USB requirement.
-	This field is reserved. Reserved

56.6.24 Next Asynch. Address (USB_nASYNCLISTADDR)

Host Controller only

This 32-bit register contains the address of the next asynchronous queue head to be executed by the host. Bits [4:0] of this register cannot be modified by the system software and will always return a zero when read.

Address: 218_4000h base + 158h offset + (512d × i), where i=0d to 1d

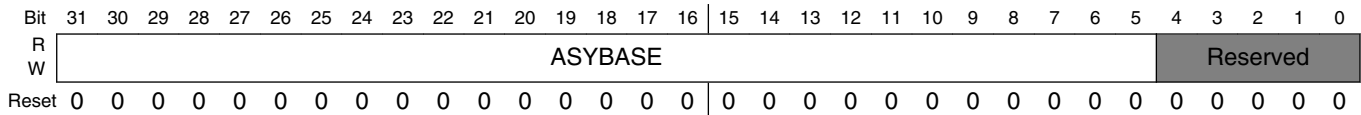

USB_nASYNCLISTADDR field descriptions

Field	Description
31–5 ASYBASE	Link Pointer Low (LPL). These bits correspond to memory address signals [31:5], respectively. This field may only reference a Queue Head (QH). Only used by the host controller.
-	This field is reserved. Reserved

56.6.25 Endpoint List Address (USB_nENDPTLISTADDR)

Device Controller only

In device mode, this register contains the address of the top of the endpoint list in system memory. Bits [10:0] of this register cannot be modified by the system software and will always return a zero when read.

The memory structure referenced by this physical memory pointer is assumed 64-byte.

Address: 218_4000h base + 158h offset + (512d × i), where i=0d to 1d

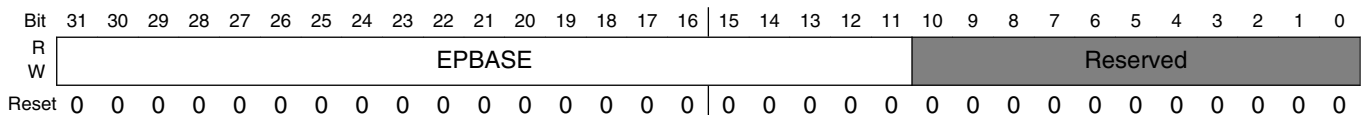

USB_nENDPTLISTADDR field descriptions

Field	Description
31–11 EPBASE	Endpoint List Pointer(Low). These bits correspond to memory address signals [31:11], respectively. This field will reference a list of up to 32 Queue Head (QH) (that is, one queue head per endpoint & direction).
-	This field is reserved. Reserved

56.6.26 Programmable Burst Size (USB_nBURSTSIZE)

This register is used to control the burst size used during data movement on the AHB master interface. This register is ignored if AHBBRST bits in SBUSCFG register is non-zero value.

USB Core Memory Map/Register Definition

Address: 218_4000h base + 160h offset + (512d × i), where i=0d to 1d

Bit	31	30	29	28	27	26	25	24	23	22	21	20	19	18	17	16	15	14	13	12	11	10	9	8	7	6	5	4	3	2	1	0
R	Reserved																TXPBURST						RXPBURST									
W	Reserved																TXPBURST						RXPBURST									
Reset	0	0	0	0	0	0	0	0	0	0	0	0	0	0	0	0	0	0	0	0	1	0	0	0	0	0	0	0	1	0	0	0

USB_nBURSTSIZE field descriptions

Field	Description
31–17 -	This field is reserved. Reserved
16–8 TXPBURST	Programmable TX Burst Size. Default value is determined by TXBURST bits in n_HWTXBUF. This register represents the maximum length of a the burst in 32-bit words while moving data from system memory to the USB bus.
RXPBURST	Programmable RX Burst Size. Default value is determined by TXBURST bits in n_HWRXBUF. This register represents the maximum length of a the burst in 32-bit words while moving data from the USB bus to system memory.

56.6.27 TX FIFO Fill Tuning (USB_nTXFILLTUNING)

The fields in this register control performance tuning associated with how the host controller posts data to the TX latency FIFO before moving the data onto the USB bus. The specific areas of performance include the how much data to post into the FIFO and an estimate for how long that operation should take in the target system.

Definitions:

T_0 = Standard packet overhead

T_1 = Time to send data payload

T_{ff} = Time to fetch packet into TX FIFO up to specified level.

T_s = Total Packet Flight Time (send-only) packet

$T_s = T_0 + T_1$

T_p = Total Packet Time (fetch and send) packet

$T_p = T_{ff} + T_0 + T_1$

Upon discovery of a transmit (OUT/SETUP) packet in the data structures, host controller checks to ensure T_p remains before the end of the [micro]frame. If so it proceeds to pre-fill the TX FIFO. If at anytime during the pre-fill operation the time remaining the [micro]frame is $< T_s$ then the packet attempt ceases and the packet is tried at a later time. Although this is not an error condition and the host controller will eventually recover, a

mark will be made the scheduler health counter to note the occurrence of a "back-off" event. When a back-off event is detected, the partial packet fetched may need to be discarded from the latency buffer to make room for periodic traffic that will begin after the next SOF. Too many back-off events can waste bandwidth and power on the system bus and thus should be minimized (not necessarily eliminated). Back-offs can be minimized with use of the `n_TSCHHEALTH` (T_{ff}) described below.

NOTE

The reset value could vary from instance to instance. Please see the detail in bit field description and ignore reset value in summary table in this case!

Address: `218_4000h base + 164h offset + (512d × i)`, where `i=0d to 1d`

Bit	31	30	29	28	27	26	25	24	23	22	21	20	19	18	17	16	15	14	13	12	11	10	9	8	7	6	5	4	3	2	1	0	
R																																	
W																																	
Reset	0	0	0	0	0	0	0	0	0	0	0	0	0	1	0	1	0	0	0	0	0	0	0	0	0	0	0	0	0	0	0	0	0

USB_nTXFILLTUNING field descriptions

Field	Description
31–22 -	This field is reserved. Reserved
21–16 TXFIFOTHRES	FIFO Burst Threshold. (Read/Write) This register controls the number of data bursts that are posted to the TX latency FIFO in host mode before the packet begins on to the bus. The minimum value is 2 and this value should be a low as possible to maximize USB performance. A higher value can be used in systems with unpredictable latency and/or insufficient bandwidth where the FIFO may underrun because the data transferred from the latency FIFO to USB occurs before it can be replenished from system memory. This value is ignored if the Stream Disable bit in <code>USB_n_USBMODE</code> register is set. Default value is '0Ah' for OTG controller core.
15–13 -	This field is reserved. Reserved
12–8 TXSCHHEALTH	Scheduler Health Counter. (Read/Write To Clear) This register increments when the host controller fails to fill the TX latency FIFO to the level programmed by <code>TXFIFOTHRES</code> before running out of time to send the packet before the next Start-Of-Frame. This health counter measures the number of times this occurs to provide feedback to selecting a proper <code>TXSCHOH</code> . Writing to this register will clear the counter and this counter will max. at 31. Default value is '00h' for OTG controller core.
TXSCHOH	Scheduler Overhead. (Read/Write) [Default = 0] This register adds an additional fixed offset to the schedule time estimator described above as T_{ff} . As an approximation, the value chosen for this register should limit the number of back-off events captured in the <code>TXSCHHEALTH</code> to less than 10 per second in a highly utilized bus. Choosing a value that is too high for this register is not desired as it can needlessly reduce USB utilization. The time unit represented in this register is 1.267us when a device is connected in High-Speed Mode. The time unit represented in this register is 6.333us when a device is connected in Low/Full Speed Mode. Default value is '08h' for OTG controller core.

56.6.28 Endpoint NAK (USB_nENDPTNAK)

Address: 218_4000h base + 178h offset + (512d × i), where i=0d to 1d

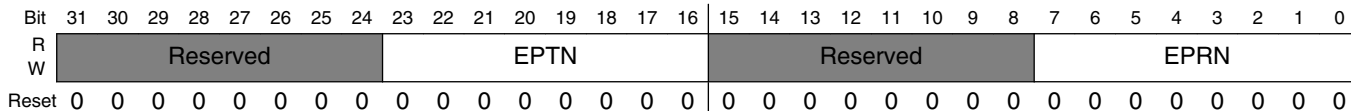

USB_nENDPTNAK field descriptions

Field	Description
31–24 -	This field is reserved. Reserved
23–16 EPTN	TX Endpoint NAK - R/WC. Each TX endpoint has 1 bit in this field. The bit is set when the device sends a NAK handshake on a received IN token for the corresponding endpoint. Bit [N] - Endpoint #[N], N is 0-7
15–8 -	This field is reserved. Reserved
EPRN	RX Endpoint NAK - R/WC. Each RX endpoint has 1 bit in this field. The bit is set when the device sends a NAK handshake on a received OUT or PING token for the corresponding endpoint. Bit [N] - Endpoint #[N], N is 0-7

56.6.29 Endpoint NAK Enable (USB_nENDPTNAKEN)

Address: 218_4000h base + 17Ch offset + (512d × i), where i=0d to 1d

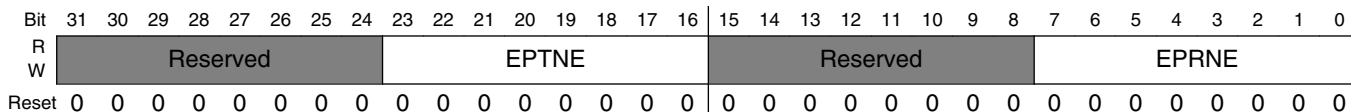

USB_nENDPTNAKEN field descriptions

Field	Description
31–24 -	This field is reserved. Reserved
23–16 EPTNE	TX Endpoint NAK Enable - R/W. Each bit is an enable bit for the corresponding TX Endpoint NAK bit. If this bit is set and the corresponding TX Endpoint NAK bit is set, the NAK Interrupt bit is set. Bit [N] - Endpoint #[N], N is 0-7
15–8 -	This field is reserved. Reserved
EPRNE	RX Endpoint NAK Enable - R/W.

Table continues on the next page...

USB_nENDPTNAKEN field descriptions (continued)

Field	Description
	Each bit is an enable bit for the corresponding RX Endpoint NAK bit. If this bit is set and the corresponding RX Endpoint NAK bit is set, the NAK Interrupt bit is set. Bit [N] - Endpoint #[N], N is 0-7

56.6.30 Configure Flag Register (USB_nCONFIGFLAG)

Address: 218_4000h base + 180h offset + (512d × i), where i=0d to 1d

Bit	31	30	29	28	27	26	25	24	23	22	21	20	19	18	17	16
R	Reserved															
W	Reserved															
Reset	0	0	0	0	0	0	0	0	0	0	0	0	0	0	0	0
Bit	15	14	13	12	11	10	9	8	7	6	5	4	3	2	1	0
R	Reserved															CF
W	Reserved															
Reset	0	0	0	0	0	0	0	0	0	0	0	0	0	0	0	1

USB_nCONFIGFLAG field descriptions

Field	Description
31–1 -	This field is reserved. Reserved
0 CF	Configure Flag Host software sets this bit as the last action in its process of configuring the Host Controller. This bit controls the default port-routing control logic. 0 Port routing control logic default-routes each port to an implementation dependent classic host controller. 1 Port routing control logic default-routes all ports to this host controller.

56.6.31 Port Status & Control (USB_nPORTSC1)

Host Controller

A host controller could implement one to eight port status and control registers. The number is determined by N_PORTs bits in HWSPARAMs register (please see [Host Controller Structural Parameters \(USB_nHCSPARAMS\)](#)). Software could read this parameter register to determine how many ports need service.

All controller cores on this product are Single-Port, so there is only one port status and control register for each controller core.

This register is only reset by power on reset or controller core reset. The initial conditions of a port are:

- No device connected
- Port disabled

If the port supports power control, this state remains until port power is supplied (by software).

Device Controller

A controller operating in device mode has only port register one (PORTSC1) and it does not support power control in that mode. Port control in device mode is only used for status port reset, suspend, and current connect status. It is also used to initiate test mode or force signaling and allows software to put the PHY into low power suspend mode and disable the PHY clock.

Address: 218_4000h base + 184h offset + (512d × i), where i=0d to 1d

Bit	31	30	29	28	27	26	25	24	23	22	21	20	19	18	17	16
R	PTS_1		STS	PTW	PSPD		PTS_2	PFSC	PHCD	WKOC	WKDC	WKCN	PTC			
W																
Reset	0	0	0	1	0	0	0	0	0	0	0	0	0	0	0	0
Bit	15	14	13	12	11	10	9	8	7	6	5	4	3	2	1	0
R	PIC		PO	PP	LS		HSP	PR	SUSP	FPR	OCC	OCA	PEC	PE	CSC	CCS
W																
Reset	0	0	0	0	0	0	0	0	0	0	0	0	0	0	0	0

USB_nPORTSC1 field descriptions

Field	Description
31–30 PTS_1	NOTE: All USB port interface modes are listed in this field description, but not all are supported. For detail feature of each controller core, please see Features . The behaviour is unknown when unsupported interface mode is selected.
29 STS	Serial Transceiver Select 1 Serial Interface Engine is selected 0 Parallel Interface signals is selected Serial Interface Engine can be used in combination with UTMI+/ULPI physical interface to provide FS/LS signaling instead of the parallel interface signals. When this bit is set '1b', serial interface engine will be used instead of parallel interface signals. This bit has no effect unless PTS bits is set to select UTMI+/ULPI interface. The Serial/USB1.1 PHY/IC-USB will use the serial interface engine for FS/LS signaling regardless of this bit value.
28 PTW	Parallel Transceiver Width This bit has no effect if serial interface engine is used. For OTG1/OTG2 core, it is Read-Only. Reset value is '1b'. 0 Select the 8-bit UTMI interface [60MHz] 1 Select the 16-bit UTMI interface [30MHz]
27–26 PSPD	Port Speed - Read Only. This register field indicates the speed at which the port is operating. 00 Full Speed 01 Low Speed 10 High Speed 11 Undefined
25 PTS_2	See description at bits 31-30
24 PFSC	Port Force Full Speed Connect - Read/Write. Default = 0b. When this bit is set to '1b', the port will be forced to only connect at Full Speed, It disables the chirp sequence that allows the port to identify itself as High Speed. 1 Forced to full speed 0 Normal operation
23 PHCD	PHY Low Power Suspend - Clock Disable (PLPSCD) - Read/Write. Default = 0b. When this bit is set to '1b', the PHY clock is disabled. Reading this bit will indicate the status of the PHY clock. NOTE: The PHY clock cannot be disabled if it is being used as the system clock. In device mode, The PHY can be put into Low Power Suspend when the device is not running (USBCMD Run/Stop=0b) or the host has signalled suspend (PORTSC1 SUSPEND=1b). PHY Low power suspend will be cleared automatically when the host initials resume. Before forcing a resume from the device, the device controller driver must clear this bit. In host mode, the PHY can be put into Low Power Suspend when the downstream device has been put into suspend mode or when no downstream device is connected. Low power suspend is completely under the control of software.

Table continues on the next page...

USB_nPORTSC1 field descriptions (continued)

Field	Description
	1 Disable PHY clock 0 Enable PHY clock
22 WKOC	Wake on Over-current Enable (WKOC_E) - Read/Write. Default = 0b. Writing this bit to a one enables the port to be sensitive to over-current conditions as wake-up events. This field is zero if <i>Port Power</i> (Port Status & Control (USB_nPORTSC1)) is zero.
21 WKDC	Wake on Disconnect Enable (WKDCNNT_E) - Read/Write. Default=0b. Writing this bit to a one enables the port to be sensitive to device disconnects as wake-up events. This field is zero if <i>Port Power</i> (Port Status & Control (USB_nPORTSC1)) is zero or in device mode.
20 WKCEN	Wake on Connect Enable (WKCENNT_E) - Read/Write. Default=0b. Writing this bit to a one enables the port to be sensitive to device connects as wake-up events. This field is zero if <i>Port Power</i> (Port Status & Control (USB_nPORTSC1)) is zero or in device mode.
19–16 PTC	Port Test Control - Read/Write. Default = 0000b. Refer to Port Test Mode for the operational model for using these test modes and the USB Specification Revision 2.0, Chapter 7 for details on each test mode. The FORCE_ENABLE_FS and FORCE_ENABLE_LS are extensions to the test mode support specified in the EHCI specification. Writing the PTC field to any of the FORCE_ENABLE_{HS/FS/LS} values will force the port into the connected and enabled state at the selected speed. Writing the PTC field back to TEST_MODE_DISABLE will allow the port state machines to progress normally from that point. NOTE: <i>Low speed operations are not supported as a peripheral device.</i> Any other value than zero indicates that the port is operating in test mode. Value Specific Test 0000 TEST_MODE_DISABLE 0001 J_STATE 0010 K_STATE 0011 SE0 (host) / NAK (device) 0100 Packet 0101 FORCE_ENABLE_HS 0110 FORCE_ENABLE_FS 0111 FORCE_ENABLE_LS 1000-1111 Reserved
15–14 PIC	Port Indicator Control - Read/Write. Default = 0b. Writing to this field has no effect if the P_INDICATOR bit in the HCSPARAMS register is a zero. Refer to the USB Specification Revision 2.0 for a description on how these bits are to be used. This field is zero if <i>Port Power</i> is zero. Bit Value Meaning 00 Port indicators are off 01 Amber 10 Green 11 Undefined
13 PO	Port Owner-Read/Write. Default = 0.

Table continues on the next page...

USB_nPORTSC1 field descriptions (continued)

Field	Description
	<p>This bit unconditionally goes to a 0 when the configured bit in the CONFIGFLAG register makes a 0 to 1 transition. This bit unconditionally goes to 1 whenever the Configured bit is zero. System software uses this field to release ownership of the port to a selected host controller (in the event that the attached device is not a high-speed device). Software writes a one to this bit when the attached device is not a high-speed device. A one in this bit means that an internal companion controller owns and controls the port.</p> <p>Port owner handoff is not supported in all controller cores, therefore this bit will always be 0.</p>
12 PP	<p>Port Power (PP)-Read/Write or Read Only.</p> <p>The function of this bit depends on the value of the Port Power Switching (PPC) field in the HCSPARAMS register. The behavior is as follows:</p> <p>PPC</p> <p>PP Operation</p> <p>0</p> <p>1b <i>Read Only</i> - Host controller does not have port power control switches. Each port is hard-wired to power.</p> <p>1</p> <p>1b/0b - <i>Read/Write</i>. OTG controller requires port power control switches. This bit represents the current setting of the switch (0=off, 1=on). When power is not available on a port (that is, PP equals a 0), the port is non-functional and will not report attaches, detaches, etc.</p> <p>When an over-current condition is detected on a powered port and PPC is a one, the PP bit in each affected port may be transitional by the host controller driver from a one to a zero (removing power from the port).</p> <p>This feature is implemented in all controller cores (PPC = 1).</p>
11–10 LS	<p>Line Status-Read Only. These bits reflect the current logical levels of the D+ (bit 11) and D- (bit 10) signal lines.</p> <p>In host mode, the use of linestate by the host controller driver is not necessary (unlike EHCI), because the port controller state machine and the port routing manage the connection of LS and FS.</p> <p>In device mode, the use of linestate by the device controller driver is not necessary.</p> <p>The encoding of the bits are:</p> <p>Bits [11:10] Meaning</p> <p>00 SE0</p> <p>10 J-state</p> <p>01 K-state</p> <p>11 Undefined</p>
9 HSP	<p>High-Speed Port - Read Only. Default = 0b.</p> <p>When the bit is one, the host/device connected to the port is in high-speed mode and if set to zero, the host/device connected to the port is not in a high-speed mode.</p> <p>NOTE: HSP is redundant with PSPD(bit 27, 26) but remained for compatibility.</p>
8 PR	<p>Port Reset - Read/Write or Read Only. Default = 0b.</p> <p>In Host Mode: Read/Write. 1=Port is in Reset. 0=Port is not in Reset. Default 0.</p> <p>When software writes a one to this bit the bus-reset sequence as defined in the USB Specification Revision 2.0 is started. <i>This bit will automatically change to zero after the reset sequence is complete. This behavior is different from EHCI where the host controller driver is required to set this bit to a zero after the reset duration is timed in the driver.</i></p>

Table continues on the next page...

USB_nPORTSC1 field descriptions (continued)

Field	Description
	<p>In Device Mode: This bit is a read only status bit. Device reset from the USB bus is also indicated in the USBSTS register.</p> <p>This field is zero if <i>Port Power</i>(Port Status & Control (USB_nPORTSC1)) is zero.</p>
<p>7 SUSP</p>	<p>Suspend - Read/Write or Read Only. Default = 0b.</p> <p>1=Port in suspend state. 0=Port not in suspend state.</p> <p>In Host Mode: Read/Write.</p> <p>Port Enabled Bit and Suspend bit of this register define the port states as follows:</p> <p>Bits [Port Enabled, Suspend] Port State</p> <p>0x Disable</p> <p>10 Enable</p> <p>11 Suspend</p> <p>When in suspend state, downstream propagation of data is blocked on this port, except for port reset. The blocking occurs at the end of the current transaction if a transaction was in progress when this bit was written to 1. In the suspend state, the port is sensitive to resume detection. Note that the bit status does not change until the port is suspended and that there may be a delay in suspending a port if there is a transaction currently in progress on the USB.</p> <p>The host controller will unconditionally set this bit to zero when software sets the <i>Force Port Resume</i> bit to zero. The host controller ignores a write of zero to this bit.</p> <p>If host software sets this bit to a one when the port is not enabled (that is, <i>Port enabled</i> bit is a zero) the results are undefined.</p> <p>This field is zero if <i>Port Power</i>(Port Status & Control (USB_nPORTSC1)) is zero in host mode.</p> <p>In Device Mode: Read Only.</p> <p>In device mode this bit is a read only status bit.</p>
<p>6 FPR</p>	<p>Force Port Resume -Read/Write. 1= Resume detected/driven on port. 0=No resume (K-state) detected/ driven on port. Default = 0.</p> <p>In Host Mode:</p> <p>Software sets this bit to one to drive resume signaling. The Host Controller sets this bit to one if a J-to-K transition is detected while the port is in the Suspend state. When this bit transitions to a one because a J-to-K transition is detected, the <i>Port Change Detect</i> bit in the USBSTS register is also set to one. <i>This bit will automatically change to zero after the resume sequence is complete. This behavior is different from EHCI where the host controller driver is required to set this bit to a zero after the resume duration is timed in the driver.</i></p> <p>Note that when the Host controller owns the port, the resume sequence follows the defined sequence documented in the USB Specification Revision 2.0. The resume signaling (Full-speed 'K') is driven on the port as long as this bit remains a one. This bit will remain a one until the port has switched to the high-speed idle. Writing a zero has no effect because the port controller will time the resume operation, clear the bit the port control state switches to HS or FS idle.</p> <p>This field is zero if <i>Port Power</i>(Port Status & Control (USB_nPORTSC1)) is zero in host mode.</p> <p>This bit is not-EHCI compatible.</p> <p>In Device mode:</p>

Table continues on the next page...

USB_nPORTSC1 field descriptions (continued)

Field	Description
	After the device has been in Suspend State for 5ms or more, software must set this bit to one to drive resume signaling before clearing. The Device Controller will set this bit to one if a J-to-K transition is detected while the port is in the Suspend state. The bit will be cleared when the device returns to normal operation. Also, when this bit will be cleared because a K-to-J transition detected, the <i>Port Change Detect</i> bit in the USBSTS register is also set to one.
5 OCC	Over-current Change-R/WC. Default=0. This bit is set '1b' by hardware when there is a change to Over-current Active. Software can clear this bit by writing a one to this bit position.
4 OCA	Over-current Active-Read Only. Default 0. This bit will automatically transition from one to zero when the over current condition is removed. 1 This port currently has an over-current condition 0 This port does not have an over-current condition.
3 PEC	Port Enable/Disable Change-R/WC. 1=Port enabled/disabled status has changed. 0=No change. Default = 0. In Host Mode: For the root hub, this bit is set to a one only when a port is disabled due to disconnect on the port or due to the appropriate conditions existing at the EOF2 point (See Chapter 11 of the USB Specification). Software clears this by writing a one to it. This field is zero if <i>Port Power</i> (Port Status & Control (USB_nPORTSC1)) is zero. In Device mode: The device port is always enabled, so this bit is always '0b'.
2 PE	Port Enabled/Disabled-Read/Write. 1=Enable. 0=Disable. Default 0. In Host Mode: Ports can only be enabled by the host controller as a part of the reset and enable. Software cannot enable a port by writing a one to this field. Ports can be disabled by either a fault condition (disconnect event or other fault condition) or by the host software. Note that the bit status does not change until the port state actually changes. There may be a delay in disabling or enabling a port due to other host controller and bus events. When the port is disabled, (0b) downstream propagation of data is blocked except for reset. This field is zero if <i>Port Power</i> (Port Status & Control (USB_nPORTSC1)) is zero in host mode. In Device Mode: The device port is always enabled, so this bit is always '1b'.
1 CSC	Connect Status Change-R/WC. 1 =Change in Current Connect Status. 0=No change. Default 0. In Host Mode: Indicates a change has occurred in the port's Current Connect Status. The host/device controller sets this bit for all changes to the port device connect status, even if system software has not cleared an existing connect status change. For example, the insertion status changes twice before system software has cleared the changed condition, hub hardware will be 'setting' an already-set bit (that is, the bit will remain set). Software clears this bit by writing a one to it. This field is zero if <i>Port Power</i> (Port Status & Control (USB_nPORTSC1)) is zero in host mode. In Device Mode: This bit is undefined in device controller mode.

Table continues on the next page...

USB_nPORTSC1 field descriptions (continued)

Field	Description
0 CCS	<p>Current Connect Status-Read Only.</p> <p>In Host Mode:</p> <p>1=Device is present on port. 0=No device is present. Default = 0. This value reflects the current state of the port, and may not correspond directly to the event that caused the <i>Connect Status Change</i> bit (Bit 1) to be set.</p> <p>This field is zero if <i>Port Power</i>(Port Status & Control (USB_nPORTSC1)) is zero in host mode.</p> <p>In Device Mode:</p> <p>1=Attached. 0=Not Attached. Default=0. A one indicates that the device successfully attached and is operating in either high speed or full speed as indicated by the High Speed Port bit in this register. A zero indicates that the device did not attach successfully or was forcibly disconnected by the software writing a zero to the Run bit in the USB_CMD register. It does not state the device being disconnected or suspended.</p>

56.6.32 On-The-Go Status & control (USB_nOTGSC)

This register is available only in OTG controller core. It has four sections:

- OTG Interrupt enables (Read/Write)
- OTG Interrupt status (Read/Write to Clear)
- OTG Status inputs (Read Only)
- OTG Controls (Read/Write)

The status inputs are debounced using a 1 ms time constant. Values on the status inputs that do not persist for more than 1 ms does not cause an update of the status input register, or cause an OTG interrupt.

See also [USB Device Mode \(USB_nUSBMODE\)](#) register.

Address: 218_4000h base + 1A4h offset + (512d × i), where i=0d to 1d

Bit	31	30	29	28	27	26	25	24	23	22	21	20	19	18	17	16
R																
W																
Reset	0	0	0	0	0	0	0	0	0	0	0	0	0	0	0	0
Bit	15	14	13	12	11	10	9	8	7	6	5	4	3	2	1	0
R																
W																
Reset	0	0	0	1	0	0	0	1	0	0	1	0	0	0	0	0

USB_nOTGSC field descriptions

Field	Description
31 -	This field is reserved. Reserved
30 DPIE	Data Pulse Interrupt Enable
29 EN_1MS	1 millisecond timer Interrupt Enable - Read/Write
28 BSEIE	B Session End Interrupt Enable - Read/Write. Setting this bit enables the B session end interrupt.
27 BSVIE	B Session Valid Interrupt Enable - Read/Write. Setting this bit enables the B session valid interrupt.
26 ASVIE	A Session Valid Interrupt Enable - Read/Write. Setting this bit enables the A session valid interrupt.
25 AVVIE	A VBus Valid Interrupt Enable - Read/Write. Setting this bit enables the A VBus valid interrupt.
24 IDIE	USB ID Interrupt Enable - Read/Write. Setting this bit enables the USB ID interrupt.
23 -	This field is reserved. Reserved
22 DPIS	Data Pulse Interrupt Status - Read/Write to Clear. This bit is set when data bus pulsing occurs on DP or DM. Data bus pulsing is only detected when USBMODE.CM = Host (11) and PORTSC1(0)[PP] = 0. Software must write a one to clear this bit.
21 STATUS_1MS	1 millisecond timer Interrupt Status - Read/Write to Clear. This bit is set once every millisecond. Software must write a one to clear this bit.
20 BSEIS	B Session End Interrupt Status - Read/Write to Clear. This bit is set when VBus has fallen below the B session end threshold. Software must write a one to clear this bit.
19 BSVIS	B Session Valid Interrupt Status - Read/Write to Clear. This bit is set when VBus has either risen above or fallen below the B session valid threshold. Software must write a one to clear this bit.
18 ASVIS	A Session Valid Interrupt Status - Read/Write to Clear. This bit is set when VBus has either risen above or fallen below the A session valid threshold. Software must write a one to clear this bit.
17 AVVIS	A VBus Valid Interrupt Status - Read/Write to Clear. This bit is set when VBus has either risen above or fallen below the VBus valid threshold on an A device. Software must write a one to clear this bit.
16 IDIS	USB ID Interrupt Status - Read/Write. This bit is set when a change on the ID input has been detected. Software must write a one to clear this bit.

Table continues on the next page...

USB_nOTGSC field descriptions (continued)

Field	Description
15 -	This field is reserved. Reserved
14 DPS	Data Bus Pulsing Status - Read Only. A '1' indicates data bus pulsing is being detected on the port.
13 TOG_1MS	1 millisecond timer toggle - Read Only. This bit toggles once per millisecond.
12 BSE	B Session End - Read Only. Indicates VBus is below the B session end threshold.
11 BSV	B Session Valid - Read Only. Indicates VBus is above the B session valid threshold.
10 ASV	A Session Valid - Read Only. Indicates VBus is above the A session valid threshold.
9 AVV	A VBus Valid - Read Only. Indicates VBus is above the A VBus valid threshold.
8 ID	USB ID - Read Only. 0 = A device, 1 = B device
7-6 -	This field is reserved. Reserved
5 IDPU	ID Pullup - Read/Write This bit provide control over the ID pull-up resistor; 0 = off, 1 = on [default]. When this bit is 0, the ID input will not be sampled.
4 DP	Data Pulsing - Read/Write. Setting this bit causes the pullup on DP to be asserted for data pulsing during SRP.
3 OT	OTG Termination - Read/Write. This bit must be set when the OTG device is in device mode, this controls the pulldown on DM.
2 -	This field is reserved. Reserved
1 VC	VBUS Charge - Read/Write. Setting this bit causes the VBus line to be charged. This is used for VBus pulsing during SRP.
0 VD	VBUS_Discharge - Read/Write. Setting this bit causes VBus to discharge through a resistor.

56.6.33 USB Device Mode (USB_nUSBMODE)

Address: 218_4000h base + 1A8h offset + (512d × i), where i=0d to 1d

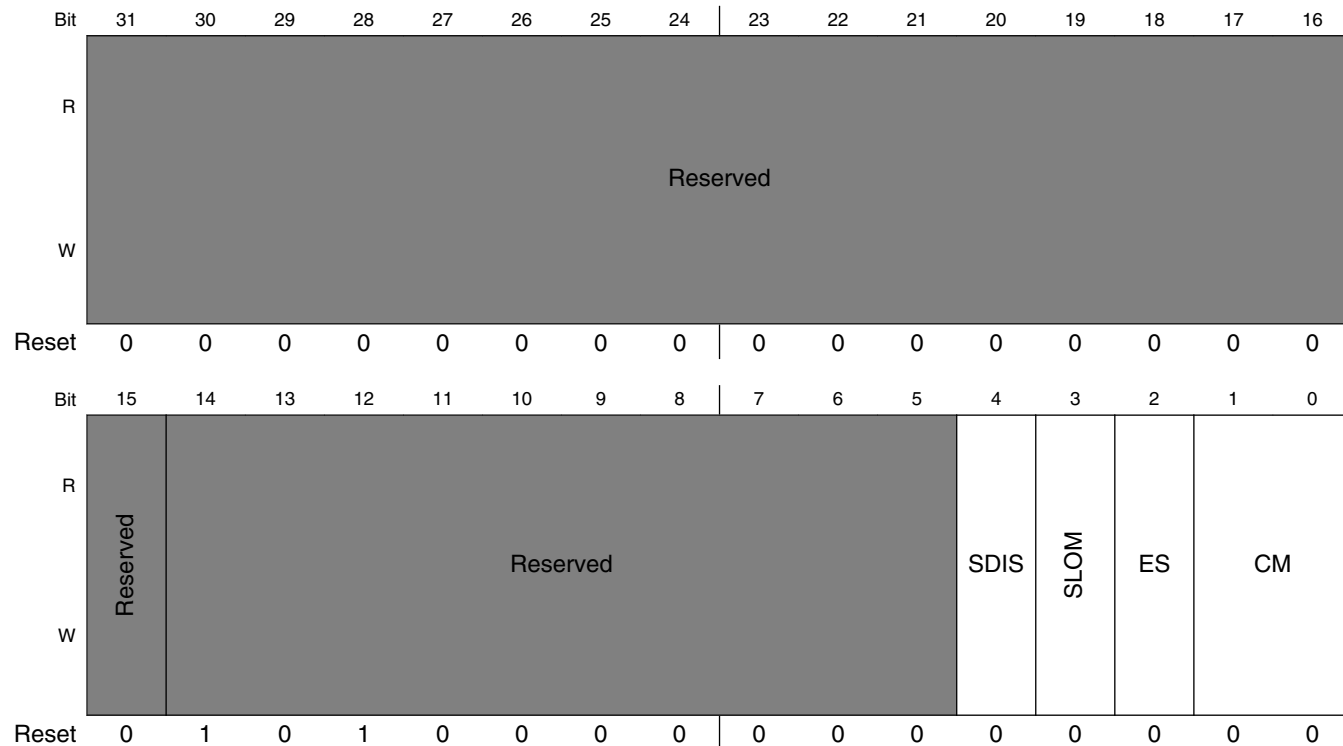

USB_nUSBMODE field descriptions

Field	Description
31–16 -	This field is reserved. Reserved
15 -	This field is reserved. Reserved
14–5 -	This field is reserved. Reserved
4 SDIS	Stream Disable Mode. (0 - Inactive [default]; 1 - Active) Device Mode: Setting to a '1' disables double priming on both RX and TX for low bandwidth systems. This mode ensures that when the RX and TX buffers are sufficient to contain an entire packet that the standard double buffering scheme is disabled to prevent overruns/underruns in bandwidth limited systems. Note: In High Speed Mode, all packets received are responded to with a NYET handshake when stream disable is active. Host Mode: Setting to a '1' ensures that overruns/underruns of the latency FIFO are eliminated for low bandwidth systems where the RX and TX buffers are sufficient to contain the entire packet. Enabling stream disable also has the effect of ensuring the TX latency is filled to capacity before the packet is launched onto the USB. NOTE: Time duration to pre-fill the FIFO becomes significant when stream disable is active. See TX FIFO Fill Tuning (USB_nTXFILLTUNING) and TXTTFILLTUNING [MPH Only] to characterize the adjustments needed for the scheduler when using this feature.

Table continues on the next page...

USB_nUSBMODE field descriptions (continued)

Field	Description
	NOTE: The use of this feature substantially limits of the overall USB performance that can be achieved.
3 SLOM	Setup Lockout Mode. In device mode, this bit controls behavior of the setup lock mechanism. See Control Endpoint Operation Model . 0 Setup Lockouts On (default); 1 Setup Lockouts Off (DCD requires use of Setup Data Buffer Tripwire in USB Command Register (USB_nUSBCMD) .
2 ES	Endian Select - Read/Write. This bit can change the byte alignment of the transfer buffers to match the host microprocessor. The bit fields in the microprocessor interface and the data structures are unaffected by the value of this bit because they are based upon the 32-bit word. Bit Meaning 0 Little Endian [Default] 1 Big Endian
CM	Controller Mode - R/WO. Controller mode is defaulted to the proper mode for host only and device only implementations. For those designs that contain both host & device capability, the controller defaults to an idle state and needs to be initialized to the desired operating mode after reset. For combination host/device controllers, this register can only be written once after reset. If it is necessary to switch modes, software must reset the controller by writing to the <i>RESET</i> bit in the USBCMD register before reprogramming this register. For OTG controller core, reset value is '00b'. 00 Idle [Default for combination host/device] 01 Reserved 10 Device Controller [Default for device only controller] 11 Host Controller [Default for host only controller]

56.6.34 Endpoint Setup Status (USB_nENDPTSETUPSTAT)

Address: 218_4000h base + 1ACh offset + (512d × i), where i=0d to 1d

Bit	31	30	29	28	27	26	25	24	23	22	21	20	19	18	17	16	15	14	13	12	11	10	9	8	7	6	5	4	3	2	1	0
R	Reserved																ENDPTSETUPSTAT															
W	Reserved																ENDPTSETUPSTAT															
Reset	0	0	0	0	0	0	0	0	0	0	0	0	0	0	0	0	0	0	0	0	0	0	0	0	0	0	0	0	0	0	0	0

USB_nENDPTSETUPSTAT field descriptions

Field	Description
31–16 -	This field is reserved. Reserved
ENDPTSETUPSTAT	Setup Endpoint Status. For every setup transaction that is received, a corresponding bit in this register is set to one. Software must clear or acknowledge the setup transfer by writing a one to a respective bit after it has read the setup data from Queue head. The response to a setup packet as in the order of operations and total response time is crucial to limit bus time outs while the setup lock our mechanism is engaged. See Managing Endpoints in the Device Operational Model. This register is only used in device mode.

56.6.35 Endpoint Prime (USB_nENDPTPRIME)

This register is only used in device mode.

When software sets the prime bit for a given endpoint, the device controller loads the transfer descriptor, pointed to by the queue head, such that the endpoint is ready to transmit or receive when the host sends a request (IN/OUT token). The endpoint will NAK all requests from the host until the endpoint is primed. The controller will automatically re-prime the endpoint with a new transfer descriptor when one is found via the next_dtd pointer of the current transfer descriptor. Hence, the prime bit must only be set by software when a descriptor is added to the queue head.

Address: 218_4000h base + 1B0h offset + (512d × i), where i=0d to 1d

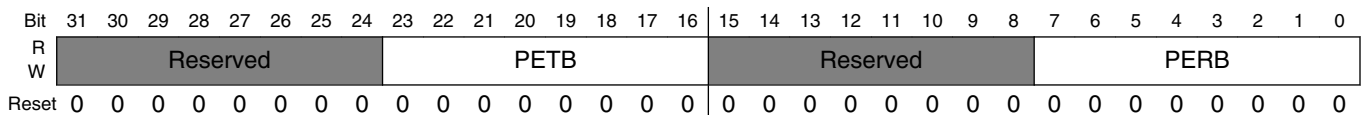

USB_nENDPTPRIME field descriptions

Field	Description
31–24 -	This field is reserved. Reserved
23–16 PETB	Prime Endpoint Transmit Buffer - R/WS. For each endpoint a corresponding bit is used to request that a buffer is prepared for a transmit operation in order to respond to a USB IN/INTERRUPT transaction. Software should write a one to the corresponding bit when posting a new transfer descriptor to an endpoint queue head. Hardware automatically uses this bit to begin parsing for a new transfer descriptor from the queue head and prepare a transmit buffer. Hardware clears this bit when the associated endpoint(s) is (are) successfully primed. NOTE: These bits are momentarily set by hardware during hardware re-priming operations when a dTD is retired, and the dQH is updated. PETB[N] - Endpoint #N, N is in 0..7
15–8 -	This field is reserved. Reserved
PERB	Prime Endpoint Receive Buffer - R/WS. For each endpoint, a corresponding bit is used to request a buffer prepare for a receive operation for when a USB host initiates a USB OUT transaction. Software should write a one to the corresponding bit whenever posting a new transfer descriptor to an endpoint queue head. Hardware automatically uses this bit to begin parsing for a new transfer descriptor from the queue head and prepare a receive buffer. Hardware clears this bit when the associated endpoint(s) is (are) successfully primed. NOTE: These bits are momentarily set by hardware during hardware re-priming operations when a dTD is retired, and the dQH is updated. PERB[N] - Endpoint #N, N is in 0..7

56.6.36 Endpoint Flush (USB_nENDPTFLUSH)

This register is only used in device mode.

Address: 218_4000h base + 1B4h offset + (512d × i), where i=0d to 1d

Bit	31	30	29	28	27	26	25	24	23	22	21	20	19	18	17	16	15	14	13	12	11	10	9	8	7	6	5	4	3	2	1	0
R	Reserved								FETB								Reserved								FERB							
W	0								0								0								0							
Reset	0																															

USB_nENDPTFLUSH field descriptions

Field	Description
31–24 -	This field is reserved. Reserved
23–16 FETB	Flush Endpoint Transmit Buffer - R/WS. Writing one to a bit(s) in this register causes the associated endpoint(s) to clear any primed buffers. If a packet is in progress for one of the associated endpoints, then that transfer continues until completion. Hardware clears this register after the endpoint flush operation is successful. FETB[N] - Endpoint #N, N is in 0..7
15–8 -	This field is reserved. Reserved
FERB	Flush Endpoint Receive Buffer - R/WS. Writing one to a bit(s) causes the associated endpoint(s) to clear any primed buffers. If a packet is in progress for one of the associated endpoints, then that transfer continues until completion. Hardware clears this register after the endpoint flush operation is successful. FERB[N] - Endpoint #N, N is in 0..7

56.6.37 Endpoint Status (USB_nENDPTSTAT)

This register is only used in device mode.

Address: 218_4000h base + 1B8h offset + (512d × i), where i=0d to 1d

Bit	31	30	29	28	27	26	25	24	23	22	21	20	19	18	17	16	15	14	13	12	11	10	9	8	7	6	5	4	3	2	1	0
R	Reserved								ETBR								Reserved								ERBR							
W	0								0								0								0							
Reset	0																															

USB_nENDPTSTAT field descriptions

Field	Description
31–24 -	This field is reserved. Reserved
23–16 ETBR	Endpoint Transmit Buffer Ready -- Read Only. One bit for each endpoint indicates status of the respective endpoint buffer. This bit is set to one by the hardware as a response to receiving a command from a corresponding bit in the ENDPTPRIME register. There is always a delay between setting a bit in the ENDPTPRIME register and endpoint indicating ready. This delay time varies based upon the current USB traffic and the number of bits set in the ENDPTPRIME register. Buffer ready is cleared by USB reset, by the USB DMA system, or through the ENDPTFLUSH register. NOTE: These bits are momentarily cleared by hardware during hardware endpoint re-priming operations when a dTD is retired, and the dQH is updated. ETBR[N] - Endpoint #N, N is in 0..7
15–8 -	This field is reserved. Reserved
ERBR	Endpoint Receive Buffer Ready -- Read Only. One bit for each endpoint indicates status of the respective endpoint buffer. This bit is set to a one by the hardware as a response to receiving a command from a corresponding bit in the ENDPTPRIME register. There is always a delay between setting a bit in the ENDPTPRIME register and endpoint indicating ready. This delay time varies based upon the current USB traffic and the number of bits set in the ENDPTPRIME register. Buffer ready is cleared by USB reset, by the USB DMA system, or through the ENDPTFLUSH register. NOTE: These bits are momentarily cleared by hardware during hardware endpoint re-priming operations when a dTD is retired, and the dQH is updated. ERBR[N] - Endpoint #N, N is in 0..7

56.6.38 Endpoint Complete (USB_nENDPTCOMPLETE)

This register is only used in device mode.

Address: 218_4000h base + 1BCh offset + (512d × i), where i=0d to 1d

Bit	31	30	29	28	27	26	25	24	23	22	21	20	19	18	17	16	15	14	13	12	11	10	9	8	7	6	5	4	3	2	1	0
R																																
W																																
Reset	0	0	0	0	0	0	0	0	0	0	0	0	0	0	0	0	0	0	0	0	0	0	0	0	0	0	0	0	0	0	0	

USB_nENDPTCOMPLETE field descriptions

Field	Description
31–24 -	This field is reserved. Reserved
23–16 ETCE	Endpoint Transmit Complete Event - R/WC. Each bit indicates a transmit event (IN/INTERRUPT) occurred and software should read the corresponding endpoint queue to determine the endpoint status. If the corresponding IOC bit is set in the Transfer Descriptor, then this bit is set simultaneously with the <i>USBINT</i> . Writing one clears the corresponding bit in this register. ETCE[N] - Endpoint #N, N is in 0..7

Table continues on the next page...

USB_nENDPTCOMPLETE field descriptions (continued)

Field	Description
15–8 -	This field is reserved. Reserved
ERCE	Endpoint Receive Complete Event - RW/C. Each bit indicates a received event (OUT/SETUP) occurred and software should read the corresponding endpoint queue to determine the transfer status. If the corresponding IOC bit is set in the Transfer Descriptor, then this bit is set simultaneously with the <i>USBINT</i> . Writing one clears the corresponding bit in this register. ERCE[N] - Endpoint #N, N is in 0..7

56.6.39 Endpoint Control0 (USB_nENDPTCTRL0)

Every Device implements Endpoint 0 as a control endpoint.

Address: 218_4000h base + 1C0h offset + (512d × i), where i=0d to 1d

Bit	31	30	29	28	27	26	25	24	23	22	21	20	19	18	17	16	
R	Reserved								TXE	Reserved				TXT		Reserved	TXS
W	Reserved								TXE	Reserved				TXT		Reserved	TXS
Reset	0	0	0	0	0	0	0	0	1	0	0	0	0	0	0	0	
Bit	15	14	13	12	11	10	9	8	7	6	5	4	3	2	1	0	
R	Reserved								RXE	Reserved				RXT		Reserved	RXS
W	Reserved								RXE	Reserved				RXT		Reserved	RXS
Reset	0	0	0	0	0	0	0	0	1	0	0	0	0	0	0	0	

USB_nENDPTCTRL0 field descriptions

Field	Description
31–24 -	This field is reserved. Reserved
23 TXE	TX Endpoint Enable 1 Enabled

Table continues on the next page...

USB_nENDPTCTRL0 field descriptions (continued)

Field	Description
	Endpoint0 is always enabled.
22–20 -	This field is reserved. Reserved
19–18 TXT	TX Endpoint Type - Read/Write 00 - Control Endpoint0 is fixed as a Control End Point.
17 -	This field is reserved. Reserved
16 TXS	TX Endpoint Stall - Read/Write 0 End Point OK [Default] 1 End Point Stalled Software can write a one to this bit to force the endpoint to return a STALL handshake to the Host. It continues returning STALL until the bit is cleared by software or it is automatically cleared upon receipt of a new SETUP request. After receiving a SETUP request, this bit will continue to be cleared by hardware until the associated ENDPTSETUPSTAT bit is cleared. NOTE: There is a slight delay (50 clocks max.) between the endptsetupstat being cleared and hardware continuing to clear this bit. In most systems it is unlikely the DCD software will observe this delay. However, should the dcd observe that the stall bit is not set after writing a one to it then follow this procedure: continually write this stall bit until it is set or until a newsetup has been received by checking the associated endptsetupstat bit.
15–8 -	This field is reserved. Reserved
7 RXE	RX Endpoint Enable 1 Enabled Endpoint0 is always enabled.
6–4 -	This field is reserved. Reserved
3–2 RXT	RX Endpoint Type - Read/Write 00 Control Endpoint0 is fixed as a Control End Point.
1 -	This field is reserved. Reserved
0 RXS	RX Endpoint Stall - Read/Write 0 End Point OK. [Default] 1 End Point Stalled Software can write a one to this bit to force the endpoint to return a STALL handshake to the Host. It continues returning STALL until the bit is cleared by software or it is automatically cleared upon receipt of a new SETUP request. After receiving a SETUP request, this bit will continue to be cleared by hardware until the associated ENDPTSETUPSTAT bit is cleared.

Table continues on the next page...

USB_nENDPTCTRL0 field descriptions (continued)

Field	Description
	NOTE: There is a slight delay (50 clocks max.) between the endptsetupstat being cleared and hardware continuing to clear this bit. In most systems it is unlikely the dcd software will observe this delay. However, should the dcd observe that the stall bit is not set after writing a one to it then follow this procedure: continually write this stall bit until it is set or until a newsetup has been received by checking the associated endptsetupstat bit.

56.6.40 Endpoint Control 1 (USB_nENDPTCTRL1)

This is endpoint control register for endpoint 1 in device operation mode.

NOTE

If one endpoint direction is enabled and the paired endpoint of opposite direction is disabled then the unused direction type must be changed from the default control-type to any other type (that is Bulk-type). leaving an unconfigured endpoint control causes undefined behavior for the data pid tracking on the active endpoint/direction.

Address: 218_4000h base + 1C4h offset + (512d × i), where i=0d to 1d

Bit	31	30	29	28	27	26	25	24	23	22	21	20	19	18	17	16
R	Reserved								TXE	TXR	TXI	Reserved	TXT	TXD	TXS	
W	Reserved															
Reset	0	0	0	0	0	0	0	0	0	0	0	0	0	0	0	0
Bit	15	14	13	12	11	10	9	8	7	6	5	4	3	2	1	0
R	Reserved								RXE	RXR	RXI	Reserved	RXT	RXD	RXS	
W	Reserved															
Reset	0	0	0	0	0	0	0	0	0	0	0	0	0	0	0	0

USB_nENDPTCTRL1 field descriptions

Field	Description
31–24 -	This field is reserved. Reserved
23 TXE	TX Endpoint Enable 0 Disabled [Default] 1 Enabled An Endpoint should be enabled only after it has been configured.
22 TXR	TX Data Toggle Reset (WS) Write 1 - Reset PID Sequence Whenever a configuration event is received for this Endpoint, software must write a one to this bit in order to synchronize the data PID's between the Host and device.
21 TXI	TX Data Toggle Inhibit 0 PID Sequencing Enabled. [Default] 1 PID Sequencing Disabled. This bit is only used for test and should always be written as zero. Writing a one to this bit causes this endpoint to ignore the data toggle sequence and always transmit DATA0 for a data packet.
20 -	This field is reserved. Reserved
19–18 TXT	TX Endpoint Type - Read/Write 00 Control 01 Isochronous 10 Bulk 11 Interrupt
17 TXD	TX Endpoint Data Source - Read/Write 0 Dual Port Memory Buffer/DMA Engine [DEFAULT] Should always be written as 0.
16 TXS	TX Endpoint Stall - Read/Write 0 End Point OK 1 End Point Stalled This bit will be cleared automatically upon receipt of a SETUP request if this Endpoint is configured as a Control Endpoint and this bit will continue to be cleared by hardware until the associated ENDPTSETUPSTAT bit is cleared. Software can write a one to this bit to force the endpoint to return a STALL handshake to the Host. This control will continue to STALL until this bit is either cleared by software or automatically cleared as above for control endpoints. NOTE: [CONTROL ENDPOINT TYPES ONLY]: there is a slight delay (50 clocks max) between the ENDPTSETUPSTAT begin cleared and hardware continuing to clear this bit. In most systems, it is unlikely the DCD software will observe this delay. However, should the DCD observe that the stall bit is not set after writing a one to it then follow this procedure: continually write this stall bit until it is set or until a new setup has been received by checking the associated endptsetupstat bit.
15–8 -	This field is reserved. Reserved

Table continues on the next page...

USB_nENDPTCTRL1 field descriptions (continued)

Field	Description
7 RXE	<p>RX Endpoint Enable</p> <p>0 Disabled [Default]</p> <p>1 Enabled</p> <p>An Endpoint should be enabled only after it has been configured.</p>
6 RXR	<p>RX Data Toggle Reset (WS)</p> <p>Write 1 - Reset PID Sequence</p> <p>Whenever a configuration event is received for this Endpoint, software must write a one to this bit in order to synchronize the data PID's between the host and device.</p>
5 RXI	<p>RX Data Toggle Inhibit</p> <p>0 Disabled [Default]</p> <p>1 Enabled</p> <p>This bit is only used for test and should always be written as zero. Writing a one to this bit causes this endpoint to ignore the data toggle sequence and always accept data packet regardless of their data PID.</p>
4 -	<p>This field is reserved.</p> <p>Reserved.</p>
3–2 RXT	<p>RX Endpoint Type - Read/Write</p> <p>00 Control</p> <p>01 Isochronous</p> <p>10 Bulk</p> <p>11 Interrupt</p>
1 RXD	<p>RX Endpoint Data Sink - Read/Write</p> <p>0 Dual Port Memory Buffer/DMA Engine [Default]</p> <p>Should always be written as zero.</p>
0 RXS	<p>RX Endpoint Stall - Read/Write</p> <p>0 End Point OK. [Default]</p> <p>1 End Point Stalled</p> <p>This bit is set automatically upon receipt of a SETUP request if this Endpoint is configured as a Control Endpoint and this bit will continue to be cleared by hardware until the associated ENDPTSETUPSTAT bit is cleared.</p> <p>Software can write a one to this bit to force the endpoint to return a STALL handshake to the Host. This control will continue to STALL until this bit is either cleared by software or automatically cleared as above for control endpoints.</p> <p>NOTE: [CONTROL ENDPOINT TYPES ONLY]: there is a slight delay (50 clocks max) between the ENDPTSETUPSTAT begin cleared and hardware continuing to clear this bit. In most systems, it is unlikely the DCD software will observe this delay. However, should the DCD observe that the stall bit is not set after writing a one to it then follow this procedure: continually write this stall bit until it is set or until a new setup has been received by checking the associated endptsetupstat bit.</p>

56.6.41 Endpoint Control 2 (USB_nENDPTCTRL2)

This is endpoint control register for endpoint 2 in device operation mode.

NOTE

If one endpoint direction is enabled and the paired endpoint of opposite direction is disabled then the unused direction type must be changed from the default control-type to any other type (that is Bulk-type). leaving an unconfigured endpoint control causes undefined behavior for the data pid tracking on the active endpoint/direction.

Address: 218_4000h base + 1C8h offset + (512d × i), where i=0d to 1d

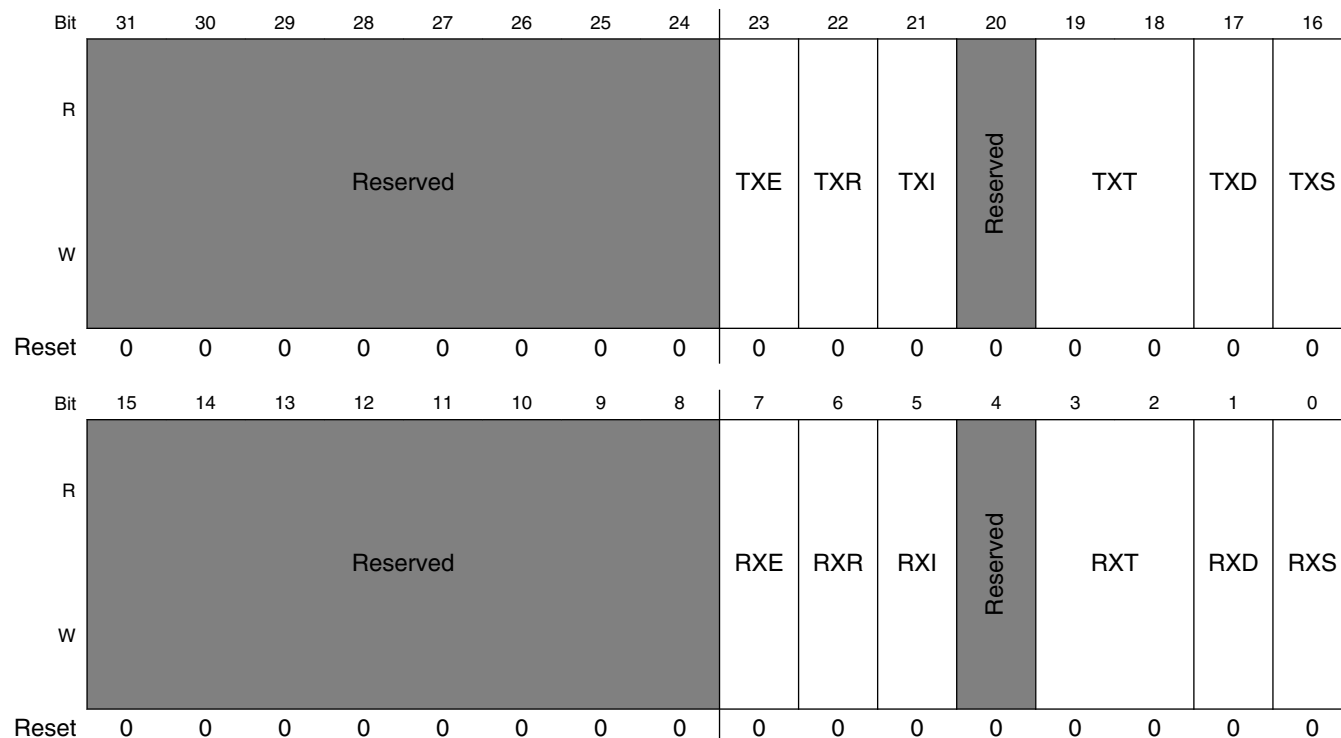

USB_nENDPTCTRL2 field descriptions

Field	Description
31-24 -	This field is reserved. Reserved
23 TXE	TX Endpoint Enable 0 Disabled [Default] 1 Enabled An Endpoint should be enabled only after it has been configured.

Table continues on the next page...

USB_nENDPTCTRL2 field descriptions (continued)

Field	Description
22 TXR	TX Data Toggle Reset (WS) Write 1 - Reset PID Sequence Whenever a configuration event is received for this Endpoint, software must write a one to this bit in order to synchronize the data PID's between the Host and device.
21 TXI	TX Data Toggle Inhibit 0 PID Sequencing Enabled. [Default] 1 PID Sequencing Disabled. This bit is only used for test and should always be written as zero. Writing a one to this bit causes this endpoint to ignore the data toggle sequence and always transmit DATA0 for a data packet.
20 -	This field is reserved. Reserved
19–18 TXT	TX Endpoint Type - Read/Write 00 Control 01 Isochronous 10 Bulk 11 Interrupt
17 TXD	TX Endpoint Data Source - Read/Write 0 Dual Port Memory Buffer/DMA Engine [DEFAULT] Should always be written as 0.
16 TXS	TX Endpoint Stall - Read/Write 0 End Point OK 1 End Point Stalled This bit will be cleared automatically upon receipt of a SETUP request if this Endpoint is configured as a Control Endpoint and this bit will continue to be cleared by hardware until the associated ENDPTSETUPSTAT bit is cleared. Software can write a one to this bit to force the endpoint to return a STALL handshake to the Host. This control will continue to STALL until this bit is either cleared by software or automatically cleared as above for control endpoints. NOTE: [CONTROL ENDPOINT TYPES ONLY]: there is a slight delay (50 clocks max) between the ENDPTSETUPSTAT begin cleared and hardware continuing to clear this bit. In most systems, it is unlikely the DCD software will observe this delay. However, should the DCD observe that the stall bit is not set after writing a one to it then follow this procedure: continually write this stall bit until it is set or until a new setup has been received by checking the associated endptsetupstat bit.
15–8 -	This field is reserved. Reserved
7 RXE	RX Endpoint Enable 0 Disabled [Default] 1 Enabled An Endpoint should be enabled only after it has been configured.
6 RXR	RX Data Toggle Reset (WS) Write 1 - Reset PID Sequence

Table continues on the next page...

USB_nENDPTCTRL2 field descriptions (continued)

Field	Description
	Whenever a configuration event is received for this Endpoint, software must write a one to this bit in order to synchronize the data PID's between the host and device.
5 RXI	RX Data Toggle Inhibit 0 Disabled [Default] 1 Enabled This bit is only used for test and should always be written as zero. Writing a one to this bit causes this endpoint to ignore the data toggle sequence and always accept data packet regardless of their data PID.
4 -	This field is reserved. Reserved.
3-2 RXT	RX Endpoint Type - Read/Write 00 Control 01 Isochronous 10 Bulk 11 Interrupt
1 RXD	RX Endpoint Data Sink - Read/Write 0 Dual Port Memory Buffer/DMA Engine [Default] Should always be written as zero.
0 RXS	RX Endpoint Stall - Read/Write 0 End Point OK. [Default] 1 End Point Stalled This bit is set automatically upon receipt of a SETUP request if this Endpoint is configured as a Control Endpoint and this bit will continue to be cleared by hardware until the associated ENDPTSETUPSTAT bit is cleared. Software can write a one to this bit to force the endpoint to return a STALL handshake to the Host. This control will continue to STALL until this bit is either cleared by software or automatically cleared as above for control endpoints. NOTE: [CONTROL ENDPOINT TYPES ONLY]: there is a slight delay (50 clocks max) between the ENDPTSETUPSTAT begin cleared and hardware continuing to clear this bit. In most systems, it is unlikely the DCD software will observe this delay. However, should the DCD observe that the stall bit is not set after writing a one to it then follow this procedure: continually write this stall bit until it is set or until a new setup has been received by checking the associated endptsetupstat bit.

56.6.42 Endpoint Control 3 (USB_nENDPTCTRL3)

This is endpoint control register for endpoint 3 in device operation mode.

NOTE

If one endpoint direction is enabled and the paired endpoint of opposite direction is disabled then the unused direction type must be changed from the default control-type to any other type (that is Bulk-type). leaving an unconfigured endpoint control

causes undefined behavior for the data pid tracking on the active endpoint/direction.

Address: 218_4000h base + 1CCh offset + (512d × i), where i=0d to 1d

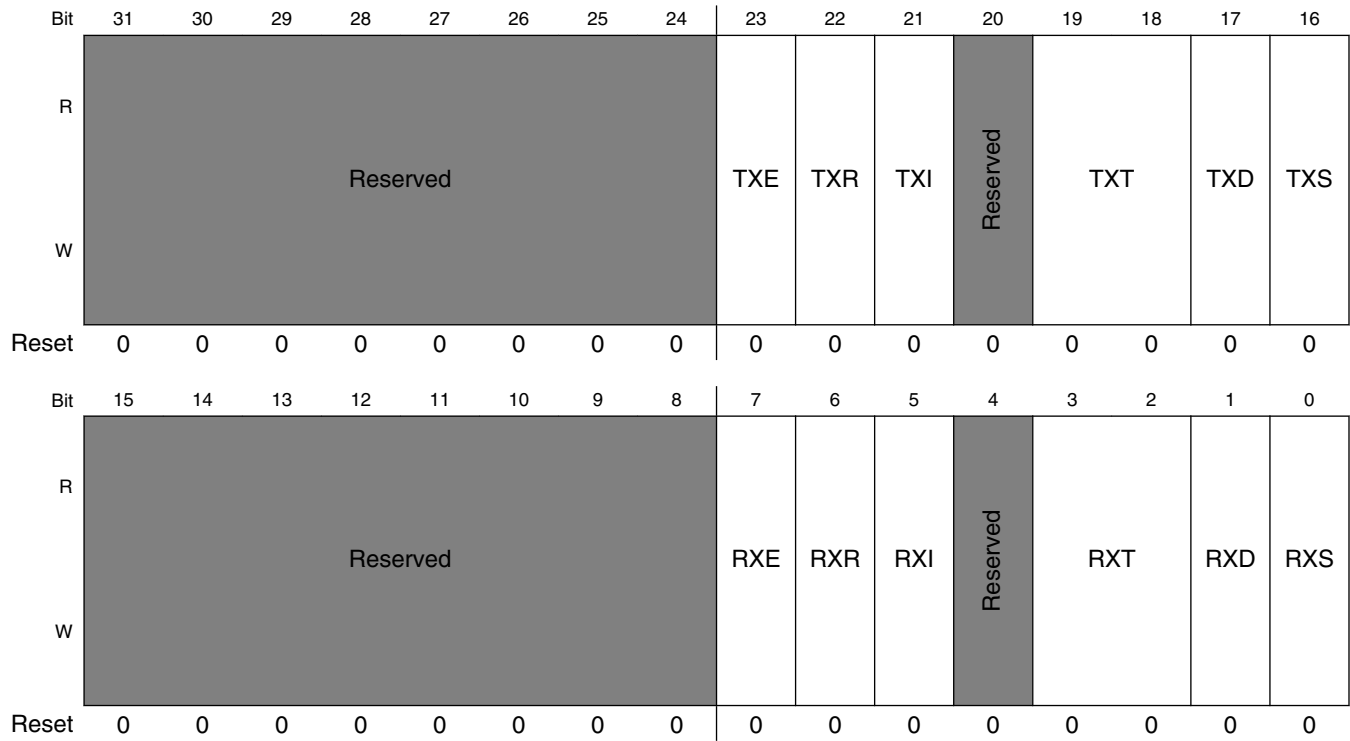

USB_nENDPTCTRL3 field descriptions

Field	Description
31–24 -	This field is reserved. Reserved
23 TXE	TX Endpoint Enable 0 Disabled [Default] 1 Enabled An Endpoint should be enabled only after it has been configured.
22 TXR	TX Data Toggle Reset (WS) Write 1 - Reset PID Sequence Whenever a configuration event is received for this Endpoint, software must write a one to this bit in order to synchronize the data PID's between the Host and device.
21 TXI	TX Data Toggle Inhibit 0 PID Sequencing Enabled. [Default] 1 PID Sequencing Disabled. This bit is only used for test and should always be written as zero. Writing a one to this bit causes this endpoint to ignore the data toggle sequence and always transmit DATA0 for a data packet.
20 -	This field is reserved. Reserved

Table continues on the next page...

USB_nENDPTCTRL3 field descriptions (continued)

Field	Description
19–18 TXT	TX Endpoint Type - Read/Write 00 Control 01 Isochronous 10 Bulk 11 Interrupt
17 TXD	TX Endpoint Data Source - Read/Write 0 Dual Port Memory Buffer/DMA Engine [DEFAULT] Should always be written as 0.
16 TXS	TX Endpoint Stall - Read/Write 0 End Point OK 1 End Point Stalled This bit will be cleared automatically upon receipt of a SETUP request if this Endpoint is configured as a Control Endpoint and this bit will continue to be cleared by hardware until the associated ENDPTSETUPSTAT bit is cleared. Software can write a one to this bit to force the endpoint to return a STALL handshake to the Host. This control will continue to STALL until this bit is either cleared by software or automatically cleared as above for control endpoints. NOTE: [CONTROL ENDPOINT TYPES ONLY]: there is a slight delay (50 clocks max) between the ENDPTSETUPSTAT begin cleared and hardware continuing to clear this bit. In most systems, it is unlikely the DCD software will observe this delay. However, should the DCD observe that the stall bit is not set after writing a one to it then follow this procedure: continually write this stall bit until it is set or until a new setup has been received by checking the associated endptsetupstat bit.
15–8 -	This field is reserved. Reserved
7 RXE	RX Endpoint Enable 0 Disabled [Default] 1 Enabled An Endpoint should be enabled only after it has been configured.
6 RXR	RX Data Toggle Reset (WS) Write 1 - Reset PID Sequence Whenever a configuration event is received for this Endpoint, software must write a one to this bit in order to synchronize the data PID's between the host and device.
5 RXI	RX Data Toggle Inhibit 0 Disabled [Default] 1 Enabled This bit is only used for test and should always be written as zero. Writing a one to this bit causes this endpoint to ignore the data toggle sequence and always accept data packet regardless of their data PID.
4 -	This field is reserved. Reserved.
3–2 RXT	RX Endpoint Type - Read/Write 00 Control

Table continues on the next page...

USB_nENDPTCTRL3 field descriptions (continued)

Field	Description
	01 Isochronous 10 Bulk 11 Interrupt
1 RXD	RX Endpoint Data Sink - Read/Write 0 Dual Port Memory Buffer/DMA Engine [Default] Should always be written as zero.
0 RXS	RX Endpoint Stall - Read/Write 0 End Point OK. [Default] 1 End Point Stalled This bit is set automatically upon receipt of a SETUP request if this Endpoint is configured as a Control Endpoint and this bit will continue to be cleared by hardware until the associated ENDPTSETUPSTAT bit is cleared. Software can write a one to this bit to force the endpoint to return a STALL handshake to the Host. This control will continue to STALL until this bit is either cleared by software or automatically cleared as above for control endpoints. NOTE: [CONTROL ENDPOINT TYPES ONLY]: there is a slight delay (50 clocks max) between the ENDPTSETUPSTAT begin cleared and hardware continuing to clear this bit. In most systems, it is unlikely the DCD software will observe this delay. However, should the DCD observe that the stall bit is not set after writing a one to it then follow this procedure: continually write this stall bit until it is set or until a new setup has been received by checking the associated endptsetupstat bit.

56.6.43 Endpoint Control 4 (USB_nENDPTCTRL4)

This is endpoint control register for endpoint 4 in device operation mode.

NOTE

If one endpoint direction is enabled and the paired endpoint of opposite direction is disabled then the unused direction type must be changed from the default control-type to any other type (that is Bulk-type). leaving an unconfigured endpoint control causes undefined behavior for the data pid tracking on the active endpoint/direction.

USB Core Memory Map/Register Definition

Address: 218_4000h base + 1D0h offset + (512d × i), where i=0d to 1d

Bit	31	30	29	28	27	26	25	24	23	22	21	20	19	18	17	16
R	Reserved								TXE	TXR	TXI	Reserved	TXT		TXD	TXS
W	Reserved											Reserved				
Reset	0	0	0	0	0	0	0	0	0	0	0	0	0	0	0	0
Bit	15	14	13	12	11	10	9	8	7	6	5	4	3	2	1	0
R	Reserved								RXE	RXR	RXI	Reserved	RXT		RXD	RXS
W	Reserved											Reserved				
Reset	0	0	0	0	0	0	0	0	0	0	0	0	0	0	0	0

USB_nENDPTCTRL4 field descriptions

Field	Description
31–24 -	This field is reserved. Reserved
23 TXE	TX Endpoint Enable 0 Disabled [Default] 1 Enabled An Endpoint should be enabled only after it has been configured.
22 TXR	TX Data Toggle Reset (WS) Write 1 - Reset PID Sequence Whenever a configuration event is received for this Endpoint, software must write a one to this bit in order to synchronize the data PID's between the Host and device.
21 TXI	TX Data Toggle Inhibit 0 PID Sequencing Enabled. [Default] 1 PID Sequencing Disabled. This bit is only used for test and should always be written as zero. Writing a one to this bit causes this endpoint to ignore the data toggle sequence and always transmit DATA0 for a data packet.
20 -	This field is reserved. Reserved
19–18 TXT	TX Endpoint Type - Read/Write 00 Control 01 Isochronous

Table continues on the next page...

USB_nENDPTCTRL4 field descriptions (continued)

Field	Description
	10 Bulk 11 Interrupt
17 TXD	TX Endpoint Data Source - Read/Write 0 Dual Port Memory Buffer/DMA Engine [DEFAULT] Should always be written as 0.
16 TXS	TX Endpoint Stall - Read/Write 0 End Point OK 1 End Point Stalled This bit will be cleared automatically upon receipt of a SETUP request if this Endpoint is configured as a Control Endpoint and this bit will continue to be cleared by hardware until the associated ENDPTSETUPSTAT bit is cleared. Software can write a one to this bit to force the endpoint to return a STALL handshake to the Host. This control will continue to STALL until this bit is either cleared by software or automatically cleared as above for control endpoints. NOTE: [CONTROL ENDPOINT TYPES ONLY]: there is a slight delay (50 clocks max) between the ENDPTSETUPSTAT begin cleared and hardware continuing to clear this bit. In most systems, it is unlikely the DCD software will observe this delay. However, should the DCD observe that the stall bit is not set after writing a one to it then follow this procedure: continually write this stall bit until it is set or until a new setup has been received by checking the associated endptsetupstat bit.
15–8 -	This field is reserved. Reserved
7 RXE	RX Endpoint Enable 0 Disabled [Default] 1 Enabled An Endpoint should be enabled only after it has been configured.
6 RXR	RX Data Toggle Reset (WS) Write 1 - Reset PID Sequence Whenever a configuration event is received for this Endpoint, software must write a one to this bit in order to synchronize the data PID's between the host and device.
5 RXI	RX Data Toggle Inhibit 0 Disabled [Default] 1 Enabled This bit is only used for test and should always be written as zero. Writing a one to this bit causes this endpoint to ignore the data toggle sequence and always accept data packet regardless of their data PID.
4 -	This field is reserved. Reserved.
3–2 RXT	RX Endpoint Type - Read/Write 00 Control 01 Isochronous 10 Bulk 11 Interrupt

Table continues on the next page...

USB_nENDPTCTRL4 field descriptions (continued)

Field	Description
1 RXD	RX Endpoint Data Sink - Read/Write 0 Dual Port Memory Buffer/DMA Engine [Default] Should always be written as zero.
0 RXS	RX Endpoint Stall - Read/Write 0 End Point OK. [Default] 1 End Point Stalled This bit is set automatically upon receipt of a SETUP request if this Endpoint is configured as a Control Endpoint and this bit will continue to be cleared by hardware until the associated ENDPTSETUPSTAT bit is cleared. Software can write a one to this bit to force the endpoint to return a STALL handshake to the Host. This control will continue to STALL until this bit is either cleared by software or automatically cleared as above for control endpoints. NOTE: [CONTROL ENDPOINT TYPES ONLY]: there is a slight delay (50 clocks max) between the ENDPTSETUPSTAT begin cleared and hardware continuing to clear this bit. In most systems, it is unlikely the DCD software will observe this delay. However, should the DCD observe that the stall bit is not set after writing a one to it then follow this procedure: continually write this stall bit until it is set or until a new setup has been received by checking the associated endptsetupstat bit.

56.6.44 Endpoint Control 5 (USB_nENDPTCTRL5)

This is endpoint control register for endpoint 5 in device operation mode.

NOTE

If one endpoint direction is enabled and the paired endpoint of opposite direction is disabled then the unused direction type must be changed from the default control-type to any other type (that is Bulk-type). leaving an unconfigured endpoint control causes undefined behavior for the data pid tracking on the active endpoint/direction.

Address: 218_4000h base + 1D4h offset + (512d × i), where i=0d to 1d

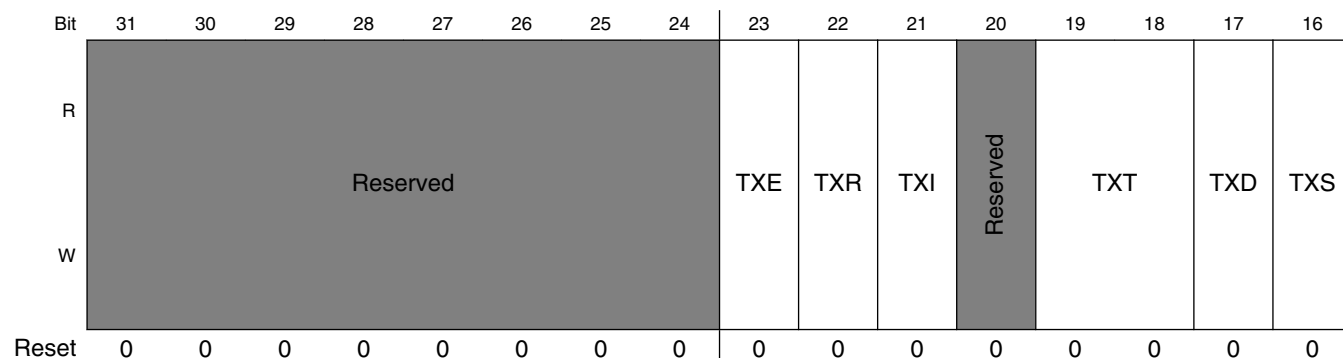

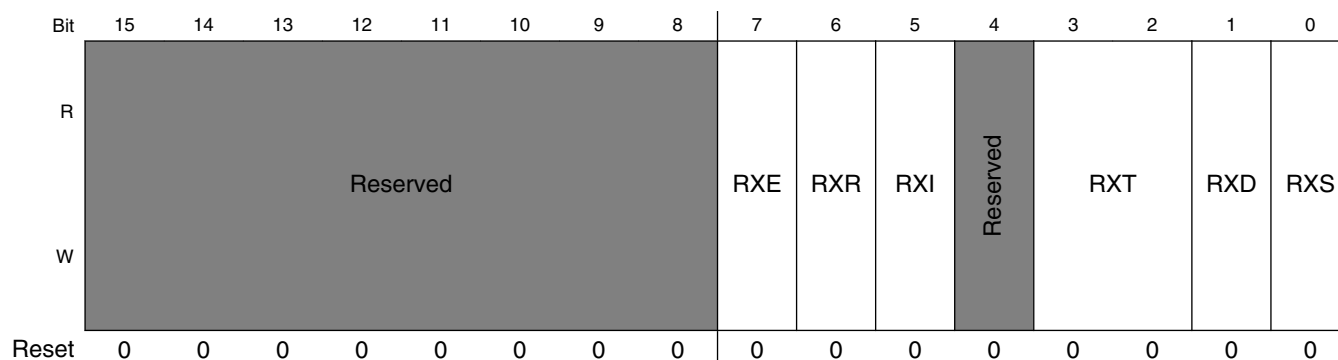

USB_nENDPTCTRL5 field descriptions

Field	Description
31–24 -	This field is reserved. Reserved
23 TXE	TX Endpoint Enable 0 Disabled [Default] 1 Enabled An Endpoint should be enabled only after it has been configured.
22 TXR	TX Data Toggle Reset (WS) Write 1 - Reset PID Sequence Whenever a configuration event is received for this Endpoint, software must write a one to this bit in order to synchronize the data PID's between the Host and device.
21 TXI	TX Data Toggle Inhibit 0 PID Sequencing Enabled. [Default] 1 PID Sequencing Disabled. This bit is only used for test and should always be written as zero. Writing a one to this bit causes this endpoint to ignore the data toggle sequence and always transmit DATA0 for a data packet.
20 -	This field is reserved. Reserved
19–18 TXT	TX Endpoint Type - Read/Write 00 Control 01 Isochronous 10 Bulk 11 Interrupt
17 TXD	TX Endpoint Data Source - Read/Write 0 Dual Port Memory Buffer/DMA Engine [DEFAULT] Should always be written as 0.
16 TXS	TX Endpoint Stall - Read/Write 0 End Point OK 1 End Point Stalled

Table continues on the next page...

USB_nENDPTCTRL5 field descriptions (continued)

Field	Description
	<p>This bit will be cleared automatically upon receipt of a SETUP request if this Endpoint is configured as a Control Endpoint and this bit will continue to be cleared by hardware until the associated ENDPTSETUPSTAT bit is cleared.</p> <p>Software can write a one to this bit to force the endpoint to return a STALL handshake to the Host. This control will continue to STALL until this bit is either cleared by software or automatically cleared as above for control endpoints.</p> <p>NOTE: [CONTROL ENDPOINT TYPES ONLY]: there is a slight delay (50 clocks max) between the ENDPTSETUPSTAT begin cleared and hardware continuing to clear this bit. In most systems, it is unlikely the DCD software will observe this delay. However, should the DCD observe that the stall bit is not set after writing a one to it then follow this procedure: continually write this stall bit until it is set or until a new setup has been received by checking the associated endptsetupstat bit.</p>
15–8 -	<p>This field is reserved. Reserved</p>
7 RXE	<p>RX Endpoint Enable</p> <p>0 Disabled [Default]</p> <p>1 Enabled</p> <p>An Endpoint should be enabled only after it has been configured.</p>
6 RXR	<p>RX Data Toggle Reset (WS)</p> <p>Write 1 - Reset PID Sequence</p> <p>Whenever a configuration event is received for this Endpoint, software must write a one to this bit in order to synchronize the data PID's between the host and device.</p>
5 RXI	<p>RX Data Toggle Inhibit</p> <p>0 Disabled [Default]</p> <p>1 Enabled</p> <p>This bit is only used for test and should always be written as zero. Writing a one to this bit causes this endpoint to ignore the data toggle sequence and always accept data packet regardless of their data PID.</p>
4 -	<p>This field is reserved. Reserved.</p>
3–2 RXT	<p>RX Endpoint Type - Read/Write</p> <p>00 Control</p> <p>01 Isochronous</p> <p>10 Bulk</p> <p>11 Interrupt</p>
1 RXD	<p>RX Endpoint Data Sink - Read/Write</p> <p>0 Dual Port Memory Buffer/DMA Engine [Default]</p> <p>Should always be written as zero.</p>
0 RXS	<p>RX Endpoint Stall - Read/Write</p> <p>0 End Point OK. [Default]</p> <p>1 End Point Stalled</p>

Table continues on the next page...

USB_nENDPTCTRL5 field descriptions (continued)

Field	Description
	<p>This bit is set automatically upon receipt of a SETUP request if this Endpoint is configured as a Control Endpoint and this bit will continue to be cleared by hardware until the associated ENDPTSETUPSTAT bit is cleared.</p> <p>Software can write a one to this bit to force the endpoint to return a STALL handshake to the Host. This control will continue to STALL until this bit is either cleared by software or automatically cleared as above for control endpoints.</p> <p>NOTE: [CONTROL ENDPOINT TYPES ONLY]: there is a slight delay (50 clocks max) between the ENDPTSETUPSTAT begin cleared and hardware continuing to clear this bit. In most systems, it is unlikely the DCD software will observe this delay. However, should the DCD observe that the stall bit is not set after writing a one to it then follow this procedure: continually write this stall bit until it is set or until a new setup has been received by checking the associated endptsetupstat bit.</p>

56.6.45 Endpoint Control 6 (USB_nENDPTCTRL6)

This is endpoint control register for endpoint 6 in device operation mode.

NOTE

If one endpoint direction is enabled and the paired endpoint of opposite direction is disabled then the unused direction type must be changed from the default control-type to any other type (that is Bulk-type). leaving an unconfigured endpoint control causes undefined behavior for the data pid tracking on the active endpoint/direction.

Address: 218_4000h base + 1D8h offset + (512d × i), where i=0d to 1d

Bit	31	30	29	28	27	26	25	24	23	22	21	20	19	18	17	16	
R	Reserved								TXE	TXR	TXI	Reserved	TXT	TXD	TXS		
W	Reserved																
Reset	0	0	0	0	0	0	0	0	0	0	0	0	0	0	0	0	

USB Core Memory Map/Register Definition

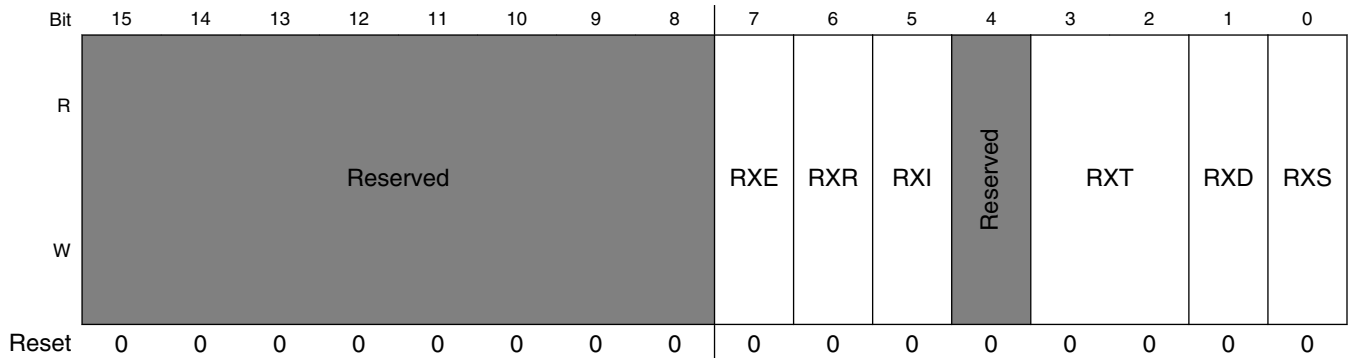

USB_nENDPTCTRL6 field descriptions

Field	Description
31–24 -	This field is reserved. Reserved
23 TXE	TX Endpoint Enable 0 Disabled [Default] 1 Enabled An Endpoint should be enabled only after it has been configured.
22 TXR	TX Data Toggle Reset (WS) Write 1 - Reset PID Sequence Whenever a configuration event is received for this Endpoint, software must write a one to this bit in order to synchronize the data PID's between the Host and device.
21 TXI	TX Data Toggle Inhibit 0 PID Sequencing Enabled. [Default] 1 PID Sequencing Disabled. This bit is only used for test and should always be written as zero. Writing a one to this bit causes this endpoint to ignore the data toggle sequence and always transmit DATA0 for a data packet.
20 -	This field is reserved. Reserved
19–18 TXT	TX Endpoint Type - Read/Write 00 Control 01 Isochronous 10 Bulk 11 Interrupt
17 TXD	TX Endpoint Data Source - Read/Write 0 Dual Port Memory Buffer/DMA Engine [DEFAULT] Should always be written as 0.
16 TXS	TX Endpoint Stall - Read/Write 0 End Point OK 1 End Point Stalled

Table continues on the next page...

USB_nENDPTCTRL6 field descriptions (continued)

Field	Description
	<p>This bit will be cleared automatically upon receipt of a SETUP request if this Endpoint is configured as a Control Endpoint and this bit will continue to be cleared by hardware until the associated ENDPTSETUPSTAT bit is cleared.</p> <p>Software can write a one to this bit to force the endpoint to return a STALL handshake to the Host. This control will continue to STALL until this bit is either cleared by software or automatically cleared as above for control endpoints.</p> <p>NOTE: [CONTROL ENDPOINT TYPES ONLY]: there is a slight delay (50 clocks max) between the ENDPTSETUPSTAT begin cleared and hardware continuing to clear this bit. In most systems, it is unlikely the DCD software will observe this delay. However, should the DCD observe that the stall bit is not set after writing a one to it then follow this procedure: continually write this stall bit until it is set or until a new setup has been received by checking the associated endptsetupstat bit.</p>
15–8 -	This field is reserved. Reserved
7 RXE	<p>RX Endpoint Enable</p> <p>0 Disabled [Default]</p> <p>1 Enabled</p> <p>An Endpoint should be enabled only after it has been configured.</p>
6 RXR	<p>RX Data Toggle Reset (WS)</p> <p>Write 1 - Reset PID Sequence</p> <p>Whenever a configuration event is received for this Endpoint, software must write a one to this bit in order to synchronize the data PID's between the host and device.</p>
5 RXI	<p>RX Data Toggle Inhibit</p> <p>0 Disabled [Default]</p> <p>1 Enabled</p> <p>This bit is only used for test and should always be written as zero. Writing a one to this bit causes this endpoint to ignore the data toggle sequence and always accept data packet regardless of their data PID.</p>
4 -	This field is reserved. Reserved.
3–2 RXT	<p>RX Endpoint Type - Read/Write</p> <p>00 Control</p> <p>01 Isochronous</p> <p>10 Bulk</p> <p>11 Interrupt</p>
1 RXD	<p>RX Endpoint Data Sink - Read/Write</p> <p>0 Dual Port Memory Buffer/DMA Engine [Default]</p> <p>Should always be written as zero.</p>
0 RXS	<p>RX Endpoint Stall - Read/Write</p> <p>0 End Point OK. [Default]</p> <p>1 End Point Stalled</p>

Table continues on the next page...

USB_nENDPTCTRL6 field descriptions (continued)

Field	Description
	<p>This bit is set automatically upon receipt of a SETUP request if this Endpoint is configured as a Control Endpoint and this bit will continue to be cleared by hardware until the associated ENDPTSETUPSTAT bit is cleared.</p> <p>Software can write a one to this bit to force the endpoint to return a STALL handshake to the Host. This control will continue to STALL until this bit is either cleared by software or automatically cleared as above for control endpoints.</p> <p>NOTE: [CONTROL ENDPOINT TYPES ONLY]: there is a slight delay (50 clocks max) between the ENDPTSETUPSTAT begin cleared and hardware continuing to clear this bit. In most systems, it is unlikely the DCD software will observe this delay. However, should the DCD observe that the stall bit is not set after writing a one to it then follow this procedure: continually write this stall bit until it is set or until a new setup has been received by checking the associated endptsetupstat bit.</p>

56.6.46 Endpoint Control 7 (USB_nENDPTCTRL7)

This is endpoint control register for endpoint 7 in device operation mode.

NOTE

If one endpoint direction is enabled and the paired endpoint of opposite direction is disabled then the unused direction type must be changed from the default control-type to any other type (that is Bulk-type). leaving an unconfigured endpoint control causes undefined behavior for the data pid tracking on the active endpoint/direction.

Address: 218_4000h base + 1DCh offset + (512d × i), where i=0d to 1d

Bit	31	30	29	28	27	26	25	24	23	22	21	20	19	18	17	16
R	Reserved								TXE	TXR	TXI	Reserved	TXT	TXD	TXS	
W	Reserved								TXE	TXR	TXI	Reserved	TXT	TXD	TXS	
Reset	0	0	0	0	0	0	0	0	0	0	0	0	0	0	0	0

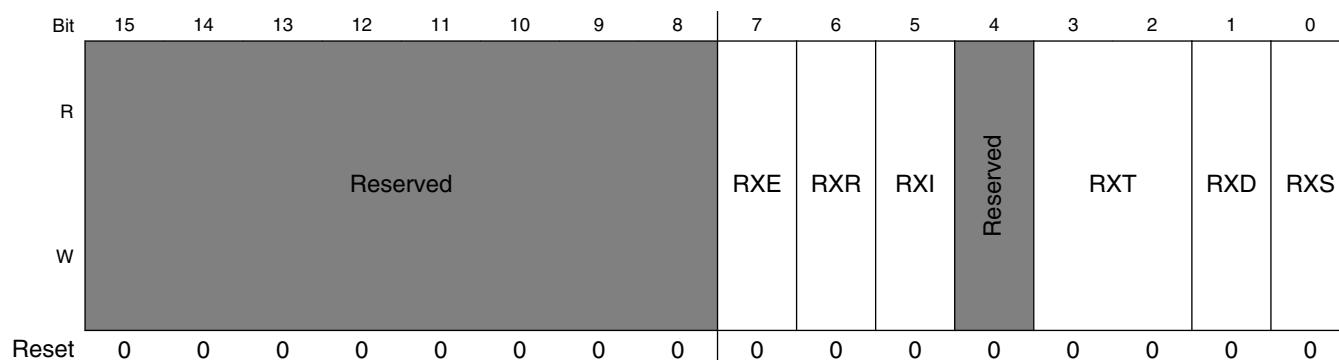

USB_nENDPTCTRL7 field descriptions

Field	Description
31–24 -	This field is reserved. Reserved
23 TXE	TX Endpoint Enable 0 Disabled [Default] 1 Enabled An Endpoint should be enabled only after it has been configured.
22 TXR	TX Data Toggle Reset (WS) Write 1 - Reset PID Sequence Whenever a configuration event is received for this Endpoint, software must write a one to this bit in order to synchronize the data PID's between the Host and device.
21 TXI	TX Data Toggle Inhibit 0 PID Sequencing Enabled. [Default] 1 PID Sequencing Disabled. This bit is only used for test and should always be written as zero. Writing a one to this bit causes this endpoint to ignore the data toggle sequence and always transmit DATA0 for a data packet.
20 -	This field is reserved. Reserved
19–18 TXT	TX Endpoint Type - Read/Write 00 Control 01 Isochronous 10 Bulk 11 Interrupt
17 TXD	TX Endpoint Data Source - Read/Write 0 Dual Port Memory Buffer/DMA Engine [DEFAULT] Should always be written as 0.
16 TXS	TX Endpoint Stall - Read/Write 0 End Point OK 1 End Point Stalled

Table continues on the next page...

USB_nENDPTCTRL7 field descriptions (continued)

Field	Description
	<p>This bit will be cleared automatically upon receipt of a SETUP request if this Endpoint is configured as a Control Endpoint and this bit will continue to be cleared by hardware until the associated ENDPTSETUPSTAT bit is cleared.</p> <p>Software can write a one to this bit to force the endpoint to return a STALL handshake to the Host. This control will continue to STALL until this bit is either cleared by software or automatically cleared as above for control endpoints.</p> <p>NOTE: [CONTROL ENDPOINT TYPES ONLY]: there is a slight delay (50 clocks max) between the ENDPTSETUPSTAT begin cleared and hardware continuing to clear this bit. In most systems, it is unlikely the DCD software will observe this delay. However, should the DCD observe that the stall bit is not set after writing a one to it then follow this procedure: continually write this stall bit until it is set or until a new setup has been received by checking the associated endptsetupstat bit.</p>
15–8 -	This field is reserved. Reserved
7 RXE	<p>RX Endpoint Enable</p> <p>0 Disabled [Default]</p> <p>1 Enabled</p> <p>An Endpoint should be enabled only after it has been configured.</p>
6 RXR	<p>RX Data Toggle Reset (WS)</p> <p>Write 1 - Reset PID Sequence</p> <p>Whenever a configuration event is received for this Endpoint, software must write a one to this bit in order to synchronize the data PID's between the host and device.</p>
5 RXI	<p>RX Data Toggle Inhibit</p> <p>0 Disabled [Default]</p> <p>1 Enabled</p> <p>This bit is only used for test and should always be written as zero. Writing a one to this bit causes this endpoint to ignore the data toggle sequence and always accept data packet regardless of their data PID.</p>
4 -	This field is reserved. Reserved.
3–2 RXT	<p>RX Endpoint Type - Read/Write</p> <p>00 Control</p> <p>01 Isochronous</p> <p>10 Bulk</p> <p>11 Interrupt</p>
1 RXD	<p>RX Endpoint Data Sink - Read/Write</p> <p>0 Dual Port Memory Buffer/DMA Engine [Default]</p> <p>Should always be written as zero.</p>
0 RXS	<p>RX Endpoint Stall - Read/Write</p> <p>0 End Point OK. [Default]</p> <p>1 End Point Stalled</p>

Table continues on the next page...

USB_nENDPTCTRL7 field descriptions (continued)

Field	Description
	<p>This bit is set automatically upon receipt of a SETUP request if this Endpoint is configured as a Control Endpoint and this bit will continue to be cleared by hardware until the associated ENDPTSETUPSTAT bit is cleared.</p> <p>Software can write a one to this bit to force the endpoint to return a STALL handshake to the Host. This control will continue to STALL until this bit is either cleared by software or automatically cleared as above for control endpoints.</p> <p>NOTE: [CONTROL ENDPOINT TYPES ONLY]: there is a slight delay (50 clocks max) between the ENDPTSETUPSTAT begin cleared and hardware continuing to clear this bit. In most systems, it is unlikely the DCD software will observe this delay. However, should the DCD observe that the stall bit is not set after writing a one to it then follow this procedure: continually write this stall bit until it is set or until a new setup has been received by checking the associated endptsetupstat bit.</p>

Chapter 57

Universal Serial Bus 2.0 Integrated PHY (USB-PHY)

57.1 USB PHY Overview

The chip contains 2 integrated USB 2.0 PHY macrocells capable of connecting to USB host/device systems at the USB low-speed (LS) rate of 1.5 Mbits/s, full-speed (FS) rate of 12 Mbits/s or at the USB 2.0 high-speed (HS) rate of 480 Mbits/s.

The integrated PHY provides a standard UTM interface. The USB_*n*_DN and USB_*n*_DP pins connect directly to a USB connector.

The following subsections describe the external interfaces, internal interfaces, major blocks, and programmable registers that comprise the integrated USB 2.0 PHY.

57.2 Operation

The UTM provides a 16-bit interface to the USB controller. This interface is clocked at 30 MHz.

- The digital portions of the USBPHY block include the UTMI, digital transmitter, digital receiver, and the programmable registers.
- The analog transceiver section comprises an analog receiver and an analog transmitter, as shown in [Figure 57-1](#).

57.2.1 UTMI

The UTMI block handles the line_state bits, reset buffering, suspend distribution, transceiver speed selection, and transceiver termination selection.

The PLL supplies a 120 MHz signal to all of the digital logic. The UTMI block does a final divide-by-four to develop the 30 MHz clock used in the interface.

57.2.2 Digital Transmitter

The digital transmitter receives the 16-bit transmit data from the USB controller and handles the tx_valid, tx_validh and tx_ready handshake.

In addition, it contains the transmit serializer that converts the 16-bit parallel words at 30 MHz to a single bitstream at 480 Mbit for high-speed or 12 Mbit for full-speed or 1.5 Mbit for low-speed. It does this while implementing the bit-stuffing algorithm and the NRZI encoder that are used to remove the DC component from the serial bitstream. The output of this encoder is sent to the low-speed (LS), full-speed (FS) or high-speed (HS) drivers in the analog transceiver section's transmitter block.

57.2.3 Digital Receiver

The digital receiver receives the raw serial bitstream from the low speed (LS) differential transceiver, full speed (FS) differential transceiver, and a 9X, 480 MHz sampled data from the high speed (HS) differential transceiver.

As the phase of the USB host transmitter shifts relative to the local PLL, the receiver section's HS DLL tracks these changes to give a reliable sample of the incoming 480 Mbit/s bitstream. Since this sample point shifts relative to the PLL phase used by the digital logic, a rate-matching elastic buffer is provided to cross this clock domain boundary. Once the bitstream is in the local clock domain, an NRZI decoder and bit unstuffer restore the original payload data bitstream and pass it to a deserializer and holding register. The receive state machine handles the rx_valid, rx_validh, and handshake with the USB controller. The handshake is not interlocked, in that there is no rx_ready signal coming from the controller. The controller must take each 16-bit value as presented by the PHY. The receive state machine provides an rx_active signal to the controller that indicates when it is inside a valid packet (SYNC detected, and so on).

57.2.4 Analog Receiver

The analog receiver comprises five differential receivers, two single-ended receivers, and a 9X, 480 MHz HS data sampling module

, as shown in the figure below and described further in this section.

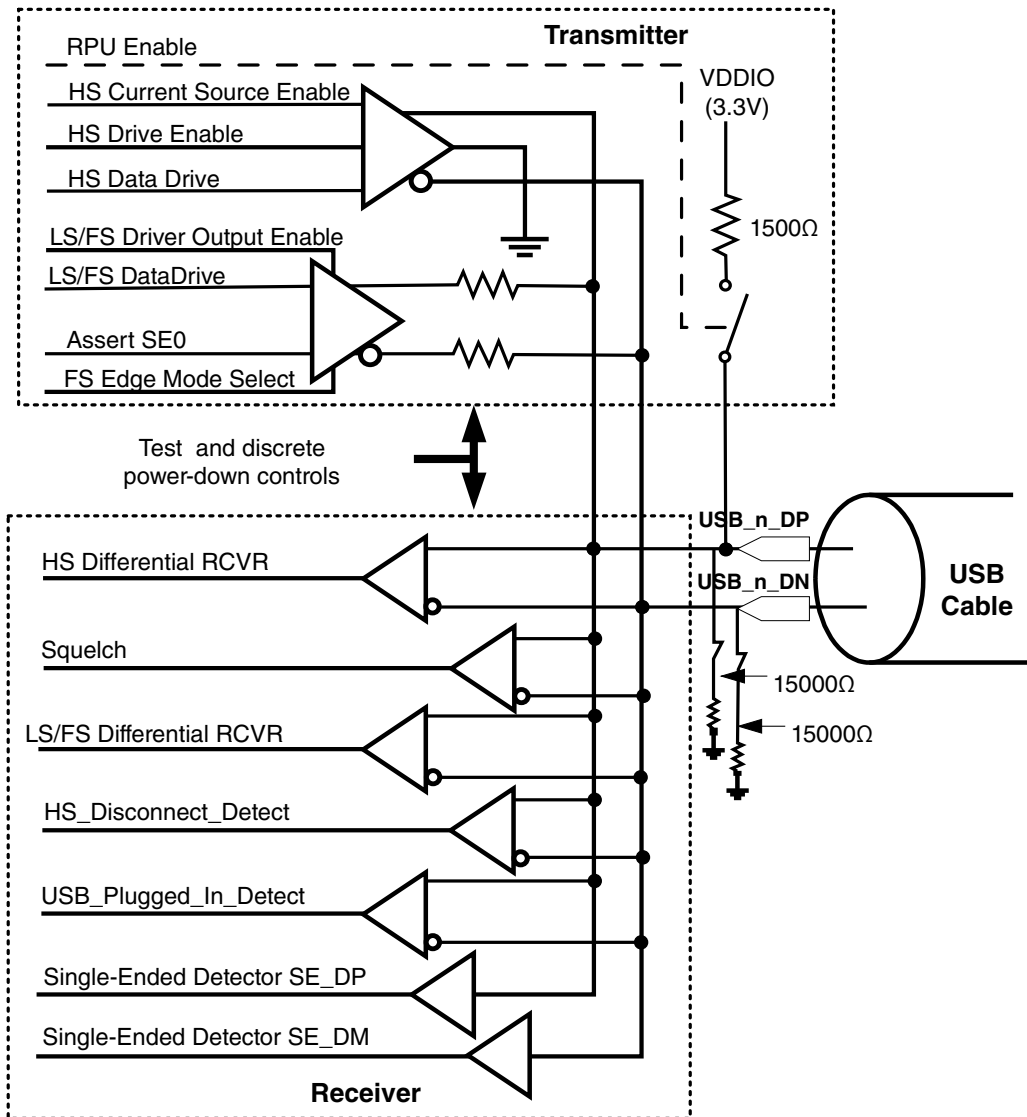

Figure 57-1. USB 2.0 PHY Analog Transceiver Block Diagram

57.2.4.1 HS Differential Receiver

The high-speed differential receiver is both a differential analog receiver and threshold comparator. Its output is a one if the differential signal is greater than a 0-V threshold.

Otherwise, its output is 0. Its purpose is to discriminate the ± 400 -mV differential voltage resulting from the high-speed drivers current flow into the dual 45Ω terminations found on each pin of the differential pair. The envelope or squelch detector, described below, ensures that the differential signal has sufficient magnitude to be valid. The HS differential receiver tolerates up to 500 mV of common mode offset.

57.2.4.2 Squelch Detector

The squelch detector is a differential analog receiver and threshold comparator.

Its output is 1, if the differential magnitude is less than a nominal 100 mV threshold. Otherwise, its output is 0.

Its purpose is to invalidate the HS differential receiver when the incoming signal is simply too low to receive reliably.

57.2.4.3 LS/FS Differential Receiver

The low-speed/full-speed differential receiver is both a differential analog receiver and threshold comparator.

The crossover voltage falls between 1.3 V and 2.0 V. Its output is 1, when the USB_n_DP line is above the crossover point and the USB_n_DN line is below the crossover point. The digital receiver section decodes the receiver data into J or K state according to the speed.

57.2.4.4 HS Disconnect Detector

It is a differential analog receiver and threshold comparator. It outputs high when differential magnitude is greater than a nominal 575-mV threshold. Otherwise, it outputs low.

57.2.4.5 USB Plugged-In Detector

The USB plugged-in detector looks for both USB_n_DP and USB_n_DN to be high. There is a pair of large on-chip pullup resistors (200 K Ω) that hold both USB_n_DP and USB_n_DN high when the USB cable is not attached. The USB plugged-in detector signals a 0 in this case.

When operating in device mode, the upstream port in host/hub interface contains a 15 K Ω pulldown resistor which could easily override the 200 K Ω pullup resistor. When plugged in, at least one signal in the pair will be low, which will force the plugged-in detector's output high.

57.2.4.6 Single-Ended USB_DP Receiver

The single-ended USB_n_DP receiver output is high whenever the USB_n_DP input is above its nominal 1.8 V threshold.

57.2.4.7 Single-Ended USB_DN Receiver

The single-ended USB_n_DN receiver output is high whenever the USB_n_DN input is above its nominal 1.8 V threshold.

57.2.4.8 9X Oversample Module

The 9X oversample module uses nine identically spaced phases of the 480 MHz clock to sample a high speed bit data. The squelch signal is sampled only 1X.

57.2.5 Analog Transmitter

The analog transmitter comprises two differential drivers: one for high-speed signaling and one for full-speed signaling. It also contains the switchable 1.5 K Ω pullup resistor.

See [Figure 57-1](#).

57.2.5.1 Switchable High-Speed 45 Ω Termination Resistors

High-speed current mode differential signaling requires good 90 Ω differential termination at each end of the USB cable. This results from switching in 45 Ω terminating resistors from each signal line to ground at each end of the cable.

Because each signal is parallel terminated with 45 Ω at each end, each driver sees a 22.5 Ω load. This load impedance is much too low for full-speed signaling levels—hence the need for switchable high-speed terminating resistors. Switchable trimming resistors are provided to tune the actual termination resistance of each device, as shown in [Figure](#)

57-2. The HW_USBPHY_TX_TXCAL45DP bit field, for example, allows one of 16 trimming resistor values to be placed in parallel with the 45Ω terminator on the USB_n_DP signal.

57.2.5.2 Low-Speed/Full-Speed Differential Driver

The low-speed/full-speed differential drivers are essentially low-impedance pulldown devices that are switched in a differential mode for low-speed or full-speed signaling, that is, either one or the other device is turned on to signal the "J" state or the "K" state.

57.2.5.3 High-Speed Differential Driver

The high-speed differential driver receives a 17.78 mA current from the constant current source (I_{ref}) and essentially steers it down either the USB_DP signal or the USB_DN signal or alternatively to ground.

This current will produce approximately a 400 mV drop across the 22.5 Ω termination seen by the driver when it is steered onto one of the signal lines. The approximately 17.78 mA current source is referenced back to the integrated voltage-band-gap (V_{bg}) circuit. The I_{ref}, I_{bias}, and V to I circuits are shared with the integrated battery charger.

57.2.5.4 Switchable 1.5KΩ USB_DP Pullup Resistor

This product contains a switchable 1.5 KΩ pullup resistor on the USB_n_DP signal.

This resistor is switched on to indicate to the host/hub controller that a full-speed-capable device is on the USB cable, powered on, and ready. This resistor is switched off at power-on reset so the host does not recognize a USB device until the processor software enables the announcement of a full-speed device.

57.2.5.5 Switchable 15KΩ USB_DP Pulldown Resistor

This product contains a switchable 15 KΩ pulldown resistor on both USB_n_DP and USB_n_DN signals. This is used in host mode to indicate to the device controller that a host is present.

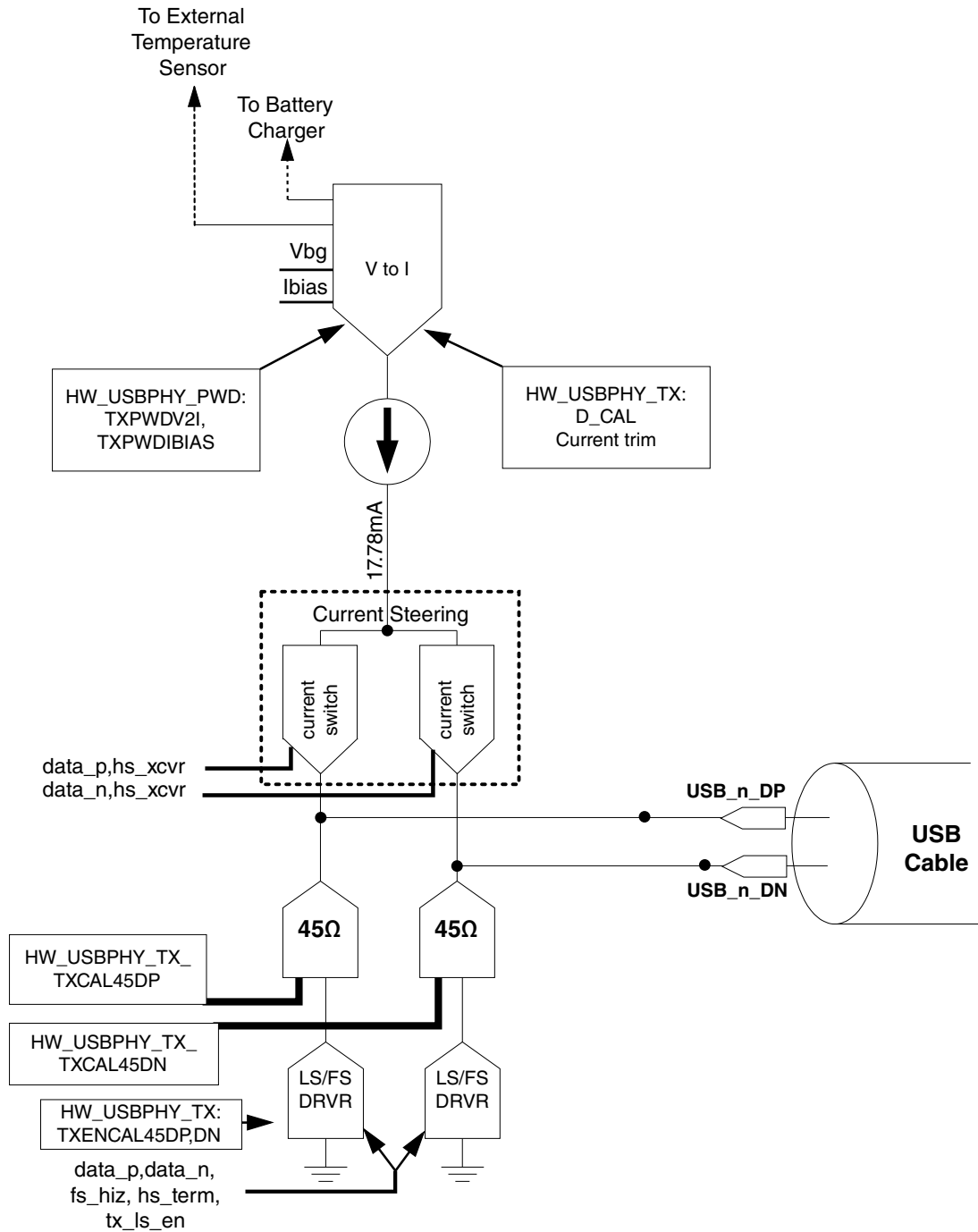

Figure 57-2. USB 2.0 PHY Transmitter Block Diagram

57.2.6 Recommended Register Configuration for USB Certification

The register settings in this section are recommended for passing USB certification.

The following settings lower the J/K levels to certifiable limits:

```
HW_USBPHY_TX_TXCAL45DP = 0x0
HW_USBPHY_TX_TXCAL45DN = 0x0
HW_USBPHY_TX_D_CAL = 0x7
```

57.2.7 Charger detection

The USB charger detector is a block that detects whether the upstream-facing device is connected to a down-stream facing charger, either a dedicated USB charger or a host charger.

The USB charger detector is comprised of two sub-blocks, namely the USB data-pin contact detector and the charger detector.

This section details those two sub-blocks and gives the software flow of USB charger detection. Finally, this chapter discusses the detection of a USB charger in case of a dead battery.

57.2.7.1 Charger detect control table

Before we dive into the details of the detectors, we show the logic table of the control signals to give the user an overall picture of the charger detector.

Table 57-1. Charger detection control table

EN_B	CHK_CHRG_B	CHK_CONTACT	Data pin contact detector	Charger detector
0	1	1	Enabled	Disabled
0	0	x(don't care)	Disabled	Enabled
1	x	x(don't care)	Disabled	Disabled

57.2.7.2 Data pin contact detector

According to Battery Charging Specification (rev 1.2), USB plugs and receptacles are designed such that when the plug is inserted into the receptacle, the power pins make contact before the data pins make contact. Therefore, there is inevitably a time interval during which USB_n_VBUS has been observed by the device while the USB_n_DP and USB_n_DN pins are not still pending for contact. The USB data pin contact detector is designed to give the software an indication of the contact of the data pins.

To enable the USB data pin contact detector, the user should set the CHK_CONTACT bit of the USB1_CHRG_DETECT register to 1 and monitor the PLUG_CONTACT bit status of the USB1_CHRG_DETECT_STAT register. If PLUG_CONTACT is 1, then it indicates that the data pins have made good contacts, otherwise the user should continue to wait until this bit is set.

According to Table 1, it should be noted that the data pin contact detector only works when EN_B=0 and CHK_CHRG_B=1, both bits being of the USB1_CHRG_DETECT register.

57.2.7.3 Charger detector

Once the data pins make contact, the user should enable the charger detector by clearing the CHK_CHRG_B bit that is low-active. Then the user should wait for 40ms and then check the status bit of CHRГ_DETECTED in register hw_anadig_usb1_chrg_det_stat. CHRГ_DETECTED=1 means that the device is connected to a charger, either a dedicated charger or a charging downstream port (or equivalently called a host charger, or charging host). To further differentiate between a host charger and a dedicated charger, the user is suggested to pull up USB_n_DP signaling a connect event to the host. Then the user should monitor the USB_n_DN line status. If USB_n_DN=1, then the charger is a dedicated charger; if USB_n_DN=0, then it is a host charger.

57.2.7.4 Charger detection software flow

Upon seeing VBUS, the software should follow the software flow for the charger detection process. The flow chart mentions the "enable the vdd3p0 current limiter". Please refer to the power chapter for details.

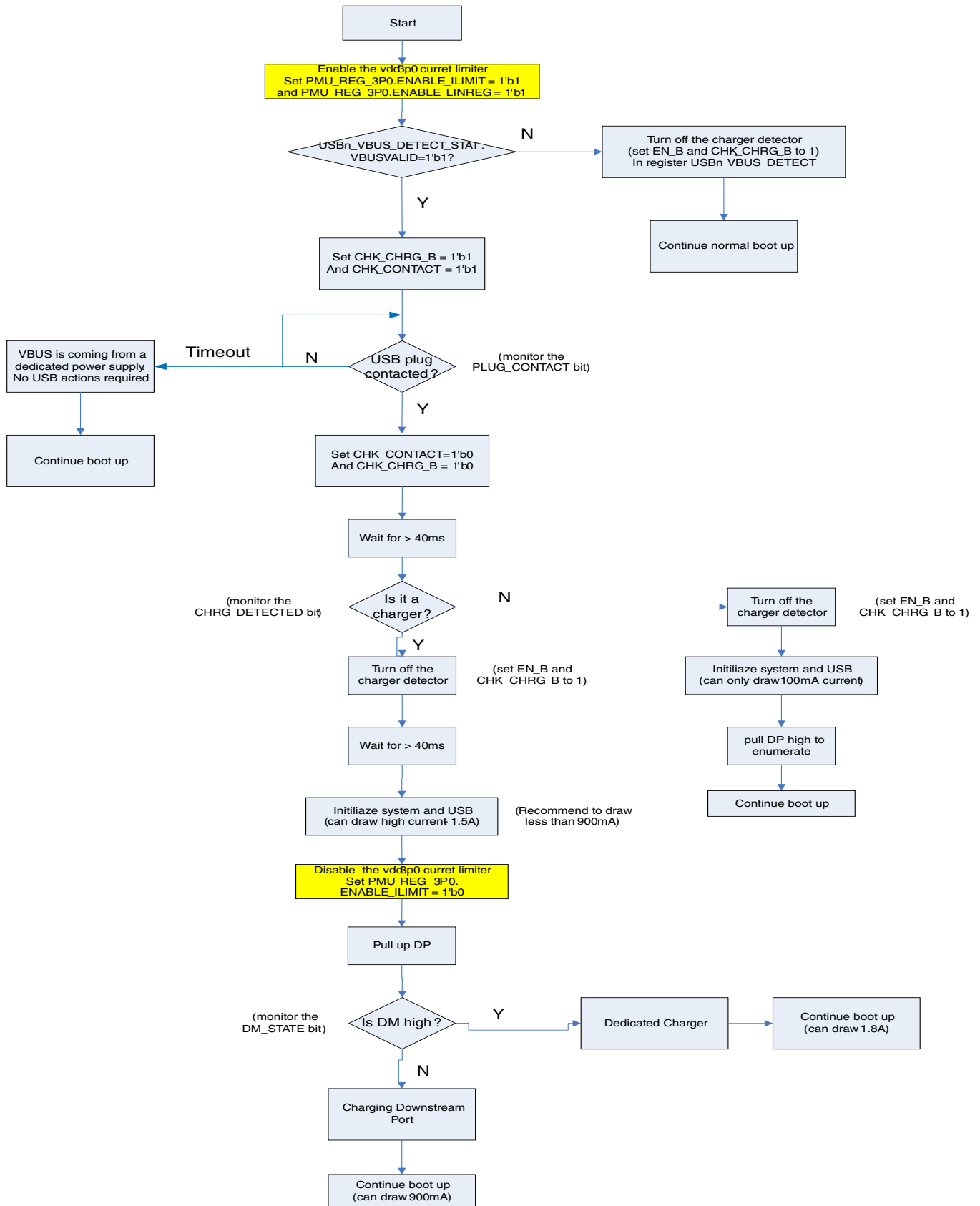

Figure 57-3. USBPHY Charger Detection Software Flow

57.2.7.5 Dead Battery Protect

All the descriptions above are based on the assumption that all the power supplies have been on when the device is plugged into a remote host (or charger). However, there are cases when the local battery of the portable device has been so depleted that the system could not be turned on. In such scenarios the user may prefer a method of signaling the external power management unit (PMIC) the existence of the USB charger to draw a current larger than 100mA from the remote host to speed up system boot up or battery charging. The charger detector indeed supports this function.

When we have a fully depleted battery, all the power supplies might be off. Upon insertion of the 5V, the supplies are brought up by the external PMIC and the internal regulators. Due to the 100mA inrush current limit of the USB spec, we cannot draw larger than 100mA current which might be a limit for system boot-up. Since by default, EN_B=0, CHK_CHRG_B=0 and CHK_CONTACT=1, the usb charger detector is automatically enabled without any software operation needed and it can signal the external PMIC the existence of a USB charger through the open-drain output pin USB_OTG_CHD_B. This pin should be pulled up to an external voltage that is acceptable to the PMIC. If this signal is low, then the PMIC can get that the device is connected to a charger. In this case, the PMIC can draw more than 100mA current from the USB.

It should be noted that this function requires cooperation between the chip and the external PMIC. It is suggested that the user consult NXP for such use cases.

57.3 USB PHY Memory Map/Register Definition

USBPHY Hardware Register Format Summary

USBPHY memory map

Absolute address (hex)	Register name	Width (in bits)	Access	Reset value	Section/page
20C_9000	USB PHY Power-Down Register (USBPHY1_PWD)	32	R/W	001E_1C00h	57.3.1/3914
20C_9004	USB PHY Power-Down Register (USBPHY1_PWD_SET)	32	R/W	001E_1C00h	57.3.1/3914
20C_9008	USB PHY Power-Down Register (USBPHY1_PWD_CLR)	32	R/W	001E_1C00h	57.3.1/3914
20C_900C	USB PHY Power-Down Register (USBPHY1_PWD_TOG)	32	R/W	001E_1C00h	57.3.1/3914
20C_9010	USB PHY Transmitter Control Register (USBPHY1_TX)	32	R/W	1006_0607h	57.3.2/3916

Table continues on the next page...

USBPHY memory map (continued)

Absolute address (hex)	Register name	Width (in bits)	Access	Reset value	Section/page
20C_9014	USB PHY Transmitter Control Register (USBPHY1_TX_SET)	32	R/W	1006_0607h	57.3.2/3916
20C_9018	USB PHY Transmitter Control Register (USBPHY1_TX_CLR)	32	R/W	1006_0607h	57.3.2/3916
20C_901C	USB PHY Transmitter Control Register (USBPHY1_TX_TOG)	32	R/W	1006_0607h	57.3.2/3916
20C_9020	USB PHY Receiver Control Register (USBPHY1_RX)	32	R/W	0000_0000h	57.3.3/3917
20C_9024	USB PHY Receiver Control Register (USBPHY1_RX_SET)	32	R/W	0000_0000h	57.3.3/3917
20C_9028	USB PHY Receiver Control Register (USBPHY1_RX_CLR)	32	R/W	0000_0000h	57.3.3/3917
20C_902C	USB PHY Receiver Control Register (USBPHY1_RX_TOG)	32	R/W	0000_0000h	57.3.3/3917
20C_9030	USB PHY General Control Register (USBPHY1_CTRL)	32	R/W	C020_0000h	57.3.4/3919
20C_9034	USB PHY General Control Register (USBPHY1_CTRL_SET)	32	R/W	C020_0000h	57.3.4/3919
20C_9038	USB PHY General Control Register (USBPHY1_CTRL_CLR)	32	R/W	C020_0000h	57.3.4/3919
20C_903C	USB PHY General Control Register (USBPHY1_CTRL_TOG)	32	R/W	C020_0000h	57.3.4/3919
20C_9040	USB PHY Status Register (USBPHY1_STATUS)	32	R/W	0000_0000h	57.3.5/3922
20C_9050	USB PHY Debug Register (USBPHY1_DEBUG)	32	R/W	7F18_0000h	57.3.6/3924
20C_9054	USB PHY Debug Register (USBPHY1_DEBUG_SET)	32	R/W	7F18_0000h	57.3.6/3924
20C_9058	USB PHY Debug Register (USBPHY1_DEBUG_CLR)	32	R/W	7F18_0000h	57.3.6/3924
20C_905C	USB PHY Debug Register (USBPHY1_DEBUG_TOG)	32	R/W	7F18_0000h	57.3.6/3924
20C_9060	UTMI Debug Status Register 0 (USBPHY1_DEBUG0_STATUS)	32	R	0000_0000h	57.3.7/3926
20C_9070	UTMI Debug Status Register 1 (USBPHY1_DEBUG1)	32	R/W	0000_1000h	57.3.8/3927
20C_9074	UTMI Debug Status Register 1 (USBPHY1_DEBUG1_SET)	32	R/W	0000_1000h	57.3.8/3927
20C_9078	UTMI Debug Status Register 1 (USBPHY1_DEBUG1_CLR)	32	R/W	0000_1000h	57.3.8/3927
20C_907C	UTMI Debug Status Register 1 (USBPHY1_DEBUG1_TOG)	32	R/W	0000_1000h	57.3.8/3927
20C_9080	UTMI RTL Version (USBPHY1_VERSION)	32	R	0402_0000h	57.3.9/3928
20C_A000	USB PHY Power-Down Register (USBPHY2_PWD)	32	R/W	001E_1C00h	57.3.1/3914
20C_A004	USB PHY Power-Down Register (USBPHY2_PWD_SET)	32	R/W	001E_1C00h	57.3.1/3914
20C_A008	USB PHY Power-Down Register (USBPHY2_PWD_CLR)	32	R/W	001E_1C00h	57.3.1/3914
20C_A00C	USB PHY Power-Down Register (USBPHY2_PWD_TOG)	32	R/W	001E_1C00h	57.3.1/3914
20C_A010	USB PHY Transmitter Control Register (USBPHY2_TX)	32	R/W	1006_0607h	57.3.2/3916
20C_A014	USB PHY Transmitter Control Register (USBPHY2_TX_SET)	32	R/W	1006_0607h	57.3.2/3916
20C_A018	USB PHY Transmitter Control Register (USBPHY2_TX_CLR)	32	R/W	1006_0607h	57.3.2/3916
20C_A01C	USB PHY Transmitter Control Register (USBPHY2_TX_TOG)	32	R/W	1006_0607h	57.3.2/3916
20C_A020	USB PHY Receiver Control Register (USBPHY2_RX)	32	R/W	0000_0000h	57.3.3/3917

Table continues on the next page...

USBPHY memory map (continued)

Absolute address (hex)	Register name	Width (in bits)	Access	Reset value	Section/page
20C_A024	USB PHY Receiver Control Register (USBPHY2_RX_SET)	32	R/W	0000_0000h	57.3.3/3917
20C_A028	USB PHY Receiver Control Register (USBPHY2_RX_CLR)	32	R/W	0000_0000h	57.3.3/3917
20C_A02C	USB PHY Receiver Control Register (USBPHY2_RX_TOG)	32	R/W	0000_0000h	57.3.3/3917
20C_A030	USB PHY General Control Register (USBPHY2_CTRL)	32	R/W	C020_0000h	57.3.4/3919
20C_A034	USB PHY General Control Register (USBPHY2_CTRL_SET)	32	R/W	C020_0000h	57.3.4/3919
20C_A038	USB PHY General Control Register (USBPHY2_CTRL_CLR)	32	R/W	C020_0000h	57.3.4/3919
20C_A03C	USB PHY General Control Register (USBPHY2_CTRL_TOG)	32	R/W	C020_0000h	57.3.4/3919
20C_A040	USB PHY Status Register (USBPHY2_STATUS)	32	R/W	0000_0000h	57.3.5/3922
20C_A050	USB PHY Debug Register (USBPHY2_DEBUG)	32	R/W	7F18_0000h	57.3.6/3924
20C_A054	USB PHY Debug Register (USBPHY2_DEBUG_SET)	32	R/W	7F18_0000h	57.3.6/3924
20C_A058	USB PHY Debug Register (USBPHY2_DEBUG_CLR)	32	R/W	7F18_0000h	57.3.6/3924
20C_A05C	USB PHY Debug Register (USBPHY2_DEBUG_TOG)	32	R/W	7F18_0000h	57.3.6/3924
20C_A060	UTMI Debug Status Register 0 (USBPHY2_DEBUG0_STATUS)	32	R	0000_0000h	57.3.7/3926
20C_A070	UTMI Debug Status Register 1 (USBPHY2_DEBUG1)	32	R/W	0000_1000h	57.3.8/3927
20C_A074	UTMI Debug Status Register 1 (USBPHY2_DEBUG1_SET)	32	R/W	0000_1000h	57.3.8/3927
20C_A078	UTMI Debug Status Register 1 (USBPHY2_DEBUG1_CLR)	32	R/W	0000_1000h	57.3.8/3927
20C_A07C	UTMI Debug Status Register 1 (USBPHY2_DEBUG1_TOG)	32	R/W	0000_1000h	57.3.8/3927
20C_A080	UTMI RTL Version (USBPHY2_VERSION)	32	R	0402_0000h	57.3.9/3928

57.3.1 USB PHY Power-Down Register (USBPHYx_PWDn)

The USB PHY Power-Down Register provides overall control of the PHY power state. Before programming this register, the PHY clocks must be enabled in registers USBPHYx_CTRLn and CCM_ANALOG_USBPHYx_PLL_480_CTRLn.

Address: Base address + 0h offset + (4d × i), where i=0d to 3d

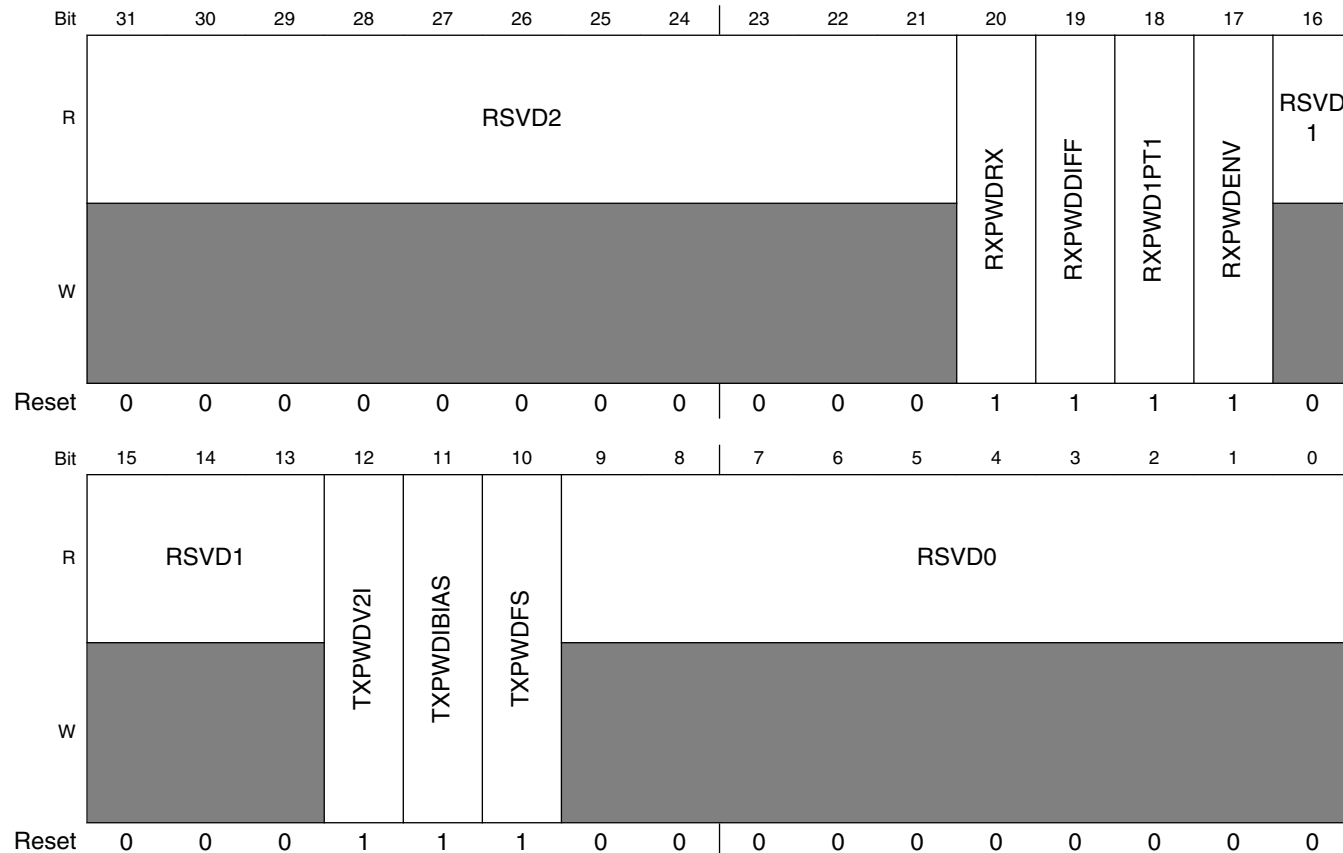

USBPHYx_PWDn field descriptions

Field	Description
31–21 RSVD2	Reserved.
20 RXPWDRX	0 = Normal operation. 1 = Power-down the entire USB PHY receiver block except for the full-speed differential receiver. Note that this bit will be auto cleared if there is USB wakeup event while ENAUTOCLR_PHY_PWD bit of USBPHYx_CTRL is enabled.
19 RXPWDDIFF	0 = Normal operation. 1 = Power-down the USB high-speed differential receiver.

Table continues on the next page...

USBPHYx_PWDn field descriptions (continued)

Field	Description
	Note that this bit will be auto cleared if there is USB wakeup event while ENAUTOCLR_PHY_PWD bit of USBPHYx_CTRL is enabled.
18 RXPWD1PT1	0 = Normal operation. 1 = Power-down the USB full-speed differential receiver. Note that this bit will be auto cleared if there is USB wakeup event while ENAUTOCLR_PHY_PWD bit of USBPHYx_CTRL is enabled.
17 RXPWDENV	0 = Normal operation. 1 = Power-down the USB high-speed receiver envelope detector (squelch signal). Note that this bit will be auto cleared if there is USB wakeup event while ENAUTOCLR_PHY_PWD bit of USBPHYx_CTRL is enabled.
16–13 RSVD1	Reserved.
12 TXPWDV2I	0 = Normal operation. 1 = Power-down the USB PHY transmit V-to-I converter and the current mirror. Note that this bit will be auto cleared if there is USB wakeup event while ENAUTOCLR_PHY_PWD bit of USBPHYx_CTRL is enabled. Note that these circuits are shared with the battery charge circuit. Setting this to 1 does not power-down these circuits, unless the corresponding bit in the battery charger is also set for power-down.
11 TXPWDIBIAS	0 = Normal operation. 1 = Power-down the USB PHY current bias block for the transmitter. This bit should be set only when the USB is in suspend mode. This effectively powers down the entire USB transmit path. Note that this bit will be auto cleared if there is USB wakeup event while ENAUTOCLR_PHY_PWD bit of USBPHYx_CTRL is enabled. Note that these circuits are shared with the battery charge circuit. Setting this bit to 1 does not power-down these circuits, unless the corresponding bit in the battery charger is also set for power-down.
10 TXPWDIFS	0 = Normal operation. 1 = Power-down the USB full-speed drivers. This turns off the current starvation sources and puts the drivers into high-impedance output. Note that this bit will be auto cleared if there is USB wakeup event while ENAUTOCLR_PHY_PWD bit of USBPHYx_CTRL is enabled.
RSVD0	Reserved.

57.3.2 USB PHY Transmitter Control Register (USBPHYx_TXn)

The USB PHY Transmitter Control Register handles the transmit controls.

Address: Base address + 10h offset + (4d × i), where i=0d to 3d

Bit	31	30	29	28	27	26	25	24	23	22	21	20	19	18	17	16
R	RSVD5			USBPHY_TX_EDGECTRL			RSVD2				TXCAL45DP					
W	[Shaded]			[Shaded]			[Shaded]				[Shaded]					
Reset	0	0	0	1	0	0	0	0	0	0	0	0	0	1	1	0
Bit	15	14	13	12	11	10	9	8	7	6	5	4	3	2	1	0
R	RSVD1			TXCAL45DN				RSVD0				D_CAL				
W	[Shaded]			[Shaded]				[Shaded]				[Shaded]				
Reset	0	0	0	0	0	1	1	0	0	0	0	0	0	1	1	1

USBPHYx_TXn field descriptions

Field	Description
31–29 RSVD5	Reserved.
28–26 USBPHY_TX_EDGECTRL	Controls the edge-rate of the current sensing transistors used in HS transmit. NOT FOR CUSTOMER USE.
25–20 RSVD2	Reserved.
19–16 TXCAL45DP	Decode to select a 45-Ohm resistance to the USB_DP output pin. Maximum resistance = 0000. Resistance is centered by design at 0110.
15–12 RSVD1	Reserved. Note: This bit should remain clear.
11–8 TXCAL45DN	Decode to select a 45-Ohm resistance to the USB_DN output pin. Maximum resistance = 0000. Resistance is centered by design at 0110.
7–4 RSVD0	Reserved. Note: This bit should remain clear.
D_CAL	Resistor Trimming Code: 0000 = 0.16% 0111 = Nominal 1111 = +25%

57.3.3 USB PHY Receiver Control Register (USBPHYx_RXn)

The USB PHY Receiver Control Register handles receive path controls.

Address: Base address + 20h offset + (4d × i), where i=0d to 3d

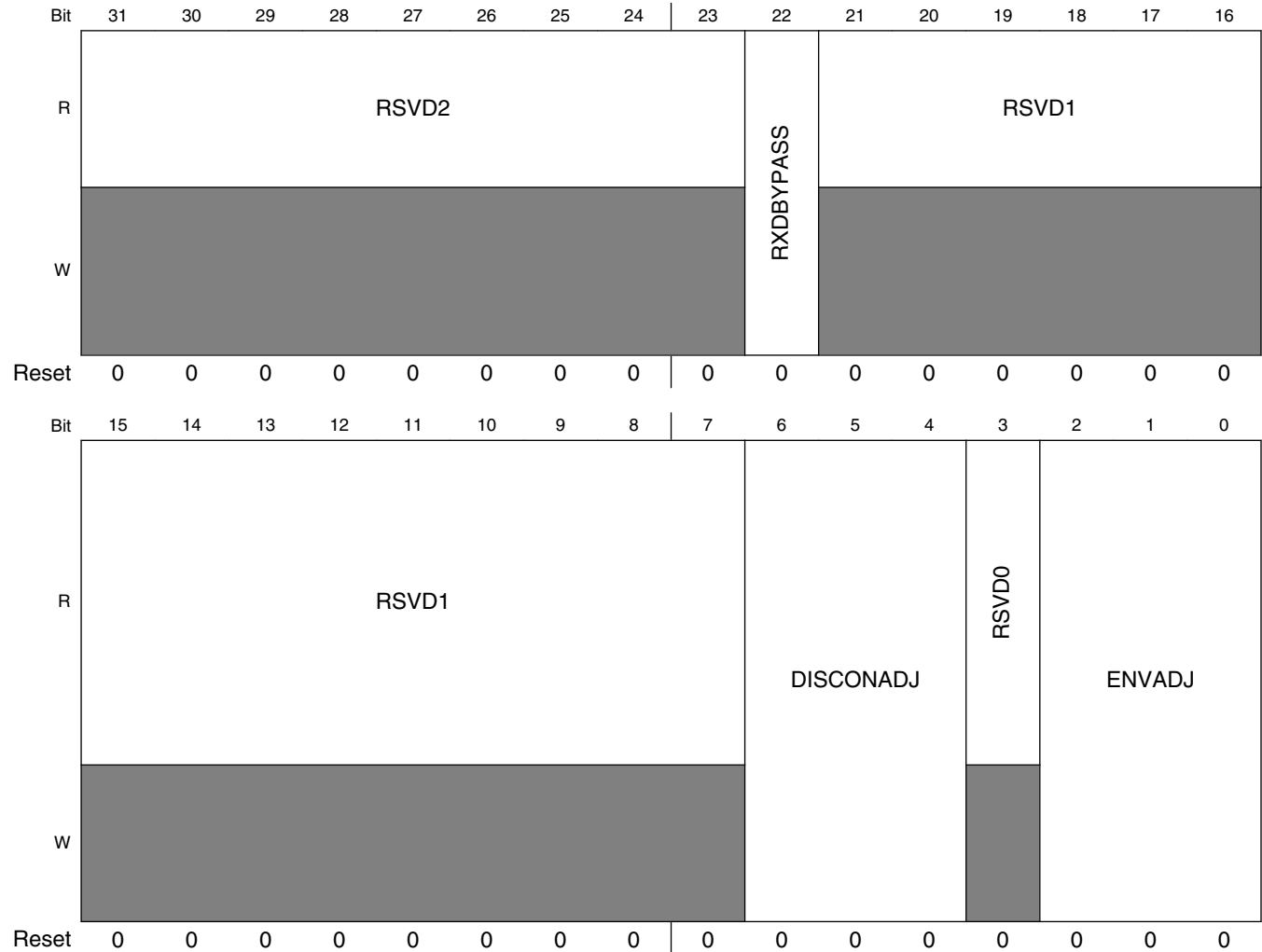

USBPHYx_RXn field descriptions

Field	Description
31–23 RSVD2	Reserved.
22 RXDBYPASS	0 = Normal operation. 1 = Use the output of the USB_DP single-ended receiver in place of the full-speed differential receiver. This test mode is intended for lab use only.
21–7 RSVD1	Reserved.

Table continues on the next page...

USBPHYx_RXn field descriptions (continued)

Field	Description
6-4 DISCONADJ	The DISCONADJ field adjusts the trip point for the disconnect detector: 000 = Trip-Level Voltage is 0.57500 V 001 = Trip-Level Voltage is 0.56875 V 010 = Trip-Level Voltage is 0.58125 V 011 = Trip-Level Voltage is 0.58750 V 1XX = Reserved
3 RSVD0	Reserved.
ENVADJ	The ENVADJ field adjusts the trip point for the envelope detector. 000 = Trip-Level Voltage is 0.12500 V 001 = Trip-Level Voltage is 0.10000 V 010 = Trip-Level Voltage is 0.13750 V 011 = Trip-Level Voltage is 0.15000 V 1XX = Reserved

57.3.4 USB PHY General Control Register (USBPHYx_CTRLn)

The USB PHY General Control Register handles OTG and Host controls. This register also includes interrupt enables and connectivity detect enables and results.

Address: Base address + 30h offset + (4d × i), where i=0d to 3d

Bit	31	30	29	28	27	26	25	24	23	22	21	20	19	18	17	16
R																
W																
Reset	1	1	0	0	0	0	0	0	0	0	0	1	0	0	0	0
	SFTRST	CLKGATE	UTMI_SUSPENDM	HOST_FORCE_LS_SE0	OTG_ID_VALUE	RSVD1		FSDLL_RST_EN	ENVBUSCHG_WKUP	ENIDCHG_WKUP	ENDPDMCHG_WKUP	ENAUTOCLR_PHY_PWD	ENAUTOCLR_CLKGATE	ENAUTO_PWRON_PLL	WAKEUP_IRQ	ENIRQWAKEUP
Bit	15	14	13	12	11	10	9	8	7	6	5	4	3	2	1	0
R																
W																
Reset	0	0	0	0	0	0	0	0	0	0	0	0	0	0	0	0
	ENUTMILEVEL3	ENUTMILEVEL2	DATA_ON_LRADC	DEVPLUGIN_IRQ	ENIRQDEVPLUGIN	RESUME_IRQ	ENIRQRESUMEDETECT	RESUMEIRQSTICKY	ENOTGIDDETECT	OTG_ID_CHG_IRQ	DEVPLUGIN_POLARITY	ENDEVPLUGINDETECT	HOSTDISCONDETECT_IRQ	ENIRGHOSTDISCON	ENHOSTDISCONDETECT	ENOTG_ID_CHG_IRQ

USBPHYx_CTRLn field descriptions

Field	Description
31 SFTRST	Writing a 1 to this bit will soft-reset the USBPHYx_PWD, USBPHYx_TX, USBPHYx_RX, and USBPHYx_CTRL registers. Set to 0 to release the PHY from reset.
30 CLKGATE	Gate UTMI Clocks. Clear to 0 to run clocks. Set to 1 to gate clocks. Set this to save power while the USB is not actively being used. Configuration state is kept while the clock is gated. Note this bit can be auto-cleared if there is any wakeup event when USB is suspended while ENAUTOCLR_CLKGATE bit of USBPHYx_CTRL is enabled.
29 UTMI_SUSPENDM	Used by the PHY to indicate a powered-down state. If all the power-down bits in the USBPHYx_PWD are enabled, UTMI_SUSPENDM will be 0, otherwise 1. UTMI_SUSPENDM is negative logic, as required by the UTMI specification.
28 HOST_FORCE_LS_SE0	Forces the next FS packet that is transmitted to have a EOP with LS timing. This bit is used in host mode for the resume sequence. After the packet is transferred, this bit is cleared. The design can use this function to force the LS SE0 or use the USBPHYx_CTRL_UTMI_SUSPENDM to trigger this event when leaving suspend. This bit is used in conjunction with USBPHYx_DEBUG_HOST_RESUME_DEBUG.
27 OTG_ID_VALUE	Almost same as OTGID_STATUS in USBPHYx_STATUS Register. The only difference is that OTG_ID_VALUE has debounce logic to filter the glitches on ID Pad.
26–25 RSVD1	Reserved.
24 FSDLL_RST_EN	Enables the feature to reset the FSDLL lock detection logic at the end of each TX packet.
23 ENVBUSCHG_WKUP	Enables the feature to wakeup USB if VBUS is toggled when USB is suspended.
22 ENIDCHG_WKUP	Enables the feature to wakeup USB if ID is toggled when USB is suspended.
21 ENDPDMCHG_WKUP	Enables the feature to wakeup USB if DP/DM is toggled when USB is suspended. This bit is enabled by default.
20 ENAUTOCLR_PHY_PWD	Enables the feature to auto-clear the PWD register bits in USBPHYx_PWD if there is wakeup event while USB is suspended. This should be enabled if needs to support auto wakeup without S/W's interaction.
19 ENAUTOCLR_CLKGATE	Enables the feature to auto-clear the CLKGATE bit if there is wakeup event while USB is suspended. This should be enabled if needs to support auto wakeup without S/W's interaction.
18 ENAUTO_PWRON_PLL	Enables the feature to auto-enable the POWER bit of HW_CLKCTRL_PLLxCTRL0 if there is wakeup event if USB is suspended. This should be enabled if needs to support auto wakeup without S/W's interaction.
17 WAKEUP_IRQ	Indicates that there is a wakeup event. Reset this bit by writing a 1 to the clear address space and not by a general write.
16 ENIRQWAKEUP	Enables interrupt for the wakeup events.
15 ENUTMILEVEL3	Enables UTMI+ Level3. This should be enabled if needs to support external FS Hub with LS device connected
14 ENUTMILEVEL2	Enables UTMI+ Level2. This should be enabled if needs to support LS device
13 DATA_ON_LRADC	Enables the LRADC to monitor USB_DP and USB_DM. This is for use in non-USB modes only.
12 DEVPLUGIN_IRQ	Indicates that the device is connected. Reset this bit by writing a 1 to the clear address space and not by a general write.

Table continues on the next page...

USBPHYx_CTRLn field descriptions (continued)

Field	Description
11 ENIRQDEVPLUGIN	Enables interrupt for the detection of connectivity to the USB line.
10 RESUME_IRQ	Indicates that the host is sending a wake-up after suspend. This bit is also set on a reset during suspend. Use this bit to wake up from suspend for either the resume or the reset case. Reset this bit by writing a 1 to the clear address space and not by a general write.
9 ENIRQRESUMEDETECT	Enables interrupt for detection of a non-J state on the USB line. This should only be enabled after the device has entered suspend mode.
8 RESUMEIRQSTICKY	Set to 1 will make RESUME_IRQ bit a sticky bit until software clear it. Set to 0, RESUME_IRQ only set during the wake-up period.
7 ENOTGIDDETECT	Enables circuit to detect resistance of MiniAB ID pin.
6 OTG_ID_CHG_IRQ	OTG ID change interrupt. Indicates the value of ID pin changed.
5 DEVPLUGIN_POLARITY	For device mode, if this bit is cleared to 0, then it trips the interrupt if the device is plugged in. If set to 1, then it trips the interrupt if the device is unplugged.
4 ENDEVPLUGINDETECT	For device mode, enables 200-KOhm pullups for detecting connectivity to the host.
3 HOSTDISCONDETECT_IRQ	Indicates that the device has disconnected in high-speed mode. Reset this bit by writing a 1 to the clear address space and not by a general write.
2 ENIRQHOSTDISCON	Enables interrupt for detection of disconnection to Device when in high-speed host mode. This should be enabled after ENDEVPLUGINDETECT is enabled.
1 ENHOSTDISCONDETECT	For host mode, enables high-speed disconnect detector. This signal allows the override of enabling the detection that is normally done in the UTMI controller. The UTMI controller enables this circuit whenever the host sends a start-of-frame packet. SW shall set this bit when it found the high-speed device is connected, suggested during bus reset, after found high-speed device in USB_PORTSC1.PSPD). SW shall make sure this bit is not set at the end of resume, otherwise a wrong disconnect status may be detected. Suggest clear it after set USB_PORTSC1.SUSP, set it again after resume is ended(USB_PORTSC1.FPR==0).
0 ENOTG_ID_CHG_IRQ	Enable OTG_ID_CHG_IRQ.

57.3.5 USB PHY Status Register (USBPHYx_STATUS)

The USB PHY Status Register holds results of IRQ and other detects.

Address: Base address + 40h offset

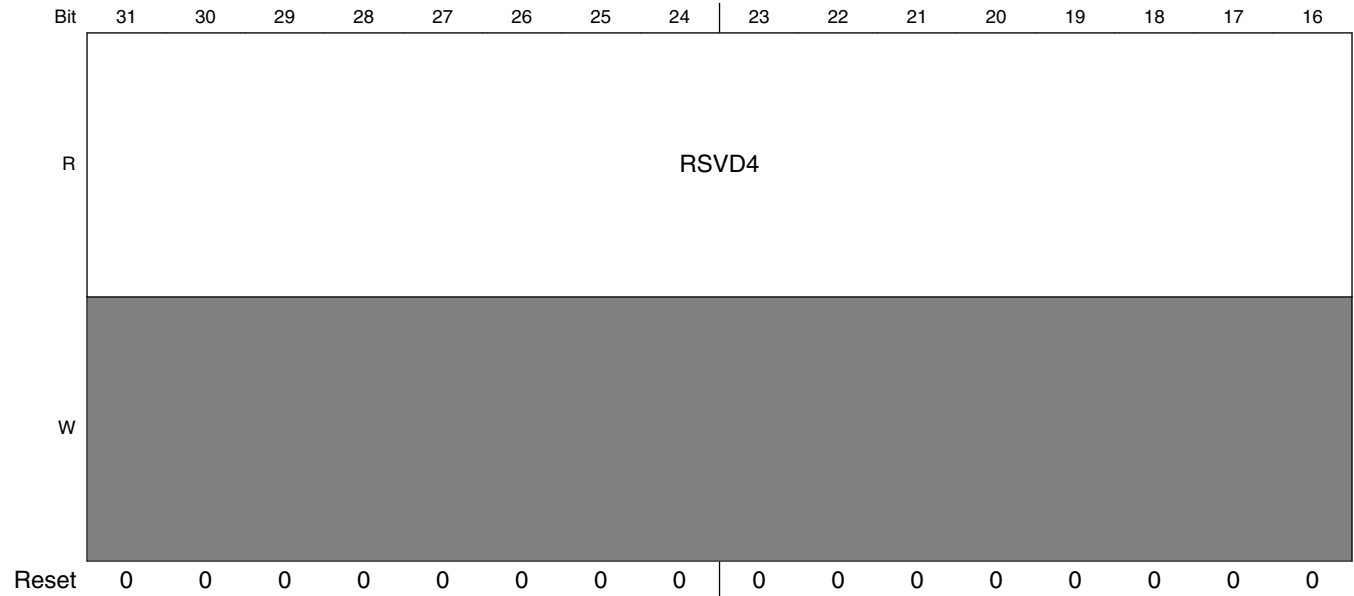

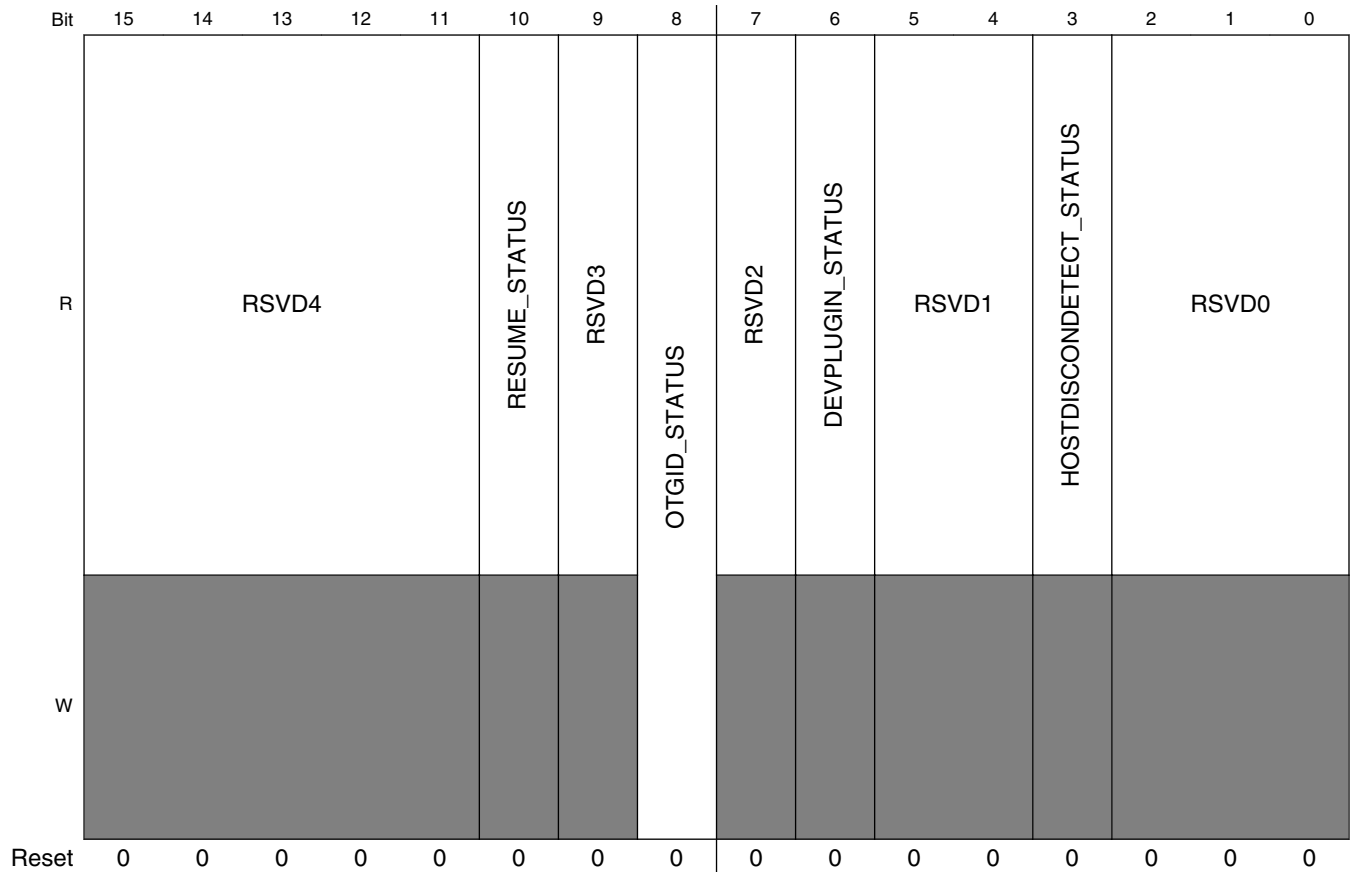

USBPHYx_STATUS field descriptions

Field	Description
31–11 RSVD4	Reserved.
10 RESUME_STATUS	Indicates that the host is sending a wake-up after suspend and has triggered an interrupt.
9 RSVD3	Reserved.
8 OTGID_STATUS	Indicates the results of ID pin on MiniAB plug. False (0) is when ID resistance is less than Ra_Plug_ID, indicating host (A) side. True (1) is when ID resistance is greater than Rb_Plug_ID, indicating device (B) side.
7 RSVD2	Reserved.
6 DEVPLUGIN_STATUS	Indicates that the device has been connected on the USB_DP and USB_DM lines.
5–4 RSVD1	Reserved.
3 HOSTDISCONDETECT_STATUS	Indicates that the device has disconnected while in high-speed host mode.
RSVD0	Reserved.

57.3.6 USB PHY Debug Register (USBPHYx_DEBUGn)

This register is used to debug the USB PHY.

Address: Base address + 50h offset + (4d × i), where i=0d to 3d

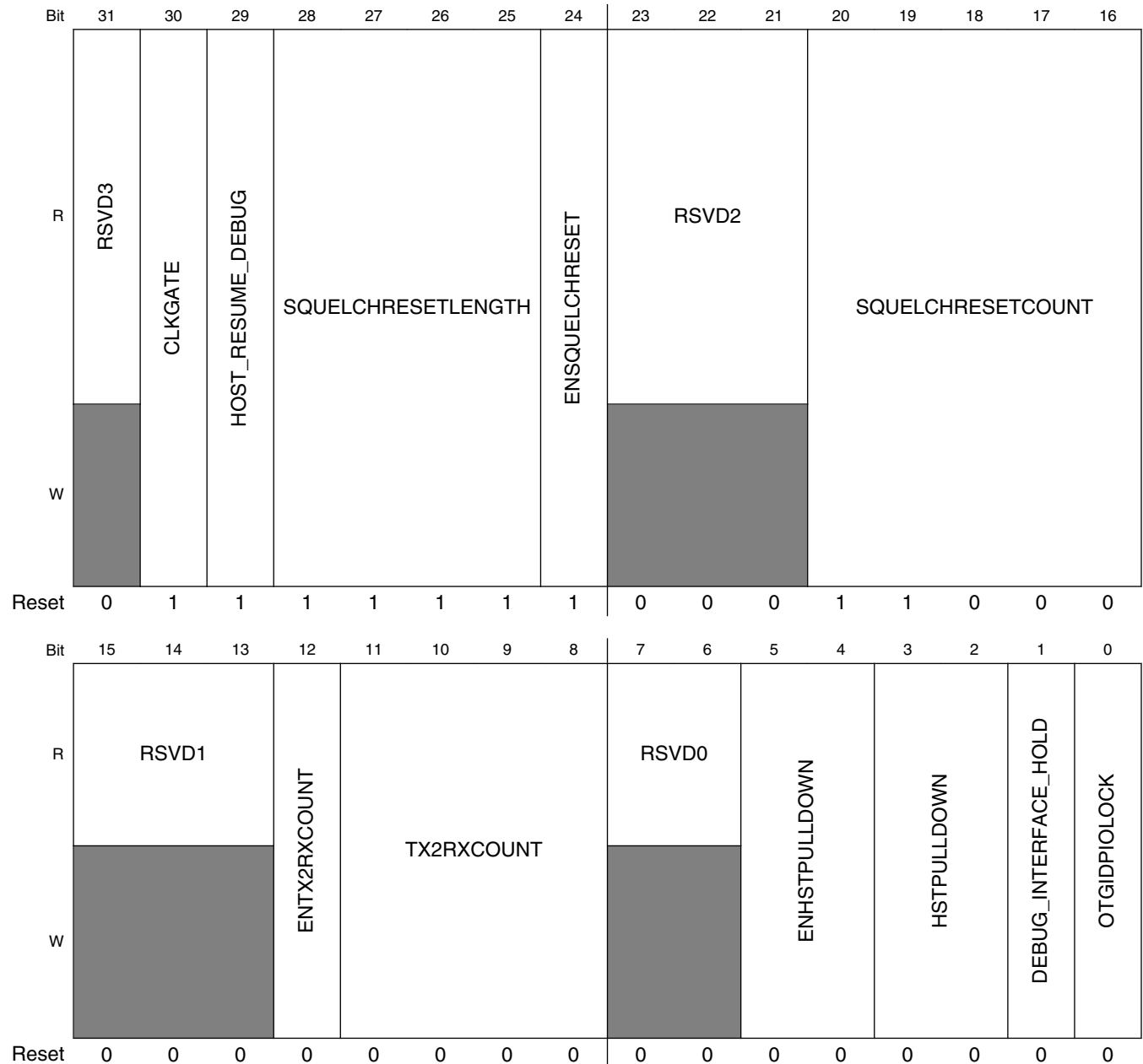

USBPHYx_DEBUGn field descriptions

Field	Description
31 RSVD3	Reserved.
30 CLKGATE	Gate Test Clocks. Clear to 0 for running clocks. Set to 1 to gate clocks. Set this to save power while the USB is not actively being used. Configuration state is kept while the clock is gated.
29 HOST_RESUME_DEBUG	Choose to trigger the host resume SE0 with HOST_FORCE_LS_SE0 = 0 or UTMI_SUSPEND = 1.
28–25 SQUELCHRESETLENGTH	Duration of RESET in terms of the number of 480-MHz cycles.
24 ENSQUELCHRESET	Set bit to allow squelch to reset high-speed receive.
23–21 RSVD2	Reserved.
20–16 SQUELCHRESETCOUNT	Delay in between the detection of squelch to the reset of high-speed RX.
15–13 RSVD1	Reserved.
12 ENTX2RXCOUNT	Set this bit to allow a countdown to transition in between TX and RX.
11–8 TX2RXCOUNT	Delay in between the end of transmit to the beginning of receive. This is a Johnson count value and thus will count to 8.
7–6 RSVD0	Reserved.
5–4 ENHSTPULLDOWN	Set bit 5 to 1 to override the control of the USB_DP 15-KOhm pulldown. Set bit 4 to 1 to override the control of the USB_DM 15-KOhm pulldown. Clear to 0 to disable.
3–2 HSTPULLDOWN	Set bit 3 to 1 to pull down 15-KOhm on USB_DP line. Set bit 2 to 1 to pull down 15-KOhm on USB_DM line. Clear to 0 to disable.
1 DEBUG_INTERFACE_HOLD	Use holding registers to assist in timing for external UTMI interface.
0 OTGIDPIOLOCK	Once OTG ID from USBPHYx_STATUS_OTGID_STATUS, use this to hold the value. This is to save power for the comparators that are used to determine the ID status.

57.3.7 UTMI Debug Status Register 0 (USBPHYx_DEBUG0_STATUS)

The UTMI Debug Status Register 0 holds multiple views for counters and status of state machines. This is used in conjunction with the USBPHYx_DEBUG1_DBG_ADDRESS field to choose which function to view. The default is described in the bit fields below and is used to count errors.

Address: Base address + 60h offset

Bit	31	30	29	28	27	26	25	24	23	22	21	20	19	18	17	16	15	14	13	12	11	10	9	8	7	6	5	4	3	2	1	0	
R	SQUELCH_COUNT						UTMI_RXERROR_FAIL_COUNT						LOOP_BACK_FAIL_COUNT																				
W	[Write Protection]																																
Reset	0	0	0	0	0	0	0	0	0	0	0	0	0	0	0	0	0	0	0	0	0	0	0	0	0	0	0	0	0	0	0	0	0

USBPHYx_DEBUG0_STATUS field descriptions

Field	Description
31–26 SQUELCH_COUNT	Running count of the squelch reset instead of normal end for HS RX.
25–16 UTMI_RXERROR_FAIL_COUNT	Running count of the UTMI_RXERROR.
LOOP_BACK_FAIL_COUNT	Running count of the failed pseudo-random generator loopback. Each time entering testmode, counter goes to 900D and will count up for every detected packet failure in digital/analog loopback tests.

57.3.8 UTMI Debug Status Register 1 (USBPHYx_DEBUG1n)

Chooses the muxing of the debug register to be shown in USBPHYx_DEBUG0_STATUS.

Address: Base address + 70h offset + (4d × i), where i=0d to 3d

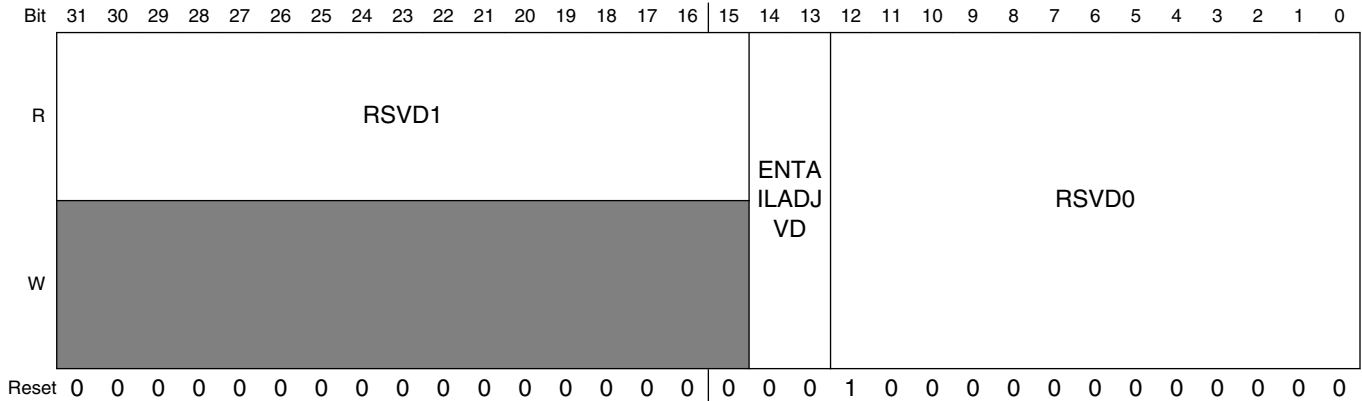

USBPHYx_DEBUG1n field descriptions

Field	Description
31–15 RSVD1	Reserved.
14–13 ENTAILADJVD	Delay increment of the rise of squelch: 00 = Delay is nominal 01 = Delay is +20% 10 = Delay is -20% 11 = Delay is -40%
RSVD0	Reserved. Note: This bit should remain clear.

57.3.9 UTMI RTL Version (USBPHYx_VERSION)

Fields for RTL Version.

Address: Base address + 80h offset

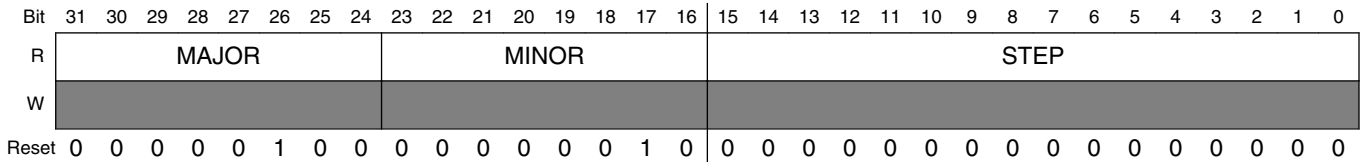

USBPHYx_VERSION field descriptions

Field	Description
31–24 MAJOR	Fixed read-only value reflecting the MAJOR field of the RTL version.
23–16 MINOR	Fixed read-only value reflecting the MINOR field of the RTL version.
STEP	Fixed read-only value reflecting the stepping of the RTL version.

57.4 USB Analog Memory Map/Register Definition

USB_ANALOG memory map

Absolute address (hex)	Register name	Width (in bits)	Access	Reset value	Section/page
20C_81A0	USB VBUS Detect Register (USB_ANALOG_USB1_VBUS_DETECT)	32	R/W	0010_0004h	57.4.1/3930
20C_81A4	USB VBUS Detect Register (USB_ANALOG_USB1_VBUS_DETECT_SET)	32	R/W	0010_0004h	57.4.1/3930
20C_81A8	USB VBUS Detect Register (USB_ANALOG_USB1_VBUS_DETECT_CLR)	32	R/W	0010_0004h	57.4.1/3930
20C_81AC	USB VBUS Detect Register (USB_ANALOG_USB1_VBUS_DETECT_TOG)	32	R/W	0010_0004h	57.4.1/3930
20C_81B0	USB Charger Detect Register (USB_ANALOG_USB1_CHRG_DETECT)	32	R/W	0000_0000h	57.4.2/3931
20C_81B4	USB Charger Detect Register (USB_ANALOG_USB1_CHRG_DETECT_SET)	32	R/W	0000_0000h	57.4.2/3931
20C_81B8	USB Charger Detect Register (USB_ANALOG_USB1_CHRG_DETECT_CLR)	32	R/W	0000_0000h	57.4.2/3931
20C_81BC	USB Charger Detect Register (USB_ANALOG_USB1_CHRG_DETECT_TOG)	32	R/W	0000_0000h	57.4.2/3931

Table continues on the next page...

USB_ANALOG memory map (continued)

Absolute address (hex)	Register name	Width (in bits)	Access	Reset value	Section/page
20C_81C0	USB VBUS Detect Status Register (USB_ANALOG_USB1_VBUS_DETECT_STAT)	32	R	0000_0000h	57.4.3/3933
20C_81D0	USB Charger Detect Status Register (USB_ANALOG_USB1_CHRG_DETECT_STAT)	32	R	0000_0000h	57.4.4/3935
20C_81F0	USB Misc Register (USB_ANALOG_USB1_MISC)	32	R/W	0000_0002h	57.4.5/3936
20C_81F4	USB Misc Register (USB_ANALOG_USB1_MISC_SET)	32	R/W	0000_0002h	57.4.5/3936
20C_81F8	USB Misc Register (USB_ANALOG_USB1_MISC_CLR)	32	R/W	0000_0002h	57.4.5/3936
20C_81FC	USB Misc Register (USB_ANALOG_USB1_MISC_TOG)	32	R/W	0000_0002h	57.4.5/3936
20C_8200	USB VBUS Detect Register (USB_ANALOG_USB2_VBUS_DETECT)	32	R/W	0010_0004h	57.4.6/3937
20C_8204	USB VBUS Detect Register (USB_ANALOG_USB2_VBUS_DETECT_SET)	32	R/W	0010_0004h	57.4.6/3937
20C_8208	USB VBUS Detect Register (USB_ANALOG_USB2_VBUS_DETECT_CLR)	32	R/W	0010_0004h	57.4.6/3937
20C_820C	USB VBUS Detect Register (USB_ANALOG_USB2_VBUS_DETECT_TOG)	32	R/W	0010_0004h	57.4.6/3937
20C_8210	USB Charger Detect Register (USB_ANALOG_USB2_CHRG_DETECT)	32	R/W	0000_0000h	57.4.7/3939
20C_8214	USB Charger Detect Register (USB_ANALOG_USB2_CHRG_DETECT_SET)	32	R/W	0000_0000h	57.4.7/3939
20C_8218	USB Charger Detect Register (USB_ANALOG_USB2_CHRG_DETECT_CLR)	32	R/W	0000_0000h	57.4.7/3939
20C_821C	USB Charger Detect Register (USB_ANALOG_USB2_CHRG_DETECT_TOG)	32	R/W	0000_0000h	57.4.7/3939
20C_8220	USB VBUS Detect Status Register (USB_ANALOG_USB2_VBUS_DETECT_STAT)	32	R	0000_0000h	57.4.8/3941
20C_8230	USB Charger Detect Status Register (USB_ANALOG_USB2_CHRG_DETECT_STAT)	32	R	0000_0000h	57.4.9/3943
20C_8250	USB Misc Register (USB_ANALOG_USB2_MISC)	32	R/W	0000_0002h	57.4.10/3944
20C_8254	USB Misc Register (USB_ANALOG_USB2_MISC_SET)	32	R/W	0000_0002h	57.4.10/3944
20C_8258	USB Misc Register (USB_ANALOG_USB2_MISC_CLR)	32	R/W	0000_0002h	57.4.10/3944
20C_825C	USB Misc Register (USB_ANALOG_USB2_MISC_TOG)	32	R/W	0000_0002h	57.4.10/3944
20C_8260	Chip Silicon Version (USB_ANALOG_DIGPROG)	32	R	0065_0000h	57.4.11/3945

57.4.1 USB VBUS Detect Register (USB_ANALOG_USB1_VBUS_DETECTn)

This register defines controls for USB VBUS detect.

Address: 20C_8000h base + 1A0h offset + (4d × i), where i=0d to 3d

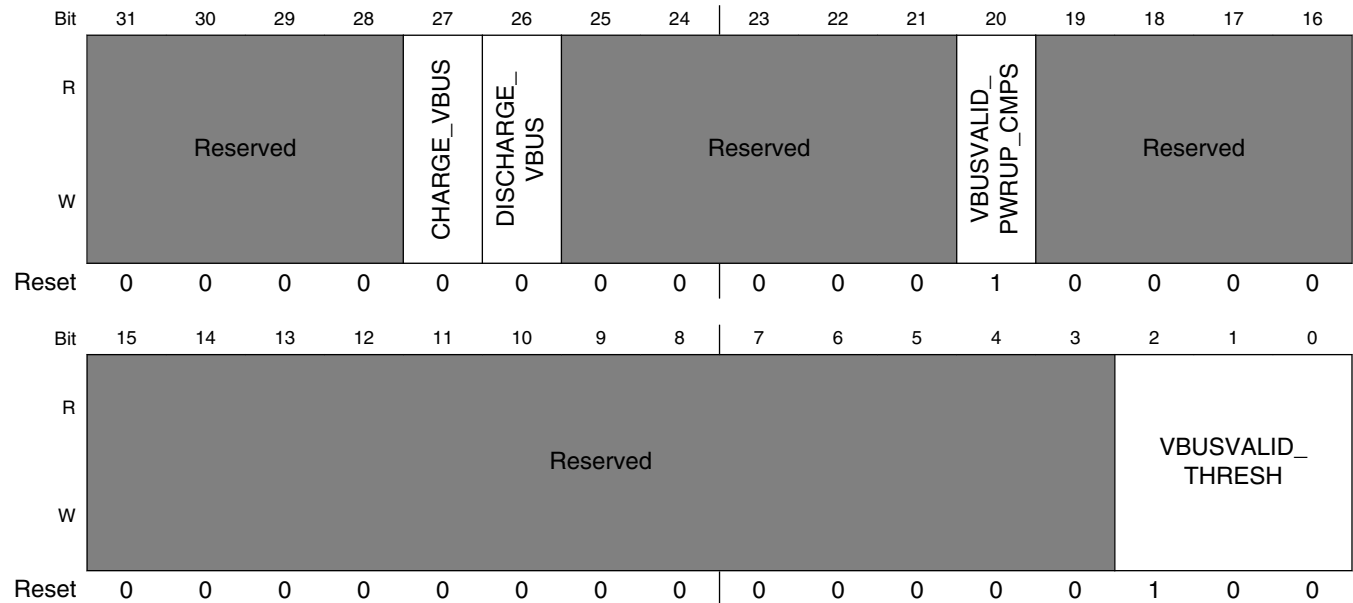

USB_ANALOG_USB1_VBUS_DETECTn field descriptions

Field	Description
31–28 -	This field is reserved. Reserved.
27 CHARGE_VBUS	USB OTG charge VBUS.
26 DISCHARGE_VBUS	USB OTG discharge VBUS.
25–21 -	This field is reserved. Reserved.
20 VBUSVALID_PWRUP_CMPS	Powers up comparators for vbus_valid detector.
19–3 -	This field is reserved. Reserved.
VBUSVALID_THRESH	Set the threshold for the VBUSVALID comparator. This comparator is the most accurate method to determine the presence of 5v, and includes hystersis to minimize the need for software debounce of the detection. This comparator has ~50mV of hystersis to prevent chattering at the comparator trip point. 000 4V0 — 4.0V

Table continues on the next page...

USB_ANALOG_USB1_VBUS_DETECT n field descriptions (continued)

Field	Description
001	4V1 — 4.1V
010	4V2 — 4.2V
011	4V3 — 4.3V
100	4V4 — 4.4V (default)
101	4V5 — 4.5V
110	4V6 — 4.6V
111	4V7 — 4.7V

57.4.2 USB Charger Detect Register (USB_ANALOG_USB1_CHRG_DETECT n)

This register defines controls for USB charger detect.

Address: 20C_8000h base + 1B0h offset + (4d × i), where i=0d to 3d

Bit	31	30	29	28	27	26	25	24	23	22	21	20	19	18	17	16	
R	Reserved								Reserved	Reserved			EN_B	CHK_CHRG_B	CHK_CONTACT	Reserved	
W	Reserved								Reserved	Reserved			EN_B	CHK_CHRG_B	CHK_CONTACT	Reserved	
Reset	0	0	0	0	0	0	0	0	0	0	0	0	0	0	0	0	
Bit	15	14	13	12	11	10	9	8	7	6	5	4	3	2	1	0	
R	Reserved																
W	Reserved																
Reset	0	0	0	0	0	0	0	0	0	0	0	0	0	0	0	0	

USB_ANALOG_USB1_CHRG_DETECT n field descriptions

Field	Description
31–24 -	This field is reserved. Reserved.

Table continues on the next page...

USB_ANALOG_USB1_CHRG_DETECT n field descriptions (continued)

Field	Description
23 -	This field is reserved. Reserved.
22–21 -	This field is reserved. Reserved.
20 EN_B	Control the charger detector. 0 ENABLE — Enable the charger detector. 1 DISABLE — Disable the charger detector.
19 CHK_CHRG_B	Check the charger connection 0 CHECK — Check whether a charger (either a dedicated charger or a host charger) is connected to USB port. 1 NO_CHECK — Do not check whether a charger is connected to the USB port.
18 CHK_CONTACT	Check the contact of USB plug 0 NO_CHECK — Do not check the contact of USB plug. 1 CHECK — Check whether the USB plug has been in contact with each other
-	This field is reserved. Reserved.

57.4.3 USB VBUS Detect Status Register (USB_ANALOG_USB1_VBUS_DETECT_STAT)

This register defines fields for USB VBUS Detect status.

Address: 20C_8000h base + 1C0h offset = 20C_81C0h

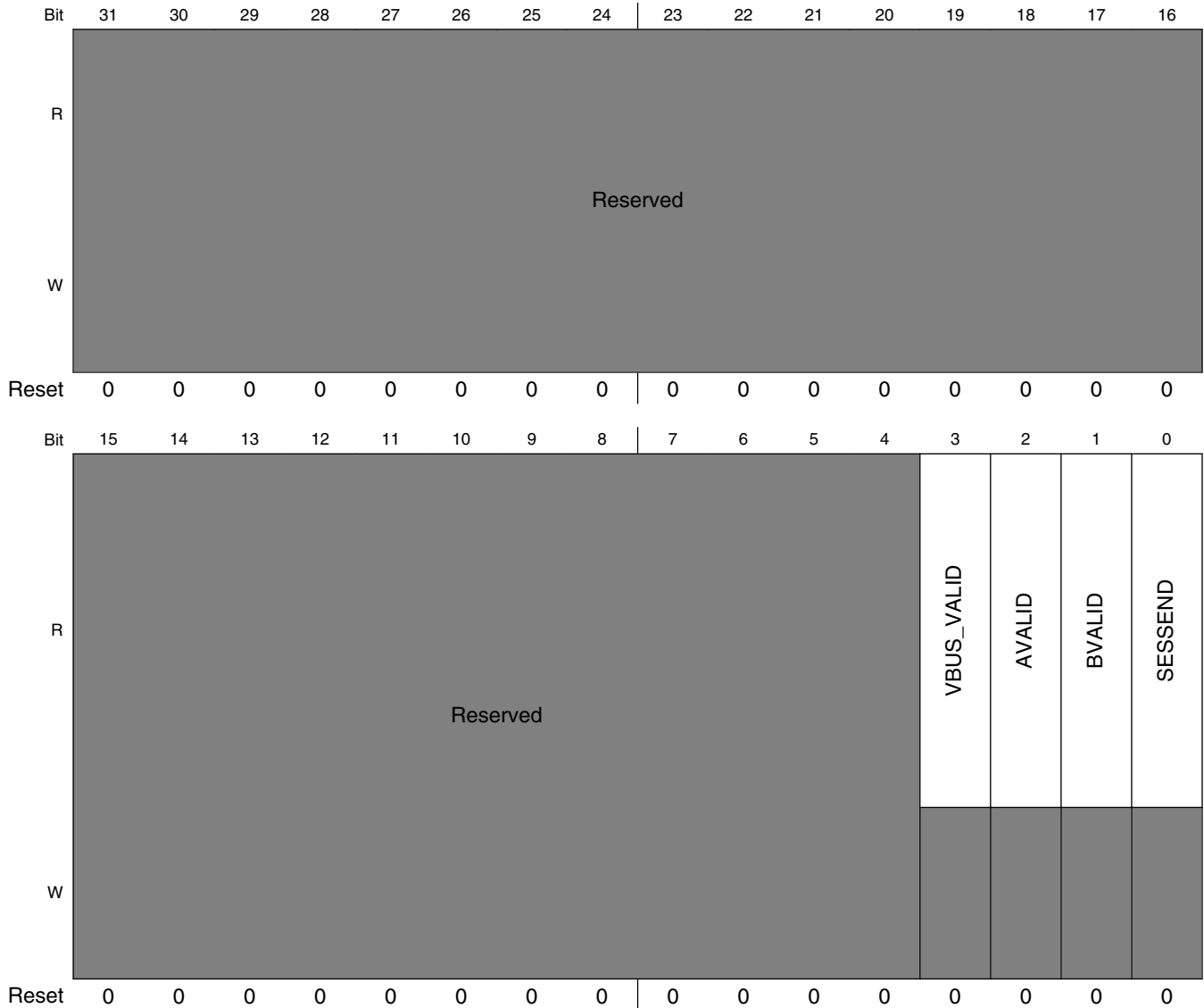

USB_ANALOG_USB1_VBUS_DETECT_STAT field descriptions

Field	Description
31-4 -	This field is reserved. Reserved.

Table continues on the next page...

USB_ANALOG_USB1_VBUS_DETECT_STAT field descriptions (continued)

Field	Description
3 VBUS_VALID	VBus valid for USB OTG. This bit is a read only version of the state of the analog signal. It can not be overwritten by software.
2 AVALID	Indicates VBus is valid for a A-peripheral. This bit is a read only version of the state of the analog signal. It can not be overwritten by software.
1 BVALID	Indicates VBus is valid for a B-peripheral. This bit is a read only version of the state of the analog signal. It can not be overwritten by software.
0 SESSEND	<p>Session End for USB OTG. This bit is a read only version of the state of the analog signal. It can not be overwritten by software like the SESSEND bit below.</p> <p>NOTE: This bit's default value depends on whether VDD5V is present, 0 if VDD5V is present, 1 if VDD5V is not present.</p>

57.4.4 USB Charger Detect Status Register (USB_ANALOG_USB1_CHRG_DETECT_STAT)

This register defines fields for USB charger detect status.

Address: 20C_8000h base + 1D0h offset = 20C_81D0h

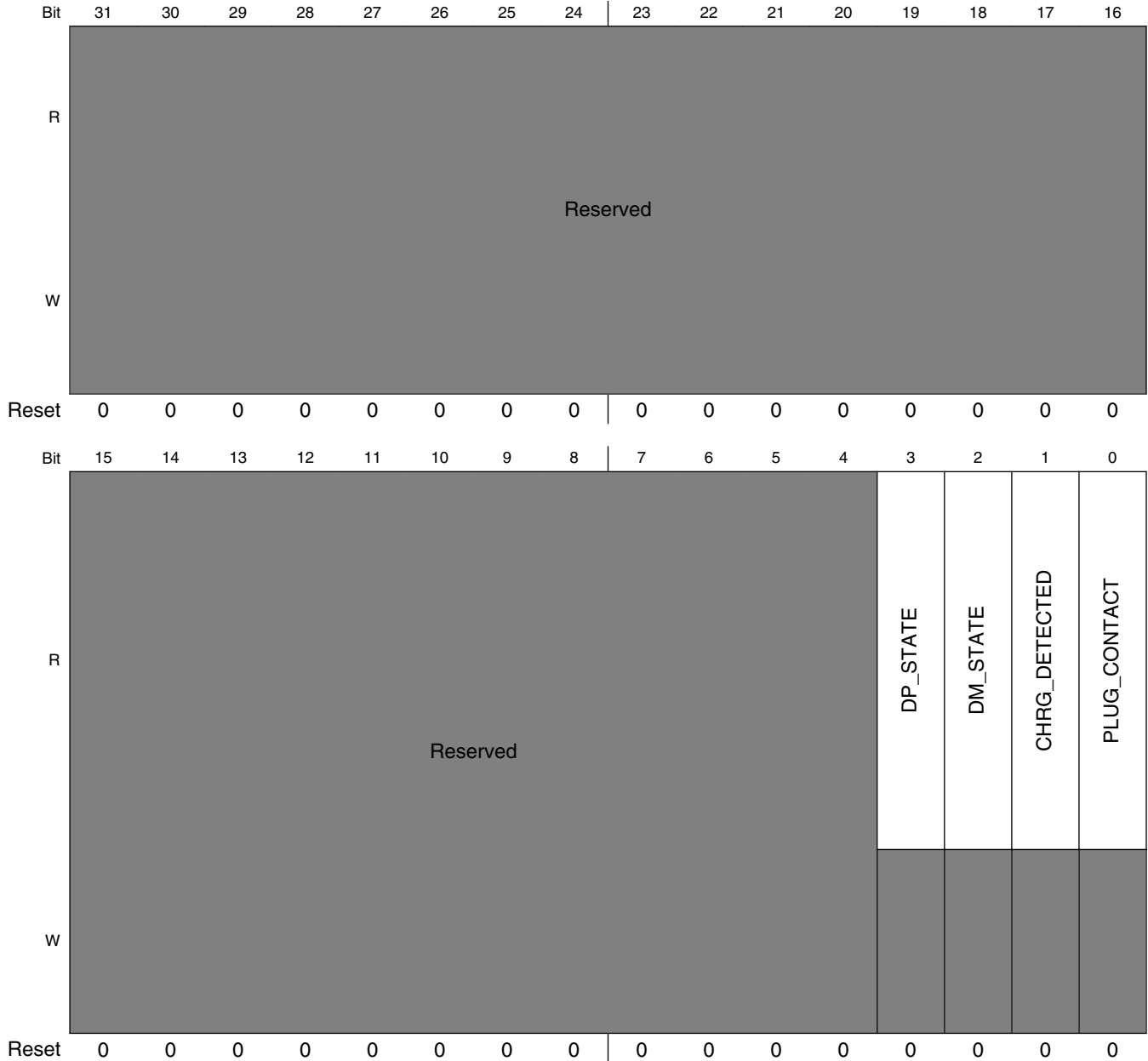

USB_ANALOG_USB1_CHRG_DETECT_STAT field descriptions

Field	Description
31–4 -	This field is reserved. Reserved.
3 DP_STATE	DP line state output of the charger detector.
2 DM_STATE	DM line state output of the charger detector.
1 CHRG_DETECTED	State of charger detection. This bit is a read only version of the state of the analog signal. 0 CHARGER_NOT_PRESENT — The USB port is not connected to a charger. 1 CHARGER_PRESENT — A charger (either a dedicated charger or a host charger) is connected to the USB port.
0 PLUG_CONTACT	State of the USB plug contact detector. 0 NO_CONTACT — The USB plug has not made contact. 1 GOOD_CONTACT — The USB plug has made good contact.

57.4.5 USB Misc Register (USB_ANALOG_USB1_MISCN)

This register defines controls for USB.

Address: 20C_8000h base + 1F0h offset + (4d × i), where i=0d to 3d

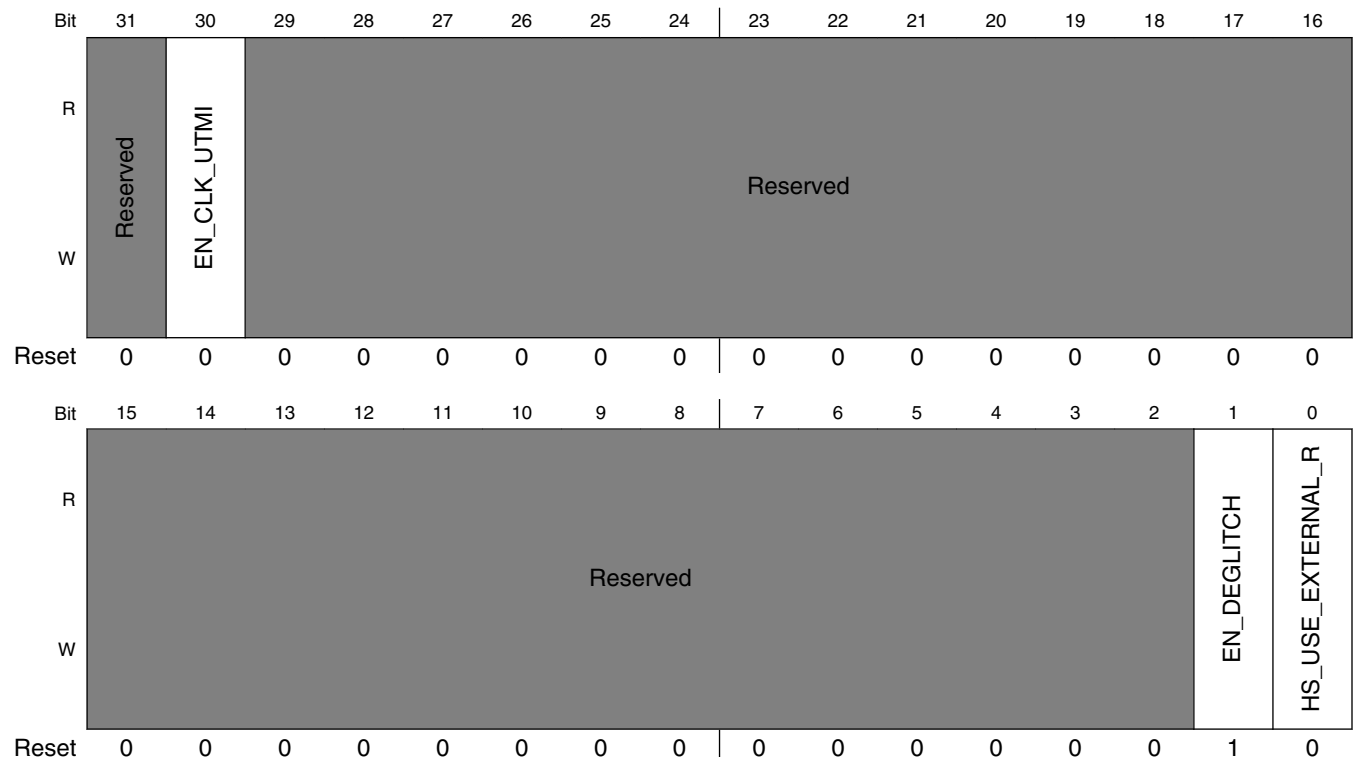

USB_ANALOG_USB1_MISC_n field descriptions

Field	Description
31 -	This field is reserved. Reserved.
30 EN_CLK_UTMI	Enables the clk to the UTMI block.
29–2 -	This field is reserved. Reserved.
1 EN_DEGLITCH	Enable the deglitching circuit of the USB PLL output.
0 HS_USE_externAl_R	Use external resistor to generate the current bias for the high speed transmitter. This bit should not be changed unless recommended by NXP.

57.4.6 USB VBUS Detect Register (USB_ANALOG_USB2_VBUS_DETECT_n)

This register defines controls for USB VBUS detect.

Address: 20C_8000h base + 200h offset + (4d × i), where i=0d to 3d

Bit	31	30	29	28	27	26	25	24	23	22	21	20	19	18	17	16
R	Reserved				CHARGE_VBUS	DISCHARGE_VBUS	Reserved						VBUSVALID_PWRUP_CMPS	Reserved		
W	Reserved				CHARGE_VBUS	DISCHARGE_VBUS	Reserved						VBUSVALID_PWRUP_CMPS	Reserved		
Reset	0	0	0	0	0	0	0	0	0	0	0	1	0	0	0	0
Bit	15	14	13	12	11	10	9	8	7	6	5	4	3	2	1	0
R	Reserved													VBUSVALID_THRESH		
W	Reserved													VBUSVALID_THRESH		
Reset	0	0	0	0	0	0	0	0	0	0	0	0	0	1	0	0

USB_ANALOG_USB2_VBUS_DETECT_n field descriptions

Field	Description
31–28 -	This field is reserved. Reserved.

Table continues on the next page...

USB_ANALOG_USB2_VBUS_DETECT n field descriptions (continued)

Field	Description
27 CHARGE_VBUS	USB OTG charge VBUS.
26 DISCHARGE_VBUS	USB OTG discharge VBUS.
25–21 -	This field is reserved. Reserved.
20 VBUSVALID_PWRUP_CMPS	Powers up comparators for vbus_valid detector.
19–3 -	This field is reserved. Reserved.
VBUSVALID_THRESH	<p>Set the threshold for the VBUSVALID comparator. This comparator is the most accurate method to determine the presence of 5v, and includes hysteresis to minimize the need for software debounce of the detection. This comparator has ~50mV of hysteresis to prevent chattering at the comparator trip point.</p> <p>000 4V0 — 4.0V 001 4V1 — 4.1V 010 4V2 — 4.2V 011 4V3 — 4.3V 100 4V4 — 4.4V (default) 101 4V5 — 4.5V 110 4V6 — 4.6V 111 4V7 — 4.7V</p>

57.4.7 USB Charger Detect Register (USB_ANALOG_USB2_CHRG_DETECT n)

This register defines controls for USB charger detect.

Address: 20C_8000h base + 210h offset + (4d × i), where i=0d to 3d

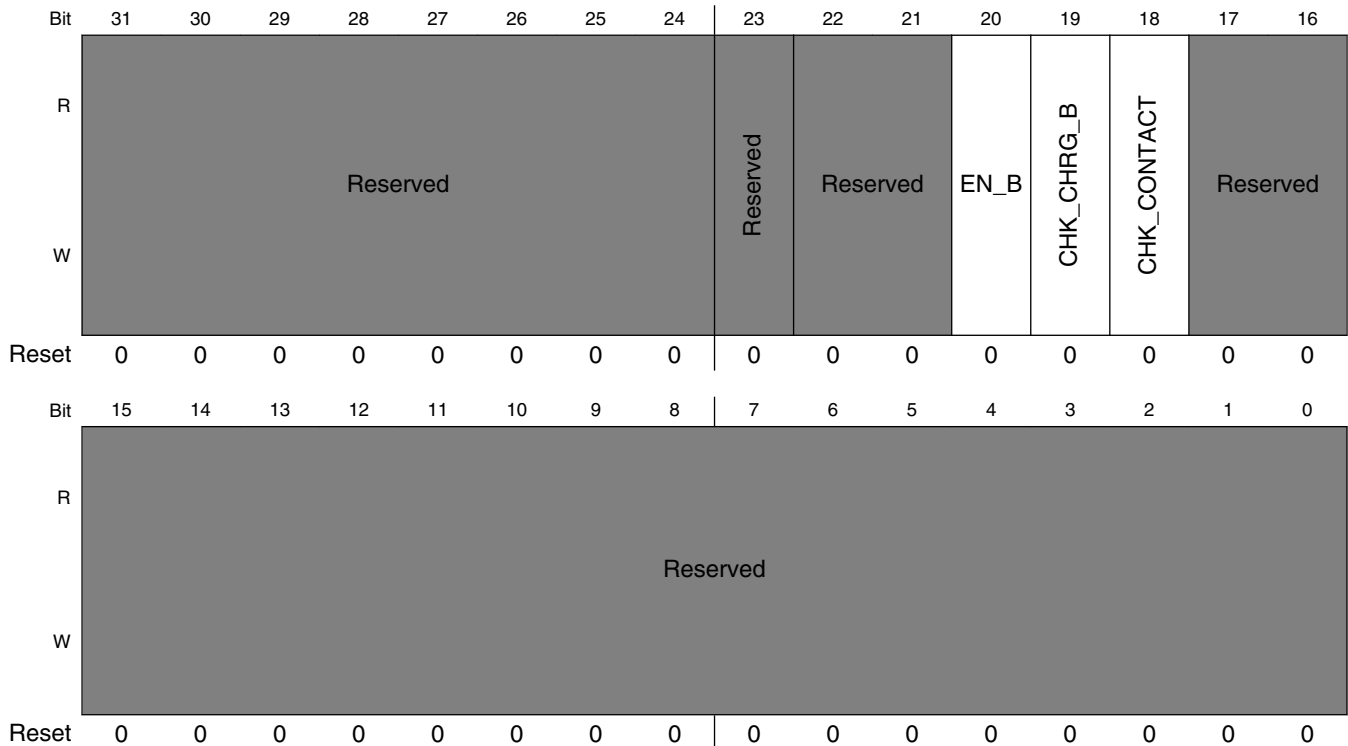

USB_ANALOG_USB2_CHRG_DETECT n field descriptions

Field	Description
31–24 -	This field is reserved. Reserved.
23 -	This field is reserved. Reserved.
22–21 -	This field is reserved. Reserved.
20 EN_B	Control the charger detector. 0 ENABLE — Enable the charger detector. 1 DISABLE — Disable the charger detector.
19 CHK_CHRG_B	Check the charger connection

Table continues on the next page...

USB_ANALOG_USB2_CHRG_DETECT n field descriptions (continued)

Field	Description
	0 CHECK — Check whether a charger (either a dedicated charger or a host charger) is connected to USB port. 1 NO_CHECK — Do not check whether a charger is connected to the USB port.
18 CHK_CONTACT	Check the contact of USB plug 0 NO_CHECK — Do not check the contact of USB plug. 1 CHECK — Check whether the USB plug has been in contact with each other
-	This field is reserved. Reserved.

57.4.8 USB VBUS Detect Status Register (USB_ANALOG_USB2_VBUS_DETECT_STAT)

This register defines fields for USB VBUS Detect status.

Address: 20C_8000h base + 220h offset = 20C_8220h

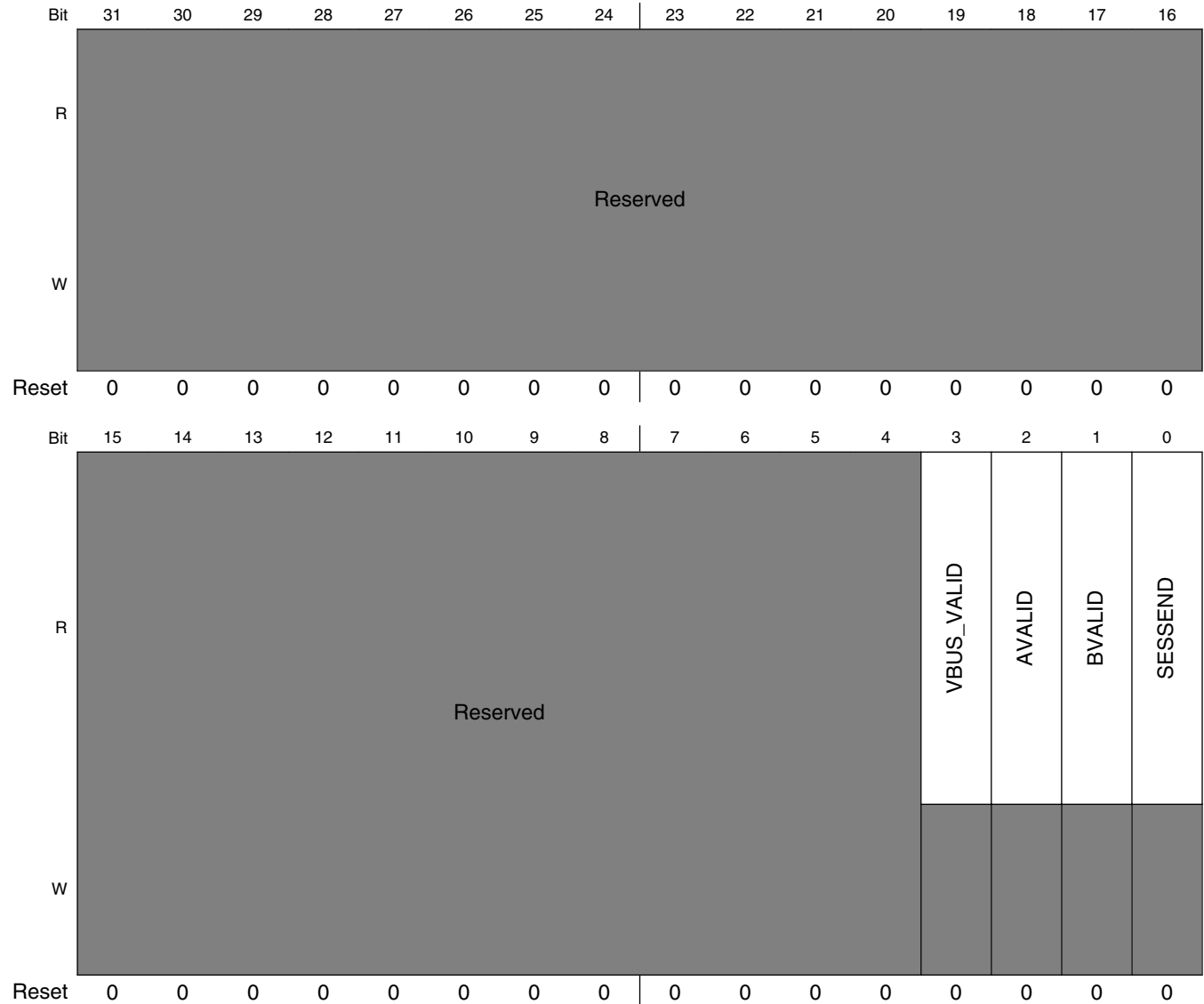

USB_ANALOG_USB2_VBUS_DETECT_STAT field descriptions

Field	Description
31–4 -	This field is reserved. Reserved.

Table continues on the next page...

USB_ANALOG_USB2_VBUS_DETECT_STAT field descriptions (continued)

Field	Description
3 VBUS_VALID	VBus valid for USB OTG. This bit is a read only version of the state of the analog signal. It can not be overwritten by software.
2 AVALID	Indicates VBus is valid for a A-peripheral. This bit is a read only version of the state of the analog signal. It can not be overwritten by software.
1 BVALID	Indicates VBus is valid for a B-peripheral. This bit is a read only version of the state of the analog signal. It can not be overwritten by software.
0 SESSEND	<p>Session End for USB OTG. This bit is a read only version of the state of the analog signal. It can not be overwritten by software like the SESSEND bit below.</p> <p>NOTE: This bit's default value depends on whether VDD5V is present, 0 if VDD5V is present, 1 if VDD5V is not present.</p>

57.4.9 USB Charger Detect Status Register (USB_ANALOG_USB2_CHRG_DETECT_STAT)

This register defines fields for USB charger detect status.

Address: 20C_8000h base + 230h offset = 20C_8230h

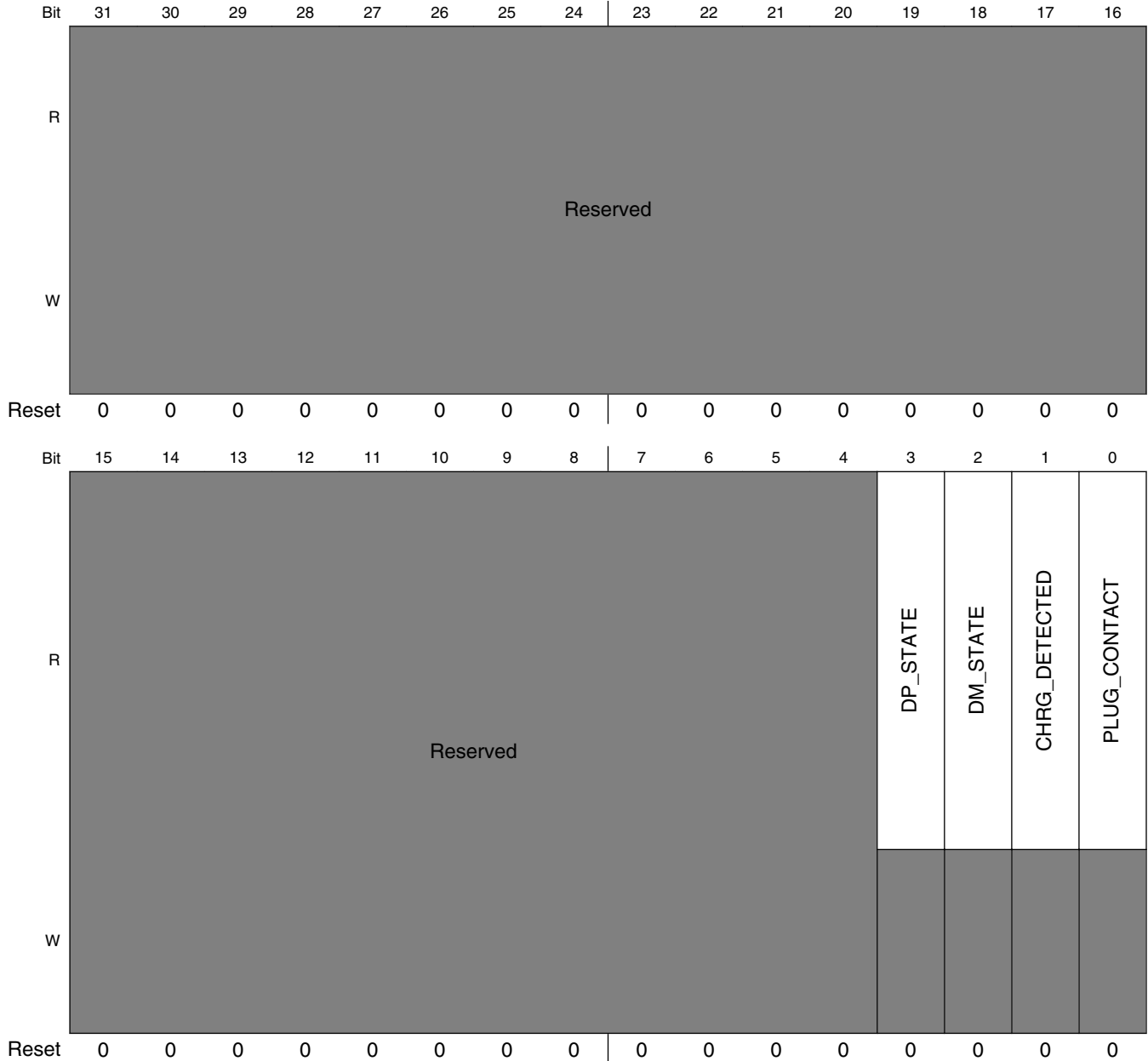

USB_ANALOG_USB2_CHRG_DETECT_STAT field descriptions

Field	Description
31–4 -	This field is reserved. Reserved.
3 DP_STATE	DP line state output of the charger detector.
2 DM_STATE	DM line state output of the charger detector.
1 CHRG_DETECTED	State of charger detection. This bit is a read only version of the state of the analog signal. 0 CHARGER_NOT_PRESENT — The USB port is not connected to a charger. 1 CHARGER_PRESENT — A charger (either a dedicated charger or a host charger) is connected to the USB port.
0 PLUG_CONTACT	State of the USB plug contact detector. 0 NO_CONTACT — The USB plug has not made contact. 1 GOOD_CONTACT — The USB plug has made good contact.

57.4.10 USB Misc Register (USB_ANALOG_USB2_MISCn)

This register defines controls for USB.

Address: 20C_8000h base + 250h offset + (4d × i), where i=0d to 3d

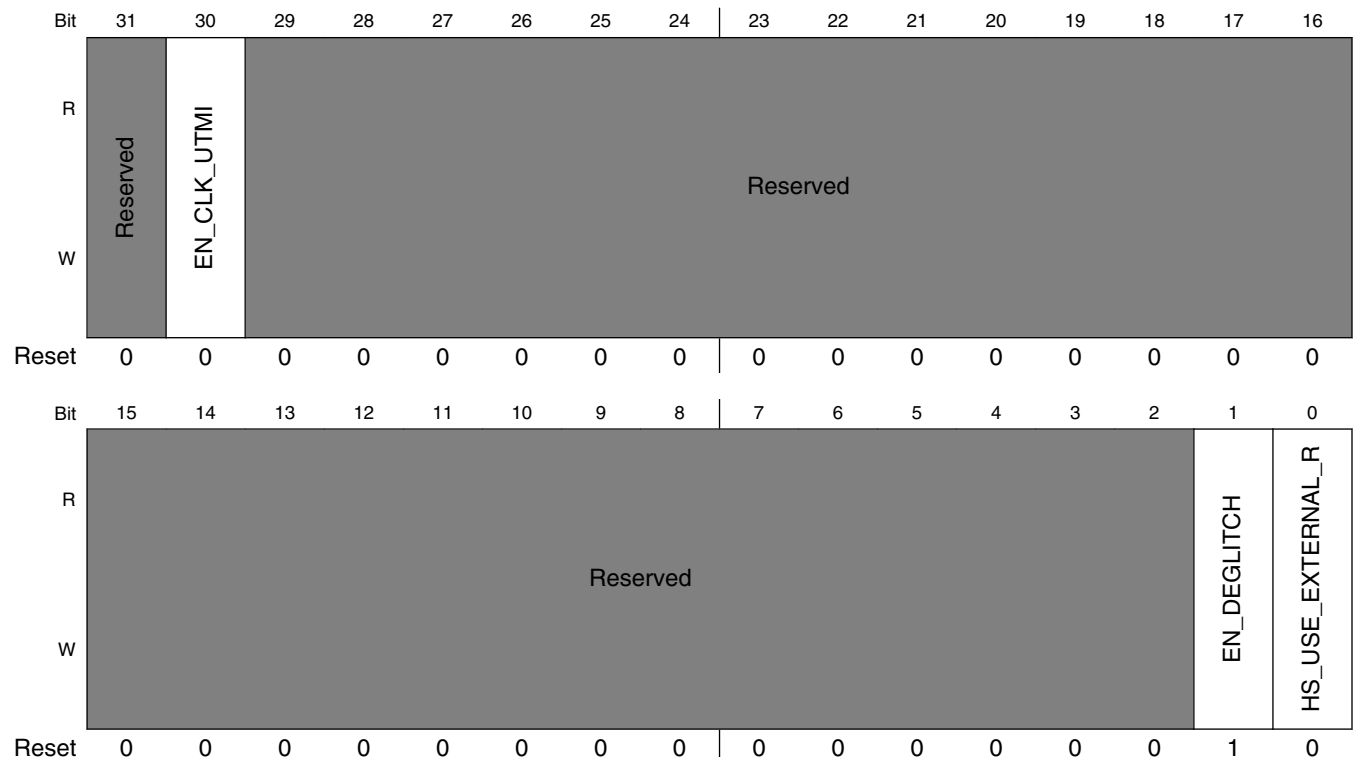

USB_ANALOG_USB2_MISC_n field descriptions

Field	Description
31 -	This field is reserved. Reserved.
30 EN_CLK_UTMI	Enables the clk to the UTMI block.
29–2 -	This field is reserved. Reserved.
1 EN_DEGLITCH	Enable the deglitching circuit of the USB PLL output.
0 HS_USE_EXTERNAL_R	Use external resistor to generate the current bias for the high speed transmitter. This bit should not be changed unless recommended by NXP.

57.4.11 Chip Silicon Version (USB_ANALOG_DIGPROG)

The DIGPROG register returns the digital program ID for the silicon.

Address: 20C_8000h base + 260h offset = 20C_8260h

Bit	31	30	29	28	27	26	25	24	23	22	21	20	19	18	17	16	15	14	13	12	11	10	9	8	7	6	5	4	3	2	1	0	
R	SILICON_REVISION																																
W	0																																
Reset	0	0	0	0	0	0	0	0	0	0	1	1	0	0	1	0	1	0	0	0	0	0	0	0	0	0	0	0	0	0	0	0	0

USB_ANALOG_DIGPROG field descriptions

Field	Description
SILICON_REVISION	0x00650000 Silicon revision 1.0 0x00650001 Silicon revision 1.1

Chapter 58

Ultra Secured Digital Host Controller (uSDHC)

58.1 Overview

The Ultra Secured Digital Host Controller (uSDHC) provides the interface between the host system and the SD/SDIO/MMC cards, as depicted in [Figure 58-1](#).

The uSDHC acts as a bridge, passing host bus transactions to the SD/SDIO/MMC cards by sending commands and performing data accesses to/from the cards.

It handles the SD/SDIO/MMC protocols at the transmission level.

The following are brief descriptions of the cards supported by the uSDHC:

The Multi Media Card (MMC) is a universal low cost data storage and communication media designed to cover a wide array of applications including mobile video and gaming. Previous MMC cards were based on a 7-pin serial bus with a single data pin, while the new high speed MMC communication is based on an advanced 11-pin serial bus designed to operate in the low voltage range.

The Secure Digital Card (SD) is an evolution of the old MMC technology. It is specifically designed to meet the security, capacity, performance, and environment requirements inherent in newly-emerging audio and video consumer electronic devices. The physical form factor, pin assignment and data transfer protocol are forward-compatible with the old MMC (with some additions).

Under the SD protocol, it can be categorized into Memory card, I/O card and Combo card, which has both memory and I/O functions. The memory card invokes a copyright protection mechanism that complies with the security of the SDMI standard. The I/O card, which is also known as SDIO card, provides high-speed data I/O with low power consumption for mobile electronic devices. For the sake of simplicity, the following figure does not show cards with reduced size or mini cards.

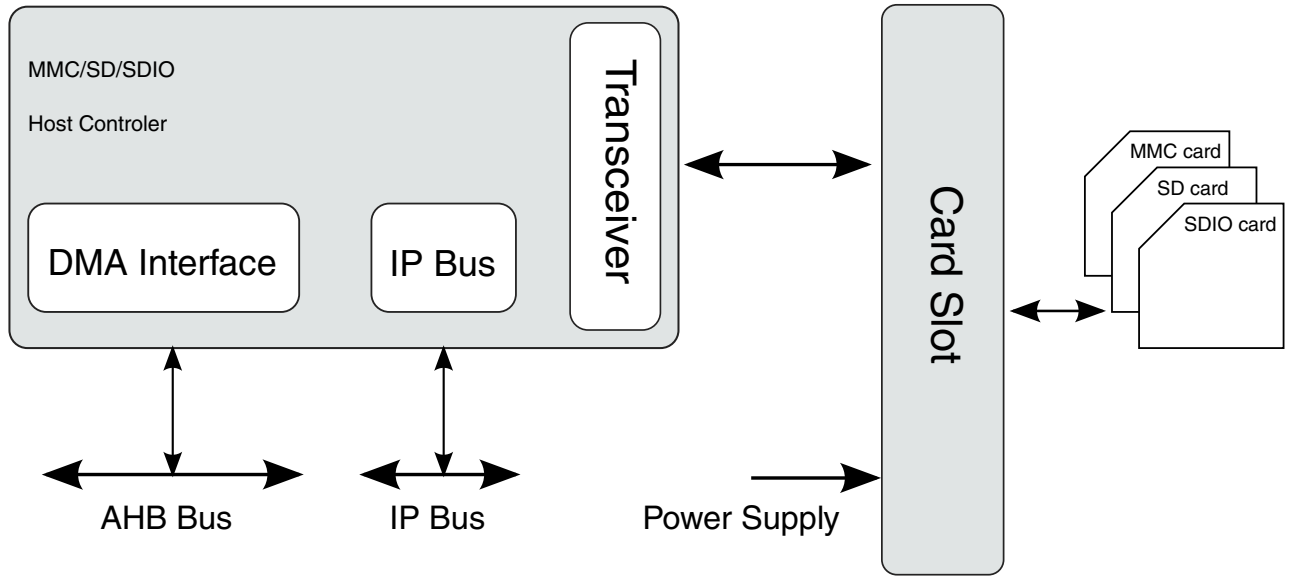

Figure 58-1. System Connection of the uSDHC

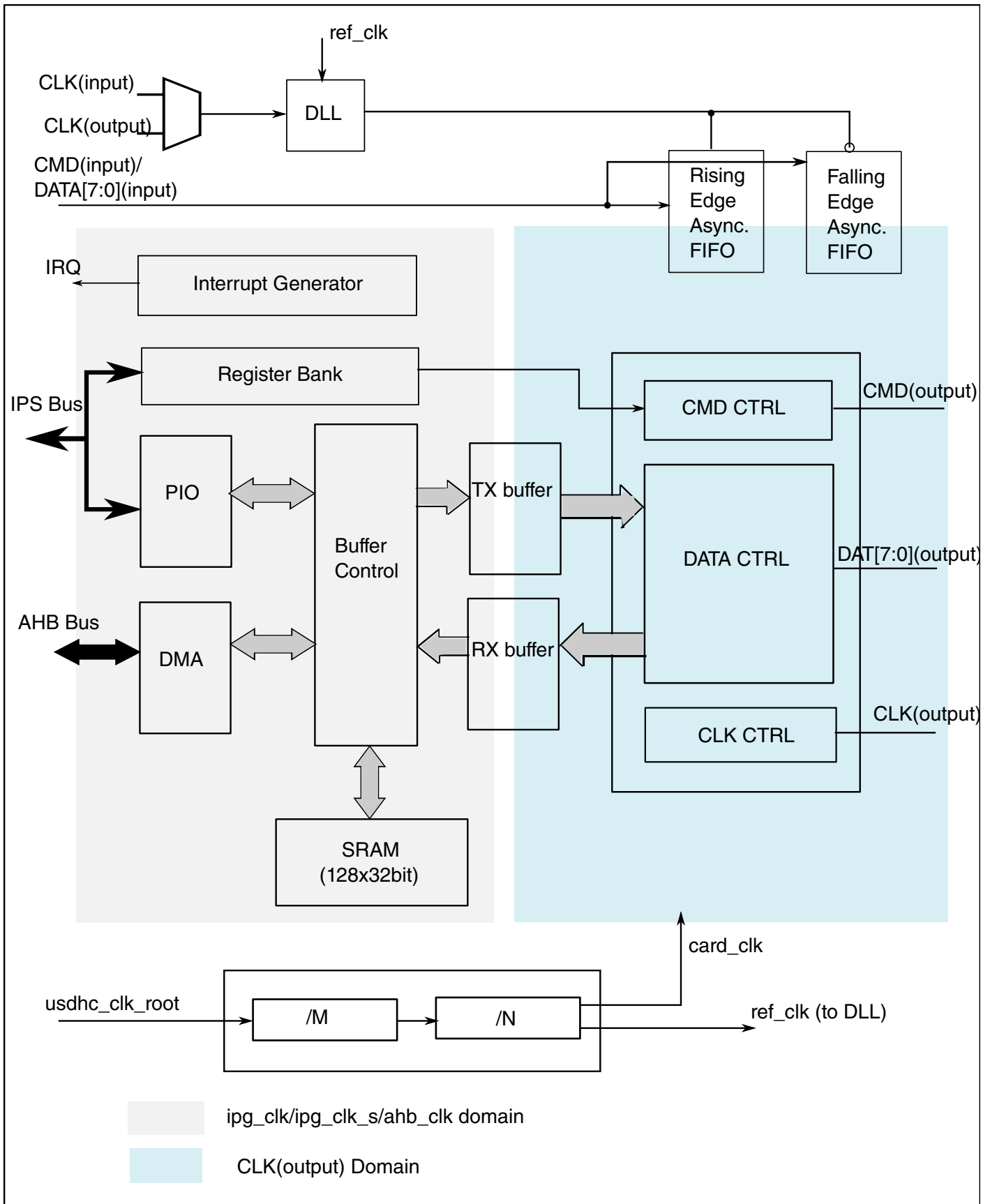

Figure 58-2. ultra Secure Digital Host Controller Block Diagram

58.1.1 Features

The features of the uSDHC module include the following:

- Conforms to the SD Host Controller Standard Specification version 3.0
- Compatible with the MMC System Specification version 4.2/4.3/4.4/4.41/4.5
- Compatible with the SD Memory Card Specification version 3.0 and supports the Extended Capacity SD Memory Card
- Compatible with the SDIO Card Specification version 3.0
- Designed to work with SD Memory, miniSD Memory, SDIO, miniSDIO, SD Combo, MMC, MMC plus, and MMC RS cards
- Card bus clock frequency up to 208 MHz
- Supports 1-bit / 4-bit SD and SDIO modes, 1-bit / 4-bit / 8-bit MMC modes
 - Up to 832 Mbps of data transfer for SDIO cards using 4 parallel data lines in SDR(Single Data Rate) mode
 - Up to 400 Mbps of data transfer for SDIO card using 4 parallel data lines in DDR(Dual Data Rate) mode
 - Up to 832 Mbps of data transfer for SDXC cards using 4 parallel data lines in SDR(Single Data Rate) mode
 - Up to 400 Mbps of data transfer for SDXC card using 4 parallel data lines in DDR(Dual Data Rate) mode
 - Up to 416 Mbps of data transfer for MMC cards using 8 parallel data lines in SDR(Single Data Rate) mode
 - Up to 832 Mbps of data transfer for MMC cards using 8 parallel data lines in DDR(Dual Data Rate) mode
- Supports single block/multi-block read and write
- Supports block sizes of 1 ~ 4096 bytes
- Supports the write protection switch for write operations
- Supports both synchronous and asynchronous abort
- Supports pause during the data transfer at block gap
- Supports SDIO Read Wait and Suspend Resume operations
- Supports Auto CMD12 for multi-block transfer
- Host can initiate non-data transfer command while data transfer is in progress
- Allows cards to interrupt the host in 1-bit and 4-bit SDIO modes, also supports interrupt period
- Embodies a fully configurable 128x32-bit FIFO for read/write data
- Supports internal and external DMA capabilities
- Support voltage selection by configuring vendor specific register bit
- Supports Advanced DMA to perform linked memory access

58.1.2 Modes and Operations

58.1.2.1 Data Transfer Modes

The uSDHC can select the following modes for data transfer:

- SD 1-bit
- SD 4-bit
- MMC 1-bit
- MMC 4-bit
- MMC 8-bit
- Identification Mode (up to 400 kHz)
- MMC full speed mode (up to 26 MHz)
- MMC high speed mode (up to 52 MHz)
- MMC HS200 mode (up to 200 MHz)
- MMC DDR mode (52 MHz both edges)
- SD/SDIO full speed mode (up to 25 MHz)
- SD/SDIO high speed mode (up to 50 MHz)
- SD/SDIO UHS-I mode (up to 208 MHz in SDR mode, up to 50 MHz in DDR mode)

58.2 External Signals

The following table describes the external signals of USDHC:

Table 58-1. USDHC External Signals

Signal	Description	Pad	Mode	Direction
SD1_CD_B	Card detection pin. If not used (for the embedded memory), tie low to indicate there is a card attached.	CSI_DATA05	ALT8	I
		GPIO1_IO03	ALT4	
		UART1_RTS_B	ALT2	
SD1_CLK	Clock for MMC/SD/SDIO card	SD1_CLK	ALT0	O
SD1_CMD	CMD line connect to card	SD1_CMD	ALT0	IO
SD1_DATA0	DATA0 line in all modes. Also used to detect busy state.	SD1_DATA0	ALT0	IO
SD1_DATA1	DATA1 line in 4/8-bit mode. Also used to detect interrupt in 1/4-bit mode.	SD1_DATA1	ALT0	IO
SD1_DATA2	DATA2 line or Read Wait in 4-bit mode. Read Wait in 1-bit mode.	SD1_DATA2	ALT0	IO

Table continues on the next page...

Table 58-1. USDHC External Signals (continued)

Signal	Description	Pad	Mode	Direction
SD1_DATA3	DATA3 line in 4/8-bit mode or configured as card detection pin May be configured as card detection pin in 1-bit mode	SD1_DATA3	ALT0	IO
SD1_DATA4	DATA4 line in 8-bit mode, not used in other modes	NAND_READY_B	ALT1	IO
SD1_DATA5		NAND_CE0_B	ALT1	IO
SD1_DATA6		NAND_CE1_B	ALT1	IO
SD1_DATA7		NAND_CLE	ALT1	IO
SD1_LCTL	LED control used to drive an external LED Active high Fully controlled by the driver Optional output	ENET1_RX_DATA0	ALT8	O
SD1_RESET_B	Card hardware reset signal, active LOW	CSI_DATA06	ALT8	O
		GPIO1_IO04	ALT4	
		GPIO1_IO09	ALT6	
		NAND_WP_B	ALT1	
SD1_TESTER_TRIGGER	-	UART1_RX_DATA	ALT7	IO
SD1_VSELECT	IO power voltage selection signal	CSI_DATA07	ALT8	O
		ENET1_RX_EN	ALT8	
		GPIO1_IO05	ALT4	
SD1_WP	Card write protect detect If not used(for the embedded memory), tie low to indicate it's not write protected.	CSI_DATA04	ALT8	I
		GPIO1_IO02	ALT4	
		UART1_CTS_B	ALT2	
SD2_CD_B	Card detection pin If not used(for the embedded memory),tie low to indicate there is a card attached.	CSI_MCLK	ALT1	I
		GPIO1_IO07	ALT4	
		UART1_RTS_B	ALT8	
SD2_CLK	Clock for MMC/SD/SDIO card	CSI_VSYNC	ALT1	O
		LCD_DATA19	ALT8	
		NAND_RE_B	ALT1	
SD2_CMD	CMD line connect to card	CSI_HSYNC	ALT1	IO
		LCD_DATA18	ALT8	
		NAND_WE_B	ALT1	
SD2_DATA0	DATA0 line in all modes Also used to detect busy state	CSI_DATA00	ALT1	IO
		LCD_DATA20	ALT8	
		NAND_DATA00	ALT1	
SD2_DATA1	DATA1 line in 4/8-bit mode Also used to detect interrupt in 1/4-bit mode	CSI_DATA01	ALT1	IO
		LCD_DATA21	ALT8	
		NAND_DATA01	ALT1	
SD2_DATA2	DATA2 line or Read Wait in 4-bit mode Read Wait in 1-bit mode	CSI_DATA02	ALT1	IO
		LCD_DATA22	ALT8	

Table continues on the next page...

Table 58-1. USDHC External Signals (continued)

Signal	Description	Pad	Mode	Direction
		NAND_DATA02	ALT1	
SD2_DATA3	DATA3 line in 4/8-bit mode or configured as card detection pin May be configured as card detection pin in 1-bit mode	CSI_DATA03	ALT1	IO
		LCD_DATA23	ALT8	
		NAND_DATA03	ALT1	
SD2_DATA4	DATA4 line in 8-bit mode, not used in other modes	CSI_DATA04	ALT1	IO
		LCD_DATA14	ALT8	
		NAND_DATA04	ALT1	
SD2_DATA5		CSI_DATA05	ALT1	IO
		LCD_DATA15	ALT8	
		NAND_DATA05	ALT1	
SD2_DATA6		CSI_DATA06	ALT1	IO
		LCD_DATA16	ALT8	
		NAND_DATA06	ALT1	
SD2_DATA7		CSI_DATA07	ALT1	IO
		LCD_DATA17	ALT8	
		NAND_DATA07	ALT1	
SD2_LCTL	LED control used to drive an external LED Active high Fully controlled by the driver Optional output	ENET1_RX_DATA1	ALT8	IO
SD2_RESET_B	Card hardware reset signal, active LOW	GPIO1_IO09	ALT4	O
		LCD_DATA13	ALT8	
		NAND_ALE	ALT1	
SD2_TESTER_TRIGGER	-	UART1_CTS_B	ALT7	IO
SD2_VSELECT	IO power voltage selection signal	ENET1_TX_DATA0	ALT8	IO
		GPIO1_IO08	ALT4	
SD2_WP	Card write protect detect If not used(for the embedded memory), tie low to indicate it's not write protected.	CSI_PIXCLK	ALT1	I
		GPIO1_IO06	ALT4	
		UART1_CTS_B	ALT8	

58.2.1 Signals Overview

The uSDHC has 14 associated I/O signals.

- The CLK is an internally generated clock used to drive the MMC, SD, SDIO cards.
- The CMD I/O is used to send commands and receive responses to and from the card. Eight data lines (DAT7~DAT0) are used to perform data transfers between the uSDHC and the card.

Clocks

- The CD and WP are card detection and write protection signals directly routed from the socket. These two signals are active low (0). A low on CD# means that a card is inserted, and a high on WP means that the write protect switch is active.
- LCTL is an output signal used to drive an external LED to indicate that the SD interface is busy.
- RST is an output signal used to reset the MMC card.
- VSELECT is an output signal used to change the voltage of the external power supplier.

CD, WP, LCTL, RST and VSELECT are all optional for system implementation. If the uSDHC needs to support a 4-bit data transfer, DAT7~DAT4 can also be optional and tied to high.

58.3 Clocks

The table found here describes the clock sources for uSDHC.

Please see [Clock Controller Module \(CCM\)](#) for clock setting, configuration and gating information.

Table 58-2. uSDHC Clocks

Clock name	Clock Root	Description
hclk	ahb_clk_root	AHB bus clock
ipg_clk	ipg_clk_root	Peripheral clock
ipg_clk_perclk	usdhc_clk_root	Base clock
ipg_clk_s	ipg_clk_root	Peripheral access clock for register accesses

58.4 Functional Description

The following sections provide a brief functional description of the major system blocks, including the Data Buffer, DMA AHB interface, register bank as well as IP Bus interface, dual-port memory wrapper, data/command controller, clock and reset manager, and clock generator.

58.4.1 Data Buffer

The uSDHC uses one configurable data buffer to transfer data between the system bus (IP Bus or AHB Bus) and the SD card in an optimized manner, maximizing throughput between the two clock domains (IP peripheral clock and the master clock).

The buffer is used as temporary storage for data being transferred between the host system and the card. The watermark levels for read and write are both configurable and can be from 1 to 128 words. The burst lengths for read and write are also configurable and can be from 1 to 31 words.

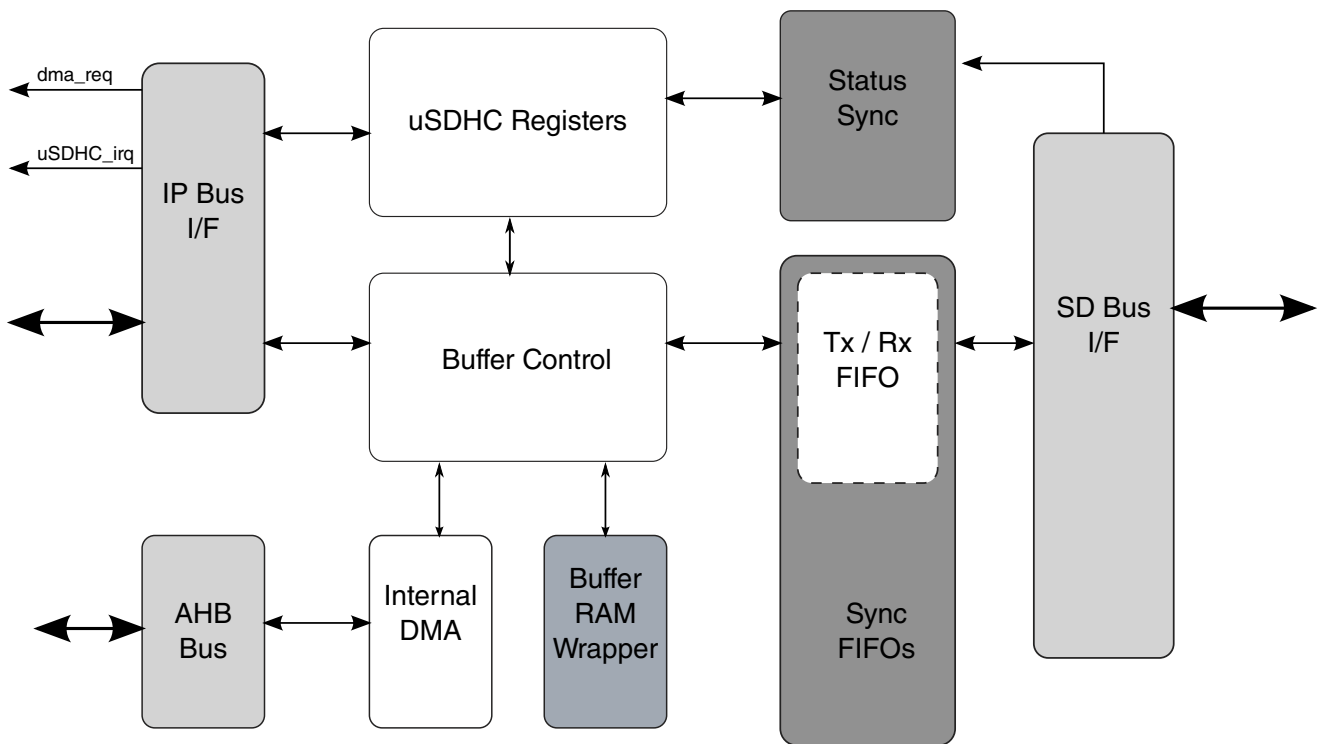

Figure 58-3. uSDHC Buffer Scheme

There are 3 transfer modes to access the data buffer:

- CPU polling mode:
 - For a host read operation, when the number of words received in the buffer meets or exceeds the `RD_WML` watermark value, by polling the `BRR` bit, the Host Driver can read the Buffer Data Port register to fetch the amount of words set in the `RD_WML` register from the buffer. The write operation is similar.
- External DMA mode:
 - For a read operation, when there are more words received in the buffer than the amount set in the `RD_WML` register, a DMA request is sent out to inform the external DMA to fetch the data. The request will be immediately de-asserted when there is an access on the Buffer Data Port register. If the number of words

Functional Description

in the buffer after the current burst meets or exceeds RD_WML value, the DMA request is asserted again. For instance, if there are twice as many words in the buffer as there are in the RD_WML value, there are two successive DMA requests with only one cycle of de-assertion between. The write operation is similar. Note the accesses CPU polling mode and external DMA mode both use the IP bus, and if the external DMA is enabled, in both modes an external DMA request is sent when the buffer is ready.

- Internal DMA mode (includes simple and advanced DMA accesses):
 - The internal DMA access, either by simple or advanced DMA, is over the AHB bus. For internal DMA access mode, the external DMA request will never be sent out.

For a read operation, when there are more words in the buffer than the amount set in the RD_WML register, the internal DMA starts fetching data over the AHB bus. Except for INCR4 and INCR8, the burst type is always INCR mode and the burst length depends on the shortest of following factors:

- Burst length configured in the burst length field of the Watermark Level register
- Watermark Level boundary
- Block size boundary
- Data boundary configured in the current descriptor (if the ADMA is active)
- 1 Kbyte address boundary defined in the AHB protocol

Write operation is similar.

Sequential and contiguous access is necessary to ensure the pointer address value is correct. Random or skipped access is not possible. The byte order, by reset, is little endian mode. The actual byte order is swapped inside the buffer, according to the endian mode configured by software (see the following figures). For a host write operation, byte order is swapped after data is fetched from the buffer and ready to send to the SD Bus. For a host read operation, byte order is swapped before the data is stored in the buffer.

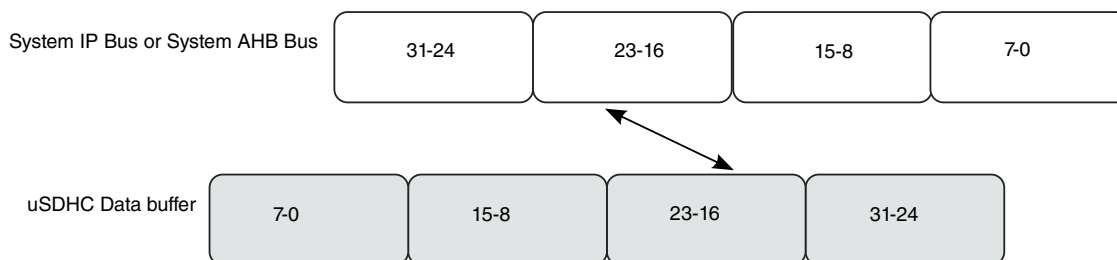

Figure 58-4. Data Swap between System Bus and uSDHC Data Buffer in Byte Little Endian Mode

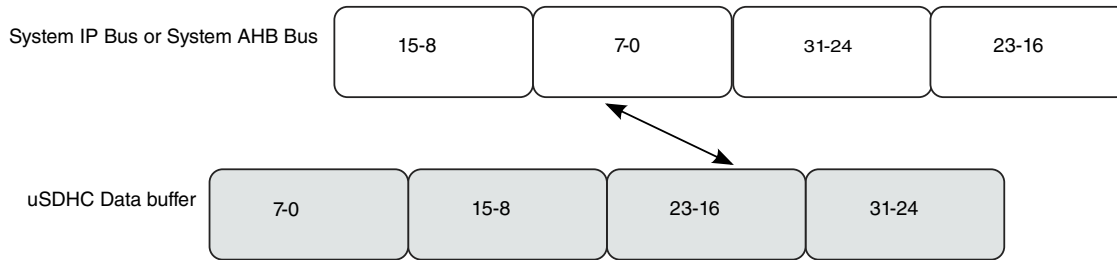

Figure 58-5. Data Swap between System Bus and uSDHC Data Buffer in Half Word Big Endian Mode

58.4.1.1 Write Operation Sequence

There are three ways to write data into the buffer when the user transfers data to the card:

- External DMA through the uSDHC DMA request signal
- Processor core polling through the BWR bit in Interrupt Status register (interrupt or polling)
- Internal DMA

When the internal DMA is not used, (the DMAEN bit in the Transfer Type register is not set when the command is sent), the uSDHC asserts a DMA request when the amount of buffer space exceeds the value set in the WR_WML register, and is ready for receiving new data. At the same time, the uSDHC sets the BWR bit. The buffer write ready interrupt will be generated if it is enabled by software.

When internal DMA is used, the uSDHC will not inform the system before all the required number of bytes are transferred (if no error was encountered). When an error occurs during the data transfer, the uSDHC will abort the data transfer and abandon the current block. The Host Driver should read the contents of the DMA System Address register to obtain the starting address of the abandoned data block. If the current data transfer is in multi-block mode, the uSDHC will not automatically send CMD12, even though the AC12EN bit in the Transfer Type register is set. The Host Driver sends CMD12 in this scenario and re-starts the write operation from that address. It is recommended that a Software Reset for Data be applied before the transfer is re-started.

The uSDHC will not start data transmission until the number of words set in the WR_WML register can be held in the buffer. If the buffer is empty and the Host System does not write data in time, the uSDHC will stop the CLK to avoid the data buffer under-run situation.

58.4.1.2 Read Operation Sequence

There are three ways to read data from the buffer when the user transfers data to the card:

- External DMA through the uSDHC DMA request signal
- Processor core polling through the BRR bit in Interrupt Status register (interrupt or polling)
- Internal DMA

When internal DMA is not used (DMAEN bit in Transfer Type register is not set when the command is sent), the uSDHC asserts a DMA request when the amount of data exceeds the value set in the RD_WML register, that is available and ready for system fetching data. At the same time, the uSDHC sets the BRR bit. The buffer read ready interrupt will be generated if it is enabled by software.

When internal DMA is used, the uSDHC will not inform the system before all the required number of bytes are transferred (if no error was encountered). When an error occurs during the data transfer, the uSDHC will abort the data transfer and abandon the current block. The Host Driver should read the content of the DMA System Address register to get the starting address of the abandoned data block. If the current data transfer is in multi-block mode, the uSDHC will not automatically send CMD12, even though the AC12EN bit in the Transfer Type register is set. The Host Driver sends CMD12 in this scenario and re-starts the read operation from that address. It is recommended that a Software Reset for Data be applied before the transfer is re-started.

For any write transfer mode, the uSDHC will not start data transmission until the number of words set in the RD_WML register are in the buffer. If the buffer is full and the Host System does not read data in time, the uSDHC will stop the CLK to avoid the data buffer over-run situation.

58.4.1.3 Data Buffer and Block Size

The user needs to know the buffer size for the buffer operation during a data transfer to utilize it in the most optimized way. In the uSDHC, the only data buffer can hold up to 128 words (32-bit) and the watermark levels for write and read can be configured accordingly.

For both read and write, the watermark level can be from 1 to 128 words. For both read and write the burst length can be from 1 to 31 words. The Host Driver may configure the value according to the system situation and requirement.

During a multi-block data transfer, the block length can be set to any value between 1 and 4096 bytes, satisfying the requirements of the external card. The only restriction is from the external card, which can be limited in size or support of a partial block access (which is not the integer times of 512 bytes).

As uSDHC treats each block individually, for block sizes which are not multiples of four (not word-aligned) stuffed bytes are required at the end of each block. For example, if the block size is 7 bytes and there are 12 blocks to write, the system side must write two times for each block. For each block the ending byte will be abandoned by uSDHC because it only sends 7 bytes to the card and picks data from the following system write, resulting in 24 beats of write access in total.

58.4.1.4 Dividing Large Data Transfer

This SDIO command CMD53 definition limits the maximum data size of data transfers according to the following formula:

Max data size = Block size x Block count

The length of a multiple block transfer needs to be in block size units. If the total data length can't be divided evenly into a multiple of the block size, then there are two ways to transfer the data which depend on the function and the card design. Option 1 is for the Host Driver to split the transaction. The remainder of the block size data is then transferred by using a single block command at the end. Option 2 is to add dummy data in the last block to fill the block size. For option 2, the card must manage the removal of the dummy data.

See the figure below for an example showing the dividing of large data transfers, assuming a kind of WLAN SDIO card that only supports a block size up to 64 bytes. Although the uSDHC supports a block size of up to 4096 bytes, the SDIO can only accept a block size less than 64 bytes, so the data must be divided (see example below).

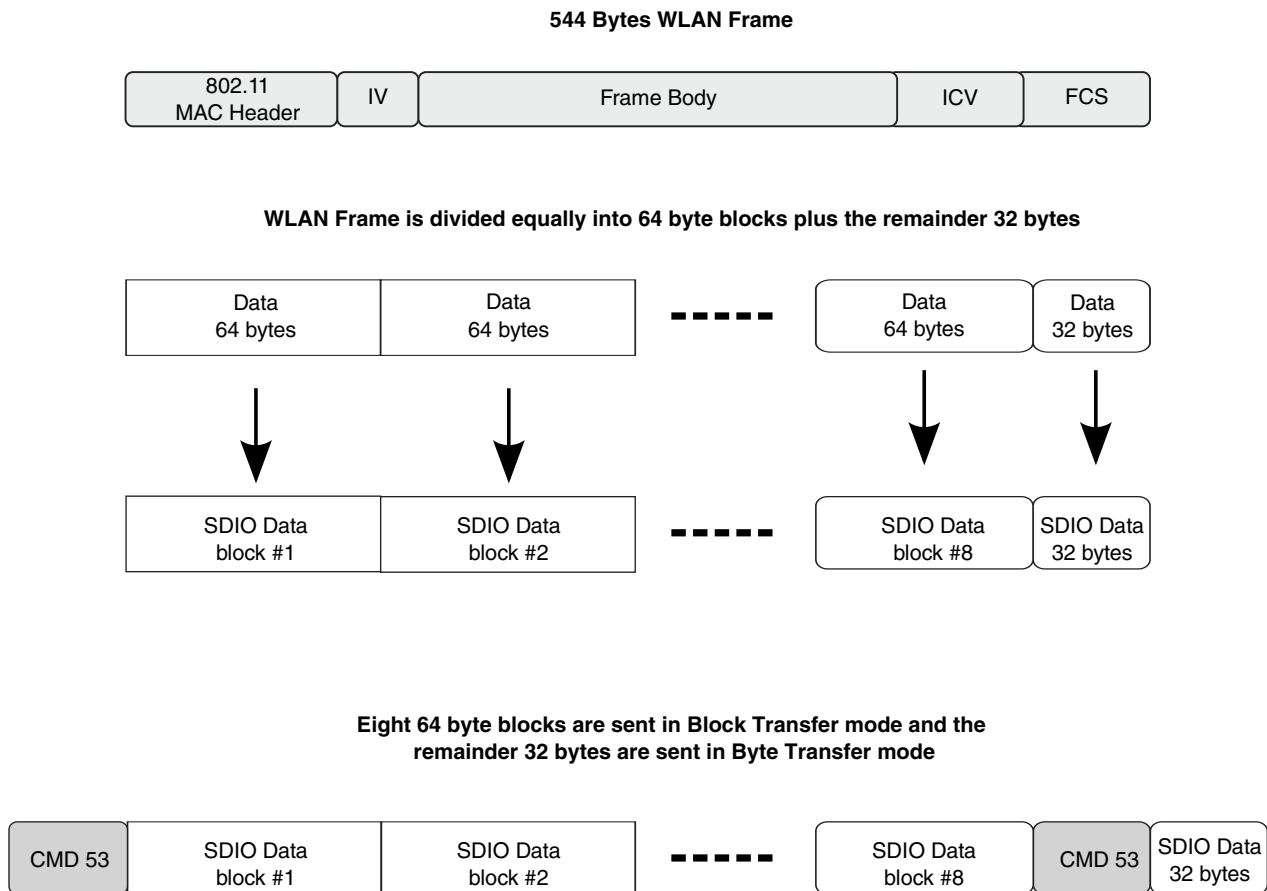

Figure 58-6. Example for Dividing Large Data Transfers

58.4.1.5 External DMA Request

When the internal DMA is not in use and external DMA is enabled, the Data Buffer will generate a DMA request to the system. During a write operation, when the number of WR_WML words can be held in the buffer free space, the signal uSDHC_dreq_b is asserted to 0, informing the Host System of a DMA write.

The BWR bit in the Interrupt Status register is also set, as long as the BWRSEN bit in the Interrupt Status Enable register is set. The DMA request is de-asserted after several accesses to the Data Port register are made while the buffer's free space can't meet the watermark condition (free space > write watermark level).

On read operation, when the number of RD_WML words are already in the buffer, the signal uSDHC_dreq_b is asserted to 0, informing the Host System for a DMA read. The BRR bit in the Interrupt Status register is also set, as long as the BRRSEN bit in the

Interrupt Status Enable register is set. The DMA request is de-asserted after several accesses to the Data Port register are made while the buffer's data can't meet the watermark condition (the number of data in buffer > read watermark level).

If the DMA burst length can't change during a data transfer for an external DMA transfer, the watermark level (read or write) must be a divisor of the block size. If it is not, transferring the block may cause buffer under-run (read operation) or over-run (write operation). For example, if the block size is 512 bytes, the watermark level of read (or write) must be a power of two between 1 and 128. For processor core polling access there is no such issue, as the last access in the block transfer can be controlled by software. The watermark level can be any value, even larger than the block size (but no greater than 128 words) because the actual number of bytes transferred by the software can be controlled and does not exceed the block size in each transfer.

The uSDHC also supports non-word aligned block size, as long as the card supports that block size. In this case, the watermark level should be set as the number of words. For example, if the block size is 31 bytes, the watermark level can be set to any number of words. For this case, the BLKSIZE bits of the Block Attribute register will be set as 1fh. For the CPU polling access, the burst length can be 1 to 128 words, without restriction. This is because the software will transfer 8 words, and the uSDHC will also set the BWR or BRR bits when the remaining data does not violate data buffer. See [DMA Burst Length](#) for more details about the dynamic watermark level of the data buffer.

For the above example, even though 8 words are transferred via the Data Port register, the uSDHC will transfer only 31 bytes over the SD Bus, as required by the BLKSIZE bits. In this data transfer, with non-word aligned block size, the endian mode should be set cautiously or invalid data will be transferred to and from the card.

58.4.2 DMA AHB Interface

The internal DMA implements a DMA engine and the AHB master. When the internal DMA is enabled, the `uSDHC_dreq_b` will not be asserted during the transfer, but the BWR and BRR bits will be set if the BWRSEN and BRRSEN bits have been set in the Interrupt Status Enable register.

See the figure below for an illustration of the DMA AHB interface block.

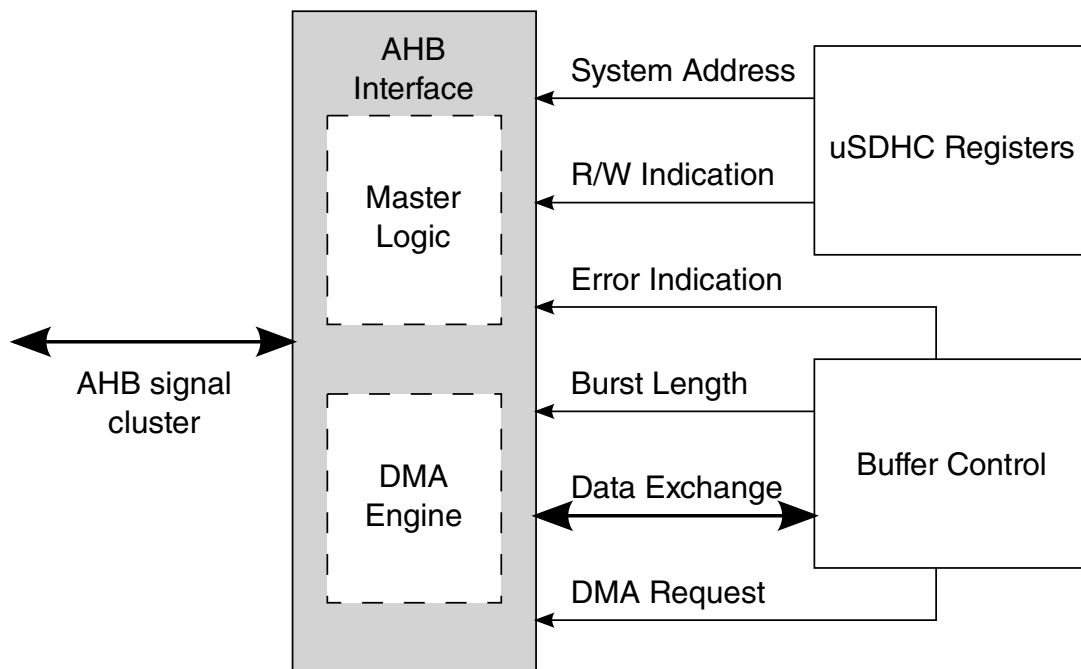

Figure 58-7. DMA AHB Interface Block

58.4.2.1 Internal DMA Request

If the watermark level requirement is met in data transfer or if the last data of current block is ready in the data buffer, and the Internal DMA is enabled, the Data Buffer block will send a DMA request to AHB interface. Meanwhile, the external DMA request signal (`uSDHC_dreq_b`) is disabled.

The delay in response from the internal DMA engine depends on the system AHB bus loading and the priority assigned to the uSDHC. The DMA engine does not respond to the request during its burst transfer, but is ready to serve as soon as the burst is over. The Data Buffer de-asserts the request if the data buffer space (for write) or bytes in data buffer is smaller than the watermark level. Upon access to the buffer by internal DMA,

the Data Buffer updates its internal buffer pointer, and when the watermark level is satisfied or the last data of current block is ready in the data buffer, another DMA request is sent.

The data transfer is in the block unit, and the subsequent watermark level is always set as the remaining number of words. For instance, for a multi block data read with each block size of 31 bytes, and the burst length set to 6 words. After the first burst transfer, if there are more than 2 words in the buffer (which might contain some data of the next block), another DMA request is sent. This is because the remaining number of words to send for the current block is $(31 - 6 * 4) / 4 = 2$. The uSDHC will read 2 words out of the buffer, with 7 valid bytes and 1 stuffed byte.

58.4.2.2 DMA Burst Length

Just like a CPU polling access, the DMA burst length for the internal DMA engine can be from 1 to 16 words. The actual burst length for the DMA depends on the lesser of the configured burst length or the remaining words of the current block.

See the example in [Internal DMA Request](#). After 6 words are read, the burst length will be 2 words, then the next burst length will be 6 words. This is because the next block starts, which is 31 bytes, more than 6 words. The Host Driver may take this variable burst length into account. It is also acceptable to configure the burst length as the divisor of the block size, so that each time the burst length will be the same.

58.4.2.3 AHB Master Interface

It is possible that the internal AHB DMA engine could fail during the data transfer. Upon detection of an AHB bus error during DMA transfer, the DMA engine stops the transfer and goes to the idle state. At that point, the internal data buffer stops receiving incoming data and sending out data. The DMAE bit in the Interrupt Status register will be generated to host CPU to report a bus error condition.

Once the DMAE interrupt is received, the software shall send a CMD12 to abort the current transfer and read the DS_ADDR bits of the DMA System Address register to get the starting address of the corrupted block. After the DMA error is fixed, the software should apply a data reset and re-start the transfer from this address to recover the corrupted block. DMA operation will resume when the interrupt is serviced by software.

58.4.2.4 ADMA Engine

In the SD Host Controller Standard, a new DMA transfer algorithm called the ADMA (Advanced DMA) is defined. For Simple DMA, once the page boundary is reached, a DMA interrupt will be generated and the new system address shall be programmed by the Host Driver.

The ADMA defines the programmable descriptor table in the system memory. The Host Driver can calculate the system address at the page boundary and program the descriptor table before executing ADMA. It reduces the frequency of interrupts to the host system. Therefore, higher speed DMA transfers could be realized since the Host MCU intervention would not be needed during long DMA based data transfers.

There are two types of ADMA: ADMA1 and ADMA2 in Host Controller. ADMA1 can support data transfer of 4KB aligned data in system memory. ADMA2 improves the restriction so that data of any location and any size can be transferred in system memory. Their formats of Descriptor Table are different.

ADMA can recognize all kinds of descriptors define in SD Host Controller Standard, and if 'End' flag is detected in the descriptor, ADMA will stop after this descriptor is processed.

58.4.2.4.1 ADMA Concept and Descriptor Format

For ADMA1, including the following descriptors:

- Valid/Invalid descriptor.
- Nop descriptor.
- Set data length descriptor.
- Set data address descriptor.
- Link descriptor.
- Interrupt flag and End flag in descriptor.

For ADMA2, including the following descriptors:

- Valid/Invalid descriptor.
- Nop descriptor.
- Rsv descriptor.
- Set data length & address descriptor.
- Link descriptor.
- Interrupt flag and End flag in descriptor.

See [Figure 58-8](#) for the format of the descriptor table for ADMA1.

Figure 58-11 explains the ADMA2 format. ADMA2 deals with the lower 32-bit first, and then the higher 32-bit. If the 'Valid' flag of descriptor is 0, it will ignore the high 32-bit. Address field shall be set on word aligned(lower 2-bit is always set to 0). Data length is in byte unit.

ADMA will start read/write operation after it reaches the Tran state, using the data length and data address analyzed from most recent descriptor(s).

For ADMA1, the valid data length descriptor is the last Set type descriptor before Tran type descriptor. Every Tran type will trigger a transfer, and the transfer data length is extracted from the most recent Set type descriptor. If there is no Set type descriptor after the previous Trans descriptor, the data length will be the value for previous transfer, or 0 if no Set descriptor is ever met.

For ADMA2, Tran type descriptor contains both data length and transfer data address, so only a Tran type descriptor can start a data transfer

Address/ Page Field		Address/ Page Field		Attribute Field					
31	12	11	6	5	4	3	2	1	0
Address or Data Length		000000		Act 2	Act 1	0	Int	End	Valid

Act 2	Act1	Symbol	Comment	31- 28	27- 12
0	0	Nop	No Operation	Don't Care	
0	1	Set	Set Data Length	0000	Data Length
1	0	Tran	Transfer Data	Data Address	
1	1	Link	Link Descriptor	Descriptor Address	

Valid	Valid = 1 indicates this line of descriptor is effective. If Valid = 0 generate ADMA Error Interrupt and stop ADMA.
End	End = 1 indicates current descriptor is the ending one.
Int	Int = 1 generates DMA Interrupt when this descriptor is processed.

Figure 58-8. Format of the ADMA1 Descriptor Table

Functional Description

System Address Register points to the head node of Descriptor Table

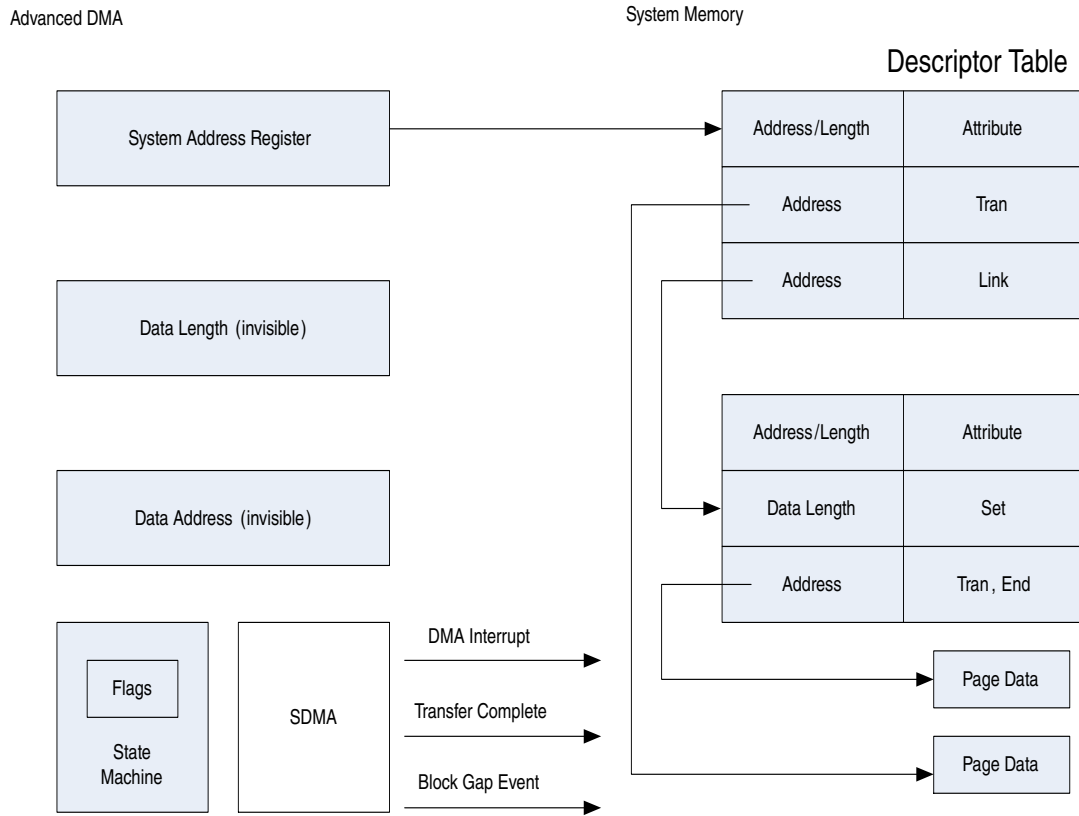

Figure 58-9. Concept and Access Method of ADMA1 Descriptor Table

Address Field		Length		Reserved		Attribute Field					
63	32	31	16	15	06	05	04	03	02	01	00
32-bit Address		16-bit length		0000000000		Act 2	Act 1	0	Int	End	Valid

Act 2	Act1	Symbol	Comment	Operation
0	0	Nop	No Operation	Don't Care
0	1	Rsv	Reserved	Same as Nop. Read this line and go to next one
1	0	Tran	Transfer Data	Transfer data with address and length set in this descriptor line
1	1	Link	Link Descriptor	Link to another descriptor

Valid	Valid = 1 indicates this line of descriptor is effective. If Valid = 0 generate ADMA Error Interrupt and stop ADMA.
End	End = 1 indicates current descriptor is the ending one.
Int	Int = 1 generates DMA Interrupt when this descriptor is processed.

Figure 58-10. Format of the ADMA2 Descriptor Table

Functional Description

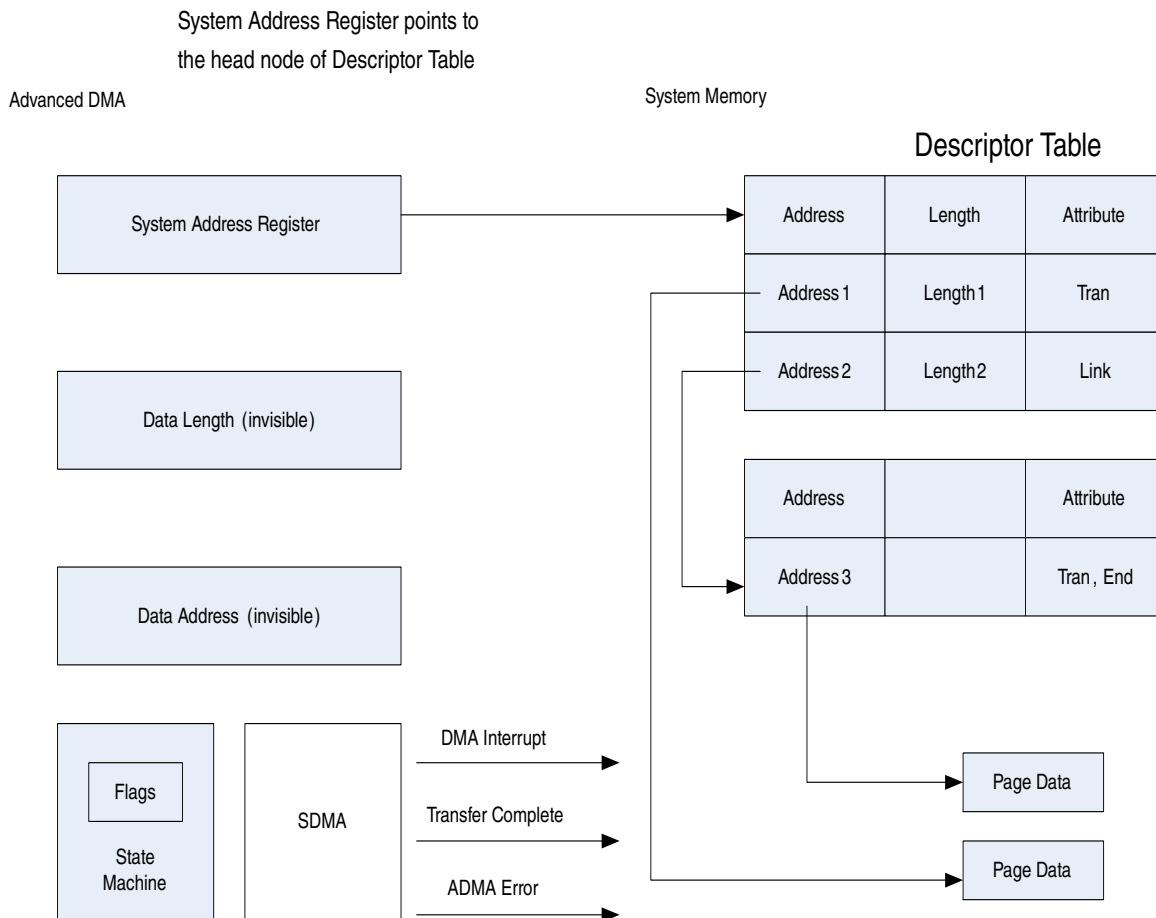

Figure 58-11. Concept and Access Method of ADMA2 Descriptor Table

58.4.2.4.2 ADMA Interrupt

If the interrupt flag descriptor is set, ADMA will generate an interrupt according to various types of descriptors:

For ADMA1:

- Set type of descriptor: interrupt is generated when data length is set.
- Tran type descriptor: interrupt is generated when this transfer is complete.
- Link type of descriptor: interrupt is generated when new descriptor address is set.
- Nop type of descriptor: interrupt is generated just after this descriptor is fetched.

For ADMA2:

- Tran type of descriptor: interrupt is generated when this transfer is complete.
- Link type of descriptor: interrupt is generated when new descriptor address is set.
- Nop/Rsv type of descriptor: interrupt is generated just after this descriptor is fetched.

58.4.2.4.3 ADMA Error

The ADMA will stop whenever any error is encountered. These errors include:

- Fetching descriptor error
- AHB response error
- Data length mismatch error

An ADMA descriptor error will be generated when it fails to detect a 'Valid' flag in the descriptor. If an ADMA descriptor error occurs, the interrupt is not generated even if the 'Interrupt' flag of this descriptor is set.

When BLKCNTEN bit is set, data length set in buffer must be equal to the whole data length set in descriptor nodes, otherwise data length mismatch error will be generated.

When BLKCNTEN bit is not set, then whole data length set in descriptor should be a multiple of block lengths; otherwise, when data set in the descriptor nodes are not performed at block boundaries, then data mismatch errors will occur.

58.4.3 Register Bank with IP Bus Interface

Register accesses via the IP Bus interface are actually on the Register Bank.

See [Figure 58-12](#) below for the block diagram.

Functional Description

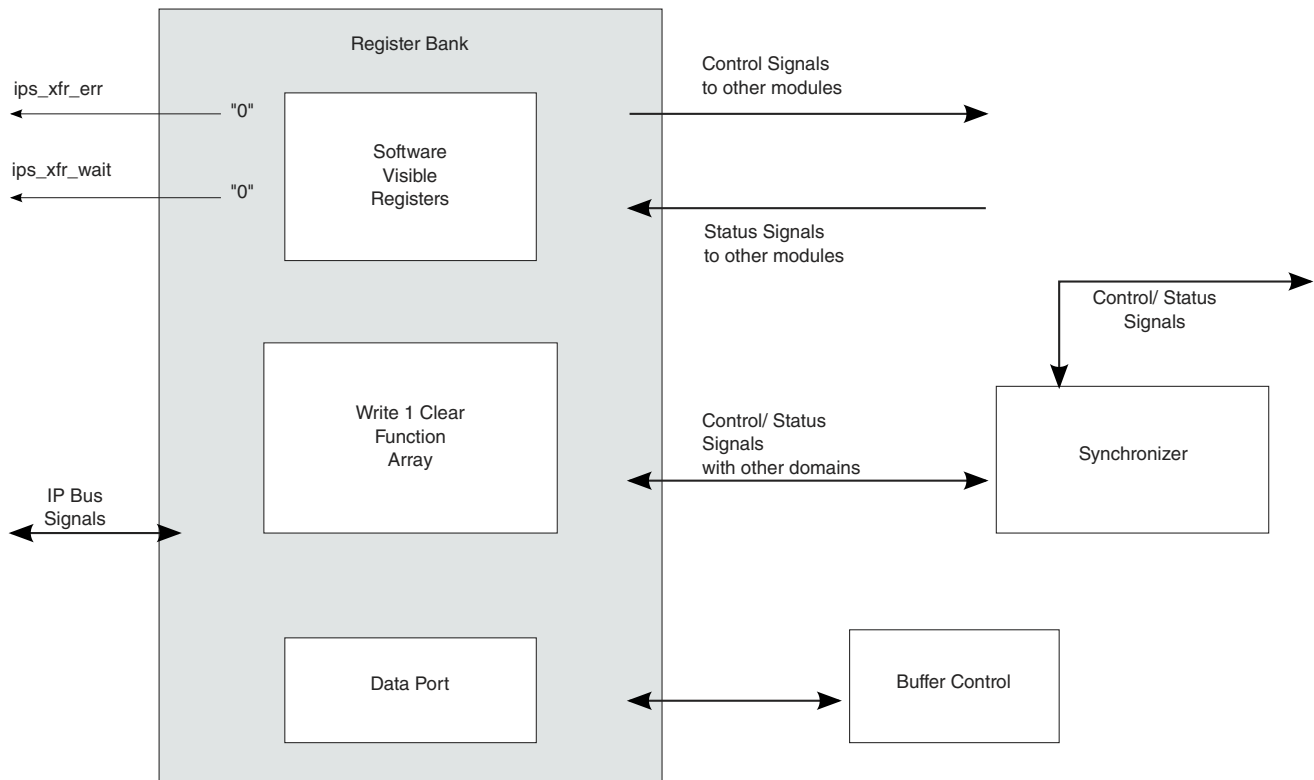

Figure 58-12. Register Bank Diagram

Only 32-bit access is allowed, and no partial read / write is supported, thus all accesses are word aligned.

58.4.3.1 SD Protocol Unit

The SD protocol unit deals with all SD protocol affairs.

The SD Protocol Unit performs the following functions:

- Acts as the bridge between the internal buffer and the SD bus
- Sends the command data as well as its argument serially
- Stores the serial response bit stream into corresponding registers
- Detects the bus state on the CMD/DAT lines
- Monitors the interrupt from the SDIO card
- Asserts the read wait signal
- Gates off the SD clock when buffer is announcing danger status
- Detects the write protect state

The SD Protocol Unit consists of four sub modules:

1. SD control misc.

2. Command control.
3. Data control.
4. Clock control

58.4.3.2 SD control misc

In the SD control misc unit, the card detect(include the CD_B and DATA3 used as Card Detection), write protection and card interrupt are implemented.

This module monitors the signal level on all 8 data lines, the command lines, and directly routes the level values into the Register Bank. The driver can use this for debug purposes.

The module also detects the WP (Write Protect) line. If WP is active, writes to the register bank will be ignored.

This module also drives the LCTL output signal when the LCTL bit is set by the driver.

58.4.3.3 SD Clock control

If the internal data buffer is near full(for read) or near empty(for write), the SD clock must be gated off to avoid buffer over/under-run, this module will assert the gate of the output SD clock to shut the clock off. After the buffer has space(for read) or has data(for write), the clock gate of this module will open and the SD clock will be active again.

58.4.3.4 Command control

The Command Control module deals with the transactions on the CMD line.

See the figure below for an illustration of the structure for the Command CRC Shift Register.

Functional Description

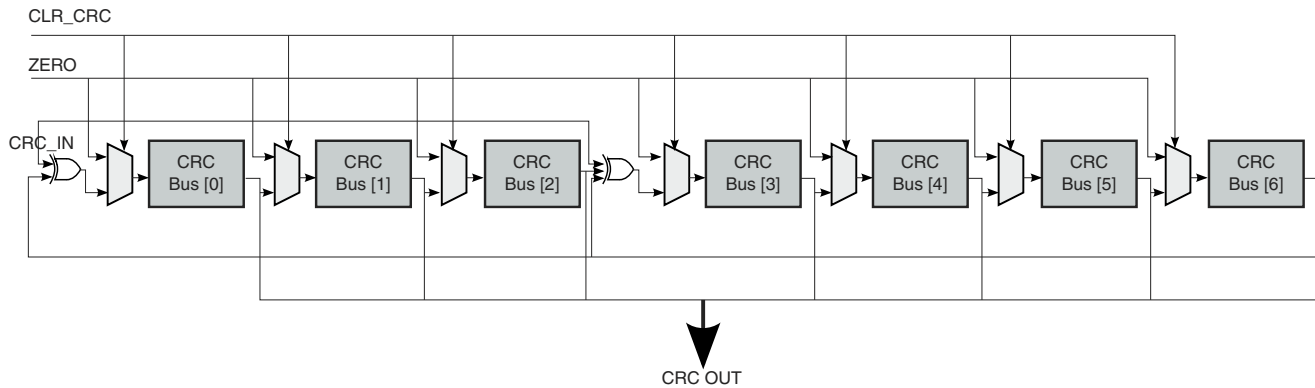

Figure 58-13. Command CRC Shift Register

The CRC polynomials for the CMD are as follows:

Generator polynomial: $G(x) = x^7 + x^3 + 1$
 $M(x) = (\text{first bit}) * x^n + (\text{second bit}) * x^{n-1} + \dots + (\text{last bit}) * x^0$
 $\text{CRC}[6:0] = \text{Remainder} [(M(x) * x^7) / G(x)]$

58.4.3.5 Data control

The Data Agent deals with the transactions on the eight data lines. Moreover, this module also detects the busy state on the DATA0 line, and generates the Read Wait state by the request from the Transceiver.

The CRC polynomials for the DATA are as follows:

Generator polynomial: $G(x) = x^{16} + x^{12} + x^5 + 1$
 $M(x) = (\text{first bit}) * x^n + (\text{second bit}) * x^{n-1} + \dots + (\text{last bit}) * x^0$
 $\text{CRC}[15:0] = \text{Remainder} [(M(x) * x^{16}) / G(x)]$

58.4.4 Clock & Reset Manager

This module controls all the reset signals within the uSDHC.

There are four kinds of reset signals within uSDHC:

1. Hardware reset.
2. Software reset for all logic.
3. Software reset for the data logic.
4. Software reset for the command logic.

All these signals are fed into this module and stable signals are generated inside the module to reset all other modules. The module also gates off all the inside signals.

58.4.5 Clock Generator

The Clock Generator generates the card CLK by peripheral source clock in two stages.

Refer to the figure below for the structure of the divider. The term "Base" represents the frequency of peripheral source clock.

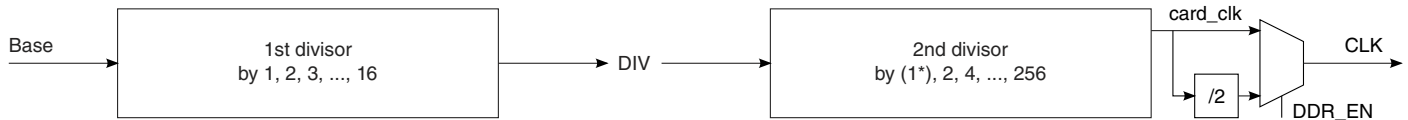

Figure 58-14. Two Stages of the Clock Divider

The first divisor stage (controlled by `uSDHCx_SYS_CTRL[DVS]`) outputs an intermediate clock (DIV), which can be Base, Base/2, Base/3, ..., or Base/16.

The second divisor stage (controlled by `uSDHCx_SYS_CTRL[SDCLKFS]`) outputs the actual internal working clock (`card_clk`). This clock is the driving clock for all sub modules of the SD Protocol Unit, and the sync FIFOs (see [Figure 58-3](#)) to synchronize with the data rate from the internal data buffer.

Please note, in SDR mode and DDR mode, the CLK are different.

- In SDR mode, CLK is equal to the internal working clock(`card_clk`).
- In DDR mode, CLK is equal to the `card_clk/2`.

58.4.6 SDIO Card Interrupt

Information on Interrupts in 1-bit Mode, Interrupts in 4-bit Mode, and Card Interrupt Handling are detailed in the sections below.

58.4.6.1 Interrupts in 1-bit Mode

In this case the DATA1 pin is dedicated to providing the interrupt function. An interrupt is asserted by pulling the DATA1 low from the SDIO card, until the interrupt service is finished to clear the interrupt.

58.4.6.2 Interrupt in 4-bit Mode

Since the interrupt and data line 1 share Pin 8 in 4-bit mode, an interrupt will only be sent by the card and recognized by the host during a specific time. This is known as the Interrupt Period. The uSDHC will only sample the level on Pin 8 during the Interrupt Period. At all other times, the host will ignore the level on Pin 8, and treat it as the data signal. The definition of the Interrupt Period is different for operations with single block and multiple block data transfers.

In the case of normal single data block transmissions, the Interrupt Period becomes active two clock cycles after the completion of a data packet. This Interrupt Period lasts until after the card receives the end bit of the next command that has a data block transfer associated with it.

For multiple block data transfers in 4-bit mode, there is only a limited period of time that the Interrupt Period can be active due to the limited period of data line availability between the multiple blocks of data. This requires a more strict definition of the Interrupt Period. For this case, the Interrupt Period is limited to two clock cycles. This begins two clocks after the end bit of the previous data block. During this 2-clock cycle interrupt period, if an interrupt is pending, the DATA1 line will be held low for one clock cycle with the last clock cycle pulling DATA1 high. On completion of the Interrupt Period, the card releases the DATA1 line into the high Z state. The uSDHC samples the DATA1 during the Interrupt Period when the IABG bit in the Protocol Control register is set.

Refer to SDIO Card Specification v1.10f for further information about the SDIO card interrupt.

58.4.6.3 Card Interrupt Handling

When the CINTIEN bit in the Interrupt Signal Enable Register is set to 0, the uSDHC clears the interrupt request to the Host System. The Host Driver should clear this bit before servicing the SDIO Interrupt and should set this bit again after all interrupt requests from the card are cleared to prevent inadvertent interrupts.

The SDIO Card Interrupt Status can be cleared by writing 1 to this bit. But as the interrupt source from the SDIO card does not clear, this bit is set again. In order to clear this bit, it is required to reset the interrupt source from the external card followed by a writing 1 to this bit. In 1-bit mode, the uSDHC will detect the SDIO Interrupt with or without the SD clock (to support wakeup). In 4-bit mode, the interrupt signal is sampled during the Interrupt Period, so there are some sample delays between the interrupt signal from the SDIO card and the interrupt to the Host System Interrupt Controller. When the SDIO status has been set, and the Host Driver needs to service this interrupt, so the SDIO bit in the Interrupt Control Register of SDIO card will be cleared. This is required to clear

the SDIO interrupt status latched in the uSDHC and to stop driving the interrupt signal to the System Interrupt Controller. The Host Driver must issue a CMD52 to clear the card interrupt. After completion of the card interrupt service, the SDIO Interrupt Status Enable bit is set to 1, and the uSDHC starts sampling the interrupt signal again.

See the figure below for an illustration of the SDIO card interrupt scheme and for the sequences of software and hardware events that take place during a card interrupt handling procedure.

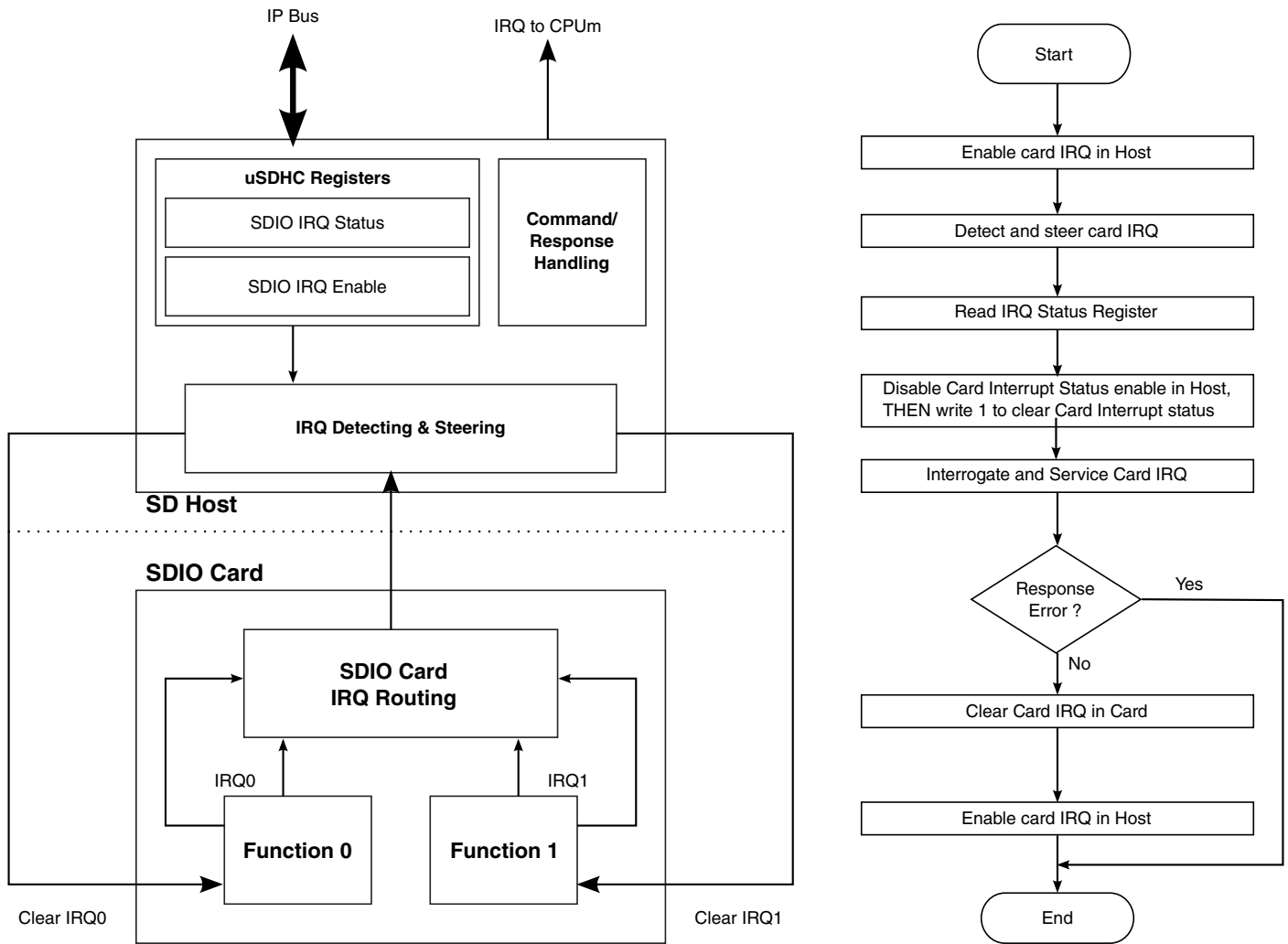

Figure 58-15. Card Interrupt Scheme and Card Interrupt Detection and Handling Procedure

58.4.7 Card Insertion and Removal Detection

The uSDHC uses either the DATA3 pin or the CD_B pin to detect card insertion or removal. When there is no card on the MMC/SD bus, the DATA3 will be pulled to a low voltage level by default.

When any card is inserted to or removed from the socket, the uSDHC detects the logic value changes on the DATA3 pin and generates an interrupt. When the DATA3 pin is not used for card detection (for example, it is implemented in GPIO), the CD_B pin must be connected for card detection. Whether DATA3 is configured for card detection or not, the CD_B pin is always a reference for card detection. Whether the DATA3 pin or the CD_B pin is used to detect card insertion, the uSDHC will send an interrupt (if enabled) to inform the Host system that a card is inserted.

58.4.8 Power Management and Wake Up Events

When there is no operation between the uSDHC and the card through the SD bus, the user can completely disable the ipg_clk and ipg_perclk in the chip level clock control module to save power. When the user needs to use the uSDHC to communicate with the card, it can enable the clock and start the operation.

In some circumstances, when the clocks to the uSDHC are disabled, for instance, when the system is in low power mode, there are some events for which the user needs to enable the clock and handle the event. These events are called wakeup interrupts. The uSDHC can generate these interrupt even when there are no clocks enabled. The three interrupts which can be used as wake up events are:

1. Card Removal Interrupt
2. Card Insertion Interrupt
3. Interrupt from SDIO card

The uSDHC offers a power management feature. By clearing the clock enabled bits in the System Control Register, the clocks are gated in the low position to the uSDHC. For maximum power saving, the user can disable all the clocks to the uSDHC when there is no operation in progress.

These three wake up events (or wakeup interrupts) can also be used to wake up the system from low-power modes.

NOTE

To make the interrupt a wakeup event, when all the clocks to the uSDHC are disabled or when the whole system is in low power mode, the corresponding wakeup enabled bit needs to be

set. Refer to [Protocol Control \(uSDHC_PROT_CTRL\)](#) for more information on the uSDHC Protocol Control register.

58.4.8.1 Setting Wake Up Events

For the uSDHC to respond to a wakeup event, the software must set the respective wakeup enable bit before the CPU enters sleep mode.

Before the software disables the host clock, it should ensure that all of the following conditions have been met:

- No Read or Write Transfer is active
- Data and Command lines are not active
- No interrupts are pending
- Internal data buffer is empty

58.4.9 MMC fast boot

The Embedded MultiMediaCard (eMMC4.3) specification adds a fast boot feature which requires hardware support. There are two types of fast boot mode, boot operation, and alternative boot operation in the eMMC4.3 specification. Each type also has with-acknowledge and without-acknowledge modes.

In boot operation mode, the master (MultiMediaCard host) can read boot data from the slave (MMC device) by keeping CMD line low after power-on, or sending CMD0 with argument + 0xFFFFFFFF (optional for slave), before issuing CMD1.

NOTE

For the eMMC4.3 card setting, please see the eMMC4.3 specification.

58.4.9.1 Boot operation

NOTE

For the purposes of this documentation, fast boot is called "normal fast boot mode".

If the CMD line is held LOW for 74 clock cycles and more after power-up before the first command is issued, the slave recognizes that boot mode is being initiated and starts preparing boot data internally.

Functional Description

Within 1 second after the CMD line goes LOW, the slave starts to send the first boot data to the master on the DATA line(s). The master must keep the CMD line LOW to read all of the boot data.

If boot acknowledge is enabled, the slave has to send acknowledge pattern '010' to the master within 50ms after the CMD line goes LOW. If boot acknowledge is disabled, the slave will not send out acknowledge pattern '010'.

The master can terminate boot mode with the CMD line HIGH.

Boot operation will be terminated when all contents of the enabled boot data are sent to the master. After boot operation is executed, the slave shall be ready for CMD1 operation and the master needs to start a normal MMC initialization sequence by sending CMD1.

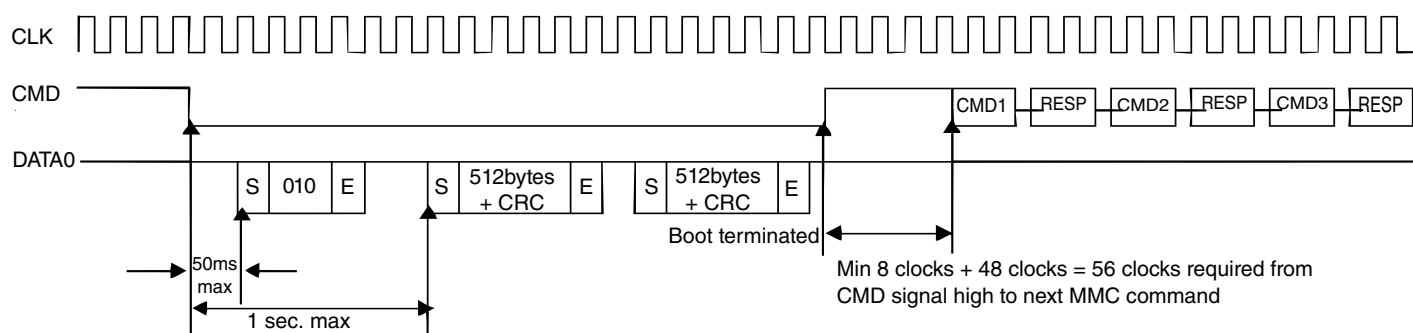

Figure 58-16. MultiMediaCard state diagram (normal boot mode)

58.4.9.2 Alternative boot operation

This boot function is optional for the device. If bit 0 in the extended CSD byte[228] is set to '1', the device supports the alternative boot operation.

After power-up, if the host issues CMD0 with the argument of 0xFFFFFFFFFA after 74 clock cycles, before CMD1 is issued or the CMD line goes low, the slave recognizes that boot mode is being initiated and starts preparing boot data internally.

Within 1 second after CMD0 with the argument of 0xFFFFFFFFFA is issued, the slave starts to send the first boot data to the master on the DATA line(s).

If boot acknowledge is enabled, the slave has to send the acknowledge pattern '010' to the master within 50ms after the CMD0 with the argument of 0xFFFFFFFFFA is received. If boot acknowledge is disabled, the slave will not send out acknowledge pattern '010'.

The master can terminate boot mode by issuing CMD0 (Reset).

Boot operation will be terminated when all contents of the enabled boot data are sent to the master. After boot operation is executed, the slave shall be ready for CMD1 operation and the master needs to start a normal MMC initialization sequence by sending CMD1.

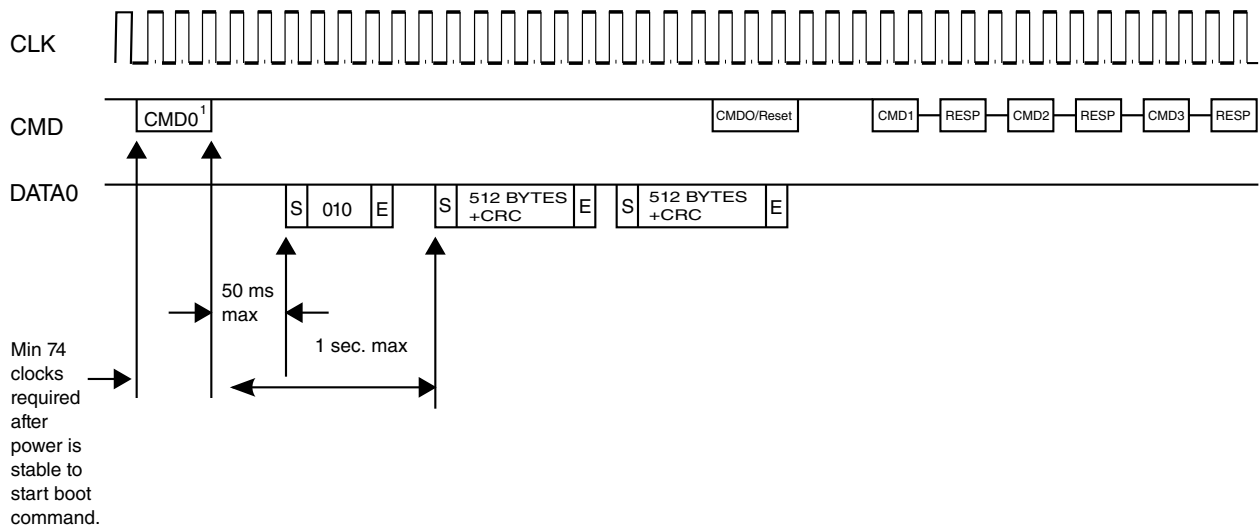

NOTE 1. CMD0 with argument 0xFFFFFFFF

Figure 58-17. MultiMediaCard state diagram (alternative boot mode)

58.5 Initialization/Application of uSDHC

All communication between the system and cards are controlled by the host. The host sends commands of two types: broadcast and addressed (point-to-point).

Broadcast commands are intended for all cards, such as GO_IDLE_STATE, SEND_OP_COND, ALL_SEND_CID. In Broadcast mode, all cards are in the open-drain mode to avoid bus contention. Refer to [Commands for MMC/SD/SDIO](#) for the commands of bc and bcr categories.

After the Broadcast command CMD3 is issued, the cards enter standby mode. Addressed type commands are used from this point. In this mode, the CMD/DATA I/O pads will turn to push-pull mode, to have the driving capability for maximum frequency operation. Refer to [Commands for MMC/SD/SDIO](#) for the commands of ac and adtc categories.

58.5.1 Command Send & Response Receive Basic Operation

Assuming the data type WORD is an unsigned 32-bit integer, the below flow is a guideline for sending a command to the card(s):

```
send_command(cmd_index, cmd_arg, other requirements)
{
WORD wCmd; // 32-bit integer to make up the data to write into Transfer Type register, it is
recommended to implement in a bit-field manner
wCmd = (<cmd_index> & 0x3f) >> 24; // set the first 8 bits as '00'+<cmd_index>
set CMDTYP, DPSEL, CICCEN, CCCEN, RSTTYP, DTDSEL accorind to the command_index;
if (internal DMA is used) wCmd |= 0x1;
if (multi-block transfer) {
    set MSBSEL bit;
    if (finite block number) {
        set BCEN bit;
        if (auto12 command is to use) set AC12EN bit;
    }
}
write_reg(CMDARG, <cmd_arg>); // configure the command argument
write_reg(XFERTYP, wCmd); // set Transfer Type register as wCmd value to issue the command
}
wait_for_response(cmd_index)
{
while (CC bit in IRQ Status register is not set); // wait until Command Complete bit is set
read IRQ Status register and check if any error bits about Command are set
if (any error bits are set) report error;
write 1 to clear CC bit and all Command Error bits;
}
```

For the sake of simplicity, the function `wait_for_response` is implemented here by means of polling. For an effective and formal way, the response is usually checked after the Command Complete Interrupt is received. When doing this, make sure the corresponding interrupt status bits are enabled.

For some scenarios, the response time-out is expected. For instance, after all cards respond to CMD3 and go to the Standby State, no response to the Host when CMD2 is sent. The Host Driver will deal with "fake" errors like this with caution.

58.5.2 Card Identification Mode

When a card is inserted to the socket or the card was reset by the host, the host needs to validate the operation voltage range, identify the cards, request the cards to publish the Relative Card Address (RCA) or to set the RCA for the MMC cards.

58.5.2.1 Card Detect

See the figure below for a flow diagram showing the detection of MMC, SD and SDIO cards using the uSDHC.

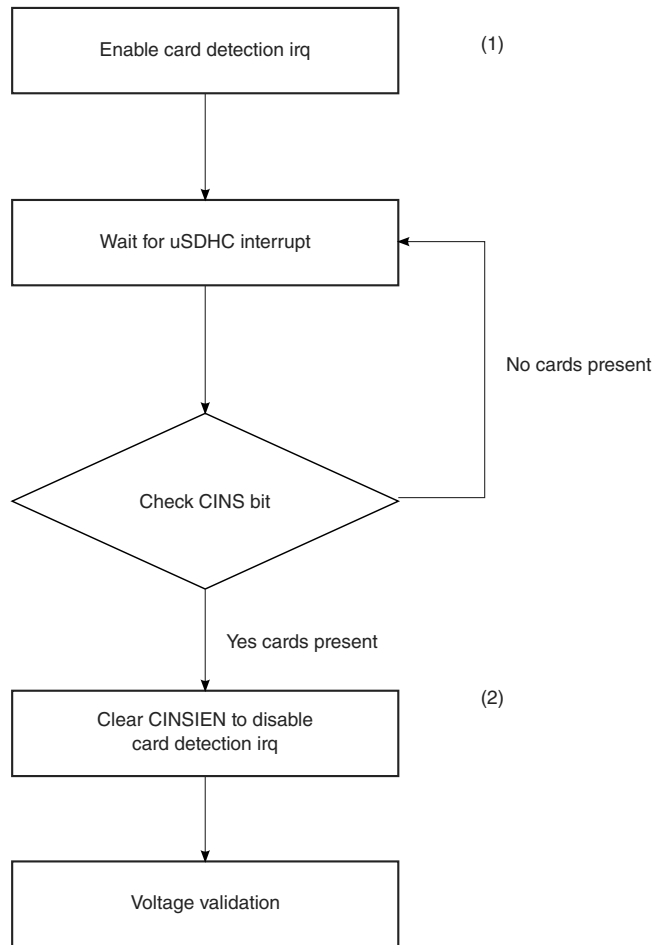

Figure 58-18. Flow Diagram for Card Detection

Here is the card detect sequence:

- Set the CINSIEN bit to enable card detection interrupt
- When an interrupt from the uSDHC is received, check the CINS bit in the Interrupt Status register to see if it was caused by card insertion
- Clear the CINSIEN bit to disable the card detection interrupt and ignore all card insertion interrupts afterwards

58.5.2.2 Reset

The host consists of three types of resets:

- Hardware reset (Card and Host) which is driven by POR (Power On Reset)

- Software reset (Host Only) is initiated by the write operation on the RSTD, RSTC, or RSTA bits of the System Control register to reset the data part, command part, or all parts of the Host Controller, respectively
- Card reset (Card Only). The command, "Go_Idle_State" (CMD0), is the software reset command for all types of MMC cards, SD Memory cards. This command sets each card into the Idle State regardless of the current card state. For an SD I/O Card, CMD52 is used to write an I/O reset in the CCCR. The cards are initialized with a default relative card address (RCA=0x0000) and with a default driver stage register setting (lowest speed, highest driving current capability).

After the card is reset, the host needs to validate the voltage range of the card. See the figure below for the software flow to reset both the uSDHC and the card.

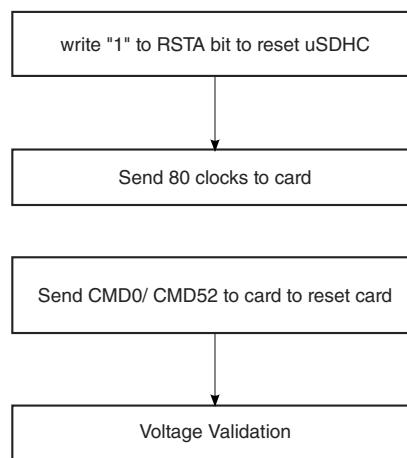

Figure 58-19. Flow Chart for Reset of the uSDHC and SD I/O Card

```

software_reset()
{
set_bit(SYSCTRL, RSTA); // software reset the Host
set_DTOCV and SDCLKFS bit fields to get the CLK of frequency around 400kHz
configure IO pad to set the power voltage of external card to around 3.0V
poll bits CIHB and CDIHB bits of PRSSTAT to wait both bits are cleared
set_bit(SYSCTRL, INTIA); // send 80 clock ticks for card to power up
send_command(CMD_GO_IDLE_STATE, <other parameters>); // reset the card with CMD0
or send_command(CMD_IO_RW_DIRECT, <other parameters>);
}
  
```

58.5.2.3 Voltage Validation

All cards should be able to establish communication with the host using any operation voltage in the maximum allowed voltage range specified in the card specification. However, the supported minimum and maximum values for Vdd are defined in the Operation Conditions Register (OCR) and may not cover the whole range.

Cards that store the CID and CSD data in the preload memory are only able to communicate this information under data transfer Vdd conditions. This means if the host and card have non-common Vdd ranges, the card will not be able to complete the identification cycle, nor will it be able to send CSD data.

Therefore, a special command Send_Op_Cont (CMD1 for MMC), SD_Send_Op_Cont (ACMD41 for SD Memory) and IO_Send_Op_Cont (CMD5 for SD I/O) is used. The voltage validation procedure is designed to provide a mechanism to identify and reject cards which do not match the Vdd range(s) desired by the host. This is accomplished by the host sending the desired Vdd voltage window as the operand of this command. Cards that can't perform the data transfer in the specified range must discard themselves from further bus operations and go into the Inactive State. By omitting the voltage range in the command, the host can query each card and determine the common voltage range before sending out-of-range cards into the Inactive State. This query should be used if the host is able to select a common voltage range or if a notification shall be sent to the system when a non-usable card in the stack is detected.

The following steps show how to perform voltage validation when a card is inserted:

```

voltage_validation(voltage_range_argument)
{
    label the card as UNKNOWN;
    send_command(IO_SEND_OP_COND, 0x0, <other parameters are omitted>); // CMD5, check SDIO
    operation voltage, command argument is zero
    if (RESP_TIMEOUT != wait_for_response(IO_SEND_OP_COND)) { // SDIO command is accepted
        if (0 < number of IO functions) {
            label the card as SDIO;
            IORDY = 0;
            while (!(IORDY in IO OCR response)) { // set voltage range for each IO
                function
                    send_command(IO_SEND_OP_COND, <voltage range>, <other
parameter>);
                    wait_for_response(IO_SEND_OP_COND);
            } // end of while ...
        } // end of if (0 < ...
        if (memory part is present inside SDIO card) Label the card as SDCCombo; // this is
an
SD-Combo card
    } // end of if (RESP_TIMEOUT ...
    if (the card is labelled as SDIO card) return; // card type is identified and voltage range
is
set, so exit the function;
    send_command(APP_CMD, 0x0, <other parameters are omitted>); // CMD55, Application specific
CMD
prefix
    if (no error calling wait_for_response(APP_CMD, <...>) { // CMD55 is accepted
        send_command(SD_APP_OP_COND, <voltage range>, <...>); // ACMD41, to set voltage
range
        for memory part or SD card
            wait_for_response(SD_APP_OP_COND); // voltage range is set
            if (Card type is UNKNOWN) label the card as SD;
            return; //
    } // end of if (no error ...
    else if (errors other than time-out occur) { // command/response pair is corrupted
        deal with it by program specific manner;
    } // of else if (response time-out
    else { // CMD55 is refuse, it must be MMC card if (card is already labelled as SDCCombo)
    { //
change label

```

```

        re-label the card as SDIO;
        ignore the error or report it;
        return; // card is identified as SDIO card
    } // of if (card is ...
    send_command(SEND_OP_COND, <voltage range>, <...>);
    if (RESP_TIMEOUT == wait_for_response(SEND_OP_COND)) { // CMD1 is not accepted,
either
        label the card as UNKNOWN;
        return;
    } // of if (RESP_TIMEOUT ...
} // of else
}

```

58.5.2.4 Card Registry

Card registry for the MMC and SD/SDIO/SD Combo cards are different. For the SD Card, the Identification process starts at a clock rate lower than 400 kHz and the power voltage higher than 2.7 V (as defined by the Card spec). At this time, the CMD line output drives are push-pull drivers instead of open-drain. After the bus is activated, the host will request the card to send their valid operation conditions.

The response to ACMD41 is the operation condition register of the card. The same command shall be send to all of the new cards in the system. Incompatible cards are put into the Inactive State. The host then issues the command, All_Send_CID (CMD2), to each card to get its unique card identification (CID) number. Cards that are currently unidentified (in the Ready State), send their CID number as the response. After the CID is sent by the card, the card goes into the Identification State.

The host then issues Send_Relative_Addr (CMD3), requesting the card to publish a new relative card address (RCA) that is shorter than the CID. This RCA will be used to address the card for future data transfer operations. Once the RCA is received, the card changes its state to the Standby State. At this point, if the host wants the card to have an alternative RCA number, it may ask the card to publish a new number by sending another Send_Relative_Addr command to the card. The last published RCA is the actual RCA of the card.

The host repeats the identification process with CMD2 and CMD3 for each card in the system until the last CMD2 gets no response from any of the cards in system.

For MMC operation, the host starts the card identification process in open-drain mode with the identification clock rate lower than 400 kHz and the power voltage higher than 2.7 V. The open drain driver stages on the CMD line allow parallel card operation during card identification. After the bus is activated the host will request the cards to send their valid operation conditions (CMD1). The response to CMD1 is the "wired OR" operation on the condition restrictions of all cards in the system. Incompatible cards are sent into the Inactive State. The host then issues the broadcast command All_Send_CID (CMD2), asking all cards for their unique card identification (CID) number. All unidentified cards

(the cards in Ready State) simultaneously start sending their CID numbers serially, while bit-wise monitoring their outgoing bit stream. Those cards, whose outgoing CID bits do not match the corresponding bits on the command line in any one of the bit periods, stop sending their CID immediately and must wait for the next identification cycle. Since the CID is unique for each card, only one card can be successfully send its full CID to the host. This card then goes into the Identification State. Thereafter, the host issues Set_Relative_Addr (CMD3) to assign to the card a relative card address (RCA). Once the RCA is received the card state changes to the Stand-by State, and the card does not react in further identification cycles, and its output driver switches from open-drain to push-pull. The host repeats the process, mainly CMD2 and CMD3, until the host receives a time-out condition to recognize the completion of the identification process.

For operation as MMC cards:

```

card_registry()
{
do { // decide RCA for each card until response time-out
    if(card is labelled as SDCombo or SDIO) { // for SDIO card like device
        send_command(SET_RELATIVE_ADDR, 0x00, <...>); // ask SDIO card to
publish its
RCA
        retrieve RCA from response;
    } // end if (card is labelled as SDCombo ...
else if (card is labelled as SD) { // for SD card
    send_command(ALL_SEND_CID, <...>);
    if (RESP_TIMEOUT == wait_for_response(ALL_SEND_CID)) break;
    send_command(SET_RELATIVE_ADDR, <...>);
    retrieve RCA from response;
} // else if (card is labelled as SD ...
else if (card is labelled as MMC) {
    send_command(ALL_SEND_CID, <...>);
    rca = 0x1; // arbitrarily set RCA, 1 here for example
    send_command(SET_RELATIVE_ADDR, 0x1 << 16, <...>); // send RCA at upper
16
bits
        } // end of else if (card is labelled as MMC ...
} while (response is not time-out);
}

```

58.5.3 Card Access

Information about Block Write, Block Read, Suspense Resume, ADMA Usage, Transfer Error, and Card Interrupt are detailed in the sections below.

58.5.3.1 Block Write

Information on Normal Write, DDR Write, and Write with Pause are detailed in the sections below.

58.5.3.1.1 Normal Write

During a block write (CMD24 - 27, CMD60, CMD61), one or more blocks of data are transferred from the host to the card with a CRC appended to the end of each block by the host. If the CRC fails, the card shall indicate the failure on the DATA line. The transferred data will be discarded and not written, and all further transmitted blocks (in multiple block write mode) will be ignored.

If the host uses partial blocks whose accumulated length is not block aligned and block misalignment is not allowed (CSD parameter WRITE_BLK_MISALIGN is not set), the card detects the block misalignment error and aborts the programming before the beginning of the first misaligned block. The card sets the ADDRESS_ERROR error bit in the status register, and while ignoring all further data transfer, waits in the Receive-data-State for a stop command. The write operation is also aborted if the host tries to write over a write protected area.

For MMC and SD cards, programming of the CID and CSD registers does not require a previous block length setting. The transferred data is also CRC protected. If a part of the CSD or CID register is stored in ROM, then this unchangeable part must match the corresponding part of the receive buffer. If this match fails, then the card will report an error and not change any register contents.

For all types of cards, some may require long and unpredictable periods of time to write a block of data. After receiving a block of data and completing the CRC check, the card will begin writing and hold the DATA line low if its write buffer is full and unable to accept new data from a new WRITE_BLOCK command. The host may poll the status of the card with a SEND_STATUS command (CMD13) or other means for SDIO cards at any time, and the card will respond with its status. The responded status indicates whether the card can accept new data or whether the write process is still in progress. The host may deselect the card by issuing a CMD7 (to select a different card) to place the card into the Standby State and release the DATA line without interrupting the write operation. When re-selecting the card, it will reactivate the busy indication by pulling DATA to low if the programming is still in progress and the write buffer is unavailable.

The software flow to write to a card incorporates the internal DMA and the write operation is a multi-block write with the Auto CMD12 enabled. For the other two methods (by means of external DMA or CPU polling status) with different transfer methods, the internal DMA parts should be removed and the alternative steps should be straightforward.

The software flow to write to a card is described below:

1. Check the card status, wait until the card is ready for data.
2. Set the card block length/size:

- For SD/MMC cards, use SET_BLOCKLEN (CMD16)
 - For SDIO cards or the I/O portion of SDCombo cards, use IO_RW_DIRECT (CMD52) to set the I/O Block Size bit field in the CCCR register (for function 0) or FBR register (for functions 1~7)
3. Set the uSDHC block length register to be the same as the block length set for the card in Step 2.
 4. Set the uSDHC number block register (NOB), nob is 5 (for instance).
 5. Disable the buffer write ready interrupt, configure the DMA settings and enable the uSDHC DMA when sending the command with data transfer. The AC12EN bit should also be set.
 6. Wait for the Transfer Complete interrupt.
 7. Check the status bit to see if a write CRC error occurred, or some another error, that occurred during the auto12 command sending and response receiving.

58.5.3.1.2 DDR Write

uSDHC supports dual data rate mode.

The software flow to write to a card in ddr mode is described as below:

1. Check the card status, wait until the card is ready for data.
2. For eMMC4.4 card, block length only can be set to 512byte.
3. Set the uSDHC number block register (NOB), nob is 5 (for instance).
4. Set eMMC4.4 card to high speed mode, use SWITCH(CMD6).
5. Set eMMC4.4 card bus with (4-bit /8-bit ddr mode), use SWITCH(CMD6).
6. Disable the buffer write ready interrupt, configure the DMA settings and enable the uSDHC DMA when sending the command with data transfer. The DDR_EN bit should be set. The AC12EN bit should also be set.
7. Wait for the Transfer Complete interrupt.
8. Check the status bit to see if a write CRC error occurred, or some another error, that occurred during the auto12 command sending and response receiving.

58.5.3.1.3 Write with Pause

The write operation can be paused during the transfer. Instead of stopping the CLK at any time to pause all the operations, which is also inaccessible to the Host Driver, the Driver can set the Stop At Block Gap Request(SABGREQ) bit in the Protocol Control register to pause the transfer between the data blocks. As there is no time-out condition in a write operation during the data blocks, a write to all types of cards can be paused in this way, and if the DATA0 line is not required to de-assert to release the busy state, no suspend command is needed.

Like in the flow described in [Normal Write](#), the write with pause is shown with the same kind of write operation:

1. Check the card status, wait until card is ready for data.
2. Set the card block length/size:
 - For SD/MMC, use SET_BLOCKLEN (CMD16)
 - For SDIO cards or the I/O portion of SDCombo cards, use IO_RW_DIRECT(CMD52) to set the I/O Block Size bit field in the CCCR register (for function 0) or FBR register (for functions 1~7)
3. Set the uSDHC block length register to be the same as the block length set for the card in Step 2.
4. Set the uSDHC number block register (NOB), nob is 5 (for instance).
5. Disable the buffer write ready interrupt, configure the DMA settings and enable the uSDHC DMA when sending the command with data transfer. The AC12EN bit should also be set.
6. Set the SABGREQ bit.
7. Wait for the Transfer Complete interrupt.
8. Clear the SABGREQ bit.
9. Check the status bit to see if a write CRC error occurred.
10. Set the CREQ bit to continue the write operation.
11. Wait for the Transfer Complete interrupt.
12. Check the status bit to see if a write CRC error occurred, or some another error, that occurred during the auto12 command sending and response receiving.

The number of blocks left during the data transfer is accessible by reading the contents of the BLKCNT field in the Block Attribute register. As the data transfer and the setting of the SABGREQ bit are concurrent, and the delay of register read and the register setting, the actual number of blocks left may not be exactly the value read earlier. The Driver shall read the value of BLKCNT after the transfer is paused and the Transfer Complete interrupt is received.

It is also possible the last block has begun when the Stop At Block Gap Request is sent to the buffer. In this case, the next block gap is actually the end of the transfer. These types of requests are ignored and the Driver should treat this as a non-pause transfer and deal with it as a common write operation.

When the write operation is paused, the data transfer inside the Host System is not stopped, and the transfer is active until the data buffer is full. Because of this (if not needed), it is recommended to avoid using the Suspend Command for the SDIO card. This is because when such a command is sent, the uSDHC thinks the System will switch to another function on the SDIO card, and flush the data buffer. The uSDHC takes the Resume Command as a normal command with data transfer, and it is left for the Driver to set all the relevant registers before the transfer is resumed. If there is only one block to

send when the transfer is resumed, the MSBSEL and BCEN bits of the Transfer Type register are set as well as the AC12EN bit. However, the uSDHC will automatically send a CMD12 to mark the end of the multi-block transfer.

58.5.3.2 Block Read

Information about Normal Read, DDR Read, Read with Pause, and DLL (Delay Line) in Read Path are detailed in the sections below.

58.5.3.2.1 Normal Read

For block reads, the basic unit of data transfer is a block whose maximum size is stored in areas defined by the corresponding card specification. A CRC is appended to the end of each block, ensuring data transfer integrity. The CMD17, CMD18, CMD53, CMD60, CMD61, and so on, can initiate a block read. After completing the transfer, the card returns to the Transfer State. For multi blocks read, data blocks will be continuously transferred until a stop command is issued.

The software flow to read from a card incorporates the internal DMA and the read operation is a multi-block read with the Auto CMD12 enabled. For the other two methods (by means of external DMA or CPU polling status) with different transfer methods, the internal DMA parts should be removed and the alternative steps should be straightforward.

The software flow to read from a card is described below:

1. Check the card status, wait until card is ready for data.
2. Set the card block length/size:
 - For SD/MMC, use SET_BLOCKLEN (CMD16)
 - For SDIO cards or the I/O portion of SDCombo cards, use IO_RW_DIRECT(CMD52) to set the I/O Block Size bit field in the CCCR register (for function 0) or FBR register (for functions 1~7)
3. Set the uSDHC block length register to be the same as the block length set for the card in Step 2.
4. Set the uSDHC number block register (NOB), nob is 5 (for instance).
5. Disable the buffer read ready interrupt, configure the DMA settings and enable the uSDHC DMA when sending the command with data transfer. The AC12EN bit should also be set.
6. Wait for the Transfer Complete interrupt.
7. Check the status bit to see if a read CRC error occurred, or some another error, occurred during the auto12 command sending and response receiving.

58.5.3.2.2 DDR Read

uSDHC supports dual data rate mode.

The software flow to write to a card in ddr mode is described below:

1. Check the card status, wait until the card is ready for data.
2. For eMMC4.4 card, block length only can be set to 512byte.
3. Set the uSDHC number block register (NOB), nob is 5 (for instance).
4. Set eMMC4.4 card to high speed mode, use SWITCH(CMD6).
5. Set eMMC4.4 card bus with (4-bit /8-bit ddr mode), use SWITCH(CMD6).
6. Disable the buffer write ready interrupt, configure the DMA settings and enable the uSDHC DMA when sending the command with data transfer. The DDR_EN bit should be set. The AC12EN bit should also be set.
7. Wait for the Transfer Complete interrupt.
8. Check the status bit to see if a write CRC error occurred, or some another error, that occurred during the auto12 command sending and response receiving.

58.5.3.2.3 Read with Pause

The read operation is not generally able to pause. Only the SDIO card (and SDCombo card working under I/O mode) supporting the Read Wait feature can pause during the read operation. If the SDIO card supports Read Wait (SRW bit in CCCR register is 1), the Driver can set the SABGREQ bit in the Protocol Control register to pause the transfer between the data blocks.

Before setting the SABGREQ bit, make sure the RWCTL bit in the Protocol Control register is set, otherwise the uSDHC will not assert the Read Wait signal during the block gap and data corruption occurs. It is recommended to set the RWCTL bit once the Read Wait capability of the SDIO card is recognized.

Like in the flow described in [Normal Read](#), the read with pause is shown with the same kind of read operation:

1. Check the SRW bit in the CCR register on the SDIO card to confirm the card supports Read Wait.
2. Set the RWCTL bit.
3. Check the card status and wait until the card is ready for data.
4. Set the card block length/size:
 - For SD/MMC, use SET_BLOCKLEN (CMD16)
 - For SDIO cards or the I/O portion of SDCombo cards, use IO_RW_DIRECT(CMD52) to set the I/O Block Size bit field in the CCCR register (for function 0) or FBR register (for functions 1~7)

5. Set the uSDHC block length register to be the same as the block length set for the card in Step 2.
6. Set the uSDHC number block register (NOB), nob is 5 (for instance).
7. Disable the buffer read ready interrupt, configure the DMA setting and enable the uSDHC DMA when sending the command with data transfer. The AC12EN bit should also be set
8. Set the SABGREQ bit.
9. Wait for the Transfer Complete interrupt.
10. Clear the SABGREQ bit.
11. Check the status bit to see if read CRC error occurred.
12. Set the CREQ bit to continue the read operation.
13. Wait for the Transfer Complete interrupt.
14. Check the status bit to see if a read CRC error occurred, or some another error, occurred during the auto12 command sending and response receiving.

Like the write operation, it is possible to meet the ending block of the transfer when paused. In this case, the uSDHC will ignore the Stop At Block Gap Request and treat it as a command read operation.

Unlike the write operation, there is no remaining data inside the buffer when the transfer is paused. All data received before the pause will be transferred to the Host System. No matter if the Suspend Command is sent or not, the internal data buffer is not flushed.

If the Suspend Command is sent and the transfer is later resumed by means of a Resume Command, the uSDHC takes the command as a normal one accompanied with data transfer. It is left for the Driver to set all the relevant registers before the transfer is resumed. If there is only one block to send when the transfer is resumed, the MSBSEL and BCEN bits of the Transfer Type register are set, as well as the AC12EN bit. However, the uSDHC will automatically send the CMD12 to mark the end of multi-block transfer.

58.5.3.2.4 DLL (Delay Line) in Read Path

The DLL(Delay Line) is newly added to assist in sampling read data. The DLL provides the ability to programmatically select a quantized delay (in fractions of the clock period) regardless of on-chip variations such as process, voltage and temperature (PVT).

The reasons why the DLL is needed for uSDHC are 1.) the path of read data traveling from card to host varies. 2.) in SD/MMC DDR mode the minimum input setup and hold time are both at 2.5 ns. The data sampling window is so small that the delay of loopback clock needs to be accurate and consistent regardless of PVT. The DLL takes the divided card_clk as the reference clock and loopback clock as the input clock. It then generates a delayed version of the input clock according to the programmed target delay.

The DLL can be disabled or bypassed, and it can also be manually set for a fixed delay in override mode. The override value set is the number of delay cells. In override mode, there is no need to set the `DLL_enable`. Another DLL mode is target value mode. In this mode, the DLL will automatically adjust the number of delay cells according to target value set by user and PVT changes. Be aware that target value is in units of 1/32 of the clock reference period. If the `card_clk` is 100Mhz, then the reference clock period is 10ns, setting target vaule of 16 means $5\text{ns} = (16/32) * 10\text{ns}$. Software can disable automatic update by setting `dll_gate_update` bit. Please refer to [Figure 58-20](#).

Since the user may change the frequency of the `card_clk` from time to time by changing `SDCLKFS[7:0]/DVS[3:0]`, the software must adjust the delay value to ensure it works correctly when the reference clock (`card_clk`) is changed. The following is the correct flow, which should be ignored if `DLL_CTRL_ENABLE` is not set.

Step 1: Set `DLL_CTRL_RESET` bit

Step 2: Configure the `SDCLKFS[7:0]` and `DVS[3:0]`

Step 3: Wait until `SDSTB` is asserted

Step 4: clear `DLL_CTRL_RESET` bit

Step 5: Wait until both `DLL_STS_SLV_LOCK` and `DLL_STS_REF_LOCK` are asserted

Step 6: set `DLL_CTRL_SLV_FORCE_UPD`

Step 7: clear `DLL_CTRL_SLV_FORCE_UPD`

NOTE:Software should make sure the `DLL_CTRL_SLV_FORCE_UPD` is lasted for at least one `card_clk`. So software may need to add some delay between step6 and step7.

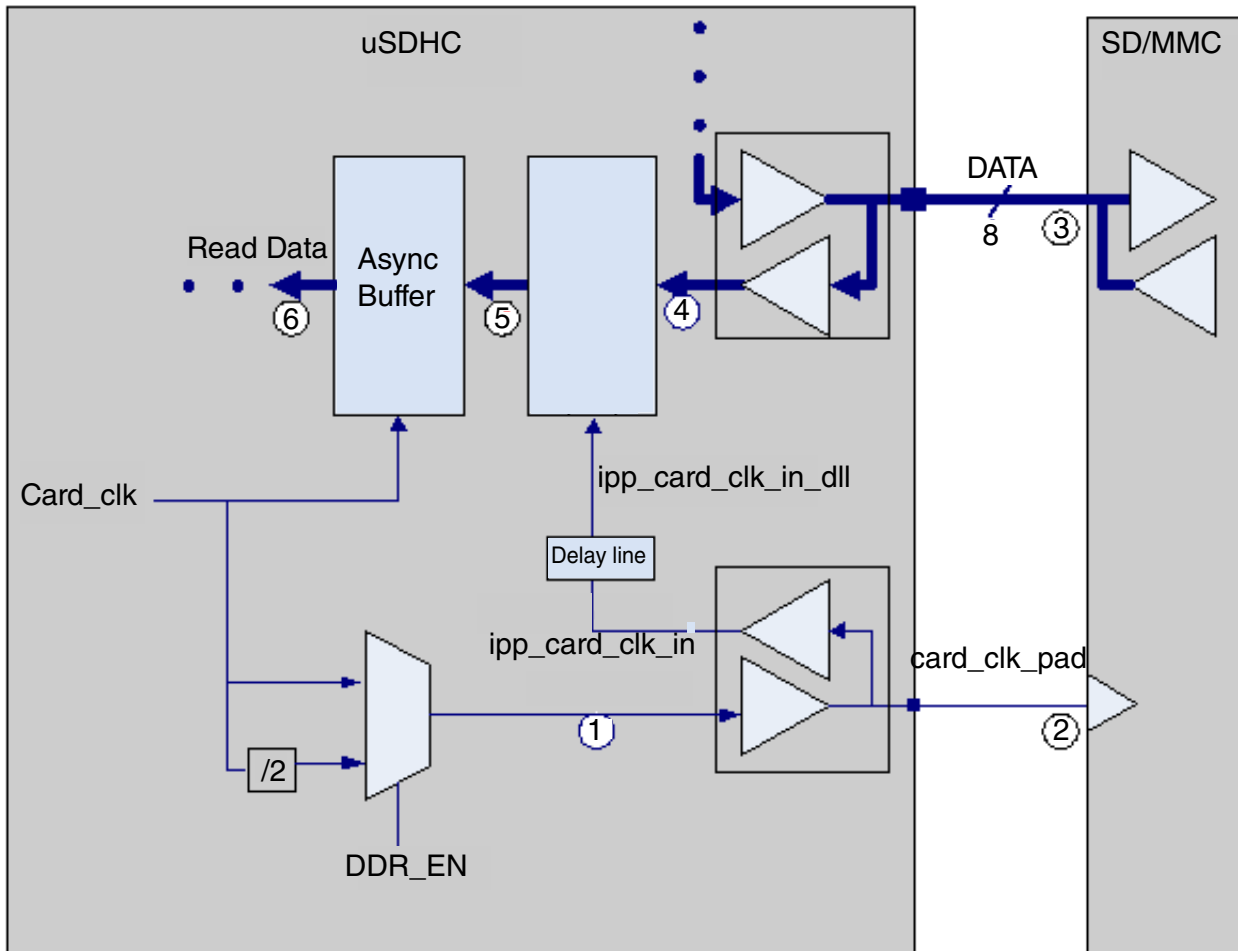

Figure 58-20. DLL(Delay Line) in Read Path

58.5.3.3 Suspend Resume

The uSDHC supports the Suspend Resume operations of SDIO cards, although slightly differently than the suggested implementation of Suspend in the SDIO card specification.

58.5.3.3.1 Suspend

After setting the SABGREQ bit, the Host Driver may send a Suspend command to switch to another function of the SDIO card. The uSDHC does not monitor the content of the response, so it doesn't know if the Suspend command succeeded or not. Accordingly, it doesn't de-assert Read Wait for read pause. To solve this problem, the Driver shall not mark the Suspend command as a "Suspend", (i.e. setting the CMDTYP bits to 01). Instead, the Driver shall send this command as if it were a normal command, and only

when the command succeeds, and the BS bit is set in the response, can the Driver send another command marked as "Suspend" to inform the uSDHC that the current transfer is suspended. As shown in the following sequence for Suspend operation:

1. Set the SABREQ bit to pause the current data transfer at block gap.
2. After the BGE bit is set, send the Suspend command to suspend the active function. The CMDTYP bit field must be 2'b00.
3. Check the BS bit of the CCCR in the response. If it is 1, repeat this step until the BS bit is cleared or abandon the suspend operation according to the Driver strategy.
4. Send another normal I/O command to the suspended function. The CMDTYP of this command must be 2'b01, so the uSDHC can detect this special setting and be informed that the paused operation has successfully suspended. If the paused transfer is a read operation, the uSDHC stops driving DATA2 and goes to the idle state.
5. Save the context registers in the system memory for later use, including the DMA System Address Register (for internal DMA operation), and the Block Attribute Register.
6. Begin operation for another function on the SDIO card.

58.5.3.3.2 Resume

To resume the data transfer, a Resume command shall be issued:

1. To resume the suspended function, restore the context register with the saved value in step #5 of the Suspend operation above.
2. Send the Resume command. In the Transfer Type register, all bit fields are set to the value as if this were another ordinary data transfer, instead of a transfer resume (except the CMDTYP is set to 2'b10).
3. If the Resume command has responded, the data transfer will be resumed.

58.5.3.4 ADMA Usage

To use the ADMA in a data transfer, the Host Driver must prepare the correct descriptor chain prior to sending the read/write command.

The steps to prepare the correct descriptor chain are:

1. Create a descriptor to set the data length that the current descriptor group is about to transfer. The data length should be even numbers of the block size.
2. Create another descriptor to transfer the data from the address setting in this descriptor. The data address must be at a page boundary (4kB address aligned).
3. If necessary, create a Link descriptor containing the address of the next descriptor. The descriptor group is created in steps 1 ~ 3.

4. Repeat steps 1 ~ 3 until all descriptors are created.
5. In the last descriptor, set the End flag to 1 and make sure the total length of all descriptors match the product of the block size and block number configured in the Block Attribute Register.
6. Set the ADMA System Address Register to the address of the first descriptor and set the DMAS field in the Protocol Control Register to 01 to select the ADMA.
7. Issue a write or read command with the DMAEN bit set to 1 in the Transfer Type Register.

Steps 1 ~ 5 are independent of step 6, so step 6 can finish before steps 1 ~ 5. Regarding the descriptor configuration, it is recommended not to use the Link descriptor as it requires extra system memory access.

58.5.3.5 Transfer Error

Information about CRC, Internal DMA, Transfer ADMA, and Auto CMD12 Errors are detailed in the sections below.

58.5.3.5.1 CRC Error

It is possible at the end of a block transfer, that a write CRC status error or read CRC error occurs. For this type of error the latest block received shall be discarded. This is because the integrity of the data block is not guaranteed. It is recommended to discard the following data blocks and re-transfer the block from the corrupted one.

For a multi-block transfer, the Host Driver shall issue a CMD12 to abort the current process and start the transfer by a new data command. In this scenario, even when the AC12EN and BCEND bits are set, the uSDHC does not automatically send a CMD12 because the last block is not transferred. On the other hand, if it is within the last block that the CRC error occurs, an Auto CMD12 will be sent by the uSDHC. In this case, the Driver shall re-send or re-obtain the last block with a single block transfer.

58.5.3.5.2 Internal DMA Error

During the data transfer with internal Simple DMA, if the DMA engine encounters some error on the AHB bus, the DMA operation is aborted and DMA Error interrupt is sent to the Host System. When acknowledged by such an interrupt, the Driver shall calculate the start address of data block in which the error occurs.

The start address can be calculated by either:

1. Reading the DMA System Address register. The error occurs during the previous burst. Taking the block size, the previous burst length and the start address of the

next burst transfer into account, it is straight forward to obtain the start address of the corrupted block.

2. Reading the BLKCNT field of the Block Attribute register. By the number of blocks left, the total number to transfer, the start address of transfer, and the size of each block, the start address of corrupted block can be determined. When the BCEN bit is not set, the contents of the Block Attribute register does not change, so this method does not work.

When a DMA error occurs, it is recommended to abort the current transfer by means of a CMD12 (for multi block transfer), apply a reset for data, and re-start the transfer from the corrupted block to recover from the error.

58.5.3.5.3 Transfer ADMA Error

There are 3 kinds of possible ADMA errors. The AHB transfer, invalid descriptor, and data-length mismatch errors. Whenever these errors occur, the DMA transfer stops and the corresponding error status bit is set.

For acknowledging the status, the Host Driver should recover the error as shown below and re-transfer from the place of interruption.

1. AHB transfer error: Such errors may occur during data transfer or descriptor fetch. For either scenario, it is recommended to retrieve the transfer context, reset for the data part and re-transfer the block that was corrupted, or the next block if no block is corrupted.
2. Invalid descriptor error: For such errors, it is recommended to retrieve the transfer context, reset for the data part and re-create the descriptor chain from the invalid descriptor and issue a new transfer. As the data to transfer now may be less than the previous setting, the data length configured in the new descriptor chain should match the new value.
3. Data-length mismatch error: It is similar to recover from this error. The Host Driver polls relating registers to retrieve the transfer context, apply a reset for the data part, configure a new descriptor chain, and make another transfer if there is data left. Like the previous scenario of the invalid descriptor error, the data length must match the new transfer.

58.5.3.5.4 Auto CMD12 Error

After the last block of the multi block transfer is sent or received, and the AC12EN bit is set when the data transfer is initiated by the data command, the uSDHC automatically sends a CMD12 to the card to stop the transfer.

When errors with this command occur, it is recommended to the Driver to deal with the situations in the following manner:

1. Auto CMD12 response time-out. It is not certain whether the command is accepted by the card or not. The Driver should clear the Auto CMD12 error status bits and re-send the CMD12 until it is accepted by the card.
2. Auto CMD12 response CRC error. Since card responds to the CMD12, the card will abort the transfer. The Driver may ignore the error and clear the error status bit.
3. Auto CMD12 conflict error or not sent. The command is not sent, so the Driver shall send a CMD12 manually.

58.5.3.6 Card Interrupt

The external cards can inform the Host Controller by means of some special signals. For the SDIO card, it can be the low level on the DATA1 line during some special period. The uSDHC only monitors the DATA1 line and supports the SDIO interrupt.

When the SDIO interrupt is captured by the uSDHC, and the Host System is informed by the uSDHC asserting the uSDHC interrupt line, the interrupt service from the Host Driver is called.

As the interrupt source is controlled by the external card, the interrupt from the SDIO card must be serviced before the CINT bit is cleared by written. Refer to [Card Interrupt Handling](#) for the card interrupt handling flow.

58.5.4 Switch Function

A switch command must be issued by the Host Driver to enable new features added to the SD/MMC spec. SD/MMC cards can transfer data at bus widths other than 1-bit. Different speed mode are also defined. To enable these features, a switch command shall be issued by the Host Driver.

For SDIO cards, the high speed mode/DDR50/SDR50/SDR104 are enabled by writing the EHS bit in the CCCR register after the SHS bit is confirmed. For SD cards, the high speed mode/DDR50/SDR50/SDR104 are queried and enabled by a CMD6 (with the mnemonic symbol as SWITCH_FUNC). For MMC cards, the high speed mode/HS200 are queried by a CMD8 and enabled by a CMD6 (with the mnemonic symbol as SWITCH).

The SDR4-bit, SDR8-bit, DDR4-bit and DDR8-bit width of the MMC is also enabled by the SWITCH command, but with a different argument.

These new functions can also be disabled by a software reset. For SDIO cards it can be done by setting the RES bit in the CCCR register. For other cards, it can be accomplished by issuing a CMD0. This method of restoring to the normal mode is not recommended because a complete identification process is needed before the card is ready for data transfer.

For the sake of simplicity, the following pseudocode examples do not show current capability check, which is recommended in the function switch process.

58.5.4.1 Query, Enable and Disable SDIO High Speed Mode

```
enable_sdio_high_speed_mode(void)
{
send CMD52 to query bit SHS at address 0x13;
if (SHS bit is '0') report the SDIO card does not support high speed mode and return;
send CMD52 to set bit EHS at address 0x13 and read after write to confirm EHS bit is set;
change clock divisor value or configure the system clock feeding into uSDHC to generate the
card_clk of around 50MHz;
(data transactions like normal peers)
}
disable_sdio_high_speed_mode(void)
{
send CMD52 to clear bit EHS at address 0x13 and read after write to confirm EHS bit is
cleared;
change clock divisor value or configure the system clock feeding into uSDHC to generate the
card_clk of the desired value below 25MHz;
(data transactions like normal peers)
}
```

58.5.4.2 Query, Enable and Disable SD High Speed Mode/SDR50/SDR104/DDR50

```
enable_sd_speed_mode(void)
{
set BLKCNT field to 1 (block), set BLKSIZE field to 64 (bytes);
send CMD6, with argument 0xFFFFF0 and read 64 bytes of data accompanying the R1 response;
(high speed mode,x=1; SDR50,x=2; SDR104,x=3; DDR50,x=4;)
wait data transfer done bit is set;
check if the bit x of received 512 bits is set;
if (bit 401 is '0') report the SD card does not support high speed mode and return;
if (bit 402 is '0') report the SD card does not support SDR50 mode and return;
if (bit 403 is '0') report the SD card does not support SDR104 mode and return;
if (bit 404 is '0') report the SD card does not support DDR50 mode and return;
send CMD6, with argument 0x80FFFFF0 and read 64 bytes of data accompanying the R1 response;
(high speed mode,x=1; SDR50,x=2; SDR104 x=3; DDR50 x=4;)
check if the bit field 379~376 is 0xF;
if (the bit field is 0xF) report the function switch failed and return;
change clock divisor value or configure the system clock feeding into uSDHC to generate the
card_clk of around 50MHz for high speed mode, 100Mhz for SDR50, 200Mhz for SDR104, 50Mhz for
DDR50;
(data transactions like normal peers)
}
disable_sd_speed_mode(void)
{
set BLKCNT field to 1 (block), set BLKSIZE field to 64 (bytes);
send CMD6, with argument 0x80FFFFF0 and read 64 bytes of data accompanying the R1 response;
check if the bit field 379~376 is 0xF;
```

```

if (the bit field is 0xF) report the function switch failed and return;
change clock divisor value or configure the system clock feeding into uSDHC to generate the
card_clk of the desired value below 25MHz;
(data transactions like normal peers)
}

```

58.5.4.3 Query, Enable and Disable MMC High Speed Mode

```

enable_mmc_high_speed_mode(void)
{
send CMD9 to get CSD value of MMC;
check if the value of SPEC_VER field is 4 or above;
if (SPEC_VER value is less than 4) report the MMC does not support high speed mode and
return;
set BLKCNT field to 1 (block), set BLKSIZE field to 512 (bytes);
send CMD8 to get EXT_CSD value of MMC;
extract the value of CARD_TYPE field to check the 'high speed mode' in this MMC is 26MHz or
52MHz;
send CMD6 with argument 0x1B90100;
send CMD13 to wait card ready (busy line released);
send CMD8 to get EXT_CSD value of MMC;
check if HS_TIMING byte (byte number 185) is 1;
if (HS_TIMING is not 1) report MMC switching to high speed mode failed and return;
change clock divisor value or configure the system clock feeding into uSDHC to generate the
card_clk of around 26MHz or 52MHz according to the CARD_TYPE;
(data transactions like normal peers)
}
disable_mmc_high_speed_mode(void)
{
send CMD6 with argument 0x2B90100;
set BLKCNT field to 1 (block), set BLKSIZE field to 512 (bytes);
send CMD8 to get EXT_CSD value of MMC;
check if HS_TIMING byte (byte number 185) is 0;
if (HS_TIMING is not 0) report the function switch failed and return;
change clock divisor value or configure the system clock feeding into uSDHC to generate the
card_clk of the desired value below 20MHz;
(data transactions like normal peers)
}

```

58.5.4.4 Set MMC Bus Width

```

change_mmc_bus_width(void)
{
send CMD9 to get CSD value of MMC;
check if the value of SPEC_VER field is 4 or above;
if (SPEC_VER value is less than 4) report the MMC does not support multiple bit width and
return;
send CMD6 with argument 0x3B70x00; (8-bit(dual data rate), x=6; 4-bit(dual data rate), x=5;8-
bit, x=2; 4-bit, x=1; 1-bit, x=0)
send CMD13 to wait card ready (busy line released);
(data transactions like normal peers)
}

```

58.5.5 ADMA Operation

Code for ADMA1 Operation and ADMA2 Operation can be found here.

58.5.5.1 ADMA1 Operation

```

Set_adma1_descriptor
{
if (to start data transfer) {
// Make sure the address is 4KB align.
Set 'Set' type descriptor;
{
Set Act bits to 01;
Set [31:12] bits data length (byte unit);
}
Set 'Tran' type descriptor;
{
Set Act bits to 10;
Set [31:12] bits address (4KB align);
}
}
else if (to fetch descriptor at non-continuous address) {
Set Act bits to 11;
Set [31:12] bits the next descriptor address (4KB aligned);
}
else { // other types of descriptor
Set Act bits accordingly
}
if (this descriptor is the last one) {
Set End bit to 1;
}
if (to generate interrupt for this descriptor) {
Set Int bit to 1;
}
Set Valid bit to 1;
}

```

58.5.5.2 ADMA2 Operation

```

Set_adma2_descriptor
{
if (to start data transfer) {
// Make sure the address is a 32-bit boundary (lower 2-bit are always '00').
Set higher 32-bit of descriptor for this data transfer initial address;
Set [31:16] bits data length (byte unit);
Set Act bits to '10';
}
else if (to fetch descriptor at non-continuous address) {
Set Act bits to '11';
// Make sure the address is 32-bit boundary (lower 2-bit are always set to '00').
Set higher 32-bit of descriptor for the next descriptor address;
}
else { // other types of descriptor
Set Act bits accordingly
}
if (this descriptor is the last one) {
Set 'End' bit '1';
}
if (to generate interrupt for this descriptor) {
Set 'Int' bit '1';
}
Set the 'Valid' bit to '1';
}

```

58.5.6 Fast Boot Operation

58.5.6.1 Normal fast boot flow

1. Software must configure `init_active` bit (system control register bit 27) to make sure 74 card clocks are finished.
2. Software must configure the MMC Boot Register (offset 0xc4) bit 6 to 1 (enable boot), and bit 5 to 0 (normal fast boot), and bit 4 to select the ack mode or not. If the data will be sent through DMA mode, the software should configure bit 7 to enable the automatic stop at block gap feature, and configure bit 3-bit 0 to select the ack timeout value according to the SD CLK frequency.
3. Software then needs to configure the Block Attributes Register to set the block size and count. If in DDR fast boot mode, the block size only can be configured to 512 bytes.
4. Software must configure the Protocol control register to set DTW (data transfer width). If in DDR fast boot mode, DTW only can be configured to 4-bit/8-bit dataline mode.
5. Software needs to configure the Command Argument Register to set argument if needed (no need in normal fast boot).
6. Software must configure the Transfer Type Register to start the boot process. In normal boot mode, `CMDINX`, `CMDTYP`, `RSPTYP`, `CICEN`, `CCEN`, `AC12EN`, `BCEN` and `DMAEN` are kept at the default value. `DPSEL` bit is set to 1, `DTDSEL` is set to 1, `MSBSEL` is set to 1.
7. `DMAEN` should be configured as 0 in polling mode. And if `BCEN` is configured as 1, it is recommended to configure the number of blocks in the Block Attributes Register to the maximum value. If in DDR fast boot mode, `DDR_EN` needs to be set to 1.
8. When the step 6 is configured, the boot process will begin. Software needs to poll the data buffer ready status to read the data from the buffer in time. If a boot timeout happens (ack times out or the first data read times out), an interrupt will be triggered, and software must configure MMC Boot Register to bit 6 to 0 to disable boot. This makes `CMD` high, then after at least 56 clocks, it is ready to begin a normal initialization process.
9. If there is no timeout, software needs to determine when the data read is finished and then configure MMC Boot Register bit 6 to 0 to disable boot. This will make `CMD` line high and command completed asserted. After at least 56 clocks, it is ready to begin normal initialization process.
10. Reset the host and then can begin the normal process.

58.5.6.2 Alternative fast boot flow

1. Software needs to configure `init_active` bit (system control register bit 27) to make sure 74 card clocks are finished.
2. Software needs to configure MMC Boot Register (offset 0xc4) bit 6 to 1 (enable boot), and bit 5 to 1 (alternative boot), and bit 4 to select the ack mode or not. If data needs to be sent through DMA mode, then configure bit 7 to enable the automatic stop at block gap feature. Software should also configure bit 3-bit 0 to select the ack timeout value according to the SD clock frequency.
3. Software then needs to configure Block Attributes Register to set the block size and count. If in DDR fast boot mode, the block size only can be configured to 512 bytes.
4. Software needs to configure the Protocol control register to set the DTW (data transfer width). If in ddr fast boot mode, DTW only can be configure to 4-bit/8-bit dataline mode.
5. Software needs to configure Command Argument Register to set argument to 0xFFFFFFFFFA.
6. Software needs to configure the Transfer Type Register to start the boot process by CMD0 with 0xFFFFFFFFFA argument . In alternative boot, CMDINX, CMDTYP, RSPTYP, CICEN, CCCEN, AC12EN, BCEN and DMAEN are kept default value. DPSEL bit is set to 1, DTDSEL is set to 1, MSBSEL is set to 1. Note DMAEN should be configured as 0 in polling mode. And if BCEN is configured as 1 in polling mode, it is recommended to configure the block count in the Block Attributes Register to the maximum value. If in DDR fast boot mode, DDR_EN needs to be set to 1.
7. When the step 6 is configured, the boot process will begin. Software needs to poll the data buffer ready status to read the data from the buffer in time. If there is a boot timeout (ack data timeout in 50ms or data timeout in 1s), the host will send out the interrupt and software needs to send CMD0 with reset and then configure the boot enable bit to 0 to stop this process..
8. If there is no time out, software needs to decide when to stop the boot process, and send out the CMD0 with reset and then after the command is completed, configure the MMC Boot Register bit 6 to stop the process. After 8 clocks from the command completion, the slave (card) is ready for the identification step.
9. Reset the host and then begin the normal process.

58.5.6.3 Fast boot application case (in DMA mode)

In the boot application case, because the image destination and the image size are contained in the beginning of the image, it is necessary to switch DMA parameters on the fly during MMC fast boot.

In fast boot, the host can use ADMA2 (Advanced DMA2) with two destinations.

The detail flow is described below:

1. Software needs to configure INIT_ACTIVE bit (system control register bit 27) to make sure 74 card clocks are finished.
2. Software needs to configure the MMC Boot Register (offset 0xc4) bit 6 to 1 (enable boot); and bit 5 to 0 (normal fast boot) or 1 (alternative boot); and bit 4 to select the ack mode or not. In DMA mode, configure bit 7 to 1 to enable the automatic stop at block gap feature. Also configure bits[31-16] to set the (BLK_CNT - VALUE1). Here VALUE1 is the value of the block count that needs to transfer the first time, so that that the host will stop at the block gap when the uSDHC controller gets VALUE1 blocks from the device. Also configure bits[3-0] to select the ack timeout value according to the SD clock frequency.
3. Software then needs to configure the Block Attributes Register to set block size and count. If in DDR fast boot mode, the block size only can be configured to 512 bytes. In DMA mode, it is recommended to set the block count (BLK_CNT) to the max value (16'hfff).
4. Software needs to configure Protocol Control Register to set DTW (data transfer width). If in DDR fast boot mode, the DTW only can be configured to 4-bit/8-bit dataline mode.
5. Software enable ADMA2 by configuring Protocol Control Register bits [9-8].
6. Software need to set at least three pairs ADMA2 descriptor in boot memory (ie, in IRAM, at least 6 word). The first pair descriptor define the start address (ie, IRAM) and data length (ie, 512byte*VALUE1) of first part boot code. Software also need to set the second pair descriptor, the second start address (any value that is writeable), data length is suggest to set 1~2word (record as VALUE2). Note: the second couple desc also transfer useful data even at lease 1 word. Because our ADMA2 can't support 0 data_length data transfer descriptor.
7. Software needs to configure Command Argument Register to set argument to 0xFFFFFFFF in alternative fast boot, and don't need set in normal fast boot.
8. Software needs to configure Transfer Type Register to start the boot process . CMDINX, CMDTYP, RSPTYP, CICEN, CCCEN, AC12EN, BCEN and DMAEN are kept default value. DPSEL bit is set to 1, DTDSEL is set to 1, MSBSEL is set to 1. DMAEN is configured as 1 in DMA mode. And if BCEN is configured as 1, better to configure blk no in Block Attributes Register to the max value. And if in ddr fast boot mode, DDR_EN need to be set to 1.
9. When the step 8 is configured, boot process will begin, the first VALUE1 block number data has transfer. Software need to polling TC bit (bit1 in Interrupt Status Register) to determine first transfer is end. Also software need to polling BGE bit (bit2 in Interrupt Status Register) to determine if first transfer stop at block gap.

10. When TC, BGE bit is 1, . SW can analyzes the first code of VALUE1 block, initializes the new memory device, if required, and sets the third pair of descriptors to define the start address and length of the remaining part of boot code(VALUE3 the remain boot code block). Remeber set the last descriptor with END.
11. Software needs to configure MMC Boot Register (offset 0xc4) again. Set bit 6 to 1(enable boot); and bit 5 to 0(normal fast boot), to 1(alternative boot); and bit 4 to select the ack mode or not. In DMA mode, configure bit 7 to 1 for enable automatically stop at block gap feature. Also configure bit31-bit16 to set the $(BLK_CNT - (VALUE1+1+VALUE3))$, that host will stop at block gap when *the uSDHC controller gets (VALUE1+1+VALUE3) blocks from device totally include the blocks received in step 9*. And need to configure bit 3-bit0 to select the ack timeout value according to the sd clk frequence. Please note, Software doesn't need to configure the *BLK_CNT* again, because it's counted down automatically by the uSDHC controller.
12. Software needs to clear TC and BGE bit. And software needs to clear SABGREQ(bit 16 in Protocol control register), and set CREQ(bit17 Protocol control register) to 1 to resume the data transfer. Host will transfer the VALUE2 and VALUE3 data to the destination that is set by descriptor.
13. Software need to polling BGE bit to determine if the fast boot is over.

Note:

1. When ADMA boot flow is started, for uSDHC, it is like a normal ADMA read operation. So setting ADMA2 descriptor as the normal ADMA2 transfer.
2. Need a few words length memory to keep descriptor.
3. For the 1~2 word data in second descriptor setting, it is the useful data, so software need to deal the data due to the application case.

58.6 Commands for MMC/SD/SDIO

A table containing the list of commands for the MMC/SD/SDIO cards can be found here.

Refer to the corresponding specifications for more details about the command information.

There are four kinds of commands defined to control the MultiMediaCard:

1. broadcast commands (bc), no response.
2. broadcast commands with response (bcr), response from all cards simultaneously.
3. addressed (point-to-point) commands (ac), no data transfer on the DATA.
4. addressed (point-to-point) data transfer commands (adtc).

Response: a response is a token which is sent from the card to the host as an answer to a previously received command. A response is transferred serially on the CMD line.

Table 58-3. Commands for MMC/SD/SDIO Cards

CMD INDEX	Type	Argument	Response type	Abbreviation	Description
CMD0	bc	[31:0] stuff bits	-	GO_IDLE_STATE	Resets all MMC and SD memory cards to idle state.
CMD1	bcr	[31:0] OCR without busy	R3	SEND_OP_COND	Asks all MMC and SD Memory cards in idle state to send their operation conditions register contents in the response on the CMD line.
CMD2	bcr	[31:0] stuff bits	R2	ALL_SEND_CID	Asks all cards to send their CID numbers on the CMD line.
CMD3 ¹	ac	[31:6] RCA [15:0] stuff bits	R1 R6 (SDIO)	SET/ SEND_RELATIVE_AD DR	Assigns relative address to the card.
CMD4	bc	[31:0] DSR [15:0] stuff bits	-	SET_DSR	Programs the DSR of all cards.
CMD5	bc	[31:0] OCR without busy	R4	IO_SEND_OP_COND	Asks all SDIO cards in idle state to send their operation conditions register contents in the response on the CMD line.
CMD6 ²	adtc	[31] Mode 0: Check function 1: Switch function [30:8] Reserved for function groups 6 ~ 3 (All 0 or 0xFFFF) [7:4] Function group1 for command system [3:0] Function group2 for access mode	R1	SWITCH_FUNC	Checks switch ability (mode 0) and switch card function (mode 1). Refer to "SD Physical Specification V1.1" for more details.
CMD6 ³	ac	[31:26] Set to 0 [25:24] Access [23:16] Index [15:8] Value [7:3] Set to 0 [2:0] Cmd Set	R1b	SWITCH	Switches the mode of operation of the selected card or modifies the EXT_CSD registers. Refer to "The MultiMediaCard System Specification Version 4.0 Final draft 2" for more details.
CMD7	ac	[31:6] RCA [15:0] stuff bits	R1b	SELECT/ DESELECT_CARD	Toggles a card between the stand-by and transfer states or between the programming and disconnect states. In both cases, the card is selected by its own relative address and gets deselected by any other address. Address 0 deselects all.

Table continues on the next page...

Table 58-3. Commands for MMC/SD/SDIO Cards (continued)

CMD INDEX	Type	Argument	Response type	Abbreviation	Description
CMD8	adtc	[31:0] stuff bits	R1	SEND_EXT_CSD	The card sends its EXT_CSD register as a block of data, with a block size of 512 bytes.
CMD9	ac	[31:6] RCA [15:0] stuff bits	R2	SEND_CSD	Addressed card sends its card-specific data (CSD) on the CMD line.
CMD10	ac	[31:6] RCA [15:0] stuff bits	R2	SEND_CID	Addressed card sends its card-identification (CID) on the CMD line.
CMD11	adtc	[31:0] data address	R1	READ_DAT_UNTIL_STOP	Reads data stream from the card, starting at the given address, until a STOP_TRANSMISSION follows.
CMD12	ac	[31:0] stuff bits	R1b	STOP_TRANSMISSION	Forces the card to stop transmission.
CMD13	ac	[31:6] RCA [15:0] stuff bits	R1	SEND_STATUS	Addressed card sends its status register.
CMD14	Reserved				
CMD15	ac	[31:6] RCA [15:0] stuff bits	-	GO_INACTIVE_STATE	Sets the card to inactive state in order to protect the card stack against communication breakdowns.
CMD16	ac	[31:0] block length	R1	SET_BLOCKLEN	Sets the block length (in bytes) for all following block commands (read and write). Default block length is specified in the CSD.
CMD17	adtc	[31:0] data address	R1	READ_SINGLE_BLOCK	Reads a block of the size selected by the SET_BLOCKLEN command.
CMD18	adtc	[31:0] data address	R1	READ_MULTIPLE_BLOCK	Continuously transfers data blocks from card to host until interrupted by a stop command.
CMD19	Reserved				
CMD20	adtc	[31:0] data address	R1	WRITE_DAT_UNTIL_STOP	Writes data stream from the host, starting at the given address, until a STOP_TRANSMISSION follows.
CMD21-23	Reserved				
CMD24	adtc	[31:0] data address	R1	WRITE_BLOCK	Writes a block of the size selected by the SET_BLOCKLEN command.
CMD25	adtc	[31:0] data address	R1	WRITE_MULTIPLE_BLOCK	Continuously writes blocks of data until a STOP_TRANSMISSION follows.
CMD26	adtc	[31:0] stuff bits	R1	PROGRAM_CID	Programming of the card identification register. This command shall be issued only once per card. The card contains hardware to prevent this operation

Table continues on the next page...

Table 58-3. Commands for MMC/SD/SDIO Cards (continued)

CMD INDEX	Type	Argument	Response type	Abbreviation	Description
					after the first programming. Normally this command is reserved for the manufacturer.
CMD27	adtc	[31:0] stuff bits	R1	PROGRAM_CSD	Programming of the programmable bits of the CSD.
CMD28	ac	[31:0] data address	R1b	SET_WRITE_PROT	If the card has write protection features, this command sets the write protection bit of the addressed group. The properties of write protection are coded in the card specific data (WP_GRP_SIZE).
CMD29	ac	[31:0] data address	R1b	CLR_WRITE_PROT	If the card provides write protection features, this command clears the write protection bit of the addressed group.
CMD30	adtc	[31:0] write protect data address	R1	SEND_WRITE_PROT	If the card provides write protection features, this command asks the card to send the status of the write protection bits.
CMD31	Reserved				
CMD32	ac	[31:0] data address	R1	TAG_SECTOR_START	Sets the address of the first sector of the erase group.
CMD33	ac	[31:0] data address	R1	TAG_SECTOR_END	Sets the address of the last sector in a continuous range within the selection of a single sector to be selected for erase.
CMD34	ac	[31:0] data address	R1	UNTAG_SECTOR	Removes one previously selected sector from the erase selection.
CMD35	ac	[31:0] data address	R1	TAG_ERASE_GROUP_START	Sets the address of the first erase group within a range to be selected for erase.
CMD36	ac	[31:0] data address	R1	TAG_ERASE_GROUP_END	Sets the address of the last erase group within a continuous range to be selected for erase.
CMD37	ac	[31:0] data address	R1	UNTAG_ERASE_GROUP	Removes one previously selected erase group from the erase selection.
CMD38	ac	[31:0] stuff bits	R1b	ERASE	Erase all previously selected sectors.
CMD39	ac	[31:0] RCA [15] register write flag [14:8] register address [7:0] register data	R4	FAST_IO	Used to write and read 8-bit (register) data fields. The command addresses a card, and a register, and provides the data for writing if the write flag is set. The R4 response contains data read from the address register. This

Table continues on the next page...

Table 58-3. Commands for MMC/SD/SDIO Cards (continued)

CMD INDEX	Type	Argument	Response type	Abbreviation	Description
					command accesses application dependent registers which are not defined in the MMC standard.
CMD40	bcr	[31:0] stuff bits	R5	GO_IRQ_STATE	Sets the system into interrupt mode.
CMD41	Reserved				
CDM42	adtc	[31:0] stuff bits	R1b	LOCK_UNLOCK	Used to set/reset the password or lock/unlock the card. The size of the data block is set by the SET_BLOCK_LEN command.
CMD43~51	Reserved				
CMD52	ac	[31:0] stuff bits	R5	IO_RW_DIRECT	Access a single register within the total 128k of register space in any I/O function.
CMD53	ac	[31:0] stuff bits	R5	IO_RW_EXTENDED	Accesses a multiple I/O register with a single command. Allows the reading or writing of a large number of I/O registers.
CMD54	Reserved				
CMD55	ac	[31:16] RCA [15:0] stuff bits	R1	APP_CMD	Indicates to the card that the next command is an application specific command rather than a standard command.
CMD56	adtc	[31:1] stuff bits [0]: RD/WR	R1b	GEN_CMD	Used either to transfer a data block to the card or to get a data block from the card for general purpose / application specific commands. The size of the data block is set by the SET_BLOCK_LEN command.
CMD57-59	Reserved				
CMD60	adtc	[31] WR [30:24] stuff bits [23:16] address [15:8] stuff bits [7:0] byte count	R1b	RW_MULTIPLE_REGI STER	These registers are used to control the behavior of the device and to retrieve status information regarding the operation of the device. All Status and Control registers are WORD (32-bit) in size and are WORD aligned. CMD60 shall be used to read and write these registers.
CMD61	adtc	[31] WR [30:16] stuff bits [15:0] data unit count	R1b	RW_MULTIPLE_BLO CK	The host issues a RW_MULTIPLE_BLOCK (CMD61) to begin the data transfer.
CMD62-63	Reserved				
ACMD6 ⁴	ac	[31:2] stuff bits [1:0] bus width	R1	SET_BUS_WIDTH	Defines the data bus width ('00'=1bit or '10'=4bit bus) to be used for data transfer. The allowed data bus widths are given in SCR register.

Table continues on the next page...

Table 58-3. Commands for MMC/SD/SDIO Cards (continued)

CMD INDEX	Type	Argument	Response type	Abbreviation	Description
ACMD13 ⁴	adtc	[31:0] stuff bits	R1	SD_STATUS	Send the SD Memory Card status.
ACMD22 ⁴	adtc	[31:0] stuff bits	R1	SEND_NUM_WR_SECTORS	Send the number of the written sectors (without errors). Responds with 32-bit plus the CRC data block.
ACMD23 ⁴	ac	[31:23] stuff bits [22:0] Number of blocks	R1	SET_WR_BLK_ERASE_COUNT	Set the number of write blocks to be pre-erased before writing (to be used for fast Multiple Block WR command). "1"=default(one write block).
ACMD41 ⁴	bcr	[31:0] OCR	R3	SD_APP_OP_COND	Asks the accessed card to send its operating condition register (OCR) contents in the response on the CMD line.
ACMD42 ⁴	ac	[31:1] stuff bits [0] set_cd	R1	SET_CLR_CARD_DETECT	Connect(1)/Disconnect(0) the 50KOhm pull-up resistor on CD_B/DATA3 of the card.
ACMD51 ⁴	adtc	[31:0] stuff bits	R1	SEND_SCR	Reads the SD Configuration Register (SCR).

1. CMD3 differs for MMC and SD cards. For MMC cards, it is referred to as SET_RELATIVE_ADDR, with a response type of R1. For SD cards, it is referred to as SEND_RELATIVE_ADDR, with a response type of R6 (with RCA inside).
2. CMD6 differs completely between high speed MMC cards and high speed SD cards. Command SWITCH_FUNC is for high speed SD cards.
3. Command SWITCH is for high speed MMC cards. The Index field can contain any value from 0-255, but only values 0-191 are valid. If the Index value is in the 192-255 range the card does not perform any modification and the SWITCH_ERROR status bit in the EXT_CSD register is set. The Access Bits are shown in [Table 2](#).
4. ACMDs shall be preceded with the APP_CMD command. (Commands listed are used for SD only, other SD commands not listed are not supported on this module).

The Access Bits for the EXT_CSD Access Modes are shown below.

Table 58-4. EXT_CSD Access Modes

Bits	Access Name	Operation
00	Command Set	The command set is changed according to the Cmd Set field of the argument
01	Set Bits	The bits in the pointed byte are set, according to the 1 bits in the Value field.
10	Clear Bits	The bits in the pointed byte are cleared, according to the 1 bits in the Value field.
11	Write Byte	The Value field is written into the pointed byte.

58.7 Software Restrictions

58.7.1 Initialization Active

The driver cannot set INITA bit in System Control register when any of the command line or data lines is active, so the driver must ensure both CDIHB and CIHB bits are cleared.

58.7.2 Software Polling Procedure

For polling read or write, once the software begins a buffer read or write, it must access exactly the number of times as the values set in the Watermark Level Register; moreover, if the block size is not a multiple of the value in Watermark Level Register (read and write respectively), the software must access exactly the remaining number of words at the end of each block.

For example, for a read operation, if the RD_WML is 4, indicating the watermark level is 16 bytes, block size is 40 bytes, and the block number is 2, then the access times for the burst sequence in the whole transfer process must be 4, 4, 2, 4, 4, 2.

58.7.3 Suspend Operation

In order to suspend the data transfer, the software must inform uSDHC that the suspend command is successfully accepted. To achieve this, after the Suspend command is accepted by the SDIO card, software must send another normal command marked as suspend command (CMDTYP bits set as '01') to inform uSDHC that the transfer is suspended.

If software needs to resume the suspended transfer, it should read the value in BLKCNT register to save the remaining number of blocks before sending the normal command marked as suspend, otherwise on sending such 'suspend' command, uSDHC will regard the current transfer is aborted and change BLKCNT register to its original value, instead of keeping the remained number of blocks.

58.7.4 Data Length Setting

For either ADMA (ADMA1 or ADMA2) transfer, the data in the data buffer must be word aligned, so the data length set in the descriptor must be a multiple of 4.

58.7.5 (A)DMA Address Setting

To configure ADMA1/ADMA2/DMA address register, when TC bit is set, the register will always update itself with the internal address value to support dynamic address synchronization, so the software must ensure that the TC bit is cleared prior to configuring ADMA1/ADMA2/DMA address register.

58.7.6 Data Port Access

Data Port does not support parallel access. For example, during an external DMA access, it is not allowed to write any data to the Data Port by CPU; or during a CPU read operation, it is also prohibited to write any data to the Data Port, by either CPU or external DMA. Otherwise the data would be corrupted inside the uSDHC buffer.

58.7.7 Change Clock Frequency

uSDHC does not automatically gate off the card clock when the Host Driver changes the clock frequency. To prevent possible glitch on the card clock, clear the FRC_SDCLK_ON bit when changing clock divisor value(SDCLKFS or DVS in System Control Register) or setting RSTA bit.

Also before changing the clock divisor value, Host Driver should make sure the SDSTB bit is high.

58.7.8 Multi-block Read

For pre-defined multi-block read operation, i.e., the number of blocks to read has been defined by previous CMD23 for MMC, or pre-defined number of blocks in CMD53 for SDIO/SDCombo, or whatever multi-block read without abort command at card side, an abort command, either automatic or manual CMD12/CMD52, is still required by uSDHC after the pre-defined number of blocks are done, to drive the internal state machine to idle mode.

In this case, the card may not respond to this extra abort command and uSDHC will get Response Timeout. It is recommended to manually send an abort command with RSPTYP[1:0] both bits cleared.

58.8 uSDHC Memory Map/Register Definition

This section includes the module memory map and detailed descriptions of all registers.

See the table below for the register memory map for the uSDHC. All these registers only support 32-bit accesses.

NOTE

The uSDHC registers are 32-bit wide and only support 32-bit access.

uSDHC memory map

Absolute address (hex)	Register name	Width (in bits)	Access	Reset value	Section/page
219_0000	DMA System Address (uSDHC1_DS_ADDR)	32	R/W	0000_0000h	58.8.1/4014
219_0004	Block Attributes (uSDHC1_BLK_ATT)	32	R/W	0000_0000h	58.8.2/4015
219_0008	Command Argument (uSDHC1_CMD_ARG)	32	R/W	0000_0000h	58.8.3/4017
219_000C	Command Transfer Type (uSDHC1_CMD_XFR_TYP)	32	R/W	0000_0000h	58.8.4/4017
219_0010	Command Response0 (uSDHC1_CMD_RSP0)	32	R	0000_0000h	58.8.5/4021
219_0014	Command Response1 (uSDHC1_CMD_RSP1)	32	R	0000_0000h	58.8.6/4021
219_0018	Command Response2 (uSDHC1_CMD_RSP2)	32	R	0000_0000h	58.8.7/4022
219_001C	Command Response3 (uSDHC1_CMD_RSP3)	32	R	0000_0000h	58.8.8/4022
219_0020	Data Buffer Access Port (uSDHC1_DATA_BUFF_ACC_PORT)	32	R/W	0000_0000h	58.8.9/4024
219_0024	Present State (uSDHC1_PRES_STATE)	32	R	0000_8080h	58.8.10/4024
219_0028	Protocol Control (uSDHC1_PROT_CTRL)	32	R/W	0880_0020h	58.8.11/4030
219_002C	System Control (uSDHC1_SYS_CTRL)	32	R/W	8080_800Fh	58.8.12/4035
219_0030	Interrupt Status (uSDHC1_INT_STATUS)	32	w1c	0000_0000h	58.8.13/4038
219_0034	Interrupt Status Enable (uSDHC1_INT_STATUS_EN)	32	R/W	0000_0000h	58.8.14/4044
219_0038	Interrupt Signal Enable (uSDHC1_INT_SIGNAL_EN)	32	R/W	0000_0000h	58.8.15/4047
219_003C	Auto CMD12 Error Status (uSDHC1_AUTOCMD12_ERR_STATUS)	32	R	0000_0000h	58.8.16/4050
219_0040	Host Controller Capabilities (uSDHC1_HOST_CTRL_CAP)	32	R	07F3_B407h	58.8.17/4053
219_0044	Watermark Level (uSDHC1_WTMK_LVL)	32	R/W	0810_0810h	58.8.18/4056
219_0048	Mixer Control (uSDHC1_MIX_CTRL)	32	R/W	8000_0000h	58.8.19/4057

Table continues on the next page...

uSDHC memory map (continued)

Absolute address (hex)	Register name	Width (in bits)	Access	Reset value	Section/page
219_0050	Force Event (uSDHC1_FORCE_EVENT)	32	W (always reads 0)	0000_0000h	58.8.20/4059
219_0054	ADMA Error Status Register (uSDHC1_ADMA_ERR_STATUS)	32	R	0000_0000h	58.8.21/4062
219_0058	ADMA System Address (uSDHC1_ADMA_SYS_ADDR)	32	R/W	0000_0000h	58.8.22/4064
219_0060	DLL (Delay Line) Control (uSDHC1_DLL_CTRL)	32	R/W	0000_0200h	58.8.23/4065
219_0064	DLL Status (uSDHC1_DLL_STATUS)	32	R	0000_0000h	58.8.24/4067
219_0068	CLK Tuning Control and Status (uSDHC1_CLK_TUNE_CTRL_STATUS)	32	R/W	0000_0000h	58.8.25/4068
219_00C0	Vendor Specific Register (uSDHC1_VEND_SPEC)	32	R/W	2000_7809h	58.8.26/4070
219_00C4	MMC Boot Register (uSDHC1_MMC_BOOT)	32	R/W	0000_0000h	58.8.27/4073
219_00C8	Vendor Specific 2 Register (uSDHC1_VEND_SPEC2)	32	R/W	0000_0006h	58.8.28/4074
219_00CC	Tuning Control Register (uSDHC1_TUNING_CTRL)	32	R/W	0021_2800h	58.8.29/4076
219_4000	DMA System Address (uSDHC2_DS_ADDR)	32	R/W	0000_0000h	58.8.1/4014
219_4004	Block Attributes (uSDHC2_BLK_ATT)	32	R/W	0000_0000h	58.8.2/4015
219_4008	Command Argument (uSDHC2_CMD_ARG)	32	R/W	0000_0000h	58.8.3/4017
219_400C	Command Transfer Type (uSDHC2_CMD_XFR_TYP)	32	R/W	0000_0000h	58.8.4/4017
219_4010	Command Response0 (uSDHC2_CMD_RSP0)	32	R	0000_0000h	58.8.5/4021
219_4014	Command Response1 (uSDHC2_CMD_RSP1)	32	R	0000_0000h	58.8.6/4021
219_4018	Command Response2 (uSDHC2_CMD_RSP2)	32	R	0000_0000h	58.8.7/4022
219_401C	Command Response3 (uSDHC2_CMD_RSP3)	32	R	0000_0000h	58.8.8/4022
219_4020	Data Buffer Access Port (uSDHC2_DATA_BUFF_ACC_PORT)	32	R/W	0000_0000h	58.8.9/4024
219_4024	Present State (uSDHC2_PRES_STATE)	32	R	0000_8080h	58.8.10/4024
219_4028	Protocol Control (uSDHC2_PROT_CTRL)	32	R/W	0880_0020h	58.8.11/4030
219_402C	System Control (uSDHC2_SYS_CTRL)	32	R/W	8080_800Fh	58.8.12/4035
219_4030	Interrupt Status (uSDHC2_INT_STATUS)	32	w1c	0000_0000h	58.8.13/4038
219_4034	Interrupt Status Enable (uSDHC2_INT_STATUS_EN)	32	R/W	0000_0000h	58.8.14/4044
219_4038	Interrupt Signal Enable (uSDHC2_INT_SIGNAL_EN)	32	R/W	0000_0000h	58.8.15/4047

Table continues on the next page...

uSDHC memory map (continued)

Absolute address (hex)	Register name	Width (in bits)	Access	Reset value	Section/page
219_403C	Auto CMD12 Error Status (uSDHC2_AUTOCMD12_ERR_STATUS)	32	R	0000_0000h	58.8.16/4050
219_4040	Host Controller Capabilities (uSDHC2_HOST_CTRL_CAP)	32	R	07F3_B407h	58.8.17/4053
219_4044	Watermark Level (uSDHC2_WTMK_LVL)	32	R/W	0810_0810h	58.8.18/4056
219_4048	Mixer Control (uSDHC2_MIX_CTRL)	32	R/W	8000_0000h	58.8.19/4057
219_4050	Force Event (uSDHC2_FORCE_EVENT)	32	W (always reads 0)	0000_0000h	58.8.20/4059
219_4054	ADMA Error Status Register (uSDHC2_ADMA_ERR_STATUS)	32	R	0000_0000h	58.8.21/4062
219_4058	ADMA System Address (uSDHC2_ADMA_SYS_ADDR)	32	R/W	0000_0000h	58.8.22/4064
219_4060	DLL (Delay Line) Control (uSDHC2_DLL_CTRL)	32	R/W	0000_0200h	58.8.23/4065
219_4064	DLL Status (uSDHC2_DLL_STATUS)	32	R	0000_0000h	58.8.24/4067
219_4068	CLK Tuning Control and Status (uSDHC2_CLK_TUNE_CTRL_STATUS)	32	R/W	0000_0000h	58.8.25/4068
219_40C0	Vendor Specific Register (uSDHC2_VEND_SPEC)	32	R/W	2000_7809h	58.8.26/4070
219_40C4	MMC Boot Register (uSDHC2_MMC_BOOT)	32	R/W	0000_0000h	58.8.27/4073
219_40C8	Vendor Specific 2 Register (uSDHC2_VEND_SPEC2)	32	R/W	0000_0006h	58.8.28/4074
219_40CC	Tuning Control Register (uSDHC2_TUNING_CTRL)	32	R/W	0021_2800h	58.8.29/4076

58.8.1 DMA System Address (uSDHCx_DS_ADDR)

This register contains the physical system memory address used for DMA transfers.

Address: Base address + 0h offset

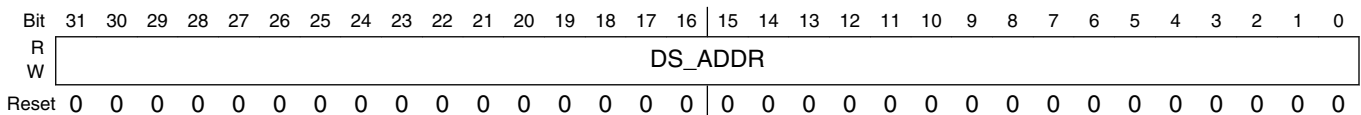

uSDHCx_DS_ADDR field descriptions

Field	Description
DS_ADDR	<p>DMA System Address / Argument 2</p> <p>When ACMD23_ARGU2_EN is set to 0, SDMA uses this register as system address and supports only 32-bit addressing mode. Auto CMD23 cannot be used with SDMA. When ACMD23_ARGU2_EN is set to 1, SDMA uses ADMA System Address register (05Fh – 058h) instead of this register to support both 32-bit and 64-bit addressing. This register is used only for Argument2 and SDMA may use Auto CMD23.</p> <p>1. SDMA System Address</p> <p>Since the address must be word (4 bytes) aligned, the least 2 bits are reserved, always 0. When the uSDHC stops a DMA transfer, this register points out the system address of the next contiguous data position. It can be accessed only when no transaction is executing (i.e. after a transaction has stopped). Read operation during transfers may return an invalid value. The Host Driver shall initialize this register before starting a DMA transaction. After DMA has stopped, the system address of the next contiguous data position can be read from this register.</p> <p>This register is protected during a data transfer. When data lines are active, write to this register is ignored. The Host driver shall wait, until the DLA bit in the Present State register is cleared, before writing to this register.</p> <p>The uSDHC internal DMA does not support a virtual memory system. It only supports continuous physical memory access. And due to AHB burst limitations, if the burst must cross the 1 KB boundary, uSDHC will automatically change SEQ burst type to NSEQ.</p> <p>Since this register supports dynamic address reflecting, when TC bit is set, it automatically alters the value of internal address counter, so SW cannot change this register when TC bit is set. Such restriction is also listed in Software Restrictions.</p> <p>2. Argument 2</p> <p>This register is used with the Auto CMD23 to set a 32-bit block count value to the argument of the CMD23 while executing Auto CMD23.</p> <p>If Auto CMD23 is used with ADMA, the full 32-bit block count value can be used. If Auto CMD23 is used without ADMA, the available block count value is limited by the Block Count register. 65535 blocks is the maximum value in this case.</p>

58.8.2 Block Attributes (uSDHCx_BLK_ATT)

This register is used to configure the number of data blocks and the number of bytes in each block.

Address: Base address + 4h offset

Bit	31	30	29	28	27	26	25	24	23	22	21	20	19	18	17	16	15	14	13	12	11	10	9	8	7	6	5	4	3	2	1	0
R	BLKCNT																0	BLKSIZE[12:0]														
W																																
Reset	0	0	0	0	0	0	0	0	0	0	0	0	0	0	0	0	0	0	0	0	0	0	0	0	0	0	0	0	0	0	0	0

uSDHCx_BLK_ATT field descriptions

Field	Description
31–16 BLKCNT	Blocks Count For Current Transfer:

Table continues on the next page...

uSDHCx_BLK_ATT field descriptions (continued)

Field	Description
	<p>This register is enabled when the Block Count Enable bit in the Transfer Mode register is set to 1 and is valid only for multiple block transfers. For single block transfer, this register will always read as 1. The Host Driver shall set this register to a value between 1 and the maximum block count. The uSDHC decrements the block count after each block transfer and stops when the count reaches zero. Setting the block count to 0 results in no data blocks being transferred.</p> <p>This register should be accessed only when no transaction is executing (i.e. after transactions are stopped). During data transfer, read operations on this register may return an invalid value and write operations are ignored.</p> <p>When saving transfer content as a result of a Suspend command, the number of blocks yet to be transferred can be determined by reading this register. The reading of this register should be applied after transfer is paused by stop at block gap operation and before sending the command marked as suspend. This is because when Suspend command is sent out, uSDHC will regard the current transfer is aborted and change BLKCNT register back to its original value instead of keeping the dynamical indicator of remained block count.</p> <p>When restoring transfer content prior to issuing a Resume command, the Host Driver shall restore the previously saved block count.</p> <p>NOTE: Although the BLKCNT field is 0 after reset, the read of reset value is 0x1. This is because when MSBSEL bit is indicating a single block transfer, the read value of BLKCNT is always 1.</p> <p>FFFF 65535 blocks 0002 2 blocks 0001 1 block 0000 Stop Count</p>
<p>15–13 Reserved</p>	<p>This read-only field is reserved and always has the value 0.</p>
<p>BLKSIZE[12:0]</p>	<p>Transfer Block Size:</p> <p>This register specifies the block size for block data transfers. Values ranging from 1 byte up to the maximum buffer size can be set. It can be accessed only when no transaction is executing (i.e. after a transaction has stopped). Read operations during transfers may return an invalid value, and write operations will be ignored.</p> <p>1000 4096 Bytes 800 2048 Bytes 200 512 Bytes 1FF 511 Bytes 004 4 Bytes 003 3 Bytes 002 2 Bytes 001 1 Byte 000 No data transfer</p>

58.8.3 Command Argument (uSDHCx_CMD_ARG)

This register contains the SD / MMC Command Argument.

Address: Base address + 8h offset

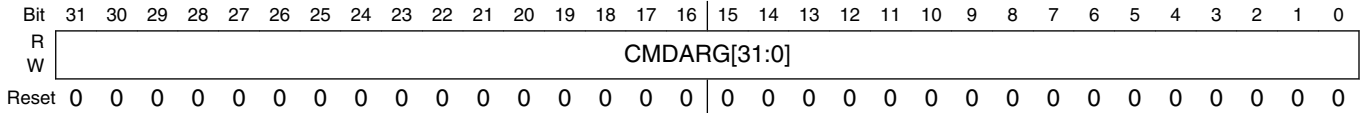

uSDHCx_CMD_ARG field descriptions

Field	Description
CMDARG[31:0]	<p>Command Argument</p> <p>The SD / MMC Command Argument is specified as bits 39-8 of the Command Format in the SD or MMC Specification. This register is write protected when the Command Inhibit (CMD) bit in the Present State register is set.</p>

58.8.4 Command Transfer Type (uSDHCx_CMD_XFR_TYP)

This register is used to control the operation of data transfers. The Host Driver shall set this register before issuing a command followed by a data transfer, or before issuing a Resume command. To prevent data loss, the uSDHC prevents writing to the bits, that are involved in the data transfer of this register, when data transfer is active. These bits are DPSEL, MBSEL, DTDSEL, AC12EN, BCEN and DMAEN.

The Host Driver shall check the Command Inhibit DAT bit (CDIHB) and the Command Inhibit CMD bit (CIHB) in the Present State register before writing to this register. When the CDIHB bit in the Present State register is set, any attempt to send a command with data by writing to this register is ignored; when the CIHB bit is set, any write to this register is ignored.

On sending commands with data transfer involved, it is mandatory that the block size is non-zero. Block count must also be non-zero, or indicated as single block transfer (bit 5 of this register is '0' when written), or block count is disabled (bit 1 of this register is '0' when written), otherwise uSDHC will ignore the sending of this command and do nothing. For write command, with all above restrictions, it is also mandatory that the write protect switch is not active (WPSPL bit of Present State Register is '1'), otherwise uSDHC will also ignore the command.

If the commands with data transfer does not receive the response in 64 clock cycles, i.e., response time-out, uSDHC will regard the external device does not accept the command and abort the data transfer. In this scenario, the driver should issue the command again to re-try the transfer. It is also possible that for some reason the card responds the command but uSDHC does not receive the response, and if it is internal DMA (either simple DMA or ADMA) read operation, the external system memory is over-written by the internal DMA with data sent back from the card.

The table below shows the summary of how register settings determine the type of data transfer.

Table 58-5. Transfer Type Register Setting for Various Transfer Types

Multi/Single Block Select	Block Count Enable	Block Count	Function
0	Don't Care	Don't Care	Single Transfer
1	0	Don't Care	Infinite Transfer
1	1	Positive Number	Multiple Transfer
1	1	Zero	No Data Transfer

The table below shows the relationship between the Command Index Check Enable and the Command CRC Check Enable, in regards to the Response Type bits as well as the name of the response type.

Table 58-6. Relationship Between Parameters and the Name of the Response Type

Response Type	Index Check Enable	CRC Check Enable	Name of Response Type
00	0	0	No Response
01	0	1	R2
10	0	0	R3,R4
10	1	1	R1,R5,R6
11	1	1	R1b,R5b

- In the SDIO specification, response type notation for R5b is not defined. R5 includes R5b in the SDIO specification. But R5b is defined in this specification to specify that the uSDHC will check the busy status after receiving a response. For example, usually CMD52 is used with R5, but the I/O abort command shall be used with R5b.
- The CRC field for R3 and R4 is expected to be all 1 bits. The CRC check shall be disabled for these response types.

Address: Base address + Ch offset

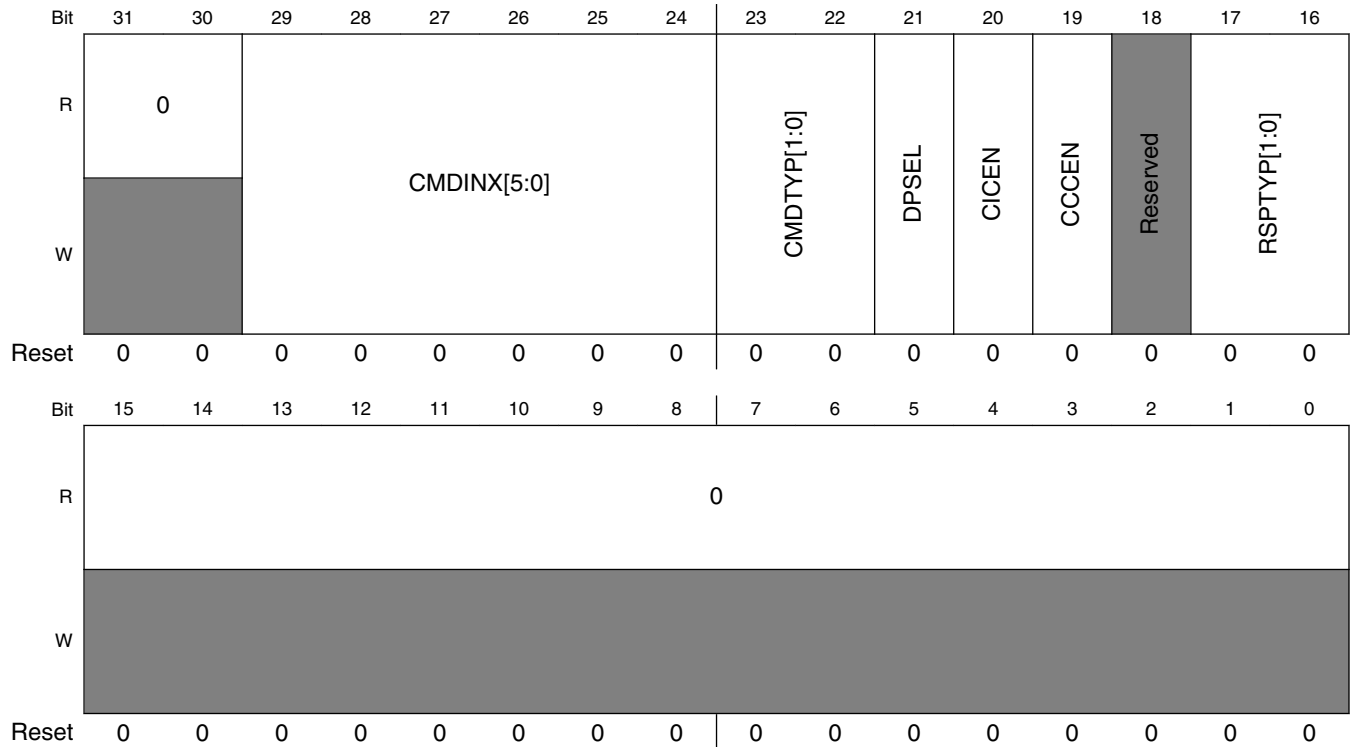

uSDHCx_CMD_XFR_TYP field descriptions

Field	Description
31–30 Reserved	This read-only field is reserved and always has the value 0.
29–24 CMDINX[5:0]	Command Index These bits shall be set to the command number that is specified in bits 45-40 of the Command-Format in the SD Memory Card Physical Layer Specification and SDIO Card Specification.
23–22 CMDTYP[1:0]	Command Type There are three types of special commands: Suspend, Resume and Abort. These bits shall be set to 00b for all other commands. <ul style="list-style-type: none"> • Suspend Command: If the Suspend command succeeds, the uSDHC shall assume that the card bus has been released and that it is possible to issue the next command which uses the DATA line. Since the uSDHC does not monitor the content of command response, it does not know if the Suspend command succeeded or not. It is the Host Driver's responsibility to check the status of the Suspend command and send another command marked as Suspend to inform the uSDHC that a Suspend command was successfully issued. Refer to Suspend Resume for more details. After the end bit of command is sent, the uSDHC de-asserts Read Wait for read transactions and stops checking busy for write transactions. In 4-bit mode, the interrupt cycle starts. If the Suspend command fails, the uSDHC will maintain its current state, and the Host Driver shall restart the transfer by setting the Continue Request bit in the Protocol Control register. • Resume Command: The Host Driver re-starts the data transfer by restoring the registers saved before sending the Suspend Command and then sends the Resume Command. The uSDHC will check for a pending busy state before starting write transfers. • Abort Command: If this command is set when executing a read transfer, the uSDHC will stop reads to the buffer. If this command is set when executing a write transfer, the uSDHC will stop driving the DATA line. After issuing the Abort command, the Host Driver should issue a software reset (Abort Transaction).

Table continues on the next page...

uSDHCx_CMD_XFR_TYP field descriptions (continued)

Field	Description
	11 Abort CMD12, CMD52 for writing I/O Abort in CCCR 10 Resume CMD52 for writing Function Select in CCCR 01 Suspend CMD52 for writing Bus Suspend in CCCR 00 Normal Other commands
21 DPSEL	Data Present Select This bit is set to 1 to indicate that data is present and shall be transferred using the DATA line. It is set to 0 for the following: <ul style="list-style-type: none"> • Commands using only the CMD line (e.g. CMD52). • Commands with no data transfer, but using the busy signal on DATA0 line (R1b or R5b e.g. CMD38) <p>NOTE: In resume command, this bit shall be set, and other bits in this register shall be set the same as when the transfer was initially launched. When the Write Protect switch is on, (i.e. the WPSPL bit is active as '0'), any command with a write operation will be ignored. That is to say, when this bit is set, while the DTDSEL bit is 0, writes to the register Transfer Type are ignored.</p> 1 Data Present 0 No Data Present
20 CICEN	Command Index Check Enable If this bit is set to 1, the uSDHC will check the Index field in the response to see if it has the same value as the command index. If it is not, it is reported as a Command Index Error. If this bit is set to 0, the Index field is not checked. 1 Enable 0 Disable
19 CCEN	Command CRC Check Enable If this bit is set to 1, the uSDHC shall check the CRC field in the response. If an error is detected, it is reported as a Command CRC Error. If this bit is set to 0, the CRC field is not checked. The number of bits checked by the CRC field value changes according to the length of the response. (Refer to RSPTYP[1:0] and Command Transfer Type (uSDHC_CMD_XFR_TYP) .) 1 Enable 0 Disable
18 -	This field is reserved. Reserved
17–16 RSPTYP[1:0]	Response Type Select 00 No Response 01 Response Length 136 10 Response Length 48 11 Response Length 48, check Busy after response
Reserved	This read-only field is reserved and always has the value 0.

58.8.5 Command Response0 (uSDHCx_CMD_RSP0)

This register is used to store part 0 of the response bits from the card.

Address: Base address + 10h offset

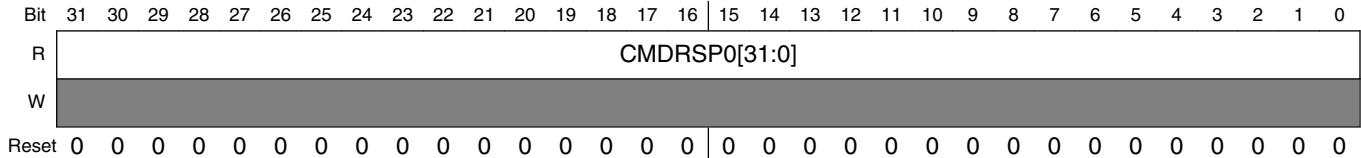

uSDHCx_CMD_RSP0 field descriptions

Field	Description
CMDRSP0[31:0]	Command Response 0 Refer to Command Response3 (uSDHC_CMD_RSP3) for the mapping of command responses from the SD Bus to this register for each response type.

58.8.6 Command Response1 (uSDHCx_CMD_RSP1)

This register is used to store part 1 of the response bits from the card.

Address: Base address + 14h offset

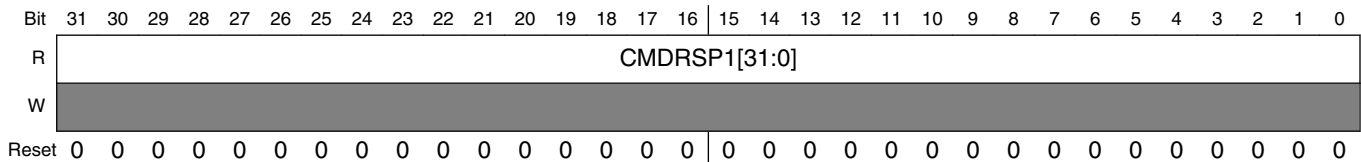

uSDHCx_CMD_RSP1 field descriptions

Field	Description
CMDRSP1[31:0]	Command Response 1 Refer to Command Response3 (uSDHC_CMD_RSP3) for the mapping of command responses from the SD Bus to this register for each response type.

58.8.7 Command Response2 (uSDHCx_CMD_RSP2)

This register is used to store part 2 of the response bits from the card.

Address: Base address + 18h offset

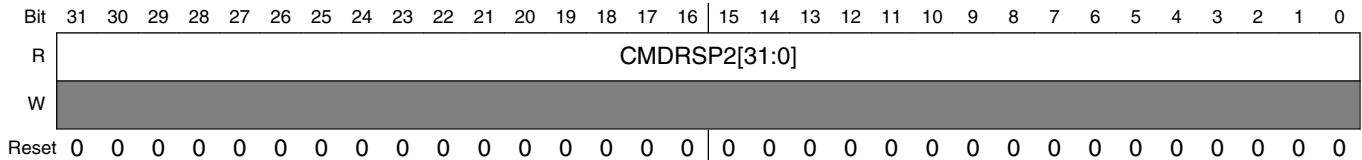

uSDHCx_CMD_RSP2 field descriptions

Field	Description
CMDRSP2[31:0]	Command Response 2 Refer to Command Response3 (uSDHC_CMD_RSP3) for the mapping of command responses from the SD Bus to this register for each response type.

58.8.8 Command Response3 (uSDHCx_CMD_RSP3)

This register is used to store part 3 of the response bits from the card.

The table below describes the mapping of command responses from the SD Bus to Command Response registers for each response type. In the table, R[] refers to a bit range within the response data as transmitted on the SD Bus.

Table 58-7. Response Bit Definition for Each Response Type

Response Type	Meaning of Response	Response Field	Response Register
R1,R1b (normal response)	Card Status	R[39:8]	CMDRSP0
R1b (Auto CMD12 response)	Card Status for Auto CMD12	R[39:8]	CMDRSP3
R2 (CID, CSD register)	CID/CSD register [127:8]	R[127:8]	{CMDRSP3[23:0], CMDRSP2, CMDRSP1, CMDRSP0}
R3 (OCR register)	OCR register for memory	R[39:8]	CMDRSP0
R4 (OCR register)	OCR register for I/O etc.	R[39:8]	CMDRSP0
R5, R5b	SDIO response	R[39:8]	CMDRSP0
R6 (Publish RCA)	New Published RCA[31:16] and card status[15:0]	R[39:9]	CMDRSP0

This table shows that most responses with a length of 48 (R[47:0]) have 32-bits of the response data (R[39:8]) stored in the CMDRSP0 register. Responses of type R1b (Auto CMD12 responses) have response data bits (R[39:8]) stored in the CMDRSP3 register. Responses with length 136 (R[135:0]) have 120-bits of the response data (R[127:8]) stored in the CMDRSP0, 1, 2, and 3 registers.

To be able to read the response status efficiently, the uSDHC only stores part of the response data in the Command Response registers. This enables the Host Driver to efficiently read 32-bits of response data in one read cycle on a 32-bit bus system. Parts of the response, the Index field and the CRC, are checked by the uSDHC (as specified by the Command Index Check Enable and the Command CRC Check Enable bits in the Transfer Type register) and generate an error interrupt if any error is detected. The bit range for the CRC check depends on the response length. If the response length is 48, the uSDHC will check R[47:1], and if the response length is 136 the uSDHC will check R[119:1].

Since the uSDHC may have a multiple block data transfer executing concurrently with a CMD_wo_DAT command, the uSDHC stores the Auto CMD12 response in the CMDRSP3 register. The CMD_wo_DAT response is stored in CMDRSP0. This allows the uSDHC to avoid overwriting the Auto CMD12 response with the CMD_wo_DAT and vice versa. When the uSDHC modifies part of the Command Response registers, as shown in the table above, it preserves the unmodified bits.

Address: Base address + 1Ch offset

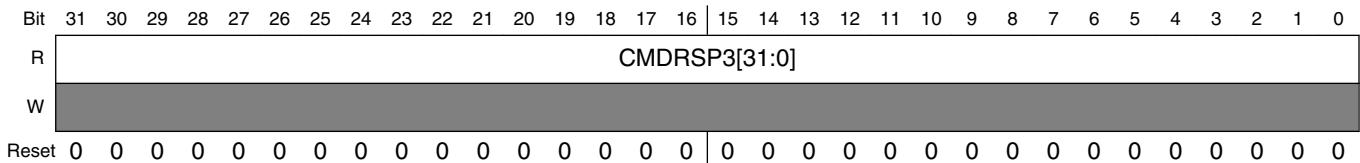

uSDHCx_CMD_RSP3 field descriptions

Field	Description
CMDRSP3[31:0]	Command Response 3 Refer to Command Response3 (uSDHC_CMD_RSP3) for the mapping of command responses from the SD Bus to this register for each response type.

58.8.9 Data Buffer Access Port (uSDHCx_DATA_BUFF_ACC_PORT)

This is a 32-bit data port register used to access the internal buffer.

Address: Base address + 20h offset

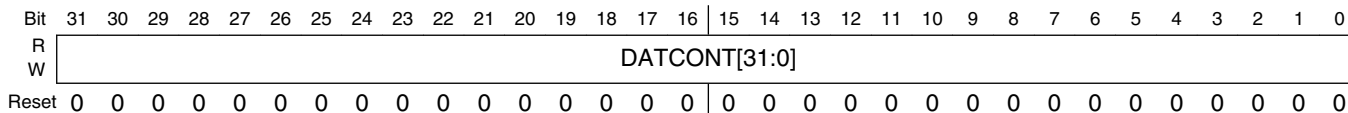

uSDHCx_DATA_BUFF_ACC_PORT field descriptions

Field	Description
DATCONT[31:0]	<p>Data Content</p> <p>The Buffer Data Port register is for 32-bit data access by the Arm platform or the external DMA. When the internal DMA is enabled, any write to this register is ignored, and any read from this register will always yield 0s.</p>

58.8.10 Present State (uSDHCx_PRES_STATE)

The Host Driver can get status of the uSDHC from this 32-bit read only register.

- The Host Driver can issue CMD0, CMD12, CMD13 (for memory) and CMD52 (for SDIO) when the DATA lines are busy during a data transfer. These commands can be issued when Command Inhibit (CMD) is set to zero. Other commands shall be issued when Command Inhibit (DATA) is set to zero. Possible changes to the SD Physical Specification may add other commands to this list in the future.
- Note: the reset value of Present State Register depend on testbench connectivity.

Address: Base address + 24h offset

Bit	31	30	29	28	27	26	25	24	23	22	21	20	19	18	17	16	
R	DLSL[7:0]								CLSL	0				WPSPL	CDPL	0	CINST
W	[Shaded]																
Reset	0	0	0	0	0	0	0	0	0	0	0	0	0	0	0	0	
Bit	15	14	13	12	11	10	9	8	7	6	5	4	3	2	1	0	
R	TSCD	0		RTR	BREN	BWEN	RTA	WTA	SDOFF	PEROFF	HCKOFF	IPGOFF	SDSTB	DLA	CDIHB	CIHB	
W	[Shaded]																
Reset	1	0	0	0	0	0	0	0	1	0	0	0	0	0	0	0	

uSDHCx_PRES_STATE field descriptions

Field	Description
31–24 DLSL[7:0]	<p>DATA[7:0] Line Signal Level</p> <p>This status is used to check the DATA line level to recover from errors, and for debugging. This is especially useful in detecting the busy signal level from DATA0. The reset value is affected by the external pull-up / pull-down resistors. By default, the read value of this bit field after reset is 8'b11110111, when DATA3 is pulled down and the other lines are pulled up.</p> <p>DATA7 Data 7 line signal level DATA6 Data 6 line signal level DATA5 Data 5 line signal level DATA4 Data 4 line signal level DATA3 Data 3 line signal level DATA2 Data 2 line signal level DATA1 Data 1 line signal level DATA0 Data 0 line signal level</p>

Table continues on the next page...

uSDHCx_PRES_STATE field descriptions (continued)

Field	Description
23 CLSL	<p>CMD Line Signal Level</p> <p>This status is used to check the CMD line level to recover from errors, and for debugging. The reset value is affected by the external pull-up / pull-down resistor, by default, the read value of this bit after reset is 1'b1, when the command line is pulled up.</p>
22–20 Reserved	<p>This read-only field is reserved and always has the value 0.</p>
19 WPSPL	<p>Write Protect Switch Pin Level</p> <p>The Write Protect Switch is supported for memory and combo cards. This bit reflects the inverted value of the WP pin of the card socket. A software reset does not affect this bit. The reset value is effected by the external write protect switch. If the WP pin is not used, it should be tied low, so that the reset value of this bit is high and write is enabled.</p> <p>1 Write enabled (WP = 0) 0 Write protected (WP = 1)</p>
18 CDPL	<p>Card Detect Pin Level</p> <p>This bit reflects the inverse value of the CD_B pin for the card socket. Debouncing is not performed on this bit. This bit may be valid, but is not guaranteed, because of propagation delay. Use of this bit is limited to testing since it must be debounced by software. A software reset does not effect this bit. A write to the Force Event Register does not effect this bit. The reset value is effected by the external card detection pin. This bit shows the value on the CD_B pin (i.e. when a card is inserted in the socket, it is 0 on the CD_B input, and consequently the CDPL reads 1.)</p> <p>1 Card present (CD_B = 0) 0 No card present (CD_B = 1)</p>
17 Reserved	<p>This read-only field is reserved and always has the value 0.</p>
16 CINST	<p>Card Inserted</p> <p>This bit indicates whether a card has been inserted. The uSDHC debounces this signal so that the Host Driver will not need to wait for it to stabilize. Changing from a 0 to 1 generates a Card Insertion interrupt in the Interrupt Status register. Changing from a 1 to 0 generates a Card Removal interrupt in the Interrupt Status register. A write to the Force Event Register does not effect this bit.</p> <p>The Software Reset For All in the System Control register does not effect this bit. A software reset does not effect this bit.</p> <p>1 Card Inserted 0 Power on Reset or No Card</p>
15 TSCD	<p>Tape Select Change Done</p> <p>This bit indicates the dealy setting is effective after write CLK_TUNE_CTRL_STATUS register.</p> <p>1 Delay cell select change is finished. 0 Delay cell select change is not finished.</p>
14–13 Reserved	<p>This read-only field is reserved and always has the value 0.</p>
12 RTR	<p>Re-Tuning Request (only for SD3.0 SDR104 mode)</p> <p>Host Controller may request Host Driver to execute re-tuning sequence by setting this bit when the data window is shifted by temperature drift and a tuned sampling point does not have a good margin to receive correct data.</p>

Table continues on the next page...

uSDHCx_PRES_STATE field descriptions (continued)

Field	Description
	<p>This bit is cleared when a command is issued with setting Execute Tuning bit in MIXER_CTRL register.</p> <p>Changing of this bit from 0 to 1 generates Re-Tuning Event. Refer to Interrupt status registers for more detail.</p> <p>This bit isn't set to 1 if Sampling Clock Select in the MIXER_CTRL register is set to 0 (using fixed sampling clock).</p> <p>1 Sampling clock needs re-tuning 0 Fixed or well tuned sampling clock</p>
11 BREN	<p>Buffer Read Enable</p> <p>This status bit is used for non-DMA read transfers. The uSDHC implements an internal buffer to transfer data efficiently. This read only flag indicates that valid data exists in the host side buffer. If this bit is high, valid data greater than the watermark level exist in the buffer. A change of this bit from 1 to 0 occurs when some reads from the buffer(read DATPORT (Base + 0x20)) are made and the buffer hasn't valid data greater than the watermark level. A change of this bit from 0 to 1 occurs when there is enough valid data ready in the buffer and the Buffer Read Ready interrupt has been generated and enabled.</p> <p>1 Read enable 0 Read disable</p>
10 BWEN	<p>Buffer Write Enable</p> <p>This status bit is used for non-DMA write transfers. The uSDHC implements an internal buffer to transfer data efficiently. This read only flag indicates if space is available for write data. If this bit is 1, valid data greater than the watermark level can be written to the buffer. A change of this bit from 1 to 0 occurs when some writes to the buffer(write DATPORT(Base + 0x20)) are made and the buffer hasn't valid space greater than the watermark level. A change of this bit from 0 to 1 occurs when the buffer can hold valid data greater than the write watermark level and the Buffer Write Ready interrupt is generated and enabled.</p> <p>1 Write enable 0 Write disable</p>
9 RTA	<p>Read Transfer Active</p> <p>This status bit is used for detecting completion of a read transfer.</p> <p>This bit is set for either of the following conditions:</p> <ul style="list-style-type: none"> • After the end bit of the read command. • When writing a 1 to the Continue Request bit in the Protocol Control register to restart a read transfer. <p>A Transfer Complete interrupt is generated when this bit changes to 0. This bit is cleared for either of the following conditions:</p> <ul style="list-style-type: none"> • When the last data block as specified by block length is transferred to the System, i.e. all data are read away from uSDHC internal buffer. • When all valid data blocks have been transferred from uSDHC internal buffer to the System and no current block transfers are being sent as a result of the Stop At Block Gap Request being set to 1. <p>1 Transferring data 0 No valid data</p>
8 WTA	<p>Write Transfer Active</p> <p>This status bit indicates a write transfer is active. If this bit is 0, it means no valid write data exists in the uSDHC.</p> <p>This bit is set in either of the following cases:</p>

Table continues on the next page...

uSDHCx_PRES_STATE field descriptions (continued)

Field	Description
	<ul style="list-style-type: none"> • After the end bit of the write command. • When writing 1 to the Continue Request bit in the Protocol Control register to restart a write transfer. <p>This bit is cleared in either of the following cases:</p> <ul style="list-style-type: none"> • After getting the CRC status of the last data block as specified by the transfer count (Single and Multiple). • After getting the CRC status of any block where data transmission is about to be stopped by a Stop At Block Gap Request. <p>During a write transaction, a Block Gap Event interrupt is generated when this bit is changed to 0, as result of the Stop At Block Gap Request being set. This status is useful for the Host Driver in determining when to issue commands during Write Busy state.</p> <p>1 Transferring data 0 No valid data</p>
7 SDOFF	<p>SD Clock Gated Off Internally</p> <p>This status bit indicates that the SD Clock is internally gated off, because of buffer over / under-run or read pause without read wait assertion, or the driver set FRC_SDCLK_ON bit is 0 to stop the SD clock in idle status. Set IPG_PERCLK_SOFT_EN and CARD_CLK_SOFT_EN to 0 also gate off SD clock. This bit is for the Host Driver to debug data transaction on the SD bus.</p> <p>1 SD Clock is gated off. 0 SD Clock is active.</p>
6 PEROFF	<p>IPG_PERCLK Gated Off Internally</p> <p>This status bit indicates that the IPG_PERCLK is internally gated off. This bit is for the Host Driver to debug transaction on the SD bus. When IPG_CLK_SOFT_EN is cleared, IPG_PERCLK will be gated off, otherwise IPG_PERCLK will be always active.</p> <p>1 IPG_PERCLK is gated off. 0 IPG_PERCLK is active.</p>
5 HCKOFF	<p>HCLK Gated Off Internally</p> <p>This status bit indicates that the HCLK is internally gated off. This bit is for the Host Driver to debug during a data transfer.</p> <p>1 HCLK is gated off. 0 HCLK is active.</p>
4 IPGOFF	<p>IPG_CLK Gated Off Internally</p> <p>This status bit indicates that the ipg_clk is internally gated off. This bit is for the Host Driver to debug.</p> <p>1 IPG_CLK is gated off. 0 IPG_CLK is active.</p>
3 SDSTB	<p>SD Clock Stable</p> <p>This status bit indicates that the internal card clock is stable. This bit is for the Host Driver to poll clock status when changing the clock frequency. It is recommended to clear FRC_SDCLK_ON bit in System Control register to remove glitches on the card clock when the frequency is changing.</p> <p><i>Before changing clock divisor value(SDCLKFS or DVS), Host Driver should make sure the SDSTB bit is high.</i></p>

Table continues on the next page...

uSDHCx_PRES_STATE field descriptions (continued)

Field	Description
	<p>1 Clock is stable. 0 Clock is changing frequency and not stable.</p>
2 DLA	<p>Data Line Active</p> <p>This status bit indicates whether one of the DATA lines on the SD Bus is in use.</p> <p>In the case of read transactions:</p> <p>This status indicates if a read transfer is executing on the SD Bus. Changes in this value from 1 to 0, between data blocks, generates a Block Gap Event interrupt in the Interrupt Status register.</p> <p>This bit will be set in either of the following cases:</p> <ul style="list-style-type: none"> • After the end bit of the read command. • When writing a 1 to the Continue Request bit in the Protocol Control register to restart a read transfer. <p>This bit will be cleared in either of the following cases:</p> <p>(1) When the end bit of the last data block is sent from the SD Bus to the uSDHC.</p> <p>(2) When the Read Wait state is stopped by a Suspend command and the DATA2 line is released.</p> <p>The uSDHC will wait at the next block gap by driving Read Wait at the start of the interrupt cycle. If the Read Wait signal is already driven (data buffer cannot receive data), the uSDHC can wait for a current block gap by continuing to drive the Read Wait signal. It is necessary to support Read Wait in order to use the suspend / resume function. This bit will remain 1 during Read Wait.</p> <p>In the case of write transactions:</p> <p>This status indicates that a write transfer is executing on the SD Bus. Changes in this value from 1 to 0 generate a Transfer Complete interrupt in the Interrupt Status register.</p> <p>This bit will be set in either of the following cases:</p> <ul style="list-style-type: none"> • After the end bit of the write command. • When writing to 1 to the Continue Request bit in the Protocol Control register to continue a write transfer. <p>This bit will be cleared in either of the following cases:</p> <ul style="list-style-type: none"> • When the SD card releases Write Busy of the last data block, the uSDHC will also detect if the output is not busy. If the SD card does not drive the busy signal after the CRC status is received, the uSDHC shall assume the card drive "Not Busy". • When the SD card releases write busy, prior to waiting for write transfer, and as a result of a Stop At Block Gap Request. <p>In the case of command with busy pending:</p> <p>This status indicates that a busy state follows the command and the data line is in use. This bit will be cleared when the DATA0 line is released.</p> <p>1 DATA Line Active 0 DATA Line Inactive</p>
1 CDIHB	<p>Command Inhibit (DATA)</p> <p>This status bit is generated if either the DAT Line Active or the Read Transfer Active is set to 1. If this bit is 0, it indicates that the uSDHC can issue the next SD / MMC Command. Commands with a busy signal belong to Command Inhibit (DATA) (for example. R1b, R5b type). Changing from 1 to 0 generates a Transfer Complete interrupt in the Interrupt Status register.</p>

Table continues on the next page...

uSDHCx_PRES_STATE field descriptions (continued)

Field	Description
	<p>NOTE: The SD Host Driver can save registers for a suspend transaction after this bit has changed from 1 to 0.</p> <p>1 Cannot issue command which uses the DATA line 0 Can issue command which uses the DATA line</p>
0 CIHB	<p>Command Inhibit (CMD)</p> <p>If this status bit is 0, it indicates that the CMD line is not in use and the uSDHC can issue a SD / MMC Command using the CMD line.</p> <p>This bit is set also immediately after the Transfer Type register is written. This bit is cleared when the command response is received. Even if the Command Inhibit (DATA) is set to 1, Commands using only the CMD line can be issued if this bit is 0. Changing from 1 to 0 generates a Command Complete interrupt in the Interrupt Status register. If the uSDHC cannot issue the command because of a command conflict error (Refer to Command CRC Error) or because of a Command Not Issued By Auto CMD12 Error, this bit will remain 1 and the Command Complete is not set. The Status of issuing an Auto CMD12 does not show on this bit.</p> <p>1 Cannot issue command 0 Can issue command using only CMD line</p>

58.8.11 Protocol Control (uSDHCx_PROT_CTRL)

There are three cases to restart the transfer after stop at the block gap. Which case is appropriate depends on whether the uSDHC issues a Suspend command or the SD card accepts the Suspend command.

1. If the Host Driver does not issue a Suspend command, the Continue Request shall be used to restart the transfer.
2. If the Host Driver issues a Suspend command and the SD card accepts it, a Resume command shall be used to restart the transfer.
3. If the Host Driver issues a Suspend command and the SD card does not accept it, the Continue Request shall be used to restart the transfer.

Any time Stop At Block Gap Request stops the data transfer, the Host Driver shall wait for a Transfer Complete (in the Interrupt Status register), before attempting to restart the transfer. When restarting the data transfer by Continue Request, the Host Driver shall clear the Stop At Block Gap Request before or simultaneously.

Address: Base address + 28h offset

Bit	31	30	29	28	27	26	25	24	23	22	21	20	19	18	17	16
R	-	NON_EXACT_BLK_RD	BURST_LEN_EN			WECRM	WECINS	WECINT	-			RD_DONE_NO_8CLK	IABG	RWCTL	CREG	SABGREQ
W																
Reset	0	0	0	0	1	0	0	0	1	0	0	0	0	0	0	0
Bit	15	14	13	12	11	10	9	8	7	6	5	4	3	2	1	0
R	0						DMASEL	CDSS	CDTL	EMODE		D3CD	DTW[1:0]		LCTL	
W																
Reset	0	0	0	0	0	0	0	0	0	0	1	0	0	0	0	0

uSDHCx_PROT_CTRL field descriptions

Field	Description
31 -	Reserved. Always write as 0
30 NON_EXACT_BLK_RD	Current block read is non-exact block read. It is only used for SDIO. 1 The block read is non-exact block read. Host driver needs to issue abort command to terminate this multi-block read. 0 The block read is exact block read. Host driver doesn't need to issue abort command to terminate this multi-block read.
29-27 BURST_LEN_EN	BURST length enable for INCR, INCR4 / INCR8 / INCR16, INCR4-WRAP / INCR8-WRAP / INCR16-WRAP This is used to enable / disable the burst length for the external AHB2AXI bridge. It is useful especially for INCR transfer because without burst length indicator, the AHB2AXI bridge does not know the burst length in advance. Without burst length indicator, AHB INCR transfers can only be converted to SINGLES on the AXI side. xx1 Burst length is enabled for INCR x1x Burst length is enabled for INCR4 / INCR8 / INCR16 1xx Burst length is enabled for INCR4-WRAP / INCR8-WRAP / INCR16-WRAP
26 WECRM	Wakeup Event Enable On SD Card Removal This bit enables a wakeup event, via a Card Removal, in the Interrupt Status register. FN_WUS (Wake Up Support) in CIS does not effect this bit. When this bit is set, the Card Removal Status and the uSDHC interrupt can be asserted without CLK toggling. When the wakeup feature is not enabled, the CLK must be active in order to assert the Card Removal Status and the uSDHC interrupt. 1 Enable 0 Disable
25 WECINS	Wakeup Event Enable On SD Card Insertion This bit enables a wakeup event, via a Card Insertion, in the Interrupt Status register. FN_WUS (Wake Up Support) in CIS does not effect this bit. When this bit is set, the Card Insertion Status and the uSDHC

Table continues on the next page...

uSDHCx_PROT_CTRL field descriptions (continued)

Field	Description
	<p>interrupt can be asserted without CLK toggling. When the wakeup feature is not enabled, the CLK must be active in order to assert the Card Insertion Status and the uSDHC interrupt.</p> <p>1 Enable 0 Disable</p>
24 WECINT	<p>Wakeup Event Enable On Card Interrupt</p> <p>This bit enables a wakeup event, via a Card Interrupt, in the Interrupt Status register. This bit can be set to 1 if FN_WUS (Wake Up Support) in CIS is set to 1. When this bit is set, the Card Interrupt Status and the uSDHC interrupt can be asserted without CLK toggling. When the wakeup feature is not enabled, the CLK must be active in order to assert the Card Interrupt Status and the uSDHC interrupt.</p> <p>1 Enable 0 Disable</p>
23–21 -	Reserved. Always write as 3'b100
20 RD_DONE_NO_8CLK	<p><i>Read done no 8 clock:</i></p> <p><i>According to the SD/MMC spec, for read data transaction, 8 clocks are needed after the end bit of the last data block. So, by default(RD_DONE_NO_8CLK=0), 8 clocks will be active after the end bit of the last read data transaction.</i></p> <p><i>However, this 8 clocks should not be active if user wants to use stop at block gap(include the auto stop at block gap in boot mode) feature for read and the RWCTL bit(bit18) is not enabled. In this case, software should set RD_DONE_NO_8CLK to avoid this 8 clocks. Otherwise, the device may send extra data to uSDHC while uSDHC ignores these data.</i></p> <p><i>In a summary, this bit should be set only if the use case needs to use stop at block gap feature while the device can't support the read wait feature.</i></p>
19 IABG	<p>Interrupt At Block Gap</p> <p>This bit is valid only in 4-bit mode, of the SDIO card, and selects a sample point in the interrupt cycle. Setting to 1 enables interrupt detection at the block gap for a multiple block transfer. Setting to 0 disables interrupt detection during a multiple block transfer. If the SDIO card cannot signal an interrupt during a multiple block transfer, this bit should be set to 0 to avoid an inadvertent interrupt. When the Host Driver detects an SDIO card insertion, it shall set this bit according to the CCCR of the card.</p> <p>1 Enabled 0 Disabled</p>
18 RWCTL	<p>Read Wait Control</p> <p>The read wait function is optional for SDIO cards. If the card supports read wait, set this bit to enable use of the read wait protocol to stop read data using the DATA2 line. Otherwise the uSDHC has to stop the SD Clock to hold read data, which restricts commands generation. When the Host Driver detects an SDIO card insertion, it shall set this bit according to the CCCR of the card. If the card does not support read wait, this bit shall never be set to 1, otherwise DATA line conflicts may occur. If this bit is set to 0, stop at block gap during read operation is also supported, but the uSDHC will stop the SD Clock to pause reading operation.</p> <p>1 Enable Read Wait Control, and assert Read Wait without stopping SD Clock at block gap when SABGREQ bit is set 0 Disable Read Wait Control, and stop SD Clock at block gap when SABGREQ bit is set</p>
17 CREQ	Continue Request

Table continues on the next page...

uSDHCx_PROT_CTRL field descriptions (continued)

Field	Description
	<p>This bit is used to restart a transaction which was stopped using the Stop At Block Gap Request. When a Suspend operation is not accepted by the card, it is also by setting this bit to restart the paused transfer. To cancel stop at the block gap, set Stop At Block Gap Request to 0 and set this bit to 1 to restart the transfer.</p> <p>The uSDHC automatically clears this bit, therefore it is not necessary for the Host Driver to set this bit to 0. If both Stop At Block Gap Request and this bit are 1, the continue request is ignored.</p> <p>1 Restart 0 No effect</p>
16 SABGREQ	<p>Stop At Block Gap Request</p> <p>This bit is used to stop executing a transaction at the next block gap for both DMA and non-DMA transfers. Until the Transfer Complete is set to 1, indicating a transfer completion, the Host Driver shall leave this bit set to 1. Clearing both the Stop At Block Gap Request and Continue Request does not cause the transaction to restart. Read Wait is used to stop the read transaction at the block gap. The uSDHC will honor the Stop At Block Gap Request for write transfers, but for read transfers it requires that the SDIO card support Read Wait. Therefore, the Host Driver shall not set this bit during read transfers unless the SDIO card supports Read Wait and has set the Read Wait Control to 1, otherwise the uSDHC will stop the SD bus clock to pause the read operation during block gap. In the case of write transfers in which the Host Driver writes data to the Data Port register, the Host Driver shall set this bit after all block data is written. If this bit is set to 1, the Host Driver shall not write data to the Data Port register after a block is sent. Once this bit is set, the Host Driver shall not clear this bit before the Transfer Complete bit in Interrupt Status Register is set, otherwise the uSDHCs behavior is undefined.</p> <p>This bit effects Read Transfer Active, Write Transfer Active, DATA Line Active and Command Inhibit (DATA) in the Present State register.</p> <p>1 Stop 0 Transfer</p>
15–10 Reserved	This read-only field is reserved and always has the value 0.
9–8 DMASEL	<p>DMA Select</p> <p>This field is valid while DMA (SDMA or ADMA) is enabled and selects the DMA operation.</p> <p>00 No DMA or Simple DMA is selected 01 ADMA1 is selected 10 ADMA2 is selected 11 reserved</p>
7 CDSS	<p>Card Detect Signal Selection</p> <p>This bit selects the source for the card detection.</p> <p>1 Card Detection Test Level is selected (for test purpose). 0 Card Detection Level is selected (for normal purpose).</p>
6 CDTL	<p>Card Detect Test Level</p> <p>This bit is enabled while the Card Detection Signal Selection is set to 1 and it indicates card insertion.</p> <p>1 Card Detect Test Level is 1, card inserted 0 Card Detect Test Level is 0, no card inserted</p>
5–4 EMODE	Endian Mode

Table continues on the next page...

uSDHCx_PROT_CTRL field descriptions (continued)

Field	Description
	<p>The uSDHC supports all three endian modes in data transfer. Refer to Data Buffer for more details.</p> <p>00 Big Endian Mode 01 Half Word Big Endian Mode 10 Little Endian Mode 11 Reserved</p>
<p>3 D3CD</p>	<p>DATA3 as Card Detection Pin</p> <p>If this bit is set, DATA3 should be pulled down to act as a card detection pin. Be cautious when using this feature, because DATA3 is also a chip-select for the SPI mode. A pull-down on this pin and CMD0 may set the card into the SPI mode, which the uSDHC does not support.</p> <p>1 DATA3 as Card Detection Pin 0 DATA3 does not monitor Card Insertion</p>
<p>2-1 DTW[1:0]</p>	<p>Data Transfer Width</p> <p>This bit selects the data width of the SD bus for a data transfer. The Host Driver shall set it to match the data width of the card. Possible Data transfer Width is 1-bit, 4-bits or 8-bits.</p> <p>10 8-bit mode 01 4-bit mode 00 1-bit mode 11 Reserved</p>
<p>0 LCTL</p>	<p>LED Control</p> <p>This bit, fully controlled by the Host Driver, is used to caution the user not to remove the card while the card is being accessed. If the software is going to issue multiple SD commands, this bit can be set during all these transactions. It is not necessary to change for each transaction. When the software issues multiple SD commands, setting the bit once before the first command is sufficient: it is not necessary to reset the bit between commands.</p> <p>1 LED on 0 LED off</p>

58.8.12 System Control (uSDHCx_SYS_CTRL)

Address: Base address + 2Ch offset

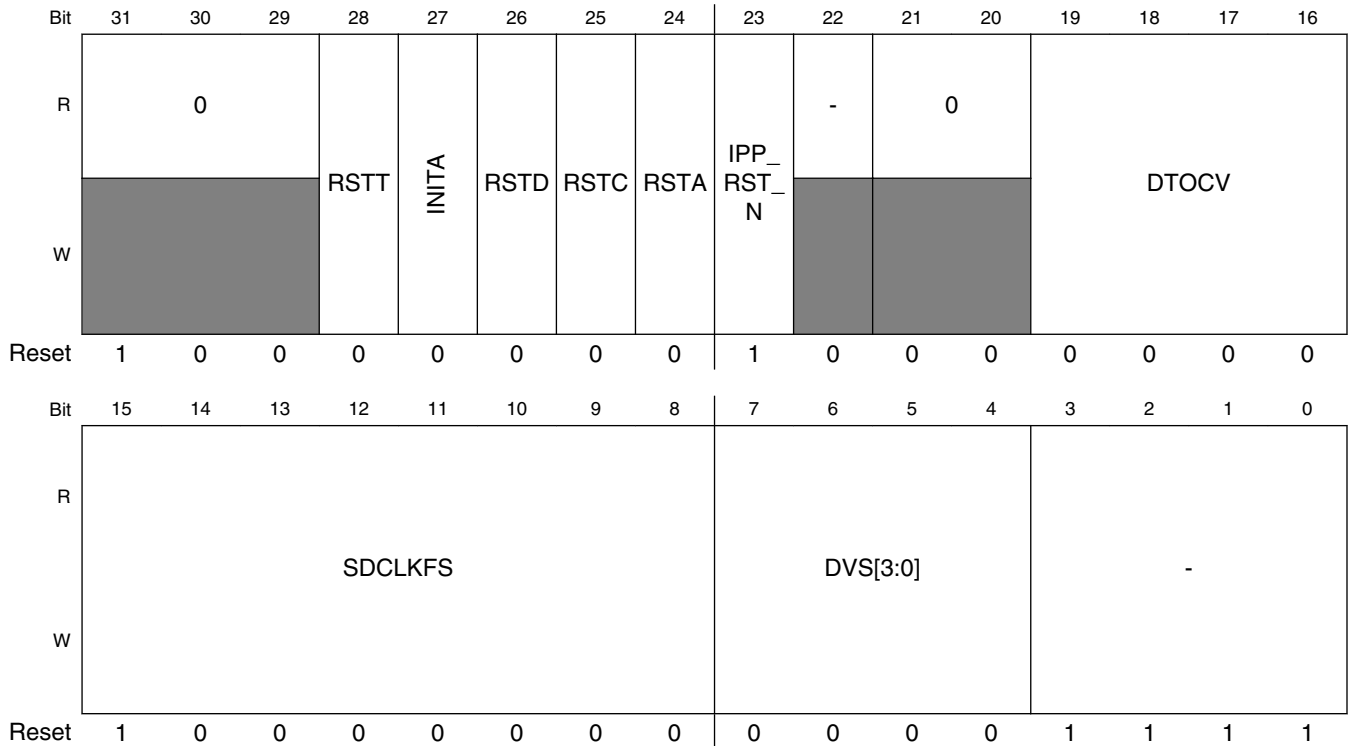

uSDHCx_SYS_CTRL field descriptions

Field	Description
31–29 Reserved	This read-only field is reserved and always has the value 0.
28 RSTT	Reset Tuning When set this bit to 1, it will reset tuning circuit. After tuning circuits are reset, bit value is 0. Clearing execute_tuning bit in AUTOCMD12_ERR_STATUS will also set this bit to 1 to reset tuning circuit
27 INITA	Initialization Active When this bit is set, 80 SD-Clocks are sent to the card. After the 80 clocks are sent, this bit is self cleared. This bit is very useful during the card power-up period when 74 SD-Clocks are needed and the clock auto gating feature is enabled. Writing 1 to this bit when this bit is already 1 has no effect. Writing 0 to this bit at any time has no effect. When either of the CIHB and CDIHB bits in the Present State Register are set, writing 1 to this bit is ignored (i.e. when command line or data lines are active, write to this bit is not allowed). On the otherhand, when this bit is set, i.e., during intialization active period, it is allowed to issue command, and the command bit stream will appear on the CMD pad after all 80 clock cycles are done. So when this command ends, the driver can make sure the 80 clock cycles are sent out. This is very useful when the driver needs send 80 cycles to the card and does not want to wait till this bit is self cleared.
26 RSTD	Software Reset For DATA Line

Table continues on the next page...

uSDHCx_SYS_CTRL field descriptions (continued)

Field	Description
	<p>Only part of the data circuit is reset. DMA circuit is also reset. After this bit is set, SW waits for self-clear.</p> <p>The following registers and bits are cleared by this bit:</p> <ul style="list-style-type: none"> • Data Port register • Buffer is cleared and initialized. • Present State register • Buffer Read Enable • Buffer Write Enable • Read Transfer Active • Write Transfer Active • DATA Line Active • Command Inhibit (DATA) Protocol Control register • Continue Request • Stop At Block Gap Request Interrupt Status register • Buffer Read Ready • Buffer Write Ready • DMA Interrupt • Block Gap Event • Transfer Complete <p>NOTE: When reset, SW must make sure there is no incomplete data transferring. If there is data transfer going on, SW need wait TC or DC uSDHC_INT_STATUS register is set.</p> <p>1 Reset 0 No Reset</p>
<p>25 RSTC</p>	<p>Software Reset For CMD Line</p> <p>Only part of the command circuit is reset. After this bit is set, SW waits for self-clear.</p> <p>The following registers and bits are cleared by this bit:</p> <ul style="list-style-type: none"> • Present State register Command Inhibit (CMD) • Interrupt Status register Command Complete <p>1 Reset 0 No Reset</p>
<p>24 RSTA</p>	<p>Software Reset For ALL</p> <p>This reset effects the entire Host Controller except for the card detection circuit. Register bits of type ROC, RW, RW1C, RWAC are cleared. During its initialization, the Host Driver shall set this bit to 1 to reset the uSDHC. The uSDHC shall reset this bit to 0 when the capabilities registers are valid and the Host Driver can read them. Additional use of Software Reset For All does not affect the value of the Capabilities registers. After this bit is set, it is recommended that the Host Driver reset the external card and re-initialize it. After this bit is set, SW should wait for self-clear.</p> <p>In tuning process, after every CMD19 is finished, this bit will be set to retest the uSDHC.</p> <p>NOTE: When reset, SW must make sure there is no incomplete data transferring. If there is data transfer going on, SW need wait TC or DC uSDHC_INT_STATUS register is set.</p> <p>1 Reset 0 No Reset</p>
<p>23 IPP_RST_N</p>	<p>This register's value will be output to CARD from pad directly for hardware reset of the card if the card supports this feature.</p>
<p>22 -</p>	<p>Reserved</p>

Table continues on the next page...

uSDHCx_SYS_CTRL field descriptions (continued)

Field	Description
21–20 Reserved	This read-only field is reserved and always has the value 0.
19–16 DTCOV	<p>Data Timeout Counter Value</p> <p>This value determines the interval by which DAT line timeouts are detected. Refer to the Data Timeout Error bit in the Interrupt Status register for information on factors that dictate time-out generation. Time-out clock frequency will be generated by dividing the base clock SDCLK value by this value.</p> <p>The Host Driver can clear the Data Timeout Error Status Enable (in the Interrupt Status Enable register) to prevent inadvertent time-out events.</p> <p>1111b SDCLK x 2²⁹ 1110b SDCLK x 2²⁸ ... 0001b SDCLK x 2¹⁵ 0000b SDCLK x 2¹⁴</p>
15–8 SDCLKFS	<p>SDCLK Frequency Select</p> <p>This register is used to select the frequency of the SDCLK pin. This register field selects the divide value of the second divisor stage.</p> <p><i>In Single Data Rate mode(DDR_EN bit of MIXERCTRL is '0')</i></p> <p>Only the following settings are allowed:</p> <p>80h) Base clock divided by 256 40h) Base clock divided by 128 20h) Base clock divided by 64 10h) Base clock divided by 32 08h) Base clock divided by 16 04h) Base clock divided by 8 02h) Base clock divided by 4 01h) Base clock divided by 2 00h) Base clock divided by 1</p> <p><i>While in Dual Data Rate mode(DDR_EN bit of MIXERCTRL is '1')</i></p> <p>Only the following settings are allowed:</p> <p>80h) Base clock divided by 512 40h) Base clock divided by 256 20h) Base clock divided by 128 10h) Base clock divided by 64 08h) Base clock divided by 32 04h) Base clock divided by 16 02h) Base clock divided by 8 01h) Base clock divided by 4 00h) Base clock divided by 2</p> <p><i>When S/W changes the DDR_EN bit, SDCLKFS may need to be changed also!</i></p>

Table continues on the next page...

uSDHCx_SYS_CTRL field descriptions (continued)

Field	Description
	<p>In Single Data Rate mode, setting 00h bypasses the frequency prescaler of the SD Clock.</p> <p>Multiple bits must not be set, or the behavior of this prescaler is undefined. The two default divider values can be calculated by the frequency of ipg_perclk and the following Divisor bits.</p> <p>The frequency of SDCLK is set by the following formula:</p> <p>Clock Frequency = (Base Clock) / (prescaler x divisor)</p> <p>For example, in Single Data Rate mode, if the Base Clock Frequency is 96 MHz, and the target frequency is 25 MHz, then choosing the prescaler value of 01h and divisor value of 1h will yield 24 MHz, which is the nearest frequency less than or equal to the target. Similarly, to approach a clock value of 400 kHz, the prescaler value of 08h and divisor value of eh yields the exact clock value of 400 kHz.</p> <p>The reset value of this bit field is 80h, so if the input Base Clock (ipg_perclk) is about 96 MHz, the default SD Clock after reset is 375 kHz.</p> <p>According to the SD Physical Specification Version 1.1 and the SDIO Card Specification Version 1.2, the maximum SD Clock frequency is 50 MHz and shall never exceed this limit.</p> <p><i>Before changing clock divisor value(SDCLKFS or DVS), Host Driver should make sure the SDSTB bit is high.</i></p> <p><i>If setting SDCLKFS and DVS can generate same clock frequency,(For example, in SDR mode, SDCLKFS = 01h is same as DVS = 01h.) SDCLKFS is highly recommended.</i></p>
7-4 DVS[3:0]	<p>Divisor</p> <p>This register is used to select the frequency of the SDCLK pin. This register field selects the divide value of the first divisor stage.</p> <p><i>Before changing clock divisor value(SDCLKFS or DVS), Host Driver should make sure the SDSTB bit is high.</i></p> <p>The setting are as following:</p> <p>0000 Divide-by-1 0001 Divide-by-2 1110 Divide-by-15 1111 Divide-by-16</p>
-	Reserved. Always write as 1.

58.8.13 Interrupt Status (uSDHCx_INT_STATUS)

An interrupt is generated when the Normal Interrupt Signal Enable is enabled and at least one of the status bits is set to 1. For all bits, writing 1 to a bit clears it; writing to 0 keeps the bit unchanged. More than one status can be cleared with a single register write. For Card Interrupt, before writing 1 to clear, it is required that the card stops asserting the interrupt, meaning that when the Card Driver services the interrupt condition, otherwise the CINT bit will be asserted again.

The table below shows the relationship between the Command Timeout Error and the Command Complete.

Table 58-8. uSDHC Status for Command Timeout Error/Command Complete Bit Combinations

Command Complete	Command Timeout Error	Meaning of the Status
0	0	X
X	1	Response not received within 64 SDCLK cycles
1	0	Response received

The table below shows the relationship between the Transfer Complete and the Data Timeout Error.

Table 58-9. uSDHC Status for Data Timeout Error/Transfer Complete Bit Combinations

Transfer Complete	Data Timeout Error	Meaning of the Status
0	0	X
0	1	Timeout occurred during transfer
1	X	Data Transfer Complete

The table below shows the relationship between the Command CRC Error and Command Timeout Error.

Table 58-10. uSDHC Status for Command CRC Error/Command Timeout Error Bit Combinations

Command Complete	Command Timeout Error	Meaning of the Status
0	0	No error
0	1	Response Timeout Error
1	0	Response CRC Error
1	1	CMD line conflict

Address: Base address + 30h offset

Bit	31	30	29	28	27	26	25	24	23	22	21	20	19	18	17	16
R	0			DMAE	0	TNE	0	AC12E	0	DEBE	DCE	DTOE	CIE	CEBE	CCE	CTOE
W				w1c		w1c		w1c		w1c	w1c	w1c	w1c	w1c	w1c	w1c
Reset	0	0	0	0	0	0	0	0	0	0	0	0	0	0	0	0

uSDHC Memory Map/Register Definition

Bit	15	14	13	12	11	10	9	8	7	6	5	4	3	2	1	0
R	0	TP	0	RTE	0			CINT	CRM	CINS	BRR	BWR	DINT	BGE	TC	CC
W		w1c		w1c				w1c	w1c	w1c	w1c	w1c	w1c	w1c	w1c	w1c
Reset	0	0	0	0	0	0	0	0	0	0	0	0	0	0	0	0

uSDHCx_INT_STATUS field descriptions

Field	Description
31–29 Reserved	This read-only field is reserved and always has the value 0.
28 DMAE	<p>DMA Error</p> <p>Occurs when an Internal DMA transfer has failed. This bit is set to 1, when some error occurs in the data transfer. This error can be caused by either Simple DMA or ADMA, depending on which DMA is in use. The value in DMA System Address register is the next fetch address where the error occurs. Since any error corrupts the whole data block, the Host Driver shall re-start the transfer from the corrupted block boundary. The address of the block boundary can be calculated either from the current DS_ADDR value or from the remaining number of blocks and the block size.</p> <p>1 Error 0 No Error</p>
27 Reserved	This read-only field is reserved and always has the value 0.
26 TNE	<p>Tuning Error: (only for SD3.0 SDR104 mode)</p> <p>This bit is set when an unrecoverable error is detected in a tuning circuit. By detecting Tuning Error, Host Driver needs to abort a command executing and perform tuning.</p>
25 Reserved	This read-only field is reserved and always has the value 0.
24 AC12E	<p>Auto CMD12 Error</p> <p>Occurs when detecting that one of the bits in the Auto CMD12 Error Status register has changed from 0 to 1. This bit is set to 1, not only when the errors in Auto CMD12 occur, but also when the Auto CMD12 is not executed due to the previous command error.</p> <p>1 Error 0 No Error</p>
23 Reserved	This read-only field is reserved and always has the value 0.
22 DEBE	<p>Data End Bit Error</p> <p>Occurs either when detecting 0 at the end bit position of read data, which uses the DATA line, or at the end bit position of the CRC.</p> <p>This bit will be not asserted in tuning process.</p> <p>1 Error 0 No Error</p>

Table continues on the next page...

uSDHCx_INT_STATUS field descriptions (continued)

Field	Description
21 DCE	<p>Data CRC Error</p> <p>Occurs when detecting a CRC error when transferring read data, which uses the DATA line, or when detecting the Write CRC status having a value other than 010.</p> <p>This bit will be not asserted in tuning process.</p> <p>1 Error 0 No Error</p>
20 DIOE	<p>Data Timeout Error</p> <p>Occurs when detecting one of following time-out conditions.</p> <ul style="list-style-type: none"> • Busy time-out for R1b, R5b type • Busy time-out after Write CRC status • Read Data time-out. <p>This bit will be not asserted in tuning process.</p> <p>1 Time out 0 No Error</p>
19 CIE	<p>Command Index Error</p> <p>Occurs if a Command Index error occurs in the command response.</p> <p>This bit will be not asserted in tuning process.</p> <p>1 Error 0 No Error</p>
18 CEBE	<p>Command End Bit Error</p> <p>Occurs when detecting that the end bit of a command response is 0.</p> <p>This bit will be not asserted in tuning process.</p> <p>1 End Bit Error Generated 0 No Error</p>
17 CCE	<p>Command CRC Error</p> <p>Command CRC Error is generated in two cases.</p> <ul style="list-style-type: none"> • If a response is returned and the Command Timeout Error is set to 0 (indicating no time-out), this bit is set when detecting a CRC error in the command response. • The uSDHC detects a CMD line conflict by monitoring the CMD line when a command is issued. If the uSDHC drives the CMD line to 1, but detects 0 on the CMD line at the next SDCLK edge, then the uSDHC shall abort the command (Stop driving CMD line) and set this bit to 1. The Command Timeout Error shall also be set to 1 to distinguish CMD line conflict. <p>This bit will be not asserted in tuning process.</p> <p>1 CRC Error Generated. 0 No Error</p>
16 CTOE	<p>Command Timeout Error</p> <p>Occurs only if no response is returned within 64 SDCLK cycles from the end bit of the command. If the uSDHC detects a CMD line conflict, in which case a Command CRC Error shall also be set (as shown in Interrupt Status (uSDHC_INT_STATUS)), this bit shall be set without waiting for 64 SDCLK cycles. This is because the command will be aborted by the uSDHC.</p>

Table continues on the next page...

uSDHCx_INT_STATUS field descriptions (continued)

Field	Description
	This bit will be not asserted in tuning process. 1 Time out 0 No Error
15 Reserved	This read-only field is reserved and always has the value 0.
14 TP	Tuning Pass:(only for SD3.0 SDR104 mode) Current CMD19 transfer is done successfully. That is, current sampling point is correct.
13 Reserved	This read-only field is reserved and always has the value 0.
12 RTE	Re-Tuning Event: (only for SD3.0 SDR104 mode) This status is set if Re-Tuning Request in the Present State register changes from 0 to 1. Host Controller requests Host Driver to perform re-tuning for next data transfer. Current data transfer (not large block count) can be completed without re-tuning. 1 Re-Tuning should be performed 0 Re-Tuning is not required
11–9 Reserved	This read-only field is reserved and always has the value 0.
8 CINT	Card Interrupt This status bit is set when an interrupt signal is detected from the external card. In 1-bit mode, the uSDHC will detect the Card Interrupt without the SD Clock to support wakeup. In 4-bit mode, the card interrupt signal is sampled during the interrupt cycle, so the interrupt from card can only be sampled during interrupt cycle, introducing some delay between the interrupt signal from the SDIO card and the interrupt to the Host System. Writing this bit to 1 can clear this bit, but as the interrupt source from the SDIO card does not clear, this bit is set again. In order to clear this bit, it is required to reset the interrupt source from the external card followed by a writing 1 to this bit. When this status has been set, and the Host Driver needs to service this interrupt, the Card Interrupt Signal Enable in the Interrupt Signal Enable register should be 0 to stop driving the interrupt signal to the Host System. After completion of the card interrupt service (It should reset the interrupt sources in the SDIO card and the interrupt signal may not be asserted), write 1 to clear this bit, set the Card Interrupt Signal Enable to 1, and start sampling the interrupt signal again. 1 Generate Card Interrupt 0 No Card Interrupt
7 CRM	Card Removal This status bit is set if the Card Inserted bit in the Present State register changes from 1 to 0. When the Host Driver writes this bit to 1 to clear this status, the status of the Card Inserted in the Present State register should be confirmed. Because the card state may possibly be changed when the Host Driver clears this bit and the interrupt event may not be generated. When this bit is cleared, it will be set again if no card is inserted. In order to leave it cleared, clear the Card Removal Status Enable bit in Interrupt Status Enable register. 1 Card removed 0 Card state unstable or inserted
6 CINS	Card Insertion This status bit is set if the Card Inserted bit in the Present State register changes from 0 to 1. When the Host Driver writes this bit to 1 to clear this status, the status of the Card Inserted in the Present State

Table continues on the next page...

uSDHCx_INT_STATUS field descriptions (continued)

Field	Description
	<p>register should be confirmed. Because the card state may possibly be changed when the Host Driver clears this bit and the interrupt event may not be generated. When this bit is cleared, it will be set again if a card is inserted. In order to leave it cleared, clear the Card Inserted Status Enable bit in Interrupt Status Enable register.</p> <p>1 Card inserted 0 Card state unstable or removed</p>
5 BRR	<p>Buffer Read Ready</p> <p>This status bit is set if the Buffer Read Enable bit, in the Present State register, changes from 0 to 1. Refer to the Buffer Read Enable bit in the Present State register for additional information.</p> <p>This bit indicates that cmd19 is finished in tuning process.</p> <p>1 Ready to read buffer 0 Not ready to read buffer</p>
4 BWR	<p>Buffer Write Ready</p> <p>This status bit is set if the Buffer Write Enable bit, in the Present State register, changes from 0 to 1. Refer to the Buffer Write Enable bit in the Present State register for additional information.</p> <p>1 Ready to write buffer: 0 Not ready to write buffer</p>
3 DINT	<p>DMA Interrupt</p> <p>Occurs only when the internal DMA finishes the data transfer successfully. Whenever errors occur during data transfer, this bit will not be set. Instead, the DMAE bit will be set. Either Simple DMA or ADMA finishes data transferring, this bit will be set.</p> <p>1 DMA Interrupt is generated 0 No DMA Interrupt</p>
2 BGE	<p>Block Gap Event</p> <p>If the Stop At Block Gap Request bit in the Protocol Control register is set, this bit is set when a read or write transaction is stopped at a block gap. If Stop At Block Gap Request is not set to 1, this bit is not set to 1.</p> <p>In the case of a Read Transaction: This bit is set at the falling edge of the DATA Line Active Status (When the transaction is stopped at SD Bus timing). The Read Wait must be supported in order to use this function.</p> <p>In the case of Write Transaction: This bit is set at the falling edge of Write Transfer Active Status (After getting CRC status at SD Bus timing).</p> <p>1 Transaction stopped at block gap 0 No block gap event</p>
1 TC	<p>Transfer Complete</p> <p>This bit is set when a read or write transfer is completed.</p> <p>In the case of a Read Transaction: This bit is set at the falling edge of the Read Transfer Active Status. There are two cases in which this interrupt is generated. The first is when a data transfer is completed as specified by the data length (after the last data has been read to the Host System). The second is when data has stopped at the block gap and completed the data transfer by setting the Stop At Block Gap Request bit in the Protocol Control register (after valid data has been read to the Host System).</p>

Table continues on the next page...

uSDHCx_INT_STATUS field descriptions (continued)

Field	Description
	<p>In the case of a Write Transaction: This bit is set at the falling edge of the DATA Line Active Status. There are two cases in which this interrupt is generated. The first is when the last data is written to the SD card as specified by the data length and the busy signal is released. The second is when data transfers are stopped at the block gap, by setting the Stop At Block Gap Request bit in the Protocol Control register, and the data transfers are completed. (after valid data is written to the SD card and the busy signal released).</p> <p>In the case of a command with busy, this bit is set when busy is deasserted.</p> <p>This bit will be not asserted in tuning process.</p> <p>1 Transfer complete 0 Transfer not complete</p>
0 CC	<p>Command Complete</p> <p>This bit is set when you receive the end bit of the command response (except Auto CMD12). Refer to the Command Inhibit (CMD) in the Present State register.</p> <p>This bit will be not asserted in tuning process.</p> <p>1 Command complete 0 Command not complete</p>

58.8.14 Interrupt Status Enable (uSDHCx_INT_STATUS_EN)

Setting the bits in this register to 1 enables the corresponding Interrupt Status to be set by the specified event. If any bit is cleared, the corresponding Interrupt Status bit is also cleared (i.e. when the bit in this register is cleared, the corresponding bit in Interrupt Status Register is always 0).

- Depending on IABG bit setting, uSDHC may be programmed to sample the card interrupt signal during the interrupt period and hold its value in the flip-flop. There will be some delays on the Card Interrupt, asserted from the card, to the time the Host System is informed.
- To detect a CMD line conflict, the Host Driver must set both Command Timeout Error Status Enable and Command CRC Error Status Enable to 1.

Address: Base address + 34h offset

Bit	31	30	29	28	27	26	25	24	23	22	21	20	19	18	17	16
R	0			DMAESEN	0	TNESEN	0	AC12ESEN	0	DEBESEN	DCESEN	DTOESEN	CIESEN	CEBESEN	CCESSEN	CTOESEN
W	[Shaded]															
Reset	0	0	0	0	0	0	0	0	0	0	0	0	0	0	0	0

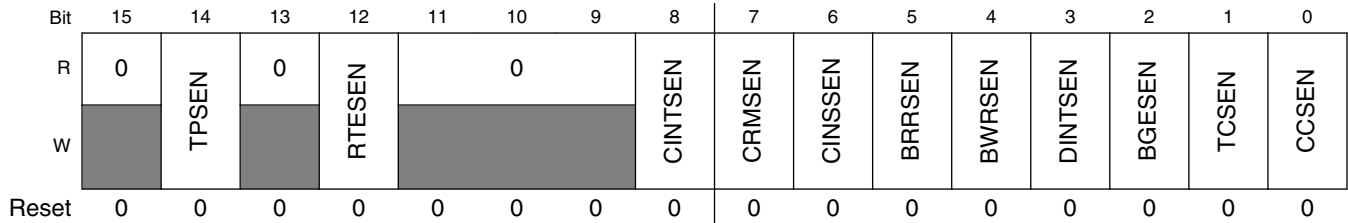

uSDHCx_INT_STATUS_EN field descriptions

Field	Description
31–29 Reserved	This read-only field is reserved and always has the value 0.
28 DMAESEN	DMA Error Status Enable 1 Enabled 0 Masked
27 Reserved	This read-only field is reserved and always has the value 0.
26 TNESEN	Tuning Error Status Enable 1 Enabled 0 Masked
25 Reserved	This read-only field is reserved and always has the value 0.
24 AC12ESEN	Auto CMD12 Error Status Enable 1 Enabled 0 Masked
23 Reserved	This read-only field is reserved and always has the value 0.
22 DEBESEN	Data End Bit Error Status Enable 1 Enabled 0 Masked
21 DCESEN	Data CRC Error Status Enable 1 Enabled 0 Masked
20 DTESEN	Data Timeout Error Status Enable 1 Enabled 0 Masked
19 CIESEN	Command Index Error Status Enable 1 Enabled 0 Masked
18 CEBESEN	Command End Bit Error Status Enable 1 Enabled 0 Masked

Table continues on the next page...

uSDHCx_INT_STATUS_EN field descriptions (continued)

Field	Description
17 CCESEN	Command CRC Error Status Enable 1 Enabled 0 Masked
16 CTOESEN	Command Timeout Error Status Enable 1 Enabled 0 Masked
15 Reserved	This read-only field is reserved and always has the value 0.
14 TPSEN	Tuning Pass Status Enable 1 Enabled 0 Masked
13 Reserved	This read-only field is reserved and always has the value 0.
12 RTESEN	Re-Tuning Event Status Enable 1 Enabled 0 Masked
11–9 Reserved	This read-only field is reserved and always has the value 0.
8 CINTSEN	Card Interrupt Status Enable If this bit is set to 0, the uSDHC will clear the interrupt request to the system. The Card Interrupt detection is stopped when this bit is cleared and restarted when this bit is set to 1. The Host Driver should clear the Card Interrupt Status Enable before servicing the Card Interrupt and should set this bit again after all interrupt requests from the card are cleared to prevent inadvertent interrupts. 1 Enabled 0 Masked
7 CRMSEN	Card Removal Status Enable 1 Enabled 0 Masked
6 CINSEN	Card Insertion Status Enable 1 Enabled 0 Masked
5 BRRSEN	Buffer Read Ready Status Enable 1 Enabled 0 Masked
4 BWRSEN	Buffer Write Ready Status Enable 1 Enabled 0 Masked
3 DINTSEN	DMA Interrupt Status Enable

Table continues on the next page...

uSDHCx_INT_STATUS_EN field descriptions (continued)

Field	Description
	1 Enabled 0 Masked
2 BGESEN	Block Gap Event Status Enable 1 Enabled 0 Masked
1 TCSEN	Transfer Complete Status Enable 1 Enabled 0 Masked
0 CCSEN	Command Complete Status Enable 1 Enabled 0 Masked

58.8.15 Interrupt Signal Enable (uSDHCx_INT_SIGNAL_EN)

This register is used to select which interrupt status is indicated to the Host System as the interrupt. These status bits all share the same interrupt line. Setting any of these bits to 1 enables interrupt generation. The corresponding Status register bit will generate an interrupt when the corresponding interrupt signal enable bit is set.

Address: Base address + 38h offset

Bit	31	30	29	28	27	26	25	24	23	22	21	20	19	18	17	16
R	0			DMAEIEIEN	0	TNEIEIEN	0	AC12EIEIEN	0	DEBEIEIEN	DCEIEIEN	DTOEIEIEN	CIEIEIEN	CEBEIEIEN	CCEIEIEN	CTOEIEIEN
W	[Shaded]			[Shaded]	[Shaded]	[Shaded]	[Shaded]	[Shaded]	[Shaded]	[Shaded]	[Shaded]	[Shaded]	[Shaded]	[Shaded]	[Shaded]	[Shaded]
Reset	0	0	0	0	0	0	0	0	0	0	0	0	0	0	0	0
Bit	15	14	13	12	11	10	9	8	7	6	5	4	3	2	1	0
R	0	TPIEIEIEN	0	RTEIEIEIEN	0			CINTIEIEN	CRMIIEIEN	CINSIEIEN	BRIIEIEN	BWRIIEIEN	DINTIEIEN	BGEIEIEN	TCIEIEN	CCIEIEN
W	[Shaded]	[Shaded]	[Shaded]	[Shaded]	[Shaded]	[Shaded]	[Shaded]	[Shaded]	[Shaded]	[Shaded]	[Shaded]	[Shaded]	[Shaded]	[Shaded]	[Shaded]	[Shaded]
Reset	0	0	0	0	0	0	0	0	0	0	0	0	0	0	0	0

uSDHCx_INT_SIGNAL_EN field descriptions

Field	Description
31–29 Reserved	This read-only field is reserved and always has the value 0.

Table continues on the next page...

uSDHCx_INT_SIGNAL_EN field descriptions (continued)

Field	Description
28 DMAEIEN	DMA Error Interrupt Enable 1 Enable 0 Masked
27 Reserved	This read-only field is reserved and always has the value 0.
26 TNEIEN	Tuning Error Interrupt Enable 1 Enabled 0 Masked
25 Reserved	This read-only field is reserved and always has the value 0.
24 AC12EIEN	Auto CMD12 Error Interrupt Enable 1 Enabled 0 Masked
23 Reserved	This read-only field is reserved and always has the value 0.
22 DEBEIEN	Data End Bit Error Interrupt Enable 1 Enabled 0 Masked
21 DCEIEN	Data CRC Error Interrupt Enable 1 Enabled 0 Masked
20 DTOEIEN	Data Timeout Error Interrupt Enable 1 Enabled 0 Masked
19 CIEIEN	Command Index Error Interrupt Enable 1 Enabled 0 Masked
18 CEBEIEN	Command End Bit Error Interrupt Enable 1 Enabled 0 Masked
17 CCEIEN	Command CRC Error Interrupt Enable 1 Enabled 0 Masked
16 CTOEIEN	Command Timeout Error Interrupt Enable 1 Enabled 0 Masked
15 Reserved	This read-only field is reserved and always has the value 0.

Table continues on the next page...

uSDHCx_INT_SIGNAL_EN field descriptions (continued)

Field	Description
14 TPIEN	Tuning Pass Interrupt Enable 1 Enabled 0 Masked
13 Reserved	This read-only field is reserved and always has the value 0.
12 RTEIEN	Re-Tuning Event Interrupt Enable 1 Enabled 0 Masked
11–9 Reserved	This read-only field is reserved and always has the value 0.
8 CINTIEN	Card Interrupt Interrupt Enable 1 Enabled 0 Masked
7 CRMIEN	Card Removal Interrupt Enable 1 Enabled 0 Masked
6 CINSIEN	Card Insertion Interrupt Enable 1 Enabled 0 Masked
5 BRIEN	Buffer Read Ready Interrupt Enable 1 Enabled 0 Masked
4 BWRIEN	Buffer Write Ready Interrupt Enable 1 Enabled 0 Masked
3 DINTIEN	DMA Interrupt Enable 1 Enabled 0 Masked
2 BGEIEN	Block Gap Event Interrupt Enable 1 Enabled 0 Masked
1 TCIEN	Transfer Complete Interrupt Enable 1 Enabled 0 Masked
0 CCIEN	Command Complete Interrupt Enable 1 Enabled 0 Masked

58.8.16 Auto CMD12 Error Status (uSDHCx_AUTOCMD12_ERR_STATUS)

When the Auto CMD12 Error Status bit in the Status register is set, the Host Driver shall check this register to identify what kind of error the Auto CMD12 / CMD 23 indicated. Auto CMD23 errors are indicated in bit 04-01. This register is valid only when the Auto CMD12 Error status bit is set.

The table below shows the relationship between the Auto CMD12 CRC Error and the Auto CMD12 Command Timeout Error.

Table 58-11. Relationship Between Command CRC Error and Command Timeout Error for Auto CMD12

Auto CMD12 CRC Error	Auto CMD12 Timeout Error	Type of Error
0	0	No Error
0	1	Response Timeout Error
1	0	Response CRC Error
1	1	CMD line conflict

Changes in Auto CMD12 Error Status register can be classified in three scenarios:

1. When the uSDHC is going to issue an Auto CMD12.
 - Set bit 0 to 1 if the Auto CMD12 can't be issued due to an error in the previous command
 - Set bit 0 to 0 if the Auto CMD12 is issued
2. At the end bit of an Auto CMD12 response.
 - Check errors correspond to bits 1-4.
 - Set bits 1-4 corresponding to detected errors.
 - Clear bits 1-4 corresponding to detected errors
3. Before reading the Auto CMD12 Error Status bit 7.
 - Set bit 7 to 1 if there is a command that can't be issued
 - Clear bit 7 if there is no command to issue

The timing for generating the Auto CMD12 Error and writing to the Command register are asynchronous. After that, bit 7 shall be sampled when the driver is not writing to the Command register. So it is suggested to read this register only when the AC12E bit in Interrupt Status register is set. An Auto CMD12 Error Interrupt is generated when one of the error bits (0-4) is set to 1. The Command Not Issued By Auto CMD12 Error does not generate an interrupt.

Address: Base address + 3Ch offset

Bit	31	30	29	28	27	26	25	24	23	22	21	20	19	18	17	16	
R	0								SMP_CLK_SEL	EXECUTE_TUNING	0						
W	[Shaded]										[Shaded]	[Shaded]	[Shaded]				
Reset	0	0	0	0	0	0	0	0	0	0	0	0	0	0	0	0	0
Bit	15	14	13	12	11	10	9	8	7	6	5	4	3	2	1	0	
R	0								CNIBAC12E	0	AC12IE	AC12CE	AC12EBE	AC12TOE	AC12NE		
W	[Shaded]								[Shaded]	[Shaded]	[Shaded]	[Shaded]	[Shaded]	[Shaded]	[Shaded]		
Reset	0	0	0	0	0	0	0	0	0	0	0	0	0	0	0	0	

uSDHCx_AUTOCMD12_ERR_STATUS field descriptions

Field	Description
31–24 Reserved	This read-only field is reserved and always has the value 0.
23 SMP_CLK_SEL	<p>Sample Clock Select</p> <p>When std_tuning_en bit is set, this bit is used to select sampling clock to receive CMD and DATA. Otherwise, this bit is reserved. This bit is set by ty tuning procedure and valid after the completion of tuning(When Execute Tuning is cleared). Setting 1 means that tuning is completed successfully and setting 0 means that tuning is failed. Writing 1 to this bit is meaningless and ignored. A tuning circuit is reset by writing to 0. This bit can be cleared with setting Execute Tuning. Once the tuning circuit is reset, it will take time to complete tuning sequence. Therefore, Host Driver should keep this bit to 1 to perform re-tuning sequence to complete re-tuning sequence in a short time. Change of this bit is not allowed while the Host controller us receiving response or a read data block.</p>

Table continues on the next page...

uSDHCx_AUTOCMD12_ERR_STATUS field descriptions (continued)

Field	Description
	1 Tuned clock is used to sample data 0 Fixed clock is used to sample data
22 EXECUTE_TUNING	Execute Tuning When std_tuning_en bit is set, this bit is used to start tuning procedure. Otherwise, this bit is reserved. This bit is set to start tuning procedure and automatically cleared when runing procedure is completed. The result of tuning is indicated to sam_clk_sel bit. Tuning procedure is aborted by writing 0.
21–8 Reserved	This read-only field is reserved and always has the value 0.
7 CNIBAC12E	Command Not Issued By Auto CMD12 Error Setting this bit to 1 means CMD_wo_DAT is not executed due to an Auto CMD12 Error (D04-D01) in this register. 1 Not Issued 0 No error
6–5 Reserved	This read-only field is reserved and always has the value 0.
4 AC12IE	Auto CMD12 / 23 Index Error Occurs if the Command Index error occurs in response to a command. 1 Error, the CMD index in response is not CMD12/23 0 No error
3 AC12CE	Auto CMD12 / 23 CRC Error Occurs when detecting a CRC error in the command response. 1 CRC Error Met in Auto CMD12/23 Response 0 No CRC error
2 AC12EBE	Auto CMD12 / 23 End Bit Error Occurs when detecting that the end bit of command response is 0 which should be 1. 1 End Bit Error Generated 0 No error
1 AC12TOE	Auto CMD12 / 23 Timeout Error Occurs if no response is returned within 64 SDCLK cycles from the end bit of the command. If this bit is set to 1, the other error status bits (2-4) have no meaning. 1 Time out 0 No error
0 AC12NE	Auto CMD12 Not Executed If memory multiple block data transfer is not started, due to a command error, this bit is not set because it is not necessary to issue an Auto CMD12. Setting this bit to 1 means the uSDHC cannot issue the Auto CMD12 to stop a memory multiple block data transfer due to some error. If this bit is set to 1, other error status bits (1-4) have no meaning. 1 Not executed 0 Executed

58.8.17 Host Controller Capabilities (uSDHCx_HOST_CTRL_CAP)

This register provides the Host Driver with information specific to the uSDHC implementation. The value in this register is the power-on-reset value, and does not change with a software reset.

Address: Base address + 40h offset

Bit	31	30	29	28	27	26	25	24	23	22	21	20	19	18	17	16
R	0					VS18	VS30	VS33	SRS	DMAS	HSS	ADMAS	0	MBL[2:0]		
W	[Shaded area indicating write protection]															
Reset	0	0	0	0	0	1	1	1	1	1	1	1	0	0	1	1

uSDHC Memory Map/Register Definition

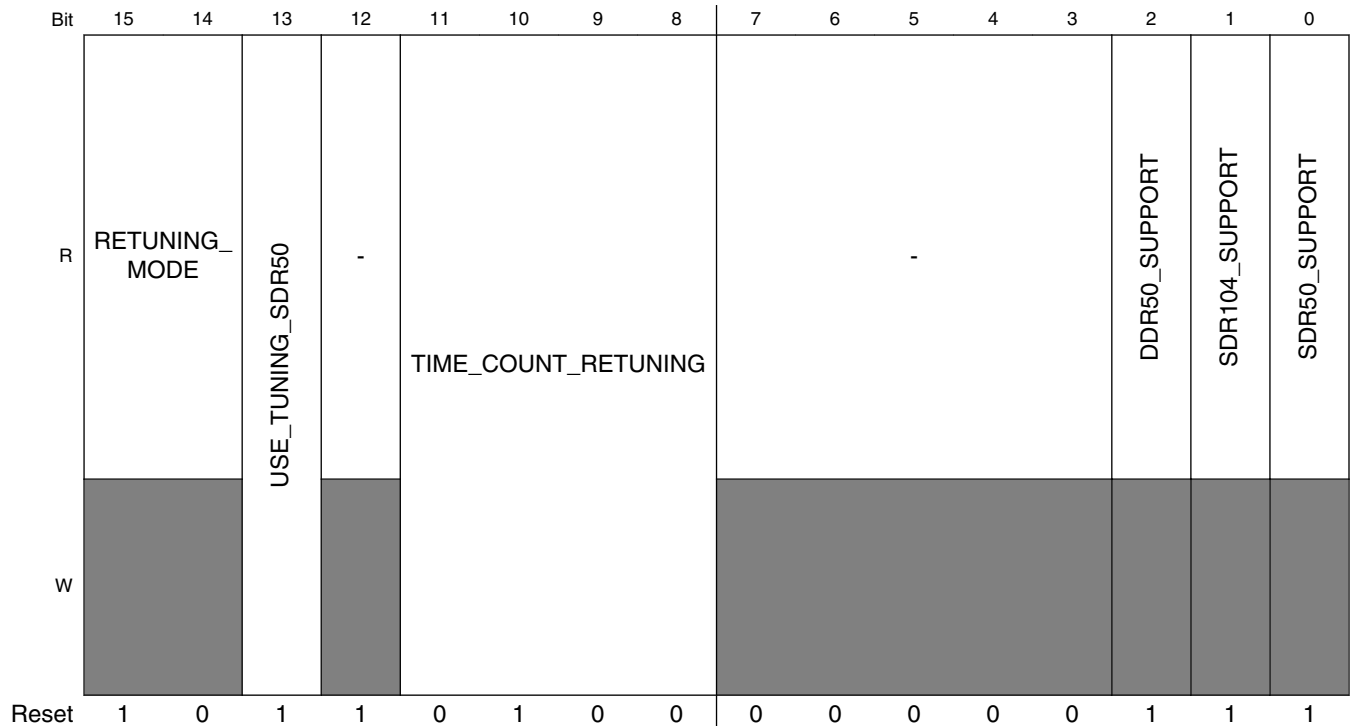

uSDHCx_HOST_CTRL_CAP field descriptions

Field	Description
31–27 Reserved	This read-only field is reserved and always has the value 0.
26 VS18	Voltage Support 1.8 V This bit shall depend on the Host System ability. 1 1.8V supported 0 1.8V not supported
25 VS30	Voltage Support 3.0 V This bit shall depend on the Host System ability. 1 3.0V supported 0 3.0V not supported
24 VS33	Voltage Support 3.3V This bit shall depend on the Host System ability. 1 3.3V supported 0 3.3V not supported
23 SRS	Suspend / Resume Support This bit indicates whether the uSDHC supports Suspend / Resume functionality. If this bit is 0, the Suspend and Resume mechanism, as well as the Read Wait, are not supported, and the Host Driver shall not issue either Suspend or Resume commands. 1 Supported 0 Not supported

Table continues on the next page...

uSDHCx_HOST_CTRL_CAP field descriptions (continued)

Field	Description
22 DMAS	<p>DMA Support</p> <p>This bit indicates whether the uSDHC is capable of using the internal DMA to transfer data between system memory and the data buffer directly.</p> <p>1 DMA Supported 0 DMA not supported</p>
21 HSS	<p>High Speed Support</p> <p>This bit indicates whether the uSDHC supports High Speed mode and the Host System can supply a SD Clock frequency from 25 MHz to 50 MHz.</p> <p>1 High Speed Supported 0 High Speed Not Supported</p>
20 ADMAS	<p>ADMA Support</p> <p>This bit indicates whether the uSDHC supports the ADMA feature.</p> <p>1 Advanced DMA Supported 0 Advanced DMA Not supported</p>
19 Reserved	This read-only field is reserved and always has the value 0.
18–16 MBL[2:0]	<p>Max Block Length</p> <p>This value indicates the maximum block size that the Host Driver can read and write to the buffer in the uSDHC. The buffer shall transfer block size without wait cycles.</p> <p>000 512 bytes 001 1024 bytes 010 2048 bytes 011 4096 bytes</p>
15–14 RETUNING_ MODE	<p>Retuning Mode</p> <p>This bit selects retuning method.</p> <p>00 Mode 1 01 Mode 2 10 Mode 3 11 Reserved</p>
13 USE_TUNING_ SDR50	<p>Use Tuning for SDR50</p> <p>This bit is set to 1. Host controller requires tuning to operate SDR50</p> <p>1 SDR50 requires tuning 0 SDR does not require tuning</p>
12 -	Reserved
11–8 TIME_COUNT_ RETUNING	<p>Time Counter for Retuning</p> <p>This bit indicates an initial value of the Retuning Timer for Re-Tuning Mode1 and 3. Setting to 0 disables Retuning Timer.</p>

Table continues on the next page...

uSDHCx_HOST_CTRL_CAP field descriptions (continued)

Field	Description
7-3 -	
2 DDR50_SUPPORT	DDR50 support This bit indicates support of DDR50 mode.
1 SDR104_SUPPORT	SDR104 support This bit indicates support of SDR104 mode.
0 SDR50_SUPPORT	SDR50 support This bit indicates support of SDR50 mode.

58.8.18 Watermark Level (uSDHCx_WTMK_LVL)

Both write and read watermark levels (FIFO threshold) are configurable. Their value can range from 1 to 128 words. Both write and read burst lengths are also Configurable. Their value can range from 1 to 31 words.

Address: Base address + 44h offset

Bit	31	30	29	28	27	26	25	24	23	22	21	20	19	18	17	16	15	14	13	12	11	10	9	8	7	6	5	4	3	2	1	0
R																																
W	0																0															
Reset	0	0	0	0	1	0	0	0	0	0	0	1	0	0	0	0	0	0	0	0	1	0	0	0	0	0	0	1	0	0	0	

uSDHCx_WTMK_LVL field descriptions

Field	Description
31-29 Reserved	This read-only field is reserved and always has the value 0.
28-24 WR_BRST_LEN[4:0]	Write Burst Length ¹ The number of words the uSDHC writes in a single burst. The write burst length must be less than or equal to the write watermark level, and all bursts within a watermark level transfer will be in back-to-back mode. On reset, this field will be 8. Writing 0 to this field will result in '01000' (i.e. it is not able to clear this field).
23-16 WR_WML[7:0]	Write Watermark Level The number of words used as the watermark level (FIFO threshold) in a DMA write operation. Also the number of words as a sequence of write bursts in back-to-back mode. The maximum legal value for the write watermark level is 128.
15-13 Reserved	This read-only field is reserved and always has the value 0.

Table continues on the next page...

uSDHCx_WTMK_LVL field descriptions (continued)

Field	Description
12–8 RD_BRST_LEN[4:0]	Read Burst Length ² The number of words the uSDHC reads in a single burst. The read burst length must be less than or equal to the read watermark level, and all bursts within a watermark level transfer will be in back-to-back mode. On reset, this field will be 8. Writing 0 to this field will result in '01000' (i.e. it is not able to clear this field).
RD_WML[7:0]	Read Watermark Level The number of words used as the watermark level (FIFO threshold) in a DMA read operation. Also the number of words as a sequence of read bursts in back-to-back mode. The maximum legal value for the read water mark level is 128.

1. Due to system restriction, the actual burst length may not exceed 16.

2. Due to system restriction, the actual burst length may not exceed 16.

58.8.19 Mixer Control (uSDHCx_MIX_CTRL)

This register is used to DMA and data transfer. To prevent data loss, The software should check if data transfer is active before writing this register. These bits are DPSEL, MBSEL, DTDSEL, AC12EN, BCEN, and DMAEN.

Table 58-12. Transfer Type Register Setting for Various Transfer Types

Multi/Single Block Select	Block Count Enable	Block Count	Function
0	Don't Care	Don't Care	Single Transfer
1	0	Don't Care	Infinite Transfer
1	1	Positive Number	Multiple Transfer
1	1	Zero	No Data Transfer

Address: Base address + 48h offset

Bit	31	30	29	28	27	26	25	24	23	22	21	20	19	18	17	16
R	-	-	-	Reserved			FBCLK_SEL	AUTO_TUNE_EN	SMP_CLK_SEL	EXE_TUNE	0					
W																
Reset	1	0	0	0	0	0	0	0	0	0	0	0	0	0	0	0
Bit	15	14	13	12	11	10	9	8	7	6	5	4	3	2	1	0
R	0								AC23EN	NIBBLE_POS	MSBSEL	DTDSEL	DDR_EN	AC12EN	BCEN	DMAEN
W																
Reset	0	0	0	0	0	0	0	0	0	0	0	0	0	0	0	0

uSDHCx_MIX_CTRL field descriptions

Field	Description
31 -	Reserved. Always write as 1
30 -	Reserved. Always write as 0.
29 -	Reserved. Always write as 0.
28–26 -	This field is reserved. Reserved
25 FBCLK_SEL	Feedback Clock Source Selection (Only used for SD3.0, SDR104 mode) 1 Feedback clock comes from the ipp_card_clk_out 0 Feedback clock comes from the loopback CLK
24 AUTO_TUNE_EN	Auto Tuning Enable (Only used for SD3.0, SDR104 mode) 1 Enable auto tuning 0 Disable auto tuning
23 SMP_CLK_SEL	When STD_TUNING_EN is 0, this bit is used to select Tuned clock or Fixed clock to sample data / cmd (Only used for SD3.0, SDR104 mode) 1 Tuned clock is used to sample data / cmd 0 Fixed clock is used to sample data / cmd
22 EXE_TUNE	Execute Tuning: (Only used for SD3.0, SDR104 mode) When STD_TUNING_EN is 0, this bit is set to 1 to indicate the Host Driver is starting tuning procedure. Tuning procedure is aborted by writing 0. 1 Execute Tuning 0 Not Tuned or Tuning Completed
21–8 Reserved	This read-only field is reserved and always has the value 0.
7 AC23EN	Auto CMD23 Enable When this bit is set to 1, the Host Controller issues a CMD23 automatically before issuing a command specified in the Command Register.
6 NIBBLE_POS	In DDR 4-bit mode nibble position indication. 0- the sequence is 'odd high nibble -> even high nibble -> odd low nibble -> even low nibble'; 1- the sequence is 'odd high nibble -> odd low nibble -> even high nibble -> even low nibble'.
5 MSBSEL	Multi / Single Block Select This bit enables multiple block DATA line data transfers. For any other commands, this bit can be set to 0. If this bit is 0, it is not necessary to set the Block Count register. (Refer to Command Transfer Type (uSDHC_CMD_XFR_TYP)). 1 Multiple Blocks 0 Single Block
4 DTDSEL	Data Transfer Direction Select This bit defines the direction of DATA line data transfers. The bit is set to 1 by the Host Driver to transfer data from the SD card to the uSDHC and is set to 0 for all other commands.

Table continues on the next page...

uSDHCx_MIX_CTRL field descriptions (continued)

Field	Description
	1 Read (Card to Host) 0 Write (Host to Card)
3 DDR_EN	Dual Data Rate mode selection
2 AC12EN	Auto CMD12 Enable Multiple block transfers for memory require a CMD12 to stop the transaction. When this bit is set to 1, the uSDHC will issue a CMD12 automatically when the last block transfer has completed. The Host Driver shall not set this bit to issue commands that do not require CMD12 to stop a multiple block data transfer. In particular, secure commands defined in File Security Specification (see reference list) do not require CMD12. In single block transfer, the uSDHC will ignore this bit no matter it is set or not. 1 Enable 0 Disable
1 BCEN	Block Count Enable This bit is used to enable the Block Count register, which is only relevant for multiple block transfers. When this bit is 0, the internal counter for block is disabled, which is useful in executing an infinite transfer. 1 Enable 0 Disable
0 DMAEN	DMA Enable This bit enables DMA functionality. If this bit is set to 1, a DMA operation shall begin when the Host Driver sets the DPSEL bit of this register. Whether the Simple DMA or the Advanced DMA is active depends on the DMA Select field of the Protocol Control register. 1 Enable 0 Disable

58.8.20 Force Event (uSDHCx_FORCE_EVENT)

The Force Event Register is not a physically implemented register. Rather, it is an address at which the Interrupt Status Register can be written if the corresponding bit of the Interrupt Status Enable Register is set. This register is a write only register and writing 0 to it has no effect. Writing 1 to this register actually sets the corresponding bit of Interrupt Status Register. A read from this register always results in 0's. In order to change the corresponding status bits in the Interrupt Status Register, make sure to set IPGEN bit in System Control Register so that IPG_CLK is always active.

Forcing a card interrupt will generate a short pulse on the DATA1 line, and the driver may treat this interrupt as a normal interrupt. The interrupt service routine may skip polling the card interrupt factor as the interrupt is self cleared.

uSDHC Memory Map/Register Definition

Address: Base address + 50h offset

Bit	31	30	29	28	27	26	25	24	23	22	21	20	19	18	17	16
R	0	0	0	0	0	0	0	0	0	0	0	0	0	0	0	0
W	FEVTCINT			FEVTDMAE		FEVTTNE		FEVTAC12E		FEVTDEBE	FEVTDCE	FEVTDTOE	FEVTCIE	FEVTCBE	FEVTCCE	FEVTCIOE
Reset	0	0	0	0	0	0	0	0	0	0	0	0	0	0	0	0
Bit	15	14	13	12	11	10	9	8	7	6	5	4	3	2	1	0
R				0					0	0		0	0	0	0	0
W									FEVTCNIBAC12E			FEVTAC12IE	FEVTAC12EBE	FEVTAC12CE	FEVTAC12TOE	FEVTAC12NE
Reset	0	0	0	0	0	0	0	0	0	0	0	0	0	0	0	0

uSDHCx_FORCE_EVENT field descriptions

Field	Description
31 FEVTCINT	Force Event Card Interrupt Writing 1 to this bit generates a short low-level pulse on the internal DATA1 line, as if a self clearing interrupt was received from the external card. If enabled, the CINT bit will be set and the interrupt service routine may treat this interrupt as a normal interrupt from the external card.
30–29 Reserved	This read-only field is reserved and always has the value 0.
28 FEVTDMAE	Force Event DMA Error Forces the DMAE bit of Interrupt Status Register to be set.
27 Reserved	This read-only field is reserved and always has the value 0.
26 FEVTTNE	Force Tuning Error Forces the TNE bit of Interrupt Status Register to be set.
25 Reserved	This read-only field is reserved and always has the value 0.

Table continues on the next page...

uSDHCx_FORCE_EVENT field descriptions (continued)

Field	Description
24 FEVTAC12E	Force Event Auto Command 12 Error Forces the AC12E bit of Interrupt Status Register to be set.
23 Reserved	This read-only field is reserved and always has the value 0.
22 FEVTDEBE	Force Event Data End Bit Error Forces the DEBE bit of Interrupt Status Register to be set.
21 FEVTDCE	Force Event Data CRC Error Forces the DCE bit of Interrupt Status Register to be set.
20 FEVTDTOE	Force Event Data Time Out Error Force the DTOE bit of Interrupt Status Register to be set.
19 FEVTCIE	Force Event Command Index Error Forces the CCE bit of Interrupt Status Register to be set.
18 FEVTCBE	Force Event Command End Bit Error Forces the CEBE bit of Interrupt Status Register to be set.
17 FEVTCCE	Force Event Command CRC Error Forces the CCE bit of Interrupt Status Register to be set.
16 FEVCTOE	Force Event Command Time Out Error Forces the CTOE bit of Interrupt Status Register to be set.
15–8 Reserved	This read-only field is reserved and always has the value 0.
7 FEVTCNIBAC12E	Force Event Command Not Executed By Auto Command 12 Error Forces the CNIBAC12E bit in the Auto Command12 Error Status Register to be set.
6–5 Reserved	This read-only field is reserved and always has the value 0.
4 FEVTAC12IE	Force Event Auto Command 12 Index Error Forces the AC12IE bit in the Auto Command12 Error Status Register to be set.
3 FEVTAC12EBE	Force Event Auto Command 12 End Bit Error Forces the AC12EBE bit in the Auto Command12 Error Status Register to be set.
2 FEVTAC12CE	Force Event Auto Command 12 CRC Error Forces the AC12CE bit in the Auto Command12 Error Status Register to be set.
1 FEVTAC12TOE	Force Event Auto Command 12 Time Out Error Forces the AC12TOE bit in the Auto Command12 Error Status Register to be set.
0 FEVTAC12NE	Force Event Auto Command 12 Not Executed Forces the AC12NE bit in the Auto Command12 Error Status Register to be set.

58.8.21 ADMA Error Status Register (uSDHCx_ADMA_ERR_STATUS)

When an ADMA Error Interrupt has occurred, the ADMA Error States field in this register holds the ADMA state and the ADMA System Address register holds the address around the error descriptor.

For recovering from this error, the Host Driver requires the ADMA state to identify the error descriptor address as follows:

- ST_STOP: Previous location set in the ADMA System Address register is the error descriptor address.
- ST_FDS: Current location set in the ADMA System Address register is the error descriptor address.
- ST_CADR: This state is never set because it only increments the descriptor pointer and doesn't generate an ADMA error.
- ST_TFR: Previous location set in the ADMA System Address register is the error descriptor address.

In case of a write operation, the Host Driver should use the ACMD22 to get the number of the written block, rather than using this information, since unwritten data may exist in the Host Controller.

The Host Controller generates the ADMA Error Interrupt when it detects invalid descriptor data (Valid=0) in the ST_FDS state. The Host Driver can distinguish this error by reading the Valid bit of the error descriptor.

Table 58-13. ADMA Error State Coding

D01-D00	ADMA Error State (when error has occurred)	Contents of ADMA System Address Register
00	ST_STOP (Stop DMA)	Holds the address of the next executable Descriptor command
01	ST_FDS (Fetch Descriptor)	Holds the valid Descriptor address
10	ST_CADR (Change Address)	No ADMA Error is generated
11	ST_TFR (Transfer Data)	Holds the address of the next executable Descriptor command

Address: Base address + 54h offset

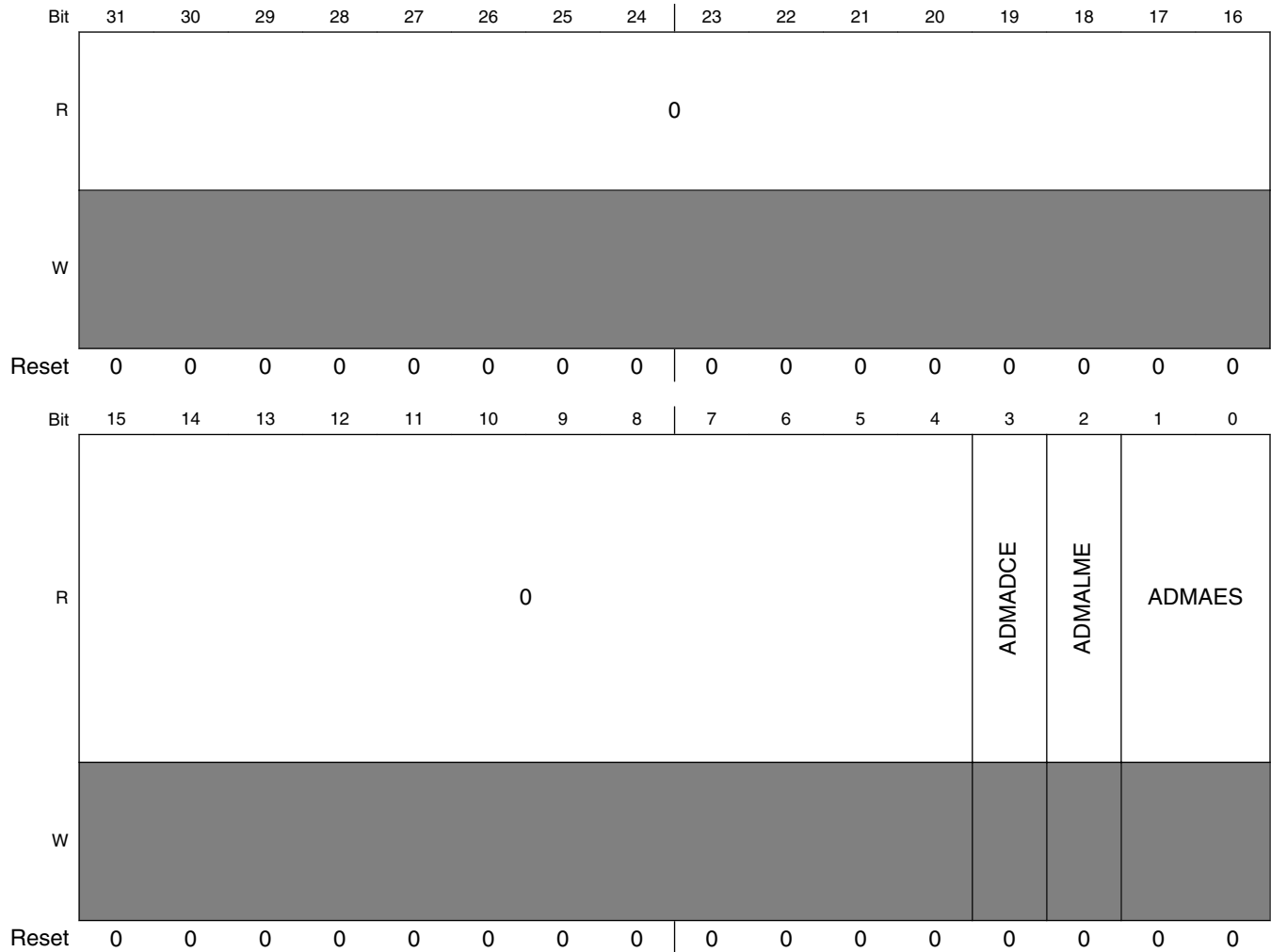

uSDHCx_ADMA_ERR_STATUS field descriptions

Field	Description
31–4 Reserved	This read-only field is reserved and always has the value 0.
3 ADMADCE	ADMA Descriptor Error This error occurs when invalid descriptor fetched by ADMA. 1 Error 0 No Error
2 ADMALME	ADMA Length Mismatch Error This error occurs in the following 2 cases: <ul style="list-style-type: none"> • While the Block Count Enable is being set, the total data length specified by the Descriptor table is different from that specified by the Block Count and Block Length. • Total data length cannot be divided by the block length. 1 Error 0 No Error
ADMAES	ADMA Error State (when ADMA Error is occurred)

Table continues on the next page...

uSDHCx_ADMA_ERR_STATUS field descriptions (continued)

Field	Description
	This field indicates the state of the ADMA when an error has occurred during an ADMA data transfer. Refer to ADMA Error Status Register (uSDHC_ADMA_ERR_STATUS) for more details.

58.8.22 ADMA System Address (uSDHCx_ADMA_SYS_ADDR)

This register contains the physical system memory address used for ADMA transfers.

Address: Base address + 58h offset

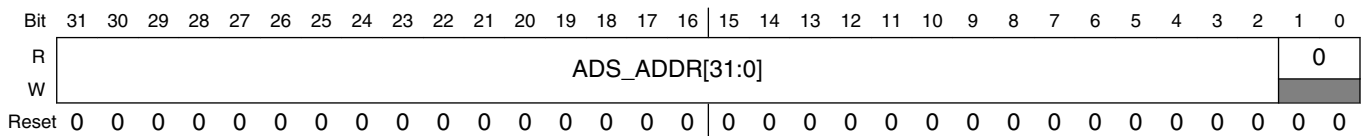

uSDHCx_ADMA_SYS_ADDR field descriptions

Field	Description
31–2 ADS_ ADDR[31:0]	ADMA System Address This register holds the word address of the executing command in the Descriptor table. At the start of ADMA, the Host Driver shall set the start address of the Descriptor table. The ADMA engine increments this register address whenever fetching a Descriptor command. When the ADMA is stopped at the Block Gap, this register indicates the address of the next executable Descriptor command. When the ADMA Error Interrupt is generated, this register shall hold the valid Descriptor address depending on the ADMA state. The lower 2 bits of this register is tied to '0' so the ADMA address is always word aligned. Since this register supports dynamic address reflecting, when TC bit is set, it automatically alters the value of internal address counter, so SW cannot change this register when TC bit is set. Such restriction is also listed in Software Restrictions .
Reserved	This read-only field is reserved and always has the value 0.

58.8.23 DLL (Delay Line) Control (uSDHCx_DLL_CTRL)

This register contains control bits for DLL.

Address: Base address + 60h offset

Bit	31	30	29	28	27	26	25	24	23	22	21	20	19	18	17	16	
R	DLL_CTRL_REF_UPDATE_INT[3:0]				DLL_CTRL_SLV_UPDATE_INT[7:0]								0	DLL_CTRL_SLV_DLY_TARGET1			
W																	
Reset	0	0	0	0	0	0	0	0	0	0	0	0	0	0	0	0	
Bit	15	14	13	12	11	10	9	8	7	6	5	4	3	2	1	0	
R	DLL_CTRL_SLV_OVERRIDE_VAL[6:0]						DLL_CTRL_SLV_OVERRIDE	DLL_CTRL_GATE_UPDATE	DLL_CTRL_SLV_DLY_TARGET0				DLL_CTRL_SLV_FORCE_UPD	DLL_CTRL_RESET	DLL_CTRL_ENABLE		
W																	
Reset	0	0	0	0	0	0	1	0	0	0	0	0	0	0	0	0	

uSDHCx_DLL_CTRL field descriptions

Field	Description
31–28 DLL_CTRL_REF_UPDATE_INT[3:0]	DLL control loop update interval. The interval cycle is $(2 + \text{REF_UPDATE_INT}) * \text{REF_CLOCK}$. By default, the DLL control loop shall update every two REF_CLOCK cycles. It should be noted that increasing the reference delay-line update interval reduces the ability of the DLL to adjust to fast changes in conditions that may effect the delay (such as voltage and temperature)
27–20 DLL_CTRL_SLV_UPDATE_INT[7:0]	Slave delay line update interval. If default 0 is used, it means 256 cycles of REF_CLOCK. A value of 0x0f results in 15 cycles and so on. Note that software can always cause an update of the slave-delay line using the SLV_FORCE_UPDATE register. Note that the slave delay line will also update automatically when the reference DLL transitions to a locked state (from an un-locked state).
19 Reserved	This read-only field is reserved and always has the value 0.
18–16 DLL_CTRL_SLV_DLY_TARGET1	Refer to DLL_CTRL_SLV_DLY_TARGET0 below.
15–9 DLL_CTRL_SLV_OVERRIDE_VAL[6:0]	When SLV_OVERRIDE = 1 This field is used to select 1 of 128 physical taps manually. A value of 0 selects tap 1, and a value of 0x7f selects tap 128.

Table continues on the next page...

uSDHCx_DLL_CTRL field descriptions (continued)

Field	Description
8 DLL_CTRL_ SLV_OVERRIDE	Set this bit to 1 to Enable manual override for slave delay chain using SLV_OVERRIDE_VAL; to set 0 to disable manual override. This feature does not require the DLL to be enabled using the ENABLE bit. In fact to reduce power, if SLV_OVERRIDE is used, it is recommended to disable the DLL with ENABLE = 0
7 DLL_CTRL_ GATE_UPDATE	Set this bit to 1 to prevent the DLL from updating (since when clock_in exists, glitches may appear during DLL updates). This bit may be used by software if such a condition occurs. Clear the bit to 0 to allow the DLL to update automatically.
6-3 DLL_CTRL_ SLV_DLY_ TARGET0	The delay target for the uSDHC loopback read clock can be programmed in 1/16th increments of an ref_clock half-period. The delay is $((DLL_CTRL_SLV_DLY_TARGET1 + 1) * REF_CLOCK / 2) / 16$ So the input read-clock can be delayed relative input data from $(REF_CLOCK / 2) / 16$ to $REF_CLOCK * 4$.
2 DLL_CTRL_ SLV_FORCE_ UPD	Setting this bit to 1, forces the slave delay line to update to the DLL calibrated value immediately. The slave delay line shall update automatically based on the SLV_UPDATE_INT interval or when a DLL lock condition is sensed. Subsequent forcing of the slave-line update can only occur if SLV_FORCE_UP is set back to 0 and then asserted again (edge triggered). Be sure to use it when uSDHC is idle. This function may not work when uSDHC is working on data / cmd / response.
1 DLL_CTRL_ RESET	Setting this bit to 1 force a reset on DLL. This will cause the DLL to lose lock and re-calibrate to detect an REF_CLOCK half period phase shift. This signal is used by the DLL as edge-sensitive, so in order to create a subsequent reset, RESET must be taken low and then asserted again.
0 DLL_CTRL_ ENABLE	Set this bit to 1 to enable the DLL and delay chain; otherwise; set to 0 to bypasses DLL. Note that using the slave delay line override feature with SLV_OVERRIDE and SLV_OVERRIDE_VAL, the DLL does not need to be enabled.

58.8.24 DLL Status (uSDHCx_DLL_STATUS)

This register contains the DLL status information. All bits are read only and will read the same as the power-reset value.

Address: Base address + 64h offset

Bit	31	30	29	28	27	26	25	24	23	22	21	20	19	18	17	16
R	0															
W																
Reset	0	0	0	0	0	0	0	0	0	0	0	0	0	0	0	0
Bit	15	14	13	12	11	10	9	8	7	6	5	4	3	2	1	0
R	DLL_STS_REF_SEL[6:0]							DLL_STS_SLV_SEL[6:0]							DLL_STS_REF_LOCK	DLL_STS_SLV_LOCK
W																
Reset	0	0	0	0	0	0	0	0	0	0	0	0	0	0	0	0

uSDHCx_DLL_STATUS field descriptions

Field	Description
31–16 Reserved	This read-only field is reserved and always has the value 0.
15–9 DLL_STS_REF_SEL[6:0]	Reference delay line select taps. This is encoded by 7 bits for 127 taps.
8–2 DLL_STS_SLV_SEL[6:0]	Slave delay line select status. This is the instant value generated from reference chain. Since the reference chain can only be updated when REF_CLOCK is detected, this value should be the right value to be updated when the reference is locked.
1 DLL_STS_REF_LOCK	Reference DLL lock status. This signifies that the DLL has detected and locked to a half-phase ref_clock shift, allowing the slave delay-line to perform programmed clock delays
0 DLL_STS_SLV_LOCK	Slave delay-line lock status. This signifies that a valid calibration has been set to the slave-delay line and that the slave-delay line is implementing the programmed delay value

58.8.25 CLK Tuning Control and Status (uSDHCx_CLK_TUNE_CTRL_STATUS)

This register contains the Clock Tuning Control status information. All bits are read only and will read the same as the power-reset value. This register is added to support SD3.0 UHS-I SDR104 mode.

Address: Base address + 68h offset

Bit	31	30	29	28	27	26	25	24	23	22	21	20	19	18	17	16
R	PRE_ERR	TAP_SEL_PRE[6:0]						TAP_SEL_OUT[3:0]				TAP_SEL_POST[3:0]				
W																
Reset	0	0	0	0	0	0	0	0	0	0	0	0	0	0	0	0
Bit	15	14	13	12	11	10	9	8	7	6	5	4	3	2	1	0
R	NXT_ERR	DLY_CELL_SET_PRE[6:0]						DLY_CELL_SET_OUT[6:0]				DLY_CELL_SET_POST[6:0]				
W																
Reset	0	0	0	0	0	0	0	0	0	0	0	0	0	0	0	0

uSDHCx_CLK_TUNE_CTRL_STATUS field descriptions

Field	Description
31 PRE_ERR	PRE error which means the number of delay cells added on the feedback clock is too small. It is valid only when SMP_CLK_SEL of Mix control register (bit23 of 0x48) is enabled.

Table continues on the next page...

uSDHCx_CLK_TUNE_CTRL_STATUS field descriptions (continued)

Field	Description
30–24 TAP_SEL_ PRE[6:0]	Reflects the number of delay cells added on the feedback clock between the feedback clock and CLK_PRE. When AUTO_TUNE_EN (bit24 of 0x48) is disabled, TAP_SEL_PRE is always equal to DLY_CELL_SET_PRE. When AUTO_TUNE_EN (bit24 of 0x48) is enabled, TAP_SEL_PRE will be updated automatically according to the status of the auto tuning circuit to adjust the sample clock phase.
23–20 TAP_SEL_ OUT[3:0]	Reflect the number of delay cells added on the feedback clock between CLK_PRE and CLK_OUT.
19–16 TAP_SEL_ POST[3:0]	Reflect the number of delay cells added on the feedback clock between CLK_OUT and CLK_POST.
15 NXT_ERR	NXT error which means the number of delay cells added on the feedback clock is too large. It's valid only when SMP_CLK_SEL of Mix control register (bit23 of 0x48) is enabled.
14–8 DLY_CELL_ SET_PRE[6:0]	Set the number of delay cells on the feedback clock between the feedback clock and CLK_PRE.
7–4 DLY_CELL_ SET_OUT[6:0]	Set the number of delay cells on the feedback clock between CLK_PRE and CLK_OUT.
DLY_CELL_ SET_POST[6:0]	Set the number of delay cells on the feedback clock between CLK_OUT and CLK_POST.

58.8.26 Vendor Specific Register (uSDHCx_VEND_SPEC)

This register contains the vendor specific control / status register.

Address: Base address + C0h offset

Bit	31	30	29	28	27	26	25	24	23	22	21	20	19	18	17	16
R									INT_ST_VAL[7:0]							
W	CMD_BYTE_EN	-	-	-												
Reset	0	0	1	0	0	0	0	0	0	0	0	0	0	0	0	0
Bit	15	14	13	12	11	10	9	8	7	6	5	4	3	2	1	0
R	CRC_CHK_DIS	CARD_CLK_SOFT_EN	IPG_PERCLK_SOFT_EN	HCLK_SOFT_EN	IPG_CLK_SOFT_EN	-		FRC_SDCLK_ON	CLKONJ_IN_ABORT	WP_POL	CD_POL	DAT3_CD_POL	AC12_WR_CHKBUSY_EN	CONFLICT_CHK_EN	VSELECT	EXT_DMA_EN
W																
Reset	0	1	1	1	1	0	0	0	0	0	0	0	1	0	0	1

uSDHCx_VEND_SPEC field descriptions

Field	Description
31 CMD_BYTE_EN	Byte access 0 Disable 1 Enable
30 -	Reserved. Always write as 0.

Table continues on the next page...

uSDHCx_VEND_SPEC field descriptions (continued)

Field	Description
29 -	Reserved. Always write as 1.
28 -	Reserved. Always write as 0.
27–24 -	Reserved. Always write as 4'b0000.
23–16 INT_ST_VAL[7:0]	Internal State Value Internal state value, reflecting the corresponding state value selected by Debug Select field. This field is read-only and write to this field does not have effect.
15 CRC_CHK_DIS	CRC Check Disable 0 Check CRC16 for every read data packet and check CRC bits for every write data packet 1 Ignore CRC16 check for every read data packet and ignore CRC bits check for every write data packet
14 CARD_CLK_SOFT_EN	Card Clock Software Enable 0 Gate off the sd_clk 1 Enable the sd_clk
13 IPG_PERCLK_SOFT_EN	IPG_PERCLK Software Enable 0 Gate off the IPG_PERCLK 1 Enable the IPG_PERCLK
12 HCLK_SOFT_EN	AHB Clock Software Enable NOTE: Hardware auto-enables the AHB clock when the internal DMA is enabled even if HCLK_SOFT_EN is 0. 0 Gate off the AHB clock. 1 Enable the AHB clock.
11 IPG_CLK_SOFT_EN	IPG_CLK Software Enable 0 Gate off the IPG_CLK 1 Enable the IPG_CLK
10 -	Reserved. Always write as 0.
9 -	Reserved. Always write as 0.
8 FRC_SDCLK_ON	Force CLK output active 0 CLK active or inactive is fully controlled by the hardware. 1 Force CLK active.
7 CLKONJ_IN_ABORT	Only for debug. Force CLK output active when sending Abort command:

Table continues on the next page...

uSDHCx_VEND_SPEC field descriptions (continued)

Field	Description
	<p>0 The CLK output is active when sending abort command while data is transmitting even if the internal FIFO is full (for read) or empty (for write).</p> <p>1 The CLK output is inactive when sending abort command while data is transmitting if the internal FIFO is full (for read) or empty (for write).</p>
6 WP_POL	<p>Only for debug.</p> <p>Polarity of the WP pin:</p> <p>0 WP pin is high active.</p> <p>1 WP pin is low active.</p>
5 CD_POL	<p>Only for debug.</p> <p>Polarity of the CD_B pin:</p> <p>0 CD_B pin is low active.</p> <p>1 CD_B pin is high active.</p>
4 DAT3_CD_POL	<p>Only for debug.</p> <p>Polarity of DATA3 pin when it is used as card detection.</p> <p>0 Card detected when DATA3 is high.</p> <p>1 Card detected when DATA3 is low.</p>
3 AC12_WR_CHKBUSY_EN	<p>Check busy enable after auto CMD12 for write data packet</p> <p>0 Do not check busy after auto CMD12 for write data packet</p> <p>1 Check busy after auto CMD12 for write data packet</p>
2 CONFLICT_CHK_EN	<p>Conflict check enable.</p> <p>It is not implemented in uSDHC IP.</p> <p>0 Conflict check disable</p> <p>1 Conflict check enable</p>
1 VSELECT	<p>Voltage Selection</p> <p>Change the value of output signal VSELECT, to control the voltage on pads for external card. There must be a control circuit out of uSDHC to change the voltage on pads.</p> <p>1 Change the voltage to low voltage range, around 1.8 V</p> <p>0 Change the voltage to high voltage range, around 3.0 V</p>
0 EXT_DMA_EN	<p>External DMA Request Enable</p> <p>Enable the request to external DMA. When the internal DMA (either Simple DMA or Advanced DMA) is not in use, and this bit is set, uSDHC will send out DMA request when the internal buffer is ready. This bit is particularly useful when transferring data by Arm platform polling mode, and it is not allowed to send out the external DMA request. By default, this bit is set.</p> <p>0 In any scenario, uSDHC does not send out external DMA request.</p> <p>1 When internal DMA is not active, the external DMA request will be sent out.</p>

58.8.27 MMC Boot Register (uSDHCx_MMC_BOOT)

This register contains the MMC Fast Boot control register.

Address: Base address + C4h offset

Bit	31	30	29	28	27	26	25	24	23	22	21	20	19	18	17	16
R	BOOT_BLK_CNT[15:0]															
W																
Reset	0	0	0	0	0	0	0	0	0	0	0	0	0	0	0	0
Bit	15	14	13	12	11	10	9	8	7	6	5	4	3	2	1	0
R	0								DISABLE_TIME_OUT	AUTO_SABG_EN	BOOT_EN	BOOT_MODE	BOOT_ACK	DTCV_ACK[3:0]		
W																
Reset	0	0	0	0	0	0	0	0	0	0	0	0	0	0	0	0

uSDHCx_MMC_BOOT field descriptions

Field	Description
31–16 BOOT_BLK_CNT[15:0]	The value defines the Stop At Block Gap value of automatic mode. When received card block cnt is equal to (BLK_CNT - BOOT_BLK_CNT) and AUTO_SABG_EN is 1, then Stop At Block Gap. Here, BLK_CNT is defined in the Block Attributes Register, bit31 - 16 of 0x04.
15–9 Reserved	This read-only field is reserved and always has the value 0.
8 DISABLE_TIME_OUT	Disable Time Out NOTE: When this bit is set, there is no timeout check no matter whether BOOT_EN is set or not. 0 Enable time out 1 Disable time out
7 AUTO_SABG_EN	During boot, enable auto stop at block gap function. This function will be triggered, and host will stop at block gap when received card block cnt is equal to (BLK_CNT - BOOT_BLK_CNT).
6 BOOT_EN	Boot mode enable 0 Fast boot disable 1 Fast boot enable
5 BOOT_MODE	Boot mode select

Table continues on the next page...

uSDHCx_MMC_BOOT field descriptions (continued)

Field	Description
	0 Normal boot 1 Alternative boot
4 BOOT_ACK	Boot ACK mode select 0 No ack 1 Ack
DTOCV_ ACK[3:0]	Boot ACK time out counter value. 0000 SDCLK x 2 ¹³ 0001 SDCLK x 2 ¹⁴ 0010 SDCLK x 2 ¹⁵ 0011 SDCLK x 2 ¹⁶ 0100 SDCLK x 2 ¹⁷ 0101 SDCLK x 2 ¹⁸ 0110 SDCLK x 2 ¹⁹ 0111 SDCLK x 2 ²⁰ 1110 SDCLK x 2 ²⁷ 1111 SDCLK x 2 ²⁸

58.8.28 Vendor Specific 2 Register (uSDHCx_VEND_SPEC2)

This register contains the vendor specific control 2 register.

Address: Base address + C8h offset

Bit	31	30	29	28	27	26	25	24	23	22	21	20	19	18	17	16		
R	Reserved								ACMD23_ARGU2_EN	Reserved								
W	Reserved									Reserved								
Reset	0	0	0	0	0	0	0	0	0	0	0	0	0	0	0	0		
Bit	15	14	13	12	11	10	9	8	7	6	5	4	3	2	1	0		
R	Reserved				Reserved				0	0	CARD_INT_AUTO_CLR_DIS	TUNING_CMD_EN	TUNING_1bit_EN	TUNING_8bit_EN	CARD_INT_D3_TEST	SDR104_NSD_DIS	SDR104_OE_DIS	SDR104_TIMING_DIS
W	Reserved				Reserved													
Reset	0	0	0	0	0	0	0	0	0	0	0	0	0	1	1	0		

uSDHCx_VEND_SPEC2 field descriptions

Field	Description
31–24 -	This field is reserved.
23 ACMD23_ ARGU2_EN	Default1 1 Argument2 register enable for ACMD23 sharing with SDMA system address register. Default is enable. 0 Disable
22–12 -	This field is reserved.
11–10 -	This field is reserved. Reserved
9 Reserved	This read-only field is reserved and always has the value 0.
8 Reserved	This read-only field is reserved and always has the value 0.
7 CARD_INT_ AUTO_CLR_DIS	Disable the feature to clear the Card interrupt status bit when Card Interrupt status enable bit is cleared. Only for debug. 0 Card interrupt status bit (CINT) can be cleared when Card Interrupt status enable bit is 0. 1 Card interrupt status bit (CINT) can only be cleared by writing a 1 to CINT bit.
6 TUNING_CMD_ EN	Enable the auto tuning circuit to check the CMD line. 0 Auto tuning circuit does not check the CMD line. 1 Auto tuning circuit checks the CMD line.
5 TUNING_1bit_EN	Enable the auto tuning circuit to check the DATA0 only. It is used with the TUNING_8bit_EN together.
4 TUNING_8bit_EN	Enable the auto tuning circuit to check the DATA[7:0]. It is used with the TUNING_1bit_EN together. NOTE: The format of these two bits are [TUNNING_8bit_EN:TUNNING_1bit_EN]. 00 Tuning circuit only checks the DATA[3:0]. 01 Tuning circuit only checks the DATA0. 10 Tuning circuit checks the whole DATA[7:0]. 11 Invalid.
3 CARD_INT_D3_ TEST	Card Interrupt Detection Test This bit only uses for debugging. 0 Check the card interrupt only when DATA3 is high. 1 Check the card interrupt by ignoring the status of DATA3.
2 SDR104_NSD_ DIS	Interrupt window after abort command is sent. This bit only uses for debugging. 0 Enable the interrupt window 9 cycles later after the end of the I/O abort command (or CMD12) is sent. 1 Enable the interrupt window 5 cycles later after the end of the I/O abort command (or CMD12) is sent.
1 SDR104_OE_ DIS	CMD_OE / DATA_OE logic generation test. This bit only uses for debugging.

Table continues on the next page...

uSDHCx_VEND_SPEC2 field descriptions (continued)

Field	Description
	0 Drive the CMD_OE / DATA_OE for one more clock cycle after the end bit. 1 Stop to drive the CMD_OE / DATA_OE at once after driving the end bit.
0 SDR104_ TIMING_DIS	Timeout counter test. This bit only uses for debugging. 0 The timeout counter for Ncr changes to 80, Ncrc changes to 21. 1 The timeout counter for Ncr changes to 72, Ncrc changes to 15.

58.8.29 Tuning Control Register (uSDHCx_TUNING_CTRL)

The register contains configuration of tuning circuit.

Address: Base address + CCh offset

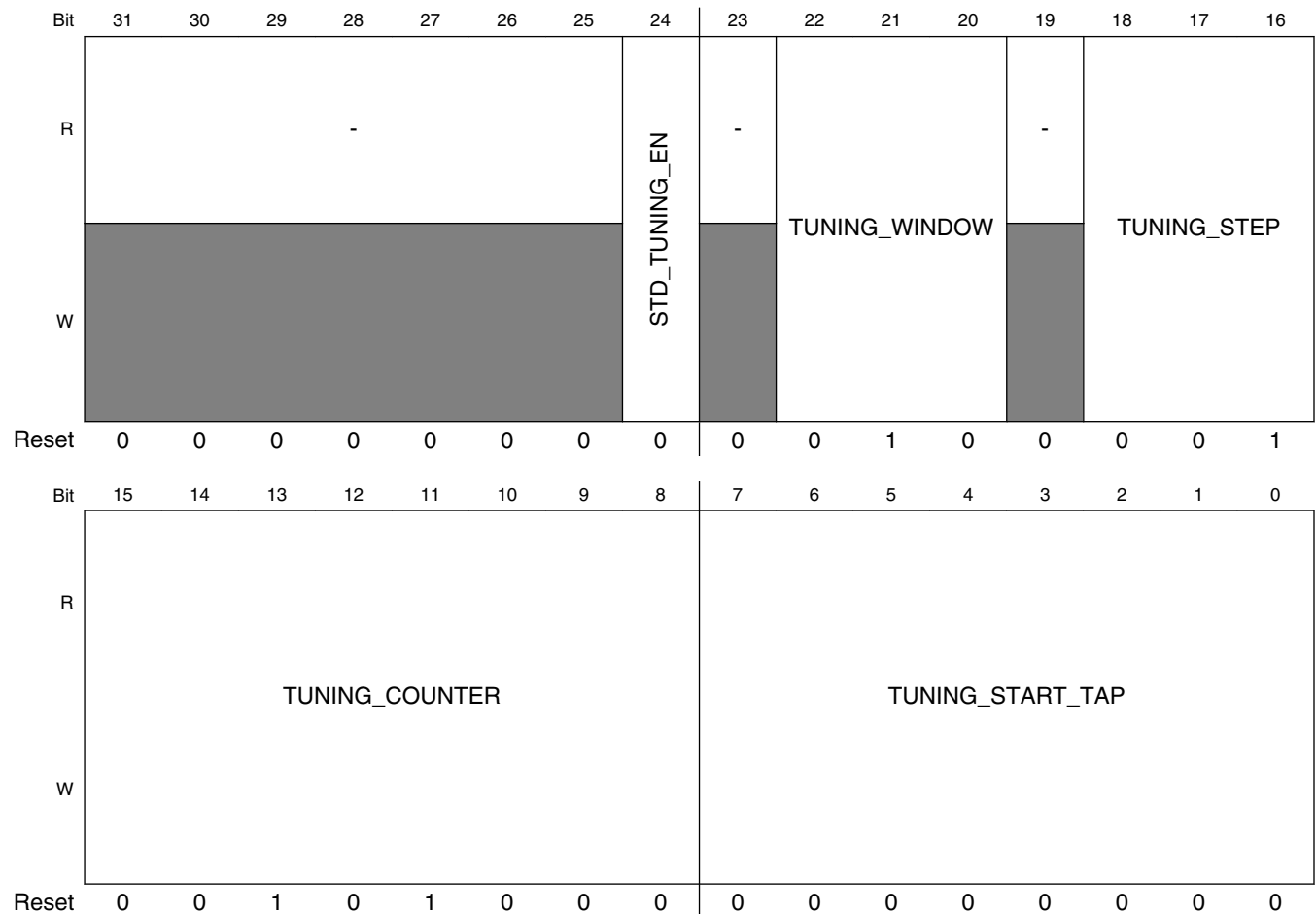

uSDHCx_TUNING_CTRL field descriptions

Field	Description
31–25 -	Reserved
24 STD_TUNING_ EN	Standard tuning circuit and procedure enable: This bit is used to enable standard tuning circuit and procedure.
23 -	Reserved
22–20 TUNING_ WINDOW	Select data window value for auto tuning
19 -	Reserved
18–16 TUNING_STEP	The increasing delay cell steps in tuning procedure.
15–8 TUNING_ COUNTER	The MAX repeat CMD19 times in tuning procedure.
TUNING_ START_TAP	The start dealy cell point when send first CMD19 in tuning procedure.

Chapter 59

Watchdog Timer (WDOG)

59.1 Overview

The Watchdog Timer (WDOG) protects against system failures by providing a method by which to escape from unexpected events or programming errors.

Once the WDOG is activated, it must be serviced by the software on a periodic basis. If servicing does not take place, the timer times out. Upon timeout, the WDOG asserts the internal system reset signal, WDOG_RESET_B_DEB to the System Reset Controller (SRC).

There is also a provision for WDOG signal assertion by timeout counter expiration. There is an option of programmable interrupt generation before the counter actually times out. The time at which the interrupt needs to be generated prior to counter timeout is programmable. There is a power down counter which is enabled out of any reset (POR, Warm/Cold). This counter has a fixed timeout period of 16 seconds, upon which it asserts the WDOG signal.

Flow diagrams for the timeout counter, power down counter and interrupt operations are shown in [Flow Diagrams](#).

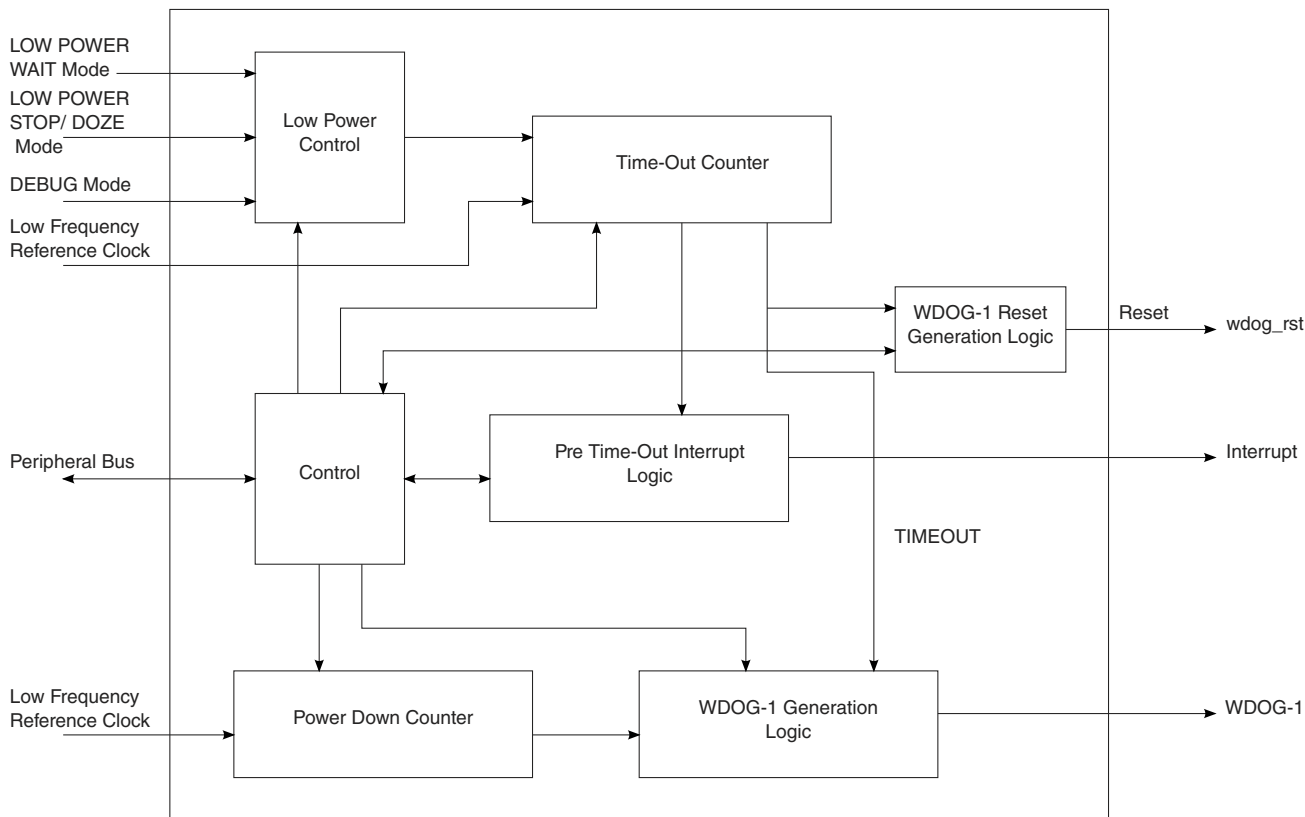

Figure 59-1. WDOG Diagram

59.1.1 Features

The WDOG features are listed below:

- Configurable timeout counter with timeout periods from 0.5 to 128 seconds which, after timeout expiration, result in the assertion of WDOG_RESET_B_DEB reset signal .
- Time resolution of 0.5 seconds
- Configurable timeout counter that can be programmed to run or stop during low-power modes
- Configurable timeout counter that can be programmed to run or stop during DEBUG mode
- Programmable interrupt generation prior to timeout
- The duration between interrupt and timeout events can be programmed from 0 to 127.5 seconds in steps of 0.5 seconds.
- Power down counter with fixed timeout period of 16 seconds, which if not disabled after reset will assert WDOG_B signal low

- Power down counter will be enabled out of any reset (POR, Warm / Cold reset) by default.

59.2 External signals

Table 59-1. WDOG External Signals

Signal	Description	Pad	Mode	Direction
WDOG1_ANY	Global WDOG signal	ENET2_RX_ER	ALT8	IO
		GPIO1_IO09	ALT1	
		LCD_DATA19	ALT2	
		LCD_RESET	ALT4	
WDOG1_B	This signal will power down the chip.	GPIO1_IO01	ALT8	IO
		GPIO1_IO08	ALT1	
		UART3_RTS_B	ALT8	
WDOG1_RST_B_DEB	This signal is a reset source for the chip.	ENET1_TX_DATA1	ALT8	O
		LCD_CLK	ALT8	
WDOG2_B	This signal will power down the chip.	LCD_VSYNC	ALT4	IO
WDOG2_RST_B_DEB	This signal is a reset source for the chip.	ENET1_TX_EN	ALT8	O
WDOG3_B	This signal will power down the chip.	GPIO1_IO00	ALT8	IO
WDOG3_RST_B_DEB	This signal is a reset source for the chip.	LCD_HSYNC	ALT4	O

59.3 Clocks

This section describes clocks and special clocking requirements of the block.

The WDOG uses the low frequency reference clock for its counter and control operations. The peripheral bus clock is used for register read/write operations.

The following table describes the clock sources for WDOG. Please see [Introduction](#) for clock setting, configuration and gating information.

Table 59-2. WDOG Clocks

Clock name	Clock Root	Description
ipg_clk	ipg_clk_root	IP Global functional clock. All functionality inside the WDOG module is synchronized to this clock.
ipg_clk_s	ipg_clk_root	IP slave bus clock. This clock is synchronized to ipg_clk and is only used for register read/write operations.

Table continues on the next page...

Table 59-2. WDOG Clocks (continued)

Clock name	Clock Root	Description
ipg_clk_32k	ckil_sync_clk_root	Low frequency (32.768 kHz) clock that continues to run in low-power mode. It is assumed that the Clock Controller will provide this clock signal synchronized to ipg_clk in the normal mode, and switch to a non-synchronized signal in low-power mode when the ipg_clk is off.

59.4 Watchdog mechanism and system integration

There are two WDOG modules, WDOG1 and WDOG2 (TZ) in the chip. The modules are disabled by default (after reset). WDOG1 will be configured during boot while WDOG2 is dedicated for secure world purposes and will be activated by TZ software if required. The TZ watchdog (TZ watchdog) module protects against TZ starvation by providing a method of escaping normal mode and forcing a switch to the TZ mode. TZ starvation is a situation where the normal OS prevents switching to the TZ mode. Such a situation is undesirable as it can compromise the system's security.

Once the TZ WDOG module is activated, it must be serviced by TZ on a periodic basis. If servicing does not take place, the timer times out. Upon a timeout, the TZ WDOG asserts a TZ-mapped interrupt that forces switching to the TZ mode. If it is still not serviced, the TZ WDOG asserts a security violation signal to the CSU. The TZ WDOG module cannot be programmed or de-activated by normal mode software.

The WDOG modules operate as follows:

- If servicing does not take place, the timer times out and the wdog_rst_b signal is activated (low)
- Interrupt can be generated before the counter actually times out
- The wdog_rst_b signal can be activated by software
- There is a power-down counter which gets enabled out of any reset. This counter has a fixed timeout period of 16 seconds upon which it will assert the ipp_wdog_b signal.

The following figure shows the WDOG1 and WDOG2 connectivity at the system level.

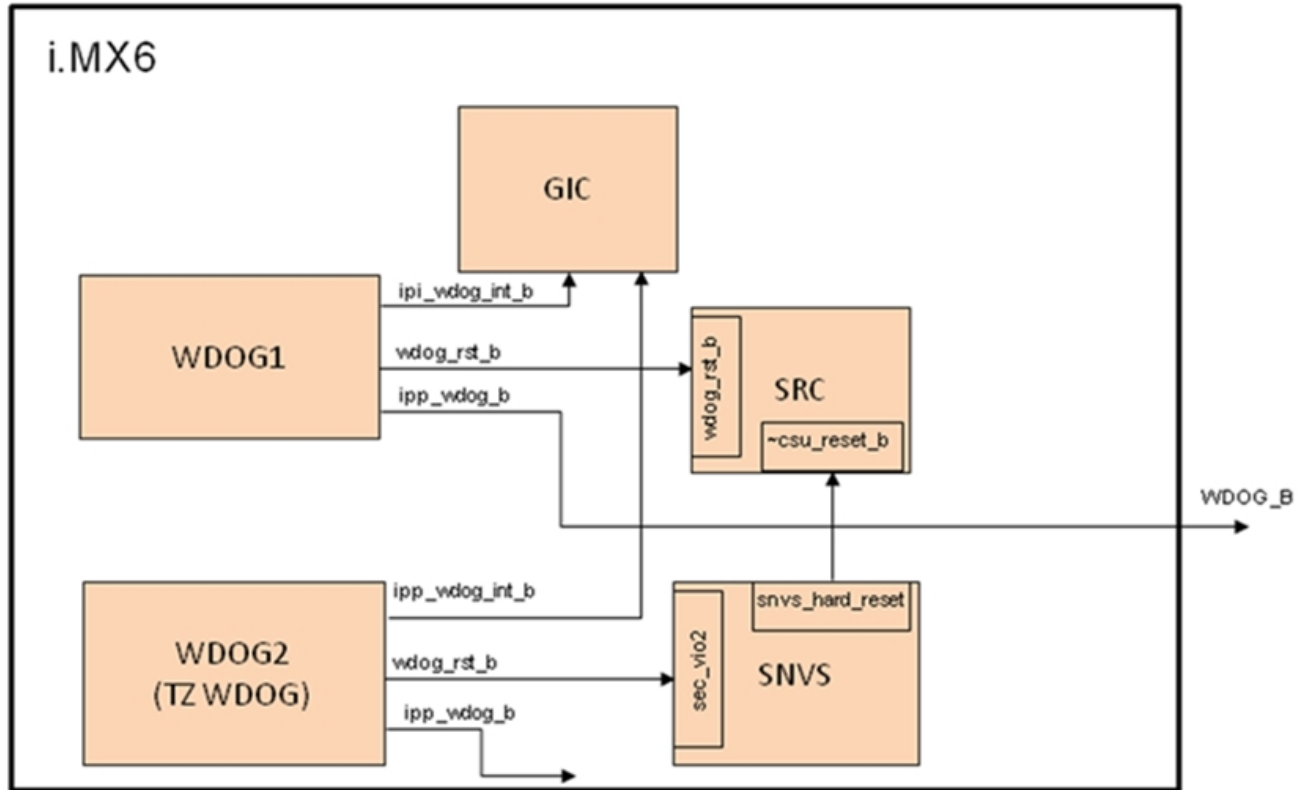

Figure 59-2. System integration

59.5 Functional description

This section provides a complete functional description of the block.

59.5.1 Timeout event

The WDOG provides timeout periods from 0.5 to 128 seconds with a time resolution of 0.5 seconds.

The user can determine the timeout period by writing to the WDOG timeout field (WT[7:0]) in the [Watchdog Control Register \(WDOG_WCR\)](#). The WDOG must be enabled by setting the WDE bit of [Watchdog Control Register \(WDOG_WCR\)](#) for the timeout counter to start running. After the WDOG is enabled, the counter is activated, loads the timeout value and begins to count down from this programmed value. The timer will time out when the counter reaches zero and the WDOG outputs a system reset signal, WDOG_RESET_B_DEB and asserts WDOG_B (WDT bit should be set in [Watchdog Control Register \(WDOG_WCR\)](#)).

However, the timeout condition can be prevented by reloading the counter with the new timeout value (WT[7:0] of WDOG_WCR) if a service routine (see [Servicing WDOG to reload the counter](#)) is performed before the counter reaches zero. If any system errors occur which prevent the software from servicing the [Watchdog Service Register \(WDOG_WSR\)](#), the timeout condition occurs. By performing the service routine, the WDOG reloads its counter to the timeout value indicated by bits WT[7:0] of the [Watchdog Control Register \(WDOG_WCR\)](#) and it restarts the countdown.

A system reset will reset the counter and place it in the idle state at any time during the countdown. The counter flow diagram is shown in [Flow Diagrams](#).

NOTE

The timeout value is reloaded to the counter either at the time WDOG is enabled or after the service routine has been performed.

59.5.1.1 Servicing WDOG to reload the counter

To reload a timeout value to the counter the proper service sequence begins by writing 0x_5555 followed by 0x_AAAA to the [Watchdog Service Register \(WDOG_WSR\)](#). Any number of instructions can be executed between the two writes. If the WDOG_WSR is not loaded with 0x_5555 prior to writing 0x_AAAA to the WDOG_WSR, the counter is not reloaded. If any value other than 0x_AAAA is written to the WDOG_WSR after 0x_5555, the counter is not reloaded. This service sequence will reload the counter with the timeout value WT[7:0] of [Watchdog Control Register \(WDOG_WCR\)](#). The timeout value can be changed at any point; it is reloaded when WDOG is serviced by the core.

59.5.2 Interrupt event

Prior to timeout, the WDOG can generate an interrupt which can be considered a warning that timeout will occur shortly.

The duration between interrupt event and timeout event can be controlled by writing to the WICT field of [Watchdog Interrupt Control Register \(WDOG_WICR\)](#). It can vary between 0 and 127.5 seconds. If the WDOG is serviced ([Servicing WDOG to reload the counter](#)) before the interrupt generation, the counter will be reloaded with the timeout value WT[7:0] of [Watchdog Control Register \(WDOG_WCR\)](#) and the interrupt will not be triggered.

59.5.3 Power-down counter event

The power-down counter inside WDOG will be enabled out of reset. This counter has a fixed timeout value of 16 seconds, after which it will drive the WDOG_B signal low.

To prevent this, the software must disable this counter by clearing the PDE bit of [Watchdog Miscellaneous Control Register \(WDOG_WMCR\)](#) within 16 seconds of reset deassertion. Once disabled, this counter can't be enabled again until the next system reset occurs. This feature is intended to prevent the hanging up of cores after reset, as WDOG is not enabled out of reset.

59.5.4 Low power modes

59.5.4.1 STOP and DOZE mode

If the WDOG timer disable bit for low power STOP and DOZE mode (WDZST) bit in the [Watchdog Control Register \(WDOG_WCR\)](#), is cleared, the WDOG timer continues to operate using the low frequency reference clock. If the low power enable (WDZST) bit is set, the WDOG timer operation will be suspended in low power STOP or DOZE mode. Upon exiting low power STOP or DOZE mode, the WDOG operation returns to what it was prior to entering the STOP or DOZE mode.

59.5.4.2 WAIT mode

If the WDOG timer disable bit for low power WAIT mode (WDW) bit in the [Watchdog Control Register \(WDOG_WCR\)](#), is cleared, the WDOG timer continues to operate using the low frequency reference clock. If the low power WAIT enable (WDW) bit is set, the WDOG timer operation will be suspended. Upon exiting low power WAIT mode, the WDOG operation returns to what it was prior to entering the WAIT mode.

NOTE

The WDOG timer won't be able to detect events that happen for periods shorter than one low frequency reference clock cycle. For example, in repeated WAIT mode entry or exit, if the RUN mode time is less than one low frequency reference clock cycle and if the WDW bit is set, the WDOG timer may never time out, even though the system is in RUN mode for a finite duration; WDOG may not see a low frequency reference clock edge during its wake time.

59.5.5 Debug mode

The WDOG timer can be configured for continual operation, or for suspension during debug mode. If the WDOG debug enable (WDBG) bit is set in the [Watchdog Control Register \(WDOG_WCR\)](#), the WDOG timer operation is suspended in debug mode. If the WDBG bit is set and the debug mode is entered, WDOG timer operation is suspended after two low frequency reference clocks. Similarly, WDOG timer operation continues after two low frequency reference clocks of debug mode exit. Register read and write accesses in debug mode continue to function normally. Also, while in debug mode, the WDE bit of [Watchdog Control Register \(WDOG_WCR\)](#) can be enabled/disabled directly. If the WDOG debug enable (WDBG) bit is cleared then WDOG timer operation is not suspended. The power-down counter is not affected by debug mode entry/exit.

NOTE

If the WDE bit of [Watchdog Control Register \(WDOG_WCR\)](#) is set/cleared while in debug mode, it remains set/cleared even after exiting debug mode.

59.5.6 Operations

59.5.6.1 Watchdog reset generation

The WDOG generated reset signal WDOG_RESET_B_DEB is asserted by the following operations:

- A software write to the Software Reset Signal (SRS) bit of the [Watchdog Control Register \(WDOG_WCR\)](#).
- WDOG timeout. See [Timeout event](#).

The $\overline{\text{wdog_rst}}$ will be asserted for one clock cycle of low frequency reference clock for both a timeout condition and a software write occurrence. It remains asserted for 1 clock cycle of low frequency reference clock even if a system reset is asserted in between. [Figure 59-4](#) shows the timing diagram of this signal due to a timeout condition.

59.5.6.2 WDOG_B generation

The WDOG asserts WDOG_B in the following scenarios:

- Software write to WDA bit of [Watchdog Control Register \(WDOG_WCR\)](#). WDOG_B signal remains asserted as long as the WDA bit is "0".
- WDOG timeout condition, WDT bit of [Watchdog Control Register \(WDOG_WCR\)](#) must be set for this scenario. A description of the timeout condition can be found in the [Timeout event](#). WDOG_B signal remains asserted until a power-on reset (POR) occurs. It gets cleared after the POR occurs (not due to any other system reset). [Figure 59-5](#) shows the timing diagram of WDOG_B due to timeout condition.
- WDOG power-down counter timeout, PDE bit of [Watchdog Miscellaneous Control Register \(WDOG_WMCR\)](#) should not be cleared for this scenario. A description of this counter can be found in the [Power-down counter event](#). WDOG_B signal remains asserted for one clock cycle of low frequency reference clock.

[Figure 59-3](#) shows the scenarios under which WDOG_B gets asserted.

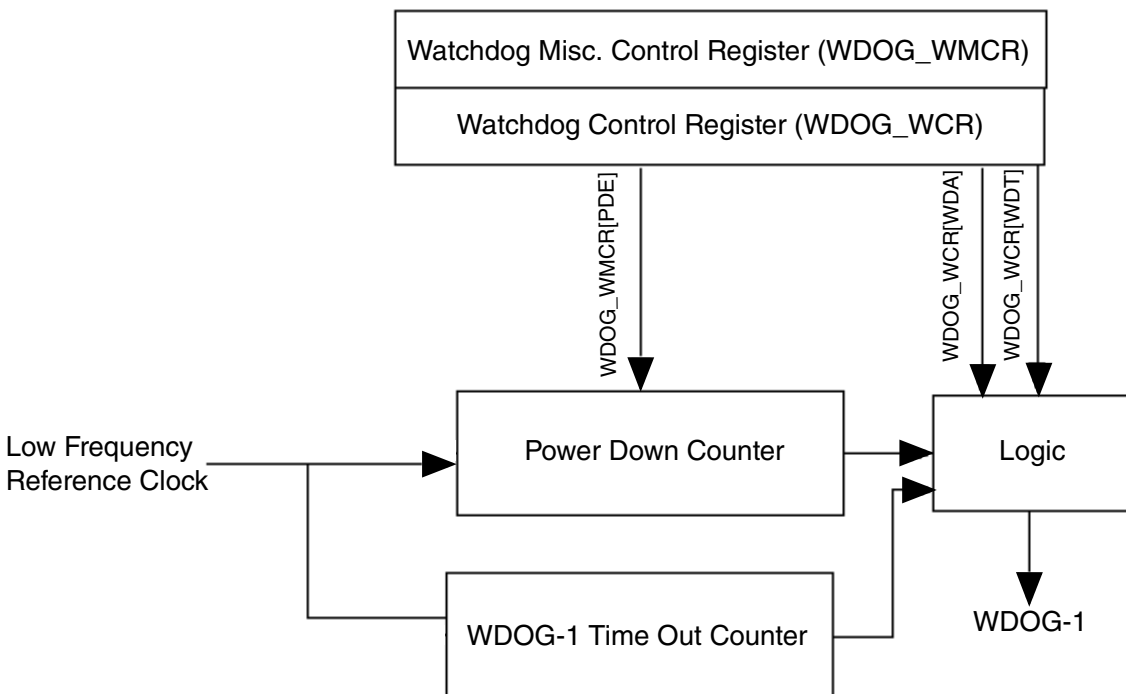

Figure 59-3. WDOG_B generation

Functional description

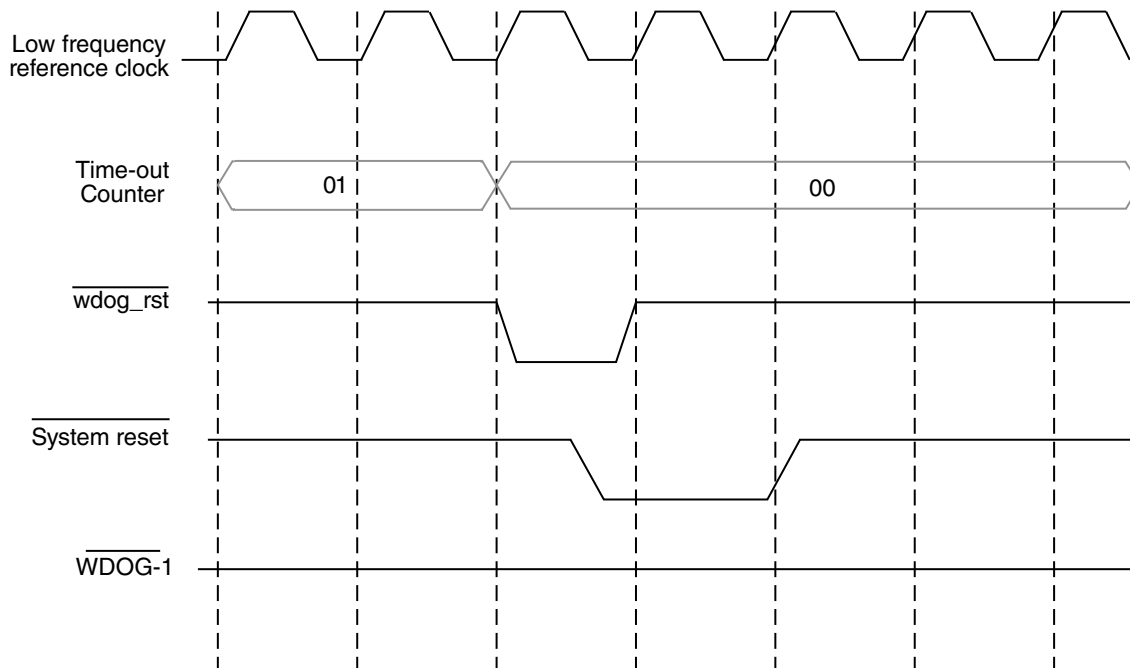

Figure 59-4. WDOG timeout condition/WDT bit is not set

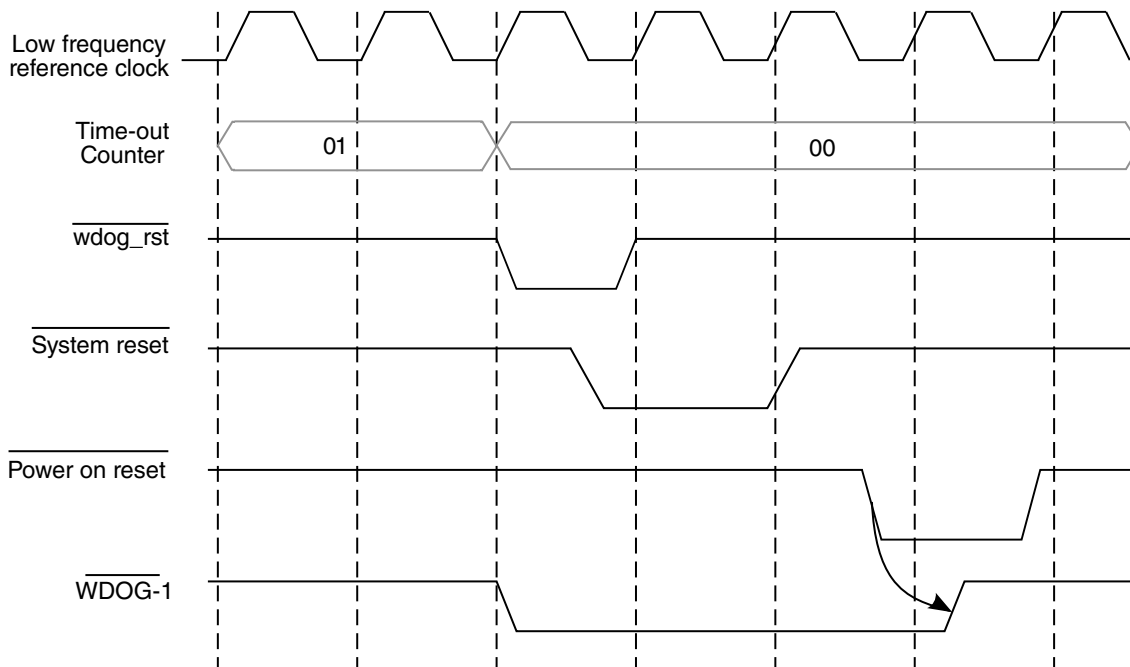

Figure 59-5. WDOG timeout condition/WDT bit is set

59.5.7 Reset

The block is reset by a system reset and the WDOG counter will be disabled. The power-down counter is enabled and starts counting.

59.5.8 Interrupt

The WDOG has the feature of Interrupt generation before timeout.

The interrupt will be generated only if the WIE bit in [Watchdog Interrupt Control Register \(WDOG_WICR\)](#) is set. The exact time at which the interrupt should occur (prior to timeout) depends on the value of WICT field of [Watchdog Interrupt Control Register \(WDOG_WICR\)](#). For example, if the WICT field has a value 0x04, then the interrupt will be generated two seconds prior to timeout. Once the interrupt is triggered the WTIS bit in [Watchdog Interrupt Control Register \(WDOG_WICR\)](#) will be set. The software needs to clear this bit to deassert the interrupt. If the WDOG is serviced before the interrupt generation then the counter will be reloaded with the timeout value WT[7:0] of [Watchdog Control Register \(WDOG_WCR\)](#) and interrupt would not be triggered.

59.5.9 Flow Diagrams

A flow diagram of WDOG operation is shown below.

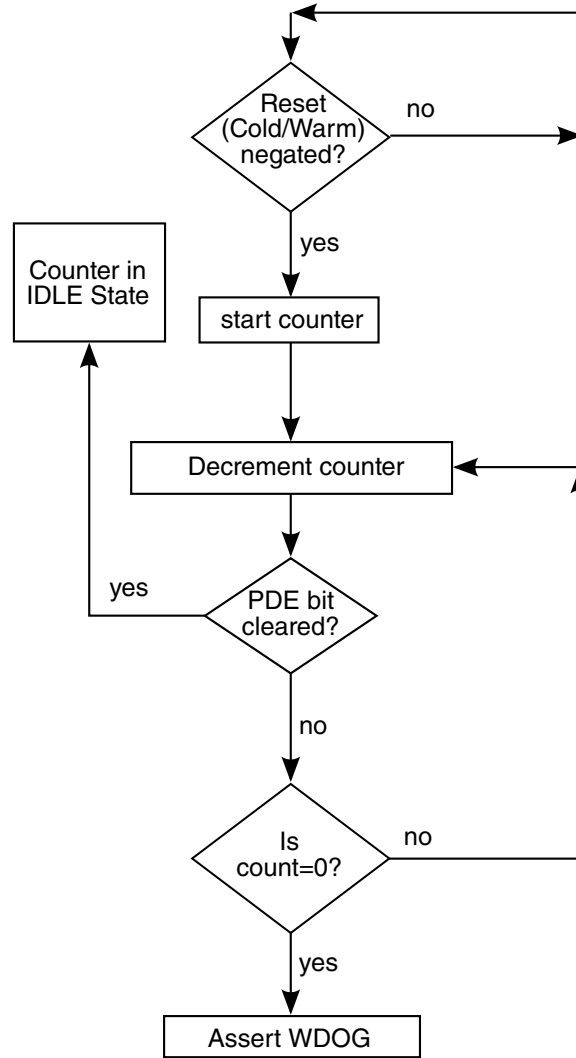

Figure 59-6. Power-Down Counter Flow Diagram

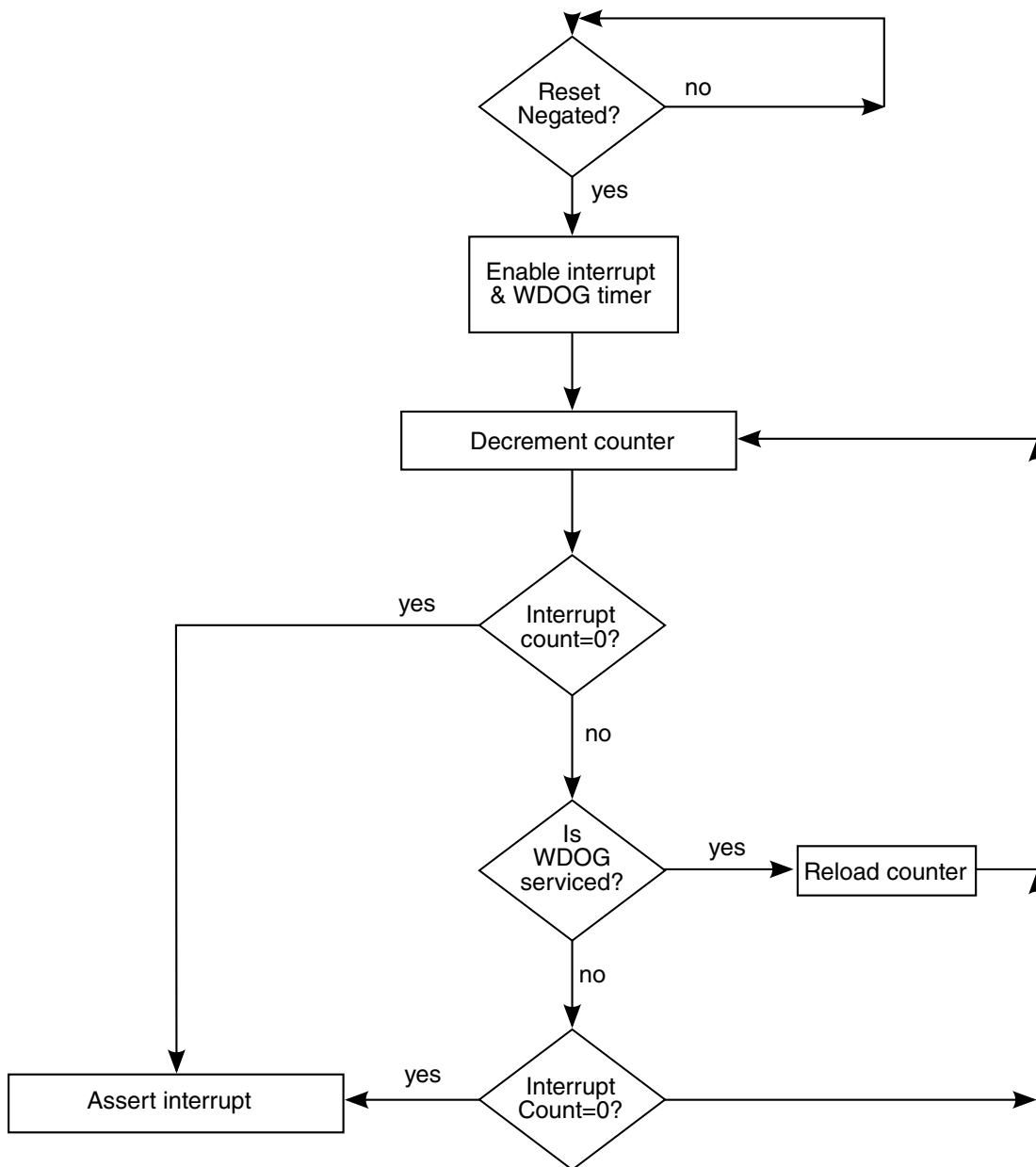

Figure 59-7. Interrupt Generation Flow Diagram

59.6 Initialization

The following sequence should be performed for WDOG initialization.

- PDE bit of [Watchdog Miscellaneous Control Register \(WDOG_WMCR\)](#) should be cleared to disable the power down counter.

- WT field of [Watchdog Control Register \(WDOG_WCR\)](#) should be programmed for sufficient timeout value.
- WDOG should be enabled by setting WDE bit of [Watchdog Control Register \(WDOG_WCR\)](#) so that the timeout counter loads the WT field value of [Watchdog Control Register \(WDOG_WCR\)](#) and starts counting.

59.7 WDOG Memory Map/Register Definition

The WDOG Memory Map/Register Definition can be found here.

The WDOG has user-accessible, 16-bit registers used to configure, operate, and monitor the state of the Watchdog Timer. Byte operations can be performed on these registers. If a 32-bit access is performed, the WDOG will not generate a peripheral bus error but will behave normally, like a 16-Bit access, making read/write possible. A 32-Bit access should be avoided, as the system may go to an unknown state.

WDOG memory map

Absolute address (hex)	Register name	Width (in bits)	Access	Reset value	Section/page
20B_C000	Watchdog Control Register (WDOG1_WCR)	16	R/W	0030h	59.7.1/4093
20B_C002	Watchdog Service Register (WDOG1_WSR)	16	R/W	0000h	59.7.2/4094
20B_C004	Watchdog Reset Status Register (WDOG1_WRSR)	16	R	0000h	59.7.3/4095
20B_C006	Watchdog Interrupt Control Register (WDOG1_WICR)	16	R/W	0004h	59.7.4/4096
20B_C008	Watchdog Miscellaneous Control Register (WDOG1_WMCR)	16	R/W	0001h	59.7.5/4097
20C_0000	Watchdog Control Register (WDOG2_WCR)	16	R/W	0030h	59.7.1/4093
20C_0002	Watchdog Service Register (WDOG2_WSR)	16	R/W	0000h	59.7.2/4094
20C_0004	Watchdog Reset Status Register (WDOG2_WRSR)	16	R	0000h	59.7.3/4095
20C_0006	Watchdog Interrupt Control Register (WDOG2_WICR)	16	R/W	0004h	59.7.4/4096
20C_0008	Watchdog Miscellaneous Control Register (WDOG2_WMCR)	16	R/W	0001h	59.7.5/4097
21E_4000	Watchdog Control Register (WDOG3_WCR)	16	R/W	0030h	59.7.1/4093
21E_4002	Watchdog Service Register (WDOG3_WSR)	16	R/W	0000h	59.7.2/4094
21E_4004	Watchdog Reset Status Register (WDOG3_WRSR)	16	R	0000h	59.7.3/4095
21E_4006	Watchdog Interrupt Control Register (WDOG3_WICR)	16	R/W	0004h	59.7.4/4096
21E_4008	Watchdog Miscellaneous Control Register (WDOG3_WMCR)	16	R/W	0001h	59.7.5/4097

59.7.1 Watchdog Control Register (WDOGx_WCR)

The Watchdog Control Register (WDOG_WCR) controls the WDOG operation.

- WZST, WDBG and WDW are write-once only bits. Once the software does a write access to these bits, they will be locked and cannot be reprogrammed until the next system reset assertion.
- WDE is a write one once only bit. Once software performs a write "1" operation to this bit it cannot be reset/cleared until the next system reset.
- WDT is also a write one once only bit. Once software performs a write "1" operation to this bit it cannot be reset/cleared until the next POR. This bit does not get reset/cleared due to any system reset.

Address: Base address + 0h offset

Bit	15	14	13	12	11	10	9	8
Read	WT							
Write	WT							
Reset	0	0	0	0	0	0	0	0
Bit	7	6	5	4	3	2	1	0
Read	WDW	SRE	WDA	SRS	WDT	WDE	WDBG	WZST
Write	WDW	SRE	WDA	SRS	WDT	WDE	WDBG	WZST
Reset	0	0	1	1	0	0	0	0

WDOGx_WCR field descriptions

Field	Description
15–8 WT	<p>Watchdog Time-out Field. This 8-bit field contains the time-out value that is loaded into the Watchdog counter after the service routine has been performed or after the Watchdog is enabled. After reset, WT[7:0] must have a value written to it before enabling the Watchdog otherwise count value of zero which is 0.5 seconds is loaded into the counter.</p> <p>NOTE: The time-out value can be written at any point of time but it is loaded to the counter at the time when WDOG is enabled or after the service routine has been performed. For more information see Timeout event .</p> <p>0x00 - 0.5 Seconds (Default). 0x01 - 1.0 Seconds. 0x02 - 1.5 Seconds. 0x03 - 2.0 Seconds. 0xff - 128 Seconds.</p>
7 WDW	<p>Watchdog Disable for Wait. This bit determines the operation of WDOG during Low Power WAIT mode. This is a write once only bit.</p> <p>0 Continue WDOG timer operation (Default). 1 Suspend WDOG timer operation.</p>
6 SRE	software reset extension, an option way to generate software reset

Table continues on the next page...

WDOGx_WCR field descriptions (continued)

Field	Description
	<p>adopt a new way to generate a more robust software reset. This bit can be set/clear with IP bus and will be reset with power-on reset .</p> <p>0 using original way to generate software reset (default) 1 using new way to generate software reset.</p>
5 WDA	<p>WDOG_B assertion. Controls the software assertion of the WDOG_B signal.</p> <p>0 Assert WDOG_B output. 1 No effect on system (Default).</p>
4 SRS	<p>Software Reset Signal. Controls the software assertion of the WDOG-generated reset signal WDOG_RESET_B_DEB . This bit automatically resets to "1" after it has been asserted to "0".</p> <p>NOTE: This bit does not generate the software reset to the block.</p> <p>0 Assert system reset signal. 1 No effect on the system (Default).</p>
3 WDT	<p>WDOG_B Time-out assertion. Determines if the WDOG_B gets asserted upon a Watchdog Time-out Event. This is a write-one once only bit.</p> <p>NOTE: There is no effect on WDOG_RESET_B_DEB (WDOG Reset) upon writing on this bit. WDOG_B gets asserted along with WDOG_RESET_B_DEB if this bit is set.</p> <p>0 No effect on WDOG_B (Default). 1 Assert WDOG_B upon a Watchdog Time-out event.</p>
2 WDE	<p>Watchdog Enable. Enables or disables the WDOG block. This is a write one once only bit. It is not possible to clear this bit by a software write, once the bit is set.</p> <p>NOTE: This bit can be set/reset in debug mode (exception).</p> <p>0 Disable the Watchdog (Default). 1 Enable the Watchdog.</p>
1 WDBG	<p>Watchdog DEBUG Enable. Determines the operation of the WDOG during DEBUG mode. This bit is write once only.</p> <p>0 Continue WDOG timer operation (Default). 1 Suspend the watchdog timer.</p>
0 WDZST	<p>Watchdog Low Power. Determines the operation of the WDOG during low-power modes. This bit is write once-only.</p> <p>NOTE: The WDOG can continue/suspend the timer operation in the low-power modes (STOP and DOZE mode).</p> <p>0 Continue timer operation (Default). 1 Suspend the watchdog timer.</p>

59.7.2 Watchdog Service Register (WDOGx_WSR)

When enabled, the WDOG requires that a service sequence be written to the Watchdog Service Register (WSR) to prevent the timeout condition.

NOTE

Executing the service sequence will reload the WDOG timeout counter.

Address: Base address + 2h offset

Bit	15	14	13	12	11	10	9	8		7	6	5	4	3	2	1	0
Read	WSR																
Write																	
Reset	0	0	0	0	0	0	0	0		0	0	0	0	0	0	0	0

WDOGx_WSR field descriptions

Field	Description
WSR	<p>Watchdog Service Register. This 16-bit field contains the Watchdog service sequence. Both writes must occur in the order listed prior to the time-out, but any number of instructions can be executed between the two writes. The service sequence must be performed as follows:</p> <p>0x5555 Write to the Watchdog Service Register (WDOG_WSR).</p> <p>0xAAAA Write to the Watchdog Service Register (WDOG_WSR).</p>

59.7.3 Watchdog Reset Status Register (WDOGx_WRSR)

The WRSR is a read-only register that records the source of the output reset assertion. It is not cleared by a hard reset. Therefore, only one bit in the WRSR will always be asserted high. The register will always indicate the source of the last reset generated due to WDOG. Read access to this register is with one wait state. Any write performed on this register will generate a Peripheral Bus Error .

A reset can be generated by the following sources, as listed in priority from highest to lowest:

- Watchdog Time-out
- Software Reset

Address: Base address + 4h offset

Bit	15	14	13	12		11	10	9	8
Read	0								
Write									
Reset	0	0	0	0		0	0	0	0
Bit	7	6	5	4		3	2	1	0
Read	0		POR		0		TOUT	SFTW	
Write									
Reset	0	0	0	0		0	0	0	0

WDOGx_WRSR field descriptions

Field	Description
15–5 Reserved	This read-only field is reserved and always has the value 0.
4 POR	Power On Reset. Indicates whether the reset is the result of a power on reset. 0 Reset is not the result of a power on reset. 1 Reset is the result of a power on reset.
3–2 Reserved	This read-only field is reserved and always has the value 0.
1 TOUT	Timeout. Indicates whether the reset is the result of a WDOG timeout. 0 Reset is not the result of a WDOG timeout. 1 Reset is the result of a WDOG timeout.
0 SFTW	Software Reset. Indicates whether the reset is the result of a WDOG software reset by asserting SRS bit 0 Reset is not the result of a software reset. 1 Reset is the result of a software reset.

59.7.4 Watchdog Interrupt Control Register (WDOGx_WICR)

The WDOG_WICR controls the WDOG interrupt generation.

Address: Base address + 6h offset

Bit	15	14	13	12	11	10	9	8	7	6	5	4	3	2	1	0	
Read	WIE	WTIS	0						WICT								
Write		w1c															
Reset	0	0	0	0	0	0	0	0	0	0	0	0	0	0	1	0	0

WDOGx_WICR field descriptions

Field	Description
15 WIE	Watchdog Timer Interrupt enable bit. Reset value is 0. NOTE: This bit is a write once only bit. Once the software does a write access to this bit, it will get locked and cannot be reprogrammed until the next system reset assertion 0 Disable Interrupt (Default). 1 Enable Interrupt.
14 WTIS	Watchdog Timer Interrupt Status bit will reflect the timer interrupt status, whether interrupt has occurred or not. Once the interrupt has been triggered software must clear this bit by writing 1 to it. 0 No interrupt has occurred (Default). 1 Interrupt has occurred
13–8 Reserved	This read-only field is reserved and always has the value 0.

Table continues on the next page...

WDOGx_WICR field descriptions (continued)

Field	Description
WICT	<p>Watchdog Interrupt Count Time-out (WICT) field determines, how long before the counter time-out must the interrupt occur. The reset value is 0x04 implies interrupt will occur 2 seconds before time-out. The maximum value that can be programmed to WICT field is 127.5 seconds with a resolution of 0.5 seconds.</p> <p>NOTE: This field is write once only. Once the software does a write access to this field, it will get locked and cannot be reprogrammed until the next system reset assertion.</p> <p>0x00 WICT[7:0] = Time duration between interrupt and time-out is 0 seconds. 0x01 WICT[7:0] = Time duration between interrupt and time-out is 0.5 seconds. 0x04 WICT[7:0] = Time duration between interrupt and time-out is 2 seconds (Default). 0xff WICT[7:0] = Time duration between interrupt and time-out is 127.5 seconds.</p>

59.7.5 Watchdog Miscellaneous Control Register (WDOGx_WMCR)

WDOG_WMCR Controls the Power Down counter operation.

Address: Base address + 8h offset

Bit	15	14	13	12	11	10	9	8	7	6	5	4	3	2	1	0	
Read	0															PDE	
Write																	
Reset	0	0	0	0	0	0	0	0	0	0	0	0	0	0	0	0	1

WDOGx_WMCR field descriptions

Field	Description
15–1 Reserved	This read-only field is reserved and always has the value 0.
0 PDE	<p>Power Down Enable bit. Reset value of this bit is 1, which means the power down counter inside the WDOG is enabled after reset. The software must write 0 to this bit to disable the counter within 16 seconds of reset de-assertion. Once disabled this counter cannot be enabled again. See Power-down counter event for operation of this counter.</p> <p>NOTE: This bit is write-one once only bit. Once software sets this bit it cannot be reset until the next system reset.</p> <p>0 Power Down Counter of WDOG is disabled. 1 Power Down Counter of WDOG is enabled (Default).</p>

Chapter 60

Crystal Oscillator (XTALOSC)

60.1 Overview

This block comprises both the 24 MHz and 32 kHz implementation of a biased amplifier that when combined with a suitable external quartz crystal and external load capacitors, implements an oscillator.

The block includes means to:

- Accept an external clock source.
- Detect if the crystal frequency is close to 24 MHz or 32 kHz.
- Reduce the operating current via software after the oscillator has started (24 MHz specific feature)
- Supply another ~32 kHz clock source based off an independent internal oscillator if there is no oscillation sensed on the RTC_XTAL bumps(contacts) (32 kHz specific feature). The internal oscillator will provide clocks to the same on-chip modules as the external 32 kHz oscillator.
- Automatically switch to the external oscillation source when sensed on the RTC_XTAL bumps(contacts) (32 kHz specific feature).

60.2 External Signals

The table found here describes the external signals of XTALOSC:

Table 60-1. XTALOSC External Signals

Signal	Description	Pad	Mode	Direction
XTALOSC_REF_CLK_32K	32 kHz reference clock	ENET1_RX_EN	ALT2	O
		GPIO1_IO03	ALT3	
		JTAG_TCK	ALT6	

Table continues on the next page...

**Table 60-1. XTALOSC External Signals
(continued)**

Signal	Description	Pad	Mode	Direction
XTALOSC_REF_CLK_24M	24 MHz reference clock	ENET1_TX_DATA0	ALT2	O
		ENET2_TX_DATA0	ALT8	
		GPIO1_IO04	ALT3	
		JTAG_TRST_B	ALT6	
XTALOSC_REF_CLK_25M	25 MHz reference clock	ENET2_RX_EN	ALT8	O
		GPIO1_IO02	ALT3	
		JTAG_MOD	ALT3	
XTALOSC_REF_CLK1	XTALOSC reference clock 1	ENET1_TX_CLK	ALT4	O
		GPIO1_IO00	ALT3	
		GPIO1_IO04	ALT0	
XTALOSC_REF_CLK2	XTALOSC reference clock 2	ENET2_TX_CLK	ALT4	O
		GPIO1_IO01	ALT3	
		GPIO1_IO05	ALT0	

Table 60-2. XTALOSC External Signals

Signal	Description	Pad	Mode	Direction
REF_CLK_32K	32 kHz reference clock	GPIO_AD_B0_00	ALT2	O
REF_CLK_24M	24 MHz reference clock	GPIO_AD_B0_01	ALT2	O
		GPIO_AD_B0_03	ALT6	
		GPIO_AD_B0_13	ALT7	
XTALI	Crystal oscillator input signal	XTALI	No Muxing	O
XTALO	Crystal oscillator output signal	XTALO	No Muxing	O

60.3 Crystal Oscillator 24 MHz

60.3.1 Oscillator Configuration (24 MHz)

The basic block diagram of the 24 MHz module configured as a crystal oscillator is shown below.

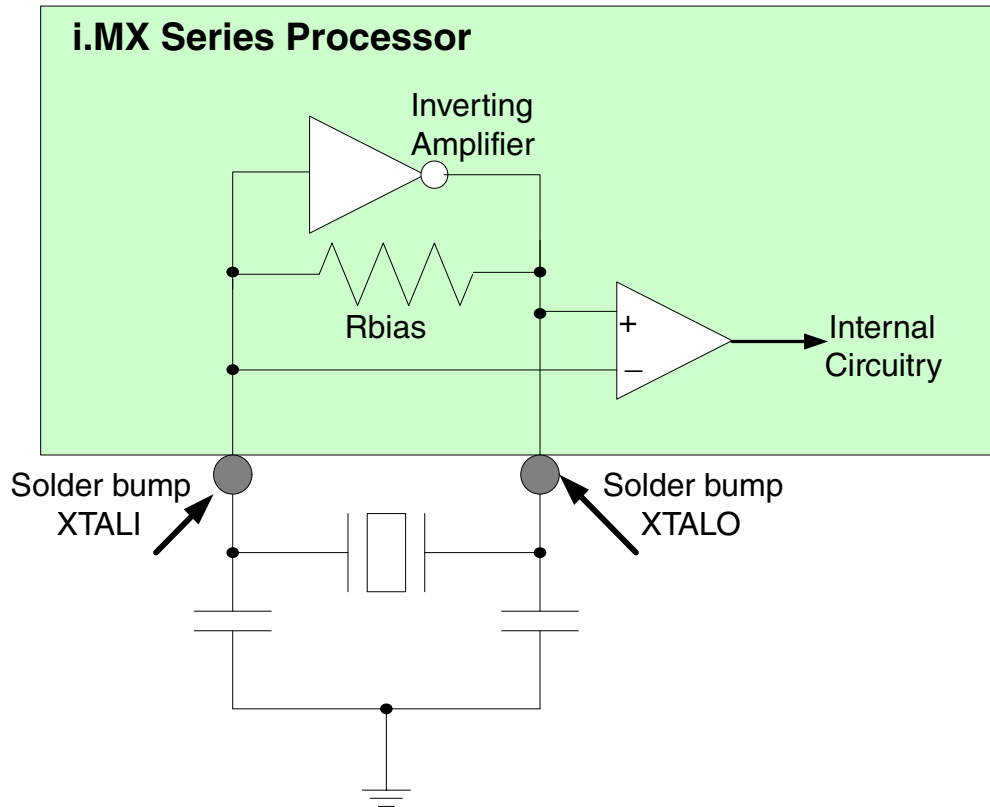

Figure 60-1. Oscillator Configuration (24 MHz)

This integrated biased amplifier can be used to create different frequency oscillators with different external component selection. However, care should be taken as many of the serial IO modules depend on the fixed frequency of 24 MHz. Please consult the sections of the document pertaining to the USB, ENET interfaces, for example. Once a healthy oscillation is established, then the bias current of the oscillator can generally be reduced to save power. This is accomplished through the XTALOSC24M_MISC0[OSC_I] bits, defined in the MISC0 register later in this chapter. Restore the XTALOSC24M_MISC0[OSC_I] bits before going into a power mode where the XTALOSC24 is powered down or oscillator startup may become an issue. The power down of the XTALOSC24 module is controlled by the CCM. See this section of the manual for more details.

60.3.2 RC Oscillator (24 MHz)

A lower-power RC oscillator module is available on-chip as a possible alternative to the 24 MHz crystal oscillator after a successful power-up sequence.

The 24 MHz RC oscillator is a self-tuning circuit that will output the programmed frequency value by using the RTC clock as its reference. This oscillator is intended for normal operation and not fast boot.

While the power consumption of this RC oscillator is much lower than the 24 MHz crystal oscillator, one limitation of this RC oscillator module is that its clock frequency is not as accurate. Therefore, care should be observed when using this oscillator as the reference for the on-chip PLLs as their output clock frequency will be lower/higher than when using the 24 MHz crystal oscillator clock.

For more details on the possible usage of this module please contact a NXP FAE for pertinent application-notes.

60.3.3 Crystal Frequency Detection(24 MHz)

A submodule exists that gives a fairly crude (relative to the accuracy of a crystal) estimation of whether the clock frequency is correct.

This function may be enabled by setting the XTALOSC24M_MISC0[OSC_XTALOK_EN] bit. It is disabled at system reset. When the oscillator is stable and the correct frequency is detected, the XTALOSC24M_MISC0[OSC_XTALOK] bit will be set. Note that the correct frequency will be observed before the oscillator fully blooms(the oscillation waveform build-up is completed).

60.4 Crystal Oscillator 32 kHz

60.4.1 Oscillator Configuration (32 kHz)

The basic block diagram of the 32 kHz module configured as a crystal oscillator is shown below.

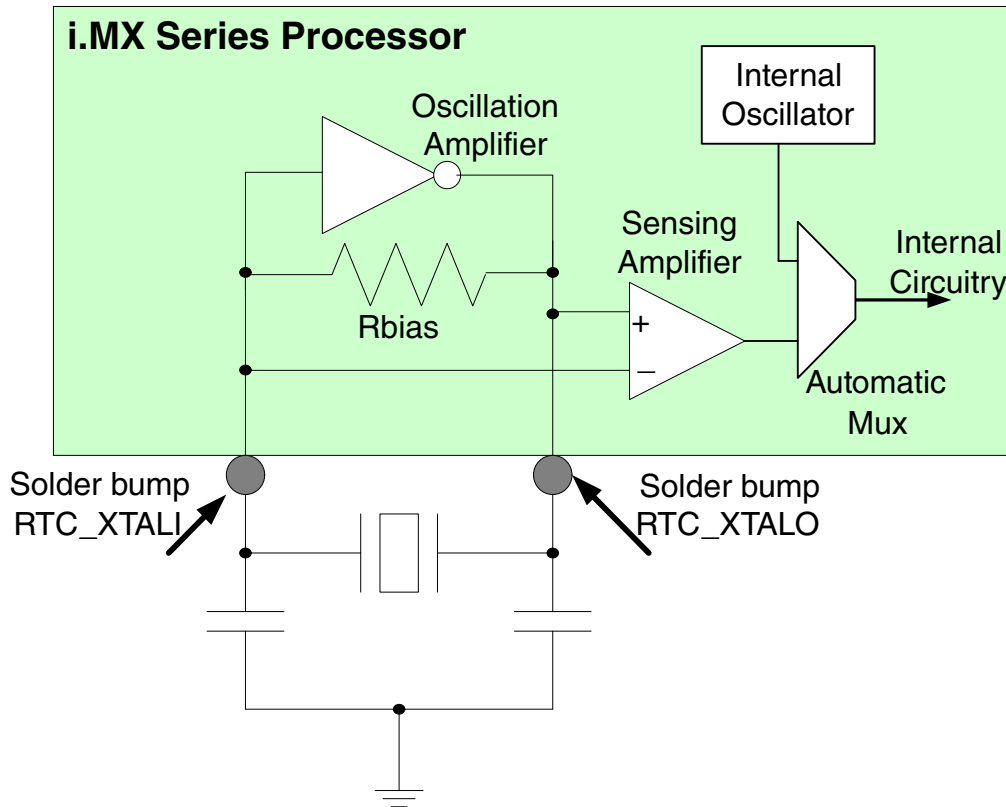

Figure 60-2. Oscillator Configuration (32 kHz)

This integrated biased amplifier can be used to create different frequency oscillators with different external component selection. Generally, RTC oscillators are either implemented with 32 kHz or 32.768 kHz crystals. Please consult the Security Reference Manual for appropriate frequency selection and configuration. Care must be taken to limit external leakage as this may debias the amplifier and degrade the gain.

The internal oscillator is automatically multiplexed in the clocking system when the system detects a loss of clock. The internal oscillator will provide clocks to the same on-chip modules as the external 32 kHz oscillator. The internal oscillator is not precise relative to a crystal. While it will provide a clock to the system, it generally will not be precise enough for long term time keeping. The internal oscillator is anticipated to be useful for quicker startup times and tampering prevention, but should not be used as the exclusive source for the 32 kHz clocks. An external 32 kHz clock source must be used for production systems.

60.4.2 Bypass Configuration (32 kHz)

If it is desired to drive the chip with an external clock source, then the 32 kHz oscillator could be driven in one of three configurations using a nominal 1.1V source.

1. A single ended external clock source can be used to overdrive the output of the amplifier (RTC_XTALO). Since the oscillation sensing amplifier is differential, the RTC_XTALI pin should be externally floating and capacitively loaded. The combination of the internal biasing resistor and the external capacitor will filter the signal applied to the RTC_XTALO pin and develop a rough reference for the sensing amplifier to compare to.
2. A single ended external clock source can be used to drive RTC_XTALI. In this configuration, RTC_XTALO should be left externally floating.
3. A differential external clock source can be used to drive both RTC_XTALI and RTC_XTALO.

Generally, configuration 2 is anticipated to be the most used configuration, but all three configurations may be utilized.

60.5 XTALOSC 24MHz Memory Map/Register Definition

NOTE

The register content is mixed with analog functions not related to the oscillator function. These bits are noted.

XTALOSC24M memory map

Absolute address (hex)	Register name	Width (in bits)	Access	Reset value	Section/page
20C_8150	Miscellaneous Register 0 (XTALOSC24M_MISC0)	32	R/W	0400_0000h	60.5.1/4106
20C_8154	Miscellaneous Register 0 (XTALOSC24M_MISC0_SET)	32	R/W	0400_0000h	60.5.1/4106
20C_8158	Miscellaneous Register 0 (XTALOSC24M_MISC0_CLR)	32	R/W	0400_0000h	60.5.1/4106
20C_815C	Miscellaneous Register 0 (XTALOSC24M_MISC0_TOG)	32	R/W	0400_0000h	60.5.1/4106
20C_8270	XTAL OSC (LP) Control Register (XTALOSC24M_LOWPWR_CTRL)	32	R/W	0000_4009h	60.5.2/4110
20C_8274	XTAL OSC (LP) Control Register (XTALOSC24M_LOWPWR_CTRL_SET)	32	R/W	0000_4009h	60.5.2/4110
20C_8278	XTAL OSC (LP) Control Register (XTALOSC24M_LOWPWR_CTRL_CLR)	32	R/W	0000_4009h	60.5.2/4110
20C_827C	XTAL OSC (LP) Control Register (XTALOSC24M_LOWPWR_CTRL_TOG)	32	R/W	0000_4009h	60.5.2/4110
20C_82A0	XTAL OSC Configuration 0 Register (XTALOSC24M_OSC_CONFIG0)	32	R/W	0000_1020h	60.5.3/4113
20C_82A4	XTAL OSC Configuration 0 Register (XTALOSC24M_OSC_CONFIG0_SET)	32	R/W	0000_1020h	60.5.3/4113

Table continues on the next page...

XTALOSC24M memory map (continued)

Absolute address (hex)	Register name	Width (in bits)	Access	Reset value	Section/page
20C_82A8	XTAL OSC Configuration 0 Register (XTALOSC24M_OSC_CONFIG0_CLR)	32	R/W	0000_1020h	60.5.3/4113
20C_82AC	XTAL OSC Configuration 0 Register (XTALOSC24M_OSC_CONFIG0_TOG)	32	R/W	0000_1020h	60.5.3/4113
20C_82B0	XTAL OSC Configuration 1 Register (XTALOSC24M_OSC_CONFIG1)	32	R/W	0000_02EEh	60.5.4/4114
20C_82B4	XTAL OSC Configuration 1 Register (XTALOSC24M_OSC_CONFIG1_SET)	32	R/W	0000_02EEh	60.5.4/4114
20C_82B8	XTAL OSC Configuration 1 Register (XTALOSC24M_OSC_CONFIG1_CLR)	32	R/W	0000_02EEh	60.5.4/4114
20C_82BC	XTAL OSC Configuration 1 Register (XTALOSC24M_OSC_CONFIG1_TOG)	32	R/W	0000_02EEh	60.5.4/4114
20C_82C0	XTAL OSC Configuration 2 Register (XTALOSC24M_OSC_CONFIG2)	32	R/W	0001_02E2h	60.5.5/4115
20C_82C4	XTAL OSC Configuration 2 Register (XTALOSC24M_OSC_CONFIG2_SET)	32	R/W	0001_02E2h	60.5.5/4115
20C_82C8	XTAL OSC Configuration 2 Register (XTALOSC24M_OSC_CONFIG2_CLR)	32	R/W	0001_02E2h	60.5.5/4115
20C_82CC	XTAL OSC Configuration 2 Register (XTALOSC24M_OSC_CONFIG2_TOG)	32	R/W	0001_02E2h	60.5.5/4115

60.5.1 Miscellaneous Register 0 (XTALOSC24M_MISC0n)

This register defines the control and status bits for miscellaneous analog blocks.

Address: 20C_8000h base + 150h offset + (4d × i), where i=0d to 3d

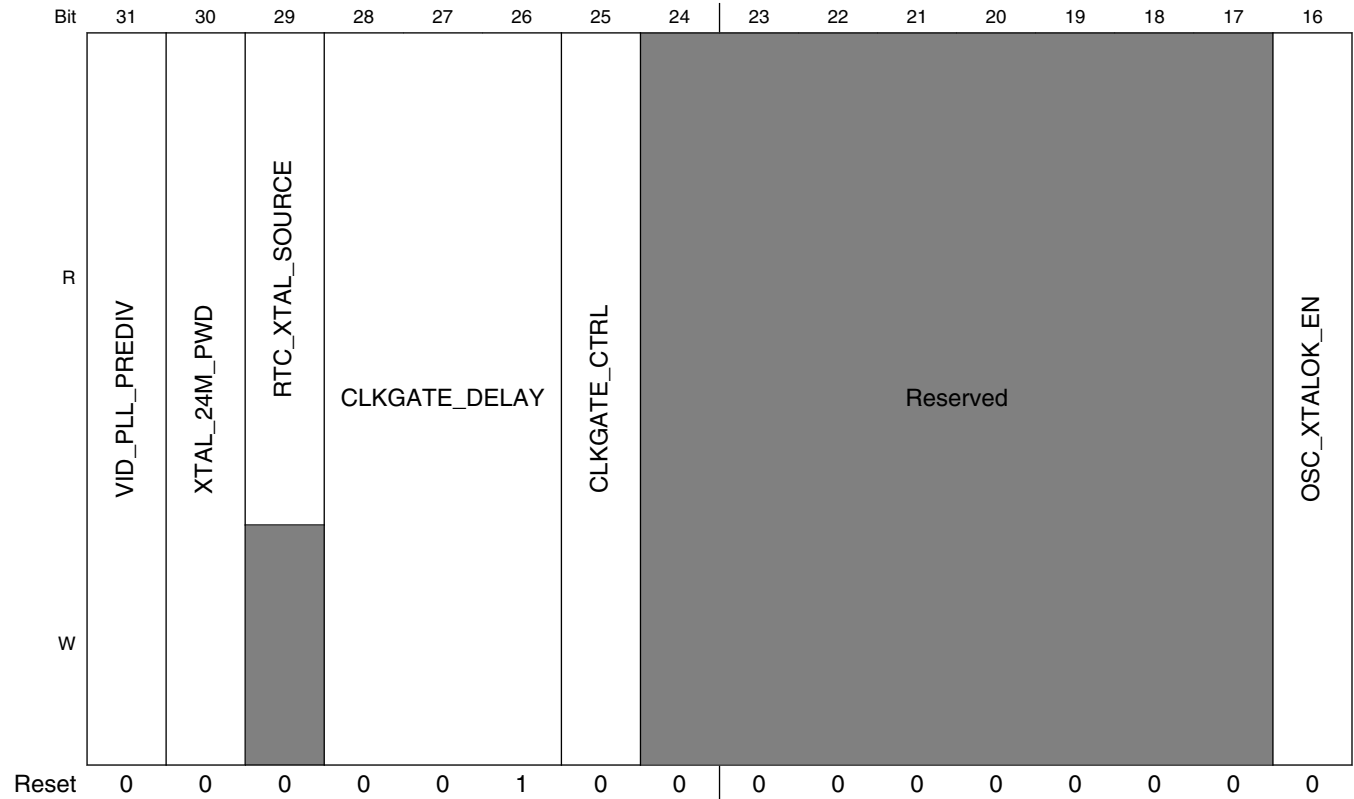

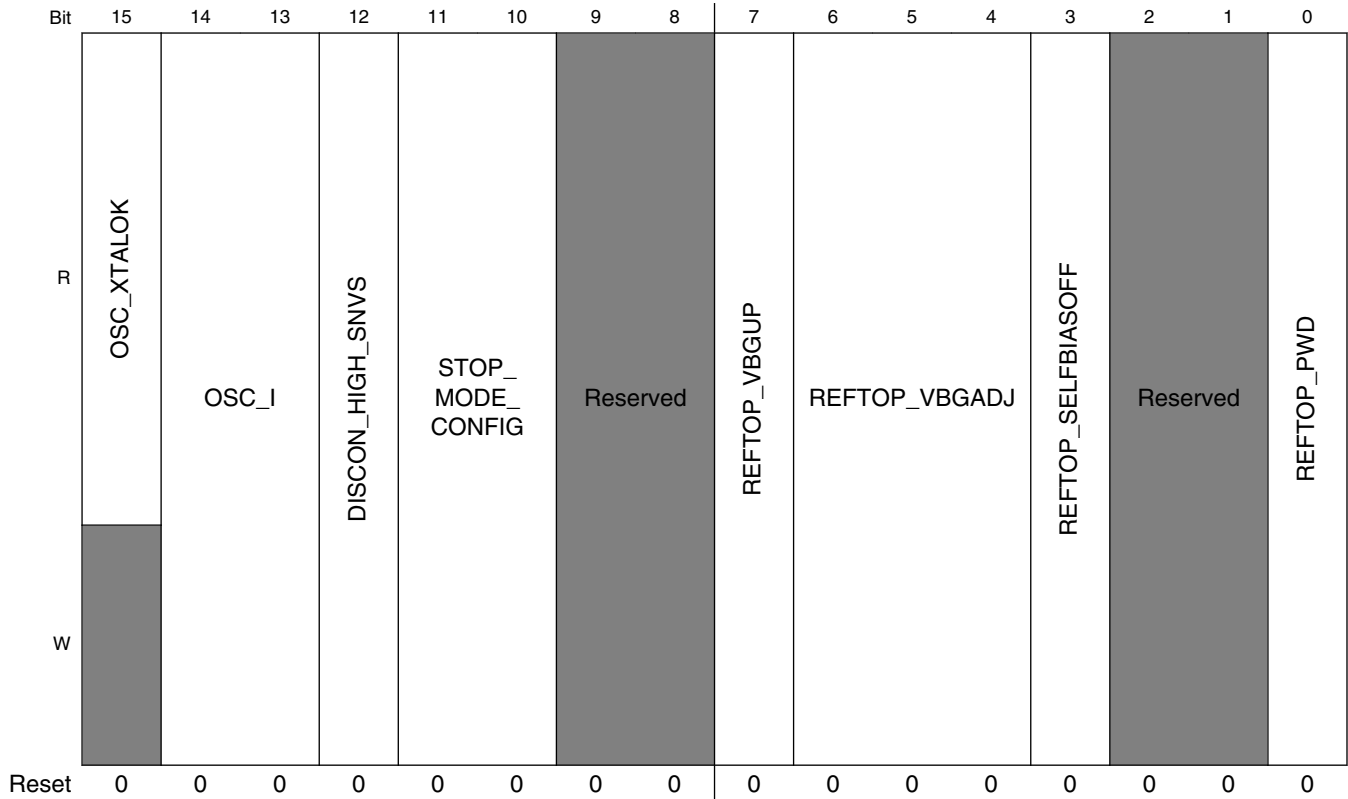

XTALOSC24M_MISC0n field descriptions

Field	Description
31 VID_PLL_PREDIV	Predivider for the source clock of the PLL's. NOTE: Not related to oscillator. 0 Divide by 1 1 Divide by 2
30 XTAL_24M_PWD	This field powers down the 24M crystal oscillator if set true.
29 RTC_XTAL_SOURCE	This field indicates which chip source is being used for the rtc clock. 0 Internal ring oscillator 1 RTC_XTAL
28–26 CLKGATE_DELAY	This field specifies the delay between powering up the XTAL 24MHz clock and releasing the clock to the digital logic inside the analog block. NOTE: Do not change the field during a low power event. This is not a field that the user would normally need to modify. 000 0.5ms 001 1.0ms 010 2.0ms 011 3.0ms 100 4.0ms

Table continues on the next page...

XTALOSC24M_MISC0n field descriptions (continued)

Field	Description
	101 5.0ms 110 6.0ms 111 7.0ms
25 CLKGATE_CTRL	This bit allows disabling the clock gate (always ungated) for the xtal 24MHz clock that clocks the digital logic in the analog block. NOTE: Do not change the field during a low power event. This is not a field that the user would normally need to modify. 0 ALLOW_AUTO_GATE — Allow the logic to automatically gate the clock when the XTAL is powered down. 1 NO_AUTO_GATE — Prevent the logic from ever gating off the clock.
24–17 -	This field is reserved. Always set to zero.
16 OSC_XTALOK_EN	This bit enables the detector that signals when the 24MHz crystal oscillator is stable.
15 OSC_XTALOK	Status bit that signals that the output of the 24-MHz crystal oscillator is stable. Generated from a timer and active detection of the actual frequency.
14–13 OSC_I	This field determines the bias current in the 24MHz oscillator. The aim is to start up with the highest bias current, which can be decreased after startup if it is determined to be acceptable. 00 NOMINAL — Nominal 01 MINUS_12_5_PERCENT — Decrease current by 12.5% 10 MINUS_25_PERCENT — Decrease current by 25.0% 11 MINUS_37_5_PERCENT — Decrease current by 37.5%
12 DISCON_HIGH_SNVS	This bit controls a switch from VDD_HIGH_IN to VDD_SNVS_IN. 0 Turn on the switch 1 Turn off the switch
11–10 STOP_MODE_CONFIG	Configure the analog behavior in stop mode. NOTE: Not related to oscillator. 00 All analog except rtc powered down on stop mode assertion. XtalOsc=on, RCOsc=off; 01 Certain analog functions such as certain regulators left up. XtalOsc=on, RCOsc=off; 10 XtalOsc=off, RCOsc=on, Old BG=on, New BG=off. 11 XtalOsc=off, RCOsc=on, Old BG=off, New BG=on.
9–8 -	This field is reserved. Reserved
7 REFTOP_VBGUP	Status bit that signals the analog bandgap voltage is up and stable. 1 - Stable. NOTE: Not related to oscillator.
6–4 REFTOP_VBGADJ	NOTE: Not related to oscillator. 000 Nominal VBG

Table continues on the next page...

XTALOSC24M_MISC0n field descriptions (continued)

Field	Description
	001 VBG+0.78% 010 VBG+1.56% 011 VBG+2.34% 100 VBG-0.78% 101 VBG-1.56% 110 VBG-2.34% 111 VBG-3.12%
3 REFTOP_ SELFBIASOFF	<p>Control bit to disable the self-bias circuit in the analog bandgap. The self-bias circuit is used by the bandgap during startup. This bit should be set after the bandgap has stabilized and is necessary for best noise performance of analog blocks using the outputs of the bandgap.</p> <p>NOTE: Value should be returned to zero before removing vddhigh_in or asserting bit 0 of this register (REFTOP_PWD) to assure proper restart of the circuit.</p> <p>NOTE: Not related to oscillator.</p> <p>0 Uses coarse bias currents for startup 1 Uses bandgap-based bias currents for best performance.</p>
2-1 -	This field is reserved.
0 REFTOP_PWD	<p>Control bit to power-down the analog bandgap reference circuitry.</p> <p>NOTE: A note of caution, the bandgap is necessary for correct operation of most of the LDO, pll, and other analog functions on the die.</p> <p>NOTE: Not related to oscillator.</p>

60.5.2 XTAL OSC (LP) Control Register (XTALOSC24M_LOWPWR_CTRLn)

This register defines xtal osc and low power configuration.

Address: 20C_8000h base + 270h offset + (4d × i), where i=0d to 3d

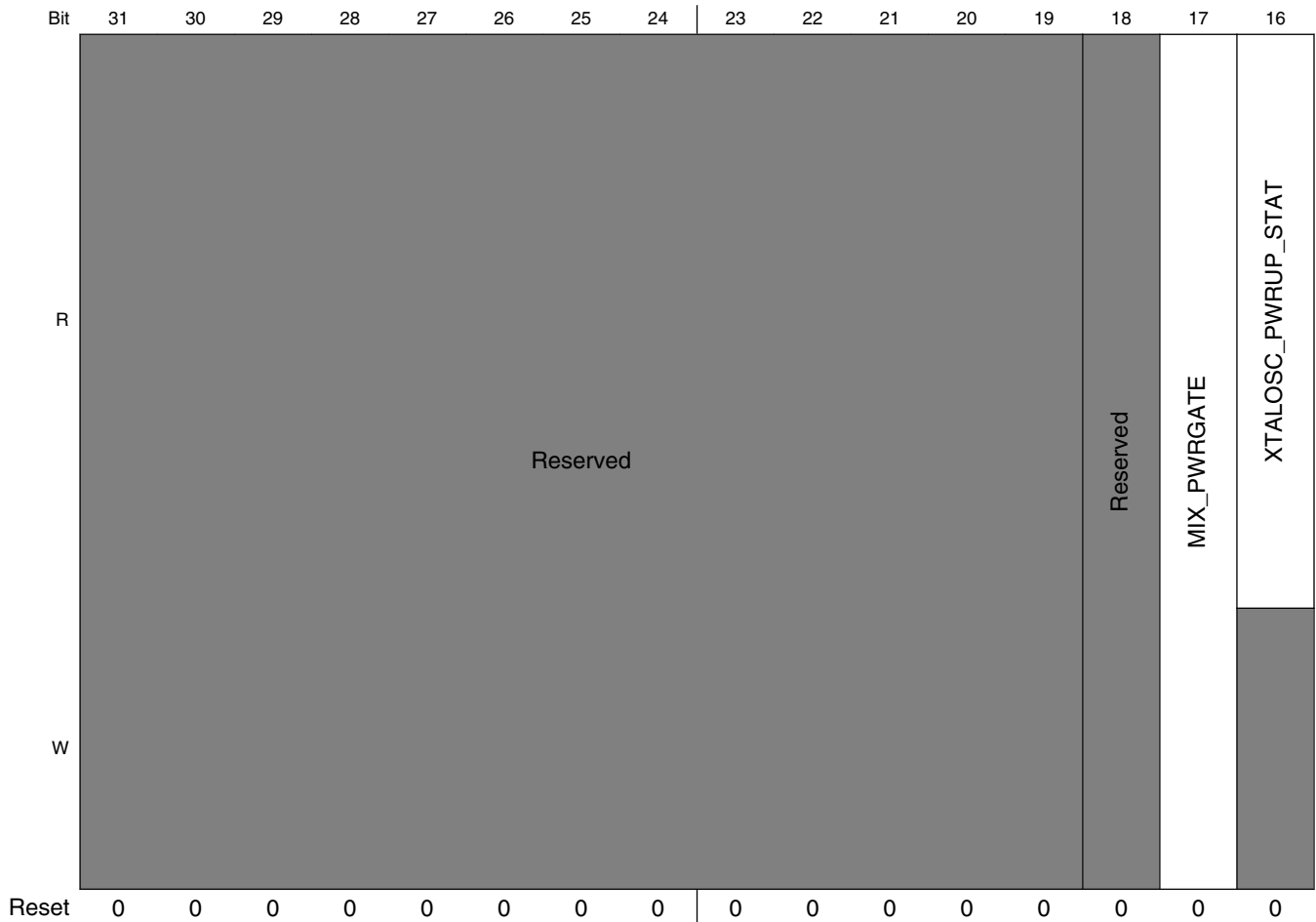

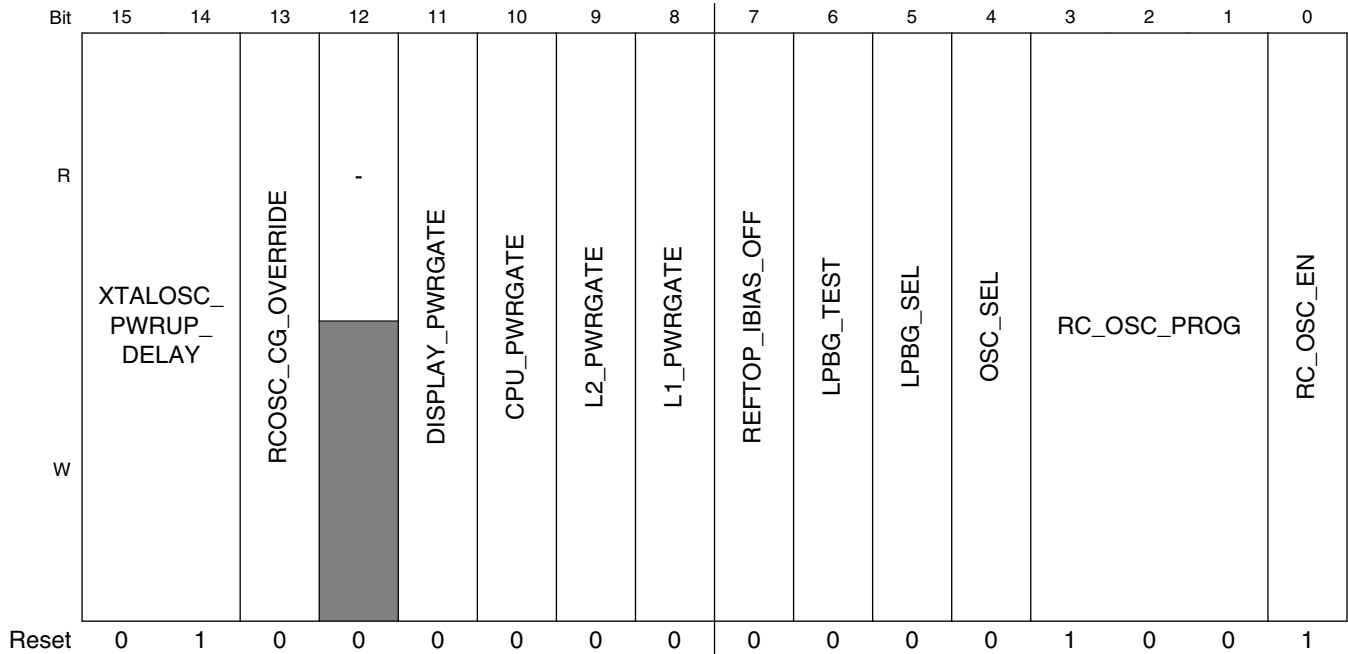

XTALOSC24M_LOWPWR_CTRLn field descriptions

Field	Description
31–19 -	This field is reserved.
18 -	This field is reserved.
17 MIX_PWRGATE	Display power gate control. Used as software mask. Set to zero to force ungated.
16 XTALOSC_PWRUP_STAT	Status of the 24MHz xtal oscillator. 0 Not stable 1 Stable and ready to use
15–14 XTALOSC_PWRUP_DELAY	Specifies the time delay between when the 24MHz xtal is powered up until it is stable and ready to use. 00 0.25ms 01 0.5ms 10 1ms 11 2ms
13 RCOSC_CG_OVERRIDE	For debug purposes only. This bit effects clock gating of certain digital logic clocked by the 24MHz clk.
12 -	Reserved
11 DISPLAY_PWRGATE	Display logic power gate control. Used as software override. NOTE: Not related to oscillator.
10 CPU_PWRGATE	CPU power gate control. Used as software override.

Table continues on the next page...

XTALOSC24M_LOWPWR_CTRLn field descriptions (continued)

Field	Description
	<p>Attention: Test purpose only</p> <p>NOTE: Not related to oscillator.</p>
9 L2_PWRGATE	<p>L2 power gate control. Used as software override.</p> <p>NOTE: Not related to oscillator.</p>
8 L1_PWRGATE	<p>L1 power gate control. Used as software override.</p> <p>NOTE: Not related to oscillator.</p>
7 REFTOP_IBIAS_OFF	<p>Low power reftop ibias disable.</p> <p>NOTE: Not related to oscillator.</p>
6 LPBG_TEST	<p>Low power bandgap test bit.</p> <p>NOTE: Not related to oscillator.</p>
5 LPBG_SEL	<p>Bandgap select.</p> <p>NOTE: Not related to oscillator.</p> <p>0 Normal power bandgap 1 Low power bandgap</p>
4 OSC_SEL	<p>Select the source for the 24MHz clock.</p> <p>0 XTAL OSC 1 RC OSC</p>
3-1 RC_OSC_PROG	<p>RC osc. tuning values.</p>
0 RC_OSC_EN	<p>RC Osc. enable control.</p> <p>0 Use XTAL OSC to source the 24MHz clock 1 Use RC OSC</p>

60.5.3 XTAL OSC Configuration 0 Register (XTALOSC24M_OSC_CONFIG0n)

This register is used to configure the 24MHz RC oscillator.

Address: 20C_8000h base + 2A0h offset + (4d × i), where i=0d to 3d

Bit	31	30	29	28	27	26	25	24	23	22	21	20	19	18	17	16
R	RC_OSC_PROG_CUR								-				HYST_MINUS			
W																
Reset	0	0	0	0	0	0	0	0	0	0	0	0	0	0	0	0
Bit	15	14	13	12	11	10	9	8	7	6	5	4	3	2	1	0
R	HYST_PLUS				RC_OSC_PROG				INVERT		BYPASS		ENABLE		START	
W																
Reset	0	0	0	1	0	0	0	0	0	0	1	0	0	0	0	0

XTALOSC24M_OSC_CONFIG0n field descriptions

Field	Description
31–24 RC_OSC_PROG_CUR	The current tuning value in use.
23–20 -	Reserved.
19–16 HYST_MINUS	Negative hysteresis value. Subtracted from target value before comparison. This, along with HYST_PLUS creates a range.
15–12 HYST_PLUS	Positive hysteresis value. Added to target value before comparison. This, along with HYST_MINUS creates a range.
11–4 RC_OSC_PROG	RC osc. tuning values.
3 INVERT	Invert the stepping of the calculated RC tuning value.

Table continues on the next page...

60.5.5 XTAL OSC Configuration 2 Register (XTALOSC24M_OSC_CONFIG2n)

This register is used to configure the 24MHz RC oscillator.

Address: 20C_8000h base + 2C0h offset + (4d × i), where i=0d to 3d

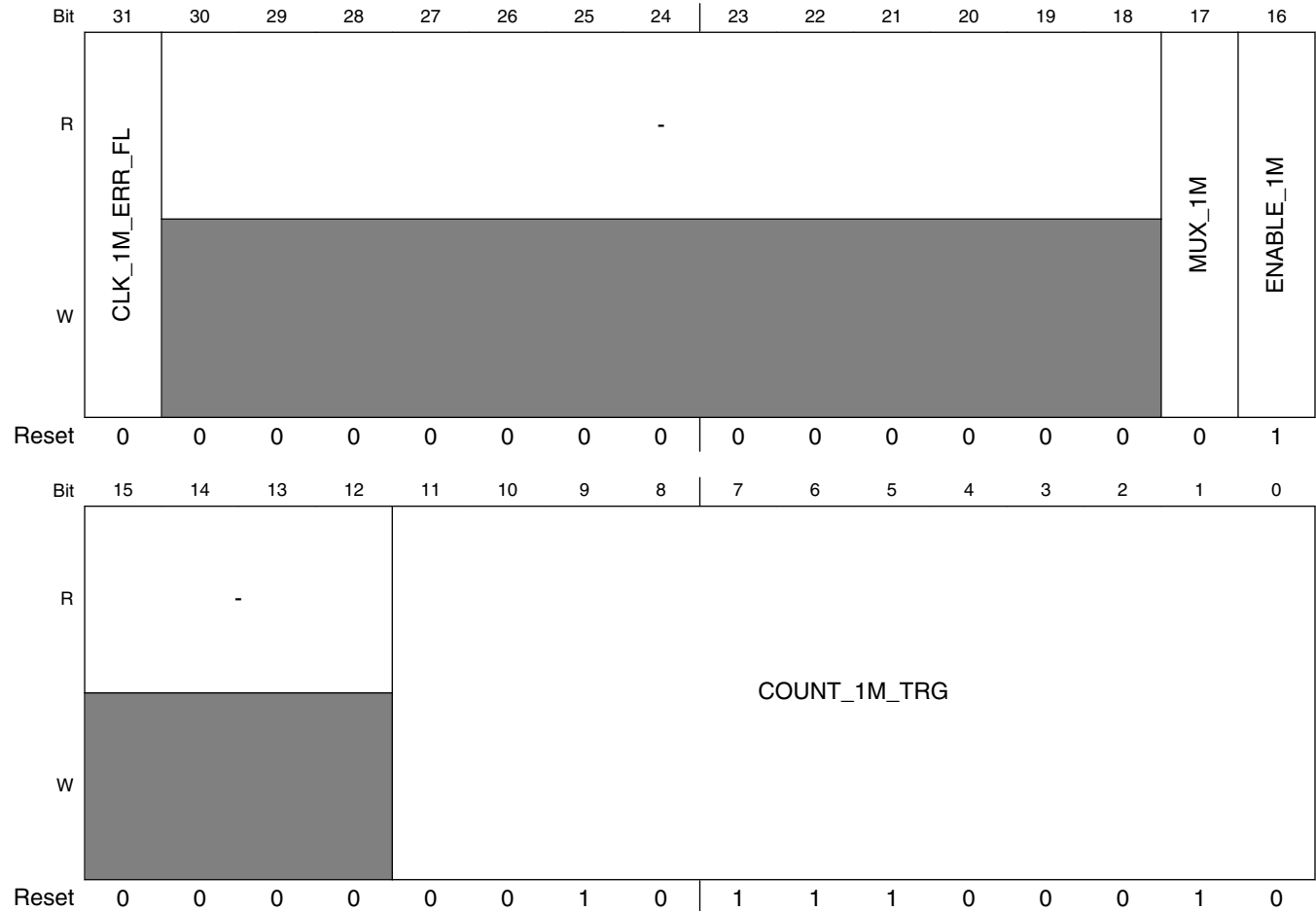

XTALOSC24M_OSC_CONFIG2n field descriptions

Field	Description
31 CLK_1M_ERR_FL	Flag indicates that the count_1m count wasn't reached within 1 32KHz period. This is intended as feedback to software that the HW_ANADIG_OSC_CONFIG2_COUNT_1M_TRG value is too high for the RC Osc frequency.
30-18 -	Reserved.
17 MUX_1M	Mux the corrected or uncorrected 1MHz clock to the output.

Table continues on the next page...

XTALOSC24M_OSC_CONFIG2n field descriptions (continued)

Field	Description
16 ENABLE_1M	Enable the 1MHz clock output. 0 - disabled; 1 - enabled.
15-12 -	Reserved
COUNT_1M_ TRG	The target count used to tune the RC OSC frequency. Essentially the number of desired RC Osc clock cycles within 1 32KHz clock cycles.

Appendix A

i.MX 6ULL Revision History

A.1 Substantive changes from revision 0 to revision 1

Substantive changes from revision 0 to revision 1 are as follows:

A.1.1 Reference Manual Revision History

No substantive changes

A.1.2 Introduction Revision History

No substantive changes

A.1.3 Memory Maps Revision History

No substantive changes

A.1.4 Interrupts and DMA Events Revision History

Topic Cross-Reference	Change Description
Cortex A7 interrupts	New IRQ table

A.1.5 External Signals Revision History

No substantive changes

A.1.6 Fusemap Revision History

Topic Cross-Reference	Change Description
Fusemap Descriptions Table	SPEED_GRADING values updated

A.1.7 External Memory Controllers Revision History

No substantive changes

A.1.8 System Debug Revision History

Topic Cross-Reference	Change Description
Clock/Reset/Power	Removed the statement about the debug system being capable of generating a system reset via a request bit in the MDM-AP register.

A.1.9 System Boot Revision History

Topic Cross-Reference	Change Description
Boot security settings	Removed Note "If the DIR_BT_DIS eFuse is not blown authentication may be bypassed..."
Boot eFUSE descriptions	For the Fuse, DIR_BT_DIS; removed from the Definition, "must be set for secure boot". Added to the Setting; "This fuse must be blown to 1 for normal operation."
MMC and eMMC boot	In the table row, <i>eMMC4.3 or eMMC4.4 device supporting special boot mode</i> , removed sentence; "The eMMC4.3/ eMMC4.4 device with the "boot mode" feature can only be supported via the ESDHCV3-3 and with or without the BOOT ACK."

A.1.10 Multimedia Revision History

Topic Cross-Reference	Change Description
Feature summary	VPU decoding/encoding capabilities table: AVS row, removed On2 VP6 and Theora standards.

A.1.11 Power Management Revision History

Topic Cross-Reference	Change Description
Static	In the <i>Static</i> section, removed sub-section <i>Voltage Domain Dependencies</i> and <i>IO Voltage</i> .

A.1.12 System Security Revision History

No substantive changes

A.1.13 ARM A7 Revision History

No substantive changes

A.1.14 ADC Revision History

No substantive changes

A.1.15 AIPSTZ Revision History

No substantive changes

A.1.16 APBH Revision History

No substantive changes

A.1.17 ASRC Revision History

No substantive changes

A.1.18 BCH Revision History

No substantive changes

A.1.19 CCM Revision History

Topic Cross-Reference	Change Description
CCM Memory Map/Register Definition	CHSCDDR reset value updated to 0x29148
System Clocks	Changed within the System Clock Frequency Values table: ACLK_EIM_SLOW_CLK_ROOT Default Freq MHz column from 396MHz to 132MHz.
CCM Memory Map/Register Definition	CLPCR[BYPASS_MMDC_CH0_LPM_HS] bit added with note to user to always set to 1.
Clock Switching Multiplexers	Penultimate paragraph: Clarified output clocks are required to be gated before switching. Previously the statement included input and output.
Divider change handshake	Added new content to explain the dividers designed with a handshake and to describe steps for dividers without a handshake design.
CCM Memory Map/Register Definition	Updates to ENFC_CLK_SEL, ESAI_CLK_SEL, and CCGRs.
System Clocks	Updates to reflect changes to CCGR assignments.

A.1.20 CSI Revision History

No substantive changes

A.1.21 DCP revision history

No substantive changes

A.1.22 ECSPi Revision History

No substantive changes

A.1.23 EIM Revision History

No substantive changes

A.1.24 ENET Revision History

No substantive changes

A.1.25 EPDC Revision History

No substantive changes

A.1.26 EPIT Revision History

No substantive changes

A.1.27 ESAI Revision History

No substantive changes

A.1.28 FLEXCAN3 Revision History

No substantive changes

A.1.29 GPC Revision History

No substantive changes

A.1.30 GPIO Revision History

Topic Cross-Reference	Change Description
GPIO Memory Map/Register Definition	Updated IMR register.

A.1.31 GPMI Revision History

No substantive changes

A.1.32 GPT Revision History

No substantive changes

A.1.33 I2C Revision History

No substantive changes

A.1.34 IOMUXC Revision History

Topic Cross-Reference	Change Description
IOMUXC_GPR	Updated GPR0 register.

A.1.35 KPP Revision History

No substantive changes

A.1.36 eLCDIF Revision History

Topic Cross-Reference	Customer-facing Description
eLCDIF Memory Map/Register Definition	Updated bit field definitions for LFIFO_FULL, LFIFO_EMPTY, TXFIFO_FULL, and TXFIFO_EMPTY in the STAT register.

A.1.37 MMDC Revision History

Topic Cross-Reference	Change Description
ZQ automatic Pull-down calibration	Corrected Step 6 to read "MMCD repeats steps 2-5 ..." instead of "MMDC repeats steps 12-15 ...".
MMDC	Switched bit field values in MAPSR[6] and MAPSR[5]. Changes bit field access to reserved, read-only in MDMISC[29:22], , and MDMISC[2].

A.1.38 MQS Revision History

No substantive changes

A.1.39 OCOTP Revision History

No substantive changes

A.1.40 OCRAM Revision History

No substantive changes

A.1.41 PMU Revision History

Topic Cross-Reference	Change Description
PMU	Added Register dimensions for 1P1, 3P0, 2P5, and Core

A.1.42 PWM Revision History

No substantive changes

A.1.43 PXP Revision History

Topic Cross-Reference	Change Description
PXP	New register set for V3 pipeline with Set/Clear/Toggle functionality
PXP Porter-Duff Alpha Blend	Removed PXP_HW_PXP_HANDSHAKE_READY_MUX1 and PXP_HW_PXP_HANDSHAKE_DONE_MUX1; updated PXP_HW_PXP_HANDSHAKE_READY_MUX0 and PXP_HW_PXP_HANDSHAKE_DONE_MUX0 ; updated the figure Porter-Duff Alpha Blend.

A.1.44 QSPI Revision History

No substantive changes

A.1.45 ROMCP Revision History

No substantive changes

A.1.46 SAI Revision History

No substantive changes

A.1.47 SDMA Revision History

No substantive changes

A.1.48 SJC Revision History

No substantive changes

A.1.49 SNVS Revision History

No substantive changes

A.1.50 SPBA Revision History

No substantive changes

A.1.51 SPDIF Revision History

No substantive changes

A.1.52 SRC Revision History

No substantive changes

A.1.53 TEMPMON Revision History

No substantive changes

A.1.54 TSC Revision History

No substantive changes

A.1.55 TZASC Revision History

No substantive changes

A.1.56 UART Revision History

No substantive changes

A.1.57 USB Revision History

No substantive changes

A.1.58 USB PHY Revision History

Topic Cross-Reference	Change Description
USB_ANALOG	Reformatted USB_ANALOG_DIGPROG register.

A.1.59 USDHC Revision History

No substantive changes

A.1.60 WDOG Revision History

No substantive changes

A.1.61 XTALOSC Revision History

Topic Cross-Reference	Change Description
Oscillator Configuration (32 kHz)	Updates to second paragraph, final sentences: clarifying the requirement of an external 32 kHz clock source for production systems.
XTALOSC24M	XTALOSC24M_MISC0 register, RTC_XTAL_SOURCE field [29] correction to Read Only.

How to Reach Us:

Home Page:

nxp.com

Web Support:

nxp.com/support

Information in this document is provided solely to enable system and software implementers to use NXP products. There are no express or implied copyright licenses granted hereunder to design or fabricate any integrated circuits based on the information in this document. NXP reserves the right to make changes without further notice to any products herein.

NXP makes no warranty, representation, or guarantee regarding the suitability of its products for any particular purpose, nor does NXP assume any liability arising out of the application or use of any product or circuit, and specifically disclaims any and all liability, including without limitation consequential or incidental damages. "Typical" parameters that may be provided in NXP data sheets and/or specifications can and do vary in different applications, and actual performance may vary over time. All operating parameters, including "typicals" must be validated for each customer application by customer, customer's technical experts. NXP does not convey any license under its patent rights nor the rights of others. NXP sells products pursuant to standard terms and conditions of sale, which can be found at the following address:

nxp.com/SalesTermsandConditions.

NXP, the NXP logo, Freescale, the Freescale logo, and the Energy Efficient Solutions logo are trademarks of NXP B.V. All other product or service names are the property of their respective owners. Arm and Cortex are trademarks of Arm Limited (or its subsidiaries) in the EU and/or elsewhere. All rights reserved.

© 2017 NXP B.V.

Document Number: IMX6ULLRM

Rev. 1

11/2017

