



# PRODUCT SPECIFICATIONS

## Preliminary Specification

**Module No: VISLCS-070HYC530F**

**PRODUCT TYPE: TFT MODULE**

**VERSION: V0**

**Huayuan:**

APPROVED BY	CHECKED BY	DESIGNED BY
		Jiang

**Customer:**

APPROVED BY	TESTED BY	INSPECTION RESULT





# Table of CONTENTS

- GENERAL DESCRIPTIONG
- OUTLINE DIMENSION
- PIN DESCRIPTION
- ABSOLUTE MAXIMUM RATINGS
- LED BACKLIGHT SPECIFICATION
- TIMING CHARACTERISTICS
- OPTICAL CHARACTERISTICS
- RELIABILITY TEST ITEMS AND CRITERIA
- DEFINITION OF INSPECTION RANGE
- PRECAUTIONS FOR USE OF LCD MODULE



## 1. General Specifications

VISLCS-070HYC530F is a TFT-LCD module. It is composed of a TFT-LCD panel, driver IC, FPC, a back light unit. The 7" display area contains 1024 x 600 pixels and can display up to 16.7M colors. This product accords with RoHS environmental criterion.

Item	Contents	Unit	Note
LCD Type	TFT	-	
Display color	16.7M		1
Viewing Direction	IPS	O'Clock	
Operating temperature	-20~+70	°C	
Storage temperature	-30~+80	°C	
Module size	Refer to outline drawing	mm	2
Active Area(W×H)	154.21 x 85.92	mm	
Number of Dots	1024×RGB×600	dots	
Outline Dimensions	Refer to outline drawing	-	
Backlight	21	pcs	
Weight	---	g	
Data Transfer	MIPI	-	

Note 1: Color tune is slightly changed by temperature and driving voltage.

Note 2: Without FPC and Solder.



## 2. Outline.Dimension

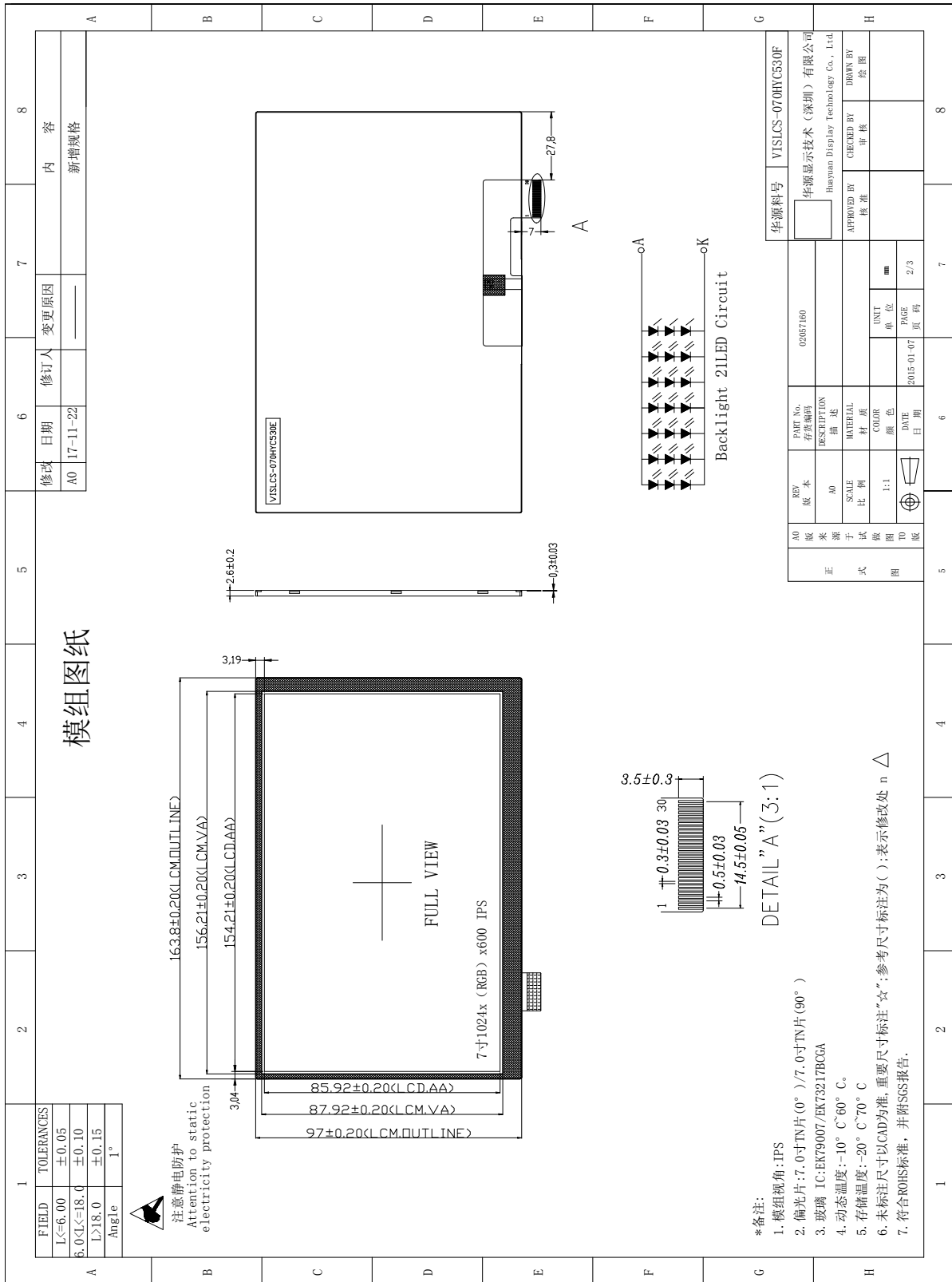



### 3. Pin Description

Pin No.	Symbol	Function	Remark
1-2	LED+	LED Anode	
3	VGH	Gate ON Voltage	
4	VGL	Gate OFF Voltage	
5	UPDN	Gate Up or Down scan control	
6	SHLR	Source Right or Left sequence	
7-8	LED-	LED Cathode	
9	AVDD	Power for Analog Circuit	
10	GND	Ground	
11	MIPI_3P	MIPI Data lane3 input	
12	MIPI_3N		
13	GND	Ground	
14	MIPI_2P	MIPI Data lane2 input	
15	MIPI_2N		
16	GND	Ground	
17	MIPI_CLK P	MIPI CLK input	
18	MIPI_CLK N		
19	GND	Ground	
20	MIPI_1P	MIPI Data lane1 input	
21	MIPI_1N		
22	GND	Ground	
23	MIPI_0P	MIPI Data lane0 input	
24	MIPI_0N		
25	GND	Ground	
26	STBYB	Standby mode	
27	RESET	Global reset pin	
28	VDD	Power Supply	
29	VDD	Power Supply	
30	VCOM	Common Voltage	



## 4. Absolute Maximum Ratings(Ta=25°C)

### 4.1 Electrical Absolute Maximum Ratings.(Vss=0V ,Ta=25°C)

Item	Symbol	Min.	Typ.	Max	Unit	Note
Power Supply Voltage	V <sub>DD</sub>	-0.3	1.8	2.5	V	1, 2
	AVDD	-0.3	9.6	10.5	V	
	VGH	-0.3	18	20	V	
	VGL	0	-6	-10	V	
	VCOM	3.1	3.2	3.3	V	
Logic Signal Input	V <sub>IO</sub>	-0.3	1.8	3.6	V	
Current of LED	I <sub>LED</sub>	0	140	160	mA	

Notes:

1. If the module is above these absolute maximum ratings. It may become permanently damaged.  
Using the module within the following electrical characteristic conditions are also exceeded, the module will malfunction and cause poor reliability.
2. V<sub>CC</sub> > V<sub>SS</sub> must be maintained.

### 4.2 Environmental Absolute Maximum Ratings.

Item	Storage		Operating		Note
	MIN.	MAX.	MIN.	MAX.	
Ambient Temperature	-30°C	80°C	-20°C	70°C	1,2
Humidity	-	-	-	-	3

1. The response time will become lower when operated at low temperature.
2. Background color changes slightly depending on ambient temperature.

The phenomenon is reversible.

3. Ta ≤ 40°C: 85%RH MAX.

Ta > 40°C: Absolute humidity must be lower than the humidity of 85%RH at 40°C.



## 5. LED backlight specification(VSS=0V ,Ta=25°C)

Item	Symbol	Condition	Min	Typ	Max	Unit	Note
Supply voltage	-	-	-	9.6	-	V	1
Supply current	I <sub>f</sub>	-	-	140	-	mA	2
Forward current	Normal	I <sub>pn</sub>	3-chip series x 7	-	-	-	mA
	Dimming	I <sub>pd</sub>		-	-	-	

Note:

1:  $V_{LED} = V_{LED(+)} - V_{LED(-)}$ .

2: The current of LED is 20mA.

A LED drive in constant current mode is recommended.

3: LED power consumption is around 1.125W.

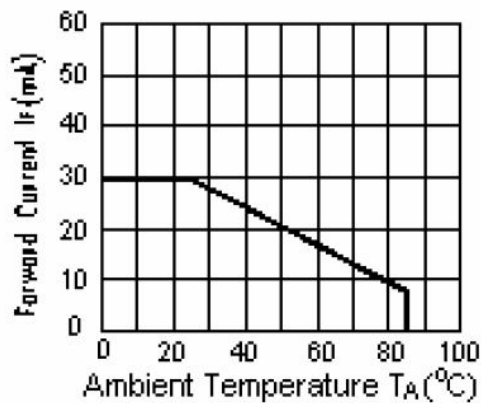

CIRCUIT DIAGRAM

I<sub>LED</sub> VS TEMP





## 6. Timing Characteristics

### 6.1 Input Clock and Data Timing Diagram

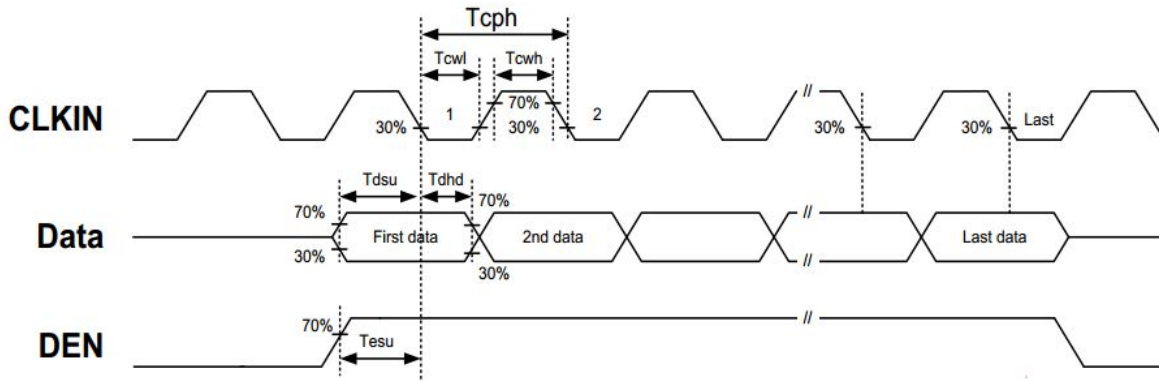

### 6.2 Power Sequence

In order to power on/off correctly, please follow the following recommended power on/off sequence.

#### 6.2.1 Power On Sequence





## 6.2.2 Power Off Sequence

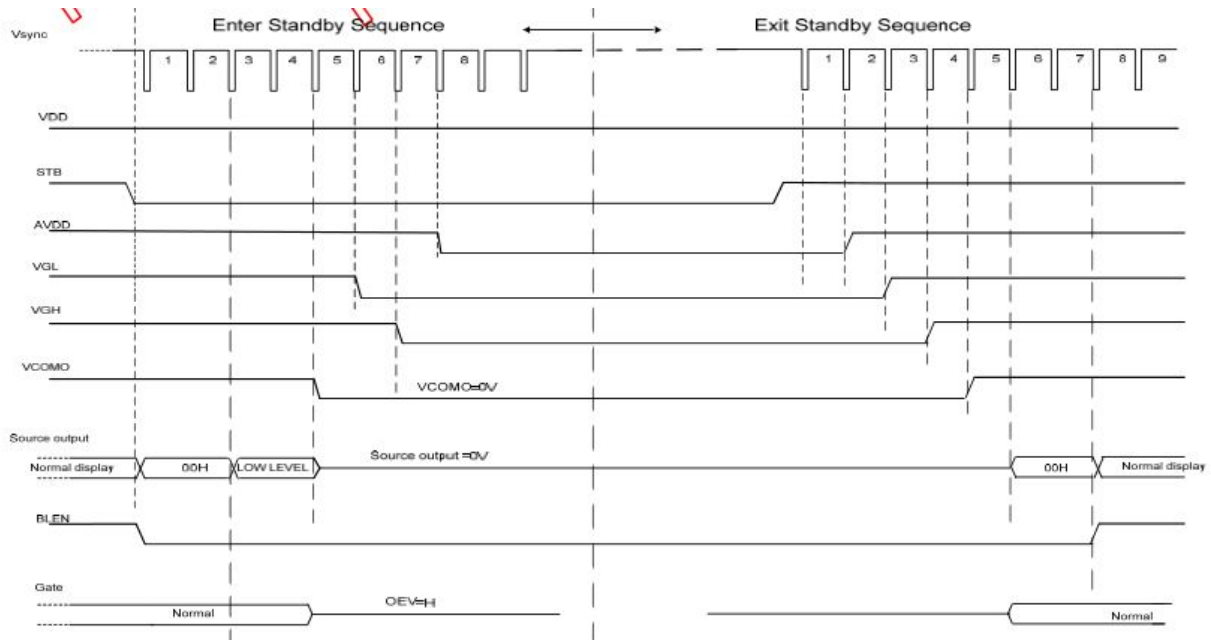

## 6.3 TIMING TABLE

DE mode

DE mode

Parameter	Symbol	Value			Unit
		Min.	Typ.	Max.	
DCLK frequency @Frame rate=60hz	fclk	40.8	51.2	67.2	Mhz
Horizontal display area	thd	1024			DCLK
HSYNC period time	th	1114	1344	1400	DCLK
HSYNC blanking	thb+thfp	90	320	376	DCLK
Vertical display area	tvd	600			H
VSYNC period time	tv	610	635	800	H
VSYNC blanking	tvb+tvfp	10	35	200	H

HV mode(1)

HV mode

Horizontal input timing

Parameter	Symbol	Value			Unit
		Min.	Typ.	Max.	
Horizontal display area	thd	1024			DCLK
DCLK frequency@Frame rate=60hz	fclk	44.9	51.2	63	Mhz
1 Horizontal Line	th	1200	1344	1400	DCLK
HSYNC pulse width	thpw	Min	1		
		Typ.	—		
		Max.	140		
HSYNC back porch	thbp	160	160	160	
HSYNC front porch	thfp	16	160	216	



HV mode(2)

Vertical input timing					
Parameter	Symbol	Value			Unit
		Min.	Typ.	Max.	
Vertical display area	tvd	600			H
VSYNC period time	tv	624	635	750	H
VSYNC pulse width	tvpw	1	—	20	H
VSYNC back porch	tvb	23	23	23	H
VSYNC front porch	tvfp	1	12	127	H

In order to power on/off correctly , please follow the following recommended power on/off sequence.

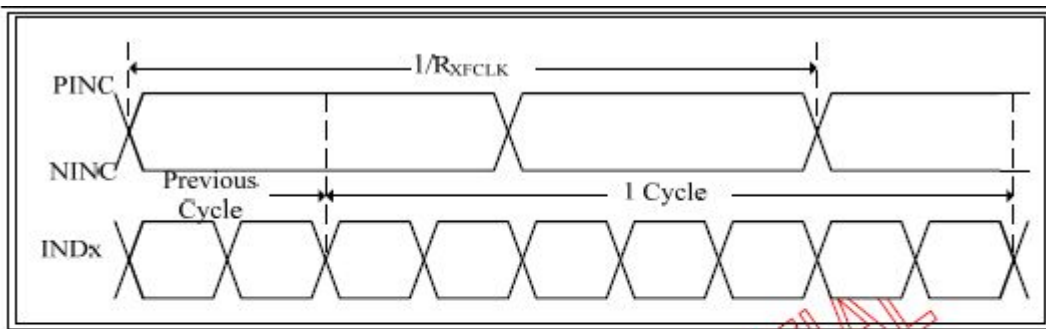

LVDS timing(1)

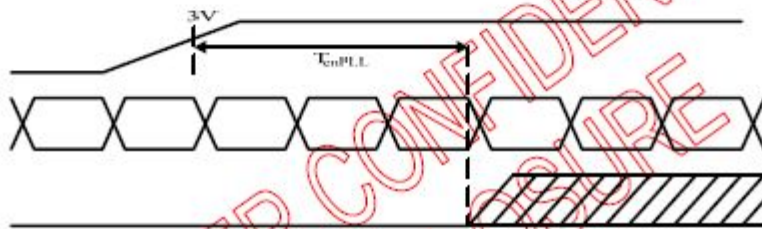

LVDS timing(2)

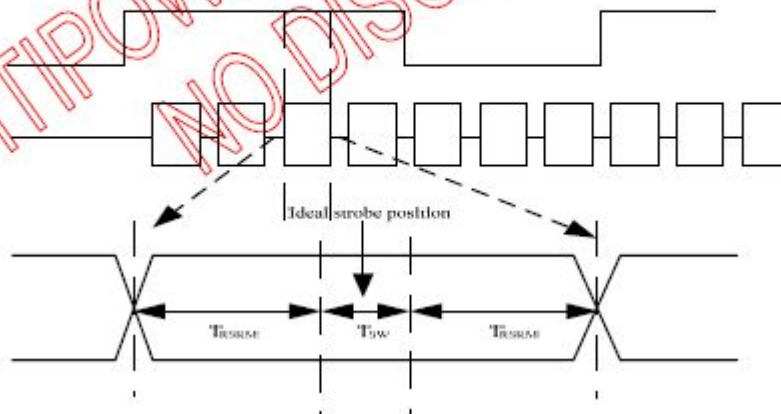



## 7. Optical Characteristics

Item	Symbol	Condition	Min.	Typ.	Max.	Unit	Note
Brightness	Bp	$\theta=0^\circ$		450	-	Cd/m <sup>2</sup>	1
Uniformity	$\Delta Bp$	$\Phi=0^\circ$	75	80	-	%	1,2
Viewing Angle	Horizontal	$Cr \geq 10$		170		Deg	3
	Vertical			170			
Contrast Ratio	Cr	$\theta=0^\circ$ $\Phi=0^\circ$	640	800		-	4
Response Time	T <sub>r</sub>		-	30	-	ms	5
	T <sub>f</sub>	-	-	-	ms		
Color of CIE Coordinate	W	x	-0.03	0.314	+0.03		1,6
		y		0.374			
		Y					
	R	x		0.631			
		y		0.345			
		Y					
	G	x		0.290			
		y		0.585			
		Y					
	B	x		0.134			
		y		0.178			
		Y		-			
NTSC Ratio	S	-	58	-	%		

Note: The parameter is slightly changed by temperature, driving voltage and material



Note 1: The data are measured after LEDs are turned on for 5 minutes. LCM displays full white. The brightness is the average value of 9 measured spots. Measurement equipment PR-705 (Φ8mm)

Measuring condition:

- ① Measuring surroundings: Dark room.
- ② Measuring temperature:  $T_a=25^{\circ}\text{C}$ .
- ③ Adjust operating voltage to get optimum contrast at the center of the display.

Measured value at the center point of LCD panel after more than 5 minutes while backlight turning on.

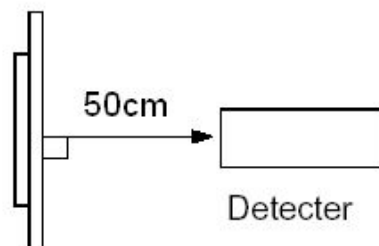

Note 2: The luminance uniformity is calculated by using following formula.

$$\Delta Bp = Bp (\text{Min.}) / Bp (\text{Max.}) \times 100 (\%)$$

$Bp (\text{Max.})$  = Maximum brightness in 9 measured spots

$Bp (\text{Min.})$  = Minimum brightness in 9 measured spots.

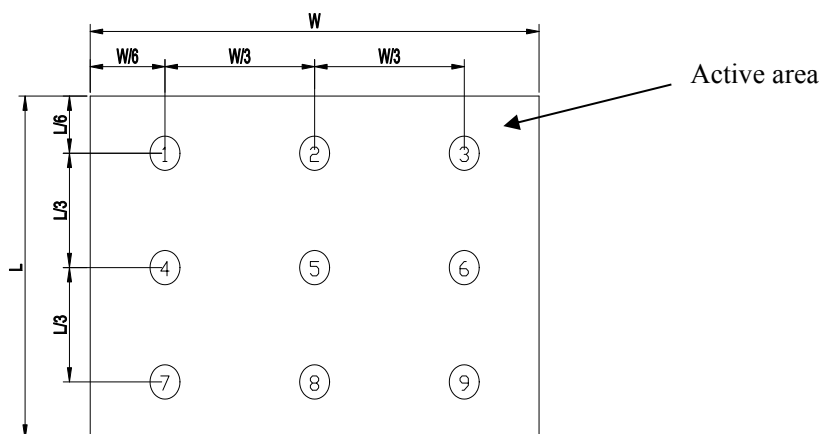

Note 3: The definition of viewing angle:



Refer to the graph below marked by  $\theta$  and  $\phi$

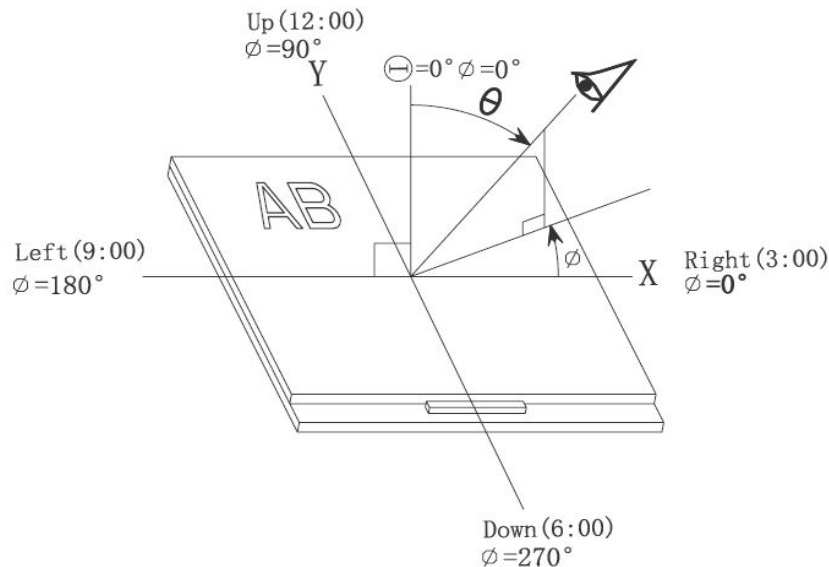

Note 4: Definition of contrast ratio.( Test LCD using DMS501)

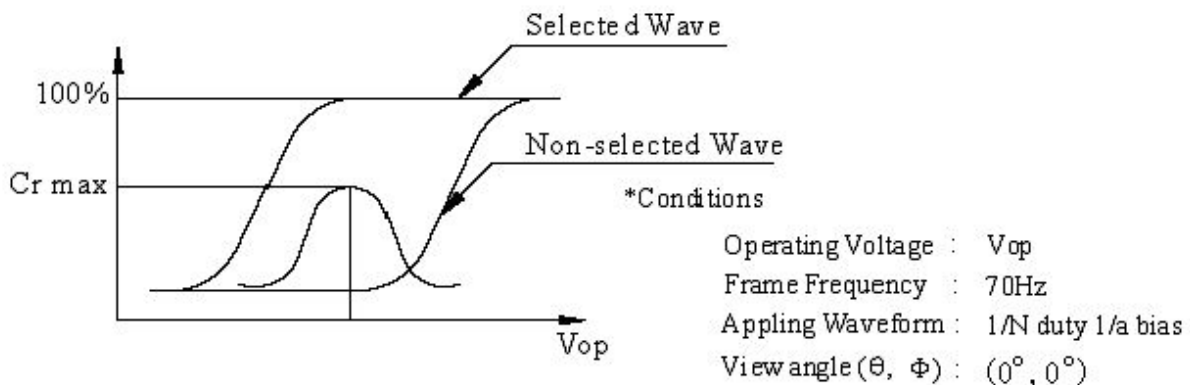

$$\text{Contrast ratio}(Cr) = \frac{\text{Brightness of selected dots}}{\text{Brightness of non-selected dots}}$$

Note 5: Definition of Response time. (Test LCD using DMS501):

The output signals of photo detector are measured when the input signals are changed from “black” to “white”(falling time) and from “white” to “black”(rising time), respectively. The response time is defined as the time interval between the 10% and 90% of amplitudes.Refer to figure as below.

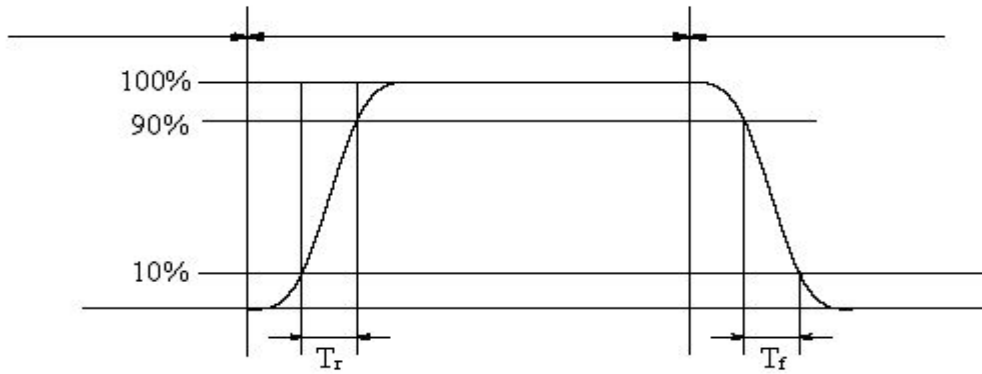

The definition of response time

Note 6: Definition of Color of CIE Coordinate and NTSC Ratio.

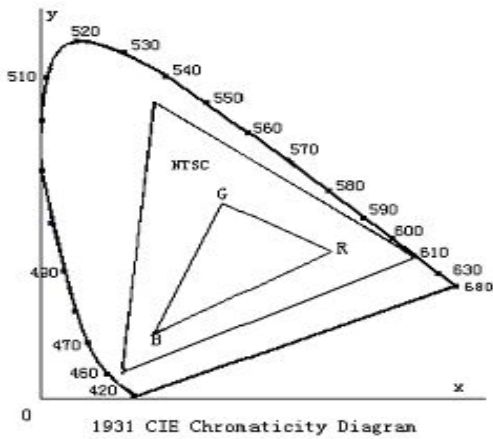

Color gamut:

$$S = \frac{\text{area of RGB triangle}}{\text{area of NTSC triangle}} \times 100\%$$

Note 7: Definition of cross talk.

Cross talk ratio(%)=|pattern A Brightness-pattern B Brightness|/pattern A Brightness\*100

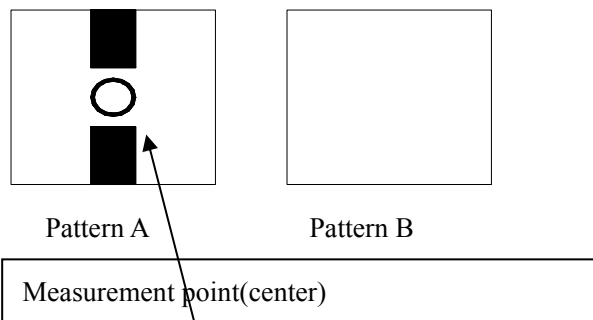

Electric volume value=3F+/-3Hex



## 8. Reliability Test Items and Criteria

No	Test Item	Test condition	Criterion
1	High Temperature Storage	80°C±2°C 96H Restore 2H at 25°C Power off	1. After testing, cosmetic and electrical defects should not happen. 2. Total current consumption should not be more than twice of initial value.
2	Low Temperature Storage	-30°C±2°C 96H Restore 2H at 25°C Power off	
3	High Temperature Operation	70°C±2°C 96H Restore 2H at 25°C Power on	
4	Low Temperature Operation	-20°C±2°C 96H Restore 4H at 25°C Power on	
5	High Temperature/Humidity Operation	60°C±2°C 90%RH 96H Power on	
6	Temperature Cycle	-30°C ← ————— → 80°C 30min 5min 30min after 5 cycle, Restore 2H at 25°C Power off	
7	Vibration Test	10Hz~150Hz, 100m/s <sup>2</sup> , 120min	Not allowed cosmetic and electrical defects.
8	Shock Test	Half- sine wave, 300m/s <sup>2</sup> , 11ms	
9	ESD Test	Air discharge: +/-8KV, Contact discharge: 4KV	

Note: Operation: Supply 2.8V for logic system.

The inspection terms after reliability test, as below

ITEM	Inspection
Contrast	CR>50%
IDD	IDD<200%
Brightness	Brightness>60%
Color Tone	Color Tone +/-0,05





## 9. Quality level

### 9.1 Classification of defects

Major defects (MA): A major defect refers to a defect that may substantially degrade usability for product applications, including all functional defects (such as no display, abnormal display, open or missing segment, short circuit, missing component), outline dimension beyond the drawing, progressive defects and those affecting reliability.

Minor defects (MI): A minor defect refers to a defect which is not considered to be able to substantially degrade the product application or a defect that deviates from existing standards almost unrelated to the effective use of the product or its operation, such as black spot, white spot, bright spot, pinhole, black line, white line, contrast variation, glass defect, polarizer defect, etc.

### 9.2 Definition of inspection range

For dot defect of TFT LCD which is not smaller than 3 inches, dividing three areas to make a judgment (according to figure 1).

A area : center of viewing area

B area : periphery of viewing area

C area : Outside viewing area

For other defects, dividing two areas to make a judgment (according to figure 2).

A zone : Inside Viewing area

B zone : Outside Viewing area

X1(A.A~V.A): 2mm    X2(A.A~V.A): 2mm

Y1(A.A~V.A): 2mm    Y2(A.A~V.A): 2mm

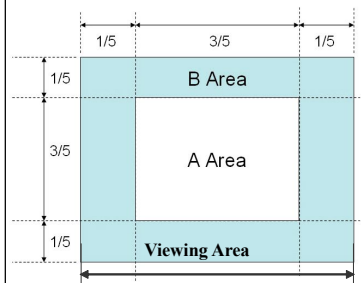
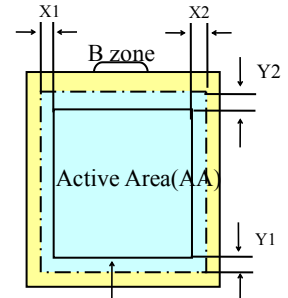

Figure 1



A zone: Viewing Area(VA)

Figure 2



### 9.3 Inspection items and general notes

General notes	1.Should any defects which are not specified in this standard happen, additional standard shall be determined by mutual agreement between customer and TIANMA. 2.Viewing area should be the area which TIANMA guarantees. 3.Limit sample should be prior to this Inspection standard. 4.Viewing judgment should be under static pattern. 5.Inspection conditions Inspection distance: 250 mm (from the sample)      Temperature : 25±5 °C Inspection angle : 45 degrees in 12 o'clock direction (all defects in viewing area should be inspected from this direction)	
Inspection items	Pinhole, Bright spot, Black spot, White spot, Black line, White Line, Foreign particle, Bubble	The color of a small area is different from the remainder. The phenomenon doesn't change with voltage
	Contrast variation	The color of a small area is different from the remainder. The phenomenon changes with voltage
	Polarizer defect	Scratch, Dirt, Particle, Bubble on polarizer or between polarizer and glass
	Dot defect (TFT LCD)	The pixel appears bright or dark abnormally when display
	Functional defect	No display, Abnormal display, Open or missing segment, Short circuit, False viewing direction
	Glass defect	Glass crack, Shaved corner of glass, Surplus glass
	PCB defect	Components assembly defect

### 9.4 Outgoing Inspection level

Outgoing Inspection standard	Inspection conditions	Inspection				
		Min.	Max.	Unit	IL	AQL
Major Defects	See 8.3 general notes	See 8.5			II	0.065
Minor Defects	See 8.3 general notes	See 8.5			II	0.065

Note: Sampling standard conforms to GB2828

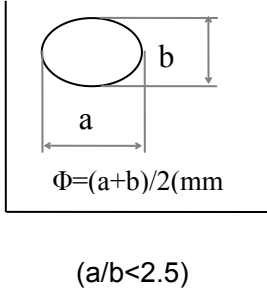
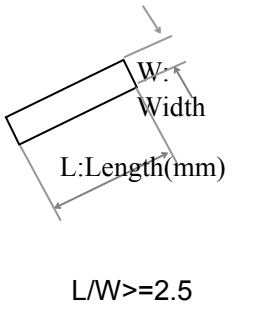
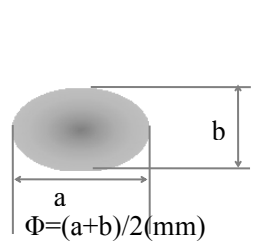

### 9.5 Inspection Items and Criteria

Inspection items			Judgment standard			
			Category		Acceptable number	
					A zone	B zone
1	Black spot, White spot, Pinhole, Foreign Particle, Particle in or on glass, Scratch on glass		A	$\Phi \leq 0.20$	Neglected	Neglected
			B	$0.20 < \Phi \leq 0.25$		Neglected
			C	$0.25 < \Phi \leq 0.3$		Neglected
			D	$0.3 < \Phi \leq 0.4$		
			E	$0.4 < \Phi \leq 0.5$		
			Total defective point(B,C)			-
2	Black line, White line, and Particle Between Polarizer and glass, Scratch on glass		A	$W \leq 0.03$	Neglected	Neglected
			B	$0.03 < W \leq 0.05$ $L \leq 3.0$	-	Neglected
			C	$0.05 < W \leq 0.1$ $L \leq 3.0$	-	Neglected
			D	$0.05 < W \leq 0.1$ $L \leq 4.0$	-	-
			E	$W > 0.1$ $L > 4.0$	-	-
			Total defective point(B,C)		-	-
3	Bright spot		any size	none	none	
4	Contrast variation		A	$\Phi < 0.2$	Neglected	Neglected
			B	$0.2 < \Phi \leq 0.3$	-	
			C	$0.3 < \Phi \leq 0.4$	-	
			D	$0.4 < \Phi$	-	
			Total defective point(B,C)		-	
5	Bubble inside cell		any size	none	none	
6	Polarizer defect (if Polarizer is used)	Scratch ,damage on polarizer, Particle on polarizer or between polarizer and glass.	Refer to item 1 and item 2.			

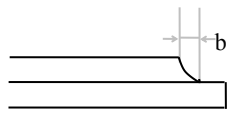
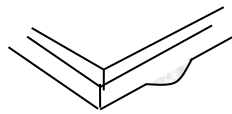

		Bubble, dent and convex	A	$\Phi \leq 0.1$	Neglected	Neglected
			B	$0.1 < \Phi \leq 0.2$	-	Neglected
			C	$0.2 < \Phi \leq 0.3$	-	-
7	Surplus glass	Stage surplus glass 	B ≤ 0.3mm			
		Surrounding surplus glass 	Should not influence outline dimension and assembling.			
8	Open segment or open common		Not permitted			
9	Short circuit		Not permitted			
10	False viewing direction		Not permitted			
11	Contrast ratio uneven		According to the limit specimen			
12	Crosstalk		According to the limit specimen			
13	Black /White spot(display)		Refer to item 1			
14	Black /White line(display)		Refer to item 2			

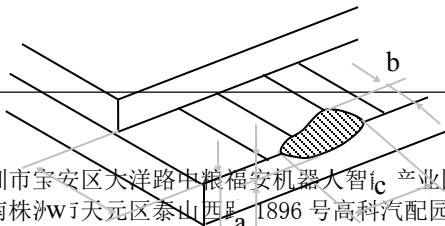
Inspection items			Judgment standard		
			Category(application: B zone)		Acceptable number
15	Glass defect crack	i )The front of lead terminals 	A	$a \leq t, b \leq 1/5W, c \leq 3mm$	Max.3 defects allowed



		B	Crack at two sides of lead terminals should not cover patterns and alignment mark
	<p>ii )Surrounding crack-non-contact side</p> <p>Inner border line of the seal Outer border line of the seal</p>		$b < \text{Inner borderline of the seal}$
	<p>iii ) Surrounding crack- contact side</p> <p>Inner border line of the seal Outer border line of the seal</p>		$b < \text{Outer borderline of the seal}$
	<p>iv )Corner</p>	A	$a \leq t, b \leq 3.0, c \leq 3.0$
		B	Glass crack should not cover patterns u and alignment mark and patterns.

Inspection items	Judgment standard
	Category(application: B zone)



16	PCB defect	<p>Component soldering: No cold soldering、short、open circuit、burr、tin ball The flat encapsulation component position deviation must be less than 1/3 width of the pin (Pic.1); the sheet component deviation: Pin deviates from the pad and contact with the near components is not permitted (Pic.2)</p>	
		<p>lead defect: The lead lack must be less than 1/3 of its width; The lead burr must be less than 1/3 of the seam; Impurities connect with the near leads is not permitted</p>	
		<p>Connector soldering: Soldering tin is at contact position of the plug and socket is not permitted No foundation is scald Serious cave distortion on plug and socket contact pin is not permitted</p>	
		<p>Glue on root of the speaker receiver and motor lead: The insulative coat of the lead must join into the PCB; the protected glue must envelop to the insulative coat.</p>	



## 10. Precautions for Use of LCD Module

### 10.1 Handling Precautions

10.1.1 The display panel is made of glass. Do not subject it to a mechanical shock by dropping it from a high place, etc.

10.1.2 If the display panel is damaged and the liquid crystal substance inside it leaks out, be sure not to get any in your mouth, if the substance comes into contact with your skin or clothes, promptly wash it off using soap and water.

10.1.3 Do not apply excessive force to the display surface or the adjoining areas since this may cause the color tone to vary.

10.1.4 The polarizer covering the display surface of the LCD module is soft and easily scratched. Handle this polarizer carefully.

10.1.5 If the display surface is contaminated, breathe on the surface and gently wipe it with a soft dry cloth. If still not completely clear, moisten cloth with one of the following solvents:

— Isopropyl alcohol

— Ethyl alcohol

Solvents other than those mentioned above may damage the polarizer.

Especially, do not use the following:

— Water

— Ketone

— Aromatic solvents

10.1.6 Do not attempt to disassemble the LCD Module.

10.1.7 If the logic circuit power is off, do not apply the input signals.

10.1.8 To prevent destruction of the elements by static electricity, be careful to maintain an optimum work environment.

a. Be sure to ground the body when handling the LCD Modules.

b. Tools required for assembly, such as soldering irons, must be properly



ground.

- c. To reduce the amount of static electricity generated, do not conduct assembly and other work under dry conditions.
- d. The LCD Module is coated with a film to protect the display surface. Be care when peeling off this protective film since static electricity may be generated.

## 10.2 Storage precautions

10.2.1 When storing the LCD modules, avoid exposure to direct sunlight or to the light of fluorescent lamps.

10.2.2 The LCD modules should be stored under the storage temperature range. If the LCD modules will be stored for a long time, the recommend condition is:

Temperature :             $0^{\circ}\text{C} \sim 40^{\circ}\text{C}$

Relatively humidity:  $\leq 80\%$

10.2.3 The LCD modules should be stored in the room without acid, alkali and harmful gas.

10.2.4 The LCD modules should be no falling and violent shocking during transportation, and also should avoid excessive press, water, damp and sunshine.