

0.4mm Pitch, 1.5mm Board-to-Board Connectors with Dual Shielding

FX12 Series

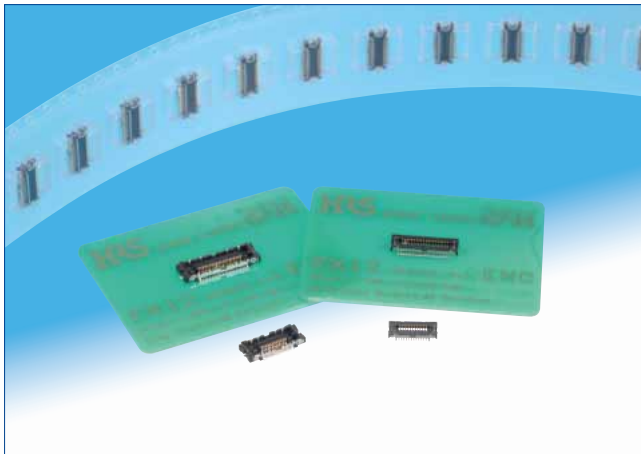

Dual Shields (when mated) [Patented Design]

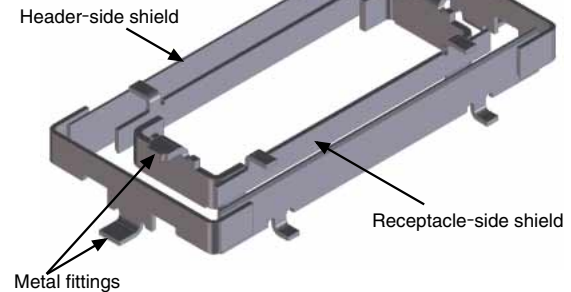

Fig.1

■ Features

1. Dual shields

Built-in shield plates and metal fittings in the plugs and receptacles prevent electromagnetic emission and external interference on the entire 360° periphery of mated connectors. (Fig.1, 2)

2. Low-Profile

A board-to-board distance of 1.5mm combined with reduced mounting areas allow for use in space-limited applications. (Fig.3)

3. Self alignment

Built-in self-alignment feature in the plug and receptacle allows mating / un-mating in limited spaces. (Fig.4)

4. Consistent mated retention force

Indents in the shield plates and contact configuration assure consistent, mated retention forces regardless of the number of contacts. A positive, tactile "click" confirms the fully mated state.

5. Solder wicking prevention

Nickel plating barrier on the contacts prevents solder compound intrusion (wicking) into the contact engagement areas.

6. High contact reliability

The narrow female contacts have a curved shape that acts like a spring, producing a long wipe length during mating and results in high contact reliability.

7. Pick-and-Place automatic mounting friendly

The compact, double shielded structure still provides enough area for vacuum pick-up machines when used in automated mounting methods.

Receptacle: 0.8mm

Header: 0.8mm

8. RoHS Compliant

All materials and substances used to produce this product comply with RoHS standards.

Effective Shielding

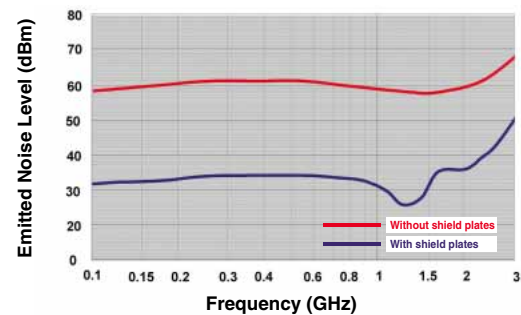

Fig.2

Low-Profile, Space-Saving with Reduced Connector Footprint

(Shown 24-Position – fully mated)

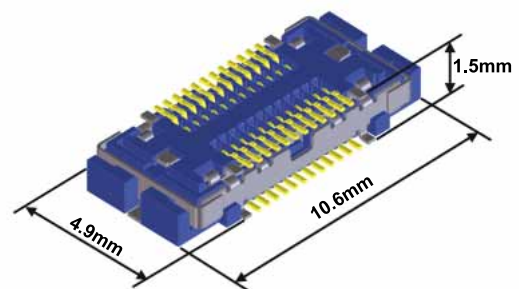
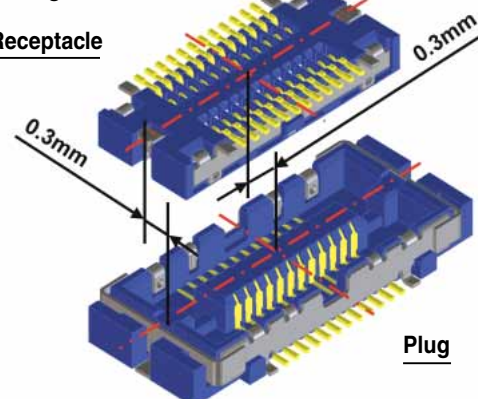

Fig.3

Self Alignment of 0.3 mm

Receptacle



Plug

Fig.4

Product Specifications

| Rating | Current rating 0.3A Voltage rating 30V AC | Operating temperature range -55°C to +85°C (Note 1) | Storage temperature range -10°C to +60°C (Note 2) Storage humidity range Relative humidity 95% max. (No condensation) |
|--------------------------------|---|--|--|
| Item | Specification | Conditions | |
| 1.Insulation resistance | 50MΩ min. | 100V DC | |
| 2.Withstanding voltage | No flashover or insulation breakdown. | 100V AC/one minute | |
| 3.Contact resistance | 100mΩ max. | 100mA | |
| 4.Vibration resistance | No electrical discontinuity of 1μs or more. No damage, cracks or parts dislocation. | Frequency: 10 to 55 Hz, single amplitude of 0.75mm, 3 axis, 10 cycles | |
| 5.Shock resistance | No electrical discontinuity of 1μs or more. No damage, cracks or parts dislocation. | Acceleration of 490m/s ² , 11ms duration, sine half-wave waveform, 3 cycles / each of 3 axis directions | |
| 6.Humidity resistance | Contact resistance: 120mΩ max. Insulation resistance: 25MΩ min. No damage, cracks or parts dislocation. | 96 hours at 40°C, 90% to 95% R.H. | |
| 7.Temperature cycle | Contact resistance: 120mΩ max. Insulation resistance: 50MΩ min. No damage, cracks or parts dislocation. | Temperature: -55°C → +15°C to 35°C → +85°C → +15°C to +35°C Time: 30 → 2 to 3 → 30 → 2 to 3 (Minutes) 5 cycles | |
| 8.Mating Cycles | Contact resistance: 120mΩ max. No damage, cracks or parts dislocation. | 30 cycles | |
| 9.Resistance to soldering heat | No deformation of components affecting performance. | Reflow: At the recommended temperature profile Manual soldering: 360°C for 5 seconds | |

Note 1 : Includes temperature rise caused by current flow.

Note 2 : The term “storage” refers to products stored for long periods of time prior to mounting and use. Operating temperature range and humidity range includes non-conducting condition of installed connectors in storage, shipment or during transportation.

Materials / Finish

| Part | Material | Finish | | Remarks |
|----------------|-----------------|--------------|---------------------------------------|---------|
| Insulator | Polyamide | Color: Black | | UL94V-0 |
| Contacts | Phosphor bronze | Header | Engagement Area: Gold Plated of 0.1μm | — |
| | | Receptacle | Termination Area: Flash Plated | |
| Ground plates | | Flash plated | | — |
| Metal fittings | | Tin plated | | — |

Product Number Structure

FX12 **B** - **24** **P** - **0.4** **SV** (**)
① ② ③ ④ ⑤ ⑥ ⑦

| | |
|---|--|
| ① Series name : FX12 | ④ Connector type P : Header S : Receptacle |
| ② Configuration B : Without guide post | |
| ③ Number of contacts : 24, 40, 60 | ⑤ Contact pitch : 0.4 mm |
| | ⑥ Mounting style SV : SMT |
| | ⑦ Blank: Embossed tape packing (3,000 pcs/reel) (30) : Embossed tape packing (100 pcs/reel) |

Header

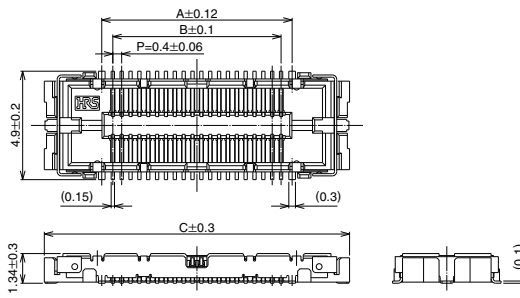
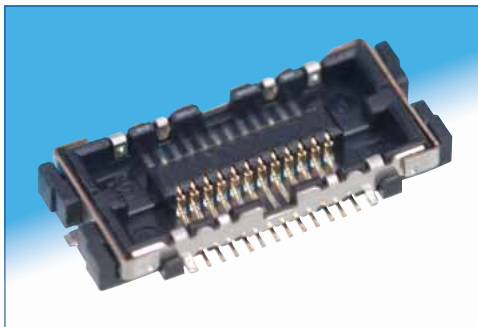

Recommended PCB Layout and Metal Mask Dimensions

Recommended metal mask thickness: 0.12 mm

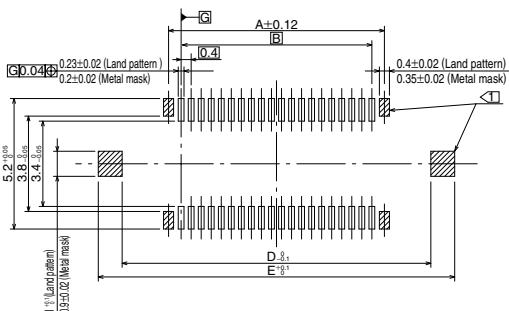

Notes:

- 1) Positions marked indicate a ground circuit connections.
- 2) The co-planarity of SMT terminations is 0.1 maximum.
- 3) No polarity orientation for board mounting.
- 4) Dimensions in parentheses () are reference dimensions.
- 5) All dimensions in mm.

| Part No. | HRS No. | No. of Contacts | A | B | C | D | E | RoHS |
|---------------------|---------------|-----------------|------|------|-------|------|------|------|
| FX12B-24P-0.4SV(**) | 573-1005-0 ** | 24 | 5.4 | 4.4 | 10.6 | 9.1 | 11.0 | Yes |
| FX12B-40P-0.4SV(**) | 573-1001-0 ** | 40 | 8.6 | 7.6 | 13.8 | 12.3 | 14.2 | |
| FX12B-60P-0.4SV(**) | 573-1007-6 ** | 60 | 12.6 | 11.6 | 17.79 | 16.3 | 18.2 | |

Blank: Embossed tape packing (3,000 pcs/reel)

(30) : Embossed tape packing (100 pcs/reel)

Receptacle

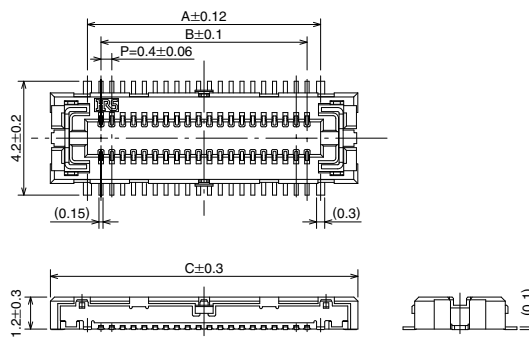
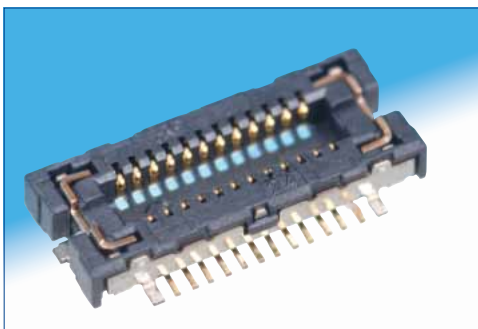

Recommended PCB Layout and Metal Mask Dimensions

Recommended metal mask thickness: 0.12 mm

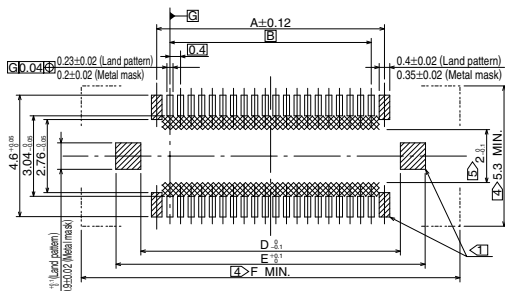

Notes:

- 1) Positions marked indicate a ground circuit connections.
- 2) The co-planarity of SMT terminations is 0.1 maximum.
- 3) No polarity orientation for board mounting.
- 4) Do NOT place any components within area indicated by the broken line .
- 5) Do NOT place conductive traces in areas indicated by .
- 6) Dimensions in parentheses () are reference dimensions.
- 7) All dimensions in mm.

| Part No. | HRS No. | No. of Contacts | A | B | C | D | E | F | RoHS |
|---------------------|---------------|-----------------|------|------|-------|------|------|------|------|
| FX12B-24S-0.4SV(**) | 573-1006-3 ** | 24 | 5.4 | 4.4 | 8.14 | 6.6 | 8.5 | 11.1 | Yes |
| FX12B-40S-0.4SV(**) | 573-1002-2 ** | 40 | 8.6 | 7.6 | 11.34 | 9.8 | 11.7 | 14.3 | |
| FX12B-60S-0.4SV(**) | 573-1008-9 ** | 60 | 12.6 | 11.6 | 15.34 | 13.8 | 15.7 | 18.3 | |

Blank: Embossed tape packing (3,000 pcs/reel)

(30) : Embossed tape packing (100 pcs/reel)

◆ Embossed Carrier Tape and Reel Dimensions

● Header

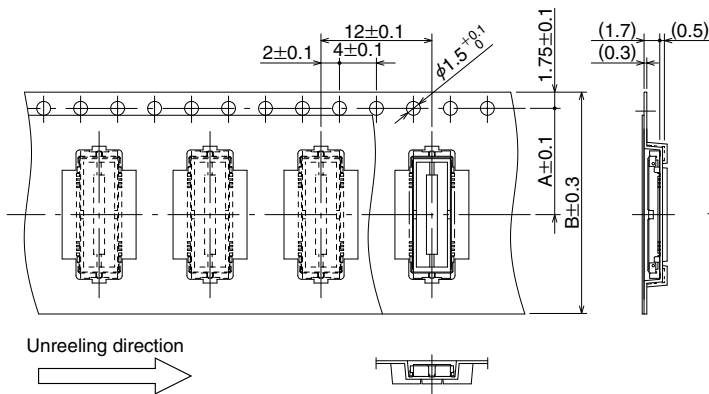

● Reel dimensions

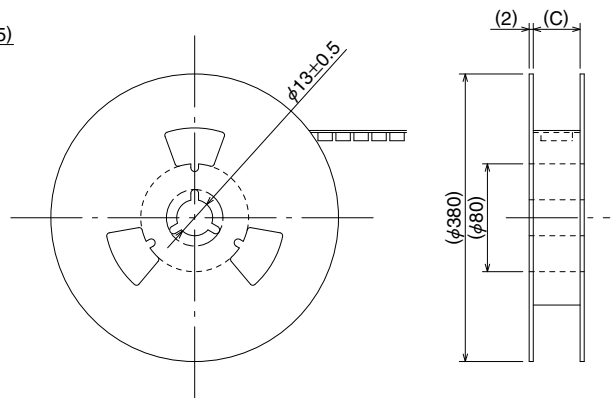

| Part No. | A | B | C |
|---------------------|------|------|------|
| FX12B-24P-0.4SV(**) | 11.5 | 24.0 | 24.4 |
| FX12B-40P-0.4SV(**) | | | |
| FX12B-60P-0.4SV(**) | 14.2 | 32.0 | 32.4 |

All dimensions in mm

◆ Embossed Carrier Tape and Reel Dimensions

● Receptacle

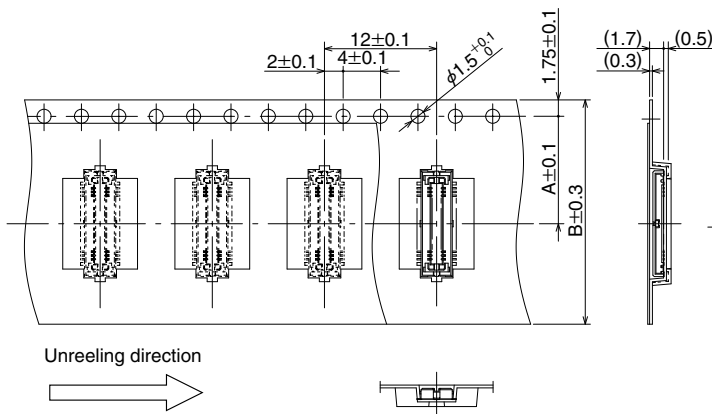

● Reel dimensions

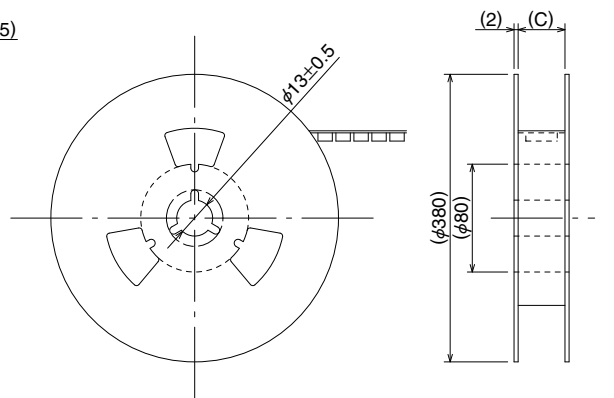

| Part No. | A | B | C |
|---------------------|------|------|------|
| FX12B-24S-0.4SV(**) | 11.5 | 24.0 | 24.4 |
| FX12B-40S-0.4SV(**) | | | |
| FX12B-60S-0.4SV(**) | | | |

All dimensions in mm

◆ Recommended solder temperature profile.

The temperature profile indicates the maximum temperature of the connector surfaces at the highest point from the PCB mounting surface.

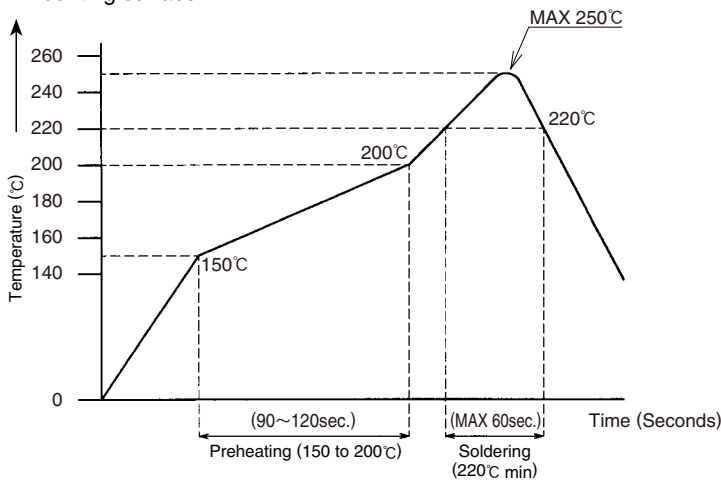

< HRS test conditions >

| | |
|---------------|-------------------------------------|
| Solder method | :Reflow |
| Environment | :Room air |
| Solder paste | :96.5%Sn/3.0%Ag/0.5%Cu |
| Test board | :Glass epoxy 40mm×30mm×1mm thick |
| Metal mask | :0.12mm thick |
| Reflow cycles | :2cycles |

Note 1 : The temperature profiles shown are based on the above conditions.

Note 2 : In individual applications the actual temperature may vary, depending on solder paste type, volume / thickness and board size/ thickness.

Note 3 : Consult your solder paste and equipment manufacture for specific recommendations.

◆ Washing Conditions

Organic solvent Washing

| Solvent type | Room temperature washing | Heated washing |
|-------------------------|--------------------------|----------------|
| IPA (Isopropyl alcohol) | Yes | Yes |

Water Type Washing

When using water type cleaning agents (e.g., terpene, and alkali saponifiers), select the cleaning agent based on the documentation issued by the various manufacturers of cleaning agents which describes the effects on metals and resins. Be careful that parts are not left with moisture remaining on them.

Washing Precautions

Residual flux or cleaning agent on the contacts when washing with organic solvents or water type cleaners can give rise to the deterioration of electrical performance. In this regard it is important to check whether a thorough washing has been performed.

◆ Handling Precautions when mating mounted connectors.

| | |
|--|---|
| <p>MAX 0.3 FX12*-**S-0.4SV MAX 0.3 FX12*-**P-0.4SV Fig.1</p> | <p>Start the engagement of the connectors within the specified self-alignment range of 0.3 mm, while keeping the boards parallel to each other.</p> |
| <p>Incorrect Incorrect</p> | <p>Do NOT start mating of the mounted connectors at an angle. Correctly position the connectors over each other and assure that both boards are parallel to each other.</p> |
| <p>(0.5mm) (0.5mm)</p> | <p>When the connectors are correctly aligned (and both boards are parallel to each other) apply even force until full mating is confirmed by the “click” sensation.</p> |
| <p>Caution</p> | <p>When the connectors are mounted on the FPC, care should taken to prevent the mated connectors from bending or twisting on the FPC. The device case or cushioning material should be used to keep the connectors fully mated and supported.</p> |

◆ Handling Precautions when un-mating

| | |
|---|--|
| | <p>Keep the boards (with mounted connectors) parallel to each other.</p> |
| <p>Fig. A Fig. B Incorrect</p> | <p>If parallel disconnection is impossible, start un-mating at one end, exercising extreme caution to apply force at the center of the connector itself, away from the solder joint rows (Ref. Fig A and Fig. B)</p> |
| <p>Incorrect</p> | <p>Do NOT start disconnection at the sides as the connector can be damaged, voiding the warranty and making the re-engagement impossible.</p> |

Feb.1.2019 Copyright 2019 HIROSE ELECTRIC CO., LTD. All Rights Reserved.

Technical Documentation

Eye Pattern Output Waveform

[700MHz]

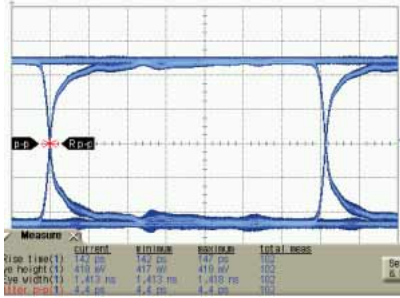

[1GHz]

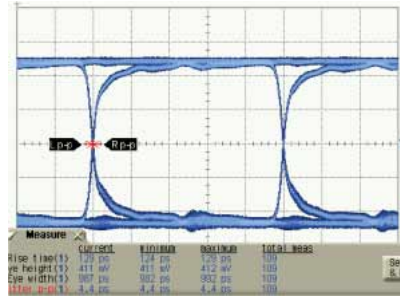

[2GHz]

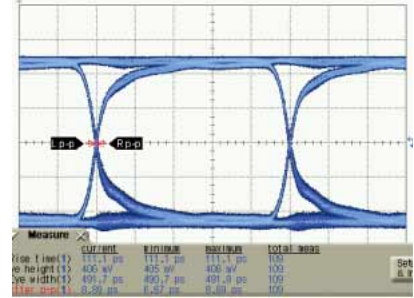

Shielding Characteristics (1) (Measurement Results Using a 2-Chamber Shielded Room)

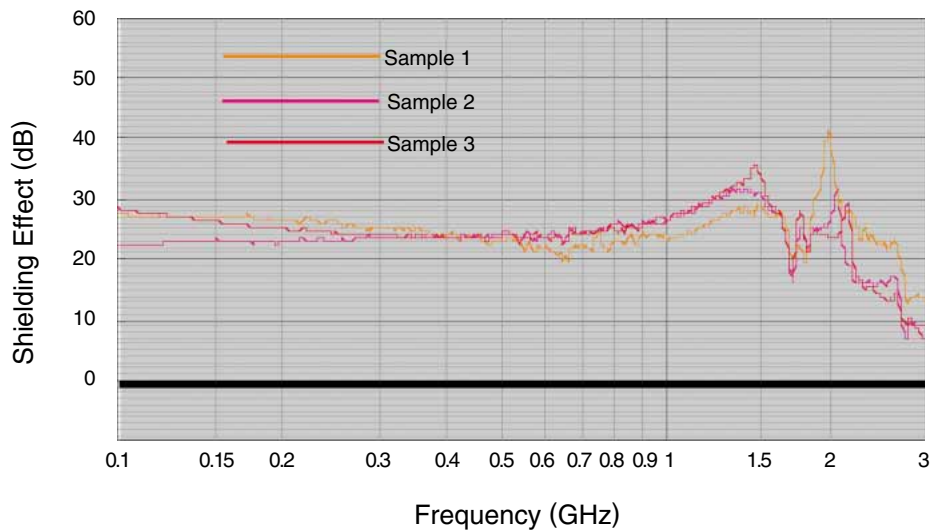

Explanatory Note

Measurement values of the unshielded connectors were set as the zero level of the vertical axis of the graph. The graph uses unshielded connectors as the reference and indicates the noise leakage suppression (shielding) effect of the shielded connectors as a relative comparison value.

In comparison to the unshielded connectors there was a noise suppression effect of 10 dB to 30 dB over the frequency range of 100 MHz to 3 GHz.

Shielding Characteristics (2) (Board-to-Board Shielding Comparison Using a Magnetic Field Probe Method: IEC 61967-6 Compliance)

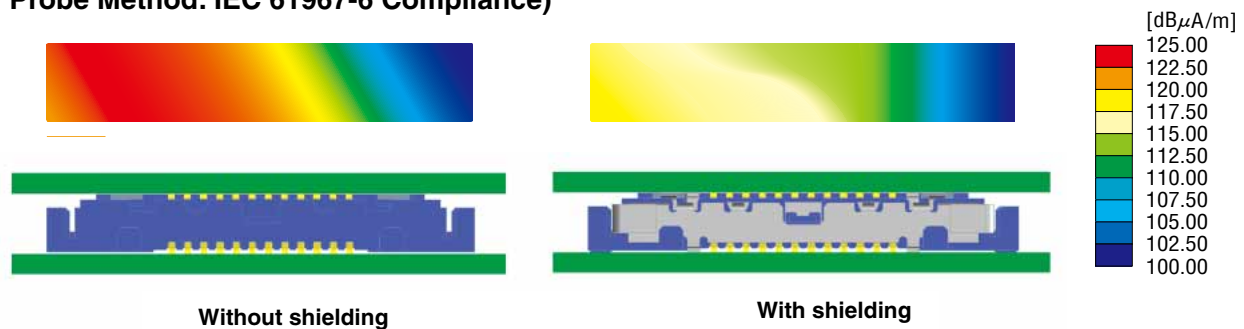

Explanatory Note

A signal of the 266 MHz operating frequency was transmitted through all contacts, over a frequency range of 10 MHz to 3 GHz. The magnetic field leaking to the surroundings from the gap between the boards was measured with a magnetic probe to provide the (mapping data) results.

USA:

HIROSE ELECTRIC (U.S.A.), INC. HEADQUARTERS
2688 Westhills Court, Simi Valley, CA 93065-6235
Phone : +1-805-522-7958
Fax : +1-805-522-3217
<http://www.hirose.com/us/>

USA:

HIROSE ELECTRIC (U.S.A.), INC. SAN JOSE OFFICE
3255 Scott Boulevard, Building 7, Suite 101
Santa Clara, CA 95054
Phone : +1-408-253-9640
Fax : +1-408-253-9641
<http://www.hirose.com/us/>

USA:

HIROSE ELECTRIC (U.S.A.), INC. CHICAGO OFFICE
580 Waters Edge Lane, Suite 205 Lombard IL
60148
Phone : +1-630-282-6701
Mail : inquiries@hirose.com
<http://www.hirose.com/us/>

USA:

HIROSE ELECTRIC (U.S.A.), INC. DETROIT OFFICE (AUTOMOTIVE)
17197 N. Laurel Park Drive, Suite 253, Livonia,
MI 48152
Phone : +1-734-542-9963
Fax : +1-734-542-9964
<http://www.hirose.com/us/>

THE NETHERLANDS:

HIROSE ELECTRIC EUROPE B.V.
Hogehillweg #8 1101 CC Amsterdam Z-0
Phone : +31-20-6557460
Fax : +31-20-6557469
<http://www.hirose.com/eu/>

GERMANY:

HIROSE ELECTRIC EUROPE B.V. GERMAN BRANCH
Herzog-Carl-Strasse 4 D-73760 Ostfildern
(Scharnhäuser Park)
Phone : +49-711-4560-02-1
Fax : +49-711-4560-02-299
<http://www.hirose.com/eu/>

GERMANY:

HIROSE ELECTRIC EUROPE B.V. NUERNBERG OFFICE
Muggenhofer Str. 136 90429 Nuernberg
Phone : +49-911 32 68 89 63
Fax : +49-911 32 68 89 69
<http://www.hirose.com/eu/>

GERMANY:

HIROSE ELECTRIC EUROPE B.V. HANOVER OFFICE
Bayernstr. 3, Haus C 30855 Langenhagen, Germany
Phone : +49-511 97 82 61 30
Fax : +49-511 97 82 61 35
<http://www.hirose.com/eu/>

FRANCE:

HIROSE ELECTRIC EUROPE B.V. PARIS OFFICE
Regus La Garenne Colombes, Place de La Belgique,
71 Boulevard National La Garenne Colombes, 92250, France
Phone : +33 (0) 1 7082 3170
Fax : +33 (1) 7082 3101
<http://www.hirose.com/eu/>

UNITED KINGDOM:

HIROSE ELECTRIC EUROPE BV (UK BRANCH)
4 Newton Court, Kelvin Drive, Knowlhill,
Milton Keynes, MK5 8NH
Phone : +44-1908 202050
Fax : +44-1908 202058
<http://www.hirose.com/eu/>

CHINA:

HIROSE ELECTRIC (SHANGHAI) CO., LTD.
1601, Henderson Metropolitan, NO.300, East Nanjing
Road, Huangpu District, Shanghai, China 200001
Phone : +86-21-6391-3355
Fax : +86-21-6391-3335
<http://www.hirose.com/cn/>

CHINA:

HIROSE ELECTRIC (SHANGHAI) CO.,LTD. BEIJING BRANCH
A1001, Ocean International Center, Building 56# East 4th
Ring Middle Road, ChaoYang District, Beijing, 100025
Phone : +86-10-5165-9332
Fax : +86-10-5908-1381
<http://www.hirose.com/cn/>

CHINA:

HIROSE ELECTRIC TECHNOLOGIES (SHENZHEN) CO., LTD.
Room 09-13, 19/F, Office Tower Shun Hing Square, Di Wang Commercial Centre,
5002 Shen Nan Dong Road, Shenzhen City, Guangdong Province, 518008
Phone : +86-755-8207-0851
Fax : +86-755-8207-0873
<http://www.hirose.com/cn/>

HONG KONG:

HIROSE ELECTRIC HONGKONG TRADING CO., LTD.
Room 1001, West Wing, Tsim Sha Tsui Centre, 66
Mody Road, Tsim Sha Tsui East, Kowloon, Hong Kong
Phone : +852-2803-5338
Fax : +852-2591-6560
<http://www.hirose.com/hk/>

TAIWAN:

HIROSE ELECTRIC TAIWAN CO., LTD.
103 8F, No.87, Zhengzhou Rd., Taipei
Phone : +886-2-2555-7377
Fax : +886-2-2555-7350
<http://www.hirose.com/tw/>

KOREA:

HIROSE KOREA CO., LTD.
250, Huimanggongwon-ro, Siheung-si,
Gyeonggi-do, Korea, 429-849
Phone : +82-31-496-7000,7124
Fax : +82-31-496-7100
<http://www.hirose.co.kr/>

SINGAPORE:

HIROSE ELECTRIC SINGAPORE PTE. LTD.
10 Anson Road #26-16, International Plaza
079903, Singapore
Phone : +65-6324-6113
Fax : +65-6324-6123
<http://www.hirose.com/sg/>

INDIA:

HIROSE ELECTRIC SINGAPORE PTE. LTD. DELHI LIAISON OFFICE
Office NO.519, Regus-Green Boulevard, Level5, Tower C,
Sec62, Plot B-9A, Block B, Noida, 201301, Uttar Pradesh, India
Phone : +91-12-660-8018
Fax : +91-120-4804949
<http://www.hirose.com/sg/>

INDIA:

HIROSE ELECTRIC SINGAPORE PTE. LTD. BANGALORE LIAISON OFFICE
Unit No-403, 4th Floor, No-84, Barton Centre, Mahatma
Gandhi (MG) Road, Bangalore 560 001, Karnataka, India
Phone : +91-80-4120 1907
Fax : +91-80-4120 9908
<http://www.hirose.com/sg/>

MALAYSIA:

HIROSE ELECTRIC SINGAPORE PTE. LTD.
1-10-07, Suntech @ Penang Cybercity (1164), Lintang
Mayang Pasir 3,11950, Bayan Baru, Penang, Malaysia.
Phone : +604-619-2564
Fax : +604-619-2574
<http://www.hirose.com/sg/>

THAILAND:

HIROSE ELECTRIC SINGAPORE PTE. LTD. BANGKOK OFFICE (REPRESENTATIVE OFFICE)
Unit 4703, 47th FL., 1 Empire Tower, South Sathorn
Road, Yannawa, Sathorn, Bangkok 10120 Thailand
Phone : +66-2-686-1255
Fax : +66-2-686-3433
<http://www.hirose.com/sg/>



HIROSE ELECTRIC CO.,LTD.

2-6-3,Nakagawa Chuoh,Tsuzuki-Ku,Yokohama-Shi 224-8540,JAPAN
TEL: +81-45-620-3526 Fax: +81-45-591-3726
<http://www.hirose.com>
<http://www.hirose-connectors.com>