

KIT912J637EVME User's Guide

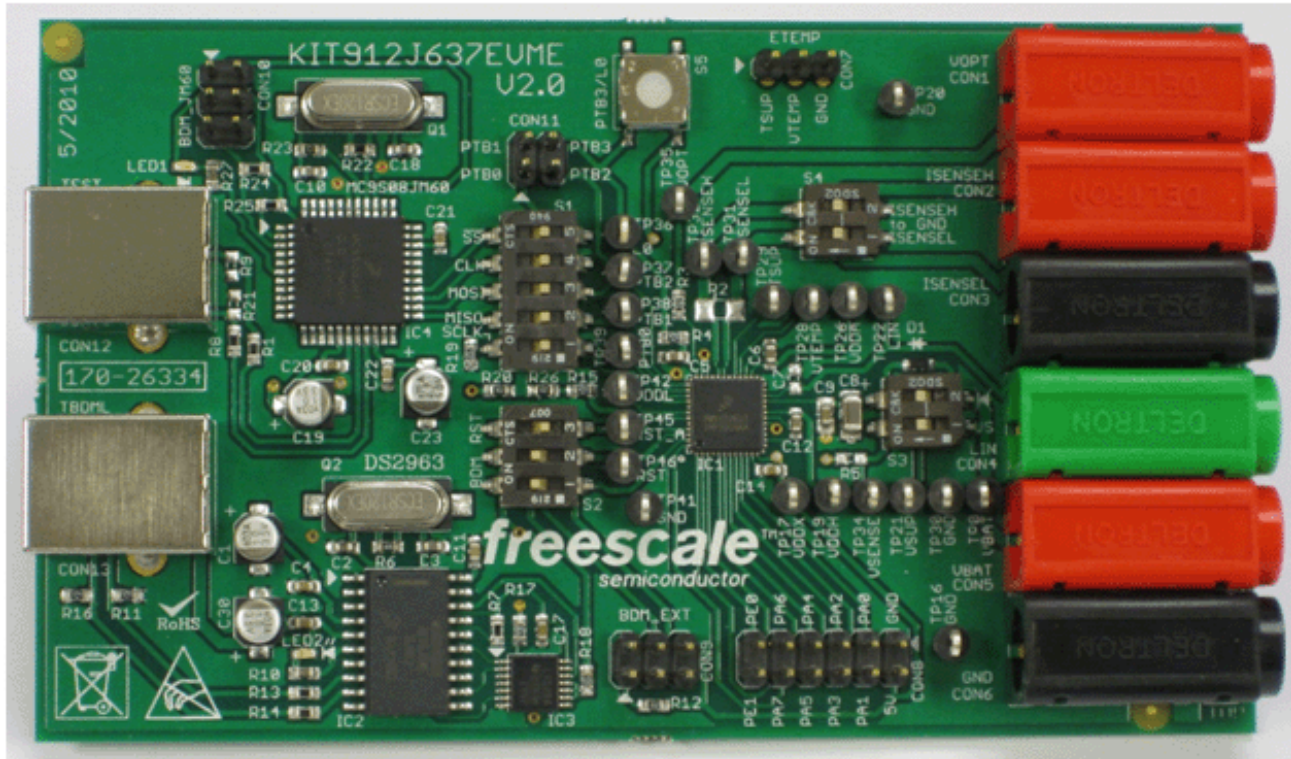

Figure 1. KIT912J637EVME Evaluation Board

Table of Contents

KIT912J637EVME Introduction	4
Required Equipment	6
Setup Guide	7
Hardware Description	8
Software Description	18
Schematics	19
Board Layout	20
Bill of Materials	22
References	25
Revision History	26

1 Kit Contents / Packing List

- MM912J637 Evaluation Board (EVB)
- Cable, 6 FT. USB 2.0 A-M to B-M
- Warranty Card, Freescale
- CD912J637 - Contains CodeWarrior Code Template and CodeWarrior software

2 Important Notice

Freescale provides the enclosed product(s) under the following conditions:

This evaluation kit is intended for use of ENGINEERING DEVELOPMENT OR EVALUATION PURPOSES ONLY. It is provided as a sample IC pre-soldered to a printed circuit board to make it easier to access inputs, outputs, and supply terminals. This EVB may be used with any development system or other source of I/O signals by simply connecting it to the host MCU or computer board via off-the-shelf cables. This EVB is not a Reference Design and is not intended to represent a final design recommendation for any particular application. Final device in an application will be heavily dependent on proper printed circuit board layout and heat sinking design as well as attention to supply filtering, transient suppression, and I/O signal quality.

The goods provided may not be complete in terms of required design, marketing, and or manufacturing related protective considerations, including product safety measures typically found in the end product incorporating the goods. Due to the open construction of the product, it is the user's responsibility to take any and all appropriate precautions with regard to electrostatic discharge. In order to minimize risks associated with the customers applications, adequate design and operating safeguards must be provided by the customer to minimize inherent or procedural hazards. For any safety concerns, contact Freescale sales and technical support services.

Should this evaluation kit not meet the specifications indicated in the kit, it may be returned within 30 days from the date of delivery and will be replaced by a new kit.

Freescale reserves the right to make changes without further notice to any products herein. Freescale makes no warranty, representation or guarantee regarding the suitability of its products for any particular purpose, nor does Freescale assume any liability arising out of the application or use of any product or circuit, and specifically disclaims any and all liability, including without limitation consequential or incidental damages. "Typical" parameters can and do vary in different applications and actual performance may vary over time. All operating parameters, including "Typical", must be validated for each customer application by customer's technical experts.

Freescale does not convey any license under its patent rights nor the rights of others. Freescale products are not designed, intended, or authorized for use as components in systems intended for surgical implant into the body, or other applications intended to support or sustain life, or for any other application in which the failure of the Freescale product could create a situation where personal injury or death may occur.

Should the Buyer purchase or use Freescale products for any such unintended or unauthorized application, the Buyer shall indemnify and hold Freescale and its officers, employees, subsidiaries, affiliates, and distributors harmless against all claims, costs, damages, and expenses, and reasonable attorney fees arising out of, directly or indirectly, any claim of personal injury or death associated with such unintended or unauthorized use, even if such claim alleges that Freescale was negligent regarding the design or manufacture of the part. Freescale™ and the Freescale logo are trademarks of Freescale Semiconductor, Inc. All other product or service names are the property of their respective owners. © Freescale Semiconductor, Inc., 2011. All rights reserved.

3 KIT912J637EVME Introduction

Freescale Semiconductor's KIT912J637EVME is a system solution that gives the user the capability to easily evaluate most of the features provided by the MM912J637 - Xtrinsic Battery Sensor. The 912J637 features two die in a single package. The 16-bit core and the analog die are connected via the die to die interface that provides direct address access to the registers on the analog die. The analog die contains three 16-bit sigma delta converters and enables simultaneous sampling of battery voltage and current, timer module, SCI module, LIN physical interface, and other general registers. All external signals are accessible via header connectors, and most of the signals can also be checked via test points. The evaluation module board also includes the TBDML programming/debugging interface, so no external interface is needed. The board is powered from two 4.0 mm banana connectors. For quick familiarization with the device, a CodeWarrior Template is provided together with the EVB.

3.1 MM912J637 Features

- Battery voltage measurement
- Battery current measurement in up to eight ranges
- On-chip temperature measurement
- Normal and two low-power modes
- Current threshold detection and current averaging in standby => wake-up from low-power mode
- Triggered wake-up from LIN and periodic wake-up
- Signal low pass filtering (current, voltage)
- PGA (programmable low-noise gain amplifier) with automatic gain control feature
- Accurate internal oscillator (an external quartz oscillator may be used for extended accuracy)
- Communication via a LIN 2.1, LIN 2.0 bus interface
- S12 microcontroller with 128 kByte flash, 6.0 kByte RAM, 4.0 kByte data flash
- Background debug module
- External temperature sensor option (T_{SUP} , V_{TEMP})
- Optional 2nd external voltage sense input (VOPT)
- 4 x 5.0 V GPIO including one wake-up capable high voltage input (PTB3/L0)
- 8 x MCU general purpose I/O including SPI functionality
- Industry standard EMC compliance

3.2 Warnings

When working with the kit, always use an isolated laboratory power supply.

Keep in mind all ESD rules when handling the board. Avoid touching the connector pins. They are directly connected to the device pins. Even though the device pins are ESD protected, this protection has its limits. Some ESD events can destroy or damage the device, or cause its malfunction.

3.3 Acronyms

Table 1. Acronyms

Acronym	Explanation	Acronym	Explanation
D2D	Die to Die bus interface	MCU	Microcontroller Unit
BDM	Background Debug Module	LIN	Local Interconnect Network
EVB	Evaluation Board	LS	Low Side (switch)
ESD	Electrostatic Discharge, Electrostatic Sensitive Device	SCI	Serial Communication Interface
GND	In the document: main supply ground	TBDML	Turbo BDM Lite
GPIO	General Purpose Input/Output		
GUI	Graphical User Interface		
ADC	Analog to Digital Conversion		

4 Required Equipment

- PC Computer running Windows XP or higher
- 12 V Power Supply
- USB Cable (supplied)

5 Setup Guide

5.1 Hardware Setup

Setup and connections for the KIT912J637EVME are straightforward.

The KIT912J637EVME requires a connection to the power supply and a connection to the PC or notebook via the USB cable. [Figure 2](#) depicts a complete setup.

Follow these steps to set up the board:

1. Plug the USB cable into the connector CON13 and connect the other end of the cable to the PC or notebook.
2. Connect a laboratory power supply via banana connectors to the board, using CON5 (VBATT supply) and CON6 (GND). The supply voltage has to be in the range of 8.0 to 18 V.

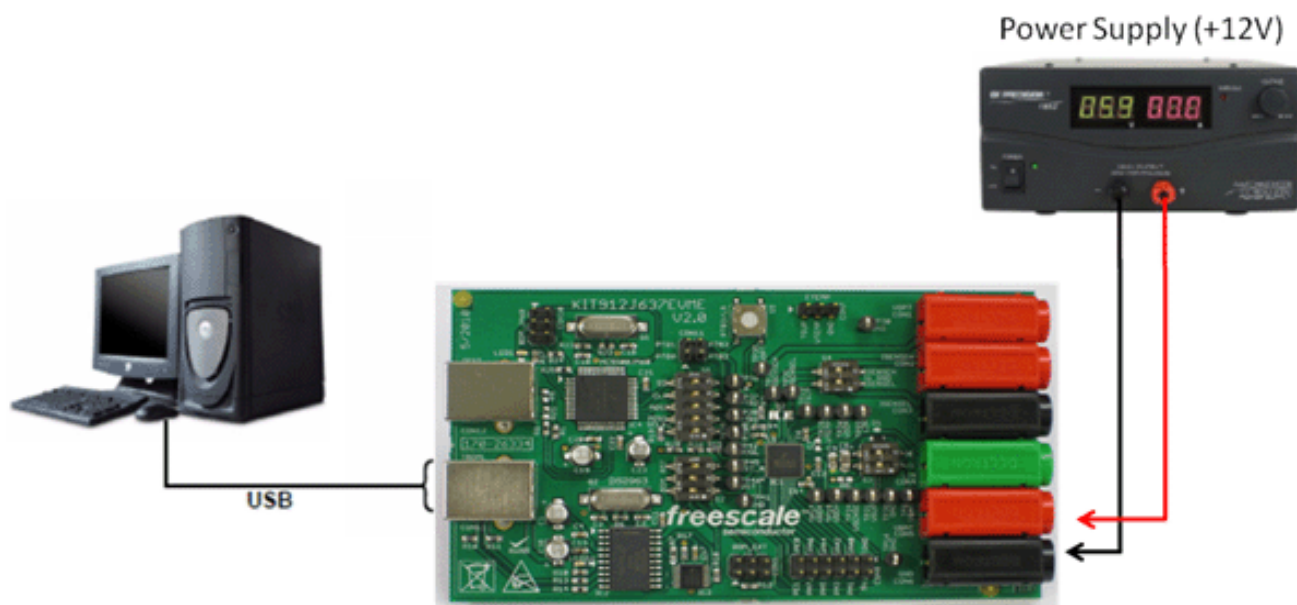

Figure 2. KIT912J637EVME Basic Hardware Setup

6 Hardware Description

6.1 Board Description

Figure 3 is a snapshot of the EVB with key component and connector locations. The following list corresponds with the numbers listed on the picture.

1. Input power connectors
2. MCU Port A & Port E connector
3. TBDML interface
4. TEST SPI to USB Interface
5. PTB3/L0 Reset button (requires software configuration)
6. BDM connector for external programming/debugging BDM interface
7. MM912J637CV1AE

The board is protected against reverse battery voltage by diode D1, which can withstand up to 3.0 A continuous current. The board operation is straightforward. As well as the TBDML interface (3), the board contains the active and passive components required for proper operation of the 912J637. Connectors and test points provide access to the device for important signals.

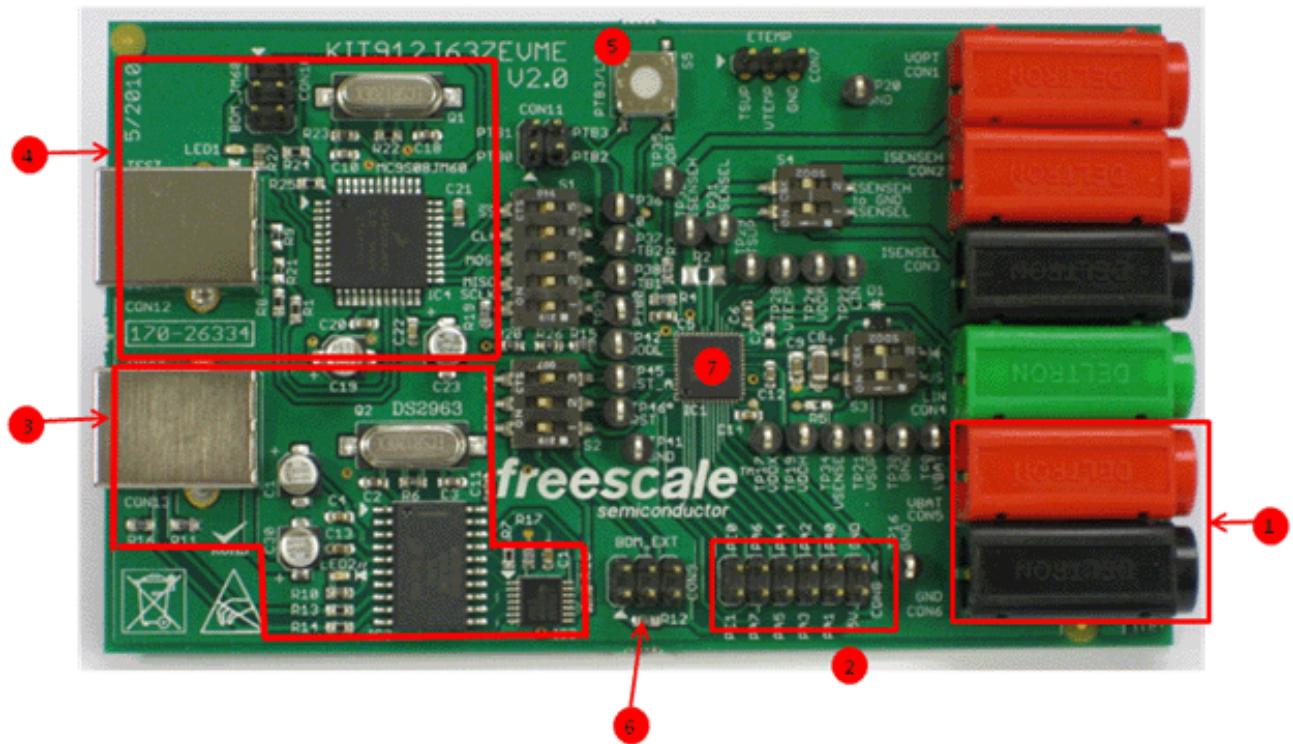

Figure 3. KIT912J637EVME Evaluation Module Board

6.1.1 MCU

The MM912J637 enables precision measurement of key battery parameters in automotive and other applications.

The device integrates an HCS12 microcontroller and a SMARTMOS analog control IC into a single package solution. The analog die combines system basis and application specific functions, including a Local Interconnect Network (LIN) transceiver, and 3 dedicated 16-bit sigma delta analog to digital converters (ADC) for synchronous measurement of battery voltage, current, and temperature.

An integrated temperature sensor combined with battery mounting allows for measurement of battery temperature. Control of the analog die is via a new high performance internal die-to-die interface (D2D), which seamlessly integrates the analog IC registers into the MCU register map, providing faster access than SPI-based systems. The MM912J637 also includes an internal oscillator, 128 k Bytes of Flash memory, and 6.0 k bytes of RAM. An optional external temperature sensor is also supported.

The 912J637 has three main operating modes: Normal (all functions available); Sleep (V_{DD} off, Wake-up via: the LIN bus, PTB3/L0 input, current threshold, current averaging, calibration request, lifetime counter, internal timer, or external reset), and Stop (V_{DD} on with limited current capability, Wake-up via: the LIN bus, PTB3/L0 input, current threshold, current averaging, calibration request, lifetime counter, internal timer, or external reset).

6.1.2 TBDML

The Turbo BDM Light interface is a programming and debugging tool, and constitutes an interface between a PC and the BDM debugging port of Freescale microcontrollers. It enables the debugger and other software tools to communicate with the microcontroller, and download code into its on-chip flash, etc. Among the benefits of using the TBDML on the EVB is a much higher communication speed than other USB/BDM interfaces. It is also unnecessary to connect external devices to the EVB when programming/debugging is needed.

A BDM connector (CON9) is placed on the EVB to allow the connection of another BDM tool, such as the P&E USB BDM Multilink. In this case, DIP switches S2-1 and S2-2 should be set to "OFF", to disable the TBDML interface.

In either case, S2-3 should be set to "OFF" during programming to disconnect RESET from RESET_A.

6.1.2.1 Switch Settings

[Figure 4](#) summarizes the location of all DIP switches and settings.

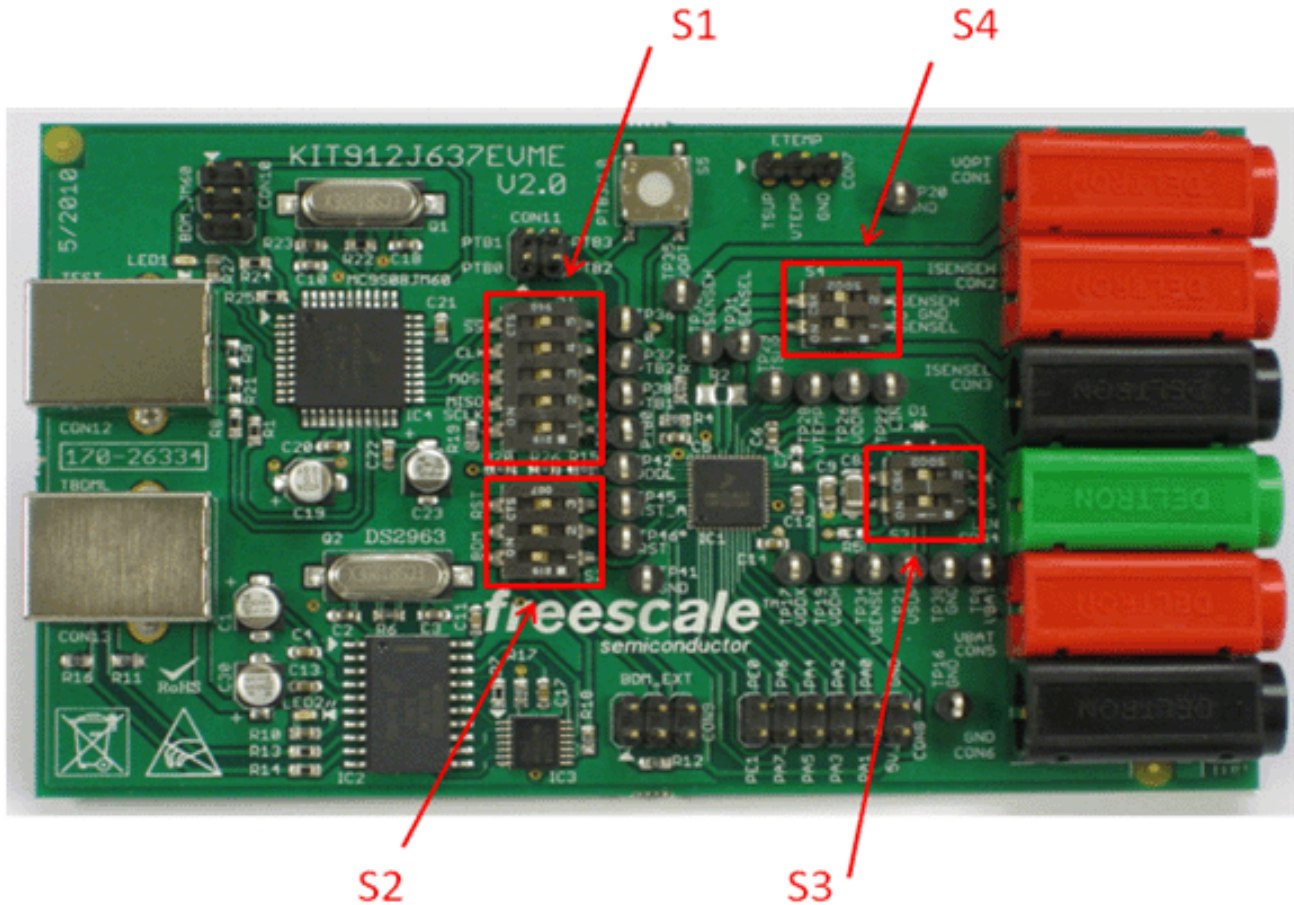

Figure 4. Position of DIP Switches on the EVB

Table 2. DIP Switch Settings

Name	Switch #	Function	ON	OFF
S1	1-5	Analog Die Test SPI connect to USB	Connected	Disconnected
S2	1-2	On Board TBDML Connected to MM912J637	Connected	Disconnected (External BDM)
	3	Analog Die and MCU Reset connection	Resets Connected	Resets Disconnected
S3	1	VSENSE connected to VBAT	Connected	Disconnected
	2	Reverse Battery Diode Short	Shorted ($V_{BAT}=V_{SUP}$)	Diode in path ($V_{SUP} = V_{BAT} - V_{DIODE}$)
S4	1-2	Current Sense Inputs short to GND	Short to GND	Not shorted to GND

6.2 Connector Description

There are 13 connectors on the EVB. A list of the connector and pin assignments is in the following paragraphs.

6.2.1 Connectors

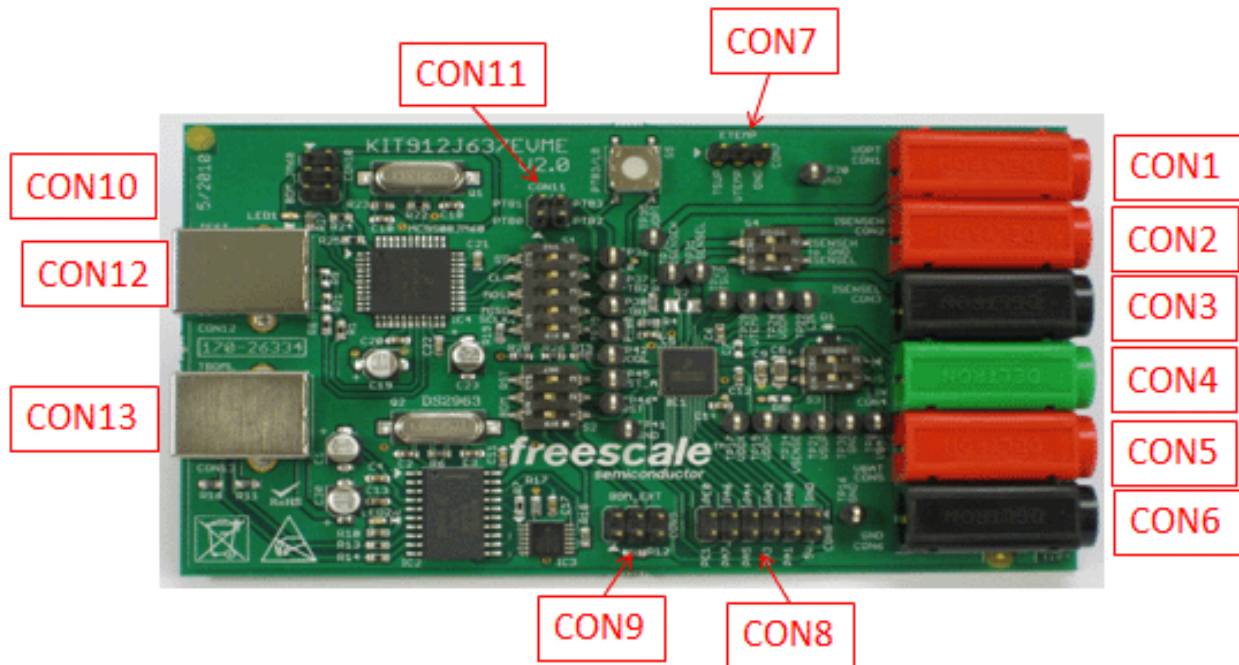

Figure 5. Connectors

Table 3. Connectors

Name	Symbol	Function
CON1	VOPT	Optional Voltage Sense Input
CON2	ISENSEH	High Level Current Sense Input
CON3	ISENSEL	Low Level Current Sense Input
CON4	LIN	LIN Physical Layer I/O
CON5	VBAT	Battery Level Supply
CON6	GND	Device Ground
CON7	ETEMP	External Temperature Sensor
CON8	PTA/E	MCU Port A and E
CON9	BDM_EXT	External BDM for MM912J637
CON10	BDM_JM60	External BDM for JM60 (not used in this application)
CON11	PTB	Analog Die Port B
CON12	TEST	TEST SPI USB Interface
CON13	TBDML	TBDML USB Interface

6.2.2 Voltage Sense Input (Optional) CON1

Connector CON1 is a socket for a 4.0 mm banana jack. It enables connection of an optional voltage sense input to pin 34.

6.2.3 High Level Current Sense Input H/L CON 2 & Con3

Connectors CON2 (red) and CON3 (black) are sockets for 4.0 mm banana jacks.

6.2.4 LIN Connector CON4

Connector CON4 (green) is a socket for a 4.0 mm banana jack. It enables connection of the LIN bus to pin 22.

6.2.5 Power Connectors CON5 and CON6

Power connectors CON5 (positive supply - red) and CON6 (ground - black) are sockets for 4.0 mm banana jacks.

6.2.6 External Temperature Sensor CON 7

Connector CON1 is a header type 3 X 1, 2.54 mm (0.1”) pitch. It enables connection of an optional temperature sense input. [Table 4](#) shows the pin assignments.

Table 4. External Temperature Sensor CON7

Pin #	Description
1	TSUP temp sensor supply output (pin 29)
2	VTEMP temp sensor input (pin 28)
3	GND

6.2.7 MM912J637 Port A & E CON 8

Connector CON 8 is a header type 6 x 2, 2.54 mm (0.1”) pitch. [Table 5](#) shows the pin assignments.

Table 5. MCU Port A & E CON8

Pin #	Description
1	GND
2	5V
3	PA0
4	PA1
5	PA2
6	PA3
7	PA4
8	PA5
9	PA6
10	PA7
11	PE0
12	PE1

6.2.8 External BDM for MM912J637 CON 9

A standard BDM Connector (header 2 X 3, 2.54 mm (0.1”) pitch) is placed on the EVB to provide the user with an external BDM programming/debugging interface connection. The pin assignment is listed in [Table 6](#).

Table 6. Signal Connector CON9

Pin #	Description
1	BKGD
2	GND
3	
4	/RESET
5	
6	+5.0V

6.2.9 External BDM for JM60 (TEST_SPI USB MCU) CON 10

A standard BDM Connector (header 2 X 3, 2.54 mm (0.1”) pitch) is placed on the EVB to provide the user with an external BDM programming/debugging interface connection. This connector is not supported by the included software. The pin assignments are listed in [Table 7](#).

Table 7. Signal Connector CON10

Pin #	Description
1	BKGD
2	GND
3	
4	/RESET
5	
6	+5.0V

6.2.10 ANALOG DIE PORT B CON 11

The J8 connector is header type 2x2, 0.1” (2.54 mm) pitch. The pin assignments are listed in [Table 8](#).

Table 8. Signal Connector CON 11

Pin #	Description
1	PTB0
2	PTB1
3	PTB2
4	L0

6.2.11 Test SPI USB Interface CON12

Connector CON12 is a standard USB connector type B. The pin assignments are listed in [Table 9](#).

Table 9. USB Connector J9

Pin #	Description
1	+5.0 V
2	USBDM
3	USBDP
4	GND

6.2.12 TBDML USB Interface CON13

Connector CON13 is a standard USB connector type B. It enables connection of the EVB to a PC or notebook.

Table 10. USB Connector J9

Pin #	Description
1	+5.0 V
2	USBDM
3	USBDP
4	GND

6.3 Test Points

There are 22 test points on the EVB, allowing easy monitoring of the key pins on the MM912J637. The test point reference numbers indicate the corresponding pins on the MM912J637. The schematic and board are marked with both reference numbers and signal names. [Table 11](#) summarizes the test points.

Table 11. Test Points

Reference designator	Signal name	Reference designator	Signal name
TP16	GND	TP32	ISENSEH
TP17	VDDX	TP34	VSENSE
TP19	VDDH	TP35	VOPT
TP20	GND	TP36	PTB3/L0
TP21	VSUP	TP37	PTB2
TP22	LIN	TP38	PTB1
TP26	VDDA	TP39	PTB0
TP28	VTEMP	TP41	GND
TP29	TSUP	TP42	VDDL
TP30	GND	TP45	RST_A*
TP31	ISENSEL	TP46	RESET*

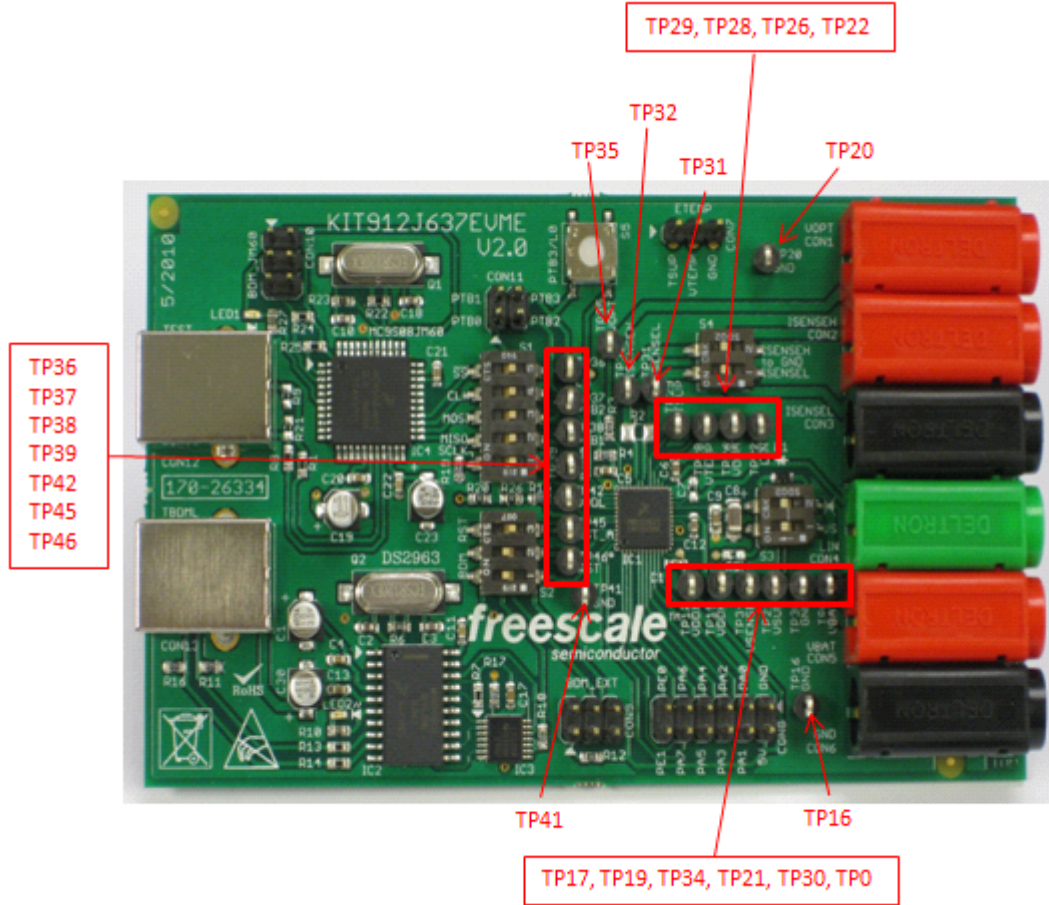

Figure 6. Test Point Locations

7 Software Description

7.1 Important Notes on Programming and Debugging of the Board

7.1.1 Hardware Considerations

During device programming the switch configuration for S2 should conform to the settings in Table 2 for either TBDML or BDM programming respectively. The minimum supply voltage during the programming and debugging is 8.0 V.

In normal operation, RESET and RESET_A must be connected by setting S2-3 "ON".

NOTE: While the EVB is being programmed, if TBDML is not used for debug, it is recommended to switch off TBDML.

7.1.2 Programming and Debugging Via the TBDML Interface

A TBDML interface is placed on the kit board for programming/debugging of the board. It is necessary to install TBDML supporting files (USB driver, interface DLL, GDI DLL plug-in for the Freescale's Hi-wave debugger) and implement modifications in the settings of the CodeWarrior Hi-wave debugger, to be able to program/debug the board. The enclosed CD contains documentation and complete source files to this open source tool. Read the [tbddl_manual_15.pdf](#) (user's manual), especially the 3.2 *Installing Windows Drivers* section, and follow the listed instructions. Omit the jumper J2 settings. This refers to another board. Installation is easy and does not require any special skills.

7.1.3 Software Included on the CD

A basic template is included on the CD in the MM912J637 folder. It initializes the MM912J637 and provides a framework for evaluation. CodeWarrior must be installed on your system before opening this template.

To install, copy and paste the subfolder KIT912J637_Template onto your desktop or other appropriate local location. Open the subfolder and double click on the CodeWarrior project file titled "KIT912J637_template.mcp." This will open the template in the CodeWarrior environment.

The code may be downloaded to the EVB using TBDML or a programmer such as the PE Micro Cyclone Pro.

8 Schematics

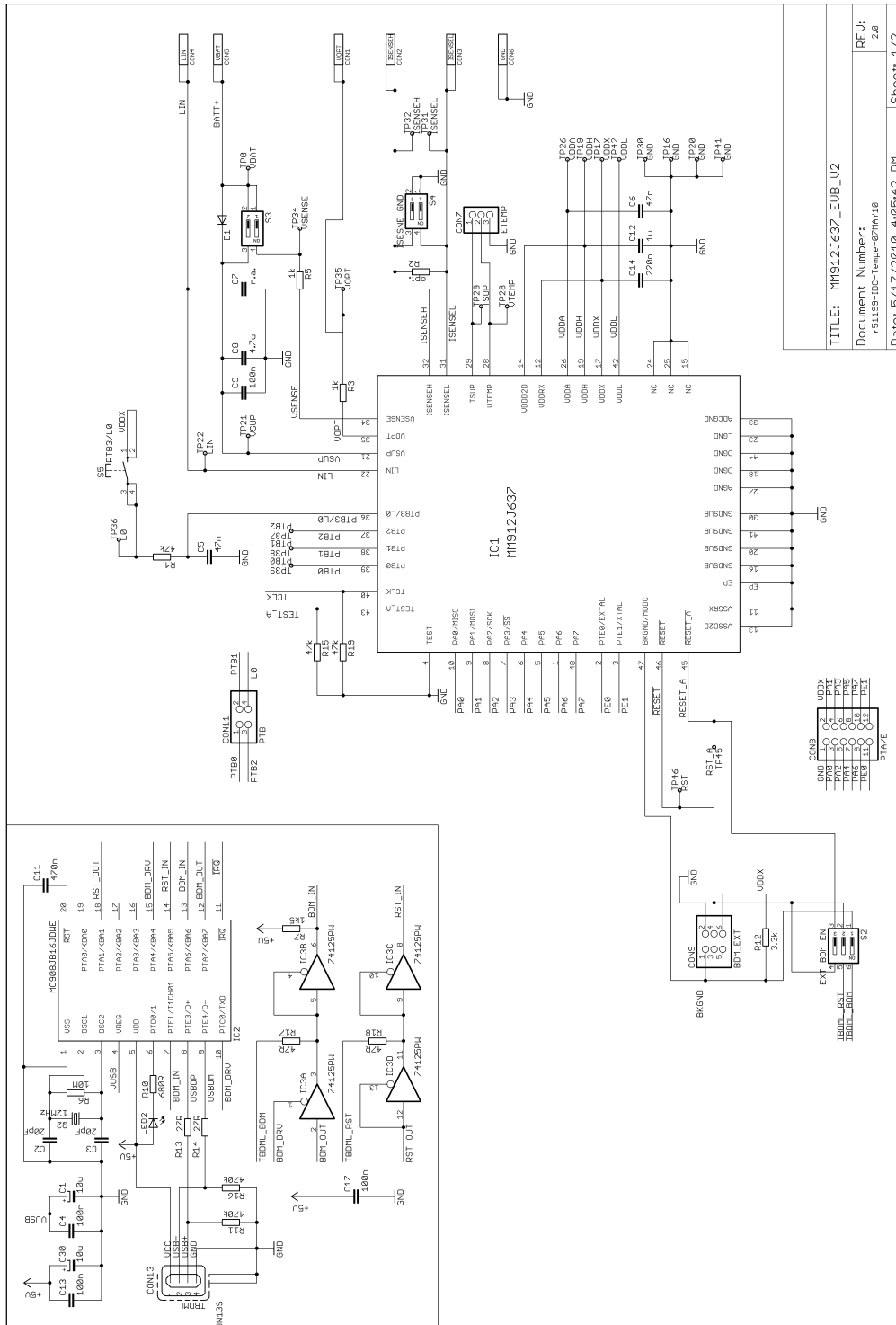

Figure 7. KIT912J637EVME Schematic 1

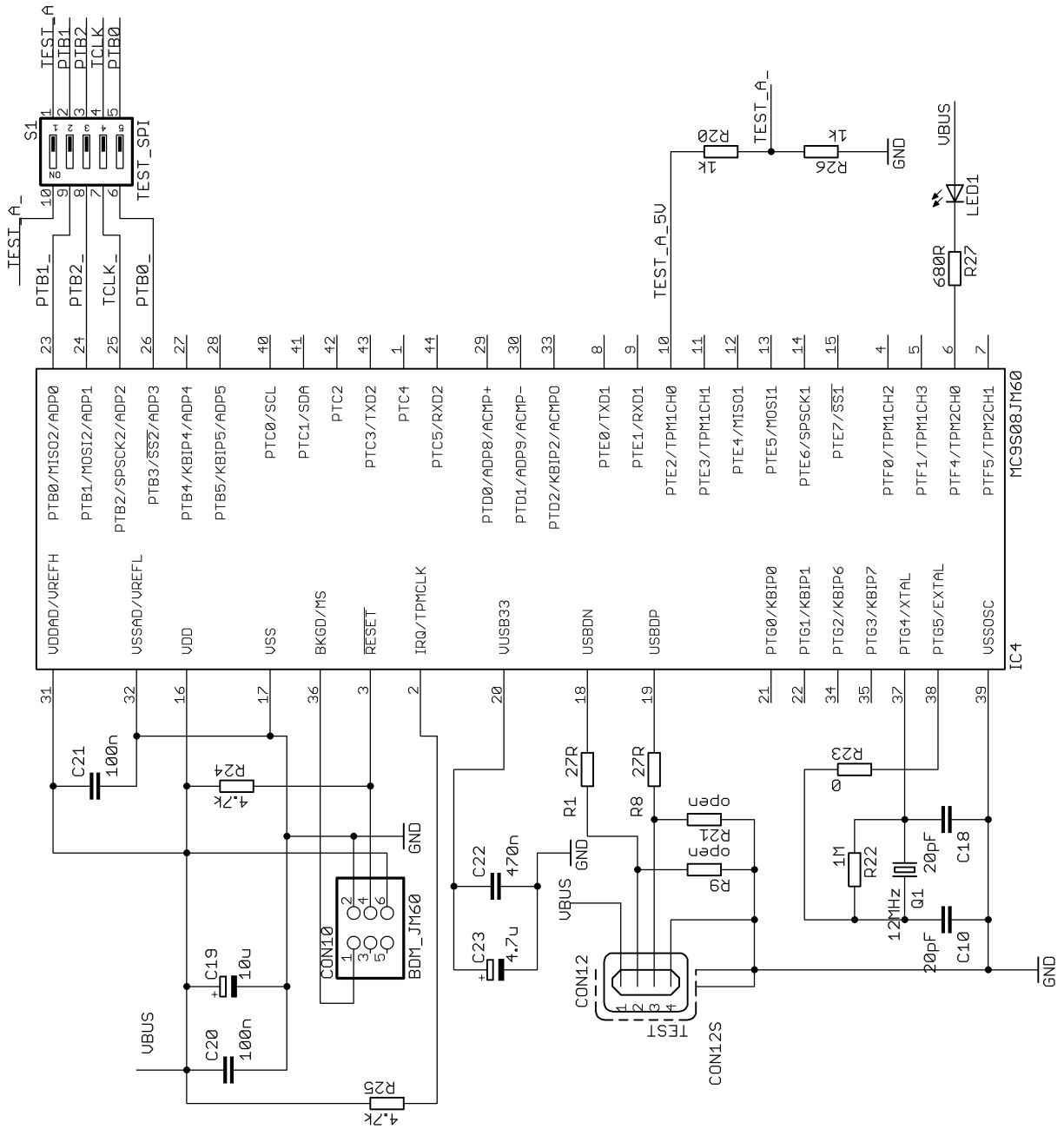

Figure 8. KIT912J637EVME Schematic 2

9 Board Layout

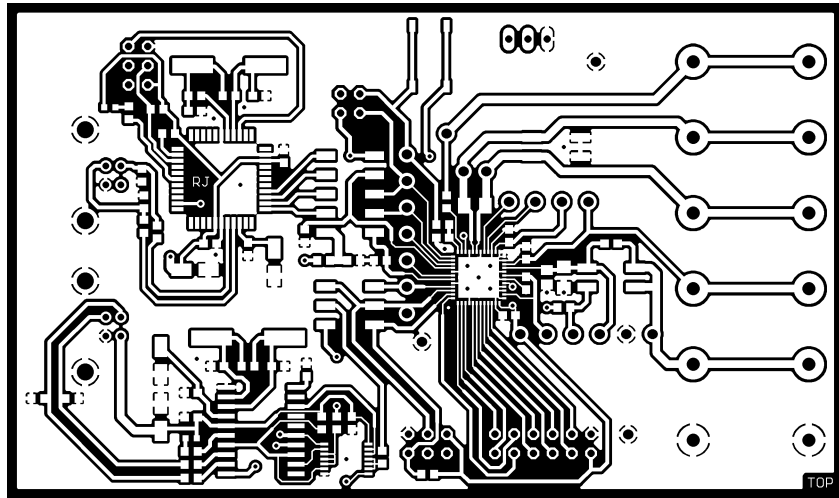

Figure 9. Top Copper Layer

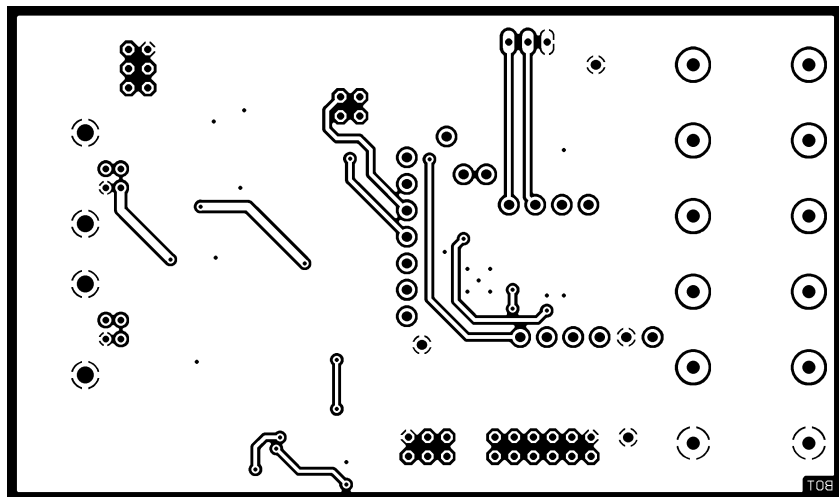

Figure 10. Bottom Copper Layer (from bottom)

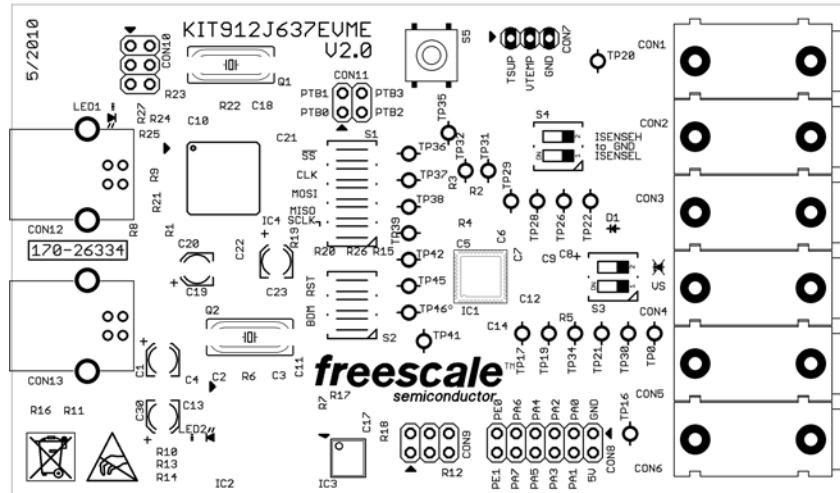

Figure 11. Top Silk-screen Layer

10 Bill of Materials

Table 12. Part List - KIT912J637EVME - V2.0

Part	Value	Package	DIGIKEY	Count
C1	10 μ	153CLV-0405	565-2100-1-ND	1/3
C2	20 pF	C0603	490-1410-1-ND	1/4
C3	20 pF	C0603	490-1410-1-ND	2/4
C4	100 n	CAP CER 0.10 μ F 5% 16 V X7R 0603	478-3726-6-ND	1/5
C5	47 n	CAP CER 47000 PF 16 V X7R 0603	587-1239-1-ND	1/2
C6	47 n	CAP CER 47000 PF 16 V X7R 0603	587-1239-1-ND	2/2
C7	opt.	C0603	open	
C8	4.7 μ	CAP CER 4.7 μ F 50 V X5R 1206	399-5507-1-ND	1/1
C9	100 n	CAP CER 0.10 μ F 50 V X7R 0805	399-1170-1-ND	1/1
C10	20 pF	C0603	490-1410-1-ND	3/4
C11	470 n	CAP CER 0.47 μ F 25 V X7R 0603	490-3291-2-ND	1/2
C12	1.0 μ	CAP CER 1.0 μ F 16 V X5R 0603	399-5090-1-ND	1/1
C13	100 n	CAP CER 0.10 μ F 5% 16 V X7R 0603	478-3726-6-ND	2/5
C14	220 n	CAP CER 0.22 μ F 16 V X7R 0603	399-5619-1-ND	1/1
C17	100 n	CAP CER 0.10 μ F 5% 16 V X7R 0603	478-3726-6-ND	3/5
C18	20 pF	C0603	490-1410-1-ND	4/4
C19	10 μ	153CLV-0405	565-2100-1-ND	2/3
C20	100 n	CAP CER 0.10 μ F 5% 16 V X7R 0603	478-3726-6-ND	4/5
C21	100 n	CAP CER 0.10 μ F 5% 16 V X7R 0603	478-3726-6-ND	5/5
C22	470 n	CAP CER 0.47 μ F 25 V X7R 0603	490-3291-2-ND	2/2
C23	4.7 μ	153CLV-0405	565-2128-2-ND	1/1
C30	10 μ	153CLV-0405	565-2100-1-ND	3/3
CON1	VOPT	DELTRON - Red	Mouser Catalog: http://www.mouser.com/catalog/629/930.pdf	1/6
CON2	ISENSEH	DELTRON - Red		2/6
CON3	ISENSEL	DELTRON - Black		3/6
CON4	LIN	DELTRON - Green (opt. Red)		4/6
CON5	VBAT	DELTRON - Red		5/6
CON6	GND	DELTRON - Black		6/6
CON7	ETEMP	1X03 (3 of 40)	WM8095-ND	1/1
CON8	PTA,E	2X06 (6 of 40)	WM8156-ND	1/4
CON9	BDM_EXT	2X03 (3 of 40)	WM8156-ND	2/4
CON10	BDM_JM60	2X03 (3 of 40)	WM8156-ND	3/4
CON11	PTBx	2X02 (2 of 40)	WM8156-ND	4/4
CON12	TEST	USB REC R/A TYPE B 4POS	A31725-ND	1/2
CON13	TBDML	USB REC R/A TYPE B 4POS	A31725-ND	2/2

Table 12. Part List - KIT912J637EVME - V2.0

D1	D0603	DIODE SCHOTTKY 200 mA 45 V	641-1284-1-ND	1/1
IC1	MM912J637	7X7QFN48_EP_WF	Freescale supplied	1/1
IC2	MC908JB16JDWE	SO20W	MC68HC908JB16JDW	1/1
IC3	74LV125PW	TSSOP14	568-4596-5-ND	1/1
IC4	MC9S08JM60	LQFP44	MC9S08JM60CLD-ND	1/1
LED1	CHIP-LED0603	LED0603	160-1435-1-ND	1/2
LED2	CHIP-LED0603	LED0603	160-1435-1-ND	2/2
Q1	12 MHz (20p)	HC49UP	XC736CT-ND	1/2
Q2	12 MHz (20p)	HC49UP	XC736CT-ND	2/2
R1	27R	RES 27 OHM 1/16 W 5% 0603	27CHCT-ND	1/4
R2	opt.	M1206	open	
R3	1.0 k	RES 1.0 k OHM 1/10 W 1% 0603 SMD	P1.0KDBTR-ND	1/4
R4	47 k	R0603	311-47.0KHRCT-ND	1/3
R5	1.0 k	RES 1.0 k OHM 1/10 W 1% 0603 SMD	P1.0KDBTR-ND	2/4
R6	10 M	R0603	P10MGCT-ND	1/1
R7	1.0 k5	R0603	P1.5KYCT-ND	1/1
R8	27R	RES 27 OHM 1/16 W 5% 0603	27CHCT-ND	2/4
R9	open	R0603	open	
R10	680R	R0603	RGH16P680CT-ND	1/2
R11	470 k	R0603	311-470KGRCT-ND	1/2
R12	3.3 k	RES 3.3 k OHM 1/10 W 1% 0603 SMD	P3.3KDBTR-ND	1/1
R13	27R	RES 27 OHM 1/16 W 5% 0603	27CHCT-ND	3/4
R14	27R	RES 27 OHM 1/16 W 5% 0603	27CHCT-ND	4/4
R15	47 k	R0603	311-47.0KHRCT-ND	2/3
R16	470 k	R0603	311-470KGRCT-ND	2/2
R17	47R	R0603	RHM47.0HCT-ND	1/2
R18	47R	R0603	RHM47.0HCT-ND	2/2
R19	47 k	R0603	311-47.0KHRCT-ND	3/3
R20	1.0 k	RES 1.0 k OHM 1/10 W 1% 0603 SMD	P1.0KDBTR-ND	3/4
R21	open	R0603	open	
R22	1.0 M	R0603	P1.0MGCT-ND	1/1
R23	0	R0603	P0.0GCT-ND	1/1
R24	4.7 k	R0603	311-4.70KHRCT-ND	1/2
R25	4.7 k	R0603	311-4.70KHRCT-ND	2/2
R26	1.0 k	RES 1.0 k OHM 1/10 W 1% 0603 SMD	P1.0KDBTR-ND	4/4
R27	680R	R0603	RGH16P680CT-ND	2/2
S1	219-05J	CTS-219-05J	219-5LPSTJ	1/1
S2	219-03J	CTS-219-03J	219-3LPSTJ	1/1
S3	219-02J	CTS-219-02J	219-2LPSTJ	1/2

Table 12. Part List - KIT912J637EVME - V2.0

S4	219-02J	CTS-219-02J	219-2LPSTJ	2/2
S5	PTB3/L0	Key switch (check dim!)	CKN9362-ND	1/1
TP0	VBAT	TESTPOINT-BLK,1.4 mm drl	5118K-ND (chk drill!)	1/23
TP16	GND	TESTPOINT-BLK,1.4 mm drl	5118K-ND (chk drill!)	2/23
TP17	VDDX	TESTPOINT-BLK,1.4 mm drl	5118K-ND (chk drill!)	3/23
TP19	VDDH	TESTPOINT-BLK,1.4 mm drl	5118K-ND (chk drill!)	4/23
TP20	GND	TESTPOINT-BLK,1.4 mm drl	5118K-ND (chk drill!)	5/23
TP21	VSUP	TESTPOINT-BLK,1.4 mm drl	5118K-ND (chk drill!)	6/23
TP22	LIN	TESTPOINT-BLK,1.4 mm drl	5118K-ND (chk drill!)	7/23
TP26	VDDA	TESTPOINT-BLK,1.4 mm drl	5118K-ND (chk drill!)	8/23
TP28	VTEMP	TESTPOINT-BLK,1.4 mm drl	5118K-ND (chk drill!)	9/23
TP29	TSUP	TESTPOINT-BLK,1.4 mm drl	5118K-ND (chk drill!)	10/23
TP30	GND	TESTPOINT-BLK,1.4 mm drl	5118K-ND (chk drill!)	11/23
TP31	ISENSEL	TESTPOINT-BLK,1.4 mm drl	5118K-ND (chk drill!)	12/23
TP32	ISENSEH	TESTPOINT-BLK,1.4 mm drl	5118K-ND (chk drill!)	13/23
TP34	VSENSE	TESTPOINT-BLK,1.4 mm drl	5118K-ND (chk drill!)	14/23
TP35	VOPT	TESTPOINT-BLK,1.4 mm drl	5118K-ND (chk drill!)	15/23
TP36	L0	TESTPOINT-BLK,1.4 mm drl	5118K-ND (chk drill!)	16/23
TP37	PTB2	TESTPOINT-BLK,1.4 mm drl	5118K-ND (chk drill!)	17/23
TP38	PTB1	TESTPOINT-BLK,1.4 mm drl	5118K-ND (chk drill!)	18/23
TP39	PTB0	TESTPOINT-BLK,1.4 mm drl	5118K-ND (chk drill!)	19/23
TP41	GND	TESTPOINT-BLK,1.4 mm drl	5118K-ND (chk drill!)	20/23
TP42	VDDL	TESTPOINT-BLK,1.4 mm drl	5118K-ND (chk drill!)	21/23
TP45	RST_A	TESTPOINT-BLK,1.4 mm drl	5118K-ND (chk drill!)	22/23
TP46	RST	TESTPOINT-BLK,1.4 mm drl	5118K-ND (chk drill!)	23/23
FEED1...4	Rubber feet	SJ-5003 (BLACK) 11.2 mm	SJ5003-0-ND	4x

11 References

[Table 13](#) provides URLs where you can obtain information on other Freescale products and application solutions.

Table 13. References

Products	Links
Data Sheet MM912_637	www.freescale.com/files/analog/doc/data_sheet/MM912_637D1.pdf
Freescale's Web Site	www.freescale.com
Freescale's Analog Web Site	www.freescale.com/analog
Freescale's Power Management Web Site	www.freescale.com/powermanagement

12 Revision History

Table 14. Revision History

Revision	Details
1.0	First Release.

How to Reach Us:

Home Page:

www.freescale.com

Web Support:

<http://www.freescale.com/support>

USA/Europe or Locations Not Listed:

Freescale Semiconductor, Inc.
Technical Information Center, EL516
2100 East Elliot Road
Tempe, Arizona 85284
1-800-521-6274 or +1-480-768-2130
www.freescale.com/support

Europe, Middle East, and Africa:

Freescale Halbleiter Deutschland GmbH
Technical Information Center
Schatzbogen 7
81829 Muenchen, Germany
+44 1296 380 456 (English)
+46 8 52200080 (English)
+49 89 92103 559 (German)
+33 1 69 35 48 48 (French)
www.freescale.com/support

Japan:

Freescale Semiconductor Japan Ltd.
Headquarters
ARCO Tower 15F
1-8-1, Shimo-Meguro, Meguro-ku,
Tokyo 153-0064
Japan
0120 191014 or +81 3 5437 9125
support.japan@freescale.com

Asia/Pacific:

Freescale Semiconductor China Ltd.
Exchange Building 23F
No. 118 Jianguo Road
Chaoyang District
Beijing 100022
China
+86 10 5879 8000
support.asia@freescale.com

For Literature Requests Only:

Freescale Semiconductor Literature Distribution Center
P.O. Box 5405
Denver, Colorado 80217
1-800-441-2447 or +1-303-675-2140
Fax: +1-303-675-2150
LDCForFreescaleSemiconductor@hibbertgroup.com

Information in this document is provided solely to enable system and software implementers to use Freescale Semiconductor products. There are no express or implied copyright licenses granted hereunder to design or fabricate any integrated circuits or integrated circuits based on the information in this document.

Freescale Semiconductor reserves the right to make changes without further to products herein. Freescale Semiconductor makes no warranty, representation or regarding the suitability of its products for any particular purpose, nor does Freescale Semiconductor assume any liability arising out of the or use of any product or circuit, and specifically disclaims any and all liability, including without limitation consequential or incidental damages. "Typical" parameters that may be provided in Freescale Semiconductor data sheets and/or specifications can and do vary in different applications and actual performance may vary over time. All operating parameters, including "Typicals", be validated for each customer application by technical experts. Freescale Semiconductor does not convey any license under its patent rights nor the rights of others. Freescale Semiconductor products are designed, intended, or authorized for use as components in systems intended for surgical implant into the body, or other applications intended to support or sustain life, or for any other application in which the failure of the Freescale Semiconductor product could create a situation where personal injury or death may occur. Should Buyer purchase or use Freescale Semiconductor products for any such unintended or unauthorized application, Buyer shall indemnify and hold Freescale Semiconductor and its officers, employees, subsidiaries, affiliates, and harmless against all claims, costs, damages, and expenses, and reasonable attorney fees arising out of, directly or indirectly, any claim of personal injury or death associated with such unintended or unauthorized use, even if such claim alleges that Freescale Semiconductor was negligent regarding the design or manufacture of the part.



Freescale and the Freescale logo are trademarks of Freescale Semiconductor, Inc., Reg. U.S. Pat. & Tm. Off. Qorivva, S12 MagniV, SMARTMOS and Xtrinsic are trademarks of Freescale Semiconductor, Inc. ARM is the registered trademark of ARM Limited. The Power Architecture and Power.org word marks and the Power and Power.org logos and related marks are trademarks and service marks licensed by Power.org. All other product or service names are the property of their respective owners. ©2011 Freescale Semiconductor, Inc.

KT912J637UG
Rev. 1.0
2/2012