



The Freescale Cup

Intelligent Car Racing

The Freescale Cup

EMEA Region

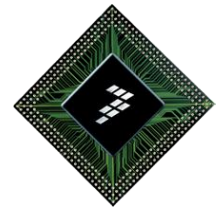

Freescale Semiconductor Confidential and Proprietary Information.

Freescale, the Freescale logo, Altivec, C-5, CodeTEST, CodeWarrior, ColdFire, C-Ware, mobileGT, PowerQUICC, StarCore, and Symphony are trademarks of Freescale Semiconductor, Inc., Reg. U.S. Pat. & Tm. Off. BeeKit, BeeStack, CoreNet, the Energy Efficient Solutions logo, Flexis, MXC, Platform in a Package, Processor Expert, QorIQ, QUICC Engine, SMARTMOS, TurboLink and VortiQa are trademarks of Freescale Semiconductor, Inc. All other product or service names are the property of their respective owners. © 2010 Freescale Semiconductor, Inc.



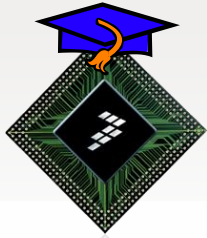

Objectives

- A collaborative, competitive, and hands-on way for students to learn about embedded systems and control
- Students get the opportunity to share their work and network with faculty, Freescale industry partners and customers, and Freescale engineers....and win an attractive prize!



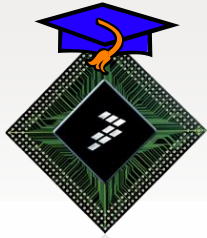

Event Overview

- Students teams build, program, and race a model car around a track for speed---fastest car to complete the track without going off, wins.
- Competitions can vary from individual schools to multiple country contests.
- The standard Intelligent Car components are the model car kit, servo, electric motors, battery and charger, and guides to get-up-and-going quickly. MCU and Sensor Package vary by region.

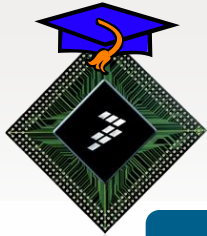

Competition Timeline Season 2011/12

School Enrollment: May 2011

Technology Trainings:
September/October 2011

Teams' racing car preparation
October 2011/December 2011

EMEA Finals: Q1 2012

Worldwide Finals: June 2012

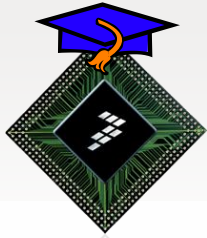

About the Track

- Black Line (3cm) on raised White Background (50cm)
- Each year the track design is changed to incorporate a different complexity. E.g. incorporate a hill followed by a sharp turn.
- Electronic Timing Gate

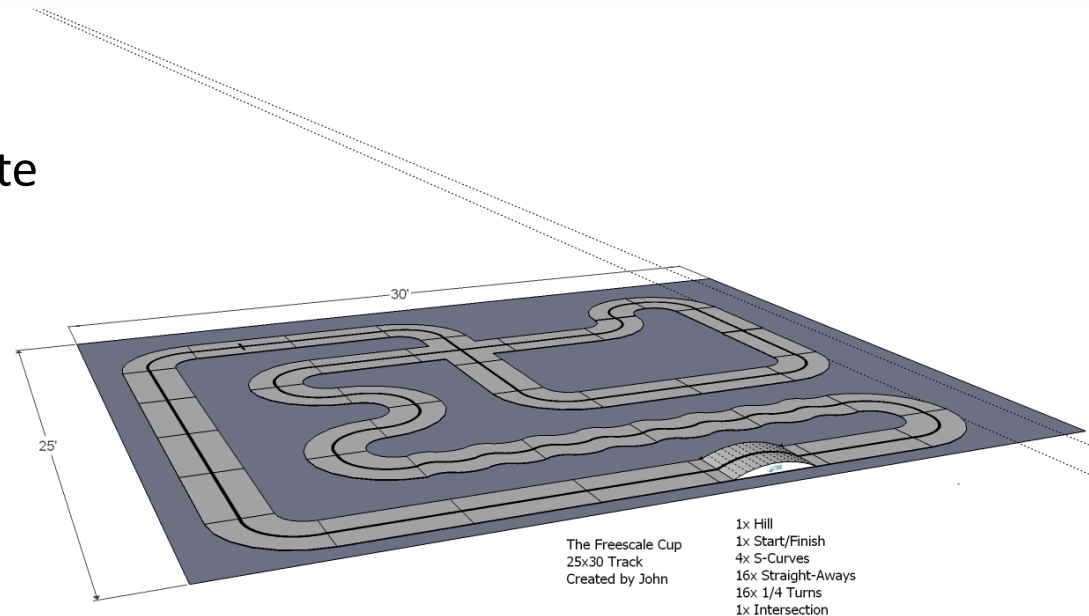

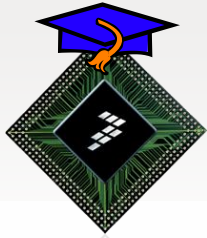

Other Examples of Race Tracks

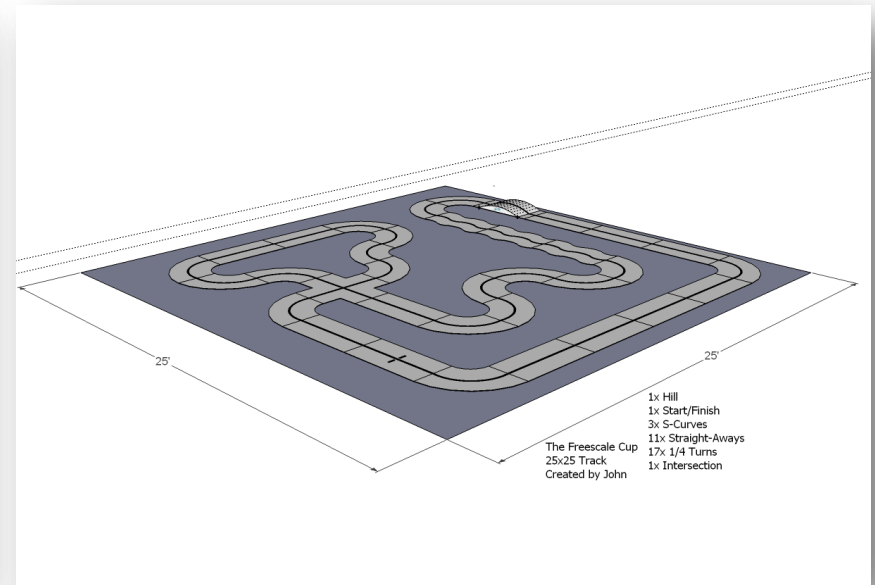
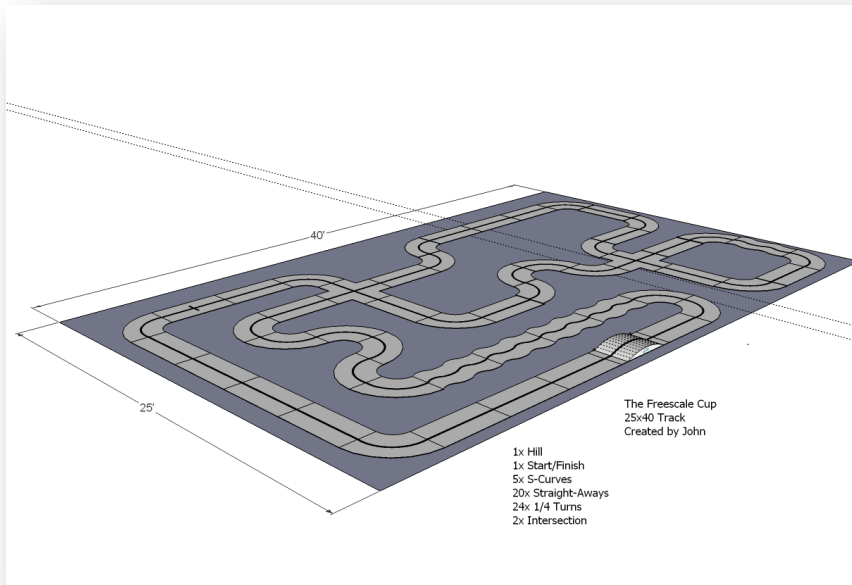

Freescale Semiconductor Confidential and Proprietary Information.

Freescale, the Freescale logo, Altivec, C-5, CodeTEST, CodeWarrior, ColdFire, C-Ware, mobileGT, PowerQUICC, StarCore, and Symphony are trademarks of Freescale Semiconductor, Inc., Reg. U.S. Pat. & Tm. Off. BeeKit, BeeStack, CoreNet, the Energy Efficient Solutions logo, Flexis, MXC, Platform in a Package, Processor Expert, QorIQ, QUICC Engine, SMARTMOS, TurboLink and VortiQa are trademarks of Freescale Semiconductor, Inc. All other product or service names are the property of their respective owners. © 2010 Freescale Semiconductor, Inc.

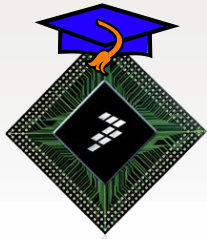

Intelligent Car Kit

Supplied by Freescale to each team

Includes:

- 1/18th Scale Model Car Chassis
- Drive Motor
- Steering Motor
- 7.2V Rechargeable Battery
- Control System (Freescale MCU 32 bit platform)

CMOS Camera sensor to be supplied by each participating team

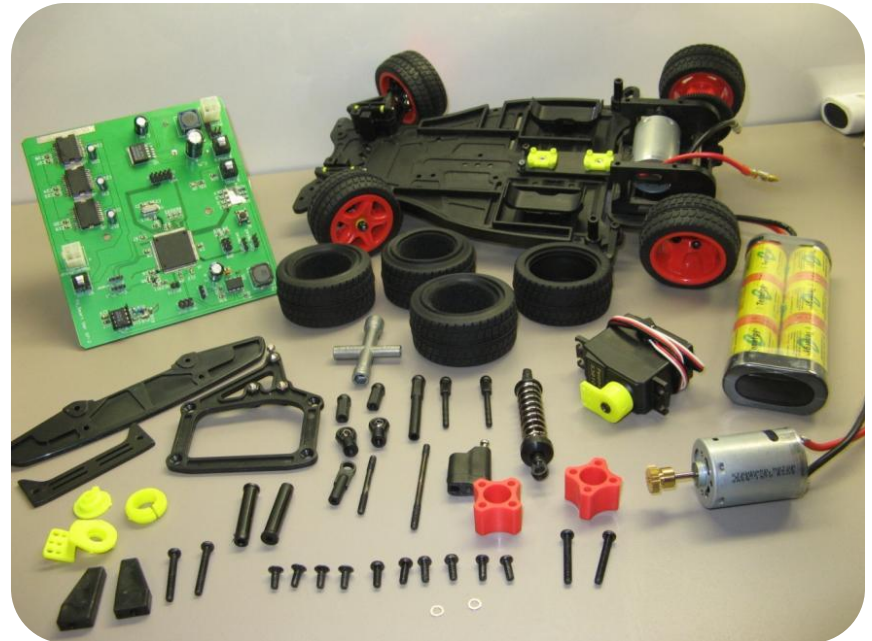

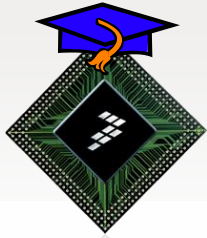

Freescale Provides...

- Intelligent Car Kit
- Training of Faculty
- Race Day Event Support – Org. Guide, People
- Online Community for students, faculty and industry to collaborate, FAQ's and training content.

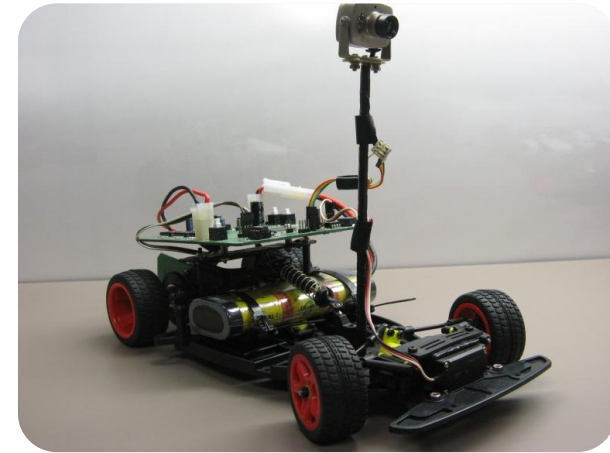

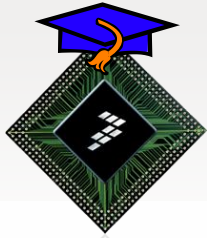

Featured Freescale Technology

- Qorivva Power Architecture MPC5607B
- Proven platform for the automotive and industrial markets
- Development using the TRK-MPC5607B (1 per vehicle)

32-bit Microcontrollers

Qorivva MPC560xB/C/D Family Automotive body and gateway applications

Overview

The Qorivva MPC560xB/C/D family of 32-bit microcontrollers (MCUs) includes Freescale's latest integrated devices for automotive body electronics applications. The advanced cost-efficient host processor core leverages the many strengths of Power Architecture® technology, such as processing capability, on-chip memory, analog capabilities, timing systems and other features required to handle complex control and diagnostic systems. In addition, these scalable devices are supported by an enablement ecosystem that includes software drivers, operating systems and configuration code to help you quickly implement your designs.

Applications

- Central body controllers
- Gateway controllers
- Body electronics
- Comfort controls

Qorivva MPC560xB/C/D Key Features

- Includes controller area network (CAN), local interconnect network (LIN) and other peripherals necessary to implement a range of functionality in the automotive body network.
- FlexCAN module supporting both FIFO and mailbox data storage, ideal for CAN gateways to manage event driven vs. periodic bus traffic.
- LINFlex module provides fully automated LIN message management, reducing CPU load intervention and message latencies.

- eMIOS timer combines multiple counter sources, including input capture, output compare and pulse-width modulation (PWM) capabilities into one very flexible module. PWM function supports shifted signal output to improve electromagnetic compatibility.
 - Cross triggering unit (CTU) synchronizes PWM output signals with analog-to-digital conversion to enable accurate diagnostic and control capabilities.
 - Scalable e200z0 core enables migration toward higher performance solutions.
 - Compatible family of products ensures reuse of software and tools infrastructures.
- In addition, the Qorivva MPC5601D, MPC5602D, MPC5605B, MPC5606B and MPC5607B are available with direct memory access (DMA).

Qorivva MPC560xB/C/D Block Diagram

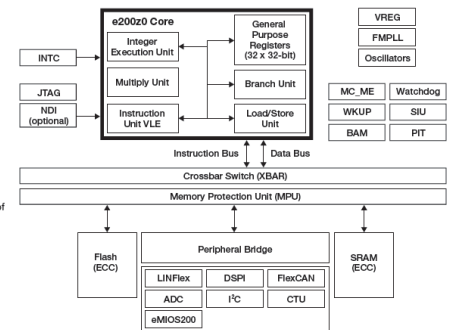

■ Freescale Technology



Freescale Semiconductor Confidential and Proprietary Information.

Freescale, the Freescale logo, AltiVec, C-5, CodeTEST, CodeWarrior, ColdFire, C-Ware, mobileGT, PowerQUICC, StarCore, and Symphony are trademarks of Freescale Semiconductor, Inc., Reg. U.S. Pat. & Tm. Off. BeeKit, BeeStack, CoreNet, the Energy Efficient Solutions logo, Flexis, MXC, Platform in a Package, Processor Expert, QorIQ, QUICC Engine, SMARTMOS, TurboLink and VortiQa are trademarks of Freescale Semiconductor, Inc. All other product or service names are the property of their respective owners. © 2010 Freescale Semiconductor, Inc.



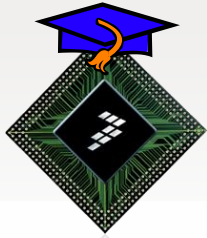

Contact Information

- EMEA Coordination: Flavio Stiffan flavio.stiffan@freescale.com
- StreetSmart EMEA Freescale Cup:
<http://streetsmarts.freescale.com/group/thefreescalecupemea>
- Freescale University Program:
www.freescale.com/universityprograms

Freescale Semiconductor Confidential and Proprietary Information.

Freescale, the Freescale logo, AltiVec, C-5, CodeTEST, CodeWarrior, ColdFire, C-Ware, mobileGT, PowerQUICC, StarCore, and Symphony are trademarks of Freescale Semiconductor, Inc., Reg. U.S. Pat. & Tm. Off. BeeKit, BeeStack, CoreNet, the Energy Efficient Solutions logo, Flexis, MXC, Platform in a Package, Processor Expert, QorIQ, QUICC Engine, SMARTMOS, TurboLink and VortiQa are trademarks of Freescale Semiconductor, Inc. All other product or service names are the property of their respective owners. © 2010 Freescale Semiconductor, Inc.

